

MRH

MODEL RAILROAD HOBBYIST

ALSO:

- DCC in brass locos
- \$500 starter layout
- Loading dock model

Richard Hendrickson on modeling Multi-compartment tank cars » **READ NOW**



EMBEDDED EDITION | LANDSCAPE



DOWNLOAD

- [TABLE OF CONTENTS](#)
- [INDEX](#)

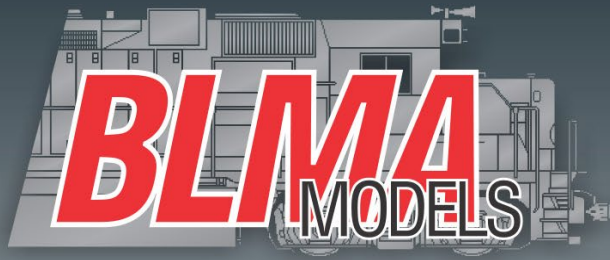

52' Gondola

ACF 70-TON

6 NEW PAINT SCHEMES

N SCALE



▶ ORDER BY: March 15th
▶ DELIVERY BY: Late 2015

CLICK HERE TO SEE MORE



MRHMAG.COM



Model Railroad Hobbyist | February 2015 | #60

STAFF CREDITS

Front Cover: Tangent's new multi-compartment tank car illustrates the kind of tank cars Richard Hendrickson had been reasearching. Read more about it in our cover story this issue.

ISSN 2152-7423

Editorial Staff

Joe D. Fugate, Publisher and Editor
Don Hanley, Assistant Editor

Production

Patty Fugate, pasteup and layout
Joe Brugger, copy editing
Mike Dodd, copy editing

Technical Assistants

Jeff Shultz
Jimmy Simmons

Advertising

Les Halmos, Account Manager
Daniel Nava, Advertising Assistant
Jean-François Delisle, Marketing Assistant



Columnists

Richard Bale, News and events
Jeff Shultz, News and events
Les Halmos, Modular railroading
Larry Smith, Narrow Gauge/Shortlines
Bruce Petrarca, DCC
Ken Patterson, Reporter at large

Special Correspondents

Joe Brugger, Questions & answers
Charlie Comstock, Contributing editor
Issue password: Feb2015

Published for the glory of God. [What's this?](#)

- [TABLE OF CONTENTS](#)
- [INDEX](#)



MRH SPONSORS

A - E



acculites.com



www.americanlimitedmodels.com



railroadhobbyshow.com



archertransfers.com



athearn.com



www.atlasrr.com



bachmanntrains.com



bachrus.com

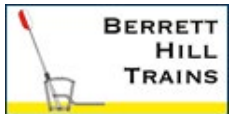

berrethill.com/trains



blairline.com



blmamodels.com



bowser-trains.com



brassexpo.com



caboosehobbies.com



coffmaneng.com



con-cor.com



cvrco.com



www.digitrax.com



crest-electronics.net



www.esu.eu/en

F - R



www.handlaidtrack.com



fiferhobby.com



modelrailroadexpo.com



foxvalleymodels.com



glxscalemodels.com



www.hobby-on.com



www.iascaled.com



iwata-medea.com



litchfieldstation.com



microscale.com



micromark.com



model-trains-video.com



modelrectifier.com



stores.ebay.com/Motrak-Models



mtalbert.com



mthtrains.com



nano-oil.com/Model%20Railroad.html



ncecc.com



nickandnoradesigns.com



www.pwrs.ca/main.php



railmasterhobbies.com



rapidotrains.com



ringengineering.com



rr-cirkits.com



rslaserkits.com



rustystumps.com

[Vendors: Get your clickable logo here ...](#)

[Vendors: Get your clickable logo here ...](#)

MRH SPONSORS | 3

S - Z

 sanjuancarco.com	 scenicexpress.com	 signaturepress.com	 soundtraxx.com
 sodigi.com	 sunsetmodels.com	 tamvalleydepot.com	 tcsdcc.com
 tonystrains.com	 traintekllc.com	 trainworld.com	 truelinetrains.com
 walthers.com	 yankeedabblers.com		

[Vendors: Get your clickable logo here ...](#)

Looking for something? Check our Hobby Marketplace!



Take me there!



N SCALE

Three-Story Warehouse (4.25" W x 1" D x 3.25" H)
MSRP \$39.00 • Item No. 35051

BIG BUILDING BOOM IN A SMALL SPACE
NEW N SCALE FALSE-FRONT RESIN BUILDINGS

Bachmann's new N scale False-Front Resin Buildings in our SceneScapes® line have true-to-life details and colors that make a huge impact without needing a lot of space. Now you can quickly and easily expand your N scale railroad by adding an instant cityscape including a Warehouse, Dairy, Parking Garage, Movie Theater, Hobby Store, and Merchants Hall. Visit your favorite hobby dealer to enjoy a big building boom today!



Farmfresh Dairy
(3.50" W x .50" D x 1.375" H)
MSRP \$39.00
Item No. 35052



Four-Story Parking Garage
(6.25" W x 1.875" D x 3.125" H)
MSRP \$79.00
Item No. 35053



Regal Cinema
(3" W x 1" D x 3.50" H)
MSRP \$47.00
Item No. 35054

Note: Accessories shown are not included with buildings.



Hobby Store
(3.75" W x .875" D x 1.875" H;
includes photo background of shop interior)
MSRP \$42.00
Item No. 35055



Merchants Hall
(4.75" W x .50" D x 2.375" H)
MSRP \$37.00
Item No. 35056

Click for more info.

SHIPPING NOW!



Bachmann Industries, Inc. • 1400 East Erie Avenue • Philadelphia, PA 19124 USA • www.bachmanntrains.com

Click to learn more.

- TABLE OF CONTENTS
- INDEX



TABLE OF CONTENTS

FEATURES

Multiple compartment tank cars

RICHARD HENDRICKSON

Gallery of these unique prototypes



ALL SCALES

Modeling a loading dock

JOHN GOLDEN

Modeling the loading dock at Burlingame, KS



HO

\$500 layout honorable mention

PHILIPPE GRÉGOIRE

Build your first module for less than \$500



ALL SCALES

Building a Schlessler coal loader

JOHN WILKES

Make this one-of-a-kind coal loader, step-by-step



HO

Modeling SP passenger trains: 2

VICTOR ROSEMAN

The definitive series on SP passenger service



ALL SCALES

ALSO: Hobby Marketplace | Bonus downloads

TABLE OF CONTENTS | 2

COLUMNS

MRH Q-A-T: Kadees for switchers, Narrow gauge

compiled by JOE BRUGGER

DCC Impulses: Installing DCC in brass locos

BRUCE PETRARCA

Getting Real: Proto layout productivity surge

MIKE ROSE

Lite & Narrow: New Merkle Connecting RR, pt 1

LARRY SMITH

What's Neat: RPM meet, Tangent interview, and more!

KEN PATTERSON

Photo feature: Yes, it's a model

compiled by DON HANLEY

Derailments: Bizarre facts & humor (supposedly)

compiled by THE MRH STAFF

NEWS and EDITORIAL

Publisher's musings: Back in the saddle again

JOE FUGATE

Staff notes: New MRH Imagineering column

compiled by THE MRH STAFF

News & Events: February 2015

RICHARD BALE & JEFF SHULTZ

Reverse running: The importance of community

JOE FUGATE

HO SCALE**FILE**

**Order
Deadline
March 9th**



**LAST CHANCE... NO MORE EXTENSIONS!
PRODUCTION STARTS ON MARCH 11th.**

FILE

Model Railroad Hobbyist | February 2015 | #60

PUBLISHER'S MUSINGS

editorial

JOE FUGATE
.....



**Click here for
reader comments**

BACK IN THE SADDLE AGAIN

ONCE MRH WENT MONTHLY (2011), I'VE NOT worked on my HO Siskiyou Line layout much because MRH was just taking too much of my time. Now that 2015 has rolled around and the NMRA National is coming to Portland, Oregon (practically in my back yard) this August, it's more important than ever to get back to working on the layout.

I've done a few piddly projects on the layout for an article in MRH over the last few years, but I've not done any serious work on the layout for three years now. And I ceased regular operating sessions midway through 2011 as well.

With the convention bearing down on me in just eight months, I've been able to rearrange my responsibilities to give me time to work on the layout again. So it's back in the saddle for me!

If you've ever taken a hiatus from working on a layout – especially a larger layout, then you know how things can get. There's deferred maintenance (cleaning the track, cleaning the loco wheels, adjusting turnout throws) and there's also a million little projects I'd like to do, but where do you start?

PUBLISHER'S MUSINGS | 2

My wife, Patty (bless her heart) is eager to help. And so is my 13-year old grandson, Bobby. Now what?

I advised another modeler on the MRH forum also needing to get the layout ready for a show to apply some Project Management 101 thinking. Maybe I need to go look in a mirror and tell the guy I see there to likewise apply this strategy? You think?

The idea is to look at all the tasks you have to do and create a prioritized list, with the most important tasks on top and the less important lower in the list. Then work the list.

Then, regardless of where you are on the list come show time, the tasks that really mattered were first and got done, while the tasks that didn't matter as much didn't make it. That should be fine because those tasks that didn't matter as much anyhow.

ADVERTISEMENT



Micro-Mark®
THE SMALL TOOL SPECIALISTS
Berkeley Heights, New Jersey 07922

THE source for over 3,000 precision tools and supplies for master model craftsmen

Click [HERE](#) to see our complete selection of tools, trains & more!

The advertisement features a collection of Micro-Mark products including CR-600 and Hi-1/EXPRESS mold releases, alongside various model train components like a locomotive, a car, and track pieces.

MRHMAG.COM

ADVERTISEMENT



FAST TRACKS

YOUR VERY OWN TRACK FACTORY

Make the most of your modeling experience.

Build perfect trackwork easily and inexpensively when YOU want it!

★★★★★

Check out our extensive (and growing!) online video library to learn how easy it is to hand lay your own trackwork with Fast Tracks tools and supplies.

Play Video ▶

The advertisement features a large image of a steam locomotive and the Fast Tracks logo. Below the logo is a call to action to build perfect trackwork easily and inexpensively. A star rating and a video play button are also present.



HELPING THE WORLD BUILD BETTER RAILROADS

shop online 24/7
1-888-252-3895

handlaidtrack.com
service@fast-tracks.net

The advertisement features a large image of a factory and the Fast Tracks logo. Below the logo is a call to action to help the world build better railroads. Contact information for the company is also provided.

- TABLE OF CONTENTS
- INDEX

NICK & NORA DESIGNS
Uniquely inspired craftsman kits

NEW!



Henlopen Landing Kit # ST024
\$95.00

Craftsman Structure Kits,
Detail Parts, Shingles,
Vehicle kits from:
Sylvan & Jordan
Tru-Color paint, glues & more!

LIKE US ON  facebook

Checked us out lately?



WHAT'S NEW? 

Established 1993...
Blair Line

PUBLISHER'S MUSINGS | 3

This kind of list needs the right granularity. Ideally, the tasks you list take less than one week each to do. If you can see the work needed as a little movie in your head and you know what done looks like, then that's about right.

Generic tasks like "finish the trackwork" are too broad and need to be broken down into tasks that can be achieved in about a week at most. On the other hand, tasks that only take an hour are too granular – you need to think in broader terms.

Armed with a prioritized list, then begin working the tasks, knowing that you should be checking off roughly one item per week and regardless of where you are come show time, the most important tasks *did* get done and that should be good enough.

Okay, time to take my own advice!

Listen Hear...

and sample the difference an **MRC decoder** can make. You'll find MRC sounds are more authentic because...

- They are recorded trackside... not in a studio
- 16-bit technology assures quality
- You'll hear real, 8-step notching
- Most of our diesels feature 34 horns and multiple bells

Sample the sounds of realism, hear and now.

CLICK HERE



MODEL RECTIFIER CORPORATION
80 Newfield Ave. ■ Edison, New Jersey 08837 ■ Phone: 732 225 6360 www.modelrectifier.com

TECHNOLOGY. PERFECTED.

Model railroads Plastic model kits Battery chargers Radio control helicopters, planes, cars & boats Slot Cars Scenery Die cast

PUBLISHER'S MUSINGS | 4

If I look at the Siskiyou Line, there are several categories of tasks to be fleshed out and prioritized:

- Room improvements
 - More storage (to make cleanup easier)
 - Upgrade lighting to dimmable LED bulb equivalents
 - Clean up and organize shop area
- Staging area improvements
 - Rebuild staging as modular (improved maintenance & performance)
- Rolling stock maintenance
 - Pull maintenance on all rolling stock (couplers, wheels, etc.)
 - Repair damaged cars stash from past op sessions
- Locomotive maintenance
 - Upgrade worst-performing locos with keep-alive decoders
 - Clean all loco wheels, relube locos with Nano Oil
- Layout improvements
 - Correct bad track issues
 - Finish track on Coos Bay branch
 - More structures
 - More scenery

Stay tuned as I march toward August 2015 on my Siskiyou Line and relay to you the progress.

Feels good to be back in the saddle again!

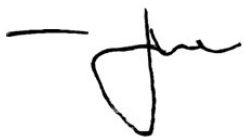

**Click here for
reader comments**

BRASS EXPO



BRASS MODEL TRAINS ALL SCALES

April 11-12, 2015 • Saturday 9-4 • Sunday 10-4.

Maryland State Fairgrounds • 2200 York Rd. • Timonium, Maryland 21093

For More Information Go To:

www.brassexpo.com

HOWARD ZANE

5236 Thunder Hill Rd • Columbia, MD 21045 • 410 730 1036

email: hzane1@verizon.net

VISA AND MASTERCARD ACCEPTED

**BRASS EXPO WILL RUN TANDEM WITH
THE GREAT SCALE MODEL TRAIN SHOW**

Brute Power

That Does More



An ALL-NEW M.T.H. Electric Trains HO articulated steam locomotive is rolling into your local retailers this Fall. The Chesapeake & Ohio 2-6-6-6 Allegheny, one of the heaviest steam engines of all time, is sure to amaze and entertain all who see her. Outfitted with sprung drivers, a powerful five-pole skew wound flywheel equipped motor, LED lighting, synchronized puffing smoke, full digital sound and a 28-function DCC decoder make this and all M.T.H. die-cast metal steam locomotives HO's best steam power value.

The Allegheny is offered in four cab numbers, including 1601 and 1604, both still on display in the Henry Ford and Baltimore & Ohio museums. Choose from 2-rail versions or our all-new 3-rail stud rail version for use on Marklin stud track.

Featuring:

- Die-Cast Boiler and Chassis
- Die-Cast Tender Body
- Engineer and Fireman Figures
- Metal Handrails
- RP25 Metal Wheels
- Sprung Drivers
- (2) #158 Scale Kadee Whisker Couplers
- Prototypical Rule 17 Lighting
- Constant Voltage Headlight
- Operating Marker Lights
- Operating Numberboard Lights
- Lighted Cab Interior
- Operating Tender Back-up Light
- Powerful 5-Pole Precision Flywheel-Equipped Skew-Wound Motor
- Synchronized Puffing ProtoSmoke™ System
- Locomotive Speed Control In Scale MPH Increments
- Wireless Drawbar
- Operates On Code 70, 83 and 100 Track
- Built-in 28-Function DCC Decoder
- Proto-Sound 3.0 Digital Sound
- Operates On 22" Radius Curves



80-3249-1 Chesapeake & Ohio 2-6-6-6 Allegheny Steam Engine

M.T.H.
ELECTRIC TRAINS®
HO TRAINS THAT DO MORE

See why M.T.H. HO Trains
Do More



Follow Us Online!



www.mthHOtrains.com

©2014 M.T.H. Electric Trains



Model Railroad Hobbyist | February 2015 | #60

STAFF NOTES

HAVING FUN WITH TRAINS

MRH

MODEL RAILROAD HOBBYIST



Click here for
reader comments

MRH'S NEW IMAGINEERING COLUMN, UPDATE ON ePUB MRH, AND MORE ...

FOR THE LAST FEW DECADES, ACCURATE PROTOTYPE modeling has become quite popular in the hobby. The more precisely you can model a prototype, the better, it seems.

While high-fidelity prototype modeling is certainly cool, there's a lot more to the hobby than realism and fidelity to the prototype. There's also what we might call the more "artsy" side of the hobby.

To give more air time to the artistic, imaginative side of the hobby, we're starting a new column in MRH called "Imagineering: Exploring the creative sides of the hobby."

Like our Getting Real column, the new Imagineering column will have a rotating collection of columnists, so readers get a broader perspective on this part of model railroading. While the more freelancing element of the hobby is certainly a part of this new column, it's much broader than that. Anything that takes

some artistic and creative spark to pull off, our columnists will be discussing.

In Joe Fugate's January editorial, he put out a call for columnists for this new column and we got almost 40 applications. Out of that 40, we pared it down to six columnists. Here they are in alphabetical order by last name:

Rob Clark, Ray Dunakin, Doug Geiger, Dave Meek, Verne Niner, and Michael Tondee. Only Doug Geiger (who is known in the hobby press from articles he's done) is not a forum regular. The other five gents regularly contribute on the MRH forums and/or have a blog on the MRH website.

★ LAST ISSUE'S RATINGS

The top 5 rated articles in the [January 2015 issue](#) of *Model Railroad Hobbyist* are:

- 4.7 John Miller's Kanawha & Lake Erie
- 4.6 DCC Impulses: DCC reversing loops
- 4.6 Modeling SP passenger trains, part 1
- 4.6 What's Neat: Dynamic digital exhaust, and more!
- 4.5 Getting Real: Managing a photo collection

Issue overall: **4.3**

Please rate the articles! Click the reader comments button on each article and select the star rating you think each article deserves. Thanks! ■

In the March issue, we'll introduce you to these fellows in the staff notes, complete with some mug shots. We expect the first column to appear in the April issue.

Update on the ePub version of MRH

Sometimes the best laid plans just don't work out, and that's the case with the ePub version of MRH. The snag we hit has to do with advertisements that have multiple links on them.

Such ads need to use something called an image map, and while ePub3 does support image maps, they don't resize properly on different screen sizes. As a result, the clickable hot spots on the ad get out of registration with the ad graphics underneath, rendering the ad more-or-less useless because the links don't work properly. Since MRH is ad-supported, we need the ads to

ADVERTISEMENT

**Light Up Your
Layout with the
Atlas O Elektra
Theater!**

**Check out a demo video of the
lighted marquee in action and
place your order!**

CLICK HERE!



STAFF NOTES | 4

work correctly, or we need to pull the ads. And if we pull the ads from the ePub3 version of MRH, it can't be free – we would have to charge for it.

We said MRH is forever free, and we mean it. If we have a technology limitation for a particular format that requires us to remove the ads from MRH and charge for it, then we just won't go there. MRH must use a technology that lets the ads be fully functional so we can keep the magazine free.

There's also a related problem that makes it difficult to do good indexes in ePub3 publications, so we'd also have a challenge doing a good advertiser index. In short, the technology just isn't mature enough yet to allow us to do a magazine full of fancy ads as an ePub3 publication.

STAFF NOTES | 5

Our eBooks are a different story. We've been doing eBooks now for over a year and they work fine because we don't put ads in them, and we charge a cover price for them. That's perfect, given the challenge we discovered with putting ads full of complex hotspot links into an ePub.

One thing modern tech companies like Google have adopted as a philosophy is an idea called "fail fast". The idea is to be daring and try things, but don't camp there if you find show-stopper problems.

In this case we tried doing the January MRH as an ePub3, hit the major ad hotspot show-stopper, and declared that the technology just isn't ready (yet) – so we're moving on. We "failed fast" on MRH as an ePub3 at this time.

ADVERTISEMENT



CABOOSE HOBBIES
WORLD FAMOUS
MODEL TRAIN STORE
Since 1938!

The World's Largest Model Train Store!

Model trains G to Z, DCC, brass models, kits, RTR, collectable models, scenery, structures, books, magazines, DVD's, hobby tools & supplies and a full service repair department.

WWW.CABOOSEHOBBIES.COM



ADVERTISEMENT



Rusty Stumps
Scale Models

WE ONLY SELL WHAT WE MANUFACTURE

DETAILS IN HO, O, S & N SCALES
LASER CUT SHINGLES, DOORS & WINDOWS, FENCES, SIDING, CRATES. Also RESIN and WHITE METAL DETAILING CASTINGS.

CRAFTSMAN KITS
IN HO, O & S SCALES

CHECK IT ALL OUT AT
WWW.RUSTYSTUMPS.COM
Send \$3.50 for Catalog - Specify Scale
RUSTY STUMPS SCALE MODELS
6785 Cherry Blossom W. Dr., Fishers IN 46038
Phone (317) 595-9489

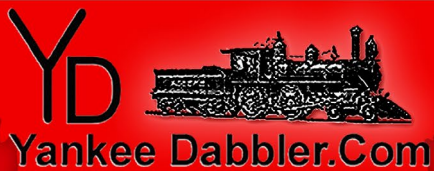

**People
who buy
with us
ALWAYS
save!**



- Kadee - NCE - SoundTraxx
- Digitrax - And more!

**Click NOW
to save!**

HO

DCC

ALL SCALES

STAFF NOTES | 6

What happened to the Tortoise from two locations article?

Sometimes, as an article hits staff review, we find some issues with the article. If we can fix the issues fast enough (which is what usually happens), then the article makes it into the issue as planned.

In this case, we found some issues with the circuit as presented and in the process of working through the permutations, we just plain ran out of time.

Rather than publish a half-baked article, we're taking the time to work with the author and get all the options ironed out ahead of time.

This is one of the benefits of magazine articles versus posts on the Internet. Our articles get reviewed by the editorial staff and any questions or concerns we have get addressed as part of the

STAFF NOTES | 7

article preparation process. The end result is a well-vetted article that you can count on. But it does mean a billed article might not make it once in a while, as was the case here.

If we can get this ironed out in the next couple weeks, then this article will be in the March issue. Otherwise, April is more likely.

New experimental mobile app

We have a new experimental MRH application available for iOS and Android devices called: **MRH Magazine**.

Just search for this app, download it, and give it a try. It's something of an all-things MRH app, because not only does it have the magazine in it, but it has recent website posts, recent MRH Facebook posts, MRH's YouTube channel videos, and what's new on TrainMasters TV.

ONE STOP SHOP

N, HO, O, ON30, S & G

SHOP ON-LINE 24/7

FOR YOUR FAVORITE PRODUCTS:

ATHEARN | ATLAS | ARISTO-CRAFT | BACHMANN | BROADWAY LTD.
DIGITRAX | KADEE | KATO | K-LINE | LIFE-LIKE | LGB
LIONEL | MANTUA | MICROTRAINS | MODEL POWER | MRC
MTH | NCE | PECO | PIKO | SOUND TRAXX | TCS
WALTHERS | WILLIAMS | WOODLAND SCENICS | AND MORE...

SIGN-UP FOR OUR E-MAIL SALES

TRAINWORLD.COM

1-800-541-7010 e-mail: ORDERS@TRAINWORLD.COM
TRAINWORLD®/TRAINLAND® - AMERICA'S LARGEST INTERNATIONAL MAIL ORDER DISCOUNT TRAIN STORE

This is an experimental version of the application, so go kick the tires and let us know what you think.

We'll be releasing a more finished version of the app once we've received your feedback and worked with the development house to do apply refinements to the app for final release.

What's new on the MRH website?

Here are a few of the more interesting threads that have been posted or had updates on the MRH website recently. Go have a look!

In search of perfect ties: mrhmag.com/node/21205

Shelf layout benchwork: mrhmag.com/node/21181

Scratchbuilding a Baldwin S-12: mrhmag.com/node/20966

Rutland Yard structures: mrhmag.com/node/11321

The club blog: mrhmag.com/node/18644

Multideck benchwork diary: mrhmag.com/node/17997

Organizing a workspace: mrhmag.com/node/21208

Bethlehem Steel on Lake Erie: mrhmag.com/node/20465

HO vehicles with turning wheels: mrhmag.com/node/21046

Hand carved rock help: mrhmag.com/node/21012

Pittsburg & West Virginia in N scale: mrhmag.com/node/14069

Enjoy the February issue!

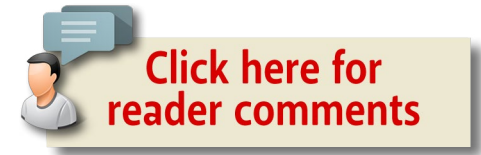

ADVERTISEMENT

Click Here

FIFER HOBBY SUPPLY LLC

Your Local N Scale Online Hobby Shop

575-523-9743
fiferhobby.com

ADVERTISEMENT

Archer
FINE TRANSFERS
PROUDLY SERVING MODEL BUILDERS SINCE 1989

THE ORIGINAL SURFACE DETAILS™

WE NOW HAVE MORE THAN 100 SHEETS OF RIVETS, LOUVERS, TREADPLATE AND MORE CAST ONTO MICROSCALE CLEAR DECAL FILM

FREE SHIPPING:

- DOMESTIC USA ORDERS \$50 OR MORE
- INTERNATIONAL ORDERS \$100 OR MORE

CLICK HERE TO VISIT OUR WEBSITE!

Archer Fine Transfers • PO Box 1277 • Youngsville, NC 27596 • USA (919) 570-1026 • info@archertransfers.com • archertransfers.com

ADVERTISEMENT

TRINITY 3281

CMO - 12 road numbers \$48.95 each

CSX - 12 road numbers \$48.95 each

TILX - 6 road numbers \$48.95 each

WSOX - 6 road numbers \$48.95 each plus CRDX and MCEX

American Limited

www.americanlimitedmodels.com

You're the kid.



Welcome to the candy store.

- 180,000 square feet of sheer bliss
- Over 250 manufacturer & retailer booths
- 50,000 square feet of modular layouts
- "Ask the Collectibles" appraiser
- Trains, accessories, collectibles & more
- Hands-on demonstrations

August 28 - 30, 2015
Portland Expo Center
 2060 North Marine Dr., Portland, OR 97217

**CLICK HERE
FOR ALL THE
DETAILS!**



www.nationaltrainshow.com

Model Railroad Hobbyist | February 2015 | #60



MRH Q-A-T

column

compiled by
JOE BRUGGER



[Click here for
reader comments](#)

? QUESTIONS AND ANSWERS

Kadees for switchers

Q. I finished painting an Athearn SW-7 locomotive and converted it to DCC but now have an issue. The couplers have the standard metal clamp over the chassis tongue. One of the knobs to latch the clamp is gone. Should I super glue the clamp to the one side? Micro Mark makes a screw and drill kit for worn Athearn couplers, but I think it is designed for plastic tongues on rolling stock. The engine is not using a #5, but an insulated equivalent.

—James Eager

A. Using super glue to attach a coupler box is a poor bet, unless you have delicate fingertip control of your trains, no grades, and never ever do any switching. Shear forces will break a CA joint. The tap, drill, and screw kits from Micro Mark, A-Line, and others will work on most metals, assuming you use a prudent drill speed and some lubrication like soap, grease or oil.

► **MRH QUESTIONS, ANSWERS, AND TIPS**

Nelson Beaudry: Drill and tap the pad for a #5 coupler in its own box. Check its height with a coupler gauge. But there is a short-circuit issue here. Even though the motor is now electrically isolated from the frame, the frame is connected to the track via the trucks. That's OK if you never MU the loco, but any loco running back-to-back with it will cause a short. Locos running the same direction will run OK. One way around this is to cut off the coupler pad, fabricate a non-conductive mounting pad to the shell, and then install a #5 Kadee in its own draft gear box.

MRH: Many years ago, we fixed a similar Athearn SW1500 chassis [1] by drilling a hole in the coupler mounting pad and

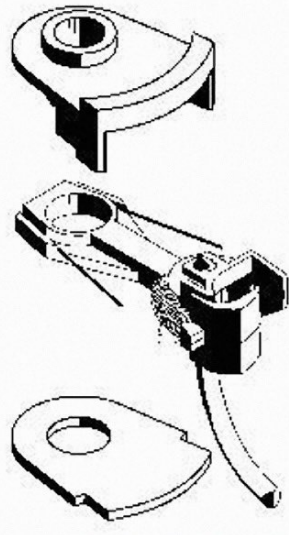
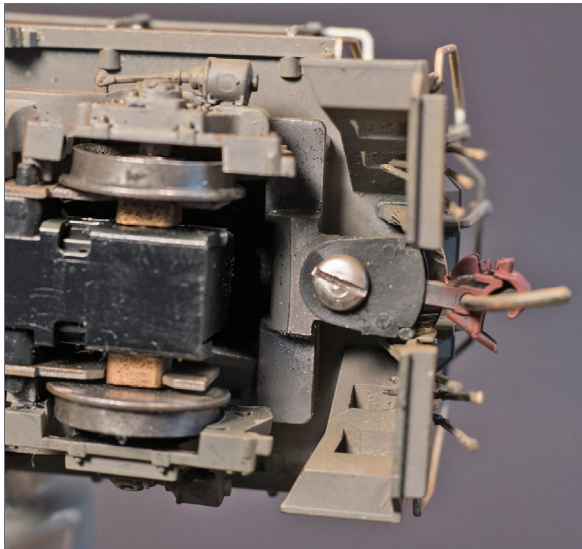

1. The Kadee #38 includes a short mounting box and a plastic-shank coupler that will insulate one locomotive from another.

2. The #252 box snap-together allows an insulated mounting using any Kadee Whisker coupler.

tapping it for a 2-56 machine screw. To keep the coupler box clear of the trucks, we used a Kadee #38 coupler. This coupler has a center-set plastic shank with a coil-and-fingers torsion centering spring. A flat file got the coupler height exactly right. We used Kadee nylon screws because they are easy to cut to length and don't vibrate loose.

Once Athearn's snap-in tab fails, there's nothing to gain by fooling around with it. The drill and tap set is a good tool to have, and Kadee sells what you need. They ship pretty quickly.

kadee.com/htmbord/page246.htm.

kadee.com/htmbord/page38.htm.

For people who get the heebie-jeebies trying to install the torsion spring, or get hives when faced with a plastic-shank coupler, Kadee has since introduced kadee.com/htmbord/page252.htm [2], the #252 snap-together insulated gear box and lid for mounting whisker couplers in a limited space. The snap-together gear boxes are a salvation for anyone who has had a coupler explode out of their fingers.

HO narrow gauge

Q. I know that HOn30 and HOn3 are two different scales and that they both run on 9mm track (N scale). My question is, what is the difference between the two scales? Is one bigger than the other?

—Donato

A. HOn30 and HOn3 do not run on the same track. You are mixing two different things. "Scale" tells you the size of the model compared to the real thing. HO scale models are 1:87 the size of a real

building or piece of equipment [3]. If you build a model of a building 87 feet long, it will be one foot long in HO scale.

The numbers 30 and 3 tell you the track gauge – how far apart the rails are spaced. Modelers mix their units here: 30 is 30” or 2½’; 3 is 3’, or 36”.

The letter “n” tells you that the models represent narrow gauge equipment. Standard gauge is 56-1/2” in North America, most of Europe, and many other places.

A railroad narrower than standard gauge can be cheaper to build and operate if it has a narrower trackbed, which requires less grading, less ballast, lighter bridges, and so on. Smaller engines and cars can use a lighter track structure and require less fuel.

HOn3 is HO scale narrow gauge running on 36” track, which was very common in the United States and elsewhere in the Western Hemisphere. HOn3 track has a 10.5 mm gauge.



3. A narrow-gauge Austrian Class 2095 600 hp diesel (right) is considerably smaller than an SW1500, but both were common sights on their respective railroads. The engines, the Toyota Land Cruiser, and the figures are all HO scale.

HOn30 is HO scale narrow gauge running on 30” track. It’s a common light narrow gauge (actually 760 mm) in Central and Eastern Europe, but rare in the U.S. except on industrial and contractors’ railways. HOn30 track has a 9 millimeter gauge, which is the same width as N scale track. It is also known as **HOe**. Another variation is **HOm**, which is HO models running on meter-gauge track (39.37”-gauge).

North American N scale is 1:160. Atlas and Kato N-scale track has cross ties scaled at 1:160. A cross tie that accurately represents a 96”x8”x7” cross tie in N scale is too small to look right as a 1:87 scale tie. Micro Engineering, Peco, and Bemo make accurate scale narrow gauge switches and flex track. Some people insist on exact scale track, and some people just go ahead and use “N-scale” track. When it’s buried in dirt and ballast, it can be hard to tell the difference.

You ask, “is one bigger than the other?” Yes and no.

The Sandy River and Rangeley Lakes Railroad in Maine, a full-fledged common carrier system with over a 118 miles of track, ran on 24”-gauge track, a size that is now found on some zoo and amusement park railroads. The East Broad Top in Pennsylvania and parts of the Denver & Rio Grande in Colorado were among the better-known 36”-gauge systems.

Their cars and locomotives were smaller than contemporary standard-gauge items. The biggest steam engine on the D&RG three-footer was about the same size as a small standard gauge engine. At a time when a standard gauge boxcar was 40’ long and carried 40 tons of freight, a big Maine two-footer boxcar was 33’ long and carried 15 tons.

MRH Q-A-T | 6

People and freight are the same size regardless of track gauge, so the proportions of narrow gauge equipment can look strange to people accustomed to standard gauge trains. An engine cab or passenger car has to have room for full-size people. This results in the “Labrador puppy” effect, where disproportionately big feet and soulful eyes are attractive. In the trains’ case, it’s a big cab, a small boiler, and a generally low-slung appearance. Fortunately, narrow gauge equipment never grows up and never chews your slippers.

Many people capture this inherent cuteness through freelance modeling in On30 or HOn30, building narrow gauge equipment to run on commercial track meant for HO (in the case of On30), or N (in the case of HOn30). Locomotive mechanisms are easy enough to adapt, as are trucks and couplers. “n30” modeling can be cheaper than searching out the exquisite exact scale products made for On3 and HOn3. “n30” models can also have a bit of whimsy and inventiveness about them, which is harder to achieve in the scale-conscious world of narrow gauge modeling, where every tie, line pole, and freight car seems to have been documented over the past couple of decades.

See the whole discussion on the Model Railroad Hobbyist forum at mrhmag.com/node/20927.

—MRH

Powering Atlas frogs

Q. How can you electrify cast frogs on Atlas turnouts? Both the Atlas Custom Line and Super switches have cast frogs that do not take solder. They do have a small tab on the guardrail and the tab has a hole. In the past I have made mechanical

Get the first 50 issues of
**Model Railroad
 Hobbyist magazine™**

On a data DVD for \$10!

Send me one!

(Sold by Model Trains Video)

**Includes a coupon
 good for \$20 off on
 TrainMasters TV**

**Over 5000
 pages of
 how-to
 information
 on model
 railroading**



**Save
 yourself
 endless
 hours of
 downloading**

A "Right Clamp"™ Mini Project

**CHECK
IT OUT!**

MRH Q-A-T | 7

connections from underneath, putting a very short 2-56 screw through a drilled brass strip, then soldering to the strip. That is a pain in the neck. I'm considering conductive adhesives like "solder paint" and don't know if that will work. Any suggestions are appreciated, but I am not going to toss all the Atlas turnouts and get a different brand. —Doug

A. Barr-ceo: For their N scale Code 55 turnouts, that's exactly what that little tab with a hole in it is for. Just slip your feeder through the hole, hit it with the solder and iron, and you're done. Quick and easy. I've used a DPDT slide switch to control the frog power polarity, change a dwarf signal showing turnout position, and to mechanically move the turnout all at the same time.

Rob Spangler: The Atlas HO frogs are zinc alloy and won't accept solder. The #8s have a separate lug off to the side of

MRH Q-A-T | 8

the ties, and you can solder to it. The holes on the #6 frogs will accept a screw, but that looks rather awful from above. Micro Mark sells some plating material specifically advertised for use on zinc alloy parts so you can solder to them, although it may be a bit spendy just for use on some frogs. See micromark.com/copper-plating-kit-for-die-cast-and-steel,8419.html.

Ken Rickman: I drill and tap the hole for a 2-56 screw, then solder to the screw.

Nathan Holmes: I swear I've soldered Atlas Custom-Line frog castings in the past on various HO layouts I've wired. You may just need a little more aggressive flux than what you're using. Don't use acid plumbing flux or something horrible like that. Those are definitely not suitable to anything that will carry current as you'll get corrosion.

I use Superior Flux Supersafe #30DS for those tough joints



AC-2-2 "Mini Right Clamp"™ used for gluing Bulkhead Frames.

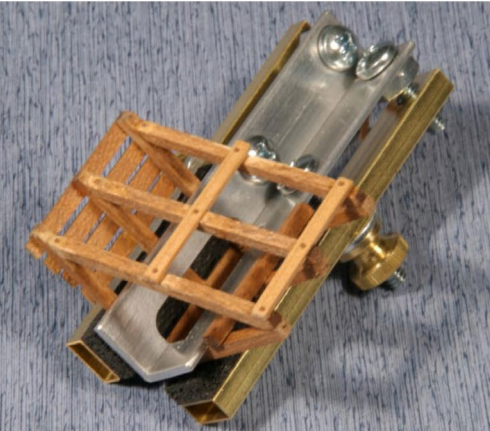

AC-1-1 "Original Right Clamp"™ used for Bulkhead Assembly.



Assembled Bulkhead in gondola with load of ring castings.

Right and Splice Clamp – Tools for Modelers

See all our products at:

www.coffmaneng.com

Coffman Graphic Solutions Co.

1500 River Circle, Richmond, KY 40475-7907

Phone: 859-527-0476, Fax: 859-527-0485

MRHMAG.COM

February 1866?

[CLICK TO KNOW MORE](#)

**It's your Love of Trains,
the researching, building,
painting and detailing,
that drives us to create
decals as Accurate and
Authentic as your build.**

**Use Microscale Decals
Quality Assured**



**Family owned
for over 75 years.**



www.microscale.com



- [TABLE OF CONTENTS](#)
- [INDEX](#)

and for all my trackwork, and it does an excellent job. It's an aggressive organic acid flux that's supposedly safe for electrical work. I've used it for years without issue, and somewhere in my mind I remember that's how I finally got those castings to wet.

You can order it from H&N Electronics ccis.com/home/hn but it's not hard to find. A bottle will last you a very long time, unless you're like me and manage to knock one over. Then again, the solder fumes may be affecting my memory. It's been a while since I've worked much with HO switches.

Doug: Tried again very carefully to solder to the HO Atlas switch and it is definitely not my lack of technique. The N scale frogs may use a different material than the HO scale. So, zinc alloy? And some fluxes help? I will research connections to zinc, and see what appears in addition to the good suggestions above. And a last resort is the screw connection. I have a few beat-up turnouts for experimentation.

In an old DCC article, Atlas suggests brass screws and a bus bar, just like I did originally. See wiringfordcc.com/switches_atlas_roco.htm which says "Atlas turnouts are already DCC friendly. Their new turnouts still have those impossible-to-solder-to frogs. So what do you do? Screw a small brass screw into the one of the holes on their frog and solder to that. Easier yet is a bus bar and screws that Atlas sells through their parts department."

The bus bar kit doesn't appear in the current list at atlasrr.com/Trackmisc/honaccessories.htm but the parts could still be hanging on hobby shop peg boards, or available at swap meets.

 **TIPS**
White glue applicator

Who has not been annoyed by distributing thinned white glue with a pipette or with a syringe? Both hold only minimal amounts



of white glue and make work on huge areas sometimes painful. I found a cheap and easy solution [4] during my landscaping work on my own railroad project. It's a simple oil can sold at parts shops or tool outlets. The cost is well under \$10. It holds about eight ounces (250 cc) of thinned white glue. The nozzle can be adjusted from a slow drip to a small stream and can also be adjusted in length. Once finished, just close the nozzle to keep the thinned glue from drying out.

I usually use it in drip mode and at full extension. Covering large areas is easy and fast with the reservoir it holds and it doesn't require much pressure by squeezing. Test the amount of pressure before starting to work.

—Andy Kesselkaul

4. Oil can with fully extended nozzle. The hair spray can in the background holds "wet" water. Andy Kesselkaul photo

 [Click here for reader comments](#)

MRH Q-A-T | 10

\$ GET PAID FOR YOUR TIP

We pay \$25 per tip we publish, or \$40 each if the tip also includes a photo or finished drawing. [Click here and select article type TIP.](#) ■



[Click here for reader comments](#)



"N" GAUGE GENERAL AMERICAN MEAT REEFER

O.R.D.E.R. D.E.A.D.L.I.N.E.
March 17th



Limited edition collector's packs also available!

ADVERTISEMENT

Bachrus inc
RUNNING ON QUALITY

CHECK IT OUT!

Click me!

NCE The Power of DCC

New Web Site!

www.ncedcc.com

New products

How to Videos

New Listings

Information Station

Secure Online Sales

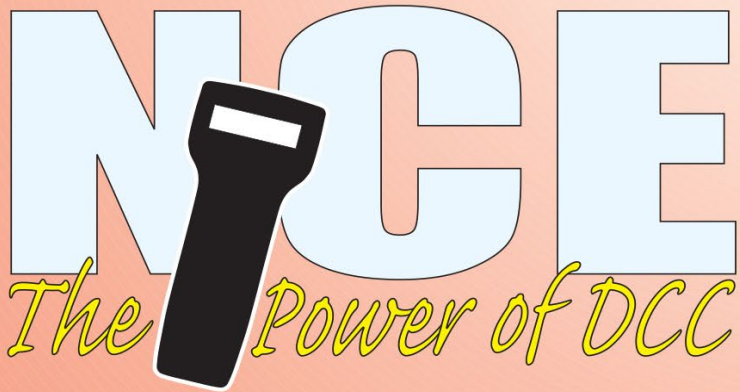

Discover the FUN!

• Made in the U.S.A. •

Call or Email
for FREE Brochure
support@ncecorporation.com

585.265.0230
9am-4pm EST.
www.ncedcc.com

Get Better Sound from your Locomotives

Can't get a good sound from your sound decoder?
Give our speakers a test drive with your ears.



RAILMASTER HOBBIES
9812 BELMONT
BELLFLOWER, CA 90706

Bass Reflex
Speakers



High Bass
Speakers



When it comes to speakers we have high quality speakers to fit many different applications. We are also a full line hobby shop. Need anything? We are an authorized dealer for Soundtraxx, Digitrax, Athearn, Walthers and many others. We provide quality speakers for your DCC sound systems and quality service.

**Click here for
the answer ...**

Model Railroad Hobbyist | February 2015 | #60



BRUCE PETRARCA
.....

DCC IMPULSES

column



**Click here for
reader comments**

BRASS STEAM LOCO DCC INSTALLATION TIPS ...

I'VE BEEN DOING A BUNCH OF HO BRASS

steam loco installations recently and want to share my thoughts and ideas with you this month. These techniques will work just fine on HO, HOn3, Sn3 or S-scale locos – generally those with 1-amp rated decoders. There might not be enough space in an N-scale engine for some of the things covered here.

O scale and larger are similar, but will need heavier connectors to go with the beefier decoders due to the larger motor load. These are all sound installations. Non-sound installations would be very similar, just no need for the speaker and associated wiring.

First, make it run well

The mantra I frequently repeat is, “DCC will exaggerate your loco’s operation. If it runs well, it may run better with DCC. If it runs poorly on DC, it will probably run *worse* with DCC.”

► **DCC TIPS, TRICKS, AND TECHNIQUES**

DCC IMPULSES | 2

Many of the brass locos folks are converting these days are 40 or more years old. A lot has changed in the interim. Here are areas to consider before starting a DCC installation.

Drivers: Over time the drivers can loosen on the axles. They can move back and forth, perhaps enough to upset the quartering, causing binding of the rods. A quick check [1] is to place the loco upside down on a foam cushion or other padding and grab the drivers on one axle. Rotate one driver forward and the other in reverse. Repeat for every driver axle. If there is any slop, then a major repair is needed. For long term durability, glue and re-quarter the drivers, even if there is no slip.

Motor: Older motors can be inefficient, noisy and may lack the smoothness of new motors. For best performance replace any of the open-frame motors [2] and test can motors for operating and stall

DCC IMPULSES | 3

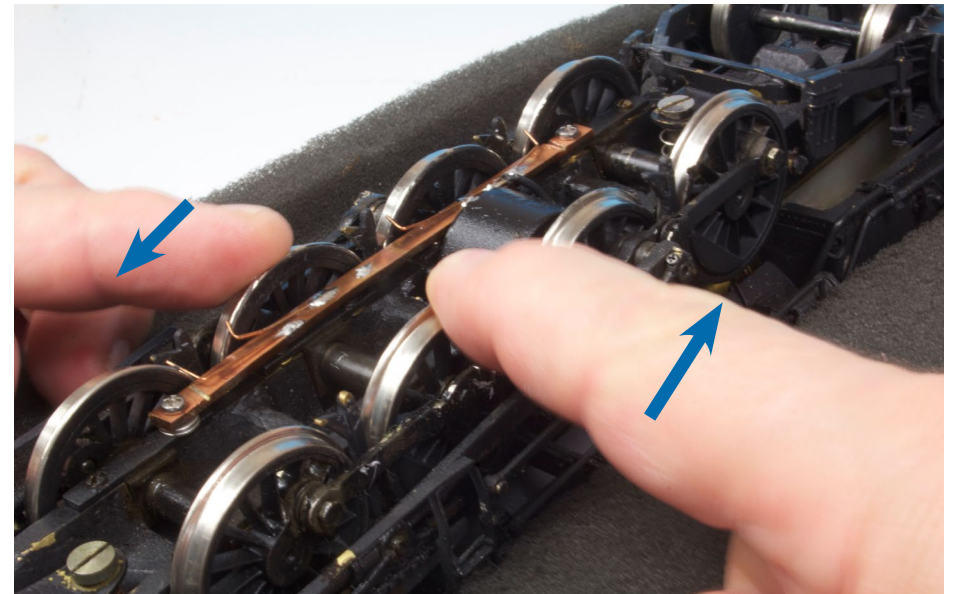

1a. Testing drivers for looseness.

ADVERTISEMENT

**IOWA SCALED
ENGINEERING**

Infrared Sensors!

- Small size (0.25" x 2.25")
- No adjustment needed
- Simple, discrete under-track installation
- Variable release time up to 20 seconds

Visit our web site: www.iascaled.com



LEARN MORE >

ADVERTISEMENT

TamValleyDepot.com
Great Electronics for Great Model Railroads



current before starting a DCC installation. See my web site for current testing information (mrdccu.com/curriculum/stall.htm). Changing out the older, inefficient motor for an efficient one makes for a better performing DCC loco.

Drive train: The drive line [2] and gear box or open gears are very likely to contribute to poor running in older locos. Solutions here revolve around installing U-joints to replace tubing in the driveline, and serious gearbox work. The



Playback problems? [Click here ...](#)

1b. Testing drivers for looseness.

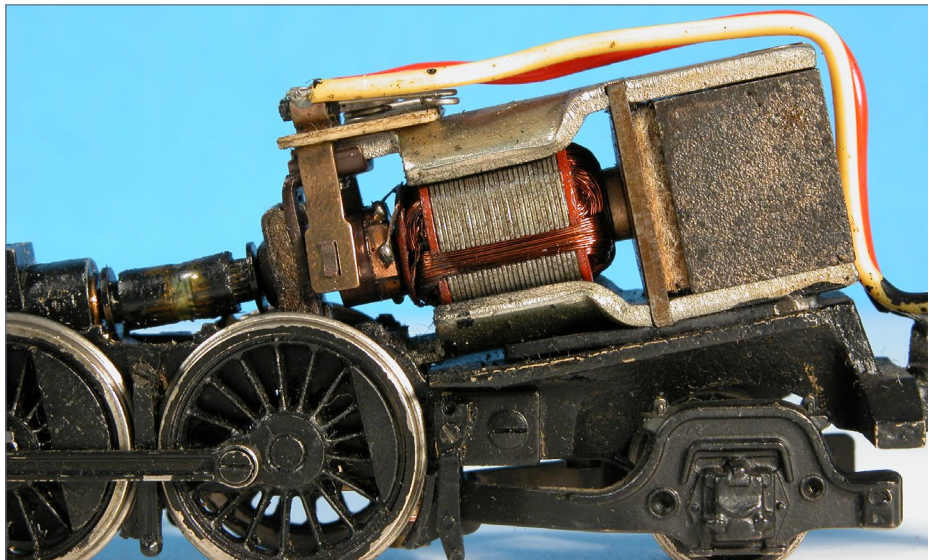

2. Older, inefficient, open-frame 3-pole motor. Note also the aged piece of tubing used in the drive line. Mark Schutzer photo

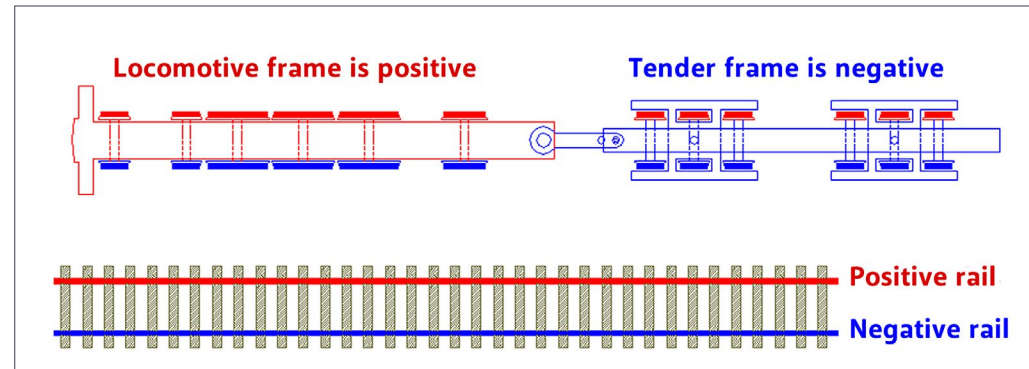

3. Brass steam locomotive wheel polarity – top view of locomotive and track. Mark Schutzer diagram

gearbox may work fine with a cleaning and lubrication. However, replacement with modern designs, including lower gear ratios, is frequently the way to go.

This repair and reworking is beyond the scope of this DCC column. However, my friend Mark Schutzer has done clinics all about this at several venues. I was able to attend his clinics at the NMRA national convention in Sacramento in 2011. His clinics are available on line at markschutzer.com/Brass_Clinics/TroubleshootingBrass2011.pdf and markschutzer.com/Brass_Clinics/RebuildingBrass2011.pdf.

A lot of information is packed into these clinics. Anyone working with brass steam locomotives can benefit from studying them.

Power pickup

Most brass steam locomotives use the same pickup methodology [3]. The locomotive frame is electrically connected to the right wheels and the tender frame connects to the left wheels and the electrical power from the left wheels is transferred to the locomotive via the draw bar.

Installation techniques

There are two basic approaches to decoder installation. One approach puts the decoder and speaker in the tender. This way, wires between the loco and tender include right rail, motor, and whatever lights are used in the loco (head, marker, firebox, cab, etc.).

This is the approach I prefer and will feature in this column. It gives the most options for speaker size and a nice-sized tender enclosure, for the most part. If a lot of different lights are going to be used in the loco, the option for a second function-only decoder in the loco exists.

The other approach is to put everything, or almost everything, in the locomotive. This method may require no additional

wires between the loco and tender, if using the draw bar to bring the left rail power to the locomotive.

Putting everything in the loco is workable in the larger scales on occasion. In the smaller scales, it is hard to find enough room in the boiler for the decoder, speaker, lighting control and motor. The sound frequently suffers from the smaller speakers necessitated by the limited space.

Frequently, too, weight must be removed to make room for all the parts. The advantages are no, or few, wires between the loco and tender and the ability to channel the sound out the stack, making for a sharper aural image coming from the loco, not the tender.

The focus here is on mounting the electronics and speaker in the tender. Most of the techniques will work regardless of where they are.

ADVERTISEMENT



STOP! WITH F11

Give your throttle a "brake" with the F11 braking function, a feature first developed by SoundTraxx. Press the F11 key to apply the brakes and listen as your train squeals to a stop.

SOUNDTRAXX

See what F11 can do for you!

Photo By Jerry Day

Getting the sound out

In my August 2012 column, "How Do I Get the Sound Out?" (mrhmag.com/aug-2012-dcc-impulses) I concentrated on baffling the sound out of a diesel locomotive. I find that steam sound is best when the entire tender is configured as an enclosure, or box.

Yes, the boiler could be configured as a baffle, with one phase of the sound (positive pressure) coming out the stack and the other being routed out near the cab. A few folks have the resources, time, talent and patience to mount larger speakers inside HO-sized boilers. However, it seems to be beyond the average modeler.

Many tenders, such as the one shown in [4] have openings in the floor for speaker mounting. Absent those holes, it is fairly easy to drill your own.

DCC IMPULSES | 8

A high-bass speaker slightly over an inch in diameter (27 or 28 mm) will usually fit the width of an HO-scale tender. The square version is a bit thinner and may fit better. If you can use the deeper round version, even better.

Many high-bass speakers need 0.04" (1 mm) thick shims in front to keep the cone from hitting the floor. Keep this space in mind when planning the installation. In [4], they are there, but, being white, they blend into the caulk.

Be sure to dry-fit all the pieces before you start mounting things permanently. I would love to say that I've never misjudged. But, yes, there are some installations that I've had to rip out and start over when I couldn't get the shell to close.

Wiring between loco and tender

Plan your work and work your plan. I used to scratch out on a sheet of paper how many wires I needed and where they would go. I found that each loco was different this way.

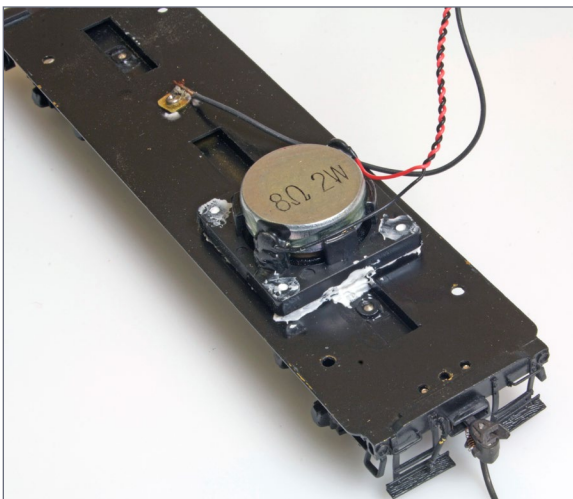

4. Speaker (high-bass type) mounting in a brass loco tender. The speaker was held down and sealed with white caulk. In the rear of the photo is the tender power connection.

TONY'S TRAIN XCHANGE

Committed to your DCC support!

ESU LokSound Sound Decoders

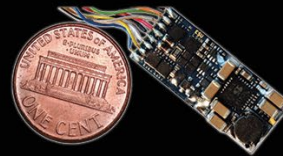

Select, Select Direct,
Select Micro, V4.0, Micro V4.0,
XL V4.0, V4.0 M4

Starting at \$81.95

Order Yours

CMX Cleaner Car



Superior, All-Brass
Build Quality, Super
Easy To Use & Cleans
Exceptionally Well!

N, HO, S, O, & G Scales

Starting at \$144.95

Order Yours

Broadway Limited HO PRR H10 2-8-0



Exceptional Detail, Die-Cast Body
& Chassis, Paragon2 Sound & DCC,
Synchronized Puffing Smoke

\$319.95

Order Yours

Do you need a Sound or
DCC Installation done?

Get a quote!

**TONY'S
TRAIN
XCHANGE**
DCC SPECIALISTS

Providing unmatched person to person DCC support for more than 20 years, the kind of service that has made us #1 in DCC. **DCC questions? CALL US! 1-800-978-3472**
*Mention this ad for \$5.00 off your next order over \$100!

We'll get you on the right track!

Feb 2015



DCC IMPULSES | 10

Then I graduated to using a paint program to draw a more formal diagram to give to the locomotive owner. That was better, but I still was inconsistent. I found that I didn't take the time to go back and look at what I had done previously, so I was constantly reinventing the wheel.

Last year, I started using a photo editing program (Photoshop is the best known but I use Pixelmator on the Mac). These programs allow more detailed drawing than paint programs and they also utilize layers.

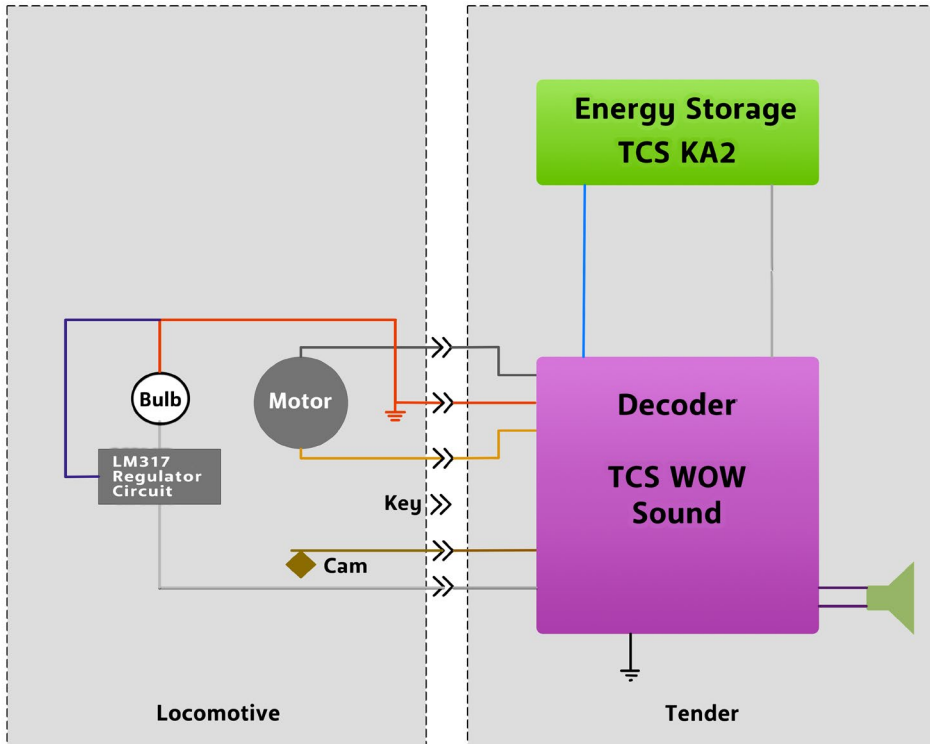

5. Sample wiring diagram created in Pixelmator. The connector is represented by the arrowheads in the middle of the diagram.

DCC IMPULSES | 11

I was able to build a master file [5] that had most of the features that I would build into an installation. Thus, I can bring up the master file and enable the layers that are used on a specific installation, such as lights, or a cam, or energy storage.

For example, in [5] the gray box labeled “LM317 Regulator Circuit” and the blue wire that connects to red wire is a layer. When that layer is turned off, it vanishes. Similarly, the “Energy Storage” module and the associated wiring are a layer.

Using a common template for wiring diagrams is not only quick, but it keeps the wiring consistent between locos.

Power pickup

Before the recent development of large energy storage systems (TCS Keep-Alive and SoundTraxx CurrentKeeper, to name two) it was imperative that opposite-rail pickup [6] be added to the locomotive and tender for reliable operation. I have rallied for adding those pickups. The last few HO-scale brass steam locos that I've done have successfully utilized energy storage modules without additional pickups.

I still recommend adding pickups in the larger scales, like O. The motors take a lot more energy to run, making the energy storage systems relatively ineffective. The good news is that the larger scales have more room for the pickups.

Lighting

Many of these older brass locos had jewels instead of active lights. If the modeler has the skill and tools to drill out the reflector and insert a light, a lot of realism can be added. A LED is the way to go. Small SMD (surface mount device) LEDs are available, some with wires attached.

DCC IMPULSES | 12

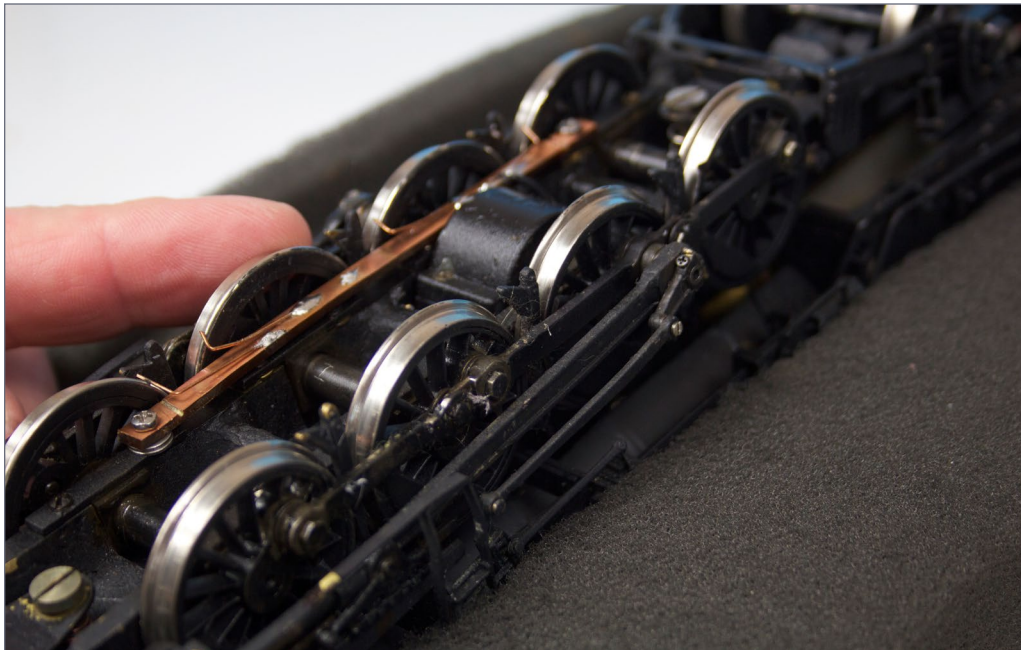

6. Added power pickup in an O-scale locomotive

Be sure to shrink 3/64 inch tubing over the enamel-insulated wires where they penetrate the shell to prevent abrasion from causing a short. It would be a good idea to strip some larger (20 AWG or so) wire and use the insulation as a cover for the enamel wire pair until you get them safely to where you can pigtail them with regular insulated wire.

“Half wave” wiring of LEDs works just fine. This is where the anode (long pin) of the LED is connected directly to one rail (the frame of the loco or tender) and the other lead connects through a dropping resistor to the function (white or yellow) decoder lead.

For more options, including 1.5 volt bulbs (not recommended due to their short life), see my web site at mrdccu.com/curriculum/lighting.

Litchfield



STATION

Looking for DCC
products?
We carry the
BEST!



623-298-7355 • www.Mr-DCC.com
www.LitchfieldStation.com

The 50-pin header

Litchfield Station stocks a 50-pin header set (litchfieldstation.com/xcart/product.php?productid=999003204) which can be cut up into connectors with exactly the number of pins needed. It has the same pin size and spacing as the 6-pin NEM651 connector found on some N-scale decoders. The pins are rated for up to three amps of current.

Use wire cutters to cut out the number of pins needed, based on the wiring diagram. Plan on losing one pin. So, if a 6-pin connector is needed, cut on the 7th pin. Keep the loose pins, as occasionally you may need a 1-pin connector.

Heat-shrink tubing (3/64" diameter) on every other pin will insulate the connections. Larger (3/8" to 1/2") shrink tubing over the entire wired area will finish off the connector and insulate all the

connections from the outside world. Finish the assembly with a bit of white paint on one side of both the male and female connectors as a reminder of the proper orientation for mating.

Tender floor assembly

As mentioned earlier [3], the tender frame and shell is connected to the left rail. This makes it the connection point for the decoder black wire. This screw is visible in the rear of figure [4].

Drill a hole and tap it for a small (0-80) machine screw. To scrape the paint off, take out the rotary tool and a cutoff disk. Just a touch with the disk will knock the burrs off and clean the area around the hole right down to the metal. A solder lug may be made out of a bit of brass with an 0-80 clearance hole drilled through it. Any copper or brass bit of metal will work.

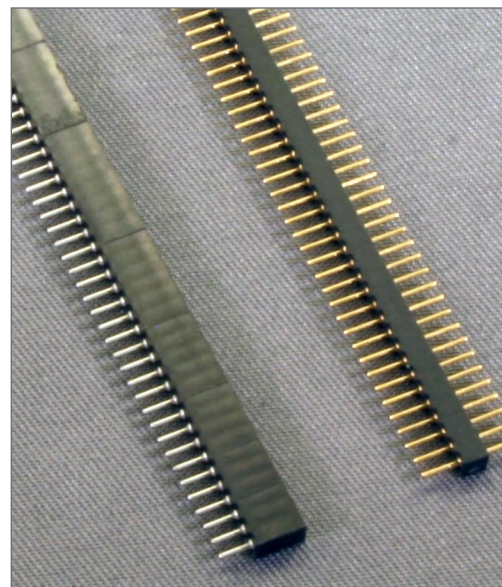

7. 50-pin header – the starting point for connectors.

ADVERTISEMENT

A DIFFERENT APPROACH TO H.O. TRAIN CONTROL



"The Crest HO Revolution is not only innovative, but it is also an ideal way for model railroaders to give radio control operations a try."

- David Bodnar, Trainelectronics.com

VISIT OUR WEB SITE FOR MORE INFO TODAY!

CREST ELECTRONICS H.O. REVOLUTION
CREST-ELECTRONICS.NET

ADVERTISEMENT

END OF TRAIN DEVICE

FLASH CIRCUIT UNDER TRUCK **TRACK POWERED**



Bright Red Flashing Light!

Installs in minutes with no freight car modification required!

RE RING ENGINEERING

Patented Technology - US Patent 7,549,609

Does not affect Load!

↓ Car without Load ↓ ↓ Car with Load ↓



For video and more click here!

The speaker [4] got .040" styrene strips glued to its front, like a picture frame. Then the assembly was held down with caulk. On this sample, I used white, instead of my usual clear, for ease of viewing. The caulk was also used to plug places where sound pressure could sneak around the speaker. These include the unused mounting holes and the small opening below the center of the speaker where the tender floor drops.

Cut a 3-pin plug and socket from the 50-pin material. Wire the male side to the wires coming from the tender floor: the speaker and power. Use the center pin for the power. That way, the connection is symmetrical and it doesn't matter which way the connectors are mated.

Tender shell assembly

The female side of the connector needs to be on the tender to protect the decoder. Also, I like to use one pin as a key. Break the end off of that male pin on the connector and shove it into the corresponding female socket. This makes it difficult to plug the connectors together offset by one pin. Making sure the key is not the center pin also helps to prevent plugging them together upside down.

Now for the scary part, making a hole in your brass baby for the connector. Use the rotary tool and a cutoff wheel to plunge into the brass on the tender shell [9] below the coal door to cut out

ADVERTISEMENT

Small Miracles

End wiring frustration with Touch Toggles™

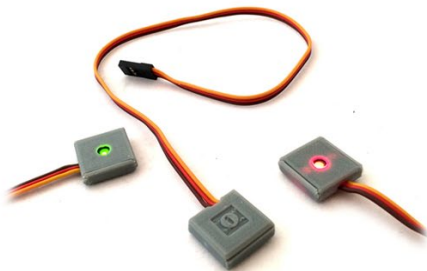

- Elegant controls
- No drilling
- No soldering

See our website for a video introduction!



Made in the USA

What will they think of next?

www.berrethillshop.com

ADVERTISEMENT

Make LocoNet wiring extremely simple!



"... great time saver as well as providing flexibility to change things ..." - Terry Nathan

PM42 breakout board



SE8C breakout board



BDL168 Multi-zone breakout board



BDL168 Single-zone breakout board



Now Offering SNAPS! in packs of 6 or 12 pieces! [CLICK TO LEARN MORE ...](#)

DCC IMPULSES | 18

the necessary material to mount the connector. Some installations need a small assembly to support the connector [8].

If you are really cautious, you may want to make a template out of styrene or wood and fit the connector to the template. Then cut the tender shell to match the template.

J-B Quick Weld epoxy is my preferred glue hold the connector into the shell. It is available from home improvement stores and Amazon ([amazon.com/dp/B0006O1ICY](https://www.amazon.com/dp/B0006O1ICY)). It dries a dark gray color that is almost the same as many loco paint schemes.

In the installation shown [9], the Tsunami and CurrentKeeper were wired together and the assembly attached to the shell. The best way to do this is using a thermally conductive adhesive so that the heat from the decoder is transferred to the shell.

Arctic Alumina Thermal Adhesive (available at [amazon.com/dp/B0087X725S](https://www.amazon.com/dp/B0087X725S)) is good and inexpensive. It transfers heat but will not conduct electricity. The heat sink (flat) side of the decoder should be glued to the shell.

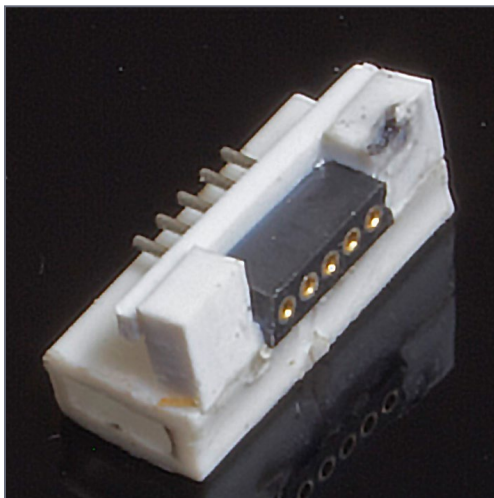

8. 5-pin connector cut out of 50-pin stock [7] with a support structure built around it with styrene. Note, the key pin is not yet installed.



Southern Digital



**20% Discount
on most items!**

Specializing in DCC Since 1992



DCC Conversions, Service & Support

Orders Received by 3:00 pm EST ship the same day

WWW.SODIGI.COM

E-mail: sales@sodigi.com

(770) 929-1888

(Photo's are from our N-Scale layout)

DCC IMPULSES | 20

Once the connector and decoder are glued into the shell, let the assembly sit for a day so that the epoxies really set up well.

Wiring the tender is a straight forward matter of following the circuit diagram and putting the colors on the right connector in the right location.

Isolate the motor

Once you have the shell off the locomotive, you will need to isolate the motor from the frame. Mark the motor contact that connects to the frame of the loco. This will be the orange lead from the decoder. The other motor lead will connect to the gray decoder lead.

Disconnect all the wires from the motor. Use a multimeter or even a buzzer to probe between a motor contact and the frame of the loco and the terminal on the draw bar. There should be no connection – very high (megohms) resistance or no buzz. Also, check to see that there is no connection between the draw bar post and the frame of the loco, as this

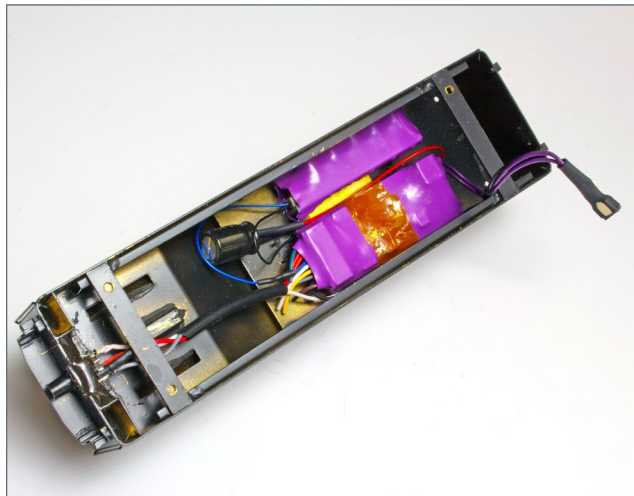

9. The tender shell with a TSU-1000 Tsunami and a SoundTraxx CurrentKeeper installed and wired to a female connector in the front. The 3-pin connector for the tender floor connections is in the upper right.

DCC IMPULSES | 21

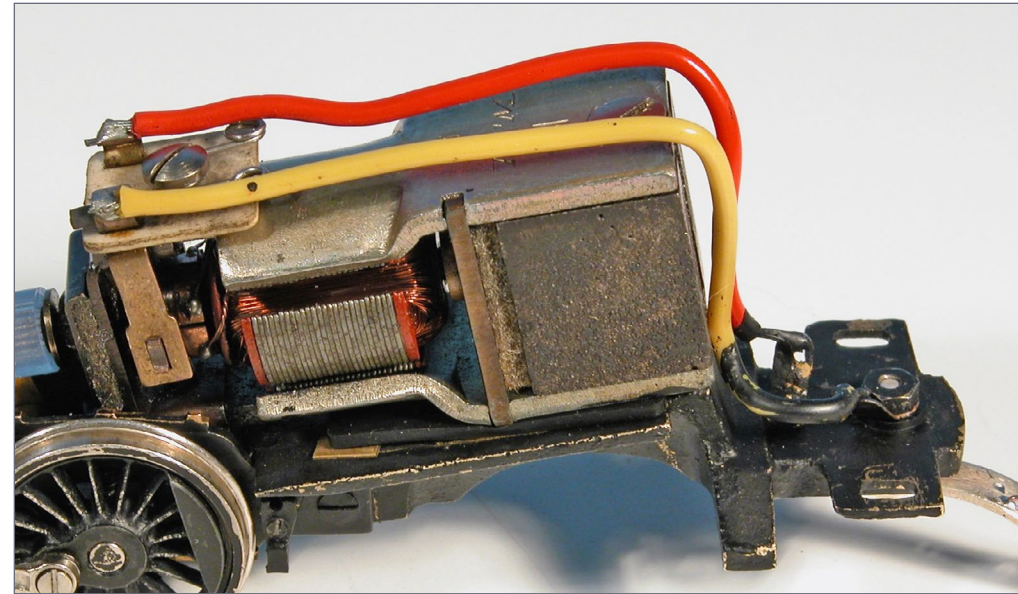

10. This (not recommended) older, 3-pole, motor would be easy to isolate from the frame. Unsoldering the yellow and orange wires from the motor and discarding them will suffice. To be certain, check with a meter or buzzer. Mark Schutzer photo

will translate into a rail-to-rail short when the loco and tender are placed on the track.

If you have continuity between a motor contact and the frame, it must be dealt with before you move on. Check for continuity between the motor frame and a contact. If you didn't replace the open frame motor, one brush of the motor may not be isolated from the frame.

Locomotive wiring

Once the motor is isolated, it is time to wire the locomotive. My favorite wire for this is a 29 AWG stranded wire made up of

DCC IMPULSES | 22

51 strands and having a rubber coating. Northwest Short Line calls it part 99007-9. Somewhat less expensive is the Wire-2951 [11] from Litchfield Station (litchfieldstation.com/xcart/product.php?productid=410120). This is very flexible, but the rubber insulation is subject to chafing. Be sure to slip some shrink tubing over the wire where it would rub against the loco or tender.

Chuff cams are a topic unto themselves. If there is enough interest, I may cover them at a future date.

In order to minimize the connections, I like to run the 2951 wire all the way from the motor, or frame, or light to the male connector. Cut the wire a few inches longer than needed and solder one end to the motor contacts or to the headlight, etc. Slide larger shrink tubing (3/16" to 1/4") over the bundle at chafe points.

As with all decoder installations, take the loco to the programming track and verify that you can read and write CVs successfully before putting it on a full power DCC track. This step may save a decoder in the event of a mistake in wiring.

Once you verify that the installation is wired correctly, shrink the tubing used to keep the wires from chafing on the loco or tender.

The process of installing a decoder as detailed here takes me a few hours spread over two or three days. That time does not

11. Wire-2951, 29 AWG wire made of 51 strands.



DCC IMPULSES | 23

include reworking the locomotive per Mark Schutzer's web site. It is not a quick process, but the results are worth the effort.

Folks always seem to have additional ideas to share. Just click on the Reader Comment icon at the beginning or the end of the column. While you are there, I encourage you to rate the column. "Awesome" is always appreciated. Thanks.

Until next month, I wish you green boards in all your endeavors. There will be no *Mr. DCC's Workbench* segment this month. This entire column would qualify.

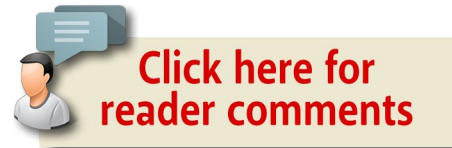

ADVERTISEMENT

RR-CirKits, Inc.
Affordable Electronics for Model Railroads

- Computer Interface
- Signaling
- General I/O
- Block Detection

SignalMan

32 Aspects!

[Learn More ...](#)

ADVERTISEMENT

Installing DCC sound just **NOT** your thing?
Trust Traintek for sales and installation of sound decoders from these fine vendors!

ESU, Digitrax, QSI, SOUNDTRAXX, LOCKSOUND, RailPro

"Taking model railroad control to the next level ..."

Traintek LLC.COM

traintekllc.com "Traintek was the way to go!"



Digitrax No Worries Warranty Keeps Your Layout Running!

That's it! A simple, straightforward one year warranty with no tricky language!

You're protected against defects and accidental damage.

Learn more at: www.digitrax.com/noworries

Need tech support?

www.digitrax.com/contact

Need a repair?

www.digitrax.com/repair

Need a throttle conversion?

www.digitrax.com/upgrade



SO REAL...You'll Think You're There!

LokSound Select · 3 SIZES, ENDLESS POSSIBILITIES!

INDUSTRY LEADING MOTOR CONTROL

- Multiple Bell types
- Multiple Brake squeals

4 OR 8 Ohm SPEAKERS!

- 4 or 6 Output functions depending on the style
- Up to 4 Prime Movers or Steam Sounds on EACH decoder
- 16 Very Playable, LOUD Horns or Whistles depending on Profile
- All Changeable by using ONE CV! No Programmers or Boosters needed!*

**Small Size
BIG POWER! 1.1Amp!
LokSound Select
"4 AUX"**



**ONE SIZE FITS ALL!
LokSound Select "DIRECT"**



**6 Outputs!
LED Resistance
Built In!
LOK SOUND
SELECT**

**\$109.99
NEW
2011**

Only Available From
ESU LLC (USA)

**Tiny Size,
HUGE Versatility!
LokSound Select
"MICRO"**



- Great NEW Size 1.18" x 0.61"
- Versatile DCC & DC "Dual Mode" decoder!
- 8 channel sound system!
- FOUR lighting outputs and a 1.1A motor controller
- Available with ALL Current LokSound Select Sound Profiles
- Use 4, 8, or 16 Ohm Speakers

- Easy Drop in Design
- Versatile DCC & DC "Dual Mode" decoder!
- 8 channel sound system!
- SIX lighting outputs ALL with built in resistors for LEDs
- Available with ALL Current Diesel Sound Profiles
- Use 4, 8, or 16 Ohm Speakers

- Great NEW size ONLY 0.98" x .417"
- Versatile DCC & DC "Dual Mode" decoder!
- 8 channel sound system!
- FOUR lighting outputs and a .75A motor controller!
- Standard 8-pin NEM 652 plug included
- Available with ALL Current LokSound Select Sound Profiles
- Use 4, 8, or 16 Ohm Speakers!

* ESU LokProgrammer needed to "Replace" Sound and for Firmware updates, not for normal editing

www.LokSound.com • 477 Knopp Drive Muncy, PA • 570-649-5048

Now on facebook!



GETTING REAL

column

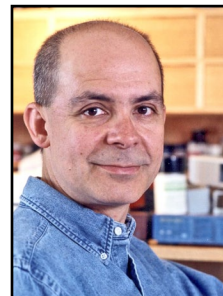

MIKE ROSE



**Click here for
reader comments**

SEEING IT ALL THE WAY THROUGH | A PRODUCTIVITY SURGE

IN MY LAST "GETTING REAL" COLUMNS, August 2014 (mrhmag.com/magazine/mrh-2014-08-aug/gr_layout-building-productivity-1), and September 2014 (mrhmag.com/magazine/mrh-2014-09-sep/gr_layout-building-productivity-2), I'd just come off of a massively productive surge of layout building that had a deadline or two driving it. Believe me, there's nothing like a deadline to get something accomplished, which is part of why I like being a columnist for *Model Railroad Hobbyist*. The surge allowed me to present a sensible clinic at the New England Proto Meet in June, and also served as the material for the aforementioned columns. But what happened after that? Could I keep the momentum going?

A review of the previous columns will give you a sense of the starting point for this next assortment of work. Although I'd made huge strides by building and installing more trees than I

► MODELING REAL RAILROADS AND WHAT THEY DO

- [TABLE OF CONTENTS](#)
- [INDEX](#)

thought humanly possible, and in essence completing the backdrops so I could now concentrate on the foreground scenes, the area was far from what I'd call "presentable." By that I mean that there is nothing glaringly wrong and it looks good in person and in photos, but is by no means finished in terms of the level of detail. Much of my layout is approaching presentable, but virtually none of it is finished. I'll begin that happy process as my whims dictate once the entire layout is presentable.

I knew I had a finite work window, since I was aiming for another op session at the end of August 2014. Therefore my intention was to work through the end of June and into July, then take the first few weeks of August to clean up and prep for the op session. So right after the New England Meet and my June op session, I ran the rolling stock out of that side of my layout and got to work.

Laceyville



1. In order to begin all the necessary ground cover in Laceyville, I realized I needed to define where the paving would be, and get it in place. Here you can see how 3/16" wood strip and some styrene were used as "forms" for the paving material. I have been using lightweight spackle mixed with powdered tempera paint for quite some time now. The ability to have the color all the way through and to get a variety of shadings is attractive, plus it's easy and quick to place. I generally apply a rough base coat, use a drywall sanding sponge to smooth it after it dries the next day, and then tweak it with top applications where needed.

ADVERTISEMENT



1st choice for model railway supplies and service.

Expedited mail service available across North America.

Click to visit
WWW.CVRCO.COM
1 800 464 1730





2. This photo shows what it looks like after the second coat is applied and everything is smoothed properly. I strip the forms before applying the second coat so I can repair any damage that occurs during that process. Note that in this photo you can see a prototype photo of each modeled house, and that I removed the paved driveway I'd roughed in prior to this. That's because after I consulted the photos again I realized that the blue house actually had a dirt driveway.

Another thing to note in this photo is how the green foam has been shaved down carefully to get lower and lower as you head from right to left. This helps to capture the feel of the town where the street actually ran downhill, but here it is level.



3. Using a model car helped me to plan the proper proportions for the shared driveway entrance of the two right-hand houses. You can see how material has been added to the side yard on the right hand house and cut away so the basement garage can be accessed. Sharpie lines define the driveway edges.

**Want to help
keep MRH free?
Then click on
Ads!**



4. The dual driveway is roughed in, with the pavement extended into the "basement" of the house so there are no unsightly seams. Also notice the "concrete" stairs under construction, another prototype feature that allowed direct access to the mailbox on the street.



5. I constructed the stairs out of two wooden sets from the scrap box, with cardstock sides and other stripwood added. Cytox was used for all construction. After all, I was in a hurry and there was no time to wait for concrete to cure.

34,000 have read this MRH forum thread - have you?

Home / Forums / Track and electrical/DCC / What DCC system do you use - and why?

What DCC system do you use - and why?

Mon, 2010-08-02 11:03 — joef Track and electrical/DCC DCC - Electrical

I'm curious what DCC system various modelers on here are using, and why? I think it's useful - so post a bit about the system you use and how you came to choose it. Also if you have any learnings, that's always helpful!

Read now



ADVERTISEMENT



Announcing
New home for Motrak Models

Motrak Models Headquarters is now at
717 Windsor Lane, Martinsville, VA. 24112



Phone number: 813-476-4784
Email: motrakmodels@centurylink.net

CHECK IT OUT!



6. With the driveways defined, it was time to blend in the front yard slopes with Sculptamold that I mixed with ground-colored paint. Blue painter's tape protects the road without any worry about pulling it up. The two old pocket knives are used to poke and prod the Sculptamold wherever it's needed. And since we're working with paint, the disposable gloves really save on cleanup time.



[Click here for reader comments](#)



7. The already-painted concrete stairs have been pressed into the wet Sculptamold and are being held in place by a lead weight.

ADVERTISEMENT

Rslaserkits

Carl's Cabin

Now in O and Ho scales



The perfect cabin for your logging or mining camp or use for housing on the wrong side of the tracks. Includes extra material to use for the piers and bracing when placed on a sloping lot. We have also included the out house.



Check out our new HO flat car decks

Dealers welcome
Salem, OR
503-371-4290



Custom Laser Cutting
and design
Sales@rslaserkits.com



8. Moving from left to right, another driveway is in place and more colored Sculptamold has been used to smooth the transition from hillside to street.



9. Already it's beginning to look more like a neighborhood. You can see how the stairway nestles right into the "ground" like it should. The driveways here are only on their first coat.

ADVERTISEMENT



**N SCALE
RD-4 HOPPERS**



CHICAGO & NORTHWESTERN



BNSF (CIRCLE CROSS)

12 NEW ROAD NUMBERS
ON EACH SCHEME

BODY MOUNTED
COUPLERS



UNION PACIFIC (CMO)



NORFOLK SOUTHERN

METAL WHEELSETS



BNSF (SWOOSH)

**RESERVE
TODAY!**

www.foxvalleymodels.com

When talking to hobby vendors, please remember to mention MRH.

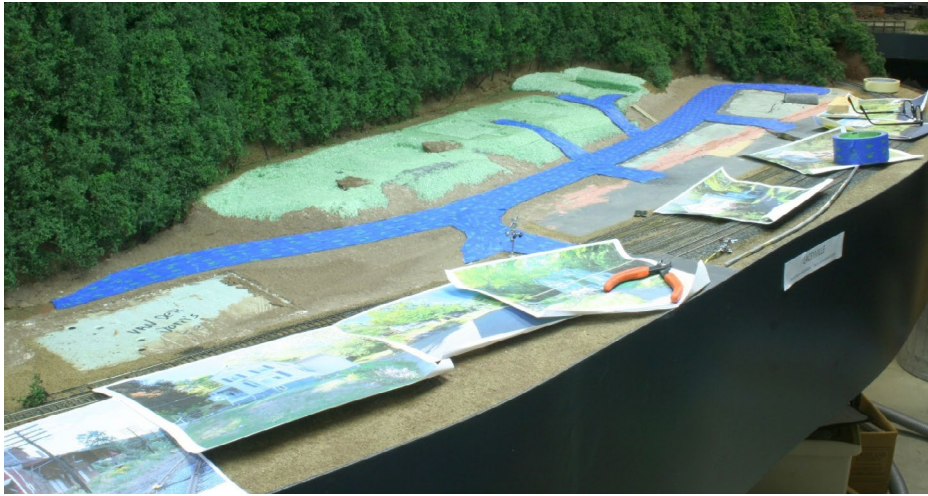

10. The next step is to apply blue painter's tape to all of the newly paved surfaces. I used the "gentle release" variety for this step. This allows the general ground cover to be applied and bonded to the ground, not the paved surfaces.



11. What often happens when you get to slinging scenic materials around is that it's hard to determine what goes where, without something to show the way. I did not want any scenic material under the buildings, since I wanted it to be snug right up to the foundations, so I masked their footprints where appropriate.

ADVERTISEMENT

Our First HO Kit! About 6" x 6"

Mt. Albert Scale Models

\$95.00 PLUS SHIPPING

ORDER NOW

Detail Parts shown included 905.664.3400



NORTHWAY TRACTOR REPAIR



Click here for reader comments

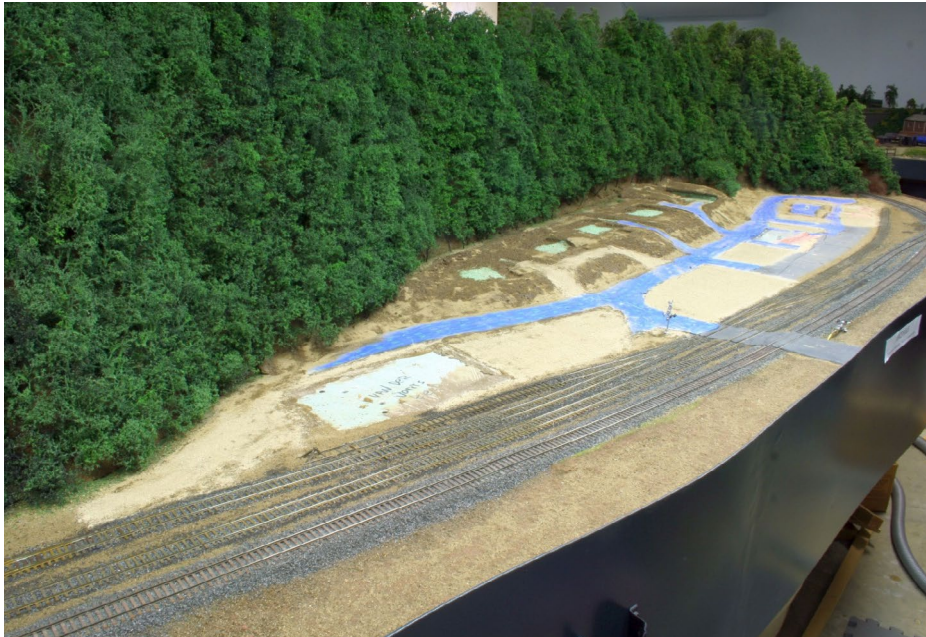

12. Now you can see why I protected the roads and driveways. I liberally applied ground-colored latex paint and then sprinkled on sifted and well-dried real dirt from the yard. The lighter colored areas that will be dusty dirt areas are done with a mix of two colors of grout and some hydraulic cement. A brush was used to sweep the sifted material off the tape.

ADVERTISEMENT

WWW.GLXSCALEMODELS.COM

RESIN CASTINGS
SCENERY DETAILS



13. Looks like it rained and areas are muddy. That's because once the material is sifted onto the wet paint, I mist it all with a 50/50 water/isopropyl alcohol mixture with a plant sprayer, then follow with a coating of 50/50 white glue and water. For large areas I use a sprayer, but a lot of it is done with a pipette, which gives me a great deal of control. **IMPORTANT:** Immediately after you are done putting down the glue mixture, you must remove the tape. The bonding liquid tends to saturate everything, and if you let it dry you'll never get it off the roads.



14. I call this instant Big Impact! With virtually no foam or plywood showing, it just changes everything for the better. Now it's time, once everything is thoroughly dry, to begin taking away that "desert southwest" look.



15. Sharp eyes will notice that the cardboard tubes that had been used for temporary mock-ups of the grain silos at Laceyville Agway have been relocated to Purina Wyalusing in the distance, and replaced with Rix bins that I built up. I've also started on the elevator leg as shown. This was all needed to determine where additional paving between the elevator and the silos, plus ground cover, were needed.

Get the Latest Model Railroading News, Tips, Reviews & Opinions

The SCOTTY MASON SHOW

S H O W
The Original Model Railroad Podcast

-Monthly Interviews

- Modeler's Spotlight: Top Modeler's Talk
- Narrow Gauge Modeling w/Chris Lane
- Contemporary Modeling w/ Mike Rose

-More Product Announcements & Reviews

Our feed has changed! To get the latest shows Please search Scotty Mason and subscribe to the new feed!

www.TheModelRailroadPodcast.com

Scott Mason Jimmy Simmons Mike Rose Joe Duckworth

[Click here for reader comments](#)



16. Static grass makes a world of difference, don't you think? Mike Confalone came down to help me with a static grass session, as he'd gotten tired of my whining about how my efforts in that department were lackluster (hey, it worked, right?), and we soon discovered that my gun was sub-par and that I had no trouble applying it with his. He let me borrow it... and, umm... I guess I still have it! So Mike, if you need your gun, just let me know!



[Click here for reader comments](#)



17. Here's the reverse angle, showing additional work done heading down to Wyalusing in the distance the next day. The grass has totally transformed the area. Some additional close-up photos follow and represent the way Laceyville looks right now.

**Want to help keep
MRH free?**

Then *click* on ads!



18-19. Finished shots of Laceyville.

Wyalusing



20. I've compressed the distance between Laceyville and the town of Wyalusing. The reason for having it on my layout is so that I could represent the very scenic Purina Feed Mill there. Here's a picture of it in my era (1985) shot by Wayne Sittner.

For me this really is an incredible find. Note how new the facility looks, with the bins still shiny and the sign fresh, yet there is evidence of rust streaking on the angled corrugated metal roofs, and subtle weathering on the ribbed square bin.



21. Here's how the same facility looked when I discovered it in July of 2003. Note that much has changed! Look at the differences in the upper bin areas, how weathered everything is, and also that the truck drive-through on the left has had its roof raised. The big red bin in the foreground is new too. If this were all I had to go by, that's how it would look on my layout, and it would not be quite right. I think the original is more interesting, though the many shots I took on this visit would definitely help in constructing the elevator and surroundings. At this time in 2003 they'd actually gone out of business, and when I stopped here to show it to my friend Dave 10 years later, I had trouble identifying the spot. Yes, that's how thoroughly it had been erased from the landscape, just a smudge where all of this had been. The moral of the story is to ALWAYS take the picture! You never know when you'll need it.

In order to even begin to mock-up this area, I realized I needed to define some boundaries.

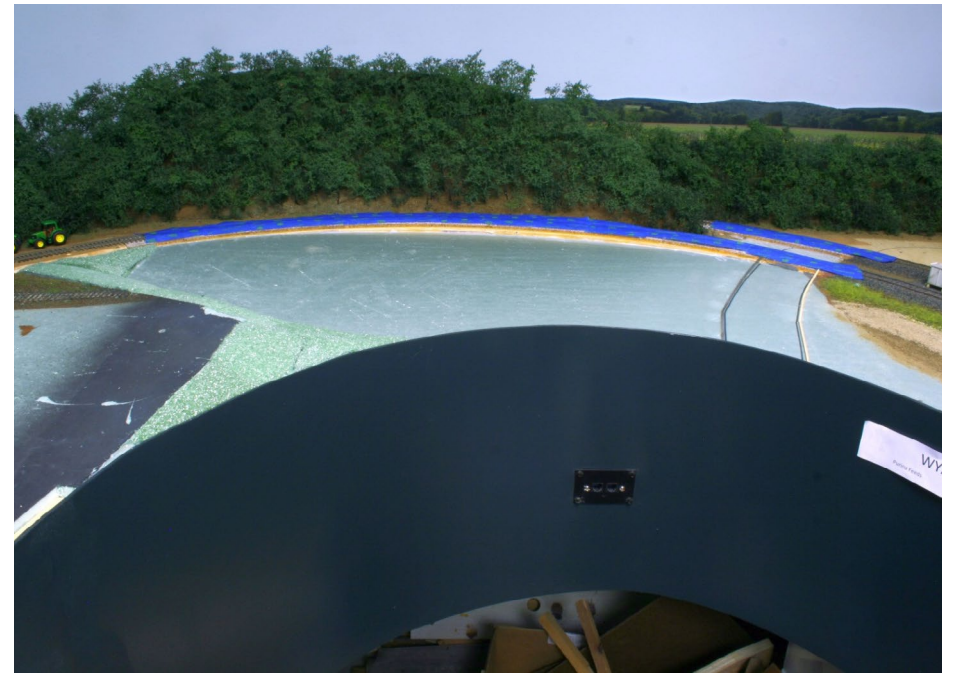

22. The grade crossing is how the elevator is accessed from the outside world. As soon as I started to define that, I began to look at the area to the left of the road and thought, "hmmm..." I love it when that happens!

Almost 30,000 have seen this MRH video - *have you?*



**Watch the
video now**





23. After defining where the street would be with more strip-wood, I covered the tracks with painter's tape to protect them from the spackle.



24. I decided to contour the entire area to the left of the road properly with earth-colored Sculptamold. The same material was added to raise the ground between the tracks to grade, once I realized that it was too deep for spackle only.

ADVERTISEMENT



NEW TECHNOLOGY



Click Here to Learn More





NEW Starter Kit \$399.99 MSRP

- Includes Wireless Color Touch Screen Handheld Controller and 56 Watt Power Supply
- Expandable to Virtually any Size Layout

NEW Locomotive Module LM-2 & LM-2S

- Direct Radio RF
- Sound and Non-Sound
- New Tiny Size
- 6 Light Outputs



For more information visit our Internet site: www.RingEngineering.com



[Click here for reader comments](#)



25. The first coating of pavement has been applied leading up to the tracks, and also serving as a driveway. Driveway into... what?



26. This overhead shot shows some tape is still being used to protect the track areas. The road has now been installed between the tracks, and on the other side leading into the facility. The tape measure is used to gauge how large (or not!) the footprint for the Purina Mill is. The item to the left of the road should help you guess what is going to go in that newly developed area. This view shows how the backdrop and berm behind Wyalusing was done, there is a hidden track (but open to the air) behind the berm in front of the wall. From a normal height, you will not see the hidden track.

Almost 30,000 have read this MRH forum thread - **HAVE YOU?**

Share your weathered rolling stock, Please!

Sat, 2012-03-24 12:34 — Bluessman Locos and rolling stock Locos - Rolling stock (general) ShareThis

I am hoping some of you will share some pictures of your weathered rolling stock. I always love to see other peoples work and of course learn something new!

Gary



Athearn Blue Box

Thu, 2012-03-29 04:56 — Tom Patterson

Here's a boxcar that I built in 1985 based upon a small photo in MR.



Read now





27. Here's the finished grade crossing. I generally do mine with wooden ties protecting the flangeway, and with paving in-between, which is typical for Conrail in my era. The ties are protected with tape; you can see that this is a multi-step, but fairly easy process. Note the shorter grass in the "mowed" area on the left.



28. Yes, I'm beginning to create East Towanda Tractor & Supply here. The tractors are off Athearn flat cars, and I'm looking into other farm equipment to flesh out the scene. Businesses like this are very common everywhere in Pennsylvania, and definitely in my modeling area.





29. Just adding a few more pieces of equipment makes the scene start to come alive. Lots more needs to be done to the building itself, plus some signs on the building and at the road will help as well. Some miscellaneous farm-type junk in back of the building is a must! The Agway fertilizer truck is a Rich Cobb creation.

102,000 have seen this MRH video - *have you?*

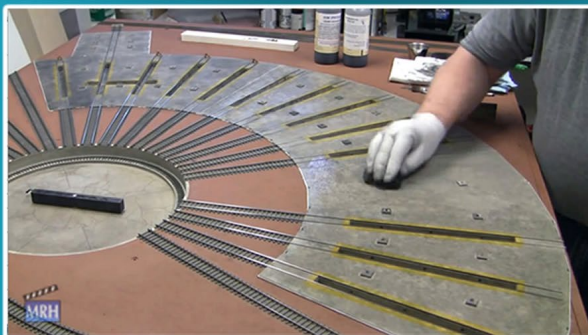

Watch the video now



30. And what about Wyalusing Purina? It's a complex enough structure, and the site is such an odd shape that I decided to do up a full-scale mock-up of it. Believe it or not that's a single piece of cardboard, the back of a legal pad, cut and painted like the prototype. I stole the bins and elevator leg from Laceyville Agway and began to build the many smaller-diameter bins that are part of the overall facility. The small bins are done with Rix N scale grain bins, which you can stack up to whatever height you want. Needless to say, this will take many of those kits.



31. One thing discovered during of this exercise is that the footprint there is just a bit too tight. I've already carved out some of the mountainside on the right to allow more room for the bins, as you can see from the non-painted light green foam. This will also permit some of the storage sheds you see to the right of the prototype picture to be replicated as well. If all goes according to plan, you'll see a construction article about this facility either as a stand-alone or in my next "Getting Real." Another layout blitz is planned for the January through March time frame, where I hope to get beyond the messy stage entirely in this aisle. ☑



[Click here for reader comments](#)

Bowser

EXECUTIVE LINE

HO F3, F7, & F9 units

Single Units produced by the original Stewart Co.
Powered & Non Powered. Available with or without Sound



[Click here to check out the details for these and other great Bowser products!](#)



Notice:

Shipping replacement trucks and new fuel tanks for 1st batch of C-636 Locomotives. If you have not ordered your replacements yet, please send an email with your name and address and what color you would like to bowser@bowser-trains.com



Many species of
Conifer trees available!



Also see our other
conifer offerings ...

Click for
more -
lots more!

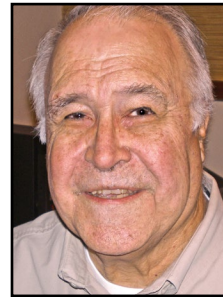

LARRY SMITH
.....

Model Railroad Hobbyist | February 2015 | #60

LITE AND NARROW

column

Click here for
reader comments

THE NEW MERKLE CONNECTING, PART 1 | A SMALL ON30 PROJECT LAYOUT THAT FITS ALMOST ANYWHERE ...

THIS IS THE FIRST IN A SERIES OF ARTICLES on building the New Merkle Connecting railroad. The railroad is based on an unnamed narrow gauge industrial railroad located on the Shelby-Jefferson county line in Alabama. Until 1994, most modelers didn't know it existed. Using the information from 1994 and uncovering new information, Phillip Griffith is building a model of this railroad in his loft. We will follow it to completion.

So how did we get to here? Our story begins in 1871, when the Elyton Land Company founded what would become the city of Birmingham. The company owned 41,000 acres of land and established the city at the junction of two railroads in the Jones Valley of north central, Alabama. The primary purpose of this land

► **NARROW GAUGE AND LIGHT RAIL RAMBLINGS**

LITE AND NARROW | 2

development venture was to entice investors to develop the recognized, but untapped, mineral wealth in the area.

The close availability, within five miles, of the three main ingredients needed to make iron: iron ore, coal, and limestone, could not be tapped until the transportation and capital came together in the Deep South, a region of the new United States that was generally tied to an agricultural economy.

The city began to grow slowly but almost ceased to exist in 1873 when a cholera epidemic nearly wiped out the town. It wasn't until 1880 that the city began to grow rapidly as industry began to develop.

When most people think of Birmingham, they think about the iron and steel industry, and rightly so. It did have the nickname of "The Pittsburgh of the South" for a very long time. However, when the city was established the iron and later steel industry didn't exist in Alabama. There had been small iron furnaces in the area prior to and into the Civil War that took advantage of the naturally occurring raw materials for the production of iron.

The largest of these operations was at Tannehill, about 35 miles west of Birmingham, that produced iron for the Confederate arsenal at Selma. This was a two furnace operation that was a major source of iron for Selma. The big problem, as the Civil War pointed out, was transportation. No railroads were near this and the other iron works at the time. The iron had to be loaded onto wagons and driven to the Cahaba River and floated by boat to Selma. The furnaces ceased operation when Union forces raided the area and destroyed Tannehill along with others.

The iron and steel industry began again when construction began on the Alice Furnace on Sept. 29, 1879. According

LITE AND NARROW | 3



1. The first locomotive and cars used at the Cahaba Valley Pumping station. Larry Smith Collection

to "Alabama Blast Furnaces," published by Woodward Iron Company in 1940, Alice was the fourth furnace (coke fired) to be built in Jefferson County. The other three were McElwain (Old Irondale, 1863-64), and Oxmoor No. 1 (1863) and No. 2 (1873).

The first furnace was located at the southwest end of the Railroad and Mechanical Reservation, where the Alabama & Chattanooga split from the Louisville and Nashville (South & North). The No. 1 furnace was completed and blown in on Nov. 23, 1880, and the second furnace, No. 2, was blown in on July 23, 1883. By 1886, this facility was setting records when No. 2 produced 150 tons of iron in one day. Alice was the first furnace in the Birmingham District to successfully make "basic" iron for a prolonged period (Armes, p.435).

According to Woodward Iron's book, this was significant because it convinced northern capitalists that iron-making with locally produced coke was practical. This also set off an explosion in growth for the new city and earned it the nickname "The Magic City."

Fast forward to 1994. I was a contributing editor for Model Railroading at that time. While doing research on another railroad, I met with Tommy Lawson, a noted rail historian who lives in the local area. During this meeting, he showed me a photograph of a locomotive and asked if I knew where it was. I didn't. He explained that it was a local railroad that no longer existed and it had served the Cahaba pumping station of the Birmingham Water Works.

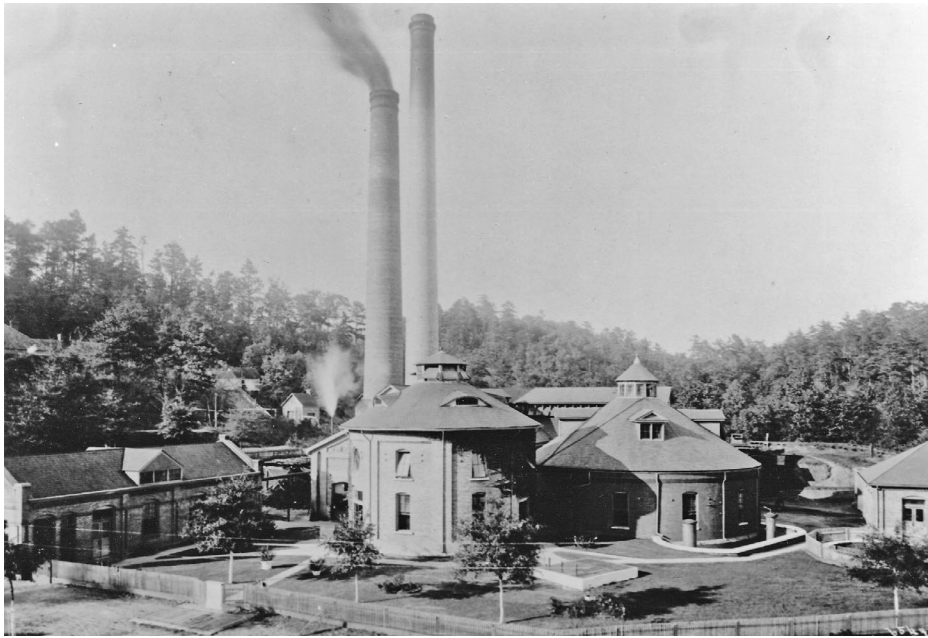

2. The Cahaba River Pumping Station of the Birmingham Water Works. Larry Smith Collection

The Cahaba pumping station is located eight miles from my home and I passed it quite often on I-459 going east. The complex consists of a large boiler house and an auxiliary building. There are also two circular deep well structures which house the pumps. The pumps are at the same level as the bottom of the Cahaba River and are connected to intake pipes.

The search for water

The Birmingham Water Works company was established by the Elyton Land Company to supply the new city of Birmingham with fresh water in 1871. To do so, the company constructed a steam-powered pumping station in 1873 on Village Creek. Village Creek wanders along the northern edge of the city. The pumping station was designed by Willis Milner, an engineer with the Elyton Land Company, and its purpose was to draw water from Village Creek and pump it to a fill basin on Reservoir Ridge.

Reservoir Ridge was between 12th and 14th Avenues North and 22nd and 23rd streets. The ponds then supplied the city through underground gravity-fed pipelines. With the exception of two businesses, the Birmingham Rolling Mill and the Relay House hotel who connected to the system, most residents still relied on wells.

This reliance on wells in marshy areas and fed by surface drainage led to the spread of the cholera epidemic in 1873. In his report on the epidemic, noted physician Mortimer Jordan, Jr. lamented that the new water works, which he described as "most admirable," was not more complete. Although the system steadily expanded, Birmingham's booming development outpaced it, and by 1884 Village Creek was proving inadequate as a source because of its limited flow and increasing levels of industrial pollution, as well as overflow from septic tanks and outhouses.

LITE AND NARROW | 6

Looking for another source of water, the Elyton Company surveyed a canal from the headwaters of Five Mile Creek north of the present day city of Tarrant, AL to the North Birmingham pumping station. Construction continued for years, hampered by lawsuits from industries along Five Mile Creek.

Meanwhile, the pumping station supplemented its reservoirs with water from artesian wells in the area until the canal finally opened in November 1887. Four million gallons per day flowed alongside the present route of Jefferson Boulevard, which is also called Canal Avenue in Tarrant. New reservoir basins were excavated adjacent to the pump house, and were known locally as “Lake Placid.”

This arrangement served all of the city’s municipal water supply until a second pumping station was constructed at the Cahaba River in 1890. The North Birmingham station remained in service until 1938, after which it was demolished and its canal filled in.

Flowing peacefully along the Shelby-Jefferson county line, 15 miles south of Birmingham, is the Cahaba River. Undammed for 140 of its 191 miles, the Cahaba is the last free-flowing river in Alabama. The shallow river flows from Leeds, AL connecting with the Alabama River south of Selma. This seemed like an ideal location for a new source of water for the fast growing city. The site chosen for the new pumping station was located 1,000 yards upstream from the mouth of the Little Cahaba River at the former site of New Town.

The pumping station was again designed by the Elyton Land Company’s engineer, Willis Milner, for a capacity of five million gallons per day and construction began in 1887. Another engineer, W.A. Merkle, took charge of the construction. At a cost of a half million dollars (\$12 million in today’s dollars) over the next three years, this

LITE AND NARROW | 7

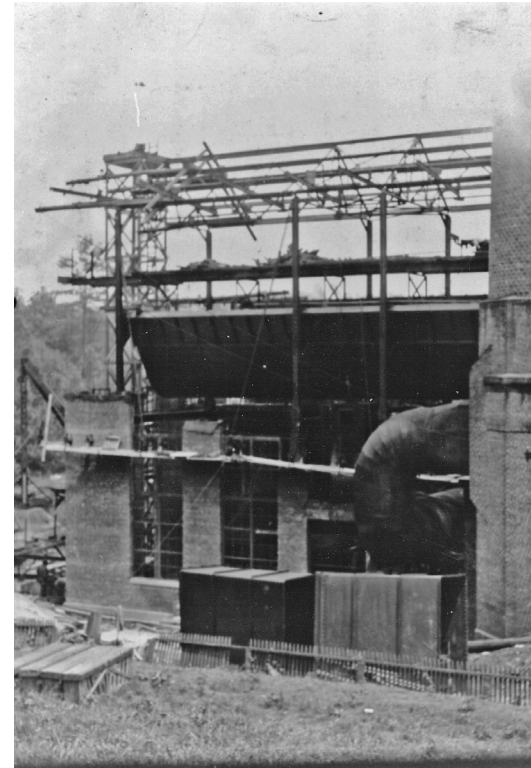

3. The boiler house under construction.
Larry Smith Collection

was a massive undertaking. The location was so remote that the first thing Merkle had to do was construct a road from the site to the siding of the Birmingham Mineral Railroad in Hedona, the closest rail connection to the site, 10 miles away. Given the lay of the land, this was no easy task.

For those of you not familiar with the Birmingham area, the city lies in Jones Valley that runs northeast to southwest. Located on the southern edge of the Jones Valley is Red Mountain, named for its major deposits of iron ore. The Birmingham Mineral Railroad operated on the south side of this ridge about two thirds up the side. Going past Hedona, the railroad crossed to the north face of the ridge just below where the famous statue of Vulcan stands today.

Between the construction site in the Cahaba Valley is another valley, Shades Valley. It has Shades Mountain on its southern flank that had to be crossed as well. Shades Mountain is the tail end of the Appalachian Mountains and literally ends within sight of my home.

LITE AND NARROW | 8

From the rail connection at Hedona, the equipment for the pumping station moved by oak sleds pulled by 10 yoke of oxen, down the south slope of Red Mountain and across Shades Valley, then up and over Shades Mountain to the Cahaba River Valley. At one point, it was easier to offload some of the equipment and lower it, by stiff-leg crane, to the valley below and reload it on sleds for the rest of the journey. This procedure was used for not only the boilers and the pumps but also the locomotive and cars used at the site.

To avoid the arduous task of bringing in construction materials for the construction, due to the lack of roads, a brick kiln was constructed. The stone for concrete came from an on-site quarry, while the sand hauled from a sand pit 3 ½ miles away. The rough lumber

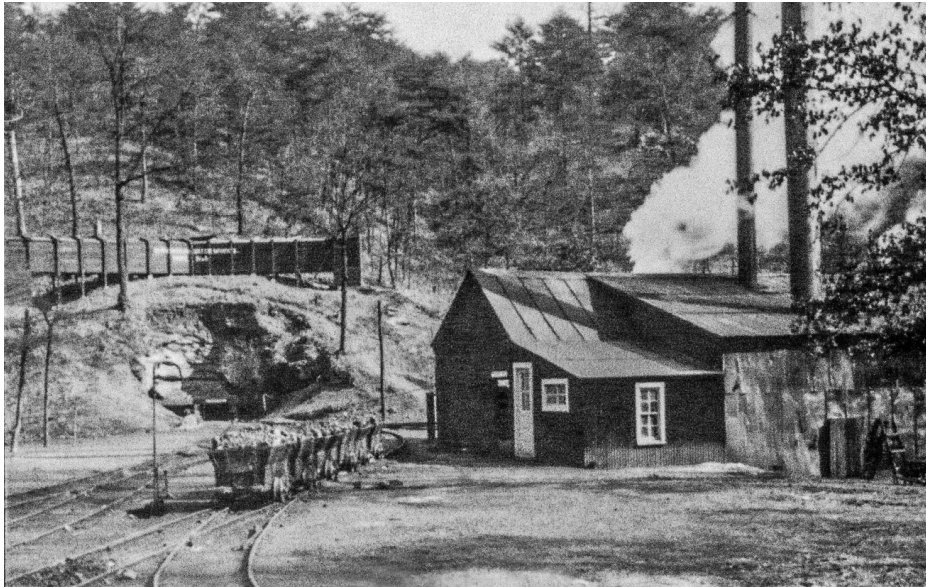

4. The Merkle Mine showing the trackage and the hoist house. The entrance can be seen to the left of the tiny mine cars. Phillip Griffith Collection

LITE AND NARROW | 9

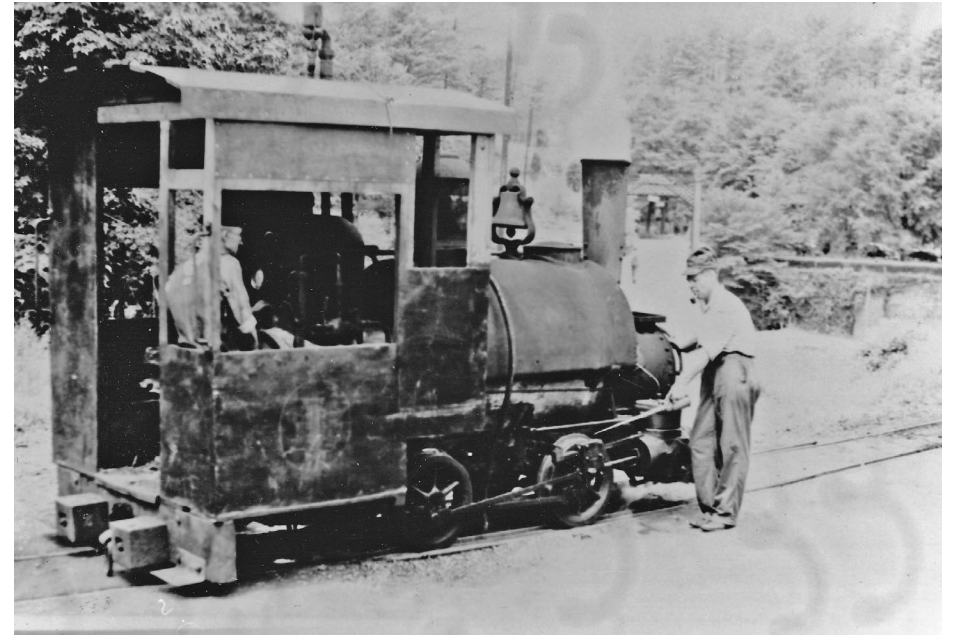

5. One of the 6 ½ ton Porters used on the railroad. Larry Smith Collection

was brought from a sawmill five miles away from the site. The coal came from a temporary mine to provide fuel for the brick kiln.

Because of the remote location, a company town of 18 houses was built along the banks of the Cahaba. The community was named Merkle after the chief engineer. In 1888, after the pump station was finished, the entire town was moved to a bluff overlooking the site and renamed New Merkle. Today, it is been renamed Cahaba Heights and is part of the City of Vestavia Hills, AL.

During the survey for the pump station, a coal seam was discovered less than three miles from the proposed construction site. In later years, the Cahaba Valley would become a major coal producer until

the early 1960s when the coal became uneconomical to produce. There is still over a million tons of coal left in the Cahaba seams. Because of the close proximity of the coal, Merkle decided to fire the boilers at the pump station with coal from the seam after the plant was completed and to use it for fuel for the on-site brick kiln during construction.

The railroad

Building the railroad wasn't a simple task either. The first mine was located about three miles up an adjacent valley. However this mine was located across the Cahaba River. To get to the mine, also being opened, a bridge had to be built across the river. There isn't any information as to what the first bridge looked like. The only photos available are of the last bridge. They show a light through-truss bridge with deck girder approaches supported by steel trusses. The supports for the truss bridge are round steel or iron posts.

There were three mines, each progressively farther from the pump station. When the first mine became unworkable a second mine was cut into the hillside. It soon failed and was followed by a third mine five miles away. All of the mines were slope mines, meaning cables were used to raise and lower the cars to the working face of the mines and mules moved the cars above and below the surface. The third mine operated for nearly 60 years, until the boilers were converted to gas.

The railroad was built with a track gauge of 33". The first locomotive was purchased used in 1880 and already set to the 33" gauge. It was a 7 ½ ton Porter 0-4-0T. The first locomotive was replaced in 1902 by a newly purchased Porter 0-4-0T that weighed 6 ½

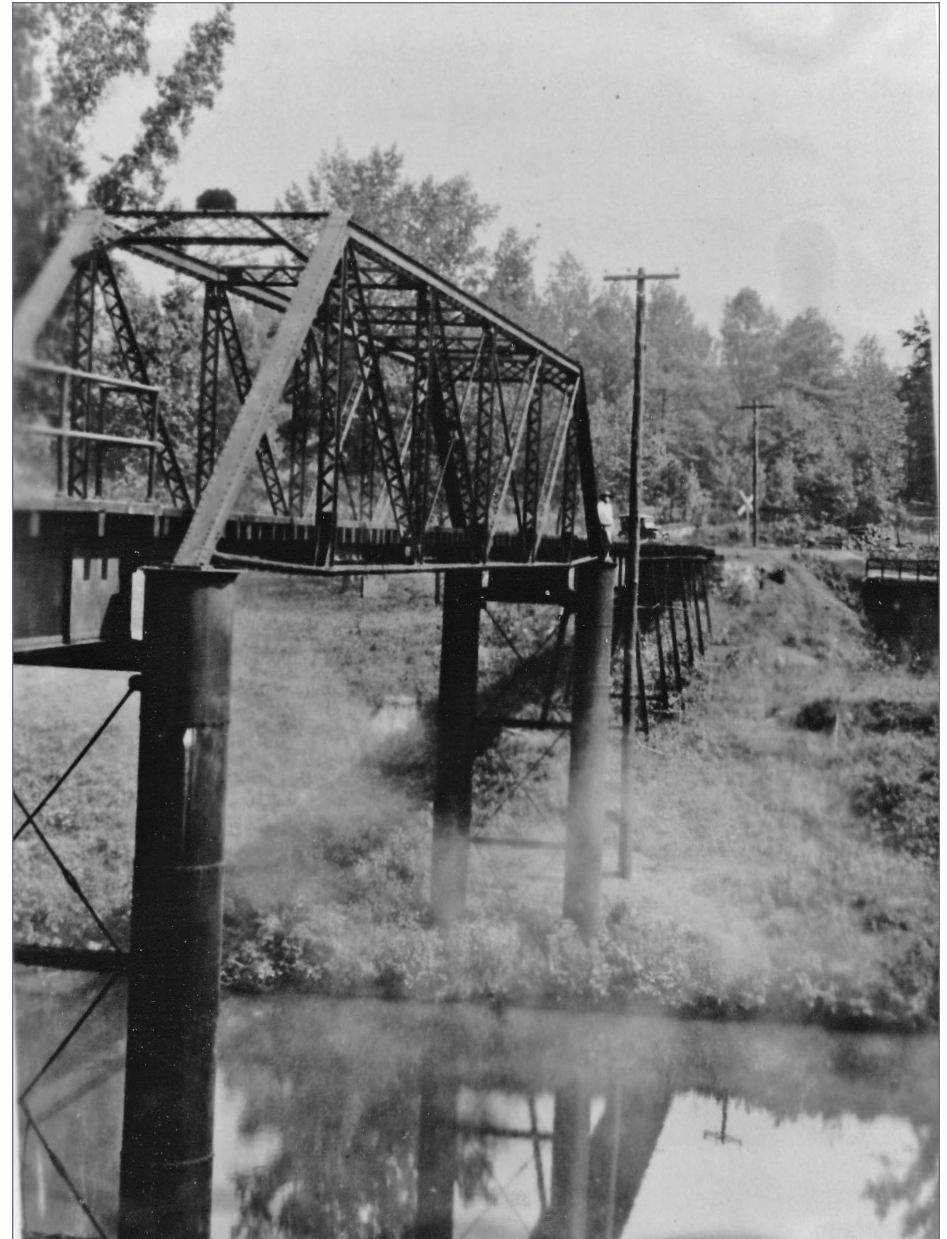

6. The Cahaba River Bridge. This is a scene being duplicated on the New Merkle Connecting. Larry Smith Collection

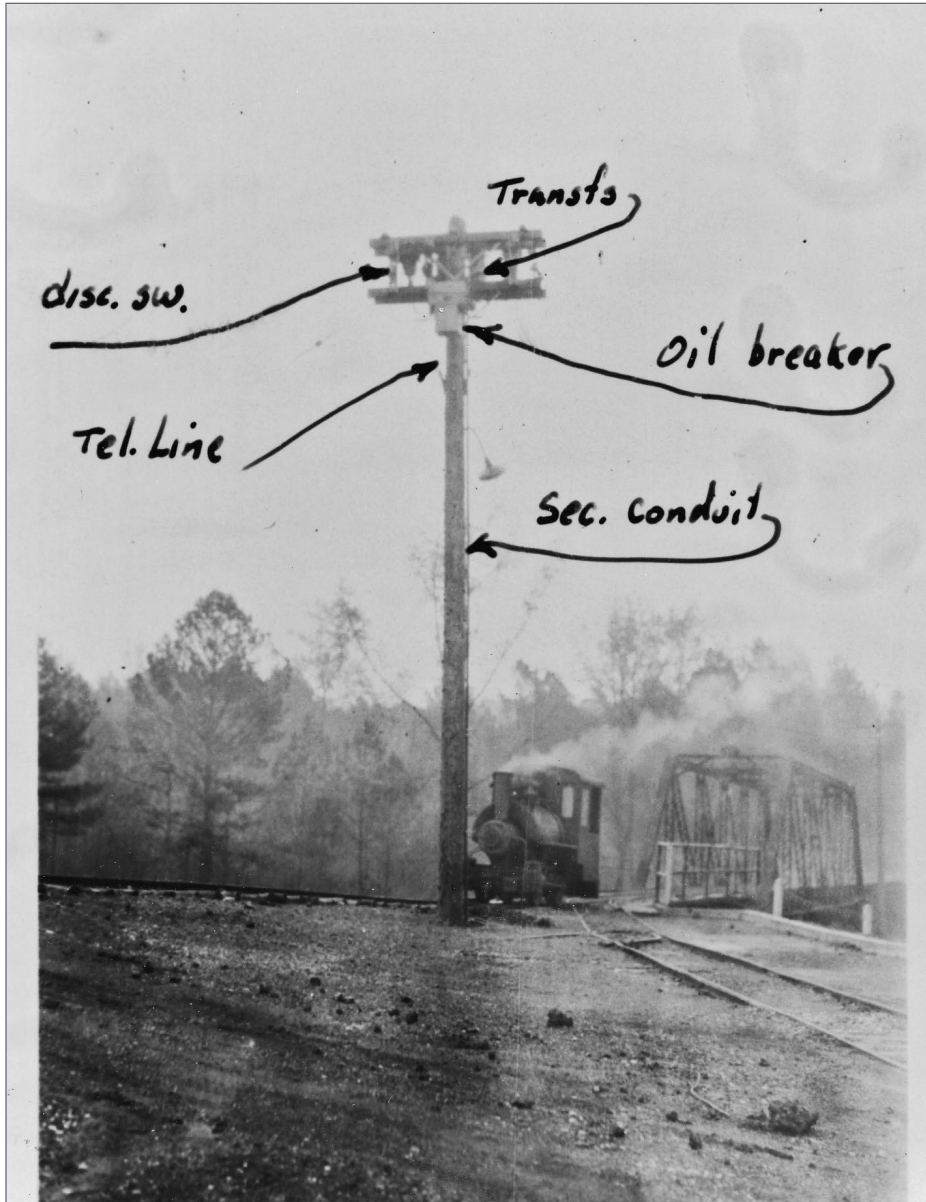

7. Another view of the Cahaba River Bridge taken from the plant side of the river. This also shows the turnout leading to the ash tunnel and engine house. Larry Smith Collection



8. The coal dump at the plant showing the relative size of the hopper cars. Phillip Griffith Collection

tons. The final locomotive was purchased in 1925, another 6 ½ ton Porter, construction number #6974. The last locomotive appears to have been purchased for the American Construction Security Company of New York.

How did it get to Birmingham? American Construction Security was a division of American Water Works Company which owned the Birmingham Water Works Company at that time. Confused? When researching a particular locomotive and you think you have all the facts, look again at the interlocking companies to see who owned who and how the property got moved between them.

In doing research on the railroad, there has been nothing found on the cars. There is nothing about how many there were, nor if they were purchased or home-built. Speculation is that the first cars were purchased and the rest were built in their own shops. From photographs, the cars appear to be similar to the mine cars used at the different coal mines around the area. They are wood construction and look to be about 4 ½ ton capacity. They were side dumps and were used in ash service as well.

Operation of the railroad

The railroad was a major component of the plant's operation, taking coal from the mine to feed the hungry boilers and then returning the ash to the dump site. It was almost like a continuous conveyor type of movement.

Loaded mine cars were pulled from the mine and hooked to the locomotive with link and pin couplers. The locomotive would then pull the cars to a wye at the east end of the bridge. Running around the cars, the locomotive would push the cars across the bridge to the elevated track where the hoppers were dumped into the crusher. The unwashed mine run coal and debris were crushed and then lifted by conveyor to the top bunker to be fed into the boilers.

The locomotive would pull the empties back to a turnout located on the plant side of the river, reverse direction and take the empties to the ash tunnel door under the boiler house. Removing the ash filled car, or cars, replacing them with empties. A track led from the ash track to the brick combination engine house, blacksmith shop, and machine shop. The empties and the ash loaded cars were taken back across the bridge and up a leg of the wye where the ash was dumped. At which time the mine cars were returned to the mine and the whole process was started over again.



9. A view of the plant showing the tracks for the coal dump and those leading to the ash tunnel. Phillip Griffith Collection

Next time we will look at a track plan for the railroad along with building the benchwork and mockups for the major structures.





TRAINMASTERS.TV

Coming in
February

Brought to you by

MRH
MODEL RAILROAD HOBBYIST

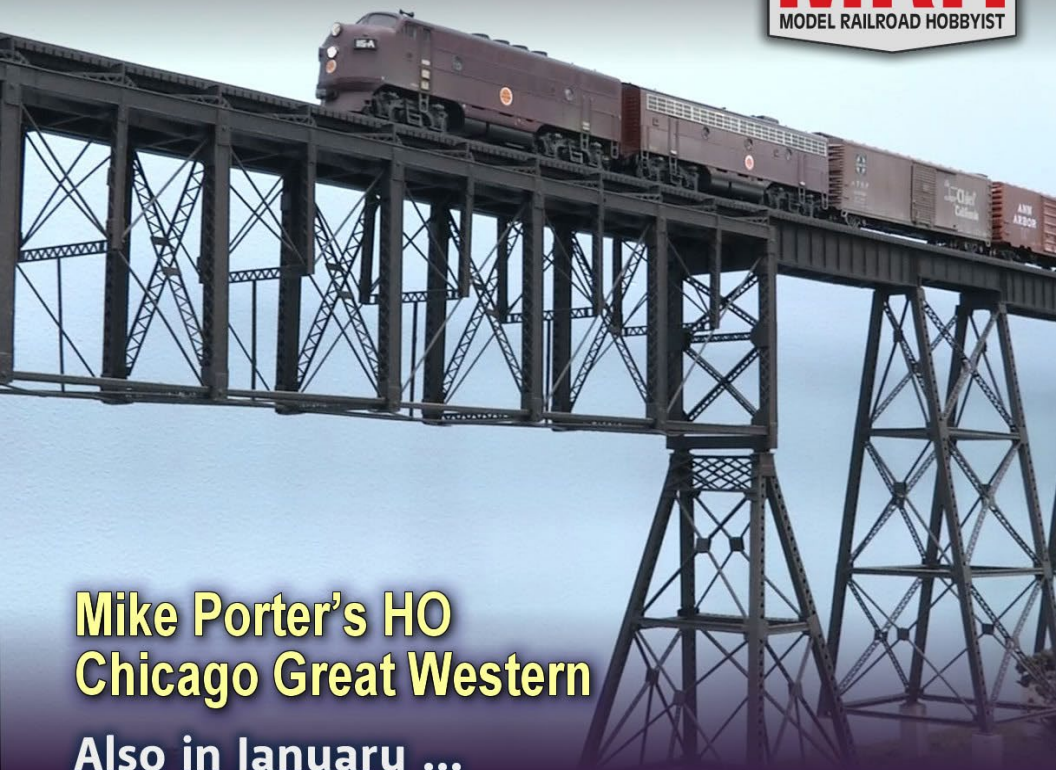

**Mike Porter's HO
Chicago Great Western**

Also in January ...

Event report: The 2015 Amherst Hobby Show
The Roadshow: Building a concrete bridge
Backshop clinic: Installing a SoundCar decoder
DVD archives: More Allagash scenery modeling

Visit TrainMasters.TV website ...



Model Railroad Hobbyist | February 2015 | #60



KEN PATTERSON

WHAT'S NEAT

column



**Click here for
reader comments**

ST. LOUIS RAILROAD PROTOTYPE MODELERS MEET ...

THIS MONTH WE'LL TALK ABOUT WHAT HAPPENED at the St Louis Railroad Prototype Modelers meet this past August, and yes, the next show is just around the corner in August 2015. Check home.mindspring.com/~icg/rpm/stlrpm.pdf for dates. The show is always packed with people and models, with hundreds of models to look at plus plenty of dealers offering prototype-looking models and parts. For 2015, I promised them an open house for my home layout for the RPM layout tour, so I'd better get some home layout construction DVDs printed for that day.

I also interview David Lehlbach of Tangent Scale Models in this month's video. He tells us that business is good, and he is developing a lot of new models in various paint schemes. I also take the opportunity to talk with Gary Christensen about some of his weathering techniques.

► **PHOTOS AND VIDEO OF SUPERB MODELS**

WHAT'S NEAT | 2

As some of you may know, Kato has started coming out with locomotives with their new coreless motors in the trucks, and the shell is basically empty. I take a look at one of these locos to see if it can hold a candle to Kato's previous great performance.

Speaking of coreless motors, I know Bachmann already installs coreless motors in their finer models in N scale and HO. The new Civil War era 4-4-0 in HO scale is a perfect example of this. No more motor in the tender with a drive shaft! Bachmann eliminated the motor in the tender by putting a tiny coreless motor in the newly designed model's boiler. The first manufacturer that fits a speaker in the boiler of a steam locomotive as well wins the next prize!

Mike Budde's still doing autoracks, and he stopped by, so I give you an update on what he's been doing. The cars Mike is building to fill these autoracks represent some great modeling.



Playback problems? [Click here ...](#)

WHAT'S NEAT | 3

And finally, Bachmann has a new line of false front buildings in N scale, so I take a closer look at these beautiful new models. In the video, I take you behind the scenes as I shoot ad photos for five of these models. I think Bachmann's on to something with this new line of buildings!

That rounds out my February's What's Neat. Be sure to watch the video and please leave feedback in the Reader's Comments section. Comments help us to deliver more of the model railroading information you want. Please vote lots of stars for this month's What's Neat This Week.



ADVERTISEMENT

Coming soon – a very limited-edition reprint!

SOUTHERN PACIFIC'S SACRAMENTO SHOPS ... Incubator of Innovation



Robert A. Pecotich

This brilliant and complete history by Bob Pecotich is returning in a limited printing. It contains a rich collection of photos and information about this SP institution. How can I learn more about this book? How can I buy it?

**Click here for
the answer ...**

SIGNATURE PRESS



1-2. Tangent's new General American tank car and their PTLX grain car show incredible fidelity and detail. As David Lehlbach said, "If you are going to spend 50 hours weathering a freight car, why not start with the best detailed model so the finished results are fantastic?"



3. With so many talented modelers were in town for the St. Louis RPM meet, I had Gary Christensen stop by with some of his latest creations.

“Kato has their new coreless motors in the trucks ... I take a look at one of these locos to see if it can hold a candle to Kato’s previous great performance.”

WHAT'S NEAT | 6



4-5. One model that jumped out was this tank car weathered with oil paints and acrylics to create the sun-bleached primer effect on top, with some fantastic rust effects brushed on very slowly. In the video, you can hear in Gary's own words on how he achieved the effect. He weathered it just as it looks by applying white paint to the top and blending the sides with black paint. He went through a few cars before the results were to his satisfaction.

WHAT'S NEAT | 7



Did you see this MRH video?



MicroEngineering
Track laying tips
from Charlie
Comstock

Watch the video now 



6-7. Kato's new Amtrak locomotive has its motors in the trucks. I bought one a few weeks back just to see if this design could hold up to hours of mainline service. The motors are only 1/4" in diameter but they can pull your walls down with their torque. The latest coreless motor technology is what led to this design, and I'll bet we will see more manufacturers go this route.

 [Click here for reader comments](#)

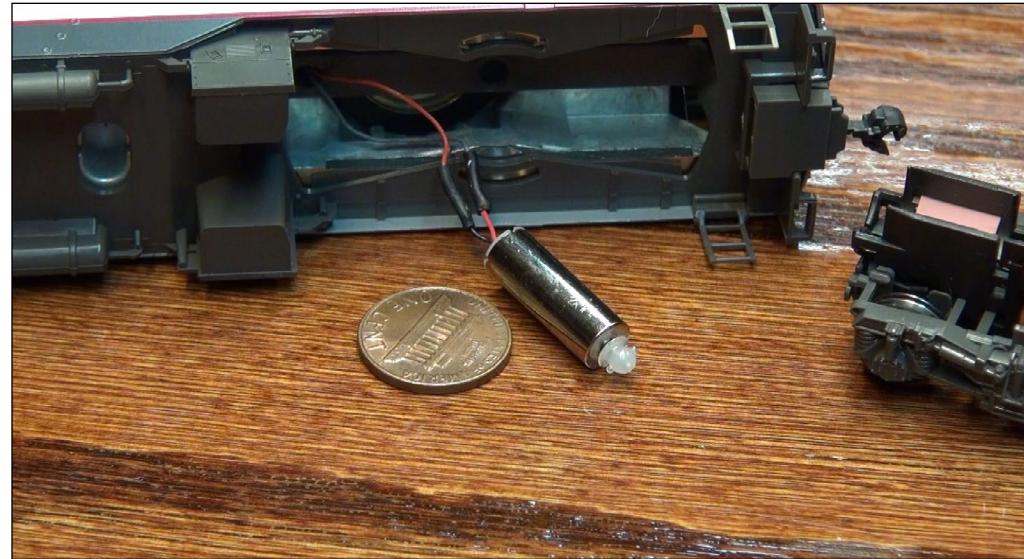

When talking to hobby vendors, please remember to mention MRH.

The Fine Scale Model Railroader Expo 2015

THE EXPO STEAMS INTO SCRANTON, PA

MARCH 26, 27 & 28

● LEARN ● BUILD
● ENJOY ● CREATE

MODELING AT IT'S BEST

SOME OF OUR VENDORS & MANUFACTURERS:

Laser Modeling 3	MRH Magazine	Crow River Products
Sterling Models	SierraWest Scale Models	Scale Creations
Train Troll	Bar Mills Scale Model Works	FSM Kits
Motrak Models	Gatorfoam	Harbor Belt Lines
Stoney Creek Designs	Fos Scale Models	Backdrop Junction
Microlumina	Atlantic Scale Modelers	Mt. Albert Scale Lumber
Rail Scale Miniatures	Sea Port Model Works	Downtown Deco
Nick & Nora Designs	VectorCut	KC's Workshop
Crusader Rail Services	Carolina Craftsman Kits	Model Tech Studios
New England Brownstone	Paw of a Bear	Scenic Express
Hunterline	Mount Blue Model Co	BEST Trains

HANDS-ON, SMALL GROUP, PLATINUM CLINICS:

- Contest Quality Weathering & Finishing Model Methods w/ Bob Mitchell
- Soldering & Structure Lighting with LEDs w/ Bill Sartore of Microlumina
- Using Digital Photos for Modeling Surfaces with author Lance Mindheim
- Carving Realistic Stonework w/ Russ Greene of New England Brownstone
- Techniques Using Pan Pastels w/Roger Malinowski - Stoney Creek Designs
- Build a Mini Board-by-Board Kit w/ Brett Gallant - SierraWest Scale Models
- Build a Truss Bridge Beginning to End. Maureen & Rick Hunter - Hunterline
- Mastering The Application of Static Grass w/ Jimmy Elster of Scenic Express
- Scratch Building and Boats - Using Card Stock with modeler Jon Addison
- Bring Life to Your Figures Dave Revelia Suncoast Center for Fine Scale Modeling
- Get Wet - A Fantastic Resin Water Clinic w/ modeler Bill "Michaels" Obenauf
- Hydrocal Kits Don't Bite Really They Don't Randy Pepprock Downtown Deco

**40 AWESOME CLINICS TO CHOOSE FROM!
THE BEST VENDORS & MANUFACTURERS!
ALL JUST STEPS AWAY FROM STEAMTOWN!**

WWW.MODELRAILROADEXPO.COM

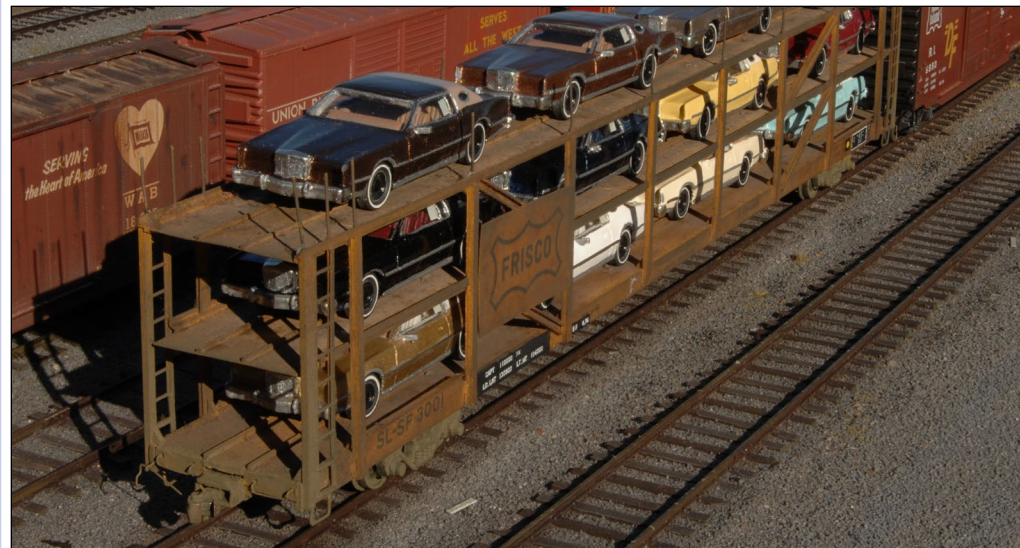

8-9. Mike Budde stopped by with some finished autorack loads he just completed. These are HO 1974 Lincoln Mark V models made using 3D prototyping. He hollowed them out to cut out the windows, sanded and primed the exterior, and painted them the actual colors from the correct color chips for their year. Vinyl roof skins, window stickers, foil trim and clear tape windows finish these models to a contest quality like I've never seen. The freight car is scratchbuilt and assembled with white glue.

WHAT'S NEAT | 11



10-11. Bachmann has come out with a new line of false front commercial buildings in N scale. These look good, in that it would be very easy to build side and rear walls to make these into free-standing buildings. The front wall details are tricked out! I really like the movie house – it's a favorite. Just a sidewalk and a few cars can make a bare wall on your layout into a city center using these flat-cast resin building fronts. They look good in a small space.



[Click here for reader comments](#)

WHAT'S NEAT | 12



**DID YOU
KNOW MRH
SUBSCRIBERS GET
FREE BONUSES?**

CLICK TO SUBSCRIBE NOW - IT'S FREE!

Have you seen this?

CHECK IT OUT!



kenpatterson.com

click here to ...

Visit Ken's website

Ken Patterson reveals his modeling secrets on video!



HOBBY MARKETPLACE

Mr. Detail Parts



www.mrdetailparts.com

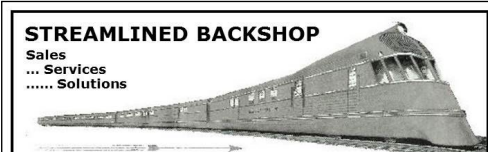

"SUGAR CUBE" SPEAKERS...

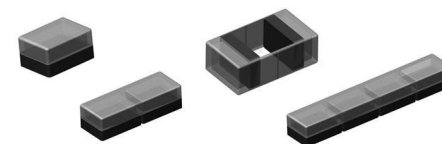

4 Sizes * 4 Baffles

... "Sweet" Speaker Options!



www.SBS4DCC.com

MRH allowed this video to be posted?



Watch the video now



Have you seen these popular blogs on the MRH website?

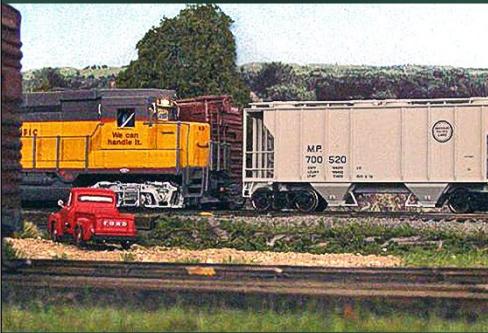

Ken Glover's Shelf Layout
57,000 reads
[CLICK TO READ IT NOW](#)



Mike Rose's N scale empire
87,000 reads
[CLICK TO READ IT NOW](#)

clever models LLC
Cardstock models & Building materials

[CLICK HERE](#)
www.clevermodels.net

Yarmouth Model Works
HO scale resin kits and detail parts

U.S.A. MAILING ADDRESS
3560 Pine Grove Ave. Unit 617
Port Huron, MI 48060

TEL: 519-633-7574
pierre.oliver@start.ca

CANADIAN MAILING ADDRESS
85 Hiawatha St.
St. Thomas, ON N5P 2T5

www.yarmouthmodelworks.com



Hobby Marketplace Ads are Economical and Effective.
[Click to learn more ...](#)

On Sale This Month...
SuperTrunks!

Made from real cedar. 1 1/2-inch "Old-Growth" trunks for making trees in HO, N, S, & O.

Get 'em at:
Coastmans Scenic Products

[CLICK AD](#)

BenchWork

Affordable Modular (domino) Benchwork in 200+ sizes
Custom built to order benchwork also available!

Minimalist Model Railroad Design

All New 2nd Edition! [Click Here](#)

RULERS-of-the-WORLD
Scale Rulers \$4 each
Over 200+ scales!
Metric or Imperial
www.rulers-of-the-world.com

ANE model
www.anemodel.com

SmartSwitch lets you have more fun on your layout control.

- Innovative product
- Uses RC servo to control your turnout and layout accessories
- Flexible installation and position adjustment
- Ultimate flexibility to operate the turnouts, crossing gates, semaphore signals or any creative animation

[Click here for more info ...](#)

True Scene Modeling

FusionFiber
NEW

Scenery Base Material for the 21st Century!
SATISFACTION GUARANTEED!
www.truescene.com or 716-523-7305

WESTERFIELD
GOLDEN AGE LINE
MODELS, LLC

NEW N.A.R. STK CAR KIT!

RESIN KITS, DECALS, DATA DISKS & DETAIL PARTS AVAILABLE.
westerfieldmodels.com

HOBBY MARKETPLACE | 4

Great Decals!TM

FEC, Interstate, Virginian
Railway, & L&N Titles
After Hours Graphics Line
Coupler Gages and More
In O, S, HO, and N Scales



Railroad Art-Prints,
Caps, Jackets,
Shirts and More ...
Jackets starting
at \$79.95

www.jelsma.com

1-904-221-3513 • Jacksonville, FL.

PRECISION DESIGN CO

LASER CUT

Chains
Flat Car loads
Joint Bars
Signs

click here

FREE SHIPPING



HOBBY MARKETPLACE | 5

Can't remember which cars you've bought?

Yard Boss**Model Train Inventory Software**

from DCC by Design
Under \$15

Download free trial now
www.dccbydesign.com

**Come & See Us
CLICK Here**

NEW! **Fusee Pro** **LOGIC RAIL™ TECHNOLOGIES**

Realistic looking and operating
railroad flares! See the video!

"Sophisticated
Model Railroad
Electronics"

Please visit our website and online store!

21175 Tomball Pkwy Suite 287 Houston, TX 77070
Phone: (281)251-5813
<http://www.logicrailtech.com>
info@logicrailtech.com

N SCALE \$39.95
HO SCALE \$54.95

MONROE MODELS

LUNDE COAL ELEVATOR
www.monroemodels.us

CLICK HERE

CANYON CREEK SCENICS

Backdrop Junction

Your stop for
Model Railroad Backdrops



click here to visit our website
backdropjunction.com
N, HO, O Scales • Custom Orders

East Penn Traction Club
22nd National Trolley Meet
Pennsylvania Convention Center
Hall G, Broad And Race Sts
Philadelphia, PA
May 15-16, 2015
Layout visits May 17

Clinics, layouts in all scales, model
contests, vendors, films, photos.

www.eastpenn.org

www.modelrailroadtunnels.com

MODEL RAILROAD TUNNELS

When talking
to hobby
vendors,
please
remember to
mention MRH.



www.hobby-on.com

**Name Brand
Hobby
Products
at Discount
Prices!**



MULTIPLE COMPARTMENT *Tank cars*

BY RICHARD HENDRICKSON
.....

Steam and early diesel era ...

THE RECENT INTRODUCTION OF TANGENT'S 6,000 gallon three-compartment tank car model in HO scale has prompted much discussion on various Yahoo lists, a lot of it misinformed. A well-illustrated account covering the history and uses of multiple compartment tank cars appears to be overdue.



[Click here for reader comments](#)

Some basic tank car history

I'll start with a clarification: It's incorrect to describe multiple-compartment tank cars as "two dome," "three dome," etc. Though it's true that most cars with two or more domes are multiple compartment cars, a few single-compartment tank cars had two or three domes for convenience in loading and unloading. In the days when tanks were riveted, radial rivet rows securing the diaphragms between the tanks were unmistakable evidence that the tank was divided into separate compartments.

Many modelers seem to have the idea that tank cars were used primarily, or almost exclusively, to haul crude oil and petroleum products. Early in the 20th century that may have been true, with some qualifications. The development of internal combustion engines and their rapidly increasing use in automobiles, motor trucks, farm tractors, and such provided a growing market for refined petroleum products, and many oil refining companies purchased fleets of tank cars to bring crude oil to their refineries and distribute kerosene, gasoline, distillate, and lubricants to wholesalers.

It quickly became apparent, however, that underground pipelines were a more efficient and less costly way to transport both crude and refined petroleum, and the rapid construction of pipelines during the 1920s and '30s greatly reduced the

petroleum industry's need for tank cars. This trend peaked during World War II with construction of, among others, the "Big Inch" and "Little Big Inch" pipelines from the mid-continent oil fields to eastern refineries.

After the war ended, tank cars were still used to deliver refined petroleum to local wholesalers but they were no longer extensively used for large bulk petroleum shipments over long distances.

Meanwhile, starting in the 1920s, tank car builders and leasing companies had been vigorously promoting rail transportation of a growing variety of other liquid commodities ranging from corn oil and molasses to alcohol to acids to many different chemical compounds. As early as 1931 the General American Tank Car Corporation published an entire book, "General American Tank Car Journeys," which identified literally hundreds of different commodities that were then being shipped in tank cars.

The typical tank car of the period from the teens to the 1950s was a single compartment car with a capacity of between 8,000 and 10,000 gallons, with a few larger cars of up to 12,500 gallons. Many commodities were shipped in smaller quantities, however, and smaller cars with tanks of as little as 2,000 gallons capacity were built for this purpose [1 & 2]. In addition, there were many shippers who wanted to keep smaller quantities of liquids separate but ship them to the same destination, and this led to the development of multiple compartment tank cars in which there were two, three, or more separate compartments within the same tank.

The genesis of multiple compartment tank cars

Some early multiple compartment tank cars consisted of separate tanks mounted on a common underframe [3], but it was

MULTI-COMPARTMENT TANK CARS | 5



1. There were few 2,000 gallon capacity tank cars, but here is one. This acid tank car was built for the Stauffer Chemical Co. in the late 1920s and photographed at San Jose, CA in November 1956. W.C. Whittaker photo



2. 4,000 gallon tank cars were more common. This one, built by General American in January 1928, was still in revenue service when photographed at Los Angeles in the early 1970s. Note the two-horizontal-section tank, the substantial wood blocks between the bolsters and small diameter tank, and the underframe design which, with minor revisions, was later designated by GATC as the Type 30.

MULTI-COMPARTMENT TANK CARS | 6

quickly recognized that incorporating all of the compartments in a single tank afforded a great improvement in strength and rigidity. This was accomplished by inserting diaphragms (essentially identical to the tank ends) inside the tank, riveting them in place with air spaces between them, and placing expansion domes above each of the compartments [4].

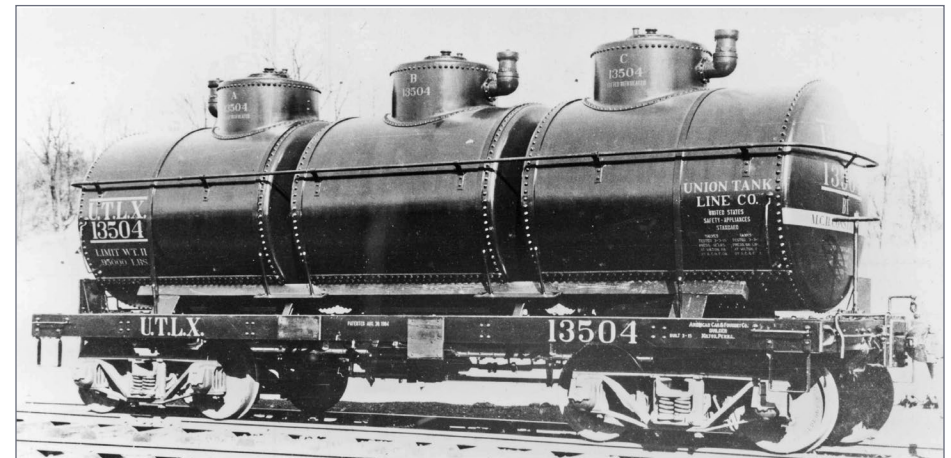

3. Built for the Union Tank Line in March 1915 at American Car & Foundry's Milton PA tank car plant, this pioneer multiple compartment tank car consisted of three separate tanks mounted on one heavy steel underframe. It was soon realized that combining separate compartments in a single tank was a stronger and stiffer arrangement. American Car & Foundry photo, Al Westerfield collection



4. The Standard Tank Car Co. built this three-compartment car for the Sinclair Refining Co. in the early 1920s. Small diameter domes with elbow-mounted safety valves were common practice at that time. Note the STC underframe's distinctive bolsters. Most Sinclair cars had billboard "SINCLAIR" stenciling on their tanks, but maneuvering that large a stencil behind all the ladders on this car would have been a serious challenge.

Multiple-compartment tank cars were built in a variety of sizes from as small as 4,000 gallons total capacity [5] to as much as 10,000 gallons [6]. However, two-compartment cars were typically of 6,000 or 8,000 gallons in total size [7] and most cars of three or more compartments carried about 6,000 gallons [8].

The reaction of many HO scale modelers that Tangent's 6,000 gallon three-compartment model was too small ("cute" was one of the descriptive terms that appeared on e-mail lists) doubtless results in part from the fact that, for decades, almost the only three compartment tank car models in HO were Athearn plastic



5. Built by General American for the Cities Service Oil Co. (or one of its predecessors) in September 1928, 4,000 gallon two-compartment tank car CSOX 3906 rode on a Type 30 underframe. It was photographed at Providence RI in October 1957. Col. Chet McCoid photo, Bob's Photo collection

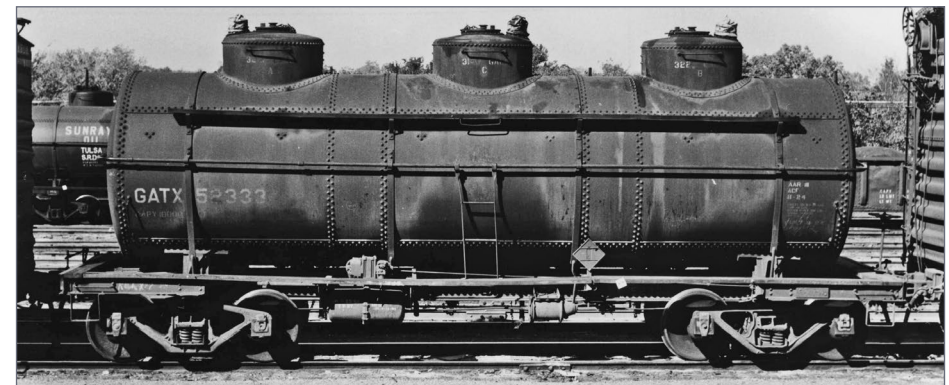

6. Unusually large for a three compartment car, 10,000 gallon GATX 52333 was built in August 1924 by American Car & Foundry on a Type 21 underframe. GATC certainly didn't buy it new from one of its major competitors, so it was probably acquired second hand in the 1930s when GATC purchased the tank car fleets of numerous private owners who were financially distressed by the post-1929 economic depression.

MULTI-COMPARTMENT TANK CARS | 9



7. Chartrand's Traffic Service of Hollywood CA purchased tank cars second (or third) hand and leased them at bargain rates. Whoever its previous owner may have been, 8,000 gallon two compartment CHAX 2821 was built by General American in February 1930 on a Type 30 underframe. Jim Gerstley collection, courtesy of Dan Smith



8. The John H. Grace & Co. owned GRYX 815 when it was photographed in the 1950s. It was built in March 1927 by the Pennsylvania Tank Car Co., a subsidiary of the Petroleum Iron Works. PTC was located right next door to the Standard Tank Car Co. in Sharon PA and installed tanks built by STC on its own underframes. Chuck Yungkurth collection

MULTI-COMPARTMENT TANK CARS | 10



9. This view shows a correctly scaled Tangent model next to Athearn's hugely oversize three compartment tank car model. No wonder that modelers who are familiar with the Athearn car think the Tangent model looks "too small". That Union 76 paint job on the Athearn car is entirely fictional as well. Models and photo by Tony Thompson

cars, which scaled out to more than 10,000 gallons in capacity. Though often seen on HO scale layouts, the Athearn models are grotesquely oversize and have no known prototypes [9].

In fact, by far the largest number of three-compartment cars built between 1920 and 1960 held a total capacity of about 6,000 gallons, and they were not at all rare; several thousand of them were built, and they were used everywhere in North America both by leasing companies and private owners. They carried different types and grades of motor fuels and lubricants, as well as many different industrial solvents and chemicals.

The Tangent HO scale model therefore represents the most common size of three-compartment prototype cars. Ironically, a very similar N scale model of an American Car & Foundry 6,000 gallon three-compartment tank car was introduced several years ago by Micro-Trains and I can't recall N scalers complaining that it was "too small" – but then, they didn't have anything in N scale like the out-of-scale and entirely fictional Athearn HO model to compare it with.

MULTI-COMPARTMENT TANK CARS | 11

A gallery of multiple compartment tank car photos

Multiple-compartment tank cars were constructed by all of the major tank car builders in the 1920s [10-13] and, in the 1930s and later, by both General American (GATC) and American Car & Foundry (ACFX). The Tangent model represents three-compartment cars built in sizable numbers between the late 1920s and the early 1940s on General American's Type 30 riveted underframes [14-19]. Similar AC&F cars were built on Type 27 underframes [20], and AC&F also built cars for Union Tank Line to Union's own X-3 design [21]. Postwar cars by both builders had welded underframes and tanks [22].



10. Built by General American in January 1926, GATX 1611 was a 6,000 gallon two-compartment car. Again, note the small diameter domes with safety valves on elbows. Oil spills like those shown here were common when cars were being loaded. This car was still in revenue service in the early 1970s when photographed at Bakersfield, CA.

MULTI-COMPARTMENT TANK CARS | 12



11. This 6,000 gallon three compartment car, built by General American in the mid-1920s, is seen here in the 1970s with elaborate handrails added to the dome running boards and lots of rust showing. DRDX was the reporting mark for the Duredo Co., a tank car lessor which first appeared in the late 1940s and specialized in refurbishing older second-hand cars. Duredo was a subsidiary of Chicago-based John H. Grace & Co. Lloyd Keyser photo



12. American Car & Foundry built this three-compartment 6,000 gallon tank car in May 1927 for the Cook Paint and Varnish Co. Note that, though freshly painted in the 1950s, this car still had its 5-27 reweigh date; tank cars were not required to be reweighed periodically, like other freight cars, because the shippers were charged by volume, not weight.

MULTI-COMPARTMENT TANK CARS | 13



13. Formerly Associated Oil Company AOX 600, this three-compartment 6,000 gallon car was built by the Pennsylvania Tank Car Co. in the early 1920s using a tank supplied by the Standard Tank Car Co. By the time this photo was taken in Avon, CA in June 1972, Phillips Petroleum has acquired the Associated tank car fleet and renumbered the cars under PSPX reporting marks. Robert A. Campbell photo



14. This is one of the prototypes for the Tangent models, a General American 6,000 gallon three-compartment tank on a Type 30 underframe. GATX 1633 was at Milwaukee WI in May 1971. Note that journal oiling was in progress, as all the journal box covers are open. Don Degner photo, J. Michael Gruber collection

MULTI-COMPARTMENT TANK CARS | 14



15. Built by General American in February 1929, GATX 1518 was photographed shortly after it was repainted in the GATC shops at Colton CA in August 1953. Modelers are often seduced by private owner cars with colorful paint and lettering, but the vast majority of tank cars were, like this one, "plain Jane" black with white or aluminum stenciling. Jim Gerstley collection, courtesy of Dan Smith



16. The tank was painted aluminum on GATX 1525 when photographed at Schiller Park IL in May 1968, so weathering is even more visible than on black cars. Note the mismatched trucks. Canvas covers over the domes, or safety valves, were often used when the tanks were empty to prevent the safety valves and manway covers from being contaminated. Bill Raia collection

MULTI-COMPARTMENT TANK CARS | 15



17. Another car owned by John H. Grace and Co., GRYX 810 was photographed on the Union Pacific in Wyoming shortly after its tank, heater coils, and safety valves had been tested in February 1972. It was loaded with a hazardous commodity, as attested by the "Dangerous" placards on the placard holders. Frank Peacock photo



18. Recently repainted, WCHX 1058 was owned by the Walter C. Haffner Co., another of the smaller tank car lessors who acquired most of their cars second hand. Built by GATC in November 1941, it was photographed at Palmer MA in October 1967.

MULTI-COMPARTMENT TANK CARS | 16



19. The number is illegible on this 6,000 gallon three-compartment General American car because it was in the process of being sandblasted and repainted at GATC's Colton CA maintenance and repair yard. A new wood running board had also just been installed. This car had formerly been in the service of the Crosby Naval Stores Co. of Pickayune, MS, a supplier of turpentine and other products made from pine sap.



20. This American Car & Foundry builder's portrait shows a three-compartment 6,000 gallon car built on an AC&F Type 27 underframe in April 1937 for North American Tank Line. Mechanical equipment included AB air brakes and Barber Stabilized S-2 trucks with spring planks. Hawkins-Wider-Long collection

MULTI-COMPARTMENT TANK CARS | 17

Three-compartment tank cars of larger than 6,000 gallons capacity were often converted from single-compartment cars by adding internal diaphragms and additional domes. This practice was especially common at General American [23] though other owners (e.g., Union Tank Line) did it as well [24]. The spotting



21. American Car and Foundry also built this 6,000 gallon three-compartment tank car for Union Tank Line in August

1936 to UTL's X-3 design. It was photographed at St. Louis MO in the early 1960s. Like many multiple compartment cars, this one had heater coils; note the uncapped outlets on the tank end. Joe Collias photo



22. Great advances were made in welding technology during World War II, and both General

American and American Car & Foundry immediately adopted welding for both underframes and tanks, heat-treating welded structures in huge ovens to remove stress from welded joints. Here at Hamlet NC in April 1959 is a postwar all welded GATC 6,000 gallon three compartment tank car built for the Carbide and Carbon Chemical Co. As the half-black placard indicates, this car is empty of its formerly hazardous cargo but still contains dangerous fumes. Col. Chet McCoid photo, Bob's Photo collection

MULTI-COMPARTMENT TANK CARS | 18

feature which always identifies such cars is that the large original center dome was left in place and the domes of the end compartments were noticeably smaller than the center dome.

Both GATC and AC&F also built three-, four-, and six-compartment insulated tank cars, many of them glass (that is, porcelain)



23. Built in November 1931 as an 8,000 gallon single-compartment car, GATX 1365 was

apparently converted to a three-compartment car less than a year later, in July 1932. Shown here as it appeared in the late 1930s, it was typical of similar conversions in that it retained its original large center dome while the outer domes were smaller with safety valves on elbows. Joe Collias collection



24. Another single-compartment car converted to three compartments was UTLX 2789, Again, the large center dome reveals

its origins as an 8,000 gallon class X-3. There was a lot of air space between the separate compartments in this tank, as evidenced by the wide space between the rivet rows securing the internal diaphragms. It was photographed at San Pedro, CA in the late 1960s.

MULTI-COMPARTMENT TANK CARS | 19



25. Both General American and American Car & Foundry built multiple compartment tank cars specifically to transport bulk wine. These insulated ICC-203s with frangible disk valves instead of spring loaded safety valves were glass (i.e., porcelain) lined. Three-compartment 6,000 gallon SHPX 6326 was an example. Built in 1946, it's seen here at Fresno CA in May 1956 under lease to E. Cribari and Sons. Bob's Photo Service collection



26. Four-compartment wine tank cars were usually of about 8,000 gallons total capacity. GATX 969, built in 1937, was on lease to the Gibson Wine Co. in the 1950s with colorful Gibson stenciling on its aluminum painted tank. Jim Gerstley collection courtesy of Dan Smith

MULTI-COMPARTMENT TANK CARS | 20

lined for bulk wine service [25-28], and those cars were usually of about 6,000 gallons in total capacity, like the three compartment non-insulated cars. Some insulated three-compartment cars converted from single compartment cars were also used in bulk wine service [28].



27. Six compartment wine tank car GATX 410 was built in June 1939 and is shown here just after having rolled out of General American's Sharon PA shops. Appearances are deceptive; despite its length, this car's total capacity was about 6,500 gallons. W. C. Whittaker photo



28. Some three-compartment cars that had been converted from single-compartment cars (note the larger center dome) also had linings installed and were used in bulk wine service. Originally built in July 1930, GATX 1388, its insulating jacket painted light gray, was waiting to be loaded at Modesto CA in 1968.

The Tangent models

Tangent's first production run of HO scale 6,000-gallon three compartment tank cars includes a Standard Tank Car Co. car from the 1930s [29 and 30]. There is also a GATX car from the early '50s painted and lettered for lessor Celanese Corporation

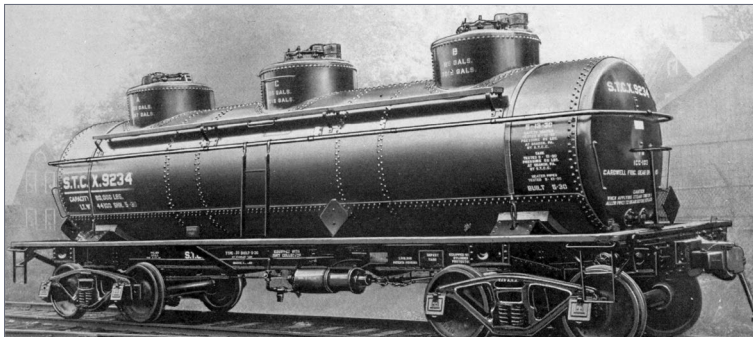

29-30. Tangent's model of STCX 9234 is shown here along with a photo of its prototype, which was built in May 1930. The model's factory lettering is unusually sharp and complete. After the Standard Tank Car Co. was acquired by General American in 1928, Standard's tank cars survived as part of the Pennsylvania-Conley tank car line, a GATC subsidiary, until they were eventually absorbed into the GATX fleet. Tangent Scale Models photo (29) and General American photo (30).

[31] and two black GATX cars with ca. 1958 and ca. 1968 lettering [32 and 33]. The ca. 1958 model is easily backdated to the late '40s and early-to-mid '50s just by altering a few digits in the small lettering [34]. See Tangent's retail dealers or tangentscale-models.com for availability.

A pre-1945 GATX model with lines above and below the reporting marks and numbers will be in the next Tangent production run. Meanwhile, such a car can be modeled by combining Tangent's undecorated model with Black Cat's GATX decal set, the latest version of which includes the data needed for this model [35]. Black Cat decals can be purchased from larger retail dealers or, on the Internet, from Great Decals greatdecals.com or Des Plaines Hobbies desplaineshobbies.com.



31. Tangent's model representing cars leased to the Celanese Corporation in the early 1950s. Yes, the Celanese tanks really were pea green. The model has been moderately weathered and half-black "empty but hazardous" placards applied to the placard boards. Model and photo by Tony Thompson

MULTI-COMPARTMENT TANK CARS | 23



32-33. Tangent's models in late 1950s and in late 1960s GATX paint and lettering. Tangent Scale Models photos

The prototypes for these models were commonly seen almost everywhere on the North American rail network. They remained in revenue service from the 1930s through the 1960s and, in some cases, as late as the 1970s and '80s. At least one or two of them are appropriate on most HO scale layouts. ✓

 [Click here for reader comments](#)

MULTI-COMPARTMENT TANK CARS | 24



34. Tangent's late 1950s model after having been backdated by changing two digits in its reweigh date, journal repacking, and brake servicing stenciling. Light weathering, chalk marks, and destination cards have been applied. Model and photo by Tony Thompson



35. An assembled but undecorated Tangent model was painted and lettered with Black Cat decals to represent a car repainted before 1946 with lines above and below the reporting marks and numbers. Weathering includes dirty wheels with treads polished, rust stains around the tank bands, chalk marks, spillage on the domes, and rusty couplers. Model and photo by the author.

MULTI-COMPARTMENT TANK CARS | 25

RICHARD HENDRICKSON

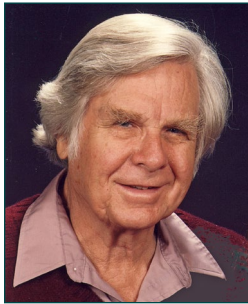

Richard Hendrickson passed away on June 28, 2014; he was 83 years old. A prolific author (seven books and hundreds of magazine articles) and a prodigious researcher, he was a true expert on railroad freight cars and on his own favorite railroad, the Santa Fe. He was also a very active collector of freight car and Santa Fe photographs; his collection

of more than 30,000 images has been donated to the California State Railroad Museum in Sacramento.

In a very active life, he had driven sports cars competitively and raced International 14 sailboats, was an expert skier, and for more than 20 years had been a licensed pilot, aerobatic-qualified during many of those years, flying his own Citabria airplane.

Richard was befriended as a teenager by Santa Fe crews at Oceanside, and they even let him run steam locomotives on occasion. That initiated a life-long love of steam power and of the Santa Fe. It also led to his appreciation for prototypical model railroad operation, including one of his favorite places on the planet, the Tehachapi layout of the La Mesa Club in San Diego.

An energetic prototype modeler, he had built more than 300 very accurate freight car models, and had several more car projects on his work bench at the time of his death. He acted as a technical advisor to many model railroad manufacturers, and at one time had his own company to market kitbashed freight cars, called WestRail. Perhaps more importantly, he frequently and generously shared information, advice, and scans from his photo collection with all who asked. That may be his greatest legacy: the information and help he gave to many, many others. ■



PWRS 

Announcing our next Limited Run
PWRS / Micro-Trains® Cars!!!

Canadian Pacific (CP) – 4-Pack
40' Heavyweight Passenger Express Reefer

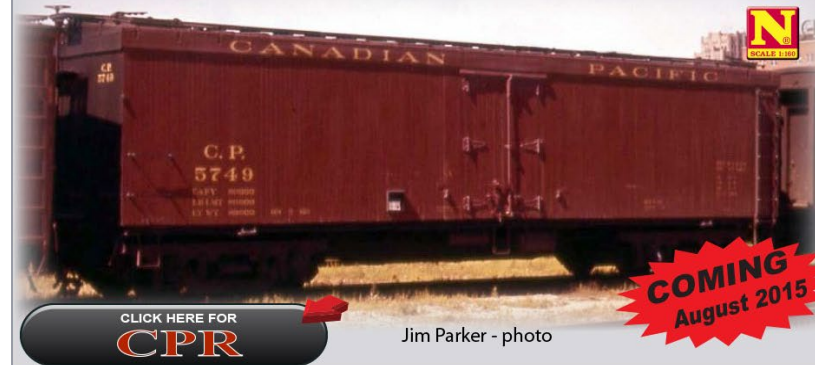

Jim Parker - photo

CLICK HERE FOR
CPR

COMING
August 2015

Perfect to run with
our previously
released PWRS /
Micro-Trains® CPR
Express Boxcars
and your other
Micro-Trains
Canadian Pacific
Railway
passenger cars.

Next in our **Canadian Trailer on Flat Car Series**

Ontario Northland (ONT) – two 3-Packs
57' TOFC w/ Schneiders® AC Trailers



CLICK HERE FOR
ONT

Set #2 - Features
1 car w/new 'face' logo
on trailer, 2 faded

Set #1 - Features
2 cars w/new 'face'
logo on trailer,
1 faded

COMING
August 2015



PACIFIC WESTERN RAIL SYSTEMS
SPECIAL RUN CAR

Pacific Western Rail Systems

- TABLE OF CONTENTS
- INDEX

From C to shiny C, we have you covered.



Features include new tooling & revised tooling, stainless steel wheels, Kadee couplers, new road numbers, new drive and decoder (where applicable)

www.truelinetrains.com for more information

Your orders are due NOW, so don't delay.
Made to order, so make sure you tell your dealers you need some!
Tooling modifications include new windows, tool box, new roof and roof walk.
Cars include new stainless steel wheel sets, kadee couplers!



Last run of CN cabooses featuring tooling changes and new numbers!



Available for order at your preferred TRUE LINE TRAINS dealer



The True Line Trains® logo and all intellectual property are the property of 2228675 Ontario Limited



YES, IT'S A MODEL

compiled by
DON HANLEY



**Click here for
reader comments**



1. NP1847 began as a Kato Mikado and a GHQ W-3 kit, plus additional parts from GHQ to customize the domes, smokebox front, and tender shell, plus all scratchbuilt piping, pipe hangers, and appliances, including the Elesco pump, boiler jacket clamps, and too many other parts to mention... Replaced the driveline with a Maxon coreless with a 4:1 gearhead. Video of a shakedown run before the detailing and painting were finished can be viewed here, [youtube.com/watch?v= isynQ_h8D4](https://www.youtube.com/watch?v=isynQ_h8D4) pulling 65 cars. Max Magliaro upgraded the Kato Mikado.

► **MRH'S MONTHLY PHOTO ALBUM**



2. EDNX sits on a rural siding waiting to be picked up by the next local that comes through. The model is an Atlas O scale six-bay cylindrical hopper that has been detailed with numerous handmade and commercially available parts. The stock two-rail trucks were converted to Proto:48 standards by installing NWSL wheels with a custom bolster to narrow the sideframes. Operational San Juan knuckle couplers were installed in scratchbuilt draft gear pockets. Weathering was based upon several prototype photos, and used a variety of artist oil and acrylic paints, combined with powdered pigments. Reporting marks are freelanced. Photographed in daylight on a small length of handlaid Proto:48 track. Ed Nadolski built and photographed the model.



3. Northbound manifest Train #92 with Motor 114-A in charge pauses at McIntire, IA (MP415) to pick up northbound cars for Minneapolis-St.Paul. The train has just set out its cars for the Rochester MN branch. Motor 114A, four B-units, and sister cab unit 111-C, a typical CGW 9,000-HP consist, groan as they begin to pull their 173-car behemoth on their 110-mile march northward from McIntire, Iowa to St. Paul, MN. It is late July 1965 and the CGW has but three more years until impressive scenes like this disappear from the Iowa landscape. Jason Klocke built and photographed the models.



4. The CPR bridge across Barr Creek in Southern British Columbia has an interesting history. When the CP initially pushed their rails through the Monashee Mountains in a race to cut off the America GN from BC's mineral wealth, tall timber trestles and tight curves ruled the day because of their relative speed of construction. However within 15 years these trestles were either filled or being replaced by steel structures. When the trestle across Barr creek was replaced, CP – ever a stingy railway

– chose to repurpose the links and pins from two through-truss bridges which spanned the Bow River in Calgary immediately to the east of CP's large Alyth yard. New deck truss and rocker bent work was let to a contractor in Montreal, and the resulting 335' bridge with its hundreds of links and pins was assembled on site. Mark Dance scratchbuilt this N scale bridge and photographed it in place on his layout.



5. Jappe Vander Bort posted this photo of a Walthers ready-to-run Thrall all-door boxcar. He detailed the car by adding grab irons, Cal Scale air hose, Kadee #158 couplers, and Kadee ACL Barber S-2 roller bearing self-centering trucks. He weathered the car using artist oil paints in layers. He also used weathering powders diluted with hairspray to add some micro texture. As Jappe says, "no photo was used to copy the weathering, just common sense."



6. "I am in charge of the operations on this layout, and if I say it's time to relax, it's time to relax." Tore Hjellset posted this photo in response to a thread on the forum cat-proofing your train room - see: mrhmag.com/node/20203. To see more of Tore's modeling, go to his blog at grimstadline.blogspot.com.

\$ GET PAID FOR YOUR PHOTO

We pay \$40 per photo we publish. If you'd like to get your modeling in our photo feature, just start posting your photos on the MRH website, especially in the Weekly Photo Fun thread created each weekend.

See mrhmag.com/help for more on how to post an image. You need to be an MRH subscriber to post photos to our website, and becoming a subscriber is free, [just fill out this form here](#).

 [Click here for reader comments](#)

When talking to hobby vendors, please remember to mention MRH.

New Innovation

Nano-Oil™
Made in U.S.A.

Nano Technology Lubricants



Nano-Grease
Available Now

"After eight years of extensive testing, the only lubricants now used in my shop are Nano-Oils and Nano-Grease. The extreme reduction in power draw by mechanically minimizing friction is simply technologically superior."
- Phil Floyd, 'The Shay Fixer'

THE SHAY FIXER 
VISIT US AT... **SHAYFIXER.COM** 
Specializing in brass Pacific Fast Mail / United geared locomotives

For more details click here ...

MODELING THE LOADING DOCK

at Burlingame, Kansas

BY JOHN GOLDEN
.....



1. The loading dock at Burlingame, Kansas. Jared Harper photo

A challenge from a friend ...

IN FEBRUARY 2013, MY FRIEND AND FELLOW modeler Jared Harper suffered a fire in his home in Athens, Georgia. The fire wasn't extensive but there was a considerable amount of smoke and water damage throughout his home, particularly upstairs in the bedrooms. At the time, Jared was constructing an HO scale layout in his basement based on the Santa Fe's Alma, Kansas branch circa 1943 (see Model Railroad

Planning 2000, "A Practical Piece of the Santa Fe"). The layout was spared, but Jared had to move to an apartment for 10 months while his home was cleaned and rebuilt.

A few weeks after the fire, I contacted Jared and offered to build something for his layout. Jared lives in Georgia and I live near St. Louis, and I thought if I could build something for him he would still feel like he was making progress on the layout. Jared

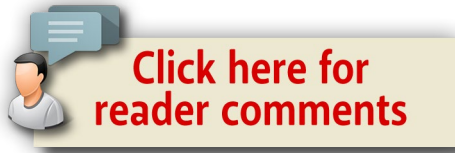

politely declined my offer, but a few weeks later he sent a second e-mail with photos and field notes. Here's his e-mail:

John,

You offered to build a model for me. Does that offer still stand? It would be helpful if you could build the loading platform at Burlingame. Attached are some sketches with measurements, and some photos. The timbers are pretty gray, but the platform has been there for some years. These pictures were taken in May 2008; I model May 1943. The platform was built in the late 1920s, and [by] 2008 it was in pretty poor shape. One will have to guess what it looked like in 1943. I was going to build the model out of wood, and perhaps try making the incline by casting anchor bolt cement.

Thanks,
Jared

I was a little surprised by the request. I consider myself a freight car builder and expected Jared to send me some cars for repair or something along those lines. I was not expecting a structure project. Nevertheless, I studied what Jared sent and a few minutes later sent back a quick reply: "Consider it done."



2. The loading dock at Burlingame, Kansas, looking west. May, 2008. Photo by Jared Harper

Starting at zero

Jared sent me drawings and photos of a public loading dock that served Santa Fe's customers at Burlingame, Kansas. Burlingame was the point where Santa Fe's Alma Branch departed the main line and continued 33 miles northwest to a connection with the Rock Island in Alma, Kansas. Alma is about halfway between Manhattan and Topeka.

Most loading ramps built during the Standard Era were all-wood structures with a simple ramp and deck built entirely of heavy timbers. The Burlingame dock, however, was built in the 1920s with a very heavy wood frame, then filled with sand and lined with a concrete top and ramp [2-5]. The dock was less than 20 years old during Jared's 1943 modeling era.

LOADING DOCK | 5



3. The loading dock at Burlingame, Kansas, looking east. May, 2008. Photo by Jared Harper



4. The ramp end of the loading dock, looking north. The interior of the entire structure was filled with sand and a concrete liner applied on top of the sand. May, 2008. Photo by Jared Harper

LOADING DOCK | 6



5. The platform end of the dock, looking south. Note the heavy timbers used as a top chord, and also where they are missing on the dock's sides. Also notice the heavy round poles used to support the structure. May, 2008. Photo by Jared Harper

At first glance this project looked like something I could easily scratchbuild in a few hours with some wood and a plastic deck. However, I thought I could make a more accurate prototype model by casting the deck with Hydrocal and building a wood superstructure around the casting. What follows is how I chose to tackle the problem and build a mixed-media structure for Jared's layout.

I began this scratchbuilding project by starting at zero. The photos and field drawings provided everything I needed to make the model. My primary focus was getting the dimensions right and using the right material to provide a prototype finish. Using the right material would allow me to get the colors right

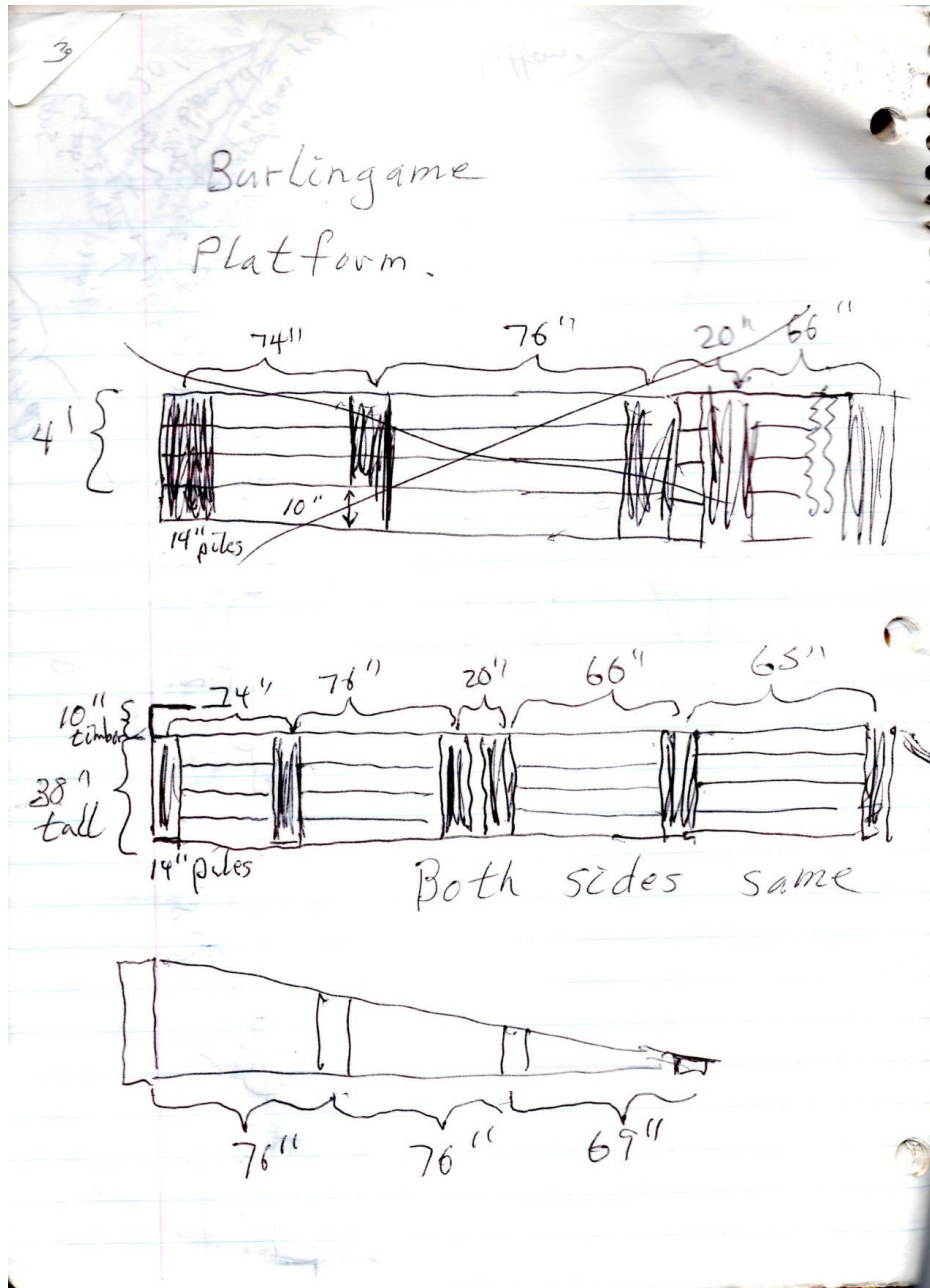

6. Page 1 of Jared Harper's field notes on the Burlingame dock.

and make this model prototypically accurate. I was particularly concerned with getting the height right so Jared could lay the model at track level and a boxcar floor or flat car deck would be perfectly flush with the platform deck. My secondary focus area was assembling a mixed-media model that would stay together and survive being shipped from St. Louis to Jared's home in Athens, Georgia.

After much consideration, I decided to construct a frame made of styrene, then build up the exterior wood superstructure around the styrene template. Once this was complete, I would fill the styrene frame with Hydrocal to simulate the dock's concrete-lined ramp and deck. I like Hydrocal because it is easy to work with when wet, can be sanded and shaped, dries slowly, and can be painted or stained easily.

Initial construction

I began construction by cutting Evergreen Styrene, 0.040" corrugated plastic, part #4526, to create the interior frame. I studied the ramp dimensions and then marked and cut the styrene with a sharp X-Acto knife. I made sure the corrugated surface would be on the inside of the frame to provide a something for the Hydrocal to hold on to. [1] below shows the dimensions I used for cutting. The dimensions were based on the field drawings sent by Jared [6-7].

After cutting the styrene frame, I taped the pieces to cardstock and brush-painted the outside surfaces black. I did this to prevent any white surfaces showing through after I attached the wood to the outside of the frame. I used Testors Gloss Black because I had it on hand, but any black color would do. A flat

LOADING DOCK | 9

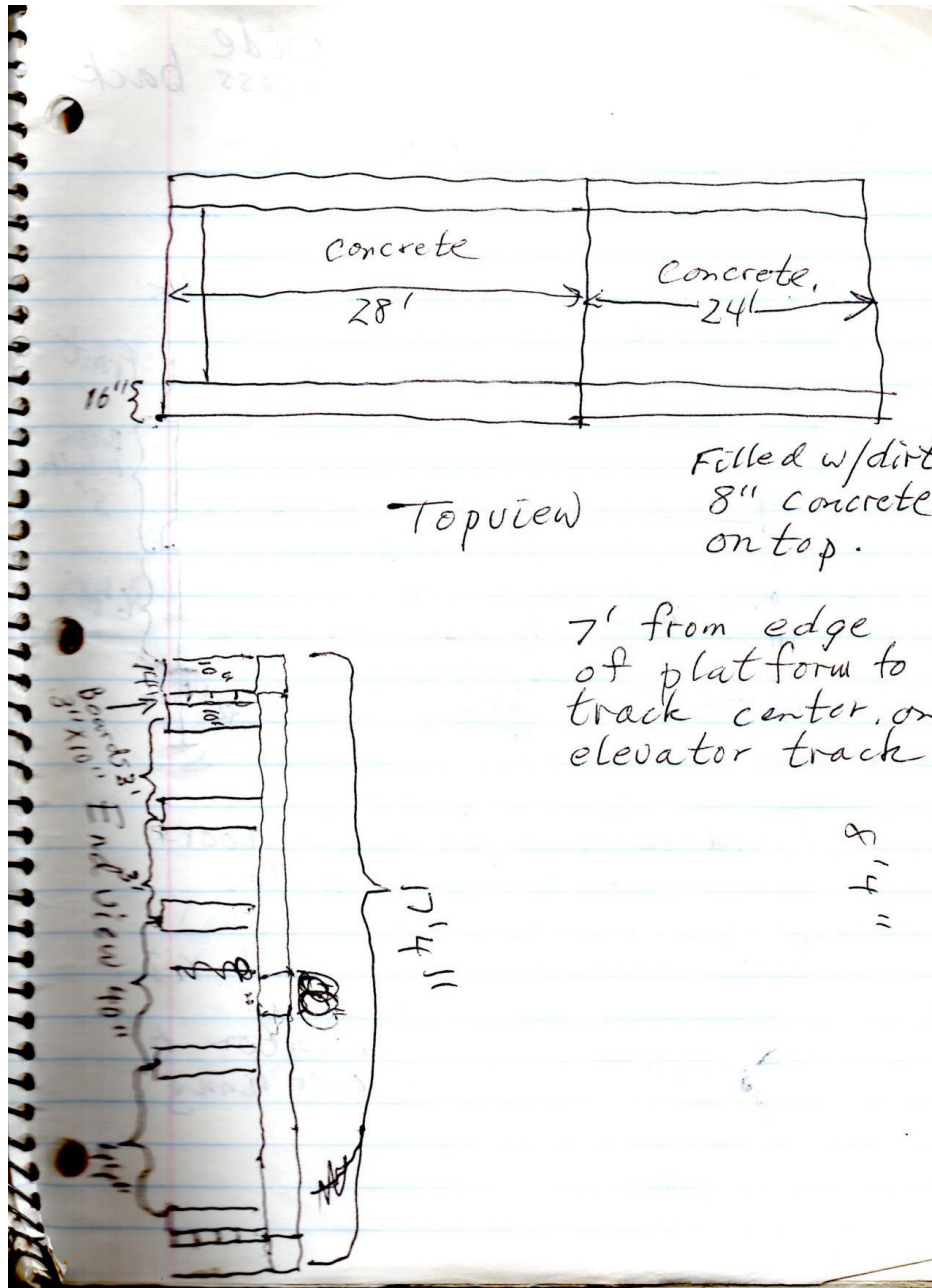

7. Page 2 of Jared Harper's field notes on the Burlingame dock.

LOADING DOCK | 10

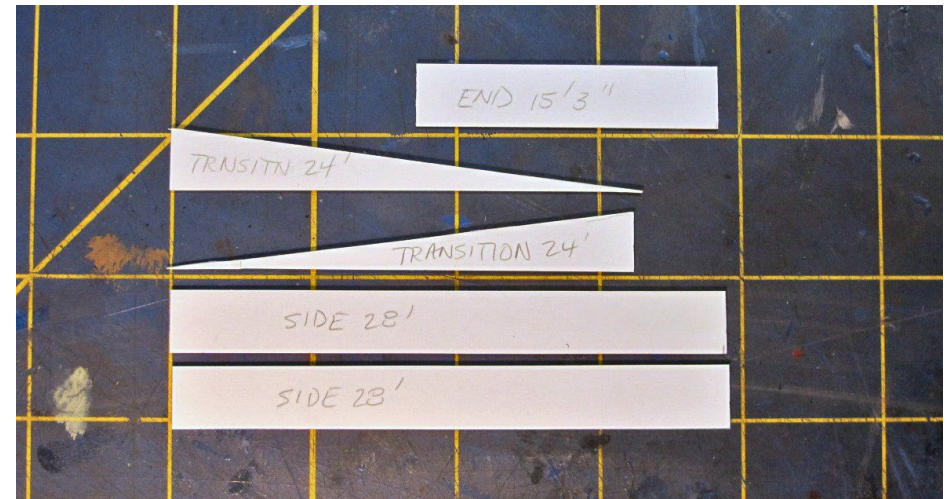

8. The styrene frame pieces cut and ready for painting.

black would be best because it is more porous and would provide a better surface for gluing.

While I was waiting for the paint to dry, I sanded the lumber and then washed it to clean off any dust and debris. I stained each piece individually and placed the wet-stained pieces on a piece of wax paper to dry. I stained the scale lumber using a Minwax Stain Marker. I have stained wood in the past by bathing it in India ink, but that process is messy and tends to stain the wood black.

For the Burlingame dock, I used a Minwax #85687 marker that I bought at Lowe's. I stained 25 Northeastern Scale Lumber 4" x 12" boards for the sides (#41211), 10 additional 4" x 12" boards for the top chord, and another five 1/8" diameter dowels for the side posts. Later I gave each piece a second coat to make sure I got a rich, even, dark brown color.

LOADING DOCK | 11

Once the paint was dry on the styrene frame, I attached scale lumber longitudinally across each piece with ACC. I started by attaching a piece of lumber on the bottom of each part, working my way up. I was not aiming at perfection in this process – I wanted the completed dock to appear well-used and slightly non-uniform.

After allowing the assemblies to dry for a few days, I trimmed the wood around the styrene forms using a sharp X-Acto #11 blade and then carefully sanded the edges of all the assemblies square using 400-grit sandpaper. I also sanded the front sides of the wood to soften the edges, which took the stain off a few spots, so I gave all the wood assemblies one more coat of stain to blend all the colors together.

Next I assembled the main structure with ACC, using a small square to keep everything aligned. First I joined the dock sides with the ramp sides, and then added the end section. Once I was satisfied that everything was squared-up, I added additional styrene stiffeners across the interior of the ramp.

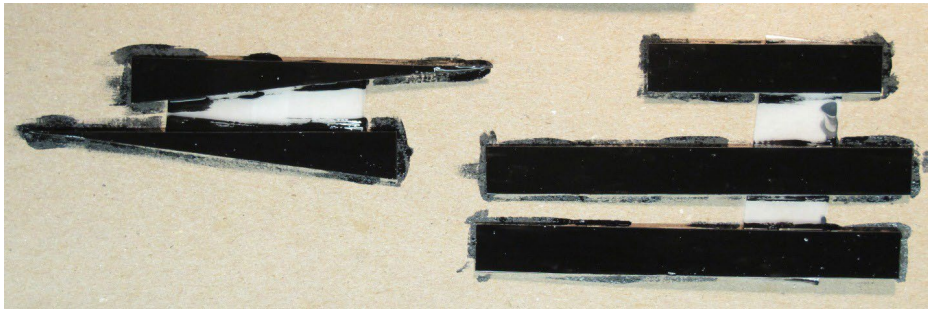

9. The painted frame ready for assembly. The five parts are the ramp pieces at left, the dock end at top, and the two dock sides on the bottom right.

LOADING DOCK | 12

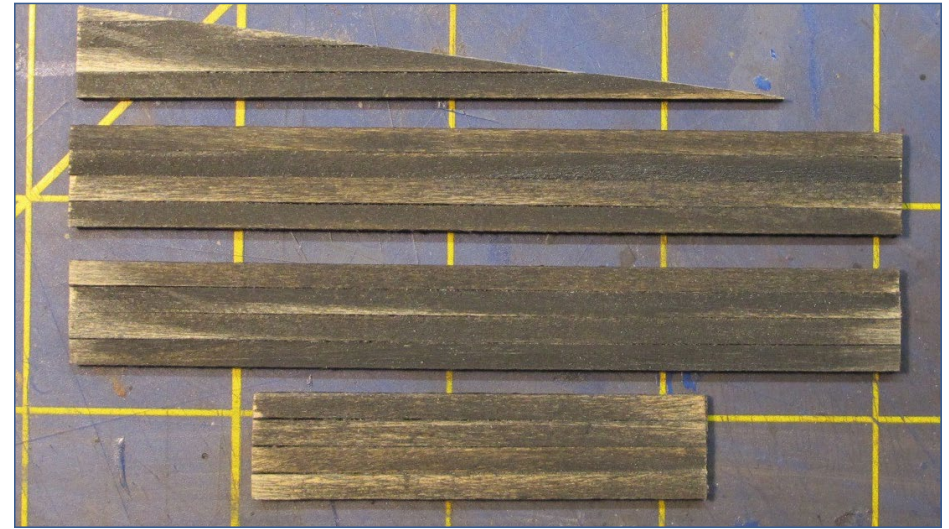

10. After gluing the wood on top of the styrene forms, I trimmed around the forms, making styrene-backed assemblies for the loading dock.

I used styrene sheet from my parts bin for the stiffeners cut from 0.060" sheet, and made sure the top of the sheet was below the ramp and dock floor so they wouldn't show through when the Hydrocal was poured. The stiffeners were easily attached, since they were attached to the interior frame, which was also made of styrene. The completed frame was quite sturdy.

Adding the Hydrocal floor

I used Hydrocal to create the interior of the dock. Hydrocal is a trade-name for white gypsum cement, and is very much like Plaster of Paris, only it is stronger, shrinks less than plaster, and is excellent for making molds and castings. I taped wax paper on a cutting board, ensuring everything was flat and level, and then placed the model on top of the wax paper. I used wax

LOADING DOCK | 13

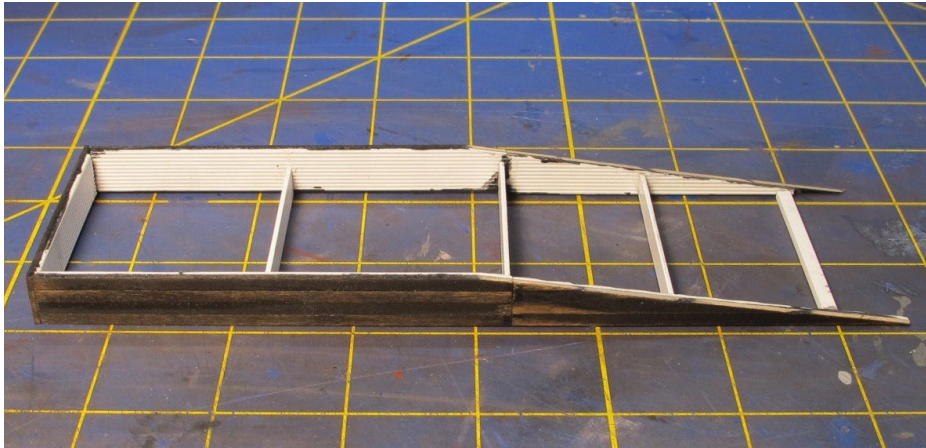

11. The completed frame, showing the wood secured to the styrene core and additional styrene cross-braces fixed to the interior of the structure.

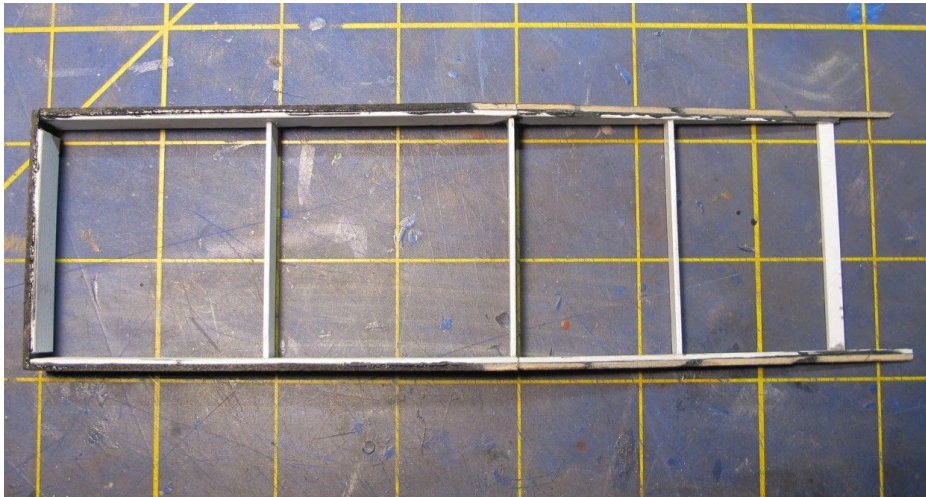

12. Top view of the completed frame, ready for filling with Hydrocal.

LOADING DOCK | 14

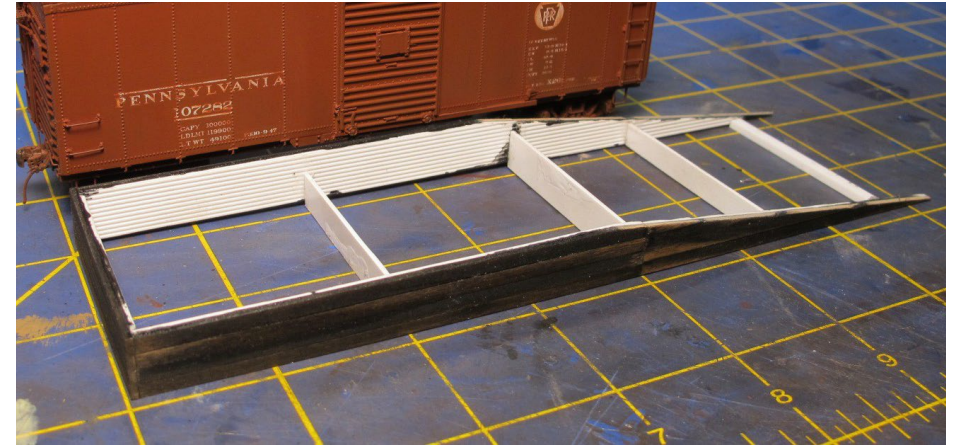

13. Testing the height of the completed frame. The top of the frame should be level with the boxcar floor. The model is a kitbashed HO scale Branchline PRR X26B.

paper on the bottom so the Hydrocal wouldn't stick to the cutting board.

I mixed up some Woodland Scenics #C1201 Lightweight Hydrocal to the consistency of a thick milkshake and carefully spooned it into the frame [15]. I used a plastic knife to pop any bubbles that appeared in the casting, and then used the knife to scrape off as much overflow as possible from the top without dripping any Hydrocal onto the wood surfaces [16].

When the Hydrocal was dry, I was able to pick up the ramp off the wax paper; it was strong and sturdy. The corrugated plastic material I used on the interior styrene frame helped hold the Hydrocal in place, and it also eliminated the opportunity for seepage through the boards.

I put a piece of 300-grit sandpaper on a flat surface, turned the ramp upside-down, and sanded the top of the dock and the

LOADING DOCK | 15

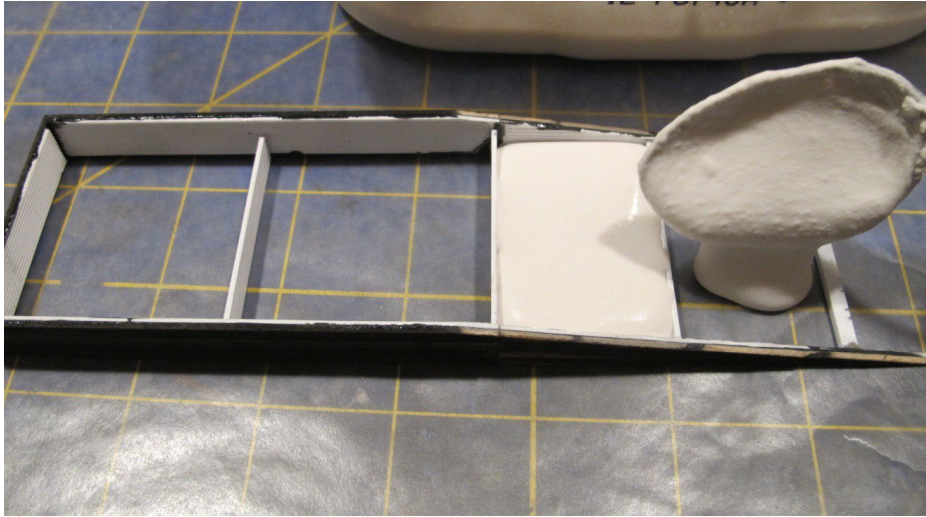

14. Filling the frame with Hydrocal.



15. Once the frame was filled I used a plastic knife to gently level the Hydrocal on top of the ramp.

LOADING DOCK | 16



16. Sanding the Hydrocal smooth on top.

top of the deck level with the wood frame. Hydrocal is easily sanded, and with care I was able to create a perfectly flat surface on the deck and the ramp. I also sanded the bottom of the dock to flatten it.

Problems and re-attack

Any new project, particularly a scratchbuilding project, is fraught with problems. An issue I encountered was failure of the Hydrocal at the extreme end of the ramp [18]. The Hydrocal was not able to bond with the styrene interior, and broke off at the end of the ramp. I patched the Hydrocal a second time, but the end broke off again as I sanded it smooth.

An easy and prototypical solution would have been to leave it unfilled, and fill the area with sand or scenic material once the dock was fixed to the layout, but I felt I wouldn't be delivering a completed product to Jared. To solve the problem, I removed

LOADING DOCK | 17

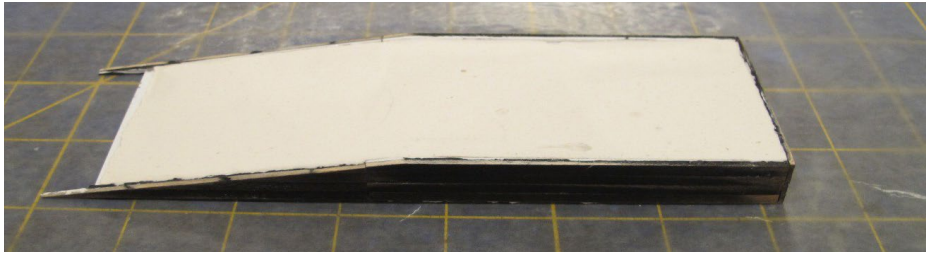

17. The broken end of the ramp. I removed the small styrene cross brace barely visible at the break point and was able to successfully add a Hydrocal patch.

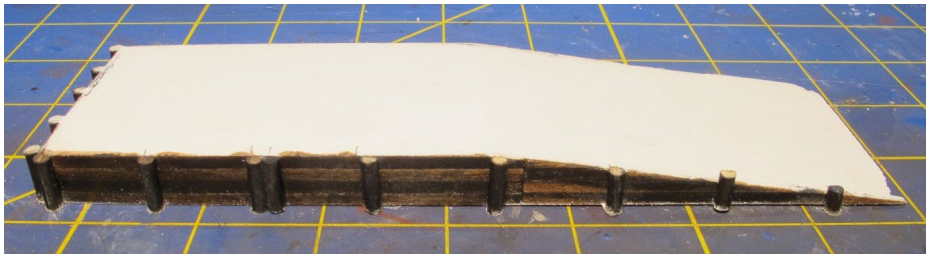

18. The ramp after the outside pole braces were applied and sanded. The shortest poles on the ramp end broke off during sanding broken end of the ramp, so I re-applied them and was able to gently sand them flush using a little less pressure.



19. The dock assembly with the top chord in place on top of the dowels. I painted the Hydrocal as a color test. Next I re-applied Hydrocal to the top of deck to bring it up to the level of the top chord, and then sanded everything smooth.

LOADING DOCK | 18

the small horizontal styrene brace at the end of the ramp where the breaks were occurring, and re-applied the Hydrocal, and that did the trick.

With the problem solved, I added the external braces. I applied the 1/8-inch dowels that I pre-stained earlier and cut them to an approximate height using a Northwest Short Line Chopper II. I installed them to the sides of the wood frame using ACC, and then trimmed them close to level with a cutting disk in my Dremel tool.

Then I turned the whole assembly upside-down and sanded the tops of the dowels flush with the top of the ramp. The very short dowels on the ramp broke off during sanding, so I re-applied them and was able to sand them flush using a little less pressure. The sanding produced a lot of dust that caked on the side of the wood, so I washed off the entire ramp, and once it was dry I re-applied the stain with the stain marker to cover up any problem areas.

Next, I used ACC to secure the outside brace along the entire top of the model. I called this part the top chord and used pre-stained Northeastern HO scale 4" x 12". This chord rested on top of the pole braces outside of the Hydrocal deck and was installed around the entire frame all the way down to the end of the ramp.

When the chord was fully secured I then added another thin layer of Hydrocal to bring the level of the Hydrocal up to the top of the top chord. When the Hydrocal was dry I turned the entire assembly over once again and sanded everything smooth on top. The completed model was nearly dead-on per the dimensions, except for the front of the structure, which measured about four inches wider than the prototype.



20. Top view of the ramp after weathering. Note that the wood frame on top is also weathered heavily, but provides just enough contrast in color and texture.



21. The completed model on the workbench ready for Jared Harper's layout.

Finishing

With the basic assembly complete, I turned my focus on painting and weathering. I washed the entire model in warm water, then touched up the wood frame in a few places where Hydrocal dust or sanding had marred the wood. Once that was dry, I brush-painted the Hydrocal with Floquil Aged Concrete.

To provide additional weathering and aging, I brush-painted the corners with Testors Dullcote and lightly sprinkled some fine sand onto the wet paint. Once that was dry, I lightly brush-painted the corners and the top chord with earth-color weathering powders. Just a little powder went a long way.

I lightly brushed over the powder with Aged Concrete again to blend in the weathering. The weathering exposed imperfections in the Hydrocal such as miniature bubble holes, but I felt they looked prototypical. I also brush-painted some light gray streaks on the ramp to simulate tire marks.

The last weathering detail I added was cracks in the concrete. They are difficult to see in [21], but I used a pencil to draw light crack lines horizontally across the ramp and dock in several places. I tried to follow the cracks present in the prototype photo [4].

Initially I intended to apply Grandt Line nut-bolt-washer castings on the model in the appropriate places, but I felt they would not be seen unless I weathered them heavily with rust color, for example, and I didn't think that would be appropriate for Jared's 1943 time frame. Also I would have to counter-sink bolts in the top chord, and I was concerned they would mar the finish and would look like imperfections rather than bolt castings. I contacted Jared about this and he said it didn't matter to him, so I left them off.

LOADING DOCK | 21

When I felt the weathering was complete I airbrushed the entire model with Dullcote to seal in the dirt, texture and color. I waited a few days for the model to dry completely and then sent it to Jared just in time for an open house he was hosting in conjunction with the NMRA National in Atlanta.

Conclusion

I'm glad I took on this project and I was happy to learn something new. Construction took me a lot longer than I thought, about three months beginning to end, but I was able to deliver a finished product just in time for Jared's open house. I was also pleased that I was able to recover from a few construction problems without much compromise.

I hope this project motivates you to do something new and different, and try your hand at scratchbuilding a mixed-media project for your own layout.



[Click here for reader comments](#)

LOADING DOCK | 22

JOHN GOLDEN



John Golden began modeling in 1970, and has been a modeler and railfan ever since. He's a "freight car guy", and is a Seaboard Air Line historian and modeler. John has written 35 articles for a variety of model and railfan magazines, and has created The Seaboard-Coast Line Modeler online magazine.

John is currently building a prototype layout depicting the Minneapolis & St. Louis Railroad in Ackley, Iowa circa 1950. John is also the longtime host of the annual St. Louis Railroad Prototype Modelers (RPM) Meet. ■

ADVERTISEMENT

Coming soon!
Allagash Ops
Live-6: New
Sharon
Yard
Ops

Running time: 1 hr 52 min

DVD media
~~29.99~~
\$24.99
+ shipping/handling

Instant download
~~14.99~~
\$9.99
HD format

from the
**Model Railroad
Hobbyist Store**

model-trains-video.com presents
Mike Confalone's
ALLAGASH RAILWAY
**Op Session
Live**
No. 5

Get Allagash Ops Live - 5

MRH \$500 layout contest Honorable mention



BY PHILIPPE GRÉGOIRE

Get started right without breaking the bank

TO MAKE A GOOD PROJECT, YOU MUST PREPARE well and start with a good plan. To me, a good plan means a drawing with dimensions, details, and proper measurements. I drew my plan using AutoCad, but a hand-drawn plan (scaled drawing) will also work. The more time I spend on planning, the better my project will look, the less it will cost, and stay inside my budget. I have less chance of being disappointed about the final result, because everything has been planned in advance.

First, I decide what I want to model: what are the features and focal points, and what I want to be seen. When that is done, I start drawing a few options. To help my creative process, I read books and search the Web for pictures of models and the prototype, and for ideas and modeling tips.

In this case, I want to model an intermodal terminal. Because the budget is limited for this contest, a sectional shelf module layout seems to me the best concept. A module takes less space and less



money! In addition, a small module offers the opportunity to try new techniques without a big investment. A shelf module is also easy to move around to work on and allows me to bring it everywhere I want to show it.

Creative process

Last year, I started my personal HO scale layout. I made my plan and produced a material list and price studies before making any major purchases.

After reading the *Model Railroad Hobbyist* October 2013 edition about the contest, I decided to build one of my layout modules for less than \$500. But, because I am a perfectionist, a maniac on realism, I could not cut back on quality. I prefer to wait for more money, and achieve a proper result.

Maybe my module plan doesn't include a lot of operation options, but the challenge here is to go through all steps of railroad modeling: making plans, building benchwork and backdrop, installing tracks, wiring lighting, switch motors, and operational dwarf lights; general scenery, modeling freight cars, containers, cranes, buildings, and creating the final convincing details. My goal is to create a nice scene of a normal day on a contemporary railroad.

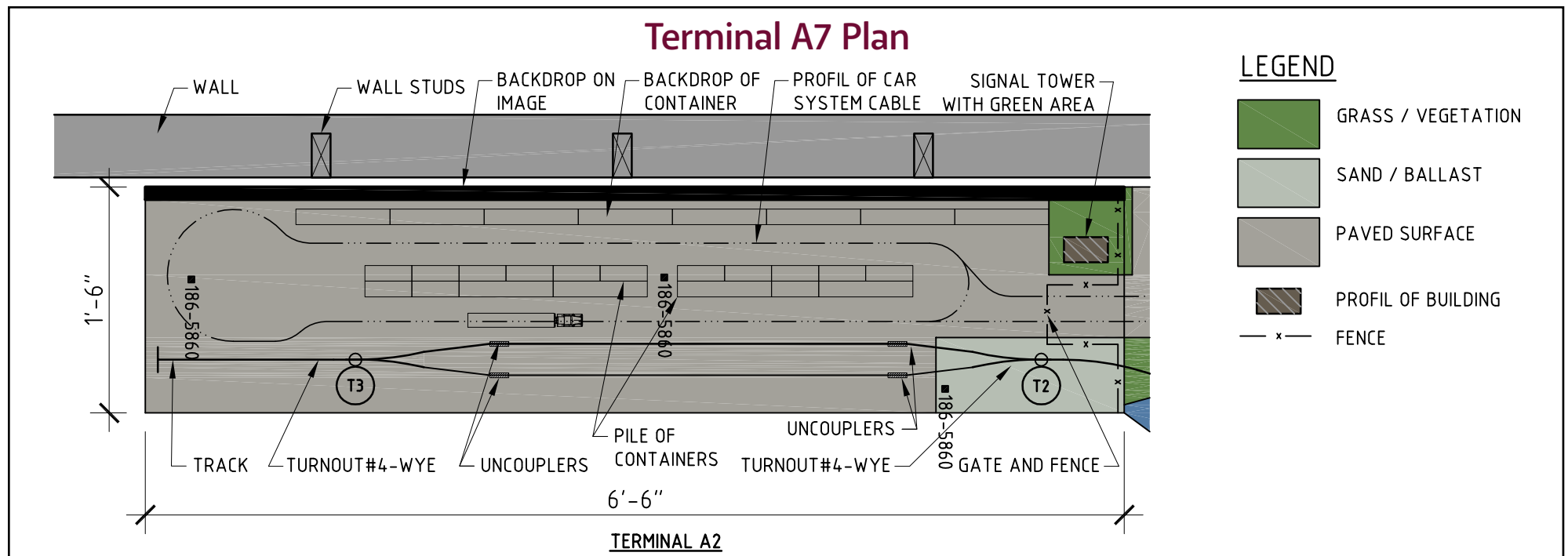

Budget

Starting with the benchwork and ending with scenery, I try to cover all items needed in my parts and price lists (previous page). This step forces me to search, to get new ideas, find new materials, and often, I find new products. Next comes the researching of prices. With my list and quantities, I can go to my local hobby shop for prices, but I prefer to search online for hobby supplies.

I realize that prices can change, even double from one place to the other, so I shop and compare. The key thing is to compare “tomato with tomato.” On my materials list, you can see in green which supplier is cheapest for each item. I also compare shipping and handling costs. This is critical with online services.

Prices depend on where you are located and the product’s availability. On my chart, when it’s noted No \$, this means that the supplier does not carry this part or it is not available for now. With this step I can also regroup my order and save on shipping cost.

For information, a yellow box means that I need to do some research to find a better product, or the product is not the same from one supplier to the other, it may be a different model or type, so I can’t compare tomato with tomato. As you notice, most yellow boxes are in the optional section. Rolling stock and a locomotive are easy to find in a local garage sale or on eBay.

For the purpose of the contest, I am allowing a budget of \$100 for a locomotive, which is a good average for a DC unit or even a good used DCC unit. Behind the loco, I just need two well cars. A budget of \$25 each is reasonable to get nice detailed units.

The budget of this module is \$484.15 including shipping, taxes, and 10% for contingencies. Most people forget contingencies and have some bad surprises.

Adding a DCC throttle, the Faller Car System, and a few scenic details would bring my module to a higher level of modeling. Of course, the DCC system will be used on my next module and reduce the overall price for that.

OK, I’m ready to start this project!

Collecting the lumber

Most hardware or lumber stores offer a cutting service for a small fee. During the time the employee cuts the plywood (refer to “Plywood Cuts” sketch), I purchase all major or critical material on my list; screws, glue, wall brackets, etc. I like to order everything I want in one purchase; so I have everything I need before starting. That’s why my material list is important; I know where to buy, the price, and the quantity needed. I have a better chance that way to respect my budget.

Putting up the hardware

At home, I attach the brackets to the wall, making sure they are screwed into wood studs and not just wallboard. I want the module at my eye level, so the top of the plywood should be 62” from the floor. The beauty of this system is that it is possible to adjust height easily without damaging the walls. I build cross supports with 1”x2” white pine. This intermodal yard module will be installed above my other under-construction module [1].

Benchwork

Building the benchwork is easy. Most of the plywood is already cut with specialized tools by my local home store. I just glue and screw each part per my framing plan. I make sure that the module is square. The plywood top helps me to align the frame.

Description	Model	Preferred Brand	Quantity			Summary									
			C	R	S	Others	Walthers	CC Hobby	Tony's	Ebay	Horizon	Udisco	Intertrain	Best Price	
Terminal A2															
Benchwork 6'6 x 1'-6"	\$47.07														
Plywood 4'x8' 1/2" standard		(local home center)	1	1	0	\$18.99	--	--	--	--	--	--	--	--	\$18.99
Cuts (on plywood at local home center)		(local home center)	13	13	0	\$6.50	--	--	--	--	--	--	--	--	\$6.50
Wall bracket 16"		(local home center)	3	3	0	\$6.45	--	--	--	--	--	--	--	--	\$6.45
Wall strip for bracket 36" or more		(local home center)	1	1	0	\$3.74	--	--	--	--	--	--	--	--	\$3.74
1"X2" X 7'-0" PINE		(local home center)	2	2	0	\$3.98	--	--	--	--	--	--	--	--	\$3.98
Screw 1-5/8", box of 100		(local home center)	1	1	0	\$3.32	--	--	--	--	--	--	--	--	\$3.32
Bolt, washer and nut (about 1/4" dia.)	(kit)	(local home center)	2	2	0	\$1.00	--	--	--	--	--	--	--	--	\$1.00
Wood glue (150ml)		(local home center)	1	1	0	\$3.09	--	--	--	--	--	--	--	--	\$3.09
Rails and accessories	\$81.76														
Rail, flextrack 36" long	SL8300	Peco	6	6	0	--	\$43.20	\$30.30	\$26.94	--	--	\$16.80	\$31.74	\$16.80	
Turnout Electrofrog #4 - Wye	SLE8348	Peco	2	2	0	--	\$69.98	\$49.16	--	--	\$62.98	\$50.00	\$55.98	\$49.16	
Hayers Bumper (pk de 2)	SL8340	Peco	1	1	0	--	\$4.99	\$3.14	--	--	--	--	\$3.99	\$3.14	
Rail Joiners (pk of 12) (metal)	SL8310	Peco	1	1	0	--	\$4.58	\$3.14	\$3.45	--	--	\$3.58	\$3.99	\$3.14	
Rail Joiners (pk of 9) (insulated)	SL8311	Peco	1	1	0	--	\$4.58	\$3.14	\$3.45	--	--	\$3.58	\$3.99	\$3.14	
Dwarf Signal (pack of 2)	538-123	Oregon Rail Supply	1	1	0	--	\$6.98	--	--	--	--	\$7.00	\$6.38	\$6.38	
Building and Others	\$83.96														
Office desk	770-5737	Vollmer	1	1	0	--	29.99 \$	--	--	--	--	--	--	\$29.99	
Container crane	933-3122	Mi-Jack Transfer	1	1	0	--	31.98 \$	--	--	--	--	--	\$23.99	\$23.99	
Spot light on post			2	2	0	--	29.98 \$	--	--	--	--	--	\$42.46	\$29.98	
Landscaping	\$40.00														
Printed containers pictures		Web search and print	10	10	0	\$0.00	--	--	--	--	--	--	--	0.00 \$	
Background print 84" x 14" (± 8 sq.ft.)		(local print store)	8	8	0	\$40.00	--	--	--	--	--	--	--	40.00 \$	
Cereal box (container print backing)			6	6	0	\$0.00	--	--	--	--	--	--	--	0.00 \$	

Itemized listing of costs, part 1. You can find the rest of the list on the next spread.

\$500 LAYOUT CONTEST | 11

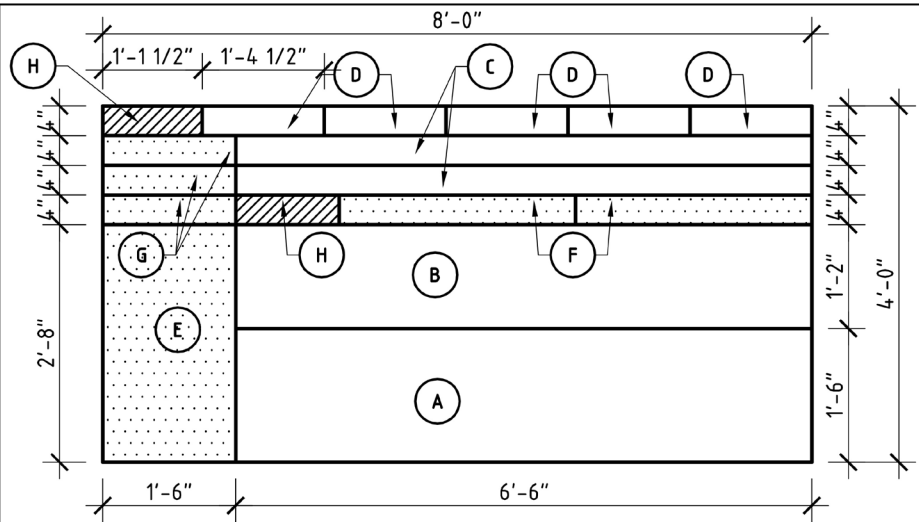

PLYWOOD CUTS

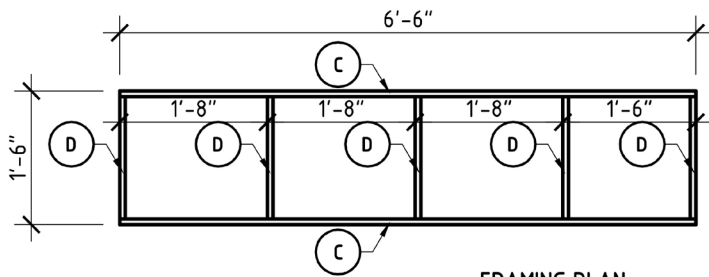

FRAMING PLAN

PARTS

- (A) BENCHWORK - TOP
6'-6" X 1'-6" X 1/2"
- (B) BACKGROUND SUPPORT
6'-6" X 1'-2" X 1/2"
- (C) BENCHWORK SUPPORT
6'-6" X 4" X 1/2"
- (D) BENCHWORK SUPPORT
1'-4-1/2" X 4" X 1/2"
- (E) BENCHWORK SUPPORT (OPTIONAL EXTENTION)
1'-6" X 2'-8" X 1/2"
- (F) BENCHWORK SUPPORT (OPTIONAL EXTENTION)
2'-8" X 4" X 1/2"
- (G) BENCHWORK SUPPORT (OPTIONAL EXTENTION)
1'-6" X 4" X 1/2"
- (H) (DISCARDED)

Plywood cuts / framing

\$500 LAYOUT CONTEST | 12

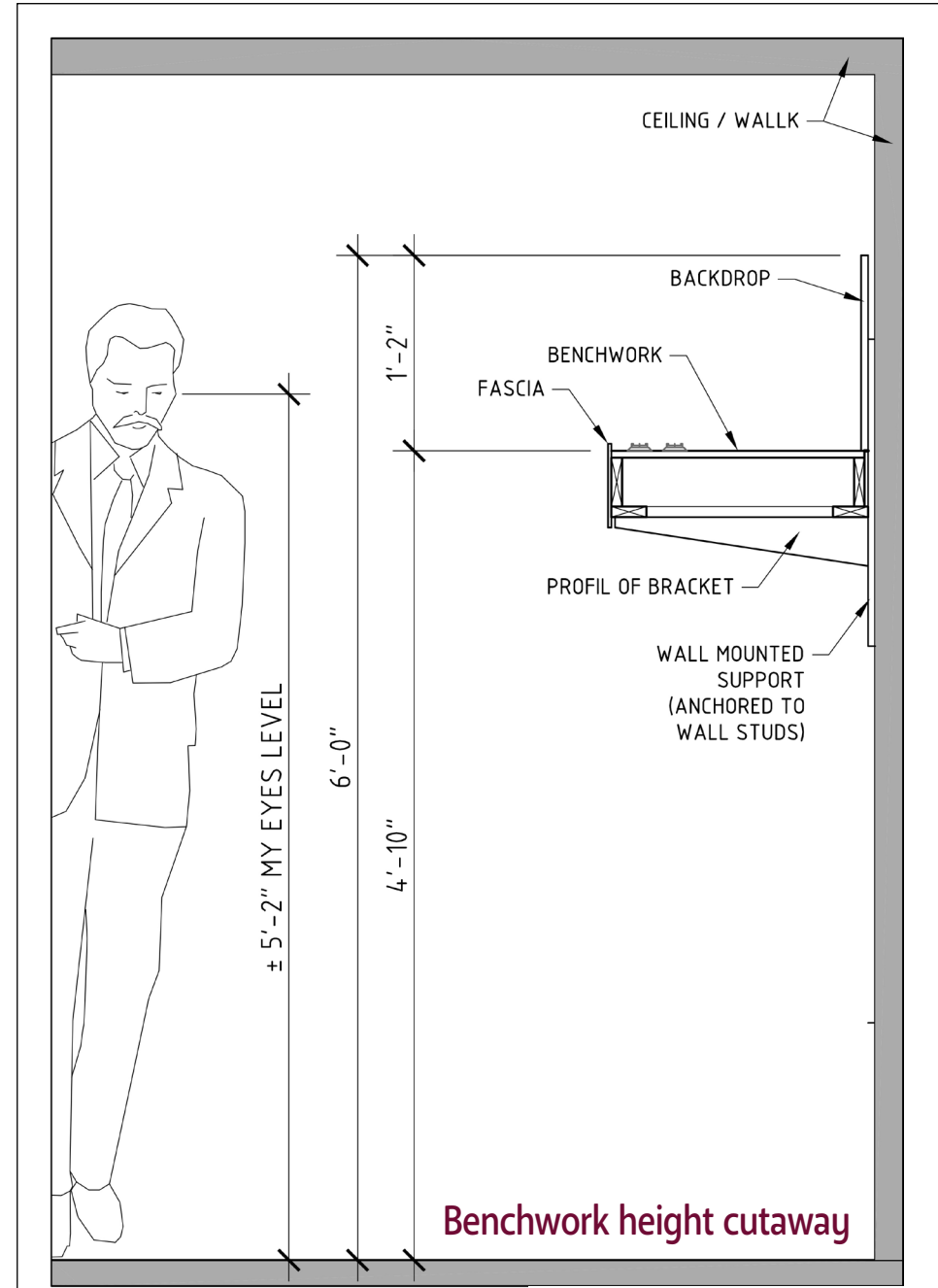

Benchwork height cutaway

\$500 LAYOUT CONTEST | 13

I make holes of 1" diameter at each of the central supports (part D). This small step allows me to run cables under the plywood surface. Once done, I can install my benchwork on the wall bracket system.

Backdrop

The background is easy to make. The hardest part is to find a great picture of a port or an intermodal yard. The Internet or personal pictures can be used for this. I recommend a minimum of 10 megapixels, because the picture will be enlarged. At my local printer (Staples), they printed my picture on a poster format

I ordered my picture 2" oversized to allow room for adjustments. Adjusting, cutting and gluing on plywood board (part B) are critical steps! I like to use the 3M Super 7 or LePage Multi-Purpose spray glue. I screw my background board to the module at 12" intervals. My background is done and looks great. Perfect!



1. Wall rails and brackets.

\$500 LAYOUT CONTEST | 14

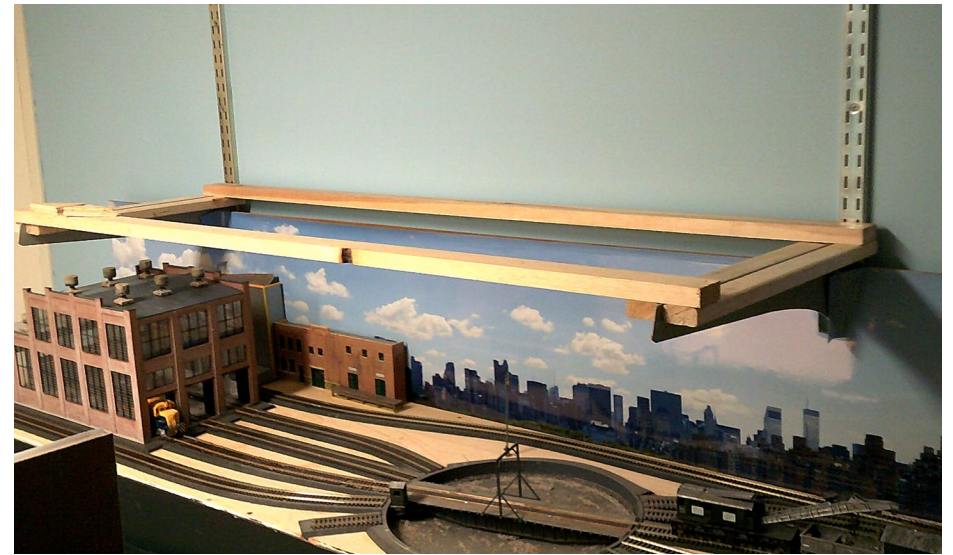

2. Support on bracket.



3. Benchwork with backdrop, and spray glue.

Containers

At any time, I can build my signal building, containers crane, my intermodal platforms set and other scenery parts like 40' containers. To build my containers, I looked on the Internet for container images. I use software to scale my images to the proper size and create six faces. I print the picture on photo paper at the best resolution my printer has. I glue the prints of the containers to cardstock, and cut the edges leaving a small tab for gluing. I fold the edges to create a box and glue each tab.

Later, I will add real HO scale containers, but for now this works. I can pick different shipping brands, container numbers, style and size, like a real intermodal yard. During operation session, drivers will also play with container waybills!



4. Container construction in progress.

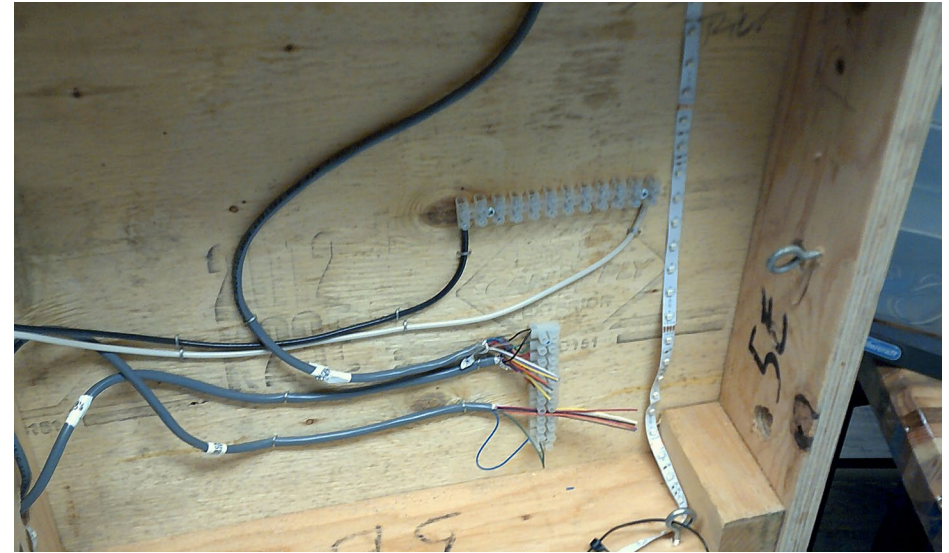

5. Cable identification.

Turnouts

Before laying track, I mark lines and make holes for the turnout switch motor pins. I like to use Peco turnouts. On the company's website, peco-uk.com/page.asp?id=pointplans you can find turnout plans to print as templates. It's a perfect tool for track planning. I also locate my floodlights and building footprint. When I'm happy with the result, I install tracks. I don't need roadbed because the entire area will be a paved surface.

Wiring

After testing my tracks and turnout, I install switch motors and wire them. I will also prepare my wiring for floodlights and dwarf lights. Bus cables are installed too. Because it's a module, it's easy to move around and work on at a comfortable level – not upside down as with normal fixed benchwork. Note: Even on this small layout, I identify all cables so maintenance will be easy in the future.

\$500 LAYOUT CONTEST | 17

A word about turnout controls. Since I use the Wabbit combo (it comes with Tortoise switch machine, connectors, a DCC decoder and a toggle switch), I can control turnouts manually, or with a DCC throttle. The contest budget does not allow me to buy a DCC controller, but the small DC throttle will do the job for now, and my turnouts are operational. With the intention of saving money, I went at my local recycling center. Computer and electronic waste contains a lot of different sizes and types of cables and this is perfect for my needs; free and ecological.

Preparing for optional moving cars

In the future, I want to add moving vehicles, like the Car System from Faller. Because of the \$500 budget for this contest, I will just do the rough-in. That means I will only lay down the small conductor cable needed for the system. The cable is not expensive, about \$10.

Drywall compound

Rail power test OK, turnout test OK, delayed uncouplers installed, Car System conductor wire installed; I'm ready to pour drywall compound. I will add a thin coat at the time, to minimize cracking. Before applying it, I will add color to the compound. This step will reduce the whiteness when working the surface. Meanwhile, if something falls on the paving and chips it, the gray will imitate aged asphalt, instead of showing a bright white chip.

Final details

I will give a last coat the final paving color. I will paint in cracks, manholes, and potholes. Before adding floodlights, building, containers and other scenery details, I will add parsley to imitate hedges. I will add ballast and sand where required. A chain link fence and gate

\$500 LAYOUT CONTEST | 18

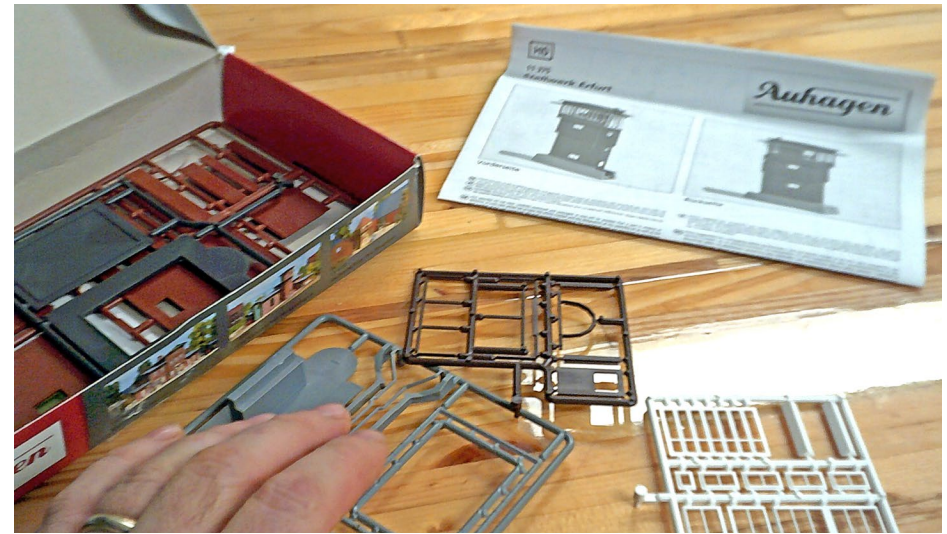

6. Signal building construction in progress.

will finalize the scenery. When the crane is installed and the building is in place, I will animate the scene with the lift moving containers around or loading van trailers.

“Mot de la fin”

I hope you will like my project, and I hope to soon show you more pictures of my completed container terminal. Modeling is all about patience! Special thanks to Loraine Smith, who helped me with my text.



\$500 LAYOUT CONTEST | 19

PHILIPPE GRÉGOIRE



Philippe came back to the hobby after he bought his house three years ago. He lives in Québec, Canada, with his wife, and his five-year-old son.

He is a building inspector and architectural technologist. His family also enjoys running their RV around North America and traveling across Europe. ■

ADVERTISEMENT



TMTV is now one-year old

We produced 72 all-new videos in our first year!

Come see what you have been missing!

TRAINMASTERS.TV

Brought to you by



MRHMAG.COM

ADVERTISEMENT

iwata

by ANEST IWATA

Just Rolling By...

Make It REAL With Iwata Climb Aboard!



Eclipse
HP - CS

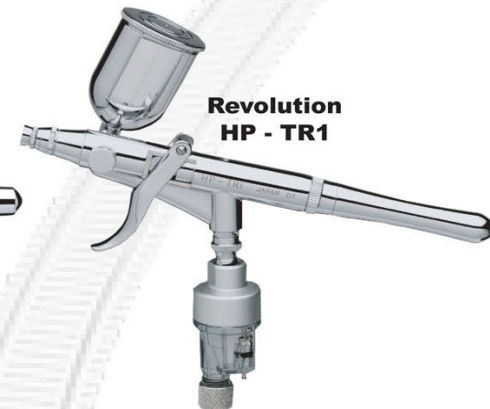

Revolution
HP - TR1



Visit... www.iwata-medea.com

To Check Out Our Full Product Line!

Models By... Alan Houtz,
North American Prototype Modelers

- TABLE OF CONTENTS
- INDEX

Build a SCHLESSER COAL LOADER

BY JOHN WILKES

Photos by the author

*Follow along,
step-by-step!*

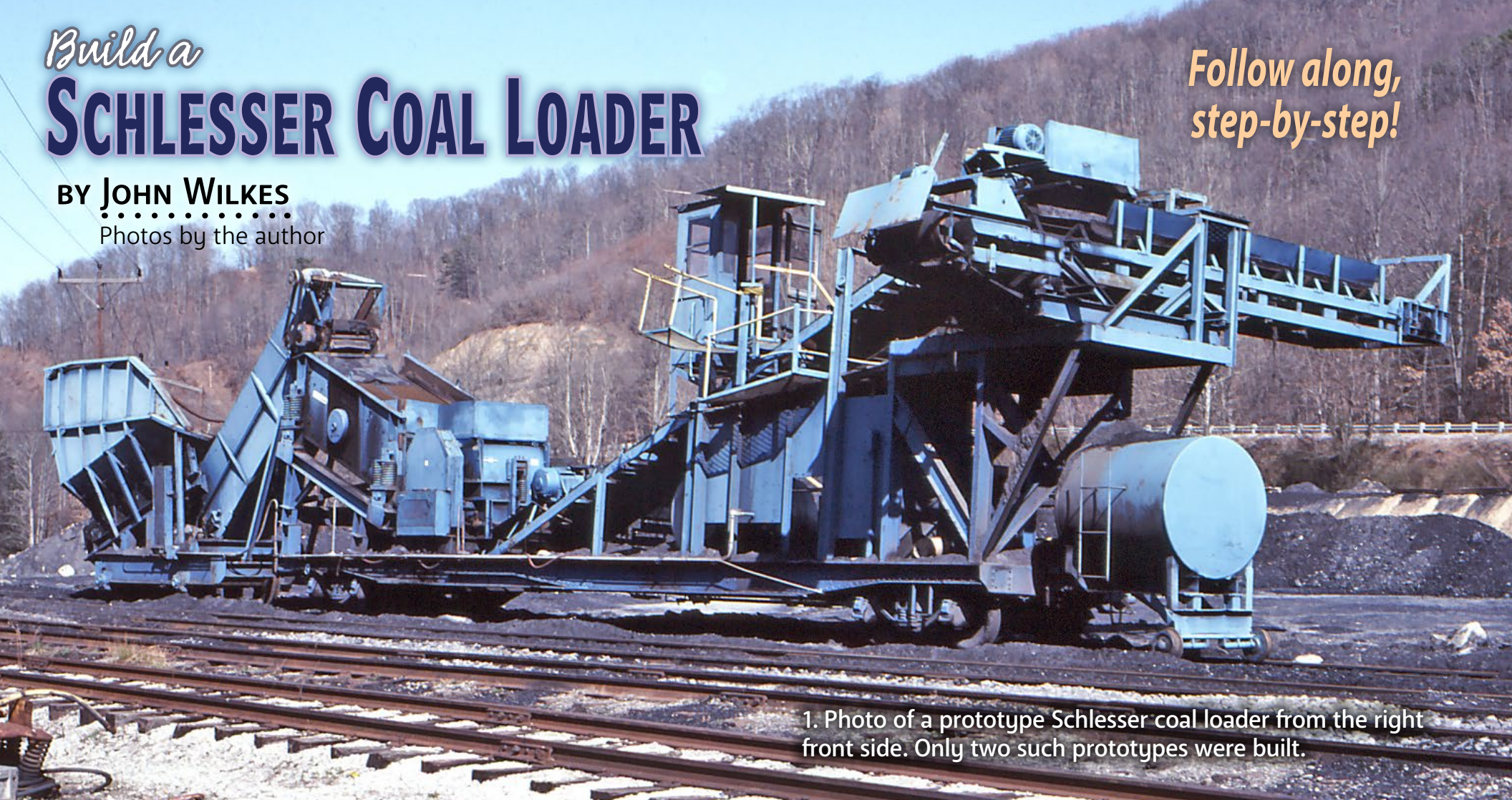

1. Photo of a prototype Schlesser coal loader from the right front side. Only two such prototypes were built.

ON RAINY DAY FAN TRIPS, I NORMALLY STAY as close to Louisville & Nashville trackage as possible. On one particular trip, I made a wrong turn late one evening and ended up spending the night in Norton, VA.

The next morning, I was amazed at what I saw, Norfolk & Western, L&N, and Southern railroads all busy in and around town. That scene changed my entire direction in modeling!

Later in the day I made my way east, following the N&W towards St. Paul, VA.

Every now and then something really grabs your attention. Such was the case when I literally stumbled upon this Virginia coal operation between Norton and Tacoma. Schlesser Coal is a unique coal loading operation. Every loader, tippie or coal dock I had seen up to that time and since has been a stationary



2. Photo of a prototype machine from the left front. The coal is loaded into the receiving hopper with a front end loader.



3. The left side of a prototype machine as viewed from the rear.

 [Click here for reader comments](#)

structure. This machine moved on a parallel track and loaded stationary hoppers. The machine appeared to have been idle for some time during my first visit. I took some photos, a few measurements, and moved on. On my next trip, a couple of years later, the operation was going strong. By talking to the workers, I was able to get some history of the coal loader.

The machine was the idea of a coal dealer, Paul Schlessers. The workers went on to say that this machine Schlessers and a local mining maintenance shop foreman sketched the machine out on the back of a place mat during lunch. They ended up building two of these machines. I found one unit but have not been

“The machine was the idea of a coal dealer, Paul Schlessers. Schlessers and a local shop foreman sketched the machine out on the back of a place mat during lunch.”

able to locate the second unit (I got some directions to the second machine once, but ended up lost again).

On a subsequent visit, the one machine I did find was down for repairs. I asked for and received permission to crawl all over the loader, taking close-up photos and measurements.

On the following pages, follow along as I describe how I built my Schlessers coal loader, step-by-step.



4. Closeup of the completed Schlesser loader model, left front view.

STEP 1: PREPARING FOR CONSTRUCTION

I had several decisions to make before beginning construction. What components could be bought commercially, and what would need to be scratch built? The receiving hopper assembly, conveyors, shaker screen, and crusher would all need to be scratchbuilt. I estimated these component's dimensions by using some known measurements of the coal loader. I decided to modify a commercially available machine platform deck, diesel motor, and trucks.

The final position of each component depended on the adjacent assembly's position. This meant building each assembly in sequence. For example, the trough conveyor could not be constructed until the receiving hopper, carriage, and the shaker screen were in position.



5. An overhead view from the right rear of the loader.

The order of assembly, then, is:

- Receiving hopper carriage & receiving hopper
- Machine main deck
- Transfer conveyor framework
- Main conveyor
- Shaker screen
- Crusher
- Trough conveyor

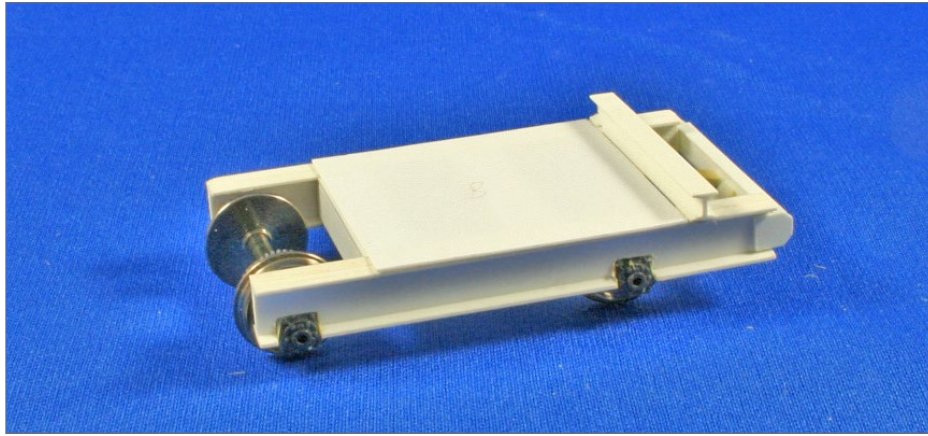

6. Hopper carriage with wheels.

STEP 2: THE RECEIVING HOPPER

The hopper carriage is built using Evergreen #267 C channel and .100" X .125" styrene strip. The carriage dimensions are 10' x 16' long. I made the hopper with Evergreen .020" styrene sheet, .040" x .060", and .020" x .040" styrene strip. I took half-inch wide twill tape (sewing material) and made the heavy duty metal chain belt underneath the hopper.

I took the large gears from a Tichy Train Group 120 ton crane kit. Many of the gears, cogs, pulleys, and plates found in this kit are used on other sub-assemblies of the loader, and can be used for other such projects.

On the prototype, the drive mechanism is located under the receiving hopper. I used InterMountain 36" semi-scale wheels with a large gear visible under the hopper assembly to represent the drive unit. I carved the journals from an old set of Atlas GP40 sideframes.

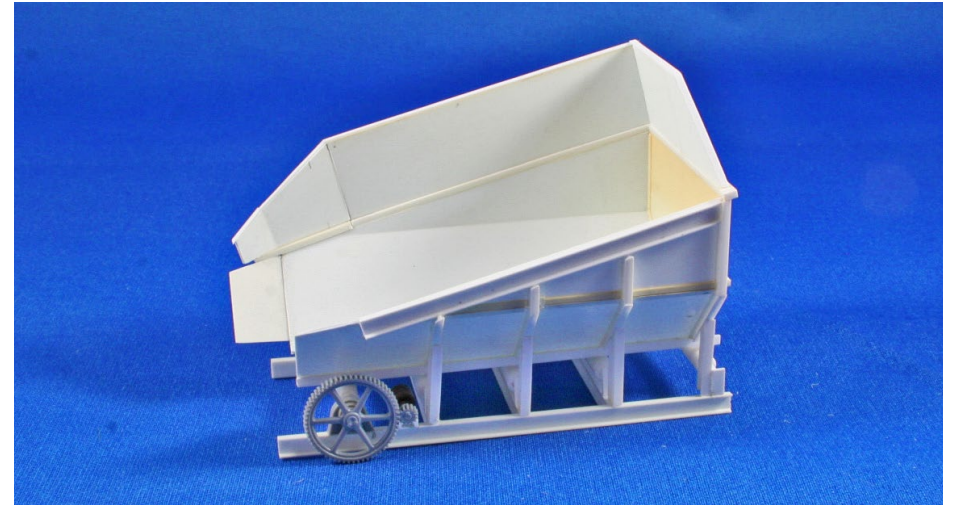

7. Receiving hopper left side.

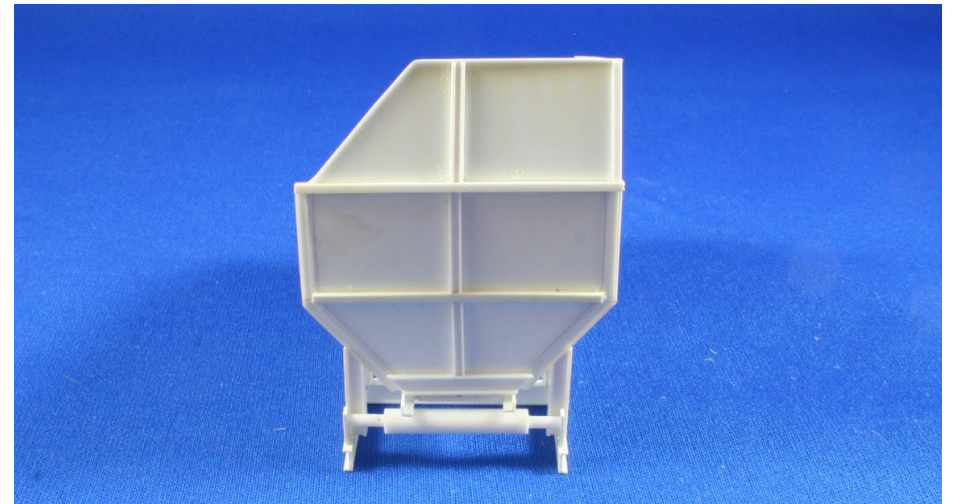

8. Receiving hopper rear view.

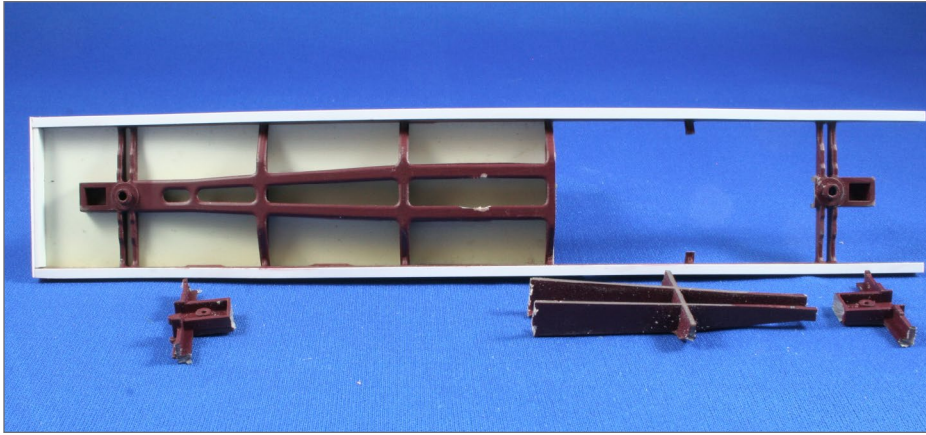

9. The modified Walthers GSC flat car bottom.

STEP 3: MACHINE MAIN DECK CONSTRUCTION

I used a Walthers GSC 54' flatcar kit as the basis of the machine's deck. I removed the stake pockets first, then cut the flat car center sill and frame to allow the main conveyor to mount just above the rail head.

I fashioned the deck cover from .015" sheet styrene. The transfer conveyor support framework was built using Evergreen #283 and #282 H-column, #274 I-beams, and .060" x .100" styrene strip.

I built the control shack from .020" styrene sheet and did the walkways from .040" x .060" styrene strip with Scale Scenics aluminum micro mesh.

I made my hand rails from .019" diameter brass wire, using a home-made jig to keep everything straight and square.

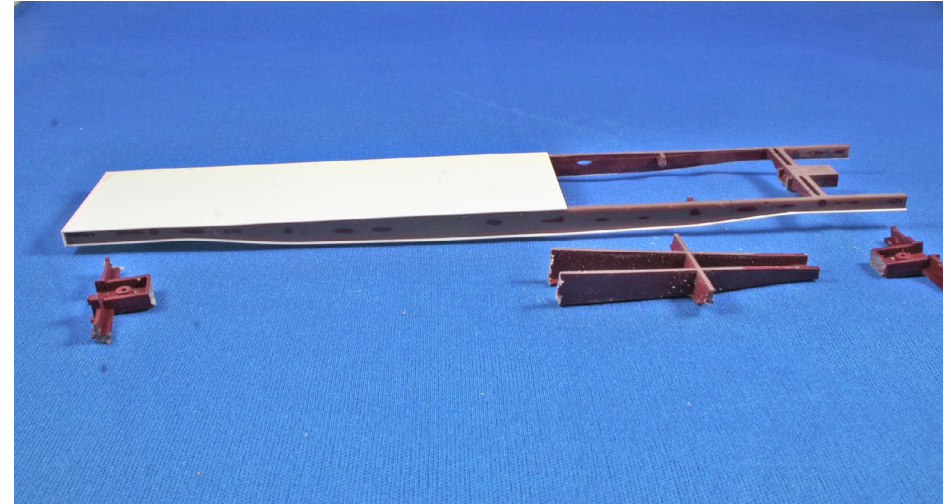

10. Modified Walthers GSC flat car, top view.

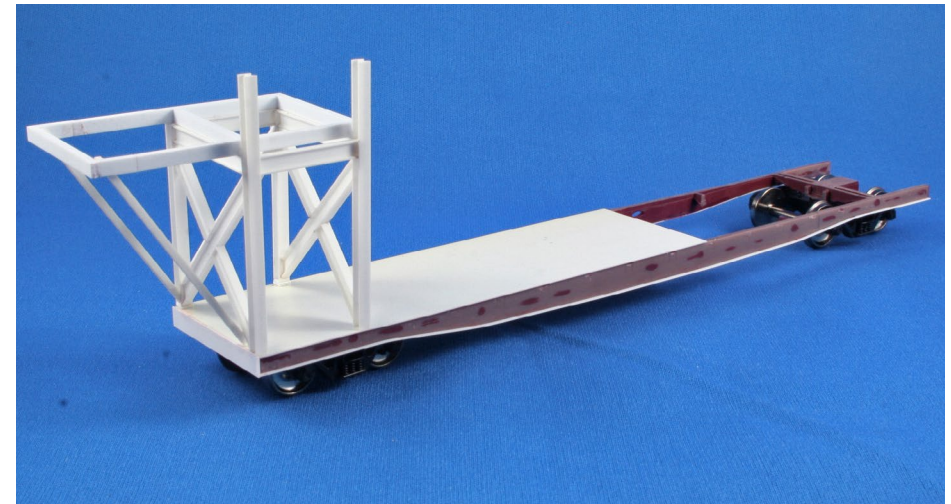

11. The main deck, with the transfer conveyor support framework added.

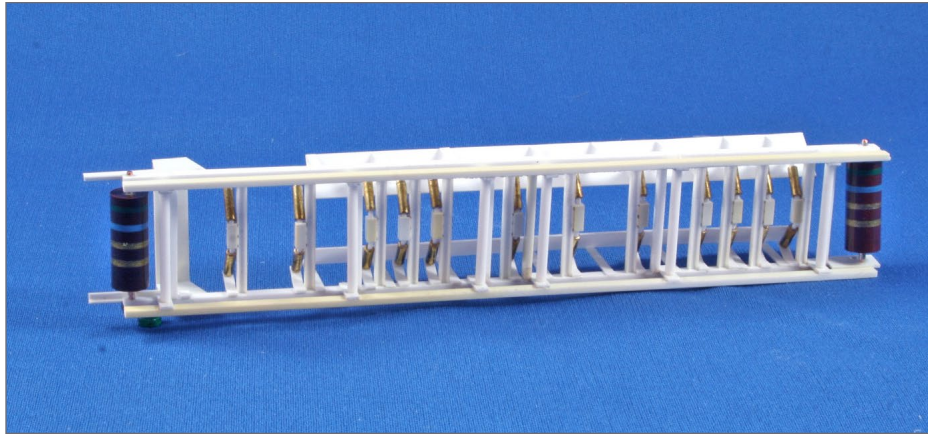

12. Transfer conveyor bottom.

STEP 4: THE TRANSFER CONVEYOR

The transfer conveyor moves the coal from the main conveyor to the rail cars. I built this conveyor the same way as the main conveyor (see step 5), but is 36' long.

The designer added wings to keep coal from spilling off the belt while loading. The frame also has an extra piece added on the bottom to enable the conveyor to be moved out and over the rail cars.

I built a cradle assembly from Evergreen #274 I-beam, # 282 H-column, #262 C-channel, .040" rod, and 1/16" brass tubing.

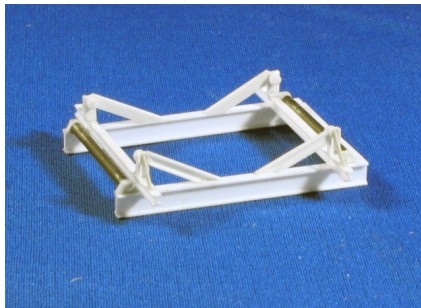

13. Transfer conveyor cradle.

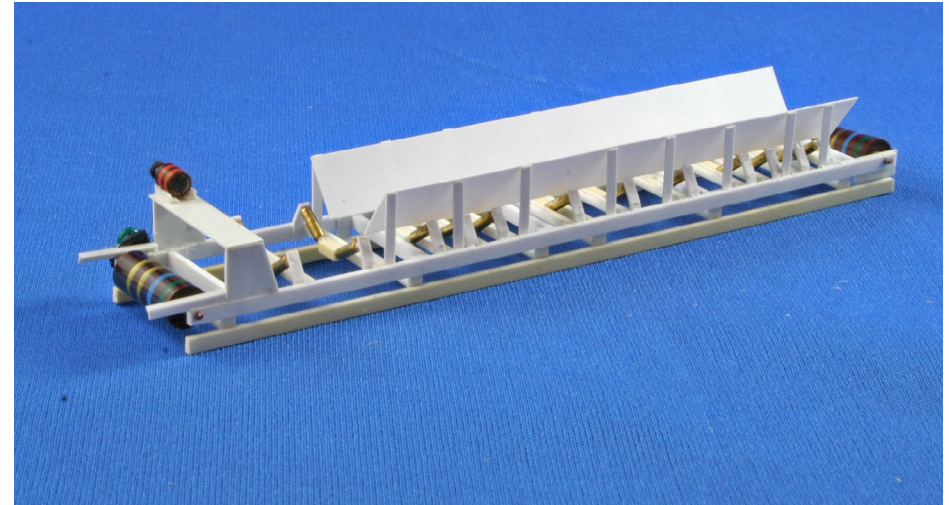

14. The finished transfer conveyor left side, ready for placement on the cradle.

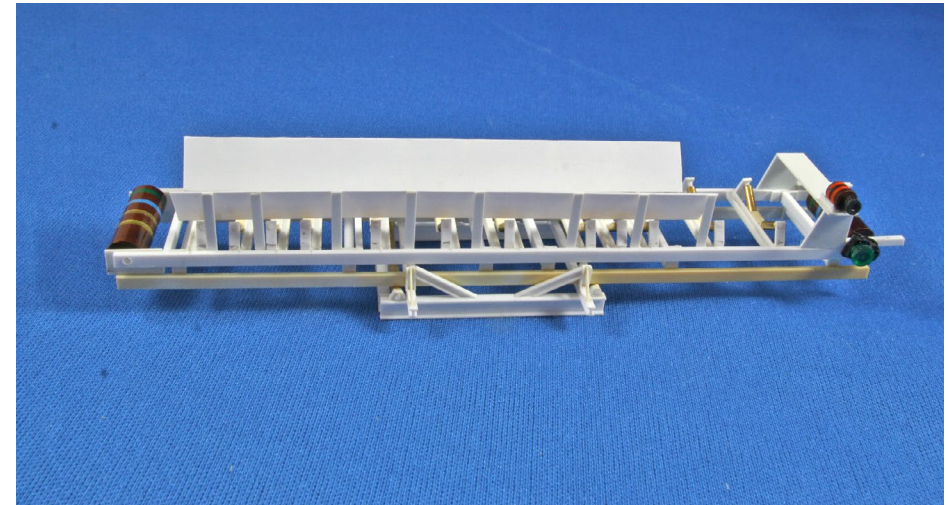

15. Right side of transfer conveyor with with cradle.

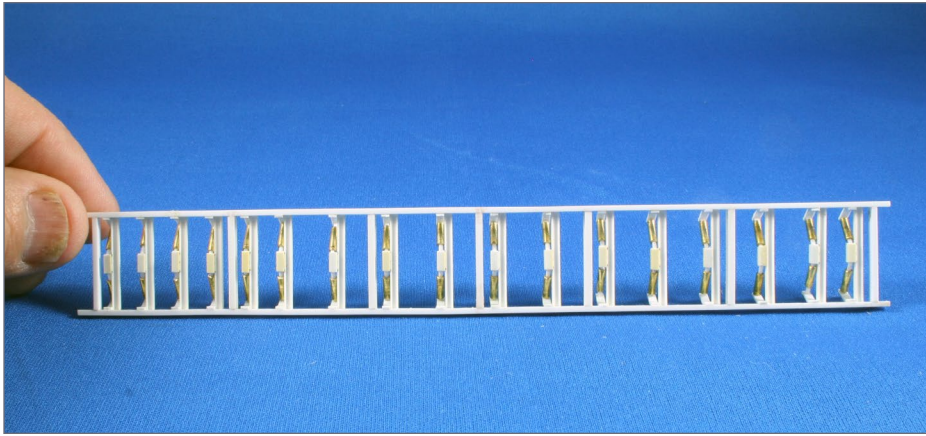

16. Main conveyor bottom view.

STEP 5: THE MAIN CONVEYOR

The main conveyor moves the coal from the crusher to the transfer belt. I made the main conveyor frame from Evergreen .040" x .080" styrene strip, 6' wide and 60' long.

I placed Evergreen #262 C-channels at 4' intervals except at the lower end of the conveyor, where they are only 2' apart. Evergreen .060" x .060" square strip, 12" long and drilled with a .060" size hole in both ends, was glued to the center of the channels.

I built the belt roller assemblies using Evergreen .020" x .060" strip, 2' long with an .040" hole centered 6" from one end. These were glued with the hole upwards to the inside of the conveyor frame. I cut 1/16" brass tubing into 18" pieces and placed over a piece of Evergreen .040" rod. I then fed the .040" styrene rod through the belt roller piece, into the end of the .060" strip and glued it.

When the glue set, I gently bent the .020" x .060" styrene roller piece over to square up with the .040" rod and then glued this end.

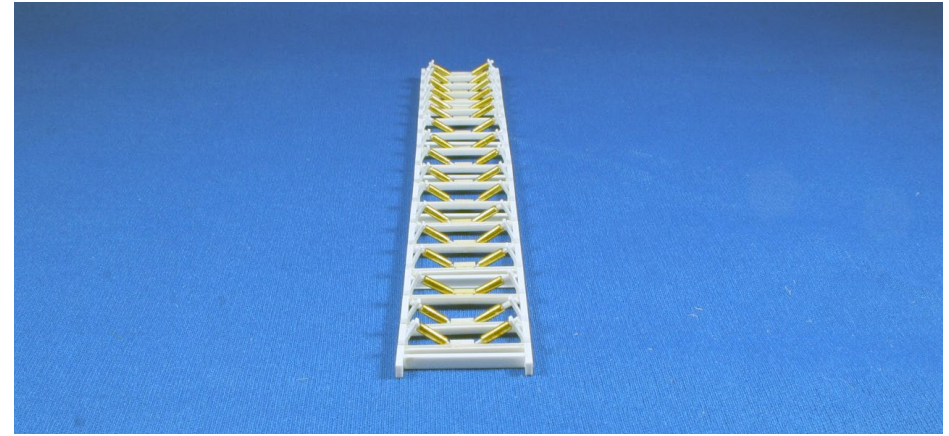

17. Main conveyor end view from the top.

A small bit of styrene cement (MEK) at the bend in the .020" x .060" styrene piece will soften the strip, making it less likely to crack or break.

When the glue set I trimmed off the excess .040" rod. For the belt drums on the ends I used carbon resistors. The drive motor assemblies are made from halved carbon resistors with Tichy Train Group pulleys. I used video cassette tape as the conveyor belt.

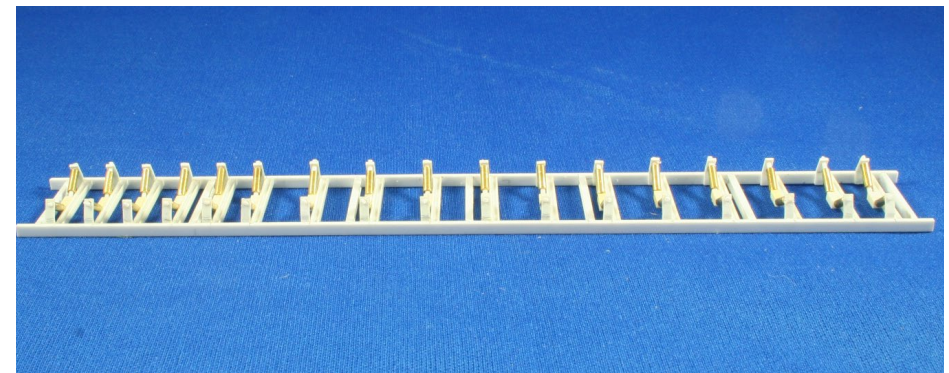

18. Main conveyor top view from the side.

SCHLESSER COAL LOADER | 15

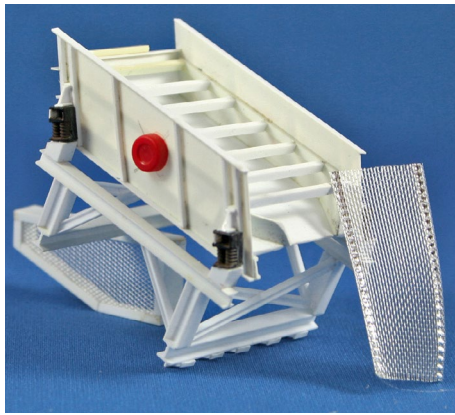

←19. Shaker screen assembly with screen material.

↓20. Close up of shaker screen in place.

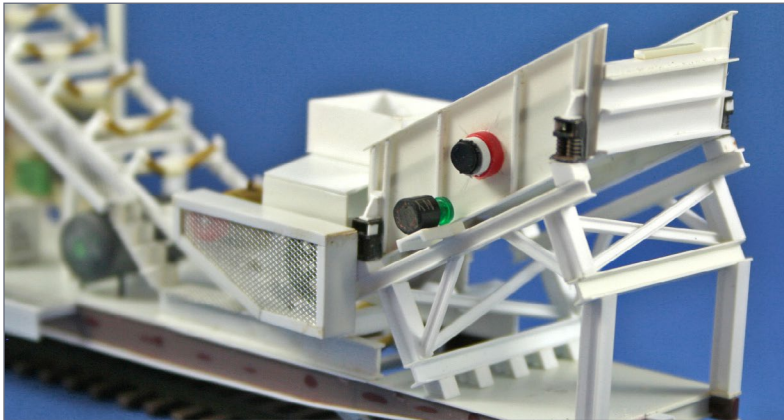

STEP 6: THE SHAKER SCREEN

I made the shaker screen assembly from .020" styrene sheet. The dimensions are 8' wide, 12' long, and 4' deep, angled at approximately 45 degrees.

I used a carbon resistor cut in half for the shaker motor. I made the flywheels from Kibri truck rims.

For the drive belts I trimmed video cassette tape to a scale four inches wide. For the screen itself, I used embroidery material.

HO CB&Q O-5 4-8-4

O-5, O-5A/B, EXCURSION (GOLD)



Get Ready for something special. Sunset Models is now in production of these fine scale HO models in "LIFE-TIME" Brass of the Burlington O-5s. Built to run on 30" Radius or larger, Each perfectly detailed model comes with a Precision Canon Motor drive, dual speakers and QSI's world renowned DC/DCC "Titan" System. Don't miss this production of only 120 models. Get the O-5 (Open Cab), O-5 a/b (Closed Cab, Convertible Oil / Coal Tender), or Brass Colored Excursion. This is the REAL DEAL. Only a few reservations left. Coming fall 2015.

Bonus - The tender on the O-5a/b is convertible with a removable oil bunker.

RESERVE AT OUR WEB SITE WWW.3RDRAIL.COM (CLICK HO SCALE)

SUNSET MODELS INC.

16 Beta Court · San Ramon CA · 94583 · 925-820-7701 · fax 925-820-7709 · www.3rdrail.com

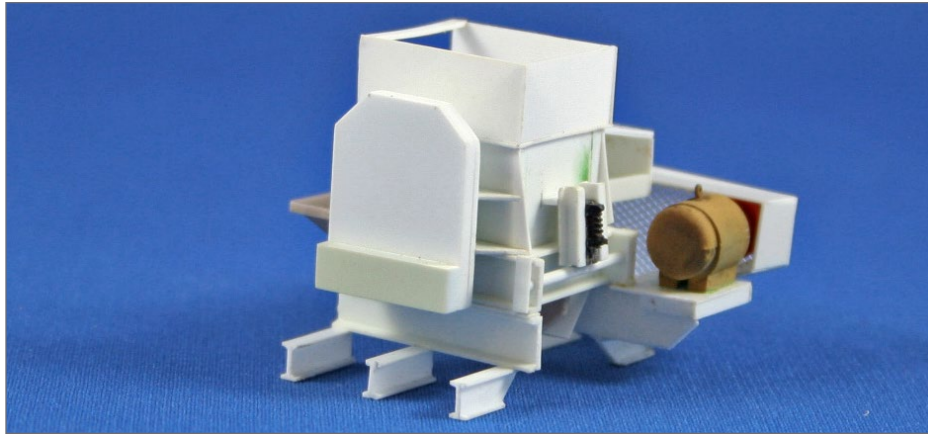

21. Crusher assembly right side.

STEP 7: THE CRUSHER

The crusher assembly is simply a box with all sorts of added pieces. The top opening is 4' x 4' and made with .010" styrene sheet. I made the main body from .020" styrene sheet. I used Evergreen I-beam #273, #274, #276, C-channel #263, #266, .040" rod, and .010" x .040" styrene strips for crusher mounts and framing.

I used a Plastruct M-2 motor with a Kibri truck rim as a pulley for the crusher drive. I took wheels from a Walthers small conveyor kit for the crusher drum pulley.

On the opposite side, I laminated two pieces of Evergreen .060" sheet together to form the crusher flywheel housing. I made the drive safety cover from Evergreen .010" sheet and Scale Scenics aluminum micro mesh.

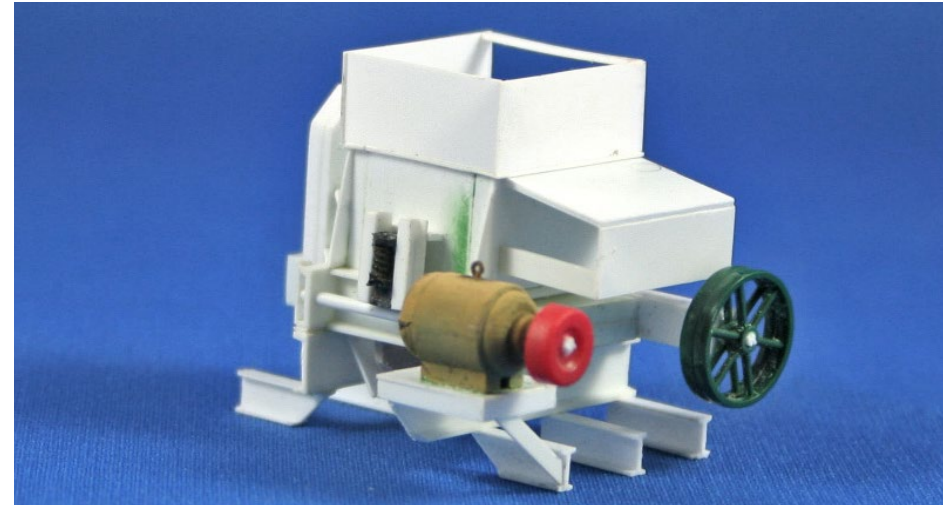

22. Crusher assembly, left side.

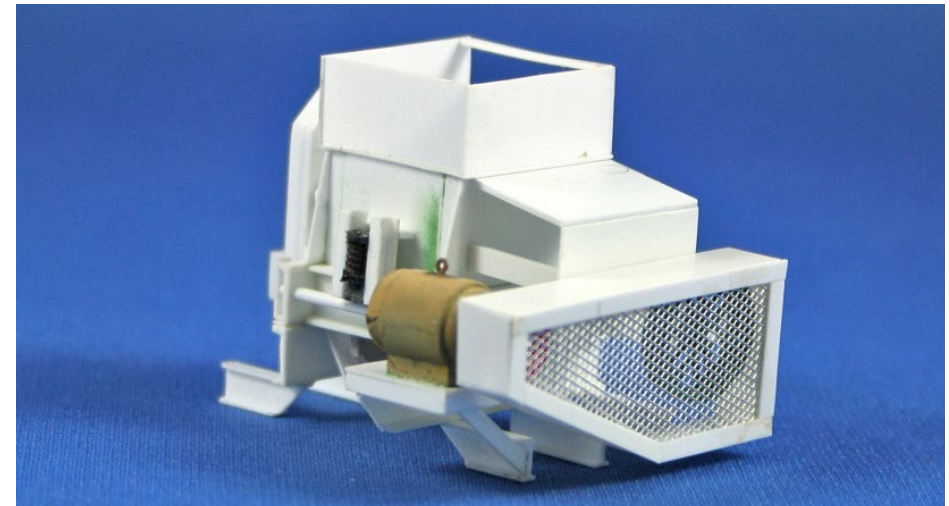

23. Crusher assembly with safety cage left side.

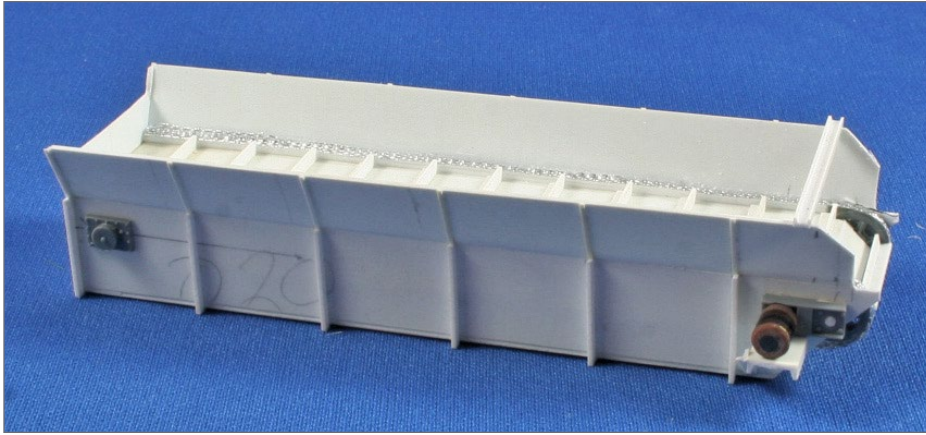

24. Trough conveyor right side

STEP 8: THE TROUGH CONVEYOR

The trough conveyor moves the coal from the receiving hopper to the shaker screen. It uses metal angles attached to a chain drive to move and break down the coal into smaller lumps. I constructed the conveyor with .020" styrene sheet, .010" x .040" and .040" x .060" styrene strip.

I made the chain drive from lace material purchased at a sewing store, guessing at the size. I also used the side portion trimmed from the ribbon material that I utilized for the screen on the shaker.

I made the electric drive motor from a carbon resistor cut in half. The gears are scavenged from the Tichy Trains 120 ton crane kit. I used Evergreen #291 angle as the lateral conveyor pieces.

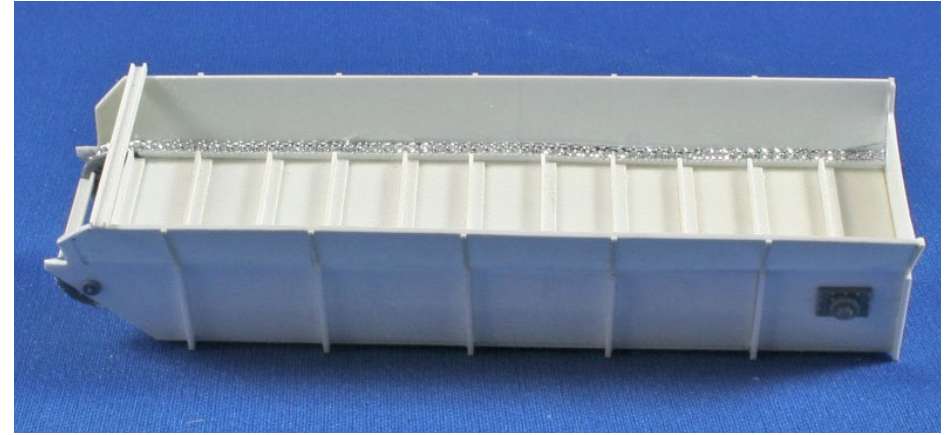

25. Trough conveyor left side



26. Trough conveyor with supports, left rear side.

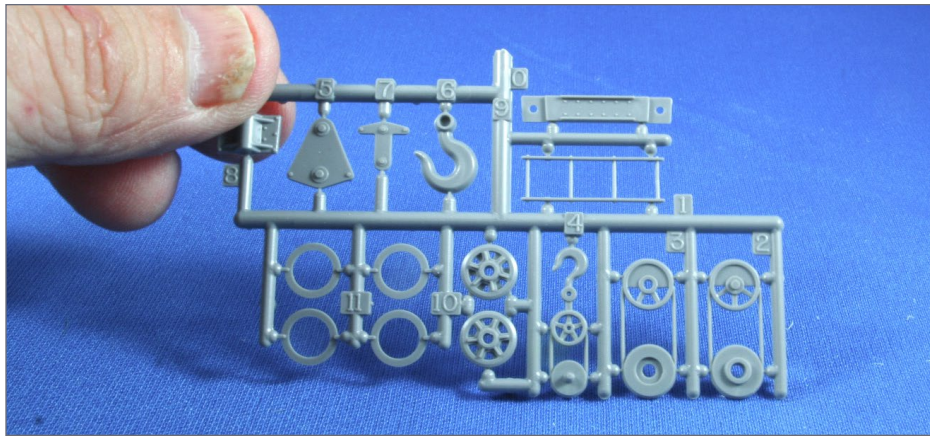

27. Tichy Train Group 120 ton wrecker crane parts that are used in different parts of the loader.

STEP 9: REMAINING DETAILS AND ASSEMBLY

At this point, the components need to be assembled and the remaining details added. The assembly that remains includes:

- Anti-freeze tank
- Diesel generator
- Miscellaneous details

I removed the pallet from the bottom of a LifeLike power plant and added a trimmed Plastruct M-2 motor and used that as the diesel generator.

I made the anti-freeze tank from two Walthers steel coils, laminated with .010" styrene sheet. The frame was made from Evergreen I-beam #273, #271, and .060" x .080" styrene strip. The bogey wheels are from a Durango Press spike puller. The anti-freeze pump is a modified Faller air conditioner unit.

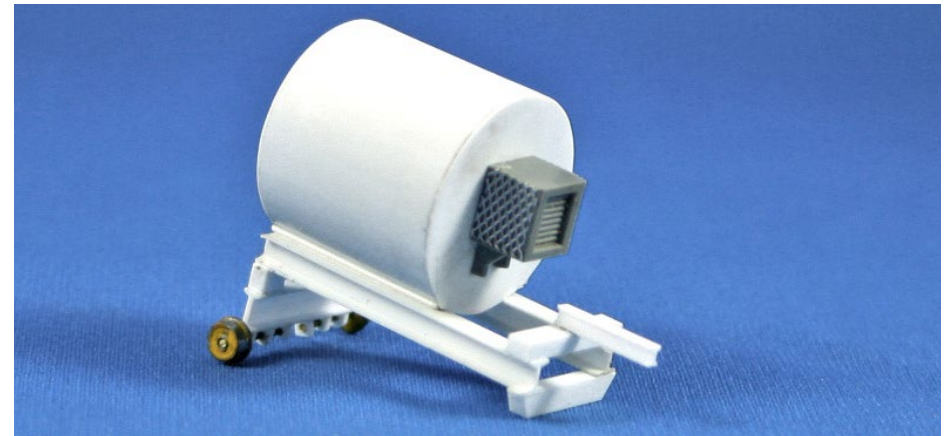

28. Anti-freeze tank assembly.

A Walthers small tank is used as the fuel tank. Evergreen .020", .030", and .040" rod are used for electrical conduit.

I used Campbell Scale Models corrugated siding for all roofs.

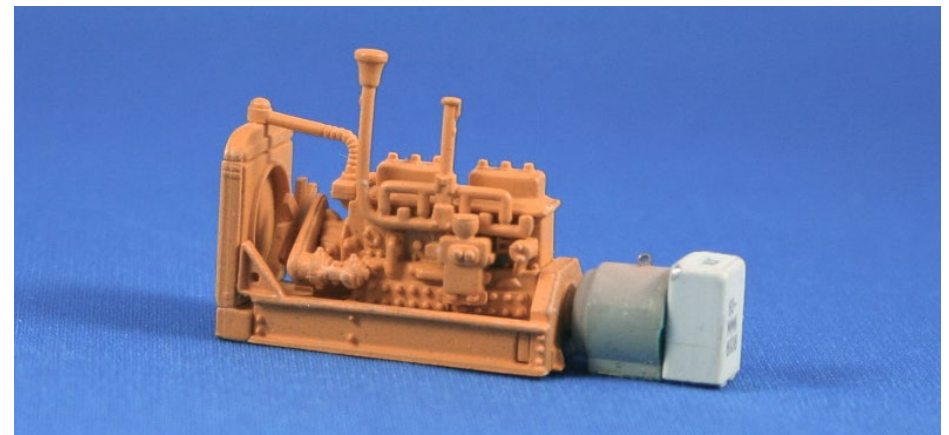

26. Diesel generator assembly.

More photos continue on the following pages ...



28. Machine deck with transfer conveyor added.



30. Diesel generator, and equipment in place.



29. Machine deck with main conveyor added.

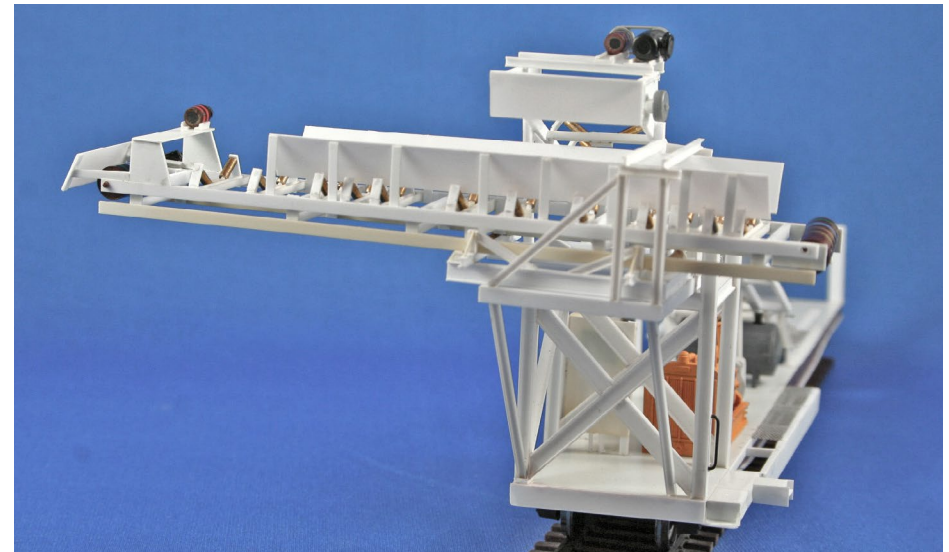

31. Another view of the transfer conveyor positioning.

Transfer conveyor

Main conveyor

Crusher

Diesel generator with
electrical cabinets

Shaker screen

32. The shaker screen, and crusher have been added. From left to right are the transfer conveyor, diesel generator with electrical cabinets, main conveyor, crusher and shaker screen.



33. The trough conveyor has been added and dumps into the shaker screen. The receiving hopper been not yet been added on the far right.

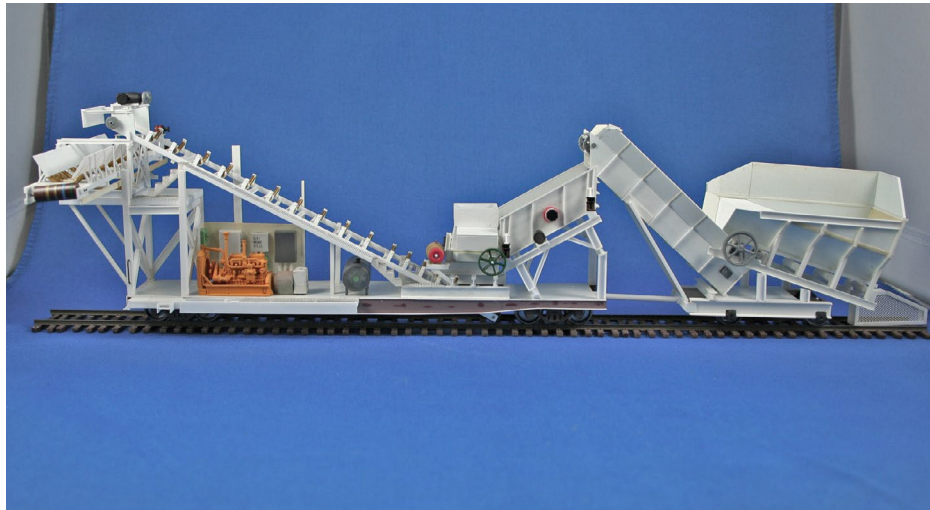

34. With the addition of the receiving hopper, the assembled machine is ready to paint.



35. I painted the finished model a light blue like the prototype, with safety yellow on the handrails.



36. The loader from the left rear with the cage removed.



37. Schlessor loader model, right front overhead view. ■



JOHN WILKES

John Wilkes has been active in modeling since the mid 1960s. John joined the NMRA in 1980, earning his Master Model Railroader certificate in 1993.

John and his wife Joyce have been married for 34 years and have 4 children and 6 grandchildren. He recently retired from GTE/Verizon after 41+ years. ■

BILL OF MATERIALS

Evergreen Scale Models:

C-channel	#261, #262, #263, #264, #266, #267
I-beam	#271, #272, #273, #274, #275, #276
H-column	#281, #282, #283, #284, #285
Angle	#291, #292, #293
Styrene rod	#209 (.020"), #210 (.030), #211 (.040), #221 (.047) #217 (Rod & Tube Assortment)
Styrene strip	#100 (.010 X .020), #102 (.010 X .040), #103 (.010 X .060), #104 (.010 X .080), #122 (.020 X .040), #123 (.020 X .060), #124 (.020 X .080), #142 (.040 X .040), #143 (.040 X .060), #144 (.040 X .080), #154 (.060 X .080), #165 (.080 X .100), #166 (.080 X .125), #175 (.100 X .100), #186 (.125 x .125)

Styrene sheet .010, .015, .020, .040, .060, .080

Tichy Train Group: Kit 4010 120 ton Steam Wrecking Crane

InterMountain Models: 33 & 36 inch semi scale metal wheels

Kibri: Miscellaneous truck rims

Plastruct: Motor M-2, Styrene stairs

Durango Press: Spike puller kit

LifeLike Scenic Masters: Power generator

Scale Scenics: Aluminum micro mesh

(List continues on the next page ...)

BILL OF MATERIALS (continued)

Campbell Scale Models: Corrugated siding

Detail Associates: 2506 .019 diameter brass wire
1/16 inch brass tube

Sewing materials: 1" twill tape

Offray: 5/8 inch ribbon screen #5820816
7/8 inch ribbon screen #10372076

Walthers: Small conveyor kit wheels, Steel coils kit,
54 foot GSC Commonwealth flat car kit

ADVERTISEMENT

Railroad Explorer Magazine

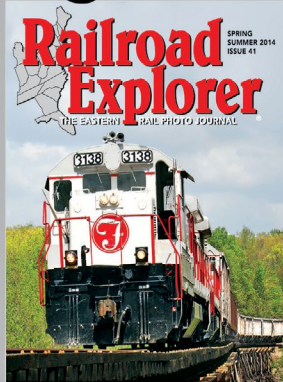
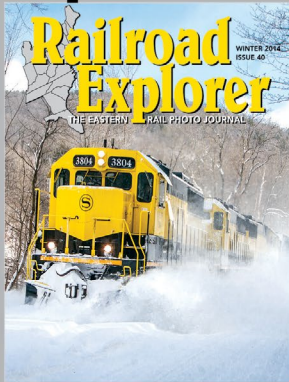
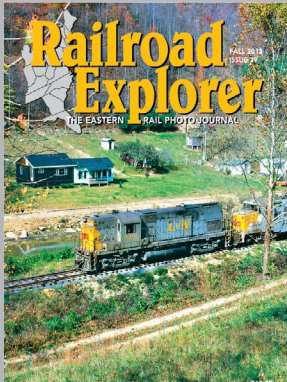

THE EASTERN RAIL PHOTO JOURNAL

- Three all-color issues per year. Exciting feature stories and spectacular photos of Eastern Railroading
- Best-in-class photo reproduction. Printed on heavy, glossy paper. Zero advertising.
- Three times per year - Winter, Spring/Summer and Fall editions.

Subscribe today!

www.railroadexplorer.com

Model Railroad Hobbyist Store

The NEXT digital Railroad Explorer is here!

Mike Confalone, editor of "Railroad Explorer", says of the digital edition, "Absolutely spectacular ... it's beyond impressive."

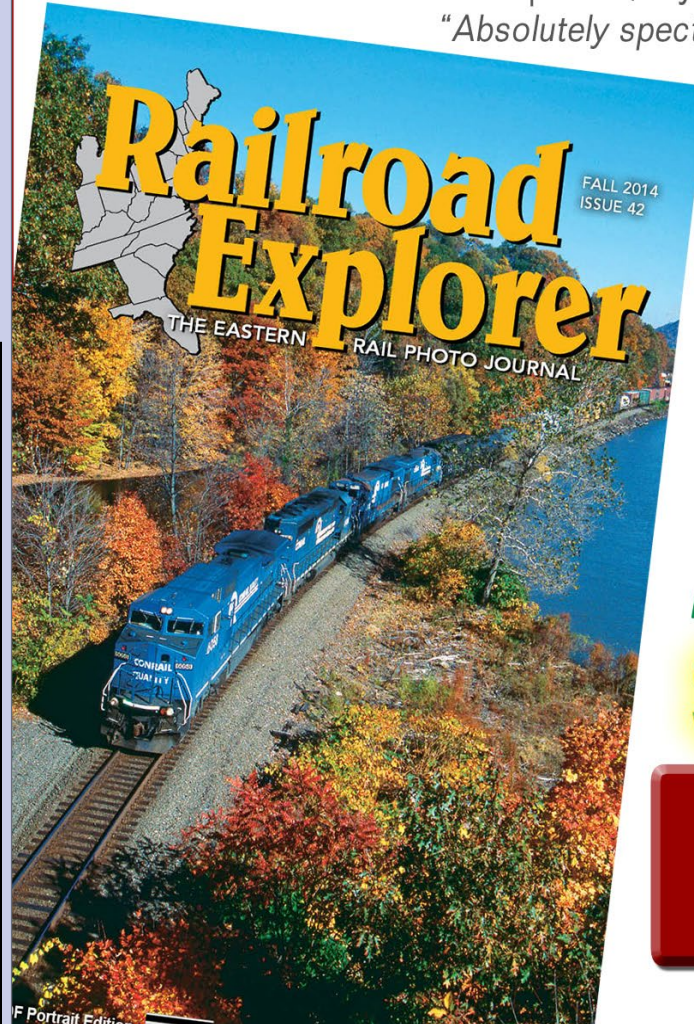

Seeing is believing:
Stunning photos of
eastern diesel era
prototypes

~~\$5.99~~

Instant download!

\$4.99

**Get it now
and SAVE**

- TABLE OF CONTENTS
- INDEX

SOUTHERN PACIFIC'S Lightweight streamlined cars: More than just the Daylight, Part 2

BY **V. S. ROSEMAN**

*Photos by V. S. Roseman
unless otherwise noted*

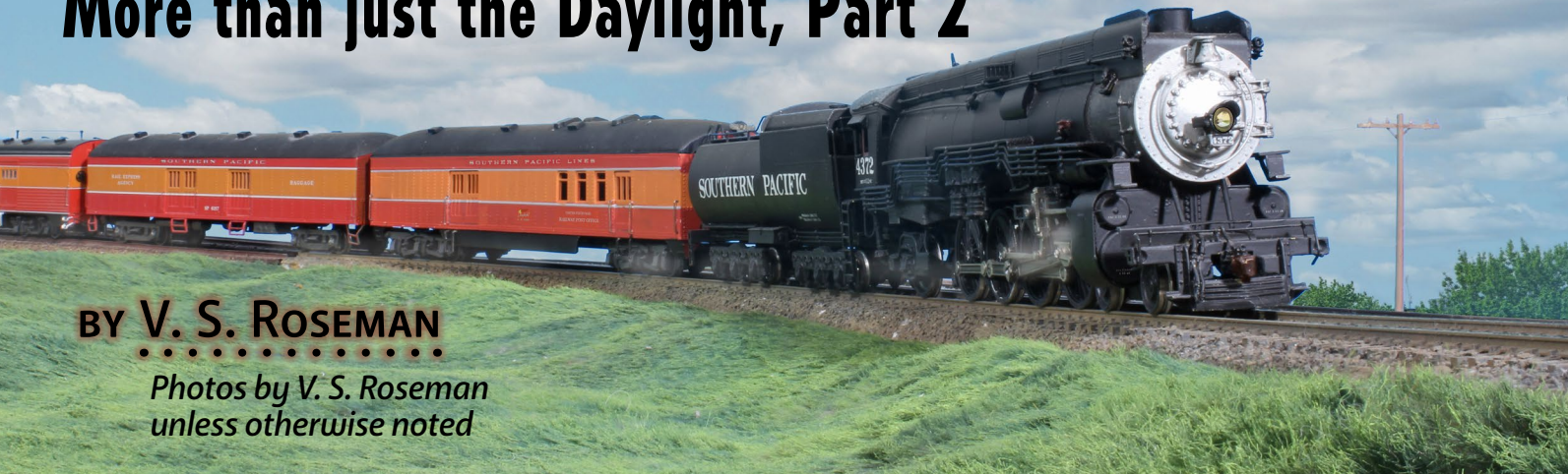

1. The 1946 San Joaquin Daylight with (left to right), a full baggage car, baggage/RPO car, and 4-8-2 Mountain locomotive with skyline casing.

PART 2: NEW STREAMLINERS

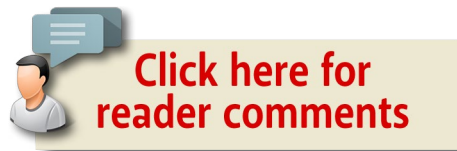

ADDED, AND THEIR OPERATIONS

SHORTLY AFTER THE DELIVERY AND INSPECTION of the first Daylight cars on the Southern Pacific, additional chair cars were ordered for the San Francisco Challenger on the Overland route to Chicago, and for the Californian on the SP-Rock

Island Golden State route between Los Angeles and Chicago. These cars arrived painted dark olive green with gold lettering, to match the heavyweight trains on which they would serve. Most would eventually be painted in the red and orange Daylight colors.

The new cars were immediately put into service in temporary assignments until their assigned trains were organized. The great success of the Coast Daylight had already encouraged the SP to begin planning new streamliners.

THE SAN JOAQUIN DAYLIGHT

Just across the bay from San Francisco is the city of Oakland, where the SP had a major terminal serving lines north and east, as well as the line to Los Angeles through the San Joaquin Valley. The valley line ran through Modesto, Merced, Fresno, and Bakersfield.

At the south end of the valley, the track traversed the Tehachapi Mountains to reach Los Angeles. On July 4, 1941, passenger service was upgraded when the new streamlined San Joaquin Daylight began operation as SP trains #51 and #52, with a consist generally similar to the Morning Daylight's.

PART 2 - SP PASSENGER TRAINS | 4



2. (Above) The San Joaquin continues with chair car, tavern, single chair car, and a baggage-chair car.

3. (Below) At the end of the San Joaquin are (left to right) the door of the last chair car, lightweight coffee shop car, heavy-weight diner, and articulated chair car pair.



While the coast line was considered to be the more scenic way to travel, the valley route featured a variety of desert panoramas with rich farmland vistas and the rugged views as the right of way twisted through the Tehachapi Mountains.

During the period of government regulation in the Second World War from January 1942 to April 1946 the Noon Daylight was discontinued. That train's triple unit food service cars (10250+10251+10252 and 10253+10254+10255) were reassigned to the San Joaquin Daylight. This released two single-unit

4. (Below) With no lounge car model available resembling 2920, I have used a Rivarossi 1920 series 12-1 sleeping car with round roof from MDC/Athearn cars in Daylight colors as a stand in, but this is stretching things. A Bachmann Spectrum sleeping car with its single end would be closer. Prototype car 2920 would have run from 1947 through early 1950s but does not show up in all consist listings.





5. Streamliner service on SP lines in California.

lightweight dining cars (10200, 10201) for relief service on other trains as required.

Baggage-express cars 6091 and 6092 in class 70-B-8 were modernized in 1941 with skirts and tapered roofs to harmonize with the San Joaquin's streamlined equipment.

A pair of Railway Post Office cars, 5069 and 5070 in class 70-BP-30-3, were also modernized with tapered roof and skirts and were assigned to the train. These cars were painted in Daylight colors. SP 5124, a non-modernized car in class 70-BP-30-2, was a protection RPO for the San Joaquin and was painted to match.

Photos taken at various times show other baggage and RPO cars on the train. In 1950 (and 1954) a total of three 80-foot horse cars were rebuilt into RPO cars for the San Joaquin in class 80-BP-60-1. All were painted in Daylight colors and similar 77-BP-60 cars rebuilt from old dining cars were seen on the San Joaquin Daylight.

In 1946, when wartime government restrictions were lifted, the Noon Daylight was reinstated and the triple-unit cars reverted to that train until it was discontinued in 1949.

The San Joaquin Daylight's cars included several that were released if a car on the Coast Daylight, City of San Francisco or some other trains needed a replacement car. It appears that the San Joaquin Daylight was at the bottom of the assignment priorities, for the train's lightweight cars were in protect service of various other streamliners. Heavyweight replacement cars were often called for service on the San Joaquin. These older cars were modernized with air conditioning and their interiors had been upgraded so they were virtually indistinguishable internally from the new lightweight cars. And on their heavy six

SAN JOAQUIN DAYLIGHT TRAIN #51, 52 JULY, 1941 INAUGURAL CONSIST

INCLUDES TRAINS #51/53, 52, 54 LOS ANGELES TO SACRAMENTO



THIS DIAGRAM IS BASED ON W. GORDON ANDERSON'S ARTICLE IN MAINLINE MODELER MAGAZINE, MAY, 1988 AND REPRODUCED IN "MY ESPEE MODELERS ARCHIVE" (<http://espee.railfan.net/san-joaquin.html>)

SAN JOAQUIN DAYLIGHT #51, 52 CONSIST CHANGES LATE JULY-AUGUST, 1941

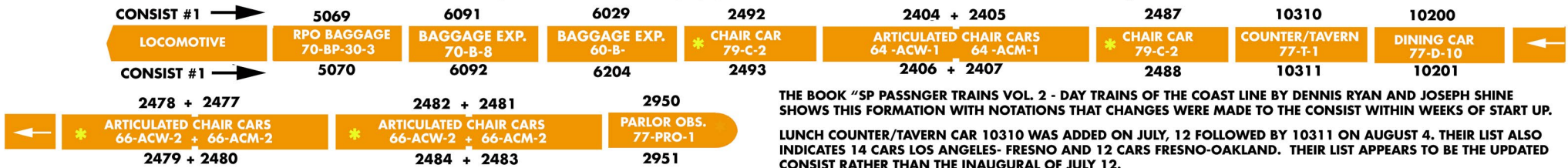

THE BOOK "SP PASSENGER TRAINS VOL. 2 - DAY TRAINS OF THE COAST LINE BY DENNIS RYAN AND JOSEPH SHINE SHOWS THIS FORMATION WITH NOTATIONS THAT CHANGES WERE MADE TO THE CONSIST WITHIN WEEKS OF START UP. LUNCH COUNTER/TAVERN CAR 10310 WAS ADDED ON JULY, 12 FOLLOWED BY 10311 ON AUGUST 4. THEIR LIST ALSO INDICATES 14 CARS LOS ANGELES- FRESNO AND 12 CARS FRESNO-OAKLAND. THEIR LIST APPEARS TO BE THE UPDATED CONSIST RATHER THAN THE INAUGURAL OF JULY 12.

SAN JOAQUIN DAYLIGHT TRAIN #51, 52 JANUARY 1942-APRIL 1946 (WARTIME CONSIST)

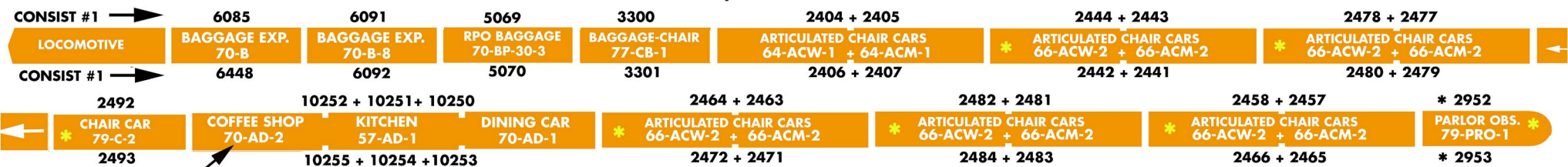

TRIPLE UNIT FROM THE NOON DAYLIGHT WHEN THAT TRAIN WAS DISCONTINUED

RPO BAGGAGE CAR ROUTED TO FRESNO ENROUTE TO SACRAMENTO IN 1941, JANUARY 5, 1942 RE-ROUTED TO OAKLAND. FIRST BAGGAGE-EXPRESS CAR RUNS TO SACRAMENTO TILL JULY, 1943, THEN BOTH BAGGAGE CARS REPLACED BY ARTICULATED CHAIR CAR PAIR.

* PARLOR OBSERVATION IS REPLACED WITH CHAIR CAR (2487, 2488) IN JUNE, 1942 - PARLOR OBSERVATION RETURNS JULY, 1943

6. Diagram of the San Joaquin Daylight in 1941 and 1946.

wheel trucks, the ride of these older cars was described to me as "like a Cadillac."

In February of 1947 a collision with a gasoline truck at Kingsburg CA destroyed some of the San Joaquin Daylight's cars. After this time, the two consists for the train were no longer identical.

The lightweight tavern car was wrecked and was replaced by heavyweight lounge car 2920. The lounge seats were sold as

parlor seating until October of 1947, when first class parlor seating was discontinued on the train. In 1955 this car was assigned to the Starlight, and in 1956, lounge car 3232 (class 75-CS-2) lounge was assigned to the train. Photos show various other lounge cars, mostly in the same classes, in San Joaquin service during these time periods.

Heavyweight dining cars including 10144, 10148, 10156 were often spotted on the train, as were lightweight coffee shop cars 10400, 10401 and lightweight tavern-lunch counter cars 10310,



7. By 1956, the San Joaquin has engine 4460, a GS-6 wartime-built 4-8-4 on the point.

10311. (for more details see Ryan and Shine “SP Passenger Trains, Volume 2: Day Trains of the Coast Line,” page 194) The consist of the San Joaquin was usually 13-14 cars.

The heavyweight food service cars on the San Joaquin Daylight lasted as late as 1962 and were among the last passenger-carrying heavyweight cars on SP trains. (See the book “Southern Pacific Passenger Cars, Vol. 5,” pg. 192-3 and the modeling section of this article).

In 1954 the triple food service units were sent into the shops for conversion to hamburger grills featuring simpler menus and needing a smaller staff than previously. The conversion of one set(#10250+10251+10252) was never completed. In 1955 dome lounge cars were assigned to work as lounge cars along with the heavyweight lounge cars such as 2980.



8. The San Joaquin Daylight has (left to right) chair cars, a class 80-BH-1 ex-horse car in sealed sack mail and express service, and a Railway Post Office/baggage car.



9. Farther back in the 1956 San Joaquin (left to right) are part of a chair car, a heavyweight lounge car, a dining car, hamburger grill car, and portion of a lightweight chair car.

SAN JOAQUIN DAYLIGHT #51, 52 AND SACRAMENTO DAYLIGHT #51-53, 52-54 1947 POSTWAR CONSIST

CAR NUMBERS ARE EXAMPLES ONLY →



* IN JUNE, 1946 THE SP INAUGURATED A THROUGH LOS ANGELES-SACRAMENTO STREAMLINER BY SPLITTING OFF THE LAST FIVE CARS OF TRAIN #51, 52 AT LATHROP. THE SACRAMENTO DAYLIGHT CARS WERE ADDED TO EXPRESS CARS AND A HEAVYWEIGHT COMBINE THAT ORIGINATED AT TRACY.

ON FEBRUARY 4, 1947 THE SAN JOAQUIN DAYLIGHT HIT A TRUCK AT KINGSBURG, CA. AFTER THIS TIME THE TWO CONSISTS WERE NO LONGER IDENTICAL. WRECKED TAVERN CAR 10310 WAS REPLACED WITH HEAVYWEIGHT LOUNGE CAR #2920 PAINTED IN DAYLIGHT COLORS TO MATCH THE TRAIN

SAN JOAQUIN DAYLIGHT #51, 52 AND SACRAMENTO DAYLIGHT #51-53, 52-54 PEAK TRAFFIC PERIOD 1958

CAR NUMBERS ARE EXAMPLES ONLY →

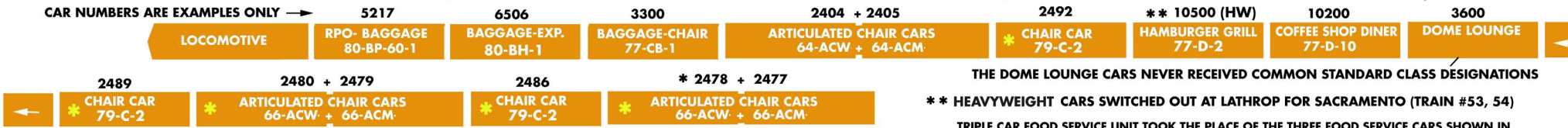

THE DOME LOUNGE CARS NEVER RECEIVED COMMON STANDARD CLASS DESIGNATIONS

** HEAVYWEIGHT CARS SWITCHED OUT AT LATHROP FOR SACRAMENTO (TRAIN #53, 54)

TRIPLE CAR FOOD SERVICE UNIT TOOK THE PLACE OF THE THREE FOOD SERVICE CARS SHOWN IN ALTERNATE CONSIST.

HARRY STEGMAIER'S BOOK INDICATES AN ADDITIONAL BAGGAGE-EXPRESS CAR OPERATED WESTBOUND, TUESDAYS ONLY

SAN JOAQUIN DAYLIGHT #51, 52 AND SACRAMENTO DAYLIGHT #51-53, 52-54 OFF PEAK TRAFFIC PERIOD 1958

BY THIS TIME CHAIR CARS WERE UTILIZED FROM THE DAYLIGHT POOL AS AVAILABLE. DINER AND LOUNGE CARS WERE CHANGED AS NECESSARY.

CAR NUMBERS ARE EXAMPLES ONLY →



* CARS SWITCHED OUT AT LATHROP FOR SACRAMENTO (TRAIN 53, 54)

IN THE 1960S THERE WAS A SLOW ATTRITION OF EQUIPMENT. IN 1961 AUTOMAT CARS REPLACED OTHER FOOD SERVICES. BY THE END OF THE 1960S THE POST OFFICE DEPARTMENT TERMINATED THE RPO CONTRACT, WHICH HAD BEEN THE MAIN SOURCE OF REVENUE FOR THE TRAIN. PHOTOS SHOW ACTUAL TRAIN CONSISTS (1968 EXAMPLE) WITH A BAGGAGE-EXPRESS CAR, ONE PAIR OF ARTICULATED CHAIR CARS AND A BOAT TAIL CHAIR CAR. IN THE LATE '60S THROUGH CARS TO SACRAMENTO WERE REPLACED WITH CROSS PLATFORM TRANSFER. THIS OPERATION RAN TILL AMTRAK TOOK OVER IN 1971.

HARRY STEGMAIER'S BOOK INDICATES AN ADDITIONAL BAGGAGE-EXPRESS CAR OPERATED WESTBOUND, TUESDAYS ONLY

10. San Joaquin Daylight diagrams for 1947, 1958.

The heavyweight equipment was often either two-tone gray or green and by about 1958 the train usually had at least two-tone gray or olive green cars on any given day. Beginning in 1958 lightweight cars were stripped and refinished in stainless steel with red stripe so the train was even more mixed. By the mid '60s, San Joaquin cars were all stainless with red letterboard stripe, into the train's final years.

In 1961 automat cars began service on the San Joaquin Daylight. The train ran this way until the end of private railroad operation in 1971, and in its last years was usually just a baggage car, the automat car and a few chair cars.

Today, Amtrak serves the San Joaquin Valley from Oakland to Bakersfield with motor coach connections to Los Angeles and San Diego. Today there are a total of 14 trains in both directions, including two L.A.-Fresno trains.



11. San Joaquin Daylight behind three F7 units, arriving Fresno en route to Los Angeles, 1955.



12. Chair cars, baggage combine and Railway Post Office car of the '55 consist of the San Joaquin.



13. San Joaquin for 1955 with (from left) silver chair cars, coffee shop car, dome car and articulated chair car pair.

This description is a very condensed version of changes that took place on the San Joaquin Daylight.

The following link to “My Espee Modeler’s archive” shows additional consists at various times through the San Joaquin Daylight’s history:

espee.railfan.net/san-joaquin.html

David Coscia’s SP site has a page listing the heavyweight cars that were painted in Daylight colors:

coscia-espee.info/sp_daylight.html



14. The Sacramento Daylight circa 1946 with one mail and express car, combine, and two Daylight-type chair cars followed by (out of photo) one more chair car.

SACRAMENTO DAYLIGHT

Shortly after the end of government wartime restrictions in 1946, two new services were instituted between Los Angeles and Sacramento. The Los Angeles to Portland, OR “West Coast” was cut back and was rerouted to become a direct overnight train between Los Angeles and the state capitol at Sacramento. A new daytime through service was started between these two cities, the Sacramento Daylight #53, 54.

Unlike the other Daylights, there was only a single consist. The 57-mile route from Lathrop, where the train was split from the San Joaquin Daylight, only took about two hours end to end, and made both the east and westbound runs on the same day.



15. The Sacramento Daylight, still behind steam with heavier mail and express consist, circa 1947 en route to its namesake city.

The inaugural train ran with a 4-8-2 (MT-4 4363, not the usual power), rebuilt heavyweight combine (3176), coffee shop diner (10400 or 10401), three lightweight Daylight-type chair cars, and a parlor observation car (2950 or 2951).

The parlor observation car was discontinued in 1946, replaced by an additional lightweight chair car. In 1949, triple-unit dining cars from the discontinued Noon Daylight were assigned to the San Joaquin Daylight, and food service for the short run on the Sacramento Daylight was discontinued.

Shortly after the inception of trains 53 and 54, the mail train on this route (261/262) was discontinued.



16. By the mid '50s the Sacramento Daylight was dieselized. It is shown here with passenger-equipped GP9 5603, a combine, and an articulated chair car pair.



17. The Lathrop to Tracy segment of the Sacramento Daylight after transferring its chair cars to the San Joaquin Daylight.

Sacramento Daylight absorbed this mail and express, sometimes carried in the combine but often in varying numbers of storage mail cars. An RPO car appears in photos of this train.

Express traffic was extremely seasonal and ran heavy before Christmas along with extra cars of mail. Traffic was also heavy at the start and end of the summer when steamer trunks for children at camp or families going to or from vacation loaded the trains.

From the start of the service, Sacramento Daylight equipment originated daily at Tracy where there were servicing facilities. Equipment ran to Lathrop, where the train dropped off some express cars and met the San Joaquin Daylight from Los Angeles. Chair cars were cut off the San Joaquin and were turned and added to the Sacramento Daylight, running through to Sacramento.

Atlantics 4-4-2 3000 and 3001 were usually assigned to the train until they were scrapped in 1950. For the remainder of the years of steam, typical power was a P-8 or P-10 heavy Pacific 4-6-2 such as 2484 or 2486 (with skyline casing) or 2475 (without the skyline casing) Diesels took over the run around 1956. Descriptions indicate that almost any engine from the San Jose commute pool might have run on the Sacramento Daylight.

The usual diesel power on the train was a dual-control steam boiler-equipped GP9 which began as T&NO 283, was renumbered to 3422, and later to 3010 and finally 3191. The engine was in black widow colors at least until 1960. An SD7 such as 5308 was also frequently used.

Combine 3176 was retired in 1961, and was replaced by baggage-club car 3076, (painted two-tone gray) in use as a baggage chair car.



18. In its last years, the Sacramento Daylight consist was usually all lightweight with rebuilt Daylight-type chair cars and baggage chair, here approaching Lathrop circa 1966.

Car 3079 is shown in 1961 in "SP Technical Historical Society Passenger Cars" volume at Lathrop, probably in Sacramento Daylight service.

A consist photographed during 1966 (SP Trainline magazine, Summer 2012, page 16) shows a lightweight baggage-chair car built for the Daylight now in regular service on the Sacramento Daylight. By this time the car had been rebuilt with a new recessed sliding door with single window and flat stainless steel replacement sides.

The SP similarly rebuilt a prewar lightweight Daylight chair car and a postwar Shasta-type tall window chair car. Lightweight combines may have operated on the train as early as 1962.

In 1968 Railway Express ceased its shipping express on passenger trains. From about this time to the start of Amtrak in 1971, the consist was usually the lightweight combine and one or two chair cars. In the last years, #3006, a GP-9 "torpedo boat" dual

control engine in bloody nose red and gray colors was typical power for the 353/3. 54.

With the decline in ridership by the 1960s, the through service to Sacramento was discontinued, and passengers from Los Angeles walked across the platform to the connecting train at Lathrop. In May, 1970 the connection point was changed to Tracy. The Sacramento Daylight lasted until May, 1971 when Amtrak took over operation of intercity passenger services.

LATHROP, CALIFORNIA

When the San Joaquin Daylight from Los Angeles reached Lathrop, the rear cars were cut off and were joined to the equipment from Tracy en route to Sacramento. These trains entered Lathrop from opposite directions. The Tracy-Lathrop mail and express cars were dropped, and the chair cars and express cars to Sacramento were turned on the wye tracks using the road engine.

The operations at Lathrop on the Sacramento Daylight and San Joaquin Daylight could be the basis for a whole model railroad. The wye at Lathrop, one terminal such as Sacramento, and either one or two loops representing Los Angeles (or Fresno) and Oakland are one possibility for such a layout.

The sketch of Lathrop illustrates the eastbound operation. It is possible that this involved method of turning the cars was due to some established railroad procedure, safety rules or work rules, for there are simpler ways to set the through cars in the right direction.

This operation is described in detail, and illustrated with photos in the SP Historical Society Magazine "SP Trainline" the publication of the Southern Pacific Historical and Technical Society, Issue #72 Summer, 2002 and #112 Summer, 2012.

SWITCHING OPERATION AT LATHROP, CALIFORNIA

Showing the Northbound San Joaquin Daylight and Sacramento Daylight trains

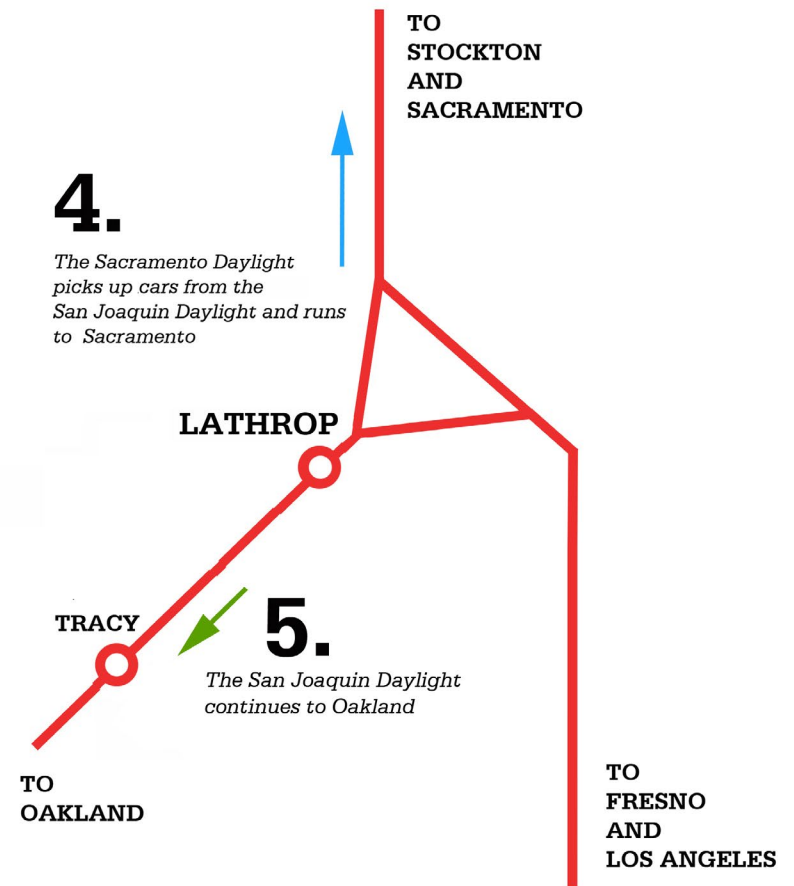
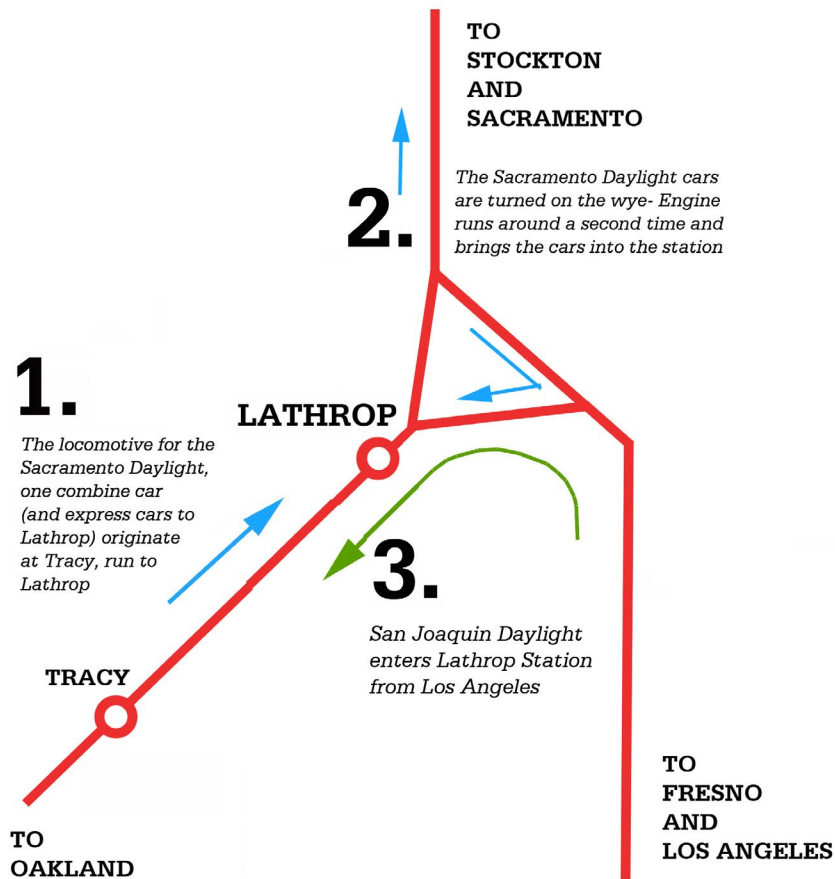

Southbound trains to Los Angeles are combined at Lathrop in similar sequence.

19. Sketch of operation at Lathrop, switching cars of the Sacramento Daylight.

Additional information is available online at the following links: Southern Pacific Passenger Train Consists - San Joaquin Daylight 51/52

Links to Karl Swartz's Southern Pacific website are:

espee.railfan.net/san-joaquin.html

www.kls2.com/~karl/rr/sp/sp-sjd-1957.html

THE STARLIGHT

The San Francisco-Los Angeles Lark provided an all-first class overnight service on the Coast Line, while the Coaster was a night coach accommodation operating for many years on this line with a heavyweight formation.

In October, 1949, the Coaster was replaced with a new overnight luxury coach streamliner, "The Starlight," #94, 95.

With the discontinuation of the Noon Daylight, many of the lightweight cars were

20. The Starlight's Alco PAs with, baggage, express, and chair cars circa 1950.



moved to the Starlight. This train had a coffee shop diner and tavern lounge that were open all night, very deluxe equipment for an overnight train. Lightweight food service cars were used as available.

The schedules of the Starlight and Daylight were coordinated to permit a car from either train to be quickly cleaned and sent out on the other when necessary.

At the start, the Starlight had a parlor car, 3000 straight parlor, or 2951 parlor observation. These were intended to provide

THE STARLIGHT TRAIN #94, 95 PEAK TRAVEL PERIOD JUNE, 1950

IN OCTOBER, 1949 THE STREAMLINED OVERNIGHT ECONOMY ALL COACH STARLIGHT TRAIN REPLACED THE EARLIER COASTER BETWEEN LOS ANGELES AND SAN FRANCISCO (VIA COAST LINE)



FLUCTUATIONS IN RIDERSHIP BROUGHT AN ELABORATE SERIES OF CHANGES IN THE CONSIST WITH SOME CARS OPERATING "AS NECESSARY" FOR PART OF THE YEAR OR EVEN FOR PART OF THE WEEK ONLY.

IN FEBRUARY, 1952 THE 12-1 HEAVYWEIGHT SLEEPING CAR WAS REPLACED BY LIGHTWEIGHT 12 DUPLEX ROOM-5 BEDROOM CAR. THESE SLEEPING CARS WERE SHUFFLED REPEATEDLY BETWEEN THE STARLIGHT AND OTHER TRAINS.

THE STARLIGHT TRAIN #94, 95 OFF PEAK TRAVEL PERIODS 1950 (OCTOBER 1 - JUNE 15)



ONE ADDITIONAL ARTICULATED CHAIR CAR PAIR PLUS ONE ADDITIONAL STAND ALONE CHAIR CAR ADDED FRI., SAT., SUN.

IN THE TIME PERIOD 1951-1955 THE STARLIGHT HAD 10 TO 16 CARS.

BY 1955-1956 RIDERSHIP FELL OFF AND THE TRAIN RAN SHORTER CONSISTS.

THE FINAL CONSIST WAS ONE ARTICULATED CHAIR CAR PAIR, TAVERN-SNACK-LOUNGE CAR PLUS BAGGAGE-EXPRESS CARS.

IN 1957 THE STARLIGHT WAS COMBINED WITH THE LARK

20. Diagram for the overnight luxury chair car streamliner Starlight in 1950

fast first class early morning and evening service between Los Angeles and Santa Barbara/Ventura and at the other end of the line between San Jose/Palo Alto and San Francisco. The cars did not prove popular and only lasted a month till October 31, 1949.

In 1953 there were changes to the car assignments too complicated to describe in full detail here. Essentially, while the feature cars ran at all times, the Starlight's summer consist included five articulated chair car pairs operating June 15th to October 15th.

There was a wintertime consist for weekdays, Monday through Thursdays only with just two articulated chair car pairs. There was a Friday through Sunday weekend setup with three articulated chair car pairs.

In the high ridership period from Christmas to New Years, cars were added as necessary up to an 18-car train. Ryan and Shine's "Passenger Trains of the SP Coast Line, Volume I, Night Trains" describes all this in greater detail.

Lightweight cars in dark olive green or two-tone gray were often used on the Starlight, although these were gradually being painted in Daylight colors.



21. Starlight showing (from left) the lounge car, coffee shop, green 12 section 1 drawing room sleeper, with 12 single room and 5 roomette lightweight duplex sleeper that was sometimes assigned to the train.

Sleeping cars on the Starlight were not shown in public timetables, but it is well documented that they handled overflow first class passengers from the Lark.

The train was assigned two heavyweight sleeping cars, an 8 section-5 double bedroom car, and a 12 section-1 drawing room car. 12 duplex room-5 bedroom cars sometimes replaced the 12-1 car. These lightweight 12-5 cars (9250, 9251) were transferred from the City of San Francisco train and came to the Starlight still painted in UP style yellow in February, 1952.

In August of 1953, 12-5s were painted two-tone gray and were assigned to the San Francisco Overland. In February 1954 they were moved to the West Coast train until they were moved back

to the Starlight in April, 1954 where they remained until their removal in August, 1955.

In 1956, chair cars were added experimentally to the traditionally all-Pullman Lark. In 1957, the Lark was reconfigured with feature cars for chair car passengers. The Starlight was finally discontinued in July, 1957. When the Lark's mail contract was withdrawn by the U.S. Post Office in 1968 the train was discontinued, ending overnight passenger service on the Coast Line between San Francisco and Los Angeles.

In Part 3 next month, I'll cover the Overland Route and the City of San Francisco.

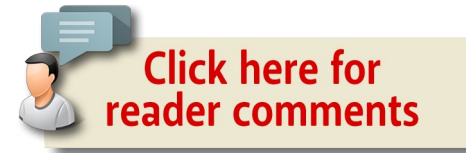

VICTOR ROSEMAN

Victor got his first train, a Lionel, at age 3. Victor graduated from the Pratt Institute with BFA and MS degrees and taught fine arts in high and junior high school for 30 years and is now retired.

Victor has written many articles and several railroad related books over the past 35 years. He's also done many freelance projects for Walthers, Atlas and other model manufacturers. ■



SWEET HOME CHICAGO NORTHWESTERN

NEW ANNOUNCEMENT NEW HEP AND B-UNIT GENESIS GP9 LOCOMOTIVES

Chicago Northwestern was a pioneer in developing Head End Power (HEP) for their commuter operations. It powered bi-level commuter cars air conditioning, lighting, and heating. This method quickly became the standard replacing steam generators and continues to be employed by passenger railroads to this day.

Athearn brings back the CNW HEP GP9's, both high and chop nose, as Athearn Genesis in HO scale!

- Era: 1961+ CNW HEP
- Brand new tooling
- Separately installed wire handrails and wire grab irons
- Fully assembled
- Etched metal fan grille
- Razor-sharp printing and painting
- McHenry® scale knuckle spring couplers
- Machined metal wheels
- Minimum radius: 18"



CNW specific HEP equipment blisters on the rear nose.



HORIZON
H O B B Y

VISIT
Your Local Retailer

CLICK
Athearn.com

CALL
1.800.338.4639

SERIOUS FUN®

©2015 Horizon Hobby, LLC. Athearn, Genesis, Ready To Roll, Trains in Miniature, Serious Fun and the Horizon Hobby logo are trademarks or registered trademarks of Horizon Hobby, LLC. The Union Pacific mark and other marks owned by Union Pacific are made under trademark license from Union Pacific Railroad Company. All other trademarks, service marks and logos are property of their respective owners. Final models may vary slightly from photos shown. 4/6/15

Model Railroad Hobbyist | February 2015 | #60

FEBRUARY NEWS

column

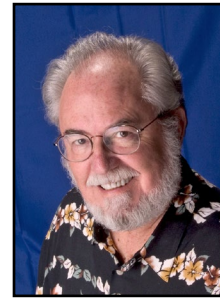

RICHARD BALE *and* JEFF SHULTZ



**Click here for
reader comments**

Rod Goodwin 1937-2014

Roderick Allan Goodwin of Almonte, Ontario, passed away December 24, following a lengthy battle with MDS. Goodwin, a native of Nova Scotia, was 77 years old. Goodwin was an enthusiastic model railroad hobbyist throughout his adult life. He was an active member of the Ottawa Valley Associated Railroaders and the Mississippi Valley Associated Railroaders. He maintained an online index (the-railroad-index.com/rd_item_control.php) of various hobby magazines including Model Railroad Hobbyist. Goodwin was a respected computer consultant throughout his career, working with such companies as Commercial Cable, Formex, IBM and the Department of National Defense, as well as consulting across the United States. Rod Goodwin is survived by his wife Betty (Lilly), three daughters Margie, Barb, and Becky, and three grandchildren.

▶ THE LATEST MODEL RAILROAD PRODUCTS, NEWS & EVENTS

Tom Muella 1936-2014

Tom Muella, founder of Muella Scale Models, passed away in October at his home in Richlands, NC. Muella was 78 years old. His company offered a selection of cast-resin structures and scenic detail items ranging from HO to ½” scale. Muella also produced castings for other model railroad manufacturers.

Auto accident takes A-West owners

Terry Westbrook and his wife Charlotte, residents of Kennesaw, GA., passed away August 2, 2014. They were in a traffic accident while traveling on vacation in Nevada. The Westbrooks owned A-West, a supplier of specialized hobby tools including plastic syringes, latex molding materials, weathering /antiquing solutions, and stainless steel needle-point applicator bottles. The Westbrooks are survived by sons Perry and Tim; daughters Pamela, Tonya, and Kami; six grandchildren, and five great grandchildren.

Hendrickson collection to CSRM

The entirety of Richard Hendrickson’s vast collection of freight car photos and other support material has been donated to, and accepted by, the California State Railroad Museum in Sacramento.

Acceptance insures that the collection will be cataloged, maintained, and available to researchers. The collection includes most of Hendrickson’s books, including ORER and Cyclopedia copies, his sets of freight car diagrams, and his

many folders of research notes. Tony Thompson, who oversaw the transfer to CSRM on behalf of the Hendrickson family, estimates the cataloged collection is in excess of 30,000 photos. Thompson, who speaks from experience, believes the Hendrickson collection is an unequalled resource for future freight cars research.

Buffalo hobby store to close

Robert Schuh, founder of K-Val Hobbies in Buffalo, NY, has decided to retire at the age of 94. A life-long train enthusiast, Schuh opened his store in 1972, naming it after two of his favorite suppliers: “K” from Kadee and “Val” from Central Valley trucks. Over time the store became a social gathering spot for hobbyists, especially on Friday nights when fellow modelers would stop in to talk about trains over pots of coffee. Schuh plans to close K-Val in a month or so, or as soon as he is able to sell off his dwindling inventory. A 52-foot-long layout depicting Bethlehem Steel already has been dismantled. Saddened by the forthcoming change, K-Val customers are calling it the passing of an era.

Milwaukee’s Greenfield Hobbies closing

Greenfield News & Hobbies, one of the largest full-line hobby stores in the Milwaukee area, plans to close its doors April 1. The family-owned business was established in the late 1960s in nearby Cudahy. In addition to trains, the store featured RC equipment, a sizable selection of plastic models, and a large art department. Jay Gordon, proprietor of the family-owned enterprise, says that the business is still relatively healthy, but

he wants to retire while he and his wife are still able to enjoy other interests. A closeout “retirement sale” will begin early this month and continue to the end of March ...

.....

NEW CLUB CARS



The **NMRA's Mid-Central Region Cincinnati Division 7** is selling a kit for an HO scale USRA twin-bay

hopper lettered for the Virginian & Ohio Railroad. The decorating scheme includes the dog-bone V&O herald. The custom car is based on an Accurail 2400-series model. For additional information visit cincy-div7.org/projects.html.

.....



The **Erie Lackawanna Historical Society** is selling a custom-decorated 40' PS-1 boxcar with 7' Youngstown doors. The HO scale

ready-to-run model was produced by Kadee Quality Products. For additional information visit erielackhs.org/index.php/store.

.....

The New York Central System Historical Society (nycshs.net) is taking reservations for N scale Boston & Albany triple-bay hopper cars with offset sides. The models are being produced by

Bluford Shops with road numbers exclusive to NYCSHS. The cars will feature coal loads, magnetically operating knuckle couplers, and Fox Valley Models metal wheelsets. Visit the above website for pricing and ordering information.

.....

NEW PRODUCTS FOR ALL SCALES



Eastern Road Models (public.fotki.com/sbhunterca/cn-566xx-series-sin) is selling 3D-printed body and cupola parts that can be assembled into a Canadian National single ended, wingless snowplow. The parts are available for N, HO, S, and O scales.

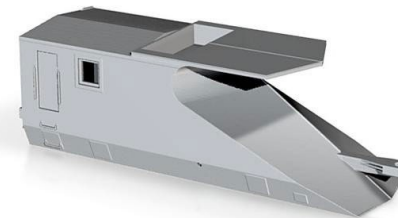

The components are printed in Shapeways FUD acrylic. A model of the all-welded prototype built at Moncton in 1954 can be assembled from the 3D-printed components.

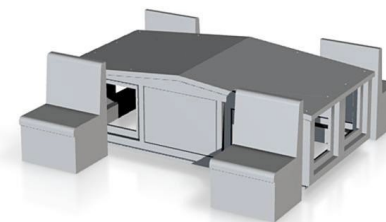

Riveted versions of the plows CNR built at its Transcona Shops in 1938 can be assembled with the addition of surface-rivet decals available from either Archer or Micro-Mark. Trucks and couplers

are not supplied. For additional information visit the above website or contact Stephen Bruce Hunter at sbh6591@gmail.com.

Micro-Mark (micromark.com) is selling Composimold, a reusable heat-and-pour molding material that requires no mixing. Composimold can be safely heated in its storage container in a microwave oven. The material will liquefy in one to two minutes and may then be poured over the pattern. When cooled to room temperature, the original master can be removed and the mold is ready for use. When the mold is no longer needed, it can be melted back into its original storage container. For a video demonstration go to youtube.com/watch?v=G9zhJFSRSTw&feature=youtu.be.

O SCALE PRODUCT NEWS



3rd Rail Division of Sunset Models (3rdrail.com) is selling an O scale Erie steel cabooses that features LED marker lights and full interior details. The handcrafted brass

model is ready for 3-rail operation (the 2-rail version is sold out). Visit the above website for additional information.



Road names on the next production run of General Electric Dash 8-40B diesels from **Atlas O** (atlaso.com) will include Conrail, CSX, and BC



Rail. Dash 8-40BW versions will be decorated for BNSF (above) and Santa Fe (warbonnet scheme).

A 3200-hp Dash 8-32BHW with a North American-type cab will be decorated in Amtrak's Phase V scheme (above). The O scale ready-to-run models are due during the third quarter of this year.

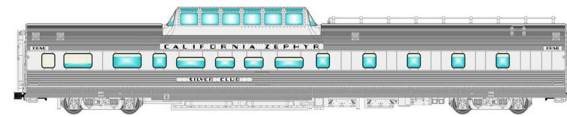

Also scheduled for release in the third quarter is a pair of Atlas O Master series

fluted passenger cars decorated for Amtrak and California Zephyr. The new car types will be a dorm-buffet-lounge (above)



and a baggage car (below)



Completing the third quarter release from Atlas O is a 55-ton twin-bay fishbelly open hopper decorated for Western Maryland, Delaware & Hudson, Norfolk & Western, Reading, and Santa Fe. Both 2-rail and 3-rail models will be available. The release will include

an undecorated model. Visit the above website for pricing on all Atlas O models.



The On30 ready-to-run model comes in a two-pack with an MSRP of \$115.00.

Bachmann Trains (bachmanntrains.com) is selling a data-only version of a black tank mounted on an 18' flat car. The On30 ready-to-run model comes in a two-pack with an MSRP of \$115.00.



On3 scenes, as well as for full-size O scale applications. The kit consists of a one-piece cast-resin waterline hull and a separate one-piece cast-resin superstructure. Detail parts include a resin smokestack, life rings, and lead-free pewter mast, funnels and searchlight. Laser-cut window glazing is included. The overall



Frenchman River Model Works (frenchmanriver.com) has a cast-resin kit for a 24' tugboat. The detail and character of the 1:48 scale vessel make it well suited to On30/On3 scenes, as well as for full-size O scale applications. The kit consists of a one-piece cast-resin waterline hull and a separate one-piece cast-resin superstructure. Detail parts include a resin smokestack, life rings, and lead-free pewter mast, funnels and searchlight. Laser-cut window glazing is included. The overall dimensions of the finished model are 6.18" x 1.875". Visit the above website for pricing and ordering information.

Rusty Rails (rustyrails.com) is selling this O scale truck and flatbed body separately. The truck is shown with new spoke wheels. The separate flatbed and load can be readily adapted to other O scale vehicles. The bed measures 2.875" long by 1.5" wide by .875" tall. All castings are unpainted. Visit the above website to order.

HO SCALE PRODUCT NEWS



Accurail (accurail.com) has released several new HO scale freight car kits this month, including a 40' single-sheathed wood boxcar decorated for Richmond, Fredericksburg & Potomac. Spotting features include Murphy corrugated steel ends and National wood and steel composite doors.

This PFE 40' steel reefer is available from Accurail in a three-car set.



A new kit for this Burlington Northern offset-side triple-bay steel hopper car is available now.

FEBRUARY NEWS | 10



This Chicago & Eastern Illinois 40' single-sheathed wood boxcar features National wood and steel composite doors and Dreadnaught ends. Accurail is selling a kit for this HO scale Green Bay & Western 40' steel refrigerator car with plug doors.

This Chicago & Eastern Illinois 40' single-sheathed wood boxcar features National wood and steel composite doors and Dreadnaught ends. Accurail is selling a kit for this HO scale Green Bay & Western 40' steel refrigerator car with plug doors.



Accurail's Pullman-Standard 4750 cu. ft. grain hopper is available in kit form decorated for Denver & Rio Grande Western. All Accurail HO kits include appropriate trucks and Accumate couplers.

Accurail's Pullman-Standard 4750 cu. ft. grain hopper is available in kit form decorated for Denver & Rio Grande Western. All Accurail HO kits include appropriate trucks and Accumate couplers.



The latest release schedule from **Athearn** (athearn.com) includes several new items arriving in September, including this 60' FMC double-door boxcar. In addition to the SSW scheme (ex Golden West Service) shown here, the Ready-to-Roll® car will be available decorated for SSW Cotton Belt, Golden West Service, and Union Pacific (ex-SSW Cotton Belt).



FEBRUARY NEWS | 11

Also set for release in September is a new production run of class F89F 89'-8" TOFC flat cars. The models are a faithful reproduction of piggyback cars built in the 1960s by Bethlehem Steel Co. for Trailer Train. Athearn's HO scale Genesis series models feature a heavy diecast underframe, formed-wire brake piping details, 70-ton ASF Ride-Control® trucks with rotating bearing caps, and metal wheels with 0.110" treads. Six road numbers each will be available for a yellow car and the brown scheme as shown here.



A new run of Genesis series GATX Tank Train cars are coming in September with new lettering schemes. Individual tank cars in both early (1977) and late (1982) body styles will be available in 12 road numbers as well as without numbers. Both body types will also be available in current lettering (above) and the large two-color scheme (below).

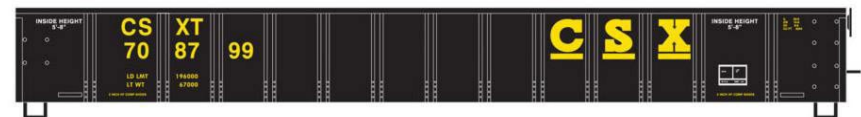

FEBRUARY NEWS | 12

Athearn Ready-to-Roll® cars in the September release include a 52' mill gondola with 14-panel sides. In addition to the CSXT car shown above, road names will include Elgin, Joliet & Eastern; Burlington Northern (black); Canadian National (wet noodle); Rail Gon; and Grand Trunk Western.

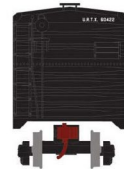

Forty-foot steel refrigerator cars in Athearn's September release will be

decorated for URTX-Needham Packing (above), UTRX-Needham Packing (yellow), URTX-Greenlee, IBPX-Iowa Beef Packers, MNX-Pepper Packing, and ART-Royal Packing (below).



Concluding Athearn's September release of HO scale models is

a steel cupola caboose decorated for Chicago Short Line, Grand Trunk Western, Southern Pacific, Texas & Pacific, and Santa Fe. Note the abbreviated road numbers on the SF cupola ends.



Athearn's October schedule includes five new road names for its superdetailed Genesis series EMD GP38-2 diesel the



FEBRUARY NEWS | 13

company initially launched in 2012. The Soo Line (ex Milw Rd in bandit scheme) version shown above has a 2000-gallon fuel tank and variations in the Sinclair antenna.



This Conrail model of the GP38-2 has an 88" nose, a 2600-gallon fuel tank, and different snow plows at the front and rear.



GP38-2 units for Detroit, Toledo & Ironton will also have a

2600-gallon fuel tank, but the nose is 81". The orange scheme (above) will be available in four road numbers.



DT&I's Bicentennial locomotive will display, appropriately

enough, road number 1776. The release includes a Delaware & Hudson unit with an 81" low nose and a 2900-gallon fuel tank, and an MKT unit with a 81" low nose and a 2600-gallon tank. The GP38-2 models will be available for standard DC non-sound at \$169.98 each. They will be DCC-ready using Athearn's Quick Plug™ technology. Sound-equipped models are priced at \$269.98 each, and come with Soundtraxx® Tsunami® DCC decoders.

A new production run of EMD GP35 diesels in Athearn's Ready-to-Roll® series are scheduled for release in October. Features

FEBRUARY NEWS | 14

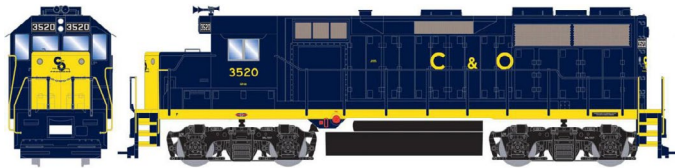

include a scale-width hood, Celcon hand-rails, and several road-specific details. Road names on the Ready-to-Roll® models will be Chesapeake & Ohio and Penn Central.

include a scale-width hood, Celcon hand-rails, and several road-specific details. Road names on the Ready-to-Roll® models will be Chesapeake & Ohio and Penn Central.

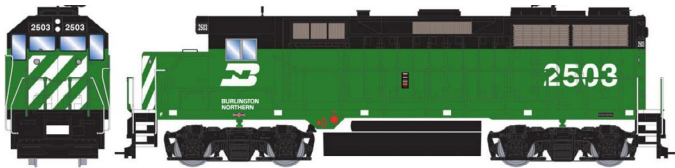

(green & black), CP Rail (Pac Man), and Great Northern. Completing the October release of GP35s is this Illinois Central Gulf unit.

Also being released are GP35s in Burlington Northern



DC non-sound operation. They are DCC-ready using Athearn's Quick Plug™ technology. Additional information is available at the above website.

The GP35s are priced at \$119.98 and come ready for standard



Atlas Model Railroad Company (atlasrr.com) has scheduled another pro-

FEBRUARY NEWS | 15

duction run of its Classic series Alco RS3 and RSD-4/5 diesel locomotives. The HO scale ready-to-run models will be available with DCC with a LokSound decoder. Models for standard DC operation will have an 8-pin socket for installation of an after-market decoder (not supplied). RS3 locomotives will be decorated for Boston & Maine, Canadian Pacific, Great Northern, Seaboard Air Line, Jersey Central, and Pittsburgh & Lake Erie (NYC System scheme).



Chesapeake & Ohio, Santa Fe, and Milwaukee Road.

RSD-4/5 diesel units with six-wheel trucks will be available for



ing in the second quarter of 2015. Decorating schemes on the Master series model will be ADMX-ADM (Molecule), DNAX-Dana Railcare (above), Southern Pacific, DOWX-Dow Chemical, CCBX-Union Carbide, and undecorated.

Atlas has a new release of HO scale ACF 23,500-gallon tank cars com-

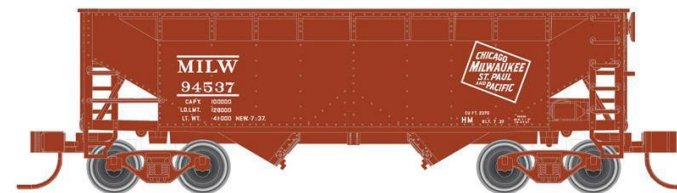

ends is part of a group of HO scale Trainman series cars Atlas

This Milwaukee Road twin-bay hopper car with offset sides and flat

FEBRUARY NEWS | 16

has scheduled for release during the second quarter. Other road names will be Baltimore & Ohio, Bessemer & Lake Erie, Central of Georgia, and Lackawanna.

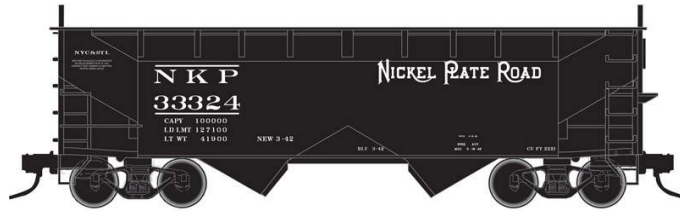

The run includes hopper cars with round ends decorated for Clinchfield,

Montour, Nickel Plate Road, and Interstate.



Atlas is selling Volvo wheel excavators and timber loaders (above) 1:87 scale Cararama series of construction vehicles.



Bachmann Trains (bachmanntrains.com) has introduced a ready-to-run model of Alco's 1,000-hp

S4 diesel switching locomotive. The HO scale model is DCC-ready with an 8-pin socket for an after-market DCC decoder (not included). The model is available decorated for Grand

FEBRUARY NEWS | 17

Trunk, Norfolk & Western, Northern Pacific, Vermont Railway, Pennsylvania Railroad, and New York Central as shown here. The MSRP is \$119.00.

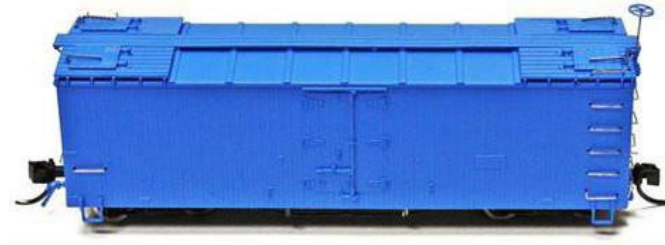

Here is an early test-shot of a 30' Denver & Rio Grande Western refrigerator car coming later this

year from **Blackstone Models** (blackstonemodels.com). The HOn3 model is based on prototypes rebuilt in 1926 with Murphy roofs. Blackstone's ready-to-run models will be available in three D&RGW liveries – Flying Grande, Moffat Tunnel, and Royal Gorge Route. They will also be offered as freshly shopped ART-American Refrigerator Transit cars with red roof and ends, and yellow sides. Blackstone is accepting reservations at the above website.



Bowser (bowser-trains) has released a preliminary computer drawing of a Kansas City-style PCC street-

car planned for production later this year. In addition to Kansas City, a tentative list of road names includes Philadelphia (green), and Bicentennial with 13 colony names. The mechanism will be Bowser's standard drive system. The model will be available for



DC analog control, as well as with ESU LokSound sound/DCC operation.

Preorders for a new run of class GLa twin-bay hopper cars are due at Bowser by the middle of this month. Delivery of the Executive series model has been scheduled for this fall. Road names on the HO scale ready-to-run model will include Buffalo, Rochester & Pittsburgh; Berwind (three variants); Buffalo Creek & Gauley; Chesapeake & Ohio, Canadian National (two variants), Pennsylvania Railroad and, as seen here, Westmoreland Coal Co. See your dealer or visit the above web site for additional information.



Classic Metal Works (classicmetalworks.com) plans to release a new series of HO scale Mini Metal vehicles this month, including 1955 Ford sedans. Decorating schemes include a black and white police car, a yellow taxi, a black sedan, and two-tone Fairlane Town Sedans.



Also due this month are Mini Metal 1941/46 Chevrolet tow trucks and Metro vans.

A new line of Mini Metals 1960 Ford trucks is expected to be released late this month or in early March. The HO scale Ford truck group will range from a basic half-ton pickup

to an F-600 stake bed workhouse. Meanwhile, work continues on a new series of MOW, utility, and inspection vehicles that will be authentically decorated for at least 10 different railroads. For pricing and ordering information, go to store.buy-hobbies.com or contact your favorite dealer.

Doctor Ben (debenllc.com) is selling a variety of palletized items that were originally developed by California Freight & Details Co. Currently available in HO scale are pallets of concrete blocks, and three different pallets of small, medium, and large shipping boxes.



include a unique Kansas City Southern hopper-gondola.



New HO scale resin kits from **Funaro and Camerlengo** (fandckits.com)

The bottom view shows details of hopper-gondola car.



above include all necessary castings to complete the body,

Also new from F&C is a Southern Railway 36' double-sheathed truss-rod boxcar with Hutchins ends. As with all F&C kits, those mentioned

plus grab irons, wire, appropriate thin-film decals, and either Tichy or resin cast brake detail parts. Trucks and couplers are not included. Visit the above website for pricing and ordering information.



InterMountain Railway (intermountain-railway.com) anticipates delivery of EMD FP7 and F7B pas-

senger diesel units in March. In addition to the original Rock Island scheme shown here, the HO scale ready-to-run models will be available decorated for Florida East coast (blue scheme), L&N (gray), VIA Rail, and MKT.



EMD FP9 and F9B diesels with the additional vent in front of the first port-hole, are also due next

month. Road names will be Pan Am Railway, Canadian Pacific (action red scheme), and Canadian National in the classic green, yellow, and black livery. Both the FP7 and FP9 models will be offered in sound and non-sound versions.



Intermountain has scheduled a release date of April for a quartet of Great Northern 40' plywood-panel boxcars with Dreadnaught ends and

Youngstown doors. Liveries include the original 1945 scheme of

orange with black roof and ends (above) and a similar scheme with Scotchlite patches at the side sills.



Completing the plywood-panel group is a GN car in the 1947 mineral-red scheme with Empire Builder style lettering (above) and similar letter-

ing on a car painted vermillion red.



Also coming from InterMountain in April are WWII War Emergency single-sheathed boxcars with Dreadnaught ends. The

prototypes had an inside length of 40'-6". CNW (above) and cars decorated for Canadian Pacific will have Youngstown doors.



Cars decorated for Wabash (above) and Nickel Plate Road will have Creco doors. Cars decorated for Gulf, Mobile & Ohio and ATSF will have

composite doors similar in appearance to an earlier design from National Door.



The availability of war-related rolling stock from InterMountain will continue with the release in

June of postwar boxcars with an inside height of 10'. In addition to the New York Central car shown here, the HO scale ready-to-run model will be available for Clinchfield, Erie Lackawanna (ex DL&W), Chesapeake & Ohio, Penn Central, Southern Pacific (san serif lettering), and NdM-Ferrocarriles Nacionales de México.

InterMountain's summer schedule includes the release of undecorated kits for 40' PS-1 boxcars. Kits will be available for cars with 6', 7', and 8' doors. Pricing will be below \$20. Appropriate trucks with plastic wheels will be included, but no couplers are provided.

InterMountain has announced its schedule of new products for August/September of this year. Leading the HO scale list are SD40-2W locomotives with eight new paint schemes including Pennsylvania Northeastern, Diesel Electric Service, New Hope & Ivyland (CN stripe paint-out), and NH&I (CN map paint-out). Schemes being rerun with new road numbers are CN, CN.CA, CN-Expo 86, and CN (map scheme). The HO scale locomotives can be equipped with a DC-only plug on request.

Bi-Level auto racks with five new road names and five rerun schemes, all with new numbers, are also in InterMountain's August/September release. Forty-eight-foot smooth-side containers in a total of six numbers per road name will be released for American Presidents Line, BN America, ITEL, CSX, XTRA, CN-Laser, CP Rail, Conrail Mercury, Southern Pacific, and NCCU-North American Container Systems. The containers will be sold in two-packs.

Completing the August/September schedule are AeroFlo and AeroFlo II coal gondolas from InterMountain's new Value Line. AeroFlo cars will be available for BN, BNSF, Procor, and CN. AeroFlo II cars will be Northwestern Oklahoma, Canadian

Pacific, Luscar, and Midwest Generation. Thirteen numbers will be available for each road name. Visit the above website for additional information.



New ready-to-run HO scale cars coming next month from **Kadee Quality Products** (kadee.com) include a 40' PS-1 boxcar decorated for Green Bay & Western. The model will have 6' Creco doors.



Also due in March is a 40' PS-1 boxcar with 6' Youngstown doors decorated for Canadian Pacific Railway.



Kadee's April delivery schedule includes a Florida East Coast twin-bay covered hopper with eight round hatches.

KatoUSA (katousa.com) has released its HO scale version of EMD's SD80MAC diesels in two new road numbers each for CSX (dark future scheme) and Norfolk Southern. CSX and NS acquired their SD80MAC locomotives from Conrail who

FEBRUARY NEWS | 24



purchased them new from EMD in 1996. Notable features of the big prototype locomotive are its 5,000-hp capability and ease of operating

at 75 mph. They are equipped with the special high-tech radial trucks designed to reduce the angle of wear between wheels and rail.



Kato's HO scale version features operating ditch lights, and directional headlights. The models have numerous detail parts that are to be

installed by the consumer, including grab irons, MU hoses, and individually molded windshield wipers. DCC models feature factory installed ESU LokSound DCC/Sound. DC models come with a standard 8-pin plug to ease installation of an aftermarket decoder.



Kato has GE's P42 Genesis locomotive in Amtrak Phase I, II, III, and IV 40th Anniversary paint schemes. Shown to the left is the Phase I scheme.



Amtrak's Phase II Anniversary scheme is shown to the left. Below is the Phase III version.



FEBRUARY NEWS | 25



To the left is Kato's Amtrak P42 Genesis locomotive in Amtrak Phase IV anniversary scheme. All versions of the HO scale ready-to-run locomotives are available for

analog DC operation, as well as with factory-equipped ESU LokSound DCC, or SoundTraxx Tsunami DCC. Check with your favorite dealer for pricing.

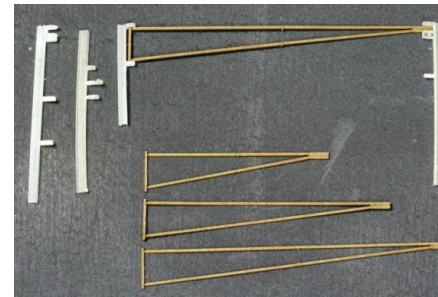

Mike Rose Hobbies (mrhobby.com) is selling a kit for an HO scale Road Gate. Although based on Conrail prototype drawings, the gate is typical of those found throughout North America. The upright posts, which simulate discarded rail, are created using 3D printing technology. The swinging portion of the gate is precision laser-cut and includes 12', 16' and 20' lengths. Additional information and ordering instructions are available at the above website.



Moloco Trains (molocotrains.com) is selling Santa Fe-built 50' class Bx-94 and Bx-97 Plate-B

insulated boxcars. Features include diagonal ribs on either side

of the 10' offset Youngstown doors, separate door rods, Stanray 4-4 ends with ATSF-type ladders, and an accurately rendered underframe with Shock Control details. Three authentic HO scale versions of the prototype are available including Bx-94 XMLI as delivered, Bx-97 XMLI as delivered, and Bx-97 XLI post-1981 as shown here. Visit the above website for pricing and ordering information.

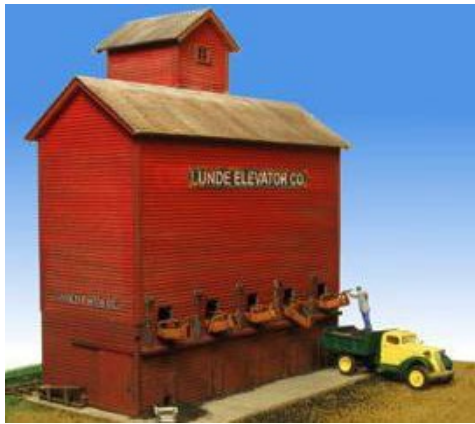

Lunde Coal Elevator is among the newest craftsman-style kits from **Monroe Models** (monroemodels.com). The laser-cut HO scale model is typical of medium-size elevators that could load local trucks to deliver fuel to businesses and homes for heating and cooking.

The kit includes basswood walls, peel-and-stick roofing, peel-and-stick doors and windows, and printed advertising signs. Cast metal parts include a coal shovel and coal buckets. The assembled structure is 6.5" tall and has a footprint of 5.875" x 3.25".



Also new from Monroe Models is a kit for a railroad Pump House based on a Baltimore & Ohio prototype. Pump houses were a fixture in rail yards, industrial sites, and as town water supplies

from the mid-1800's through today. The kit includes laser-cut basswood walls, peel-and-stick roofing material, and peel-and-stick doors and windows, plus assembly instructions and several detail parts. The assembled structure has a footprint of approximately 5.375" x 2".



MTH Electric Trains (mth-trains.com) is selling an HO scale 70-ton center-discharge ore car. The injection molded ready-to-run model is available decorated for the 50th

Anniversary of Bessemer & Lake Erie Veteran Employees Association (ignore the misspelling on the sample model pictured above). Additional road names for individual cars as well as six-packs are Burlington Northern, Canadian Pacific, Great Northern, Long Island Rail Road, Milwaukee Road, Soo Line, and Union Pacific. Three numbers are available for each road name. See your dealer or visit the above website for additional details.

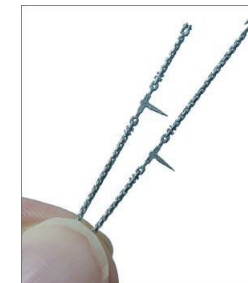
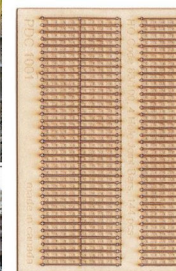

Precision Design Co. (pdc.ca) has introduced several new HO scale detail parts, including Rail Joint

Bars. The joint bars are laser-cut from composite resin material

and are cosmetic only. They cannot be used to mechanically join rail. PDC's rail joiners are available in four-hole and six-hole types, both with and without bolts. Joint bars are available now for code 55, 70, 83, and 100 rail.

PDC also has laser-cut heavy-duty tie-down chain with either hooks or anchor shackle ends



An HO scale kit for the ubiquitous mobile 6' x 9' sign seen throughout North America is available now from Precision Design. The kit includes laser-cut components, an assembly jig, and decals to make up the sign message. Custom sign faces are also available from PDC. Visit

the above website for details on all PDC products.



Q Connection (qconnection.biz) is selling two versions of CB&Q's class HC-1 twin-bay covered sand hoppers. The proto-

type cars hauled sand from northern Illinois to foundries and glass manufacturers throughout the country. The HO scale kits are produced for Q Connection by Bowser. The 1943-built HC-1 (above) is available in two road numbers and comes with Kadee® HGC National type B-1 50-ton solid bearing trucks with metal wheel sets. The 1958 HC-1B version of the car comes with InterMountain metal wheelsets. Both kits include extra weights and Kadee® No. 158 Whisker® couplers. Visit the above website for pricing and ordering information.

late Terry Wegman. A total of seven decorating schemes will be available including single and double heralds (color, above), double heralds (black & white), and single black SP herald with stripes (below). Delivery is expected about July.



Red Caboose has several HO scale ready-to-run freight cars available from stock, including the General

Service drop-bottom gondola. In addition to the D&RGW car shown (composite sides), available road names include Great Northern (steel sides), and Illinois Central (steel sides with Mainline of Mid America slogan).



This Erie Lackawanna 57' class R-70-15 mechanical refrigerator car is available

from Red Caboose decorated for ART, SPFE, UPFE, Soo Line, and Tropicana (white with green ends).

Red Caboose offers this 40' stock car decorated for Western



Pacific as well as for Northwestern Pacific as shown here. InterMountain Railway is responsible for marketing Red Caboose

products. For additional information visit intermountain-railway.com.

The Trainmaster (thetrainmaster.com) is selling an HO scale craftsman-type kit called Pete's Freight Dock. The complex consists of three structures, including an office and fence, an



LCL storage shed, and a loading dock. Components include laser-cut walls, windows, doors, and roofing material, strip wood, and color signage. Numerous detail items include crates of various sizes, drums, casks, pallets, trash cans, sacks, a hand cart, broom, and a pile of tires. Written instructions

are supported by templates and several construction photos. The office is 3.75" x 2.75", and the loading dock is 2.125" x 11". The shed, which can be positioned anywhere on the dock, measures 1.75" x 4.25". Visit the above website for pricing and ordering information.



New releases from **Walthers** (walthers.com) this month include a kit for this Cornerstone® Mission-style bungalow. Features include an authentic stucco finish and Spanish tile roof. The finished

model has a foot print of 5" x 5.5". ZIMU-Zim, HJCU-Hanjin Shipping, CBHU-Cosco, and TTRU-Tropical.

Walthers new product releases for March include this HO scale ready-to-run North Eastern style all-steel caboose. In addition to the



Western Maryland Chessie System version shown here, other

road names are Chesapeake & Ohio, Conrail, New Haven, and Chicago & North Western.



The all-new 40' AAR 1944 boxcar Walthers previewed at the National Train Show in Cleveland last year is scheduled for release in

April. Features of the 10'-6" interior height boxcar include AAR tab side sills, 4-4 Improved Dreadnaught ends, 6' Youngstown doors, and a Murphy panel roof. Road names will be Santa Fe (El Capitan slogan), Chicago & North Western (The Overland Route slogan), Delaware & Hudson, Nickel Plate Road, Wabash, and Union Pacific (Route of the Streamliners slogan) as shown here. The HO scale ready-to-run Mainline® series model will have an MSRP of \$24.95.



Walthers has scheduled another release of its Bi-Level gallery

commuter cars in April. The 85' prototypes were built by Pullman-Standard in the 1960s. Walthers 12-year-old tooling was substantially upgraded two years ago. Road names in the April release will include the RTA/Metra shown here as well as Alaska Railroad, and Amtrak's Phase III scheme. Both standard and lighted versions will be available.

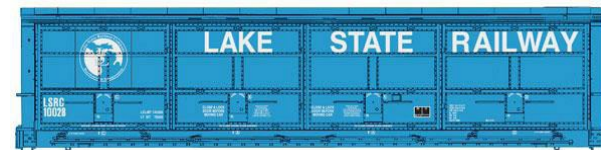

A Proto® series 56' Thrall All-Door boxcar with newly tooled etched plat-

forms will be released by Walthers in April. The unique lumber

carrier will be decorated for Boise Cascade, Canadian Forest Products, Weyerhaeuser, and Lake State Railways.



Also due for release from Walthers in April is an EMD E8A HEP diesel decorated in Amtrak's Phase I scheme. The

HO scale Proto® series model is based on former PRR/PC units rebuilt with head-end power (HEP) controls in the mid-1970s. Spotting features include roof mounted cooling fans, dual mufflers, an extended pilot, and MU connections with covers.

HO SCALE PRODUCT NEWS



Athearn Division of Horizon Hobby

(athearn.com) has scheduled a September delivery date for a new production run of 14-panel 52' mill gondolas. In addition to the Rail Gon car shown above, road names on the N scale Ready-to-Roll® models will be Elgin, Joliet & Eastern; Burlington Northern (black); Canadian National (wet noodle); GSXT; and Grand Trunk Western. The N scale models will have an MSRP of \$19.98 each.



Atlas Model Railroad Company (atlasrr.com) has a new release of N scale

ACF 23,500-gallon tank cars coming in the second quarter of 2015. Decorating schemes will be ADMX-ADM (Molecule), DNAX-Dana Railcare, Southern Pacific, DOWX-Dow Chemical, CCBX-Union Carbide (above), and undecorated.



Also due from Atlas in the second quarter is another production run of Trainman series steel cabooses. In addition to the SP version shown here, road names will be Elgin, Joliet & Eastern; Gulf,

Mobile & Ohio; Vermont Railway; Burlington Route; Santa Fe, and Great Northern. The HO scale ready-to-run model will have an MSRP of \$19.95. An undecorated version will list at \$13.95.



Coming from Atlas in the third quarter of 2015 is an N scale ready-to-run

model of an EMD GP30 Phase 2 diesel locomotive. In addition to the Reading, Blue Mountain & Northern version shown above, road names will be BNSF, C&O, C&NW, Cotton Belt, GM&O, and Illinois Central Gulf. See your favorite dealer or visit the above website for pricing and additional details on Atlas N scale models.

Bachmann Trains (bachmanntrains.com) has an N scale Baltimore & Ohio class EM-1 2-8-8-4 steam locomotive. It is equipped with a Bachmann/Lenz DCC decoder that controls speed, direction, and lighting. Additional features include twin



flywheels, all-wheel pickup, traction tires, soft-white LED headlight, and backup light, chemically blackened wheels, and separately applied handrails and stanchions. Four road numbers are available with variants including single or dual headlights in combination with small and large boiler domes. See your dealer for additional details including pricing.

Classic Metal Works (classicmetalworks.com) has solved some minor QC problems on the latest production run of N scale Mini Metal vehicles and expects to make a major release later this month. The new items include 1953 Ford Couriers, 1953 Ford Customline Station Wagons, and International R-190 Trucks --all in new prototype paint schemes. For pricing and ordering information, go to store.buy-hobbies.com or contact your favorite dealer.

InterMountain (intermountain-railway.com) has released its schedule of new N scale products due for release in August/September of this year. Leading the list are SD40-2W locomotives with eight new paint schemes, including Pennsylvania Northeastern, Diesel Electric Service, New Hope & Ivyland (CN stripe paint out), and NH&I (CN map paint out). Schemes being rerun with new road numbers are CN, CN.CA, CN-Expo 86, and CN (map scheme).

Completing the August /September schedule are AeroFlo and AeroFlo II coal gondolas from InterMountain's new Value Line.

AeroFlo cars will be available for BN, BNSF, Procor, and CN. AeroFlo II cars will be Northwestern Oklahoma, Canadian Pacific, Luscar, and Midwest Generation. Thirteen numbers will be available for each road name. An Atlas Trainman series 90-ton triple-bay hopper will be available decorated in Norfolk Southern's "Pier 6" scheme. New road numbers will be available for Chicago North Western, CSX (NYC), Union Pacific, Northern Pacific, and Bessemer & Lake Erie. Visit the above website for additional details including pricing.

Kato (katousa.com) is selling ready-to-run N scale models of EMD E8A and E8B diesel locomotives decorated for Chicago & North Western, and Alaska Railroad. Features of the A units include dual headlights, a chin pilot, and internal steam generator.



Smooth-side passenger equipment for each road is available in two groups. A six-car set includes an RPO, baggage car, coach, diner, sleeper, and observation car. A four-car set consists of a baggage car, coach, dome coach, and sleeper.

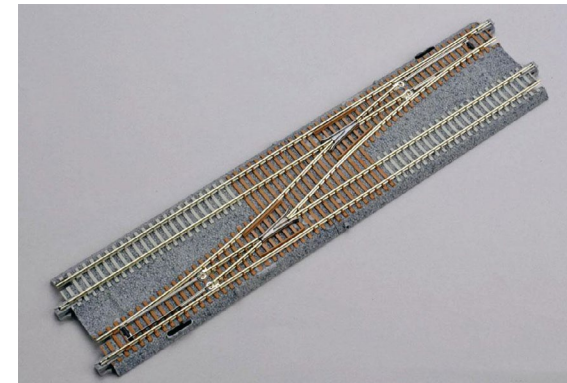

In other news, Kato has announced the release of a new double-track single-crossover in its N scale Unitrack line. The crossover incorporates #4 turnouts and will be available in both left (shown) and right hand variants at an MSRP of \$49.00 each.

The built-in turnout throws can be operated manually or connected to Kato #2-840 control switches. The crossover is DCC-compatible.

.....



Micro-Trains Line (micro-trains.com) is selling an N scale model of an EMD SW1500 switcher decorated for Kansas City Southern. The ready-to-run model is available in two road numbers.



M-T has a 40' double-sheathed wood boxcar decorated for MWR-Muncie & Western Railroad. The N scale model has a fishbelly

underframe, National composite wood and metal doors, and Murphy corrugated steel ends.



M-T's version of 40' Spokane, Portland & Seattle steel drop-bottom gondolas have been fitted with wood side extensions. The N scale model is available in a four-pack.



Also new from Micro-Trains is a WIF-West India Fruit & Steamship Co. ice refrigerator car.



M-T is selling 56' General Service tank cars decorated for PROX-Procors. The model is based on a prototype car built in 1999.

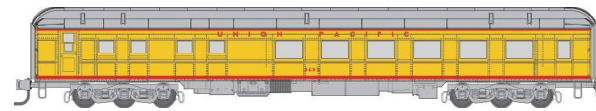

Completing our February list of new N scale ready-to-run model from Micro-Train is a Union Pacific heavyweight steel diner. Contact your dealer for pricing information or visit the above web site.

.....

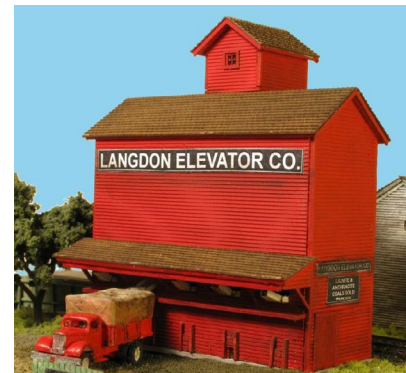

Monroe Models (monroemod-els.com) is selling an N scale craftsman style kit for Langdon Coal Elevator. The laser-cut model is typical of medium-size elevators that could load local trucks to deliver fuel to businesses and homes for heating and cooking. The kit includes laser-cut and etched walls, and laser-cut peel-and-stick roofing, windows, doors and trim. The assembled structure is 3.75" tall and has a footprint of 3.25" x 3.75".



Also new from Monroe Models is a kit for a railroad Pump House based on a Baltimore & Ohio prototype. Pump houses were a fixture in rail yards, industrial sites, and as town water supplies from the mid-1800s through today. The

kit includes laser-cut basswood walls, peel-and-stick roofing material, and peel-and-stick doors and windows, plus assembly instructions and several detail parts. The assembled N scale structure has a footprint of approximately 3” x 1”.



Monroe Models has introduced sheets of Cedar Shake Shingles that ease the challenge of achieving authentic looking shingles on N scale structures. The shingle material consists of 3D laser-etched peel-and-stick sheets that will cover a roof approximately 7” long by 3.25” wide. Visit the above website for complete details, including pricing.

.....
Trainworx (train-worx.com) is taking reservations this month for several styles of N scale trailers set to arrive during the third quarter of this year. The selection includes Erie Lackawanna 40’ corrugated meat reefers, and 40’ exterior post vans decorated for Erie Lackawanna, and for Lackawanna with a Phoebe Snow slogan. Also 40’ drop-frame parcel vans decorated with yellow stripe, red stripe, red nose and tail, plain, and plain with DOT striping.

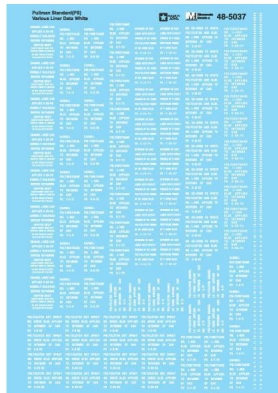

NEW DECALS, SIGNS AND FINISHING PRODUCTS

New decals from **Microscale Industries** (microscale.com) this

month include CWEX-Commonwealth Edison, and Yankeetown Docks-YTD for Thrall high-side gondolas. Also new are N, HO, and O scale sets of various data for Pullman-Standard hoppers in both black and white lettering.

.....
Great Decals (greatdecals.com) is selling a set of white decals to letter a Piedmont & Northern boxcar. The set includes the “Service with Courtesy” slogan, all dimensional data, and four road numbers – all in P&N’s unique typeface. A number jumble is also included to facilitate additional road numbers. Visit the above website for pricing and information on other road names.

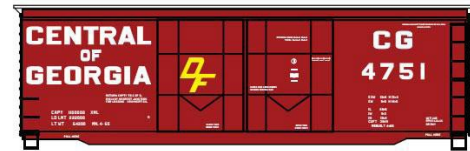

Mask Island Decals (maskislanddecals.com) has released new HO scale lettering sets for Central of Georgia double-door brick boxcar (above) and a similar Southern Railway car.

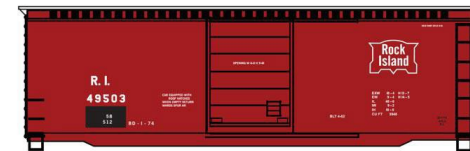

Also new from Mask Island are decals for a Rock Island 40’ boxcar with a roof hatch for bauxite loading (above) and a Texas & Pacific 40’ boxcar. Visit the above website for full details.

.....
Mount Vernon Shops (mountvernonshops.com) is selling decals for a Cambria & Indiana AAR standard twin-bay offset-side hopper car. One decal set has enough data to decorated

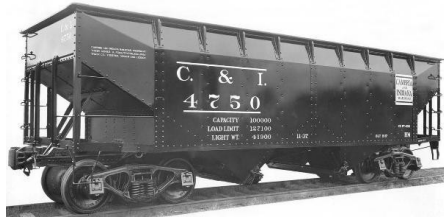

three cars. C & I cars were frequently seen on the PRR and NYC, the only two interchange partners the smaller road had. Contact John Frantz at the above website for pricing and ordering instructions.

i SEND US YOUR PRODUCT ANNOUNCEMENTS

If you are a hobby manufacturer with a product announcement, just [click here](#) and submit your announcement to us. Our web site and free magazine reach continues to grow, so get on board this new media train! ■

DISCLAIMER

The opinions expressed in this column are those of the writer and do not necessarily reflect the opinion of *Model Railroad Hobbyist* or its sponsors. Every effort is made to provide our readers with accurate and responsible news and information, however, neither *Model Railroad Hobbyist* or the writer of this column can be held responsible for any inaccuracies or typographical errors that may inadvertently appear in this column.

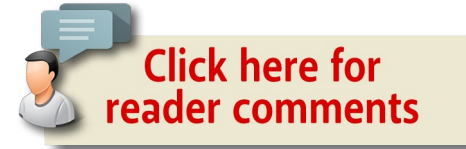

+ THIS MONTH'S BONUS EXTRAS

MRH SUBSCRIBERS GET ACCESS TO FREE BONUS extras, but you do have to be a subscriber! That's easy because [subscribing is free \(just click this link\)](#).

The bonus extras this month include:

- High quality versions of the issue videos
- Special eBook "Big-Boy" addendum to What's Next column
- Updated DCC Shortcuts card

To access the bonus extras, click the link below:

[BONUS DOWNLOADS FOR THIS ISSUE](#)

Want to help keep MRH free? Then click on Ads!



.....
BRIEFLY NOTED AT PRESS TIME ...

Several manufacturers announced major new products at the Amherst Railway Society's annual Railroad Hobby Show held last week in West Springfield, Mass. MRH will bring you full details including images next month; meanwhile here is a quick summary of some key announcements.

... **Athearn** showed their new Genesis GP9B and HEP diesel locomotives at Springfield with preproduction samples decorated for Chicago & North Western. GP9B Phase I locomotives with a new short hood and GP9B Phase III units decorated for Union Pacific and PRR were shown. New schemes for Genesis SDP45-2s were announced including Burlington Northern, Conrail, Erie Lackawanna and Great Northern. On the horizon are new Athearn Ready-to-Roll® models of SD40 diesels decorated for Santa Fe, Burlington Northern, Chesapeake & Ohio, Conrail, Southern Pacific, and Montana Rail Link. Athearn also announced plans to produce both H0 and N scale versions of 4-8-8-4 Big Boy steam locomotives, and 50' SIECO boxcars.

... **Tangent Scale Models** announced the availability of a new PRR X58 boxcar at the Springfield show. Beautifully detailed samples of the H0 model included cars in the original 1965 PRR scheme with galvanized roof and DFB/Cushion Car stenciling. Variations on display were repaints for PC (1973), Conrail (1987), and NS (1999). Tangent's new X58 boxcar will also be available painted but unlettered in PRR red, PC green, and Conrail red. Correct X58 decals for PRR, Penn Central, and possibly other roads, are coming soon from Daniel Kohlberg.

... After weeks of speculation, **Rapido** officials announced that their newest locomotive would be H0 scale models of BUDD's self-propelled RDC units. Phase 1 and Phase 2 versions of RDC-1, RDC-2 and RDC-3 will all be included in the production run. The initial release is expected late this year or in early 2016. The exterior configuration of the model will be based on electronic scans made of full-size prototypes. Among the surprises is a twin-motor drive system that will be completely hidden from the fully detailed interior. Lots of decorating schemes are promised with many road-specific details. A list of road names and ordering information is expected to be announced in a week or so.

Rapido also revealed plans to produce a group of New Haven 8600-series stainless steel coaches. The H0 scale models replicate the lightweight coaches Pullman-Standard produced in 1945-46 in their Osgood Bradley factory in Worcester, MA. The model is being produced in association with New Haven Railroad Historical & Technical Association. ■



SELECTED EVENTS

February 2015

(Please note that many events charge a fee. Check individual info website for details.)

CANADA, ONTARIO, BARRIE, February 14-15, 45th Annual Model Train Show hosted by Barrie Allandale Railway Modellers, at Bradford Greenhouses Garden Gallery. Hwy 90 and Hwy 27. Info at barm.ca.

CANADA, ONTARIO, COPETOWN, February 8, 2015 Copetown Train Show, sponsored by Bayview Junction Modular Group and Canadian Association of Railway Modellers, at Copetown Community Centre, 1950 Governor's Road. Info at caorm.org/copetown.

CALIFORNIA, SAN DIEGO, February 14, NMRA PSR Winter Meet featuring Hands On Weathering Clinic at Clairmont Christian Fellowship, 4570 Mount Herbert Ave. Participants need to bring a car that is boxcar redish as only materials to weather cars of that color will be available. Limited to 25 participants. To reserve a seat contact Pete Steinmetz at psr2014clinics@gmail.com.

CALIFORNIA, SANTA CLARA, February 5-7, O Scale West and S West 9 Convention, at Hyatt Regency Hotel, 5101 Great America Parkway. Hotel reservations at 800-233-1234. Details including vendor information at oscalewest.com.

FLORIDA, INVERNESS, February 14, NMRA, Sunshine Region, Western Division Winter Meet hosted by the Citrus Model Railroad Club featuring clinics with an OP session on the Club layout at the conclusion of the event. At Citrus County Fairgrounds Horticulture Building 4600 South Florida Ave. info at citrusmodelrrclub.org.

FLORIDA, THE VILLAGES, February 7-8, Spring Rail Expo Sale & Show, hosted by The Villages Railroad Historical Society at Savannah Regional Rec Center, 1545 Buena Vista Blvd. For info contact Alan Goldberg at 352-205-4322.

KANSAS, LAWRENCE, February 21-22, 14th Annual Train Show & Swap Meet, sponsored by Lawrence Model Railroad Club. At Douglas County Fairgrounds. Info at lawrencemodelrailroadclub.org.

KANSAS, WICHITA, February 7, Train Show and Swap Meet with 100 plus dealer tables plus model contests, clinics and switching contest, at the Cessna Activity Center, 2744 George Washington Blvd. Info from Phil at 316 259 5190 or email aylward1@cox.net.

NORTH CAROLINA, NEW BERN, February 21-22, 20th Annual Train Show sponsored by Carolina Coastal Railroaders, at The New Bern Riverfront Convention Center, 203 East Front Street. Info at carolinacoastalrailroaders.org.

OREGON, PORTLAND, February 14, Railroad Swap Meet, sponsored by Spokane, Portland & Seattle Railway Historical Society, at Holiday Inn Portland Airport, 8439 NE Columbia Blvd. Info from Jerry Pickellat at 360-735-0516.

TEXAS, HOUSTON, February 21, The Greater Houston Train Show, presented by the San Jacinto Model Railroad Club, at Stafford Center, 10505 Cash Road. Info at sanjac.leoslair.com.

SELECTED EVENTS | 3

WEST VIRGINIA, CHARLESTON, February 21-22, 10th Model Train Show sponsored by Kanawha Valley Railroad Association, at the Clubhouse in Coonskin Park. Info at kvrailroad.org.

WISCONSIN, MADISON, February 21-22, Mad City Model Railroad Show & Sale, at Exhibition Hall, Alliant Energy Center. Info at nmra-scwd.org.

March 2015

AUSTRALIA, CANBERRA, March 28-29, 27th Annual Canberra Model Railway Expo, hosted by Canberra Model Railway Club, at University of Canberra High School, 104 Baldwin Drive. Info at canberra-model-railway-club.webs.com.

CANADA, ONTARIO, TORONTO, March 14, Toronto Railway Prototype Modellers Meet, featuring prototype clinics. Attendees are encouraged to contribute to this learning experience by bringing a model, whether completed or not. At Humber College, North Campus, Building B, rooms B215 & B216. Info from Brian Gauer at bdgauer@yahoo.ca.

CALIFORNIA, BAKERSFIELD, March 14-15, The Model Train Show, hosted by Golden Empire Historical & Modeling Society, at Kern County Fairgrounds, 1142 South P Street.

CALIFORNIA, CROCKETT, February 28-March 1, Carquinez Model Railroad Society Open House at 645 Loring Avenue. Info at cmrstrainclub.org.

GEORGIA, ATLANTA, March 14-15, 2015 Model Train Show, hosted by NMRA Piedmont Division, at Cobb Galleria Centre, 2 Galleria Parkway. Info at themodeltrainshow.com.

SELECTED EVENTS | 4

GEORGIA, SAVANNAH (Port Wentworth), March 27-28, Savannah RPM, at Georgia Community Center, Port Wentworth. Savannah RPM [facebook.com/groups/523388394345622](https://www.facebook.com/groups/523388394345622).

MICHIGAN, FARMINGTON HILLS, March 15, Trainorama Show & Sale, hosted by Redford Model Railroad Club at Costick Community Center, 28600 Eleven Mile Road. Info redfordmodel-railroadclub.com.

ILLINOIS, ROCKFORD, March 28- 29, Train Show & Sale, hosted by NMRA Rock River Valley Division at Jefferson High School, 4145 Samualson Road. Info from Joe Whinnery at phowhin@yahoo.com.

MISSOURI, SPRINGFIELD, March 15, 37th Annual Train Show sponsored by Ozarks Model Railroad Association, a fun oriented family event with over 100 vendor tables. At Remington's, 1655 W. Republic Road. Info at omraspringfield.org.

NEW YORK, ROCHESTER, March 7-8, Open House at Rochester Model Railroad Club, 150 South Clinton Avenue. Info at rocmrrc.com.

NORTH CAROLINA, FLETCHER, March 6-7, 25th Annual WNC Train Show, at WNC Ag Center Expo Building, 1301 Fanning Bridge Road. Info at asheville-trainshow.com.

OHIO, KIRTLAND, March 14-15, Railfest Train Show, at Lakeland Community College. Event sponsored by NMRA Western Reserve Division 5.

OKLAHOMA, TULSA, March 20-22, 6th Annual Layout Design and Operations Meet, with clinics and noted speakers, plus operating sessions at 13 layouts. Event at Shriner's Temple, 28th & Sheridan. Special rates available at Hampton Inn and Suites, 3418 S. 79th East Avenue, phone: 918-779-4000. Info at ldopsig-meet.tulsanmra.org.

SELECTED EVENTS | 5

PENNSYLVANIA, GREENSBURGH (suburban Pittsburgh), March 27-28, 2015 RPM-East Seminar with two days of prototype modeling presentations, displays, and vendor tables, plus Op session Thursday evening. Hosted by Division 2, MCR-NMRA at Ramada Greensburg Hotel & Conference Center, Route 30 just east of Greensburg (Formerly Sheraton Four Points). Seminar and hotel info at hansmanns.org/rpm_east.

PENNSYLVANIA, SCRANTON, March 26-27, Fine Scale Model Railroad Expo, a specialty event dedicated to the art of craftsman kit structures and scenery building, with clinics, demonstrations, and displays. At Hilton Scranton Hotel & Conference Center, 100 Adams Avenue. Info at modelrailroadexpo.com.

UTAH, OGDEN, March 6-8, 26th Annual Hostler Model Train Festival at Ogden's Historic Union Station. Info at www.hostlers.info or contact Micke Murphy at 801-394-4952.

VIRGINIA, ANNANDALE, March 28, NMRA, Potomac Division of the M.E.R, One day Minicon with operating modular layouts, clinics, and contests. At St. Matthew's United Methodist Church, 8617 Little River Turnpike. Info at potomac-nmra.org.

Future 2015 (by location)

AUSTRALIA, NEW SOUTH WALES, BOWRAL, April 3-5, 12th Australian Narrow Gauge Convention, sponsored by NMRA, with hands-on workshops, contests, tours, and modeling clinics on NG prototypes from Fiji, US, UK, and Australia. Info at austnarrow-gaugeconvention.com.

AUSTRALIA, QUEENSLAND, BRISBANE, April 9-12, 14th National N Scale Convention, April 9-12, 2015, at Hotel Grand Chancellor, 23 Leichardt St, Spring Hill. Info at facebook.com/NationalNScaleConvention2015.

SELECTED EVENTS | 6

CANADA, ONTARIO, BRAMPTON, October 3-4, Annual Brampton Model Railway Show with 33,000 square feet of display including N, HO, O and G scale operating equipment. At Brampton Fairgrounds, 12942 Heart Lake Road. Info at brampton-modelrailwayshow.com.

ARIZONA, CLARKDALE, April 11, Rails Along the River, display and swap meet at Clark Memorial Clubhouse Auditorium, 9 North Ninth Street. Contact Wendy at VRVNO.Info@gmail.com for info including details on riding nearby Verde Canyon Railroad.

CALIFORNIA, NEWARK, May 13-17, 2015, NMRA Pacific Coast Region Convention, at Newark-Fremont Double Tree by Hilton Hotel, 39900 Balentine Drive. Info at pcrnmra.org/conv2015.

CALIFORNIA, LOS ANGELES, April 25-28 and May 2-3, Pasadena Model Railroad Club celebrating 75 years of operation on the Sierra Pacific Lines, one of the largest HO scale operating model railroads in the world. Info from Justin Ausman at ausmanjustin@yahoo.com or 909-236-2732.

CALIFORNIA, SONORA, April 18, Westside Logging & Mining Reunion, a rare and entirely unique opportunity to eat, drink, and talk about narrow gauge logging with like-minded fellows. Event includes clinics and a limited number of vendor tables. At Sonora Elks club, 100 Elk Drive. Volunteers and those with questions contact Frank Markovich MMR at frank@frankmarkovich.com.

CONNECTICUT, COLLINSVILLE, May 29-30, New England/Northeast Prototype Modelers Meet. Info at neprototypemeet.com.

ILLINOIS, NAPERVILLE, October 15-17, 22nd Annual Naperville RPM Conference, hosted by Joe D'elia, at Sheraton Lisle-Chicago Hotel, 3000 Warrenville Road, Lisle. Info at railroad-prototypemodelers.org/naper_meet.htm.

SELECTED EVENTS | 7

INDIANA, MARTINSVILLE, April 11, Spring Train Show And Meet, sponsored by NMRA Central Indiana Division, with operating layouts, clinics, and vendor tables, at National Guard Armory, 1900 Hospital Drive. Info from Trevor Jones at trevin@sbcglobal.net, or Dan Goins at santafedangoins@comcast.net.

MARYLAND, TIMONIUM, April 11-12, Brass Expo in conjunction with the Great Scale Model Train Show, presented by Howard Zane, at Maryland State Fairgrounds, 2200 York Road. Info at brassexpo.com.

MASSACHUSETTS, TAUNTON, April 12, Spring TRAINing - Annual Model Train Show, at Holiday Inn Taunton-Foxboro Hotel, 700 Myles Standish Blvd. Hosted by HUB Division of NMRA. Info at hubdiv.org.

MICHIGAN, MUSKEGON, April 26, Muskegon Railroad Historical Society Train & Hobby Show, onboard the USS LST 393, at Veterans Museum, 560 Mart Street. Info at mrhs-online.org.

OHIO, HILLIARD, May 15-17, 7th Ohio N-scale Weekend at Franklin County Fairgrounds. Event sponsored by Central Ohio N-Tra. Info at www.centralohiontrak.org.

OHIO, MARION, April 23-25, Central Ohio RPM, at Marion Union Station. Includes rail fanning, fellowship, and dinner at The Shovel. Info at facebook.com/groups/438383252883060.

OREGON, PORTLAND, August 23-30, NMRA National Convention, at Double Tree by Hilton Hotel Portland. Info at nmra2015.org.

OREGON, PORTLAND, August 28-30, National Train Show, at Portland Expo Center. Info at nmra2015.org/trainshow.

SELECTED EVENTS | 8

PENNSYLVANIA, MONACA, April 12, Beaver County Spring Model Train Show, at Center Stage, 1495 Old Brodhead Road. Info at bcmrr.railfan.net

PENNSYLVANIA, PHILADELPHIA, May 15-17, 22nd National Model Trolley Meet at Pennsylvania Convention Center, Exhibit Hall G, Broad and Race Streets. Event sponsored by East Penn Traction Club. Info at eastpenn.org.

TEXAS, HOUSTON, September 2-5, 35th National Narrow Gauge Convention. Info at nngc-2015.com.

VIRGINIA, FREDERICKSBURG, September 25-26, 3rd Annual Mid-Atlantic RPM Meet, at Wingate by Wyndham Fredericksburg, 20 Sanford Drive. Info at marpm.org.

WASHINGTON, BELLEVUE, April 16-18, 30th Annual Sn3 Symposium, at Bellevue Sheraton Hotel, 100 112th Ave NE. Info at sn3symposium-2015.com.

Future 2016 and beyond (by location)

CANADA, BRITISH COLUMBIA, SALMON ARM, June 15-19, 2016, Pacific Northwest Region Annual Convention and Train Show. Info at selkirkexpress2016.ca.

COLORADO, DENVER, 2017, National Narrow Gauge Convention.

INDIANA, INDIANAPOLIS, July 3-10, 2016, NMRA National Convention and National Train Show. Info at nmra2016.org.

MAINE, AUGUSTA, Sept. 7-10, 2016, 36th National Narrow Gauge Convention. Info at nngc2016.org.



**Click here for
reader comments**

Clickable advertiser index – 1

[Accu-Lites](#)
[American Ltd \(San Juan\)](#)
[ANE Models](#)
[Archer Fine Transfers](#)
[Atlas Model Railroad Co.](#)
[Athearn](#)
[Bachmann](#)
[Bachrus](#)
[Backdrop Junction](#)
[Berrett Hill Trains](#)
[Blair Line](#)
[BLMA](#)
[Bowser](#)
[Brass Expo \(Howard Zane Asc.\)](#)
[Caboose Hobbies](#)
[Canyon Creek Scenics](#)
[Clever Models](#)
[Coastmans Scenic Products](#)
[Coffman Graphics](#)
[Credit Valley Railway](#)
[Crest Electronics](#)
[DCC by Design](#)
[Deepwoods Software](#)
[Digitrax \(2 page spread\)](#)
[East Penn Traction Club](#)
[ESU LokSound](#)
[Fast Tracks](#)
[Fifer Hobby Supply](#)
[Fine Scale MR Expo](#)
[Fox Valley Models](#)
[GLX Scale Models](#)
[Great Decals](#)
[Hobby-On \(MRS Hobby\)](#)
[Iowa Scaled Engineering](#)
[Iwata-Medea](#)
[Jelsma Graphics](#)
[Ken Patterson.com](#)
[Litchfield Station](#)
[Logic Rail Technologies](#)
[Micro Mark](#)
[Microscale](#)
[Minimalist Model Railroad](#)
[Model Railroad Benchwork \(1\)](#)
[Model Railroad Benchwork \(2\)](#)
[Model Railroad Tunnels](#)
[Model Rectifier Corporation](#)
[Monroe Models](#)
[Motrak Models](#)
[Mr. Detail Parts](#)
[MRH Store \(Model Trains Video\) \(1\)](#)
[MRH Store \(Model Trains Video\) \(2\)](#)
[MRH Store \(Model Trains Video\) \(3\)](#)
[Mt. Albert Scale Models](#)
[M.T.H.](#)
[Nano-Oil](#)
[2015 National Train Show](#)
[NCE \(2 page spread\)](#)
[Nick & Nora Designs](#)
[North American Rail Car](#)
[Precision Design Co.](#)
[RailMaster Hobbies](#)
[Railroad Explorer](#)
[Rapido \(1\)](#)
[Rapido \(2\)](#)

Clickable advertiser index – 2

[Ring Engineering \(1\)](#)
[Ring Engineering \(2\)](#)
[RR-CirKits](#)
[RSlaserKits, Inc.](#)
[Rulers-of-the-World](#)
[Rusty Stumps](#)
[Signature Press](#)
[Streamlined Backshop](#)
[Scenic Express](#)
[Scotty Mason Show](#)
[Soundtraxx](#)
[Southern Digital](#)
[Sunset Models](#)
[TAM Valley Depot](#)
[T-Kits](#)
[Tony's Train Exchange](#)
[TrainMasters TV \(1\)](#)
[TrainMasters TV \(2\)](#)
[Traintek](#)
[TrainWorld](#)
[True Line Trains](#)
[True Scene Modeling](#)
[Westerfield Models](#)
[Yankee Dabbler](#)
[Yarmouth Model Works](#)

Clickable "other" index

[Other – Bonus Extras](#)
[Other – Cover](#)
[Other – Derailments](#)
[Other – Hobby Marketplace](#)
[Other – MRH Sponsors](#)
[Other – Staff Notes](#)
[Other – Table of Contents](#)



DOWNLOAD PORTRAIT



DOWNLOAD LANDSCAPE



JOE FUGATE
.....



[Click here for reader comments](#)

THE IMPORTANCE OF COMMUNITY



MODEL RAILROADING can be a lone wolf hobby, but it can also be a great team sport if you include things like operating sessions. These days with the internet and the many model railroading blogs and forums that exist,

model railroading can also be a group activity online. And of course, going to meets, shows, and conventions also give ample opportunity to connect with your fellow modelers.

For me, it's the group activity part that really enhances the enjoyment of the hobby!

I love attending shows and getting to catch up with old friends. And operating sessions bring everything on a layout together in a way that's extremely enjoyable for me. But I want to focus here on the internet, especially on the MRH website, with its forums

▶ [STEPPING OUTSIDE THE BOX WITH A CONTRARY VIEW](#)

and blogs. Being a community, almost a family if you will, is very important there, too.

Unfortunately, it's all too easy in an online setting to sidestep the niceties we all expect of each other in face-to-face contact. In polite society, you try to be nice and not verbally assault people when you disagree. But online, flame wars and personal attacks seem to happen more easily because people see the web as something of a protective wall, so they get more reckless.

We have [posting guidelines on the MRH forum](#) and in short, the guidance is "play nice". A few forum regulars have a tendency to be "contrary" or often want to disagree. While we encourage a devil's advocate view (see the [Reverse Running in May 2014](#)), if people take the anti-view often enough, others will start to see that person as disloyal to the group and start emailing us that we need to eject the "troublemaker".

The last thing we want on our forums and blogs is to have a bunch of "yes men" or to get some kind of "good old boys club" where it's "our way or the highway". This means it's important you disagree politely and allow that others may never agree with you and allow that as okay. Studies have shown those who play the devil's advocate a lot need to also communicate their loyalty to the group or they risk being given the boot.

Communicating your loyalty to the group is key, and that brings us back to community. Personal expression is great, but not at the expense of making our forums feel unfriendly. If readers feel critical people frequent our forums, they either won't post for fear they may get "assaulted" or worse – they will leave.

So when you post on online model railroading forums and comment on blogs: yes, you can disagree, but be nice about it, just like you would do face-to-face. Remember the importance of community and of also making others feel welcome.



DERAILMENTS

compiled by the
MRH STAFF



[Click here for
reader comments](#)



S. Sackett

One of the little-known properties of CA glue, it adheres *best* to the first thing it comes in contact with!

► BIZARRE FACTS AND HUMOR (SUPPOSEDLY)

TRAIN QUOTATIONS ...

“There is absolutely no need to avoid Pennsy fans just because some of them have the Enola bug!”

“Even if you’re on the right track, you’ll get run over if you just sit there.”

“The best thing about a ‘Railroad wife’ is she keeps him *on track!*”

A SLOW TRAIN THROUGH ARKANSAS ...

“An old man with long gray whiskers came through the cars selling popcorn, chewing gum and candy. “Hey!” said one of his customers. “I thought young boys were supposed to do your job.”

“I was a boy when this train started.”

– Thomas W. Jackson, 1903

Coming next issue ...

- Wally Brady’s CN Railroad
- Brass steamer tuneup and repair
- Building a turntable in N scale
- Selecting signature freight cars
- Part 3 of SP Passenger train modeling by V.S. Roseman
- SP GE Dash 7 finale
- And lots more ...

