

HAVING FUN WITH TRAINS

APRIL 2015 | FREE

MRH

MODEL RAILROAD HOBBYIST

ALSO:

- Conrail GP35 kitbash
- Making pine trees
- DCC bus wiring

Introducing MRH's new Imagineering column

>> READ NOW



EMBEDDED EDITION | LANDSCAPE



DOWNLOAD

- [TABLE OF CONTENTS](#)
- [INDEX](#)

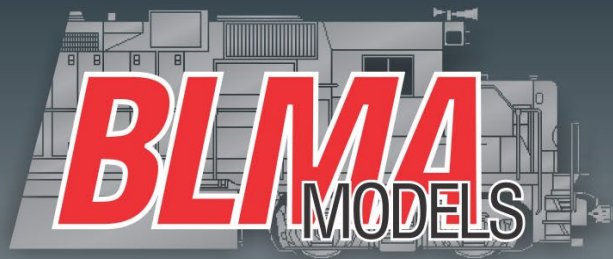

N SCALE

Trinity Rail

31K CRUDE OIL

• TANK CAR •

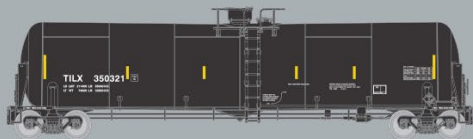

▶ ORDER BY: MAY 15

▶ DELIVERY BY: LATE 2015

CLICK HERE TO SEE MORE



BLMAMODELS.com

BLMA
BLOG

MRHMAG.COM



Model Railroad Hobbyist | April 2015 | #62

STAFF CREDITS

Front Cover: Imagineering columnists Dave Meek and Verne Niner collaborate to get this hypothetical shot of Verne's idea for a freelanced D&RGW narrow gauge branch.

ISSN 2152-7423

Editorial Staff

Joe D. Fugate, Publisher and Editor
Don Hanley, Assistant Editor

Production

Patty Fugate, pasteup and layout
Joe Brugger, copy editing
Mike Dodd, copy editing

Technical Assistants

Jeff Shultz
Jimmy Simmons

Advertising

Les Halmos, Account Manager
Daniel Nava, Advertising Assistant
Jean-François Delisle, Marketing Assistant



Columnists

Richard Bale, News and events
Jeff Shultz, News and events
Les Halmos, Modular railroading
Larry Smith, Narrow Gauge/Shortlines
Bruce Petrarca, DCC
Ken Patterson, Reporter at large

Special Correspondents

Joe Brugger, Questions & answers
Charlie Comstock, Contributing editor
Issue password: Apr2015

Published for the glory of God. [What's this?](#)

- [TABLE OF CONTENTS](#)
- [INDEX](#)



MRH SPONSORS

A - E



acculites.com



americanlimitedmodels.com



railroadhobbyshow.com



archertransfers.com



athearn.com



www.atlasrr.com



bachmanntrains.com



bachrus.com

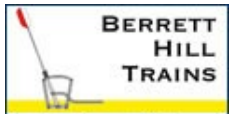

berretthill.com/trains



blairline.com



blmamodels.com



bowser-trains.com



brassexpo.com



caboosehobbies.com



coffmaneng.com



con-cor.com



cvrco.com



www.digitrax.com



crest-electronics.net



esu.eu/en

F - R



www.handlaidtrack.com



fiferhobby.com



modelrailroadexpo.com



foxvalleymodels.com



glxscalemodels.com



georgestrains.com

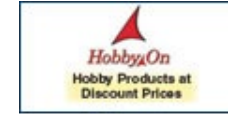

www.hobby-on.com



www.iascaled.com



iwata-medea.com



litchfieldstation.com



microscale.com



micromark.com



model-trains-video.com



stores.ebay.com/Motrak-Models



mthtrains.com



nano-oil.com/Model%20Railroad.html



ncedcc.com



nickandnora.com



www.pwrs.ca/main.php



ottawatrainexpo.com



nmra2015portland.org



railmasterhobbies.com



rapidotrains.com



ringengineering.com



rr-cirkits.com



rslaserkits.com



rustystumps.com

Vendors: Get your clickable logo here ...

Vendors: Get your clickable logo here ...

MRH SPONSORS | 3

S - Z



sanjuancarco.com



scenicexpress.com



signaturepress.com



soundtraxx.com



sodigi.com

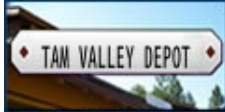

tamvalleydepot.com



tonystrains.com



traintekllc.com



trainworld.com



walthers.com

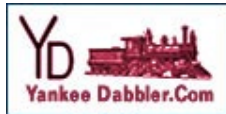

yankeedabblers.com

[Vendors: Get your clickable logo here ...](#)

Looking for something? Check our Hobby Marketplace!

Take me there!

MRHMAG.COM



N SCALE

TURNING IN A GREAT PERFORMANCE

Bachmann introduces a DCC-ready motorized turntable in N scale. With 12 indexed track positions, slow-speed gear drive, and direction control switch, it will turn in a great performance on your N scale railroad!

Features include:

- 12 nickel silver track positions
- slow-speed gear drive
- spring-loaded direction switch
- turntable indexed to each track section for accurate alignment
- DCC-ready with 8-pin dummy plug
- painted maintenance building
- prototypical operator's cabin
- designed for use with Bachmann's E-Z Track®
- easily adaptable to other popular track systems

Use our 16 x 25 x 5mm E-Z Command® DCC Decoder with NMRA 8-Pin Plug (Item No. 44915) or our 9.5 x 25 x 5mm E-Z Command® DCC Decoder with NMRA 8-Pin Plug (Item No. 44926) to add DCC control to this Motorized Turntable.



SHIPPING NOW!
MSRP \$169.00

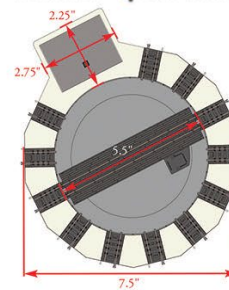

Item No. 46799 Motorized Turntable
Click for more information

Locomotives are not included.



Bachmann Industries, Inc. • 1400 East Erie Avenue • Philadelphia, PA 19124 USA • www.bachmanntrains.com
Click to learn more.

- [TABLE OF CONTENTS](#)
- [INDEX](#)



TABLE OF CONTENTS

FEATURES

Kitbash a Conrail GP35, part 1

CHRISTOPHER THOMPSON

Methods you can use for any diesel kitbash project



DCC bus wiring 101

JOE FUGATE

Wiring tips for getting your DCC layout to run its best

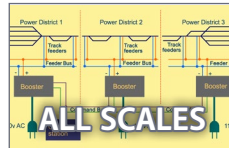

Building scale pine trees

BOB GRECH

New take on a tried-and-true technique



SP's lightweight streamlined cars: 3

VICTOR ROSEMAN

Part 3 of going beyond just the Daylight trains



Digitrax battery saver

BRENT CICCONE

Easily turn off the batteries between sessions



ALSO: Hobby Marketplace | Bonus downloads

COLUMNS

MRH Q-A-T: Paint removal, sequential ops

compiled by JOE BRUGGER

Imagineering: Meet the "Gang of Six" columnists

compiled by the MRH STAFF

DCC Impulses: JMRI - More than DecoderPro: 2

BRUCE PETRARCA

Getting Real: Track wiring, turnouts, and ballast

NICK MUFF

Lite and Narrow: New Merkle Connecting: 2

LARRY SMITH

What's Neat: Scotty Mason, soldering tips, and more ...

KEN PATTERSON

Derailments: Bizarre facts & humor (supposedly)

compiled by the MRH STAFF

NEWS and EDITORIAL

Ass't Editor's Thoughts: No youth in the hobby?

DON HANLEY

Staff notes: The *new* MRH Store, and more ...

compiled by THE MRH STAFF

News & Events: April 2015

RICHARD BALE & JEFF SHULTZ

Reverse running: Time for a change?

JOE FUGATE

**MICRO-
TRAINS®
LINE**

Announcing our next Limited Run
PWRS / Micro-Trains® Cars!!!

PWRS

Pacific Great Eastern (PGE) – 6-Pack

50' Rib Side Box Car, Plug Door, w/o Roofwalk

*Insulated
Heated*

- Harvest Gold w/Black Lettering
- Aluminum Roof
- Weathering

COMING
October 2015

CLICK HERE FOR
PGE

N
SCALE 1:80

Next in our North American Petroleum Tank Car Series!

Procor (PROX) – 4-Pack

54' General Service Tank Car

- White w/Black Lettering
- Reflective Tape
- Road Number on Top
- Light Weathering

COMING
October 2015

CLICK HERE FOR
PROX

N
SCALE 1:80

PACIFIC WESTERN RAIL SYSTEMS
SPECIAL RUN CAR

Pacific Western Rail Systems

Model Railroad Hobbyist | April 2015 | #62



ASSISTANT EDITOR

editorial

DON HANLEY
.....



Click here for
reader comments

NO YOUTH IN THE HOBBY?

THERE SEEMS TO BE A CONSTANT CONCERN in the hobby about the lack of new blood, i.e., youth. As I see it, there are several high barriers for young people seeking to enter the hobby.

1. The high cost of equipment. Unless you can catch a sale on the locomotive you want, you're looking at a \$100 - \$200 investment, and freight cars can be upwards of \$20 each. This doesn't include anything else needed to run a train. Most teenagers do not have that kind of money lying around, so if they are the least bit interested in trains they have to ask mom or dad for the money.
2. We are an instant-gratification society, more so with the advent of smart phones which are used to find all sorts of information at the touch of a button. Model railroading is definitely not an instant-gratification hobby. Most of us will spend many years in tiny bits of time to build a layout.
3. There are numerous railroad-related computer games that can be played for free online. After all, why spend money for

ASSISTANT EDITOR'S THOUGHTS | 2

models and take time to build a layout, when you can do it online faster and for less?

- As a teenager, if you let your friends know that you play with trains, you will most certainly be laughed at and ridiculed. The average teen has enough problems, so why add another target for your peers to shoot at?

A recent survey indicates that almost 82% of the people responding have been involved in the hobby over 20 years, with a whopping 32% over 50 years. Given these results, it would appear that most of the “young” modelers are in their 60s. That doesn't seem to bode well for the longevity of the hobby. After all, those of us 60 and older are more likely to kick the bucket than somebody in their teens or twenties.

ADVERTISEMENT



Your Local **N Scale**
Online Hobby Shop 575-523-9743
 fiferhobby.com

ADVERTISEMENT



ANNOUNCEMENT



ALL FIRED UP! HO AND N SCALE BIG BOYS ARE BACK

Union Pacific recently reacquired the former UP 4014 steam locomotive where it sat for the past 40 years. An extensive restoration is now underway which will take nearly five years. Anticipating the moment where one of the world's largest locomotives rides the rails again, Athena is re-releasing the iconic Union Pacific Big Boy in both HO and N-scale. Capture the majesty of these legendary locomotives on your own layout and relive the age when giants ruled the rails.

- Separately installed wire grab irons
- Sound Versions feature DCC and Tsunami Sound Equipped
- Fully assembled
- Razor-sharp printing and painting
- McHenry® scale knuckle spring couplers
- Machined metal wheels

ATHG97125	HO 4-8-8-4 Big Boy, UP #4014	\$549.98
ATHG97203	HO 4-8-8-4 Big Boy w/DCC & Sound, UP #4005 Oil Tender, Cooling Coils	\$649.98
ATHG97205	HO 4-8-8-4 Big Boy w/DCC & Sound, UP #4014 Coal, Cooling Coils	\$649.98
ATHG97207	HO 4-8-8-4 Big Boy w/DCC & Sound, UP #4019 Coal, Cooling Coils, Smoke Lifters	\$649.98
ATHG97210	HO 4-8-8-4 Big Boy w/DCC & Sound, UP #4000 Coal, Cooling Coils	\$649.98
ATHG97211	HO 4-8-8-4 Big Boy w/DCC & Sound, UP #4007 Coal, No Cooling Coils	\$649.98
ATHG97212	HO 4-8-8-4 Big Boy w/DCC & Sound, UP #4013 Coal, Cooling Coils	\$649.98
ATHG97213	HO 4-8-8-4 Big Boy w/DCC & Sound, UP #4014 Oil Tender, No Cooling Coils, Two Generators	\$649.98
ATHG97214	HO 4-8-8-4 Big Boy w/DCC & Sound, UP #4022 Coal, No Cooling Coils	\$649.98
ATH22900	N RTR 4-8-8-4 Big Boy w/DCC & Sound, UP #4005	\$499.98
ATH22902	N RTR 4-8-8-4 Big Boy w/DCC & Sound, UP #4014	\$499.98
ATH22903	N RTR 4-8-8-4 Big Boy w/DCC & Sound, UP #4019	\$499.98
ATH22905	N RTR 4-8-8-4 Big Boy w/DCC & Sound, UP #4000	\$499.98
ATH22906	N RTR 4-8-8-4 Big Boy w/DCC & Sound, UP #4007	\$499.98
ATH22907	N RTR 4-8-8-4 Big Boy w/DCC & Sound, UP #4013	\$499.98
ATH22908	N RTR 4-8-8-4 Big Boy w/DCC & Sound, UP #4014	\$499.98
ATH22909	N RTR 4-8-8-4 Big Boy w/DCC & Sound, UP #4022	\$499.98
ATH22992	N RTR 4-8-8-4 Big Boy, UP #4014	\$399.98

HORIZON
 H O B B Y

VISIT
 Your Local Retailer

CLICK
 Athena.com

CALL
 1.800.338.4639

SERIOUS FUN

©2015 Horizon Hobby, LLC. Athena, Genesis and McHenry are registered trademarks of Horizon Hobby, LLC. All other trademarks, service marks and logos are property of their respective owners. Final models may vary slightly from photos shown. ©1998

NICK & NORA DESIGNS
Uniquely inspired craftsman kits

NEW!



Henlopen Landing Kit # ST024
\$95.00

Craftsman Structure Kits,
Detail Parts, Shingles,
Vehicle kits from:
Sylvan & Jordan
Tru-Color paint, glues & more!



Checked us out lately?



WHAT'S NEW? Established 1993...
Blair Line

ASSISTANT EDITOR'S THOUGHTS | 3

We have witnessed a decline in the circulation of major hobby magazines over the last two decades to approximately 70% of their peak subscription. And not just in hobby magazines, but all forms of publications.

With preceding list of items – and I am sure that there are more that we could come up with if we took the time – it seems “obvious” that the hobby is in a downward spiral, if not dying. Do we throw in with the naysayers and declare that the hobby is dying? Should we all prepare to close up shop and find something else to do?

To do so would be to ignore other compelling empirical evidence. MRH's subscriptions are increasing, our Facebook “likes” are increasing, and the hits to our site are increasing. The model railroad manufacturers are constantly adding new products and expanding what is available for us to purchase.

Bowser

EXECUTIVE LINE

HO ALCo C-430 Locomotives

Delivery
March 2015



Road Names: Demo, NYSW, WNY & P, NYC, PC, Conrail, Morristown & Erie, GBW, LV, & RI

HO Retro Fit Sound Kits

Retro fit LOK Sound; sound kits for Stewart and Bowser EMD F-3, F-7 and F-9, Alco Century C-628, C-630, MLW C-630M locos or add sound to non sound Alco C430 and Alco C-636. \$110.00 Each

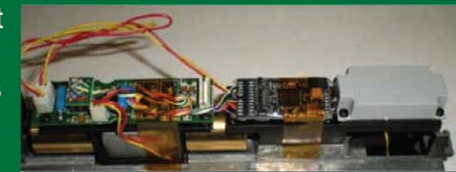

Click here to check out the details for these and other great Bowser products!

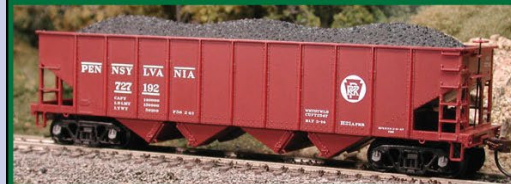

N Scale H21 Hopper Cars

Due Late Summer
Ready to Run
PRR, PC, N&W, & Virginian
MSRP \$18.95

HO DRS 4-4-1000 & RS-12 Locomotives

Delivery
March 2015



Road Names: CP, CNJ, PRR, Oregon California & Eastern, Escanaba, Seaboard & CWR Bicentennial

ASSISTANT EDITOR'S THOUGHTS | 4

The number of the mom-and-pop business appears to be increasing, but this is a little more difficult to gauge because it is constantly in flux.

There are the Brio trains for children, along with Thomas the Tank Engine and Lego trains – all big-time manufacturers with international exposure. Granted, these are not the model trains we normally think of, but still they are trains catering to children. Do these guys know something the rest of us don't?

I was at the recent Amherst Railway Society railroad hobby show where over 18,000 people participated. This was in spite of 8 inches of snow on a Saturday. There are many other swap meets that take place around the country that appear to do well and happen like clockwork every year.

What I think is happening to the hobby – and especially communication about the hobby – is that it is changing. To say the hobby is dying is to miss some new indicators modelers may not be seeing. And this brings me back to to be beginning of this editorial: the lack of new blood in the hobby. I don't believe there is a lack of new blood – which I defined as a lack of youth in the hobby. I think we are looking at the wrong age group for the hobby's youth.

Based on the study I referenced, maybe we should instead define the youth of the hobby as anyone under the age of 40.



[Click here for reader comments](#)

ADVERTISEMENT



FAST TRACKS

YOUR VERY OWN TRACK FACTORY

Make the most of your modeling experience.

Build perfect trackwork easily and inexpensively when YOU want it!



★★★★★
Check out our extensive (and growing!) online video library to learn how easy it is to hand lay your own trackwork with Fast Tracks tools and supplies.

Play Video ▶



HELPING THE WORLD
BUILD BETTER RAILROADS

shop online 24/7
1-888-252-3895

handlaidtrack.com
service@fast-tracks.net



RailCrew

SWITCH MACHINE with OPERATING SWITCH STAND
includes three different stands and ten alternative targets

**HO
SCALE**

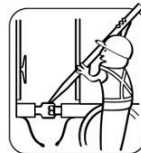
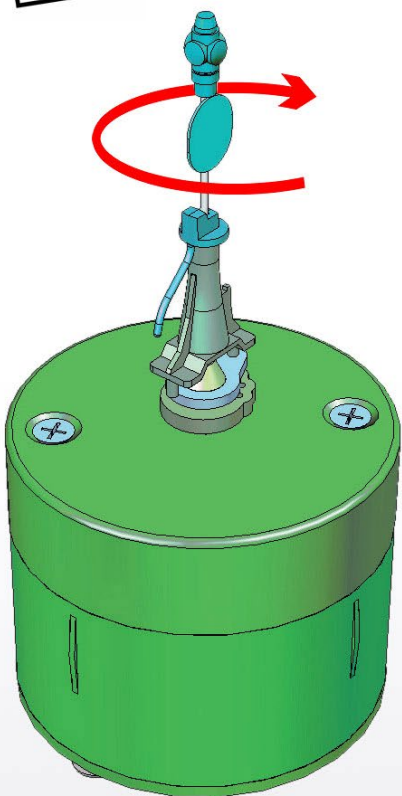

RailCrew

ON-OFF REMOTE UNCOUPLER

No unintended uncoupling on main line or in sidings

- Easy to install on existing layouts
- Momentary power - single source 12V dc handles multiple units
- Works with all major brands of magnetic couplers
- Low profile compact design for multi-deck and portable layouts
- Ideal for uncoupling freight and passenger cars
- LED between and below the rails marks uncoupling zone when in 'ON' position

**HO
SCALE**

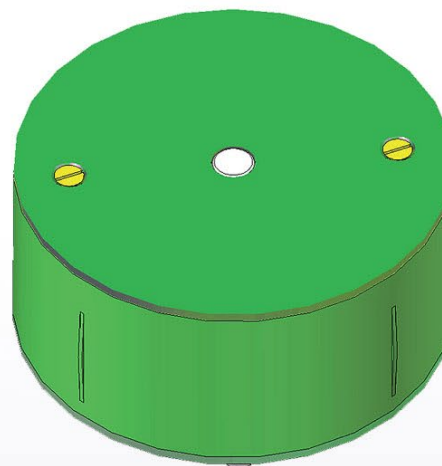

COMPACT DESIGN
1 3/4" (44mm) diameter
7/8" (22mm) deep



New
Innovation

Nano-Oil™
Made in U.S.A.

Nano Technology Lubricants

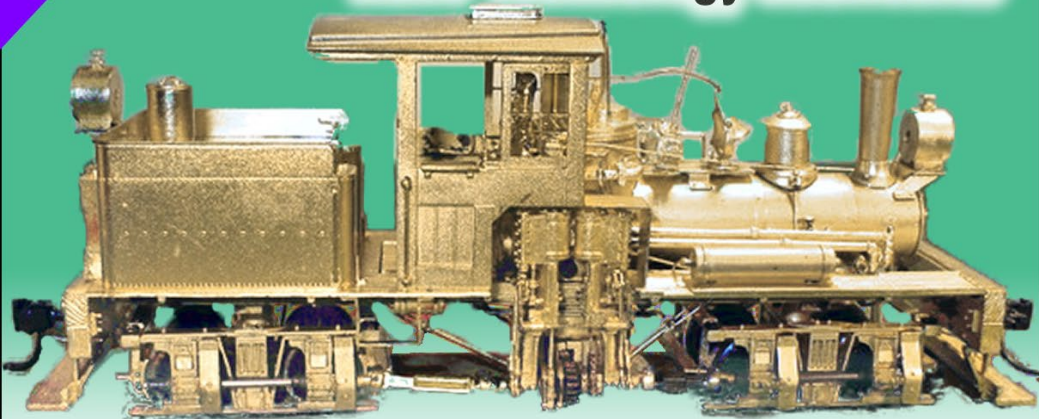

Nano-Grease

"After eight years of extensive testing, the only lubricants now used in my shop are Nano-Oils and Nano-Grease. The extreme reduction in power draw by mechanically minimizing friction is simply technologically superior."

- Phil Floyd, 'The Shay Fixer'

THE SHAY FIXER 

VISIT US AT... SHAYFIXER.COM 

Specializing in brass Pacific Fast Mail / United geared locomotives

**For more details
click here ...**

MRHMAG.COM



Model Railroad Hobbyist | April 2015 | #62

STAFF NOTES

**Model
Railroad
Hobbyist
Store**



**Click here for
reader comments**

**THE NEW MRH STORE,
SISKIYOU LINE PROGRESS UPDATE, AND
MORE ...**

WE'RE THRILLED TO ANNOUNCE THE NEW Model Railroad Hobbyist Store website! This new site has all our products on it and it's easily navigated on a mobile device. To get to the store, just type: store.mrhmag.com ...

We're retiring the old Model-Trains-Video website and branding because MRH and Model Railroad Hobbyist have become better known. If you go to model-trains-video.com, it now auto-forwards to the new MRH Store at store.mrhmag.com.

These days, having a mobile-friendly website is very important, especially now that Google, as of this month, will penalize websites that are not mobile-friendly in Google searches. We've also

- [TABLE OF CONTENTS](#)
- [INDEX](#)

STAFF NOTES | 2

gotten questions over the years about how to find our videos and eBooks. By making the new store an extension of the MRH branding, it becomes very easy to tell people how to find our store: just type store.mrhmag.com.

Another exciting development that's store-related has to do with TrainMasters TV videos. More than a few who participated in our video survey last year told us they don't have good enough bandwidth to do

1 (below). Here's the front page of the New MRH Store. It's easier to navigate and purchase items from, allowing both credit card and Paypal purchases. The products include DVDs, downloadable videos, eBooks, and coming soon - hardcopy books and other items like mugs and shirts.

★ LAST ISSUE'S RATINGS

The five top-rated articles in the [March 2015 issue](#) of *Model Railroad Hobbyist* are:

- 4.6 DCC Impulses: JMRI: More than DecoderPro
- 4.6 Getting Real: More signature freight cars
- 4.6 Scratchbuild a turntable and pit
- 4.5 What's Neat: Photo shoot with Athearn
- 4.4 Brass steam engine tune-up and repair

Issue overall: 4.4

Please rate the articles! Click the reader comments button on each article and select the star rating you think each article deserves. Thanks! ■



ADVERTISEMENT

Check out the Latest Atlas Track and Accessories Catalog!

Atlas offers the high quality track and accessories you need to build the layout of your dreams!

CLICK HERE!

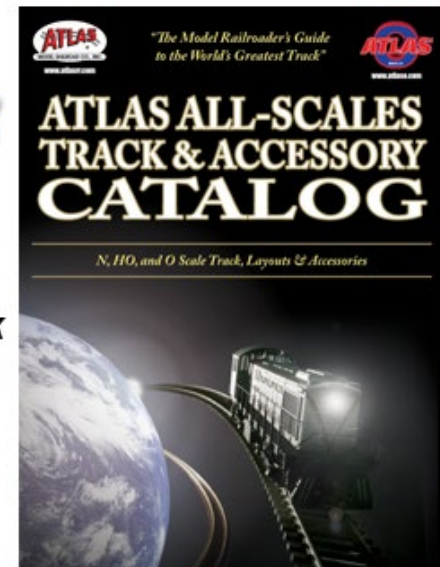

streaming video over the Internet, which is what TrainMasters TV is all about. Instead, they'd like the option to buy DVDs or downloadable video of the segments that interest them.

Well, you're shortly going to get your wish. Starting this month, we'll be rolling out many new titles with the 80-some new video segments we did for TMTV last year.

2 (below). The new MRH Store website is also mobile-friendly, making it easy to navigate and buy from while on the go. The sample screen capture below shows what the new MRH Store looks like on an iPhone 6 screen. Everything is large and easily scrolled or tapped by your fingers, just as you would want on mobile.

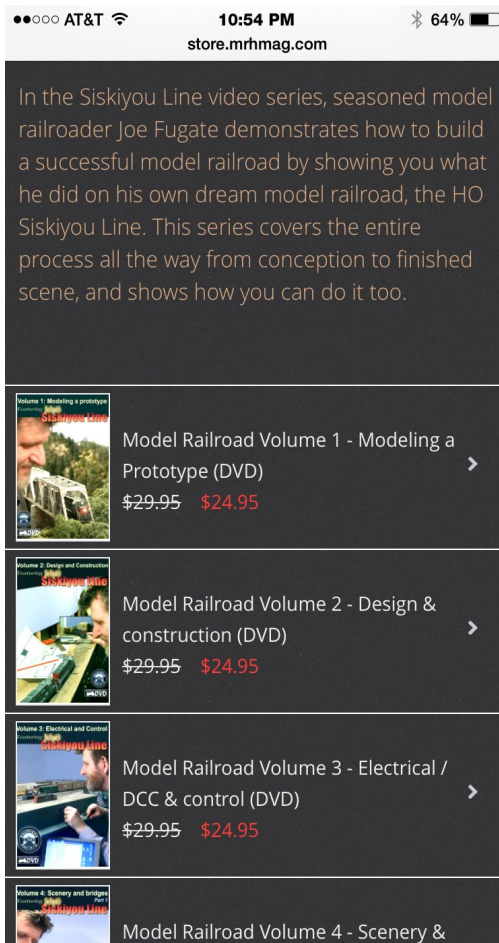

Stay tuned for more information soon on all these new TMTV video titles coming to the MRH store ...

Siskiyou Line progress update

Publisher Joe Fugate is working on his Siskiyou Line layout and getting it ready to show this coming August and the NMRA National Convention in Portland, Oregon. Here's what Joe has to say about the latest developments on his layout:

"I'm working on the upper deck of my Siskiyou Line in the area that represents the towns of Sutherlin and Oakland. On the prototype between Oakland and Sutherlin, there's a short deck girder span across a country road. I'm modeling this span as faithfully as I can.

ADVERTISEMENT



ADVERTISEMENT



STAFF NOTES | 6

“You can see a photo of the prototype bridge here [3].

“Just like the prototype, my bridge is on a curve. Here’s a shot of my model of this bridge [4] taken from about the same angle as the prototype bridge in the photo on the right.

“The road will climb upgrade from the fascia, curve under the bridge, and then just beyond the abutment on the right will meet up with another road curving around to the right beyond the track. I’ll be using green florist’s foam to build up the contours in this scene (that’s next).



3 (above) and 4 (below). Joe Fugate is modeling this prototype bridge scene above on his HO Siskiyou Line. The photo below shows the current model scene in its early stages of construction.



STAFF NOTES | 7

“This is a MicroEngineering 30’ deck girder bridge, with abutments scratchbuilt out of 60 thousandths styrene, and then abused with a file to roughen up the styrene to add weathering and form seams as are visible on the prototype. I replaced five of the plastic ties on the bridge with matching dimension basswood ties so I could spike the rail in place over the bridge.”

To read more about the latest Siskiyou Line updates, see Joe’s MRH blog at:

mrhmag.com/blog/joef

No Yes, it’s a model this time ...

This issue got very full and we’ve pre-empted the *Yes, it’s a model* photo feature to bring you an extra article instead. *Yes, it’s a model* will be back next month.

ADVERTISEMENT

Rslaserkits

Carl’s Cabin

Now in O and Ho scales



The perfect cabin for your logging or mining camp or use for housing on the wrong side of the tracks. Includes extra material to use for the piers and bracing when placed on a slopping lot. We have also included the out house.



Check out our new HO flat car decks

Dealers welcome
Salem, OR
503-371-4290



Custom Laser Cutting
and design
Sales@rslaserkits.com

What's new on the MRH website?

You'll find useful discussion threads posted on our website every day, and if you're eagerly awaiting the next monthly MRH magazine, you'll find material that's almost like more articles on our website. Here's a recent sampling of these posts.

Resetting QSI decoder in sleep mode: mrhmag.com/node/21951

Making wrecked equipment: mrhmag.com/node/21947

Red Mountain Railway progress: mrhmag.com/node/19041

Buffalo Line layout link: mrhmag.com/node/21954

Doing soldering right: mrhmag.com/node/21944

Point of Rocks train station: mrhmag.com/node/21936

Steeple Cab project: mrhmag.com/node/21641

What's on your workbench March 2015: mrhmag.com/node/21728

Scenery at Fleur: mrhmag.com/node/21922

Modeling smaller evergreens: mrhmag.com/node/21943

Layout in a shadow box: mrhmag.com/node/21914

Extraordinary flatcar load: mrhmag.com/node/20932

Sergent couplers in op sessions: mrhmag.com/node/21421

Cars restricted from interchange: mrhmag.com/node/21925

Enjoy the April MRH!

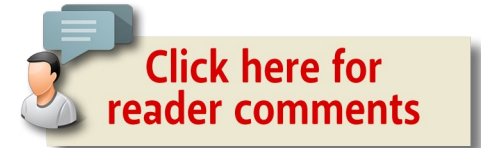

ADVERTISEMENT



NEW!
Micro-Mark introduces the **MicroLux LaserKnife 2525™**

Makes cuts impossible to do with a knife, punch or saw

The first in a series of affordable, easy-to-use table-top laser cutters/engravers that will revolutionize the way you make scale model parts, fabricate creative arts and crafts projects, build engineering prototypes, and more!

Click HERE for more information!

ADVERTISEMENT

TRINITY 3281



CMO - 12 road numbers \$48.95 each



CSX - 12 road numbers \$48.95 each



TILX - 6 road numbers \$48.95 each



WSOX - 6 road numbers \$48.95 each plus CRDX and MCEX

American Limited

www.americanlimitedmodels.com

ADVERTISEMENT



HO & N SCALE HIAWATHAS

FINAL BOARDING CALL FOR MORE CARS AND LOCOMOTIVES!
NOW AVAILABLE WITH SOUND!



RESERVE TODAY! www.foxvalleymodels.com

Introducing the **Model Railroad** **ALL NEW Hobbyist Store**

store.mrhmag.com

**FREE
SHIPPING**

Visit the MRH Store



DVDs



10-Vol video set
Get our ten most popular videos and save!
~~\$259.50~~ **\$149.00**



2-Vol scenery set
Get both our popular Siskiyou Line scenery videos and save!
~~\$59.00~~ **\$39.00**

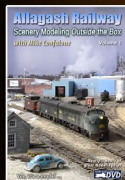

Allagash scenery-1
Simple but brilliantly realistic scenery techniques.
~~\$29.95~~ **\$24.00**



Ops Live-5 Allagash
Get our newest Ops Live video on the Allagash today!
~~\$19.95~~ **\$14.00**



Pine Ridge Railroad
An amazing Gorre & Daphetid look-alike by Tom Hokel.
~~\$19.95~~ **\$14.00**

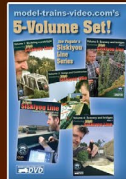

5-Siskiyou Line set
Get all five Siskiyou Line videos for a special price!
~~\$149.75~~ **\$99.00**

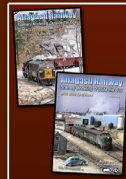

Allagash Scenery set
Add these must-have scenery videos to your collection!
~~\$59.90~~ **\$39.00**

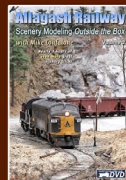

Allagash scenery-2
Small space but big scenery techniques that rock!
~~\$29.95~~ **\$24.00**

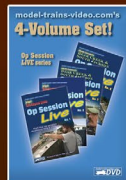

4-Vol Ops Live set
Ops Live 1-4 on the Siskiyou (1-2) and Bear Creek (3-4).
~~\$79.80~~ **\$49.00**

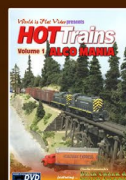

Hot trains - Alcomania
A don't miss railfanning video of the Bear Creek & South Jackson!
~~\$29.95~~ **\$24.00**



Videos available for instant download!

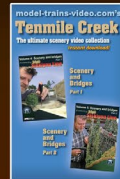

Tenmile Creek HD video
Get our highly popular Tenmile Creek scenery how-to.
\$14.99 HD video



Sound decoder install
MRH DCC columnist Bruce Petrarca installs a sound decoder.
\$5.99 HD video

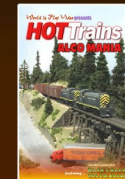

Hot Trains HD video
See the Bear Creek & South Jackson layout vision come alive.
\$9.99 HD video



OPs Live-5 HD video
Live operating session on Mike Confalone's Allagash Railway.
\$7.99 HD video



eBooks available for instant download!

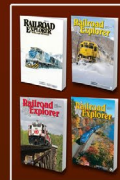

RR Explorer 37, 40, 41, 42
Four digital volumes of Railroad Explorer loaded with superb photography.
\$14.77 PDF • ePub • Kindle

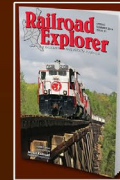

Railroad Explorer #41
Eastern Rail Journal - superb photography and railfan stories.
\$5.99 PDF • ePub • Kindle



Allagash Story 1-4
In-depth story of Mike Confalone's Allagash layout in 4 volumes.
\$24.77 PDF • ePub • Kindle



Railroad Explorer #40
Eastern Rail Journal - superb photography and railfan stories.
\$5.99 PDF • ePub • Kindle

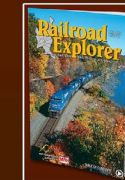

Railroad Explorer #42
Eastern Rail Journal - superb photography and railfan stories.
\$5.99 PDF • ePub • Kindle

Visit the MRH Store

store.mrhmag.com

FREE SHIPPING! Use coupon code: FREE-SHIPPING

Coming soon! TrainMasters.TV DVDS / downloads

HO Heavyweight Passenger Sets Arrive



Check out the quality and value found inside the M.T.H. HO heavyweight passenger cars now arriving at your local M.T.H. Authorized Retailer. An intricately detailed, durable ABS body rides atop smooth rolling trucks that won't bog down a locomotive struggling to pull heavy passenger cars. Detailed car interiors, detailed car undercarriage, Kadee couplers and overhead, constant voltage flicker-free LED lighting ensure that these cars won't disappoint.

- Durable ABS Intricately Detailed Bodies
- Metal Wheels and Axles
- Constant Voltage Overhead LED Interior Lighting
- Detailed 6-Wheel Trucks
- Authentic Paint Scheme
- Separate Metal Handrails
- Detailed Car Interiors
- Kadee Couplers
- Detailed Car Undercarriage
- Operates On 22" Radius Curves



Pullman
80-40009 2-Car Heavyweight Sleeper/Sleeper Passenger Set
80-40008 2-Car Heavyweight Baggage/Sleeper Passenger Set
80-40007 5-Car Heavyweight Passenger Set



Union Pacific
80-40006 2-Car Heavyweight Sleeper/Sleeper Passenger Set
80-40005 2-Car Heavyweight Baggage/Sleeper Passenger Set
80-40004 5-Car Heavyweight Passenger Set



Pennsylvania
80-40003 2-Car Heavyweight Sleeper/Sleeper Passenger Set
80-40002 2-Car Heavyweight Baggage/Sleeper Passenger Set
80-40001 5-Car Heavyweight Passenger Set



Milwaukee Road
80-40012 2-Car Heavyweight Sleeper/Sleeper Passenger Set
80-40011 2-Car Heavyweight Baggage/Sleeper Passenger Set
80-40010 5-Car Heavyweight Passenger Set

M.T.H.
ELECTRIC TRAINS
HO TRAINS THAT DO MORE
www.mthHOtrains.com

Follow Us
Online!



©2015 M.T.H. Electric Trains



Model Railroad Hobbyist | April 2015 | #62

MRH Q-A-T column

compiled by
JOE BRUGGER



[Click here for
reader comments](#)

? QUESTIONS AND ANSWERS

Using air erasers

Q. I'm looking at buying an air eraser to remove letters and numbers from O scale freight cars without removing the underlying paint. I plan to use baking soda as the abrasive medium. The products I'm considering are a Paasche model AEC air eraser and a Badger model 260 mini sandblaster. I know that Harbor Freight sells a knockoff version of the Paasche AEC. I have been through two of those and both had terminal problems.

—Bob Bartizek

A. Steve: Air erasers are great for getting stubborn paint off of plastic without hurting it. Also a good prep prior to painting. Works on both plastic and metal.

Brian I: I have used the Paasche model AEC air eraser to remove lettering and paint on N scale rolling stock. It worked

► MRH QUESTIONS, ANSWERS, AND TIPS

MRH Q-A-T | 2

really great and can remove car numbers and such in about two seconds without damage to the underlying paint. I found the generic baking soda clogged the tip much faster, whereas as the Arm & Hammer brand baking soda clogged a lot less.

Fishmack: If an air eraser (soda blaster) gets ANY condensed moisture in the air supply line, it will plug, regardless of the brand. Before buying a new model of soda blaster, consider a good quality moisture trap for your air supply line. Besides the soda blaster, clean dry air is a must for quality painting.

Peter H.: I bought a Badger which works, but is very limited in removal, which is what you want, I guess. If all you want to



1. Air erasers are available in kits that include a sprayer, hoses, abrasive, and filters. Paasche Airbrush photo

MRH Q-A-T | 3

do is remove lettering, it will do the job. If you are thinking of roughing up a whole car (especially O scale) for paint prep, you will be working a long time. I got a bead blasting cabinet and have not used the eraser since. If all I want is to remove lettering, I use the finest grit and turn the PSI way down.

Brian II: I have had great success in using a fiberglass eraser pen for removing decals on my locos, rolling stock, and the odd plastic buildings. They are available from any good art supply shop or watch maker supply store. It removes the decal without damaging the paint work underneath it.

Gordon: For what you want to do I think Brian has the right idea – fiberglass eraser pen. My Paasche Air Eraser AEC will take off lettering but also the surrounding paint as well. I'm in HO scale so, working with a small area.

I ditched the baking soda when I found it was turning the eraser tip corrosion green on the inside, and constantly clogging. I couldn't keep the baking soda dry enough. I switched to using Paasche Air Eraser Compound AEX-6. This is aluminum oxide. It doesn't absorb moisture, and worked great in the air eraser. Clean tip and no clogging. Do follow the cautions on the label, and use a moisture trap. The compound comes in various grits for varying degrees of cutting power.

I have used the air eraser to remove lettering and strip paint off locomotive shells. You do have to play with air pressure and distance from the work. It is a slow process, so you need patience. You can go too far and start to smooth or remove subtle detail on the surface. Do remove the shell from any mechanism, as oxide dust and paint dust will be everywhere. A good wash/cleaning is needed on any surface you air-erase when done.

Fiberglass pens: micromark.com/ultra-micro-fiberglass-brush,7850.html.

Q. I'm wondering if there are forms for sequential running available for download? I'd like some for myself and two friends for their layout. —rsn48

A. For sequential train ops, all the scheduled trains have a time they're scheduled to leave but, in practice, they just leave in their assigned order whenever the yardmasters have them ready. Or, they can start out at any time at, or after, their scheduled departures. Your choice.

CREW		CALL BOARD			
		A M		P M	
JOB	CREW	TRAIN	CALL TIME	ENGINEER	CONDUCTOR
DISPATCHER		#23	7:30		
ASSISTANT DISPATCHER		#26	7:30		
HEAD MOLE		G47	7:30		
ASSISTANT MOLE		#20	8:05		
LEBANON YARD MASTER		#424	8:20		
LEBANON YARD SWITCHER		#311	8:35		
SHELburn YARD MASTER		#25	8:50		
SHELburn SWITCH		R98	9:05		
TALLMAN LOCAL		G42	9:20		

2. The call board shows bid jobs on the left and pool jobs on the right, as well as the train line-up and scheduled release times. Members mark-up to work using magnetic name tags. This railroad dispatches with track warrants. Graham Line photo

If you're not running to the clock, specific times will keep things in sequence, so you can number everything in easy-to-understand increments, and boldface the meeting points and times in your timetable. Assigned departures can also keep trains from bunching up on the railroad, and allow a smoother, more predictable traffic flow.

For example: Train No. 1 (a westbound) heads through towns A, B, C, D with respective times 0100, 0200, 0300, and 0400. Train No. 2 (an eastbound) leaves D at 0200, meeting No. 1 at C at 0300 and so on, arriving at A at 0500. If the next train you want to run is another A-D train, and you want to do it after No. 2, you could "schedule" it to run at 0600.

In this way, you have to develop the proper scheduling sequence of events, but throw out all the subtleties of actually running according to timetable and train orders, and throw out all rules regarding superiority of trains and train orders. On a railroad with a handful of trains, it should work well.

You can keep the superiority by class/direction part to identify who takes the siding at meets without too many additional instructions. But at least formal TT&TO things like extra trains and "right" (modifications to superiority given by train order) aren't an issue because everything is listed and set in stone.

To keep things easier for crews, use the actual sequence timetable purely as your master planning document, and work up little train instruction cards for each job. These would read a bit like modified train orders, and the train crews don't need to follow a timetable at all.

Each train just gets its written order(s). Use the planned sequence to set up the paperwork in advance. Reuse the same

MRH Q-A-T | 6

orders every session if you want. Because each meeting point is specified, there's no need for a clock.

Then provide a sign-up/call board with the departures listed in sequence.

If you are modeling a prototype railroad you can use an employee timetable as a template for the graphics and type, etc., then put in your own stations and trains in sequence. If you stipulate that everything runs "on time" and throw out the clock, you won't need anything more than the sequence and some specific instructions for each train pertaining to meets, scope of work, etc.

Thanks to M. David Johnson, Dave B., Graham Line, and Chris van der Heide.

Sequential ops: mrhmag.com/node/3550.

See how modeler Keith Jordan runs several jobs on a compact Santa Fe switching district at patchrailroad.net/The_Patch/Patch_Operations.html.

Charlie Comstock has devoted a considerable amount of thought to organizing train schedules: s145079212.onlinehome.us/rr/operations/index.shtml.



TIPS

Lost tool time

Don't know about you guys, but I'm forever setting stuff down on the layout I'm building and then can't find it. The item I kept losing was my flat metal NMRA gauge. Solution: Dayglo orange duct tape! It make things easy to see. And, yes, I've been to the eye

MRH Q-A-T | 7



3. Puzzle time: Find the NMRA gauge! How about the MLR resin track tool?



4. Now the only problem is the glare from all the orange tape.



The Hunt for Savings Ends Here!



- Kadee - NCE - SoundTraxx
- Digitrax - And more!

Click NOW!
(while supplies last)



MRH Q-A-T | 7

doctor: 20-20 corrected!!!
I came up with this idea when I lost that track gauge for three days!! I had spent a couple of days in the layout room cleaning up all the detritus from a construction hiatus. Gathered all the similar tools together and tossed all the extra pieces of material that got left behind. Put all the track laying stuff in one box, the cork roadbed and its accessories in another.

I put the gauge where I would be sure to see it. Ha-ha. Three or four days later, I needed to check a clearance, and looked for the gauge. Looked high and low. I knew it would turn up eventually.

One day I was looking at a spot on the layout visualizing what type of backdrop I might use, when I saw it sitting up as plain as day against a riser. I missed it every time I was looking specifically for it. My layout is not THAT big for O scale, 19 x 20 feet! Anyway, that orange X fixed the problem. Haven't lost it since. The wooden pieces are

MRH Q-A-T | 8

gauges for tie installation and alignment. They really disappear on the layout.

I agree I can't mark everything, as that could become self-defeating but so far I have marked the items in the pictures, my tape measure, and my marking pencil. Other items usually stay in or next to boxes but items I tend to "set down" will probably get marked.

—Peter Herron

More at mrhmag.com/node/21317.

GET PAID FOR YOUR TIP

We pay \$25 per tip we publish, or \$40 each if the tip also includes a photo or finished drawing. [Click here and select article type TIP.](#) ■

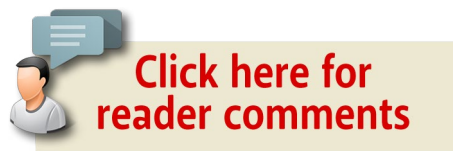

Come & See Us
[CLICK Here](#)



www.hobby-on.com

**Name Brand
Hobby
Products
at Discount
Prices!**

You're the kid.

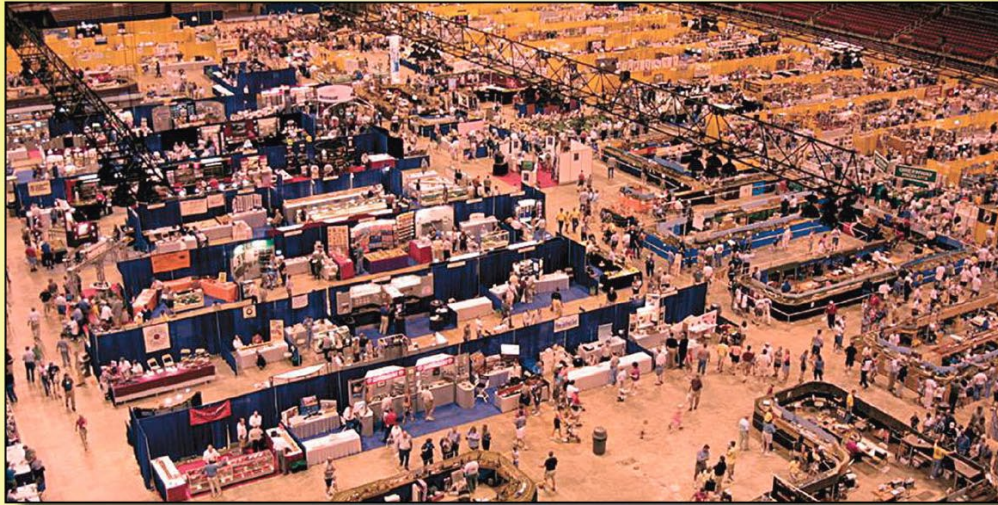

Welcome to the candy store.

- 180,000 square feet of sheer bliss
- Over 250 manufacturer & retailer booths
- 50,000 square feet of modular layouts
- "Ask the Collectibles" appraiser
- Trains, accessories, collectibles & more
- Hands-on demonstrations

August 28 - 30, 2015
Portland Expo Center

2060 North Marine Dr.
 Portland, OR 97217

Sponsored by



**CLICK HERE
 FOR ALL THE
 DETAILS!**

www.nationaltrainshow.com

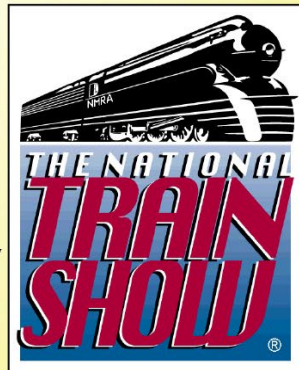

GANG OF SIX

Model Railroad Hobbyist | April 2015 | #62

IMAGINEERING

column



**Click here for
 reader comments**

WELCOME TO THE NEWEST MRH COLUMN ...

LAST WINTER, SOME MRH FORUM DISCUSSION lead to the idea of doing a new column in MRH focusing on the creative sides of model railroading. There's plenty of press on getting every bolt and rivet in the right place, but what about the parts of doing the hobby well that have less to do with prototype fidelity, and more with the art of being creative?

Enter this new column. Yes, freelancing is a component of this column, certainly. But the imagineering part of the hobby is much broader than prototype versus freelance. At its core, it's about using your imagination to get a more satisfying model railroad.

To launch this first column, each columnist has penned an introduction to themselves and their perspective on this column. We'll be rotating through these columnists one per month, giving six different perspectives on the art of Imagineering your model railroad.

Without any further ado, here's our six new columnists!

▶ **EXPLORING THE CREATIVE SIDES OF THE HOBBY**

DAVE MEEK

HOWDY, AMIGOS!

My name is Dave Meek, and I have always been fascinated with trains and railroading.

I started out in N scale 40 years ago and can't remember a time when I didn't have some kind of layout going in one scale or another.

These days I'm busy with an On30 layout called the Thunder Mesa Mining Company, a rollicking, frontier tribute to the work of Disney Imagineers whom I admire, and the real canyon country that I love. I also keep my hand in N scale with a small switching layout on a shelf, and I've just started a new project in On18 that will connect and contribute to the larger world of Thunder Mesa.

I'm a dyed-in-the-wool freelancer, both as a model railroader, and as a working professional. My job as a freelance commercial artist has taken me to some fascinating places, creatively speaking, and allowed me to work with a wide array of talented folks.

Collaborating with ad men and architects, publishers, writers, marketers, theater people, and theme-park designers has been an invaluable experience. Thanks to modern technology, I'm now able to work from home in rural Arizona and spend plenty of time with my kids when I'm not working (playing) on the railroad.



My approach to model railroading has been deeply influenced by my experience in the creative fields. I see a model railroad very much as a themed environment, a show if you will, where story drives the choices about what to model and how.

This leads me to think of things in terms of scenes, transitions, and characters, rather than the more generic structures, scenery, and rolling stock. In the end, my goal is not just to model a miniature transportation system, but also an entertaining and immersive world that can take you away to another place and time.

For this column on model railroad imagineering, I hope to bring that story-based perspective to life. Sometimes it's useful to step back from what we're doing, and realize that this wonderful hobby is part of a larger world of creative endeavor. There is much that can be learned by shifting perspective and taking-in the bigger picture.

Looking beyond the rails to arts and technologies, storytelling and show-craft that overlap with the needs of the hobby can help us to achieve the full potential of our model worlds. ■



DOUG GEIGER, MMR

IN 1982, after three months of intense design work, I began construction on my Granite Mountain Railway, an HO/HOn3 model railroad.



Set in the 23-foot by 43-foot basement of our Colorado home, my 1988-era GMRy is a multi-level, freelanced layout planted firmly in both the Rocky Mountains and the Cascades. While primarily a bridge route, the GMRy connects to four prototype railroads, including the BN, the Milwaukee Road, the ATSF and the Rio Grande.

Operations are a passion for me and my wife, Barbara. In fact, we just held the 327th op session in late February. In 1991, the layout was featured as Video Eight in the “Great Model Railroads” series.

Several years ago, I purchased, refurbished, and installed an authentic ex-Santa Fe US&S centralized traffic control machine for dispatching the railroad. Since then, the GMRy has continued to evolve through several major catastrophes, including replacing the floor to install a new sewer line.

The current project on the GMRy is the design, construction, and operation of Pacific Steel, a large freelanced steel complex.

I also enjoy scratchbuilding and kitbashing structures and hand-laying track.

Although most modelers begin the hobby with Lionel or American Flyer as a youth, I was wheelchair-bound for two years at the age of 15 from multiple surgeries due to a “factory-defect” foot and leg. With nothing to do to pass the time, a neighbor (who was an HO-scale modeler) provided me with kits, tools and a few magazines. And the rest, as they say, is history!

In 1985, I obtained my Master Model Railroader certificate (earning nine of the 11 categories) just before I turned 40 years young. Then in 1991, after retirement, I began writing for various model railroad publications, including 12 years as a contributing editor for Model Railroading (“Ding”) magazine.

I have had many articles, reviews and editorials published since then on a variety of topics and techniques. I have also given many clinics at both regional and national NMRA conventions.

For MRH’s new Imagineering column, I hope to bring you some of what my freelancing has accomplished and the thought processes behind those projects. As a civil engineer and computer graphics programmer, my freelancing is based on sound engineering practices and hopefully good “business” decisions as the CEO of the Granite Mountain Railway. ■

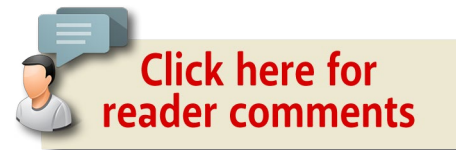

MICHAEL TONDEE

HI EVERYONE.

My name is Michael Tondee and I'm an enthusiastic and unapologetic freelancer!

I got started in model railroading somewhere around my seventh or eighth birthday, when I received a Tyco over-under figure-eight train set complete with a Santa Fe diesel loco in the blue and yellow scheme.

I started getting really serious in the hobby at the age of 15, and I'm now 52 years of age, so that gives me 37 years in this great hobby.

One of my great influences in the hobby was and is the work of John Allen. I can vividly remember the feeling of awe and wonderment I had the very first time I saw the famous center spread of "French Gulch" in the classic book "Scenery for Model Railroads." That book, with its pictures of work by great model railroaders of the time like John, Jack Work, Linn Westcott, and the author himself, Bill McClanahan, is what shaped my impressions of what a model railroad should be. All these years later, those impressions haven't changed much.



When I started out, I first dabbled in HO but I eventually switched to N scale, and that would be my scale of choice for many years. I was a diesel modeler too, but finally switched to steam some years back. Soon after that came a switch back to HO scale, which is where I am now.

My present layout is a mountain switching line known as "The Blackwater and Blue Hollow" or as it's more commonly and affectionately known, "The Ole Black N' Blue." The layout is not super-specific as far as era and location. I prefer to think in general terms like "steam era" and "somewhere west," rather than nailing down an exact time and place.

My goals for my part of this column are to help to impart that sense of wonder, whimsy, and fun I got from my heroes so many years ago. I look to the prototype for many things, I'm not an "anything-goes modeler," but I'd much rather model a scene entirely from my mind's eye than try to directly copy a real life scene. I'm looking to model an "atmosphere" more than anything else.

I usually have a pretty clear vision of what I want a scene or structure to end up looking like when I start out, but that vision can change and adapt as different problems are encountered or better ideas come along. I find inspiration will pop up at the strangest times too. I look forward to giving you a small peek into my creative mind. ■



[Click here for reader comments](#)

RAY DUNAKIN

HI! MY NAME is Ray Dunakin, and I'm a former illustrator and developer of adventure games for the Mac.

I'm also the creator of the In-ko-pah Railroad, a 1/24th-scale line serving mines and mining towns in a fictionalized version of the desert east of San Diego.

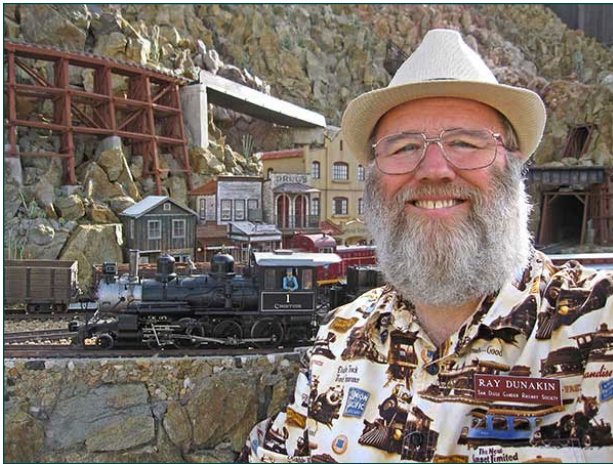

I am something of a “late bloomer” when it comes to model railroading. I’ve loved trains since I was a child, and always wanted a model railroad, but lack of money and space conspired to limit my entry into the hobby. For a while I contented myself with scratchbuilding structures and small dioramas, first in N scale and later in HO. But what I really wanted was a complete layout, where I could combine trains, structures, and scenery to create a miniature world.

The closest I came to achieving this goal was in the mid-1980s. I was recently married, we owned our home, and I finally had some garage space to build a layout. I built the benchwork and started hand-laying track for an HO_n30 railroad. When I became self-employed, it was necessary to remodel and add space for my office, which meant tearing down the garage – and the layout. About that time I got

involved in my other hobby, rocket aerial photography, and gave up on model railroading.

In December 2005 I saw a G scale starter set on display in the window of a discount store. I loved the realistic sound of the 2-6-2 steam locomotive! The set was marked down from \$499 to \$100, so I bought it. As I listened to the engine chugging around the oval of track on our front patio, I began to dream again of having a railroad empire. A steep hillside in our backyard was the only place available to me. I dug out vast quantities of soil, hauled in an insane amount of rocks, concrete, and mortar, and by May 21, 2008 I had completed the mainline, and could finally run trains.

My focus has always been on the visual and creative aspects of model railroading. I love the drama of a train snaking its way through realistic scenery, whether it’s the solitude of open desert, the spectacle of high cliffs and tall bridges, or the man-made sights of towns, mines, and industries. I also love scratchbuilding detailed models – mainly structures, but also some motive power and rolling stock. Obviously, an outdoor layout is not the ideal situation for modeling realistic scenery and detailed models, but I’ve found ways to make it work.

My approach to model railroading is a kind of “idealized realism.” I’ve combined the features I want, from disparate sources, to create a place that doesn’t truly exist, yet looks and feels true-to-life. It’s a fantasy grounded in reality. How I achieve that, and how you can put it to work for you, is what I hope to bring to this column. ■

ROB CLARK

HI FOLKS – Rob Clark here; recently semi-retired IT Project Manager just raring to share my free-lance model railroad journey.

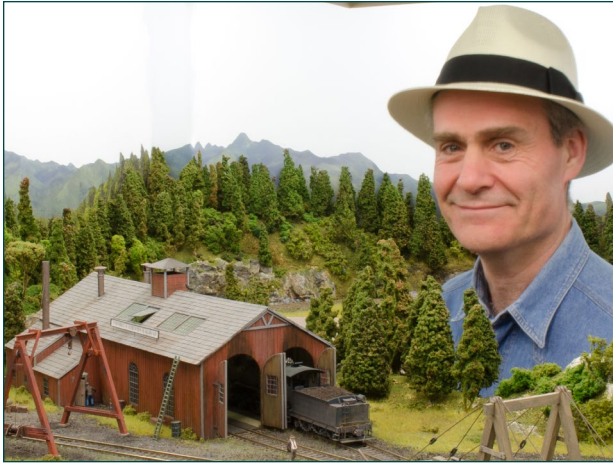

As one of the six new columnists, I consider myself the “joker in the pack” because I’m not only a relative newbie, but also British.

My interest in American model railroads started in the ‘60s when I was a huge fan of Meccano (metal construction toy). I saw a Union Pacific 4-12-2 locomotive built in Meccano, and its sheer magnificence led me to start reading up on railroads in general. A copy of “Steam in the Sixties” by Ron Ziel and George Foster was the clincher and I was hooked.

Then, like Michael Tondee (and many others), I got a copy of “Scenery for Model Railroads” by Bill McClanahan, but never managed to build anything of significance. Rock music, cars, girls, and life in general caused a 40-year hiatus, during which I could only read lots of books and dream.

So fast-forward to 2010, and I find myself with the time, money, space, and inclination to build a model railroad. The

simultaneous discovery of MRH magazine as a great source of inspiration meant the tool kit was complete – but what to build?

So the Cornhill & Atherton railroad was born. An HO scale steam shortline set in the mid-1930s. Despite a lot of international travel, I have never been to the US, and have intentionally avoided attempting to copy any prototype railroad or even geographical area. Totally “imagineered” in every respect, the C&A is simultaneously “no place” and “every place,” rural America.

Other than the track plan and basic two-deck-with-helix construction, nothing is decided and each scene will evolve. As I write this, the C&A is only 3/8 complete. Through this column you can share in and influence (through reader feedback) the future direction.

So how is it that with such an unpromising pedigree, I might be able to create something convincing?

I think my lack of experience is my strength, and the challenge is to convey through the coming articles, the creative thought processes and building techniques that result in a believable world.

There are a lot of fascinating folks working on the C&A that we just haven’t met yet, and there are a lot of hills and valleys waiting to be surveyed. Climb aboard and let’s see where that track takes us! ■

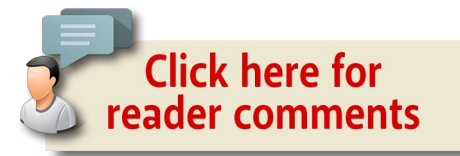

VERNE NINER

HI THERE....

My name is Verne Niner, and I've been fascinated by trains as long as I can remember. Over the past 45 years I have modeled in N, HO, back to N, On30, and in HOn3. My interest has always

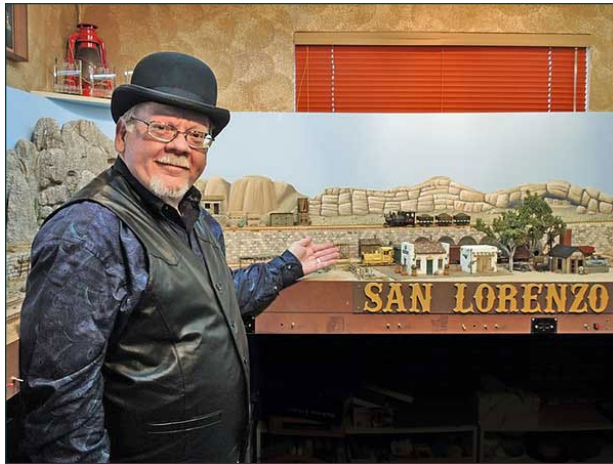

been centered on imagineering miniature worlds that have a “rhyme and reason” behind them.

My current project, the Estrella & Sonora Grande in On30, has been a very rewarding experience. I enjoyed learning about the history of hard-rock copper mining in southeastern Arizona, and the myriad narrow gauge railroads in the area. Very soon, my old layout will be history and I'll be creating a new On30 project from the ashes of the E&SG. It will be a gold mining road named the Arroyo Verde & Western.

The thread that ties these projects together is my love of historical research and the fun of integrating a freelanced railroad into the history, geography and economy of a specific place and time.

My modeling was influenced at a young age by Frank Ellison, who so eloquently described our model railroads as the stage,

and our trains as the actors. Railroading – and the world and life around it all – is the show. And if we take that message to heart, we can create compelling themes and stories that leave our audiences entertained and asking for more! This is one of the most wonderful aspects of our hobby, and has always made “having fun with trains” a fresh and delightful pursuit over the years.

Model railroads that go beyond the sum of their parts to become something special all have a “rhyme and reason” behind them. The “reason” is the logic and design to achieve the modeler's goals, whether the objective is a four-track trunk line connecting Class A roads, or a sleepy narrow gauge branch line.

The “rhyme” is the creative and theatrical flair employed by the modeler to tell a story. Together, both play a critical part. Our challenge is to communicate that story through sight, sound, color and form...to lead the eye where we want the audience to look, and to give them an entertaining view into our miniature world.

I am pleased to join a fine group of columnists as we share our excitement (and some practical tips) to help demystify the artistic side of the hobby. Regardless what our modeling preferences may be, we all face similar challenges when creating our miniature worlds.

How we go about doing that – and turning square feet and benchwork into compelling scenes that captivate the audience – will be the central theme of our monthly columns. I can't wait to get started, and I hope you will climb on board for the journey!.



Digitrax No Worries Warranty Keeps Your Layout Running!

That's it! A simple, straightforward one year warranty with no tricky language!

You're protected against defects and accidental damage.

Learn more at: www.digitrax.com/noworries

Need tech support?

www.digitrax.com/contact

Need a repair?

www.digitrax.com/repair

Need a throttle conversion?

www.digitrax.com/upgrade

Visit
Our
Website!

Litchfield
STATION

SHOPPING AT
LITCHFIELD STATION
FOR ALL YOUR
DCC PRODUCTS?

WHAT A
BRIGHT
IDEA!

TRAIN CONTROL
SYSTEMS

SOUNDTRAXX™

NCE
The Power of DCC

Tam Valley Depot

DiGiTraX
Complete Train Control

623-298-7355 • www.Mr-DCC.com
www.LitchfieldStation.com



BRUCE PETRARCA
.....

Model Railroad Hobbyist | April 2015 | #62

DCC IMPULSES

column



Click here for
reader comments

JMRI: MORE THAN DECODERPRO

| AN INTERVIEW WITH SOME OF THE
FOLKS BEHIND JMRI, PART 2

IN MY LAST COLUMN, WE BEGAN OUR LOOK
inside JMRI with the founder, Bob Jacobson. This time, I con-
tinue with some others folks who have had some notable influ-
ence on JMRI.

Michael Mosher on using a mobile device as a throttle

Now, let's talk with Michael Mosher, who, in addition to work-
ing on decoder definitions has a lot of information about using
JMRI as a wireless throttle network. Although we've exchanged
eMails, I have not had the pleasure of a face-to-face meeting
with him.

MRH: Tell me how I can run trains with my cell phone
or tablet. What hardware is needed to take advantage of
this, assuming you are starting with JMRI connected to
your DCC system?

► DCC TIPS, TRICKS, AND TECHNIQUES

DCC IMPULSES | 2



Mosher: You can use JMRI as a portal between a WiFi network and your DCC system, allowing you to run trains from your portable device.

If your computer is connected to a WiFi network, then make sure your cell phone or tablet is connected to the same WiFi network. Open the app on your phone and you should see the layout advertised.

If the computer is not already on a WiFi

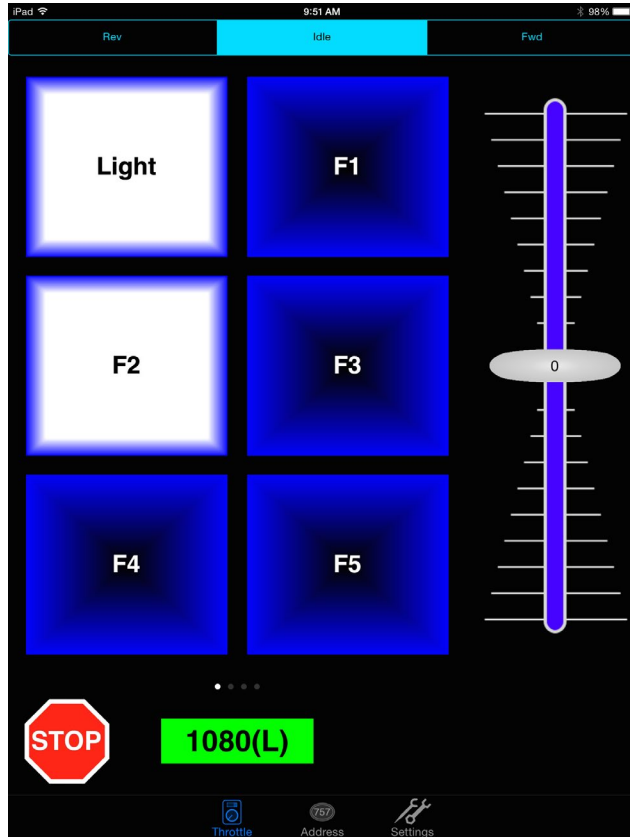

network, then a WiFi access point will be needed, typically a WiFi router. Internet connection is not required for throttle operation. The JMRI computer can be connected to the router either over WiFi or via a wired (USB or Ethernet) connection.

1. WiThrottle Lite running train 1080 with Yard Mode enabled. Capture by Bruce Petrarca

DCC IMPULSES | 3

If you have a smart phone already, you can use it as soon as you download the appropriate app. See the sidebar for app information and inexpensive sources for usable devices.

Start the WiThrottle Server by clicking the menu Tools - Throttles - Start WiThrottle or the menu Debug - Start WiThrottle.

Once in the app, give it a moment for auto-configure to find the WiThrottle server then select it. There will be a list of locos based on DecoderPro roster IDs that you can select from or enter any address. If the Function Labels tab has been filled out for the selected loco then the function buttons will have that text rather than just a number.

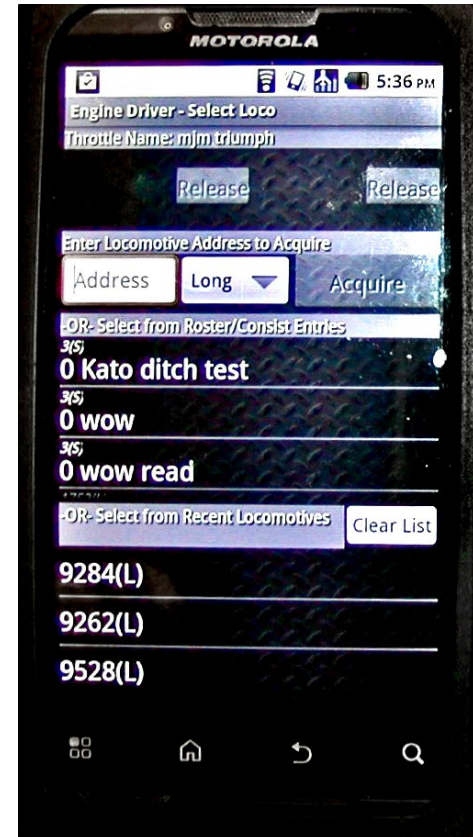

I've also included some data on the frequency allocations in the 2.4 GHz band. Check out the sidebar, if you are interested.

MRH: Thanks, Michael. Now we know another use for our phones.

2. Engine Driver running on an Android phone. Photo courtesy Michael Mosher

SIDEBAR

PORTABLE DEVICES AND APPS

For throttle devices, portable devices will need to be connected to the Internet long enough to download the app. Once the app is installed, no Internet connection is needed.

For iPhone, iPod Touch, iPad, go to App Store and search for WiThrottle Lite [1] for free basic functions app, or WiThrottle [a] for paid full feature app.

For Android version 1.6 or later, go to Google Play Store and search for Engine Driver [2] for a free full-feature app. If Android tablet does not have access to Play Store or is version 1.5 or earlier, then download Engine Driver app directly from enginedriver.rrclubs.org.

The cell radio can be turned off by setting the device to airplane mode. Battery life will be better with it off. WiFi needs to be turned on and connected to the same WiFi network as the host computer.

Since the cell radio is not needed, a source for low-cost throttles is to look for used phones that have bad Electronic Serial Number or otherwise disabled or non-functioning cell radio.

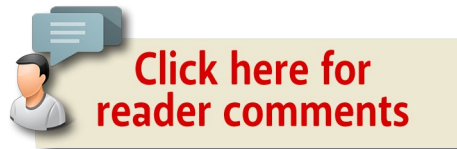

2.4 GHz SPECTRUM ALLOCATIONS

The non-licensed portion of the 2.4 GHz spectrum is very crowded with lots of overlapping services. In order to avoid interference, you need to carefully choose the frequencies you use.

In the US, WiFi has 11 channels, as shown in dark blue. Channels 12, 13, 14 (light blue) are used outside the US. WiFi channels are overlapping, so you cannot use, for example, channels 1 and 2 in the same place at the same time, as they interfere. The largest group of non-overlapping channels is 1, 6, and 11 (and 14 if in a country that allows that channel), therefore those are the most-used channels.

Some wireless video cameras frequently used for train cams are also in 2.4 GHz band in four channels, as shown in green. The cameras in the 1.2 GHz and 5.8 GHz bands will not interfere.

Digitrax duplex radio throttles also use the 2.4GHz band in 16 channels (11-26 - shown in red). Select channel 26 if possible, as that won't conflict with any US WiFi channel or camera channel.

Bluetooth is also in the 2.4 GHz band but is a frequency hopping protocol so it will find a free space for itself. ■

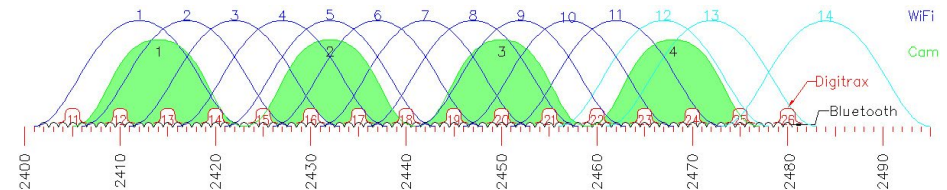

Dick Bronson discussing prototypical signaling

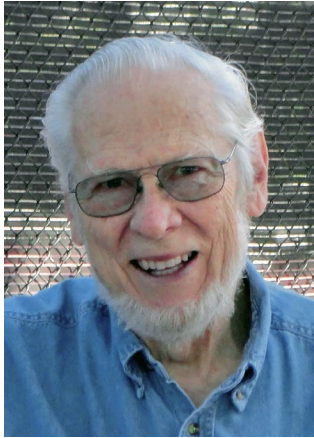

Dick Bronson is a manufacturer of support electronics for model railroads through his company RR-CirKits, Inc. (rr-cirkits.com) an MRH sponsor. Linda and I met Dick and his wife, Karen, at one of the NMRA national conventions, perhaps Seattle in 2004. We have enjoyed time together whenever we have attended the same convention ever since.

MRH: How did you get involved with supporting JMRI?

Bronson: My first contact with JMRI signaling was a clinic that Nick Kulp gave at Timonium. During the clinic he not

only managed to completely delete the panel that he was demonstrating, but also to recover well enough to show signals changing on his demo layout.

We had just recently started our company with some products aimed at detection and signaling, so I was very interested in this new RR software concept. I was already familiar with some other open source software from my day job, (Apache and Linux) so I knew the concept could work to create useful results.

As a fledgling company we decided that what we needed from the growing JMRI community was contact with potential new customers for our new products. In exchange what we could contribute to the project was training for new users, like Nick had done for me. Because our new products supported signals we headed off in that direction.

The PanelPro section of JMRI has grown out of this cooperation.

MRH: Have you done things other than give clinics for the JMRI project?

Bronson: Actually yes. The first time I gave a JMRI clinic on signaling the program didn't work like I expected it to at all. It had the basics of what we now call SSL (Simple Signal Logic) but there were some common signaling situations that did not have any way to set them up. I was able to dig around in the code enough to add in the missing options. Some one else (I suspect probably Bob Jacobsen) took what I had cobbled together and straightened it out into an acceptable format. This emphasized to me that JMRI really is an open project that honors the efforts of anybody that is willing to make a contribution.

As my efforts to present clinics grew we found that there was an opportunity to improve on and create new graphics for the

ADVERTISEMENT

END OF TRAIN DEVICE

FLASH CIRCUIT UNDER TRUCK



TRACK POWERED

READY TO RUN!

Bright Red Flashing Light!

Installs in minutes with no freight car modification required!

RE RING ENGINEERING

Patented Technology - US Patent 7,549,609

Does not affect Load!

↓ Car without Load ↓

↓ Car with Load ↓



For video and more click here!

DCC IMPULSES | 8

creation of CTC panels. This was back in the days when the only way to create a JMRI CTC panel was to paste together multiple images of the background, track, levers, and lamps.

MRH: How has this 'open source' software concept worked out for you as a manufacturer?

Bronson: The synergy between RR-CirKits and JMRI has actually been critical to our growth as a company. I would like to think that this give and take has worked to improve JMRI as well.

One specific area for us is in the JMRI signaling support. Originally the only JMRI support was for direct drive signal lamps (CMRI) and for LocoNet (Digitrax) signal heads. One of our LocoNet products (the RR-CirKits LNCP) optionally included



3. SP's Canyon Dispatch machine in the day. Photo courtesy Bob Jacobsen

TONY'S TRAIN XCHANGE

Committed to your DCC support!

Atheam Genesis
Union Pacific
GE ES44AC



Starting at \$149.95

Order Yours

SoundTraxx Tsunami
Sound Decoders



IM1000,
BW1000,
KT1000, GN1000,
AT1000, 1000, 750

Starting at \$81.96

Order Yours

DCC Specialties
RRampMeter™



Accurately measures DCC,
AC and DC Volts and Amps!

Versions I, II, III & IV

Starting at \$59.95

Order Yours

Do you need a Sound or
DCC Installation done?

Get a quote!

**TONY'S
TRAIN
XCHANGE**
DCC SPECIALISTS

Providing unmatched person to person DCC support for more than 25 years, the kind of service that has made us #1 in DCC. **DCC questions? CALL US! 1-800-978-3472**
*Mention this ad for \$5.00 off your next order over \$100!

We'll get you on the right track!

April 2015



support for signal masts using the NMRA accessory signal decoder commands, but there was no way to actually use it.

One of the JMRI programmers, Kevin Dickerson from the UK, was trying to add the concept of controlling signal masts as a basic unit to JMRI. It was a natural thing for Kevin to add in the NMRA DCC signal accessory decoder support found in the LNCP into his new signal mast concept. That support has in turn led to other manufacturers designing signal mast hardware using the NMRA signal accessory decoder definitions.

This DCC signal aspect definition has been part of the NMRA DCC specifications for many years now, but has suffered the classic 'chicken or egg' syndrome.

Why build a product with no way to control it? Why spend the time to figure out how to control something that doesn't exist.

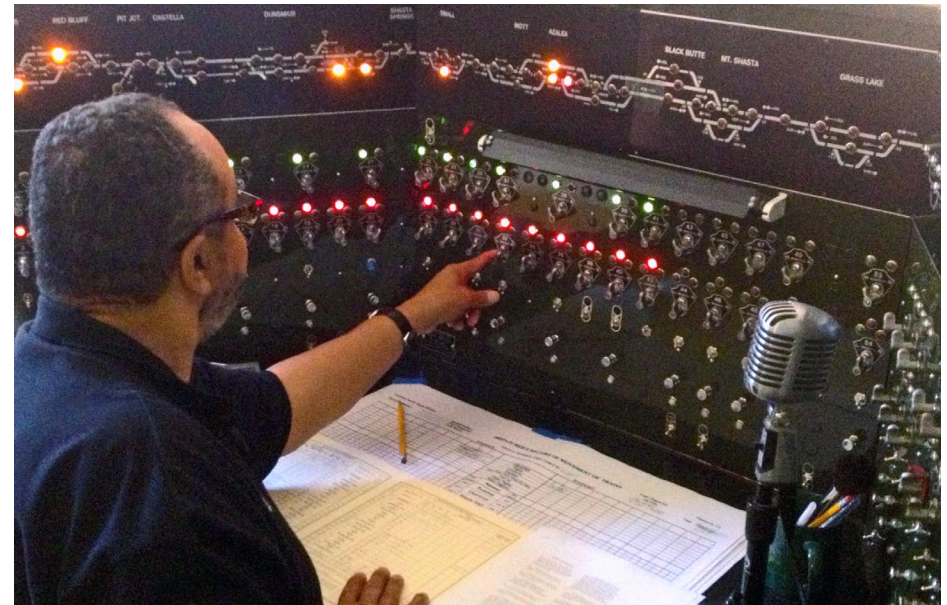

4. This model of the Canyon Dispatch machine is being operated by Otis McGee on his layout. It works through JMRI's PanelPro to control signals and turnouts. Photo courtesy Bob Jacobsen

Alex Shepherd and Kevin Dickerson, both JMRI developers, broke the deadlock and I expect that soon the modeler will see a new class of signal decoder available from several different sources.

I just took a look at the current list of JMRI contributors (jmri.org/help/en/Acknowledgements.shtml) and counted representatives that I recognize from over half a dozen different manufacturers. Apparently we are not the only company that has been helped along by the existence of JMRI.

Some commercial software has existed for controlling a modeler's hardware before JMRI came along, but the relatively high cost of the commercial products greatly limits the size of their user base. As a small business we could never have grown, or

ADVERTISEMENT

Installing DCC sound just **NOT** your thing?
Trust Traintek for sales and installation of sound decoders from these fine vendors!

ESU DIGITRAX QSI SOUNDTRAXX DCC

RailPro

"Taking model railroad control to the next level..."

Traintek LLC

traintekllc.com

Click here for more details...

"Traintek was the way to go!"

ADVERTISEMENT

IOWA SCALED ENGINEERING

Infrared sensors!

open source hardware

LEARN MORE >

DCC IMPULSES | 12

even survived, with the number of customers that could afford to purchase commercial software to run our products.

MRH: Why would the modeler want signals in the first place, especially prototypical ones?

Bronson: Before the advent of command control systems, especially DCC systems, operating signals of any kind were the exception on model railroads. Most folks were satisfied with sticking a few dummy heads at appropriate locations to complete the scenery. Because flashing lights are interesting, we sometimes even animated them to some degree. They were not an important part of operating our railroads because running one train into another was not a big problem when you only had one or two power packs to work with, and trains always went the same way at the same speed on the same tracks.

DCC IMPULSES | 13

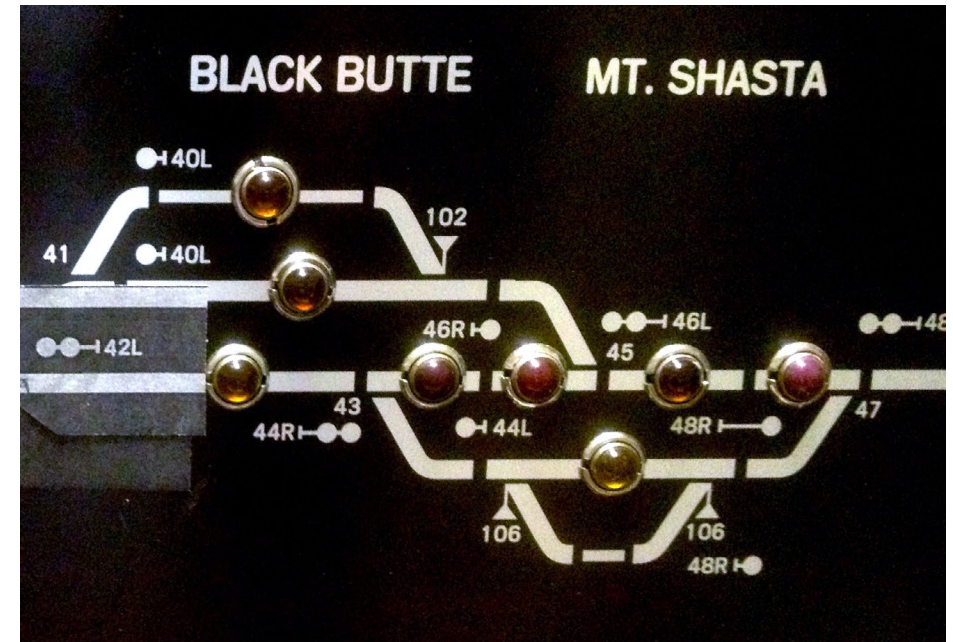

5. Close up of the Black Butte/Mt. Shasta sections of the machine in. Photo courtesy Bob Jacobsen

Now in the last decade or so we have moved much closer to the prototype in our train operations. Our controllers now only control a single train, and it has no limits on speed or direction when compared with any other trains on the same piece of track. It has become much more important to operate our trains like the real railroads do.

There is a growing interest in 'operating sessions' where folks run their trains like a real railroad does. That of course includes not running into other trains. Suddenly it is important to figure out how the real railroads managed that, and one way was to use signals. It is no longer just a nice addition to the scenery, it has become important to the safe operation of our trains.

ADVERTISEMENT

Make LocoNet wiring extremely simple!

ACCU-LITES, inc

Your DCC Center!

Dealer Inquiries Accepted

PM42
breakout
board



SE8C
breakout
board



BDL168
Multi-zone
breakout board

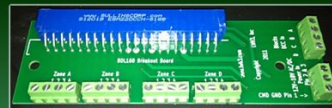

BDL168
Single-zone
breakout board



Now Offering SNAPS! in packs of 6 or 12 pieces! [CLICK TO LEARN MORE ...](#)

DCC IMPULSES | 14

Simple signals may be all that we actually require as modelers, but for many folks, if you are going to add signals, then you may as well do it correctly. Few would think of sticking a coal tender behind an SP cab forward, nor would they put searchlight signals beside the tracks on a Pennsy layout. The latest JMRI versions recognize this and are starting to include built in rules for the prototype signals of different railroads and eras. Like everything else in JMRI, once someone does the work required to codify the rules for a particular signal system, they become available to any one else that wants to take advantage of them.

MRH: Just how prototypical can you get with JMRI signaling?

Bronson: About as prototypical as you may ever want or need.

I happen to know that one current Class I railroad has just started using JMRI to control the signals on their latest training layout for engineers and conductors. In other words some real world railroaders are now learning how to follow signals controlled by JMRI before they are allowed behind a throttle on the main line. Not only that, but their officials were simply amazed to discover that such sophisticated software is available to any hobbyist at the cost of a free download. This railroad uses the NORAC signal rules, so we are talking about signals capable of displaying over a dozen different aspects, not just simply stop and proceed.

One of the instructors told me that it is not uncommon to see the trainees literally break out in a sweat as they try to remember the correct radio traffic while they make up a train or what speed to approach a signal and what reports to give as they do. They forget that it is actually just a model train they are running. For them it is a very serious undertaking to learn how to do their jobs efficiently and safely.



Southern Digital



**20% Discount
on most items!**

Specializing in DCC Since 1992



DCC Conversions, Service & Support

Orders Received by 3:00 pm EST ship the same day

WWW.SODIGI.COM

E-mail: sales@sodigi.com

(770) 929-1888

(Photo's are from our N-Scale layout)

DCC IMPULSES | 15

MRH: Thanks, Dick, for your insight.

There you have a lot of the back story of JMRI. Perhaps more than you ever wanted.

Please join the conversation after the column on the MRH web site. A lively discussion frequently ensues. If you liked the column, please rate it awesome. You can do both with the reader feedback links at the beginning and end of the column.

Until next month, I wish you green boards.



[Click here for reader comments](#)

ADVERTISEMENT

RailPro™

NEW TECHNOLOGY

DIRECT™ RADIO



[Click Here to Learn More](#)



RE RING™ ENGINEERING

NEW Starter Kit \$399.99 MSRP

- Includes Wireless Color Touch Screen Handheld Controller and 56 Watt Power Supply
- Expandable to Virtually any Size Layout

NEW Locomotive Module LM-2 & LM-2S

- Direct Radio RF
- Sound and Non-Sound
- New Tiny Size
- 6 Light Outputs

For more information visit our Internet site: www.RingEngineering.com

Get Better Sound from your Locomotives

Can't get a good sound from your sound decoder?
Give our speakers a test drive with your ears.



RAILMASTER HOBBIES
9812 BELMONT
BELFLOWER, CA 90706

Bass Reflex Speakers



High Bass Speakers



When it comes to speakers we have high quality speakers to fit many different applications. We are also a full line hobby shop. Need anything? We are an authorized dealer for Soundtraxx, Digitrax, Athearn, Walthers and many others. We provide quality speakers for your DCC sound systems and quality service.

Click here for the answer ...

From first train set to railroad empire...

*Our complete line of DCC products
grows with you. Discover the fun!*

- Designed and manufactured in the U.S.A.
- Preferred for ease of use and ergonomic design
- Unlimited scalability for any size model railroad
- Plug-and-play means more time running trains
- Great customer service and excellent support



Visit our new and improved web site for all your DCC needs!

- Get the latest new product announcements
- Watch our detailed how-to videos
- Browse the all-new Information Station
- Enjoy secure online sales, day or night!



See your dealer

Visit ncedcc.com





SO REAL...You'll Think You're There!

LokSound Select · 3 SIZES, ENDLESS POSSIBILITIES!

INDUSTRY LEADING MOTOR CONTROL

- Multiple Bell types
- Multiple Brake squeals

4 OR 8 Ohm SPEAKERS!

- 4 or 6 Output functions depending on the style
- Up to 4 Prime Movers or Steam Sounds on EACH decoder
- 16 Very Playable, LOUD Horns or Whistles depending on Profile
- All Changeable by using ONE CV! No Programmers or Boosters needed!*

**Small Size
BIG POWER! 1.1Amp!
LokSound Select
"4 AUX"**

\$99.99

NEW 2011

Only Available From ESU LLC (USA)

**ONE SIZE FITS ALL!
LokSound Select "DIRECT"**

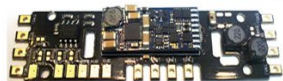

**6 Outputs!
LED Resistance
Built In!**



\$109.99



Only Available From ESU LLC (USA)

- Easy Drop in Design
- Versatile DCC & DC "Dual Mode" decoder!
- 8 channel sound system!
- SIX lighting outputs ALL with built in resistors for LEDs
- Available with ALL Current Diesel Sound Profiles
- Use 4, 8, or 16 Ohm Speakers

**Tiny Size,
HUGE Versatility!
LokSound Select
"MICRO"**

\$99.99

NEW 2011

Only Available From ESU LLC (USA)

- Great NEW size ONLY 0.98" x .417"
- Versatile DCC & DC "Dual Mode" decoder!
- 8 channel sound system!
- FOUR lighting outputs and a .75A motor controller!
- Standard 8-pin NEM 652 plug included
- Available with ALL Current LokSound Select Sound Profiles
- Use 4, 8, or 16 Ohm Speakers!

* ESU LokProgrammer needed to "Replace" Sound and for Firmware updates, not for normal editing

www.LokSound.com • 477 Knopp Drive Muncy, PA • 570-649-5048

Now on facebook!



Model Railroad Hobbyist | April 2015 | #62

GETTING REAL

column

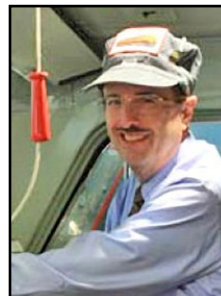

NICK MUFF



Click here for reader comments

MODELING THE KANSAS CITY TERMINAL RAILWAY | MAINLINE SOUTH – TRACK WIRING, SWITCH MACHINES, PAINT, WEATHERING AND BALLAST

IN THE LAST INSTALLMENT I FINISHED laying track. Now it's time to bring it to life with switch machines, wiring, paint, and weathering!

WIRING THE TRACK

When I began construction of my Kansas City Terminal Railway – Kansas City Southern Lines layout, it was designed for standard DC throttles with block control. Now I have entered the world of DCC, having gotten past the steep part of the learning curve with the help of friends and the folks at Digitrax.

What were once blocks on the DC layout are now handy power districts with DCC operation. With their advice, I have proceeded

► **MODELING REAL RAILROADS AND WHAT THEY DO**

GETTING REAL | 2

to wire the KCS mainline section of the layout with blocks as originally planned. This has proven to be very useful in isolating electrical shorts. On a new DCC layout these would be called power districts.

In the past I created an electrical block diagram for the layout with feeder wire positions indicated in their actual positions. This helped me to know exactly where to cut the gaps, and where to drill the holes for the feeder wires for each block. I cut the gaps for each block using an abrasive cutoff wheel. Small pieces can and do fly into your eyes. Be sure to wear eye protection!

To drill the holes for the feeder wires I used a six-inch-long 1/16" drill. These are available from McMaster-Carr as their part number 2986 A12. They are online@McMasterCarr.com and shipping fees are reasonable. They have other small diameter drills in long lengths.

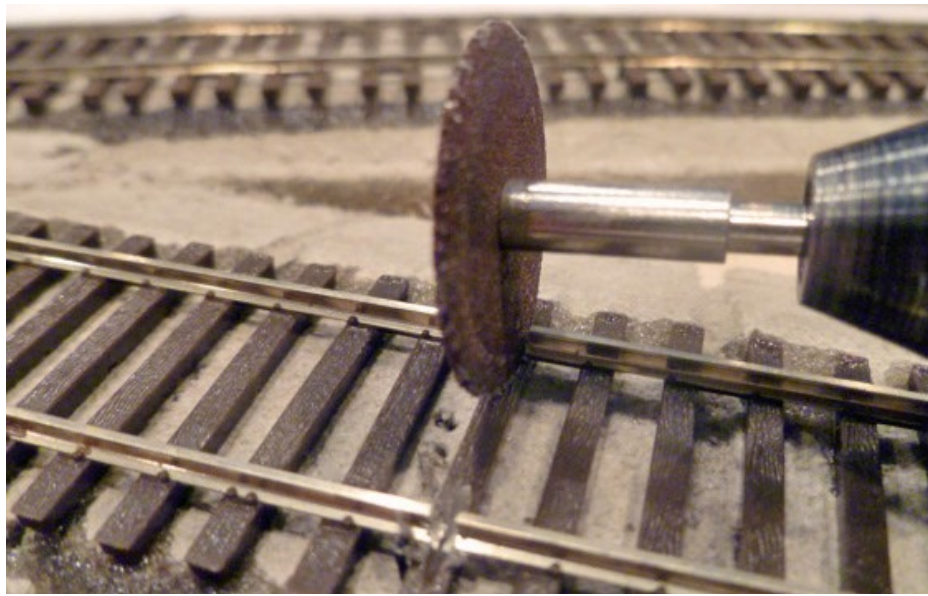

1. Cutting the rail gaps.

GETTING REAL | 3



3. Six-inch drill for feeder wires.



4. Checking for shorts.

ELECTRICAL Block Diagram

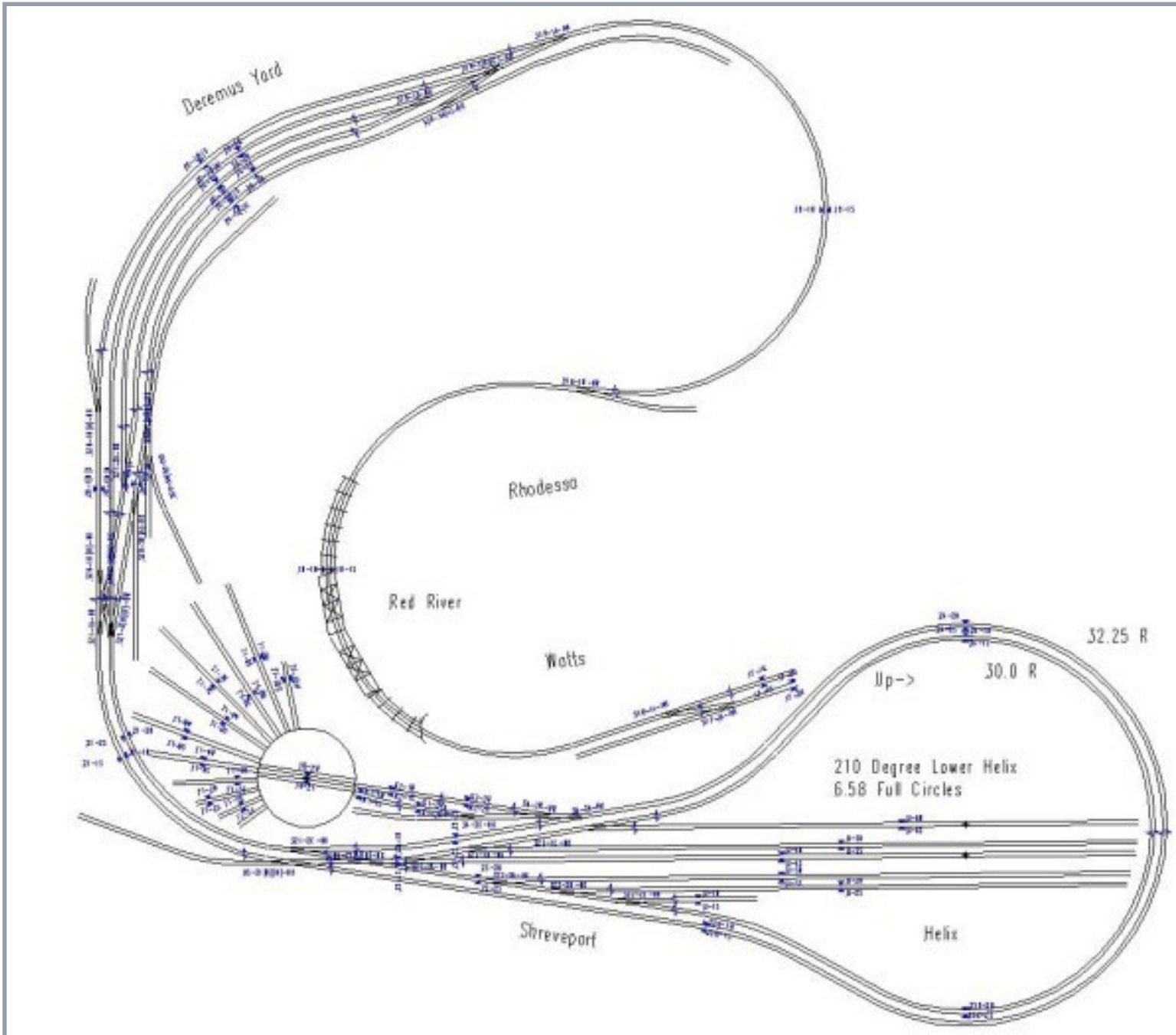

2. Layout electrical Block Diagram.

GETTING REAL | 6

After the gaps are cut, I use a multimeter to check that the gap is complete, and that there is no electrical connection. Sometimes in a tight spot it is easy to not cut through the lower edge of the rail. To make doubly certain that there never will be a connection, I insert a small section of 0.030 by 0.080 inch styrene strip into the joint using tweezers. I then secure the styrene in place using gap-filling ACC. The glue helps to stabilize the rail at the gap.

Once the glue is set, I use a scalpel to trim off the styrene at the top, then to trim down both sides. Lastly, I finish the gap with a Bright Boy abrasive block.

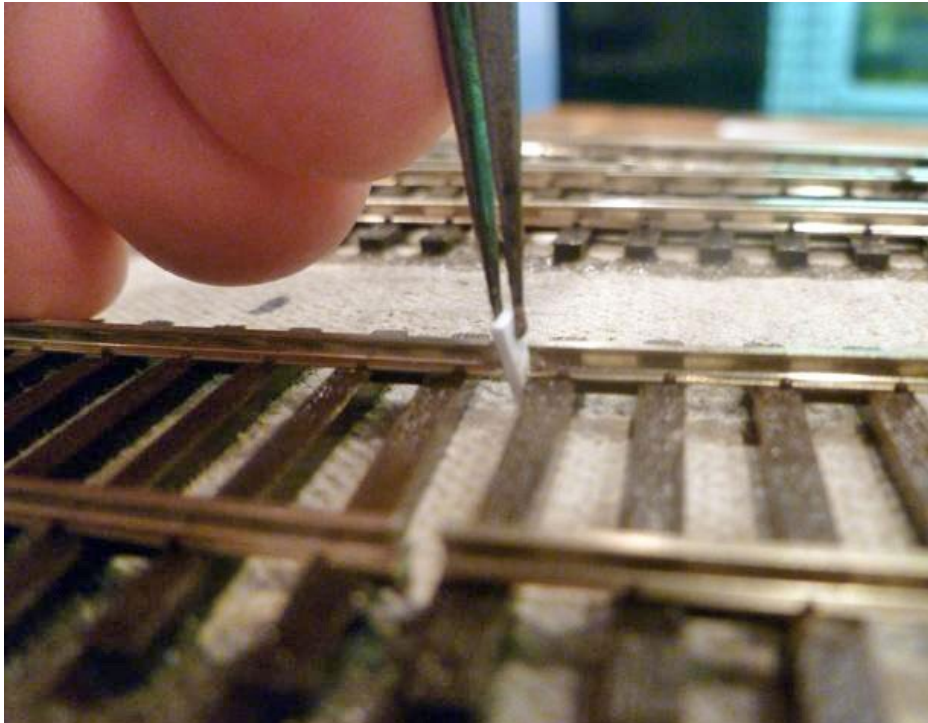

5. Inserting styrene insulation place.

GETTING REAL | 7



6. Gluing the styrene strip in place.

ADVERTISEMENT

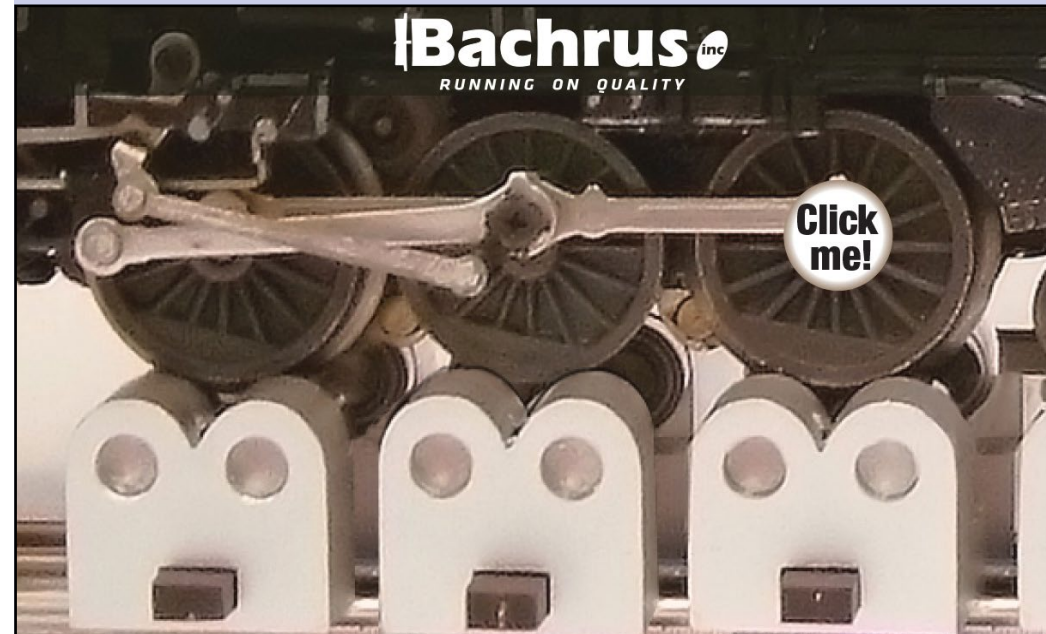

GETTING REAL | 8



7. Trimming the top and sides of the styrene strip.

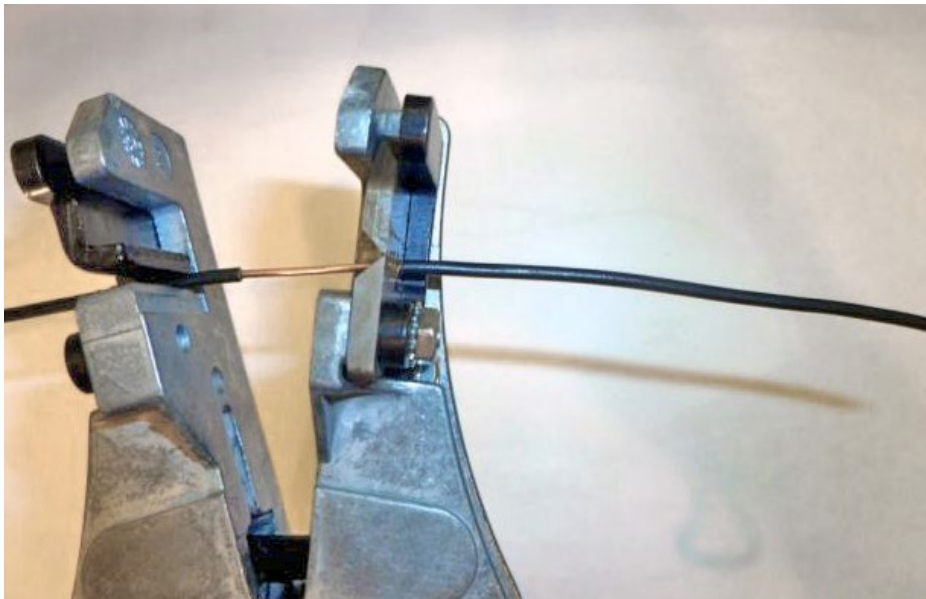

8. Stripping wire for the feeder.

GETTING REAL | 9

I use 14-gauge solid wire for the feeders, with black insulation for the north rail and red insulation for the south rail. I use a pair of wire strippers to remove the insulation from the end of the wire over a length of about 1-1/2 inches. I insert the bare end of the wire from below.

I then use needle-nose pliers to bend the wire down at a right angle, parallel to the track, and Xuron rail cutters to cut it to about 1/8" long. Next bend the "L" inward so that it will hug the base of the rail when the wire is pulled down into place. Solder the feeder wire to the rail with a small amount of flux and solder.

On the underside of the layout, I create a terminal board for the wires, using the plywood of the layout itself. This turns out to be very convenient and very flexible. I use 8" x 9/16" wafer-head screws (like a screw with attached washer). My original Word document with the list of block names has been

ADVERTISEMENT

A "Right Clamp"™ Mini Project

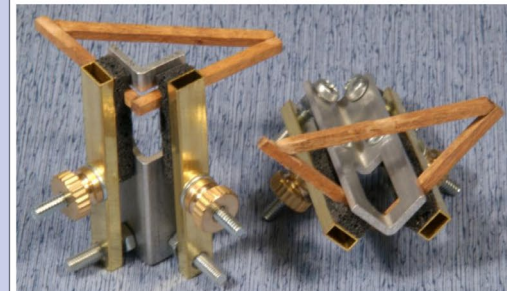

AC-2-2 "Mini Right Clamp"™ used for gluing Bulkhead Frames.

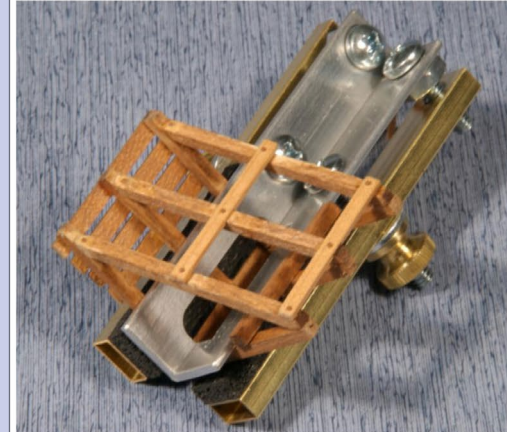

AC-1-1 "Original Right Clamp"™ used for Bulkhead Assembly.



Assembled Bulkhead in gondola with load of ring castings.

Right and Splice Clamp – Tools for Modelers

See all our products at:

www.coffmaneng.com

Coffman Graphic Solutions Co.

1500 River Circle, Richmond, KY 40475-7907

Phone: 859-527-0476, Fax: 859-527-0485

- [TABLE OF CONTENTS](#)
- [INDEX](#)

GETTING REAL | 10

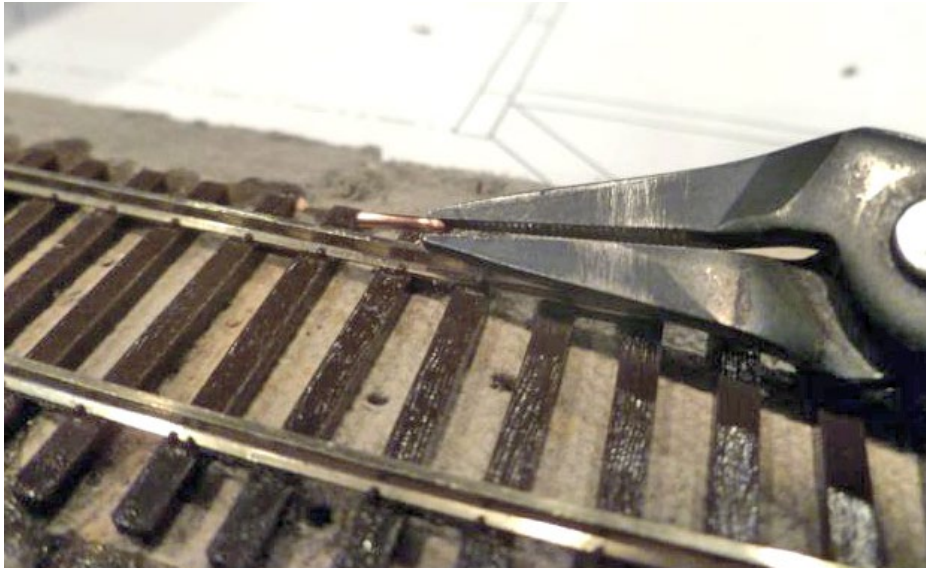

9. Bend the wire into an "L" parallel to the rail.

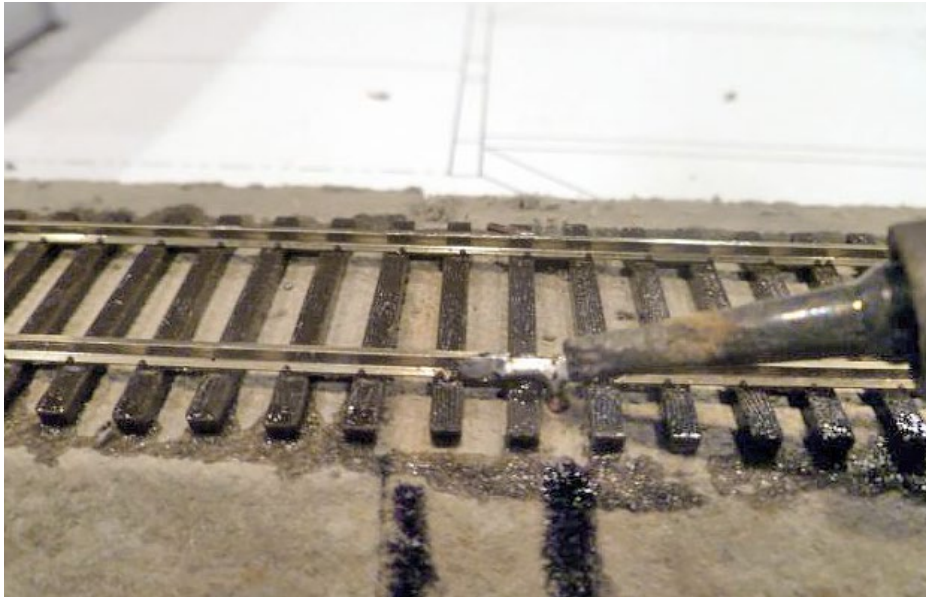

10. Soldering the feeder wire to the rail.

GETTING REAL | 11

turned into a table which I use to create labels I then tape to the underside of the layout with clear packing tape. The wire junctions are thus clearly identified, and any later problems are easy to track down.

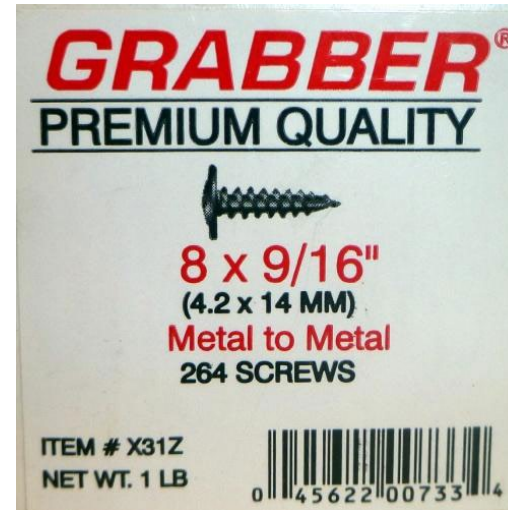

11. Wafer-head screws.

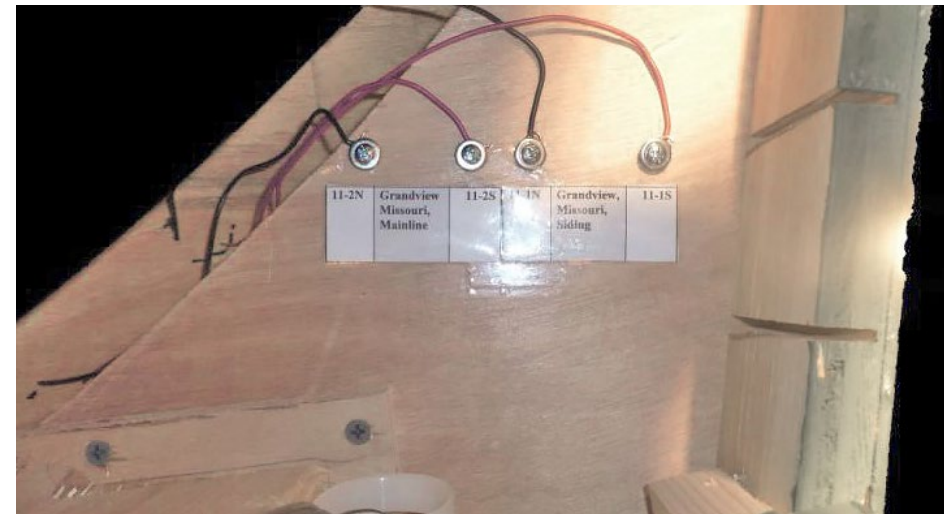

12. Wire junction on the underside of the layout.

GETTING REAL | 12

The face of one of the layout supports became a convenient terminal board for wires for the two tracks of helix and return loops. Because of the way I constructed my benchwork, there are some areas where, as the grade changes, the sub-roadbed was high enough that it was difficult to feed a wire through from the bottom, but there was not enough space for fingers in-between the two. In this case I fed bare wire down from above, attaching the feeder to the rail, and then pulling the lower end out to the side of the roadbed. Next I fed insulated wire up from the bottom and pulled it out to the side, soldering the two together. I then pulled the insulated wire down from below and tucked the junction back under the roadbed.

GETTING REAL | 13

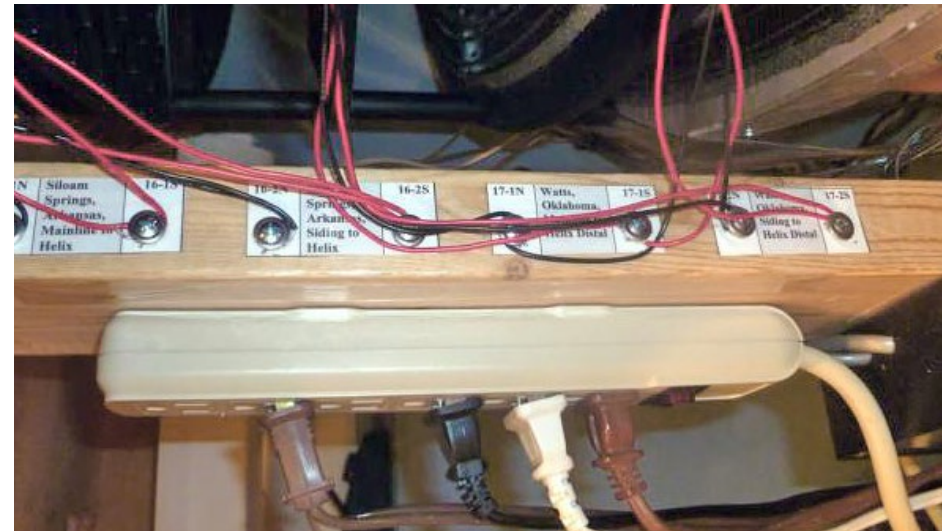

13. Terminal board for the helix and return loops.

ADVERTISEMENT



Announcing
New home for Motrak Models

Motrak Models Headquarters is now at
717 Windsor Lane, Martinsville, VA. 24112



Phone number: 813-476-4784
Email: motrakmodels@centurylink.net

CHECK
IT OUT!

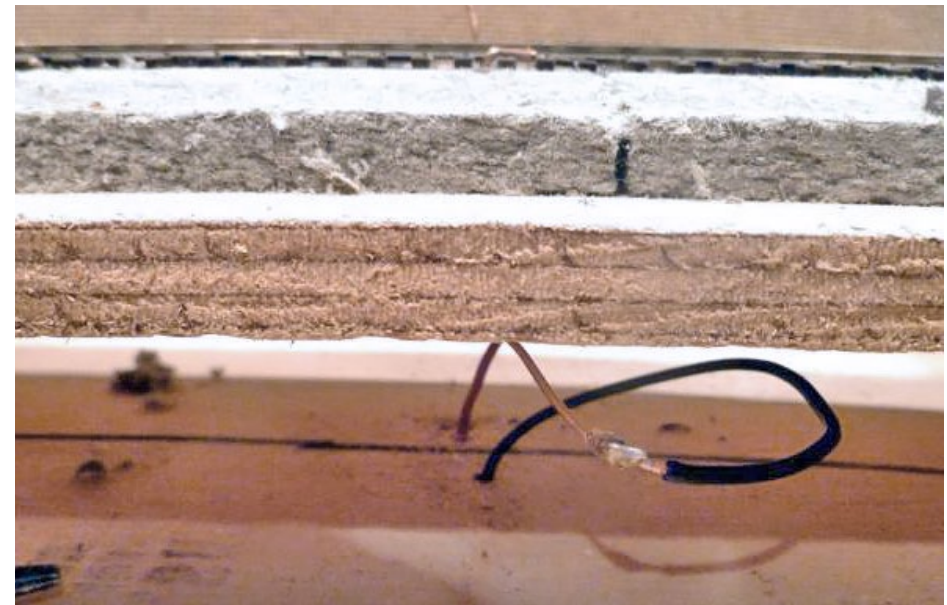

14. Adding feeder wires in a difficult location.

INSTALLING SWITCH MACHINES

I use Tortoise switch machines on my layout. It was encouraging during the initial construction phase when a club from Canada visited and told me they had over 100 machines in operation on their layout for over five years with no problems. I have had the same experience with 152 switch machines on my own layout.

The first step is to prepare the switch machines for installation. I bend the activating wire per the diagram included with the switch machines and attach them with the screw provided. To facilitate wiring, I solder an 8-pin right-angle header to the soldering terminals on the switch machine. This makes it easy to change a switch machine if necessary and also turns the wires horizontally at a 90° angle. This is important to keep the switch machine and wires dressed up under the top deck.



15. Right-angle header.



16. Tortoise switch machine assembled with header installed.

The Mouser part numbers for the Molex “KK” series (0.156”) header, plug and terminals:

8-pin right angle header, 538-26-60-1802

8-pin plug, crimp terminal housing, 538-09-50-3081

.156 crimp terminal for 18-20 gauge wire, 538-08-56-0106

Next I affix a piece of 1” double-sided tape to the mounting surface of

the switch machine. I adjust the position of the actuator wire so that is in the middle of its range of travel. I then thread the actuating rod up from the bottom of the layout and through the hole in the throw bar.

I then position the switch machine parallel to the track and move the Tortoise slightly, from side to side, until the throw bar is centered. Pressing the double-sided tape against the bottom of the layout will then hold the machine in place temporarily while its proper operation is verified with even pressure when thrown in either direction. The double-stick tape allows the switch machine to be repositioned if necessary.

GETTING REAL | 16

17. Attach the switch machine with double stick tape.

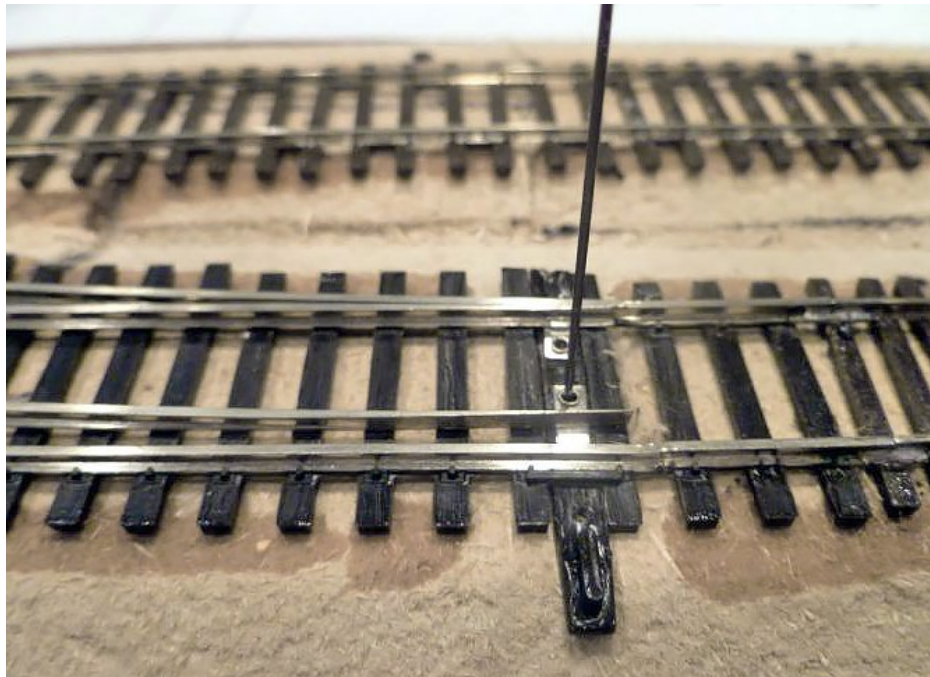

18. Check for proper operation.

GETTING REAL | 17

Once proper operation of the switch machine is verified, I mount it permanently with four screws at the places provided on the base. The long drill that I used for drilling the feeder wire holes gives great access for drilling the pilot holes for the mounting screws.

I use #4 x 1/2-inch combo pan-head sheet metal screws for mounting. I purchased a small, economical combination screwdriver from the hardware store, then removed the long metal bit, and chucked it in the electric drill. This is very convenient for driving the screws when working from the bottom side of the layout. Once the switch machine is mounted in position, I use an abrasive cutoff disk to cut off the excess actuating rod above the throw bar. The hard music wire will damage Xuron rail cutters. This is the appearance I like. Only the tiny tip of the actuating rod shows above the track, and no other part of the mechanism is visible.

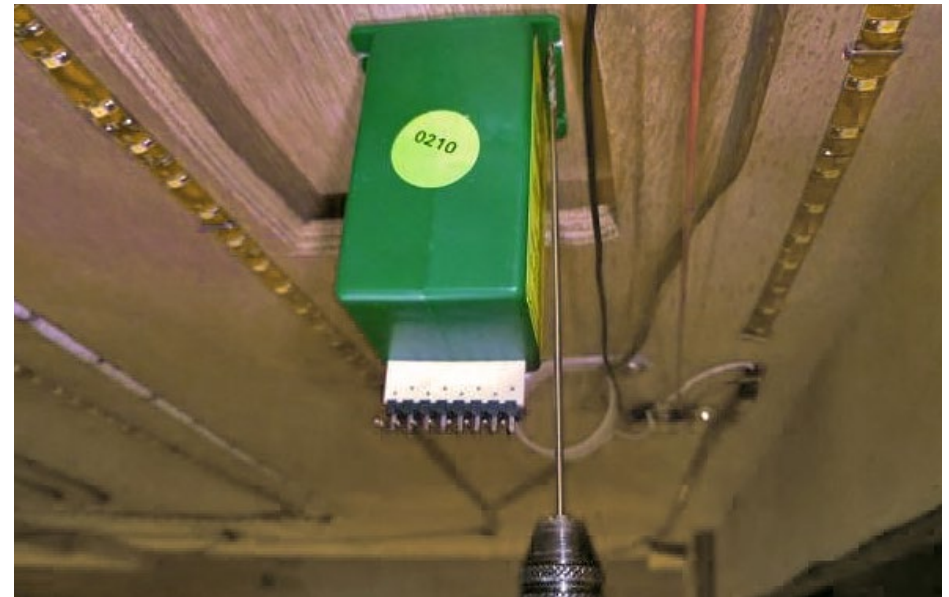

19. Drilling pilot holes for the tortoise.

GETTING REAL | 18

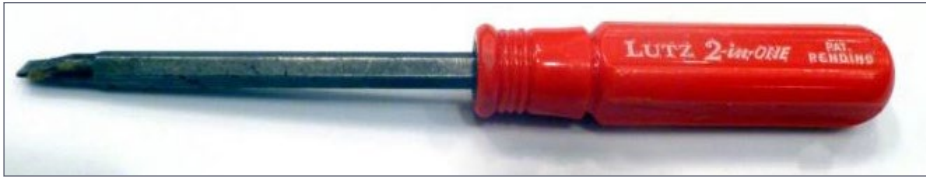

20. Small combination screwdriver.



21. Driving mounting screws for the tortoise.



22. Cutting off the excess.

GETTING REAL | 19

I learned a trick in a magazine article long ago, called “Hiding the Point.” Picking the point is a common cause of derailments when operating through turnouts. The flange of an approaching wheel catches the point, moving it away from the stock rail and causing a derailment. To hide the point, I take a small pair of needle-nose pliers and grab the stock rail just before the point. I then make a tiny twisting motion with pliers to create a slight outward kink in the rail where the point is located. This allows the point to recess into that kink, so the flange of an approaching wheel set cannot even see the point until it is beyond it. The keys here are “tiny” and “gentle.”

In mounting the switch machines, a special challenge was the south switch at Siloam Springs, AR. This turnout is located above the helix, so the switch machine cannot be located beneath it. The solution was to locate the Tortoise in a warehouse adjacent to the track with the actuating wire moving horizontally from the building to the turnout. I constructed a special mounting bracket for this purpose, using a piece of 1.5-inch aluminum angle and a piece of 1/16-inch plywood. This arrangement works very well.



23. Making a slight bend in the stock rail.

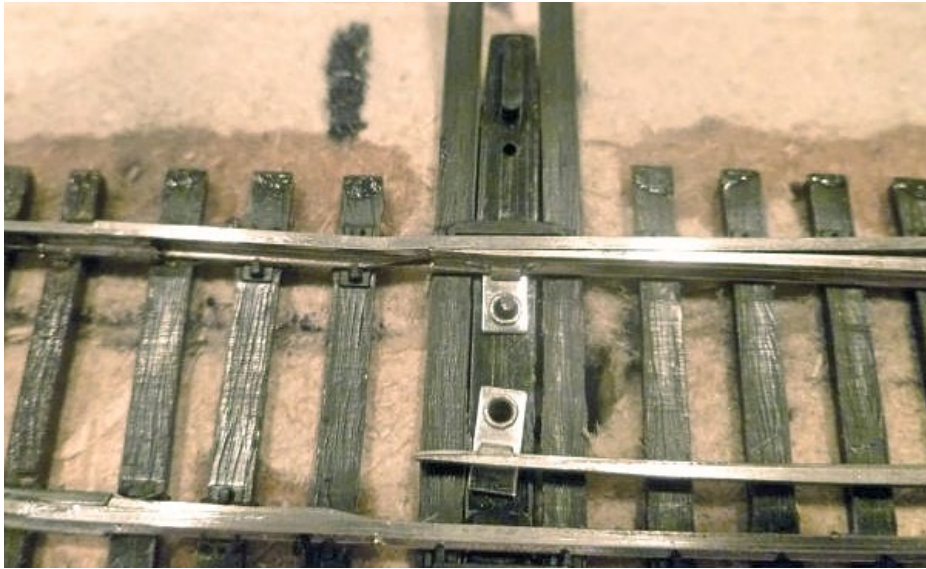

24. The "Point" is now hidden.



25. Switch machine mounting bracket.

Once the Tortoises are in place, it's nice to be able to test them in operation. For this purpose I took a project work box and installed a DPDT switch on top. Inside the box is a 9-volt battery. The wires coming out are attached to a Molex connector which plugs onto the switch machines. Throwing the switch back and forth operates the switch machine. I made a matching 10-foot extension cord to use in reaching remote locations.

The last thing to do is label the switch machines and the plugs so they can be easily identified if a problem crops up years later. The original Word document with the designation for each switch machine was converted into a table which provided the labels.

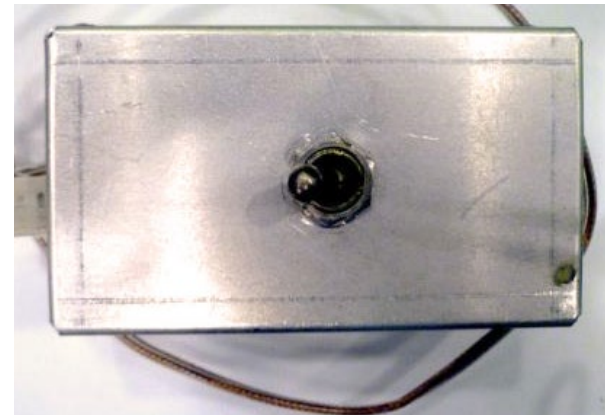

26. Tortoise testing unit.



27. Identification labels have been applied to the switch machines and plugs.

TRACK PAINTING, WEATHERING AND BALLASTING

Now that the track is installed and operates well, it's time to pay attention to appearances. Some preparation of the turnouts is required before painting. I spray a small amount silicone lubricant in the area of the throw bar. This helps prevent paint and ballast glue from penetrating into this vital area. If paint or glue does penetrate, it helps it not to stick. I also placed pieces of stripwood between the point and stock rail on each side to keep spray paint out of that important contact area. This also makes it much easier to get the turnouts operating again after weathering and ballasting. When all is done, I add a touch of powdered graphite lubricant to this area.

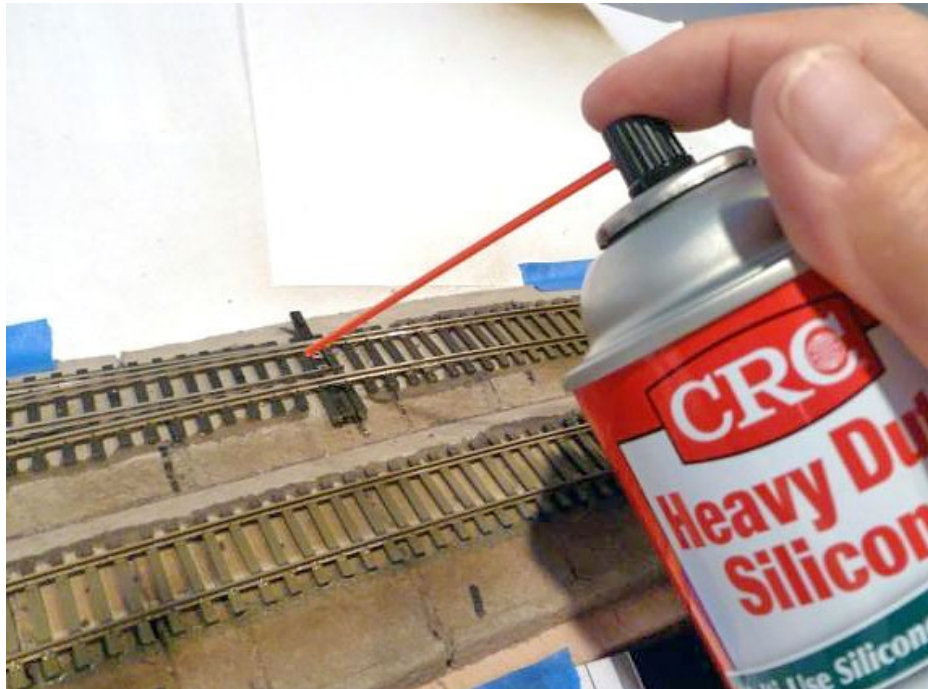

28. Applying silicone oil to the throw bar.

The techniques I will describe here are borrowed from the master, George Sellios. First the track is sprayed with Floquil Rail Brown. Remember Floquil? Sniff sniff. That color, I understand, was developed by Floquil in conjunction with George. For less-used track, you can use Rust or Reefer Gray. I have yet to find a good substitute for Rail Brown. Use paper or drop cloth material to mask the area you do not want to paint.



29. Place strip wood between the point and stock rail on each side.



30. Spray the rail and ties Rail Brown.

GETTING REAL | 24



31. Weathering paints for the ties.

GETTING REAL | 25

Now the ties and rails are all the same color. The next step is to paint the ties and weather the track. I used Floquil Oak and Driftwood stain, along with black and raw sienna oil paints. Since Floquil paints are no longer available, I have found Craftsmart Acrylic paint in Taupe and Gray colors to be a good match. The acrylic colors need to be thinned to make a stain.



32. Floquil Oak and Driftwood stain.

ADVERTISEMENT

THE CREDIT VALLEY RAILWAY COMPANY LTD.

1st choice for model railway supplies and service.

Expedited mail service available across North America.

Click to visit **WWW.CVRCO.COM**
1 800 464 1730

Facebook and Twitter icons are visible in the bottom left corner.



33. Craftsmart Taupe and Gray Acrylic.

GETTING REAL | 26

Using a ½-inch-wide flat brush, I paint the center of the ties between the rails and the ties on either side of the rails with the dark Oak stain. I allow this to dry for a while and then paint random ties about every three to five ties or so with the lighter Driftwood stain. When this has dried for about 30 minutes, I paint alternate ties again with the Oak stain to deepen the color of those ties.



34. Paint all the ties with Oak Stain.



35. Paint Random ties with Driftwood.

GETTING REAL | 27



36. Paint random ties again with Oak Stain, here is the final appearance.

When the tie paint has dried, it's time for ballasting. The mixture described by George Sellios works well for my Kansas City Southern Railroad.

I use Woodland Scenics, two parts Fine Ballast Gray, and one part Woodland Scenics Fine Ballast Buff. In the past when applying ballast, I have found it difficult to keep it on the sloping sides of the roadbed. To combat this, my first step now is to brush full-strength white glue on both ballast slopes, using a small disposable foam brush. I then use a large Woodland Scenics shaker bottle to distribute the ballast over the track and roadbed. Then I come back, with a two-inch soft brush, and distribute the ballast evenly, sweeping it off the tops of the ties and away from the rails.

When this is complete, I gently mist the area with water containing a few drops of detergent as a wetting agent. Once the area is wet, I come back and spray it again to make sure the water saturates down through the entire thickness of the ballast. Otherwise the glue will not penetrate.

GETTING REAL | 28

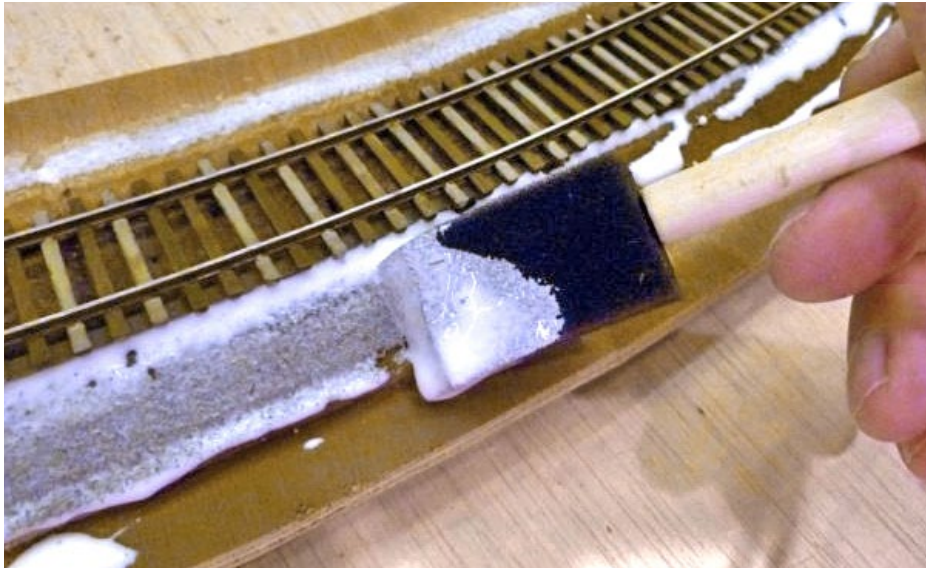

37. Full strength white glue both sides.

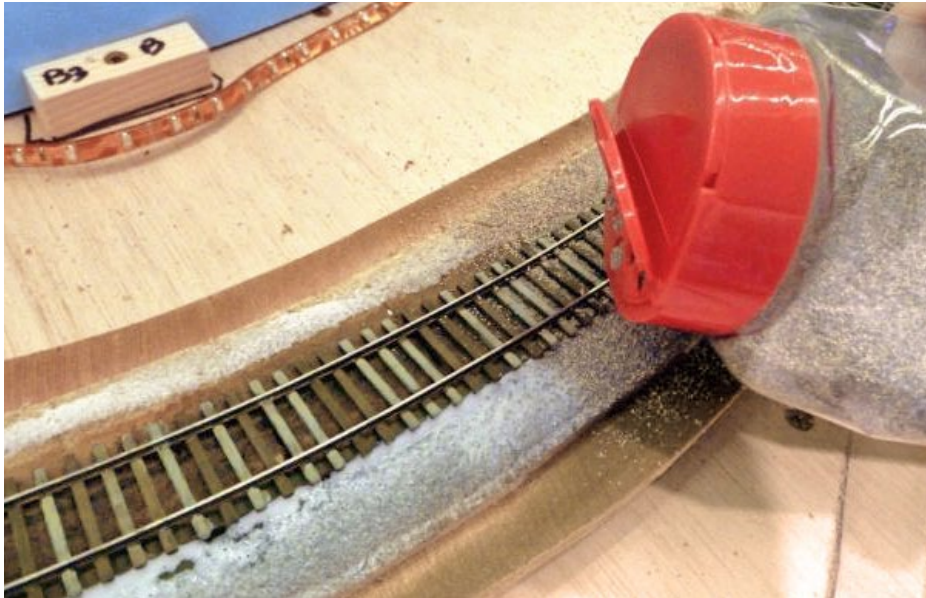

38. Apply ballast with a shaker bottle.

GETTING REAL | 29

Once the ballast has been wetted thoroughly, I apply white glue diluted 1:3 with water. Using the glue solution in a sprayer has never worked well for me. Regardless of how carefully I clean and maintain the sprayers, they inevitably clog. So I use an empty white glue bottle, with the inside “plug” removed, to gently distribute the dilute glue over the rails and ballast. When I have done this once, and the glue has had time to soak in, I come back again and apply more glue to make sure the depths of the ballast are thoroughly saturated with adhesive. Now it’s time to let everything dry.

When the glue is dry, I scrape sideways across the tops and ends of the ties with an outdated plastic credit card or hotel room key to remove stray pieces of ballast. Ballast in those locations would be unusual on the prototype. Then I vacuum the area to remove loose ballast



39. Brush ballast from top of ties.



40. Mist with "wet" water.



41. Apply Dilute White Glue.

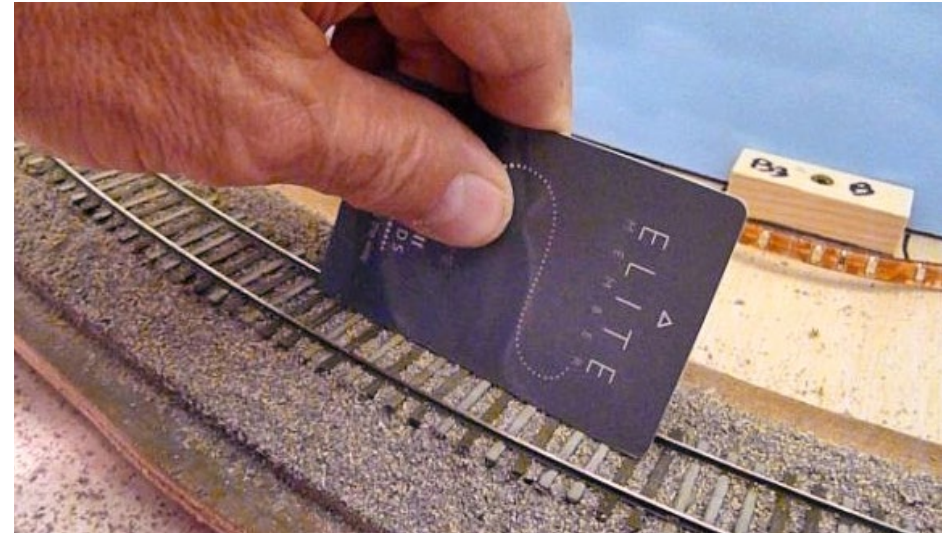

42. Knock ballast from tops of ties and rails.

The track is weathered with black and raw sienna oil paints. Here a half-inch-wide flat brush works well. I thin the oil paints with Turpenoid, a turpentine substitute without the pungent odor of turpentine. I use an empty plastic deli container to mix the paint. I run diluted black paint up the center of the track to simulate grime from all the passing trains on my busy main-line. Then turn the brush sideways, to run diluted raw sienna up both sides of the track outside the rail, simulating rust and drainage from passing freight cars and iced refrigerator cars.

**Want to help keep
MRH free?
Then click on ads!**



43. Black paint up the center of the track.



44. Raw Sienna up the sides of the track.

When the oil paint has dried overnight, I use a Bright Boy abrasive block to clean off the tops of the rails, and the track is ready for service! Now I can actually run trains!

NEXT TIME

Next time we will begin adding scenery.



[Click here for reader comments](#)



45. Ready for service.

iwata

by ANEST IWATA

Just Rolling By...

Make It **REAL** With Iwata
Climb Aboard!



Visit...
www.iwata-medea.com

**To Check Out Our
Full Product Line!**

*Models By... Alan Houtz,
North American Prototype Modelers*

Model Railroad Hobbyist | April 2015 | #62

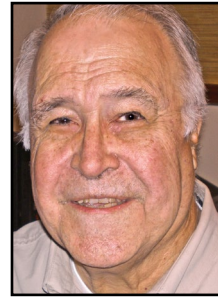

LARRY SMITH
.....

LITE AND NARROW

column



**Click here for
reader comments**

THE NEW MERKLE CONNECTING PART 2 | A SMALL ON30 PROJECT LAYOUT: GOTTA HAVES AND LAYOUT PLANNING ... IN THE FIRST ARTICLE ON THE NEW

MERKLE CONNECTING railroad (mrhpub.com/2015-02-feb/port/), I explained how the Cahaba Pumping station had been constructed and the integral part the railroad played in its operation before and after the plant went on line. By 1921, the original boilers were beginning to wear out from heavy usage, making their replacement necessary. Because larger boilers were available at the time, the Cahaba Pumping Station underwent a major upgrade, resulting in a larger boiler house. The boilers, numbers 16 & 17, were built as one unit and were rated at 1000 horsepower. A reserve boiler, Number 18, was also constructed at this time and was rated at an additional 500 horsepower.

With the construction of the new boiler house, the method of handling the coal and ash changed. Coal was dumped into a bin,

► **RAMBLINGS ON THE NARROW GAUGE**

LITE AND NARROW | 2

crushed, and then lifted to the top of the boiler house where it was sent to each of the boilers by a tube. This was much like the way sawdust was fed to the boilers at sawmills for fuel, only these boilers weren't Dutch oven types. A Dutch oven boiler had a platform in front of the boiler with door that was opened and the fuel swept into them for feeding to the firebox.

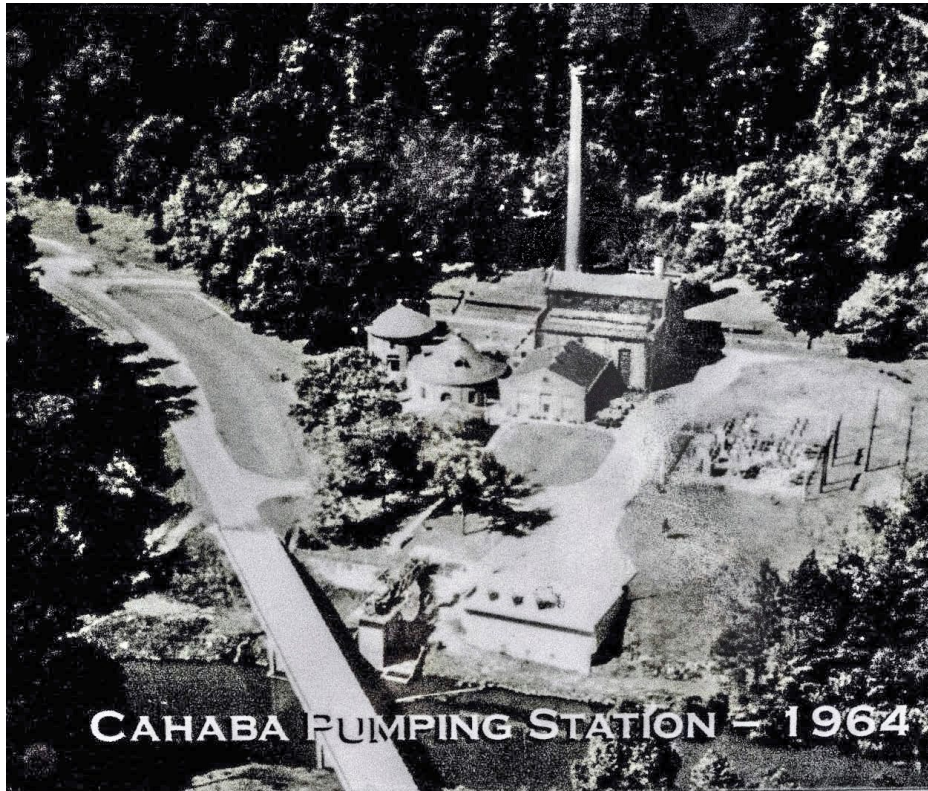

1. Aerial view of the Cahaba pumping station pumping station in 1964. This was after the pumps were converted to electrical operation, thus the power substation seen in the photograph, and 15 years after the railroad had been removed. Birmingham Water Works photo. Philip Griffith collection

LITE AND NARROW | 3



2. Inside the boiler house today. Boilers 16 & 17 are on the left, and Boiler 18 on right. The tube in front of No. 18 delivered coal to a crusher which fed fuel into the boiler's firebox. The building is a lot cleaner than when it was in operation with the coal-fired boilers. Philip Griffith photo

Another change was the construction of tracks in the basement of the boiler house for the collection of ash. The space was large enough for a mine car to be switched into the ash tunnel door and then moved by manual labor to gather the ash from the boilers. When full, the cars were pushed to the entrance door to be hauled away by the locomotive.

Exactly where the ash dump was located hasn't been determined, however it is theorized to be at one leg of the wye. With major construction taking place in the area since the 1970s, it would be impossible to locate now.

To meet the growing water demands for the city, the plant was upgraded again, in 1931, with installation of another boiler,

LITE AND NARROW | 4



LITE AND NARROW | 5

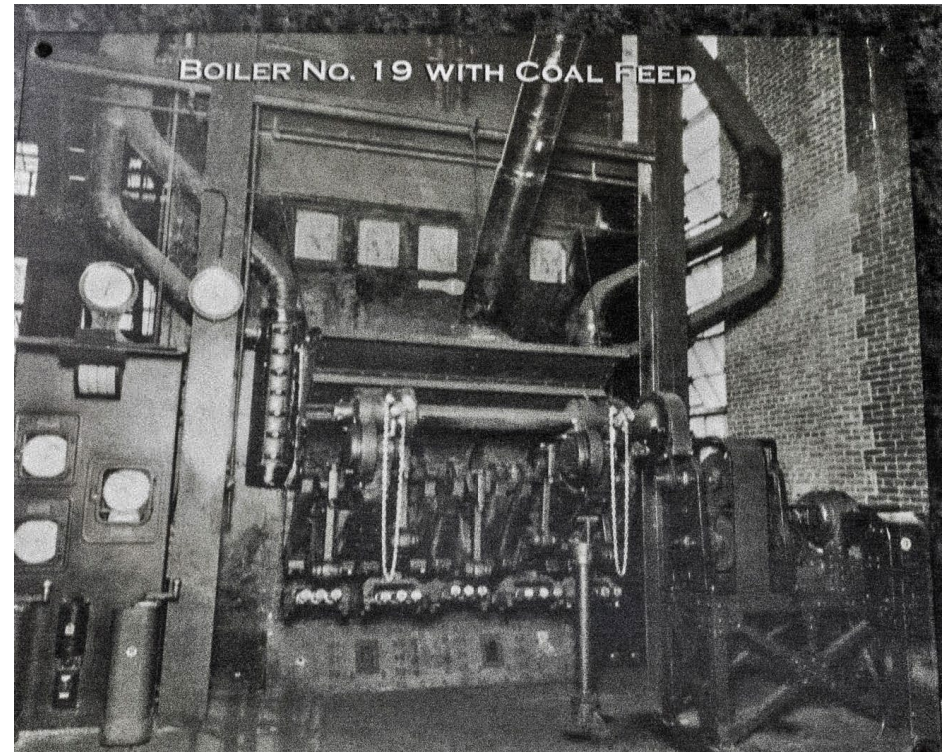

3. Coal bunker at the top of the boiler house showing the tubes that lead to the boilers. Philip Griffith photo

4. Boiler No. 19 with coal feed. Note the tube running from the overhead coal bunker to the crusher feeder of the largest boiler in the plant. Philip Griffith collection. Used by permission

LITE AND NARROW | 6

Number 19. The boiler was rated at 4339 horsepower and was larger than the three boilers installed in the 1921 rebuild. This new boiler immediately multiplied the coal consumption of the plant and the disposal of the ash, requiring more frequent operation of the trains from the mine.

Butler the mule

There is one character that will have a special place on the layout and that is Butler the mule. As was typical of many of the mining



5. Ash track in the basement of boiler house. The car is an inoperable model and is there for show only. The car bears no resemblance to the real cars used in the basement. This must have been the dirtiest, nastiest job in the entire plant. Philip Griffith photo

LITE AND NARROW | 7

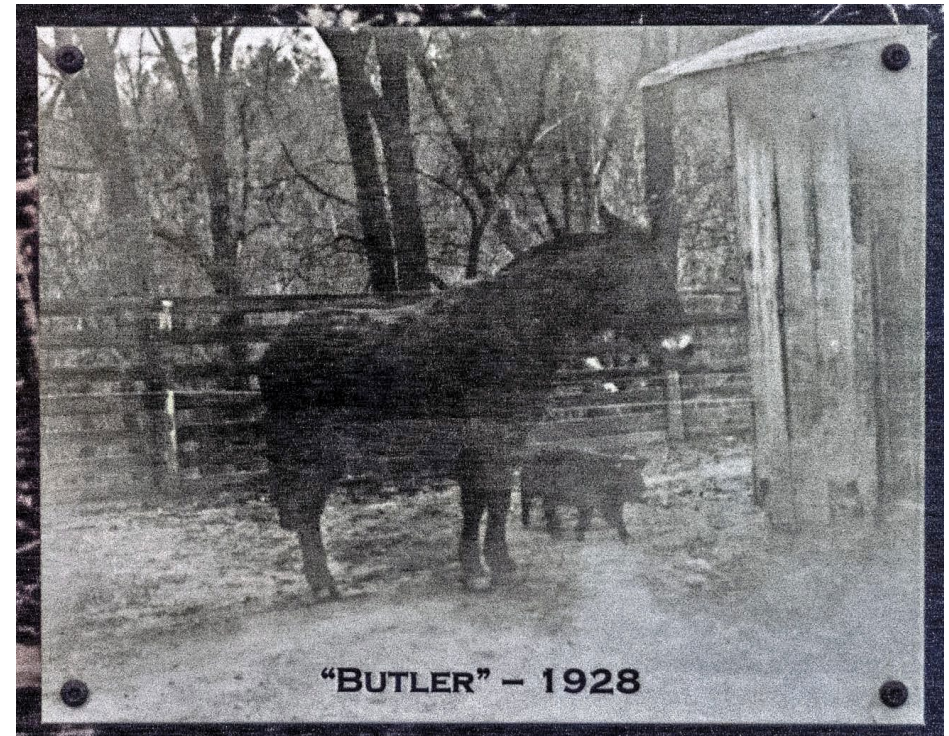

6. The very special Butler. Photograph taken at the mule barn, location unknown. Wonder who his friend is? Birmingham Water Works photo, Philip Griffith collection

operations in the early 20th century, mules were used both above-ground and underground in the mines. Some mules, once they went underground, never saw the light of day again. That wasn't the case with either the Merkle mine or the Jollar mine which was previously presented in this column. Both mines took care of the animals that worked the mines.

Butler was a very special mule. He was considered the hardest-working employee at the pumping station and won a special place in the hearts of the employees. One day, an accident happened and

Butler broke his back leg. For most animals this would have been a life-ending accident, but the employees made a sling harness to keep the weight off the leg, to allow it to heal. The leg healed and Butler worked an additional six years at the mine. Our story of Butler doesn't end there, though.

With Butler's death, the workers wanted to make sure that he was treated with respect and made arrangements for him to get a proper burial. They located an abandoned well on the property and had him buried in it. They also had a tombstone erected with his name on it. Today that burial site is somewhere on the property but the underbrush and the cottonmouth snakes have kept any of us from trying to find it.

Got to have, and want to have: Defining the layout

Anytime I start a layout project for or with someone, I ask: What do you want and what do you have to have? From the answers, you can get a pretty good idea of what you are going to build. Carey Jenkins, a longtime friend, developed a very long questionnaire which asks questions of which era, scale, location, etc. to make individuals take the time to stop and think about what they are trying to accomplish. This exercise can actually save money in the long haul. While not everything on the form may be relevant to your layout planning, you might want to use the parts that are, and with Carey's permission, I have included it here for your use.

Reality vs. layout

A railroad to serve only the pumping station and the mine would become very boring after a very short time. To make it more interesting, we expanded the concept to serve the company town

Text continued on page 12...

GIVENS/GOT TO HAVES:

1. Room size in feet and inches for the layout
 1. Era (what year or decade is the layout set in _____)
 2. Local/area _____
2. Railroad type (bridge line, class 1, branch line. Etc
_____)
3. Scale _____
4. Gauge: standard/narrow _____
5. Governing rolling stock
 1. Engine _____
 2. Rolling stock _____
6. Relative emphasis

track /operation	scenic realism

mainline running	switching
7. Operating priorities Train length Number of trains
 1. local freight _____ cars _____
 2. through freights _____ cars _____
 3. Passenger
 1. through/express _____ cars _____
 2. local _____ cars _____

DRUTHERS/GIVENS

8. Track standards
 1. minimum radius
 1. absolute _____"
 2. mainline _____"
 3. branch line _____"
 4. industrial/yard _____"

DRUTHERS/GIVENS *CONTINUED...*

8. Track standards

1. minimum radius

1. absolute _____"

2. mainline _____"

3. branch line _____"

4. industrial/yard _____"

2. grades

1. mainline _____%

2. staging _____%

3. other _____%

3. track centers

1. mainline _____"

2. staging _____"

3. yard _____"

9. Benchwork standards

1. Height

1. normal _____"

2. maximum _____"

2. Width (normal reach is 30")

1. normal _____"

2. minimum _____"

3. maximum _____"

3. Aisles

1. normal _____"

2. minimum _____"

3. in front of yard _____"

DRUTHERS/GIVENS *CONTINUED...*

10. Key scenic features

1. _____

2. _____

3. _____

4. _____

11. Industry and car needs

Industry	Car type
----------	----------

1. _____	_____
----------	-------

2. _____	_____
----------	-------

3. _____	_____
----------	-------

4. _____	_____
----------	-------

5. _____	_____
----------	-------

12. Operational features (example loads in/empties out)

1. _____

2. _____

3. _____

4. _____

13. Brief history of the railroad

Although we did not use most of this form because we were working from historical information we did utilize parts of it when it came to size and additional items we included.

of New Merkle. In reality, the town was located on a high bluff overlooking the pumping station. Today there is a shopping center named The Summit in this location that overlooks I-459, 200 feet below. To represent this would require a shelf five feet above the layout. This also gives you an idea of what the builders of the pumping station faced when the construction began.

We took two primary factors into consideration. The first was that the coal mine would be on a shelf and could be detached from the main layout. The second: Philip is a professional photographer and holds exhibitions at his loft, so the main part of the layout needed to be able to move out of the way for these exhibitions. With these two constraints, we set out to design the layout.

Equipment

After the last column was published, Tommy Lawson compiled an updated locomotive roster for the Birmingham Water Works. A short synopsis of the railroad was included. It indicates that the Birmingham Water Works was a subsidiary of the American Water Works Guarantee Company. This information clarifies the speculation about the first locomotive being from New York.

The second piece of information contained in the synopsis was about the delivery of the locomotives. All three of the locomotives were delivered to a siding at Hedona, AL and delivered by animal drayage to the railroad as there wasn't any direct connection to the railroad. This is still true today as the closest railroad is over 10 miles away to the west.

None of the locomotives ever received numbers, so in the following roster, they are listed in the order they were received.

1st Porter 11880 C/N #358

Orig. Belmont Coal & R.R. Co, #1, Boyd's Switch, AL

Sold to Birmingham Water Works c. 1880

Sold to Helvetia Copper Co. #1 Vail, AZ 1905 rebuilt to 36" gauge.

2nd Porter 11902 C/N #2435 New

Scrapped 1950

3rd Porter 11925 C/N #6974

New in 6/1925 (via Birmingham Rail & Locomotive Co.)

Scrapped 1950

For this layout, the motive power chosen is the Bachmann Porter 0-4-0t since it closely represents the actual locomotives used on the railroad.



7. Buck jimmies that are being used on the New Merkle Connecting. Boulder Valley Models photo

LITE AND NARROW | 16

assembled the building, using T-pins. I have not worked in O Scale in over 50 years, so I really needed to do this to get the feel of how large even small structures can be.

The mock-up for the boiler house was done from actual blueprints of the building. Fortunately they were done to ¼-inch scale, making them easy to use and get the right size for the area it would require.

For the combination engine house, blacksmith shop and machine shop, there is a plan in the May, 1994 issue of *Model Railroading*. Downloads of the article and plans are available on Trainlife.com. Be aware, there have been difficulties in the past several months downloading full articles with photographs and complete texts from the site, making the articles hard to read.

To date no plans for the hoist and boiler house at the mine have been discovered. Based on the photos of Butler, there were auxiliary buildings located at the mine, but as with the hoist house, we have been unable to locate drawings of these either.



10. Mock-up of the company house for the town of New Merkle. It's not pretty, but it doesn't have to be.

Get the first 50 issues of
**Model Railroad
Hobbyist magazine™**

On a data DVD for \$10!

Send me one!

(Sold by Model Trains Video)

**Includes a coupon
good for \$20 off on
TrainMasters TV**

**Over 5000
pages of
how-to
information
on model
railroading**

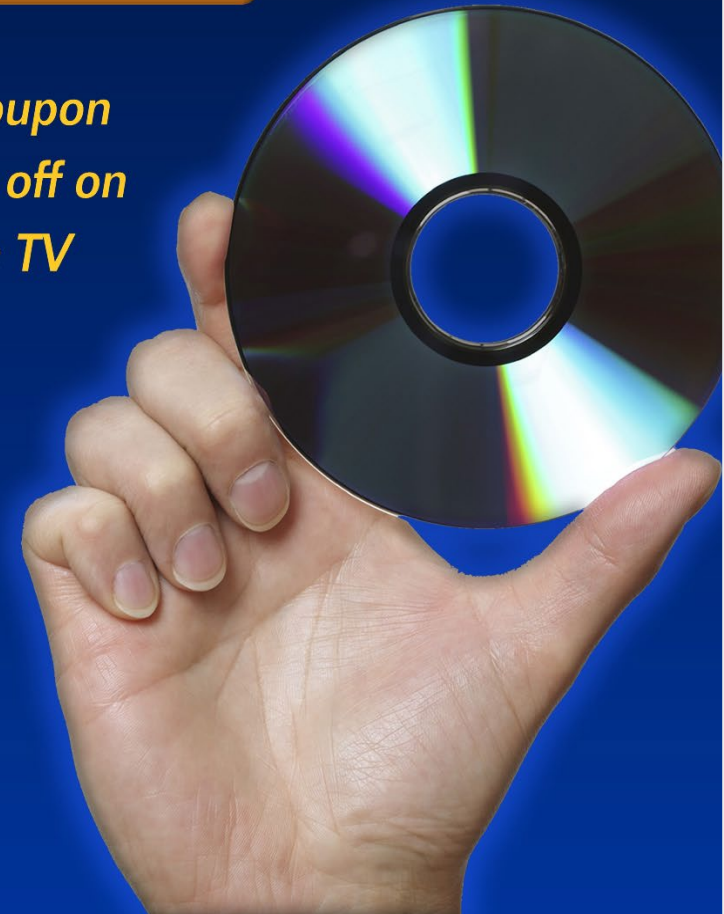

**Save
yourself
endless
hours of
downloading**

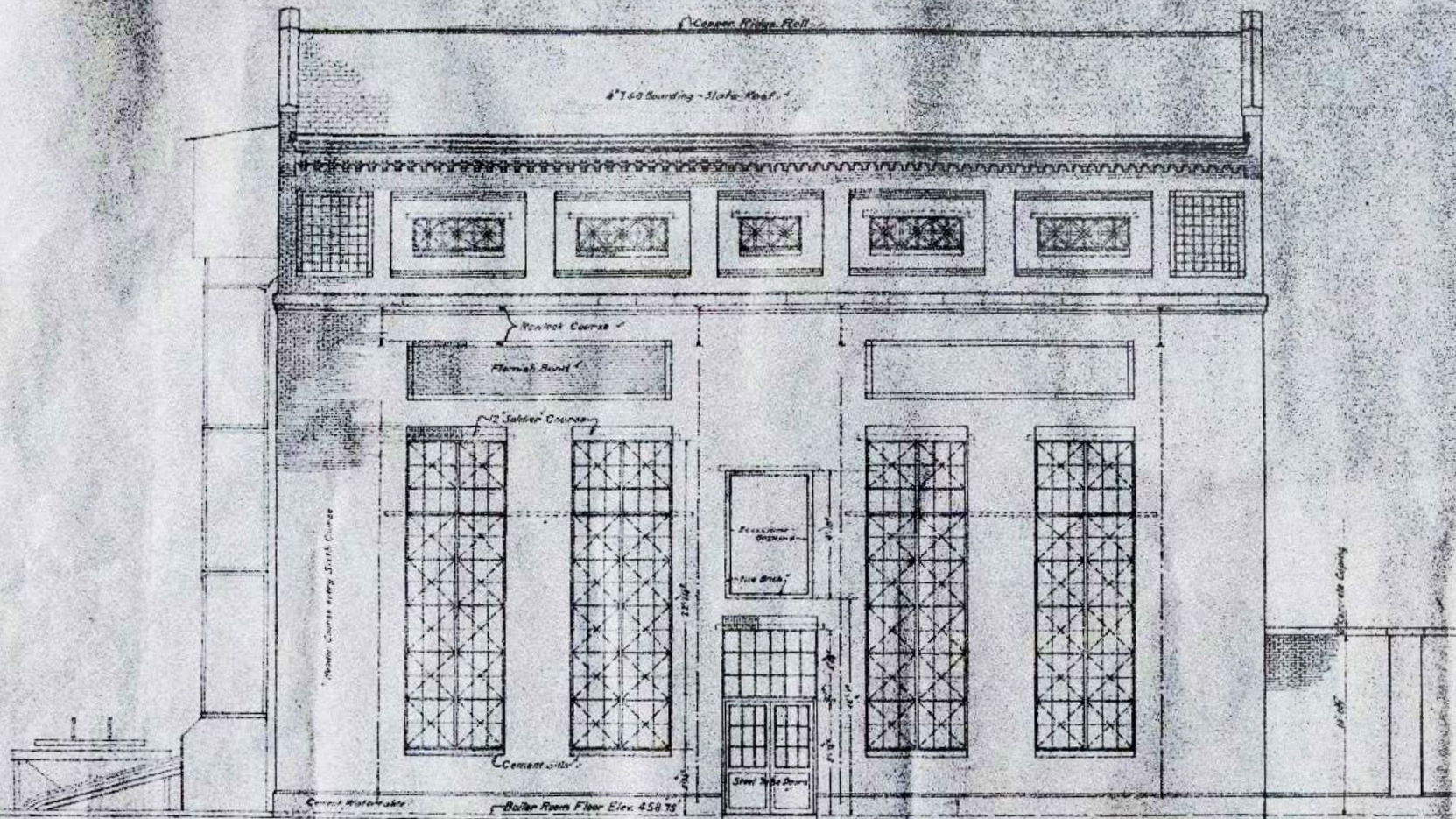

NORTH WEST ELEVATION

<p>EXHIBIT - CHINA STATION NORTH WEST ELEVATION FOR THE BIRMINGHAM WATER WORKS COMPANY, BIRMINGHAM, ALA.</p>	
<p>AMERICAN CONSTRUCTION & SECURITIES COMPANY ENGINEERS AND CONTRACTORS 20 BROAD STREET NEW YORK</p>	
<p>DATE: 1911-10-20</p>	<p>DATE: 1911-10-20</p>
<p>APPROVED BY: [Signature]</p>	<p>DATE: 1911-10-20</p>
<p>USE APPROVED EXAMINE ONLY FOR CONSTRUCTION PURPOSES</p>	

11. Northwest or rear of the boiler house showing the location of the receiving track. It is still undecided about whether to cut the building in half to allow the ash tracks to show.



12. The locomotive, blacksmith and machine shop as it exists today. The building is 30 x 70 feet, with 20-foot walls at the eaves. The locomotive shed was in the left bay with the double doors, and the blacksmith shop was in the next bay with the double doors. To accurately model the building as it was when the railroad was operating, the far right window needs to be replaced with a double door which had a square header.

Preliminary track plan

Philip and I have arrived at a preliminary track plan for the layout. There is still more to do and we need to get started on the benchwork. The thinking right now – and who knows what changes we will make when we get into this further – are that the layout will have two shadowboxes along the wall. One will be the mine with

the hoist house and boiler. At the other end will be the town of New Merkle, consisting of company houses and the lumber yard. On a peninsula will be the water works plant and buildings. The peninsula will be on wheels so it can be detached and moved out of the way during Philip's exhibitions.

Time to get to work on the benchwork. Until next time. ✓

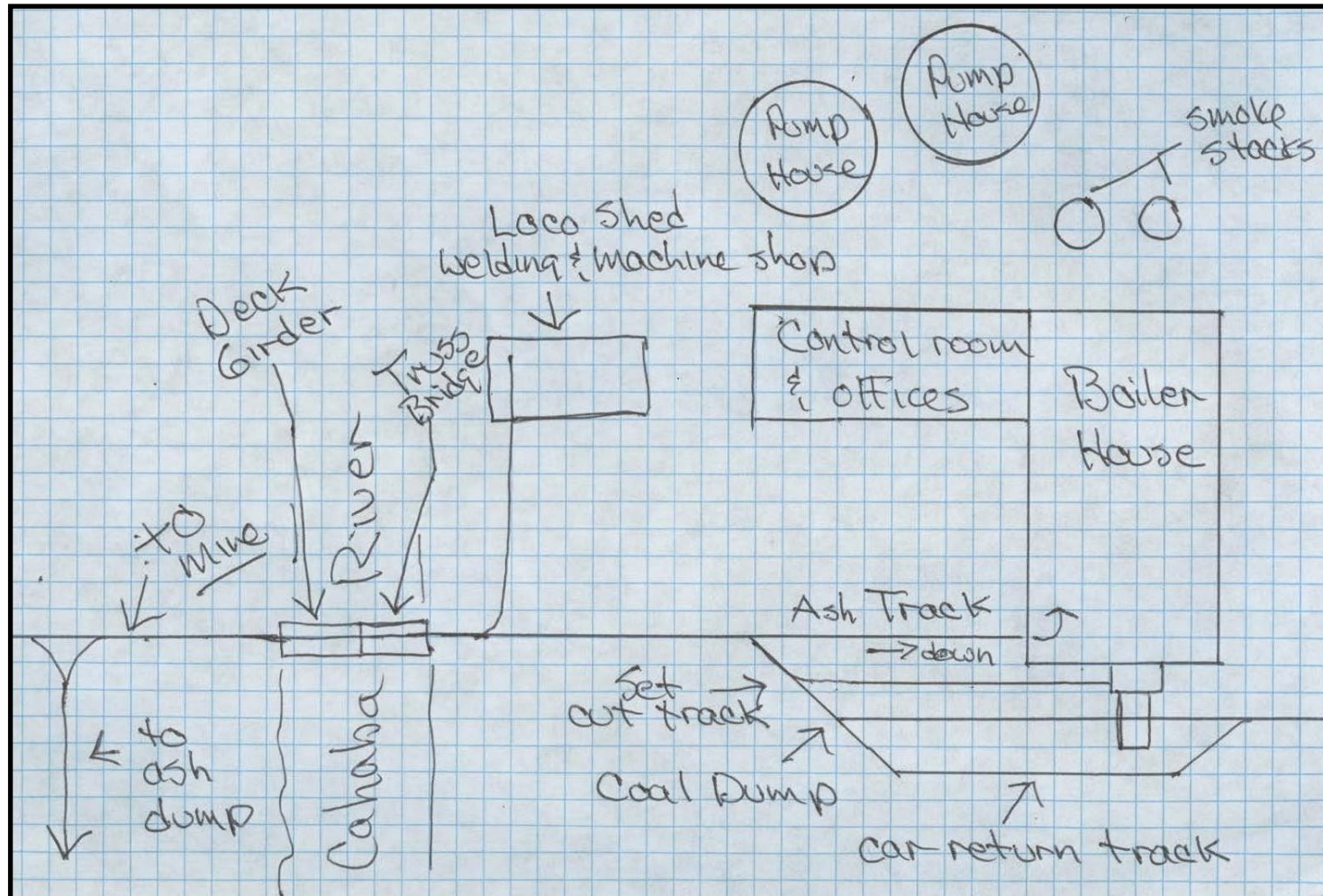

13. Preliminary track plan for the peninsula portion of the layout.

 [Click here for reader comments](#)

When talking to hobby vendors, please remember to mention MRH.

Coming this month:
Big name. Small details.
On the April edition of TrainMasters TV!



The April show on
TRAINMASTERS.TV

Brought to you by



Visit the TrainMasters TV website 



Model Railroad Hobbyist | April 2015 | #62

WHAT'S NEAT

column

KEN PATTERSON



[Click here for reader comments](#)

SCOTTY MASON, NEW AUTOMOBILES, FOAM ADHESIVES, SOLDERING, AND A PHOTO SHOOT ...

THIS MONTH, WE START OUT WITH AN INTERVIEW



of podcast host Scotty Mason. He explains how he got into the business end of model railroading with DVD sales, craftsman structure kits

and the Scotty Mason Show podcast. His long list of podcasts goes back eight years in his I-tunes archives, interviewing folks like Dave Frary, Tony Koester and other guests who have had an impact on the hobby. In the video, his interview is educational

▶ PHOTOS AND VIDEO OF SUPERB MODELS

WHAT'S NEAT | 2

and entertaining, showing his wealth of experiences in the model railroad industry.



Mike Budde is here this month with some new HO scale automobiles from Riko that will look fantastic in autoracks, and on your layout's streets.



I recognized the Jeep Grand Cherokee that we are about to see from Jurg Ruedi's model photos. He uses

only the best props when creating his scenes. Here you see how he worked the Jeep into two outstanding photographs in HO scale.

WHAT'S NEAT | 3



Playback problems? [Click here ...](#)

WHAT'S NEAT | 4

In this set of six photographs you can see the fidelity and detail on these magnificent HO scale model cars. The Ford pickup looks dead on, the Caprice, Cadillac, Buick and station wagon have details that include license plates, mirrors, steering wheels, gauges in the dash, and dimensions that look perfect. These are the best model cars to date that are finished, right out of the box. They are not cheap, at about 40 to 50 dollars each, but if you shoot model photos they are props that will add quality to your finished shots.



WHAT'S NEAT | 5



WHAT'S NEAT | 6



WHAT'S NEAT | 7



Subscribers got this WHAT'S NEAT bonus extra ... did you?

WHAT'S NEAT: BONUS EXTRA | 7

WHAT'S NEAT: BONUS EXTRA | 8

final shot. Chris Palomares at Athearn added 'tweaked' the photo in photo shop for what is future when Big 4014 finally rolls out of shops in Omaha. This shot better represents the ad hoc chaos from railfans running to grab that perfect vantage point for witnessing the run-by and recording it on video or as that memorable still image.

Subscribe today (It's free!)

WHAT'S NEAT | 8

In the next segment we test spray adhesives and foam glues for gluing foam scenery together. I test 3M's 77 and 90 spray glues, Loctite spray adhesive and two types of Great Stuff foam glues. The 3M 90 and Loctite ate the foam, so you will have to seal the foam with paint before using these. The 3M 77 did not eat the foam and held pretty well. The Great Stuff foam glues were the clear winner, in that they held up. The Great Stuff Pro simply did not come apart and sets up in less than one hour. That was the winner. It's my suggested glue for attaching foam sections for your model railroad scenery. In the video you can watch the process in real time, as I test the glues.

WHAT'S NEAT | 9



Subscribers got this WHAT'S NEAT bonus extra ... did you?



Model photo by
Ken Patterson

Subscribe today
(It's free!)

WHAT'S NEAT | 10

In the next segment of the video I go over the various types of soldering tools available, and show how to apply them to our modeling, track laying and wiring needs. I show resistance soldering, pencil-tip irons and soldering stations.



Here you see me desoldering a computer chip with simple hot air. This method gives wide coverage of the area without touching a hot iron to the circuit boards. It works really well. It is worth looking into, as an addition to your soldering skills.

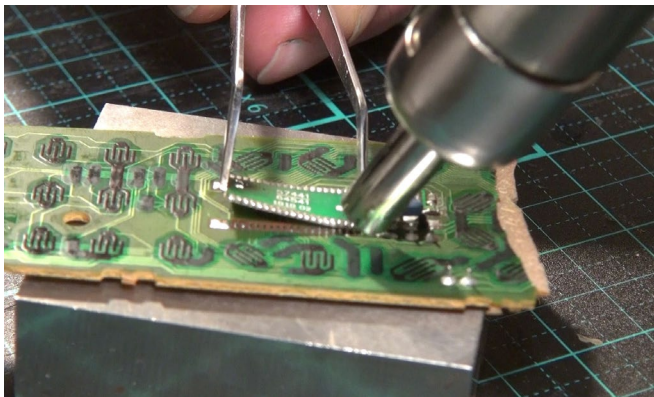

WHAT'S NEAT | 11

I am using a pencil-tip iron to solder Bachmann Easy-Track. The pencil tip is just the right size for track work and wiring. It gives the right amount of heat without melting plastic ties.

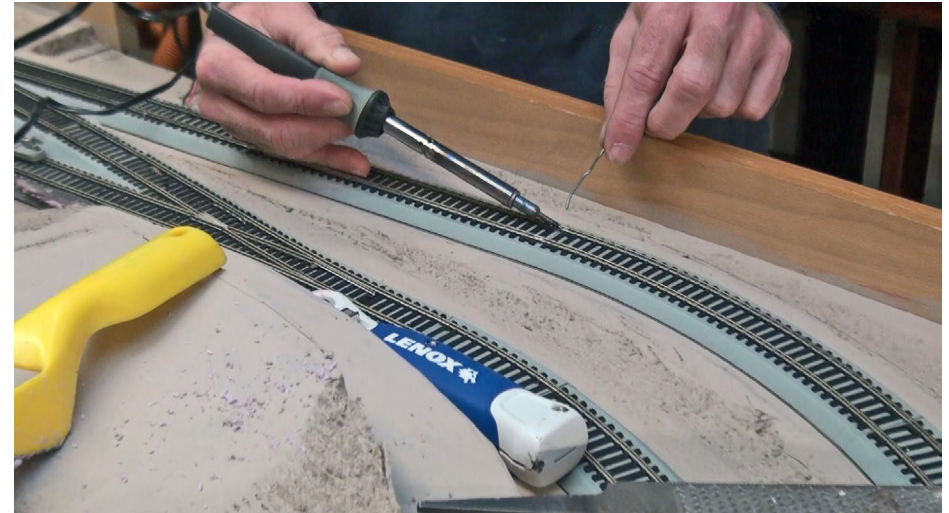

I use resistance soldering to add jumper wires to garden railroad track. It works well on code 250 rail without melting because it produces a great amount of heat in less than a second. The rail quickly gets very hot at the joint, without spreading very much. This tool also works great for fabricating brass models.



WHAT'S NEAT | 12

This month, I talk about the benefits of building a home layout with foam sections that can easily be removed for cleaning and maintenance. The design concept is essential to my outdoor photography for the manufacturers. This system also allows you to change scenes without tearing out all of your benchwork. When using them as photography sets, I place the sections on flat table-top benches and they stay in place without shifting. The track bridges the module joints with three-inch sections of rail. It makes layout construction something you can do at the workbench rather than in the layout room. In the video there is a short segment covering this, and a live Bachmann photo shoot to demonstrate the advantages of this layout design.



WHAT'S NEAT | 13



That wraps up this month's video coverage. Please vote my column a few stars in the Reader Feedback link. Thank you in advance for all of your feedback on "What's Neat This Week." That brings me to one more thing. Effective with the May issue, we are changing the name of the column and video show to **"What's Neat with Ken Patterson."**

 [Click here for reader comments](#)



HOBBY MARKETPLACE

Mr. Detail Parts
Bulk Packs and Bundles
Now Available

EXPLORE HERE

Available Scales: HO - N - S - O - G - TT - 1:72
www.mrdetailparts.com

BenchWork
Affordable built to order Benchwork
starting at only \$20 a Sq Ft.

PRECISION DESIGN CO
Jumpers to next board or power feeders LED Location Screw Mounting Location Solder Here Dot

BRIGHT - EVEN LAYOUT LIGHTING

STREAMLINED BACKSHOP
Sales
... Services
..... Solutions

"SUGAR CUBE" SPEAKERS...

4 Sizes * 4 Baffles
... "Sweet" Speaker Options!

Elektronik TCS SOUNDTRAXX Digital Plus DCC ON BOARD
DCC ESU MRC QSI Zimo

www.SBS4DCC.com

KMP Models... Now at Coastmans!

Loaders, Yarders, Sawmills and Spar Trees. HO, O, N & S.

Get 'em at **Coastmans** Scenic Products **click this ad**

Special functions, Special price

In ANE MODEL SmartSwitch slow motion turnout machine
US patent no. (US 7,987,026 B2)

BenchWork
Affordable track planning starting at \$250

Minimalist Model Railroad Design

All New 2nd Edition! **Click Here**

RULERS-of-the-WORLD
Scale Rulers \$4 each
Over 200+ scales!
Metric or Imperial
www.rulers-of-the-world.com

clever models LLC
Cardstock models & Building materials

CLICK HERE
www.clevermodels.net

Yarmouth Model Works
HO scale resin kits and detail parts

U.S.A. MAILING ADDRESS
3560 Pine Grove Ave. Unit 617
Port Huron, MI 48060
Tel. 519-633-7574
pierre.oliver@start.ca
www.yarmouthmodelworks.com

CANADIAN MAILING ADDRESS
85 Hiawatha St.
St. Thomas, ON N5P 2T5



Hobby Marketplace Ads are Economical and Effective.
Click to learn more ...

W GOLDEN AGE LINE
WESTERFIELD
 MODELS, LLC
NEW N.A.R. STK CAR KIT!



**RESIN KITS, DECALS,
 DATA DISKS & DETAIL
 PARTS AVAILABLE.**
westerfieldmodels.com

GRAND CENTRAL
 MODEL RAILWAY

Ph: 0448534212
 What we do:

Benchwork, Layout Design, Display Cabinets, Layout Photography,
 Backdrops, Home Consultations and Valuations
www.australianpacificrailways.com



PRE-SIZE
 MODEL SPECIALTIES

P.O. Box 6 Paonia, CO 81428
 Ph. 970 527 4586
 Made in The USA

Cast resin items for your O & On layout.
 Tunnel portals, bridge piers, abutments,
 culverts, and retaining walls.
 Trackside details and sage brush tree
 armatures.

NEW

BURLINGTON
BULLETIN
 No. 50 \$4.95

Overnight, Every Night, Act I:
 Burlington's 1936 Denver Zephyr

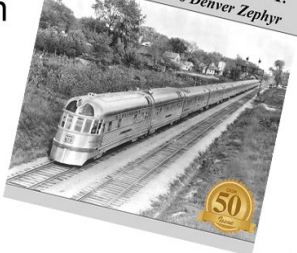

Burlington
 Route
 Historical
 Society's
 50th
 Issue!!

**Click here
 for details!**

Questions? Email Info@BurlingtonRoute.com

True Scene™ Modeling

NEW FusionFiber™

Scenery Base Material for the 21st Century!
SATISFACTION GUARANTEED!
www.truescene.com or 716-523-7305

MOUNTAIN SUBDIVISION HOBBIES

www.modelrrsupply.com

FREE USA SHIPPING OVER \$29.00

NCE - SOUNDTRAXX - DIGITRAX - PECO - CIRCUITRON
 DCC SPECIALTIES - INTERMOUNTAIN - CMX - ATLAS
 BAR MILLS - BOWSER - KATO - MRC - TOMAR - RIX -
 PIKESTUFF - LOGICRAIL - CENTRAL VALLEY AND MORE!

When talking to
 hobby vendors,
 please remember to
 mention MRH.

www.modelrailroadtunnels.com

**MODEL RAILROAD
 TUNNELS**



Great Decals!™

FEC, Interstate, Virginian
 Railway, & L&N Titles
 After Hours Graphics Line
 Coupler Gages and More
 In O, S, HO, and N Scales

AMERICA'S NUMBER ONE
 RAILROAD PRINT SOURCE

Jelsma
 Graphics

America's Railroad Embroiderer

Railroad Art-Prints,
 Caps, Jackets,
 Shirts and More ...
 Jackets starting
 at \$79.95

www.jelsma.com
 1-904-221-3513 • Jacksonville, FL.

Don't settle for lifeless signals!
 We've got signaling circuits!

LOGIC RAIL™ "Sophisticated
 Model Railroad
 Electronics"

LED LIGHTS | NEON SIGNS

NEW PRODUCTS
 ADDED MONTHLY

Please visit our website and online store!

21175 Tomball Pkwy Suite 287 Houston, TX 77070
 Phone: (281)251-5813
<http://www.logicrailtech.com>
info@logicrailtech.com

**LIGHTS 4
 MODELS**

N & Z SIGNS

LED LIGHTS | NEON SIGNS

NEW PRODUCTS
 ADDED MONTHLY

Check out all the
 N & Z Signs



STRUCTURE KITS AND ACCESSORIES

**MONROE
 MODELS**

WWW.MONROEMODELS.US



CLICK HERE

**CANYON CREEK
 SCENICS**



Backdrop Junction

Your stop for
Model Railroad Backdrops

www.backdropjunction.com

click here to visit our website
backdropjunction.com
 N, HO, O Scales • Custom Orders



**East Penn Traction Club
 22nd National Trolley Meet**

Pennsylvania Convention Center
 Hall G, Broad And Race Sts
 Philadelphia, PA
 May 15-16, 2015
 Layout visits May 17

Clinics, layouts in all scales,
 model contests, vendors, films,
 photos.
www.eastpenn.org

Can't remember which cars you've bought?

Yard Boss

Model Train Inventory Software
 from DCC by Design
 Under \$15
 Download free trial now
www.dccbydesign.com

CONRAIL

Ex-Reading GP35 #3627 Part 1



CONRAIL[®]



BY **CHRIS THOMPSON**
.....

Modelling a well-worn Conrail GP35 in HO...

GROWING UP IN THE EARLY CONRAIL DAYS I saw many trains similar to what's pictured above in my home town of South Bend, Indiana. A chance to build an Ex-Reading GP35 patched out for Conrail for my friend Jason in Australia allowed me to re-live some of those childhood memories. There were two orders of GP35s for the RDG. The first had a recessed sand-filler hatch under the number boards on the long-hood end,

 [Click here for reader comments](#)

and the second order had the normal filler hatch on the roof, but added angled access doors under the number boards, presumably for sander cleanout access. I decided to forgo these details in order to actually complete the model in a timely fashion, as they're not very visible when running in a consist on the layout.



STEP 1: ADDING READING DETAILS

Starting with an Undecorated Kato GP35, I removed the footboards, leaving the MU hose holders in place. Next, I added the usual details, including scratchbuilt brake cylinder piping from Tichy phosphor-bronze wire, Details West speed recorder drive, Leslie horn and Sinclair radio antenna; and of course Tichy grab irons and Detail Associates lift rings.

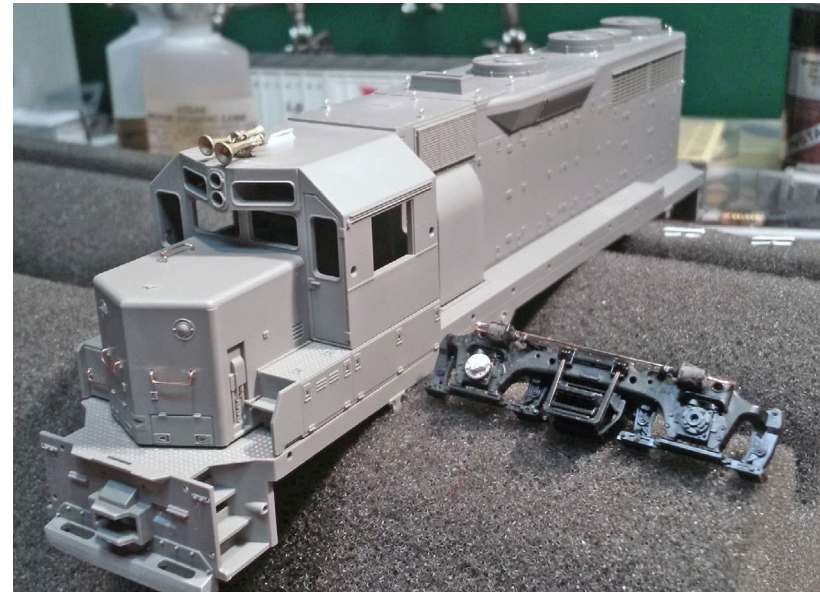

1. Here are the basic details added to the Kato model; next come the unique Reading cab gutters [2].



2. I used strips of Evergreen .010 x .020" styrene cut to an eye-balled length to match pictures.

STEP 1: ADDING READING DETAILS *CONTINUED*

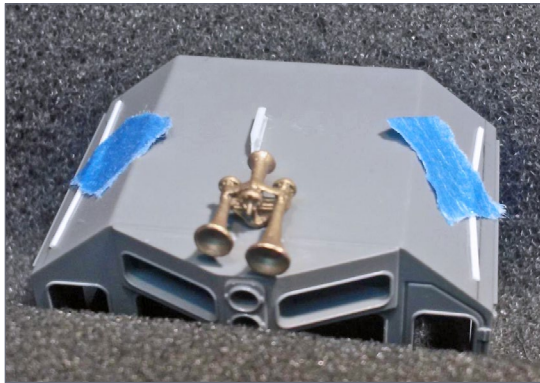

3. I drew light pencil lines across the cab angle to ensure both sides were installed at the same height. I bent a slight angle into the styrene, then attached it temporarily with painter's tape at the center. This held it in

place while I glued the ends with Tenax cement and a Touch-N-Flow applicator. After the ends were secured I removed the tape and glued the rest of the gutter to the cab.

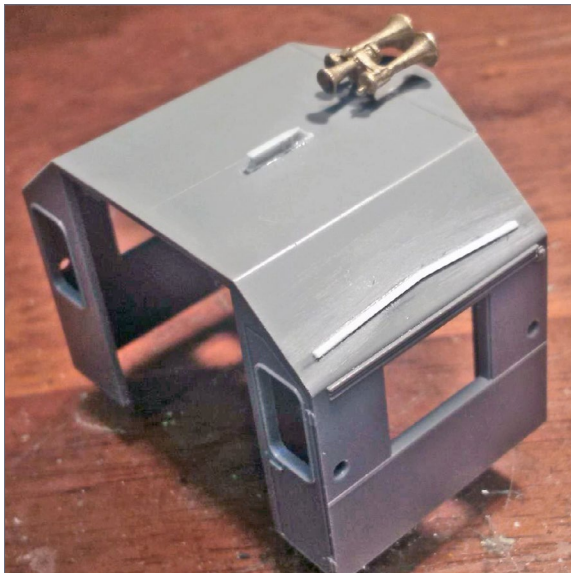

4. Here's the installed gutter after cleaning up the excess glue with sandpaper.

STEP 2: PAINTING THE MODEL

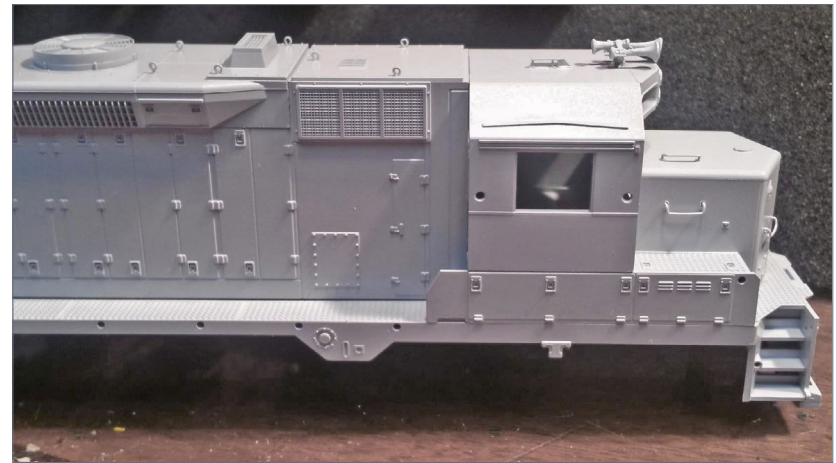

5. The cab has been attached to the body and Scalecoat Primer has been sprayed on.



6. Vallejo 70917 Beige I used for the Reading faded yellow.

I don't know of anyone making Reading Yellow paint, and I didn't want a fresh-looking paint job anyway, so I decided to use Vallejo brand Beige paint. This was my first experiment with their paints and all went very well. I read that others are thinning the paint for spraying using distilled water with a drop or two of Windex to cut the surface tension. I followed those tips and airbrushed it at 20 psi with excellent results. The beige color is a flat finish, but I plan to gloss it before decaling.

STEP 2: PAINTING THE MODEL *CONTINUED*

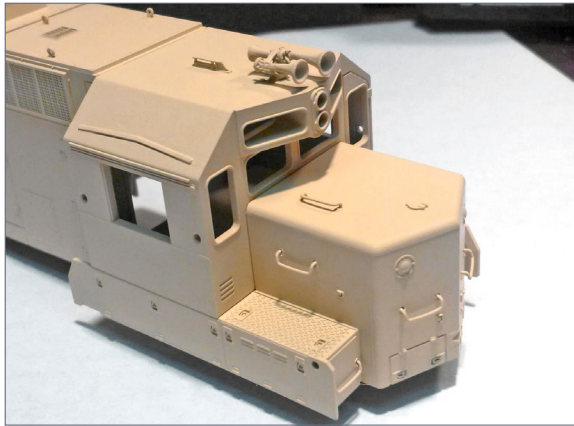

7-8. A couple of pictures of the beige applied.

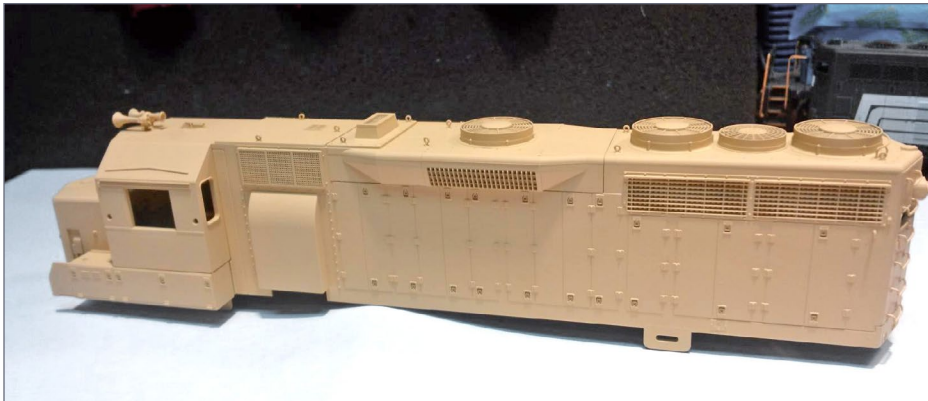

STEP 3: MASKING FOR MULTI-COLOR PAINT SCHEME

The next step is the most time-consuming to get good results – masking it! I don't like doing it, but try to relax and not hurry anything. I'll peel and re-tape a piece six times if need be. I read a long time ago to always cut the edge off the tape with a brand new blade for a smoother edge, and it does the trick.

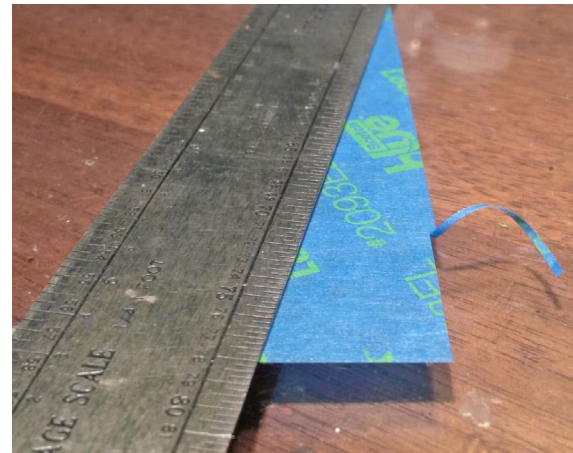

9. I use a straight edge and a new knife blade to get clean straight lines on the tape for masking.

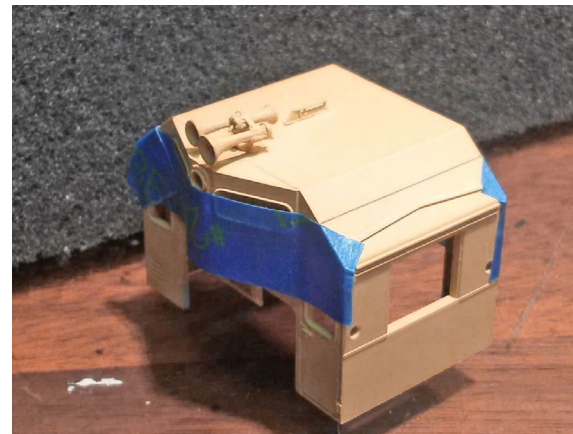

10 (below). I drew lines across the angled portion of the cab to ensure matching paint lines with the hood of the loco. Across the cab face, I had to go a little lower with the green compared to most photos in order to line up with the Kato body and its masking line. I did find one picture where the green went almost to the bottom of the number boards, so I'm still in range.

STEP 3: MASKING FOR MULTI-COLOR PAINT SCHEME *CONTINUED*



11. Here's the masked cab. After I'm done taping, I seal the tape overlaps with liquid masking film to prevent any painting accidents.



12. I purchased Scalecoat II Reading Green for this project, but after opening it I decided it was way too bright to use for a loco that will be this beat-up when finished, so I mixed it 50/50 with SC2 Engine Black to darken it. The weathering process later will fade both the beige and green, and I believe that will get me to where I want to be. Here's a shot of the green curing in the oven. I reckon I could have just used the C&NW green I had.



13. I decided to mask and paint the top, then re-mask and paint the bottom. This seems like the long way around, but I thought it would be easier than trying to get the perfect mask on the top and bottom at the same time. Here is the bottom mask being applied.



14. All the green has been applied to the body and walkway.

STEP 3: MASKING FOR MULTI-COLOR PAINT SCHEME *CONTINUED*

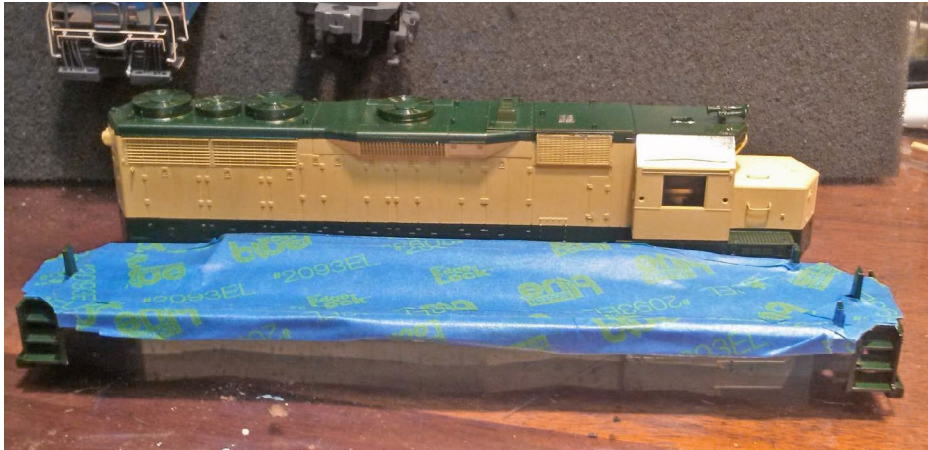

15. Next I masked the walkway and painted the step wells and pilots black.

16. You can see a bit of another project in this shot. I had to do something while waiting for all this paint to dry!



STEP 4: APPLYING THE DECALS

With painting now completed, I'll continue with decals, weathering, headlights, and Tsunami decoder installation.



17. Decaling pilots can be very frustrating, especially with the narrow stripes Reading units have. I found that making a quick-and-dirty template from styrene helps a lot.

When talking to hobby vendors, please remember to mention MRH.

STEP 4: APPLYING THE DECALS *CONTINUED*

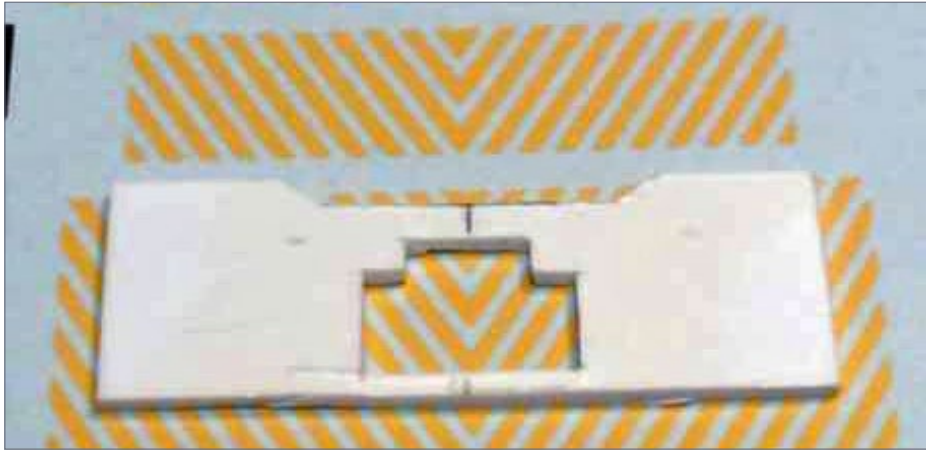

18. I cut the styrene template to fit around the coupler box and anti-climber, and used a sanding block to get overall width correct. I laid the template on the decal sheet, making sure to line up the center of the template with the center "V" of the striping.

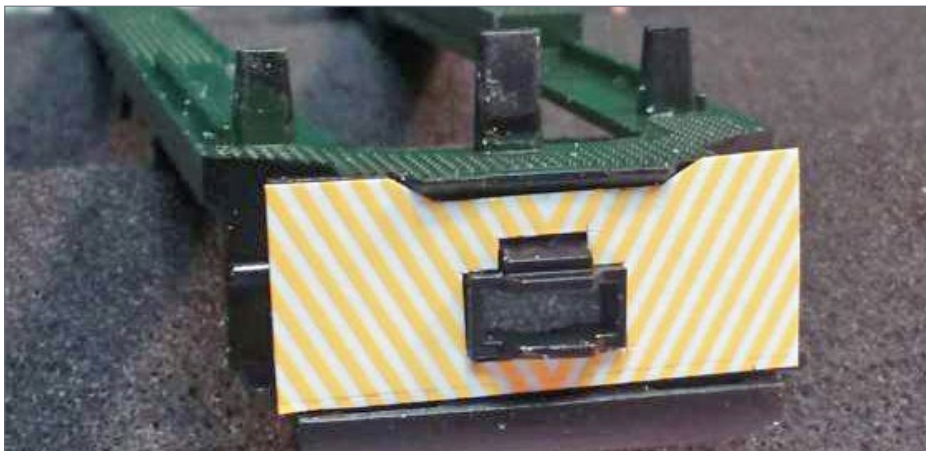

19. After cutting the decal sheet, I tried a dry test-fit to the pilot before applying.



20-21. A couple of shots of the completed decals.

STEP 4: APPLYING THE DECALS *CONTINUED*

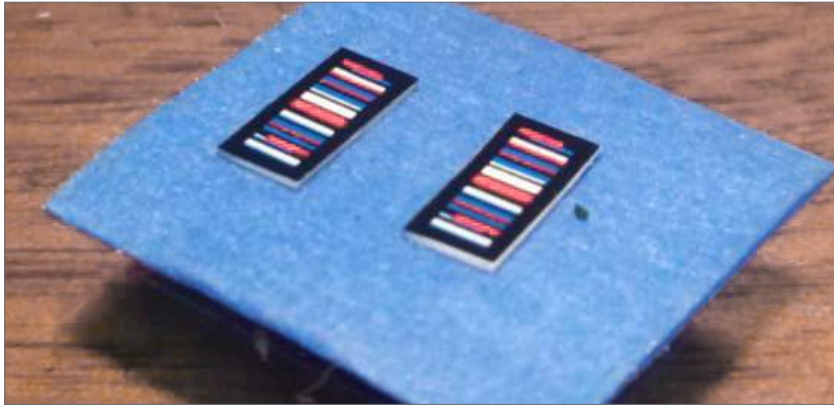

22. Next I modeled the steel plates that carry ACI tags. I cut out Highball Graphics ACI labels, then cut a piece of 0.010" styrene to the same size, applied the decal to the white styrene, then brush-painted any visible white styrene with Floquil Engine Black. Sticking small parts to a loop of painter's masking tape helps keep the styrene in place while applying the decal.



23. I installed the factory uncoupling levers that were painted black, along with the step wells and pilots painted earlier. After a coat of paint, their diameter grew, and they no longer fit into the holes in the pilot. To remedy this I used my sprue nippers to gently grab the mounting pin. I turned the nippers around the mounting

pin a couple times to cut a groove into the paint, and it fell right off the mounting pin. I did the same for handrails for a perfect fit. Describing this takes longer than doing it!



24. Speaking of handrails, these are by far the most difficult handrails I've ever painted! The long-hood rails have green stanchions, beige long rails, and safety yellow corners. The end rails get beige stanchions, safety yellow corners, and a green drop step, MU receptacle and tip where the railing attaches to the pilot. Brush-painting seemed the only way to go for this mess! I forgot to mention earlier that I grit-blasted all the railings before painting, for better paint adhesion. For the safety yellow I used Pactra paint for



polycarbonate RC Car bodies, with a flex agent. These two steps result in handrail paint that doesn't flake off.

25. Handrails, grab irons, cut levers, MU hoses and brake pipe hose installed.

STEP 5: NUMBER BOARDS AND LIGHTING

Next I began work on the number boards by brush-painting them Floquil Engine Black followed by Testor's Glosscote when dry, leaving a smooth shiny surface for decals.



26. I made sure to paint the areas around and behind the number boards so no light bleeds through. I followed up with two more coats of gloss after decaling to hide any edges. In this photo you can also see that I've outlined the number board and window gaskets with a black Sharpie marker. After weathering and Dullcoat, it will look great.

I modified the factory light bars to suit my own tastes. Trimming them leaves plenty of room inside the shell for decoder, speaker, and additional weight. The downside is having to unsolder the connections for complete shell removal. This only takes a couple minutes to do, and by using LEDs I won't be removing the shell to replace bulbs! I cut off the light bar about half an inch behind the headlights and drilled a hole to accept the tip of a 3mm warm white LED. A drop of superglue secured the two parts, then I used Aileen's Tacky Glue® to build up around the joint. Once dry and tested, I painted the entire light bar with Testor's Silver Chrome Trim to not only keep light from bleeding out, but reflect it back into the light bar.



27-8. Rear headlight [25] and front headlight [26] after testing and ready for silver paint.

STEP 6: OTHER DETAILS ADDED



29. After Conrail was created, cab signals were installed on many locomotives to allow them to lead trains in ex-Pennsy cab signal territories. I used a Detail Associates cab

signal box mounted on the right front walkway per the prototype. These add-on boxes blocked the nose access grab iron, while newly purchased units with cab signals had the grab iron relocated to the fireman's side of the nose.



30. The ACI placard glued to the side sill, and the Fuel Filler and Emergency Fuel Cutoff button outlined in red.

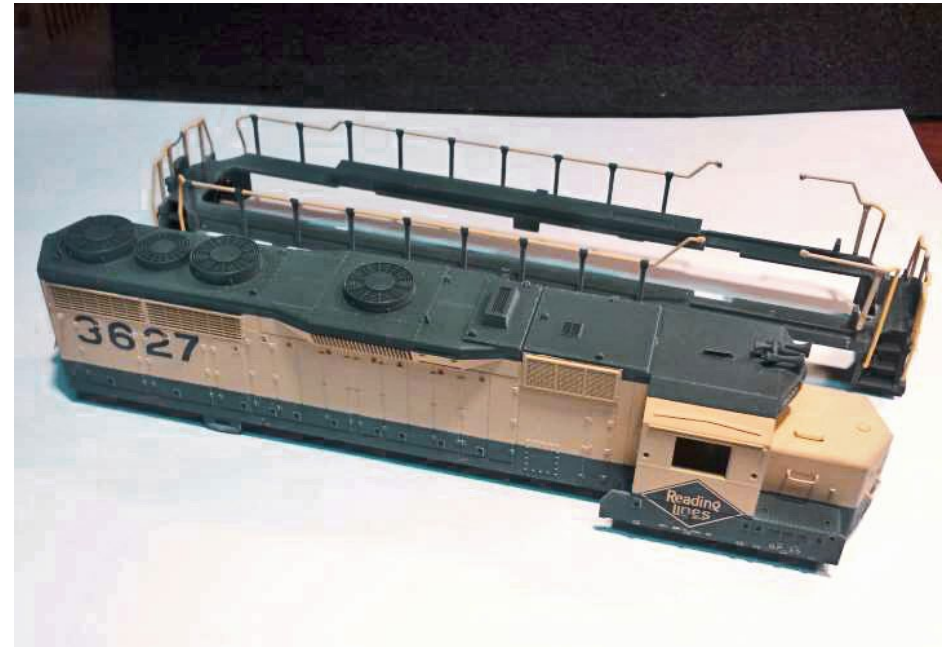

Next month I will detail my weathering process of the locomotive. Until then have a great time modeling. ☑

 [Click here for reader comments](#)

Want to help keep MRH free?
Then *click* on ads!

CHRISTOPHER THOMPSON



Chris Thompson has been a life-long model builder. He has given several

presentations and clinics on his building and weathering methods at NMRA conventions amongst other places.

While he does not currently have his own layout, he enjoys contributing to his friend's layouts including Jack Ozanich's Atlantic Great Eastern Rwy. Chris worked in the retail hobby industry for 15 years before hiring out with Conrail (now Norfolk Southern) in 1997 so he could play with the big trains. His wife Laurie and son Nick are very supportive of his hobby. ■

April 1870?
CLICK TO KNOW MORE

Its was our Love of the rich history of the railroad that sparked the begining of Microscale.

That Love has never faided, as we stand true to our goal.

To supply the world with the finest quality water slide decals !

Proudly made in the U.S.A.



Family owned for over 75 years.



www.microscale.com



TRAINMASTERS.TV

Recent new videos ...

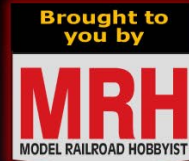

ZEN OF HANDLAYING TRACK

Trevor experiences the Zen of Laying Track, with great tips on realistic tie weathering and making reliable track transitions between modules.

LAYOUT OPEN HOUSE

Jim Dufour greets old friends and new as he hosts an open house on his HO-scale Boston & Maine Cheshire Branch.

CRICUT HINTS/TIPS

Miles Hale answers questions about the Cricut and shows pitfalls to be aware of when using for modelling purposes.

QUICK TIN ROOF

John Lowrance shows how to create the illusion of individual panels on flat corrugated plastic.

... and lots more! Almost 100 all-new video segments in all.

Watch these videos on TrainMasters.TV





DCC Bus Wiring 101

DCC Power feed best practices

BY **JOE FUGATE**

1. Wired properly, the cries of “Okay, who shorted the layout?” go away on a DCC layout. Joe Fugate’s Siskiyou Line (shown here) has been so wired for almost 15 years now.

Selecting and wiring DCC boosters, made easy ...

MODELERS NEW TO DIGITAL COMMAND CONTROL (DCC) often have questions about DCC bus wiring best practices.

Here are some common questions and their answers, pulled together from my own experience and from discussions on the web with modelers who have experience with DCC wiring for

layouts both small and large. Once you understand these basics, you’ll find it’s not hard to do and your layout on DCC will perform very well.

Common questions

Here are some of the more common questions I hear often about doing layout wiring for DCC:



[Click here for reader comments](#)

- How do you decide how many booster districts you need?
- What size boosters are best: 3 amps, 5 amps, or 8 amps?
- If I have both sound and non-sound locomotives, what does that do to the current needs of a layout?
- How do you decide where to locate your DCC boosters, given that wire run length can be a concern?
- Are there standards for bus wire size, color and/or labeling?
- Is it better to wire feeders directly to the power bus or is it better to use connectors like terminal strips?
- Where's the best place to get layout wiring supplies?

Rather than cover these questions one-by-one, let's start with some hard-knock insights into the overall issues behind why you should wire your DCC layout a certain way for best performance and maintenance.

DCC wiring principles

If you could count on your layout wiring working perfect the first time and never having any issues later, then you wouldn't need many of these wiring practices I'm going to suggest.

The minute your layout develops a mystery short, however, you'll need some way to break up the power distribution on the layout to quickly isolate and locate the short. If your entire layout is all one big block with all feeder connections soldered to the main bus, then localizing the short will be very difficult.

DCC BUS WIRING 101 | 4

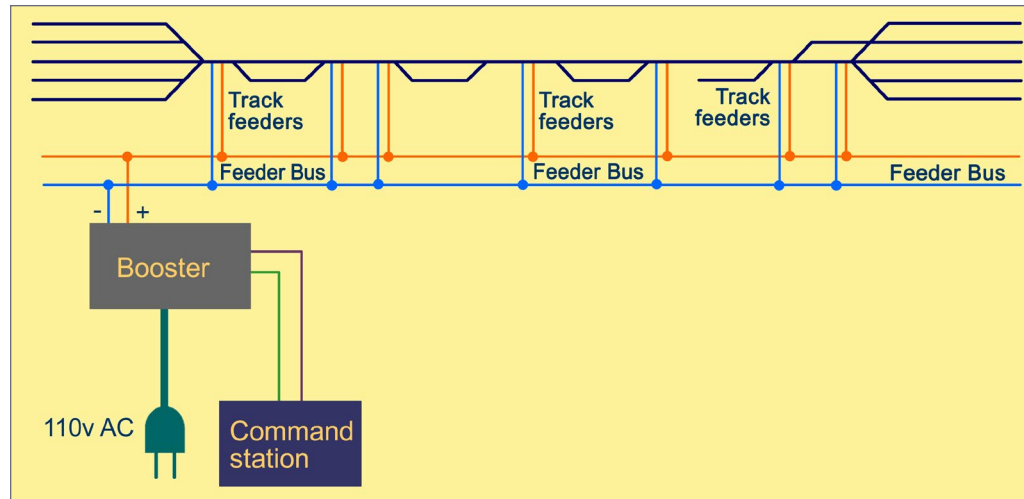

2. While you might get by with powering your layout completely from a single booster as shown here, you will probably regret it. When someone derails on a turnout and causes a short, it can shut down your entire layout until it's cleared.

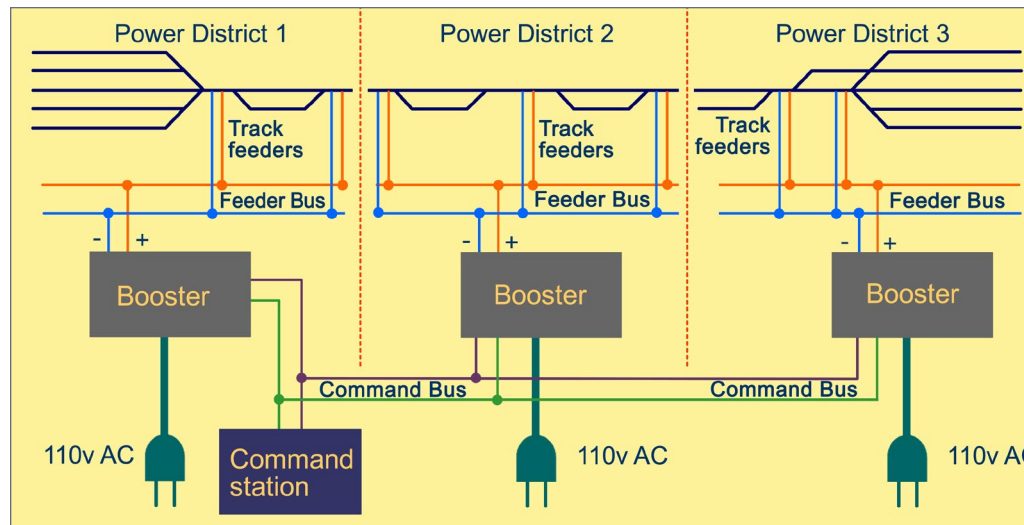

3. Better is to break up your layout into power districts, with each district powered by its own booster. This article details how to do this using DCC bus wiring best practices.

A DIFFERENT APPROACH TO H.O. TRAIN CONTROL



"The Crest HO Revolution is not only innovative, but it is also an ideal way for model railroaders to give radio control operations a try."

- David Bodnar,
Trainelectronics.com

VISIT OUR WEB SITE
FOR MORE INFO TODAY!



CREST ELECTRONICS
H.O. REVOLUTION
CREST-ELECTRONICS.NET

RR-CirKits, Inc.

Affordable Electronics for Model Railroads

- Computer Interface
- Signaling
- General I/O
- Block Detection



SignalMan



32 Aspects!

Learn More ...

DCC Bus WIRING 101 | 5

Breaking up the layout into power districts, first and foremost, allows you to isolate shorts when they occur and to quickly determine where the short is at.

By connecting your track feeders to terminal strips instead of directly to the bus, all you need to debug a mystery short is a screw driver: you can disconnect feeders until the short goes away. If you've run feeders to every track section, then the instant you disconnect a feeder and the short disappears, you will know exactly what track section has the short!

In the interest of isolating shorts, you need to gap both rails between booster power districts. This way, a short in one booster district will be completely isolated from any other booster district

As an aside here: Because the DCC signal resembles an AC wave rather than pure DC, some assume there's no polarity to the two rails of a booster district. Wrong! The AC-like wave signal of DCC

DCC Bus WIRING 101 | 6

does have a "phase" to it where one signal can be going positive while an out-of-phase signal will be going negative. This will give you a short just as certainly as with DC.

This "phasing" of the DCC signal means if you connect one booster district's rails out-of-phase to the next booster district's rails, then your locos will "short" when they try to cross the booster district gaps. This polarity differential also matters at reverse loops, wyes, and turntables, so DCC does not in any way negate the need for reversing section wiring.

To help isolate shorts and to keep things manageable as to amperage needs, you want to split all but the smallest of layouts up into more than one power district. Each power district gets its own booster and you gap the rails on both ends of that layout section to isolate it into its own power district.

If at all possible, you want each booster's power district gaps to be in areas of single track. Gap both rails and you're good. Putting a booster district split mid-yard, for instance, is a bad idea and will create an excessive number of gaps.

Keep in mind your locos are moving between different boosters at the power district gaps. While odd behavior at these gaps is very rare, the fewer gaps, the better. Most often, it's that once-in-a-lifetime oddball derailment at one of the power district section gaps that can blow a booster, so fewer joints are a best practice.

Identifying power districts on the layout

First, isolate any major yard into a single power district of its own. Put the block gaps in the single track at the ends of the yard, not in the middle of the yard (as discussed previously).

By isolating each major yard into its own power district, this typically means any staging yards at the ends of the railroad will

- Power district 3 Roseburg yard
- Power district 4 Siskiyou Line main
- Power district 5 Dillard and staging

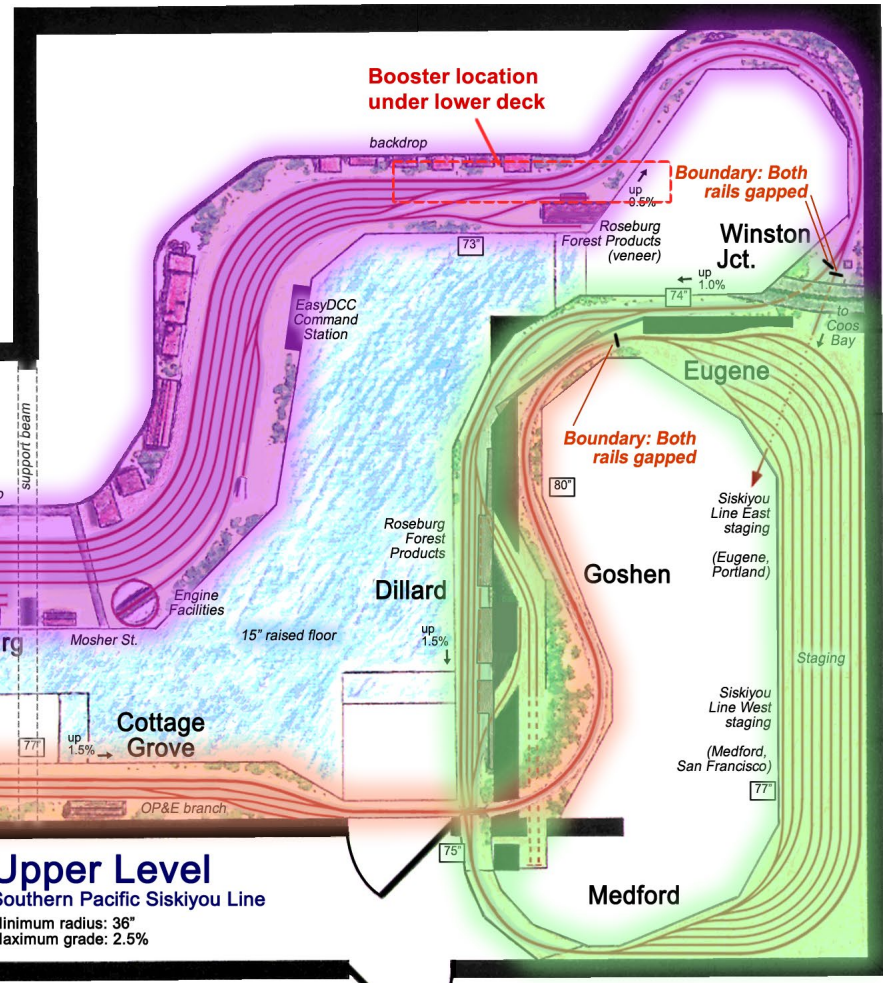
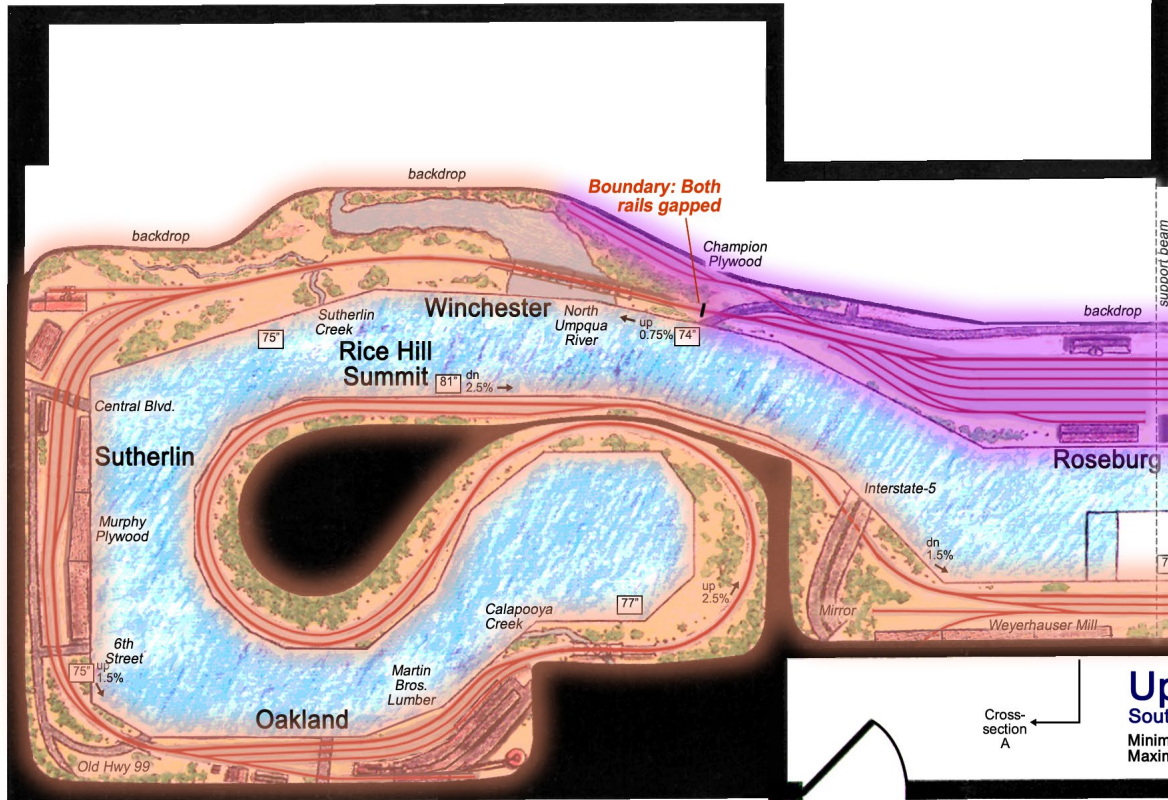

Upper Level
Southern Pacific Siskiyou Line
Minimum radius: 36"
Maximum grade: 2.5%

5. Here's how I did the upper deck power districts. First, I put the two yards – Roseburg yard and Eugene/Medford staging yard – into their own power districts, plus I included the large Dillard lumber complex in the staging yard power district because it's relatively compact. Finally, the Siskiyou Line main is its own power district. For further short management benefits, I later divided the Dillard main into one sub-block, put the Dillard siding and mill spurs in a second sub-block, and finally put the staging yard in a third sub-block.

For layouts with a multi-track main, make each main its own power district, gapping at crossovers. Treat each main as "single track" with regard to gaps at yards and major switching areas.

A good reason to have several power districts is short management. Here the question is: where do shorts occur most often? You want to isolate shorts into their own power district. Derailments cause most shorts and most derailments will

occur at turnouts. You want to isolate areas with lots of turnouts into their own power district. In other words, a major yard or industrial switching district should be its own power district, which explains the rationale we discussed above.

Booster amp rating and power districts

It's not the layout size in square feet or the length of the mainline that dictates how many power districts and boosters you'll need. In fact, it's the number of locos that you'll be using at one time and how many may be idling (think sound locos) on the layout consuming residual power.

Boosters come in 3 amp, 5 amp, 8 amp, and 10 amp power output ratings. Generally speaking, the 3A and 5A models are for the smaller scales like S, HO, TT, N, and Z. The 8A boosters can be used for HO, S, or O, and the 10A boosters are mostly for O and G scales.

When selecting a booster, you want to get the smallest booster you can get by with because the larger power output boosters cost more and when you have a short, the more amperage, the greater the chance of serious damage to your equipment and track.

Here are some comments Charlie Comstock posted on the MRH forum in a thread about loco amperage needs:

"If you looked at my DCC Specialities RRampmeter during my last op session, you'd see that with two trains and four locos in action, the current drawn was seldom more than 0.2 amps – and this with about two dozen locos idling away on the layout."

Unless you're planning something massive with respect to the number of trains and locos or you're using a bunch of old locos with open frame motors in them (which draw

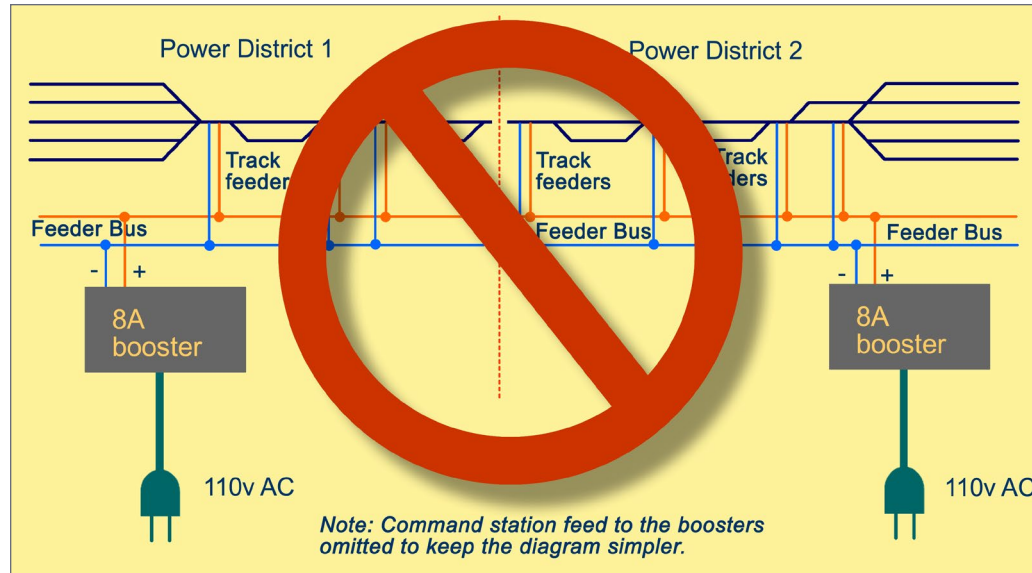

6. Don't be tempted to think of using fewer high amperage boosters. The higher amp boosters generally cost a lot more and they can do some serious damage in the smaller scales (S scale and below) when equipment derails and you get a short. High amperage boosters should be limited to the larger scales like O and G scale. This is a common best practice, but there may be some exceptions. See the text for details.

lots of current compared with modern can-motored locos) a single booster is most likely going to be fine for many layouts."

However, remember our general DCC wiring guidelines earlier about breaking up the layout to make debugging and managing shorts easier?

With the entire layout on just a single booster, the most common shout you will hear during an op session is "Hey! Who shorted the layout?" when everything stops because someone derailed on a turnout somewhere.

UNIVERSAL DCC BOOSTERS

Listing as of March 2015







Image									
Name	TAM Valley Booster	LV102	DB5	PB105	DB150	ZoneMaster SZB7	DB200 Plus	MRC1521	PB110
Maker	TAM Valley Depot	Lenz	NCE	NCE	Digitrax	CVP/EasyDCC	Digitrax	Model Rectifier Corp.	NCE
List price with power supply*	\$66.90	\$319.00	\$179.95	\$199.95	\$238.99	\$134.95	\$369.94	\$209.98	\$439.45
Amps out	3 amps	4 amps	5 amps	5 amps	5 amps	7 amps	8 amps	8 amps	10 amps
Comments	Assume TAM's 4.5A power supply. No case, comes as a board only.	Assume Digitrax PS514 power supply.	Power supply included. Plastic enclosure.	Power supply included. Metal enclosure.	Assume Digitrax PS514 power supply. Includes auto-reverse management and command station capabilities also.	Assume CVP's ZoneMaster power supply.	Assume NCE Brutus power supply. Using Digitrax PS2012 power supply adds \$10 more to price but can supply two DB200s.	Power supply included.	Assume NCE Brutus power supply. Using Digitrax PS2012 power supply adds \$10 more to price but can supply two PB110s.

Table 1. Universal DCC Boosters table: These boosters can be used to supply power to power districts for most any DCC command station on the market. See the text for how to select the proper amps out based on your layout needs.

* Vendors often list only the booster price and let you add the power supply separately. Because a booster needs a power supply, we always include a power supply to get the true total cost.

The best practice is to break a layout up into at least two power districts, with one being the main yard and the other being the main line. A third power district for staging also makes sense on most layouts. Now when someone derails in the yard, the main and staging will keep running, only something else in the yard will stop from the short.

As a rough current draw guideline in HO, figure a modern can-motored HO scale loco without sound draws about 0.1 amps per loco. If the loco has sound it draws about 0.3 amps per loco (or about the same as three non-sound locos). These figures are a rough guide and give you some headroom, as Charlie's previous comments illustrate.

On my Siskiyou Line, a typical train has three diesels on the head-end and a two-diesel mid-train helper. I typically run one sound loco per consist. This means per train I have:

$$0.1 + 0.3 + 0.1 = 0.5 \text{ amps head-end}$$

$$0.1 + 0.3 = 0.4 \text{ amps mid-train helpers}$$

$$\text{Total: } 0.9 \text{ amps}$$

DCC Bus WIRING 101 | 15

Two trains per power district gives me 1.8 amps, three trains gives me 2.7 amps – or just enough that a 3 amp booster will cover it. For many years I ran my layout on old Lenz 3.5 amp boosters, but I've recently upgraded to 5 amp boosters because I am planning to run more sound units than before. As a worst case, if every unit in a train had sound, then the figures become:

$0.3 + 0.3 + 0.3 = 0.9$ amps head-end

$0.3 + 0.3 = 0.6$ amps mid-train helpers

Total: 1.5 amps

Two such trains per power district gives me 3.0 amps, and three trains gives me 4.5 amps. This means a 5 amp booster per power district should be more than adequate if I run more sound-equipped locos on my trains.

If I need more amps, then I am better off to break up the power district in two and keep the booster amperage lower.

DCC Bus WIRING 101 | 16

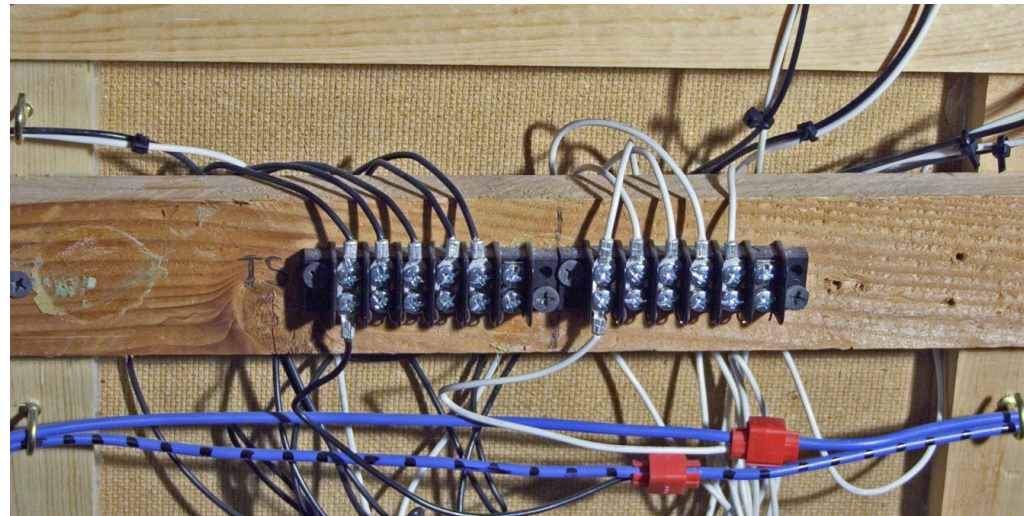

7. Using terminal strips and cable ties helps you organize and trace wire connections to your main power bus. It also means if you ever get a mystery short, all you need is a screwdriver

to locate the short - just start disconnecting bus wire feeds and you will localize the short to a single terminal strip and from there you can disconnect rail feeds until you find which one is the source of the problem.

If I just increase the booster to 8 amps, for example, now I have 60% more amperage on all the track in that power district, and the current flowing in a short will be a whopping 60% higher. A good short at 8 amps will damage

ADVERTISEMENT

Small Miracles

End wiring frustration with Touch Toggles™

- Elegant controls
- No drilling
- No soldering

See our website for a video introduction!



Made in the USA

What will they think of next?

www.berrethillshop.com

ADVERTISEMENT

TamValleyDepot.com
Great Electronics for Great Model Railroads



We are loading up the boxcars with Frog Juicers ready for your layout!

Single Power District with sub-bus wiring for optimum short management

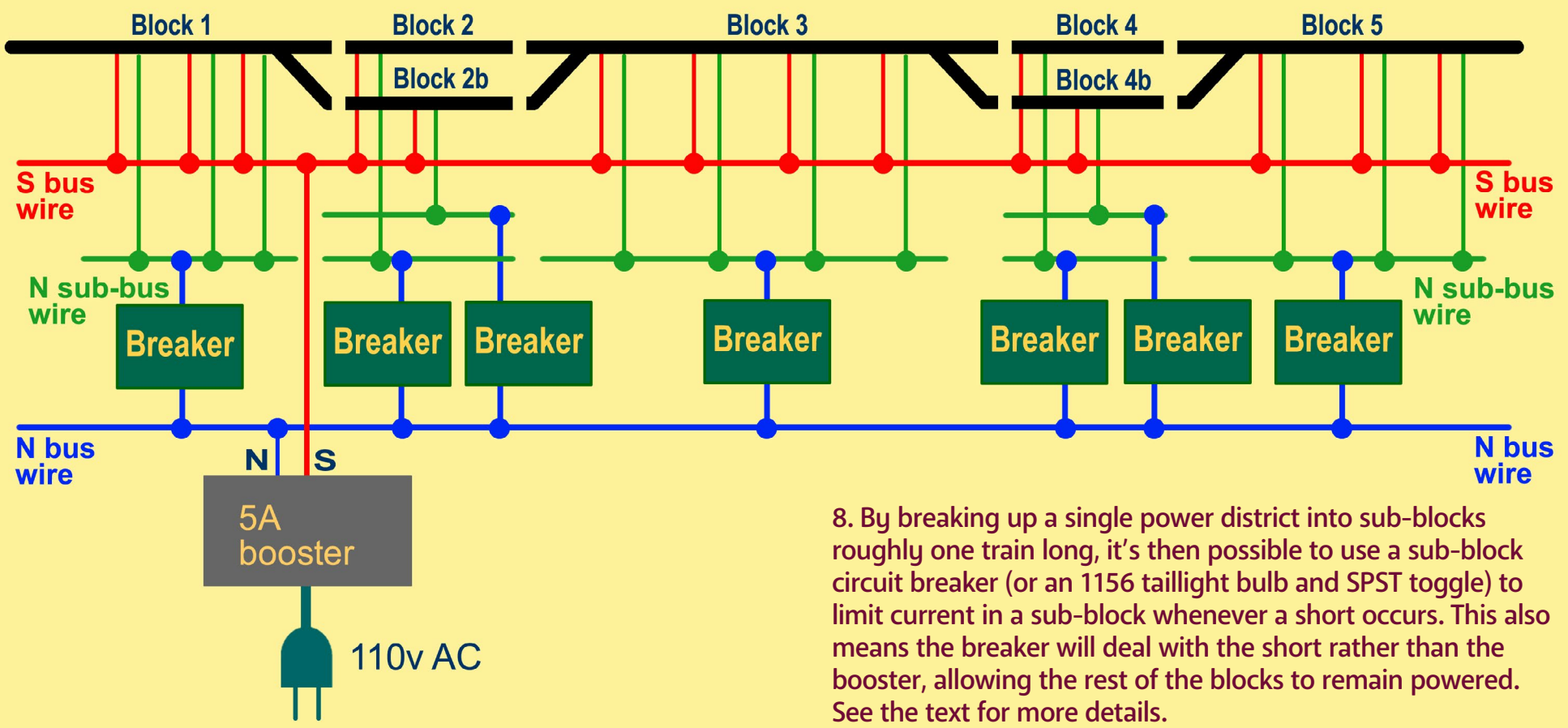

8. By breaking up a single power district into sub-blocks roughly one train long, it's then possible to use a sub-block circuit breaker (or an 1156 taillight bulb and SPST toggle) to limit current in a sub-block whenever a short occurs. This also means the breaker will deal with the short rather than the booster, allowing the rest of the blocks to remain powered. See the text for more details.







track and melt wheelsets, in the smaller scales such as S and smaller. It's a best practice to only use 8 amp boosters and larger for O or G scale.

It's best to aim for more power districts with smaller amperage rated boosters than fewer power districts with higher amp boosters.

Only add boosters if you see it's required based on actual operating experience. Get a DCC Specialities RR amp meter (or two) from Tony's Trains and use them to measure the actual current going out of a booster. You're likely to be pleased at how little current gets used in ordinary operation for S scale and smaller.

DCC SUB-BLOCK CIRCUIT BREAKERS

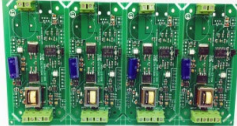
Listing as of March 2015

Image							
Name	PM42 Power Manager	EB-1 Electronic breaker	OnGuard OG-CB	DFJ Circuit Breaker	ZoneShare	PSX Power Shield	MRC-1527
Maker	Digitrax	NCE	DCC Specialties	TAM Valley	CVP/EasyDCC	DCC Specialties	Model Rectifier Corp.
Price per sub-block	\$23.23	\$29.95	\$29.95	\$31.95	\$32.49	\$33.74	\$49.98
Breaker current	from 1.5 to 12 amps	from 2.5 to 8 amps	4 amps only	2 amps or 4 amps	from 1.5 - 4 amps	from 1.27 to 17 amps	5 amps only
Comments	PM42 does 4 sub-blocks and requires a PS14 power supply.	Not recommended for use with the Powercab or Zephyr starter systems.	Fixed current limit, not adjustable.	Adjustable to 2 or 4 amps.	Each unit will protect 4 sub-blocks. Also available with a case for \$12.50 more per block.	Priced the 4-block unit because most layouts will need many sub-blocks.	Fixed current limit, not adjustable.

Adding sub-blocks for short management

Besides doing booster power districts, modern DCC practice also has shown breaking up a single power district into sub-blocks has a lot of benefit.

To get this enhanced short management, you divide up each power district into sub-blocks. Like booster power districts, you want each sub-block completely isolated, which means you need to gap both rails and put a breaker or other short management device (like an 1156 bulb) on the bus feed that goes out to that sub-block. The sub-block feed can tap off the power district bus as long as the feed to the sub-block first goes entirely through your short management device. Then

Table 2. DCC sub-block circuit breakers table: These circuit breakers allow sub-dividing a single power district into sub-blocks for better short management. See the text for details.

it can become however many rail feeds you need for the sub-block by using terminal strips for the feeders.

Remember, I'm recommending terminal strips because if you ever need to debug a mystery short, all you need is a screw driver, not wire cutters and a soldering iron! If you don't use terminal strips, the first mystery short you get will make a believer out of you.

Remember, you must run an entire sub-block's bus through the short management device first, otherwise your short



9. On my HO Siskiyou Line, I use centrally-located Lenz LV100 boosters, rated at 3.5 amps each, for my five power districts. However, as I add more sound units to the layout, I'm finding a need to move up to 5 amp boosters. Because I'm using sub-block current limit protection wiring, moving to higher amp boosters won't cause any problem.

management device won't work properly, since it's not protecting the entire sub-block.

Having multiple sub-blocks with independent circuit breakers helps during op sessions to keep trains running and isolate shorts to just the train causing the short.

These sub-blocks also help when the layout develops a mystery short and you're wondering where it is. Options for sub-block protection include electronic ones like the DCC Specialties PowerShieldX or the good old 1156 auto tail light bulbs.

The most important thing about wiring multiple sub-blocks is to make absolutely sure that each section is totally isolated. Don't cross-connect any sub-block feeds and always gap both rails at sub-block boundaries. If there are any connections between two sub-blocks it totally defeats the purpose of having multiple protected sub zones.

Originally, I was a big fan of using 1156 auto taillight bulbs for "poor man" short management on a large layout. However, this method does have its drawbacks, with a significant one being how the bulb filament begins to glow dull orange and limit track voltage as current exceeds more than about 50% of the limit of the bulb. This is just over 1 amp for an 1156 bulb, which has a total amp rating of about 2.1 amps.

An incandescent bulb filament when cold has almost no resistance. But as the current to the track increases, the slowly increasing resistance behavior of the bulbs means if I have a full sound-equipped train in an 1156 protected sub-block, I've got 1.5 amps flowing to the train and the bulb filament glows dull orange, limiting the voltage to the sub-block. The limited voltage causes the locos to slow, making the throttle behavior sluggish and reducing loco effectiveness on long heavy trains.

As the current increases, the 1156 bulb filament starts glowing bright orange, now very noticeably reducing loco speed and making the loco performance extremely sluggish even at full throttle.

It's possible to alleviate this somewhat by using different bulb combinations in parallel, but that increases the current limit, making the bulbs less effective if there's a short.

There's also the problem that it's getting ever harder to find incandescent auto taillight bulbs. More and more, auto supply stores are moving to LED equivalent bulbs, which of course do not exhibit the same low resistance behavior at low current levels. Before long, it's going to become very difficult to find any incandescent auto taillight bulbs except as high-priced specialty items, which will eliminate their price advantage or circuit breaker boards.

These days, I see going with fewer sub-blocks and using circuit protector boards. See Table 2 for a listing of commonly available circuit protector boards and their amp setting options.

Booster placement in the layout room

Like many things, it depends. For my boosters and bus wiring on my HO Siskiyou Line, I centralized the boosters. But the configuration of my layout puts four of the five booster power districts within a few feet of a central location at the west end of my Coos Bay branch.

I can feed my Coos Bay yard right above this location, and the west end of Roseburg yard is right above Coos Bay yard on the second deck of the mushroom benchwork. Main staging is eight feet away, just past Roseburg yard. Only the rest of the upper deck Siskiyou main is not right above this location, it's about 15 feet away.

So for me and my layout configuration, this location actually allows for a central placement of boosters. If you decentralize your boosters, then you will have to run a long command bus between your command station to your boosters, instead of running a long power bus to your boosters when you centralize.

Generally speaking, it's best to keep command bus length to no more than 25 feet. EasyDCC recommends a maximum of 14 feet. The maximum length for a power bus depends on the wire size you use for your power bus.

I don't think there's a right way or a wrong way to do this. I've seen both centralized and decentralized done and both work. If you want to centralize and you can find a good central location like I did, you won't have to run much extra wire at all for centralized.

Bus wire size, color, and labeling

You want to minimize voltage drop on your bus wire run, so don't scrimp on bus wire size. The length of run is from your booster

Stranded Wire Size AWG	Minimum Acceptable 10% Voltage loss at 5 Amps Bus Run	Best Performance 5% Voltage Loss at 5 Amps Bus Run
18	30 Ft	15 Ft
16	40 Ft	20 Ft
14	70 Ft	35 Ft
12	100 Ft	50 Ft
10	130 Ft	65 Ft

to the far end of your power district on the layout. See the table above for recommendations, adapted from DCC clinic materials by Mark Gurries. Keep in mind, the bus run is the total length of run for *both* bus wires, so you need to multiply the run length by two to get the amount of bus wire you will need.

Which is best, stranded or solid? Either works well, and stranded has the advantage it's more flexible. Solid wire in larger sizes may be easier to get at places like Home Depot or Lowes. Do whatever is easiest and the most affordable. On my Siskiyou Line, I use stranded wire for my power bus because I prefer the greater wire flexibility.

As for bus wire colors, there are no standards, per se. However, it's a good idea to get contrasting colors for the two bus wires, such as white and black, or red and blue so you can easily tell them apart. As to labeling, just call them whatever you like, such as bus N and bus S for north and south. The terms north (N) and south (S) is common DC wiring layout terminology for the two rail feeds.

North is typically the farthest rail from you and south is the nearest rail. Of course, this can change if the track goes through a reverse loop, wye, or is on a turntable. (Note: The

wiring of reverse loops, wyes, or a turntable is beyond the scope of this article.)

Track feeder best practices

Track feeders typically run off the bus feed to a terminal strip and kept from one to three feet long at most. That said, it's best not to go too small on track feeder wire size. Here's a table with recommendations on track feeder wire size and length of run to keep the voltage drop from the terminal strip to the track well under 1%.

Stranded Wire Size	Recommended Maximum feeder length
AWG	Feeder run
24	12 inches
22	18 inches
20	24 inches
18	36 inches

The best approach for trouble-free track power is to feed every section of track and to not rely on unsoldered rail joiners. Don't just solder all the rail joiners because track needs rail joiners every 6 feet or so that are loose and have a space of about 20 thousandths for expansion / contraction. An easy way to get that 20 thousandths is to use two business cards and make sure they will slip into loose rail joiner gaps.

Powering every section of track means running feeders roughly every three feet. One option is to solder two track sections together and just place feeders every six feet – this works especially well on curves to help keep track in alignment. For sections of track shorter than 3 feet, solder the rail joiners to the larger section of track and attach the feeders to the longer section.

Methods vary when it comes to attaching feeders to the rail. On my HO Siskiyou Line, I use 18 gauge wire for track feeders and I solder the feeders to the backside of the rail base on

Coming soon to the **NEW**

Model Railroad Hobbyist Store

DVDs and downloadable videos from ...

TRAINMASTERS.TV



Titles include:

- Streamliners at Spencer
- 2014 Layout tours
- Backdrop painting how-to
- Extreme weathering how-to
- Best of TMTV 2014
- Each monthly show on a DVD



Most common comment in our video survey last summer:

"My internet bandwidth doesn't do streaming very well. Can I get TrainMasters videos on DVD or as a download instead?"

Our answer: **Yes, now you can! Coming soon ... watch for them!**

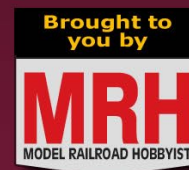

Visit store.mrhmag.com

The **NEW** Model Railroad Hobbyist STORE

both rails. On the front inside rail, I must make sure to not restrict flange clearance, but with a little care, I've found that's easy enough to do. By soldering the feeders to the back sides of both rails, the feeders completely disappear, yet can be found easily using a mirror if needed.

Conclusion

If the DCC signal is strong (read: wired well by following these bus wiring best practices) then your layout will perform better and operating it will be a lot more satisfying. Hassle-free performance of a layout is worth every penny and every minute you spend to do the bus and feeder wiring properly. ✓

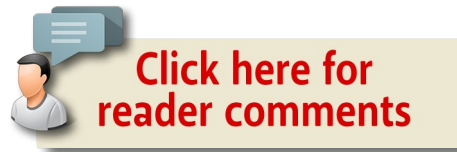

TURNOUT POWER FEED TRICK

If you use the contacts on your turnout throw to change frog polarity for live powered frogs, there's always a chance an operator approaching a turnout from the frog end might forget to throw the turnout – and then they'll short the track when they reach the live frog because the polarity will be backwards. Don't underestimate how often this can happen!

One clever trick to alleviate this problem is to put an 1156 auto taillight bulb in the frog feeder wire. That way, the one loco or train running the turnout thrown against them will stop and light the bulb, but all the other trains in that power block will keep running. This one trick will alleviate 99% of the accidental layout short shutdowns that can happen when using powered frogs. ■

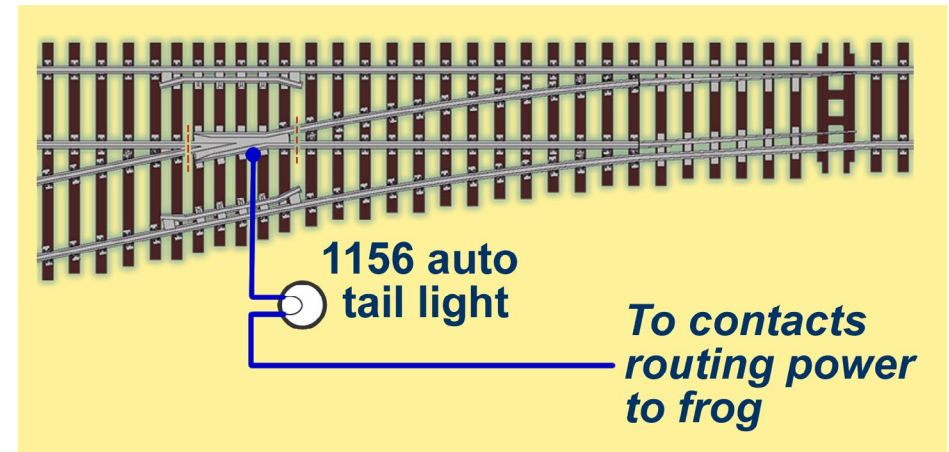

ADVERTISEMENT

Real Cool!

H0n3 Refrigerator Cars Arriving this Summer!

Visit our [authorized retailers](#) to reserve yours by April 17.



Click for More Details

- Available in 8 road numbers and 3 D&RGW heralds
- Painted and ready-to-run
- Tsunami SoundCar-ready

Blackstone Models™



**Follow along,
step-by-step!**

BY **BOB GRECH**
.....



**Click here for
reader comments**

Make trees using common craft store supplies ...

BUILDING REALISTIC PINE TREES IS A REAL fails challenge. As a result, many model railroaders would rather buy than build. If you are one of the folks who is frightened by the thought of building trees from scratch, let me show you how I go about building mine.

This is a tutorial on how to build HO scale pine trees. The methods used can be applied to any scale as long as you remember to adjust the height and circumference of your tree trunks to accommodate the scale your working with. For HO scale trees, I

found that 1/2 inch square balsa wood works best. If you model in N scale, your trunk would be about half that size, or about 1/4 inch in diameter. For O scale, use one-inch diameter trunks.

I hope you enjoy my clinic, and will consider adding these pine trees to your layout. Have fun ...

.....

STEP 1: MATERIALS

These are the materials I use for this presentation. For branches, I like caspia fern. If I'm modeling needle pines, then asparagus fern is the material of choice. Caspia fern can be purchased at most craft stores, such as Michael's. Also shown is a small wire brush, and a utility knife I use to taper the trunk and make a bark effect. To insert the individual branches, I use a sharp scribe to add holes where needed.



STEP 2: TREE TRUNK



trunk as shown to form an even taper.

Using a sharp blade, cut the balsa sticks to their appropriate heights. For full-grown HO scale pine trees, cut your trunks 8 to 10 inches tall. Once cut to size, take your knife and slowly start tapering the balsa



Form the top of your tree trunk. Extra care is needed at this step, as the trunk tips can easily be broken.

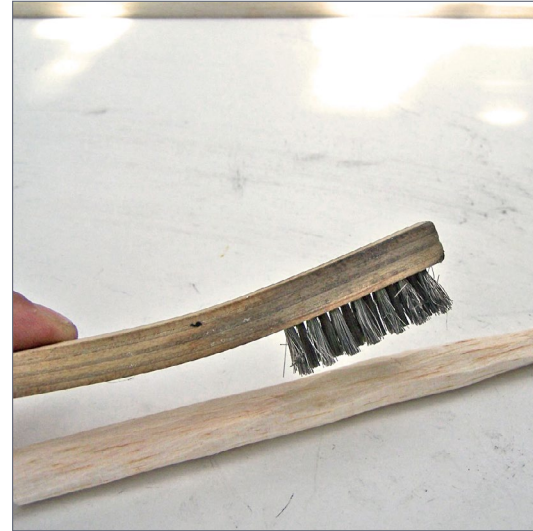

I use a wire brush to add the “bark” effect to my tree trunks. You’ll find that the softness of the balsa allows the brush to cut into the wood easily. Take care to avoid warping. One way to minimize warping is to turn the trunk frequently as you add your bark texture.

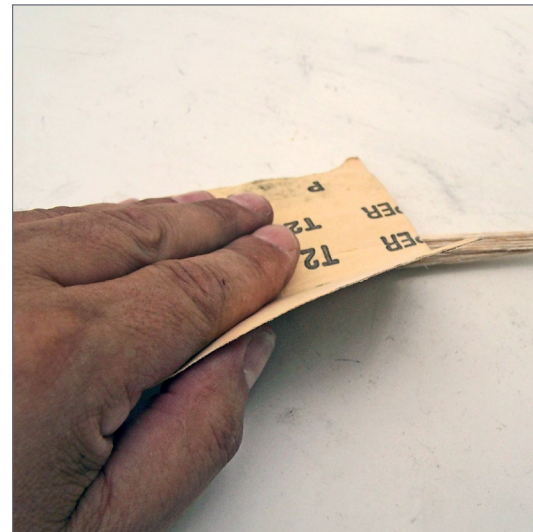

To remove those fuzzy members of wood left by the wire brush, I use #240 grit sandpaper. The trunk is now ready to be stained.

STEP 2: TREE TRUNK *CONTINUED*

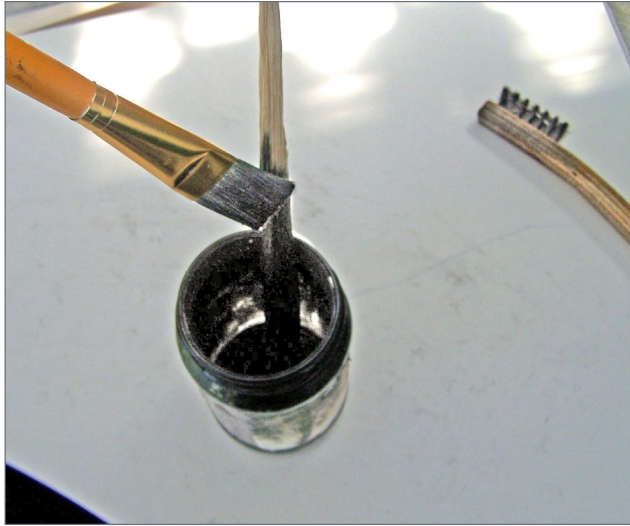

Dunk your textured trunk into a wash of alcohol and India ink, or brush it on. Make the wash with two full tablespoons of ink to one pint of denatured alcohol. Set the stained trunks aside and allow them to dry.



Here's how the completed trunk should look.

STEP 3: TREE BRANCHES

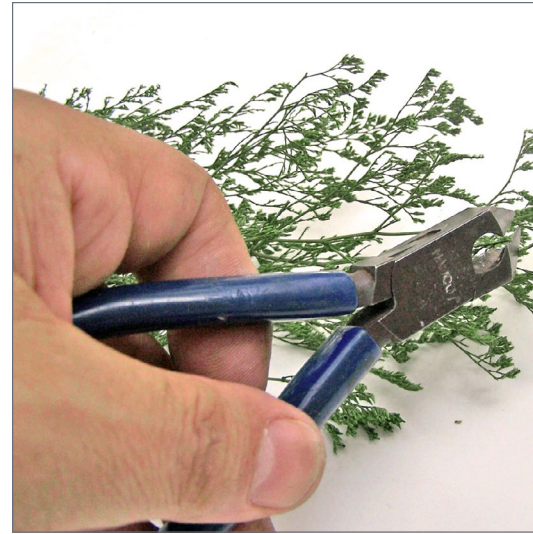

To add the branches, first take a pair of nippers and snip off the fern ends.



Sort the cut branches by size, leaving the larger ones for the bottom half of your tree and the shorter ones for the top half. For HO scale, these branches should be about two inches in length.

STEP 4: INSTALLING THE BRANCHES

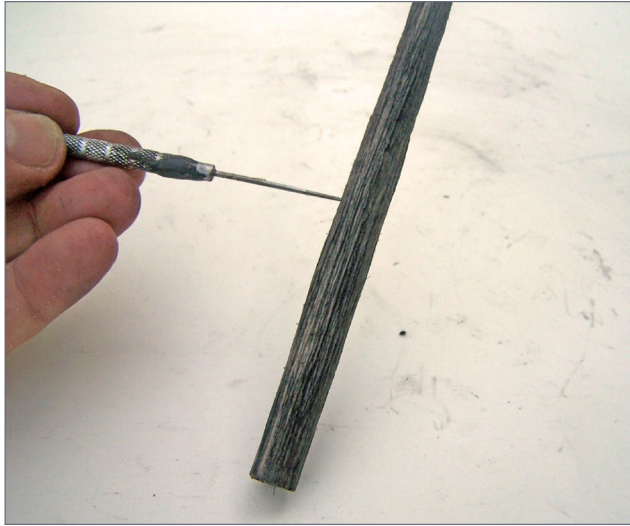

Using a sharp scribe, poke holes into the trunk where each branch will go. Instead of poking all of the holes at one time, I like to add holes as I go. This makes it easier for me to see where the holes will be needed.

Here's how the completed trunk should look.



Measure approximately 2 inches up from the bottom of your trunk and insert the lower branches first. Turning your trunk, insert the branches as shown.



The bottom half of the tree is complete.



Reduce the lengths of the remaining branches to provide an even taper toward the top of your tree. As you reach the top of the trunk, insert the smaller branches on a slight upward tilt and leave a bit more space between each branch. Real pine trees often have fewer branches towards the top.

STEP 4: INSTALLING THE BRANCHES *CONTINUED*



Examine your completed pine tree to see if anything seems out of place. Fill in any bare areas with additional branches and trim any branch that is out of proportion. Don't make your taper too perfect, or it will look toy-like.



As a finishing touch, I like to add a few "dead" branches to the lower half of my trees. To add this detail, use the dried (no leaf) portion of your fern.



The completed pine tree is installed on my layout. I think you'll agree that these trees look great. Besides looking good, building trees from scratch can really stretch your layout budget. The total cost of materials used to make six trees was less than \$6.00! ☑

Get the Latest Model Railroading News, Tips, Reviews & Opinions

The SCOTTY MASON SHOW

S H O W
The Original Model Railroad Podcast

-Monthly Interviews

- Modeler's Spotlight: Top Modeler's Talk
- Narrow Gauge Modeling w/Chris Lane
- Contemporary Modeling w/ Mike Rose

-More Product Announcements & Reviews

 Our feed has changed! To get the latest shows, please search Scotty Mason and subscribe to the new feed!

www.TheModelRailroadPodcast.com

Scott Mason Jimmy Simmons Mike Rose Joe Duckworth

BUILDING PINE TREES | 11



BOB GRECH

Bob's interest in model trains spans over 40 years. His Western Pacific layout was featured in the November 2006 issue of *Model Railroader*, and also in *How To Build Realistic Layouts, volume 4*.

Bob lives in Fountain Valley Ca, and is employed as a mechanical engineer for the Boeing Company. ■



[Click here for reader comments](#)



Many species of Conifer trees available!



Also see our other conifer offerings ...

ADVERTISEMENT



WE ONLY SELL WHAT WE MANUFACTURE

DETAILS IN HO, O, S & N SCALES
LASER CUT SHINGLES, DOORS & WINDOWS, FENCES, SIDING, CRATES. Also RESIN and WHITE METAL DETAILING CASTINGS.

CRAFTSMAN KITS IN HO, O & S SCALES

CHECK IT ALL OUT AT WWW.RUSTYSTUMPS.COM

Send \$3.50 for Catalog - Specify Scale

RUSTY STUMPS SCALE MODELS
6785 Cherry Blossom W. Dr., Fishers IN 46038
Phone (317) 595-9489

SOUTHERN PACIFIC'S Lightweight streamlined cars: More than just the Daylight, Part 3

BY V. S. ROSEMAN

Photos by V. S. Roseman
unless otherwise noted

1. EMD E7 diesel engine 907-A leads a pair of "B" units at the head of today's City of San Francisco, ready for departure time at Oakland Mole.

PART 3: THE OVERLAND ROUTE AND THE CITY OF SAN FRANCISCO

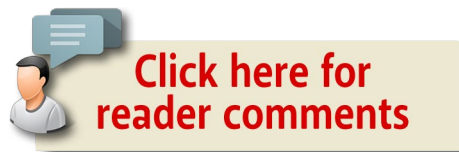

IN 1937 SP STREAMLINED DAYLIGHT-TYPE chair cars SP 2424, 2425, 2426, 2427, 2428 and 2429 were assigned to the Oakland-Chicago "San Francisco Challenger" as part of the SP's contribution to the Overland route in conjunction

with the Union Pacific and Chicago Northwestern railroads. These cars were painted dark olive green with gold lettering and red "Challenger" script logo below the windows to match the train. This was a new luxury coach formation.

By 1940, chair cars 2424 and 2426 were shifted to Coast Daylight service, and 2427(1st) was moved to the subsidiary Texas and New Orleans RR. for Sunbeam service. SP cars 2432, 2433, 2434, and 2435 were moved to the S.F. Challenger, where they remained throughout World War II.

The cars continued in Overland route service after the train was discontinued, and some were assigned to the new Gold Coast train on the same route. Several of these Daylight type cars were assigned to the flagship train on the Overland Route, the City of San Francisco, or "COSF."

This fast coach and Pullman formation ran several times a month using two consists. Then the decision was made to operate the train daily starting in October, 1947.

The other SP trains described here so far made their runs daily with two sets of equipment. Running time for COSF between Oakland and Chicago was 40 hours or more. Daily operation of the train required five consists. In 1947 the carbuilders were swamped with orders to replace the cars worn out during World

PART 3 - SP PASSENGER TRAINS | 4

War II and the additional cars required for the COSF were not even promised for about a year.

The SP, UP and CNW each pulled the best cars that could be spared, assigning these to the COSF. Their best efforts just made up two additional consists, totaling four equipment sets for the COSF train. This was found to be just barely adequate, but the turn-around time needed for maintenance at terminals was drastically reduced.

For this time period, maintenance operations on these trains must have been like a circus, with arriving trains going right into the yards to be cleaned and serviced for quick departure in order to keep the schedule. The arrival of new equipment for a fifth consist in 1949 permitted fully adequate turn-around time at terminals, normalizing maintenance.

4. (Below) After the cars in [3] comes a pair of Southern Pacific fluted-side 77-D-10 diners following the coach section of COSF, coupled kitchen to kitchen.



2. (Above) Full baggage car, baggage-dormitory and chair cars follow the diesels in [1].

3. (Below) A new Fairbanks-Morse switcher shifting cars is about to obscure our view of the Southern Pacific Daylight type fluted-side chair car (center) and Union Pacific Challenger type smooth-side chair cars on the left which come after the cars in [2] above.





5. Sleeping cars make up the tail of the train, with 4 bedroom 4 compartment 2 drawing room cars (right) followed by 6 section 6 roomette 4 bedroom cars, and the buffet-observation lounge car Nob Hill (out of the photo to the left) completing the 18th train as it would have appeared in 1947.

Even with the cooperation of the other railroads on the Overland Route, there could never be enough equipment to permit identical consists for all the COSF consists.

The complete “City” fleet included trains to Portland and Los Angeles, as well as Oakland/San Francisco, plus additional destinations including Denver and St. Louis. In fact, the UP interline operation was so huge that just the COSF consists were listed as the eighth, tenth, eighteenth, nineteenth (and later twentieth) trains. A great effort was made to provide the similar services across all the equipment sets.

In peak travel periods or when tour groups bought blocks of tickets, additional chair cars or sleepers swelled the COSF’s consist that day, resulting in its being run in sections. Usually the first class sleeping cars ran as one section, and chair cars as the other, with some feature cars on each.

A complete assignment sheet for just the City of San Francisco would require diagrams for all four or five consists, plus each section operated for every time period, a book length venture. As a result, this is a brief description of the SP’s involvement in the COSF.

Data is provided for the various cars, but concentrates on modeling the 18th train which had two SP Daylight-type diners (one in use as a coffee shop) and a Daylight chair car. (The other consists had fewer Daylight cars assigned.)

Until 1946, much of the equipment for the City of San Francisco (COSF) was owned by the consortium of the three operating railroads and was lettered with the train name in the letterboard. The group split up the cars between 1946 and 1948, relettering the cars with the name of the railroad in the letterboard.

As carbuilders had been unable to supply new equipment for the daily start in 1947, all the cars were from the prewar period for at least a year into daily operation.

To model this train, a substitute has to be found for the prewar SP class 77-D-10 coffee shop and dining cars, 10300, 10301. The only similar cars I could find would be a pair of MTH, BLI or Kato Daylight tavern cars repainted into UP yellow colors. These have the correct fluting pattern but don’t have kitchens. Alternatives would be a pair of Athearn (blue box) diners in UP colors --as the prototypes were only 77 feet long

This map shows some important U.P. interline trains- Secondary trains were often renamed or otherwise changed- See Official Guide to the Railways for specific dates.

SOME IMPORTANT UNION PACIFIC INTERLINE TRAINS c1950

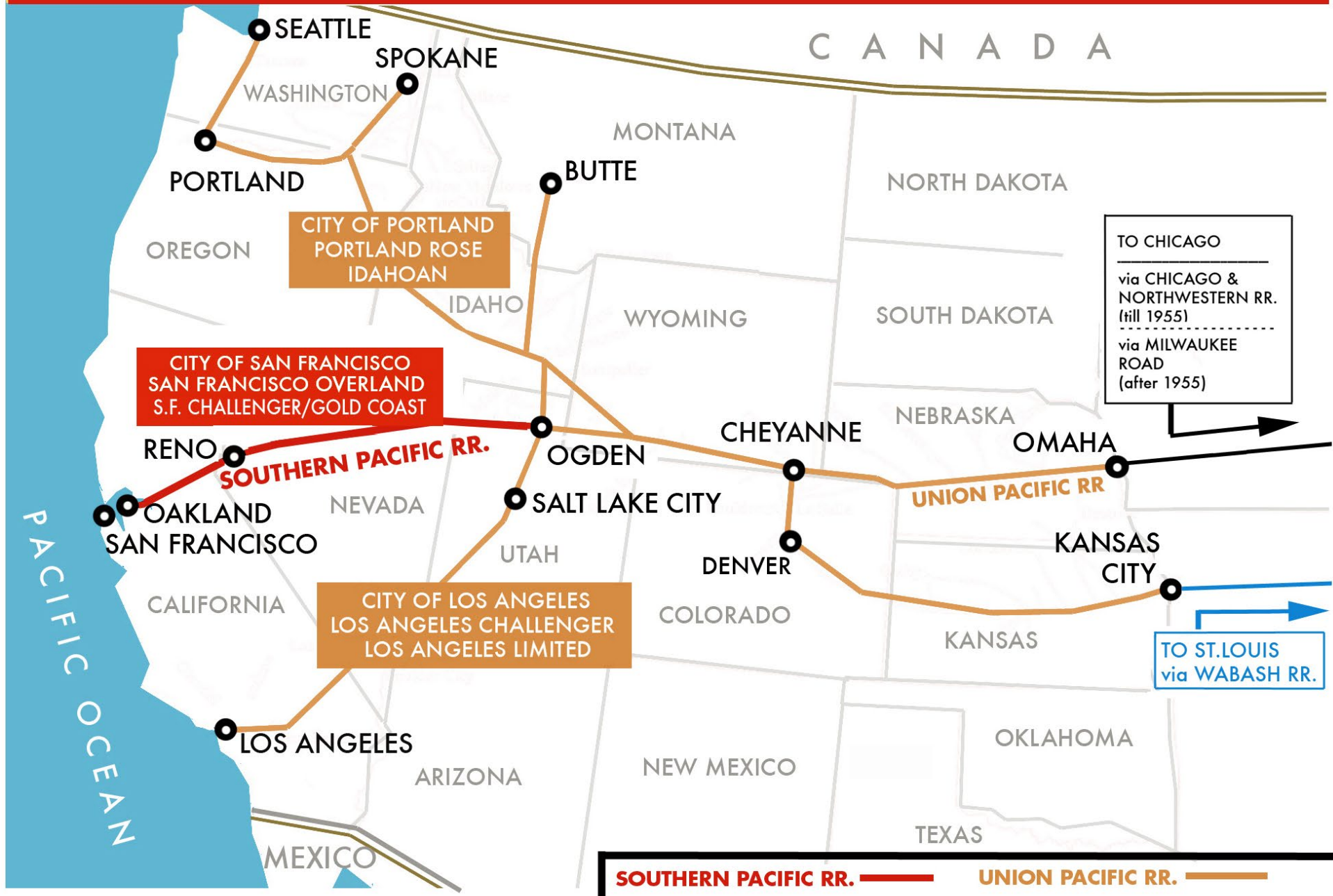



7. In 1955 the City of San Francisco enters Oakland terminal with Alco PA units, circa 1955.

the Athearn car is not too far off – or another corrugated-side dining car in UP colors.

Brass Car Sides Co. offers their kit #7469R for UP dormitory baggage car 5613, of the group including 5601 and 5602 rebuilt from full baggage cars in 1947, and this was a COSF car. “Louvered” center skirts could be made up from Evergreen corrugated plastic sheet, or N scale clapboard and added to the model.

The Walthers baggage dormitory from their City train sets (932-9560) representing UP 6000-6008 could stand in for the baggage dormitory cars on some consists.

The sleeping cars for 1947 proved to be an interesting research problem. While the 18th train had only 4-4-2 and 6-6-4 cars, some had plain full depth center skirting, while other cars had the UP-style louvered skirts. Behind the skirts were “W” housings that enclosed the underbody appliances.



8. City of San Francisco (COSF) head end with baggage-express cars and baggage-dormitory car c1955.



9. COSF coach section of train with a baggage-dormitory car and UP and SP chair cars, c1955.



10. Left to right are the final chair car of the COSF train, coffee shop lounge, and dining car, with the beginning of the Pullman sleeping car section.



11. COSF's three 6-6-4 sleepers and a Budd 10-6 sleeper at the tail end of train in 1955 nears the western terminal at Oakland.

Some of the cars had aluminum trim strips above and below the window band. As with the lettering, photos in books or online for the time will show how individual cars appeared.

The 18th train had a club observation car, SF901, named Nob Hill which is available as a car side set from Union Station Products. The prototype car may have only remained on the train for a year or so, for late in 1948 it was transferred to the City of Los Angeles. An IHC smooth side observation or E&B Valley observation car could stand in for SF901.

The 19th train also had a club observation car, "Russian Hill" which texts indicate was an early squared-off observation car. The Rivarossi 1930 series observation car (Pennsylvania RR prototype for 1948 Broadway Limited) resembles this car and in UP colors could stand in.

The Walthers ACF baggage-express car (932-9570) represents the Union Pacific cars 5631-5638 and 5639-5663 built in 1953-4. These are very similar to the 1942 cars numbered 5601-5630. These earlier cars came with louvered skirts that were removed in the 1950s, and had four windows in each door instead of the later single windows.

These cars rode on six-wheel trucks. I had to settle for a modified model based on a Rivarossi coach fitted with new bolsters for the six-wheel trucks.

Chicago North Western "400" chair car and Union Pacific "Challenger" chair cars for the 1947 consists can be modeled using Brass Car Sides Company sides. Some of these are intended to fit Rivarossi coaches.

Others fit car core kits as indicated in their illustrated online catalog. The construction portion of this article shows

CITY OF SAN FRANCISCO TRAINS 101-102 OCTOBER, 1947

DIAGRAM COMPARES THE FOUR COSF CONSISTS IN USE AFTER THE START UP OF DAILY SERVICE SAN FRANCISCO (OAKLAND) -CHICAGO

*** INDICATES DAYLIGHT TYPE CARS**

8th TRAIN 14 CARS



10th TRAIN 14 CARS

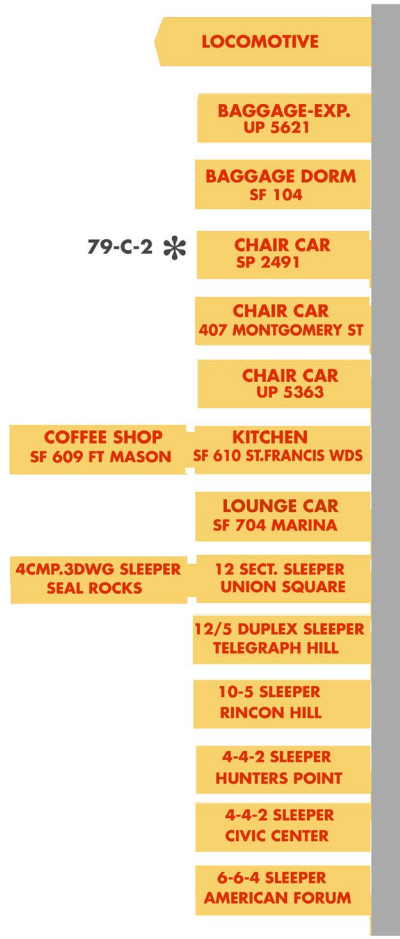

18th TRAIN 15 CARS

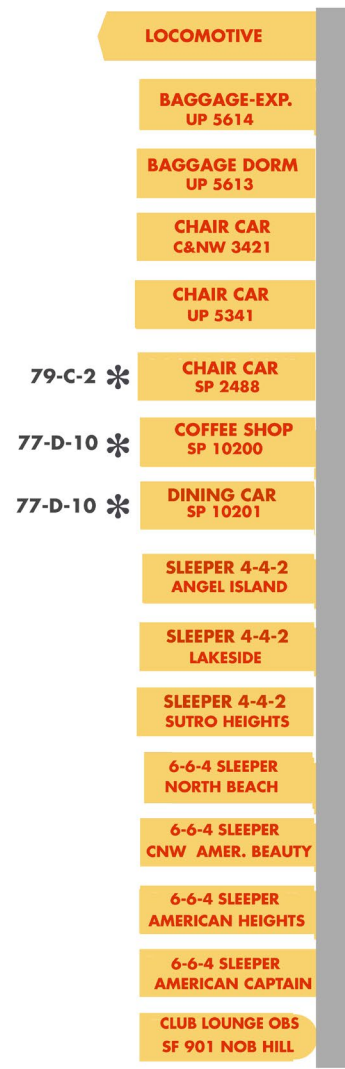

19th TRAIN 14 CARS

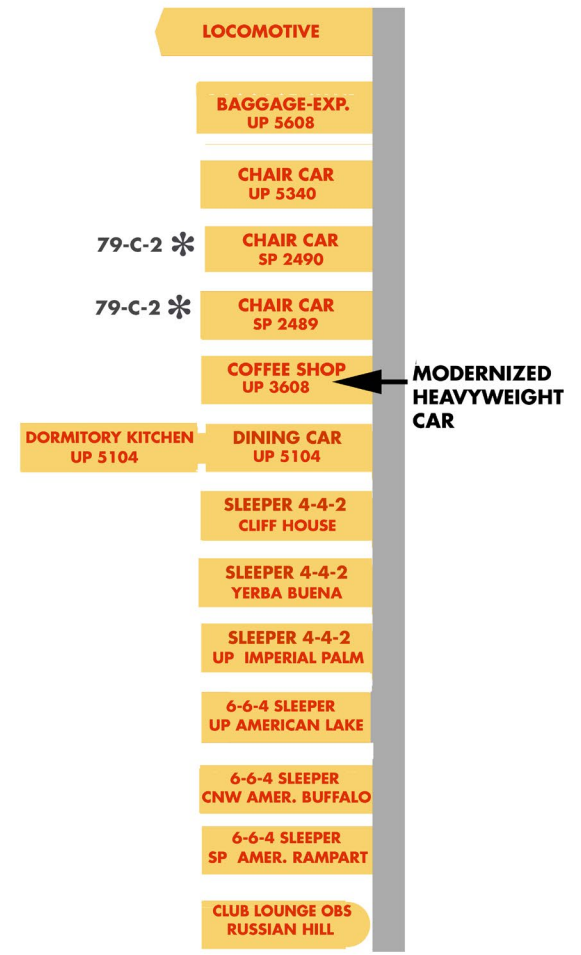

PART 3 - SP PASSENGER TRAINS | 15

sketches of some of these cars. You can access their catalog here by using this link:

brasscarsides.com.

As traffic patterns changed in the 1950s, the Overland Route trains were restructured. There were many reassignments of SP prewar lightweight chair cars including movements in and out of the Overland pool of cars.

SP chair cars 2432, 2434, 2435 were repainted from dark olive green into two tone gray in 1950 for use on the new City of St. Louis train, originating at Oakland. In 1948 and 1949 new cars finally arrived from carbuilders, replacing the prewar cars as they arrived, so a 1950, 1951 COSF would look a lot different than the 1947 train.

In 1949 the San Francisco Overland Limited was upgraded with SP 77-foot 1937 parlor observation cars 2950 and 2951 operating in Daylight colors from Oakland to the popular resort city of Reno, NV.

These cars had been released from the Noon Daylight when it was discontinued. The cars ran daily until 1952. After this time one car remained in this assignment and was run as required. A 79-foot Daylight observation car from BLI, MTH or Kato could stand in for the earlier 77-foot car. The Overland Limited was painted two tone gray and had a mix of light and heavyweight cars.

In March, 1949 the Burlington, Rio Grande and Western Pacific railroads started an all new Chicago-Oakland streamliner, the California Zephyr. This train directly competed with the City of San Francisco and had five brand-new Budd dome cars. The schedule was arranged so the train would pass the most dramatic scenery in daylight.

PART 3 - SP PASSENGER TRAINS | 16

In 1951 SP Daylight-type chair cars 2432, 2434, 2435, were repainted in UP yellow and gray with red Southern Pacific style lettering for Overland route service.

In March of 1952, Union Pacific discontinued painting two tone gray colors on their heavyweight trains, changing all passenger equipment to their streamliner colors of Armour Yellow and Harbor Mist Gray with red striping and lettering.

In 1955, two SP 77-foot Daylight chair cars, 2424 and 2426, were repainted in yellow for UP interline service, and they received revised interior seating with increased leg room and leg rests. New SP postwar equipment was also assigned to COSF, bumping some of the prewar chair cars to the equipment pool. Also in 1955, the Omaha to Chicago portion of the Overland route partnership was changed from Chicago North Western RR. to

ADVERTISEMENT

Railroad Explorer Magazine

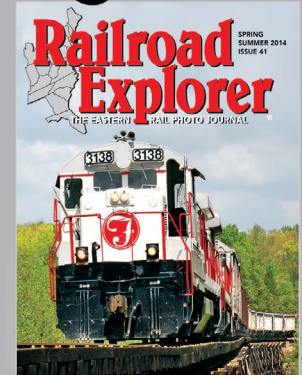
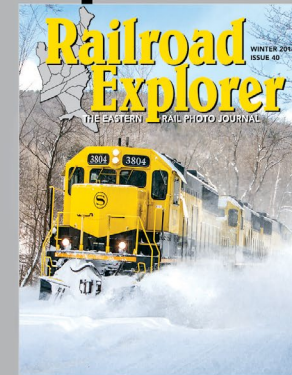
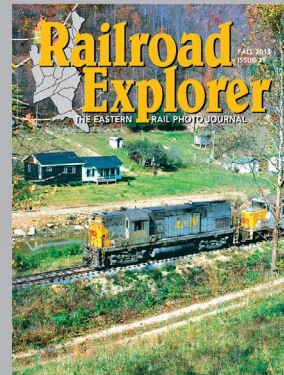

THE EASTERN RAIL PHOTO JOURNAL



- Three all-color issues per year. Exciting feature stories and spectacular photos of Eastern Railroading
- Best-in-class photo reproduction. Printed on heavy, glossy paper. Zero advertising.
- Three times per year - Winter, Spring/Summer and Fall editions.

Subscribe today!

www.railroadexplorer.com

CANADA

SOUTHERN PACIFIC R. R. STREAMLINER ROUTES

- SOUTHERN PACIFIC COAST LINE 
- OTHER S.P. MAIN LINES 
- IMPORTANT INTERLINE ROUTES 

(FOR CLARITY, OVERLAND ROUTE AND GOLDEN STATE ROUTE BRANCHES ARE OMITTED)



PART 3 - SP PASSENGER TRAINS | 19

The Milwaukee Road. After this time, various Milwaukee Road cars took the place of CNW equipment.

With the increase in highway and airline competition in the 1950s, ridership on the Overland Route trains fell off, and secondary trains were eliminated by 1955. This left just an unnamed mail train (#21/22), the San Francisco Overland Limited, and the City of San Francisco operating via the Overland route on SP rails.

It is possible to simulate some of the huge mid-1950s operation in the form of ready to run plastic models.

Walthers has recently manufactured a whole fleet of HO models of the Union Pacific City trains for 1955-60 period. These can be combined with Athearn-Genesis, Broadway Limited and MTH Daylight equipment the modeler can repaint to UP yellow and gray. The Walthers basic consist information is available at their site:

walthers.com/exec/page/up_cities.

(Click "Consist Info")

Kato now has their N scale Daylight as well as a City of Los Angeles which is similar to the City of San Francisco train. Kato's N scale UP train link is:

katousa.com/N/COLA.

Union Station Products has a link showing their Union Pacific car kits which include some additional cars to be built with car core kits. Their online listings are available:

unionstationproducts.com.

An excellent set of UP interline train consist listings for November, 1950 is available online at the UtahRails.net site:

utahrails.net/pass/consists-1950.php.

PART 3 - SP PASSENGER TRAINS | 20

As I wrote at the start of this article, this is a work in progress, for new information is being written all the time.

In Part 4, I will describe how I built a number of these cars.

Note: As part of [April's Subscriber bonus downloads](#), we provide a summation and bibliography of the prototype data presented in parts 1-3 of this series.



ADVERTISEMENT

Archer
FINE TRANSFERS
PROUDLY SERVING MODEL BUILDERS SINCE 1989
THE ORIGINAL
SURFACE DETAILS™

WE NOW HAVE MORE THAN 100 SHEETS OF RIVETS, LOUVERS, TREADPLATE AND MORE CAST ONTO MICROSCALE CLEAR DECAL FILM

FREE SHIPPING:

- DOMESTIC USA ORDERS \$50 OR MORE
- INTERNATIONAL ORDERS \$100 OR MORE

CLICK HERE TO VISIT OUR WEBSITE!

Archer Fine Transfers • PO Box 1277 • Youngsville, NC 27596 • USA
(919) 570-1026 • info@archertransfers.com • archertransfers.com

"Archer rivets are easy to apply and look great. To me, they are now a vital tool in building railroad models."
Tony Thompson, Model Railroad Author/Historian

ADVERTISEMENT

GLX
TOP QUALITY PRODUCTS
FOR THE MODEL RAILROAD CRAFTSMAN
WWW.GLXSCALEMODELS.COM

RESIN CASTINGS
SCENERY DETAILS

- [TABLE OF CONTENTS](#)
- [INDEX](#)



14. SP facilities in San Francisco-Oakland area in the 1940s and 1950s.

PART 3 - SP PASSENGER TRAINS | 23



VICTOR ROSEMAN

Victor got his first train, a Lionel, at age 3. Victor graduated from the Pratt Institute with BFA and MS degrees and taught fine arts in high and junior high school for 30 years and is now retired.

Victor has written many articles and several railroad related books over the past 35 years. He's also done many freelance projects for Walthers, Atlas and other model manufacturers. ■



[Click here for
reader comments](#)

ADVERTISEMENT

Still available: a great new book about SP steam power!



**Southern Pacific
Ten-Coupled
Locomotives**

Bob Church, renowned authority on SP steam, presents a rich collection of information and photos about ten-coupled locomotives.

How can I learn more about this book?
How can I buy it?

[Click here for
the answer ...](#)

SIGNATURE PRESS

MRHMAG.COM

BRASS EXPO



BRASS MODEL TRAINS ALL SCALES

April 11-12, 2015 • Saturday 9-4 • Sunday 10-4.

Maryland State Fairgrounds • 2200 York Rd. • Timonium, Maryland 20193

For More Information Go To:

www.brassexpo.com

HOWARD ZANE

5236 Thunder Hill Rd • Columbia, MD 21045 • 410 730 1036

email: hzane1@verizon.net

VISA AND MASTERCARD ACCEPTED

BRASS EXPO WILL RUN TANDEM WITH
THE GREAT SCALE MODEL TRAIN SHOW

- [TABLE OF CONTENTS](#)
- [INDEX](#)

*Follow along,
step-by-step!*

Battery Saver

for Digitrax Throttles



BY BRENT CICONNE
.....



[Click here for
reader comments](#)

A tasty way to make an on/off switch ∞

FOR SOME INEXPLICABLE REASON, DIGITRAX fails to provide an on/off switch on their wireless throttles and, unlike NCE, the Digitrax throttle continues to draw power even when not in use. The result is usually drained batteries when you have forgotten to take the battery out after an operating session.

There a number of websites and YouTube videos showing how to add an on/off switch to a Digitrax Throttle. All of these involve taking the throttle apart and making modifications to the innards of the throttle. I have found a simple way that involves a minimum of modification to the throttle, requires no soldering and, even better, it is free! All you need is a popsicle stick!

The following pictures and descriptions show how to make a battery saver.

STEP 1: PREPARING THE STICK



The first step might be the most difficult, find a Popsicle, and eat it! What we want is the stick. Use the dry end of the stick for the rest of the construction! You could make this out of styrene, but then you would miss out on eating the Popsicle, and what fun would that be?

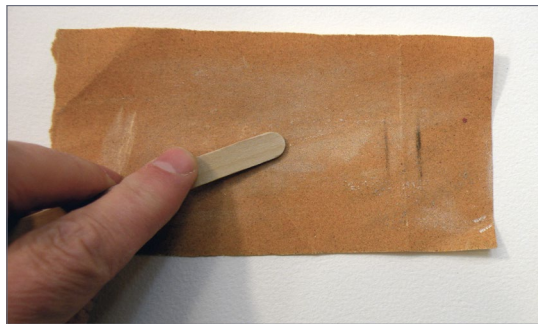

Sand down the end of the stick so that it is tapered; the end should be thin. We want to keep the rounded end.

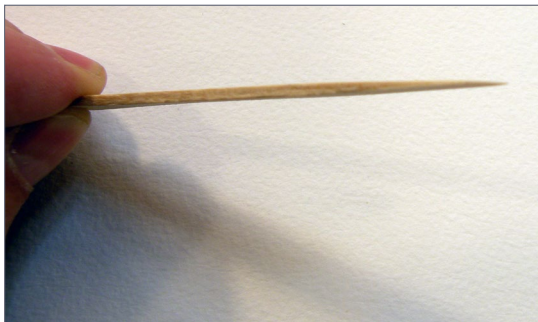

It should look something like this, thinned down to a nice taper.



If you have it thin enough, the popsicle stick should slide easily between the positive terminal on the battery and the electrical contact. You have just turned the power off!

ADVERTISEMENT

ONE STOP SHOP

N, HO, O, ON30, S & G

SHOP ON-LINE 24/7



FOR YOUR FAVORITE PRODUCTS:

ATHEARN | ATLAS | ARISTO-CRAFT | BACHMANN | BROADWAY LTD.
DIGITRAX | KADEE | KATO | K-LINE | LIFE-LIKE | LGB
LIONEL | MANTUA | MICROTRAINS | MODEL POWER | MRC
MTH | NCE | PECO | PIKO | SOUND TRAXX | TCS
WALTHERS | WILLIAMS | WOODLAND SCENICS | AND MORE...

SIGN-UP FOR OUR E-MAIL SALES

TRAINWORLD.COM

1-800-541-7010 e-mail: ORDERS@TRAINWORLD.COM

TRAINWORLD®/TRAINLAND® - AMERICA'S LARGEST INTERNATIONAL MAIL ORDER DISCOUNT TRAIN STORE

STEP 2: INSTALLING THE STICK



Take the battery cover, and mark where the positive electrical contact lines up. Make it wide enough for the popsicle stick.

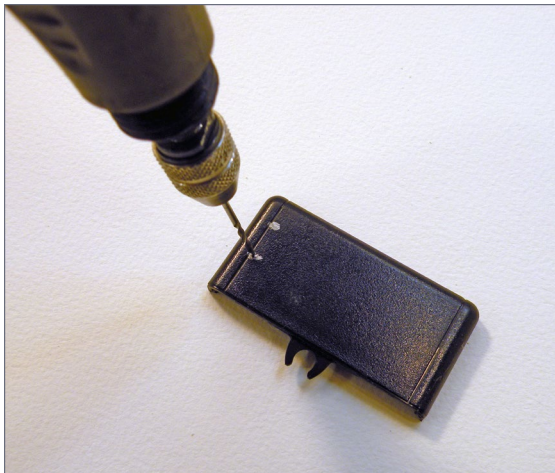

Drill holes at the marked locations, note that there's already a groove molded onto the back of the cover. You want to drill just inside this groove. Marking the starting position with the point of a hobby knife will help to get the holes in the right place.



Using a jeweler's saw or one of the small bits for the Dremel motor tool, or even a series of drilled holes, cut a slot for the popsicle stick to slide through. Sand the edges of the slot smooth.

STEP 3: FINAL FINISHING TOUCHES

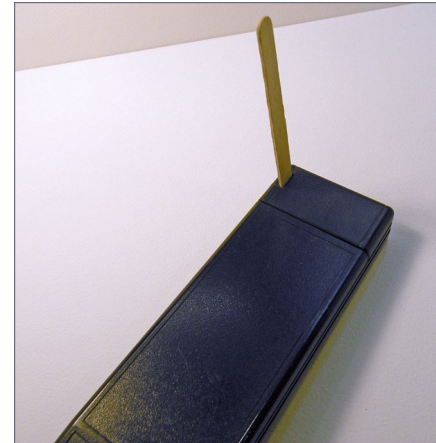

Put the battery cover back on the throttle and test-fit it. The Popsicle stick should slide into the slot and go between the positive terminal on the battery and the electrical contact, disconnecting the power in the process. You shouldn't have to force it; it should slide into place.

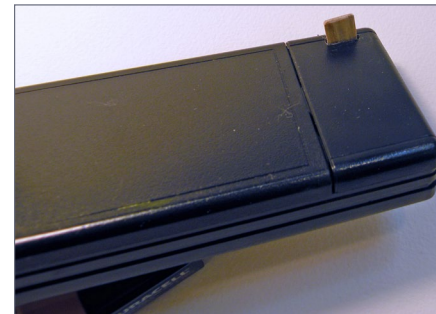

Mark the popsicle at a suitable length, making sure to leave enough length that you can get your fingers on it, but not too long that it sticks out too far. Cut it off and smooth the cut end with sandpaper.



BATTERY SAVER | 7**STEP 3: FINAL FINISHING TOUCHES** *CONTINUED*

Now when you want to use the throttle, simply pull the popsicle stick out and put it in your pocket. That turns the power on. At the end of the session, slide the popsicle stick back in, and your batteries will be saved for the next time you use the throttle. That is a lot easier than pulling the battery cover off and taking the battery out, or reversing the battery and putting the cover back on again!

If you do happen to lose the stick, then you will be punished by having to eat another popsicle so you can make a replacement stick! ☑

**BRENT CICONNE**

Brent recently retired from working as a production analyst with Shell Canada. Since retiring, he has taken on the role of editor for the Calgary Model Railway Society's publication "The Order Board." He also belongs to the Bow Valley Model Railroad club. Brent's other hobby interests including oil painting, and he runs an art school in Calgary. He enjoys hiking and cross-country skiing in the mountains outside Calgary with his wife of 33 years. ■

Have you seen this?**CHECK IT OUT!****kenpatterson.com***click here to ...***Visit Ken's website**

**Ken Patterson
reveals his modeling
secrets on video!**

ALL ABOARD!Ottawa
TRAINEXPO
d'Ottawa**EASTERN CANADA'S LARGEST TRAIN SHOW**
APRIL 25th & 26th, 2015**WWW.OTTAWATRANEXPO.COM**MANUFACTURERS, VENDORS, LAYOUTS, CLINICS AND DISPLAYS.
ALL DEDICATED TO THE PASSION OF TRAINS**CANADIAN INTERNATIONAL HOCKEY ACADEMY**

8720 COUNTY ROAD 17

ROCKLAND, ON K4K 1T2

ADULTS - \$10.00 STUDENTS (13-17 YEARS) - \$5.00

CHILDREN (12 & UNDER) - \$2.00

EVERY \$2.00 TICKET WILL BE DONATED TO ROGER'S HOUSE

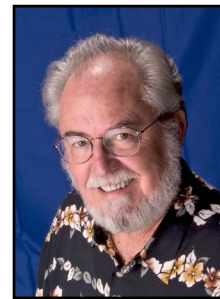
We proudly support
Rogers House

Model Railroad Hobbyist | April 2015 | #62

APRIL NEWS
column.....
RICHARD BALE and JEFF SHULTZ
.....**Click here for
reader comments****Thieves Burglarize Bowser**

Bowser Manufacturing and the adjoining facility of English's Model Railroad Supply in Montoursville, Pennsylvania were broken into over the weekend of March 15. An estimated 100 models were stolen, with most of the items listed as new O scale Lionel, MTH, American Flyer, and Atlas-O locomotives. The models were taken from display shelves without manufacturers' boxes. Numerous train sets and other model railroad merchandise were also reported missing. Officials speculated the thieves would attempt to dispose of the stolen items on eBay or at swap meets. Anyone with information should contact the Montoursville Police at 570-433-3166.

Exact Rail and Spring Creek Partner

ExactRail has announced that Spring Creek Model Trains will represent the manufacturer at many future train shows.

▶ **THE LATEST MODEL RAILROAD PRODUCTS, NEWS & EVENTS**

APRIL NEWS | 2

ExactRail executive Blaine Hadfield explained that his company would like to expand their participation in model train shows, but the same employees who staff shows are also responsible for developing, manufacturing, and marketing ExactRail products. According to the announcement, ExactRail values interacting with its customers, but the reality is that as a small team, it does not have the staff to aggressively attend shows without impacting other business responsibilities. Hadfield noted that Spring Creek attends over 40 shows each year and they are more than qualified to represent ExactRail at these events ...

NEW CLUB CARS



NMRA Northern Utah Division, home of the 2019 National NMRA Convention, is selling a custom kit for a Fisher Beer Car

The HO scale kit is based on an Accurail 40' steel refrigerator car with Dreadnaught ends and plug doors. This is a limited-edition custom model with only 48 kits scheduled to be produced. They are available at \$40.00 each plus \$5.00 shipping from Stan Jennings, 5412 Colter, Kearns UT 84118. For additional information call Stan at 801-967-0999 or visit northernutahnmra.org.

NEW PRODUCTS FOR ALL SCALES

New hardbound books from **Morning Sun** include "X Car Color Guide Volume One." This first volume includes more than 300

APRIL NEWS | 3

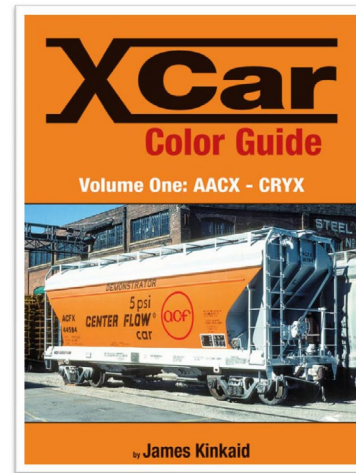

color photos of privately owned freight cars with reporting marks from AACX to CRYX. Also new is "Burlington Northern Power in Color Volume 3: Locomotives," which presents images of the colorful merger of this multi-road company. Visual tours include the shops, yards, and right-of-way, with a look at a range of locomotives including SD38-2, SD45, F45, B39-8E, SD60 and SD70MAC, plus some E and F-units.

"Pittsburgh Trolleys in Color, Volume 2 – The West End and the South Side," features a pictorial tour of the once-extensive Pittsburgh Railways and Port Authority Transit trolley lines, with abundant images of standard cars, PCCs, and LRVs.



New ebooks from **Morning Sun** include "CSX Five Years of Change in the Rust Belt 1985-1990." The ebook focuses on the changes on former B&O trackage in western Pennsylvania and eastern Ohio where

routes were consolidated, traffic patterns shifted, and a variety of motive power came and went. Corporate merging is dramatized in the above illustration from the eBook that shows a CSX GP40-2 leading GP40s in Chessie System and Seaboard Coast Line livery. For additional information visit morningsunbooks.com.

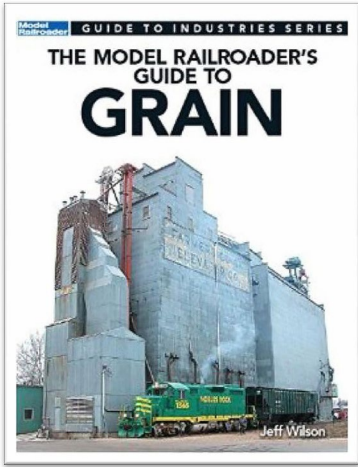

The latest addition to **Kalmbach's** series of industry books is "The Model Railroader's Guide to Grain." Author Jeff Wilson, who has written more than 25 books on railroads and model railroading, covers three essential subjects in the book – a guide to prototype covered hopper cars, how elevators and mills work, and a history of the evolution of grain train operations. Regardless of the era or region being modeled, this 95-page softcover book

demonstrates that the grain industry can effectively serve on virtually any layout. The book is available from hobby dealers or it can be purchased direct from the publisher at kalmbachstore.com.



As an introduction to its unique engraved basswood material, **Monster Model Works** has introduced a simplified starter kit that assembles into a single-story brick store. N, HO, and S scale versions of the kit are currently available. The kit comes with laser-engraved 3D

brick walls, brick overlays, and a brick chimney. Stairs and chimney pipes are 3D-printed. The rear door and arched double-hung four-pane windows are all easily assembled using laser-cut peel-and-stick materials. Additional details include a freight door, brick corner pieces, acrylic glazing for the storefront, and peel-and-stick tar paper roofing. For complete information, visit monstermodelworks.com.

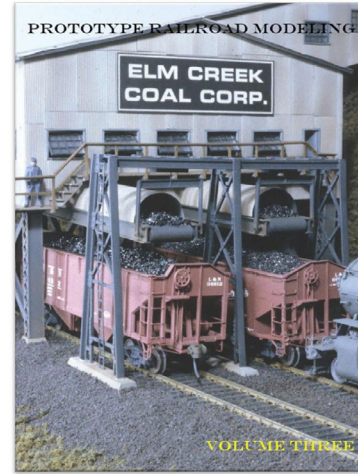

Speedwitch Media has released volume three of "Prototype Railroad Modeling." This latest edition includes modeling a Louisville & Nashville coal train, a pair of 50' single-sheathed boxcars, and Texas & New Orleans single-sheathed boxcars fitted with rare Allen doors. Also included is a heartfelt tribute to the late Richard Hendrickson. The 112-page book includes both color and B&W images. It is available

direct at \$48.00. Visit speedwitchmedia.com to order.

O SCALE PRODUCT NEWS



3rd Rail Division of Sunset Models is taking reservations for an O scale version of Southern

Pacific's S-12 class 0-6-0 switchers. SP owned a total of 464 0-6-0 switchers, of which 37 were S-12s. Preserved S-12s are on display at Stockton and Martinez, California. 3rd Rail's handcrafted brass model is scheduled for production later this year. Both two-rail and three-rail versions will be available. Unless stated otherwise, three-rail versions come with TMCC/Railsounds, Coil Couplers,

APRIL NEWS | 6

Synchronized Smoke, and Pittman Motors. For additional information visit 3rdrail.com.

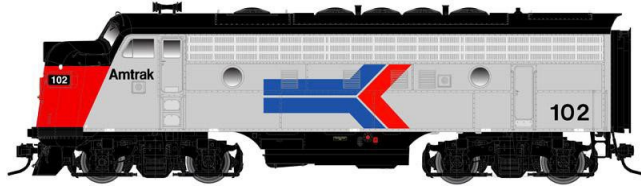

Atlas O is scheduled to release an EMD F7 diesel during the third quarter of this year. The Master series model represents locomotives with Type II side panels equipped with Farr filter panels. In addition to the Amtrak unit shown here, matching A and B units will be available for Erie Lackawanna, Milwaukee Road, Pennsylvania Railroad, Denver & Rio Grande Western, and Santa Fe.



Also coming from Atlas O in the third quarter of 2015 are 70-ton twin-bay covered hoppers. Road names will be Atlantic Coast Line, Chessie System (WM), Monon-CIL, International Minerals & Chemicals, and Soo Line.



This Trainman series bay-window caboose is scheduled for release by Atlas O in the third quarter of this year. The model will be available for New York Central, Milwaukee Road, Union Railroad, Bethlehem Steel, and U.S. Steel. All of the Atlas O models mentioned in this report

APRIL NEWS | 7

will be available for either two-rail or three-rail operation. Visit atlaso.com for additional information.



Bachmann has expanded its selection of On30 mining equipment with the addition of a side-dump mine car with a wood body painted dark green. The model is available in a three-pack at an MSRP of \$109.00. Previously announced oxide red and a V-dump version of the mine car continue to be available. For additional information visit bachmanntrains.com.



Rusty Rails has a pair of resin-cast dilapidated cars that can be developed into an interesting scene almost anywhere on a layout. Each of the unpainted O scale autos is roughly 3.5" long. They are priced at \$12.00 each. To order visit rustyrail.com/OMiniScenesCastings.htm.

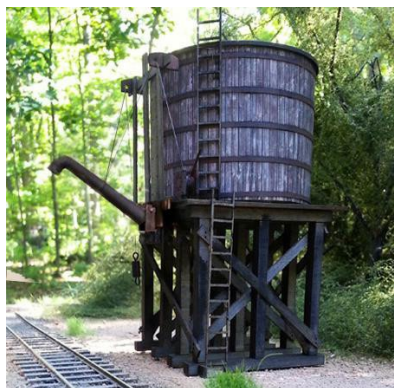

Trackside Scenery is selling a kit for a small O scale water tower that is sized for branchline or narrow gauge service. The spout is movable and may be positioned as desired. When lowered, the mouth of the spout is approximately 2" from the tank. The assembled structure is 5.5" high and has a footprint 2.5" by 3". The kit is composed of laser-cut wood parts and a photo-realistic tank wrap. It is priced at \$39.95. Optional simulated concrete feet that raise the structure about 7/8" are available at \$4.00. To order visit tracksidescenery.com.

HO SCALE PRODUCT NEWS



New freight car kits from **Accurail** include this Denver & Rio Grande Western 40' steel boxcar. The model has Youngstown corrugated steel doors and Dreadnaught ends. The car follows a prototype built in 1939. It has an MSRP of \$16.98.

This Illinois Central Gulf 50' steel boxcar with an 8' Superior door is available from

Accurail at an MSRP of \$16.98

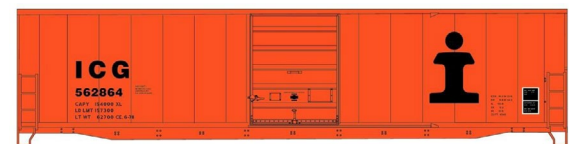

Accurail at an MSRP of \$16.98



Accurail is selling a kit for this Boston & Maine offset-side twin-bay hopper at an MSRP of \$16.98. The model is patterned after a 50-ton prototype B&M acquired in 1939.

This 40' Lackawanna double-sheathed wood refrigerator car is available from Accurail at an MSRP of \$17.98. The model is based on a prototype built in 1940 for ice service.

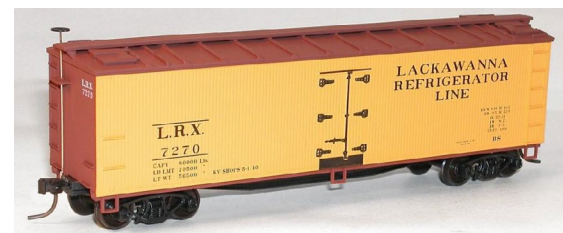

ACF built the prototype of this triple-bay covered hopper. The HO scale kit decorated for Penn Central is available from Accurail at an MSRP of \$17.98.

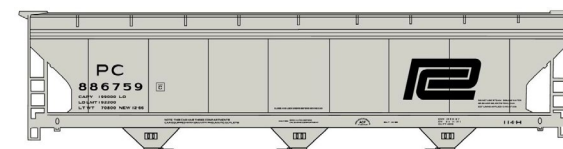

Accurail is offering an HO scale kit for this Burlington 89' bi-level open auto rack car. It follows a prototype car built in 1966.

The kit for this CSX Transportation grain



The kit for this CSX Transportation grain



APRIL NEWS | 10

hopper has an MSRP of \$18.98. The model is a match for the 4750 cu. ft. prototype Pullman-Standard built in 1989. All of the Accurail kits mentioned in this report include appropriate trucks and Accumate automatic couplers. For additional information visit accurail.com.

.....

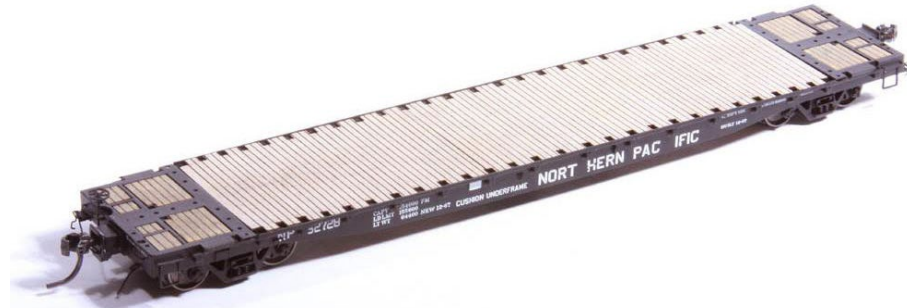

American Models Builders (LaserKit brand) has developed a selection of real wood decks specifically sized for various HO scale models including the flush-deck ExactRail GSC 53' 6" flat car shown here. Keep in mind that ExactRail sells two 53' 6" flat cars with different deck designs. American Models offers wood decks for each car, and they are not interchangeable. Wood deck kits for HO scale flat cars and gondolas are available for selected models produced by Athearn, Bowser, ExactRail, InterMountain, and Walthers. Details on the laser-cut 1/32" Birch decks includes engraved planking and bolt holes. The wood can be painted or stained and weathered.



American Model Builders also sells

APRIL NEWS | 11

laser-cut wood running boards and longitudinals for Athearn, InterMountain and Walthers boxcars. The sample shown here is applied to a 40' Athearn model. For more information visit laserkit.com.

.....



November 2015 is the date **Athearn** has announced for the release of its Genesis series 4-6-6-4 Challenger steam locomotive. Union Pacific versions of the HO scale model will be available both with and without smoke lifters, and with a choice of a coal or oil tender. A Denver & Rio Grande Western version will have a coal tender. Pivoting front and rear engines allow the model to negotiate 18"-radius curves, however 22" or greater is recommended for reliable operation, as well as a more realistic appearance. The HO scale model will be available with sound at an MSRP of \$629.98 and without at \$529.98. Sounds are channeled through a factory-installed DCC and soundboard with speakers. The DCC decoder automatically senses what type of power supply is in use (conventional DC or NMRA-compliant DCC), and adapts its functions.

Also coming from Athearn in November are EMD SD40M-2 MK diesel locomotives. Southern Pacific versions (next page) represent former Erie Lackawanna and Conrail locomotives rebuilt

APRIL NEWS | 12



by Morrison-Knudsen in the early 1990s. Also available will be Union Pacific repaints of the SP units. Standard DC versions of the Genesis model will have an MSRP of \$189.98. Models with sound will list at \$289.98.



Athearn plans to release a group of Alco RS3 diesels in December. In addition to the Missouri Pacific version shown here, road names will be Spokane, Portland & Seattle; Denver & Rio Grande Western; Rock Island; Penn Central; and Pacific Great Eastern. The HO scale model will have an MSRP of \$114.98. An undecorated version will also be available.



Athearn's January 2016 release schedule includes a Southern Pacific Mt-4 class 4-8-2 steam locomotive. A distinguishing feature of the HO scale model is the skyline casing along the top of

APRIL NEWS | 13

the boiler. The model comes with an SP class 160-C-1 semi-Vanderbilt tender. Three Daylight schemes will be produced along with two black locomotives. Variations in the different models will be in the crosshead (Laird or alligator), the main driver (spoke or Boxpok), the type of pilot (corrugated steel or boiler tube), and tender lettering (Southern Pacific or Southern Pacific Lines). Sound models will have an MSRP of \$419.98 with non-sound DC models listing at \$100.00 less. Additional tenders will be available at an MSRP of \$99.98.



Another production run of Athearn's Union Pacific gas turbine locomotive is scheduled for release in January 2016. The concept behind the turbine was its ability to operate on super-cheap Bunker-C fuel, a thick, low-grade oil that remains after crude oil is refined into higher quality products such as gasoline and diesel fuel. Like the 83'-long prototype, Athearn's HO scale version rides on AAR Type B span-bolster trucks with a B+B+B+B arrangement. Standard DC models will have an MSRP of \$349.98. Sound versions will list at \$449.98. Models without a tender will list at \$100.00 less.

Additional items coming from Athearn in December include a 30,000-gallon Ethanol tank car in six new road names, a 40' pulpwood bulkhead flat car with a pulpwood load available separately, a new 40' container chassis in six road names, and a Ford F-850 truck fitted with a boom and decorated for PRR, Santa Fe, UP, CP, WP, and MOW. Also a wide-vision steel

caboose decorated for Spokane, Portland & Seattle; Union Pacific; Missouri Pacific; SSW-Cotton Belt; and Pacific Great Eastern. For more information visit athearn.com.



release during the third quarter of this year. Heading the list is another release of Atlas Trainman series aluminum rotary gondola with a coal load. The model is based on an AAR type J311 high-side gondola with a double-tub bottom. Four new numbers will be available for BNSF, CIT Group, Conrail, Great Northern, Norfolk Southern (yellow end), and Norfolk Southern (gray with Thoroughbred scheme).

Atlas Model Railroad Company has announced HO scale items scheduled for



double doors. The car has fishbelly side sills under the 15' opening which is covered by 7' and 8' Youngstown corrugated steel doors. Additional features include either Improved Dreadnaught, dartnot, or Despatch steel ends as appropriate for the road name. The HO scale model will be available in two different road numbers for cars decorated for Frisco-St. Louis & San Francisco (above), Monon-CIL, Maine Central, New York Central, Santa Fe, and Southern Pacific.

Also due in the third quarter is an Atlas Master Line 50' boxcar with



Atlas has scheduled the next release of its HO scale General Electric B23-7 and B30-7 die-

sel locomotives for the third quarter of 2015. Variable details depending on prototype road practice will include pilots with and without anti climbers, cab headlights or low-nose headlights, and either two or four cab side windows. Truck side frames will be either FB-2, AAR Type B, or Bloomberg. The prototype of the B23-7 version had a 12- cylinder engine identified by the six power access doors. Road names on the Atlas version will be CSX, Missouri Pacific, and Nacional de Mexico. Models replicating the B30-7 (eight access doors) will be decorated for Cotton Belt, Southern Pacific, East Penn Railway, and Chessie System (C&O). For additional information visit atlasrr.com.

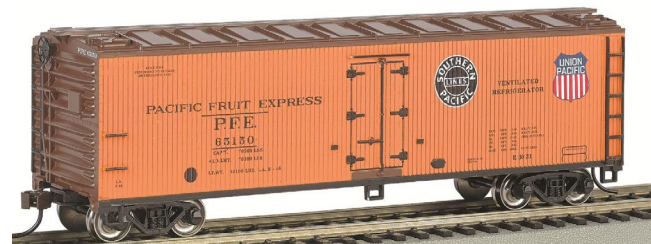

Bachmann has released a new group of 40' wood refrigerator cars in its Silver Series line of HO rolling

stock. The models come with body-mounted knuckle couplers and metal wheelsets with non-magnetic axles. Road names are Merchants Despatch, Union/Soo Line, American Refrigerator Transit Company, Pacific Fruit Express (with SP and UP twin heralds), and Pure Carbonic Company. The models have an MSRP of \$36.00. See bachmanntrains.com for more info.

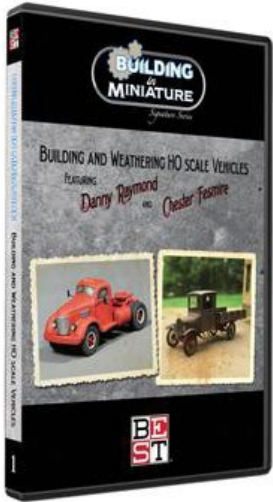

B.E.S.T Trains has released the first in a new series of video tutorials titled Building in Miniature. The subject of the initial release is “Building and Weathering HO Scale Vehicles.” It features Chester Fesmire and Danny Raymond, two thoroughly qualified hobbyists. Any modeler dissatisfied with the unrealistic look of shiny pre- assembled automobiles and trucks can easily learn the secret of assembling and weathering museum-quality vehicles with this video.

Dan shows viewers how to assemble a Sheepscoot KB-11 International truck. Chester shares his expertise on assembling a Jordan Miniature 1923 Ford Model T stake truck. The video includes a personal interview with the builders, as well as interviews with George Barrett of Sheepscoot Scale Products and Clare Gilbert of Sylvan Scale Models. The DVD is available at \$24.95. A Blu-Ray version is \$29.95. To order visit besttrains.com.



model planned for late this summer. Eight road numbers will

This is a computer drawing of **Blackstone's** new 30' Denver & Rio Grande Western refrigerator car. Reservations are being taken through April 17, with delivery of the all-new new

be offered in three D&RGW liveries at an MSRP of \$55.95 each. The HOn3 models are based on prototype cars as they appeared after being shopped in 1926. The rebuild included new Murphy roofs, altered needle beams, and larger icebox hatches. The cars were painted boxcar red, with ART yellow sides. Like the prototype, the models will ride on arch bar trucks with a 4' 8" wheelbase. The models will be delivered with pre-cut holes in the chassis to accommodate installation of Tsunami SoundCar Digital Sound Decoders. For additional information visit blackstonemodels.com.



prototype decorating schemes including yellow cabooses with four different slogans. The yellow cars have bright-red handrails and a boxcar red roof.

Centralia Car Shops has scheduled a production run of HO scale Union Pacific steel cabooses for delivery this fall. The production run will offer a range of



UP cabooses with white safety sides will be available with four different slogans.



A class CA-3 caboose painted in standard boxcar red will be available in four different numbers.



Completing the run is a selection of Union Pacific maintenance-of-way cabooses painted silver, and two versions in

MOW green. All of the cabooses will have an MSRP of \$49.95 each. InterMountain Railway is responsible for marketing Centralia Car Shops products. For additional information visit intermountain-railway.com.

.....

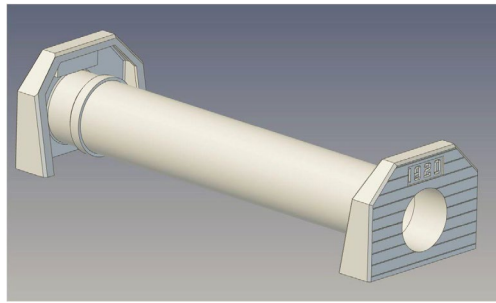
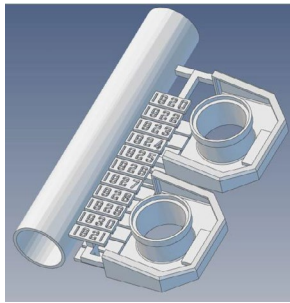

Eastern Road Models has introduced a kit for a concrete culvert. The HO scale model is based on culverts used by Canadian National and Prince Edward Island Railroad, however they are somewhat universal in appearance, and are suitable for most North American railroads and highways. The kit includes two concrete end walls complete with simulated casting form texture, a length of pipe, and two sets of date inserts for each year from 1920 to 1930. The date inserts fit in a recess in the end walls. Similar kits for N, S, and O scales are expected to be released shortly. The kit sells for \$19.99. For more info visit shapeways.com/product/6ELG3RHS4/peir-cnr-concrete-single-culvert-ho-scale?li=shop-results&optionId=55938016.

.....

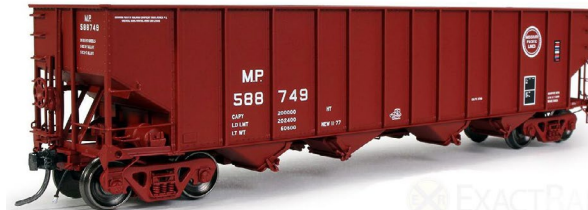

ExactRail is selling the second production run of its Platinum series Bethlehem-built 3737/3716 cu. ft. open-top hopper cars in four new Missouri Pacific paint schemes. The first prototypes were delivered to Chicago & Eastern Illinois in 1973. Subsequent orders went to the Texas & Pacific, Missouri Pacific, and Chicago & North Western. Many are still in service today. The HO scale models have an MSRP of \$38.95. The car shown above (item 81502) represents a 1977 car as delivered with an MP buzzsaw herald.



ExactRail's item 81508 displays MP's screaming eagle paint scheme on a car delivered in May 1979.



Item 81509 also carries MP's screaming eagle but has a build date of June 1979.



ExactRail item 81510 represents a Missouri Pacific car after the C&EI and Texas Pacific merged into the MP. The C&EI buzzsaw logo has been repainted to reflect the new ownership.

The model is based on a car photographed in 1986 with Seaboard Railway service dates. An undecorated kit has also been released. For additional details and ordering information visit exactrail.com.



InterMountain Railway has released HO scale modified AAR 40' boxcars modified with 4/4 Improved Dreadnaught ends.

Additional features of the HO scale models include etched metal running boards, appropriate trucks with metal wheelsets, and Kadee couplers. Six numbers each are available for Chicago, Burlington & Quincy; Burlington (1967 rebuild); Erie Lackawanna; CP (script); CP Rail; CP Rail (grain symbol); and Canadian National (maple leaf scheme).

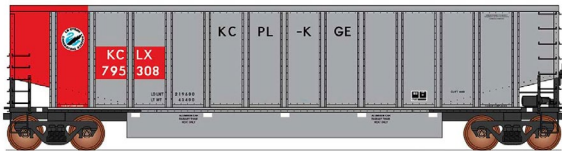

HO scale 14-panel Coalporters from InterMountain's Value Line are scheduled for release next month. In

addition to the Kansas City Power & Light car shown here, road names will include Burlington Northern, Canadian National, Oklahoma Gas & Electric, Portland General Electric (rose scheme), Union Pacific, American Electric Power, Central Illinois Power, Somerset Railroad, and Northern Indiana Public Service. The models will be available individually and in six-packs with different numbers.

InterMountain has scheduled a June release for a group of Trinity Aluminator II coal gondolas. The Value Line HO models will be



available in 13 road numbers for Burlington Northern, CIT Group, Canadian National, Detroit Edison, Transport Capital Rail Partners, Transcisco Leasing, Union Pacific, and Trinity demo as shown here.



InterMountain has scheduled a new production run of FGE wood refrigerator cars for release in October/November. Decorating schemes will be FGE-New York, New Haven & Hartford; WFE-Great Northern Ventilator; Kahn's; FGE-Ice Service; West India Fruit; National Car; Holscher Packing and URTX Milwaukee Road. The HO scale cars will have an MSRP of \$34.95. Reservations are being accepted through the end of this month.



Also coming from InterMountain late this year are A-Line 40' ribbed-side containers. In addition to the Maersk scheme shown above, the HO scale containers will be available in Maersk's early scheme, APL (early), APL (late), APL (large initials), and Sealand in both early and late schemes. The containers will be sold in two-packs at an MSRP of \$23.95. For additional information visit intermountain-railway.com.



PS-1 12-panel steel boxcar in June. One car will be decorated for a 1961-era Milwaukee Road car with a running board and full-height ladders.



prototype with a cushion underframe. The running board on the prototype was removed when the car was shopped in 1973. Both cars feature Pullman-Standard washboard ends and Youngstown corrugated steel sliding doors. Additional information is available at kadee.com.

Look for **Kadee Quality Products** to release two versions of a 50'

The second version of the 50' PS-1 boxcar represents a Bangor & Aroostook



will be available for Pacer Stacktrain and TTX (new logo). The

KatoUSA has expanded its selection of Gunderson MAXI-IV three-unit articulated double-stack cars. Two different numbered sets

cars can handle containers from 20' to 53' in the well and 40' to 57' containers in the top, double-stacked, position. Like the prototype, the two end trucks on Kato's HO scale version have 33" scale wheels, while the wheels on the two middle trucks are 38" in diameter. This is done on the prototype for weight-bearing reasons, with the greater weight of the load being borne by the wheels of the mid-car trucks than by the wheels of the trucks on each end. Each of Kato's 3-unit sets has an MSRP of \$105.00. For additional information visit katousa.com.



Monster Model Works has introduced HO scale brick and terra cotta coping to cap structure walls. The detailed three-dimensional texture is laser-engraved. The coping is available in .125" and .1875" widths. The brick coping is approximately 5.75" long and comes in a package of four at \$9.99. The terra cotta coping is about 6.75" long and is priced at \$11.99 for a pack of four. For complete information visit monstermodelworks.com.



Speedwitch Media is selling a prototypically accurate body kit for a Georgia Railroad rebuilt USRA steel 50-ton boxcar. Features of the HO scale

kit include a Murphy radial roof, one-piece cast resin body, wire details, and accurate decals that cover the life of the car including GA's silver and black scheme. Printed instructions for assembling the craftsman-type kit include detailed information about the prototype car. The kit is priced at \$45.00. Trucks and couplers are not included. To order visit speedwitchmedia.com.

.....



Walthers is selling an HO scale 75' flat car equipped for piggyback service. The Mainline series model is patterned after a Pennsylvania Railroad class F39A prototype. Two road numbers are available for PRR; Chicago, Burlington & Quincy; Erie; Southern Pacific; Trailer Train; and Wabash. An undecorated model is also available. For additional information visit walthers.com/exec/productinfo/910-5211.



Walthers plans to release a Proto series EMD GP60 locomotive early this month. In addition to the UP Cotton Belt patch

shown here, road names will include Santa Fe, Norfolk Southern, and Southern Pacific. For additional information visit walthers.com/exec/productinfo/920-41815.



Also due for release early this month is a Walthers Mainline-series EMD F40PH diesel locomotive.

Road names will be Amtrak (phase III scheme), Amtrak (phase IV scheme), CalTrain (San Francisco scheme), CalTrain (County of Santa Clara), Alaska Railroad, VIA (renaissance scheme), Metra (City of Houston), and Metra (City of Evanston, above). For additional information visit walthers.com/exec/productinfo/910-19459.



Walthers will release several previously unannounced HO scale items in June, including a new EMD SD70ACe diesel locomotive. The Mainline series model features the same drive system Walthers uses on its Proto series models. Road names with high-mounted headlights will be Norfolk Southern and CSX. Locomotives decorated for BNSF, Canadian National, Kansas City Southern, and Union Pacific will all have low headlights. SD70ACe models equipped with SoundTraxx Sound and DCC will have an MSRP of \$199.98. Standard DC models will list at \$129.98.

A new group of Southern Pacific 30' class C-30-1 wood-sheathed cabooses are also coming from Walthers in June. Among the features of the Proto series models are individual grab irons and flush-fitting windows. Four different SP lettering



schemes will be available at an MSRP of \$44.98 each.

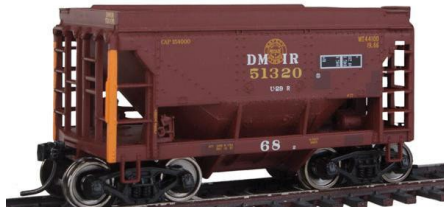

Sets of four 24' Taconite ore cars with correct trucks with a 5' wheelbase are set to be released by Walthers in June. Each set of cars will have Proto MAX metal knuckle couplers

on the end cars, and dummy knuckle couplers on intermediate cars. Each four-car set will have an MSRP of \$79.98. Two different lettering styles will be available for cars decorated for Duluth, Missabe & Iron Range. Additional roads include BN, Lake Superior & Ishpeming, and Great Northern. Each scheme will be available in a total of 12 different numbers.



A Walthers Proto series Gunderson 53' well car is scheduled for release late this month. This is Walthers' first Proto series intermodal car. The HO scale model follows an all-purpose prototype rebuilt to haul containers from 20' to 53' in length. Features include etched-metal walkways and individual wire grabs. Road names will be TTX DTTX (above), Florida East Coast, FEC (Hurricane scheme), and St. Mary's Railroad. An undecorated car is also in the release.

Walthers plans to release a total of six different containers in June. Heading the list are 53' corrugated-side containers in nine schemes, 40' corrugated-side containers in eight schemes, 40' Hi-Cube containers in 13 schemes, 48' Stoughton smooth-side containers in six schemes, and 20' framed tank containers in six schemes. For additional information contact your favorite dealer or visit walthers.com.

.....
Westerfield is selling prototypically accurate kits for Rock Island stock cars as converted from class B-2 boxcars. The conversion process that began in 1944 included replacing the side sheathing with wood boards that lined up with the holes in the original metal side framing. The cars received AB brakes and Barber lateral-motion trucks. The original ends and underframes were retained.



Westerfield HO scale resin-cast kits include both double and single-deck (left) versions of the RI stock cars with a choice of Hutchins, Murphy XLA, or single-board wood roofs. A second group of kits cover similar RI stock cars that were converted later with a different side slat board pattern.

Westerfield kits include unpainted urethane castings, decals covering all versions of the prototype car, detailed assembly instructions, and history sheets. Trucks and couplers are not included. The kits are available direct from Westerfield Models at \$40.00 plus shipping. To order visit westerfieldmodels.com.

N SCALE PRODUCT NEWS

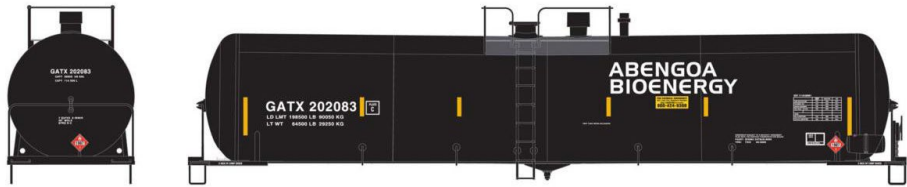

Athearn is scheduled to release a 30,000-gallon Ethanol tank car in December. In addition to the GATX Abengoa Bioenergy scheme shown here, the model will be available decorated for Chief, CHS, NATX, Renewable Products, and DODX U.S. Department of Defense. The N scale model will have an MSRP of \$25.98. They will also be available in a three-pack with different numbers at a list price of \$75.98.

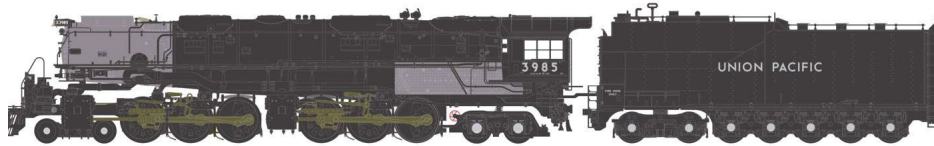

Athearn has announced plans to release an N scale 4-6-6-4 Challenger steam locomotive in June 2016. Union Pacific locomotives with oil tenders will be available in five numbers including two decorated in two-tone gray. The production run includes a Denver & Rio Grande Western version with a coal tender. Pivoting front and rear engines allow the model to negotiate an 11" radius, although a minimum of 15" is recommended for reliable operation and more realistic appearance. The N scale model will be available with sound at an MSRP of \$479.98 and without at \$379.98. Sounds are channeled through a factory-installed DCC and soundboard with speakers. The DCC decoder automatically senses what type of power supply is in use (conventional DC or NMRA compliant-DCC) and adapts its functions. For more information see your dealer or visit athearn.com.

.....



New items coming from **Atlas Model Railroad Company** in the third quarter of this year include new paint and road numbers on a twin-bay offset-side hopper cars with flat ends. The model comes with a removable coal load. New road names on the Master-series model will be Peoria & Eastern, Litchfield & Madison (CNW), Norfolk Southern, and Illinois Central. Paint schemes being reissued with new road numbers will be Baltimore & Ohio, Canadian Pacific, Reading, and Louisville & Nashville. The models will have an MSRP of \$18.95. They will also be available in three-packs with different road numbers at an MSRP of \$56.85. An undecorated version will be available at a list price of \$16.95.

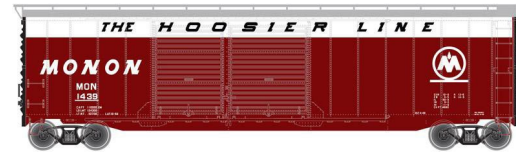

Also due in the third quarter of 2015 is an Atlas Trainman Series 50' boxcar with double Youngstown corrugated steel doors. The N scale model will be available in two different road numbers for cars decorated for Monon (above), Frisco, Maine Central, New York Central, Santa Fe, and Southern Pacific.



New Atlas N scale models due in the fourth quarter of this year include General Electric B23-7 and B30-7 locomotives. Road names for the low-hood version of the B23-7 will be Conrail, Union Pacific, and Santa Fe (above). High-hood models of the B23-7 will be Southern and

Norfolk Southern. GE's B30-7 will be decorated for Frisco and Southern Pacific. CSX and Seaboard System paint schemes will be on B36-7 versions of the diesel locomotive. Additional information is available at atlasrr.com.



Bachmann is selling an N scale 2-8-4 Berkshire steam locomotive

equipped with DCC sound at an MSRP of \$329.00. The 16-bit polyphonic SoundTraxx steam package includes a chuff, short and long whistles, bell, air pump, steam release, and blower. Notable features include metal stanchions and handrails, and LED headlight and tender backup light. Road names are Pere Marquette, and two road numbers each for Chesapeake & Ohio Kanawha, and Nickel Plate Road in contemporary railfan scheme.



Bachmann is selling an EMD NW-2 diesel switcher in five decorating schemes. In addition to the Great Northern version shown above, the N

scale locomotive is available for Union Pacific, New York Central, and Pennsylvania Railroad. It is also available unlettered in yellow and black. The model comes with a dual-mode NMRA-compliant DCC decoder for speed, direction, and lighting. It has an MSRP of \$159.00. For more information contact your favorite dealer or visit bachmanntrains.com.

.....
BLMA has announced plans to produce an N scale version of TrinityRail's 31,000-gallon crude oil tank car. This computer

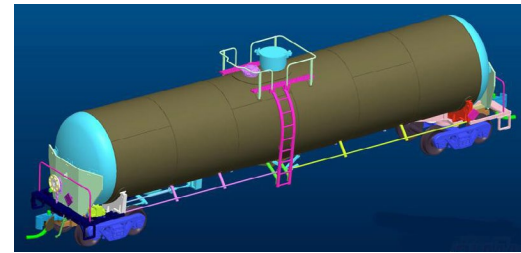

rendering from BLMA shows some of the details that will be included on the new car. The model will come with 100-ton ASF Ride Control trucks with 36" wheelsets.

Two decorating schemes will be available including DPRX



(white tank with black belt) and TILX (all black). The model will have an MSRP of \$26.95 with a choice of 24 numbers

available for each scheme. Delivery is planned for late 2015. For additional details including information about reservations visit blmamodels.com.



Centralia Car Shops has scheduled a new production run of N scale Union Pacific steel cabooses for delivery this fall. The run will offer a range of proto-

type decorating schemes including yellow cabooses with four different slogans. The yellow cars have bright red handrails and a boxcar red roof.



Four cabooses with white sides will be available with different safety slogans.

APRIL NEWS | 32



A class CA-3 caboose painted in standard boxcar red will be available in four road numbers.



Completing the run is a selection of Union Pacific cabooses painted silver and two versions in MOW green. All of the N scale cabooses

will have an MSRP of \$32.95 each. Note that the above illustrations are of HO scale models. InterMountain Railway is responsible for marketing Centralia Car Shops products. For additional information go to intermountain-railway.com.



This month **InterMountain Railway** is scheduled to release a group of N scale cylindrical covered hoppers with trough hatches. Road names for the N scale models will be Canada, Pillsbury, and two variations of Alberta.

The same car with rounds hatches will be released next month decorated for Toronto, Hamilton & Buffalo;

CSX; Canpotex; CP Rail; CPLX (CP Rail paintout); Anahuac del Golfo; CN (red lettering); and CN (rainbow, left).



CSX; Canpotex; CP Rail; CPLX (CP Rail paintout); Anahuac del Golfo; CN (red lettering); and CN (rainbow, left).

APRIL NEWS | 33



EMD FT locomotives in A-B sets are scheduled for release in June. Road names will be St. Louis & Southwestern (SP black widow scheme, above), St. Louis & Southwestern (gray), Denver & Rio Grande Western, Baltimore & Ohio, Chicago Burlington & Quincy, Chicago & North Western, Northern Pacific, Santa Fe (blue with cigar band), and Southern.



Also Milwaukee Road (two schemes), Lehigh Valley, Reading, Boston & Maine, Atlantic Coast Line, NYO&W, Erie Lackawanna, and EMD demo (above).

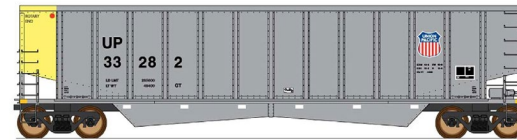

InterMountain's June/July release schedule includes a new run of N scale Trinity Aluminator coal gondolas. Road names for the Value Line models will be available in 13 numbers each for Union Pacific, BN, CIT Group, Canadian National, Detroit Edison, Transport Capital Rail Partners, Transcisco Leasing, and Union Pacific.



Also due in June are N scale models of WWII War Emergency single-sheathed boxcars. A Wabash car will have a

seven-panel Superior door as seen here on this unpainted sample. Cars decorated for Chicago North Western, Nickel Plate Road, and Canadian Pacific will have Youngstown standard steel doors. Santa Fe and Gulf, Mobile & Ohio cars will be fitted with the seldom-seen Youngstown composite war-doors shown below.



InterMountain has scheduled a new production run of FGE wood refrigerator cars for release in October/November. Decorating schemes will be FGE-New York, New Haven & Hartford; Kahn's; FGE-Ice Service; West

India Fruit; National Car; URTX-Milwaukee Road; Holscher Packing; and WFE-Great Northern Ventilator. The N scale cars will have an MSRP of \$24.95. Reservations are being accepted through the end of this month. Additional information is available at intermountain-railway.com/newscomingsoon.html.



Micro-Trains Line is selling six-wheel passenger trucks with 36" wheels. The N scale trucks are designed for heavy-

weight passenger equipment and are based on a PRR type 3D-7P2 prototype made by Commonwealth Steel Company. M-T's version has an offset bolster to allow for body-mounted couplers (not included). The trucks have an MSRP of \$5.60 a pair.



Micro-Trains has released several new N scale cars including two heavyweight diners. The car shown above is decorated for the Baltimore & Ohio Railroad. It is based on a car built in 1923 with mechanical air conditioning and ducting added seven years later. It has an MSRP of \$33.80.



Another heavyweight diner is decorated in the orange and maroon scheme of the Milwaukee Road. The lack of ducting on the roof indicates this car has not been converted to air conditioning. The N scale model has an MSRP of \$30.80. Both the B&O and Milwaukee Road diners ride on the above-mentioned six-wheel heavyweight trucks.



This Western Pacific model represents a 50' boxcar with double Youngstown corrugated steel doors. Built in 1954, the lack of a running board indicates the car has been upgraded to meet changing industry safety requirements. The model has an MSRP of \$26.75.



This Burlington Northern center-flow triple-bay covered hopper represents a grain hauler built in 1978 by American Car & Foundry. The prototype had trough hatches and was rated at a capacity of 4,650 cu. ft. M-T's version has an MSRP of \$31.90.

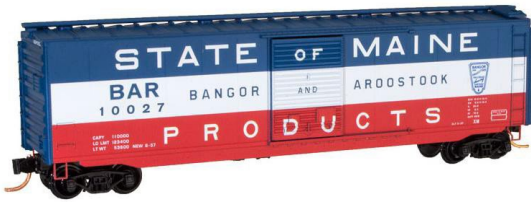

Micro-Trains is offering this highly-recognizable 50' BAR boxcar in two road numbers. The N scale models have an MSRP of \$29.95 each. For

additional information on all Micro-Train Line products see your dealer or visit micro-trains.com.

Trainworx Inc. is taking reservations through April 30 for a new run of N scale quad hopper cars. Delivery is scheduled for sometime this fall. Six road numbers each will be available for Great Northern, Burlington Northern, Burlington Northern (90s), Inland Steel (centered logo), and Inland Steel (left logo). Twelve numbers will be available for a car decorated for Indianapolis Power and Light. The models have an MSRP of \$25.95 each. For more information or to make a reservation, click on train-worx.com/15-3quadhopper.pdf.

Walthers plans to release two new N scale containers in June. A 40' Hi-Cube container will be available decorated for Maersk, K-Line, Hapag-Lloyd, and Evergreen at an MSRP of \$7.98 each. Also priced at \$7.98 each are 48' ribbed-side containers decorated for Canadian National, Santa Fe, Conrail-Mercury, and undec. For additional information contact your dealer or visit walthers.com.

NEW DECALS, SIGNS AND FINISHING PRODUCTS

The newest HO scale lettering set from **Mask Island Decals** is for an ATSF open-frame tri-level auto rack. The white lettering

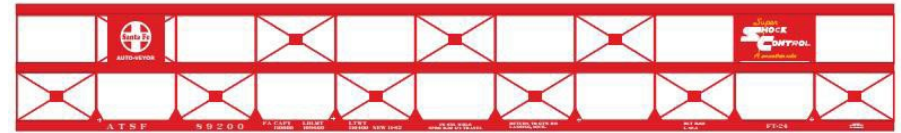

includes a Shock Control logo. The set is priced at \$7.00. To order visit maskislanddecals.com.

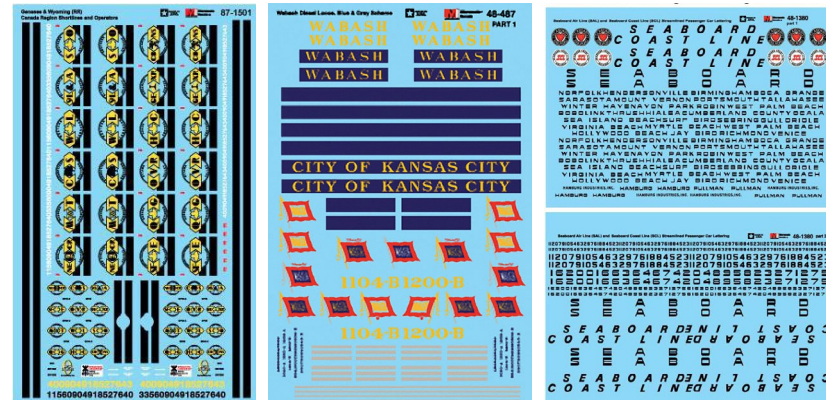

New water-slide decals available from **Microscale Industries** include Genesee & Wyoming, Canada Region Shortlines, Wabash "City of Kansas City," and Seaboard Coast Line. Decal sets have recently been reissued for Rio Grande Caboose (1940-1972) and Canadian National steam locos (1931-1960). All lettering sets mentioned are available in both HO and N scale. Contact your dealer or visit microscale.com.

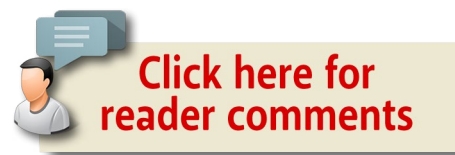

SEND US YOUR PRODUCT ANNOUNCEMENTS

If you are a hobby manufacturer with a product announcement, just [click here](#) and submit your announcement to us. Our web site and free magazine reach continues to grow, so get on board this new media train! ■

.....

DISCLAIMER

The opinions expressed in this column are those of the writer and do not necessarily reflect the opinion of *Model Railroad Hobbyist* or its sponsors. Every effort is made to provide our readers with accurate and responsible news and information, however, neither *Model Railroad Hobbyist* or the writer of this column can be held responsible for any inaccuracies or typographical errors that may inadvertently appear in this column.

.....

THIS MONTH'S BONUS EXTRAS

MRH SUBSCRIBERS GET ACCESS TO FREE BONUS extras, but you do have to be a subscriber! That's easy because [subscribing is free \(just click this link\)](#).

The bonus extras this month include:

- High quality versions of the issue videos
- High-res version of Getting Real block wiring diagram
- SP passenger trains summary and bibliography

To access the bonus extras, click the link below:

[BONUS DOWNLOADS FOR THIS ISSUE](#)

.....

BRIEFLY NOTED AT PRESS TIME ...

Look for Athearn to release both HO and N scale versions of its 4-6-6-4 Challenger steam locomotive in January. Road names will be Northern Pacific, and Spokane, Portland & Seattle. Additional HO scale Genesis series motive power expected early next year include GP40-2 locomotives decorated for Florida East Coast (Phase III), Grand Trunk Western (both Phase I and Phase IIa), Louisville & Nashville Family Lines (Phase II), and St. Louis-Southwestern Cotton Belt (Phase III with an 88" nose). A Guilford/MEC repaint of an ex-CN GP40-2L will be included in the run.

February will see the arrival of a new group of Genesis HO scale GP9 diesels. Road names will be New Haven, Boston & Maine (Head End Power units with HEP cabinets at the front of the long hood), Penn Central with long hood forward, and a newly tooled PC cabled B unit. Genesis series Union Pacific U50 diesels are also expected in February.

Athearn HO scale ready-to-run locomotives due in January include SD40T-2 diesels for New York, Susquehanna & Western (both 88" and 124" noses); Denver & Rio Grande Western; Kansas City Southern; and Southern Pacific (88" nose and L-window cab). The release will include an undecorated version of the SD40T-2 with SP details.

Freight cars due from Athearn early next year include HO scale 24' ore hopper cars in 13 numbers each for CN, Milw Rd, NP, UP, Soo Line, and CNW, along with a group of 50' smooth side boxcars with both sliding and plug doors. A Genesis series 57' FGE mechanical refrigerator car with a Tsunami refrigerator sound unit is due in January for Burlington Northern-Western Fruit Express (Phase II body), Fruit Growers Express (Phase III body), St. Louis-San Francisco (Phase I early body), TPIX repaint (Phase I, late body), and Union Pacific/ARMN (modernized Phase I body). Non-sound versions will also be offered.

Completing Athearn's first release next year will be both HO and N scale versions of a PS-2 triple-bay 2893 covered hopper car with round hatches and individual wire grab irons. Road names will be CB&Q, DT&I, Soo, Southern, SP/TNO, L&N, and undecorated. ■

.....



SELECTED EVENTS

April 2015

(Please note that many events charge a fee. Check individual info website for details.)

AUSTRALIA, NEW SOUTH WALES, BOWRAL, April 3-5, 12th Australian Narrow Gauge Convention, sponsored by NMRA, with hands-on workshops, contests, tours, and modeling clinics on NG prototypes from Fiji, US, UK, and Australia. Info at austnarrowgaugeconvention.com.

AUSTRALIA, QUEENSLAND, BRISBANE, April 9-12, 14th National N Scale Convention, at Hotel Grand Chancellor, 23 Leichardt St, Spring Hill. Info at facebook.com/NationalNScaleConvention2015.

CANADA, ALBERTA, CALGARY, April 18-19, SuperTrain – Canada's Largest Model Train Show, at Genesis Centre, 7555 Falconridge Blvd, NE. Info at supertrain.ca.

CANADA, ONTARIO, SCHOMBERG, April 18, The Ontario Narrow Gauge Show at Schomberg Community Hall. Help celebrate the 10th anniversary of Canada's only exclusively narrow gauge show, with layouts, modules, displays, vendors, model contests, clinics, and a panel discussion. Sponsors include Fast Tracks, Mt Albert Scale Lumber Co, and TrainMasters TV. Info at narrowgagemadness.com/ngm-home. Vendors contact David Woodhead at davidwoodhead@bell.net.

ALABAMA, GADSDEN, April 18, 29th Annual Train Show, at Convention Hall, 344 South First Street. Hosted by Coosa Valley Model Railroad Association. Info at coosavalleymodelrailroad.com/3.html.

ARIZONA, CLARKDALE, April 11, Rails Along the River, display and swap meet at Clark Memorial Clubhouse Auditorium, 9 North Ninth Street. Info at vrvno.info@gmail.com.

ARKANSAS, PINE BLUFF, April 11, 20th Annual Railroadiana Show, at Arkansas Railroad Museum. Info at arkansasrailroad-museum.org.

CALIFORNIA, LOS ANGELES, April 25-28 and May 2-3, Pasadena Model Railroad Club celebrating 75 years of operation on the Sierra Pacific Lines, one of the largest HO scale operating model railroads in the world. Info at pmrrc.org/#OPENHOUSE.

CALIFORNIA, SONORA, April 18, Westside Logging & Mining Reunion, a rare and entirely unique opportunity to eat, drink, and talk about narrow gauge logging with like-minded fellows. Event includes clinics and a limited number of vendor tables. At Sonora Elks Club, 100 Elk Drive. Volunteers needed. Info at westsidereunion.com.

FLORIDA, MELBORNE, May 16, Brevard Train Expo, at Melbourne Auditorium, 625 E Hibiscus Street. For more see: model-railroad-hobbyist.com/node/21687.

INDIANA, MARTINSVILLE, April 11, Spring Train Show and Meet, sponsored by NMRA Central Indiana Division, with operating layouts, clinics, and vendor tables, at National Guard Armory, 1900 Hospital Drive. Info at cid.railfan.net/upcoming.html.

SELECTED EVENTS | 3

INDIANA, NOBLESVILLE, April 25, 7th Annual Hoosier On30 Mini-Meet (all scales welcome), with modules, dioramas, clinics, and swap tables, at Noblesville Community Center, 372 South 8th Street. For info contact michelerobinson14@att.net.

MARYLAND, TIMONIUM, April 11-12, Brass Expo in conjunction with the Great Scale Model Train Show, presented by Howard Zane, at Maryland State Fairgrounds, 2200 York Road. Info at gsmts.com.

MASSACHUSETTS, TAUNTON, April 12, Spring TRAINing - Annual Model Train Show, at Holiday Inn Taunton-Foxboro Hotel, 700 Myles Standish Blvd. Hosted by HUB Division of NMRA. Info at hubdiv.org.

MICHIGAN, MUSKEGON, April 26, Muskegon Railroad Historical Society Train & Hobby Show, onboard the USS LST 393, at Veterans Museum, 560 Mart Street. Info at facebook.com/events/381878965303887.

MINNESOTA, EAGAN (twin cities), April 25-26, 4th Annual Great Minnesota Train Expo, at Civic Arena, 3870 Pilot Knob Road.

MISSISSIPPI, GULFPORT, April 18, Mississippi Coast Model Railroad Museum, opening day of new museum featuring antique toy trains, operating layouts, refreshments, and door prizes, at 504 Pass Road. Info at facebook.com/pages/Mississippi-Coast-Model-Railroad-Museum/1494896290722873.

MISSOURI, SEDALIA, April 25-26, Model Train Show, with operating model layouts, vendor booths with all types of train and railroadiana items for sale, at State Fairgrounds, FFA Building, 2503 West 16th Street. Proceeds benefit the American Passenger Rail Heritage Foundation. Info from Bob Cox at 660-287-1714.

SELECTED EVENTS | 4

OCEANSIDE, CALIFORNIA, April 18, First Annual All-Scale Swap Meet at Heritage Park, 20 Peyri Drive, sponsored by North County Model Railroad Society. Info at ncmrs.org. Vendor info from Al Cuevas at f7awp913@gmail.com.

OHIO, MARION, April 23-25, Central Ohio RPM, at Marion Union Station. Includes rail fanning, fellowship and dinner at The Shovel. Info at facebook.com/groups/438383252883060.

PENNSYLVANIA, MONACA, April 12, Beaver County Spring Model Train Show, at Center Stage, 1495 Old Brodhead Road. Info at bcmrr.railfan.net.

SOUTH DAKOTA, SIOUX FALLS, April 18-19, Model Railroad Swap Meet at Expo Building, W. H. Lyon Fairgrounds, with special presentation Saturday on Railroading in South Dakota by Rick Mills, Director of the South Dakota State Railroad Museum. Co-sponsored by Sioux Valley Model Engineers Society and NMRA Dakota Southeastern Division. Info at svmes.net/greater-sioux-falls-model-railroad-swap-meet-and-vendor-show.

TEXAS, NEW BRAUNFELS, April 11-12, Railroad Jamboree with 60 vendors, 300 tables and kids operating layout. At Civic Center, 375 South Castell Avenue.

WASHINGTON, BELLEVUE, April 16-18, 30th Annual Sn3 Symposium, at Bellevue Sheraton Hotel, 100 112th Ave NE. Info at sn3symposium-2015.com.

WISCONSIN, MANITOWOC, April 17-19, NMRA MidWest Region Convention at Holiday Inn, 4601 Calumet Avenue. Info at mwr-nmra.org/convention/conventions.html.

May 2015

AUSTRALIA, NEW SOUTH WALES, ALBURY,

LAVINGTON, May 23-24, Annual Train Show, hosted by Murray Railway Modellers Inc., featuring model railways from different regions of Australia in N, HO, and O scale, plus a variety of vendor tables, at Mirambeena Community Centre, 19 Martha Mews. Info at murrayrailwaymodellers.com or phone (03) 5728 2023.

NEW ZEALAND, DUNEDIN, May 9-10, Model Train Show sponsored by American Modular Group of New Zealand. Visit more than 16 layouts and vendor tables at Forbury Park, 146 Victoria Road. Info at dunedinmodeltrainshow@vodafone.co.nz.

ARIZONA, TUCSON, May 29-30, Summer Train Show & Meet for all popular scales, at Tucson Expo Center, 3750 East Irvington Road. Sponsored by Gadsden Pacific Division Toy Train Operating Museum. Info at gpdToyTrainMuseum.com.

CALIFORNIA, NEWARK, May 13-17, NMRA Pacific Coast Region Convention, at Newark-Fremont Double Tree by Hilton Hotel, 39900 Balentine Drive. Info at pcrnmra.org/conv2015.

CONNECTICUT, COLLINSVILLE, May 29-30, New England/Northeast Prototype Modelers Meet. Info at neprototypemeet.com.

MASSACHUSETTS, HYANNIS, May 16, Dinner Train Excursion aboard Cape Cod Central Railroad, sponsored by NMRA HUB Division. Info at hubdiv.org or contact Manuel Escobar at president@hubdiv.org or call 781-718-5693.

OHIO, HILLIARD, May 15-17, 7th Ohio N-scale Weekend at Franklin County Fairgrounds, sponsored by Central Ohio N-Tra. Info at centralohiontrak.org.

PENNSYLVANIA, PHILADELPHIA, May 15-17, 22nd National Model Trolley Meet at Pennsylvania Convention Center, Exhibit Hall G, Broad and Race Streets. Event sponsored by East Penn Traction Club. Info at eastpenn.org/meet.html.

VIRGINIA, FISHERSVILLE, May 4, 29th Annual Shenandoah Valley Model Train and Railroading Show sponsored by the Augusta County Model Railroad Club at Augusta Expo, 277 Expo Road. Event features model train sales, railroad historical societies, railroad memorabilia sales, and operating model train layouts. Vendors contact Bill Kauffman at kauffmanb@gmail.com.

Future 2015 (by location)

CANADA, ONTARIO, BRAMPTON, October 3-4, Annual Brampton Model Railway Show with 33,000 square feet of display including N, HO, O and G scale operating equipment. At Brampton Fairgrounds, 12942 Heart Lake Road. Info at brampton-modelrailwayshow.com.

CANADA, QUEBEC, LAVAL, Oct 3-4, The North Shore Train Show, Complexe Multi-Sports, 955 ave Bois-de-Boulogne. Info at salondutrainrivenord.org/english.html.

COLORADO, GREENWOOD VILLAGE (DENVER), June 3-7, NMRA Rocky Mountain Region Annual Smoke & Steam Convention, at Sheraton DTC Hotel, 7100 South Clinton. Info at sas2015.net.

SELECTED EVENTS | 7

ILLINOIS, LISLE (Naperville), October 22-24, 22nd Annual Naperville RPM Conference, hosted by Joe D'elia, at Sheraton Lisle-Chicago Hotel, 3000 Warrenville Road. Info at railroadprototypemodelers.org/naper_meet.htm.

MISSOURI, JEFFERSON CITY, June 5-7, NMRA Mid-Continent Region Convention, at Capital Plaza Hotel, 415 West McCarty Street. Info at showmecentral.com.

NEBRASKA, NORTH PLATTE, September 18-20, Rail Fest 2015, info at nprailfest.com.

OREGON, PORTLAND, August 23-30, NMRA National Convention, at Double Tree by Hilton Hotel Portland. Info at nmra2015.org.

OREGON, PORTLAND, August 28-30, National Train Show, at Portland Expo Center. Info at nmra2015.org/trainshow.

SOUTH CAROLINA, GREENVILLE, June 5-6, Palmetto Excursion, NMRA South East Region Convention, at Greenville Marriott. Info at palmetto-excursion.org.

TEXAS, HOUSTON, September 2-5, 35th National Narrow Gauge Convention. Info at nngc-2015.com.

VIRGINIA, FREDERICKSBURG, September 25-26, 3rd Annual Mid-Atlantic RPM Meet, at Wingate by Wyndham Fredericksburg, 20 Sanford Drive. Info at marpm.org.

Future 2016 and beyond (by location)

CANADA, BRITISH COLUMBIA, SALMON ARM, June 15-19, 2016, Pacific Northwest Region Annual Convention and Train Show.

SELECTED EVENTS | 8

COLORADO, DENVER, 2017, National Narrow Gauge Convention. **INDIANA, INDIANAPOLIS**, July 3-10, 2016, NMRA National Convention and National Train Show. Info at nmra2016.org.

MAINE, AUGUSTA, Sept. 7-10, 2016, 36th National Narrow Gauge Convention. Info at nngc2016.org.

GEORGIA, KENNESAW, September 18-19, Atlanta Railroad Prototype Modelers Meet, at Southern Museum of Civil War & Locomotive History, 2829 Cherokee Street. Event hosted by Southern Railway Historical Association. Info at srha.net. Vendors contact Paul Faulk at aclsalhshelp1@att.net.

FLORIDA, LARGO, April 25-26, Train Show and Open House sponsored by Suncoast Model Railroad Club, at Minnreg Hall 6340 126th Avenue. Info at suncoastmrrc.com/pdfs/Show_Flyer.pdf. ■

A "Right Clamp"™ Mini Project

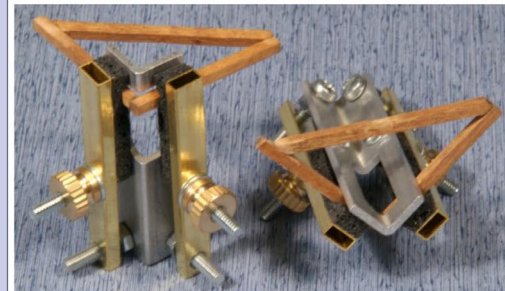

AC-2-2 "Mini Right Clamp"™ used for gluing Bulkhead Frames.

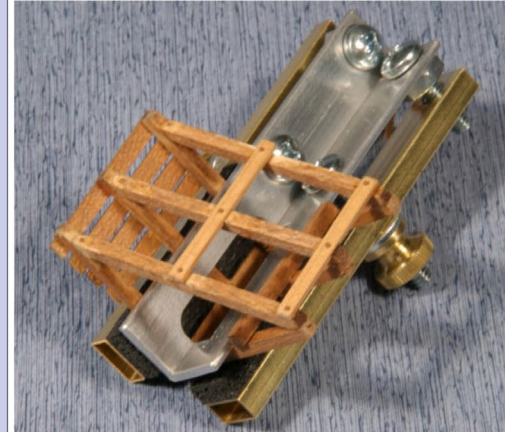

AC-1-1 "Original Right Clamp"™ used for Bulkhead Assembly.



Assembled Bulkhead in gondola with load of ring castings.

Right and Splice Clamp – Tools for Modelers

See all our products at:

www.coffmaneng.com

Coffman Graphic Solutions Co.
1500 River Circle, Richmond, KY 40475-7907
Phone: 859-527-0476, Fax: 859-527-0485

Clickable advertiser index – 1

[Accu-Lites](#)
[American Ltd \(San Juan\)](#)
[ANE Models](#)
[Archer Fine Transfers](#)
[Athearn](#)
[Atlas Model Railroad Co.](#)
[Bachmann](#)
[Bachrus](#)
[Backdrop Junction](#)
[Berrett Hill Trains](#)
[Blair Line](#)
[BLMA](#)
[Bowser](#)
[Brass Expo \(Howard Zane Asc.\)](#)
[Burlington Route Historical Society](#)
[Caboose Hobbies](#)
[Canyon Creek Scenics](#)
[Clever Models](#)
[Coastmans Scenic Products](#)
[Coffman Graphic Solutions](#)
[Credit Valley Railway](#)
[Crest Electronics](#)
[DCC by Design](#)
[Digitrax \(2 page spread\)](#)
[East Penn Traction Club](#)
[ESU LokSound](#)
[Fast Tracks](#)
[Fifer Hobby Supply](#)
[Fox Valley Models](#)
[George's Trains](#)
[GLX Scale Models](#)
[Grand Central Model Railway](#)

[Great Decals](#)
[Hobby-On \(MRS Hobby\)](#)
[Iowa Scaled Engineering](#)
[Iwata-Medea](#)
[Jelsma Graphics](#)
[Ken Patterson.com](#)
[Lights 4 Models](#)
[Litchfield Station](#)
[Logic Rail Technologies](#)
[Micro-Mark](#)
[Microscale](#)
[Minimalist Model Railroad](#)
[Model Railroad Benchwork \(1\)](#)
[Model Railroad Benchwork \(2\)](#)
[Model Railroad Tunnels](#)
[Monroe Models](#)
[Motrak Models](#)
[Mountain Subdivision Hobbies](#)
[Mr. Detail Parts](#)
[MRH Store \(2 page spread\) \(1\)](#)
[MRH Store \(2\)](#)
[MRH Store \(3\)](#)
[M.T.H.](#)
[Nano-Oil](#)
[NCE \(2 page spread\)](#)
[Nick & Nora Design](#)
[North American Railcar](#)
[Ottawa Train Expo](#)
[Portland National Train Show](#)
[Precision Design Co.](#)
[Pre-size Model Specialties](#)
[RailMaster Hobbies](#)

Clickable advertiser index – 2

[Railroad Explorer](#)
[Rapido \(2 page spread\)](#)
[Ring Engineering \(1\)](#)
[Ring Engineering \(2\)](#)
[RR-CirKits](#)
[RSlaserKits, Inc.](#)
[Rulers-of-the-World](#)
[Rusty Stumps](#)
[Streamlined Backshop](#)
[Scenic Express](#)
[Scotty Mason Show](#)
[Signature Press](#)

[Soundtraxx](#)
[Southern Digital](#)
[TAM Valley Depot](#)
[Tony's Train Exchange](#)
[TrainMasters TV \(1\)](#)
[TrainMasters TV \(2\)](#)
[Traintek](#)
[TrainWorld](#)
[True Scene Modeling](#)
[Westerfield Models](#)
[Yankee Dabblers](#)
[Yarmouth Model Works](#)

Clickable "other" index

[Other – Bonus Extras](#)
[Other – Cover](#)
[Other – Derailments](#)
[Other – Hobby Marketplace](#)
[Other – MRH Sponsors](#)
[Other – Staff Notes](#)
[Other – Table of Contents](#)



DOWNLOAD PORTRAIT



DOWNLOAD LANDSCAPE



REVERSE RUNNING

commentary

JOE FUGATE
.....



[Click here for reader comments](#)

TIME FOR A CHANGE?



I'VE DECIDED THAT I'M READY for a change once the NMRA Convention is over this August: My Siskiyou Line layout has run its course. I've always had an interest in the larger scales, and I turn 60 this year.

As I age, I'm finding it's getting harder to see the small details on the rolling stock and locos. I used to be glad I didn't do N scale because everything's so small. Now

even HO is starting to look tiny to me, and these old eyes need magnifying glasses just to read the road numbers on the cars.

I've always had a fancy for S scale, but it's only slightly larger than HO, and most likely in a few more years, even S scale will look too small.

O scale's larger still, and On30 is all the rage. But then again, that's O scale stuff on HO track, and I'm leaving HO because it's

▶ **STEPPING OUTSIDE THE BOX WITH A CONTRARY VIEW**

getting too small. On30 feels a lot like just larger HO because of the track, so quite likely it will feel like S in a few years as my eyes continue to age.

At this point, I'm thinking of going G scale. That's large enough to really see well, and aging eyes should be able to see car numbers and the finer details just fine for a long time to come.

So I'm going to rip out the Siskiyou Line after this August and replace it with a G scale layout, all one deck. No more mushroom multi-deck benchwork. Just a simple single-deck G scale steam era layout in my 25 x 50 foot space.

G scale is large enough, I'd also like to try something more interesting like live steam. If you look on the internet, you can find G scale live steam, and it's pretty cool! Talk about an interesting new challenge!

Now there is the problem of running live steam indoors in my layout room, but I can install an air circulating system to flush the room air out quickly to avoid any problems with steam loco exhaust. Just think, real bunker oil aroma!

I really like the look of steam plumes on a steamer, so I'm thinking it would be great with a room air conditioning / air recycling system to keep the room temperature below 50 degrees so the steam plumes in the room have that great cold weather look. And needing to wear a jacket to railfan my indoor live steam G scale layout will just add to the realistic ambiance.

I'm getting more excited about this new adventure in model railroading and can't wait for August to be over so I can finally start dismantling my HO Siskiyou Line layout and begin building my new live steam G scale layout indoors!

To get this project really fleshed out, I've been rolling up my sleeves and sketching up the new layout. Looks like my first CAD drawings of the new layout will be ready by April 1. ☑



DERAILMENTS

compiled by the
MRH STAFF



[Click here for
reader comments](#)



GETTING OFF ON THE RIGHT FOOT - A 1972 railroad safety video done with a bit of humor.

Even though this old railroad safety video is a bit blurry, it's still quite interesting - and has some clever humorous moments. You'll appreciate the care real life railroaders need to take to avoid losing life or limb on the railroad!

► **BIZARRE FACTS AND HUMOR (SUPPOSEDLY)**

SUPPOSEDLY TRUE ...

We were running a loaded welded rail train with a single SD45 loco. The train had single 1000-foot long sections of welded rail spread over that length on special flat cars with racks.

Ordinarily, a single SD45 should have no problem with this train, but our SD45 would not go past notch 5 (out of 8 notches). We just figured we'd have to take it slow.

Eventually, we reached a long hill and it was taking us quite a while to crawl along up the hill. Dispatch called to see how we were coming along since traffic was starting to back up. We told him we were having problems getting up the hill.

Dispatch told us that we could "double the hill" if necessary! Yeh, right ...

("Double the hill" means split the train in two and take each part over the hill separately.)

Coming next issue ...

- Jeff Sargeant's GN/SP&S N-scale layout
- Get awesome track conductivity
- Car card boxes
- Freemo in a foreign land
- Part 4 of SP Passenger train modeling by V.S. Roseman
- Designing your layout to a theme
- And lots more ...

