

HAVING FUN WITH TRAINS

MAY 2015 | FREE

MRH

MODEL RAILROAD HOBBY

ALSO:

- Dirty track solution
- Photos on backdrop
- Car card boxes



Jeff Sargeant's GN / SP&S N-scale layout

» READ NOW

EMBEDDED EDITION | LANDSCAPE



DOWNLOAD



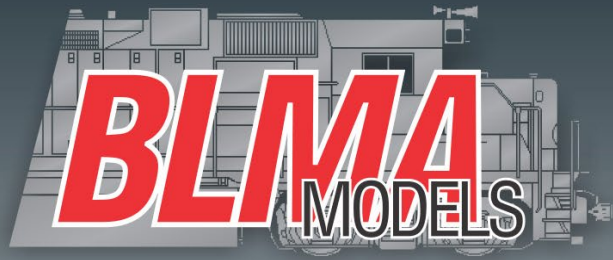

N SCALE

Trinity Rail

31K CRUDE OIL

• TANK CAR •

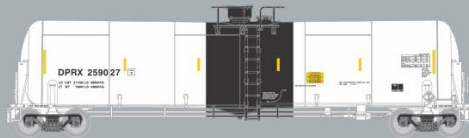
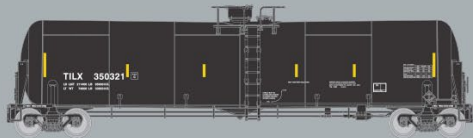

▶ ORDER BY: MAY 15

▶ DELIVERY BY: LATE 2015

CLICK HERE TO SEE MORE



BLMAMODELS.com

BLMA
BLOG

MRHMAG.COM



Model Railroad Hobbyist | May 2015 | #63

STAFF CREDITS

Front Cover: Jeff Sargeant shares how he's building his N-scale GN/SP&S layout. This layout will be on tour at the NMRA National in Portland, OR this coming August.



ISSN 2152-7423

Editorial Staff

Joe D. Fugate, Publisher and Editor
Don Hanley, Assistant Editor

Production

Patty Fugate, pasteup and layout
Joe Brugger, copy editing
Mike Dodd, copy editing

Technical Assistants

Jeff Shultz
Jimmy Simmons

Advertising

Les Halmos, Account Manager
Daniel Nava, Advertising Assistant
Jean-François Delisle, Marketing Assistant

Columnists

Richard Bale, News and events
Jeff Shultz, News and events
Les Halmos, Modular railroading
Larry Smith, Narrow Gauge/Shortlines
Bruce Petrarca, DCC
Ken Patterson, Reporter at large

Special Correspondents

Joe Brugger, Questions & answers
Charlie Comstock, Contributing editor
Issue password: May2015

Published for the glory of God. [What's this?](#)

- [TABLE OF CONTENTS](#)
- [INDEX](#)



MRH SPONSORS

A - E



acculites.com



americanlimitedmodels.com



railroadhobbyshow.com



archertransfers.com



athearn.com

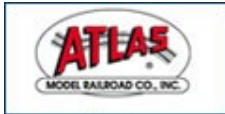

www.atlasrr.com



bachmanntrains.com



bachrus.com



backdropjunction.com

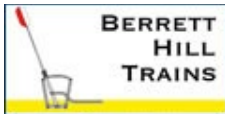

berretthill.com/trains



blairline.com



blmamodels.com



bowser-trains.com



caboosehobbies.com



coffmaneng.com



con-cor.com



cvrco.com



www.digitrax.com



crest-electronics.net



esu.eu/en

F - R



www.handlaidtrack.com



fiferhobby.com



foxvalleymodels.com



glxscalemodels.com



georgestrains.com



www.hobby-on.com



www.iascaled.com



iwata-medea.com



litchfieldstation.com



microscale.com



micromark.com



store.mrhmag.com



stores.ebay.com/Motrak-Models



mthtrains.com



nano-oil.com/Model%20Railroad.html



ncedcc.com



nickandnora.com



www.pwrs.ca/main.php



nmra2015portland.org

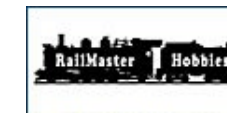

railmasterhobbies.com



rapidotrains.com



ringengineering.com



rr-cirkits.com



rslaserkits.com



rustystumps.com

[Vendors: Get your clickable logo here ...](#)

[Vendors: Get your clickable logo here ...](#)

MRH SPONSORS | 3

S - Z



sanjuancarco.com



scenicexpress.com



signaturepress.com



soundtraxx.com



sodigi.com

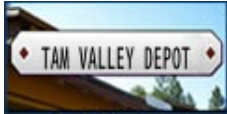

tamvalleydepot.com



tonystrains.com



traintekllc.com



trainworld.com



walthers.com



yankeedabblers.com

[Vendors: Get your clickable logo here ...](#)

Looking for something? Check our Hobby Marketplace!

Take me there!

MRHMAG.COM

ADVERTISEMENT



ORIGINAL
Demonstrator
20—SD70ACE—12
LOCOMOTIVE



THEY'RE BACK!

ANNOUNCEMENT DEMONSTRATOR EMD GENESIS SD70ACE

By popular demand we are bringing out the yellow SD70ACE along with the EMD Demo locomotive. These models are already sold out at Athena so be sure to contact your local retailer to get yours before they are gone!



ATHG68823 – EMD/Yellow #1201
With DCC/sound: \$299.98



ATHG68819 – NS/Horsehead #1029
With DCC/sound: \$299.98



ATHG68815 – EMD/Blue #1202
With DCC/sound: \$299.98

- ATHG68823 HO SD70ACE w/DCC & Sound, EMD/Yellow #1201
- ATHG68822 HO SD70ACE w/DCC & Sound, NS/Horsehead #1063
- ATHG68821 HO SD70ACE w/DCC & Sound, NS/Horsehead #1054
- ATHG68820 HO SD70ACE w/DCC & Sound, NS/Horsehead #1043
- ATHG68819 HO SD70ACE w/DCC & Sound, NS/Horsehead #1029

- ATHG68818 HO SD70ACE w/DCC & Sound, EMD/Blue #1205
- ATHG68817 HO SD70ACE w/DCC & Sound, EMD/Blue #1204
- ATHG68816 HO SD70ACE w/DCC & Sound, EMD/Blue #1203
- ATHG68815 HO SD70ACE w/DCC & Sound, EMD/Blue #1202



HORIZON
HOBBY

VISIT
Your Local Retailer

CLICK
Athena.com

CALL
1.800.338.4639

SERIOUS FUN[®]

©2014 Horizon Hobby, LLC. Athena, Genesis, Ready To Roll, Trains in Miniature, Serious Fun and the Horizon Hobby logo are trademarks or registered trademarks of Horizon Hobby, LLC. The Union Pacific mark and other marks owned by Union Pacific are made under trademark license from Union Pacific Railroad Company. All other trademarks, service marks and logos are property of their respective owners. Final models may vary slightly from photos shown. 46301

- TABLE OF CONTENTS
- INDEX



TABLE OF CONTENTS

FEATURES

Jeff Sargeant's GN/SP&S

JEFF SARGEANT and the MRH Staff

N-scale layout inspired by railroading in the Northwest



Southern Pacific's GE Dash 7s: 2

JEFF SKINNER

Part 2 of how to easily add detail to your GE locos



Fighting dirty rails with graphite

TREVOR MARSHALL

New "miracle solution" for rail electrical contact



Operating system card boxes

BILL WHEELER

Add these easy-to-make car card boxes to your layout

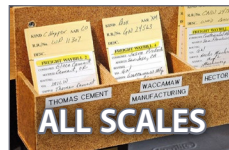

Free-mo in a foreign land

MATTHEW PICCIOTTO

Keep modeling, even if you're deployed overseas



SP's lightweight streamlined cars: 4

VICTOR ROSEMAN

Part 4 of going beyond just the Daylight trains



ALSO: Hobby Marketplace | Bonus downloads

COLUMNS

MRH Q-A-T: Superelevated curves, scenicked staging

compiled by JOE BRUGGER

Getting Real: Using photos on a backdrop

MARTY McGUIRK

What's Neat: Weathering, small layouts, and more ...

KEN PATTERSON

Imagineering: Modeling a themed environment

DAVE MEEK

Photo feature: Yes, it's a model

compiled by DON HANLEY

Derailments: Bizarre facts & humor (supposedly)

compiled by the MRH STAFF

NEWS and EDITORIAL

Publisher's musings: Failure to plan

JOE FUGATE

Staff notes: Videos, videos, we have videos ...

compiled by the MRH STAFF

News & Events: May 2015

RICHARD BALE & JEFF SHULTZ

Reverse running: If it's worth doing ...

DON HANLEY

HO Scale
Amtrak
 F40PH (Ph I)

Order deadline May 15, 2015!



Model Railroad Hobbyist | May 2015 | #63



PUBLISHER'S MUSINGS
 editorial

JOE FUGATE



Click here for
 reader comments

FAILURE TO PLAN

SOMETIMES YOU JUST LEARN THINGS BY HARD knocks. As I prepare my SP Siskiyou Line layout for the big NMRA Convention this August, I'm back working on the layout again at a feverish pace.

But I need to be careful, because in the rush to get things done, I may do something I will regret later. Fortunately, I had enough good sense (or was it just dumb luck?) to stop and think about what I was about to do next.

If you read the April Staff Notes, you know I'm working on a bridge scene in one corner of my layout. I'm eager to get to the scenery stage and see the final scene take shape. But before getting too hasty, I stopped to consider where the signals should go in this part of the layout.

Oops, wouldn't you know it – they should go right here, just past the bridge! So let's see what we're dealing with. Oh, great! There's a joist and a riser precisely under the location where the signals need to go! Because the prototype Siskiyou Line used lower quadrant semaphores, installing signals on my

PUBLISHER'S MUSINGS | 2

layout is a bit like the proverbial iceberg: there's a lot more under the layout than the signals would lead you to believe.

This part of the Siskiyou Line lies between the towns of Oakland and Sutherlin, and just like on the prototype, I need to install two dual-headed semaphores at this location, midway between the two towns. Those two signals, each with two independently operating arms, means I need to install four – count them, *four* servos under the track at this location.



Dual-head semaphores on the SP Siskiyou Line.

ADVERTISEMENT

CABOOSE HOBBIES
WORLD FAMOUS MODEL TRAIN STORE
Since 1938!

The World's Largest Model Train Store!

Model trains G to Z, DCC, brass models, kits, RTR, collectable models, scenery, structures, books, magazines, DVD's, hobby tools & supplies and a full service repair department.

WWW.CABOOSEHOBBIES.COM

START SOME FUN!
CLICK HERE!

MRHMAG.COM

ADVERTISEMENT



THE 2-8-4: OUR FIRST N SCALE SOUND VALUE STEAM LOCOMOTIVE!

Now N scale modelers can enjoy a locomotive with the Sound Value *SoundTraxx*® steam package that includes authentic prototypical chuff, short and long whistles, bell, air pump, steam release, and blower—all in 16-bit polyphonic sound. The Berkshire also features a die-cast chassis, precision motor, and finescale detailing per prototype. Visit your favorite hobby dealer to enjoy the first N scale sound-equipped steam engine from Bachmann!

Features include:

- DCC sound-equipped
- precision motor
- die-cast chassis
- details and tender style per prototype
- brass-machined flywheel
- metal handrails and stanchions
- LED headlight and tender backup light
- die-cast marker lights
- see-through underframe
- metal wheels
- magnetically operated E-Z Mate® Mark II couplers

Click for more info.

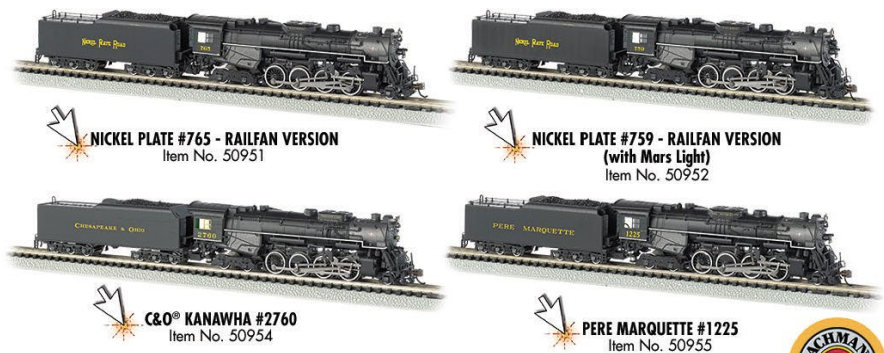

SHIPPING NOW! • MSRP \$329.00 each



Bachmann Industries, Inc. • 1400 East Erie Avenue • Philadelphia, PA 19124 USA • www.bachmanntrains.com

Click to learn more.

- TABLE OF CONTENTS
- INDEX

RR-CirKits, Inc.

Affordable Electronics for Model Railroads

The venerable
LocoBuffer-USB
has a new face!



Rev-n
Leaner
Smarter
Tougher
LocoNet® to USB interface

LocoNet is a trademark of Digitrax

[Learn More ...](#)

Checked us out lately?



Established 1993...
Blair Line

PUBLISHER'S MUSINGS | 3

Not only is there a joist and riser in the way, but this part of the layout is in a corner where the L-girders sit at 90-degree angles to each other, and one set of L-girders sits across the top of the other because the track is climbing upgrade, and raising the L-girders meant less lumber under the roadbed for support. But all these benchwork complexities also mean I'll need some real shoe-horning to get four servos under those signals.

This isn't the only place I discovered my failure to plan for signal placement when I had built the benchwork. No, it's not the end of the world – if I'm determined enough, I can rebuild anything. More often than not, failing to plan the signal locations while building benchwork has meant I need to remove and move joists, risers and even adjust fascia location.

As I think through the placement of these semaphores around the layout now, I'm realizing with all the servo mechanisms

You're the kid.



Welcome to the candy store.

- 180,000 square feet of sheer bliss
- Over 250 manufacturer & retailer booths
- 50,000 square feet of modular layouts
- "Ask the Collectibles" appraiser
- Trains, accessories, collectibles & more
- Hands-on demonstrations

August 28 - 30, 2015
Portland Expo Center

2060 North Marine Dr.
Portland, OR 97217

Sponsored by



**CLICK HERE
FOR ALL THE
DETAILS!**

www.nationaltrainshow.com

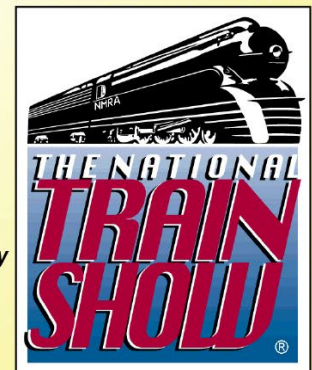

PUBLISHER'S MUSINGS | 4

needed underneath these signals, it's important to have some easy way to get access for maintenance.

Since I built my layout as a walkaround design with narrow shelf benchwork for the most part, I just need to make a panel in the fascia large enough I can get my hands in under the signals. As I plan out each signal installation now, I'm adding a removable fascia access panel so I don't need to crawl around under the layout to get to the servos for maintenance.

Even though I'm eager to get to the scenery work in this new scene, I'm very glad I stopped to think about signal placement. As a result, I've modified the benchwork and fascia in this area, giving me room to place the four servos under the signals, and have easy access to them from the fascia.

So here's my advice to those of you starting a layout that will have working signals: *Plan the signal locations while you're designing the layout.* As you build the benchwork, make sure there are no joists or risers under the signal locations. And where it makes sense, provide maintenance access under each signal location by building a removable access panel into the fascia.

Because of my failure to plan ahead with my signals, I get to retrofit the benchwork now, after the fact. But at least I'm doing this thinking now before I install the scenery too, and then get to tear out both scenery and benchwork to install the working lower quadrant semaphore signals!

Follow my Siskiyou Line progress [on my MRH blog...](#)



Click here for
reader comments

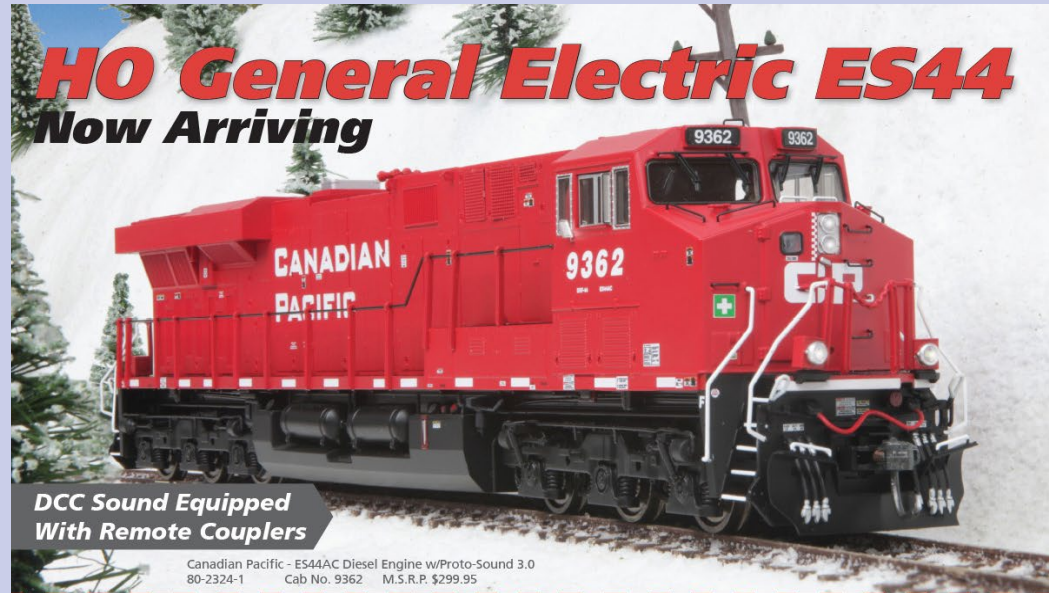

DCC Sound Equipped
With Remote Couplers

Canadian Pacific - ES44AC Diesel Engine w/Proto-Sound 3.0
80-2324-1 Cab No. 9362 M.S.R.P. \$299.95

Check out the M.T.H. HO GEVO diesel locomotive at your local M.T.H. Authorized Retailer. Outfitted with a powerful five-pole skew wound flywheel equipped motor, LED lighting, remotely operated Kadee® compatible remote couplers, user-installed Kadee® replacement couplers, full digital sound and a 28-function DCC decoder with Advance Consisting, Feature Mapping and Speed Mapping make this and all M.T.H. diesel locomotives HO's best motive power value.

Features Include:

- Metal Chassis
- (2) Operating Kadee Compatible Remote Controlled Proto-Couplers
- Prototypical Rule 17 Lighting
- Directionally Controlled Constant voltage LED Headlights
- Lighted Cab Interior
- Illuminated Number Boards
- Flashing Ditch Lights
- Powerful 5-Pole Precision Flywheel Equipped Skew-Wound Balanced Motor
- Built-in 28-Function DCC Decoder
- Proto-Sound 3.0 Digital Sound
- Operates On 22" Radius Curves



Union Pacific - ES44AC Diesel Engine w/Proto-Sound 3.0
80-2318-1 Cab No. 7926 M.S.R.P. \$299.95



Norfolk Southern - ES44AC Diesel Engine w/Proto-Sound 3.0
80-2321-1 Cab No. 8110 M.S.R.P. \$299.95



BNSF - ES44AC Diesel Engine w/Proto-Sound 3.0
80-2327-1 Cab No. 7028 M.S.R.P. \$299.95

M.T.H.
ELECTRIC TRAINS®
HO TRAINS THAT DO MORE
www.mthHOtrains.com

Additional Roadnames Available

Follow Us
Online!



YouTube



©2015 M.T.H. Electric Trains

From first train set to railroad empire...

*Our complete line of DCC products
grows with you. Discover the fun!*

- Designed and manufactured in the U.S.A.
- Preferred for ease of use and ergonomic design
- Unlimited scalability for any size model railroad
- Plug-and-play means more time running trains
- Great customer service and excellent support



Visit our new and improved web site for all your DCC needs!

- Get the latest new product announcements
- Watch our detailed how-to videos
- Browse the all-new Information Station
- Enjoy secure online sales, day or night!



See your dealer

Visit ncedcc.com



Coming in JUNE ...

TRAINMASTERS.TV

DVDs and downloadable videos!

Titles include:

- Streamliners at Spencer
- 2014 Layout tours (16 layouts)
- Backdrop painting how-to
- Extreme weathering how-to
- Best of TMTV 2014 (4 hours)
- Each monthly 90+ min show on a DVD



Most common comment in our video survey last summer:

"My internet bandwidth doesn't do streaming very well. Can I get TrainMasters videos on DVD or as a download instead?"

Our answer: *Yes, you can! Coming in June ... watch for them!*

Only from the **Model Railroad Hobbyist Store**

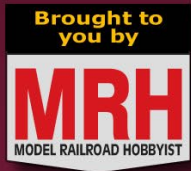

Visit store.mrhmag.com

The NEW Model Railroad Hobbyist STORE

Model Railroad Hobbyist | May 2015 | #63



STAFF NOTES



Click here for reader comments

Model Railroad Hobbyist Store

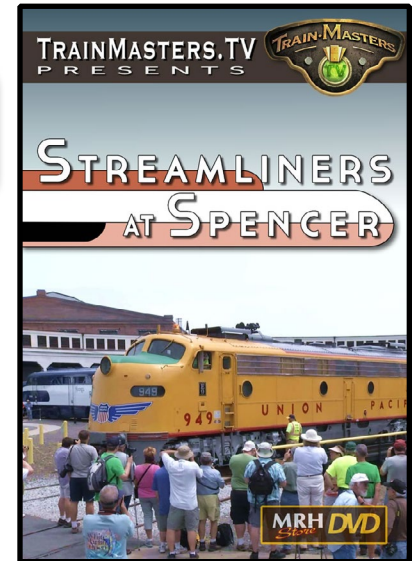

VIDEO, VIDEOS, WE HAVE VIDEOS! ... AND MORE

THERE ARE MORE THAN 20 NEW VIDEO TITLES

coming to the MRH Store in the next 60 days. We're pretty excited about all these new videos – most of them are TrainMasters TV original productions we produced in 2013-2014 and posted on the TMTV website for members to watch. Now they're coming to DVD and download for those of you who prefer DVDs and instant downloads to Internet streaming video.

Also, Ops Live 6, New Sharon Yard Operations on Mike Confalone's Allagash, is coming in the next 5 weeks. We're offering a pre-order special right now on the DVD, so don't miss out – [just visit this link](#).

STAFF NOTES | 2



The new TrainMasters TV video titles are from the TMTV sitesite, now offered on DVD or as video downloads. If you're already a TMTV member, then you are already able to access this video content.

New TMTV DVDs coming soon ...

These video titles will be available either as all-region DVDs or as instant video downloads you can download and keep:

Spencer Streamliners Event

1 disk: \$29.99 - Preorder special \$19.77

Best of TrainMasters TV 2014

2-Disk set: \$39.99 - Preorder special \$24.77

TrainMasters TV First Season, all 14 monthly shows

6-disk set: \$149.99 - Preorder special \$99.77

Individual monthly shows: \$19.99 - Preorder special: \$12.77

Monthly shows are:

Nov 2013 - Dec 2013 - Jan 2014 -
Feb 2014 - Mar 2014 - Apr 2014 -
May 2014 - Jun 2014 - Jul 2014 -
Aug 2014 - Sep 2014 - Oct 2014 -
|Nov 2014 - Dec 2014

Extreme weathering by Ralph Renzetti

1-Disk: \$19.99 - Preorder special \$12.77

★ LAST ISSUE'S RATINGS

The five top-rated articles in the [April 2015 issue](#) of *Model Railroad Hobbyist* are:

4.5 DCC Bus Wiring 101

4.4 DCC Impulses: JMRI: More than DecoderPro, part 2

4.2 Getting Real: Modeling the KCT - Trackwork

4.2 Modeling a well-worn Conrail (ex-Reading) GP35

4.1 Imagineering: Meet the "Gang of Six"

Issue overall: 4.4

Please rate the articles! Click the reader comments button on each article and select the star rating you think each article deserves. Thanks! ■

ADVERTISEMENT

**Check out the
Latest Atlas Track
and Accessories
Catalog!**

**Atlas offers the high quality track
and accessories you need to
build the layout of your dreams!**

CLICK HERE!

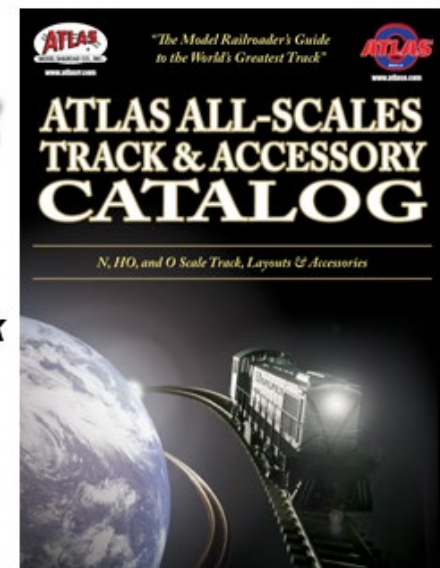

STAFF NOTES | 4

Backdrop painting techniques by Chris Lyon

1-Disk: \$19.99 - Preorder special \$12.77

TrainMasters layout tours (16 layout stories)

2-Disk set: \$39.99 - Preorder special \$24.77

The layouts in this set include:

- Tom Patterson's Chesapeake, Wheeling, and Erie
- Lex Parker's On3 narrow gauge layout
- Jim Rollwage's Union Pacific Wyoming Division
- Bob Bartizek's O scale Pennsy
- Whatever happened to the NEB&W?
- Fn3 Sundance Central
- Bill Doll's Forest Park Southern
- Pat Harriman's O-scale structures by the book

STAFF NOTES | 5

- Michel Boucher's Delaware & Hudson
- Tom Wilson's steel industry modeling
- Jerry Fassnacht's HO Pennsy/Reading layout
- Layouts at the 2014 National Train Show
- John Miller's HO-scale Kanawha and Lake Erie
- Quebec & New England RR operations
- Virginia Southwestern coal loaders
- The Aberfoyle Junction club layout

The preorder specials on the DVDs are available now, and the videos will ship in June. Once the DVDs are available, you will also be able to buy instant downloads of these same titles for roughly half the price of the DVDs, since there's no media production and shipping overhead.

ADVERTISEMENT



TamValleyDepot.com
Great Electronics for Great Model Railroads

Home of the Frog Juicer

We are loading up the boxcars with Frog Juicers ready for your layout!

ADVERTISEMENT



NICK & NORA DESIGNS
Uniquely inspired craftsman kits

Craftsman Structure Kits,
Detail Parts, Shingles & More!
www.nickandnoradesigns.com

Nick & Nora Designs
a division of:
TMB Custom Models

LIKE US ON  **facebook**

ADVERTISEMENT



Small Miracles

End wiring frustration with Touch Toggles™

- Elegant controls
- No drilling
- No soldering

See our website for a video introduction!

BERRETT HILL TRAINS
Made in the USA

What will they think of next? www.berretthillshop.com

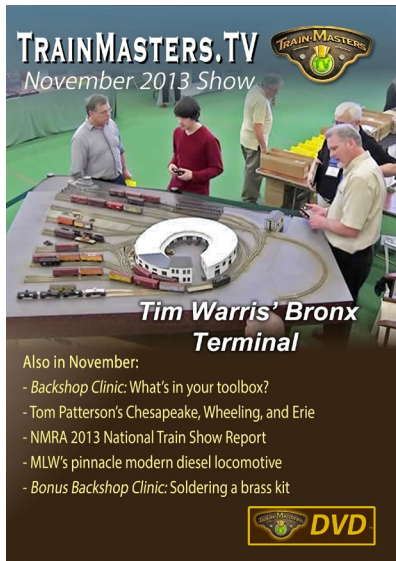

TrainMasters TV members can also buy these titles if they'd like their own personal offline copy by using their special TMTV member discount coupon code that's good for saving money on anything in the MRH store.

Why are we offering these videos?

When we did our video survey last summer for TrainMasters TV, many respondents said they didn't have the fastest Internet connection, and

they prefer to get DVDs so they can watch TrainMasters videos on their big screen TV.

Other respondents said they like the instant gratification of downloadable videos, and they prefer to own a copy of the videos so they can watch them offline whenever they liked, and would rather not be dependent on their web connection's ability to stream video smoothly.

So here you go – you're getting your wish! The 80-some original video stories done for TrainMasters TV will now be available to buy as DVDs or downloadable videos you can watch offline!

One less column, one more article ...

Bruce Petrarca is taking the month off this time. His column will be back next month. As a result, we added an extra feature story this issue to make up for there being one less column in the magazine than we normally have.

What's new on the MRH website?

There are a number of helpful discussion threads posted on our website every day, and if you're eagerly awaiting the next monthly MRH magazine, you can find threads that are almost like more articles there. Here's a recent sampling of these posts.

Bad car order forms: mrhmag.com/node/22200

Layout from Slovenia: mrhmag.com/node/10445

What's on your workbench - Apr 2015: mrhmag.com/node/22018

Ontario Northland MOW Flatcar 2092: mrhmag.com/node/22286

Preparing the basement: mrhmag.com/node/22280

A handy scale calculator: mrhmag.com/node/22197

Operating chain link industry gate: mrhmag.com/node/22249

ADVERTISEMENT

ONE STOP SHOP

N, HO, O, ON30, S & G

SHOP ON-LINE 24/7



FOR YOUR FAVORITE PRODUCTS:

ATHEARN | ATLAS | ARISTO-CRAFT | BACHMANN | BROADWAY LTD.
DIGITRAX | KADEE | KATO | K-LINE | LIFE-LIKE | LGB
LIONEL | MANTUA | MICROTRAINS | MODEL POWER | MRC
MTH | NCE | PECO | PIKO | SOUND TRAXX | TCS
WALTHERS | WILLIAMS | WOODLAND SCENICS | AND MORE...

SIGN-UP FOR OUR E-MAIL SALES

TRAINWORLD.COM

1-800-541-7010 e-mail: ORDERS@TRAINWORLD.COM

TRAINWORLD®/TRAINLAND® - AMERICA'S LARGEST INTERNATIONAL MAIL ORDER DISCOUNT TRAIN STORE

STAFF NOTES | 8

Scratchbuilding your own detail parts: mrhmag.com/node/22153

Construction of UP Caliente Sub: mrhmag.com/node/19999

Somewhere Southwest layout: mrhmag.com/node/21520

Red Mountain Railway layout: mrhmag.com/node/19041

Layout lighting options: mrhmag.com/node/22241

Indian Creek is finally done: mrhmag.com/node/22148

Siskiyou Line progress #2: mrhmag.com/node/22288

We hope you like the May MRH!



**Click here for
reader comments**

Get the Latest Model Railroading News, Tips, Reviews & Opinions

The SCOTTY MASON SHOW

S H O W
The Original Model Railroad Podcast

-Monthly Interviews

- Modeler's Spotlight: Top Modeler's Talk
- Narrow Gauge Modeling w/Chris Lane
- Contemporary Modeling w/ Mike Rose

-More Product Announcements & Reviews

Our feed has changed! To get the latest shows, Please search Scotty Mason and subscribe to the new feed!

www.TheModelRailroadPodcast.com

Scott Mason Jimmy Simmons Mike Rose Joe Duckworth

ADVERTISEMENT

END OF TRAIN DEVICE

FLASH CIRCUIT
UNDER TRUCK



TRACK
POWERED

READY TO RUN!

**Bright Red
Flashing Light!**

Installs in minutes
with no freight car
modification required!

RE RING
ENGINEERING

Patented Technology - US Patent 7,549,609

Does not affect Load!

↓ Car without Load ↓

↓ Car with Load ↓



For video
and more
click here!

MRHMAG.COM

ADVERTISEMENT

TRINITY 3281



CMO - 12 road numbers \$48.95 each

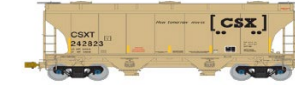

CSX - 12 road numbers \$48.95 each



TILX - 6 road numbers \$48.95 each



WSOX - 6 road numbers \$48.95 each
plus CRDX and MCEX

American Limited

www.americanlimitedmodels.com

ADVERTISEMENT

LOOK
at what's new at
Black Cat this month

Click here for
our orderform

New this month:
NP/SP&S box car
with 60" monad
CNR Side dump Gondola

Black Cat Publishing
234 Lindenwood Dr. W.
Winnipeg, MB R3P 1X7
(204)489-5005
ajfergus@mymts.net



• TABLE OF CONTENTS
• INDEX

Introducing the **Model Railroad** **ALL NEW Hobbyist Store**

store.mrhmag.com



DVDs

Visit the MRH Store

FREE SHIPPING



10-Vol video set
Get our ten most popular videos and save!
~~\$259.50~~ **\$149.00**



5-Siskiyou Line set
Get all five Siskiyou Line videos for a special price!
~~\$149.75~~ **\$99.00**



2-Vol scenery set
Get both our popular Siskiyou Line scenery videos and save!
~~\$59.00~~ **\$39.00**



Allagash Scenery set
Add these must-have scenery videos to your collection!
~~\$59.90~~ **\$39.00**

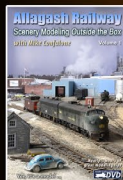

Allagash scenery-1
Simple but brilliantly realistic scenery techniques.
~~\$29.95~~ **\$24.00**

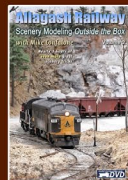

Allagash scenery-2
Small space but big scenery techniques that rock!
~~\$29.95~~ **\$24.00**



Ops Live-5 Allagash
Get our newest Ops Live video on the Allagash today!
~~\$19.95~~ **\$14.00**



4-Vol Ops Live set
Ops Live 1-4 on the Siskiyou (1-2) and Bear Creek (3-4).
~~\$79.80~~ **\$49.00**



Pine Ridge Railroad
An amazing Gorre & Daphetid look-alike by Tom Hokel.
~~\$19.95~~ **\$14.00**

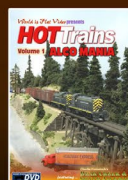

Hot trains - Alcomania
A don't miss railfanning video of the Bear Creek & South Jackson!
~~\$29.95~~ **\$24.00**



Videos available for instant download!



Tenmile Creek HD video
Get our highly popular Tenmile Creek scenery how-to.
\$14.99 HD video

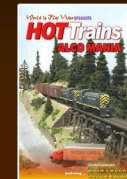

Hot Trains HD video
See the Bear Creek & South Jackson layout vision come alive.
\$9.99 HD video



Sound decoder install
MRH DCC columnist Bruce Petrarca installs a sound decoder.
\$5.99 HD video



OPs Live-5 HD video
Live operating session on Mike Confalone's Allagash Railway.
\$7.99 HD video



eBooks available for instant download!

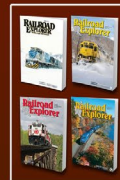

RR Explorer 37, 40, 41, 42
Four digital volumes of Railroad Explorer loaded with superb photography.
\$14.77 PDF • ePub • Kindle



Railroad Explorer #40
Eastern Rail Journal - superb photography and railfan stories.
\$5.99 PDF • ePub • Kindle

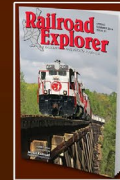

Railroad Explorer #41
Eastern Rail Journal - superb photography and railfan stories.
\$5.99 PDF • ePub • Kindle

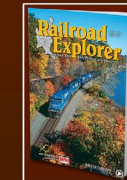

Railroad Explorer #42
Eastern Rail Journal - superb photography and railfan stories.
\$5.99 PDF • ePub • Kindle



Allagash Story 1-4
In-depth story of Mike Confalone's Allagash layout in 4 volumes.
\$24.77 PDF • ePub • Kindle

Visit the MRH Store

store.mrhmag.com

FREE SHIPPING! Use coupon code: FREE-SHIPPING

Coming soon! TrainMasters.TV DVDS / downloads

Bowser

EXECUTIVE LINE HO ALCO Century C-628

Ready To Run and fully detailed. Featuring revised tooling, MU hoses, air hoses, windshield wipers, operating headlight, can motor, flywheels, blackened nickel silver wheels with RP25 flanges. Handrails installed. Available with sound and DCC or just DC. Analog (DC) version features NMRA 21 pin plug for DCC, DCC/Sound version features LokSound Select decoder. DC Version \$199.95 Sound Version \$299.95



Still in stock & in stock at distributors - order yours today!

HO ALCO Century C-636

Ready To Run and Detailed. Features: air hoses, windshield wipers, grab irons, coupler lift bars, operating headlight, window glass, can motor, flywheels, nickel silver wheels with RP25 flanges and knuckle couplers. Available with sound and DCC or just DC. Analog (DC) version features NMRA 21 pin plug for DCC, DCC/Sound version features LokSound Select decoder. DC Analog Version \$199.95 Sound/DCC Version \$299.95



Click here to check out the details for these and other great Bowser products!

MRHMAG.COM



Model Railroad Hobbyist | May 2015 | #63

MRH Q-A-T

column

compiled by
JOE BRUGGER



[Click here for reader comments](#)

? QUESTIONS AND ANSWERS

Superelevated curves

Q. I've never built a layout with superelevated curves, but after seeing some really cool pictures taken on layouts that have them, I'd like to give it a try. How much do you super-elevate the curves? Do superelevated curves cause any problems with long trains? Should I lay down a fillet of vinyl spackling to fill the void from elevating the outside edge?

—Paul Krentz

A. Crandell: Generally, less is more. With a small increment, you are on the right track. Superelevation has two main considerations: speed and curvature. I have seen steam-headed drag freights rounding superelevated curves at a crawl in the prototype that made me wonder if it was safe. I have video of hulking Norfolk & Western articulateds seeming to want to tip over on curves elevated so much that it was scary, but they trundled right along. Later, a fast articulated A Class came

► MRH QUESTIONS, ANSWERS, AND TIPS

- [TABLE OF CONTENTS](#)
- [INDEX](#)

MRH Q-A-T | 2

thundering around the same curve near 45 mph and it looked much more reasonable.

You don't need to spackle to fill voids. Ballast grains, once groomed to look right, will do that, and the glue will do the rest. Save yourself the trouble.

I used MDF splined roadbed on a past layout. I merely canted the risers supporting the roadbed splines. Instead of having them plumb, I'd tilt the top maybe a degree and a half, perhaps more, and when the splines were attached, they adopted the correct superelevation. From there, I affixed the ties directly to the roadbed using a thin sheen of DAP acrylic latex caulking.



1. A C&O 2-6-6-6 Allegheny leans into a superelevated curve. Crandell photo

MRH Q-A-T | 3

Joe Musgrove: There are different methods to get your super-elevated heights. I used plastic shims under my ties. The link below will take you to a method using layers of masking tape under the roadbed.

While the method and materials can differ, there are rules most of the experts go by to prevent issues.

1. Use proper easements on your curves.
2. Superelevation should not exceed six prototypical inches: 1/16 inch for HO, 1/32 for N scale.
3. Even with a slight elevation, you want to ease into your maximum height. You would not want to go from no elevation to your maximum elevation in one step.

Don't force it! A tighter curve radius may prevent going with the maximum allowable elevation. Don't increase your elevation to rapidly to make it fit. Even a slight elevation will give the observer the impression of trains leaning into the curve.

I start the height adjustment right before entering the curve with a slight elevation increase every two inches. More at rgwrail.com/SuperElev.pdf.

Verne Niner: Superelevation of curves added a lot of enjoyment on my previous N scale layout ... simple shims cut from cereal box cardboard was all it took, placed under the outside edge of the flex track.

Cajon Pass Jon: On all American railroads, superelevated track has the inside rail height unchanged so shimming the outside of the ties is not accurate because that raises the inside rail. It may be argued that this is a small effect but it also

MRH Q-A-T | 4

leaves the inside rail unsupported and subject to deflection due to bending of the ties. I think a better way is to mount the subroadbed on risers and tilt it to create the superelevation. If the risers are attached to the benchwork with screws you can adjust the angle to get the right look.

By carefully measuring the height, as well as the angle, of the riser you can keep the inside rail at constant elevation. To set the riser angle you can use any of a number of digital levels available that measure in degrees. Using some simple triangle geometry it turns out that the tilt angle in degrees equals the height of the outside rail in inches to within about one percent. This applies to any scale. A prototype superelevation of three inches is achieved by a tilt of three degrees. I model the steam-diesel transition era, and by experimentation I have found that about two degrees looks right.

Paul Krentz: Before actually laying some superelevated curves I decided to do some tests to see what looked

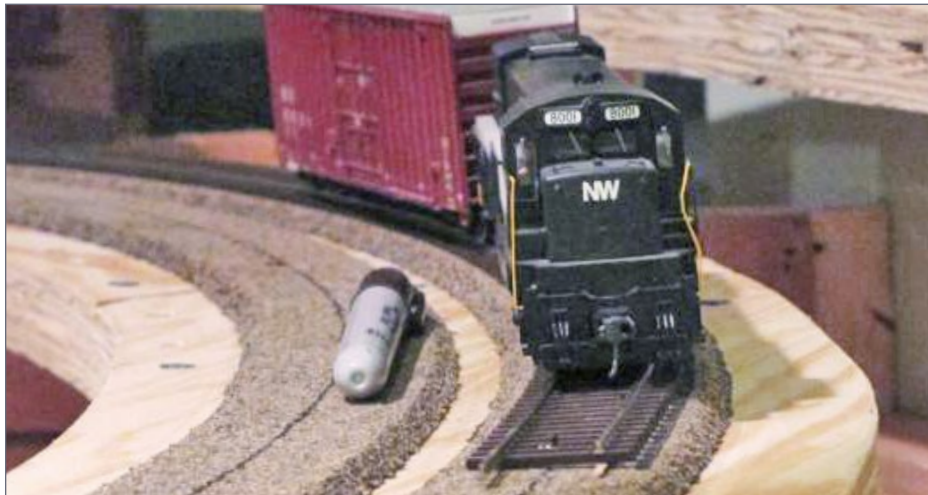

2. A 1/32" shim under the rail produces a distinct superelevation effect. Paul Krentz photo

MRH Q-A-T | 5

good. I think you all are absolutely right about too much superelevation looking toy-like.

To superelevate my curves, I'm using 1/32" basswood strips. On the following picture [2] I have the basswood strip directly under the outside rail.

In the next picture [3] I moved the basswood shim strip out to the very end of the ties.

It's not a very big change, but personally I think the second picture looks better. I just get the feel that there's some real weight involved going around the curve. I don't get that same impression with the first picture.

You might be right about the inner rail being raised slightly and possible deflection of the ties occurring because of that unsupported rail. If you glue down your track with white glue though as I do, that might not be an issue. I usually put a bead



3. A 1/32" shim at the outside edge of the ties the rail produces a less obvious effect in HO. Paul Krentz photo

MRH Q-A-T | 6

of white glue down the center line, flatten it out a bit with my finger, then lay the track in it. I've decided that on my super-elevated curves I'm going to put the glue bead a little more toward the inside of the curve. That way it will grab the ties and hold the track in place better.

Ted Shasta: The curves on my HO scale layout have a minimum radius of 48" and maximum superelevation of .040" measured at the outside rail. As noted in other posts, easements are critical in laying out super-elevated curves. For 48-inch radius curves, I use a 1/2-inch offset and a 28-inch easement. Superelevation takes place evenly throughout the easement at .005" every 3.5 inches. While prototype practice varies, a typical



4. Rich Abramson used 1/16 X 1/8 inch stripwood shims, placing the 1/16 side for the elevation. The 1/16" in HO equals 5-7/16" in actual elevation. He sanded ramps at the ends of the stripwood to form a gradual vertical easement.

MRH Q-A-T | 7

ELEVATION OF OUTER RAIL IN INCHES						
Degree of Curve	Velocity in Miles per Hour					
	10	20	30	40	50	60
1/2	0	1/8	3/8	1/2	7/8	1 1/4
1	0	1/4	5/8	1 1/8	1 5/8	2 3/8
2	1/8	1/2	1 1/4	2 1/2	3 3/8	4 3/4
3	1/4	3/4	1 3/4	3 1/4	5	6
4	1/4	1	2 3/8	4 3/4	6	
5	3/8	1 1/4	3			
6	3/8	1 1/2	3 5/8			
7	1/2	1 7/8				
8	1/2	2 1/8				
9	5/8	2 3/8				
10	5/8	2 5/8				

5. A table in "Track and Turnout Engineering" by C.M. Kurtz, published in 1945 by Simmons Boardman, relates super-elevation, degree of curvature, and train speed.

maximum rate of vertical change is 1 inch every 62 feet, equivalent to .0047 inches of vertical change for every 3.5 inches of linear travel. Close enough. I use styrene shims of varying thicknesses to achieve smooth and predictable transitions.

For more, see mrhmag.com/node/21690.

Scenery in staging?

Q. In a visible staging yard, what do you do for quick and easy scenery? I don't like the idea of just tracks on cork in staging. I'd like to give the staging yard the look of a yard, without all the work of actually ballasting each track. What have you done to make your staging look better? Something between bare cork and fully scenicked, quick and easy, but at least presentable. —Randy Seiler

A. Clackamas: Our main staging area is off-scene and has

May 1869?

CLICK TO KNOW MORE

Like the Transcontinental Railroad revolutionized the transport of goods from coast to coast. Making it faster, flexible and more economic. Microscale has worked toward delivering the finest quality modeling products world wide.



Proudly made in the U.S.A.



www.microscale.com



MRH Q-A-T | 8

white paint on the Homasote track base, as well as white paint on the walls. All that brightness makes it a lot easier to read car numbers and reporting marks. For a three- or four-track staging/interchange yard at the end of a branch, adjacent to the scenicked part of the railroad, we plan very basic standard ground cover, with minimal detailing, if any.

Joe Atkinson: I struggled with my operators and I having to look at my staging yard for quite a while. Eventually I just put up a taller fascia, as covered in *Model Railroad Planning 2015*. Trains are still easily accessible, but to me at least, it seems cleaner and less cluttered now.

Dave B.: I like to look at yards both on scene and staging so minimal scenery is the way I go. A staging yard doesn't need a lot of care in ballasting, I'd put some rock along the tracks and blend it with cinders or

MRH Q-A-T | 9

dirt in between the tracks. A few puddles in the ditches and a MW pile of rails and ties along the yard perimeter helps the atmosphere too.

M.E. Simpson: While at the local Canadian Tire, I happened into the paint department. I recalled an article in a magazine about using texture paint for "ballasting" around switches in order to make them look ballasted while at the same time keeping stray granules away from the points. I found several types of texture paints by Krylon. I decided to try out the "Make It Stone" one with a dark gray base color with black and tan splatters mixed in.

The ballast on my Hudson Bay Railway is a mixture of crushed granite, limestone and possibly basalt, depending on which ballast pit supplied the material. Colors tend towards the gray and black tones with

Combo Right Clamp™

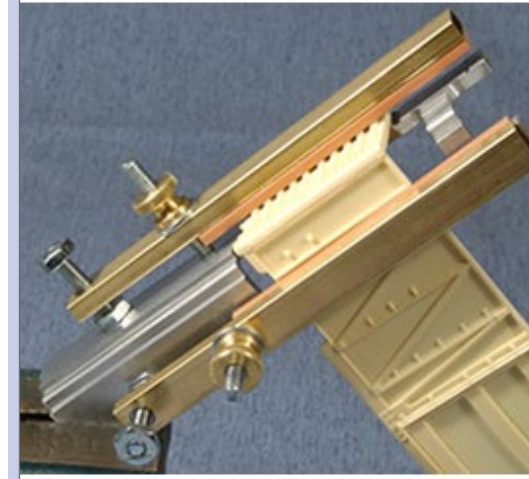

Combo Right Clamp™ with cast resin boxcar

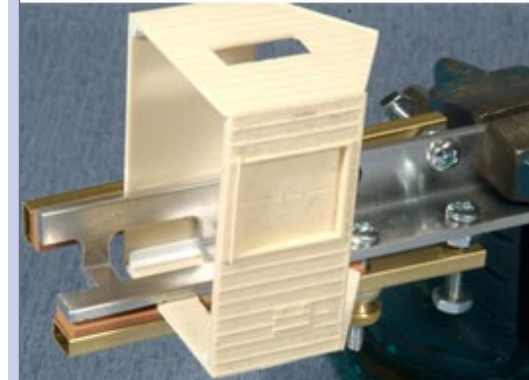

Combo Right Clamp™ with Wolf Design Pump House

[Click here for all our products ...](#)

Tools for Modelers

Coffman Graphic Solutions Co

- [TABLE OF CONTENTS](#)
- [INDEX](#)

some off-white to cream colors mixed in. The Krylon looked quite similar to what I wanted to use for the ballast colors, so I picked up a can.

After the kids were in bed I headed down to the layout to test the spray. Realizing that there would likely be overspray, I took a piece of cardboard and backed the area I planned to spray [6] to minimize collateral damage.

It looks quite good, in my opinion, as it has relatively fine splatters and a matte finish which won't require a matte overspray. The only drawback is the paint is fairly strong-smelling, so ventilation is required.

Look at: krylon.com/products/make-it-stone-textured-paint

testors.com/product-catalog/testors-brands/createfx/specialty-paint/texture-spray

valsparpaint.com/en/find-the-right-product/interior/spray-paint/stone.html

rustoleum.com/product-catalog/consumer-brands/stops-rust/multicolor-textured

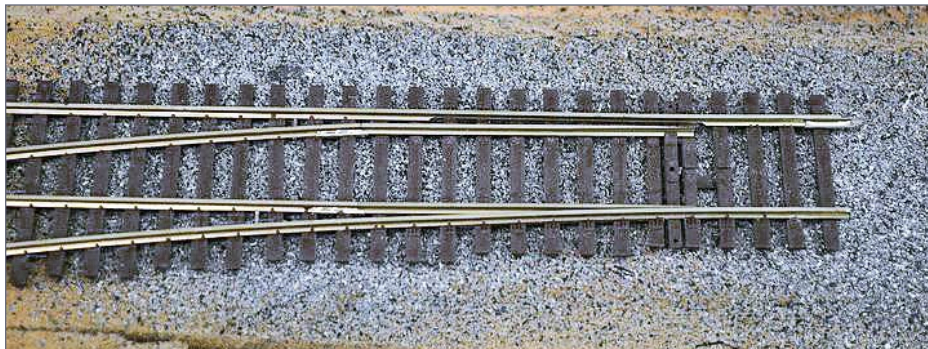

6. Krylon's textured spray paints have a matte finish and a slightly uneven, multicolored surface

 TIPS

Ancient solution to a modern problem



I often find myself with scenery material on hand that strikes me as being too coarse to be convincing on an HO layout. This could be dirt from a parking lot, dried leaves, or commercial tree foliage that was actually intended for a larger scale. Over the years, I've bought several used blenders and coffee grinders to grind down this stuff to a smaller

size, but most of these tools wouldn't grind fine enough to satisfy me, and none gave me the ability to vary the final size easily.

I found my answer in the past: the ancient hand-powered mortar and pestle, which many use to crush and grind spices for cooking. I bought mine for under \$15 at a kitchen supply store. With it I reduce dirt and other scenery material to the size and texture I want simply by varying how long I grind it. Now my dirt roads look less clumpy to me, and I feel that my foliage and the deadfall beneath my trees is more convincing.

—Fritz Milhaupt

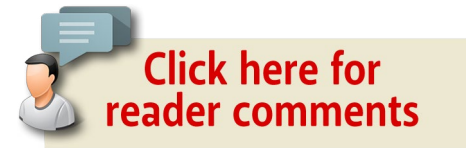

MRH Q-A-T | 12

\$ GET PAID FOR YOUR TIP

We pay \$25 per tip we publish, or \$40 each if the tip also includes a photo or finished drawing. [Click here and select article type TIP.](#) ■



Click here for reader comments

ADVERTISEMENT

RailPro™

NEW TECHNOLOGY

DIRECT™
RADIO



Click Here to Learn More



RE RING™ ENGINEERING

NEW Starter Kit \$399.99 MSRP

- Includes Wireless Color Touch Screen Handheld Controller and 56 Watt Power Supply
- Expandable to Virtually any Size Layout

NEW Locomotive Module LM-2 & LM-2S

- Direct Radio RF
- Sound and Non-Sound
- New Tiny Size
- 6 Light Outputs



For more information visit our Internet site: www.RingEngineering.com



FAST TRACKS

YOUR VERY OWN TRACK FACTORY

Make the most of your modeling experience.

Build perfect trackwork easily and inexpensively when YOU want it!



★ ★ ★ ★ ★

Check out our extensive (and growing!) online video library to learn how easy it is to hand lay your own trackwork with Fast Tracks tools and supplies.

Play Video ▶



HELPING THE WORLD

BUILD BETTER RAILROADS

shop online 24/7

handlaidtrack.com

1-888-252-3895

service@fast-tracks.net



Southern Digital



**20% Discount
on most items!**

Specializing in DCC Since 1992



DCC Conversions, Service & Support

Orders Received by 3:00 pm EST ship the same day

WWW.SODIGI.COM

E-mail: sales@sodigi.com

(770) 929-1888

(Photo's are from our N-Scale layout)



Model Railroad Hobbyist | May 2015 | #63

GETTING REAL

column

MARTY MCGUIRK
.....



**Click here for
reader comments**

INCORPORATING PHOTOS INTO A BACKDROP

HANDLING THE TRANSITION BETWEEN

the a three-dimensional layout and a two-dimensional backdrop can be challenging.

While I've seen many very well-executed photo backdrops (where pictures of real scenery are pasted to the walls of the layout room), I've found in many cases a photo mural backdrop incorporates so much "hyper reality" it can actually attract more attention than it deserves and draw the eye away from the modeled scene. I mean, it is a photo, so that wealth of well-defined detail has to be expected.

Lighting is another issue I've noticed with photograph backdrops. In person, photo backdrops often look fine, but in photographs, if they extend much above the horizon line they tend to wash out, so the colors of the background trees and scenery never really match those modeled on the layout.

► **MODELING REAL RAILROADS AND WHAT THEY DO**

GETTING REAL | 2



1. When the author found painting a road onto the two-dimensional backdrop was beyond his skills, he used a photo to handle the transition.

The third issue is cost. For a small layout, a photo mural can fit in the model railroad budget. For a large basement-sized layout like mine, a photo backdrop can be a budget buster that quickly exceeds the cost of several brass locomotives!

The other option is painting backdrop elements using artists' acrylic paints. As you can tell from the photos, this is the approach I've taken for the majority of my backdrops.

They aren't perfect, but I actually find I enjoy painting them. It's a process I find so engaging I get lost in it. While the resulting artwork will never hang in a gallery, I enjoy doing it, and it serves the purpose of visually extending the railroad beyond the walls of the room.

GETTING REAL | 3

I can handle painting distant hillsides and some suggestions of clouds [2] using techniques I've picked up from watching two excellent online video series – one from Chris Lyons on Train Masters TV, the other a series that Jay Smith presented on MR Video Plus.

If you're looking to get started with painting a backdrop for your model railroad, I highly suggest one or both of these. But painting things like buildings, fences, roads, and the like present a challenge far exceeding my skills.

In the case in question, the scene consists of a country lane that starts at the fascia, crosses the tracks, and then runs almost directly into the backdrop. The challenge was getting the road



2. One of the author's first attempts at painting a backdrop uses tips from MR Video Plus and TrainMasters TV instructional videos.



3. Initial attempts to paint a road extending into the distance were less than convincing.

to appear as if it continued into the distance and didn't suddenly end at the wall. The completed scene is shown in [1]. How I got to this point may be of interest, if you're facing a similar challenge on your layout.

My first attempt at painting the road onto the backdrop [3] was, to say the least, less than satisfactory.

I've come to terms with the fact that I stink at painting man-made objects like buildings, trains, ships, boats, and yes, even roads. So, using a photo for the road seemed to be a logical solution.

Bernie Kempinski has successfully incorporated photos of structures (barns, houses, and the like) into painted backdrops. In fact, he and I cut out some farmhouses and barns, and pasted

them to my backdrop at few other locations on the layout [4] so I knew combining the painted backdrop with photos for detailed elements would work.

But would this technique work for something larger than a small distant barn or farmhouse?

The buildings can be readily blended into the scene by painting a tree or bush around the base, or even partially obscuring the building with a larger tree. I was concerned a larger photo incorporated into the otherwise painted "stylized" backdrop would be distracting and unrealistic.

I decided to test the concept a little further, and see if I could use a photo to transition the road from the 3D scenery to the



4. A photo of a farmhouse and barn, pasted to the wall, blends into the painted backdrop. The bottom edge of the print was visible, so we painted in some trees to match those in the picture.



5. This prototype scene, photographed in October in rural Maryland, was used for the backdrop road.

backdrop. As you might expect, the key to success with this process is starting with the right photo. I took this photo [5] in Maryland last autumn.

Although I didn't realize it at the time, the photo works so well because of the lighting – the trees on the side of the road create a shadow but there are no shadows in the foreground, and the road drops downhill slightly before rising up a distant hill. In my case, this present-day country back road was ideal because I'm modeling a remote two-lane road in rural Vermont in the 1950s. I didn't want a lot of markings, lane lines, and the like.

I reduced the photo to the size where the road just about matched the width of the modeled road, and then printed it on

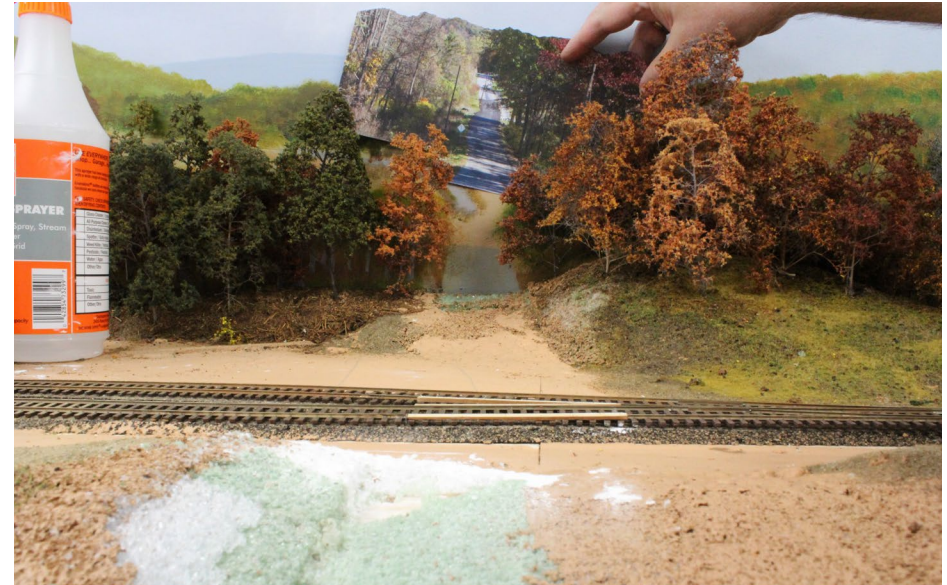

6. Sliding the printed photo into place.



7. The background photo in position, prior to completion of paving.

GETTING REAL | 8

ordinary color photo paper. I trimmed the sky and some of the foreground out of the print and slid the picture into place [6].

I did move some of the trees around, since the picture has green trees on the right and almost barren trees on the left [7]. This helped to blend the image into the foreground.

Once the photo was in place, I finished the grade crossing, added some details to the road, and added sifted dirt, static grasses and the like.

I think the resulting scene looks convincing in photos and in person.



Click here for
reader comments

Want to help
keep MRH free?
Then click on
Ads!

ADVERTISEMENT

iwata

by ANEST IWATA

Just Rolling By...

Make It **REAL** With Iwata *Climb Aboard!*

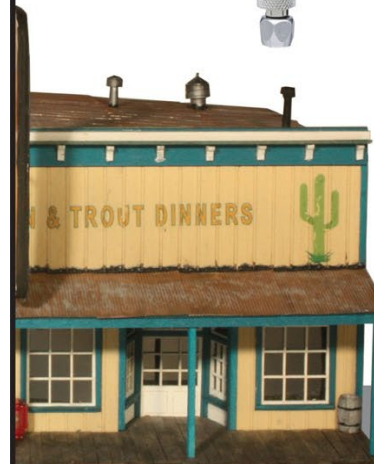
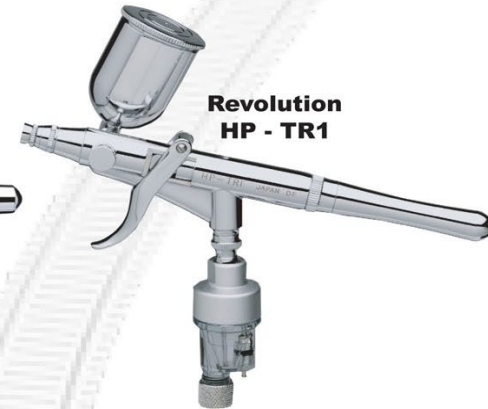

Visit...
www.iwata-medea.com
To Check Out Our
Full Product Line!

Models By... Alan Houtz,
North American Prototype Modelers



Digitrax No Worries Warranty Keeps Your Layout Running!

That's it! A simple, straightforward one year warranty with no tricky language!

You're protected against defects and accidental damage.

Learn more at: www.digitrax.com/noworries

Need tech support?

www.digitrax.com/contact

Need a repair?

www.digitrax.com/repair

Need a throttle conversion?

www.digitrax.com/upgrade

NORTH AMERICAN RAILCAR CORPORATION



Hawker Siddeley
4550 cu.ft.
Cylindrical
Hopper



CLICK HERE FOR
HO Scale



CLICK HERE FOR
N Scale

NARC Cars are sold
exclusively through

Pacific Western Rail Systems

MRHMAG.COM

Model Railroad Hobbyist | May 2015 | #63



KEN PATTERSON

WHAT'S NEAT WITH KEN PATTERSON

column



Click here for
reader comments

SIX SEGMENTS THIS MONTH COVER WEATHERING, A SMALL LAYOUT PROJECT, WORKING WITH ROCK, AND MUCH, MUCH MORE ...

WE START WITH JEFF MEYER AND AN OUT-
door photo shoot featuring his ex-Rock Island, now CNW, box-
car with a cool "wavy metal" weathering effect Jeff creates with
oil paint. By dry-brushing black oil paint, and then feathering it
out with a makeup sponge, the car has the appearance of wavy
metal sides. With a little experimenting you can master this
technique in an evening. Study prototype equipment and how
the sun plays on the dirt collected on the top side of each flexed
metal panel to understand the affect you are trying to achieve.
Jeff also shot photos of some Tangent hoppers he gave a simple
airbrush weathering.

▶ PHOTOS AND VIDEO OF SUPERB MODELS

- [TABLE OF CONTENTS](#)
- [INDEX](#)

WHAT'S NEAT | 2



WHAT'S NEAT | 3



Playback problems? [Click here ...](#)



1-3. Jeff Myer photo shoot.

WHAT'S NEAT | 4

In the second segment I talk about a project layout for Athearn. My assignment was to lay the track and finish the scenery on a folding 4x6-foot layout. We used Bachmann E-Z Track and ballasted over it. The folding design was achieved with piano hinges. The magic was the fact that the layout scenery was finished with fake fur as grass. This hid the door hinges and allows the scenery to fold without any damage. The overall effect is very nice. The layout can be folded for transport to train shows, or stored in the garage until you feel like running trains.



WHAT'S NEAT | 5



4-7. Project layout for Athearn.

WHAT'S NEAT | 6

The third segment of the video show covers the subject of making your own ballast and scenery rock. I take you to a creek where I screen raw rock material through eight different sizes of screen to make scenery material sorted by size to use on our layouts. A restaurant supply house is a good source for various sizes of colanders and deep-fry baskets that allow the screening to be done quickly. I get rock sizes ranging from ½-inch ballast to 1- to 2-inch stones, 3- to 4-inch, 6-inch and 8-inch rock, and boulders from 1 foot to 3 feet, and 6 feet to 8 feet. We then

can select material for the layout to achieve the effect we are trying to create.



WHAT'S NEAT | 7



8-11. Making your own ballast and scenery rock.

WHAT'S NEAT | 8

Segment four talks about an idea I came up with, of embedding layout wiring in foam to hide it under the layout. Great Stuff's Pro Foam dries in 30 minutes and can be cut with a saw to cover the wires in a routed groove. This works really well, and leaves the underside of your foam modules looking clean, with no dangling wires to snag.

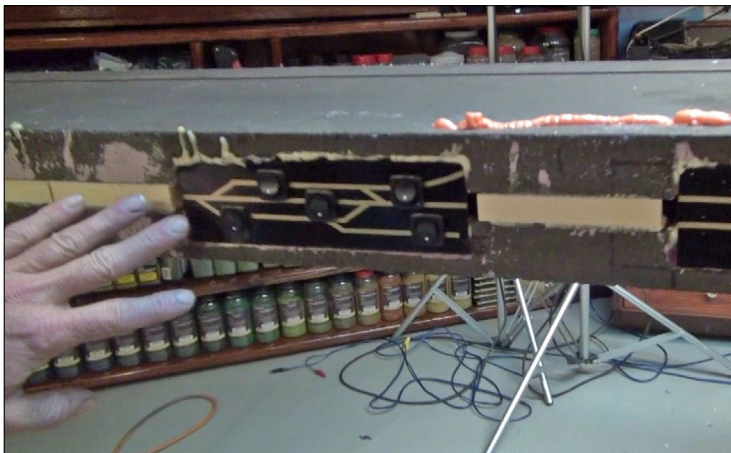

12-13. Embedding layout wiring in foam to hide the wires.

TONY'S TRAIN XCHANGE

Committed to your DCC support!



The Jack-Wabbit Quad™ 4 Output Stationary Decoder



Patented Features:

Auto Throw™, Auto Throw™ Timer,
Auto Return™, Smart Route™,
Dispatcher Over-Ride™, Lock Block™, Locked
Route Control™, Smart Default Ops™,
and Smart Power Routing

Compatible with Stall Motors,
Snap Coils, Servos and all Others! Use Stall
Motors & Solenoids Simultaneously! Feed Back, Turnout
Position Reporting to: Digitrax (LocoNet), Lenz (ExpressNet)
and NCE (Cab Bus). Optional Direct Interface to LocoNet!

Starting at \$55.95

Order Yours

Do you need a Sound or
DCC Installation done?

Get a quote!

**TONY'S
TRAIN
XCHANGE**
DCC SPECIALISTS

Providing unmatched person to person
DCC support for more than 20 years, the
kind of service that has made us #1 in DCC.
DCC questions? CALL US! 1-800-978-3472
*Mention this ad for \$5.00 off your next order over \$100!

We'll get you on the right track!

May 2015



WHAT'S NEAT | 9

Then, we move on to modeling three-rail dual-gauge track in HO scale, and making live-frog turnouts DCC-friendly. This subject is easy to understand and accomplish successfully, as long as you follow specific instructions. What do I mean by that? You must cut notches with a Dremel cut-off wheel on the center rails nearest to the frogs. Then you must solder jumper wires under the turnout between the ties. These jumper wires feed power beyond the frog, from the outside rail of track 1 to the outside rail of track 2. Then you do the same with the inside rail of track 1 to the inside rail of track 2.

This ensures short-free operation with both DCC and DC systems. The points conduct the power to the frog in what is referred to as a live frog turnout. Shinohara HO scale code 70 and narrow gauge 2- and 3-rail turnouts have live frogs. Code 83 Shinohara turnouts have insulated “dead” frogs, and are referred to as DCC friendly. This segment shows how to make live frog turnouts DCC friendly by eliminating possible short circuits, and is demonstrated live in the video. The video is a lot easier to understand than a step-by-step textbook.

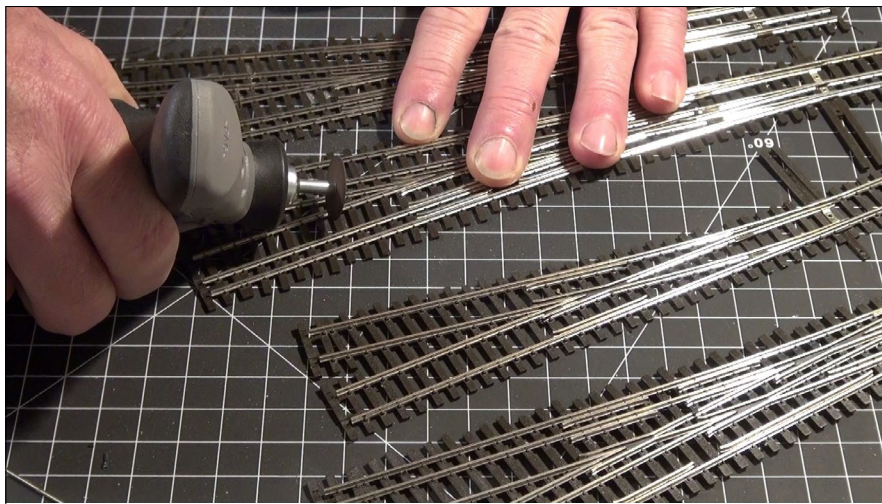

WHAT'S NEAT | 10

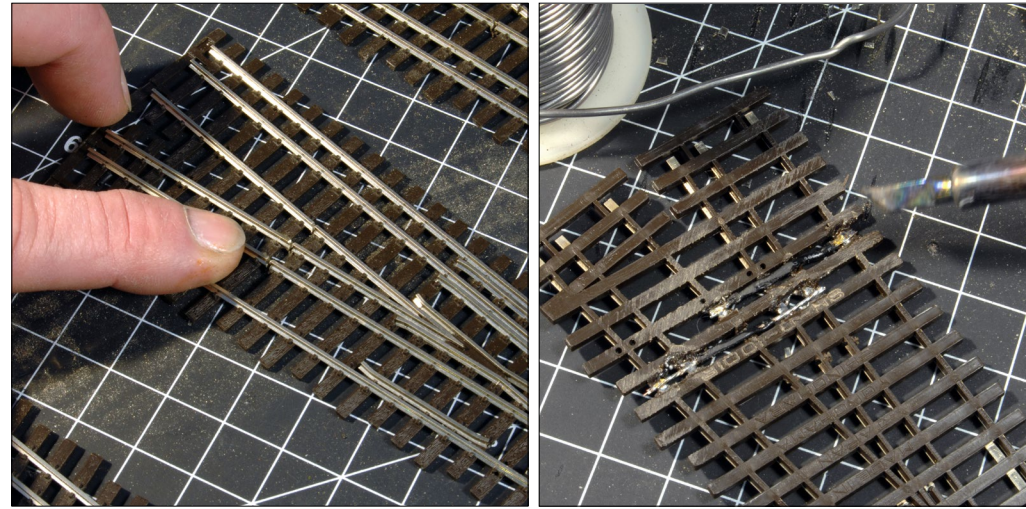

14-17. Modeling the three-rail dual-gauge track.

WHAT'S NEAT | 11

I have been laying a lot of code 70 rail as third rail on my existing HO scale track so I can run some Colorado narrow gauge equipment. I have put down about three scale miles of dual-gauge track in the last four weeks. So far, things are running smoothly. Wipe the underside of the rail clean, apply some contact adhesive to it, then gauge the rails and spike it into place on your existing HO scale track.

It is very interesting to switch with a idler flat car with a set of couplers allowing standard gauge locomotives to pick up narrow gauge cars. This really adds a lot of interest and operating potential to my existing home layout, without tearing it out and starting over. It is the best of both worlds, and doesn't cost a lot of money or take much time to finish. Finally I can run the wonderful Blackstone models on my HO layout.



WHAT'S NEAT | 12



18-20. Adding a third rail to run HOn3 trains on standard-gauge flex track.

WHAT'S NEAT | 13

Segment six is an overview of how an ultrasonic cleaner helps in cleaning airbrush parts and paint bottles. The cleaner is also useful for removing fine sand after sandblasting a brass model prior to painting. In the video there is visual action as the paint bottles are cleaned in a bath of lacquer thinner, right before your eyes. It is also great for cleaning your wife's jewelry, as long as you don't put her pearls in it. They will explode! Not good!



[Click here for reader comments](#)

WHAT'S NEAT | 14



21-23. Cleaning your airbrush parts with an ultrasonic cleaner.

WHAT'S NEAT | 15

For the big wrap-up this month, I photograph a C-19 locomotive on my water reflection diorama during a sunrise. I vary the exposures from 1/2 to 1 second, and use an f/25 aperture setting to make the photos clear and crisp. There are a lot of visually pleasing modeled runbys that can't be enjoyed in still photos. Trust me, this month's video is full of pretty runbys in various scales, using some new video tools and tricks that up the game of production quality to a higher level. Use the Readers Comment feature to tell us what you think, and please rate the column.



24-25 (following page). Blackstone sunrise.



**Click here for
reader comments**

Have you seen this?



**CHECK IT
OUT!**

kenpatterson.com

click here to ...

Visit Ken's website

Ken Patterson reveals his modeling secrets on video!



A NEW WAY OF LOOKING AT HO LAYOUT ACCESSORIES... IN ASSOCIATION WITH

RAPIDO
TRAINS INC.

RailCrew

Coming in July!



ON-OFF REMOTE UNCOUPLER

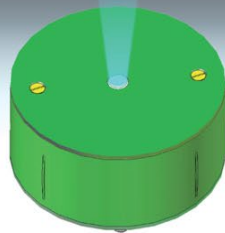

SWITCH MACHINE WITH OPERATING SWITCH STAND

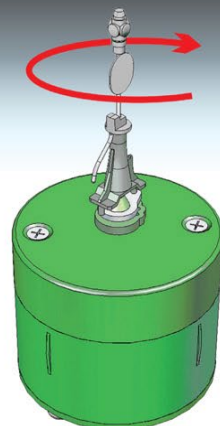
Includes 10 different
etched targets!

CLICK
HERE

to see them
in action!

MRHMAG.COM



DAVE MEEK
.....

Model Railroad Hobbyist | May 2015 | #63

IMAGINEERING

column



Click here for
reader comments

A MODEL RAILROAD AS THEMED ENVIRONMENT ...

I'D LIKE TO FOCUS MORE ON THE "WHY-TO" THAN the "how-to." Future columns will no doubt delve more deeply into the nuts-and-bolts of presentation, but for now, I want to discuss the general principles of themed design and how they apply to the hobby of model railroading.

My On30 Thunder Mesa Mining Company layout is a freelanced work of fiction. While it borrows from the long tradition of trains at Disney Parks, in building it, I also try to emulate Disney's design process and strong focus on story. My goal is to create an immersive and entertaining miniature world built around model trains. I like to think of it as a place for stories to happen. A place Disney Imagineers would call a "themed environment."

At its most basic level, a themed environment is a designed space for interactive storytelling. It's a place to play. It can be a room, a store, a restaurant, a single attraction, or an entire park. The idea borrows many tricks and techniques from movie making but

▶ EXPLORING THE CREATIVE SIDES OF THE HOBBY

• [TABLE OF CONTENTS](#)
• [INDEX](#)

IMAGINEERING | 2

applies them to a three-dimensional space that people can move through and experience. Often, themed environments represent idealized versions of other times and places, providing an entertaining escape from the day-to-day world. They employ what legendary Disney Imagineer John Hench called “enhanced reality;” using form, color, sound, and other sensory cues to immerse you in the story. Naturally, all Disney parks are wonderful examples of themed environments.

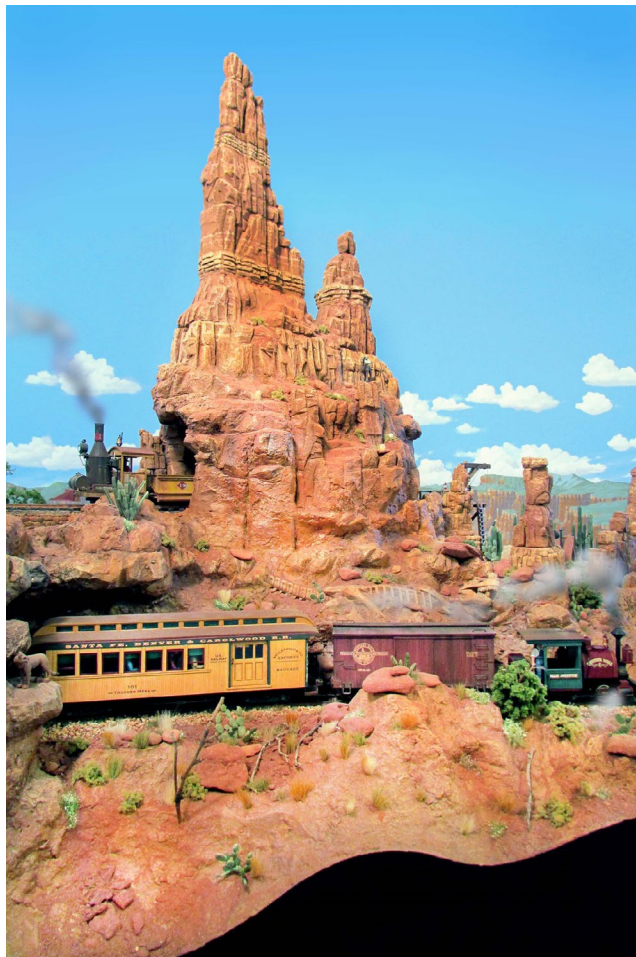

I’ve found overlaying the concept of themed environment on a train layout to be very helpful. It fuels

1. The On30 Thunder Mesa Mining Company uses theme park design principles to create an engaging and immersive miniature world. In this scene, the careful use of forced perspective on Baxter’s Butte makes it appear even taller than it is.

IMAGINEERING | 3

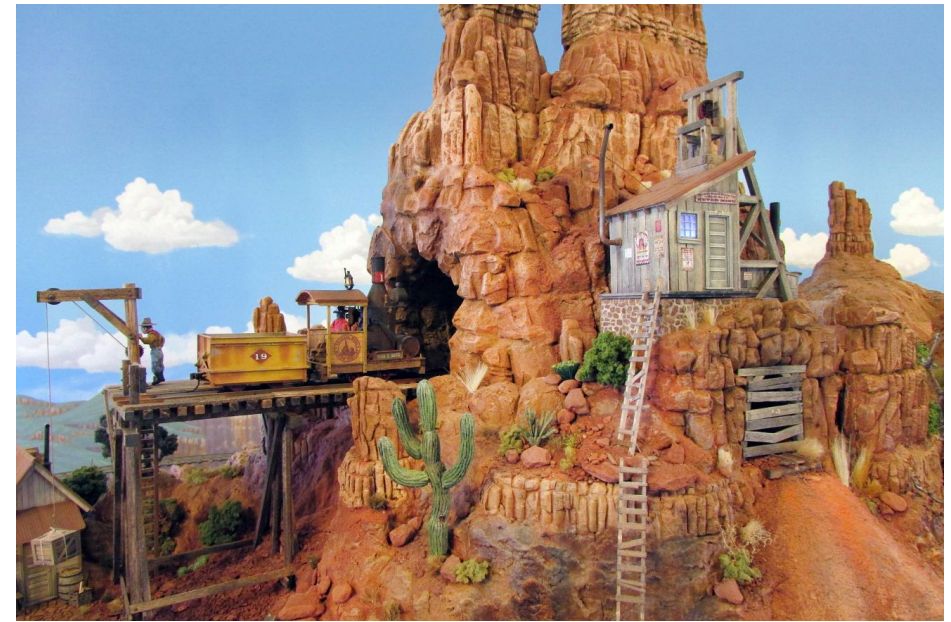

2. Thinking of the entire layout as a themed space helps to keep focus on the bigger picture. An off-the-shelf mine kit here would have overpowered the scale of the scene. The solution was to scratchbuild for the specific location, keeping the forced perspective illusion intact.

my imagination to think of a model railroad as more than just tracks and trains. Understanding a layout as a themed environment also makes the design process more manageable. Even an entirely fictional railroad takes its cues from the real world, but the real world is messy and complicated. Zeroing-in tightly on theme helps to focus attention on what is important and allows you to leave out what is not.

When done well, the result can be like stepping into another world. It can be as realistic or fantastical as your tastes prefer. It can be a place to experience history in miniature, or a soaring playground for the imagination. It all depends on the story you choose.

It starts with a story

Every model railroad tells some kind of story, and that story determines what the theme will be. In this context, “story” doesn’t really mean plot or a connected series of events, it means, “story-premise.” The central idea that all the action springs from. It’s the “who, what, where, when, and why” of a model railroad.

Imagine you are making a movie rather than a model railroad. What is it about? Where does it take place, and when? Is it a documentary or a work of fiction? If fictional, is it entirely invented or



3. On Thunder Mesa, the story dictates that structures, scenery, and rolling stock should all have a strong family resemblance to their Disney counterparts without being exact copies. This helps support the central fiction that the TMMC came first and is really the “prototype” for the Disney trains.

based on a true story? Is it a comedy, a drama, or an action-packed summer blockbuster? Personally, I’m making an old-fashioned, popcorn munching, wide-screen, Technicolor western (with a bit of fantasy thrown in for extra flavor).

To translate all of this into model railroad lingo: If it’s a documentary, you’re a prototype modeler. If it is fiction, you’re a freelancer. Based on a true story? Proto-freelanced.

Obviously, my Thunder Mesa line is a work of imagination. Like a lot of genre fiction, it begins with the question, “*what if?*” Specifically, what if there had actually existed a specific, real-world prototype for Disney’s Nature’s Wonderland and Big Thunder Mountain Railroads? What would such a line have been like? Answering those questions acts as the catalyst behind everything modeled on the railroad. It’s the story-premise behind the themed environment of Thunder Mesa. Inventing a prototype for an existing fictional railroad might be a little backwards from how others approach the hobby, but it does allow me to have an awful lot of fun.

The story questions above help me to fill in the broad strokes of the layout’s theme. For example, it exists somewhere in the American Southwest, some time around the turn of the last century. The landscape is an almost mythical place, like half-a-dozen national parks rolled into one. Tourists flock to see the natural wonders of the area, and that helps to augment the local mining economy. The railroad does well, and the equipment itself is rather ornate and well looked after. The boomtown structures have that classic Wild West flavor from a hundred-year-old horse opera. This is the basic framework, the essential ideas that guide the design and construction of Thunder Mesa.

If you are a prototype modeler or proto-freelancer, your questions and answers will be very different than mine, but the same story process applies. Even on a strictly fact-based layout, creative decisions must be made about *which facts* to include. It's impossible to know everything about a prototype, and even if you could, it would be impossible to include everything. Deciding what is essential to the story, determining which facts to present and how, defines the parameters of your themed environment.

An interactive space

In a way, calling a model train layout a themed environment is just putting a handy label on what a lot of great modelers have been doing for some time. Many model railroads use scenery, structures, lighting, backdrops, animation, and sound to enhance the experience. A lot of modelers also pay close attention to era, theme, and the realistic operation of trains. Ergonomics are well considered too. These days, just about any good track plan recognizes the importance of managing space for both trains *and* the people who operate them. Things like benchwork height and all of that nuts-and-bolts advice about minimum aisle width and maximum reach has largely become conventional wisdom in the hobby. I believe that understanding all of these factors as an attempt to create a themed environment helps to clarify the goal and to prioritize what needs to be done.

Thinking about Thunder Mesa as a themed environment forces me to consider how everything in the space affects the layout and the story. It makes me look beyond the tabletop at the bigger picture of how the railroad is experienced. While the movie analogy is handy for grasping the basic concept behind a model railroad's story-premise, it falls short when we realize that, unlike a movie, we're



4. Theme is established largely with visual cues that impart era, locale, and mood. In the case of Thunder Mesa, the character of the terrain and equipment also convey a sense of fun and whimsy.



5. A themed environment is designed to engage the senses and immerse you in the story. Here on Big Thunder Creek, hidden speakers playing the sounds of rushing water, frogs, and woodland birds enhance the show.

not just watching, we are moving through and interacting with the environment. A model railroad exists in a three-dimensional space where time, distance, and geography all play a role in the story. We start with an empty room and transform it into a themed environment where full sized people interact with miniature trains. For me, it's very much like creating a show.

“Show,” in this context, is another term borrowed from Disney Imagineering and it refers to everything that's onstage in a themed environment. All elements of the show are designed to support the theme, and further the story. That means architecture, landscape, color palette, lighting, costumes, music, vehicles – you name it. This is a big part of the magic pixie dust that helps you suspend disbelief and immerse yourself in the experience. On a model railroad, we can define the onstage show as every part of the operating layout that has scenery; that is, the parts that are meant to be seen. “Backstage” would be the staging tracks, lighting valances, control panels, unfinished sections, and that bird's nest of wiring underneath the layout.

Scenes and transitions

On Thunder Mesa the show is revealed as a series of scenes and transitions. Timing is very important, and the movement of people and trains through the space dictates the placement of scenic highlights. One scene transitions into the next, building upon the established theme and adding a little bit more to the story. There's a lot going on in these scenes, but I do my best to avoid both visual and auditory clutter. For example, technology now allows us to add sound to just about anything, but I've found that a little can go a long way. Too much visual detail all at once can also be overwhelming. The eye needs a place to rest between areas of intense visual interest.

IMAGINEERING | 10

When planning areas of the layout I also pay a lot of attention to sightlines – basically what can be seen and from where. Large rock formations like Baxter's Butte are not just scenic highlights; they can also be effective scenic dividers or view blocks, visually dividing areas of the layout into different experiences.

Returning again to the movie analogy, I often think in cinematic terms when planning scenes. I've found that breaking scenes down into establishing shots, medium shots, and close-ups is more useful and story specific than just thinking in terms of scenery and structures.



6. Much like a theme park attraction, the entire railroad is laid out in a series of scenes, each building upon the experience before gradually transitioning into the next. Here, a train exits Rainbow Caverns and enters Dinosaur Gap.

New
Innovation

Nano-Oil™
Made in U.S.A.

Nano Technology Lubricants

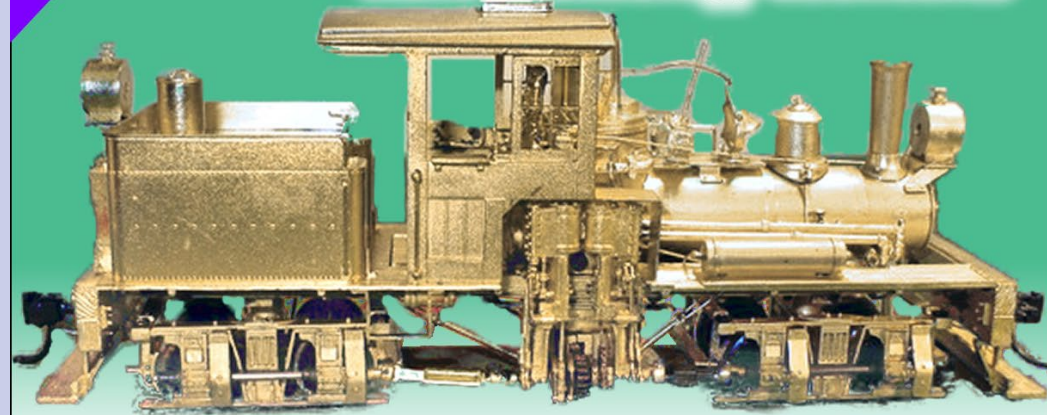

Nano-Grease

"After eight years of extensive testing, the only lubricants now used in my shop are Nano-Oils and Nano-Grease. The extreme reduction in power draw by mechanically minimizing friction is simply technologically superior."

- Phil Floyd, 'The Shay Fixer'



THE SHAY FIXER 

VISIT US AT...
SHAYFIXER.COM 

Specializing in brass Pacific Fast Mail / United geared locomotives

**For more details
click here ...**



7. This overall view of the Cactus Forest is a good example of what is meant by an establishing shot. This is the wide view that sets up theme, era, mood, and locale.

An establishing shot is everything that can be seen at a glance when standing about mid-aisle and looking at the layout. This is often about two square feet of scenery and sets up the general location and era of a scene. Usually, a clearly defined foreground, middle ground, and background can be seen from this angle. In the movies this could be a wide shot of Dracula's Castle, the New York City skyline, or a dusty western street; whatever is needed to set up the story. On Thunder Mesa there are several establishing shots that change depending on where you are standing. The visual cues all generally communicate the same thing: the Desert Southwest circa 1900.

Moving in closer we come to the medium shots. This constitutes the heart of what most folks think of when they think of model railroad scenery. Medium shots are the basic scenes that convey theme and help move the story forward. This is where all of those carefully crafted structures live, alone, or grouped together to common purpose. This is where water and trees and cacti are modeled. The medium shot covers individual modeled elements that make up the larger scene.



8. Taking a step closer, we can focus on this medium shot of Saguaro Siding. All the structures and details in this scene help advance the story of a lonesome desert mining operation. Flickering lanterns and other special lighting effects help set the mood.



9. Close-up at Saguaro Siding we can see the tiniest details; wood grain and nail holes, signs, individual weeds, and, for the sharp eyed, a wildcat lurking near the woodpile.

Way down at the detail threshold we come to the close-ups. These are mini-scenes with human figures and animals, signs, tools, weeds, bullet holes, books on a shelf, nut-bolt-washer castings, and other miniscule details. I like to think of close-ups as tiny surprises, rewards for looking closer at a model. At a distance they can disappear and blend into the larger scene, but the layered texture they add again reinforces the theme and story.

Transitions are where scenes meet, overlap, and blend together. Tunnels and bridges make great scenes in and of themselves, but can also act as transitional areas between other scenes. Some

transitions can be handled with an interesting scenic element that draws the eye forward, like an unusual rock formation. I do this quite a bit on Thunder Mesa with the most notable example being McKennon Arch. Here the trains pass right through the rock “gateway” in a literal transition to the next scene. Transitions can also be handled more subtly with visually quiet areas, like a pond or grove of trees that offers a brief rest between busier scenes. Once again it all depends on the needs of the story.

Believability, detail, and visual contradictions

A themed environment only works when it is believable, when it immerses you in the world of the story to such a degree that you



10. This natural arch on Thunder Mesa is a scenic highlight, but as trains pass through, it also serves as an effective visual transition between different scenes.

IMAGINEERING | 15



11. On Thunder Mesa, the goal is believability rather than a strict adherence to realism. Realistic details are important as visual cues relating to theme and story, but everything is in service to create an entertaining show.

want to accept it as a real place. The human imagination plays a key role in this; we love a good illusion, and enjoy clever things that fool the eye. It's really a form of play. I try to take full advantage of this on Thunder Mesa by creating fun-to-look-at scenes that push the boundaries a bit, but remain believable within the context of the world I'm building. Realism for realism's sake has never been my goal. To me, realistic detail is just another storytelling tool, not the ultimate point of the hobby.



Many species of
Conifer trees available!



Also see our other
conifer offerings ...

Click for
more -
lots more!

Realistic details are there to help involve us in the story. Drawing on shared experience, they provide the necessary clues to set the scene. The era, locale, and purpose of a model railroad can all be established with the judicious use of realistic detail. It's the seasoning that makes the soup.

When planning any new scene or equipment for my Thunder Mesa layout, I first ask myself if it will enhance or detract from the story. A contest-quality model of Canyon Diablo Bridge that is accurate down to the last rivet might be beautiful to behold,



12. Imagine how modern signage or a late 20th century automobile would destroy the Wild West illusion of this scene. When creating believable scenes, what you leave out can be as important as what you put in. A sharp focus on theme helps to eliminate visual contradictions.

but its overwhelming size would dwarf the rest of my scenery and destroy the illusion of space and distance. In short, it would create a visual contradiction, so I choose to leave it out.

Visual contradictions are details that disagree within a theme. They can be realistic, fantastic, or just poorly done, but the resulting discord is something that takes you out of the story. Mixed visual signals create confusion, like the cacophony of two radios playing different music in the same room.

A miniature railroad becomes a themed environment when it is more than just a collection of models. Everything within the space must be planned and built within the boundaries of the story-premise. These become the rules of the world. My Thunder Mesa layout places entertainment above realism, but that doesn't mean anything goes. On the contrary, there are some pretty strict rules underpinning this miniature world, without which the entire illusion would fall apart. One of the most important rules I set early on was that structures and equipment would have a "family resemblance" to their Disney counterparts without attempting to be outright copies. This rule comes directly from the established story-premise that my TMMC is the prototype for the Disney attractions and therefore came first. All the rules I follow when building Thunder Mesa arise from similar story considerations to reinforce the internal logic of the theme.

At the other end of the spectrum, a strict prototype modeler might create rules based upon a specific place and time in the history of their railroad. Regardless of where a story begins, the need for a defining set of rules remains the same. The rules determine the background narrative, geographic location, and time period. They advise you on types of equipment and modes of operation. They tell you what details to leave in, and what to leave out.

IMAGINEERING | 18

Plussing the show

A final Imagineering concept I'd like to end with is the idea of "plussing the show." It's a term that Walt Disney coined for taking something good and making it even better. He was always looking for that little extra detail that would "plus" an experience and take it to the next level. A model railroad can be so much more than just tracks, trains, structures and scenery. With a little skill and imagination, it can transport us beyond our daily experience to another time and place. It can use story to educate, inspire, and entertain. Thinking of a model railroad as a themed environment is a way of plussing the show.

Beyond the nuts-and-bolts of model building, it's a way of focusing attention on how a layout is experienced. It sets a high bar for a wonderfully creative hobby, and a goal to always improve. ☑



Click here for reader comments

When talking to hobby vendors, please remember to mention MRH.

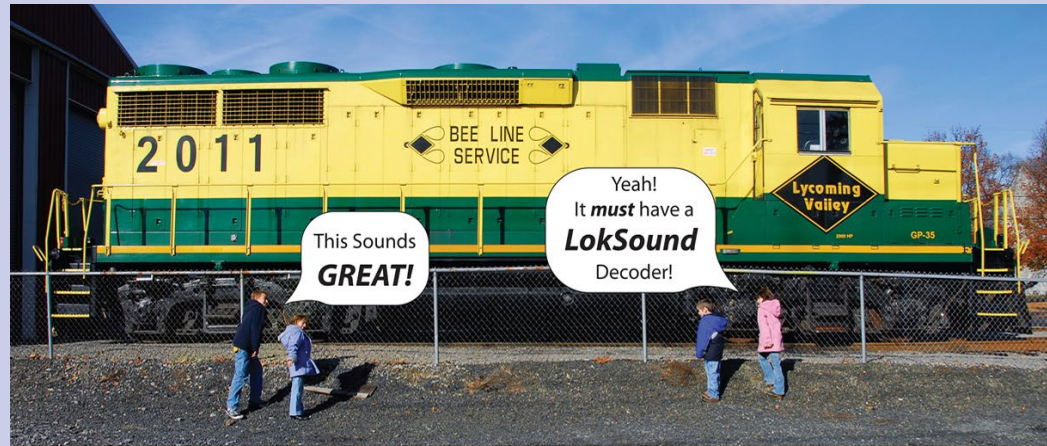

SO REAL...You'll Think You're There!

LokSound Select · 3 SIZES, ENDLESS POSSIBILITIES!

INDUSTRY LEADING MOTOR CONTROL

- Multiple Bell types
- Multiple Brake squeals

4 OR 8 Ohm SPEAKERS!

- 4 or 6 Output functions depending on the style
- Up to 4 Prime Movers or Steam Sounds on EACH decoder
- 16 Very Playable, LOUD Horns or Whistles depending on Profile
- All Changeable by using ONE CV! No Programmers or Boosters needed!*

**Small Size
BIG POWER! 1.1Amp!
LokSound Select
"4 AUX"**



\$99.99

NEW 2011

Only Available From ESU LLC (USA)

- Great NEW Size 1.18" x 0.61"
- Versatile DCC & DC "Dual Mode" decoder!
- 8 channel sound system!
- FOUR lighting outputs and a 1.1A motor controller
- Available with ALL Current LokSound Select Sound Profiles
- Use 4, 8, or 16 Ohm Speakers

**ONE SIZE FITS ALL!
LokSound Select "DIRECT"**



\$109.99

NEW 2011

Only Available From ESU LLC (USA)

- 6 Outputs!
LED Resistance Built In!**
- Easy Drop in Design
 - Versatile DCC & DC "Dual Mode" decoder!
 - 8 channel sound system!
 - SIX lighting outputs ALL with built in resistors for LEDs
 - Available with ALL Current Diesel Sound Profiles
 - Use 4, 8, or 16 Ohm Speakers

**Tiny Size,
HUGE Versatility!
LokSound Select
"MICRO"**



\$99.99

NEW 2011

Only Available From ESU LLC (USA)

- Great NEW size ONLY 0.98" x .417"
- Versatile DCC & DC "Dual Mode" decoder!
- 8 channel sound system!
- FOUR lighting outputs and a .75A motor controller!
- Standard 8-pin NEM 652 plug included
- Available with ALL Current LokSound Select Sound Profiles
- Use 4, 8, or 16 Ohm Speakers!

* ESU LokProgrammer needed to "Replace" Sound and for Firmware updates, not for normal editing



HOBBY MARKETPLACE

WESTERFIELD

GOLDEN AGE LINE
MODELS, LLC

NEW N.A.R. STK CAR KIT!



RESIN KITS, DECALS,
DATA DISKS & DETAIL
PARTS AVAILABLE.
westerfieldmodels.com

clever models LLC

Cardstock models & materials



kitbash by Robert Bruce
www.clevermodels.net



Affordable built to order Benchwork starting at only \$20 a Sq Ft.

PRECISION DESIGN CO
Chains
Flat Car loads
Joint Bars
Signs & Posts
FREE SHIPPING

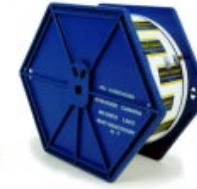

Don't settle for lifeless signals!
We've got signaling circuits!
LOGIC RAIL™ "Sophisticated Model Railroad Electronics"
TECHNOLOGIES

Please visit our website and online store!
21175 Tomball Pkwy Suite 287 Houston, TX 77070
Phone: (281)251-5813
http://www.logicrailtech.com info@logicrailtech.com



MOUNTAIN SUBDIVISION HOBBIES
www.modelrrsupply.com
FREE USA SHIPPING OVER \$29.00

NCE - SOUNDTRAXX - DIGITRAX - PECO - CIRCUITRON
DCC SPECIALTIES - INTERMOUNTAIN - CMX - ATLAS
BAR MILLS - BOWSER - KATO - MRC - TOMAR - RIX -
PIKESTUFF - LOGICRAIL - CENTRAL VALLEY AND MORE!

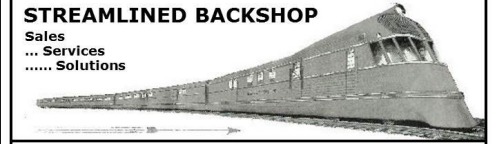

"SUGAR CUBE" SPEAKERS...

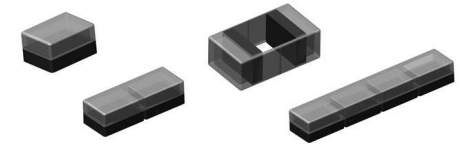

4 Sizes * 4 Baffles
... "Sweet" Speaker Options!

Teletronik TCS SOUNDTRAXX Digitrax DCC DCC SPECIALTIES
DIGITRAX PECO ESU MRC OSI
www.SBS4DCC.com

SmartSwitch™

ANE model

Route Control device for SmartSwitch

Which track is correct line?
We can solve your confusion.

Trees

Evergreen
Conifers for HO,
N, S, and O Scales

Make Your Own,
Save Money and
Have Fun

Real Wood Trunks

All Components
Available
Separately

Made in Oregon, USA

coastmans.com

GRAND CENTRAL MODEL RAILWAY

Ph: 0448534212
What we do:
Benchwork, Layout Design, Display Cabinets, Layout Photography,
Backdrops, Home Consultations and Valuations
www.australianpacificrailways.com

Mr. Detail Parts

Bulk Packs and Bundles Now Available

EXPLORE HERE

Available Scales: HO - N - S - O - G - TT - 1:72
www.mrdetailparts.com

PRE-SIZE MODEL SPECIALTIES
 P.O. Box 6 Paonia, CO 81428
 Ph. 970 527 4586
 Made in The USA

Cast resin items for All Scales.
 Tunnel portals, bridge piers, abutments, culverts, and retaining walls.
 Trackside details and sage brush tree armatures.

LIGHTS 4 MODELS CLASSIC LAMP POST
 LED LIGHTS | NEON SIGNS
 NEW PRODUCTS ADDED MONTHLY

Classic Lamp Post
 • Warm White LED
 • Connector Wires
 • Rectifier/Resistor

Special Voltage: 7-19 Volts AC/DC
 www.Lights4Models.com
 2860 Falls Ave. Ct. Dublin, OH 43019 614-296-8091

Jelsma Graphics
 AMERICA'S NUMBER ONE RAILROAD PRINT SOURCE
 Railroad Art-Prints, Caps, Jackets, Shirts and More ...
 Jackets starting at \$79.95

www.jelsma.com
 1-904-221-3513 • Jacksonville, FL.

STRUCTURE KITS AND ACCESSORIES
HICKSON DEPOT
 HO AND N SCALE

www.MONROEMODELS.US

RULERS-of-the-WORLD
 Scale Rulers \$4 each
 Over 200+ scales!
 Metric or Imperial
www.rulers-of-the-world.com

NEW
BURLINGTON BULLETIN
 No. 50 \$4.00
 Overnight, Every Night, Act I:
 Burlington's 1936 Denver Zephyr

Burlington Route Historical Society's 50th Issue!!

Click here for details!
 Questions? Email Info@BurlingtonRoute.com

Minimalist Model Railroad Design

All New 2nd Edition! **Click Here**

True Scene Modeling
NEW FusionFiber
 Scenery Base Material for the 21st Century!
SATISFACTION GUARANTEED!
www.truescene.com or 716-523-7305

Great Decals!
 FEC, Interstate, Virginian Railway, & L&N Titles
 After Hours Graphics Line
 Coupler Gages and More
 In O, S, HO, and N Scales

Have you seen these popular blogs on the MRH website?

Ken Glover's Shelf Layout
 69,000 reads
CLICK TO READ IT NOW

Mike Rose's N scale empire
 120,000 reads
CLICK TO READ IT NOW

Yarmouth Model Works
 HO scale resin kits and detail parts

U.S.A. MAILING ADDRESS
 3560 Pine Grove Ave. Unit 617
 Port Huron, MI 48060

TEL. 519-633-7574
pierre.oliver@start.ca

CANADIAN MAILING ADDRESS
 85 Hiawatha St.
 St. Thomas, ON N5P 2T5

BenchWork
 Affordable Modular (domino) Benchwork in 200+ sizes
 Custom built to order benchwork also available!

Can't remember which cars you've bought?
Yard Boss
 Model Train Inventory Software
 from DCC by Design
 Under \$15
 Download free trial now
www.dccbydesign.com

Hobby Marketplace Ads are Economical and Effective.
 Click to learn more ...

JEFF SARGEANT'S N-SCALE GN/SP&S



Also coming to
TMTV in May

An N-scale layout inspired by Pacific Northwest railroading ...



[Click here for
reader comments](#)

MRH: JEFF, TELL US A LITTLE ABOUT YOURSELF,
and introduce us to this layout.

Jeff: I'm Jeff Sargeant, and this is an N scale layout. It's the seventh layout that I've built in N scale. The layout is meant to look like the Pacific Northwest, what I call high mountain railroading.

I set my layout in the mid-50s transition era and it's a railfan-ning style layout. While it has some operation capability, so far it's mostly for running trains. It has about 300 feet of mainline, including all the double track, sidings, and branch lines.

I run the Great Northern (GN) and the Spokane Portland and Seattle (SP&S). I have a branch lumber line, which is the Teal Mountain Railroad, named after a family member. I also have a Standley Mining-labeled road name for the mining district. And I'm planning to have Victoria harbor, named for my wife, Victoria.

You can see from the layout that the scenery is just over half done. All of the track and electronics are in place.

1. This is the seventh layout Jeff Sargeant has built in N scale. He set his layout in the mid-'50s transition era, modeling the Great Northern and the Spokane, Portland and Seattle railroads in the Pacific Northwest. Jeff's putting lots of trees on his layout: he's trying to capture the scenery he sees every day, since he has lived in the Northwest most of his adult life.

BY JEFF SARGEANT AND THE MRH STAFF



2. Jeff loves tall mountains with trees, and finds mountain rail-roading to be especially impressive. Jeff has memories as a child of big steam engines' exhaust echoing off the mountains as they worked against a grade, and his dream has been to model steam- and diesel-powered trains in a mountain setting. With this layout, he's finally realizing that dream.

I have 95 rostered locos on the layout. I've placed eight distinct sound modules on the layout, and I have sound modules in some locomotives. Everything on the layout can be operated with DCC, using accessory functions on the MRC cab.

MRH: How did you get started in the hobby?

Jeff: I'll never forget the day my friend Jack rolled his brand new Lionel train set out from under his bed as we were playing. His

grandfather had built a small loop with a couple of sidings and a few buildings on a board with rollers, and it was Jack's pride and joy. I was enthralled! From that moment on I knew I had to have my own layout. Fortunately, I had a very encouraging father who was willing to part with some hard-earned cash to encourage my youthful ambition.

I also credit Jack for my life-long interest in modeling in N scale. When my dad said I could use the garage to put up a 4x8 sheet of plywood on sawhorses, it was Jack who suggested I try N scale.

I was raised in southern California and I wanted to model the Tehachapi loop. It seems like everyone has tried to model that at one time or another.

My model of Tehachapi was exceptionally poorly executed, but I was very proud of it, being a nine-year-old at the time. Since then, as is often the case for modelers, as I got into my 20s, 30s, and 40s and focused more on the family, my career and so forth, I didn't model much.

But I did have several small layouts, all in N scale. These would be more of the tabletop door variety. You know, the old N scale "Build a layout on a door" concept that was popular for a time.

I have built an HO scale layout for a family member, but all of my own layouts have been in N scale.

MRH: You could have any hobby you want, so why this one?

Jeff: I've loved trains since I was a child and I also like working with my hands. My career has been in the computer industry, so I did a lot of typing and mental work. Working hands-on is such an incredible experience. Model railroading encompasses so many different aspects: basic carpenter skills, electronic skills, the

engineering aspects of making sure the tangents and curvatures of your track are correct, and then there's the artistic side of things.

If it just came to art, I am horrible – I'm a stick-figure artist. But when it comes to modeling, for some reason it seems to click. I like, for example, how natural my scenery looks. The hobby is a great way to express my art rather than just in stick figures. Yes, model railroading is so immersive in so many ways. It has been a great counterbalance to a computer career and just thinking through a computer solution.

MRH: Why this particular modeling subject, the GN and SP&S?

Jeff: I've been in the Northwest all of my adult life, and it's why I wanted to model this region in particular. I just love tall mountains with trees, and mountain railroading is impressive to me. I just missed the steam era, so for me it's like a wish to see what the big steamers would look like up against a grade, working hard getting over the hill, and then dealing with the issues of braking down the other side.



3. Modeling the transition era with steam has been a very nostalgic trip. Another of Jeff's aims has to been to model big mountains with a series of tunnels as well as mountain railroading structures like this snowshed. The winding curves needed to represent a mountain line make the route seem longer as the trains punch through ridges entering and exiting the different scenes.



4. The folding terrain of the mountain ridges and gullies allows Jeff to create an immersive experience, letting you step into a scene and be surrounded completely by the trains. Jeff's attention to detail in this scene really stands out – this area has been subject to snow slides and shifting ground – a seldom modeled but not uncommon feature of high mountain scenery.

I love the Northwest: there are lots of trees, lots of water features, and very colorful trains in the area. I have always been attracted to the colorful Great Northern, while appreciating the hard-working Spokane, Portland & Seattle, both fallen flags that were incorporated into Burlington Northern long ago. And while I missed most of the great steam era of railroading, I love the action and sound of steam. This made it easy to select the transition era of American railroading, focusing on the mid-1950s.

Now retired from my computer career, I can dedicate some real time and space to the hobby. So I knew this layout would be what everyone would call a “dream layout.”

MRH: How did you get this layout space?

Jeff: After retiring from my career in software development, and with the kids grown and out of the house, my wife and I moved to the country to pursue second careers, and finally devote some time and space to our personal interests and hobbies. With that in mind, we built a detached shop with dedicated space upstairs that we have split between us.

This leaves me room for a 14' x 18' N-scale layout and includes custom lighting, wiring, and climate control. There is room in one corner for my workbench, Wi-Fi and A/V, plus a bathroom.

MRH: Knowing you wanted to do this layout, what then, was your approach?

Jeff: As you can see from the layout design, I tried really hard to present what you might say is a natural scenic design. I think it would be difficult to run this as an operation-only type layout because the scenery can get in the way and it's not designed with the let's see everything from one place approach.

The layout uses a stylized horseshoe walk-in design and a loop track plan. My goal is to model northwest mountain forests with an emphasis on the lumber industry. Additionally the plan calls for a full cityscape and rail yard with port.

The mountain scenes are at the “top” of the horseshoe and are single track. One arm of the horseshoe includes a full-loop lumber railroad and camp (see February in the NMRA 2015 Calendar for a picture of the lumber camp), sawmill, millpond, and mill

town. The other arm is the city, port, and rail yard. Both arms are double-tracked.

This intentionally creates an operations bottleneck between the towns and the mountains. Due to the loop design, one person can run trains that all run in the same direction on the track yet appear to be traveling in opposite directions in the mountain areas.

While I designed the layout for running trains, it includes numerous “static” scenes that are currently display only. When fully implemented, I expect an operations session to support four to six operators, though everything can be run from a single DCC wireless throttle.

I deliberately aimed to present vignettes – you know, little scenes that make you stop and study them. In many cases, I make the viewer move to more than one location to see the entire small scene. To do that I’m using a lot of natural scenery – namely, lots of trees!

MRH: You wanted to see things like doubleheaders going up the grade – has this layout fulfilled that for you?

Jeff: I’ve been absolutely thrilled, especially with how the mountain area lets me visualize being in the transitional era. When I was very young, we used to travel up into the Sierra Nevada Mountains, and one of my earliest memories is hearing, not seeing, but hearing the sound of the steam locomotives echoing off of the hills. The sound they made is such a nostalgic sound.

While I haven’t been able to replicate my memories in their entirety, the visual part does really apply and it adds a lot to the sound experience. I also love all the variety of the early first-generation diesels mixed in with the last of the steam.

“I deliberately aimed to present vignettes ... to do that I’m using a lot of natural scenery – namely, lots of trees!”

I’m sure a lot of people consider the ‘50s the Golden Age of railroading, but even in modern diesel era today there’s a lot of visual variety. But yes, modeling the transition era with steam has been a very nostalgic trip for me.

MRH: How did you come up with the track plan?

Jeff: The track plan is my own design and incorporates ideas I’ve thought of or that I’ve seen in other layouts. Being an avid modeler all my life, I’ve seen a lot of other layouts and I’ve seen many pictures too, since I’ve subscribed to all the leading magazines.

My layout incorporates just about everything I’ve wanted to do. I want to be immersed and lost in what I’m seeing. That’s what led to this design.

I sat down at the kitchen table, took a couple of nights, and laid it all out. I’ve got many scribbled notes of little segments, like where I want this S-curve to look such a way against this backdrop with a line going behind it, and so forth. I jotted down many notes as I would think about different things.

When I first got started, I would just stare at this space, at the empty room. My wife would ask, “What are you doing?” I told her I was just visualizing, trying to get in my head how I wanted this room to look. I tried to picture when you stood at this point, or

when you were over there, or when you walked around over here, and that helped a lot. The more you can visualize and plan it in your head, the better the execution.

MRH: Did you use paper and pencil, CAD, or any computer layout design tools?

Jeff: I used paper and pencil for this layout. I have used some CAD for other designs, and I'm doing some CAD now to make a digital track plan of this layout.

MRH: As far as visualizing the layout, was it all in your head, or did you actually mock anything up?

Jeff: It was all in my head for the most part. The only thing I did visually mock-up with the empty room was a tape outline like a police outline on the floor of the outer edges of the fascia. That way I could visualize my walkways and how I would fit in the available space.

With any area, you want to maximize your space. With the tape down on the floor, it let me better visualize how things would look if I stand here, and so forth.

MRH: How did you set the layout height and aisle width?

Jeff: To my wife's dismay, my layout height is what works best for me. I wanted it to be comfortable for the typical 5'-10" to 6' viewer looking at the layout, without too much looking down from a high altitude. I wanted things to be almost at eye level. Unfortunately for my wife, she's shorter, so that's why we have a step stool available!

As for aisle width, you can see I'm "Big Sarge" and I'm a big guy. I want to make sure there is plenty of room for me and another person to pass in the aisle. My aisles have a minimum of three



5. Bridges and water features also fascinate Jeff, and they fit right into his Pacific Northwest theme. Jeff enjoys the color variations of the GN and SP&S equipment from the 1950s. Here, SP&S Alcos rumble on a tall multi-truss bridge across Lost Lake. In the background is a hint of melting snow on a rock slide.

foot clearance. As you can see, I prefer a rounded fascia. I think it has a more natural look, tricking the eye into seeing the scene in a more natural way. It also avoids the cries of "Ouch, caught my hip!" on corners.

MRH: How did you do the benchwork and trackwork?

Jeff: The benchwork is a conventional open grid, using 1 x 4s with 2 x 2 girders for support. The top of the horseshoe is attached directly to the room wall which has a 20-foot long curved sky/clouds photo backdrop of 1/8-inch fiberboard. The



same fiberboard is also used for the curved fascia. I used half-inch plywood as support for the roadbed and larger flat areas.

The track is Atlas Code 55 throughout the layout, laid down as 200 feet of main-line (65 feet in double track), 50 feet for the lumber line, and 35 feet for the port line, 4.25 scale miles of track in all. Additionally, I have four 15-foot hidden staging tracks. I laid all of the track on cork roadbed except for the rail yard, which is on fiberboard.

The ruling grade is 2% for the mainline and 3% for the lumber branch. All main-line curves are a minimum 16-inch radius and super-elevated. The lumber branch has 13-inch radius curves. There are 105 turnouts on the layout, with #10 for the mainline, #7 for sidings, and #5 in the yard. All turnouts are DCC-friendly and powered through the frog.

6. Jeff likes to increase viewer interest by adding vignettes to scenes, like this family camping under the trees in this mountain hollow. Meanwhile, TLRR Shay #7 rumbles by, up on the mountain-side. Nestled on the ridge high above is another common Pacific Northwest sight: a Forest Service lookout tower. These towers dot the tall ridges, their lookouts keeping a vigilant eye out for any signs of a forest fire starting.

MRH: When did you start and is it going like you expected?

Jeff: Oh, that is a great question! Once I had the layout plan down and I was ready to start construction, I told my wife it would be three years from start to finish. This is now year seven. And I probably have two or three more years of work left, and that's probably being optimistic. It's going to be a 10-year project, I think!

My original expectations were way off as to how long this would take. I knew I wanted to build my dream layout, but I was surprised how I kept finding more details I wanted – and it's the details that take the time.

MRH: What kinds of things were the biggest surprises to you?

Jeff: I think the biggest surprise I did not anticipate was what I just mentioned – the details. When I sit down with a model, my log dump for instance, it's a very detailed craftsman kit. I expected to just put it together by the numbers.

But as I got into it, I realized there are all these extra details: I want people standing here, I want clutter over there, and I want a chain here. How much do I want to model as static and how much do I want to model in motion? Oh, and by the way, shall I animate some of it? Maybe show logs actually moving and so forth?

Suddenly you can just let things get away from you and spend an inordinate amount of time. All the details – that's what caught me off-guard the most.

MRH: How did you select the various industries on your layout?

Jeff: My interest in logging stems from family members who were involved with it. My father used logging to help pay his way through college – he took a year off and logged in eastern Washington. My wife's grandfather used to plant portable sawmills deep in the forest.



7. Logging runs in the family with Jeff, so he just had to model a logging branch. Here's a signature scene on the Teal Lumber Railroad, named after his wife's grandfather, Otto Teal, who was in the lumber mill business. While Otto never did lumber rail-roading, Jeff altered history just a bit to allow him to honor Otto's contributions to the lumbering business on his layout.

He's reported to have done over 25 of these portable sawmills. So between these two, there's been a lot of interest in logging.

I'm also fascinated with, how shall we say, the pre-digital, pre-power logging days and how they dealt with moving huge loads. I like the days of using just steam to do that hard work. Thus the donkey spar pole, and things like jib movement fascinate me.

I've named or planned almost everything on the layout around someone in the family right from the first scene you see, which shows a dairy farm owned by a family member.



8. A lumber train full of log cars rolls through this logging camp scene on Jeff's layout. By the 1950s, which Jeff models, most of the railroad lumber business was moving on to more modern methods, but Jeff took a bit of modeler's license to portray the last holdout of the steam donkey logging that was at its zenith in the 1930s. Jeff is fascinated with this more basic brute-force form of logging, as a contrast to 21st century high-powered, digitized industrial technology.

I named my mining district after my father-in-law. Then there's the lumber experience.

I named the lumber branch after my wife's grandfather. His name was Teal, Otto Teal. In the '20s and '30s he planted all these lumber mills, like I said. But he didn't have a railroad, so this is a little extra tribute to him, and it's called the Teal Lumber Railroad or TLRR. It rosters nine Shays, an old 4-4-0 and some rolling stock, mostly skeleton cars for hauling logs. It's a fair representation of a



10. Take note of all the small details Jeff's added to his steam donkey scene. There's a Cat diesel pulling a log, the hillside is riddled with stumps, there's a loading ramp for bringing in needed supplies for the camp, and there are many figures moving about in a beehive of activity. And of course, there are a number of spindly cables and pulleys around the centerpiece spar pole.

'40s- to '50s-era logging line. They would have been wrapping up the donkey engines and spar poles by this time, however.

Regarding the logging era in railroading, there is documented usage into the 1960s of this style of lumber line. Of course, going into the modern era, you have firms like Simpson Lumber, where their lumber line lasted clear into the early 1990s.

I automated my lumber line with two automated passing sidings, allowing up to three trains to run "hands-off" on the lumber

branch if I want. The first train leaves the lumber mill with empties and heads up the grade, passes the lumber camp, and continues deeper into the mountains and tunnels.

Once inside the tunnel the train stops, the siding turnouts are thrown automatically and train two starts its way down the line with loaded lumber cars. This train stops at the mill for unloading which triggers the same process at the mill and train three, a work train, makes its way up the grade and into the tunnel.

This allows train one to continue onward and complete its journey back to the mill where the whole process repeats. In addition to the automated lumber line, I plan to do an automated point-to-point trolley car that will run from one end of my city scene, down to the passenger station at the rail yard and back.

MRH: Let's talk about animation: there are lots of little surprises everywhere. Tell us about that!

Jeff: I'm trying to draw the viewers' eyes deeper into the scene. Too often the case can be, "Oh, that looks good." They've quickly absorbed the entire scene and want to move on. On my spar pole scene, I have a fire in the boiler that's flickering off the water tank behind the donkey engine. I've animated the raising and lowering of a log onto the skeleton car. I've added digitized sound of an actual steam donkey at work and incorporated a smoke effect to work with the spar pole as it raises and lowers the log.

And that's just one scene. I have other smaller details: things that draw people's eyes, like flickering campfires. Anything that is moving or spinning catches the eye. My layout also incorporates semaphore signal action, which was prevalent through the Northwest in the '50s. I will say, though, trying to make the semaphores work has been an interesting animation problem in N scale!

MRH: Tell us what DCC system you use, and why.

Jeff: At the time, I wanted ease of use. This is my first and only DCC layout. I found MRC Prodigy Wireless DCC system to be exceptionally easy to use – everything can be coded from the hand-held cab. I don't have to worry about CV this or CV that. It is as close to a plug-and-play system as I have found, but that was at the time. Today, there are many choices.

MRC does have some drawbacks. It doesn't support feedback but I've only had a need for that in one area, my hidden staging. And I wish it had a more robust interface to the PC, however, my career was in software development so I don't really want to write code while modeling! We will see if my choice of system comes back to bite me later, but I've been very happy with the MRC system so far.

Suspecting the layout could consume a lot of power, I had a dedicated 20-amp outlet installed on a separate breaker when we built the shop. All elements of the layout are powered by my MRC DCC system. It includes two 8-amp booster units in addition to the 3-amp base unit.

I further broke these down into 11 power districts; one is the base unit powering the lumber line, while for the remaining ten I use DCC Specialties PSX circuit-breaker boards.

I divided the mainline into 12 physical blocks and 6 virtual blocks (blocks that group individual blocks together as one) using Team Digital DBD22 block detectors. These provide train detection for trackside signaling which I control with Team Digital SMC4 controllers. They also display occupancy for the staging tracks.

All 105 turnouts use Tortoise switch machines for turnout control. These, in turn, I control with DCC Specialties Hare decoders to manage power routing. All hidden turnouts display point direction on the schematics on the fascia.



11. Teal Lumber Railroad's Shay takes on water at the center of the camp. Jeff has nine Atlas Shays on his roster, and this nicely detailed and weathered scene really shows off Jeff's attention to detail. Jeff noted that of all the things he underestimated when building his layout, it's how much time he needs to create detailed scenes. Still, Jeff insists it's the details that hold your attention, and he's pleased with how the layout is looking, even if it's taking longer than he expected!

Additionally, I use Traintek's Aux-Box accessory decoders as digital switches for my accessory and stationary sound modules. Each arm of the layout has 12v and 3v DC power for accessories which can be turned on/off with the Aux-Box as needed. The same is true for the eight stationary sound modules distributed around the layout. So I'm able to control all elements of the layout from a single wireless handheld throttle.

All of this comes together into an APC Backup-UPS power supply. This unit delivers surge suppression, contoured power, and full



12. Modeling snow has been a new experience for Jeff with this layout. He wanted the look of a high mountain snowline on his layout, and he's captured it well in this scene. You can also see the great scenery-to-track ratio that's possible with N scale. Jeff's tree-laden mountains do a good job of dwarfing the trains, just as mountain scenery does on the prototype.

roster, and getting them to run with DCC was a difficult challenge in the beginning.

MRH: How important is it to have the layout room be a nice place to be?

Jeff: To me, having a "train cave" is very important. I have a separate space that I can do what I want with the layout. When we moved to this location, I built a shop on my property and

battery backup in case of an emergency. This allows for a single on/off button to power the entire layout. It also provides about 15 minutes of battery power for an orderly shutdown of the system if needed.

MRH: What kind of decoders are you using?

Jeff: The majority of the decoders are TCS. They were one of the early adopters of NMRA-compliant decoders for the size. They have some incredible two- and four-function decoders that are so small they fit well in Z scale locos, let alone in N scale locos. One of my early constraints was having a DCC Shay in N scale. I have nine Atlas Shay locomotives in the

incorporated the whole idea of a train cave into that. I ran power for appropriate lighting and set a place aside for a workbench.

To me, having this pleasant dedicated space makes all the difference in the world. I've had numerous layouts before – this is my seventh. Most of my previous layouts were in very small rooms that wasn't dedicated space – the space was shared. So I found it very difficult to spread out and work with the hobby. I fully recommend if someone has the space, make themselves a train cave.

MRH: What about the lighting?

Jeff: I've been able to put in whatever I chose as far as lighting in this space. I went with track lighting (of course, my friends have made jokes about a model railroader using "track" lighting). I did this to give the layout more of a stage presence for the various stories I wanted and allow me an almost spotlight effect.

For instance, I model a partly-cloudy day in the mountains, which you can see when you pan around through the trees. Notice you have brighter areas and softer areas. That's the look I was trying to capture. The addition of track lighting also gives me full flexibility as to how much light I want in a specific area versus how little.

I'm using dimmable LEDs, so power constraints are really not an issue. I can throw almost as many lights as I want to in here.

One of the things I've tried to incorporate is four 15-foot-long staging tracks hidden under the layout. Hidden staging is always kind of a good thing/bad thing.

I found if you're going to have *hidden staging* you need a way to easily monitor it. I use four infrared cameras in the staging space so I can monitor it remotely.

I have the automated passing siding for my lumber branch. For that I used a pair of cameras allowing me to monitor the turnouts

and see what's occupied. Installing the cameras was easy to do. I bought a camera package, mounted them and then ran the camera feed through the processor into a TV screen monitor – any monitor will do. It's pretty easy to set up and it's been very helpful.

MRH: How about the scenery and structures on the layout?

Jeff: I made the basic scenery forms using traditional cardboard strips with plaster cloth. Kudos to Woodland Scenics for their vast array of scenery products, which I used extensively throughout my layout. Additionally, Arizona Rock & Mineral products are used for ballast, river rock, and ground covers.

For trees, I use mostly Grand Central Gems products with over a thousand of them planted on the layout now! I have over 100 rock castings

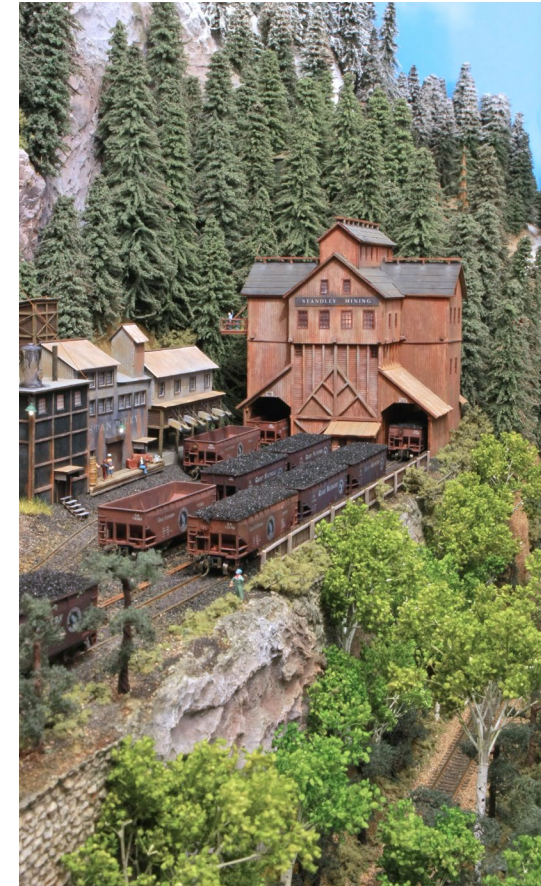

13. Another of Jeff's industries is this mine nestled on a ridge across the layout room from the lumber scene. Keeping with the family theme among his layout's industries, he named it after his father-in-law. This mining area has a number of small details to catch the viewer's eye and draw them into the scene.



in the mountain areas. I used Details N Scale stumps and pond logs in the lumber areas and have their banded log loads on my skeleton log cars. I weathered everything with a variety of “spritzes” using oil colors diluted with “wet water.”

My structures are pre-dominately laser-cut wood craftsman kits. Some are kitbashed while a few are scratchbuilt. All of them have been aged and stained using Micro-Mark and Hunterline stains.

For the lumber camp, mill, and associated buildings I used the McCabe line from BTS Structures. I made use of some plastic kits for the larger industrial areas and city skyscrapers along with an excellent line of plaster kits I used in old town. To complete things, I sprinkled a few brass kits around the layout. I put a lot of effort into presenting a scene as realistically as possible

14. A GE switcher works the mine on a blustery spring day as the clouds move overhead, creating areas of light and shadow. In the lower elevations along the bottom of the scene, we can see the bright green new foliage of trees beginning to leaf out. High overhead we still see the winter snowline hasn't yet subsided, as a bit of winter remains yet.

with nano-LED lighting, campfires, and animations, including, of course, the functioning spar pole in the lumber camp.

I have N.J. International crossing gate, semaphore, and searchlight signals scattered throughout the layout. I completely disassembled each semaphore and cut the mast a scale 10 feet shorter to more closely match the prototype. When reassembled, I replaced the lights with nano-LED and painted the signal blades to match GN standard practice.

As to sound effects, I have placed eight so far around different scenes using ITT Product sound modules – barnyard, sawmill, etc. I wired these to an Aux-Box so they can be turned on/off using the DCC cab.

MRH: What's next for the layout?

Jeff: The goal, of course, is to finish the scenery. Next I'm going to work on the lumber town itself, and that's going to have a full sawmill, a millpond, the associated town and all the support facilities for the Teal Lumber Railroad.

The other unfinished peninsula is a cityscape with full harbor and manufacturing. It will have some coastal view homes, and I have a whole skid row planned. I also plan a “wrong side of the tracks,” and of course there's the full yard that will be next, too.

As is the case with the hobby, once it's completed I'll start back to the beginning again and do more tweaking. I'll go back to those things where I said “Oh, I'll do that someday.”

What's really neat about the hobby is that every year there's advancement in the technology, and there's miniaturization of more and more things. It's becoming incredible what we can do in the hobby. For me it's dovetailed nicely into my career with computers. DCC for example is just an extended network.



15. Jeff uses track lighting and has deliberately lit the layout to create an effect of light and dark dancing along the mountain ridges on a sunny, but windy day with broken clouds. Jeff feels this effect also helps separate the scenes and the lighter areas to pull viewers in as they move along to study the layout. Jeff prefers a flowing curved fascia, believing it looks much more natural with mountainous terrain. The lack of sharp corners in the fascia is also a lot more “hip-friendly.”

I like long trains and have run 40-50 car mixed-freights on a regular basis. The scenery on the layout is about 60%-65% complete. It never ceases to amaze me how much time is spent on all those little details!

MRH: What do you like most and what do you like least about the layout?

Jeff: As far as modeling, I love doing scenery like the mountains. I just love planting trees and getting the colors and textures just

right. This layout has more water features already than I've ever done before and it's the first time I have ever modeled snow.

So I found some new fun challenges in the scenery. Being a big guy, I don't like crawling around under the layout so I tried to get as much done as possible before adding the scenery.

As far as the gotchas, there's the animations and the electronics. I took a lot of time testing the trackwork, so the trains run very smooth. There's always some gotchas though, I will still have something that will derail once in a while, so I'm not too worried about that. But crawling around under the layout is the thing I like the least.

MRH: If you had it to do over again would you do it any different?

Jeff: I'm actually very pleased with how this is turning out.

But as I mentioned, I'm trying to model semaphores as an automated and working block system and I have found that extremely difficult to do. It may end up just being searchlight signals.

MRH: You said you are more of a railfan when operating. Have you considered more serious operation?

Jeff: As far as operations, the layout currently is for railfanning. I can run four trains comfortably on the main by myself. And the lumber line is a separate loop system with an automated passing siding, so I can run a pair of trains there. It's a fire-and-forget kind of thing.

But my entire layout is designed with serious operations as a possibility. I've never participated in full-on operations on a layout with a dispatcher, etc. I have six cabs that can be used, so we could have someone in the rail yard, someone for the manufacturing district, another for the Mountain District, and so forth.



16. Infrared video cameras in the hidden staging areas are a real boon to monitoring what's happening in this trackage. Jeff installed inexpensive off-the-shelf surveillance packages, and the video feed plugs right into any TV monitor.

Currently I have 95 DCC-equipped locomotives available for use on the layout, a handful of which have sound. Sixty-four are GN, 19 are SP&S, and 10 are Teal Lumber Railroad, with one industrial and one port switcher. Thirty of these locos are steam, including a pair of More Brass 4-6-6-4 monsters.

The track plan comfortably supports four trains on the mainline and three on the lumber line. Add port switching, four-train staging, and a full yard with eight-stall roundhouse and there should be 40-50 locos on the layout at any given time, depending on the number of consists.

Additionally, I have approximately 350 rail cars to go with all the locomotives. Each has metal, resistive wheelsets with Micro-Trains couplers. Some are body-mounted and it is expected that once the layout is done the remaining cars will be converted to match. About 200 cars will be on the layout at any given time.

A full operating session would need 4 to 6 operators. One would handle the yard, one the lumber line and interchange, another the port and its interchange, while the rest would handle the mainline trains.

Your train could pass through one district, go into a tunnel and end up on the other side of the layout in another district. So it could work for multiple operators handing off a train, with the train going to different subdivisions, as it were. I've yet to try that – the layout is designed to provide for that kind of operation, but maybe not full-on dispatcher level operation. But I could give it a go and see.

Even though the design supports this kind of operation, the entire layout also facilitates running from a single wireless throttle, as I like running trains whenever I can!

MRH: Have you had a lot of visitors to the layout?

Jeff: As far as visitors to the layout, it's predominately been non-modelers at this point. I am almost obsessed with the idea of presenting a finished product when showing the layout to my peers in the hobby.

One of the things I've learned from being a member of different organizations within the hobby though – I'm finding that most of the hobby members don't care that your work's not done. They want to see it even if it's not complete and that's been a real good learning experience for me.

I always like to present a done deal and wow everyone with what I can get accomplished. But an increasing number of my peers within the hobby have come in and shared their viewpoints and tips, that type of thing – that's been a real plus to this hobby for me.

Up until probably about six months ago, almost everyone who visited the layout was a non-modeler. Most were impressed with the small size of N scale.

MRH: How do you like N scale? Would you ever consider doing a layout in a different scale or gauge?

Jeff: Oh absolutely. In fact, I think this will be my last N scale layout. I had planned on installing a garden railroad here at the house, LGB scale, that is. So far, the wildlife around the house have prevented me from actually following through with a garden railroad. But I can see myself going to a larger scale as I get older.

MRH: What would you say is your philosophy on doing a layout well?

Jeff: That is a tough question. Going back to my career in computers, I was always known as the “bell-and-whistle” guy. Someone would ask me to do software a certain way and I would come back with, “You know if we just add these extra buttons here and put these cool little options over here, you are going to have a much better end-user experience.” And that's how I have approached my layout, too.

I look at the layout and ask, “What is going to be the experience of the end user?” I'm not thinking of just for myself or the way I want to enjoy it myself as a hobby. As I see visitors, family, and friends come by, I ask myself what is going to give them the best end-user experience? That's what's driving a lot of the things I



Stairs

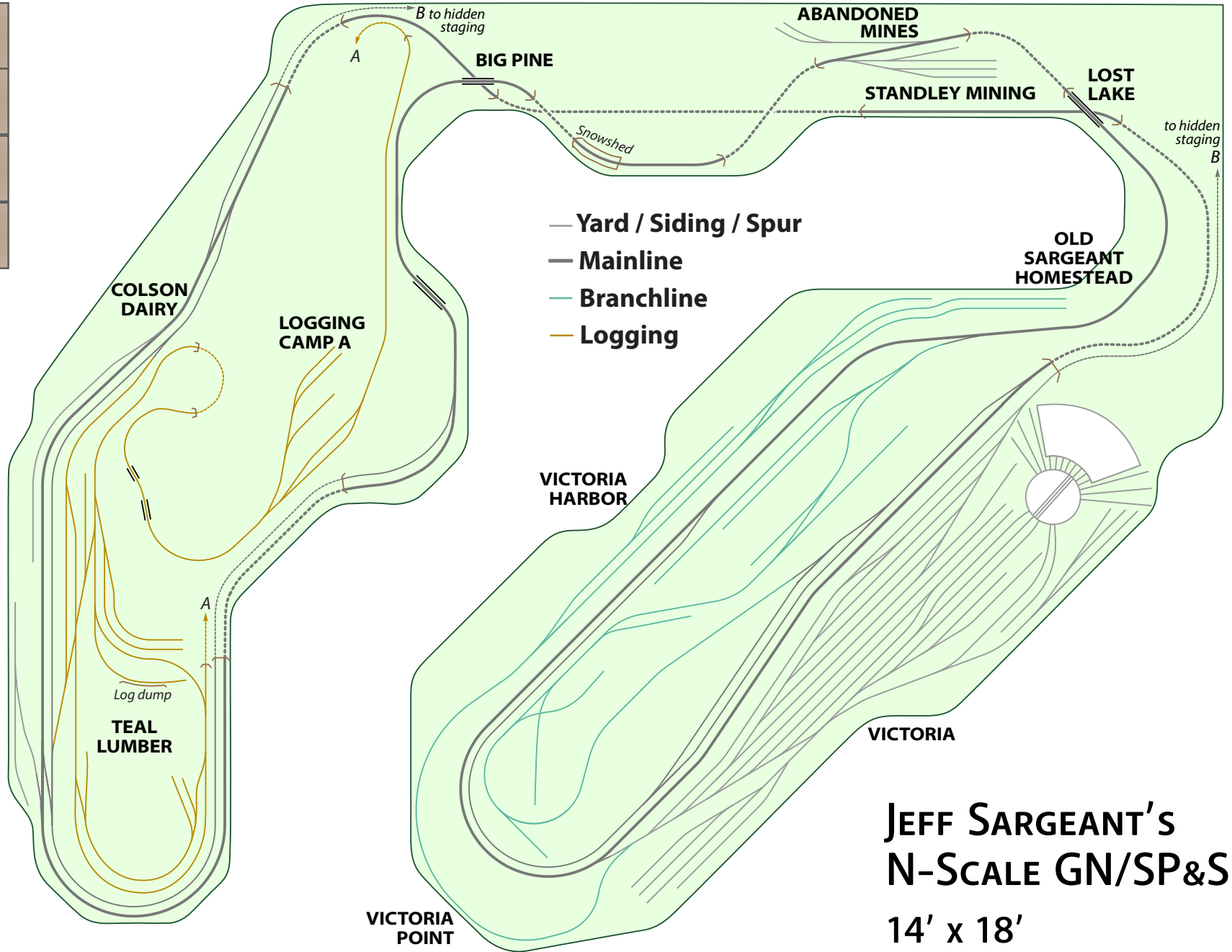

**JEFF SARGEANT'S
N-SCALE GN/SP&S
14' x 18'**



17. Jeff's major yard peninsula still needs scenery. Jeff plans a cityscape here with full harbor and manufacturing. He wants to include some coastal view homes, plus a whole skid row. Besides the full yard to detail, he'd like to have some fun with a "wrong side of the tracks" scene. Jeff's trademark: more scenes telling a story to hold the viewer's interest.

want to do such as animations and all the details in some scenes, like outhouses beside the lumber camp. It's amazing how many visitors notice the outhouses!

That may not seem like such a big deal to modelers, but it's amazing how these things wow somebody who gets to see the layout. The more detail you can add, the better the layout is going to look! But conversely, the more detail you add, the longer it is going to take!

MRH: What would be your advice to someone who's just getting started in the hobby?

Jeff: If you're just getting started, you need to visit layouts. You need to visualize what other people are doing. Go to school on

what people have already accomplished, so you can see what you may want to do yourself.

There is a reason why this is my layout number seven – there are six that went before that I was not totally happy with. I wanted something more and different, and I think just about every modeler has that learning experience.

You get some of the best "ah-hah!" moments when visiting another layout or when reading an article or how-to book. That's what I would do as a beginner – immerse yourself in the hobby, but first do it vicariously through reading or visiting someone else's layout.

MRH: Any final thoughts?

Jeff: Like I've said, I've had many non-modelers here and they are all wowed. But then they're not used to model railroad layouts. They don't really know what to expect.

I have seen lots of good layouts as far as clubs and public displays, but I have not visited many home layouts. So I wasn't sure if my layout would be considered acceptable among my peers: how is the layout progressing, or how good is its design, or how well does it operate? Does it have a good wow factor?

So far everyone in the hobby who has visited the layout has said: "Wow, this layout is great!" That helps me know I'm accomplishing my goal!

I am excited to share my layout this summer with those attending the Portland NMRA convention. I look forward to a great time operating trains and meeting new friends in the hobby. There are so many great layouts in the Portland region and I'm honored to be included.

I hope to have a full slate of four trains running on the main with another two or three on the lumber line. I invite you to drop by,

enjoy the trains, and share in the camaraderie that makes this hobby so great! ☑



You can see Jeff's layout at the Portland NMRA Convention this August ...

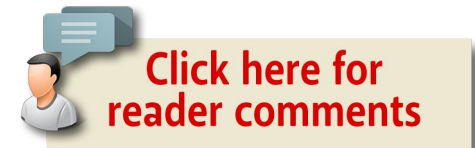

General Info	
Owner	Jeff Sargeant
Scale	N
Type	Walk-in
Size	14' x 18'
Era	Spring 1958
Roadnames (Locos)	Great Northern (64) Spokane, Portland & Seattle (19) Teal Lumber Railroad (10) Standley Mining (1) Victoria Harbor (1)
Construction	
Benchwork	L-girder
Backdrop	Photo mounted on hardboard
Scenery Base	Plaster cloth over cardboard strips
Track	
Type	Atlas Code-55
Mainline Run	150' single; 50' double (4.25 scale miles)
Lumber Line Run	50' (1.5 scale miles)
Harbor Line Run	35' (1 scale mile)
Hidden Staging	Four 15' tracks
Ruling Grade	Mainline = 2%; Lumber line = 3%
Mainline Super Elevated	Yes
Minimum Curve Radius	Mainline = 16"; Lumber line = 13"
Number of Turnouts	105
Turnout Type	Mainline = #10; Sidings = #7; Yard = #5
Electrical	
Power Supply	APC Back-UPS RS 1500 (Contoured power, battery backup)
Controller	MRC Wireless DCC (6 Cabs)
Power	Twin 8 Amp Boosters
Districts	10 DCC Specialties PSX; 1 MRC Base Unit
Blocks	12 Physical; 6 Virtual
Block Detection	Team Digital DBD22
Signal Control	Team Digital SMC4
Accessory Controllers	TrainTek Aux Box, 16 addresses
Equipment	
Locomotives	95
Rolling Stock	~350

JEFF SARGEANT



Jeff Sargeant was a Senior Software Developer before retiring to write and pursue his life-long passion for N-scale model railroading. He lives in the Pacific Northwest of the U.S. with his wife Vicki.

When Jeff can tear himself away from his trains, he enjoys riding his motorcycle if the sun comes out (yes, it does come out once in a while in the

Northwest!) Jeff is an avid gamer and meets regularly with friends for a virtual night out.

Jeff and his wife love to travel, especially to locations where there is a tourist train! ■

TRAINMASTERS.TV
Coming in May:



Brought to you by



Big Sarge's

**Great Northern / Spokane,
Portland & Seattle layout**

Visit the TrainMasters TV website 



Model Railroad Hobbyist May 2015 | #63

YES, IT'S A MODEL

compiled by
DON HANLEY
.....



**Click here for
reader comments**



1. It's August. Summer thunderstorms have brought needed rain, and the weeds are thriving. Train #426 is awaiting its departure time. The train will meet its southbound counterpart, #425 at Embudo station. The Santa Fe's Lamy, NM, branch passenger train has arrived across the way. Ernie Barney posted these photos in MRH's Weekly Photo Fun thread.

► **MRH'S MONTHLY PHOTO ALBUM**

- [TABLE OF CONTENTS](#)
- [INDEX](#)



2. It is a hot summer day as 9388 waits in the siding near Prescott, AZ, on the former Arizona division of the Atchison, Topeka & Santa Fe. As soon as the crew gets the clear signal they will head back into town. On another day, BNSF 8720 was captured on film switching a local industry. The models were photographed by Federico Martinez of Argentina. Federico returned to the hobby a few years ago and “discovered wonderful things.”



YES, IT'S A MODEL | 4

YES, IT'S A MODEL | 5

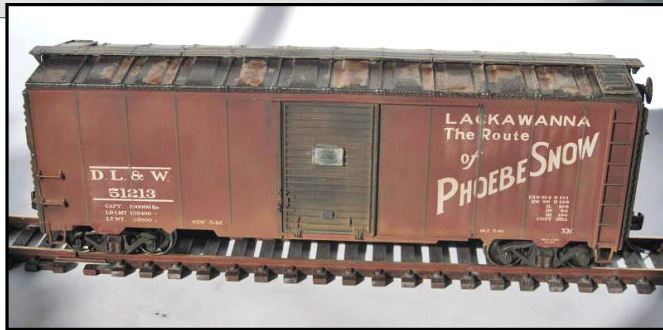

3. Jeff Shoe posted this picture of a well-worn Lackawanna boxcar. The car is a Branchline Yardmaster kit that he weathered with powders and oils. The factory black roof was weathered with several layers of paint and salt. Jeff started with a rust color and then added rock salt on the roof. The salt was sprayed with gray. Table salt was added and then a coat of thinned black enamel. Once the paint was dried the salt was brushed off to reveal the colors. He then dry brushed the rust spots for added effect.



4. Business is brisk at Dave's Antiques. There so many things to see it will take hours for the shoppers to look over everything. The photo was posted by Dave Roehrle in the forum. The amount of detail is amazing. To see more of his work go to public.fotki.com/daveinthehat/davetown/daves-antiques.



5. Here is a sampler of a great work in progress. Kurt wanted an O scale Baldwin diesel switcher, but nothing was available commercially in O scale. Rather than let that stop him, he decided to scratchbuild one. As he put it: "So I thought if I cannot buy an engine, how hard could it be to build one? Will I end up having a nice loco or if it will go directly to the scrap yard? Well, I will soon find out." In our opinion, he hit a home run. Check out the build at mrhmag.com/node/20966 in the MRH forum.

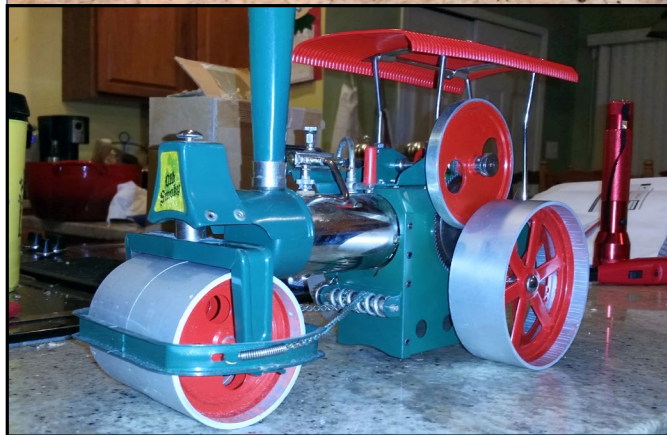

6. OK, so it's a tractor and not a train, but it is live steam. That should count for something. John Whitten and his son fired up a

60+ year-old live steam tractor. John remembers running it with his uncle and now his son is getting the opportunity to learn about live steam. Way to go, John.

\$ GET PAID FOR YOUR PHOTO

We pay \$40 per photo we publish. If you'd like to get your modeling in our photo feature, just start posting your photos on the MRH website, especially in the Weekly Photo Fun thread created each weekend.

See mrhmag.com/help for more on how to post an image. You need to be an MRH subscriber to post photos to our website, and becoming a subscriber is free, [just fill out this form here](#).

 [Click here for reader comments](#)

 **DID YOU KNOW MRH SUBSCRIBERS GET FREE BONUSES?**
CLICK TO SUBSCRIBE NOW - IT'S FREE!

Southern Pacific's GE Dash 7s Part 2



BY JEFF SKINNER

Part 2 on detailing a GE diesel for the SP

ADDING A DETAILED CAB INTERIOR, FITTING SP-SPECIFIC APPLIANCES TO THE TRUCKS, AND COMPLETING THE UNDERFRAME AND RADIATORS

Interior

I based my interior on a YouTube video of an ex-Union Pacific C30-7. The following pictures show you how it looks [35-37].

I used the Cannon and Company cab as the basis for the interior. I began by increasing the backs of the seats with styrene. The toilet is at the back of the cab behind a door on the back wall. I cut and sanded an EMD-type cab back to represent the GE door.



**Click here for
reader comments**

I placed the back wall further into the cab space, reducing the size compared to that of the

EMD. I added a toilet door with 0.005" styrene and 0.010" styrene rod for the hinges. The handle is modeled using an extra door handle I had from one of my GE cab kits.

I painted the interior a light gray, the seats black, and the control stand with a combination black and gun metal, using different dry-brushing techniques. I used the multiple colors from a piece of an ACI plate decal to give the illusion of a busy command station on the rear wall. I installed GE labels on the back of the seats to add variety and uniqueness to the cab. To get the mechanism to run without interference, I had to remove portions of the floor.

 [Click here for reader comments](#)

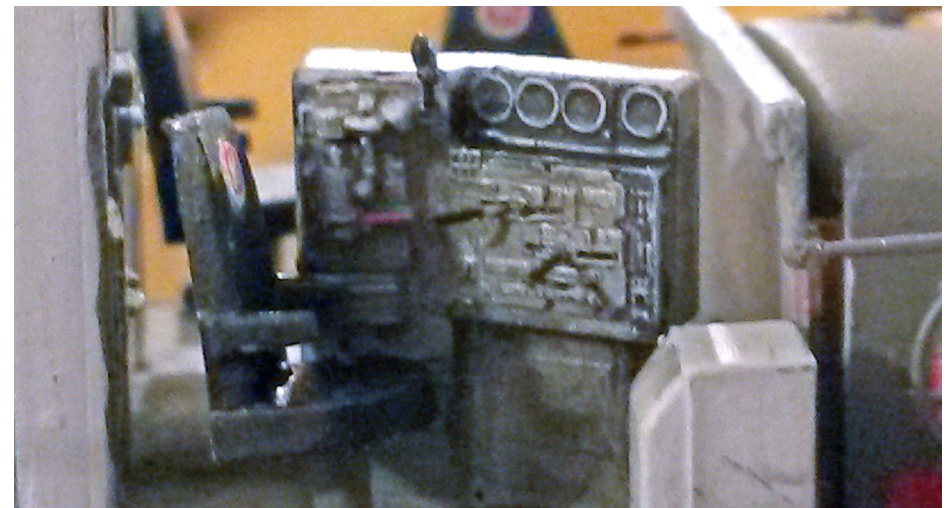
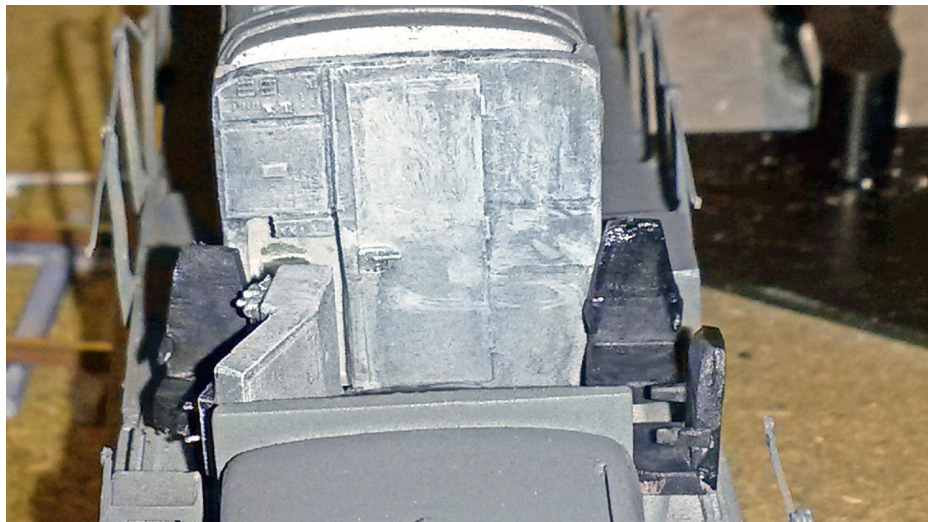

35-37. A look at the interior detail.

I found the following example of the Dash 7 interior at the website railroadlocomotives.blogspot.com/2014/01/general-electrics-1977-series.html.

Unfortunately this discovery was after I had built my interior, hence the differences.

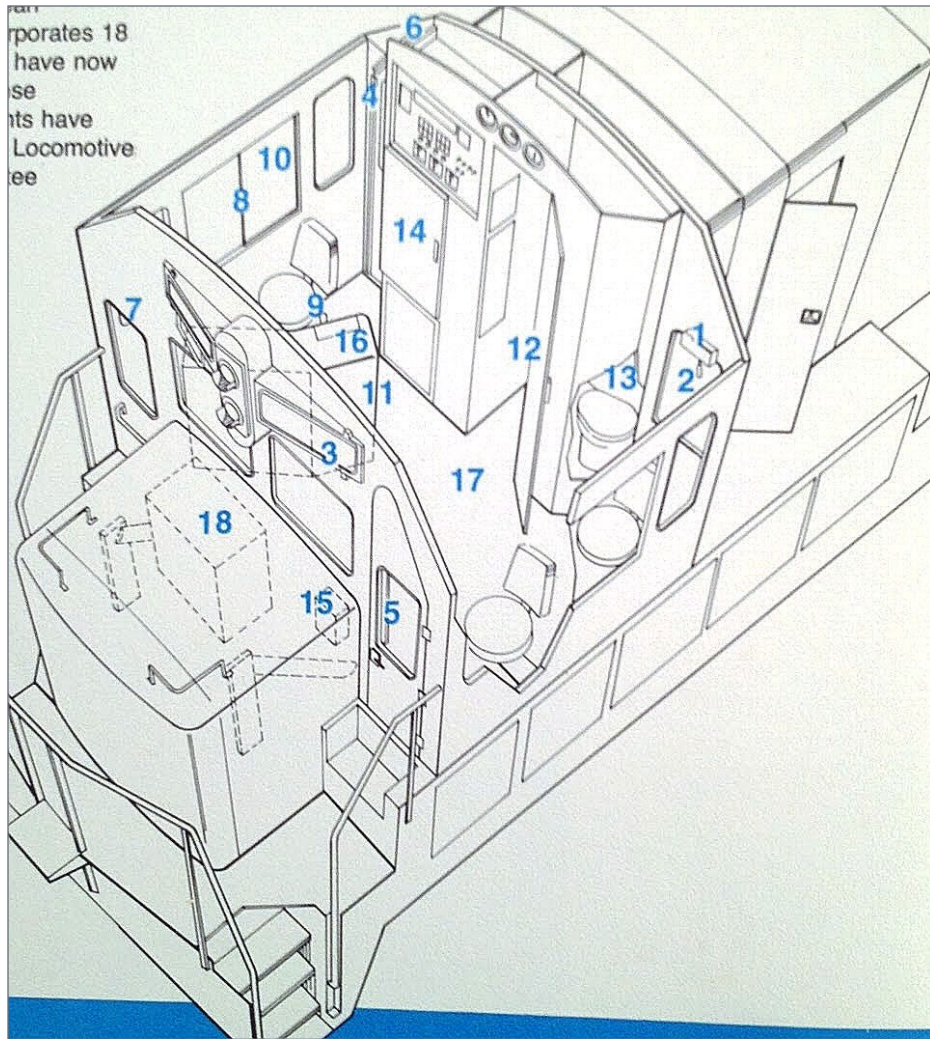

38. Example of a Dash 7 interior on the web.

Trucks

I began by adding airlines to the brake cylinder on the FB-2 trucks, and installing the wheel-slip/speedometer to the front left side frame [39].

I used excess photo-etch material to create sand line brackets, soldering 0.010" wire to the brackets to represent sand lines. I mounted them on to the bottom of the side frame by drilling two holes and added nut/bolt/washer details [40].

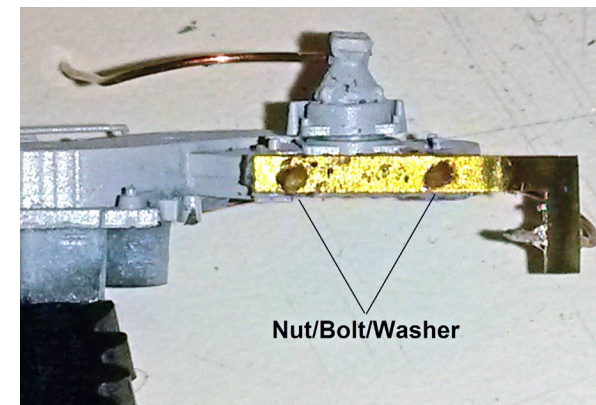
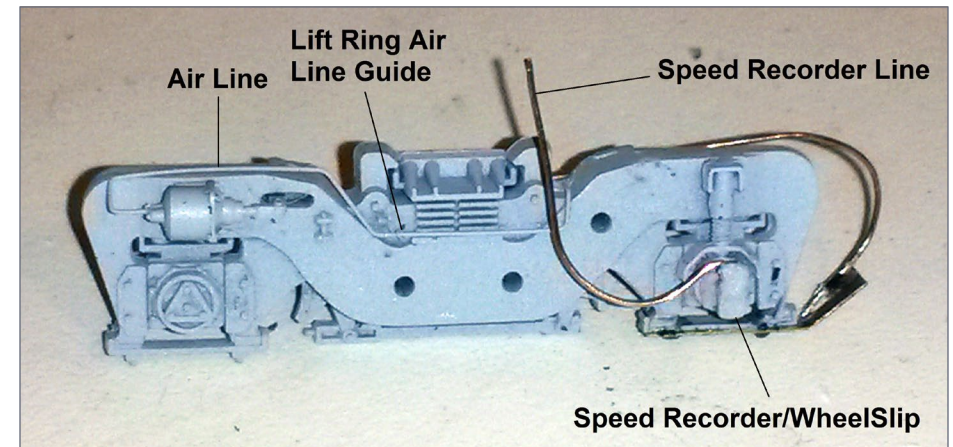

39. Added airlines and wheel-slip.

40. Sand line brackets.

Underframe/fuel tank

I removed the ends from the frame to provide room for couplers. Then I added styrene under the shell to help line up the chassis and provide a mounting location for the couplers and frame [41]. The frame is connected to the shell with two screws at the diagonal ends. I also installed coupler mounts with screws to hold the couplers in place.

I sanded 0.020" off the fuel tank and added sheet styrene to help with the fuel sight gauges. Unique to the SP 36-7 is the center fuel tank gauge. The other SP GE models do not have this detail [42].

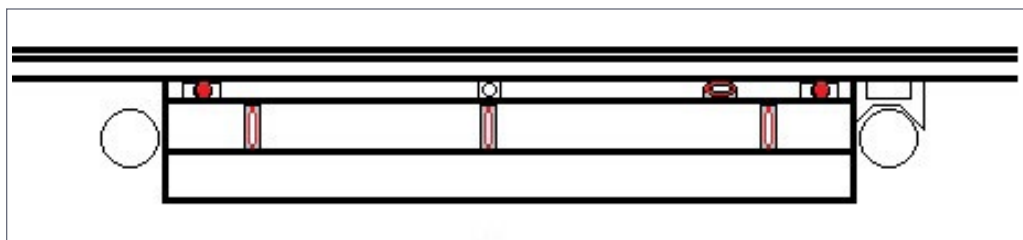
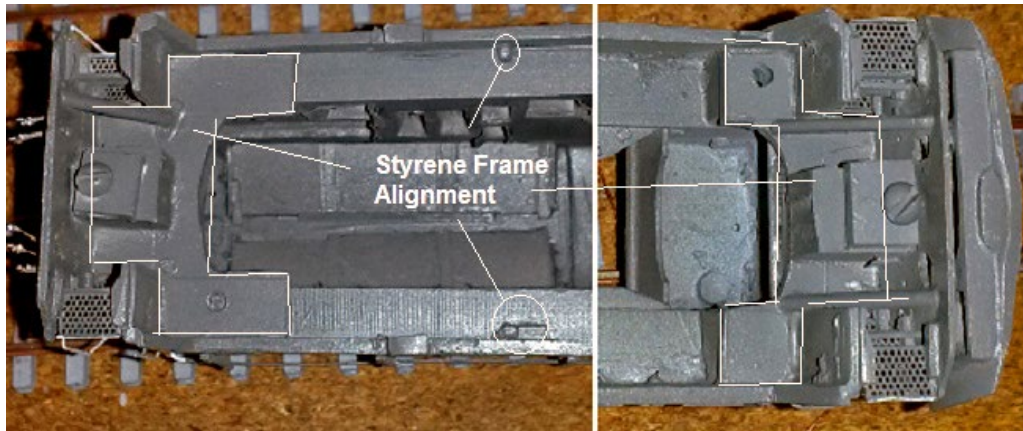

41. Adjusting the frame to make room for couplers.

42. Center fuel tank gauge.

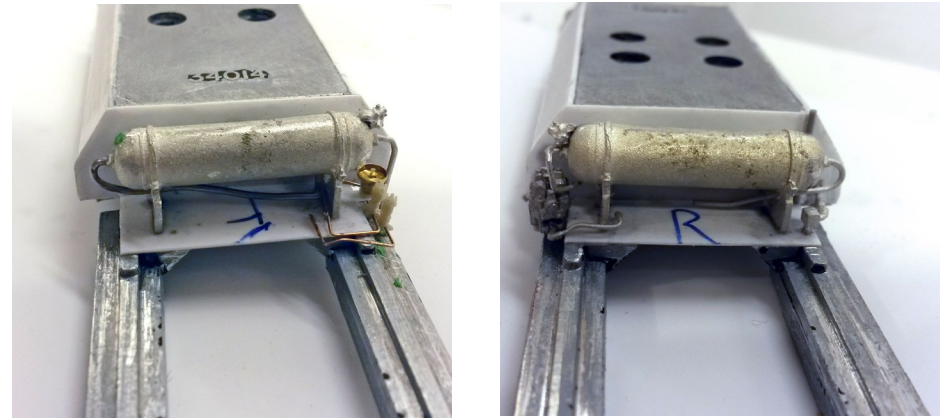

43. Front and rear of the air tank.

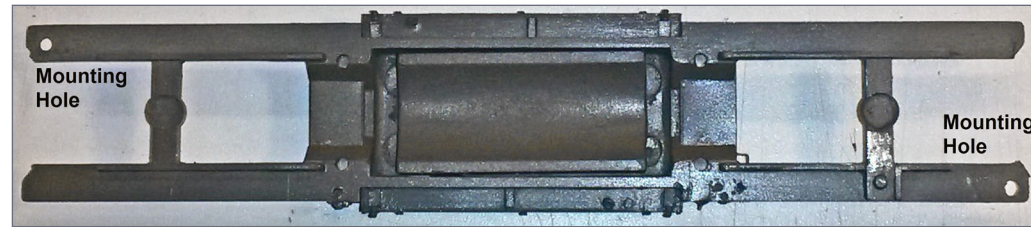

44. Mounting holes.

Next I added 0.010" styrene at the ends of the fuel tank to represent the welded steel plates per the prototype. I installed an A-Line weight to the chassis. Details West (DW) air tanks and appropriate piping were added, as well as the air filter. I added the DW fuel fillers and associated accessories as identified in prototype pictures.

Grilles

There are several more openings in the grille on this model than the rest of the Dash 7 fleet. I looked for a way to build the prototypical see-through grilles on the rear of the locomotive.

I removed the molded grilles and cleaned up the openings in preparation for new grilles.

I remembered an article by Steve Orth in the October 2001 *Railmodel Journal* where he was creating a see-through radiator screen for an SD45T-2 (article is available through the Train Life website, trainlife.com). I decided to use this technique for my model. I obtained the stainless steel mesh he identified in the article. After putting corrugations in the mesh, I installed it on the model. I think it looks pretty good, but on my next effort I might refine my process to make them a little more correct.

Also note the door at the bottom-right of the conductor side of the hood. I created this from a Cannon and Company cab sub-base door, then scratchbuilt the handle with 0.020" square styrene, and the rib at the top of the door with 0.010" styrene rod.



45. Shot of the grilles.

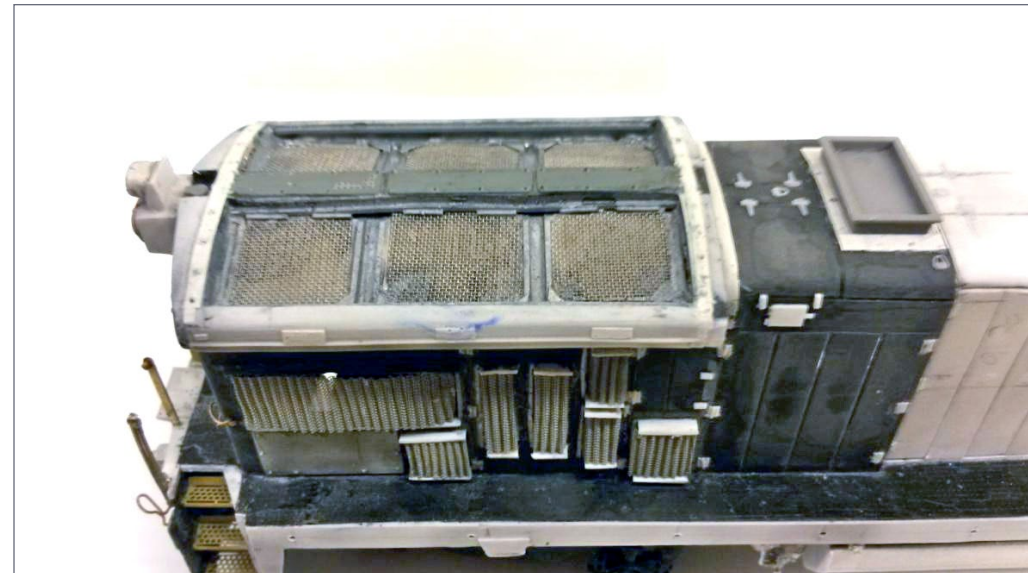

46. First shot of the radiator.

Radiator

Encouraged by other SP modelers, I investigated ways to add depth and detail to the radiator. Using a combination of scratchbuilt parts, photo-etched products, and micro-mesh screen, I was able to accurately model the depth of the prototype. I began by cutting out the radiator from the shell and adding some ledges for the screen to sit on.

I scratchbuilt the details to represent the multiple radiator cores. I used extra parts I had lying around to build my radiators. I cut doors from an old Rix Models kit, and used them to replicate a reasonable radiator core. I put a piece of stainless steel mesh over the cores and added some framing. The results are shown in [46].

Looking beyond the model railroad industry to make a better-looking radiator screen, I found a company in Poland called Aber that makes photo-etched items for ship modelers. A quick Internet search provided several domestic retailers, and I purchased mine through eBay. Aber has a specific product called netting with 1 mm square spacing. After some measurements, I concluded this would be a close representation of the Dash 7 radiator.

I cut two pieces of the netting to the size of the radiator openings. I shaped them a little bit and installed them in the openings. When I finished, I was extremely satisfied with the results, as shown in the test fit [47]. I added the separation bar by soldering a piece of photo-etch scrap material on the net. I painted the radiator area gun metal color prior to adding the radiator screen.

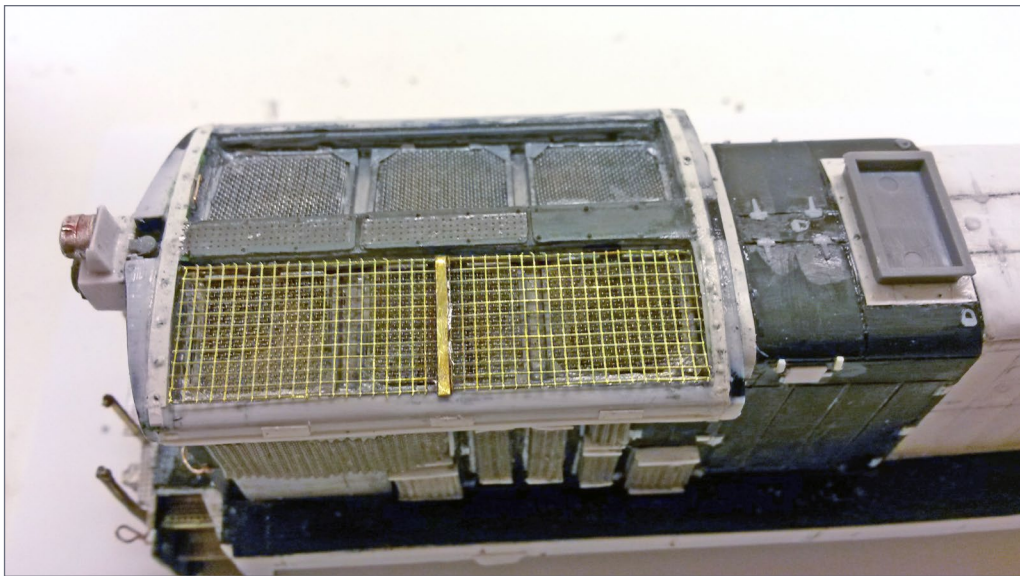

47. First set of netting added.

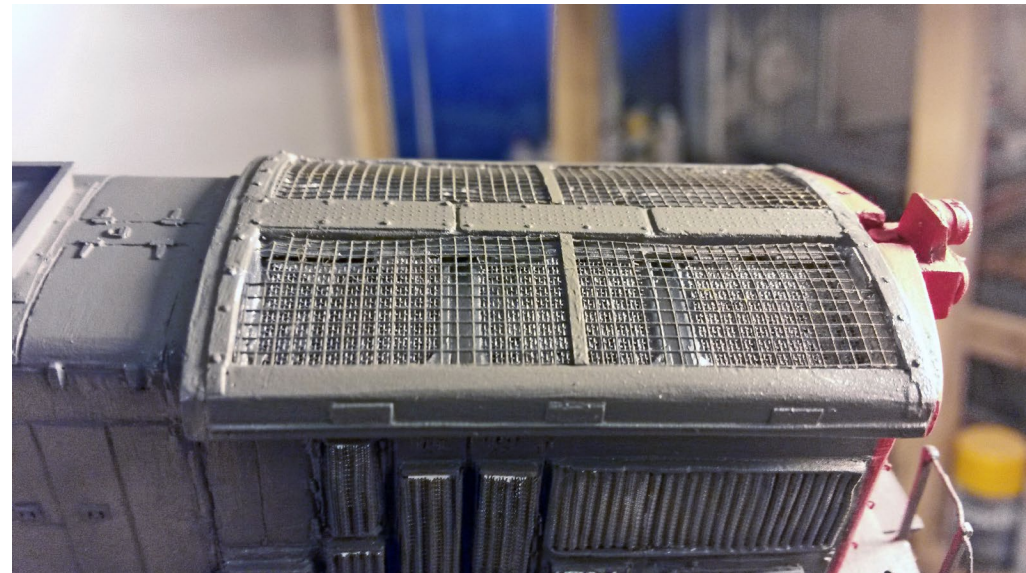

48. Finished radiator.

The results from this effort turned out far better than I had anticipated, as shown in the finished model [48].

Decal details

I purchased Archer GE tread plate decals and added them to the model. These are very fine, and an excellent representation of the GE walkways. [49] shows an example of the finished tread plate on the model.

I added the tread plate decal to the walkway over the radiator section. I installed the product like any other decal. After a coat of gloss clear on the unpainted plastic, I cut and applied the decal in the normal manner. I painted the decal once it had settled and dried.

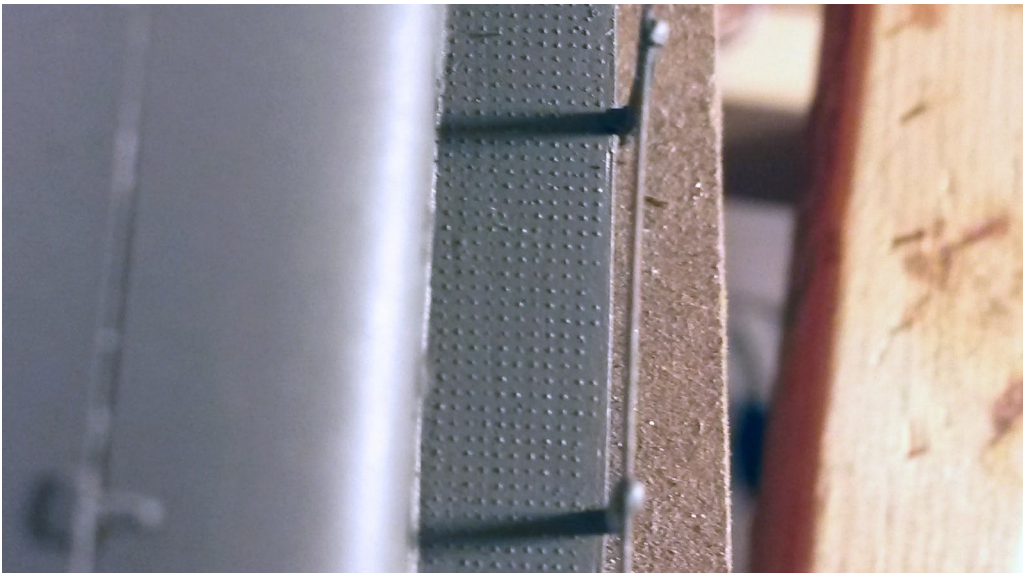

49. Tread plate decal on the walkway.

Painting

After the recent railroad paint upheaval, I decided to try Tru-Color Paint. I purchased Light Primer, SP Light Lark Gray, and SP Scarlet. I prepared the model by cleaning the shell with warm soapy water, rinsed, and let the model air dry.

I prefer to paint a primer coat. After letting the primer dry for a couple of days, I painted the scarlet. After a couple more days of drying, I cut the wings from masking tape and taped off the scarlet. I then painted the unit with the Light Lark Gray. This paint dries to a gloss finish that is suitable for decaling without further preparation.

Decals

I decaled the unit using Southern Pacific diesel locomotive decals, builder's plate decals, and other small decals from set

87-527, "GE-EMD Locomotive Data." I installed all decals per photos and decal instructions. To get the decals to settle, I used Microscale's Micro Sol.

After all the decals were applied, settled in, and dried, I sprayed a light coat of gloss on to render the decal film nearly invisible. Allowing the gloss coat to dry, I then sprayed the model with Dullcote to remove the shine. At this point I added light weathering to represent a newer model with little time working on the Southern Pacific.

Assembly

Once the final coat of Dullcote had dried, it was time to put it all together. I began by installing the windows in the cab using 0.005" clear styrene. I installed the lights at this time. I used micro light emitting diodes (LEDs) available through various Digital Command Control (DCC) retailers. Red LEDs are used for the single warning lights, and soft-white LEDs for the headlights and Gyalites. I drilled out the lights on the shell to add the LEDs. They were installed and set using Microscale Kristal Klear. Once set, I added more Kristal Klear to create the lenses.

I used an a TCS A6X six-function decoder to handle all the lights of the SP. I also like the TCS decoder for its flash effects of the Gyalite and Mars lights, and ease of installation for LEDs.

At the end of this project I am very satisfied with the new modeling techniques I tried. This unit will bring a unique addition to my locomotive roster. I would like to thank Rob Spangler for use of his layout for finished photos (see the finished photo on the next page). ☑

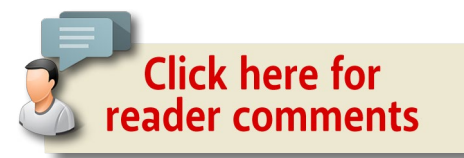



50. Finished model.

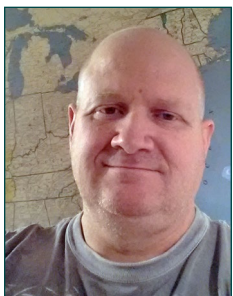

.....
JEFF SKINNER

Jeff Skinner is married with three grown children, and works as an engineer in the aerospace industry. He has always had an interest in trains, but it really took off with an HO scale Bicentennial train set that he received when

young. As a child he was always interested in the Southern Pacific and the Rio Grande. This was primarily because he didn't see them half as much as he saw the Union Pacific.

He is currently working on a Southern Pacific layout modeling the line from Eugene to Summit, Oregon. He enjoys detailing locomotives and freight cars. In addition to trains, he enjoys off-road motorcycle riding and playing the guitar. ■

.....



Fighting ... **DIRTY RAILS** BY TREVOR MARSHALL

A simple graphite stick improves electrical performance ...

THERE'S NO QUESTION: MODEL RAILROADS are only fun if the trains run – and run reliably. Unless one is using a battery-power system, reliable running depends on

1. Everybody has to deal with dirty track, especially those running DCC and sound on their layouts. When the author's MoW forces are called in, they bring the Big Stick: A piece of graphite that's rubbed on the rails to banish bad electrical conductivity.

excellent electrical contact between rails and wheels. This is especially important for layouts that feature DCC and sound, since sound decoders need a reliable source of power.



[Click here for reader comments](#)

Over the years, modelers have tried many things to improve the electrical path between wheels and rails, from additional wipers on locomotives,

to hair clipper oil spread on rails, to special circuits hooked into the power supply and designed to burn away non-conductive contaminants. I too have tried a number of possible solutions, often with disappointing results.

Then, several years ago, a British modeler I know shared a trick with me that's helped to keep layouts in the UK running reliably for decades. And it's as easy as scribbling.

2. In this video, the author demonstrates his technique for applying graphite to the rails on plain track and around turnouts.



[Click here to play video.](#)

Playback problems? [Click here ...](#)

It is the graphite drawing stick which can be purchased for next to nothing at any art supply store. I picked up a stick of 2B hardness more than a decade ago and used it on a finicky layout. My wheel-to-track conductivity problems disappeared. Since then, I've been a convert, and after an initial cleaning when building a layout, I've never had to clean track.

Welding the stick

This is one of those cases in which a video is worth a thousand words, so I've created one to show how I use the graphite stick on plain track and around turnouts. Here are a few notes about using graphite on the rails:

1. Paint the rails, let them dry, then clean the railheads using your favorite method. Anything from a piece of strip wood dipped in

ADVERTISEMENT

Make LocoNet wiring extremely simple!

ACCU-LITES, inc
Your DCC Center!

CELEBRATING 20 YEARS ANNIVERSARY
Dealer Inquiries Accepted

PM42 breakout board

BDL168 Multi-zone breakout board

SE8C breakout board

BDL168 Single-zone breakout board

Now Offering SNAPS! in packs of 6 or 12 pieces! [CLICK TO LEARN MORE ...](#)

FIGHTING DIRTY RAILS | 5

thinner, to an “eraser” style track cleaner, to a fine emery board works for me. Be sure to include the inside edge of the railhead on each rail; this can be done by angling your track-cleaning tool.

2. Make sure the layout is powered down. Graphite conducts, that’s the whole point, and you don’t want to short your layout while applying it.

3. Rub the graphite stick lightly over the tops of the rails. Complete coverage is not necessary, because train wheels will pick up graphite and help spread it.

4. Be astonished at how much better things run.

As the video shows, on plain track I lay the stick across both rails, then lightly press down in the middle of the stick and rub it back and forth while sliding the stick along the track. I stated it earlier, but it’s important enough to repeat: Use a light touch. Even with a



2. The author’s graphite of choice is a 2B artist’s stick he bought more than a decade ago. Any of the softer (“B” as opposed to “H”) grades should work fine.

FIGHTING DIRTY RAILS | 6

light touch, my graphite stick has developed a slight bow over the past decade of use. This is great, since it helps apply the graphite to the inside edge of the railheads.

This rubbing action works well for plain track but could damage special track work. Here, I use different approaches, also as shown in the video.

For switch points, I throw the switch so the first point is next to its stock rail. I then draw the graphite stick across the point in one direction only: Toward the stock rail. Then I throw the switch to the opposite direction, and do the second point.

For frogs and guard rails, I draw one end of the stick along the rail. This prevents catching the end of a guard rail and ripping it off the ties. This is also useful on bridges, beside buildings, or anywhere else where a side-to-side motion might bash into things.

ADVERTISEMENT

**IOWA SCALED
ENGINEERING**

Exciting and affordable sound player for your model railroad

open source hardware

LEARN MORE >

ADVERTISEMENT

FOX VALLEY MODELS

**HO & N SCALE
HIAWATHAS**

FINAL BOARDING CALL FOR MORE CARS AND LOCOMOTIVES!
NOW AVAILABLE WITH SOUND!

RESERVE TODAY!
www.foxvalleymodels.com

I don't worry too much about gaps between blocks or gaps in turnouts, since any graphite powder that bridges such gaps will get burned out the first time the power is applied to the layout. That said, I try not to rub over rail gaps. Instead, I rely on the train wheels to pick up some graphite and redistribute it to these spots.

And that's it. For many years I have run layouts including, for more than two years now, my current S scale layout, without any need to do routine cleaning of track or locomotive wheels.

The only time I routinely reapply graphite is after I have worked on track or scenery. I'll clean the track where I've been working, then give the area a quick wipe with the graphite stick.

People occasionally ask whether graphite presents any traction problems. They worry about reduced pulling power, for example. While my layout is mostly level, and I run only short trains, one

of the largest layouts in our area the Waterloo Region Model Railway Club (sudburydivision.ca) started using graphite sticks after a member visited my layout. They went with a softer stick, a 4B, and I'm told the layout not only runs better, but they've had no problems pulling 40-car freight trains up 2% grades.

Want to know more? There's been an extensive discussion about using graphite on the Model Railroad Hobbyist forum. You'll find it here:

model-railroad-hobbyist.com/node/17181.

If you try graphite, be sure to share your experience with the forum. Everybody has a favorite method for cleaning track, and what works best for one hobbyist may not work at all for another. But if you're having problems with reliable electrical contact, you might want to give graphite a try, especially before you invest in more

ADVERTISEMENT

ADVERTISEMENT

ADVERTISEMENT

FIGHTING DIRTY RAILS | 7

expensive options. Pick a known trouble spot on the layout and apply some graphite using the techniques shown in the video. If it doesn't work for you, you can always clean off the railhead and try something else, then give away the stick to a budding artist. ✓



**Click here for
reader comments**

TREVOR MARSHALL



Trevor is a lifelong model railway enthusiast who has worked in several scales and gauges - including HO, On2, Proto:48 and various garden scales. He started his current S scale layout in mid-2011 and writes about it at:

themodelrailwayshow.com/cn1950s.

Trevor created and co-hosted "The Model Railway Show," a podcast about the hobby, and has written several dozen articles and reviews for the hobby press. Trevor also has been host-

ing segments on MRH's TrainMasters TV of late. Trevor lives in Toronto, Canada, where he divides his time between his model railway, his work (a mix of speech writing and technology reporting), and training his Border Collies to work sheep. ■

Visit
Our
Website!

Litchfield
STATION

TRAIN CONTROL
SYSTEMS

SOUNDTRAXX™

NCE
The Power of DCC

Tam Valley Depot

Digitrax®
Complete Train Control

SHOPPING AT
LITCHFIELD STATION

FOR ALL YOUR
DCC PRODUCTS?

WHAT A
BRIGHT
IDEA!

623-298-7355 • www.Mr-DCC.com
www.LitchfieldStation.com

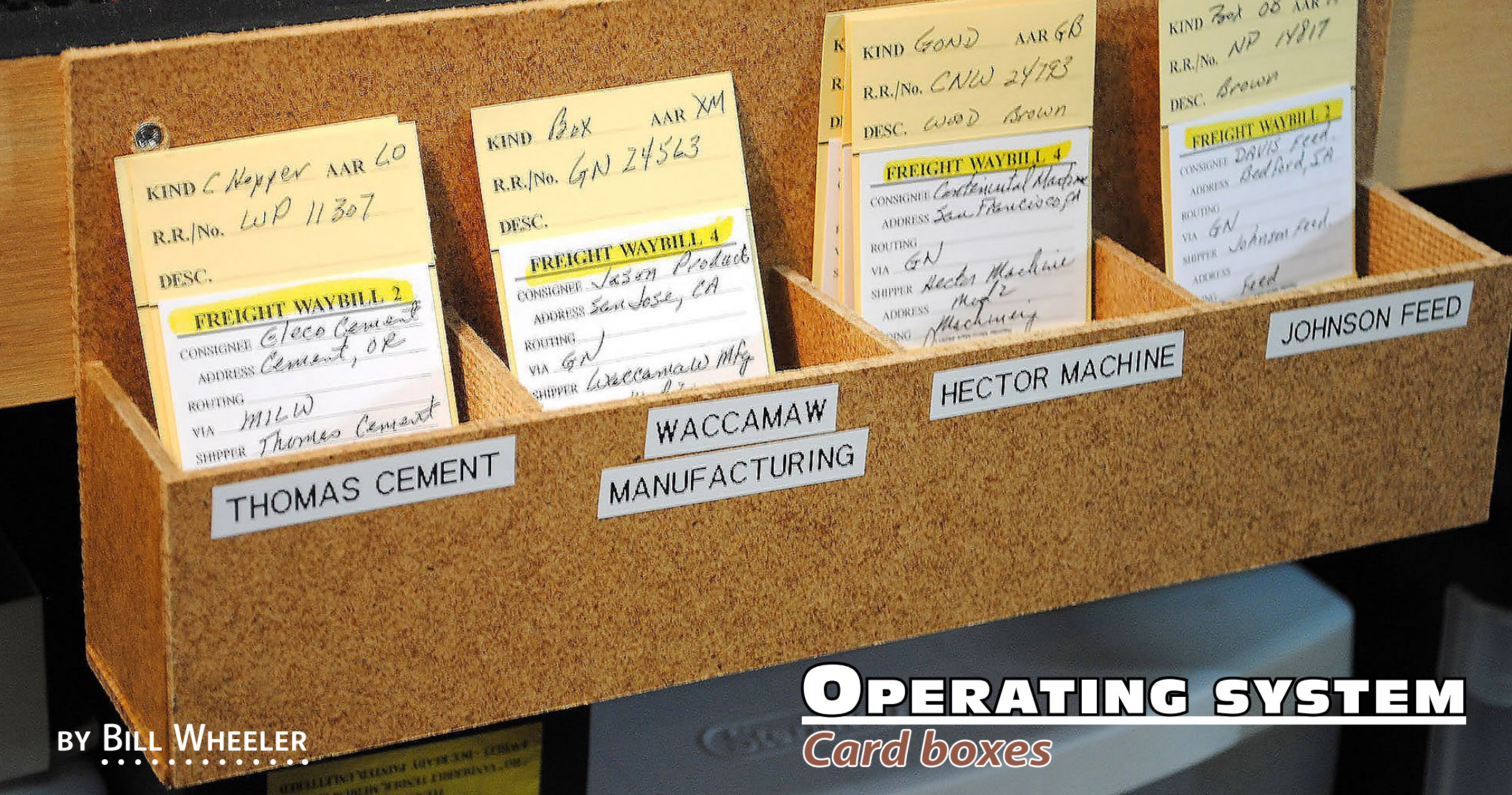

BY BILL WHEELER

OPERATING SYSTEM Card boxes

Custom-built boxes fit a club's needs ...

WHEN THE SOUTHWEST WASHINGTON MODEL Railroaders wanted to upgrade its card operating system, we purchased a starter kit from Micro-Mark. This kit included the cards and three-compartment card boxes to place at industry locations on the layout. They are great boxes, but we found that in some

locations we wanted boxes that could take four, five, or six sets of cards (see sidebar on the last page).

We decided to build our own boxes of about the same size out of Masonite that some members were using for fascia on their layouts. We used 1/8-inch thick material for the front and back of the boxes and 1/4-inch material for the sides, bottoms and dividers. In some cases we have used 1/4-inch material for all pieces. Carpenter's glue was used to assemble the boxes.



[Click here for reader comments](#)

CUTTING THE PARTS

The first step was to rip strips, on a table saw, from the appropriate thickness of Masonite for the front, back and sides, bottoms, and dividers. We cut 4¼-inch wide panels for the back, 2½-inch for the front and 1½-inch for the sides/bottoms/dividers [2].

The second step was to cut the strips to length. For the front, bottom and back we used the formula of three inches for the first pocket and 2¾ inches for each additional pocket. This came out to 11¼ inches for a four-pocket box, 14 inches for a five-pocket

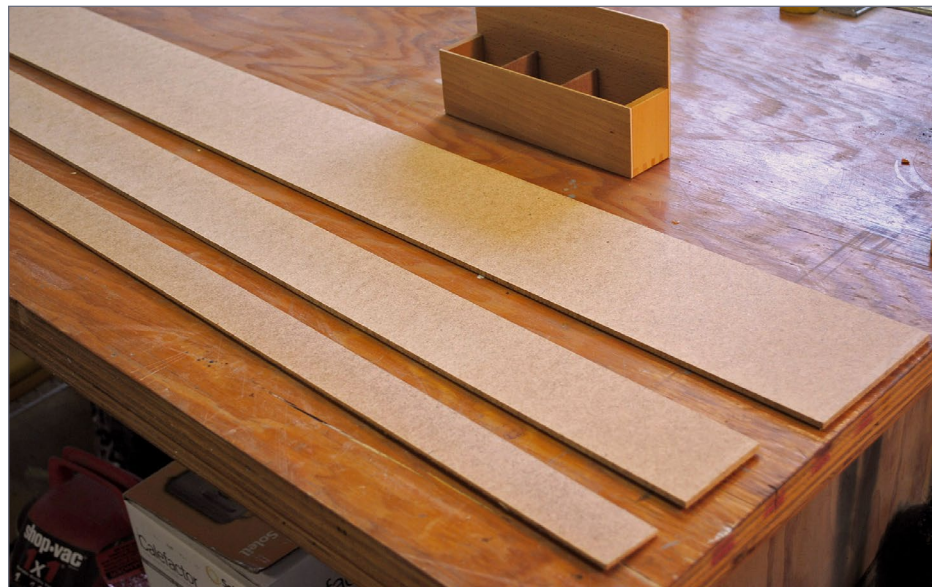

2. Strips for the front, bottom and back of the boxes.

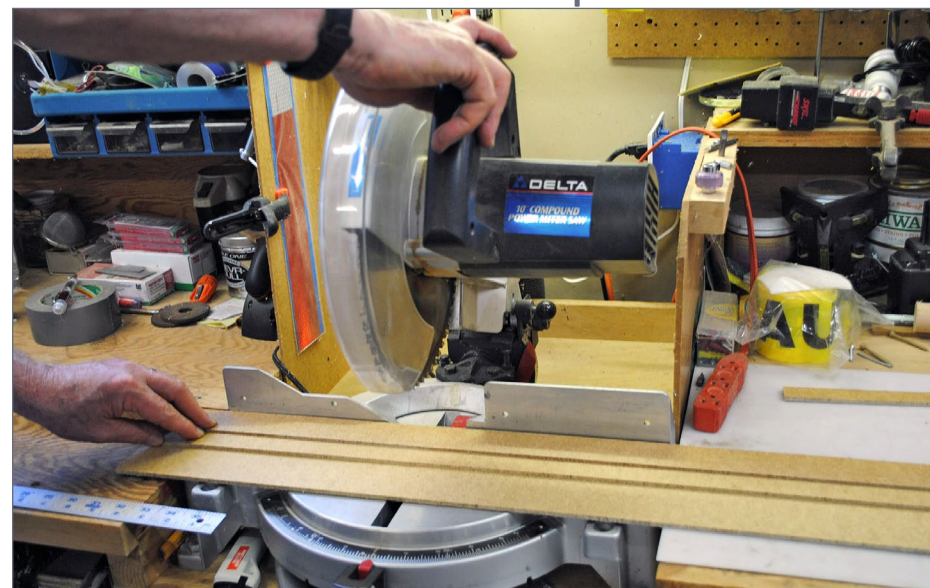

3. Chop saw cutting front, back, and bottom at one time so all will be the same length.

box and 16¾ for a six-pocket box. We used a chop saw for this cut [3]. The sides and dividers were cut to 2¼ inches long. We set up a jig and used a band saw because there were so many to cut (number of pockets + one) for each box [4].

ASSEMBLY

The third step was assembly. First, the front, bottom and back were lined up next to each other and lines measured and drawn across at one side of each divider. A square was used to ensure the lines would be good guidelines during gluing [5]. Next, the back was laid on the workbench and glue was placed on the long edge of the bottom. The bottom was then placed on the back. Glue was put on the bottom and back edges of the sides/dividers and then put in place using the guide lines. The front edges were glued and the front put in place. Clamps were used to hold things

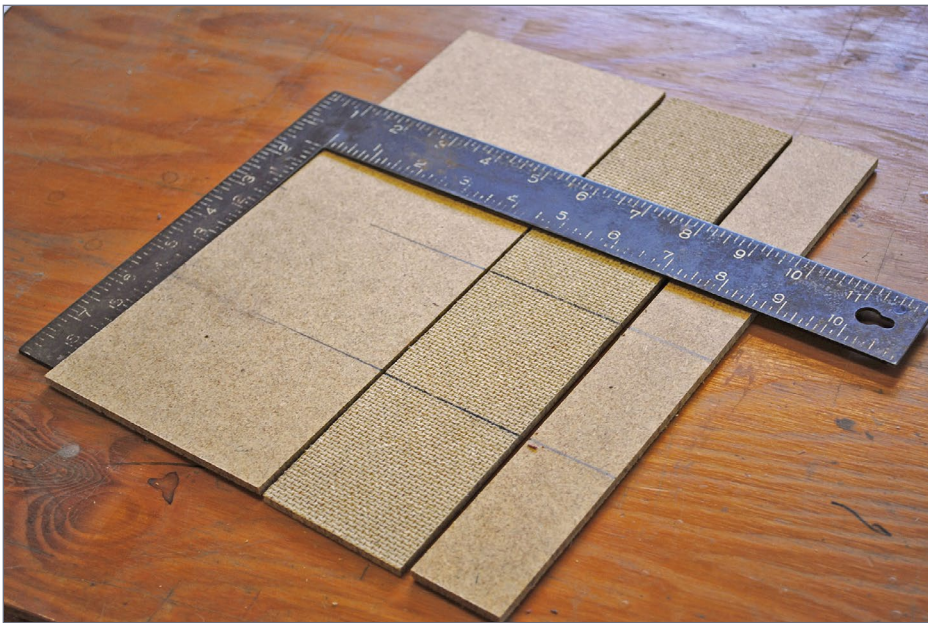
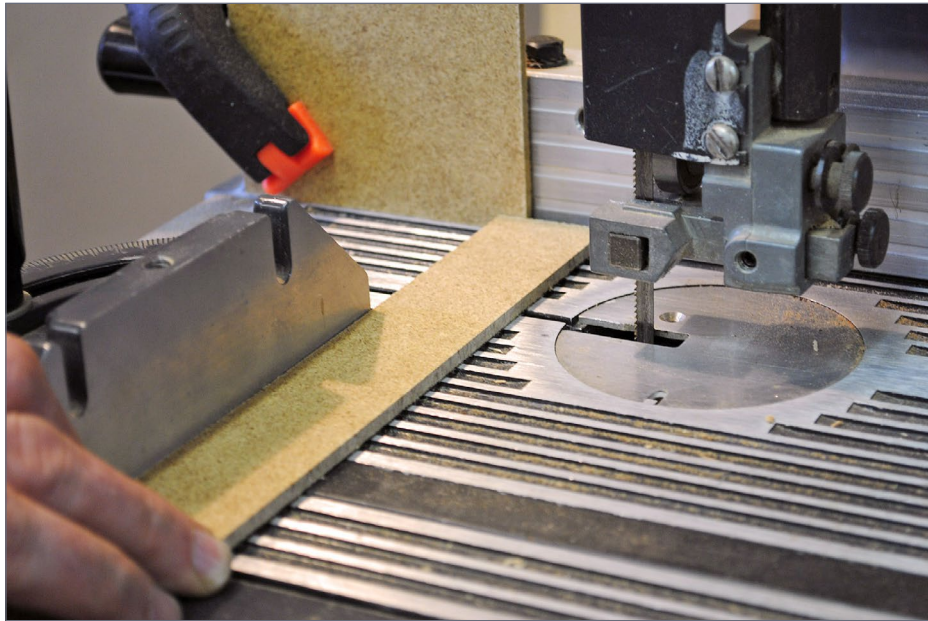

4-5. Cutting the dividers, and marking the glue lines.

in place while the glue dried. Wipe off the excess glue with a wet paper towel or cloth.

After they dry, you have card boxes that meet your needs. The boxes can be made out of other materials. I have seen ones made out of sheet plastic. ✓

SIMPLIFIED CARD SYSTEM

On the club layout, each car has a car card and a waybill. The waybill has at least two destinations and may have up to four. Each industry, or car destination, has a box where the cards for the cars spotted at that industry are placed. When a car is spotted at an industry, a car at the industry is picked up. If there is more than one car, the innermost car is picked up. When a car is spotted at the industry, the waybill is turned to the next destination.

If two cars are to be delivered to an industry where there is only one spot, one car is spotted and one is placed nearby, "off-spot," and spotted the next time the local is at that town. The waybill for the off-spot car is not turned since it has not reached its destination.

The cars picked up are routed based on the destination showing on the waybill, and may be routed to a yard for inclusion in a train to off-layout destinations. While the train is travelling off-layout, the cards are turned to the next destination. When the train reaches the yard, the cars are delivered to the industries that are now showing on the waybill. ■

 [Click here for reader comments](#)

BILL WHEELER

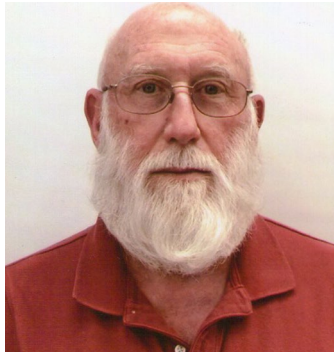

Bill Wheeler is a retired US Navy officer and mostly retired professor of Engineering at Clark College in Vancouver, WA.

He received his first HO train for Christmas 1950 and has been interested in trains ever since.

His 12 x 24 foot Cascade Timber logging layout has been under construction since 2000, and he is a member of the Southwest Washington Model Railroaders. ■



Announcing
New home for Motrak Models

Motrak Models Headquarters is now at
717 Windsor Lane, Martinsville, VA. 24112



Phone number: 813-476-4784
Email: motrakmodels@centurylink.net



1st choice for model railway supplies and service.

Expedited mail service available across North America.

Click to visit
WWW.CVRCO.COM
1 800 464 1730



Rusty Stumps
Scale Models

WE ONLY SELL WHAT WE MANUFACTURE

DETAILS IN HO, O, S & N SCALES
LASER CUT SHINGLES, DOORS & WINDOWS, FENCES, SIDING, CRATES. Also RESIN and WHITE METAL DETAILING CASTINGS.

CRAFTSMAN KITS
IN HO, O & S SCALES

CHECK IT ALL OUT AT
WWW.RUSTYSTUMPS.COM

Send \$3.50 for Catalog - Specify Scale
RUSTY STUMPS SCALE MODELS
6785 Cherry Blossom W. Dr., Fishers IN 46038
Phone (317) 595-9489

FREE-MO

In a foreign land



BY MATTHEW PICCIOTTO
.....

How I built a module while deployed as a civilian contractor in Afghanistan ...

ON MAY 2012 I WAS ON MY WAY TO KANDAHAR

Airfield outside Kandahar, Afghanistan as an HVAC mechanic for a defense contractor. Before leaving, some members of the

Capitol Free-Mo module group capitolfreemo.org met for a pizza sendoff party. We joked about me building a module while I was overseas. Within a few weeks, it looked like the idea was actually possible ...

Afghanistan's railway infrastructure is about a hundred years behind the rest of the world. But railway construction is under way as the country begins to develop its mineral resources and international trade. One of the industries using rail is



**Click here for
reader comments**

petroleum. The New Afghan Petroleum Company, or NAPCO Group, has constructed two rail-served fuel depots. My module is a freelance model of a fuel depot under construction.

The railway line that was the inspiration for my module is constructed to the Russian broad gauge and runs from Uzbekistan



1. I modeled the module scenery based not only on photographs of the Hairatan rail link, but also on photographs I took, such as this one. On the module I chose to place a Kochi nomadic herder with his sheep, goats, and camels, although a donkey would have been appropriate as well.



2. In a nation with few forests but plentiful sand and rock, concrete is the go-to building material. The current railway projects in Afghanistan follow the construction methods of Turkmenistan and Uzbekistan, which build railroads the same as Russia does, with concrete ties, or sleepers, in the vernacular outside North America. Turnouts still use wood sleepers. Commercial concrete flex track suffers the same problem as commercial wood flex track. The color just isn't right. I solved that with a layered approach of spray paint followed by a concrete pigment intended for plaster work.

south into Afghanistan on the Friendship Bridge to Hairatan and continuing to Mazar-i-Sharif. To learn more about railways in Afghanistan the best place is Andrew Grantham's website andrewgrantham.co.uk/afghanistan.

The line is built to modern standards, with track laid on concrete sleepers (ties), and turnouts laid on wood sleepers. Russian

FREE-MO IN FOREIGN LAND | 5

railway lines are built to 1520 mm rail spacing. This works out to be about three inches wider than standard gauge. The difference in HO scale is small enough that models of Russian locomotives and rolling stock can use standard HO track.

Modules built 7,000 miles from home have to be small enough to ship, and a 3'-long HO module doesn't provide a lot of room for a realistic industrial scene. My solution to this problem was to build my module in segments. The first segment was built to debut at the Great Scale Model Train Show in Timonium MD, October 2012. This segment is the entrance to the NAPCO

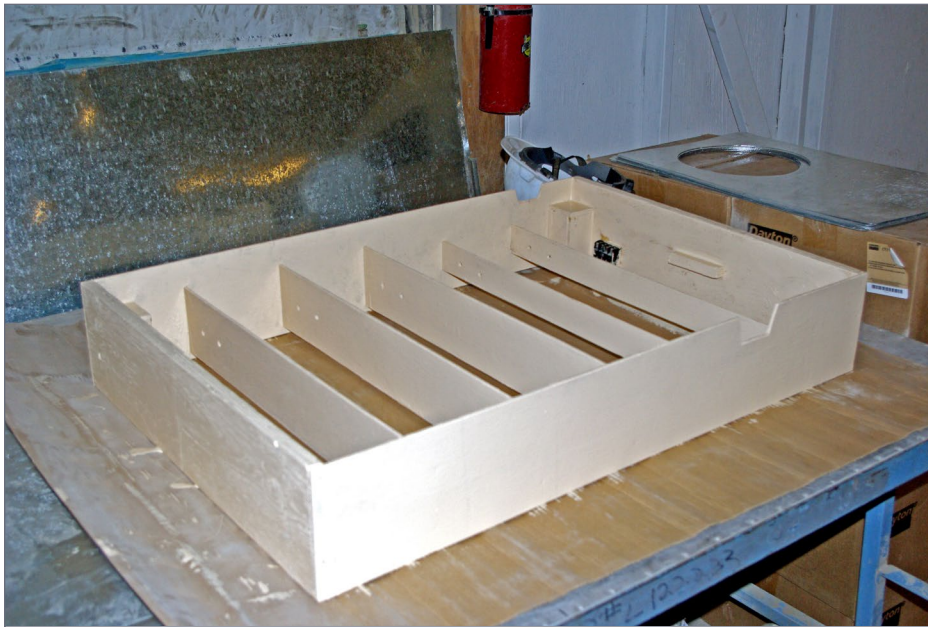

4. Here you can see how I painted every surface of the module frame. Only finished wood products can be shipped into the United States without a license. Also I was concerned about the wood swelling, or other issues when the desert-dry wood left southern Afghanistan for the temperate and comparatively humid climate of Maryland.

FREE-MO IN FOREIGN LAND | 6

fuel depot. The next two will be of the depot proper in various stages of completion, with a small portion operational and able to receive fuel by rail and dispense to road transport.

Modeling an industry under construction has several benefits for my situation. Most importantly, I am able to keep a low overall profile of the module, keeping shipping cost down. Additionally each segment can be a complete module. The spur track isn't a track to nowhere – it's a spur still under construction. Also, when carefully done, incomplete scenery can be the landscape disturbed by the construction project.

An industrial construction site offers loads of potential for operations, which is what Free-mo is all about. Carloads of pipe, rebar, equipment such as pumps, and generators can all be dropped on the spur. A large-enough site would even have its own concrete batch plant requiring cement hoppers and loads of aggregate. These don't have to be entire trains either. One or two cars at a time are very common, similar to the variety of loads you would have at a team track, but with a higher volume of traffic and shorter turnaround times.

When I arrived in Kandahar, I was fortunate enough to find myself working in a large maintenance yard with a well-equipped carpentry shop. After making careful plans for the module frame, I used scrap lumber that a friendly carpenter cut to my specifications. I painted the module fascia and frame in Desert Khaki, a color the sign shop had in abundance. Painting all the exposed wood seals against moisture, but more importantly, I couldn't have taken the module home with me if it wasn't painted. Without the right licensing, only finished wood products can be brought into the U.S. I chose a ladder type frame instead of a spline because I wanted to include a wadi, or dry creek bed, in the scene with a culvert under the railway track.

I was able to use foam board from my own shop. There is a type of HVAC duct board used in Europe and the Middle East that

consists of foam with aluminum foil facing on both sides. It is only about 3/4" thick, quite a bit thinner than is typically used on modules in the U.S. I chose to use two layers of the foam for strength, and three near the wadi. I removed the foil to save weight. The foam is glued to the frame using polyurethane glue. Polyurethane glue is gap-filling and also it bonds extremely well to the foam and the wood. After the glue cured, the module became very rigid, but still very lightweight. The terminal blocks were salvaged from broken air conditioners.

I couldn't have completed this project without the help of my father, Dan, and my wife, Nicole. She collected my modeling supplies from home and mailed them here, along with track my father had cut to length and added feeder wires to. I couldn't risk damaging the track by soldering feeders myself, not having



5. Polyurethane glue works excellently for bonding the foam to the painted wood, and for laminating layers of foam.



6. A mix of mail order, supplies from home, and the limited selection from a Dutch store on base, combined with creativity and ingenuity, were enough for me to build this module 7,000 miles from my local hobby shop.

any in reserve. My father also mailed a turnout from his local hobby shop. I mail-ordered other items, like the Monroe Models concrete box culvert, the Preiser sheep, camels and shepherd. I ordered scenery supplies from Scenic Express.

Painting structures or detail parts is a challenge because I don't have access to a well-ventilated area to work with solvent-based paints, and I can't have aerosol cans shipped here. I try to work with watercolor acrylics, water-based pigments from Woodland Scenics, India ink, and A.I.M weathering powders. I use Scenic Express acrylic matte medium in place of Dullcote. I did find a Dutch PX on base that stocked a few Revell of Germany items such as brush cleaner, small bottles of paint, and plastic cement

which helped to fill a void until my model railroader care packages started arriving from my family.

Sometimes I have to get creative. When my paints arrived, I found that the black paint had completely dried out. To paint the sleepers on the turnout, I mixed India ink with tube acrylics. Painting the concrete sleepers was another challenge. My bottle of Woodland Scenics “Concrete Pigment” worked great on the plaster castings, but it would not adhere to plastic or resin. After a series of experiments, I determined that the pigment would adhere to a base coat of primer. I found some gray primer, and sprayed the track with it, and then hand-painted



7. Heavy rains and flash floods are a problem in Afghanistan, especially in the winter. As the next two module segments will have the oil depot, I wanted a signature element on this segment as well. The concrete box culvert and drainage ditch is a very common sight here.



8. The Afghanistan Model Railway Club is a bit of humor. Our numbers are small at this time. I am the only member, but the logo designer and the sign printer, both friends from my Free-mo group, are honorary members. The khaki fascia is a sharp contrast from the other modules in our group, but it complements the scenery well. Importantly it was readily available.

the individual sleepers with the WS pigment to get the right color for concrete.

For scenery, I am using Sculptamold mixed with Earth pigment from Woodland Scenics and topped off with a variety of Scenic Express Silfor grass tufts. I use the autumn and late summer grass in the 2 and 4mm height. The Silfor Buffalo Grass Tufts are exactly the look I was trying to achieve with this module set. Planting the grass was one of the simple but tedious processes. I had a few hours during a ground-attack drill when I had to stay in my tent. I used all that time plus some more to set the tufts.

FREE-MO IN FOREIGN LAND | 11

The rocks and gravel were all locally harvested from the ground outside my tent.

Getting the module segment home from Afghanistan was difficult. Even at the small size of only 2' x 3' my airline still classified it as oversize baggage. Oversize baggage fees from Dubai to Washington, DC would have been \$300! So that left the Army Post Office or APO. To make sure the module segment got home in time for its debut show, I had to quit working on it nearly a month before. I shipped the segment with track and scenery completed. My father completed the legs and wiring just before

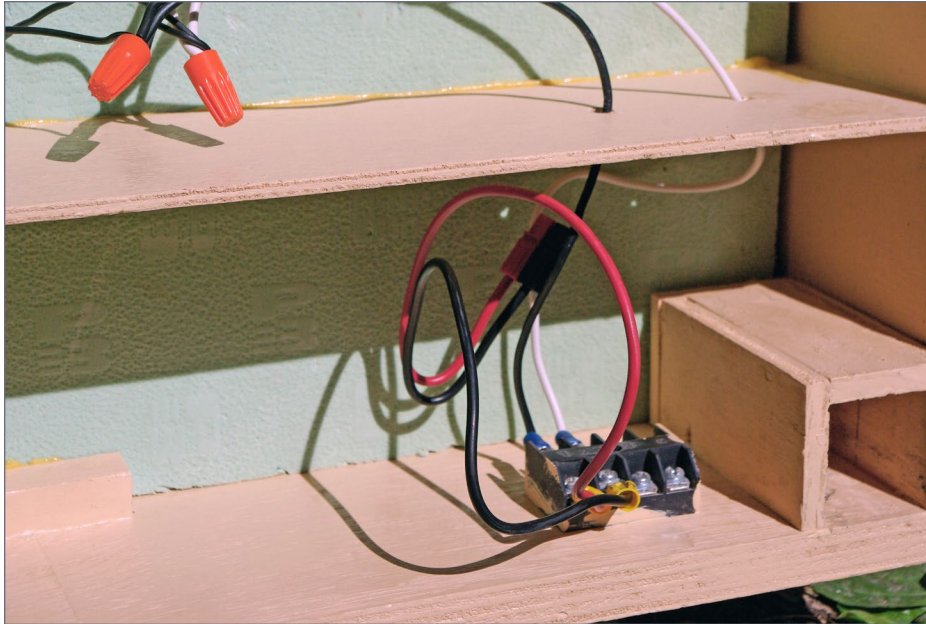

9. The module frame and foam were both from scrap sources, as were these wire terminal blocks salvaged from no-longer-working air conditioners. I was able to equip my module for the wiring my father completed back in Maryland after I shipped the module home.

Get Better Sound from your Locomotives

Can't get a good sound from your sound decoder?
Give our speakers a test drive with your ears.



RAILMASTER HOBBIES
9812 BELMONT
BELLFLOWER, CA 90706

Bass Reflex
Speakers



High Bass
Speakers



When it comes to speakers we have high quality speakers to fit many different applications. We are also a full line hobby shop. Need anything? We are an authorized dealer for Soundtraxx, Digitrax, Athearn, Walther's and many others. We provide quality speakers for your DCC sound systems and quality service.

**Click here for
the answer ...**



10. The primary traffic on the rails in Afghanistan right now is tank cars of fuel, box cars of food and materiel, and ballast and rail. The rolling stock is typically Era IV aging former Soviet equipment acquired by Uzbekistan when the Soviet Union dissolved. Sources for Soviet/Russian HO scale rolling stock are limited, with the supply coming mostly from Eastern European cottage manufacturers. These small shops build to the NEM, or European standards. Typically the cars are equipped with a NEM-type coupler and large flanges. I will eventually upgrade the fleet to semi-scale wheels and Sergent couplers, which more closely resemble the Russian coupler.

the show date. The segment is very light, weighing less than 10 pounds, yet it made the journey from Kandahar to the model train show outside Baltimore without any damage at all.

I photographed a mountain near the Arghandab River to use as a backdrop. A fellow group member printed it for me in the

Railroad Explorer Magazine

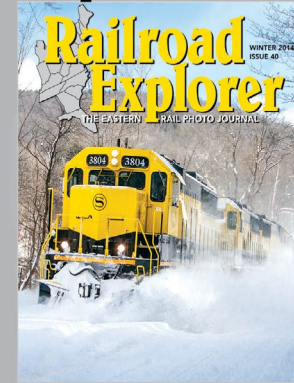
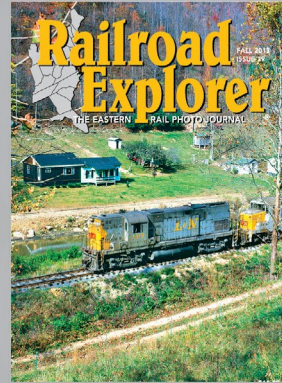

THE EASTERN RAIL PHOTO JOURNAL

- Three all-color issues per year. Exciting feature stories and spectacular photos of Eastern Railroading
- Best-in-class photo reproduction. Printed on heavy, glossy paper. Zero advertising.
- Three times per year - Winter, Spring/Summer and Fall editions.

Subscribe today!

www.railroadexplorer.com

Rslaserkits

Carl's Cabin

Now in O and Ho scales



The perfect cabin for your logging or mining camp or use for housing on the wrong side of the tracks. Includes extra material to use for the piers and bracing when placed on a slopping lot. We have also included the out house.



Check out our new HO flat car decks

Dealers welcome
 Salem, OR
 503-371-4290



Custom Laser Cutting
 and design
Sales@rslaserkits.com

large format. The rolling stock is a mix of Red Star Railways, Omega and Bergs. All three are small producers, the latter two in Eastern Europe. European models use NEM couplers to represent the European coupling system. But in the former Soviet Union, a coupler very similar to the North American knuckle coupler is used. A future project will be to convert the rolling stock to Sergent couplers and semi-scale wheelsets.

Building a module thousands of miles from the nearest hobby shop in a tent in Southern Afghanistan was a challenge, but it was also very rewarding. When I pulled it out of the box at the show a fellow group member who had been there said it looked just like Kandahar! ✓



11. The box I shipped the module home in has become the de facto storage box. A carefully thought-out design and attention to detail during construction resulted in a module weighing only nine pounds, and costing under \$20.00 to mail home.

MATTHEW PICCIOTTO



Matthew can remember playing with trains as young as four-years-old. Throughout his childhood he dabbled in HO and Gauge 1 with his parents. Many tourist and scenic train rides and countless train shows later, he now models in HO scale.

He likes to build models, do scenery and create vignettes, so he has chosen Free-mo as his outlet. He has three modules so far, two are in progress, and this one will make three. He

has drawings for two more modules, a plan in his head for a sixth, and a notion about modules seven and eight. He has plans for modules representing railroading in five different nations. When he sets up with other Free-mo modelers, he may or may not run a train across the tracks, but he gets enjoyment watching other locomotives and rolling stock pass through his modules.

His vocation is HVAC. He has worked in Afghanistan for two years, and now is in Iraq in support of the U.S. military. When he travels on R&R back to the US, he typically flies through The Netherlands to take advantage of a several-hour window to train watch. He has been known to go on railfanning day trips during his time home as well. ■

 [Click here for reader comments](#)

SOUTHERN PACIFIC'S

Lightweight streamlined cars:

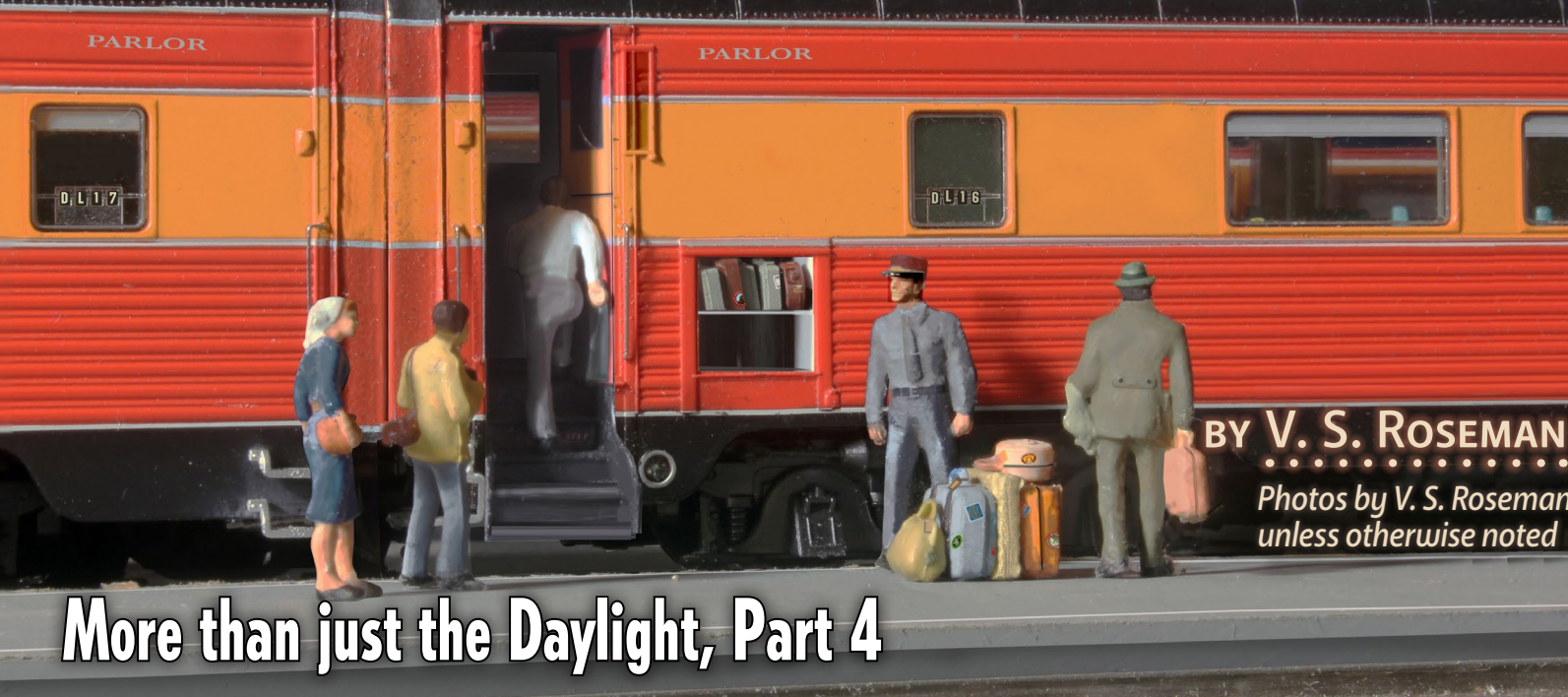

More than just the Daylight, Part 4

1. In the mid-1950s, Daylight parlor car passengers left their carry-on luggage on the platform for the red cap to load into the baggage elevator. This scene shows a train departing Third and Townsend streets in San Francisco, in model form. I made the car lettering shown here from computer fonts: Microscale has decals with the exactly correct style of letters.

PART 4: A MODELER'S CHRONOLOGY OF DETAIL CHANGES TO SOUTHERN PACIFIC'S PRE-WAR LIGHTWEIGHT CARS

LOOKING OVER photos of the Southern Pacific lightweight passenger cars, it is often possible to approximate when the photo was taken by the various notable changes in the appearance of the car.

The list of changes to these cars is a long one, but I have chosen some of the most visible and easy to model for this article.

Modeling note: *Painting or modifying your models may void their warranty. In my case, the manufacturers provided excellent warranty service and parts for the few minor problems I had.*

Steam ejector and Waukesha air conditioning systems

Most air conditioning mechanisms were mounted beneath the cars, and during the 1950s the skirts covering these were removed, making the underbody detail much more visible. On some models, appliances under the car may be molded to the skirts and will have to be replaced. Precision Scale Co. is one of the manufacturers offering aftermarket HO scale air conditioning parts.

Southern Pacific lightweight passenger cars were all air conditioned. The Carrier-Safety Steam Ejector air conditioning

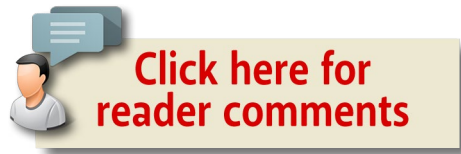

system used on the initial orders of Daylight cars delivered in 1937 was popular on a number of railroads, including Santa Fe and Erie. An attraction of this system was that it had nearly no moving parts.

Essentially, the system pipes steam from the locomotive through the heating lines to the cars. The steam gets funneled through venturi (precision nozzles), which lowers the temperature of the air. For a more detailed explanation of the theory and operation of the steam ejector system see these websites:

www.atsfr.net/resources/Sandifer/SEAC/SFM.pdf

www.freepatentsonline.com/2081905.html

The Southern Pacific operated many long trains, and it was difficult to maintain the required steam pressure all of the way to the tail end of these longer trains. There was always a small amount of leakage at each steam line connection between cars.

As a result, the railroad began specifying Waukesha air conditioning units in new cars as early as 1941. In the Waukesha

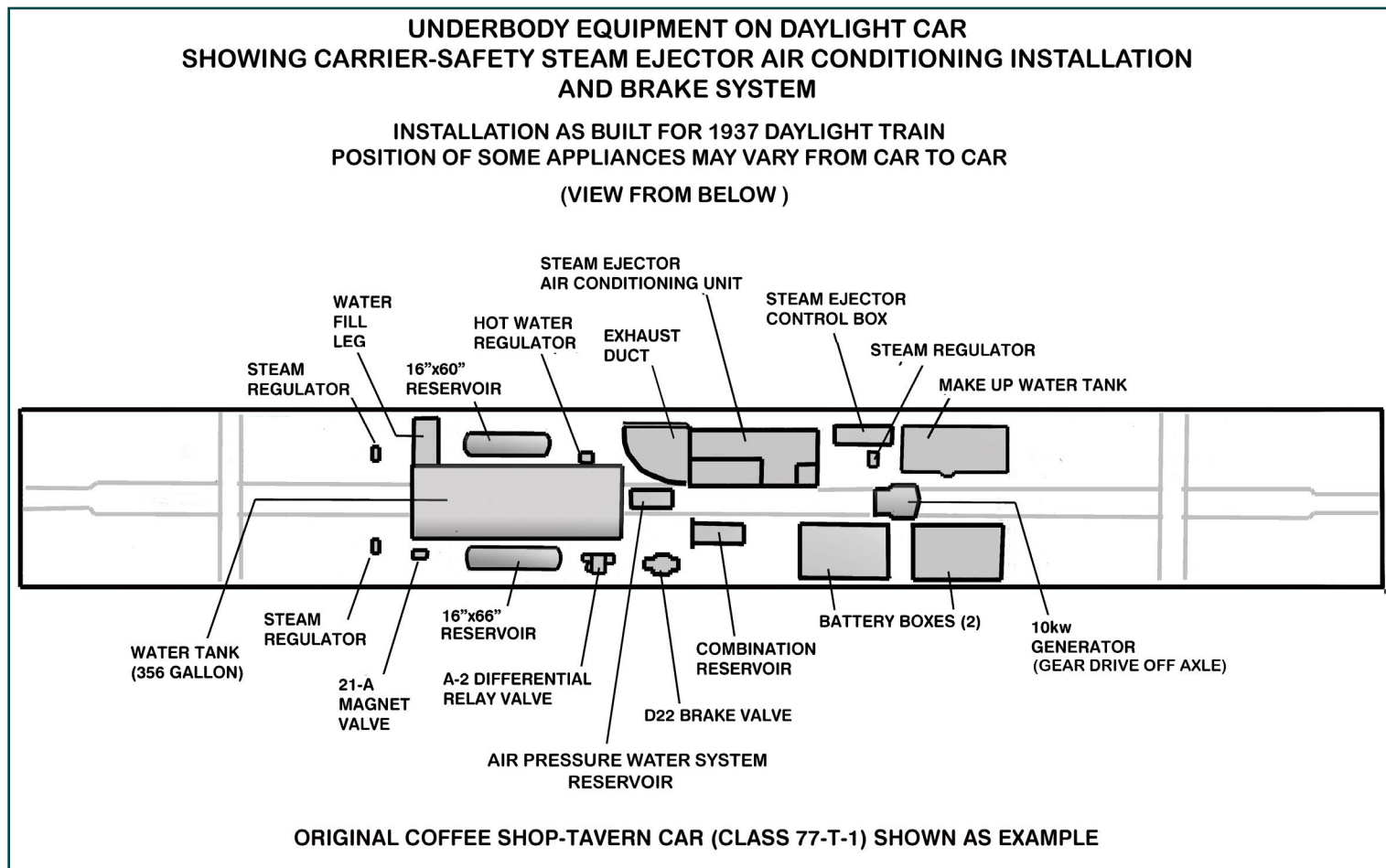

2. Steam ejector air conditioning system as applied in 1937 to a 77-foot Daylight chair car. (Note: view is looking up from below.)

system, a propane-fueled generator under each car supplies electric power to operate a conventional electromechanical type air conditioner for the car.

Some cars had a second generator (Enginator) for lighting, which eliminated the drag of belt driven electric systems that worked off the axles of the cars.

WAUKESHA AIR CONDITIONING SYSTEMS

(ALL VIEWS FROM BELOW CAR)

THIS SYSTEM SHOWS AN INTERNAL COMBUSTION ENGINE WHICH POWERS BOTH LIGHTS AND AIR CONDITIONING

SYSTEM INSTALLED IN CLASS 79-C-1 CHAIR CAR

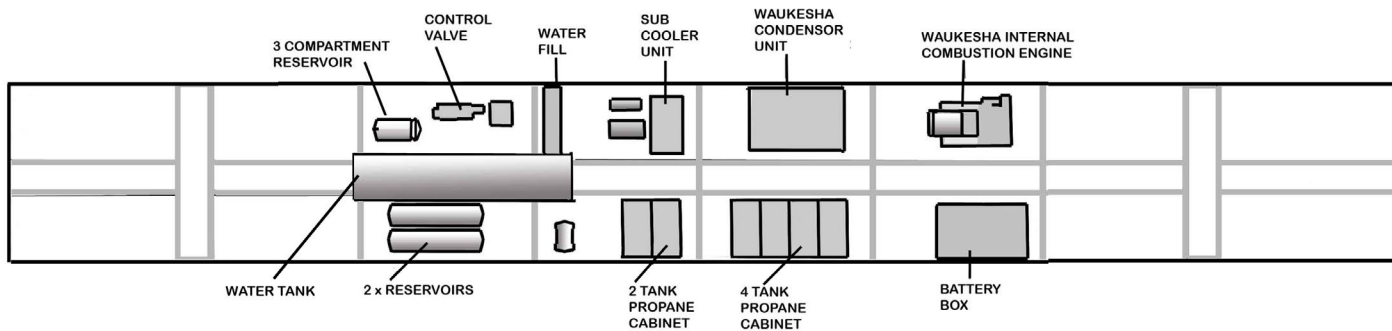

SYSTEM INSTALLED IN CLASS 79-PRO-1 PARLOR-OBSERVATION CAR

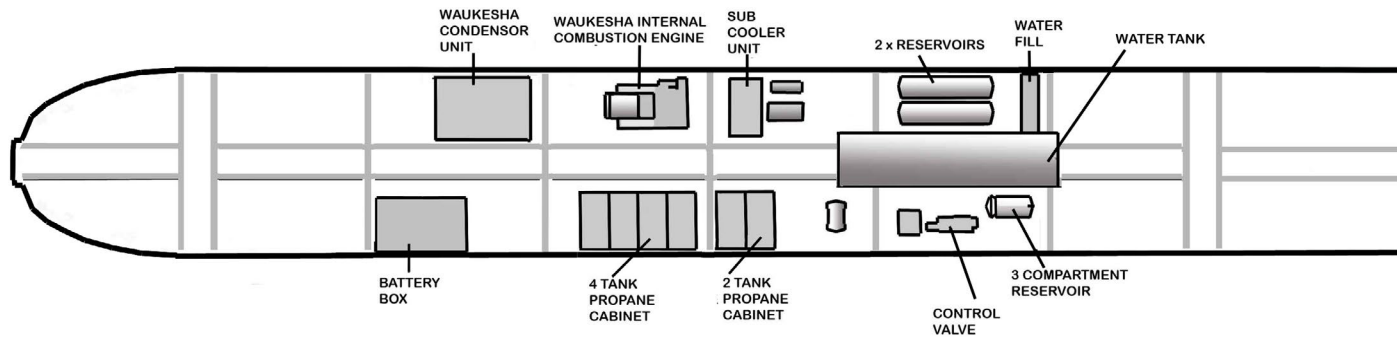

SINGLE WAUKESHA ICE ENGINE AIR CONDITIONING SYSTEM BATTERIES FOR LIGHTING ARE CHARGED BY AXLE DRIVEN GENERATOR

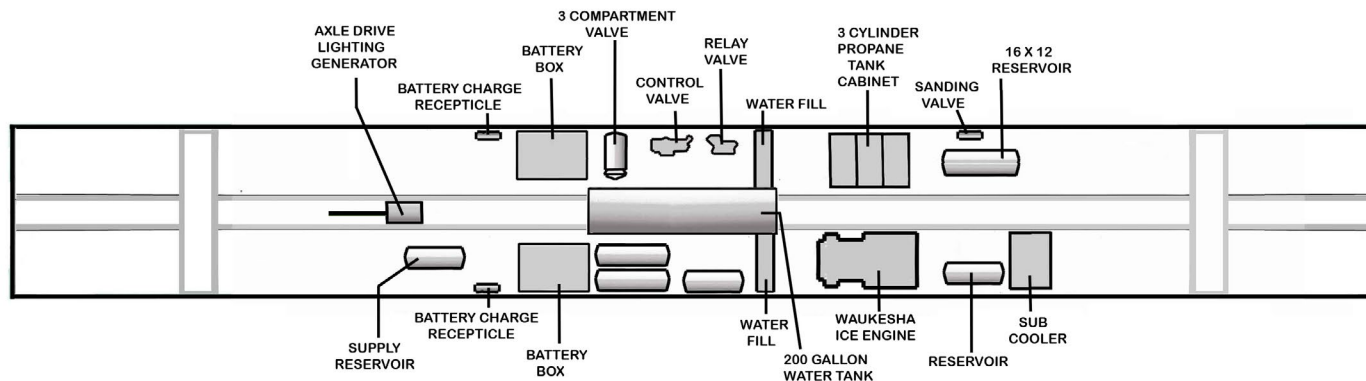

3. Three applications of Waukesha air conditioning systems showing some of the variations.

A document detailing the complete operation of Waukesha systems is available through the following link:

www.erixrailcar.com/tech-pubs/Waukesha_Diesel_Enginator.pdf

This system was especially useful where there was no station power to pre-cool cars, such as when adding cars to trains in desert locations.

Many of the steam ejector air conditioned cars were converted to Waukesha systems by the mid-1950s. Some cars, such as prewar triple-unit food service cars, kept their original systems until they were scrapped in the 1960s.

The class 83-C-5 cars built for the Daylight in 1954, along with some other cars, were built with axle generator-driven Pullman electromechanical air conditioning systems.

Diaphragms

The Coast Daylight of 1937 had full-width diaphragms colored to match the cars. Designed to reduce drag, they gave the train the appearance of being a single unit. There was an inner diaphragm plus the outer unit. The design involved more maintenance than conventional narrow concertina-type car diaphragms. For this reason, most of the outer diaphragm units were removed beginning in the 1950s.

Modeling full-width diaphragms rates an article of its own. Please refer to photos to see what type of diaphragms were being used in your time period. There are various types of operating and non-operating model units on the market.

BLI offers full-width diaphragms as an accessory. For layouts with passenger switching operations, I suggest using narrow diaphragms as these are easier to couple and uncouple.

Streamlined skirting

An element of most streamlined cars built into the 1950s was the decorative skirt extending below the car side. Skirting sometimes corroded and also had to be removed and replaced when maintaining essential equipment located under the body. Beginning in the 1950s, the center skirts were removed to improve accessibility.

The Budd cars for the Sunset had stainless steel skirting which did not corrode. On September 30, 1960, the railroad officially ordered center skirts removed from all lightweight cars. The order indicated that a three inch wide stainless steel hinged skirt would replace these.

On cars with the center skirt completely removed, there was a step or notch visible at the inside edge of the end skirts. The



4. Photo of deskirted coffee shop car and articulated chair car pair in postwar years. *Photo courtesy Bob's Photos*

three-inch metal strip gave a finished appearance to the lower edge of the car sides, forming a continuous line. Not all cars ever received these.

It is possible to remove the skirts from most models by cutting them off carefully. I have done this using a steel rule with thin cork non-skid backing for my cutting edge.

It may be possible to leave the floor of the car in place while doing this work, to keep the sides from bending inwards under the pressure of the knife blade. Otherwise, use a block of wood fitted inside to keep the body rigid as you cut the skirts off.

Most of the HO Daylight passenger car models are available with or without skirts, and I recommend buying exactly the version you want to save the work of modification.

Kato N scale cars have a removable floor plate that includes the skirts, but I don't know if it is possible to cut these down to

DECORATIVE SKIRTING ON LIGHTWEIGHT CARS

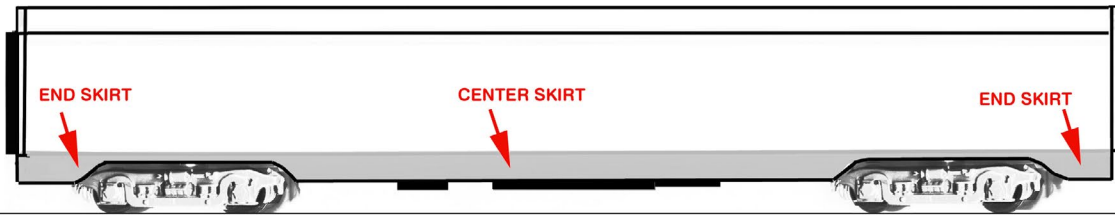

STREAMLINED LIGHTWEIGHT CARS INCLUDING DAYLIGHT CARS WERE DELIVERED WITH DECORATIVE SKIRTS

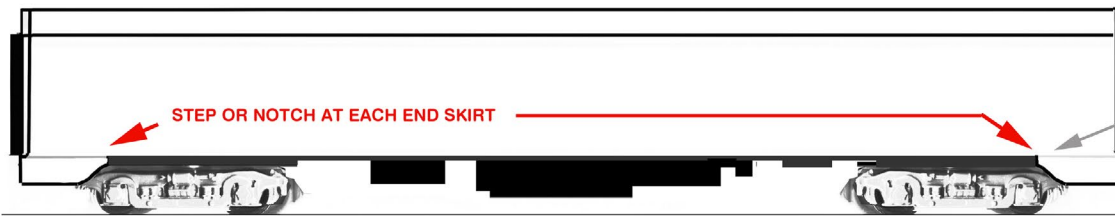

THE CENTER SKIRTS WERE REMOVED IN THE 1950s TO IMPROVE ACCESSABILITY OF UNDERBODY APPLIANCES



SOME CARS WERE FITTED WITH A 3" HINGED DECORATIVE STRIP

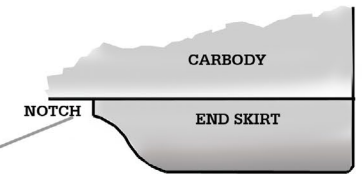

A NOTCH IS FORMED WHEN THE CENTER SKIRT IS REMOVED

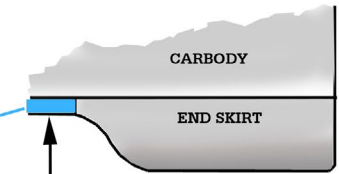

3" HINGED DECORATIVE SKIRT MAKES A SMOOTHER APPEARANCE

Rotating and fixed vestibule steps

Lightweight cars with vestibules were built with rotating hideaway step units that blended into the end skirts of the car when retracted. The step units were linked so that when the vestibule trap cover was raised, the step unit rotated down to permit passenger boarding.

By the end of the 1950s, many SP cars

received new fixed aluminum step units. These can be modeled by cutting away the end skirt below the door and fitting an aftermarket step part.

There may be some aftermarket parts companies making step units that can fit Daylight cars. Photos of SP lightweight cars with their doors closed and the steps still showing indicate that the car had these fixed step units.

5. Development of skirts on lightweight streamlined passenger cars.

remove the skirt. You can refer to the Kato Online parts catalog. Click on any blue numbered item to see a photo of the part.

The following is a link to the Kato online parts list:

search.cartserver.com/search/search.cgi?cartid=s-1078&keywords=NDAYLIGHT&maxhits=100&go=List+Parts&bool=AND&bool=AND

CUTTING SKIRTS OFF CAR

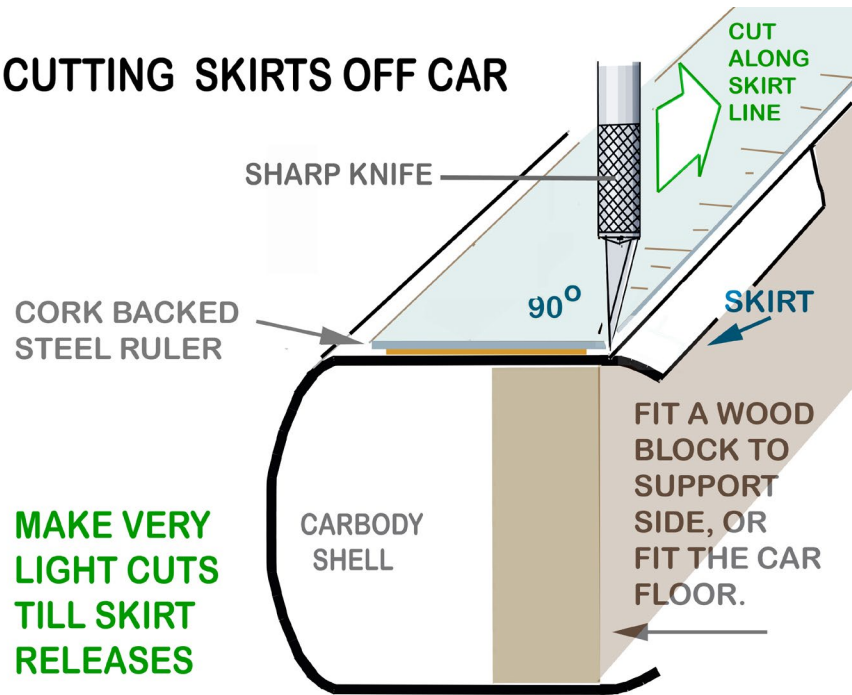

6. Removing the skirting from model passenger car.



8. Light array of car SP 2951 after 1965.

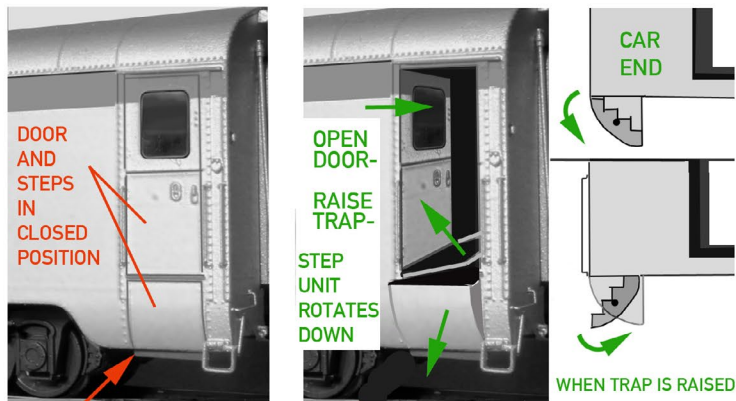

STREAMLINED ROTATING STEPS

7. New fixed step application on Daylight type car in COSF service.



REPLACEMENT ALUMINUM FIXED STEP UNIT REDUCES MAINTENANCE COSTS

Observation car light arrays

The Daylight parlor observation cars came equipped with a flush backup light and one pair of rear marker lights in streamlined nacelles near the back end of the letterboard. These small markers appear to have been changed to a slightly larger type on some cars in the 1950s.

In May 1959 the railroad stopped using the letterboard mounted marker lights due to the maintenance cost. These were gradually removed, some lasting until the cars were plated with flat stainless steel in the 1960s.

PARLOR OBSERVATION CARS SP2950- SP2955 AND T&NO 951 ROOF LIGHT ARRAYS

DATES SHOWN ARE FOR THE EARLIEST PHOTO SHOWING THE INSTALLATION ON THE SPECIFIC CAR INDICATED

THESE CARS WERE DELIVERED WITH SINGLE FLUSH BACKUP LIGHT AND LEFT AND RIGHT SIDE MARKER LIGHTS IN STREAMLINED FAIRINGS MOUNTED NEAR THE REAR OF THE LETTERBOARD.

THE ROOF MOUNTED LIGHT ARRAYS WERE CHANGED, WITH THE ADDITION OF THE REAR MOUNTED MARKERS REPLACING THE LETTERBOARD MOUNTED SIDE MARKER LIGHTS.

CENTRAL RED OSCILLATING MARS LIGHT

GREEN MARKERS

RED MARKERS

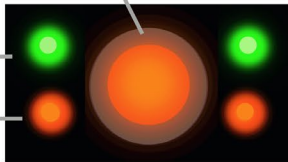

MAIN LIGHT IN TALL FAIRING WITH STREAMLINED MARKER MOUNTS

CAR 2955 RECEIVED THIS STYLE BY 1949

CAR T&NO, 951 RECEIVED THIS STYLE BY 1951

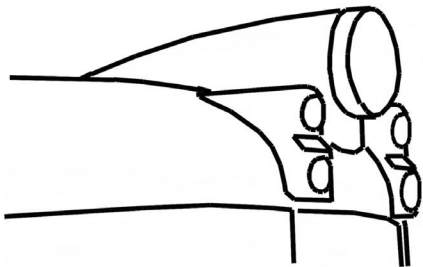

FLUSH MAIN LIGHT WITH STEPPED MARKERS

CAR 2950 RECEIVED THIS INSTALLATION BY 1954

CAR 2951 HAD THIS INSTALLED 1951, CHANGED IN ABOUT 1964

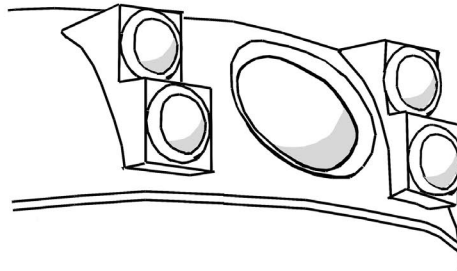

FLUSH MAIN LIGHT w/ STEPPED MARKER ARRAY AND PLATFORM

CAR 2951 RECEIVED THIS ARRANGEMENT BY 1965

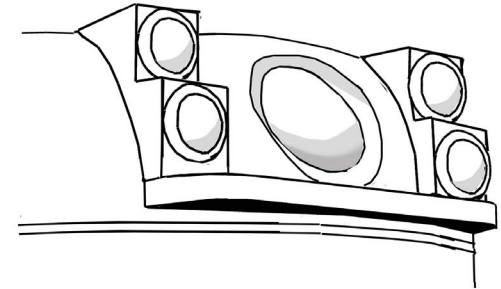

FLUSH MAIN LIGHT WITH ROUND TOPPED MARKERS

CAR 2952 RECEIVED THIS STYLE BY 1955

CAR 2953 RECEIVED THIS STYLE BY 1953

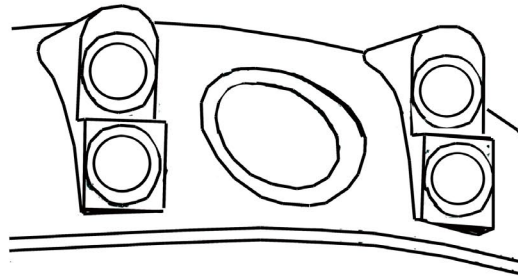

BOX TYPE LIGHT ARRAY w/ PLATFORM

INSTALLED ON 2297, 2954, 2955 BY 1959

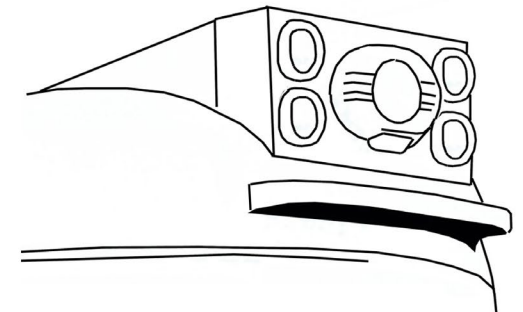

9. Observation car lighting arrays which replaced the single recessed lamp of the original parlor observation cars.

Beginning about 1949, stepped rooftop mounts fitted with red and green marker lights were applied to both sides of the backup light at the rear car roof. Some of these had round tops, such as on car 2955, but other cars, such as car 2950, had square top rear markers.

The center flush-mounted light was usually replaced with an oscillating Mars light. Some of the cars, as 2954, 2955 and T&NO car 951 had their Mars light set in a raised fairing while other cars such as 2950, 2951 and 2953 kept their flush mounting for the Mars light.

A complete rear light array in a box-shaped mounting was fitted to the rear of the roof of car 2954 in the early 1960s. This included



10. Lighting array of car SP 2951 with platform after car is rebuilt with flat stainless steel panels in the 1960s.

the red and green markers plus a central light. Some of the earlier roof lighting sets were replaced with these box form arrays. In photos, the box arrays do not all appear to be the same size.

The BLI postwar Daylight parlor observation model comes with the small stepped rear markers and central flush Mars light, but I have not seen the MTH deskirted postwar observation car.

PARLOR OBSERVATION CAR LETTERBOARD MARKERS

MARKER
HOUSING

LETTERBOARD

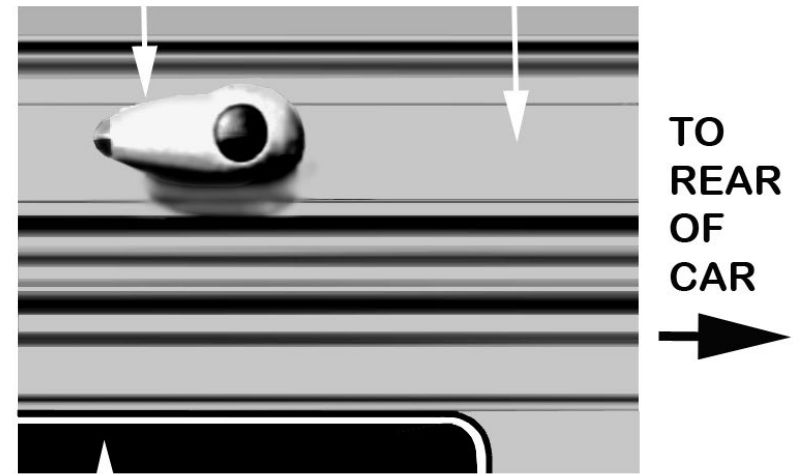

WINDOW

11. Observation car letterboard marker lights, as built. During the 1950s their function was replaced by the rooftop lighting arrays and the individual nacelles were removed when the cars were rebuilt with new stainless steel sides.

The raised-fairing lights might be built up of styrene. Lucite rods could transmit light from inside the roof. Plastruct has colored translucent rod that should work for this application.

Detail Associates has a Gyalite unit similar to the center Mars light for the box type units.

SOUTHERN PACIFIC RAILROAD

CLASS 57-AD-1 KITCHEN CAR IN THE 1939 ARTICULATED TRIPLE FOOD SERVICE UNITS

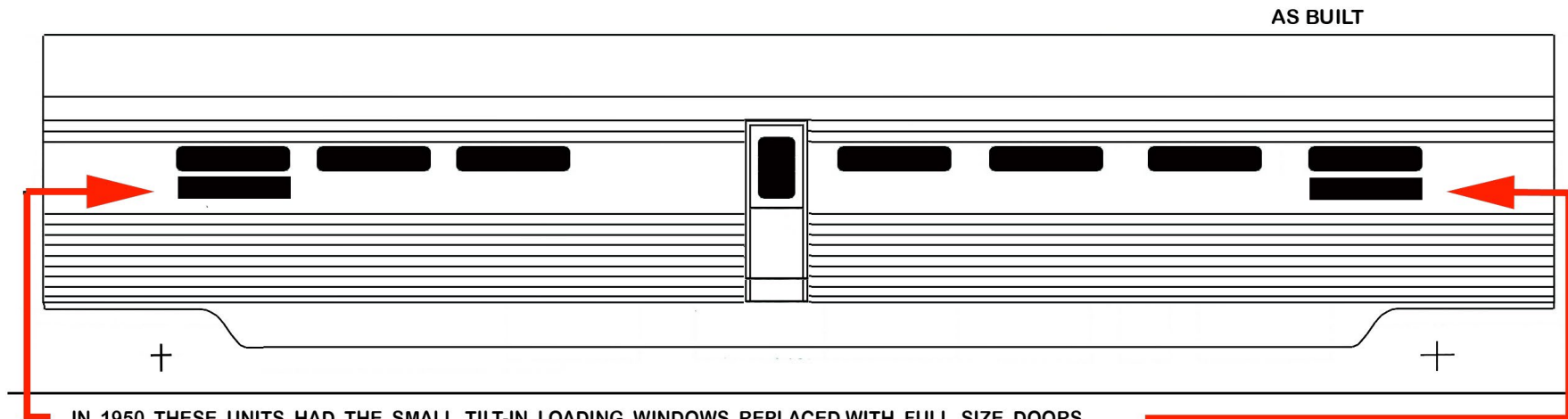

IN 1950 THESE UNITS HAD THE SMALL TILT-IN LOADING WINDOWS REPLACED WITH FULL SIZE DOORS, MAKING THEM PRACTICALLY IDENTICAL WITH THE LATER FOOD SERVICE TRIPLE UNITS BUILT IN 1940.

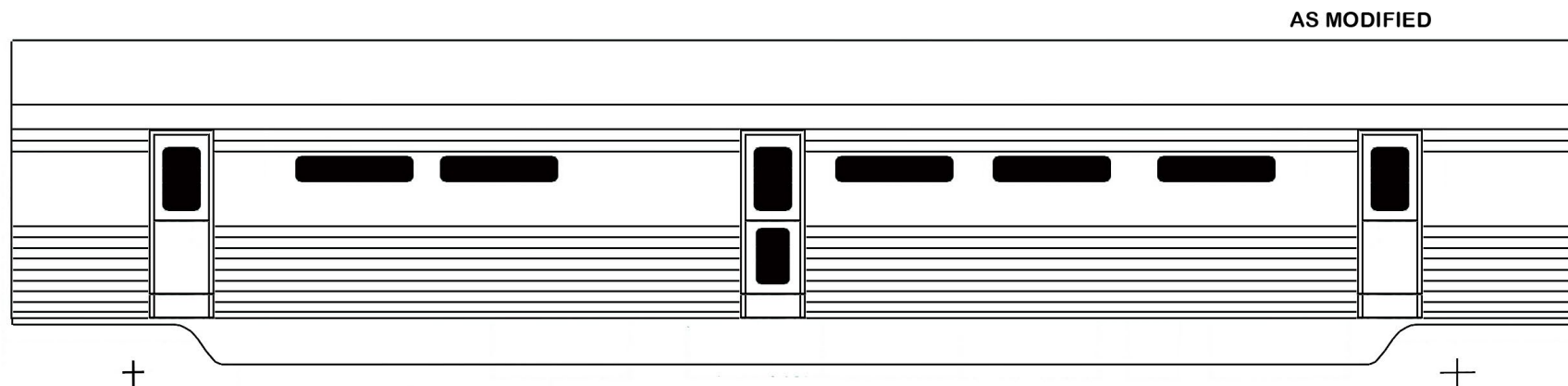

12. Configuration of original triple unit kitchen and 1950 modification of 1950.

Kitchen doors (food service triple units)

These cars incorporated a kitchen unit between a coffee shop and full diner. All of the Daylight pre-war triple units received an improvement in their kitchens in 1950.

As built, there was a single kitchen door and two loading windows. This was changed with an additional door replacing each loading window.

The sketch shows these arrangements. The postwar triples of all three manufacturers (deskirted sets) have this modification, as do the flush-sided triple units built after World War II.

BAGGAGE ELEVATORS

CAR EXTERIOR
AT STATION PLATFORM

1.

CAR PORTER OR REDCAP
PLACES LUGGAGE ON
SHELF OF BAGGAGE
ELEVATOR

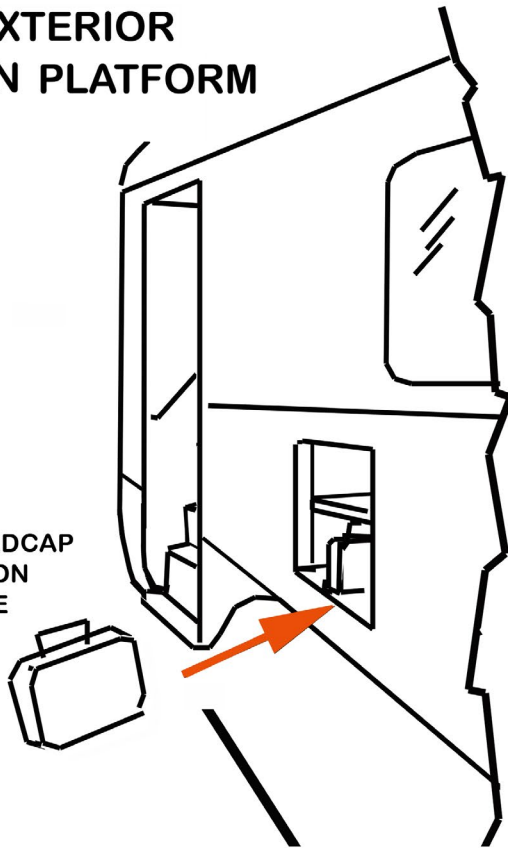

CAR INTERIOR

2.

LUGGAGE SHELVES ARE RAISED
AND CARRY-ONS CAN BE ACCESSED
BY PASSENGERS IF DESIRED

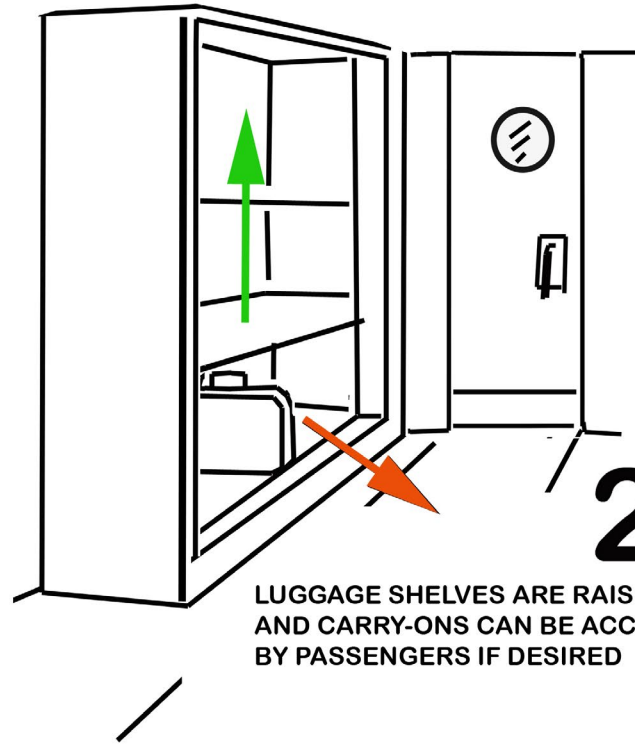

13. Baggage elevators were used to prevent delays at stations. In lowered position they could be accessed from the outside sliding door, and when raised, the carry-on luggage was accessible for passengers in the car.

Baggage elevators

A problem that caused delays was that passengers boarding with bulky carry-on luggage got in the way of those trying to disembark on the narrow vestibule steps.

The railroad developed electric baggage elevators (dumbwaiters). Passengers would hand carry-on luggage to redcaps on the platform. Luggage was placed on shelves of the baggage elevator, and was raised. The shelves could then be accessed by passengers inside their car at any time. No other railroad used baggage elevators.

New Daylight cars so equipped entered service in 1940-41. These cars were each two feet longer than previous Daylight car designs to accommodate the new baggage elevators. Despite the additional car length, the new cars each held a few less seats due to the size of the baggage elevators.

The Kato N scale models, the BLI and MTH HO car sets have the baggage elevator simulated. The Athearn-Genesis 77-foot chair cars are earlier 1937 prototypes that do not have these.

Baggage elevators were also built into the 1949 Shasta Daylight cars and into 1954 class 83-C-5 cars for the Coast Daylight. In September, 1961 a maintenance directive was issued phasing out the baggage elevators, and they were sealed off.



14. SP 2471+2472 articulated chair car pair, class ACW-66+ACM-66, shown in 1955. The retracted staircase in the rotating unit is shown, and at left is the baggage elevator door. *Courtesy Bob's Photos*



15. Class ACW-66+ACM-66 articulated cars in N scale model form by Kato.

DAYLIGHT TYPE CARS IN OVERLAND ROUTE SERVICE

77 FT. 1937 SP CHAIR CAR PAINTED FOR CITY OF SAN FRANCISCO SERVICE (UNTIL 1946-8)



IN 1946 THE CONSORTIUM OF RAILROADS COOPERATING WITH UNION PACIFIC FOR CITY TRAIN OPERATION SPLIT THE FLEET OF CARS AND EACH WAS LETTERED FOR ITS OWNER INSTEAD OF WITH THE TRAIN NAME.



THE RELETTERING OF EQUIPMENT TOOK UNTIL ABOUT 1948, AND DURING THE 1950s SOME CHAIR CARS RECEIVED MORE MODERN TRUCKS REPLACING THE OLD TRIPLE BOLSTER TYPE. (BY THE 1950s THE CENTER SKIRTS WOULD HAVE BEEN REMOVED FROM THESE CARS)

16a-b (next spread). While equipment for Overland Route trains was owned by the consortium of railroads, the train name was painted in the letterboard as in the top illustration. Later, the equipment was divided between the railroads, and the road name was painted in the letterboard as shown. Use the Athearn Genesis 77 foot chair car to model this car.

Southern Pacific passenger car colors in the streamlined era

This subject requires a whole book, and the recently released "Southern Pacific Painting and Lettering Guide" by J.A. Cauthen and J.R. Signor published by the Southern Pacific Historical and Technological Society, has a great deal of information on 1913-1996 locomotive and passenger car appearance.

Fortunately, Microscale and other decal makers offer most of the important lettering needed. The following is a capsule which should give modelers some direction in selecting ready to run cars, or in painting their equipment. Use reference photos.

DAYLIGHT TYPE CARS IN OVERLAND ROUTE SERVICE

77 FT. 1937 SP CHAIR CAR PAINTED FOR CITY OF SAN FRANCISCO SERVICE (UNTIL 1946-8)

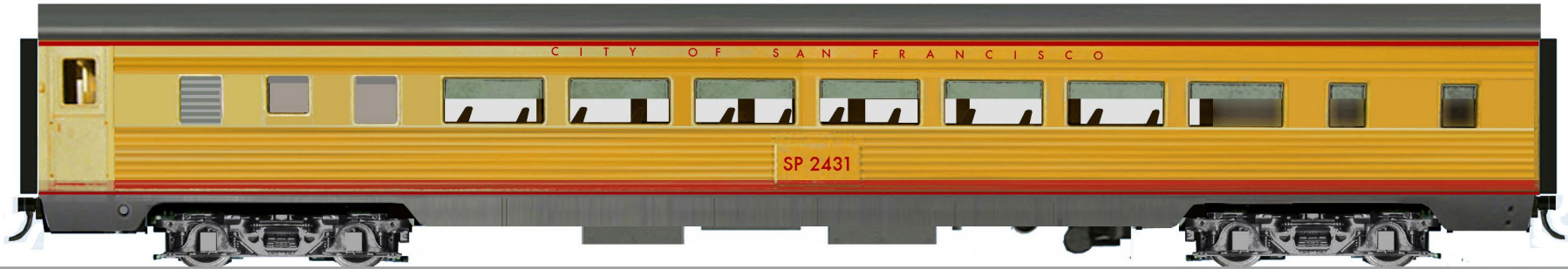

IN 1946 THE CONSORTIUM OF RAILROADS COOPERATING WITH UNION PACIFIC FOR CITY TRAIN OPERATION SPLIT THE FLEET OF CARS AND EACH WAS LETTERED FOR ITS OWNER INSTEAD OF WITH THE TRAIN NAME.



THE RELETTERING OF EQUIPMENT TOOK UNTIL ABOUT 1948, AND DURING THE 1950s SOME CHAIR CARS RECEIVED MORE MODERN TRUCKS REPLACING THE OLD TRIPLE BOLSTER TYPE. (BY THE 1950s THE CENTER SKIRTS WOULD HAVE BEEN REMOVED FROM THESE CARS)

From the inception of steel passenger cars, the Pullman Co., the SP and many other railroads painted their passenger cars dark olive green. Lettering was originally gold leaf process that required hand application by skilled workers.

Around the 1930s, gold leaf began to be replaced by imitation gold paint, a gold-bronze color in which bronzing powder gave the paint

a metallic shine. This was far cheaper than gold leaf process and could be applied by less skilled workers.

By this time, or a little later, a non-metallic tan or buff color (almost the color of a manila or red rope envelope) was used. The metallic color lettering and numbers tended to “disappear” when seen from certain angles, and the buff color eliminated this problem.



17. Chair car in the later lettering for Overland service, car 2432 in class 77-C-3. The drop-equalizer type trucks are replacements, usually taken from a scrapped sleeping car. The car still has its original fluted sides. Courtesy Bob's Photos

Apparently there were slight changes in the Southern Pacific's choice of dark green, for it is reported appearing different from Pullman Green as time passed.

In 1937, the Daylight and Sunbeam streamlined cars were delivered painted with black roofs, underbody, trucks, and a bright red body overall with an orange window band. All lettering and striping was in silver bronze (metallic) paint edged with black. The letterboard read SOUTHERN PACIFIC LINES in 4-1/2 inch tall letters.

In 1946 the black edging was eliminated and pale "Lettering Grey" (non metallic) was substituted for the more expensive silver bronze metallic color. It was very difficult to tell the difference in the color in person or photos except when viewed from up close.

The word "LINES" was now omitted and 5" letters were used on passenger car letter boards. Streamlined equipment on subsidiary

Texas and New Orleans RR continued the use of metallic silver lettering and striping.

Shortly after the railroad's inspection of the first lightweight equipment delivered for the Daylight, six additional stand-alone chair cars (#2424-2429) and two articulated car pairs (#2424-2417) were ordered for the San Francisco Challenger, plus three sets of articulated chair cars, (#2418-2423) for the Californian. These were delivered painted dark olive to harmonize with these heavy-weight trains.

In the late 1930s, the SP joined with Union Pacific and Chicago & North Western railroads in a consortium that owned a portion of the City of San Francisco equipment which operated interline on these railroads. All of this equipment was painted Armour yellow with leaf brown trim.

In 1941, the colors were revised to Armour yellow with harbor mist gray trim and red stripes and lettering, outlined in black.

In 1946, the ownership arrangements changed, distributing the equipment to the individual railroads. Between 1946 and 1948 the train names on the letter boards were changed to the name of the owning railroad. (See fig.# 5-20 COSF car lettering)

Also on this route was the San Francisco Overland Limited, a dark green heavyweight formation until 1942 when the two-tone gray scheme was instituted. The cars were pale gray with dark gray window stripe and silver pinstripes and lettering, all outlined in black. The colors matched Pullman pool cars, SP's Lark and other SP overnight trains.

In 1952 the Union Pacific began painting all of its passenger cars in the yellow and gray Streamliner colors with red lettering. SP cars assigned to the Overland trains were painted in these colors, but

had the Southern Pacific lettering font. Several of the Daylight type cars remained in Overland Route service.

In 1948, 2-1/2 inch lettering at the end of the letterboard identified each car's type, such as CHAIR, PULLMAN, DINER, LOUNGE on all SP-owned equipment. This lasted till 1958.

For more information, use this link:

www.urbaneagle.com/sp/sp-daylightcolors.html

Beginning with the Lark in 1941, some overnight trains, such as the Golden State and the Cascade, received the two-tone gray scheme described above. Lark cars received an orange LARK emblem on the car side plaques. Cascade-assigned cars had a green emblem.

The Golden State Limited (L.A.-Chicago interline with Rock Island) was dieselized with E7 engines delivered in in 1947, and streamlined cars came in 1948. The train was polished stainless steel or painted imitation stainless steel (dark silver) below the windows, with Daylight red from the window piers up and over the roof.

Silver rectangles or stainless steel plaques formed the background for black lettering. Class 77-C-3 Daylight type cars numbered 2430, 2431 and 2437 became named cars Golden Vein, Golden Sand and Golden Lode respectively for this service.

The large areas of red tended to fade unevenly and cars were repainted in Sunset Limited colors described below. The red and silver E-7 diesel locomotives were repainted in Daylight colors that conformed with the rest of the passenger diesel fleet.

The Sunset Limited (New Orleans-Los Angeles) was streamlined in 1950 with full trains of new all-stainless steel cars built by Budd. The trucks were painted aluminum silver and the letterboard was painted in Daylight red with black edging. Remaining exterior surfaces were all polished stainless steel.

“In the late 1930s the SP joined with the UP and the CNW to operate the interline City of San Francisco ... all of this equipment was painted Armour yellow.”

In 1951, all Texas and New Orleans RR. (SP Atlantic Lines) cars with stainless steel fluted sides were stripped to their stainless steel bodies. Heavyweight cars assigned to streamliner trains were painted imitation stainless steel color overall with red letterboard stripe to match the Sunset Limited.

More details and interesting photos of the Sunset Limited, and images of some promotional brochures can be found at the following sites:

www.rits.org/www/histories/goldenstate/gs.htm

www.trainweb.org/fredatsf/g50.htm

www.streamlinerschedules.com/concourse/track9/gold-state194812.html

In 1954, SP began to paint head-end cars and commute cars in pale gray with dark gray window stripe, similar to the overnight service intercity cars. Also included in the specification were lightweight cars not assigned to specific trains.

In 1958, an attempt to standardize colors resulted in all lightweight cars and some heavyweight cars assigned to intercity trains being painted imitation stainless steel (dark metallic silver paint) or were

stripped to their stainless steel sides. The letter boards were red with pale gray lettering (but without any black outlining on letters or on the letterboard) as they came due for painting.

With this final intercity car color scheme, the railroad then introduced another color scheme for head-end equipment and the commute cars: solid gray overall with very light gray lettering.

The railroad continued to paint cars assigned to Overland route trains in UP yellow colors, but SP silver and red cars sometimes appeared on the Overland trains. Until the 1950s, cars were sometimes repainted for new assignments, but after about 1960 it appears that cars were only painted in rotation or as needed. As a result, cars painted in most any previous color scheme might appear on any train.

Plaques

SP prewar fluted lightweight cars had a plaque at the center of the car side below the windows. This had the car number, usually with a colorful script herald with the name of the train to which the car was assigned.

On the Daylights, the plaque was five flutes tall. On the Sunbeam and some other name trains, plus cars in pool service, the plaques were four flutes tall. Pool cars generally had only the car type and number on the plaque, but there were exceptions.

“San Joaquin” was painted on that train’s plaques until it was changed to “Daylight” in 1961, and “Sunbeam” appeared on that train’s cars.

The color and lettering styles on these plaques were changed over the years to harmonize with the various color schemes. For particulars, refer to photos of individual cars in the time period in

TWO TONE GREY LIVERY SHOWN ON CHAIR CAR ASSIGNED TO THE CASCADE



1950s APPEARANCE WITH FULL SKIRTS AND ORIGINAL TRIPLE BOLSTER TRUCKS

18a-b (next spread). Rendering of 77-C class chair car in two-tone gray with Cascade plaque of the 1950s.

which you are interested.

Various train name plaques are included in Microscale decal set 87-761 (HO) and 60-76.1 (N). The following link has illustrations of all their SP decals for reference:

www.microscale.com/Merchant2/merchant.mvc?Screen=CTGY&Category_Code=SP

In the 1960s, the plaques (except for Sunset Limited) were simplified by replacing script lettering with an orange ball and black outlined wing design with black car number on a plain stainless plaque. Some cars had only had “S.P.” and the car number in black, and there were variations.

All head-end equipment (and commute cars) were all to be painted solid Lark dark gray with pale gray lettering.

Trucks (bogies)

The prewar Daylight passenger cars were delivered on Pullman type 43 triple bolster type trucks with several bearing sizes. The truck journals had the appearance of of two bell-forms or bicorne hats of the style Napoleon made famous.

Union Pacific, Pennsylvania RR, Santa Fe and other roads used these trucks on lightweight sleeping cars. The four-wheel trucks

c1950s

TWO TONE GREY LIVERY SHOWN ON CHAIR CAR ASSIGNED TO THE CASCADE



1950s APPEARANCE WITH FULL SKIRTS AND ORIGINAL TRIPLE BOLSTER TRUCKS

under most of the non-articulated cars were in general Southern Pacific class 4-TC.

The trucks on the original 1937 Daylight cars all had solid bearings and did not have bolster anchors. The 1941 cars did have bolster anchors. Most cars had 4-TC-7/43-C-11 trucks, while the articulated chair cars had 6-TCA-3/43-A-11 type. The triple-unit car articulated joints were supported by type 6-TCA-1/62-A-11.

The bearings had spring pad lubrication, with woven pads that bathed the axles in oil. In service, it was found this system worked better on engines that had mechanical lubricating devices. Passenger cars eventually had their spring pads replaced with conventional waste packed solid bearings, and in later years some cars received roller bearings as wheels were serviced. It was not uncommon to see different bearing types on the same truck.

In the 1950s the railroad began replacing these trucks with more modern (SP Class) 4-TC-8 trucks, generally type 41N drop equalizer type. SP Type 4-TD-2 type with disc brakes were used on some cars as replacements, and other types were used as well.

Some or all of the replacement trucks were taken from retired lightweight sleeping cars. The triple-car articulated food service units had four wheel trucks type 4-TC-6 at outer ends of dining and coffee shop segments (upgraded and classified as 4-TC-7 type) with six wheel trucks type 6-TCA-1 at the articulation points between the kitchen unit and the two outer units.

Fluted and flat side Daylight equipment

While the first streamlined trains were aerodynamic and colorful, when the Burlington introduced its first streamliner, its styling was so advanced that it was another shock to viewers. This train was built entirely of polished stainless steel with corrugated sides which themselves suggested great speed. The Budd company was able to use thinner (and lighter) sheet metal for they pressed the metal into corrugations which increased its strength.

The material and process to build these trains was significantly more expensive than other high-tech metals such as Cor Ten, but the expense was offset to some degree, for it never needed painting and would never corrode. Until this time, it had been impossible



19. Parlor car 2951, class 77-PRO-1 parlor observation in its final configuration shown in San Francisco as of April 1971. The car has late box type rear lighting array, flat stainless steel sides with red letterboard stripe, and Waukesha air conditioning. Propane bottle containers show under the car. This car still has its triple bolster trucks.

to build with this metal, but the Budd Company developed the method of joining stainless steel parts. They patented both the method and the equipment they invented to build their train cars.

On seeing the Budd streamliner, Southern Pacific insisted that Pullman-Standard create a train with corrugated stainless steel.

All of the prewar lightweight SP cars were built by Pullman-Standard with fluted stainless steel sides welded to Cor Ten steel frames. Over time the car body frames corroded due to the inability of sealing the car sides against corrosive cleaning agents.

After World War II, the SP only ordered new passenger cars with flat steel sides that could be sealed against the corrosive cleaning agents used on the equipment.



20a-b (next spread). Athearn-Genesis 77 foot chair car shown with stainless sides, imitation stainless steel painted roof and red stripe of 1955 and later.

An exception were the Budd-built corrugated side cars made entirely of stainless steel for the SP Sunset Limited in 1950 and 1954. This stainless steel was not affected by the cleaning chemicals.

Rebuilding all the damaged prewar lightweight cars began in the mid-1950s. The amount of corrosion varied from car to car, but nearly all of the prewar lightweight cars received extensive carbody frame replacements. The cars were covered with new flat polished stainless steel sheets.

A few cars kept their original fluted stainless sides, and those had their Daylight paint removed down to the bare stainless steel. All of these cars received the new color scheme of stainless with a single red letterboard stripe and pale gray lettering.

In 1953, class 83-C-5 chair cars were delivered for the Coast Daylight. These had windows 1/3 taller previously and were similar to the Shasta Daylight cars built in 1949.

Union Station Products lists their kit #7571 for a class 83-C-1 aluminum Shasta coach with the same window arrangement as the 83-C-5 cars for the Coast Daylight, and can be used to simulate these cars, too.



MTH offers a flush-side five-car passenger car set, which they sell as product number #81-60007 painted for ERIE. These are actually Daylight cars and can be repainted in imitation stainless with red letterboard to simulate 1958 Coast Daylight cars. The cars have rectangular instead of SP style round end door windows and come with postwar-type drop-equalizer trucks.

You can fill out the rest of a post-1958 Coast Daylight train with BLI or MTH triple unit dining car and Athearn's stainless and red 77-foot (1937) coaches. Cars in Daylight red and orange ran on the train into the mid-1960s. The San Joaquin, the West Coast, the Owl and other trains that lasted into the post-1958 period can also be simulated with these cars. Kits are also available to fill in your updated Daylight train, and these are described later in this series. Examining photos of your favorite time period may show additional changes to these cars.

In the next part of this series, I get into the kitbashing methods for modeling specific cars. ☑



21. Prototype chair car 2488 (class 79-C-2) in 1969 as rebuilt with flat stainless sides, but with its original triple bolster trucks.

COMPARISON OF 77 FT AND 79 FT CARBODIES

77 FT DAYLIGHT CHAIR CAR 1937



79 FT DAYLIGHT CHAIR CAR 1941



(BAGGAGE ELEVATOR DOOR)

A SPOTTING FEATURE OF THE 79 FOOT CARS IS THE SMALL FIRST WINDOW IN THE PASSENGER SECTION

22. Comparison of 77 foot cars built 1937 and 79 foot chair cars built 1939-41. The additional length accommodated the new baggage elevators. Articulated cars were also longer when constructed with baggage elevators. Before World War II, there were no established standards for the length of lightweight cars.



Click here for reader comments

106,000 have seen this MRH video - have you?

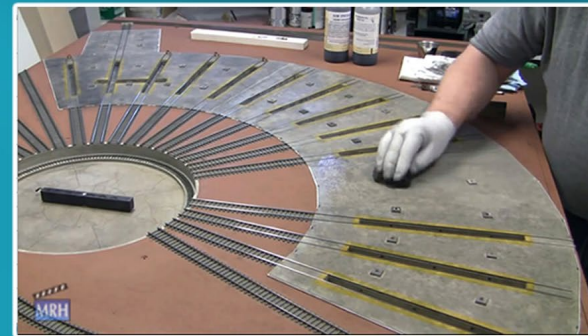

Watch the video now



PART 4 - SP PASSENGER TRAINS | 39



[Click here for reader comments](#)



VICTOR ROSEMAN

Victor got his first train, a Lionel, at age 3. Victor graduated from the Pratt Institute with BFA and MS degrees and taught fine arts in high and junior high school for 30 years and is now retired.

Victor has written many articles and several railroad related books over the past 35 years. He's also done many freelance projects for Walthers, Atlas and other model manufacturers. ■

Still available: a great new book about SP steam power!



Bob Church, renowned authority on SP steam, presents a rich collection of information and photos about ten-coupled locomotives. How can I learn more about this book? How can I buy it?

CHECK IT OUT!

Click here for the answer ...

SIGNATURE PRESS

ADVERTISEMENT



FIFER HOBBY SUPPLY LLC

Your Local **N Scale** Online Hobby Shop
 575-523-9743
 fiferhobby.com

ADVERTISEMENT

Archer
 FINE TRANSFERS
 PROUDLY SERVING MODEL BUILDERS SINCE 1989
 THE ORIGINAL
SURFACE DETAILS™

WE NOW HAVE MORE THAN 100 SHEETS OF RIVETS, LOUVERS, TREADPLATE AND MORE CAST ONTO MICROSCALE CLEAR DECAL FILM

FREE SHIPPING:

- DOMESTIC USA ORDERS \$50 OR MORE
- INTERNATIONAL ORDERS \$100 OR MORE

CLICK HERE TO VISIT OUR WEBSITE!

Archer Fine Transfers • PO Box 1277 • Youngsville, NC 27596 • USA (919) 570-1026 • info@archertransfers.com • archertransfers.com

ADVERTISEMENT

George's Trains
 EST. 1962
 Canada's Greatest Model Train Store!

20 NEW Colours Just added!

PROTO-PAINT
 ACRYLIC-Air-Brush Ready
 NOW OVER 45 Canadian Railway Colours!

Dealer inquiries welcome.

PP-001 CNR Green #11	PP-020 TH&B Maroon	PP-038 TTC CREAM
PP-002 CNR Imitation Gold	PP-021 Primer	PP-039 TTC Maroon
PP-003 CNVIA Blue #16	PP-022 Reducer	PP-040 Warm BLACK
PP-004 CNVIA Yellow #18	PP-023 Flat Finish	PP-041 Grimy BLACK
PP-005 VIA Grey	PP-024 Stencil White	PP-042 Anti-Glare Black
PP-006 CN Red/Orange #11	PP-025 Loco Black	PP-043 Slag Brown
PP-007 CN Lettering Grey #17	PP-026 Flat Haze	PP-044 GO Green
PP-008 CN Grey #11	PP-027 CNR LT BLUE	PP-045 GO White
PP-009 CNR Red #12	PP-028 CNR DK BLUE	PP-046 CONRAIL Blue
PP-010 CPR Tuscan	PP-029 CNR YELLOW	
PP-011 CPR Diesel Grey	PP-030 CNR Post 2000 Yellow	
PP-012 CPR Diesel Yellow	PP-031 CNR GREEN	
PP-013 CPR Slean Grey	PP-032 BCR/PGE DK GREEN	
PP-014 CPR Mineral Brown	PP-033 BCR RED	
PP-015 CP Action Red	PP-034 BCR Blue	
PP-016 CP Action Yellow	PP-035 BCR Yellow	
PP-017 CP Action Green	PP-036 BCR/PGE LL GREEN	
PP-018 CP Bright Red	PP-037 GTW Blue	
PP-019 TH&B Cream		

\$8.98 each Canadian

ORDER NOW!

550 Alden Rd., Unit 101 Markham, On, Canada L3R 6A8
 Tel: 905-470-6200 Toll Free: 1-877-8TRAINS (887-2467)
 www.georgestrains.com



TRAINMASTERS.TV

Recent new videos ...

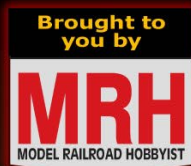

2015 FINE SCALE MRR EXPO

TrainMasters TV host Trevor Marshall brings you the 2015 Fine Scale Model Railroad Expo report featuring contests, dealers, and clinics.



KITBASHING CONTEST

Witness the one of the the craziest modeling contests ever staged (2015 Fine Scale Modeling Expo). Also: The legacy of modeler Brian Nolan.

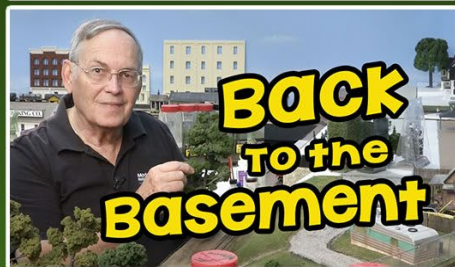

MODEL RURAL SCENERY

Miles Hale gives many tips on creating rural scenery in part 8 of the *Back to the Basement* series on TrainMasters TV.



BULLETPROOF WIRING

Trevor and friend Chris Abbott build rugged module wiring able to survive trips to train shows.

... and lots more! 100+ all-new video segments in total.

Watch these videos on TrainMasters.TV

(TMTV is Model Railroad Hobbyist's ad-free video membership site for model railroaders)



Model Railroad Hobbyist | May 2015 | #63

MAY NEWS

column

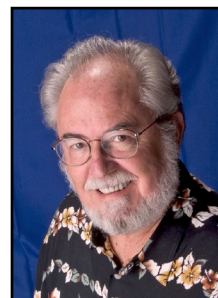

RICHARD BALE and JEFF SHULTZ



[Click here for reader comments](#)

Donald Strait 1940-2015



Don Strait, a life-long model railroad hobbyist best known as an associate editor of *On30 Annual*, passed away in Northglen, Colorado in February. Following a 30-year career as an educator in Colorado Springs, Strait joined the staff of Highlands Publishing in Denver where he worked with Chris Lane in the development of *On30 Annual*. He continued in that role when

On30Annual was taken over by Carstens Publications and most recently by White River Productions where Strait served as editor-at-large ...

▶ THE LATEST MODEL RAILROAD PRODUCTS, NEWS & EVENTS

National Train Day

Mark your calendar for National Train Day, May 9, 2015. The event is held each year on the Saturday closest to May 10, the anniversary of the completion of the first transcontinental railroad celebrated by the Golden Spike ceremony at Promontory, Utah in 1869. Events marking the occasion have been scheduled at Amtrak stations, railroad museums, and model railroad clubs across the country. Amtrak will conduct major events in Washington, D.C., Philadelphia, Chicago, and Los Angeles. For additional information visit amtraktraindays.com ...

Proposed NMRA standard for LCC-Layout Command Control published

The NMRA board of directors has agreed to adopt standards for Layout Command Control (LCC), formerly known as NMRANet. LCC is an operating system protocol which will work hand-in-hand with DCC, handling all non-motive power related functions, such as signaling, on a model railroad layout. In essence, LCC is DCC for the rest of a layout. LCC was developed over the past several years by the OpenLCB Group, a volunteer committee with expertise in electronics, networking, programming, and model railroading, similar to the group that developed the Java Model Railroad Interface (JMRI). The final draft of the LCC protocols and specification documents have been published for comment on nmra.org ...

Korber acquires Pecos River Structure Line

Korber Models, a supplier of HO and O scale model structures and detail parts based in Milford, Ohio, has agreed to purchase the assets of the structure products line from Pecos River Models.

According to Teresa Redmond, president of Korber, the acquisition includes all of the tooling and existing inventory of model railroad structures and tilt-up O scale building components. For additional information visit korbermodels.com ...

NEW CLUB CARS

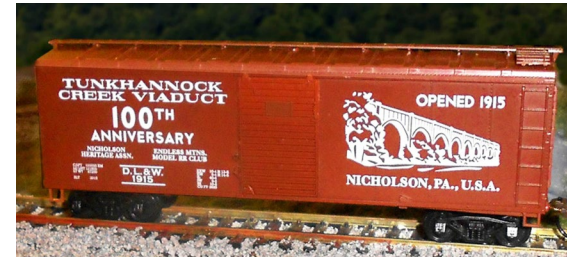

The Endless Mountains Model Railroad Club of Montrose, PA is selling boxcars custom-decorated to mark the 100th Anniversary of the

Tunkhannock Creek Viaduct. Both O and HO scale cars are available. The HO model is based on a Bowser product. It is available as a kit at \$20, or assembled at \$25, plus \$7 shipping. Available road numbers are DL&W 1915 or DL&W 2015. The O scale model is a Lionel car custom-decorated by RGS Trains, Old Forge, PA. It is available fully assembled at \$60 plus \$14 shipping. For additional information visit emmrrc.wix.com/trains#!club-boxcars.

NEW PRODUCTS FOR ALL SCALES

The Burlington Route Historical Society has released the 50th edition of *Burlington Bulletin*, a special 148-page edition that presents a comprehensive study of the Burlington's 1936 Denver Zephyr. Beginning with the Zephyr's 3-unit articulated predecessor, author John W. (Bill) Schultz presents the famous train's role in the eventual collapse of the Pullman monopoly, its record-setting Chicago-Denver non-stop run, and the little-known attempt

MAY News | 4

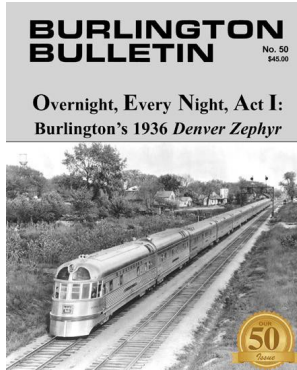

by saboteurs to dynamite the train off the tracks during WWII. The publication includes 178 historical black-and-white photos, 12 color photos, numerous equipment drawings, and rosters. This special commemorative issue is available at \$45.00 from the society's company store at burlingtonroute.com.

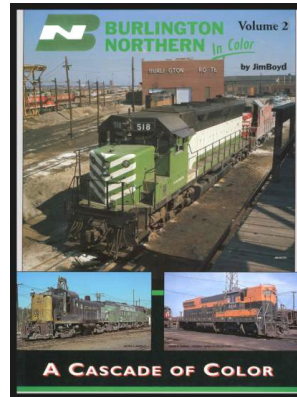
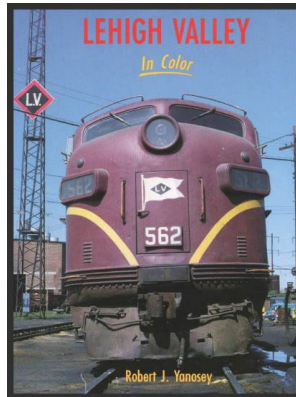
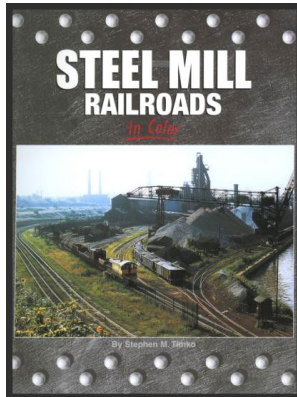

New eBooks from **Morning Sun** include *Steel Mill Railroad Facilities and Equipment* which serves as a complement to the original hardback volume of *Steel Mill Railroads*, long out of print but now available as a digital reprint. Together, the digital releases feature nearly 550 photos of steel mill railroading. Additional Morning Sun titles re-issued in digital format include *Lehigh Valley*, an all-color trip on the LVRR from New York Harbor to Pennsylvania and on to Buffalo. Also *Burlington Northern* in which author Jim Boyd traces the massive merger and the challenge of organizing and renumbering an eclectic locomotive roster.

MAY News | 5

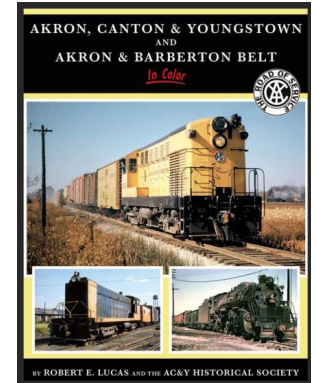
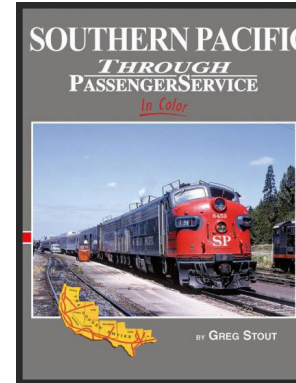
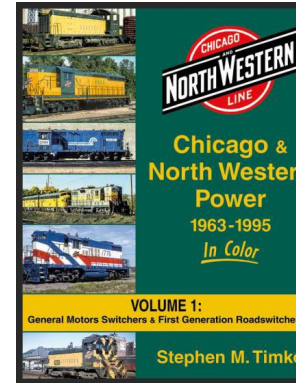

Among the newest traditional hardcover books from Morning Sun are *Chicago & North Western Power 1963-1995* in which author Stephan Timko reviews the period when first-generation locomotives from SW1 to SD7s to GP9s entered C&NW territory. Also new is *Southern Pacific Through Passenger Service* from the postwar period to the Amtrak era. Greg Stout presents a pictorial look at a railroad that spared no expense to attract passengers... then spared no effort to drive them away. The final new book this month provides an interesting review of two related roads in *Akron, Canton & Youngstown and Akron & Barberton Belt*. The book was created by Robert Lucas with extensive help from the AC&Y Historical Society. Additional details on these and other titles are available at morning-sunbooks.com.

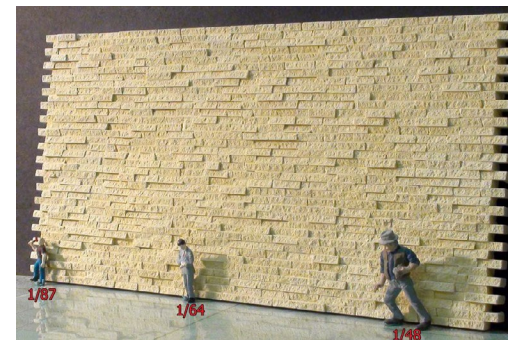

Doctor Ben's is selling Scale Model Masterpieces' split granite wall cast in Labstone. The interlocking ends allow multiple sections to be used with a nearly invisible joint. To

demonstrate the suitability of using the nicely detailed wall in a variety of scales, it is shown above with (from left to right) HO, S, and O scale figures. The dimensions of each section are 8.875” wide by 4.625” tall by .375” thick. For additional information visit debenllc.com.

.....

O SCALE PRODUCT NEWS

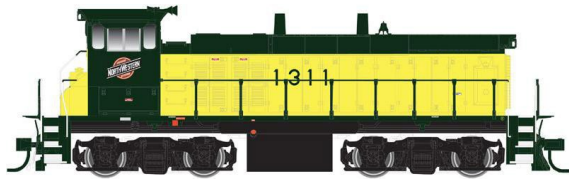

Atlas O has set a fourth-quarter release date for a new production run of MP15DC diesel

locomotives. EMD’s MP15DC differs from its SW1500 predecessor in that it is fitted with Blomberg B road trucks. In addition to the Chicago & North Western version shown above, the O scale MP15DC will be available decorated for Norfolk Southern, Union Railroad, U.S. Steel, and Bethlehem Steel. Both 2-rail and 3-rail models will be available.



Also due in the third quarter of this year is a run of USRA rebuilt steel boxcars. Road names will be Pennsylvania Railroad, Burlington Northern, Chesapeake & Ohio, and Lackawanna. A special four-pack of



Santa Fe cars will also be available. Cars decorated with the Super Chief and El Capitan slogan will have a straight system

map on the opposite side. Santa Fe All The Way will be on the opposite side of cars displaying The Chief and Grand Canyon slogans. Cars ready for 3-rail operation will have an MSRP of \$72.95. Two-rail cars will list at \$77.95. For additional information see your dealer or visit atlaso.com.



San Juan Car Company has released a new O scale tank car. The ready-to-run models features new two-rail standard gauge Bettendorf

trucks with metal wheelsets and couplers. The cars are available decorated for Pioneer Oil (three numbers), UTLX (seven numbers), and Milwaukee Road (four numbers). For additional information visit sanjuancarco.com.

.....

HO SCALE PRODUCT NEWS



New HO scale kits available from **Accurail** include this Pullman Standard 4750 cu. ft. triple-bay covered grain hopper decorated for Soo Line. All Accurail kits include Accumate knuckle

couplers and appropriate trucks.



able now.

An ACF triple-bay covered hopper is available decorated in the 1971 as-built scheme of Englehard Chemicals is avail-



able now. The three-car set has an MSRP of \$52.98.

Also new is a trio of Golden West cars that includes a 50' exterior-post boxcar, a triple-bay Center Flow covered hopper, and a PS 4750



able now. The three-car set has an MSRP of \$52.98. The models are decorated for three of Santa Fe's famous passenger trains: El Capitan, Chief, and Super Chief. The opposite side of the cars have the Ship and Travel Santa Fe All The Way slogan. For more information visit accurail.com.

ATSF class RR-23 SFRD steel reefers with hinged doors are available in a three car set at \$52.98. The models are decorated for three of Santa

American Model Builders is selling an HO scale LaserKit for McCready's Pickle Packers and Condiments. The model is based on an industry of the same name in Saint John, New Brunswick, Canada. The modular design of the kit, including the open platform with vats and loading docks, provides flexibility in



placement of the various structures. The basswood and birch plywood construction is well-suited to a variety of stained weathering techniques. Features include peel-and-stick windows, door, trim, and roofing material; custom-scribed platform and dock decking; tab-and-slot wall and platform substructure assembly; laser-cut ladders and wheelbarrows; white metal smokejacks and elevator drive chain assembly; cast-resin casks, crates, sacks, and cucumber loads for the wheelbarrows; and color signage. Illustrated instructions are included. As shown, the complex has a footprint of 8.5" long x 5.25" wide by 6.5" high. The HO scale kit has an MSRP of \$139.95. For more information visit laserkit.com.

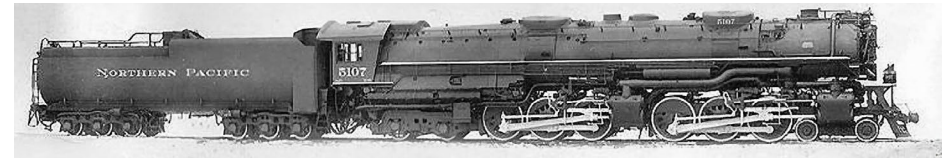

Athearn's 2016 production schedule begins with the release of HO scale 4-6-6-4 Challenger steam locomotives in January. The Genesis series model will be available decorated for Spokane, Portland & Seattle, and Northern Pacific.



Additional HO scale Genesis motive power expected in January include GP40-2 locomotives decorated for Grand Trunk

MAY NEWS | 10

Western (both Phase I and Phase IIa), Florida East Coast (Phase III), Louisville & Nashville Family Lines (Phase II), and St. Louis-Southwestern Cotton Belt (Phase III with an 88" nose).



A Guilford/MEC repaint of an ex-CN GP40-2L is included in the January run.



HO ready-to-roll locomotives expected from Athearn in January include

SD40T-2 diesels decorated for New York, Susquehanna & Western (with both 88" and 124" noses); Denver & Rio Grande Western; Kansas City Southern; and Southern Pacific (with an 88" nose and L-window cab).



The release will include an undecorated version of the

SD40T-2 with SP details.



Freight cars planned for release early next year include 24' ore hopper cars for Milwaukee Road, Canadian National, Northern

Pacific, Union Pacific, Soo Line, and Chicago North Western. Each road name of the ready-to-roll HO scale models will be available in 13 numbers.

MAY NEWS | 11

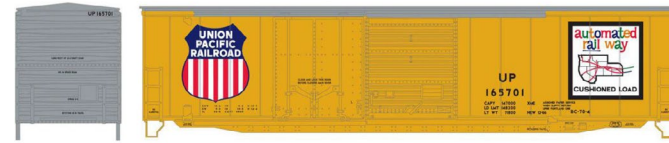

Fifty-foot smooth-side boxcars with a combination of

both sliding and plug doors are also planned for release in January. Three numbers each will be available for Union Pacific, Denver & Rio Grande Western, Great Northern, Norfolk & Western, Norfolk Southern, and Southern Pacific. An undecorated model is also planned.



A Genesis series 57' FGE mechanical refrigerator car with a Tsunami refriger-

ator sound unit is due in January for Burlington Northern-Western Fruit Express (Phase II body), Fruit Growers Express (Phase III body), St. Louis-San Francisco (Phase I early body), TPIX repaint (Phase I, late body), and Union Pacific/ARMN (modernized Phase I body). Non-sound versions will also be offered.



February will see the arrival of a new group of Athearn Genesis HO scale GP9

diesels. Road names will be New Haven, and Boston & Maine with HEP (head end power) cabinets located at the front of the long hood.



The GP9 release will include a Penn Central unit configured

MAY NEWS | 12

for long-hood-forward operation paired with a newly tooled cabless B unit.



Completing Athearn's first HO scale release next year will be a PS-2 triple-bay 2893

cu. ft. covered hopper car with round hatches and individual wire grab irons. Road names will be Chicago Burlington & Quincy, Detroit Toledo & Ironton, Soo Line, Southern, Southern Pacific/Texas & New Orleans, and Louisville & Nashville. An undecorated version will also be available. For additional information see your Athearn dealer or visit athearn.com.

Atlas Model Railroad Company has set a fourth quarter release date for a new produc-

tion run of MP15DC diesel locomotives. EMD's MP15DC differs from its SW1500 predecessor in that it is slightly longer to allow the installation of Blomberg B road trucks. In addition to the Norfolk Southern version shown here, road names for the HO scale ready-to-run locomotive will be Chicago & North Western, Seaboard System, Southern Railway of British Columbia, Union Railroad, U.S. Steel, NdeM-Nacionales de Mexico, and TFM-Transportacion Ferroviaria Mexicana. An undecorated version will also be available. A sound-equipped Atlas Gold series model will be available, as well as a Silver series version with an NMRA 8-pin plug for an aftermarket DCC decoder (not supplied).



MAY NEWS | 13



Also due in the third quarter of this year is a run of USRA rebuilt steel boxcars. Road

names will be Southern Pacific, Muncie & Western, Western Pacific and two Santa Fe cars (Grand Canyon and The Chief). Depending on prototype practice, the HO scale ready-to-run models will have either Andrews or Bettendorf-type trucks, and 5-5-5 or 7-8 corrugated steel ends. An undecorated model will also be available. For more information see your dealer or visit atlasrr.com.



Bowser has released a new production run of Baldwin DRS 4-4-1000 and RS-12 diesel locomotives. Road

names currently available for the HO scale DRS unit are CP Rail (Pacman scheme, above) and Canadian Pacific (gray and maroon). RS-12s are available for Oregon, California & Eastern; Escanaba & Lake Superior; Pennsylvania Railroad (with antenna); Central of New Jersey; Seaboard; and California Western (bicentennial).

Alco Century C-430 locomotives have also been released to dealers by Bowser. In addition to the New York & Susquehanna Western scheme shown here, road names include New York

MAY NEWS | 14



Central, Penn Central, Western New York & Pennsylvania,

Conrail (blue), Conrail (black), Morristown & Erie, Lehigh Valley, Rock Island, and Alco Demo.

Bowser locomotives equipped for DC operation have an NMRA-compliant 21-pin plug for an aftermarket DCC decoder (not supplied). DCC sound models come with factory installed LokSound Select Dual-Mode decoder which allows locomotive to operate on DC as well as on DCC layouts.



Bowser is projecting a November release date for a new production run of its 100-ton,

14-panel, triple-bay, rib-side boxcars. Road names will include CSX-NYC, CSX-WM, CSX-B&O, CSX-C&O, CSX-CSXT, Burlington Northern, PEPX (black), PEPX (brown), PEPX (yellow end), Reading & Northern (red end), Reading & Northern (blue end), and Shawmut Line. For additional information see your dealer or visit bowser-trains.com.



Classic Metal Works has released a new group of 1960 Ford F-series trucks

MAY NEWS | 15

in its Mini Metal line of HO scale vehicles. Available now are F-100 pickups, F-500 flat bed and stake trucks, and an F-500 dual-wheel refrigerator box decorated as City Ice. See your favorite dealer for additional information or visit store.buy-hobbies.com.



Digital Fox Service is selling a kit for a 40' steel refrigerator car decorated in the 1966 scheme of Fruit Growers Express. Three different road numbers are available at \$17.99 each.

Orders for four or more cars will receive a decal renumbering set with 12 additional road numbers. The HO scale custom-decorated model is based on an Accurail product. For additional information visit digitalfox.com/digitalfox/fgex.htm.



The newest model from **ExactRail** is an FMC 5327 cu. ft. exterior-post boxcar with 12' plug doors. The HO scale Evolution series model comes

with Kadee #58 knuckle couplers and ASF 100-ton Ride Control trucks with 36" machined metal wheels. Features include wire grab irons, separately applied door tracks and door bars, and a narrow-style draft box with shank wedges, striker casting and nut and bolt detail. Tooling for this model was prepared by Chris Clune before he left ExactRail in early 2011.

MAY NEWS | 16

Six numbers are available for cars decorated for Minnesota, Dakota & Western; New Orleans Public Belt Railroad; and East Camden & Highland. Two Quebec Central cars (one mineral brown and one yellow) will be available in one road number for each scheme. For more info visit exactrail.com.

.....

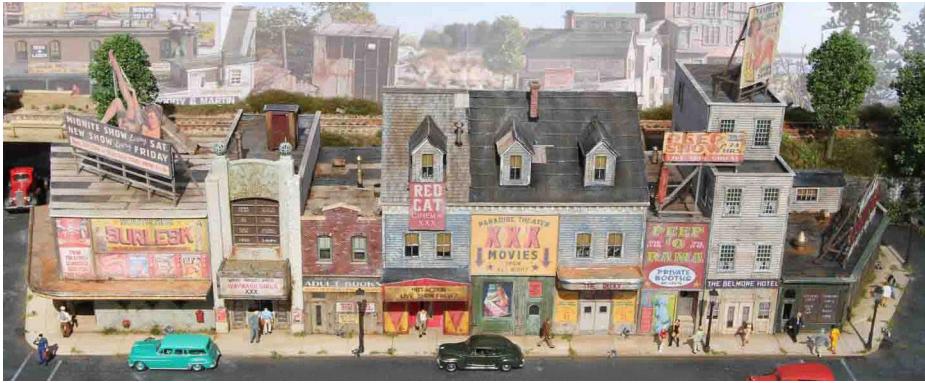

Fos Scale Models has introduced The Red Light District, a craftsman kit that builds into a full block of nine tawdry business enterprises. Although assembling this complex is not without a few challenges, Doug Fos claims his latest HO kit is relatively easy to build. The stores are designed to be connected as a single structure with front and back walls and partial sides. Major components include laser-cut clapboard, scribed, and brick siding. The doors and windows are a combination of plastic and laser-cut material. Signage, sidewalks, metal detail parts, and detailed assembly instructions are all included. The completed block has a footprint of about 24" x 6". This is a limited-run kit. It is available now at \$345.00 plus shipping. Vehicles, figures, and the backdrop shown in the above illustration are not included.

.....

MAY NEWS | 17

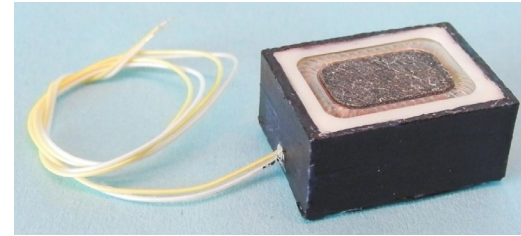

Cast resin manufacturer, **GLX Scale Models**, has introduced an extremely small pre-assembled 8-ohm speaker with a cast-resin enclosure for

DCC and sound module installations. Identified as a Sugarcube Speaker, the unit measures 0.83 x 0.60 x 0.40 inches. The speaker provides high quality sound output through the use of triple magnet technology. Item GLX-SCS-01 is available direct from the manufacturer at an MSRP of \$10.00. For additional details including ordering information visit glxscalemodels.com/glx-products.

.....



Hornby America is selling four different types of Rivarossi HO scale 60' heavyweight passenger cars. A coach (above), combine, RPO, and baggage car are available decorated for New York Central, Union Pacific, Santa Fe, Southern Pacific, and painted but unlettered.



Southern Pacific combination baggage and coach.



New York Central railway post office car with six-wheel trucks.

MAY NEWS | 18



Santa Fe baggage car with six-wheel trucks. The ready-to-run HO scale models have an MSRP of \$42.99 each. For additional information contact your dealer or visit hornby.com/us-en/rivarossi/rivarossi-coaches.html.



InterMountain Railway has released a new series of ACF twin-bay covered hopper cars to its dealers. Available road names

include Southern, The Rock, Winchester & Western, Blue Circle Cement, Saskatchewan Minerals, ACFX (plain gray), Chessie B&O, Chessie C&O, Chicago North Western, CSX, Great Northern (big sky), Grand Trunk Western, BN, BNSF (boxcar red), and BNSF (swoosh).



InterMountain plans to begin shipping EMD FT A- and B-diesel locomotive sets this month. The HO scale models have several etched-metal details including metal screens for the roof fan and the dynamic brake openings. In addition to the Santa Fe scheme shown here, road names will include Erie Lackawanna, Reading, St. Louis & Southwest, Missouri Pacific, Milwaukee Road, Chicago Burlington & Quincy, Northern Pacific, EMD Demonstrator, and Rio Grande.

MAY NEWS | 19



The locomotives come as an A-B pair. Both units are powered with DC and DCC functions and are also available with optional ESU LokSound sound. The MSRP for the pair is \$439.95 with sound and \$329.95 for non-sound versions.



Also due from InterMountain this month are ES44DC Evolution Series locomotives. Features include etched-metal details, wire grab irons, and Kadee couplers. Prototype specific details will match the cab, trucks, and rear lights of each prototype road name. Non-sound models come with a DCC decoder capable of operating on analog DC or DCC. Sound models will have a factory-installed ESU LokSound DCC decoder. Road names will be Norfolk Southern, BNSF (Heritage II), BNSF (new image with black logo), CSX, and Canadian National.



Based on the sales attraction of the previous release, InterMountain has made a re-run of its ES44AC famous image collector series. Although these schemes did not appear on the prototype, they have proved to be popular with hobbyists. Road names in this release are Florida East Coast, Union Pacific, Sana Transportation, and Citirail.

Several years ago InterMountain released an N scale model of EMD's SD40T-2 tunnel motor diesels. Now, an HO version of the

MAY NEWS | 20



locomotive is being tooled for release late this year. EMD designed the prototype for tunnel service, with radiator intakes along the deck to gather cooler air and avoid hot exhaust fumes near the top of the tunnels. Road names on the initial release will include SP (Kodachrome, above), Southern Pacific (bloody nose), Southern Pacific (long nose and L-cab windows), and SSW Cotton Belt. Other road names will be New York, Susquehanna & Western; Denver & Rio Grande Western; R. J. Corman; Kansas City Southern; Ohio Central; and Genesee & Wyoming.



Additional HO scale models coming from InterMountain late this year include 4750 cu. ft. covered hoppers. In addition to the ICG car shown here, the triple-bay, 18-ribbed car will be available for MNS Minneapolis, Northfield & Southern; Jewell Coop Elevator; Norfolk & Western; Santa Fe; Grain Train; Ralston-Jefferson; BNSF (new image scheme); and West Bend Elevator. Also in the release is an undecorated model and a gray data-only car.



InterMountain's late 2015 release includes 19,600 gallon tank cars decorated for GATX, Tate & Lyle, Tate & Lyle (repaint), ADM (old logo), TILX, Cerestar, Domino Sugar, and GATX-MCP. See your dealer for additional information or visit intermountain-railway.com.

MAY NEWS | 21



Kadee Quality Products plans to release a new Boston & Maine boxcar in July. The 50' PS-1 car will have 9' Youngstown doors and Pullman-Standard washboard corrugated steel ends. The blue-and-black decorating scheme of the HO scale ready-to-run model replicates the prototype car after it was shopped in late 1977.



Also due from Kadee in July is a PS-2 twin-bay covered hopper car with eight round hatches. The HO scale model will be decorated for Frisco Lines (St. Louis-San Francisco Railway) in the road's 1958 as-built alkali-resistant gray. For more information visit kadee.com.



Kato USA has added two new road numbers (91 and 150) to the previously announced numbers (68, 161, and 188) of General Electric's P42 Amtrak (phase Vb) locomotives. They are scheduled for release next month. The HO scale ready-to-run model will be available for both DC-only operation, as well as with ESU or Loksound DCC and sound pre-installed.

Kato's Online Store is booking reservations for HO scale GP35 Phase Ia locomotives custom-painted by Kobo. Reservations



are currently being accepted for MoPac, Montana Rail Link, and Chicago & Eastern Illinois. For information visit katousa.com/Zcart/index.php?main_page=index&cPath=166.

http://katousa.com/Zcart/index.php?main_page=index&cPath=166.



Monster Model Works has introduced a craftsman kit for McCampbell's Storage and an adjoining building named Bonded Warehouse and Storage. These are highly detailed back-

ground flat buildings less than 2" deep. The components of the structure, including the aged brick walls, corners, fire escapes, wall anchors, and security bars are 3D laser-engraved bass-wood which lends itself to extensive weathering opportunities. Additional details include laser-cut peel-and-stick window and door material, and laser-cut sign stencils. The dimensions of the three-story building are 11" long x 7.375" high x 1.562 deep. The HO scale kit has an MSRP of \$68.00. The kit for the single-story Bonded Warehouse follows the same construction methods. It measures 15" long x 2.5" high x 1.75" deep. It has an MSRP of \$34.99. To order visit monstermodelworks.com.

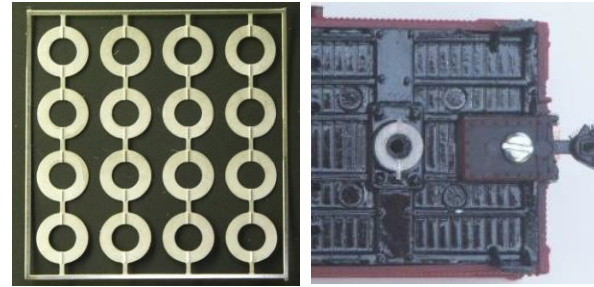

Proto 87 has developed a system of car stabilizers that are said to straighten up cars that randomly jiggle or tilt to one side. Called "Fast and Easy" the

car stabilizers have a precision edge bearing that allows one truck to freely tilt relative to the other, which keeps both sets of truck wheels firmly on the rails. This can be especially helpful in controlling tilt and car jiggle when traversing frogs and curved grades such as a helix. Installing the specialized 0.010" thick washers raised the car height less than one scale inch. A fret of 16 washers (enough for four cars) is priced at \$5.95. For additional information including mounting instructions visit proto87.com/model-railroad-fast-n-easy-riders-working-suspension.html.



Here is an early look at a pre-production sample of **Rapido's** FL9 locomotive. Development of the HO scale model has moved ahead quickly from the original computer drawings, below, to the model pictured above. A Rapido spokesman confirmed that the FL9 project has progressed so quickly he is cautiously optimistic that completed models may be available several months earlier than planned.

MAY NEWS | 24

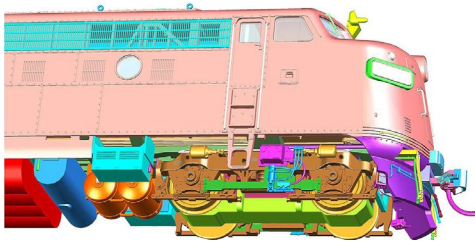

Decorating schemes on the introductory run will be New Haven EDER5 (as delivered), New Haven EDER5 (modernized), New Haven EDEER5a (as delivered), Penn Central (black), Penn Central (patch),

Conrail (blue and yellow), MTA (silver and blue), Metro North (red, silver and blue), Amtrak (Phase II), and Amtrak (Phase III). The model will be available with factory-installed ESU LokSound DC/DCC/SOUND decoders or as DC models (DCC-ready).

Although this initial run is sold out and production is already underway, some distributors may have ordered uncommitted inventory. Anyone interested in buying this model should have their dealer get in touch with a distributor to check availability. In view of the positive response to the FL9 announcement and sell-through of the initial production run, Rapido is looking favorably at investing in tooling for a HEP version. For more information visit rapidotrains.com.



Walthers is taking reservations for fall delivery of Union Pacific Heritage passenger cars. The

well preserved prototypes, along with beautifully restored steam locomotives and E9 diesels, are a key part of Union Pacific's public relations programs. Walthers HO scale Proto series models feature individual grab irons, prototypical window tinting, window

MAY NEWS | 25



gasket detail, and optional factory-installed LED lighting.

All of the cars are 85' in length. With the exception of the Budd-built 10-6 sleeper, the cars model prototypes built by American Car & Foundry. They include a 44-seat coach, a 48-seat diner, a dome diner, a dome lounge, a dome coach, and the 10-6 sleeper. Walthers recommends a minimum 24" radius for reliable operation.



Walthers has released a new production run of EMD GP15-1 diesels. The Mainline series model is available deco-

rated for Chessie System – C&O, Chicago North Western, Canadian Pacific, and Missouri Pacific. The HO scale locomotive is available for DC operation or for DCC with Soundtraxx sound.



Fifty-foot double-door boxcars equipped with high-speed trucks for express service are available now from Walthers.

The HO scale Proto series cars have separate grab irons, 5/5 Dreadnaught corrugated steel ends, and Youngstown doors. Road names are Missouri Pacific (GSC trucks), CNW (Allied Full-Cushion trucks), and Kansas City Southern (Barber S2 trucks).

Three Santa Fe express cars are also available. Decorating schemes include a small SF herald (Barber S2 trucks), a SF large

MAY News | 26



herald (Barber S2 trucks), and The Chief with a system map on opposite side (above, with Allied Full-Cushion trucks).



Walters plans to release a group of rebuilt 53' well-cars cars next month. The HO scale Proto series cars will have etched-metal see-through walkways and factory-installed wire grab irons. In addition to the Florida East Coast yellow scheme shown here, the all-purpose well cars will be available for FEC (boxcar red), St. Mary's Railroad, and TTS-DTTX. See your dealer or visit walters.com for more information.

N SCALE PRODUCT NEWS

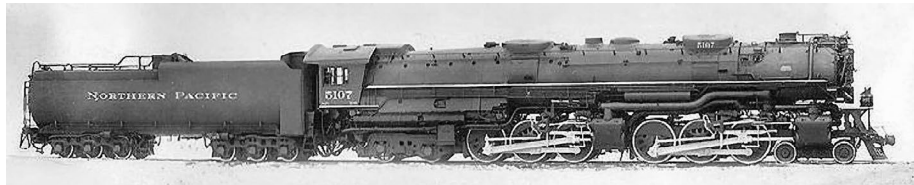

Athearn's 2016 production schedule begins with the release of an N scale 4-6-6-4 Challenger steam locomotive in January. The model will be available decorated for Spokane, Portland & Seattle and Northern Pacific.

Additional N scale models coming early next year include a PS-2 triple-bay 2893 cu. ft. covered hopper car with round hatches and individual wire grab irons. Road names will be Chicago

MAY News | 27



Burlington & Quincy, Detroit Toledo & Ironton, Soo

Line, Southern, Southern Pacific/Texas & New Orleans, and Louisville & Nashville. For additional information see your dealer or visit athearn.com.



Atlas Model Railroad Company has planned a third-quarter release for another production

run of its 42' coiled-steel cars with distinctive fishbelly side sills. In addition to the AK Steel scheme shown here, the N scale ready-to-run model will be available decorated for Armco Steel, CSI-California Steel Industries, Nucor, Republic Steel, US Steel-Geneva Works, and Union Railroad. An undecorated model will also be offered.

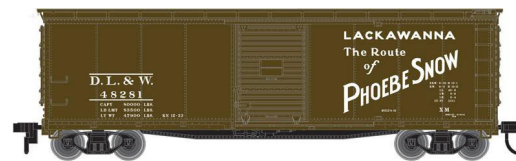

Additional models scheduled for release in the third quarter include a group of USRA rebuilt steel boxcars. Road names

are Muncie & Western, Southern Pacific, Western Pacific, and two Santa Fe cars (El Capitan and Super Chief). Depending on prototype practice, the N scale models will have either Andrews or Bettendorf-type trucks, and 5/5/5 or 7/8 corrugated steel ends.

Atlas has set a fourth quarter release date for a new production run of MP15DC diesel locomotives. EMD's MP15DC differs from



its SW1500 predecessor in that it is fitted with Blomberg B road trucks. In addition to Seaboard System shown here, road names will be Chicago & North Western, Norfolk Southern, Southern Railway of British Columbia, Union Railroad, U.S. Steel, NdeM-Nacionales de Mexico, and TFM-Transportacion Ferroviaria Mexicana. An undecorated version will also be available. For additional information visit atlasrr.com/NLoco/nmp15f.htm.



Bachmann Trains
Bachmann Trains has N scale models of a 52' 6" flat car with a 35' piggy-back trailer. Matchups

include an ATSF flat with a Navajo Freight Lines trailer, a Baltimore & Ohio flat with a Railway Express Agency trailer, and an Atlantic Coast Line flat with a Yale Freight trailer. Both the freight car and the trailer display the same road name on sets for New York Central, Reading, and Western Maryland.



Also new from Bachmann is a 50' boxcar with plug doors. The Silver series N scale model features blackened metal wheels,

and a detailed underframe with separate brake rigging. Road names are New York Central, Santa Fe, Pennsylvania Railroad, CP Rail, and New Haven. For additional information see your dealer or visit bachmanntrains.com.



InterMountain Railway plans to release a new run of EMD's SD40T-2 tunnel

motor diesels late this year. EMD designed the prototype for tunnel service with radiator intakes along the deck to gather cooler air and avoid hot exhaust fumes near the top of the tunnels. Road names on the initial release will include D&RGW (above); New York, Susquehanna & Western; R. J. Corman; Kansas City Southern; Ohio Central; Genesee & Wyoming, and SSW Cotton Belt. Southern Pacific will be well represented in this release with SD40T-2s available for SP (Kodachrome), Southern Pacific (bloody nose), and Southern Pacific (long nose and L-cab windows).



Additional N scale models coming from InterMountain late this year include 4750 cu. ft. covered hoppers.

In addition to the Jewell Coop Elevator car shown here, the triple-bay, 18-ribbed car will be available for MNS Minneapolis, Northfield & Southern; Illinois Central Gulf; Norfolk & Western; Santa Fe; Grain Train; Ralston-Jefferson; BNSF (new image scheme); and West Bend Elevator. For additional information see your dealer or visit intermountain-railway.com.



Kato's Online Store is booking reservations for N scale steel cupola cabooses custom-painted by Kobo to match selected NS Heritage locomotives. In addition to

the Illinois Terminal caboose shown here, reservations are

also being taken for Virginian Railway and New York Central. For complete information visit katousa.com/Zcart/index.php?main_page=index&cPath=166.



New N scale models from **Micro-Trains** include a 33' twin-bay hopper car with off-set sides. The ready-to-run model is decorated for Chessie System B&O.



A quartet of 40' steel boxcars decorated for Boston & Maine are being sold as a four-pack.



This 60' Denver & Rio Grande Western boxcar from Micro-Trains has waffle sides and double plug doors.



Also new from Micro-Trains is this traditional 40' Southern boxcar with Dreadnaught ends and

Creco doors. For more information see your favorite dealer or visit micro-trains.com.



Walthers has released an N scale DCC-ready EMD GP38-2 diesel. Features include all-wheel drive, Bloomberg trucks, and directional LED headlights. Road names available now are BNSF, Canadian National, CSX, Soo Line, Union Pacific, and Conrail. See your dealer or visit walthers.com for more information.

NEW DECALS, SIGNS AND FINISHING PRODUCTS

Curt Fortenberry has released new HO scale decal sets for Louisville & Nashville hopper cars. Set #SE-18 has bold white block letters for decorating L&N 70 & 80-ton triple-bay hoppers. Set #SE-19 is suitable for Tangent's 100-ton Bethlehem Steel quad hopper car. The set will decorate one car with white lettering and includes the yellow circle for cars equipped with Class C wheels. For additional details visit greatdecals.com/Curt.htm.

Daniel Kohlberg has released new silk screened HO scale decal sets for Burlington Northern Airslide covered hopper cars, Gulf Mobile & Ohio 50' GATC boxcars, Illinois Central 50' GATC boxcars, and Gulf Mobile & Ohio 42' gondolas. Photos, prototype details, and ordering information are available at home.mindspring.com/~paducah.

MAY News | 32

Highball Graphics has HO scale decals for Canadian equipment including ONR 40' boxcars in the road's Development & Progressive scheme. Also available are lettering sets for CNR 40' grain loading boxcars, Mobile Grain SD40-3 diesels, and both CP and CN MOW vehicles. For additional information visit highballgraphics.com.

Mask Island Decals has released a new HO scale decal for a MoPac Desoto rebuilt open hopper car. Also new are S scale decals for Rock Island Route of the Rockets and Rock Island PS-1 boxcars. For additional information visit maskislanddecals.com.

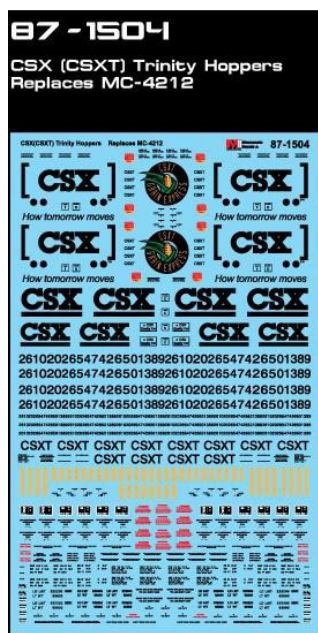

information visit microscale.com.

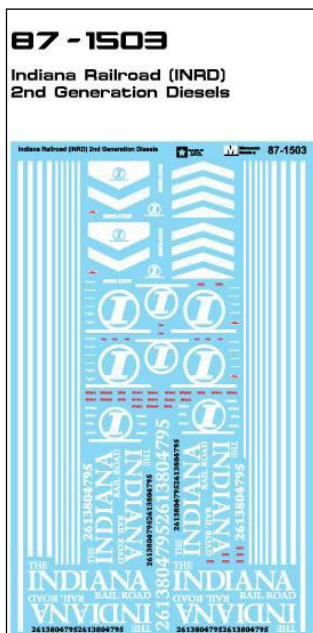

New water-slide decals from **Microscale Industries** include lettering material for CSX Trinity hopper cars and Indiana Railroad second generation diesels. Also new is a sheet of HO scale rivets in a variety of patterns. For additional information

MAY News | 33

i SEND US YOUR PRODUCT ANNOUNCEMENTS

If you are a hobby manufacturer with a product announcement, just [click here](#) and submit your announcement to us. Our web site and free magazine reach continues to grow, so get on board this new media train! ■

DISCLAIMER

The opinions expressed in this column are those of the writer and do not necessarily reflect the opinion of *Model Railroad Hobbyist* or its sponsors. Every effort is made to provide our readers with accurate and responsible news and information, however, neither *Model Railroad Hobbyist* or the writer of this column can be held responsible for any inaccuracies or typographical errors that may inadvertently appear in this column.



Click here for reader comments

HobbyOn

Come & See Us
[CLICK Here](#)



www.hobby-on.com

**Name Brand
Hobby
Products
at Discount
Prices!**

Backdrop Junction

Your Stop for Model Railroad Backdrops



CLICK
HERE



to visit
our
website

Any Scale or Size • Custom Orders backdropjunction.com

THIS MONTH'S BONUS EXTRAS

MRH SUBSCRIBERS GET ACCESS TO FREE BONUS extras, but you do have to be a subscriber! That's easy because [subscribing is free \(just click this link\)](#).

The bonus extras this month include:

- High quality versions of the issue videos
- Infinitely zoomable Jeff Sargeant layout track plan

To access the bonus extras, click the link below:

[BONUS DOWNLOADS FOR THIS ISSUE](#)

Get the first 50 issues of

Model Railroad Hobbyist magazine™

Save
yourself
endless
hours of
downloading

On a data DVD for \$10!

Send me one!

(Sold by the MRH Store)

Includes a coupon
good for \$20 off on
TrainMasters TV

Over 5000
pages of
how-to
information
on model
railroading



! BRIEFLY NOTED AT PRESS TIME ...

Rapido Trains has announced a unique auction for 40 Bombardier LRC (Light, Rapid, Comfortable) locomotives custom-decorated as USS Enterprise Shuttlecraft. All funds generated by the auction (except shipping) will go to the Canadian Lung Association in memory of Leonard Nimoy of Star Trek fame. Bidding begins at \$199.95. Jason Shron, president of Rapido, announced the program at the Train Expo held in Ottawa on April 25th. For details on the auction visit: rapidotrains.com/shuttlecraft.

Preliminary reports indicate The Brass Show held last month in conjunction with The Great Scale Model Train Show in Timonium, Maryland, was a major success. Brass models have lost their luster in recent years, and it has been more than a decade since a show has presented only brass models. The event was conducted in a tightly secured facility adjacent to The Great Scale Model Train Show. More than 650 people went through the security check to enter the sequestered brass area. In announcing that a similar event would be repeated next year, show officials Dan Glasure and Howard Zane reported that 32 brass importers and vendors set up displays. Speakers included Glasure and John Glaab.

HO scale models coming from Athearn in September include matching F7A and B units in Santa Fe's iconic warbonnet scheme. Also GP38-2 diesels decorated for Alaska, CP Rail, Union Pacific, and Grand Trunk Bicentennial. GP50 Phase I diesels for C&NW, BNSF, Florida TriRail, MP, and Union Pacific are scheduled to arrive in February. Roadnames for the Phase II versions of the GP50 will be Santa Fe (blue and yellow), BNSF, and BN (black and green with an orange nose). Genesis series Amtrak FP7A and matching FP7A/F7B sets are scheduled for release in March.

New RTR HO scale rolling stock coming from Athearn in September includes ACF 50' Plate B boxcars decorated for ATSF, Bangor & Aroostook, BC Rail, and RailBox. The same release will have single-dome

tank cars for Shell, Alaska, and Department of Defense. Wide-vision cabooses are also due in September. Road names will be BNSF, Norfolk Southern, Union Pacific, Santa Fe, Alaska, Canadian Pacific, and Grand Trunk.

February's schedule includes a new production run of FMC 4700 cu. ft. triple-bay covered hoppers. Road names on the HO scale RTR model will be D&RGW, FMC Leasing, UP ex-CNW, Boone Valley Coop, BN, BNSF, and a BNSF Buffer car. Also coming in February are 40' postwar boxcars with Dreadnaught ends and 6' Superior doors. Road names will be B&M, EJ&E, GN, NYC, Rutland, and WP.

Both HO and N scale versions of a 50' ATSF ice refrigerator car with Dreadnaught ends and swing doors are set for release in February. Noting that the cars are prototypically correct only for ATSF, Athearn said it plans to also release the big steel reefers decorated for Milwaukee Road, CB&Q, NP, and C&NW. ■

The Right TRACK to Savings ...

YD Yankee Dabblers.Com

- Kadee - NCE - SoundTraxx
- Digitrax - And more!

Click NOW!
(while supplies last)

HO
DCC
ALL SCALES



SELECTED EVENTS

May 2015

(Please note that many events charge a fee. Check individual info website for details.)

AUSTRALIA, NEW SOUTH WALES, ALBURY,

LAVINGTON, May 23-24, Annual Train Show, hosted by Murray Railway Modellers Inc., featuring model railways from different regions of Australia in N, HO, and O scale, plus a variety of vendor tables, at Mirambeena Community Centre, 19 Martha Mews. Info at murrayrailwaymodellers.com or phone (03) 5728 2023.

CANADA, ONTARIO, THUNDER BAY, May 22-24, Northwood Rails; NMRA Thousand Lakes Region Convention, at Prince Arthur Waterfront Hotel, 17 No. Cumberland St. Info at thousandlakesregion.org/#!/trthunderbinfo/cx6.

NEW ZEALAND, DUNEDIN, May 9-10, Model Train Show sponsored by American Modular Group of New Zealand. Visit more than 16 layouts and vendor tables at Forbury Park, 146 Victoria Road. Info at dunedinmodeltrainshow@vodafone.co.nz

ARIZONA, TUCSON, May 29-30, Summer Train Show & Meet for all popular scales, at Tucson Expo Center, 3750 East Irvington Road. Sponsored by Gadsden Pacific Division Toy Train Operating Museum. Info at gpdToyTrainMuseum.com.

SELECTED EVENTS | 2

CALIFORNIA, NEWARK, May 13-17, NMRA Pacific Coast Region Convention, at Newark-Fremont Double Tree by Hilton Hotel, 39900 Balentine Drive. Info at pcrnmra.org/conv2015.

CONNECTICUT, COLLINSVILLE, May 29-30, New England/Northeast Prototype Modelers Meet. Info at neprototypemeet.com.

FLORIDA, MELBOURNE, May 16, Brevard Train Expo, at Melbourne Auditorium, 625 E Hibiscus. , Melbourne, Florida 32901. Info at melbourneflorida.org/leisure/audmap.htm.

KENTUCKY, LEXINGTON, May 14-17, NMRA Mid-Central Region Thoroughbred Limited Convention, at The Campbell Hotel, 1375 So. Broadway Road. Info at thoroughbredlimited2015.yolasite.com.

MASSACHUSETTS, HYANNIS, May 16, Dinner Train Excursion aboard Cape Cod Central Railroad, sponsored by NMRA HUB Division. Info at hubdiv.org or contact Manuel Escobar at president@hubdiv.org or call 781-718-5693.

NEW YORK, JAMESTOWN, May 9, National Train Day Celebration at Jamestown Gateway Train Station (formerly Erie-Lackawanna Depot) 211-217 West Second Street, with prototype and model train displays, and vintage cocktail hour at 6 PM. Info at jamestowntrainstation.com.

OHIO, COLUMBUS, May 15-17, 7th Annual Ohio N Scale Weekend, at Franklin County Fairgrounds, sponsored by CONtrak (Central Ohio N Trak). Info at www.centralohiontrak.org/p/central-ohio-ntrak-n-scale-weekend.html.

SELECTED EVENTS | 3

OHIO, HILLIARD, May 15-17, 7th Ohio N-scale Weekend at Franklin County Fairgrounds, sponsored by Central Ohio N-Tra. Info at www.centralohiontrak.org.

PENNSYLVANIA, DuBOIS, May 9, Railroad Day at DuBois Mall, Route 255 and I-80 exit 101. With operating layouts and train sales. Sponsored by NMRA, MCR.

PENNSYLVANIA, PHILADELPHIA, May 15-17, 22nd National Trolley Meet at Pennsylvania Convention Center (Exhibit Hall G), Broad and Race Streets, sponsored by The East Penn Traction Club. Info at trolleymeet.com.

VIRGINIA, FISHERSVILLE, May 4, 29th Annual Shenandoah Valley Model Train and Railroading Show sponsored by the Augusta County Model Railroad Club at Augusta Expo, 277 Expo Road. Event features model train sales, railroad historical societies, railroad memorabilia sales, and operating model train layouts. Vendors contact Bill Kauffman at kauffmanb@gmail.com.

June 2015

AUSTRALIA, VICTORIA, WAVERLEY, June 6-8, Model Railway Exhibition, at Brandon Park Community Centre, 645 Ferntree Gully Road, Glen Waverley. Sponsored by Waverly Model Railway Club. Info at waverleymrc.org.au.

CALIFORNIA, RICHMOND, June 20, BAPM 2015 - The San Francisco Bay Area Prototype Modelers Meet, St. David's School Hall, 871 Sonoma St. Info at bayareaprototypemodelers.org.

CALIFORNIA, SACRAMENTO, June 24-28, National N Scale Convention, at Double Tree Hotel, 2001 Point West Way, Sacramento. Info at nationalnscaleconvention.com/Sacramento/index.html.

SELECTED EVENTS | 4

COLORADO, GREENWOOD VILLAGE (DENVER), June 3-7, NMRA Rocky Mountain Region Annual Smoke & Steam Convention, at Sheraton DTC Hotel, 7100 South Clinton. Info at sas2015.net.

ILLINOIS, ST. CHARLES, June 14, 39th Annual Railroadiana & Model Train Show & Sale, at Kane County Fairgrounds, 525 So. Randall Road. Info at www.rrshows.com.

MARYLAND, TIMONIUM, June 20-21, Great Scale Model Train Show & Railroad Marketplace, Maryland State Fair, 2200 York Road. Info at gsmts.com.

MISSOURI, JEFFERSON CITY, June 5-7, NMRA Mid-Continent Region Convention, at Capital Plaza Hotel, 415 West McCarty Street. Info at showmcentral.com.

SOUTH CAROLINA, GREENVILLE, June 5-6, Palmetto Excursion, NMRA South East Region Convention, at Greenville Marriott. Info at palmetto-excursion.org.

Future 2015 (by location)

CANADA, ONTARIO, BRAMPTON, October 3-4, Annual Brampton Model Railway Show with 33,000 square feet of display including N, HO, O and G scale operating equipment. At Brampton Fairgrounds, 12942 Heart Lake Road. Info at brampton-modelrailwayshow.com.

CANADA, QUEBEC, LAVAL, Oct 3-4, The North Shore Train Show, Complexe Multi-Sports, 955 ave Bois-de-Boulogne. Info at salondutrainrivenord.org/english.html.

SELECTED EVENTS | 5

COLORADO, LONGMONT, December 11-13, 38th Annual Model Railroad Expo, at Boulder County Fairgrounds, Hover & Nelson Roads, sponsored by Boulder Model Railroad Club. Info at bouldermodelrailroadclub.org.

GEORGIA, KENNESAW, September 18-19, Atlanta Railroads Prototype Modelers Meet, at the Southern Museum of Civil War and Locomotive History, 2829 Cherokee Street. The meet is jointly presented by SRHA, Atlantic Coast Line & Seaboard Airline Railroads Historical Society, Central of Georgia Railway Historical Society, Louisville and Nashville Historical Society, and Nashville Chattanooga & St. Louis Preservation Society. Info at srha.net.

ILLINOIS, COLLINSVILLE (Metro St Louis), August 7-8, St. Louis Railroad Prototype Modelers Meet, featuring 16,000 sq. ft. of display area, at Gateway Convention Center, One Gateway Drive. Event is co-sponsored by RPM committee and the Gateway Division, Mid-Continent Region, National Model Railroad Association. Nearby hotels include Doubletree (618- 345-2800), Fairfield Inn (618-346-0607), Super 8 (618-345-8008), and Extended Stay Suites (618-345-0800). Info at home.mindspring.com/~icg/rpm/stlrpm.pdf.

ILLINOIS, LISLE (Naperville), October 22-24, 22nd Annual Naperville RPM Conference, hosted by Joe D'elia, at Sheraton Lisle-Chicago Hotel, 3000 Warrenville Road. Info at railroadprototypemodelers.org/naper_meet.htm.

NEBRASKA, NORTH PLATTE, September 18-20, Rail Fest 2015, info at nprailfest.com.

SELECTED EVENTS | 6

OREGON, PORTLAND, August 23-30, NMRA National Convention, at Double Tree by Hilton Hotel Portland. Info at nmra2015.org.

OREGON, PORTLAND, August 28-30, National Train Show, at Portland Expo Center. Info at nmra2015.org/trainshow.

TEXAS, FOREST HILLS, October 10-11, Texas Western Model Train Show, presented by the Texas Western Model Railroad Club, at Forest Hill Civic Center, 6901 Wichita, Street. Info at twmrc.org.

TEXAS, HOUSTON, September 2-5, 35th National Narrow Gauge Convention. Info at nngc-2015.com.

VIRGINIA, FREDERICKSBURG, September 25-26, 3rd Annual Mid-Atlantic RPM Meet, at Wingate by Wyndham Fredericksburg, 20 Sanford Drive. Info at marpm.org.

Future 2016 and beyond (by location)

CANADA, BRITISH COLUMBIA, SALMON ARM, June 15-19, 2016, Pacific Northwest Region Annual Convention and Train Show.

COLORADO, DENVER, 2017, National Narrow Gauge Convention.

INDIANA, INDIANAPOLIS, July 3-10, 2016, NMRA National Convention and National Train Show. Info at nmra2016.org.

MAINE, AUGUSTA, Sept. 7-10, 2016, 36th National Narrow Gauge Convention. Info at nngc2016.org. ■



Click here for
reader comments

Clickable advertiser index – 1

[Accu-Lites](#)
[American Ltd \(San Juan\)](#)
[ANE Models](#)
[Archer Fine Transfers](#)
[Athearn](#)
[Atlas Model Railroad Co.](#)
[Bachmann](#)
[Backdrop Junction](#)
[Berrett Hill Trains](#)
[Black Cat Publishing](#)
[Blair Line](#)
[BLMA](#)
[Bowser](#)
[Burlington Route Historical Soc.](#)
[Caboose Hobbies](#)
[Canyon Creek Scenics](#)
[Clever Models](#)
[Coastmans Scenic Products](#)
[Coffman Graphics](#)
[Credit Valley Railway](#)
[DCC by Design](#)
[Digitrax \(2 page spread\)](#)
[ESU LokSound](#)
[Fast Tracks](#)
[Fifer Hobby Supply](#)
[Fox Valley Models](#)
[George's Trains](#)
[GLX Scale Models](#)
[Grand Central Model Railway](#)
[Great Decals](#)
[Hobby-On \(MRS Hobby\)](#)
[Iowa Scaled Engineering](#)

[Iwata-Medea](#)
[Jelsma Graphics](#)
[Ken Patterson.com](#)
[Litghts 4 Models](#)
[Litchfield Station](#)
[Logic Rail Technologies](#)
[Microscale](#)
[Minimalist Model Railroad](#)
[Model Railroad Benchwork \(1\)](#)
[Model Railroad Benchwork \(2\)](#)
[Monroe Models](#)
[Motrak Models](#)
[Mountain Subdivision Hobbies](#)
[Mr. Detail Parts](#)
[MRH Store \(Model Trains Video\) \(1\)](#)
[MRH Store \(Model Trains Video\) \(2\)](#)
[MRH Store \(Model Trains Video\) \(3\)](#)
[M.T.H.](#)
[Nano-Oil](#)
[NCE \(2 page spread\)](#)
[Nick & Nora Design](#)
[North American Railcar](#)
[Portland National Train Show](#)
[Pre-Size Model Specialities](#)
[Precision Design Co.](#)
[RailMaster Hobbies](#)
[Railroad Explorer](#)
[Rapido \(1\)](#)
[Rapido \(2\)](#)
[Ring Engineering \(1\)](#)
[Ring Engineering \(2\)](#)
[RR-CirKits](#)

Clickable advertiser index – 2

[RSlaserKits, Inc.](#)
[Rulers-of-the-World](#)
[Rusty Stumps](#)
[Streamlined Backshop](#)
[Scenic Express](#)
[Scotty Mason Show](#)
[Signature Press](#)
[Soundtraxx \(Blackstone\)](#)
[Southern Digital](#)
[TAM Valley Depot](#)

[Tony's Train Exchange](#)
[TrainMasters TV \(1\)](#)
[TrainMasters TV \(2\)](#)
[Traintek](#)
[TrainWorld](#)
[True Scene Modeling](#)
[Westerfield Models](#)
[Yankee Dabbler](#)
[Yarmouth Model Works](#)

Clickable "other" index

[Other – Bonus Extras](#)
[Other – Cover](#)
[Other – Derailments](#)
[Other – Hobby Marketplace](#)
[Other – MRH Sponsors](#)
[Other – Staff Notes](#)
[Other – Table of Contents](#)



DOWNLOAD PORTRAIT



DOWNLOAD LANDSCAPE



DON HANLEY
.....



[Click here for reader comments](#)

IF IT'S WORTH DOING ...



AS A CHILD YOU were probably told, “If it is worth doing, it is worth doing well.” It was most likely a well-meaning parent, relative, or teacher who said it, and it has become a part of our subconscious thinking.

Is it really true? What does this saying mean, if we can't

do something well? The implication is we should not do it at all. If this is the case, where is the room for creativity, to learn and to experiment? Is that how life really works? How many of us do something well the first time around? Often, some of the best lessons come from discovering *what doesn't work*.

▶ **STEPPING OUTSIDE THE BOX WITH A CONTRARY VIEW**

I know I can't do every project well. Every hobby project I undertake, I realize that if I had changed this or that procedure, or changed the order in which I built the model, it would have been easier and probably better. As an example, I have built numerous kits made by Sunshine and Westerfield. Until recently I built the car, then painted and decaled it, the normal process most of us take.

A modeling problem I have always had is successfully painting a two- or three-color paint scheme. Taping around all of the details is tedious. It's easy to damage details, and often there is bleeding under the tape. The last two kits I built, I painted and decaled the major parts prior to assembling the model. I found the decaling work much easier on a flat surface – especially the ends – and I put the car together like a pre-painted kit.

If I had followed this so-called sage advice of “doing it well,” I would never have attempted building a craftsman kit to begin with. And I would never have learned a new process that works better for me.

It's time we reword this old saying to better fit with reality. How about, “If it's worth doing, it's worth doing, even if it's done poorly.” What do you think will happen if we take *this* approach to our modeling?

I expect this change in our thinking will cause us to experiment more, and to learn new ways of doing things in the hobby. We will lose the fear of doing something wrong, and begin to venture into new areas that we have assumed are over our head.

So, go ahead, try something new, and muck it up big time. Repeat the process, and each time you do, you will do it just a little better. ☑



DERAILMENTS

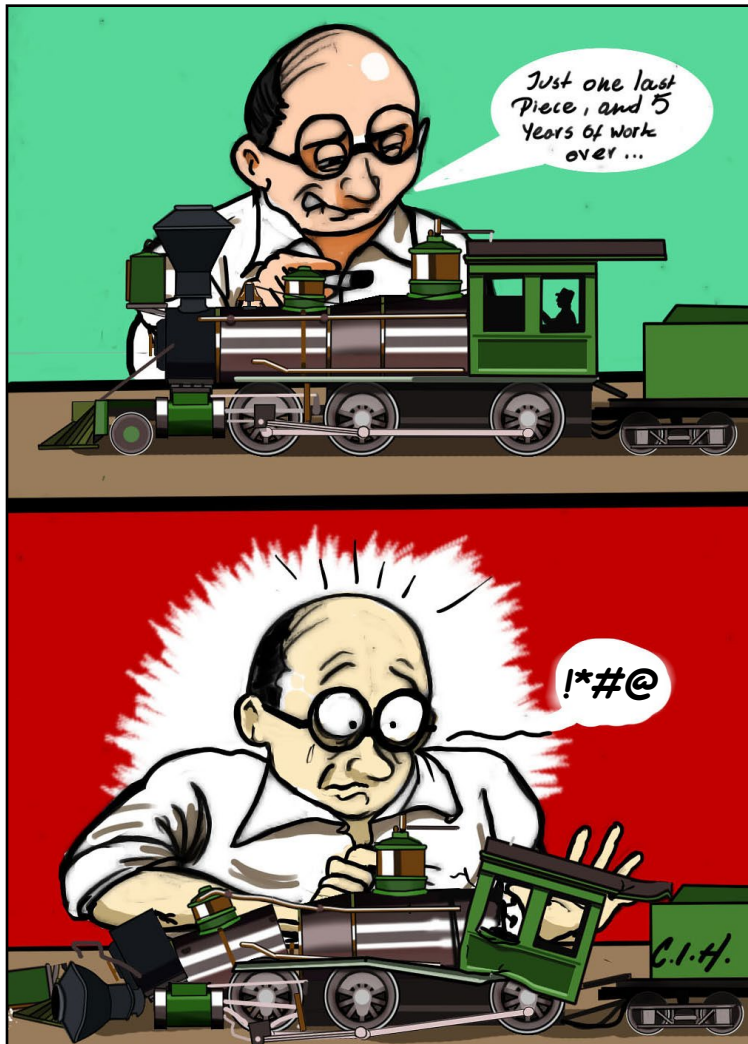

► BIZARRE FACTS AND HUMOR (SUPPOSEDLY)

QUICK HUMOR ...

What do you call a train man who steps on a live 3rd rail?

A conductor!

Who adds grease to axle journals in Wisconsin?

A Green Bay Packer!

If John Allen had ever made a full length movie, what might it have been called?

Death of a Diesel Salesman.

(John had a scene on his famous Gorre & Daphetid featuring a lynched diesel salesman.)



[Click here for reader comments](#)

Coming next issue ...

- Pascal Latulippe on making realistic conifers
- Shaun Toman's UP Oregon Division layout
- New life for an Athearn blue box loco
- JMRI signalling how-to
- Building a road with spackling paste
- And lots more ...

