

APRIL 2016 | FREE

MRH

MODEL RAILROAD HOBBYIST

ALSO:

- Wireless layout lighting control
 - Chama "modular" track plan
 - DCC for railroad operations
 - Burlington Northern Santa Fe layout
 - Doing better model railroad video
- ... and lots more inside!*

Jack Burgess explores building Edendale Creek Diorama in Proto:48

» READ NOW



ADVERTISEMENT

HO
#87 SCALE

UP Water Tender Set

Available April 2016



[Learn More](#)



© 2016 ScaleTrains.com, Inc. ScaleTrains.com and Rivet-Counter, plus respective logos are trademarks of ScaleTrains.com, Inc. ScaleTrains.com, Inc. 7598 Highway 411 Benton, TN 37307 844-9TRAINS 844-987-2467

Scene and photography by Ken Johnson. Actual models shown

• INDEX

• TABLE OF CONTENTS



STAFF CREDITS

Front cover: Jack Burgess takes a diversion from his HO scale Yosemite Valley layout to build this Proto:48 module. Follow along as he shares his discoveries for modeling in a larger scale.

ISSN 2152-7423

Editorial Staff

Joe D. Fugate, Publisher and Editor
Don Hanley, Assistant Editor

Production

Patty Fugate, pasteup and layout
Joe Brugger, copy editing
Mike Dodd, copy editing

Technical Assistant

Jeff Shultz

Advertising

Les Halmos, Account Manager
Daniel Nava, Advertising Assistant
Jean-François Delisle, Marketing Assistant



Columnists

Richard Bale, News and events
Jeff Shultz, News and events
Les Halmos, Modular railroading
Larry Smith, Narrow Gauge/Shortlines
Bruce Petrarca, DCC
Ken Patterson, Reporter at large

Special Correspondents

Joe Brugger, Questions & answers
Charlie Comstock, Contributing editor

Issue password: Apr2016

Published for the glory of God. [What's this?](#)



MRH SPONSORS

A - E



acculites.com



onlinetrainauctions.com



americanlimitedmodels.com



railroadhobbyshow.com



anemodel.com



archertransfers.com



athearn.com



www.atlasrr.com



bachmanntrains.com



bachrus.com



backdropjunction.com

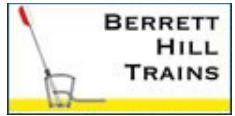

berretthill.com/trains



blairline.com



bowser-trains.com



caboosehobbies.com



coastmans.com



coffmaneng.com



cvrco.com



www.digitrax.com



esu.eu/en

[Vendors: Get your clickable logo here ...](#)

MRH SPONSORS | 2

F - R



www.handlaidtrack.com



fiferhobby.com



foxvalleymodels.com



georgetrains.com



glxscalemodels.com



www.iascaled.com



iwata-medea.com



litchfieldstation.com



micromark.com



modelrectifier.com



model-trains-video.com



monstermodelworks.com



stores.ebay.com/Motrak-Models



modelrectifier.com



nano-oil.com/Model%20Railroad.html



ncedcc.com



nickandnora.com



www.pwrs.ca/main.php



nationaltrainshow.org



railmasterhobbies.com



rapidotrains.com



ringengineering.com



rslaserkits.com



rustystumps.com

[Vendors: Get your clickable logo here ...](#)



Item No. 51403 • SOUTHERN #1087

DRIVEN TO PERFECTION

BALDWIN 4-6-0 IN DCC SOUND VALUE-EQUIPPED and DCC-READY VERSIONS

The Baldwin Ten Wheeler has returned to our HO scale line in a DCC sound-equipped 52" driver version that includes our Sound Value *SoundTraxx*® steam sound package with authentic prototypical chuff, short and long whistles, bell, air pump, steam release and blower—all in polyphonic 16-bit sound. The DCC-ready version has an 8-pin socket ready for DCC decoder installation of your choice. Both feature a die-cast chassis and *E-Z Mate*® Mark II couplers. Visit your favorite hobby dealer to see why these new Baldwin 4-6-0 steam locomotives are driven to perfection.

Click for more info  **DCC SOUND VALUE-EQUIPPED • MSRP \$399.00 each**



PENNSYLVANIA RAILROAD #7080
Item No. 51401



UNION PACIFIC® #1429
Item No. 51402



CHESAPEAKE & OHIO® #377
Item No. 51404



SANTA FE #498
Item No. 51405



SHIPPING NOW!

Click for more info 

DCC READY with NMRA 8-PIN PLUG • MSRP \$299.00 each
 Item No. 52201 NEW YORK CENTRAL® #1238
 Item No. 52202 BALTIMORE & OHIO® #1357
 Item No. 52203 CANADIAN PACIFIC #847
 Item No. 52204 MARYLAND and PENNSYLVANIA #27
 Item No. 52205 TEXAS PACIFIC #316



Bachmann Industries, Inc. • 1400 East Erie Avenue • Philadelphia, PA 19124 • www.bachmanntrains.com
 Click to learn more.



TABLE OF CONTENTS

FEATURES

Edendale diorama in Proto:48

JACK BURGESS

Jack Burgess explores building in another scale



DRGW layout design using TOMA

PETER VASSALLO

One Module Challenge Grand Prize winner



Esteban Martinez's BNSF

ESTEBAN MARTINEZ and the MRH STAFF

Layout on tour at this summer's NMRA National



Using Monster Modelworks brick: 2

DAVID KARKOSKI

Doing the roof, eaves, and details



FIRST LOOK: MRC's Light Genie™

LES HALMOS

Easy wireless light control for your layout

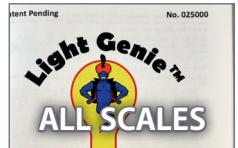

ALSO: MRH Marketplace | Bonus extras

TABLE OF CONTENTS | 2

COLUMNS

MRH Q-A-T: Crossing rules, moving railcars, ...

compiled by JOE BRUGGER

DCC Impulses: DCC for operations

BRUCE PETRARCA

Lite & Narrow: Birmingham Southern, modelgenic shortline

LARRY SMITH

What's Neat: Fun with foil, WOW Sound, and more ...

KEN PATTERSON

Imagineering: Model railroad video tools and techniques

ROB CLARK

Photo feature: Yes, it's a model

compiled by DON HANLEY

Derailments: Bizarre facts & humor

compiled by the MRH STAFF

NEWS and EDITORIAL

Asst Editor's Thoughts: Painting in a post-Floquil world: 2

DON HANLEY

Staff Notes: Achieving your hobby dreams ...

compiled by the MRH STAFF

News & Events: April 2016

RICHARD BALE & JEFF SHULTZ

Reverse Running: The reclusive layout

DON HANLEY

PRIME MOVERS BY RAPIDO





Model Railroad Hobbyist | April 2016 | #74

ASSISTANT EDITOR

editorial

DON HANLEY
.....



[Click here for
reader comments](#)

PAINTING MODELS IN A POST-FLOQUIL WORLD, PART 2

IN LAST MONTH'S EDITORIAL, PUBLISHER JOE FUGATE wrote about his preference for acrylic or water-based paints. I, on the other hand, prefer solvent-based lacquer or enamel paints for painting my locomotives and rolling stock, as well as for painting other things.

I have experimented with acrylic paints in my airbrush, but was never satisfied with the results. That is not to say they are not great products, and that excellent results can't be achieved. Far from it. It is just that solvent-based paints remain my comfort zone, and I've never really wanted to spend the serious time it will take to become proficient with acrylic paints.

When using solvent-based paints, extra care is needed to protect your health. The inhalation of the volatile Organic Compounds (VOCs) found in the paint solvents can cause long-term health problems. While most of us will likely not inhale enough of the VOCs to cause any issues with our relative infrequent painting, it is better to be safe than sorry.

Personal Protective Equipment or PPE for painting with solvent-based paints requires a respirator, not just a dust mask.

ASSISTANT EDITOR'S THOUGHTS | 2

Respirators can be purchased at any quality paint store. Good ventilation is important. This can be a spray booth exhausting outside or, as I do, I paint in my garage and open the big garage door as well as the back door to get good cross-ventilation. Granted, this does put restrictions on when I paint, but where I live (Nevada), it only prohibits me from painting a few times a year.

Here's my pick of solvent-based paints available for us to use.

Tru-Color paint: trucolorpaint.com

Testors Model Master lacquers and enamels:

testors.com/product-catalog/testors-brands/model-master

Scalecoat paint: minutemanscalemodels.com/category-s/127.htm

AK Interactive: ak-interactive.com/v2/?product_cat=afv-paint-sets

ADVERTISEMENT



1st choice for model railway supplies and service.

Expedited mail service available across North America.

Click to visit:
WWW.CVRCO.COM
1 800 464 1730



• INDEX

• TABLE OF CONTENTS

Nano-Oil™

Made in U.S.A.

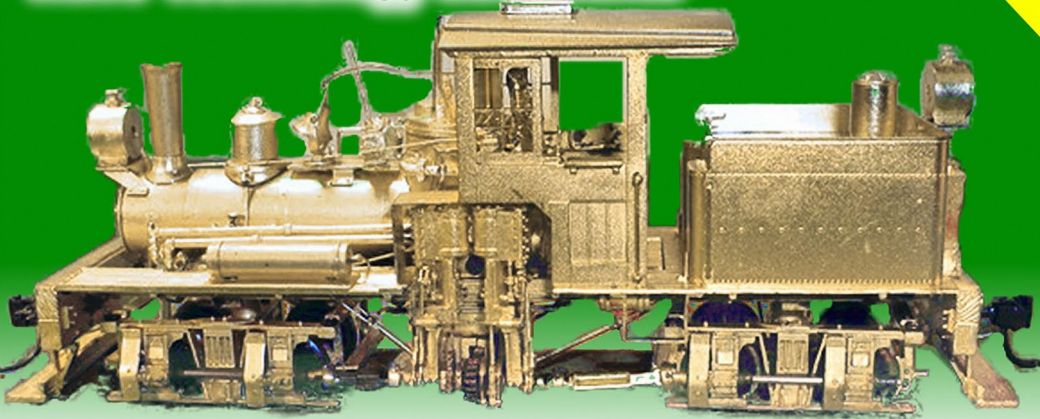
**New
Innovation****Nano Technology Lubricants**

"After eight years of extensive testing, the only lubricants now used in my shop are Nano-Oils and Nano-Grease. The extreme reduction in power draw by mechanically minimizing friction is simply technologically superior."

- Phil Floyd, 'The Shay Fixer'

**Nano-Grease**

**For more details
click here ...**

**THE SHAY FIXER** 

VISIT US AT...

SHAYFIXER.COM

Specializing in brass Pacific Fast Mail / United geared locomotives

• INDEX

• TABLE OF CONTENTS



The New Home of...



Scalecoat Model Paint

Phone: (603) 921-5139

Info@minutemanscalemodels.com

DCC and Sound in N Scale?

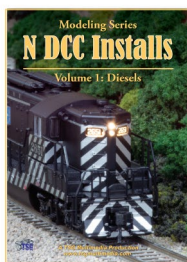

We'll show you how!
N DCC Installs
Examples with and without sound!

CLICK FOR
DCC

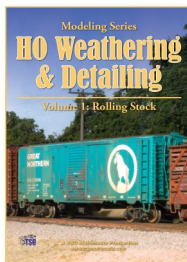

Want it now?
Our titles are now available in digital download format!

CLICK FOR
DIGITAL



TSG Multimedia

ASSISTANT EDITOR'S THOUGHTS | 3

Of this group the Tru-Color and Scalecoat paints are the ones that have a range of railroad-specific colors. Testors Model Master lacquer and enamel paints as well as AK Interactive have a lot of weathering colors available.

I use Tru-Color for painting my locomotives and rolling stock. The paint has a very finely ground pigment with a matte to semi-gloss finish, eliminating the need for a gloss coat to apply decals. The paint dries quickly and I have been able to mask and apply a second color after about an hour of drying time with no removal of the first layer of paint.

Another advantage I have found with the Tru-Color paints is that the bottles have the same cap as my Paasche airbrush bottles. I use this to my advantage by simply fitting the cap with the siphon on the bottle of paint, taking the paint directly from the bottle.

Bowser

EXECUTIVE LINE

HO New Orleans Streetcars

Recently Arrived - In Stock
Available with and without Sound
Ready to Run: Fully Detailed

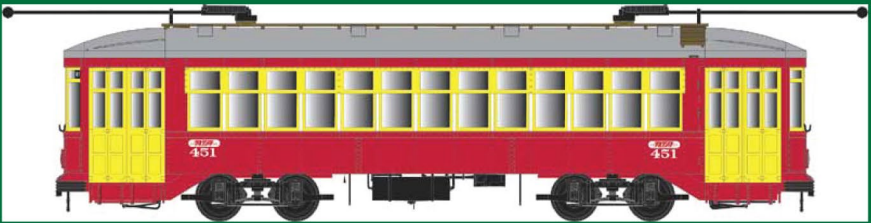

HO H30 Covered Hopper Cars

Recently Announced - Delivery Late 2016
Ready to Run: Fully Detailed



HO Cal Scale

New Items - In Stock Now!!
Lost Wax Brass, Plastic Molded Parts & Wire Form Parts



Nathan K5
Air Horn



Fuel Filter

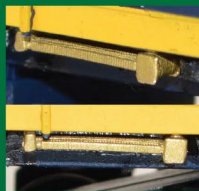

ALCo Cooler
Horizontal Mount

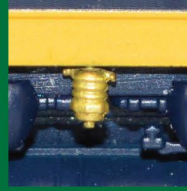

Air Dryer
Filter



Nathan K3
Air Horn

Click here to check out the details for these and other great Bowser products!

Micro-Mark®

Berkeley Heights, New Jersey 07922

The Micro-Mark Email Newsletter is your ticket to exclusive web-only sales, product previews, special offers and much more. Sign up today!



See over 3,000 unique items in our catalog and web site, including...

**#84519
Mini
Digital Level
Measures
Grades and
Superelevation
with Ultra
Precision**



Click HERE for more!

ASST EDITOR'S THOUGHTS | 4

I do need to turn up the air pressure to 35 psi to 40 psi, but have not had any problems controlling the paint.

This allows me to reduce the amount of thinner, acetone in this case, and the amount of VOCs. It also reduces the amount of cleanup required after a painting session.

The other paint that I use regularly is the Testors Model Masters lacquer and enamel paints. I particularly like the Metalizer lacquer paints. Their Burnt Iron color is my favorite for painting rail. As with the Tru-Color Paint, I don't need to thin the paint to run it through my airbrush.

The other Testors Model Master metal colors work well for the many exposed metal parts we have on our models.

The Testors Model Master paints also have many military colors that I find useful for weathering. In addition, they have an extensive line of other colors that can be used for painting buildings, signs, automobiles, and trucks.

ASST EDITOR'S THOUGHTS | 5

The disadvantage of these paints is that you cannot apply them with a brush. They are too thin. All-in-all, don't exclude these paints.

Scalecoat paints have a long history in the hobby and recently these paints changed hands – they're now being produced by MinuteMan Scale Models. I have not personally used Scalecoat paint, but many modelers, including Mike Confalone, swear by the Scalecoat paints.

The AK Hobby paints also have many military and weathering colors. I have not used them yet, so I can offer no

Take the MRH
2016 Reader Survey yet?



TAKE THE SURVEY >>

Free How-To Video!



coastmans

ASSISTANT EDITOR'S THOUGHTS | 6

comments on how well they work, but the research I have done indicates they should be a very good product.

As far as price, here are list prices for each of these paints.

- Tru-Color, \$5.69 per 1 oz (30 ml) bottle.
- Testors Model Master lacquer/enamel, \$3.69 per 0.5 oz (15 ml) bottle.
- Scalecoat, \$6.95 per 2 oz (60 ml) bottle.
- AK Interactive, \$4.99 per 0.6 oz (17 ml) bottle (sold in sets).

In conclusion, I recommend that you keep an open mind regarding solvent-based paints. Just use some sensible precautions and your Personal Protective Equipment (PPE) when using solvent-base paints, with good ventilation.

Solvent-based paints still have a great place in our hobby for painting our models.



**Click here for
reader comments**

NOTE: Joe Fugate has also updated his acrylic painting guide from last month. You can get the latest version from this month's [Subscriber Bonus downloads](#).

AVOID COSTLY MISTAKES



“I can’t imagine life before Trainmasters TV.
It is worth every penny.” – *Guy E.*

Learn from
the best with
TrainMasters TV!



trainmasters.tv – We help you
achieve your hobby dreams.

click to learn more

iwata

by ANEST IWATA

Be Realistic

From weathering broad areas to painting concentrated details, an Iwata airbrush gives you precision and reliable performance for a natural, smooth finish.



Iwata Eclipse CS

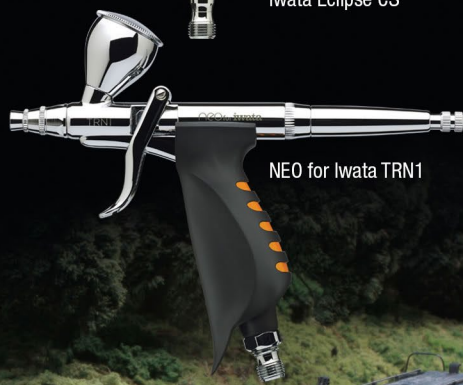

NEO for Iwata TRN1



iwata
MEDEA
ANEST IWATA-MEDEA Inc



Locomotive from Alan Houtz, North American Prototype Modelers

Click to see the entire line of Iwata Airbrush and Artool Products

• INDEX

• TABLE OF CONTENTS



Model Railroad Hobbyist | April 2016 | #74

STAFF NOTES



[Click here for reader comments](#)

Achieve your model railroading dreams ... with MRH magazine and TrainMasters TV!

Yes, it's a model ...



mrhmag.com



TRAINMASTERS.TV

MRH: HELPING YOU ACHIEVE YOUR MODEL RAILROADING DREAMS ... AND MORE

WE HAVE RECENTLY ADDED A NEW SLOGAN to the MRH product family: *Helping you achieve your model railroading dreams.*

Here at MRH Media, we do MRH magazine, TrainMasters TV, and the MRH Store. This slogan is more than some nice words. We have a philosophy that underpins it.

• [INDEX](#)

• [TABLE OF CONTENTS](#)

STAFF NOTES | 2

While the MRH Staff has some modelers who are very experienced in the hobby, we're not know-it-alls and we don't claim to be. There are a lot of great modelers out in the hobby at large who know a lot of things too – other model railroad *hobbyists* if you will, besides us.

The word *hobbyist* in our name is more than just something to make our name look different. We firmly believe it's part of our charter to bring you the best ideas and how-tos from as many of the best and brightest model railroaders as we can.

A big part of the model railroading hobby is solving the various challenges that come up, so we see MRH Media as helping you find superior solutions to these hobby challenges!

ADVERTISEMENT



RUNNING STANDS



SPEEDOMETER For Speed in Real Time!



Analogue
or digital

Bachrus inc
RUNNING ON QUALITY

www.bachrus.com
Hannon, ON Canada

• INDEX

• TABLE OF CONTENTS

To that end, we're constantly beating the bushes to find modelers who are willing to write an article about their clever approach, or to see if they're willing to appear on TrainMasters TV to do an eye-opening demo or how-to.

Remember too, we pay for the articles we publish in the magazine, and we also pay TMTV guests an honorarium for being a presenter, *and* we offer to help with expenses for your trip to and from the TMTV studios if you're willing to come and show your methods.

At the end of the day, it's all about hobby satisfaction. If we can get as many superior solutions as possible into your hands, then you're more likely to be passionate about the hobby. You're also likely to find the hobby more satisfying as well – which means you will be realizing your hobby dreams, we could say.

So that's the idea. It's all about bringing you the best the hobby has to offer, and that goes far beyond just the MRH staff. We see ourselves as mostly facilitators who work on your behalf to bring you the best we can find from the hobby at large.

This issue's "One Module" Challenge winner

In this issue, we are publishing Peter Vassallo's Chama, San Juan extension contest entry to our "One Module" Challenge contest. Peter's entry won Grand Prize, and for good reason.

Take note of what this article contains. If you're thinking of entering this contest for 2017 (and we are planning to run it again, this time with a different room configuration), pay close attention to everything that Peter included in this article to see why we felt he deserved to be the grand prize winner.

Peter did a superb job of presenting TOMA (the one module approach) in building this layout one module at a time and

STAFF NOTES | 4

evolving it to eventually become a room-filling layout. He provided staging with the very first module, allowing operation to take place even though the initial layout was only a single module. That's an important concept when doing a layout using TOMA, and Peter shows this clearly in his piece.

Peter also did his homework by planning construction details and costing things out. He also planned out his basic roadbed and foam scenery approach.

Finally he included thinking on the structures he wants to use and wrote that up to include in his submission as well. Peter's submission is thorough, well thought out, and balanced.

In other words, Peter didn't dive deep into some nuance, he didn't skip over critical details, he kept things just detailed enough to convey the idea without drowning in minutiae.



**Take the MRH
2016 Reader Survey ...**
... and get a chance to win a 10"
Kindle Fire tablet!



amazon
fire HD10
OUR LARGEST
DISPLAY
— ON OUR —
THINNEST TABLET

TAKE THE SURVEY >>

ADVERTISEMENT



RAILROAD AUCTIONS
RAILROAD CROSSING
AMERICAN EAGLE
RAILROAD GROUP

**Quality
Convenience
Variety
Pricing**

www.onlinetrainauctions.com



LAST ISSUE'S RATINGS

The five top-rated articles in the [March 2016 issue](#) of *Model Railroad Hobbyist* are:

4.7 DCC Impulses: Is DCC dead?

4.7 Scratchbuilding with Monster Model Works brick

4.7 Publisher's Musings: Painting in a post-Floquil world

4.6 Getting Real: Tank car basics, part 2

4.6 Boxcar & reefer doors of the 20th century

Issue overall: **4.2**

Please rate the articles! Click the reader comments button on each article and select the star rating you think each article deserves. Thanks! ■

ADVERTISEMENT



Your Local **N Scale**
Online Hobby Shop

575-523-9743
fiferhobby.com

• INDEX

• TABLE OF CONTENTS

If you wondered what a thorough, well-done TOMA layout construction project plan would look like, study this article. Peter nailed it!

MRH website: Blast from the past!

There are tens of thousands of threads on the MRH website now since we're seven years old and counting. You can use the Google site search field on the website on the upper right to search our website for relevant posts on just about any topic you can imagine related to model railroading, and you're likely to find something about it.

This time, rather than feature what's new on the MRH website as to threads, we thought it might be fun to dig through older threads. We're calling it a *blast from the past*.

Enjoy this perusal through some very interesting older threads.

Weathering steam era cars: mrhmag.com/node/2280

Building an engine shed track: mrhmag.com/node/14542

Weathered track colors: mrhmag.com/node/2591

Painting the inside of hopper cars: mrhmag.com/node/14071

Less steam modeling today? mrhmag.com/node/5553

Modeling the 1970s: mrhmag.com/node/8256

Modeling dents and dings: mrhmag.com/node/21645

Backdating a Spectrum 4-4-0: mrhmag.com/node/18419

Paint brushes for weathering: mrhmag.com/node/21620

Finishing an engine shed: mrhmag.com/node/3263

Experiments with brick: mrhmag.com/node/4307

STAFF NOTES | 7

Gapping complex trackwork: mrhmag.com/node/1121

Building complex crossings: mrhmag.com/node/14343

Be sure to check out these older threads. They're something of a gold mine, frankly.

Also give our Google site search a try for some topics of interest to see if there's anything helpful out on our website. This search does a Google search, but restricts it to *only* searching on the MRH website.



**Click here for
reader comments**

ADVERTISEMENT

Lasercut structures. Highway, storefront and billboard signs.

NEW KIT in HO & N!



**WHAT'S
NEW?**



HO-N-O scales

Blair Line

ADVERTISEMENT

ANE MODEL new accessories :

Crossing gate module

- 2 to 4 set infrared detector to make it more real
- Suitable for double to triple track detect
- One set warning lighting LED output
- 2 type Warning sound with Built-in speaker
- Connect to SmartSwitch to control boom gate up and down
- Suitable for N to O scale

This module is not include crossing gate signal. You need to order them individually.

Have you seen **Railroad Explorer?**

Mike Confalone's

Mike Confalone, modeler of the popular Allagash layout also publishes a spectacular eastern prototype railroading magazine! MRH now offers exclusive digital versions of Mike's *Railroad Explorer Magazine*, loaded with fabulous prototype photos!

Each issue ... ~~\$5.99~~

Instant download!

\$4.99

**Get it now
and SAVE**

Get all four digital issues of *Railroad Explorer* for a special price ...



~~\$23.96~~ **\$15.99**

Get ALL FOUR and save

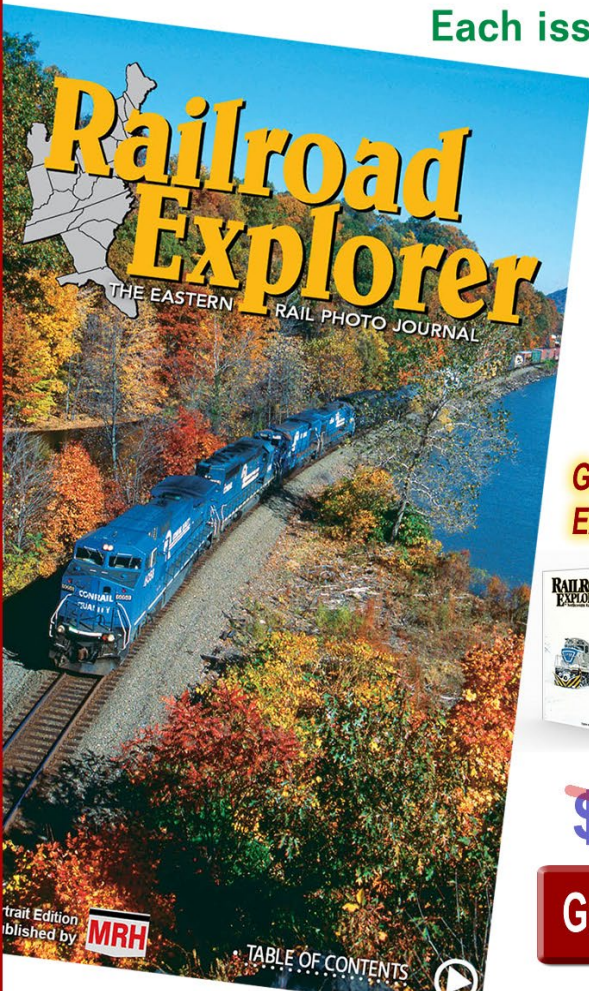

• INDEX

• TABLE OF CONTENTS



MRH Q-A-T

column

compiled by
JOE BRUGGER
.....



[Click here for
reader comments](#)

QUESTIONS AND ANSWERS

Flat crossing rules

Q. Where two railroads cross or connect, back in the earlier years of the steam era, you would find an interlocking tower to control the junction; i.e. between the Southern Pacific and Santa Fe. Which railroad would construct and/or operate the tower?

—Cliff Rasco

A. Generally, the road with the highest traffic volume will control a crossing, but there are many exceptions. The first railroad in place has precedence, but in practice, these situations are negotiated to benefit both companies. Some of the considerations would be the relative busyness of the two lines, signaling systems in place, and the presence of related facilities.

Manned interlocking towers are pretty scarce these days, with the same functions now being run by remote control. The

▶ MRH QUESTIONS, ANSWERS, AND TIPS

set-up at a crossing can be as simple as a locked pipe gate and a telephone, or as elaborate as an interlocking tower and/or a full set of signals.

At an unsignaled crossing, the secondary outfit is required to stop and will need to contact the superior line and get permission to cross. In some cases, the secondary crew will be able to unlock a control box and manually set signals to protect their crossing.

—MRH

Moving railcars

Q. Are there any means in modern times to move a freight car without an engine? Let's assume there is an industry which receives bulk material in a covered hopper. It can be unloaded into an underground bunker or conveyor, but only one outlet at the same time, so the car has to be moved until the next outlet is over the bunker. How would the prototype do this? Would the engine of the local freight do this and therefore stay at this single industry until the hopper is unloaded? Or would it spot the car and the industry itself needs something to move this car to unload it?

—engineer

A. Even on the friendliest, most accommodating short line, there's little chance that an engine crew is going to hang around to shift a covered hopper 15 feet at a time.

There is always gravity. In the past, spur tracks at most grain elevators and coal tipples were graded so cars could be rolled into place for loading and unloading. But you said modern times. Large facilities will often have a rubber-tired Trackmobile to spot cars.

A Trackmobile [1] has both steel railroad wheels and rubber tires, allowing it to maneuver around a storage yard and



1. Hopper cars at a modern rail-to-water transfer are moved by a Trackmobile which can maneuver on and off the rails as needed. *Graham Line photo*

a loading facility without the need of complex trackwork. A railroad coupler and weight-transfer linkage allow it to couple to cars and move them around.

Large facilities may also have a moving drum, or capstan, system to pull cars into position via a rope or cable. A tractor or loader may substitute for the car-puller, but in both cases the outfit needs someone riding the car to apply brakes.

Businesses like the Aldon Company Inc., a supplier of rail safety and track repair products since 1904, can furnish a manual car mover [2], as do a few other companies.



2. A manual car mover, sometimes called a railcar jack, allows a worker to move a car on level track. Shove the tool in between the railhead and the wheel, and push down. The joint at the head of the tool multiplies worker’s efforts through compound leverage. *Aldon Company Inc. photo*

There is also the “redneck railcar mover” which is more sophisticated than its creator lets on. See the following video.

Read railroaders’ stories, find more about moving railcars and get links several other videos at mrhmag.com/node/25538.

—Mountain Goat Greg, Bill Brillinger, hoghead40, Don Mitchell, Pete M., BOK, and others

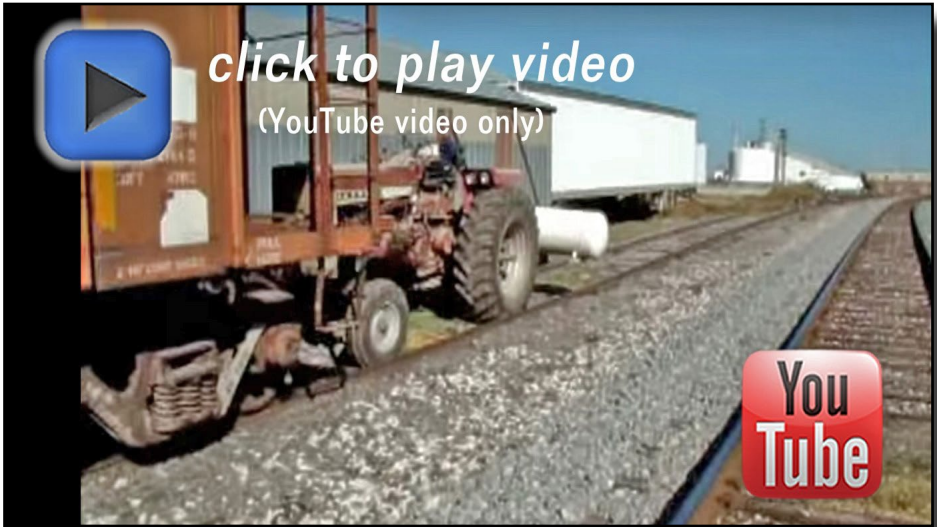

Playback problems? [Click here ...](#)

Peeling and lifting paint

Q. How do people replicate the peeling paint, rusty and scabby look in their modeling? The 3D look is quite intriguing. The grain cars of my modeling era (mid-'90s) were in much better condition, but I might try doing a couple with the chipped paint and rust patches.

—Marc Simpson

A. This is the final finish I went for when using the salt technique to simulate a rusty, peeling, painted galvanized roof. I started by spraying the entire roof a rust color, adding rock salt in spots (straight from the water conditioner!), over-spraying that with gray, then covering the rock salt spots with actual table salt, making somewhat larger “mounds.” The entire roof was then sprayed black. When dry, brush off all the salt with a stiff brush, add some dry brush streaking to the “galvanized rust,” and this [3] is the final product.



3. Two applications of salt, acrylic-thinned enamel, hair-spray, and carefully applied color produced a well-weathered metal roof and wooden running boards. *Jeff Youst photo*

As for the cracking black, that was achieved by thinning a black enamel with an acrylic resin thinner. It made the paint crack as it dried. It looked pretty messed up when first sprayed, but once the salt is removed to reveal the underlying colors it really adds to the effect.

The roof walk peel was achieved by spritzing it with hair spray (the walk was black in color out of the box), then painting it with a custom mix weathered wood color. When dry, a good scrubbing with a water and a wet stiff brush will drive the water down through

the paint to the hair spray, dissolve it and allow the paint to release from the surface. Scrub until happy with the look, and that's it.

—Jeff Youst

Ship, aircraft, and vehicle modelers have developed many painting and weathering techniques which are not often used in model railroading. Search via Google for “military modeling weathering techniques.”

Read the complete layered weathering thread, and contribute your own ideas and experiences at mrhmag.com/node/25096 For more discussion on the Model Railroad Hobbyist forums, look at:

mrhmag.com/magazine/mrh-2011-05-May/weathering_colored_pencils.

mrhmag.com/magazine/mrh-2014-06-jun/weather-steam-era-cars.

mrhmag.com/node/12126 for extreme diesel weathering.

mrhmag.com/magazine/mrh-2012-10-oct/weathering-oil-paints.



TIPS

Carving foam

My technique for cutting foam is one I learned for upholstery foam cutting, but it also works great for rigid foam. Use an electric carving knife with moving blades. It cuts a nice smooth edge and doesn't make much of a mess. The knives are easy to find in the kitchen and cooking sections at most stores, and are common items at second-hand and resale shops, too.

—Peter Attanasio



GET PAID FOR YOUR TIP

We pay \$25 per tip we publish, or \$40 each if the tip also includes a photo or finished drawing. [Click here and select article type TIP.](#) ■
.....



**Click here for
reader comments**

The Get the Latest Model Railroading News, Tips, Reviews & Opinions

SCOTTY MASON

S H O W

The Original Model Railroad Podcast

-Monthly Interviews

- Modeler's Spotlight: Top Modeler's Talk
- Narrow Gauge Modeling w/Chris Lane
- Contemporary Modeling w/ Mike Rose

-More Product Announcements & Reviews



**Our feed has changed! To get the latest shows,
Please search Scotty Mason and subscribe to the new feed!**

www.TheModelRailroadPodcast.com

Scott Mason Jimmy Simmons Mike Rose Joe Duckworth

ARRIVING JUNE 2016



THE NEW ATHEARN® ROUNDHOUSE

Historically, the Roundhouse brand delivered quality pre-1940s era models while maintaining a terrific value. Building upon this tradition, Athearn® Roundhouse is now home to the hobby's best-loved models. No matter your era or favorite railroads, Athearn Roundhouse has a complete product selection for the beginning and experienced hobbyist.



Check out the new Athearn Roundhouse line at Athearn.com.



HORIZON
H O B B Y

VISIT
Your Local Retailer

CLICK
Athearn.com

CALL
1.800.338.4639

SERIOUS FUN™

©2016 Horizon Hobby, LLC. Athearn, Genesis, Ready To Roll, Trains in Miniature, Serious Fun and the Horizon Hobby logo are trademarks or registered trademarks of Horizon Hobby, LLC. The Union Pacific mark and other marks owned by Union Pacific are made under trademark license from Union Pacific Railroad Company. All other trademarks, service marks and logos are property of their respective owners. Final models may vary slightly from photos shown. 4/9/2013

• INDEX

• TABLE OF CONTENTS

ZEPHYR xtra™

\$255 MSRP



All-In-One Throttle / Command Station /
Booster to run your layout!

Super EMPIRE BUILDER xtra™

\$355 MSRP



Super Empire Builder Xtra has everything you
need to get started in Advanced Digitrax
Command Control.



Complete Train Control

Digitrax Starter Sets for great operation!

View more at: www.digitrax.com

Super **Chief** *xtra*™
\$455 MSRP



**Maximum capacity, maximum features.
Take it to the Max with Super Chief Xtra!**

Get Better Sound from your Locomotives

Can't get a good sound from your sound decoder?
Give our speakers a test drive with your ears.



RAILMASTER HOBBIES
9812 BELMONT
BELFLOWER, CA 90706

Bass Reflex
Speakers



High Bass
Speakers



When it comes to speakers we have high quality speakers to fit many different applications.

We are also a full line hobby shop. Need anything? We are an authorized dealer for Soundtraxx, Digitrax, Athearn, Walthers and many others. We provide quality speakers for your DCC sound systems and quality service.

**Click here for
the answer ...**



DCC IMPULSES

column

BRUCE PETRARCA
.....



[Click here for
reader comments](#)

DCC FOR OPERATIONS

I'M WRITING THIS COLUMN STARTING IN THE Kansas City airport. I'm returning from an invitational operations weekend called Prairie Rail. This year over 120 folks operated on a few of the many fine layouts here.

The experience here led me to think about sharing some ideas about hosting operations and making guests feel comfortable. Many modelers with DCC layouts are hosting operations or are planning to do so. My observations are based on attending various op sessions (as they are frequently called) and hosting some at our club layout (pcmrc.org),

Soon, I'll be hosting small op sessions on my layouts, too. While this is pitched to the beginning host, the old-timers could take a point or two away. Also, check out Mr. DCC's Workbench at the end of this column for some ideas about tuning your locos.

So, what is operating and what are op sessions? I define operating as moving freight and passengers across your railroad

► DCC TIPS, TRICKS, AND TECHNIQUES

DCC IMPULSES | 2

with a purpose. Then, op sessions are formal or informal gatherings of like-minded modelers to do so.

There are myriad schemes to mimic various forms of prototype practice on a model railroad. Some are as simple as sorting cars by type (box vs. gondola) and color and delivering some to industries or making them up into a train to move across the layout. From these simple beginnings, ops can move to amazing levels of complexity involving fast clocks, timetables, dispatchers, radios or telephones, and control panels.



1. Railfanning on Jim EuDaily's gorgeous O scale West Virginia fall layout.

DCC IMPULSES | 3

Some folks can sit and watch a train go around their layout for hours. Others want more out of their layout. Ops offers many ways of structuring the moves on your layout with a goal, not just moving trains. Many folks enjoy the mental stimulation that these multi-dimensional puzzles can provide.

I'm interested in operating

How do I get started as an operator, since I'm not ready to host?

Ask around at local clubs and meets. You may find lots of options in your area.

One really great place to find folks who are interested is the NMRA Operations Special Interest Group (opsig.org). Don't fret

ADVERTISEMENT

Make LocoNet wiring extremely simple!

ACCU-LITES, inc

Your DCC Center!

CELEBRATING
20
YEARS
ANNIVERSARY

Dealer Inquiries Accepted

PM42
breakout
board



SE8C
breakout
board



BDL168
Multi-zone
breakout board



BDL168
Single-zone
breakout board

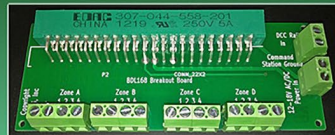

Now Offering SNAPS! in packs of 6 or 12 pieces! [CLICK TO LEARN MORE ...](#)

• INDEX

• TABLE OF CONTENTS

DCC IMPULSES | 4

if things there seem to be over your head. These folks are pretty involved in their operations. Buried within their web site is a listing of open ops activities (opsig.org/events/events.cgi) and even their suggestions for hosting (opsig.org/events/hosting.shtml).

Start with a simple job on a nearby layout. Or practice on your own layout. I have a set of car cards and waybills made up for some of my cars. If I have more than a couple of tracks of waybilled cars set up, I can do some switching and practice my moves.

Get ready

You are scheduled to host an op session. You want to look good. First, relax. The goal of model railroading should be to have fun, both as an

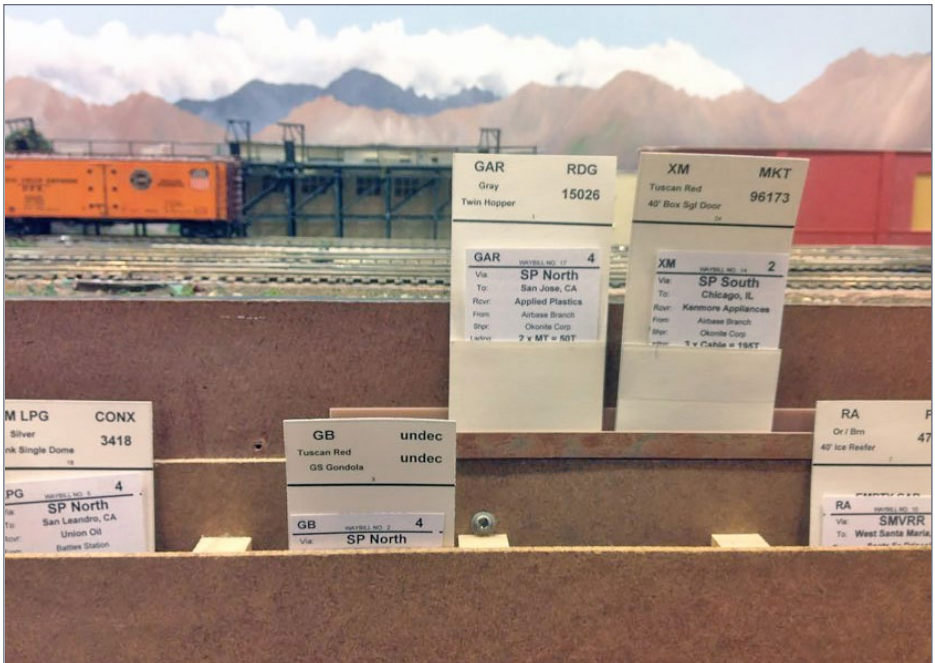

2. Car card and waybill paperwork on my prior 8½ by 1 foot HO scale layout.



3. O scale modules with no scenery can still be used to switch cars.

operator and as a layout owner. There the obvious things to do, like having your track clean and clear and in good repair.

The better the condition of your rolling stock and track, the more fun the session will be for the owner, any helpers and the operators. Spend your time here in preparation for a session. Don't worry about finishing that last scenery project [3].

It is a good idea to have some practice sessions with good friends who are seasoned operators. These sessions will benefit you most if they are followed with a serious debriefing session. "Gee, thanks, that was fun," isn't useful in the long run.

Find out what worked well and what didn't. Were the instructions clear? How could they be made better? Were the jobs long enough or too long?

DCC IMPULSES | 6

I find I can do a better job if I know up front what the goal is, beyond spending a few fun hours with fellow model railroaders. Expectations may or may not be fulfilled, but at least it is nice to know what is par for the course. A written job sheet goes a long way towards alleviating the anxiety of an operator who is new to your layout or to the specific job. Periodically, you should review these sheets for changes and updates.

Perhaps you will find that you need to do a few more test sessions before you are ready for prime time.

ADVERTISEMENT



NEW TECHNOLOGY



NEW Starter Kit
\$399.99 MSRP

- Includes Wireless Color Touch Screen Handheld Controller and 56 Watt Power Supply
- Expandable to Virtually any Size Layout

NEW Locomotive Module
LM-2 & LM-2S



- Direct Radio RF
- Sound and Non-Sound
- New Tiny Size
- 6 Light Outputs

Click Here to Learn More

For more information visit our Internet site: www.RingEngineering.com

Get set

Your layout knows when out of town guests are visiting. It is more likely to act up then. That's the rule. Don't asked me who made it.

Our club layout has failed a couple of times during op sessions. The biggest failures have occurred during guest sessions, not during our member op sessions. We have never had an electrical failure during a work session, to my memory.

Consider the three fellas who were discussing the most amazing invention in history. One suggested the airplane; the second suggested television. The last said, "The Thermos bottle." Amazed, the other two asked why. "Well, you put something hot into it and it stays hot. Something cold stays cold." Still unconvinced, they asked why that was so amazing. "Well, how does it know?" was the reply [4].



4. Perhaps the most amazing invention in history, the Thermos bottle.

Electrons know. They know when you have guests and react accordingly. Sometimes to your chagrin.

At Prairie Rail, every layout I operated on had electrical problems. The electrons seem to recognize me, too. Twice, there were throttles that didn't want to behave. A couple of layouts had boards fail. One signaling problem reared its head. The layout owners and helpers worked

DCC IMPULSES | 8

hard to keep the sessions running as well as possible in spite of the challenges.

The solution for the throttle and board problems is spares.

Once we recognized that a throttle had issues, a change got trains rolling again. If you can swap a booster or a circuit breaker easily, you can overcome some of those major failures quickly.

Batteries die. Be ready. If you use non-rechargeable ones [5], have a large supply of new batteries. If you use rechargeable ones, have a spare for each throttle fully charged.

Go

Okay, we are closing in on your session(s). Get the refreshments ready. And don't forget the human comfort issues: temperature, lighting, places to sit when not operating, and restrooms.

I was impressed by the Prairie Rail layout owner who took the time to email the operators for his layout. The email included the background story of his layout and an idea of what the various jobs were and weren't. He even worked out a car pool and gave us the

information on how that would work.

Hosting new folks

New folks may be concerned about operating on your layout and not looking like a dolt. No matter how seasoned the operator

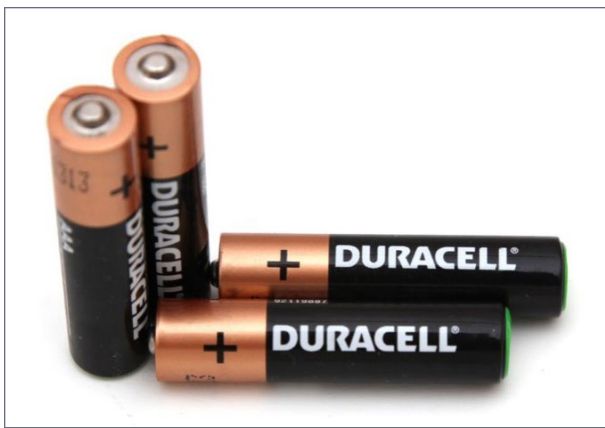

5. Non-rechargeable alkaline batteries.



LokSound L -Premium Quality Low Cost DCC and Sound in O Scale!

Coming Soon in "Atlas O"



Each Decoder set
comes with Decoder
and Adaptor board



FULL FEATURED "LOKSOUND L SELECT"

ESU Item# 73399 ****ONLY \$149.99****
Shipping Now!

- Dimensions: 1 Inch x 2 inch
- Amperage: 3Amps continuous (up to 4Amps for a short time)
Overload Protected
- Function Outputs: 11(!)
- Servo Outputs: 2
- And More Features!

-
- Perfect for ESU Synchronized Smoke Units 54678 and 54679 with supported Sound Files
 - Smoke units will work with Steam and Diesel files
 - Smoke units can be set up to work with Smoke Chuff and Cylinder Steam!

**Click here for
MORE FEATURES ...**

Also Available: 54399 Fully Programmable LokSound L V4.0 199.99

ESU LLC 23 Howard Street Montoursville PA 17754 - 1-570-980-1980

www.LokSound.com

DCC IMPULSES | 9

is, he may be anxious early on at a new layout. Such anxiety may manifest itself as everything from braggadocio to reserved silence. If you, as a layout owner, can be sensitive to the symptoms and put in a kind word or two, it will help relationships along nicely.

One of the layouts that I operate on frequently became a lot more fun when the owner actively promoted the concept that the goal was to have fun, not to get “done.”

Brief your guests [6]. You know where things are in your house, they may not. Yes, there are the obvious ones, like where the rest rooms are. But don't forget the safety issues: fire exits and extinguishers (you do have one or two around the layout, don't you?) and emergency medical aid.

If you have a job way back in some serpentine layout, it would be nice to know if there is a fire exit nearby, as opposed to



6. A pre-op session briefing on the PebbleCreek Model Railroad Club. (pcmrc.org)

DCC IMPULSES | 10

having to work one's way all the way back out to the original entrance. If you are in frequent earthquake country, mention your safety plan for that.

A layout tour should be more than just a chance for you to show off your handiwork. Point out landmarks and reporting locations. Town names are helpful to know and easier to remember if there are labels: depot signs or fascia plaques or signs hanging from the ceiling. It is nice to have railroad directions mentioned on the fascia. Likewise, have a map of how your layout fits into the world [7]

If I'm working in a layout town between Omaha and Kansas City and I have an outbound load it is nice to see a list of what goes where and not rely on my (meager) knowledge of Midwest

ADVERTISEMENT

ADVERTISEMENT



Installing DCC sound just **NOT** your thing?

Trust Traintek for sales and installation of sound decoders for these fine vendors!



RailPro™

"Taking model railroad control to the next level..."



trainteklc.com

Click here for more details...



"Traintek was the way to go!"



George's Trains

EST. 1962
Canada's Greatest Model Train Store!

PROTO-PAINT

20 NEW Colours
Just added!

ACRYLIC-Air Brush Ready
NOW OVER 45 Canadian Railway Colours!

Dealer inquiries welcome.

PP-001 CNR Green #11	PP-020 TH&B Maroon	PP-038 TTC CREAM
PP-002 CNR Imitation Gold	PP-021 Primer	PP-039 TTC Maroon
PP-003 CN VIA Blue #16	PP-022 Reducer	PP-040 Warm BLACK
PP004 CNvia Yellow #18	PP-023 Flat Finish	PP-041 Grimy Black
PP-005 VIA Grey	PP-024 Stencil White	PP-042 Anti-Glare Black
PP-006 CN Red/Orange #11	PP-025 Loco Black	PP-043 Slag Brown
PP-007 CN Lettering Grey #17	PP-026 Flat Haze	PP-044 GO Green
PP-008 CN Grey #11	PP-027 CNR LT BLUE	PP-045 GO White
PP-009 CNR Red #12	PP-028 CNR DK BLUE	PP-046 CONRAIL Blue
PP-010 CPR Tuscan	PP-029 CNR YELLOW	
PP-011 CPR Diesel Grey	PP-030 CNR Post 2000 Yellow	
PP-012 CPR Diesel Yellow	PP-031 CNR GREEN	
PP-013 CPR Steam Grey	PP-032 BCR/PGE DK GREEN	
PP-014 CPR Mineral Brown	PP-033 BCR RED	
PP-015 CP Action Red	PP-034 BCR Blue	
PP-016 CP Action Yellow	PP-035 BCR Yellow	
PP-017 CP Action Green	PP-036 BCR/PGE LL GREEN	
PP-018 CP Bright Red	PP-037 GTW Blue	
PP-019 TH&B Cream		

\$8.98 each
Canadian

ORDER NOW!

550 Alden Rd. Unit 101, Markham, On, Canada L3R 6A8
Tel: 905-470-6200 Toll Free: 1-877-8TRAINS (887-2467)
www.georgetrains.com

DCC IMPULSES | 11

geography. If you use car cards & waybills, put it on the waybill. Or put it on the switch list. Perhaps, in your world, a load for New England would go to Kansas City, not to the more obvious Omaha. Just remember to have fun, always.

Folks always seem to have additional ideas to share. Just click on the Reader Feedback icon at the beginning or the end of the column. While you are there, I encourage you to rate the column. “Awesome” is always appreciated. Thanks.

Until next month, I wish you green boards in all your endeavors. Mr. DCC’s Workshop continues this month. Skip ahead to find about settings of locos for operations.

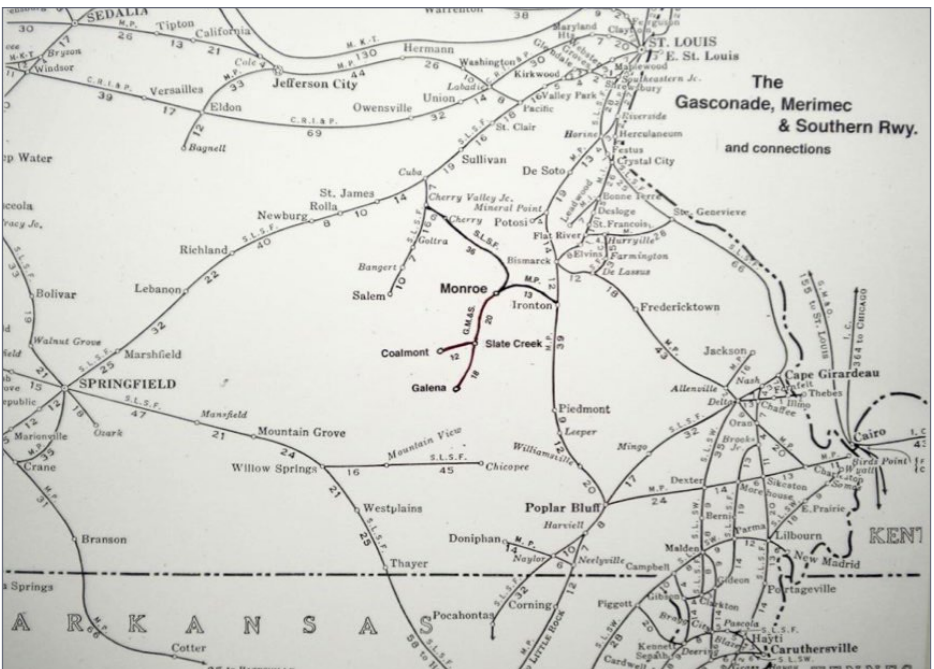

7. Map showing how Bill Sommerfield’s fictitious O scale layout joins the real world in southeast Missouri.



STATION

Litchfield

**Making
DCC FUN
for 15 Years!**

**Everything Digital
Command Control
Decoders,
Command Systems
Layouts,
Accessories
& More!**

**We carry
12 volt LEDs!**

623-298-7355

www.LitchfieldStation.com

TONY'S TRAIN XCHANGE

Committed to your DCC support!

Tony's Is Your Locomotive Price Leader!

Steam



BLI PRR K4
w/Paragon3 Coming Soon!

Athearn Genesis, Bachmann,
Broadway Limited Imports,
MTH, Rapido, Rivarossi & More

Starting at \$129.95

[View Stock](#)

Diesel



New Athearn Genesis
UP SD70M FlareSides Announced!

Athearn, Atlas, Bowser, Broadway
Limited, Intermountain, Kato,
Korea Brass, Walthers & More

Starting at \$97.95

[View Stock](#)

PSX Circuit Breakers



PSX1, PSX2, PSX3, PSX4:

Protect up to 4 DCC
Power Districts!

PSX-AR: Integrated
DCC Circuit Breaker
and Auto-Reverser!

Starting at \$37.95

[View Stock](#)

Do you need a Sound or
DCC Installation done?

[Get a quote!](#)



Providing unmatched person to person
DCC support for more than 25 years, the
kind of service that has made us #1 in DCC.

DCC questions? CALL US! 1-800-978-3472

We'll get you on the right track!

Mar 2016



MR. DCC'S WORKSHOP

LIMITING LOCOMOTIVE SPEED & CONFIRMING COMMANDS ...

Many of the layout owners in the Kansas City area are using an operation scheme where the locomotives have a lot of momentum programmed into them. The brake function is then used to stop the loco. Every owner that I've discussed this with is using SoundTraxx Tsunami decoders. So, I'll discuss how to set it up for the Tsunami.

Adjust the momentum to very large values (100 or so). That's CV3 for acceleration (starting) and CV4 for deceleration (stopping) [8].

I would like to have more control than naturally comes from this set up. The top speed of the locos is much higher than the top speed of many operating schemes. Here is a quick way to get your

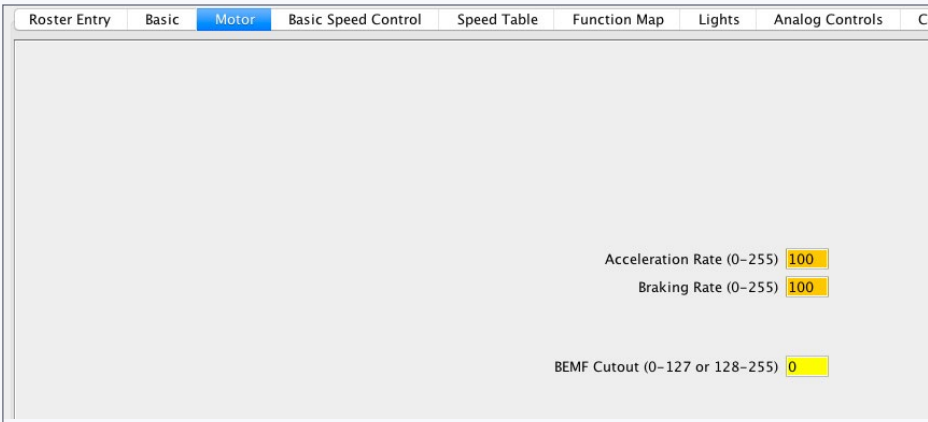

8. DecoderPro screen shot - setting momentum to 100 (out of 256).

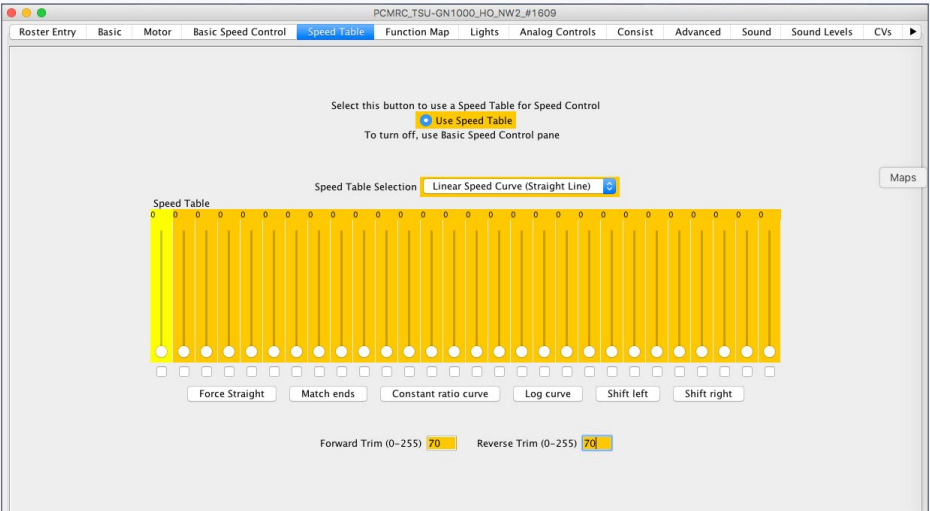

9. DecoderPro Screen shot - limiting top speed to 70 (out of 128), or about 60%

operators using the entire range of the throttle, not just the first 25% of the range with Tsunami decoders [9].

Here's what I did (and why). Items that I changed appear in orange in the screen shot [9]. First, I selected the radio button for USE SPEED TABLE (activates this pane by setting CV 29). Then I selected LINEAR SPEED CURVE from the SPEED TABLE SELECTION pulldown (this overrides the 28 speed steps in the graph). Then I set all speed steps to zero (since they are disabled, I might as well set them to zero, making future reads faster). Here is the real reason we are here. Use the FORWARD TRIM and REVERSE TRIM values to adjust the top speed. Unless your loco is way off base forward to reverse, I recommend using the same value in both. The maximum is 128. Any number less than that

MR. DCC'S WORKSHOP CONTINUED...

CV	value
25	2
29	16 more than was in it
66	70
68	0
69	0
70	0
71	0
72	0
73	0
74	0
75	0
76	0
77	0
78	0
79	0
80	0
81	0
82	0
83	0
84	0
85	0
86	0
87	0
88	0
89	0
90	0
91	0
92	0
93	0
94	0
95	70

will slow the loco down. The setting of 70 in [9] means that the loco will go about 55% of its original top speed ($70/128 = 54.9\%$).

The CVs that need to be set to achieve what I mentioned above (for a Tsunami decoder) are as shown in [10]. Once these values are programmed, CVs 66 (forward) and 95 (reverse) can be adjusted to achieve the maximum top speed for your operation needs. If you are doing this manually (not using DecoderPro), I recommend you read the value in CV 29 before you do any manipulation. This CV adjusts many of the features of your decoder. Finding CV 29's value first and adding 16 to it will achieve the result you seek, once the new value is written back into CV 29. Here's where DecoderPro shines.

Mapping functions together to help confirm command receipt

It is difficult, with a lot of momentum set, to know for sure that the brake command (either set or release) has been received by the decoder. One of the throttle failures I

10. CV values to achieve what was done with DecoderPro in [9].

ic Motor Basic Speed Control Speed Table **Function Map** Lights Analog Controls Consist Advanced Sound S

Use this sheet to determine which functions will control which outputs

Description	1 White	2 Yellow	3 FX5	4 FX6	Air Horn	Bell	Output wire or operation Dynamic Brakes	Short Horn	Fans RPM +	Dimming	Mute	Compressor RPM -	Brakes	Coupler
Forward Headlight F0(f)	<input checked="" type="checkbox"/>	<input type="checkbox"/>	<input type="checkbox"/>	<input type="checkbox"/>	<input type="checkbox"/>	<input type="checkbox"/>	<input type="checkbox"/>	<input type="checkbox"/>	<input type="checkbox"/>	<input type="checkbox"/>	<input type="checkbox"/>	<input type="checkbox"/>	<input type="checkbox"/>	<input type="checkbox"/>
Reverse Headlight F0(r)	<input type="checkbox"/>	<input checked="" type="checkbox"/>	<input type="checkbox"/>	<input type="checkbox"/>	<input type="checkbox"/>	<input type="checkbox"/>	<input type="checkbox"/>	<input type="checkbox"/>	<input type="checkbox"/>	<input type="checkbox"/>	<input type="checkbox"/>	<input type="checkbox"/>	<input type="checkbox"/>	<input type="checkbox"/>
Function 1	<input type="checkbox"/>	<input type="checkbox"/>	<input type="checkbox"/>	<input type="checkbox"/>	<input type="checkbox"/>	<input checked="" type="checkbox"/>	<input type="checkbox"/>	<input type="checkbox"/>	<input type="checkbox"/>	<input type="checkbox"/>	<input type="checkbox"/>	<input type="checkbox"/>	<input type="checkbox"/>	<input type="checkbox"/>
Function 2	<input type="checkbox"/>	<input type="checkbox"/>	<input type="checkbox"/>	<input type="checkbox"/>	<input checked="" type="checkbox"/>	<input type="checkbox"/>	<input type="checkbox"/>	<input type="checkbox"/>	<input type="checkbox"/>	<input type="checkbox"/>	<input type="checkbox"/>	<input type="checkbox"/>	<input type="checkbox"/>	<input type="checkbox"/>
Function 3	<input type="checkbox"/>	<input type="checkbox"/>	<input type="checkbox"/>	<input type="checkbox"/>	<input type="checkbox"/>	<input type="checkbox"/>	<input type="checkbox"/>	<input checked="" type="checkbox"/>	<input type="checkbox"/>	<input type="checkbox"/>	<input type="checkbox"/>	<input type="checkbox"/>	<input type="checkbox"/>	<input type="checkbox"/>
Function 4	<input type="checkbox"/>	<input type="checkbox"/>	<input type="checkbox"/>	<input type="checkbox"/>	<input type="checkbox"/>	<input type="checkbox"/>	<input checked="" type="checkbox"/>	<input type="checkbox"/>	<input type="checkbox"/>	<input type="checkbox"/>	<input type="checkbox"/>	<input type="checkbox"/>	<input type="checkbox"/>	<input type="checkbox"/>
Function 5	<input type="checkbox"/>	<input type="checkbox"/>	<input checked="" type="checkbox"/>	<input type="checkbox"/>	<input type="checkbox"/>	<input type="checkbox"/>	<input type="checkbox"/>	<input type="checkbox"/>	<input type="checkbox"/>	<input type="checkbox"/>	<input type="checkbox"/>	<input type="checkbox"/>	<input type="checkbox"/>	<input type="checkbox"/>
Function 6	<input type="checkbox"/>	<input type="checkbox"/>	<input type="checkbox"/>	<input checked="" type="checkbox"/>	<input type="checkbox"/>	<input type="checkbox"/>	<input type="checkbox"/>	<input type="checkbox"/>	<input type="checkbox"/>	<input type="checkbox"/>	<input type="checkbox"/>	<input type="checkbox"/>	<input type="checkbox"/>	<input type="checkbox"/>
Function 7	<input type="checkbox"/>	<input type="checkbox"/>	<input type="checkbox"/>	<input type="checkbox"/>	<input type="checkbox"/>	<input type="checkbox"/>	<input type="checkbox"/>	<input checked="" type="checkbox"/>	<input type="checkbox"/>	<input checked="" type="checkbox"/>	<input type="checkbox"/>	<input type="checkbox"/>	<input checked="" type="checkbox"/>	<input type="checkbox"/>
Function 8	<input type="checkbox"/>	<input type="checkbox"/>	<input type="checkbox"/>	<input type="checkbox"/>	<input type="checkbox"/>	<input type="checkbox"/>	<input type="checkbox"/>	<input type="checkbox"/>	<input type="checkbox"/>	<input type="checkbox"/>	<input type="checkbox"/>	<input type="checkbox"/>	<input type="checkbox"/>	<input type="checkbox"/>
Function 9	<input type="checkbox"/>	<input type="checkbox"/>	<input type="checkbox"/>	<input type="checkbox"/>	<input type="checkbox"/>	<input type="checkbox"/>	<input type="checkbox"/>	<input type="checkbox"/>	<input checked="" type="checkbox"/>	<input type="checkbox"/>	<input type="checkbox"/>	<input type="checkbox"/>	<input type="checkbox"/>	<input type="checkbox"/>
Function 10	<input type="checkbox"/>	<input type="checkbox"/>	<input type="checkbox"/>	<input type="checkbox"/>	<input type="checkbox"/>	<input type="checkbox"/>	<input type="checkbox"/>	<input type="checkbox"/>	<input type="checkbox"/>	<input type="checkbox"/>	<input checked="" type="checkbox"/>	<input type="checkbox"/>	<input type="checkbox"/>	<input type="checkbox"/>
Function 11	<input type="checkbox"/>	<input type="checkbox"/>	<input type="checkbox"/>	<input type="checkbox"/>	<input type="checkbox"/>	<input type="checkbox"/>	<input type="checkbox"/>	<input type="checkbox"/>	<input type="checkbox"/>	<input type="checkbox"/>	<input type="checkbox"/>	<input type="checkbox"/>	<input type="checkbox"/>	<input checked="" type="checkbox"/>
Function 12	<input type="checkbox"/>	<input type="checkbox"/>	<input type="checkbox"/>	<input type="checkbox"/>	<input type="checkbox"/>	<input type="checkbox"/>	<input type="checkbox"/>	<input type="checkbox"/>	<input type="checkbox"/>	<input type="checkbox"/>	<input type="checkbox"/>	<input type="checkbox"/>	<input type="checkbox"/>	<input checked="" type="checkbox"/>

Function Group 2 and 3 Exchange

11. DecoderPro screen shot - mapping the dim function to the same button as the brake function.

mentioned in the column was a failure of the radio cab to send the desired function command to the decoder. Feedback from the loco would have helped diagnose this issue.

With a Tsunami decoder, if you map the dim command to the same function as the brake command, the lights will dim to 60% when the brakes are set. Be sure to adjust the lighting setting to LEDs, if appropriate.

For the case shown in [11], the brakes were on F11. That box was unchecked and the box for F7 was checked. This puts both the brakes and the dimmer on F7. Given the myriad of options for the brake function, providing specific CV values for every situation is not possible.

Great control in a tiny package



**Original
Touch Toggles**

- Touch Toggle™ plug in controls
- Bright clear indication
- Easy setup
- Flexible system

Stall Motors, Twin-coils,
Power, and Servos

Now for Tam Valley Depot
and MRservo too!



Made in the USA



What will they think of next?

www.berretthillshop.com

ADVERTISEMENT

ADVERTISEMENT

IOWA SCALED ENGINEERING

Enhance Prototype Realism
Electronics for "Your" Model Railroad

- Switch Machines
- Time Lock Controllers
- Fast Clocks
- Sound Players
- Infrared Detectors
- Block Detectors
- And more!



open source
hardware

LEARN MORE >

TamValleyDepot.com

Great Electronics for Great Model Railroads

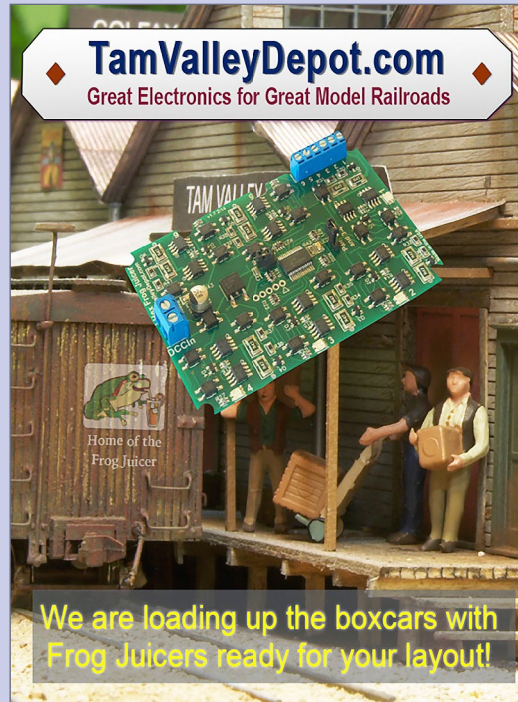

We are loading up the boxcars with
Frog Juicers ready for your layout!

• INDEX

• TABLE OF CONTENTS

.....

MR. DCC's WORKSHOP CONTINUED...

Other sound and non-sound decoders can be similarly programmed.

With the Econami, the sound of the brakes setting or releasing will be your clue. No need for exotic programming. ■

.....



[Click here for reader comments](#)

ADVERTISEMENT



SOUNDTRAXX®

Fun Features for a Fraction of the Cost!

As the most versatile, feature-packed sound decoder, Econami redefines *value*. Starting at \$79.95 and available now!



Hear how you can get more for less!





Southern Digital



**20% Discount
on most items!**

Specializing in DCC Since 1992



DCC Conversions, Service & Support

Orders Received by 3:00 pm EST ship the same day

WWW.SODIGI.COM

E-mail: sales@sodigi.com

(770) 929-1888

(Photo's are from our N-Scale layout)

From first train set to railroad empire...

*Our complete line of DCC products
grows with you. Discover the fun!*

- Designed and manufactured in the U.S.A.
- Preferred for ease of use and ergonomic design
- Unlimited scalability for any size model railroad
- Plug-and-play means more time running trains
- Great customer service and excellent support



See your dealer



Visit our new and improved web site for all your DCC needs!

- Get the latest new product announcements
- Watch our detailed how-to videos
- Browse the all-new Information Station
- Enjoy secure online sales, day or night!

Visit **ncedcc.com**





Announcing our next Limited Run PWRS / Micro-Trains® Car!!!

PWRS

CP Rail (CP) 4-pack



50' Superior Plug Door Box Car

- Action Green
- Black Sills
- Multi-Mark
- Lightly Weathered



CLICK HERE FOR
CP Rail 

COMING
October 2016

NORTH AMERICAN RAILCAR CORPORATION

**DO YOU MODEL ANY
OF THESE ROADS?**

**NEW TOOLING
COMING!!!**

**WE WILL SOON BE
TAKING ORDERS FOR
2 BRAND NEW, NEVER
BEFORE RELEASED
MODELS... FOR ALL
OF THESE ROADS.
STAY TUNED FOR
MORE INFORMATION
ON OUR FIRST 2
RELEASES.**



CLICK HERE FOR
NARC Teaser 

NARC Cars are sold
exclusively through

Pacific Western Rail Systems

• INDEX

• TABLE OF CONTENTS

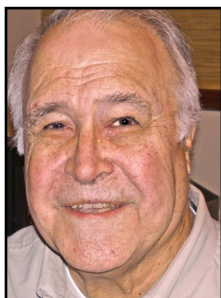

LITE AND NARROW

column

LARRY SMITH
.....



[Click here for
reader comments](#)

**THE BIRMINGHAM SOUTHERN | IT'S NOT
LITE OR NARROW BUT VERY SHORT.
HERE'S ANOTHER SPECIALIZED SHORT LINE
RAILROAD YOU CAN MODEL ...**

CONTINUING WITH OUR LOOK AT THE

various short lines and branch lines surrounding the Birmingham, Alabama area, we turn our attention to the Birmingham Southern, now the Birmingham Terminal Railroad, a Watco railroad.

Do you like heavy motive power in a short line situation? If so, the Birmingham Southern/Birmingham Terminal Railroad is an ideal prototype for you to model.

In the steam era, the smallest locomotives were 0-6-0s used for in-plant switching at TCI's Ensley and Fairfield Works, while 2-8-0s and 2-10-2s were used for over-the-road traffic. This is significant since the Birmingham Southern received common-carrier status

▶ **RAMBLINGS ON THE NARROW GAUGE**

LITE AND NARROW | 2

in 1906 and was able to serve on-line industries other than TCI (Tennessee Coal and Iron; see sidebar for details).

Required elements

To effectively model the Birmingham Southern or any other industrial based railroad, you have to identify key structures to use. In addition to the ones identified in the Woodward article: IE blast furnaces, coke ovens, and by-products plant, there were cast iron pipe foundries, fertilizer plants (bat guano), quarries, coal mines, and a railroad car manufacturer on the railroad. For the Birmingham Southern, a major feature of the railroad was the docks at Birminghamport. Located on the Warrior River, the port featured a large transloader for receiving taconite (iron ore that is mixed with clay to form balls for easy shipment), and



1. Restored 19th century blast furnace at Tannehill State Park. Photo by Tannehill State Park.

the shipping of coal from the on-line mines, making this a very important element for modeling the railroad.

In the diesel era, your choice of locomotives runs from SW1s and HH900s in 1937, through the 1940s and '50s, with Alco RS-3s and Baldwin AS-616s. If you're interested in the contemporary diesel era, you have SD40-2s and GP38-2s. You also can use a multitude of paint schemes on your locomotives.

Heavy industry modelers will find the railroad appealing, with not only the Ensley and Fairfield Works of TCI/US Steel, but also Pullman-Standard car shops in Bessemer and Koppers Coke Works.

Other heavy industry includes Wade Sand and Gravel, US Pipe's foundry, and the Birmingham Warrior River terminal (the terminal has a return loop that holds a 100-car train).

In 1999, at the 100th birthday of the railroad, it consisted of 15 miles of mainline and two branches, one six miles and the other 18 miles. Today, the six-mile branch is gone and the 18-mile branch is quiet with little traffic.

Brief history

The Birmingham Southern had its beginnings as a 6½-mile line constructed July 18, 1878, by The Pratt Coal and Coke Company for the purpose of hauling coal from a mine at the eastern edge of the Warrior coal field to a connection with the Louisville & Nashville Railroad and the Alabama & Chattanooga Railroads.

Once the line was established and shown to be reliable, it attracted other industries to it. One of the first customers for the little shortline was Alice Furnace.

Alice Furnace was notable in that it was one of the first iron producers in the Birmingham area to produce iron made with

LITE AND NARROW | 4

locally produced coke that proved to be equal in quality to northern iron. Birmingham Rolling Mills and Linn Iron Works also built plants along the little railroad.

In December, 1886, TCI (Tennessee Coal, Iron and Railroad Company) purchased The Pratt Coal and Iron Company (formally The Pratt Coal and Coke Company), and came into the Birmingham area.

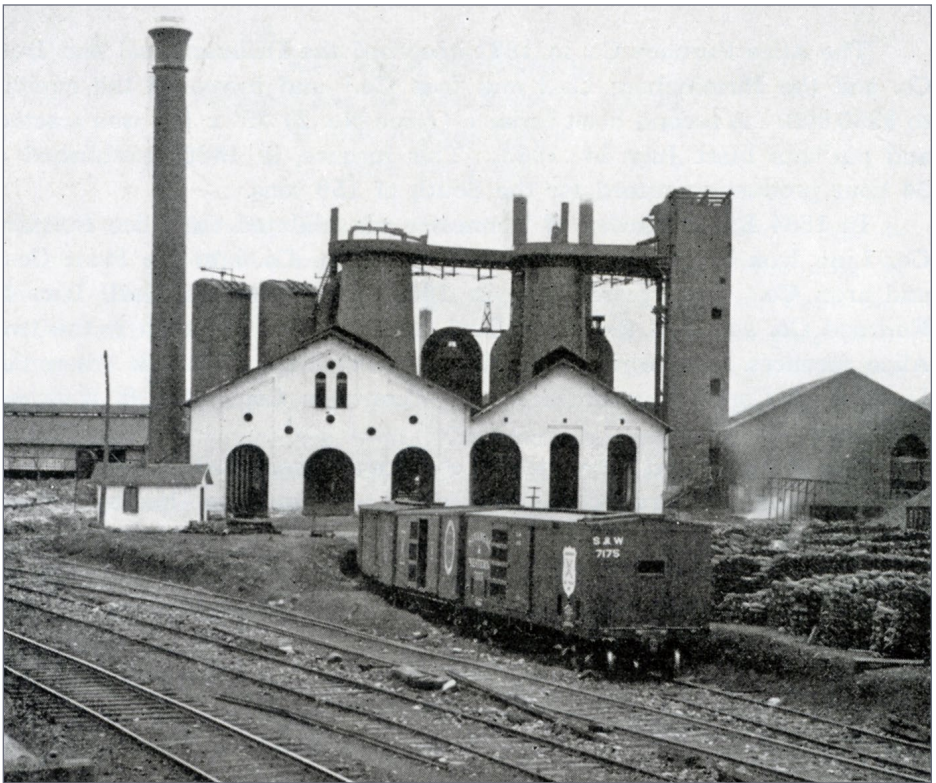

2. Early photo showing Alice Furnace No. 1 and No. 2. Note the S & W ventilated boxcar setting in the foreground. Photo from *Alabama Blast Furnaces*, published by Woodward Iron Company, 1940, p. 37.

With this purchase, TCI gained 10 operating mines, beehive coke ovens and the railroad. Immediately, TCI began construction of four 200-ton-per-day blast furnaces in Ensley and addition beehive coke ovens located in the Pratt Coal seam. The railroad was expanded five miles into Ensley to serve the new furnaces.

On February 10, 1893, TCI obtained a charter from the State of Alabama allowing the company to extend its rail lines as needed to connect all of its holding with trunk line railroads.

In 1899, TCI established a separate corporation in which to place all of their railroad assets. The new charter enabled TCI to incorporate the Birmingham Southern Railroad Company.

Multiple owners

The Birmingham Southern as a quasi-independent railroad was short-lived when the railroad came under the control of the Southern Railway and the Louisville & Nashville Railroad.

There are two reasons for this. First, this purely self-defensive move by the two railroads prevented the BSRR from being a common carrier, disallowing joint-rate agreements with other railroads. Second, it became evident to TCI that running a railroad was outside their expertise and better left to other railroads.

While under the control of the Southern and the L&N, the railroad was allowed to deteriorate due to minimal investment by the two railroads. TCI wanted to expand trackage to new mining operations, but wouldn't without having control of the railroad. Additionally, TCI and other industrial customers were receiving inadequate rail service

In 1906, confronted with these problems, TCI purchased the BSRR back, paying the two railroads exactly the same amount they had paid TCI for it.

Expansion and contraction

The expansion of the railroad to serve the needs of TCI began almost immediately with the return to TCI control.

TCI constructed a branch from Village Creek Junction to the coal mining community of Docena where No. 12 mine was located. They also opened other mines at Bayview and Edgewater and built rail lines to serve them. They also constructed to Wenonah, Muscoda, and Ishkooda where the Red Mountain ore mines were located.

Between 1910 and 1916, TCI built other lines, including the main classification yard at 34th Street in Ensley to meet the expanding steel-making facilities at Ensley and Fairfield. During World War I, TCI transferred the Birmingham Southern into its Rail Transportation Department to keep the USRA from taking over its in-plant operations as well as the mining operations.



3. Birmingham Southern 2-8-0 on the dead line at the end of steam. Transferred to TCI #37. March, 1938. Photo taken at Pratt City, AL 1937. *John E. Jones photo, Tom Lawson Collection*

In time, the mining operations played out and the lines were abandoned. Bayview lasted only until the late 1920s. Wenonah, Edgewater, and Docena ceased production in 1962.

TCI made a significant addition to the railroad in 1926 with the construction of the Ensley-Thomas Line. The increased volume of interchange traffic from the class-one railroads in the Birmingham area made this line a necessity. With this line, TCI avoided the congestion of the Ensley Works area. TCI constructed the new line parallel to the L&N and Southern tracks, skirting the south end of Ensley Works, allowing for easier movement to and from downtown Birmingham.

A goal from the beginning, in 1899, was to connect TCI Ensley with Bessemer. At first, TCI accomplished this with trackage rights over a branch line of the Frisco.

Then in 1910, the railroad built its own line. It completed the connection by leasing a 2½-mile portion of the Alabama Terminal Railroad. The Alabama Terminal Railroad was operated by the Atlanta, Birmingham, and Coast.

This line gave the Birmingham Southern access to the lucrative Bessemer market. In addition to serving the TCI Bessemer rolling mill, the railroad also served Harbison-Walker Refractories and, starting in 1929, The Pullman-Standard freight car building facilities. Griffin Wheel Company also located their plant along the BSRR.

In September, 1930, TCI restructured their transportation department and ended their joint operation of the Birmingham Southern, making it a separate company with 26 miles of track.

This status changed again in 1975 when US Steel, TCI's owner, purchased all of the BSRR stock and unified all of their railroads under one president and managed them from their home office in Pittsburgh, PA.

LITE AND NARROW | 8

In 1966, the Birmingham Southern acquired the 18-mile Federal Barge Lines (also known as the Barge Line Railroad) that ran from Ensley to Port Birmingham, giving the Birmingham Southern access to Mobile via the barge lines of the Warrior River. The Barge Line Railroad track was formerly owned by the Southern.

In 1988, the Birmingham Southern sold to Transtar, Inc., the transportation subsidiary of United States Steel. In 1989, United



4. BSRR HH900 #82 has just been restored By the Heart of Dixie Railroad Museum, and here is sitting outside of the shops in the bright Sunshine for a few photographers to get some shots. This locomotive was built in March 1937 as Birmingham Southern #82; it was sold to ACIP as #103 in December 1963, and then donated to the Heart of Dixie Railroad Museum in 1985. The only thing left to fix is a crankshaft. A big thanks to the Heart of Dixie Railroad Museum for putting this locomotive in a few different spots for me and a couple of other photographers to get our shots. *Bradley Bates photograph, posted at railpictures.net*

States Steel sold Transtar and it became a privately held company specializing in the operation of short line railroads and barge lines that primarily serve United States Steel and its predecessors.

On December 2, 2011, Watco Companies announced plans to purchase the Birmingham Southern. They renamed the railroad the Birmingham Terminal Railway and operations under the new name began on 1 February 2012.

Motive power

The Birmingham Southern's steam motive power wasn't unique. Being a switching railroad, it consisted mainly of 0-6-0s and 2-8-0s. They did, however, have four 2-10-2s on the roster they purchased new from Alco in 1917. On June 30, 1939, all steam locomotives left the roster of the Birmingham Southern, never to return.

Diesels had first arrived in 1934, when Westinghouse lent their demonstrator #12 to the BSRR, TCI, and Warrior River Terminal for testing. By 1937, a diesel maintenance facility was constructed, followed by the private car shed in 1942. Because of the hostile environment in which diesels worked, EMD and Alco technicians spent countless hours trying to solve various problems with the locomotives.

The first full-service diesels arriving on the railroad were four NC-1 GM-EMC locomotives. An additional ten Alco HH900 locomotives followed in 1937-38, and then two S1s in 1941.

For modeling the railroad, the most interesting time would be the Transtar period. During this time, the Birmingham Southern managed the in-plant operations for US Steel under the Fairfield Southern name. This railroad resumed its independence when WATCO purchased the Birmingham Southern in 2011.

Also during this period, Transtar moved motive power between all of the different railroads making for a multicolored fleet of locomotives: Union Railroad's blue, DM&IR maroon, and EJ&E orange, along with Birmingham Southern's green livery.

Industries

From 1906, the Birmingham Southern has been designated a common carrier. This common-carrier status has made for some interesting industries being located along its lines from two major steel producing complexes, Ensley and Fairfield.

Ensley had six blast furnaces and Fairfield had four. Depending on the time modeled, you could have coal tipples and beehive coke ovens operating, as well as the more modern coke ovens.



5. BSRR (Former Cedar Rapids & Iowa City Railway) GP38-2s 714 and 711 rebuilt from GP35s are sitting at Fairfield, AL awaiting their next assignment. *William Davis photograph, posted at rrpicturesarchives.net*

In the 1990s, the line had a diverse mix of industries. This included the docks at Birminghamport where barges of taconite were loaded into ore cars for transport to US Steel's Fairfield Works, and refractory clay going to A. P. Green Refractories in Bessemer. Trinity Industries still produced freight cars, and Griffin Wheel still shipped wheels to the various freight car makers. Finally, the customers included a coal flood loader on the Exum branch.

Modeling an operations-oriented small railroad using ideas from the Birmingham Southern could be most interesting.

Next time, we will visit Craig Gardner's Birmingham Southern, and see how he has modeled this railroad, even to duplicating specific scenes on the railroad.

Craig's version of the Birmingham Southern represents the railroad from Fairfield yard to Birminghamport in one direction, then to Ensley and off-line in the other direction. I will discuss how Craig arrived at this configuration and how he operates the layout. To whet your appetite, I have included a few photographs of Craig's layout at the end of this article.

Tell your friends about MRH!

**We depend on word-of-mouth to grow
... if you don't share us, we don't grow**



6. BSRR (former DM&IR 125, Union RR 632) SD-9 wearing Union RR colors and patch painted for BSRR. Locomotive low-nosed by DM&IR. Off the roster by 1998. *From the collection of Marty Bernard, posted at rppicturesarchives.net*

ADVERTISEMENT

GET ON BOARD WITH THE MOST TALKED ABOUT TRAIN IN AMERICA!

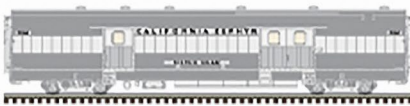

Baggage Car - "A" Set CB&Q - Silver Bear



Dome-Buffer-Lounge Car - "A" Set CB&Q - Silver Roundup



Diner Car - "A" Set CB&Q - Silver Dimer



16 Section Sleeper Car - "A" Set CB&Q - Silver Cedar

Atlas Master O California Zephyr® 12-Car Train Sets (CB&Q, D&RGW, Western Pacific) Available for Pre-Order thru May 4, 2016

For a copy of our latest All Scales Catalog, please call 908-687-0880 or visit www.atlasrr.com/catalog

Check It Out!

California Zephyr is a registered service mark of the National Railroad Passenger Corporation, used under license.





7. BSRR Northbound taconite train BS1 General has just departed BNSF'S East Thomas Yard after BNSF interchanged a U-SEMBIR taconite train with the BSRR. The BSRR takes the taconite trains to Flint Ridge for U.S. Steel. On the point is SD9 640 still in DM&IR Paint with BSRR patches. Second locomotive is BSRR 702, a GP38-2 in Birmingham Southern green and yellow scheme. *William H. Davis collection. Posted on rpicturesarchives.net*



**Click here for
reader comments**



8. BSRR Baldwin VO1000 332. From TCI 800 to U.S. Steel-Fairfield 133 to BSRR in 1984, retired 1986. *Photograph by Doug Boyd, Ryan Kertis collection used by permission. Posted on rpicturesarchives.net*



9. BSRR SD9 661. From EJ&E 802 still in EJ&E colors with only BSRR herald and number under the cab. *G. Gerard collection, posted on rpicturesarchive.net*



10. BSRR 202 SW7 still in Woodward Iron colors. Formerly WIRR 50, in 1974 rebuilt by EMD and renumbered 302. *Glenn Marsh photo Hank Stephens collection Posted on rrpicturesarchives.net*



[Click here for
reader comments](#)



11. BSRR 19 SW1001 Purchased new in 1973, renumbered 219.
Robert Farkas photo. Post on rrpicturesarchives.net



12. BTR 3875 WATCO patch paint with the new Dragon herald
for Birmingham Terminal. *Rad McGuire photo, posted on rrpicturesarchives.net*



13. BSRR caboose X-1. *Hank Stephens collection, posted on rrpicturesarchives.net*

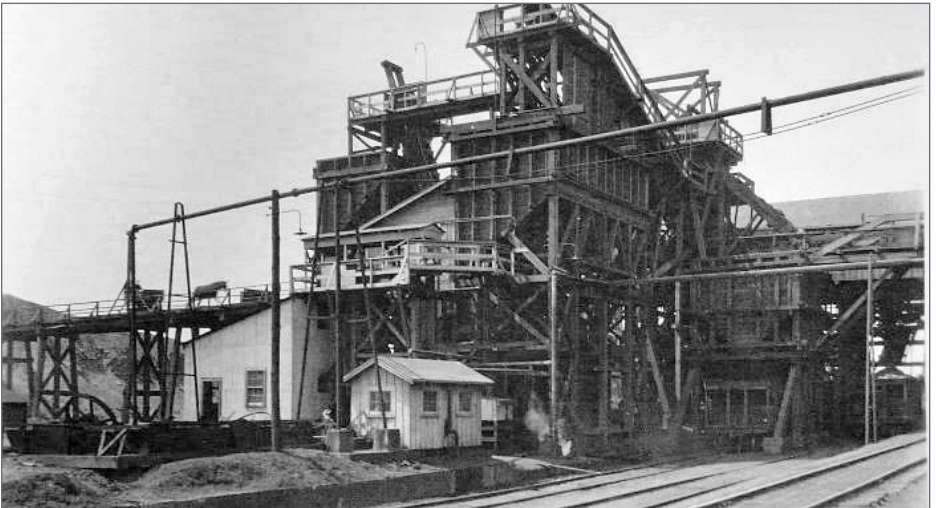

14. Pratt No. 5 tippel. Lots of modeling ideas from this photo, including the mule-powered slate cars on the upper level. *John Stewart collection*



15. Pratt No. 5 tipple. In the background are the four-square company houses that were built by TCI. The beehive coke ovens are visible as well. *John Stewart collection*

Take the MRH
2016 Reader Survey ...



... and get a chance
to win a 10" Kindle
Fire tablet!



fireHD10
OUR LARGEST
DISPLAY
ON OUR
THINNEST TABLET



TAKE THE SURVEY >>

Coming next time ...



16. Birminghamport as depicted by Craig Gardner on his layout. The massive bulk materials loader was kitbashed using a container crane. *Craig Gardner photo*



17. Mulga, AL residential area along the Birmingham Southern on Craig Gardner's layout. *Craig Gardner photo*



18. Short Creek trestle on Craig Gardner's Birmingham Southern.
Craig Gardner photo

**Want to help keep
MRH free?**

Then *click* on ads!



19. Coal train at Mulga, running from Powhatan Mine to Fairfield yard. *Craig Gardner photo*



20. Powhatan tipples. *Craig Gardner photo*



21. Birminghamport, showing the raw materials transfer crane and the oil depot in the background. *Craig Gardner photo*



[Click here for
reader comments](#)

.....

EARLY HISTORY OF THE STEEL INDUSTRY IN ALABAMA

Geographically, Birmingham, Alabama lies in northern Alabama, at the tail end of the Appalachian Mountains where they butt up against the Gulf Coastal Plain in a region known as “the Ridge and Valley.”

It was in this northern Gulf Coastal Plain area that Woodward Iron established their empire (*Model Railroad Hobbyist*, September, 2015, Issue 67).

Hidden wealth

The first indication of the vast mineral wealth hidden in the Jones Valley region of North Central Alabama came from a report by Professor R.T. Brumby of the University of Alabama, published in 1839 (*Bernard’s Almanac*).

The lack of railroad development in Alabama was a problem. There were only three tiny railroads operating in Alabama prior to the Civil War – and all of them served only the southern agricultural areas.

A much longer railroad, The Northeast & Southwest, running from Meriden, Mississippi to Chattanooga, Tennessee began construction. The route roughly followed today’s I-59, taking the railroad right through the heart of what would eventually become Birmingham, Alabama.

It was 1858, and state leaders feared this new out-of-state railroad would siphon off the northern Alabama mineral wealth. To counter this, the state commissioned John T. Milner to

study building an Alabama-based railroad from the Tennessee River to Mobile Bay to stimulate development of the northern Alabama mineral wealth of Jefferson County.

Construction on both Alabama Central and the Northeast & Southwest came to a halt with the beginning of the Civil War. It wouldn't be until after the war that construction resumed with new capital from northern bankers.

As for iron furnaces in the region, the largest was Tannehill, a five-furnace operation. There were few blast furnaces for making iron in the south at the start of the Civil War, and limited rail connections to the furnaces that existed. Tannehill's iron went by wagon overland to Helena, and then loaded onto rail-cars for shipment to Selma.

The Confederacy needed arms, and arms required iron. Two men, Frank Gilmer and John T. Milner, went to Richmond to meet with the Confederate Secretary of War, James Seddon, to get financial support to build new iron furnaces. They were contracted to build a blast furnace and a railroad to provide a means to ship iron to Selma Arsenal.

The newly formed Alabama Arms Manufacturing Company sought to answer the Confederacy's need for armaments requiring iron. They built a new blast furnace and railroad in Jefferson County along the line of the Alabama Central, later renamed to the South & North Alabama Railroad. This later became the Red Mountain Iron & Coal Company and the region, the Oxmoor.

As the Civil War ended, the economic potential of the mineral wealth in Jefferson County was widely known, but the ravages of war and lack of viable transportation within the area impeded growth. This changed when two railroads, The South & North

Alabama and the Alabama & Chattanooga, each built new lines that crossed in central Jefferson County, sparking the founding of a new city: Birmingham.

The Birmingham District

On December 19, 1871, the Elyton Land Company incorporated the city of Birmingham. James Powell, an associate of the South & North Alabama Railroad builder and pioneer iron maker John T. Milner, selected the name for the city after a visit to England's iron making center, Birmingham.

Northern operations had moved onto using coke to produce iron, while charcoal was still being used in what remained of the southern iron furnaces, including the Birmingham District. After testing, it was found that Jefferson County coal was comparable to the bituminous coal found in the north, and could be used to make coke.

The Pratt Coal & Coke Company incorporated on July 18, 1878 and built a 6½-mile railroad from a coal mine on the eastern edge of the Warrior coal field to a connection with the Louisville & Nashville (previously the South & North Alabama) and the Alabama & Chattanooga railroads.

With dependable transportation, the Pratt Company Railroad drew new industry along its tracks. Most notable of these was Alice Furnace.

Construction began on Alice Furnace September 29, 1879 by the Alice Furnace Company formed by Henry DeBardeleben and T. T. Hillman. According to Alabama Blast Furnaces (Woodward Iron Company, 1940), Alice was the fourth coke-fired furnace to be built in Jefferson County. The other three

were McElwain (Old Irondale, 1863-64), Oxmoor No. 1 (1863), and Oxmoor No. 2 (1873).

Alice Furnace's first furnace went in where the Alabama & Chattanooga split with the Louisville & Nashville. Their first furnace, No. 1, was blown-in on November 23, 1880, and the second furnace, No. 2, was blown-in on July 23, 1883. By 1886, this facility set records when No. 2 produced 150 tons of iron in one 24-hour day.

After this came the construction of the Birmingham Rolling Mill and the Linn Iron Works. Through a series of purchases and sell-outs, Alice Furnace Company and Linn Iron Works came under the control of Colonel Enoch Ensley, a prominent Memphis industrialist, in 1882. Ensley incorporated them as the Pratt Coal & Iron Company.

Four years later, Ensley sold his interest to Tennessee Coal, Iron & Railroad Company (TCI), a new rapidly expanding mining and iron producer in the south. This acquisition included the Pratt coal seam with 10 operating mines, its beehive coke ovens, and the railroad from Pratt mine to Birmingham.

Almost immediately, TCI began construction of four 200-ton-per-day blast furnaces at Ensley, as well as building additional beehive coke ovens and opening new mines in the Pratt seam. The following year, 1887, The Pratt Coal & Coke Railroad expanded five miles to Ensley to serve the new furnaces.

In 1892, TCI absorbed the DeBardeleben Coal & Iron Company, the Cahaba Coal Mining Company, and the Excelsior Mining Company, bringing with it five blast furnaces at Bessemer and two at Oxmoor. Also included with the transaction were several coal mines, 920 coke ovens, and the Woodstock &

Blocton Railroad that had been constructed by the Cahaba Coal Company.

Since this time, TCI and Woodward Iron have been the major players in Birmingham's iron and steel district. ■
.....



[Click here for reader comments](#)

ADVERTISEMENT

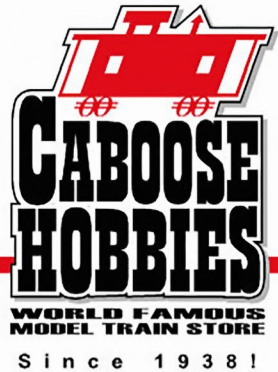

**The World's
Largest
Model Train Store!**

Model trains G to Z, DCC, brass models, kits, RTR, collectable models, scenery, structures, books, magazines, DVD's, hobby tools & supplies and a full service repair department.

WWW.CABOOSEHOBBIES.COM



WHAT'S NEW!

ON
TRAINMASTERS.TV



DAVE PETTY LAYOUT TOUR

Dave Petty's freelanced N scale Midwest Central layout is the result of 40 years of imagination and a love for trains.

Non-members: Watch for \$1.49 / episode!



DIESEL LOCO WEATHERING

Mike Confalone moves from weathering freight cars to now weathering diesel locos in his latest weathering projects series.

Non-members: Watch for \$1.49 / episode!



UNDERBODY BRAKE RIGGING

Pierre Oliver shares his techniques for adding detailed brake rigging to freight car underframes. Part 2 of 2.

Non-members: Watch for \$1.49 / episode!



COUPLER & WHEEL TIPS

In Back to the Workbench episode 2, Miles Hale shares his tips for better wheel and coupler performance.

Non-members: Watch for \$1.49 / episode!



Watch these videos on TrainMasters.TV

(Non-members can now watch one of these videos for just \$1.49, or download-to-own for \$3.49)



• INDEX

• TABLE OF CONTENTS



WHAT'S NEAT WITH KEN PATTERSON

KEN PATTERSON

column



[Click here for
reader comments](#)

MAKE FOIL COPIES, VISIT GRIZZLY FLATS, AND INSTALL WOW SOUND IN A U25C ...

THIS MONTH WE START WITH MIKE BUDDE, who, with a roll of aluminum foil, shows us how to create wrecked freight cars and automobiles. Ken also shows off a Grizzly Flats project for Bachmann, and installs a WOW Sound decoder in a Korea Brass USA U25C. The video wraps up as he remodels his too-tall studio shelf layout that had stopped being fun to run.



[Click here for
reader comments](#)

▶ PHOTOS AND VIDEO OF SUPERB MODELS

WHAT'S NEAT | 2



1. Here is a photo of Mike's SP beer car with its sides torn out in a derailment. Mike used prototype photos of this very car to model the damage. Strapping bands and wood shipping scrap were added to the finished model.



2. Mike replicated the damage of a wrecked auto rack with its load of smashed vehicles in HO, using household aluminum foil.

WHAT'S NEAT | 3



3. With a soft cotton swab, Mike embosses the freight car's detail into the foil. He then paints the foil the correct freight car color and decals it to match the car's lettering. Then he folds and crushes the foil part to match the prototype photos.



Playback problems? [Click here ...](#)

WHAT'S NEAT | 4



4. Mike makes a roof section from foil using the cotton swab to press and rub the aluminum into the roof panel detail.

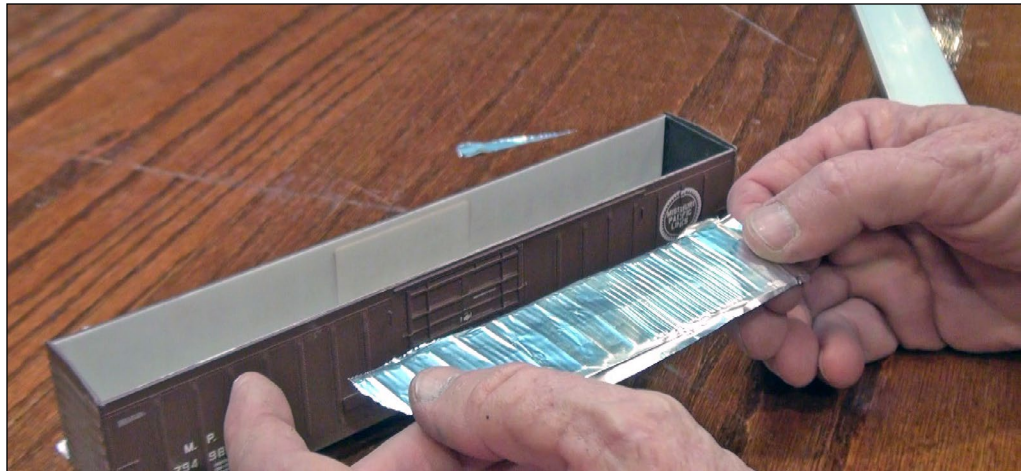

5. He then flips this roof section upside down and coats it with a heavy pour of Elmer's Glue to add strength. The part dries overnight before he positions it on top of the wrecked model.

WHAT'S NEAT | 5

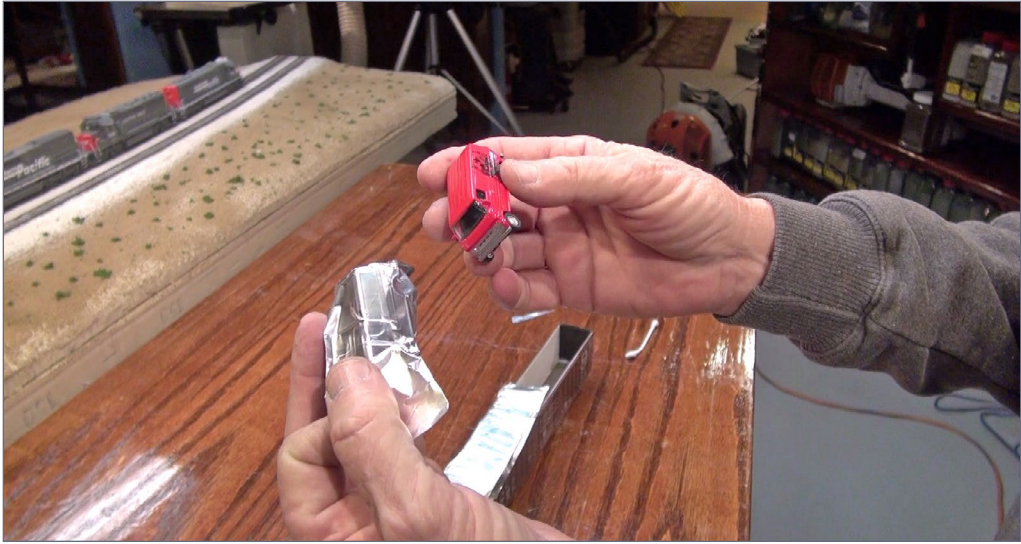

6. Mike follows the same process to build wrecked automobiles. An aluminum copy of the van's side allows him to cut panels out and replace them with shaped and painted foil parts.

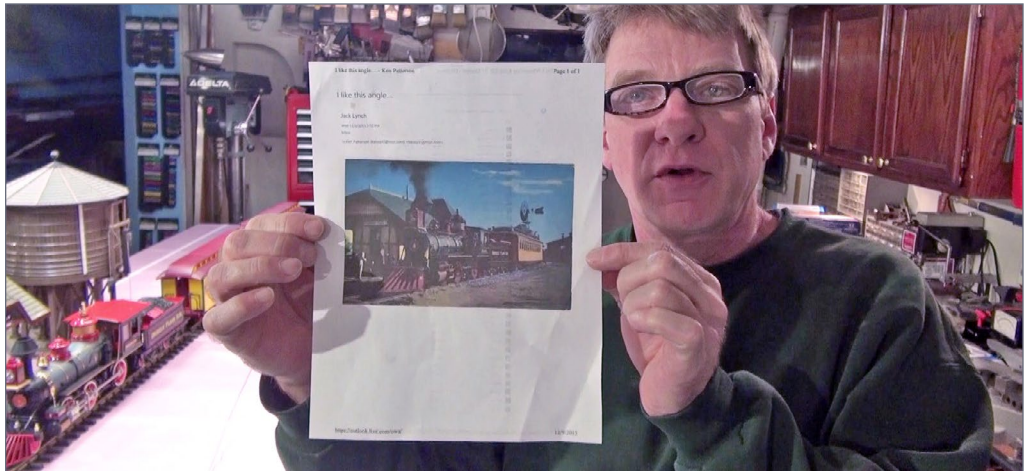

7. Bachmann asked me to copy this prototype photo of famous Disney animator Ward Kimball's full-size Grizzly Flats Railroad in 1:20.3 scale for the cover of the company's 2016 catalog.

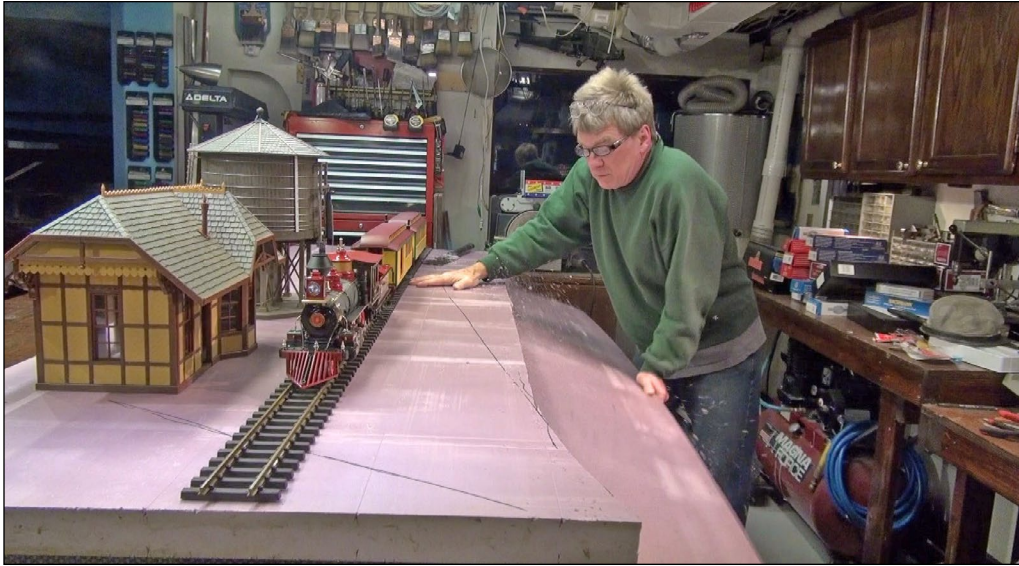

8. I built the scene on an 8-foot foam board cut to 30 inches wide. I built the Piko water tank, and the train station which is an exact match for the train station Ward had built on his property.

**Want to help keep
MRH free?**

Then *click* on ads!

WHAT'S NEAT | 7



9. Using a router, I cut the foam to a depth of $\frac{1}{4}$ of an inch to sink the Bachmann G scale track into the scene, saving on ballast.

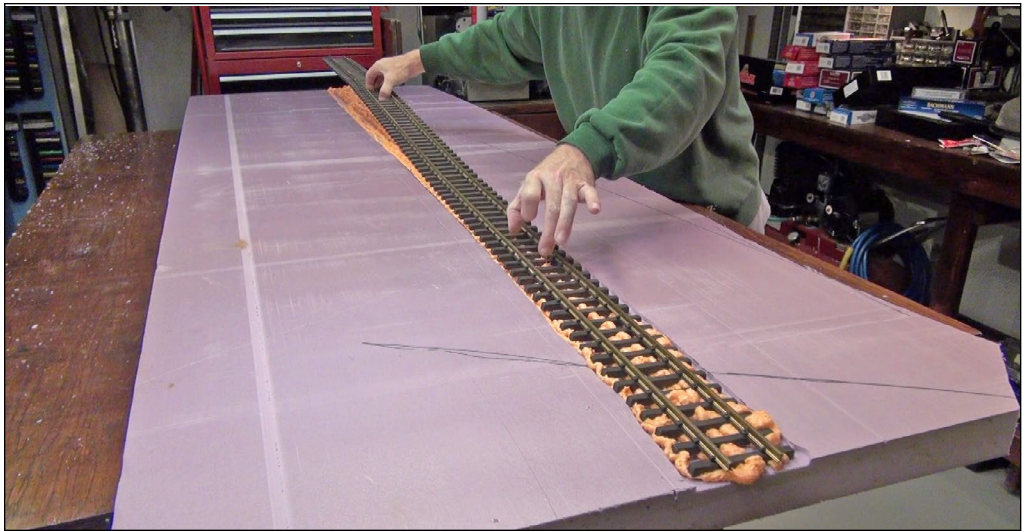

10. I glued the track down using Great Stuff Foam Pro, shaving off the excess foam with a wire brush after it cured.

WHAT'S NEAT | 8



11. Using sifted creek rock as ballast, I brushed and groomed this before gluing the ballast and some dirt to the diorama with Woodland Scenics Scenic Cement.



12. After setting up the scene outdoors, I shot photos over two days making test shots for Bachmann's review. After studying the pictures and making a few tweaks, I shot the final cover photo.

ADVERTISEMENT

HO SCALE FA-2 AND FPA-2

THEIRS



OURS

A MUSEUM-QUALITY

FA-2

IS LONG OVERDUE.

• INDEX

• TABLE OF CONTENTS

BACHMANN TRAINS

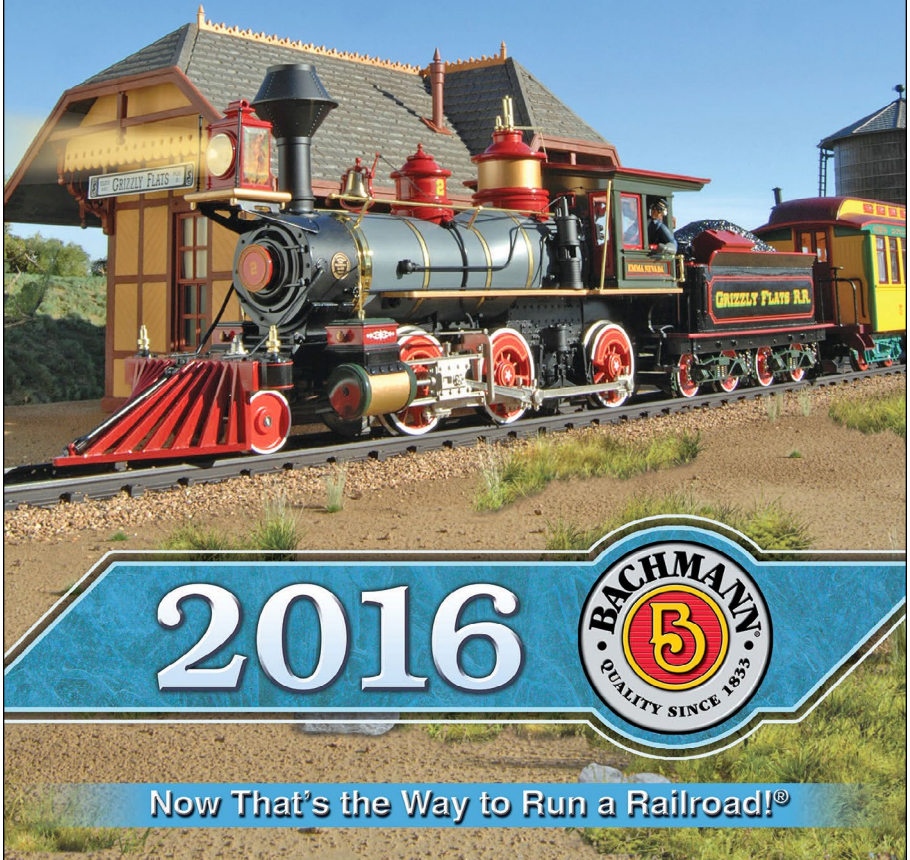

13. The next time you are at a trade show and are given a new Bachmann catalog from their trade show booth, you will have a little “behind the scenes” knowledge of what went into creating this 2016 Bachmann cover photograph.

WHAT'S NEAT | 10



14. This month we do an overview and a sound decoder installation in this New Korea Brass USA U25C locomotive in HO. The details and paint work are fantastic on the model, as you can see in this outdoor photograph.

112,000 have seen this MRH video - *have you?*

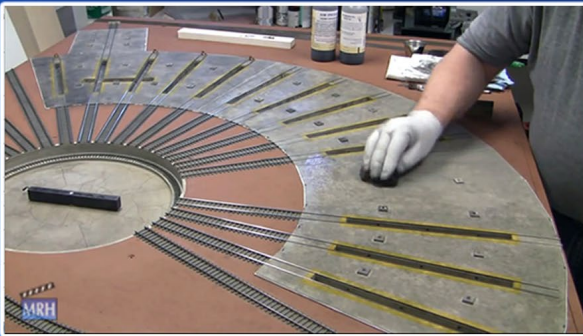

Watch the
video now



WHAT'S NEAT | 11



15. Korea Brass USA sent me locomotives without sound so I could demonstrate what goes into the sound decoder installation. Here you see the three components necessary for the conversion: a TCS WOW Sound 101 decoder, a keep-alive module, and a 16x35mm WOW speaker.

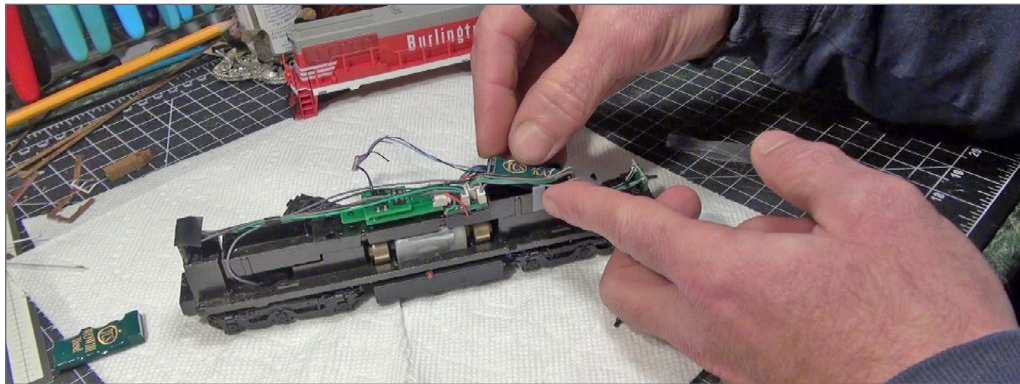

16. I removed the spring lighting contacts to install the keep-alive in the locomotive's front speaker enclosure, then reinstalled the lighting contacts.

WHAT'S NEAT | 12

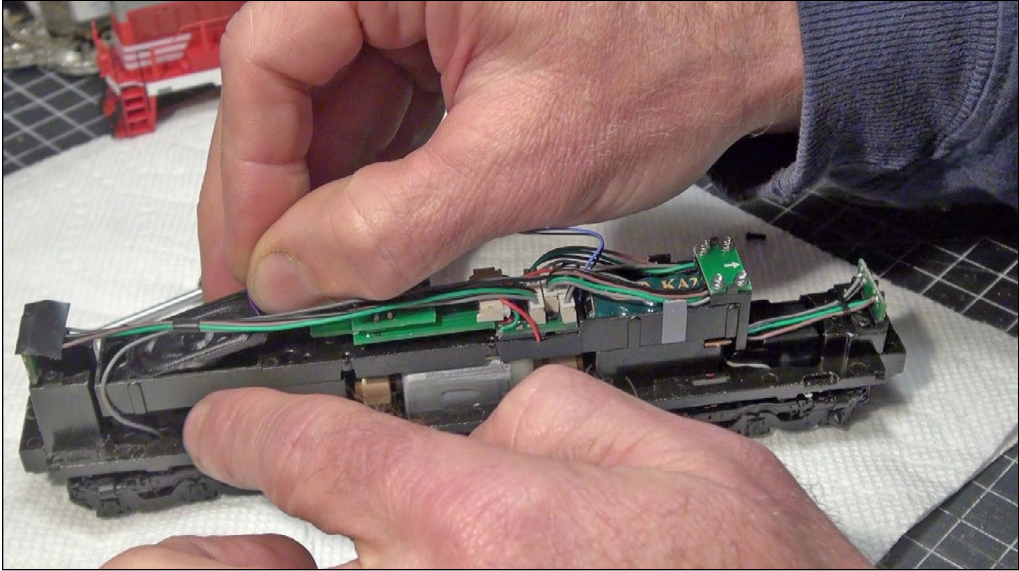

17. Using a little Walther's Goo, I installed the WOW sound 16x35 speaker into the locomotive's rear speaker housing.

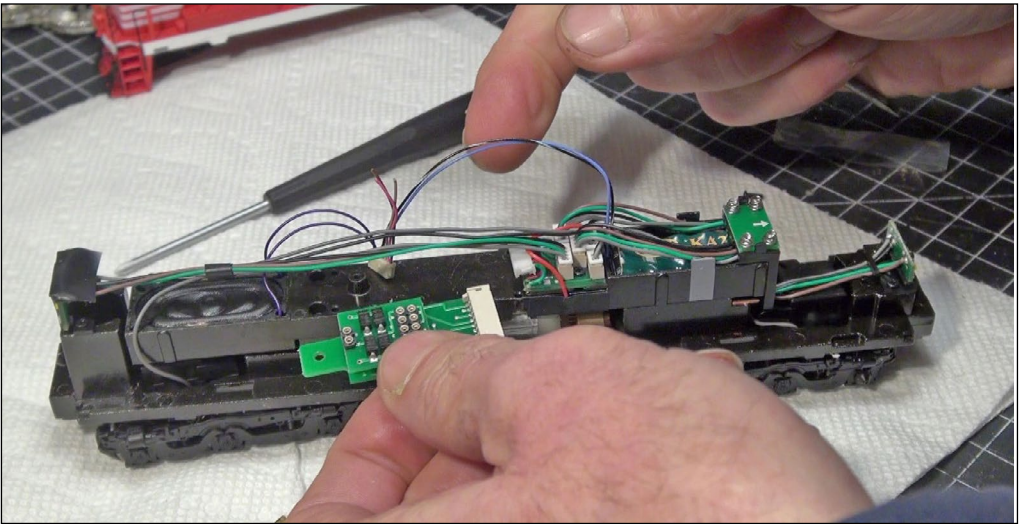

18. I pulled out and removed the locomotive's DC circuit board attached to the 9-pin harness . . .

WHAT'S NEAT | 13

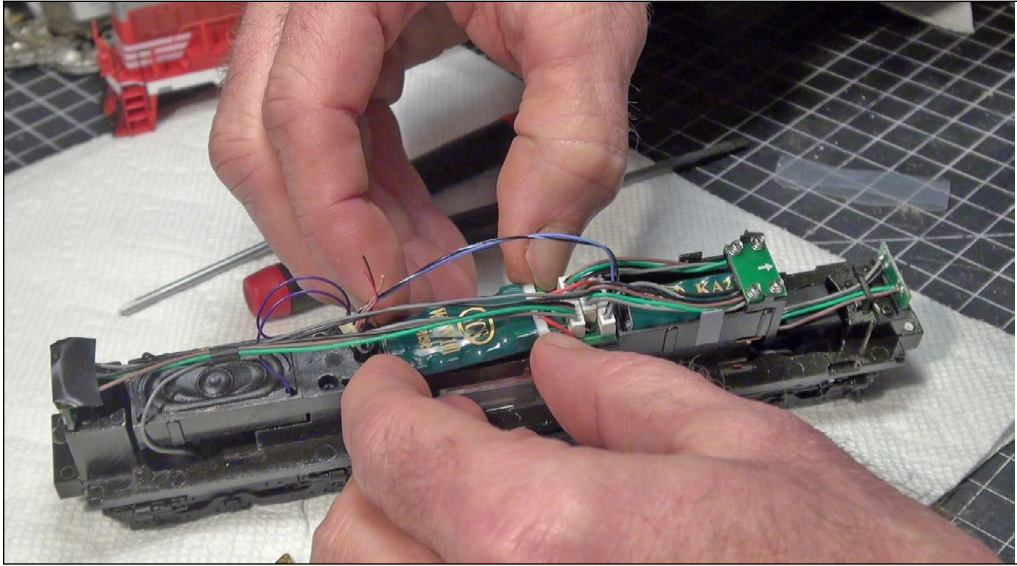

19. . . . and replaced it with the TCS decoder, plugging this into the 9-pin harness.

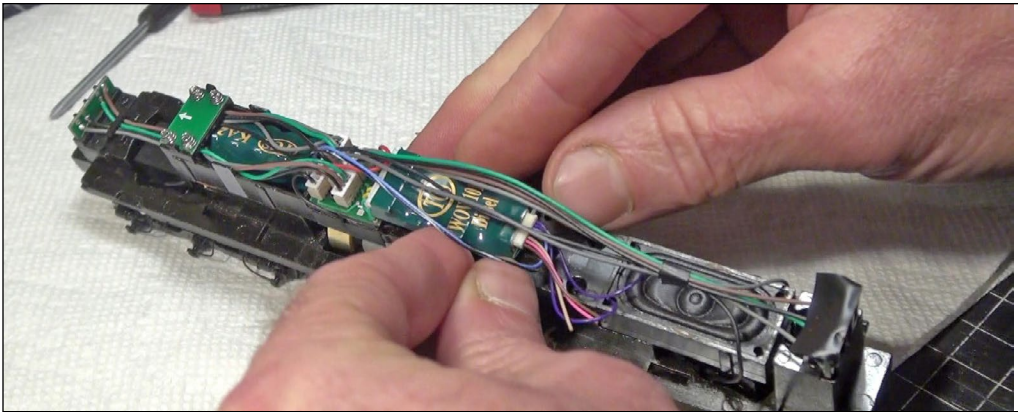

20. I plugged the speaker and keep-alive in to the decoders rear harness. That was it! Simple plug and play with no soldering. It took nine minutes from start to finish. I did the second locomotive sound and decoder installation in six minutes. Totally true.

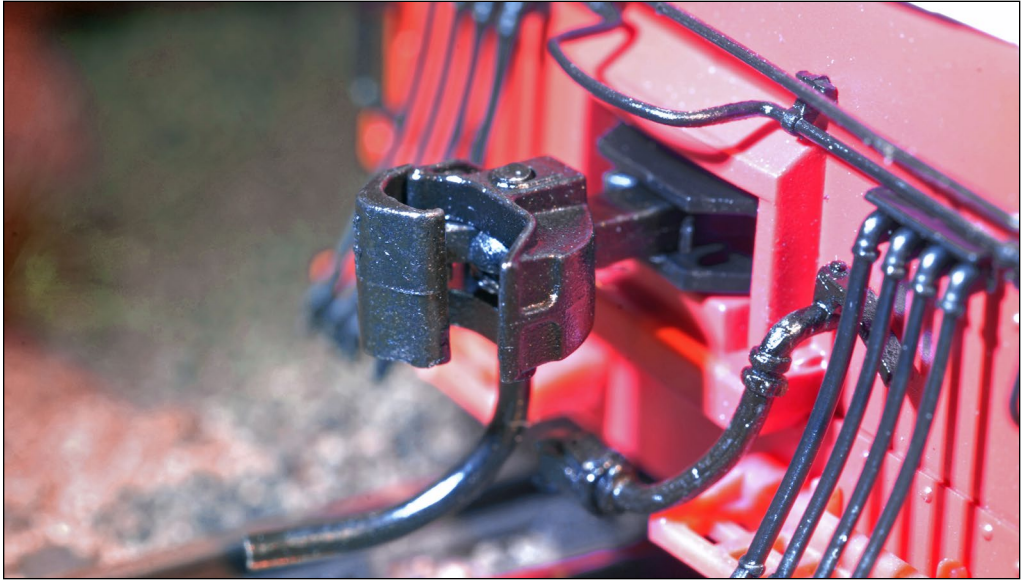

21. One thing I noticed while putting the shell back on the locomotive was the new-design metal coupler with the knuckle spring built into the assembly. Pretty neat!

***TrainMasters TV is part of
the MRH product family.***

TMTV members not only get great network TV level videos, they help pay for MRH and keep it free ...

WHAT'S NEAT | 15



22. We put the locomotives on the layout and had them pull a freight. The sound was great and very realistic. The models throttle up and down automatically depend on the grade on my layout. The decoders are also special, in that they can talk to you out loud and walk you through the entire CV programming process. Just like paying a utility bill over the phone. Pretty impressive and simple to use. See the tcsdcc.com website for very detailed information on all the features of the TCS 101 WOW Sound decoder. Also see korea-brass-usa.com.



**Click here for
reader comments**



23. Eddy Bauer used an E-Vapor cigarette to blow moisture-laden fog onto the layout's bridge scene as the locomotives ran past for the video. The vapor was heavy and followed gravity as it flowed, to create a pretty cool photography and video trick using a very common item.

**Did you know
there's an
MRH index
available?**

[CLICK TO FIND OUT MORE](#)

WHAT'S NEAT | 17



24. I build this shelf layout as part of a two-hour video available at kenpatterson.com as a download on shelf layout design. To access the town on the shelf a train has to pull up a 4 percent grade making operation interesting. Problem was, it was 73 inches high and I lost interest in running trains on it because I could not see them without standing on a stool.



25. I ripped down the shelf brackets and repositioned the scene to around 62 inches, so I could see it comfortably while standing on the floor. Now the staging yard under the shelf layout seemed too dark as the room lighting was blocked by the shelf layout.

WHAT'S NEAT | 18



26. I simply pulled the plywood roadbed, with the track still attached, loose from the wall and repositioned it with the aid of a laser level to meet with the shelf layout's new height.

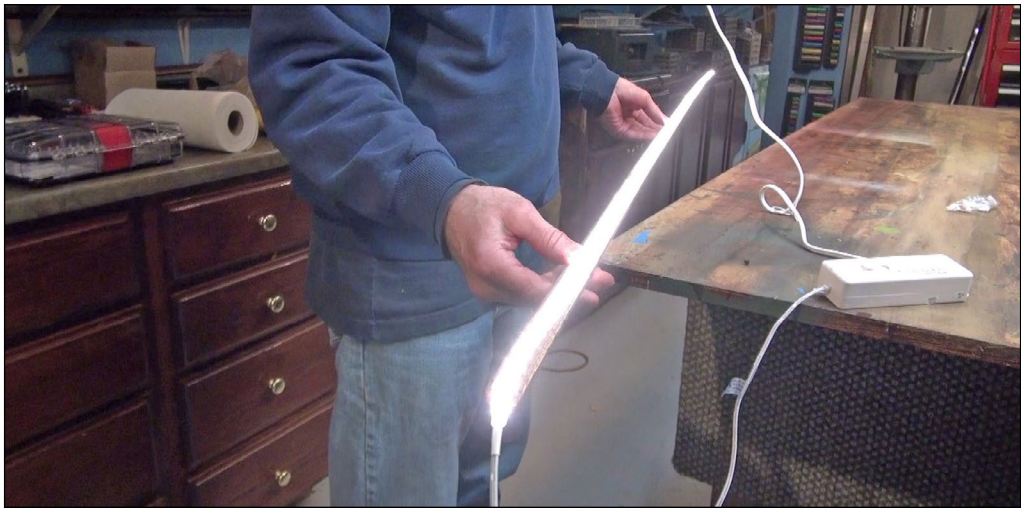

27. I took a 1/2 inch oak stock angle trim piece 8 feet long to act as a valance for a row of strip LED lights. This was going to work out well under the shelf layout. I used wood screws to attach this to the underside of the shelf layout's plywood table surface.



28. Now my staging yard, under the shelf layout, is well-lit with the new LED lights.

ADVERTISEMENT



Rusty Stumps
Scale Models

WE ONLY SELL WHAT WE MANUFACTURE

DETAILS IN HO, O, S
& N SCALES

LASER CUT SHINGLES, DOORS & WINDOWS,
FENCES, SIDING, CRATES. Also RESIN and
WHITE METAL DETAILING CASTINGS.

CRAFTSMAN KITS
IN HO, O & S SCALES

CHECK IT ALL OUT AT
WWW.RUSTYSTUMPS.COM

Send \$3.50 for Catalog - Specify Scale

RUSTY STUMPS SCALE MODELS

6785 Cherry Blossom W. Dr., Fishers IN 46038

Phone (317) 595-9489

*Learn to solder track, wiring and
brass models in this video!*

**CHECK IT
OUT!**



kenpatterson.com

click here to ...

Visit Ken's website

**Ken Patterson shows
you how to solder like
an expert!**

**VOL 2:
Diesel
Locos
coming
in May**

WEATHERING *with Mike Confalone* **Vol 1: Freight cars**

Most comprehensive freight car weathering
video set ever produced



*8 different
freight car
projects,
start to finish*

**Over 5 hours
of step-by-step
video**

Instant Download

~~\$24.99~~ **\$19.99**
HD format

GET DOWNLOAD NOW >>

Large video files: Good broadband
connection required

DVD media

~~\$44.99~~

\$29.99
+ shipping/handling

ORDER DVD SET >>

3-DISK SET

Expected to start shipping April 6th



ROB CLARK
.....

IMAGINEERING

column



[Click here for
reader comments](#)

IMAGINATIVE MODEL RAILROAD VIDEO TOOLS AND TECHNIQUES FOR “FIRST TIMERS” ...

I MUST GIVE THE USUAL WARNINGS ABOUT MY lack of expertise. This article is intended for newbie model railroad video makers, and has been written by a very newbie video maker. The advice given here is based on my personal experiences, but since most issues are faced early in the process, I think I can help first timers to “fast-track” to a reasonable result.

Those of you who have already made videos will know better, and this article will probably have as much entertainment, as educational value; regardless, please enjoy ...

The why

Why would we want to make a model railroad video?
Some possible reasons are:

▶ EXPLORING THE CREATIVE SIDES OF THE HOBBY

IMAGINEERING | 2

- For the sheer fun of it (probably the best reason of all)
- Promote your club/organization
- Promote the hobby in general
- Show friends/family what the hobby is about
- Critiquing your own work – and therefore improving

All of the above are valid, but I also see it as another tool in the box to assist in achieving reality in an imagined world.

Creating a movie involves a lot of thought about the story you are trying to convey. Probably as much about the feelings you want to convey. A lot of folks remember childhood railroading experiences and how they felt at the time and in some cases try to recreate those feelings with a model railroad.

All a bit theoretical I suppose, but for the imagineered subject the exercise of video creation is a great test of the validity of your model world: – does everything hang together well? Put another way, can you tell a story in pictures which will leave a viewer with the “feel” of your railroad?

This is an exercise that you can also do with still photography, which is a great way of putting your RR under the microscope and highlighting things that can be improved. Video is equally revealing and probably a lot less forgiving. That pleasant, “Is it a model?” moment is going to be a lot less frequent! Some warnings- This is an addictive and time consuming facet of the hobby. Make sure you don’t divert too much effort from your main construction tasks.

You can spend ludicrous amounts of cash on camera gizmos. I suggest you don’t, unless you’re planning to make some kind of career or revenue stream out of this.



1. I use a Nikon D5100 shown here fitted with 18-55mm VR Kit lens which is very versatile. I also use a Nikkor 35mm f/1.8G prime (no zoom) lens, for better light capture in more challenging situations.

If anyone other than you is going to see the results, then do the best possible job you can, because if you mess up you run the risk of getting “negative publicity effect.”

So, motivational speech and cautions out of the way – how do we go about it?

There is a very clear division between technical (tools) and the artistic (techniques) issues. So we will proceed first with technical, which is probably the easier of the two. If you are confident with the equipment you already have, then skip straight to the post-production section.

The camera

You need to take some moving pictures and with today’s rapidly improving technologies this is pretty straightforward. Camcorders, Smart phones and DSLR cameras are all options.

Smart phones are getting very good at movie recording and the main problem is camera shake. Just taping your camera to a tripod head is going to help solve that one! They also open up opportunities to film from unusual angles and at a push, can operate on a camera car for “in cab” shots.

The technical section of this article focusses (excuse the pun) on using a DSLR (Digital Single Lens Reflex) camera to record video, mainly because that’s how I prefer to do it, in my case with a modest Nikon D5100 [1]. Many people have a DSLR and despite not being their primary function, they can do an excellent job of video recording, as long as your understand the issues.

If you have a decent quality camcorder, things are easier for you, because you pretty much point and shoot. However, where the DSLR scores over a standard video camera is because of its flexibility. You can use different lenses and control depth of field, which permits a much more professional finish than you can get with camcorder type equipment.

We cover the basics of how to do this in the sections ahead, but when you have finished reading this article, you can check out the following links for additional information on using DSLRs for HD video:

youtube.com/watch?v=cgZ4yhhI9Qw

youtube.com/watch?v=w8BzeZEGEYY

youtube.com/watch?v=5Qsi2kkz6Jg

Taking control

Cameras have many “auto” settings that make life a whole lot easier for the still photographer. For the movie maker, these get in the way – for example; autofocus and white balance are going to

trip you up. The camera will focus on the thing you don't want it to, and the color balance may oscillate like a 1950s sci-fi B movie. Also, if you are using the built-in microphone it will pick up motor whirr as the focus changes – not good!

In short, you need to take control. Let's look at the various topics.

Focus

Switch off the autofocus and start practicing the manual way. Don't underestimate how important and tricky this is. You may have seen "Focus Puller" mentioned in movie credits.

It's complicated enough to merit a separate and skilful camera-man trade, and for me it's the main thing to practice. Unlike most other visual problems, focus can't be "fixed" post-production – it's either right or wrong. Sadly, no one will notice when you get it right – it's expected. Manual focus also has the advantage of allowing you to deliberately focus (or not) on subjects you want to emphasize.

White balance

Auto white balance should be turned off or your camera will be constantly trying (and failing) to adjust the white balance of the picture, resulting in partial "white-outs." It's best to set a custom white balance for the shooting conditions you have; instructions for this step will come with your camera.

Essentially you use a custom white balance option to take a picture of a sheet of white paper under the lighting conditions you will use for the final shot. The camera then has a datum point for what "white" looks like, and can it adjust the other colors accordingly.

Frame rate and shutter speed

If you need maximum detail (let's say you want to show your finished video on a full HD monitor or TV), then you want to



2. I recommend using “custom” picture control. Note that sharpening and contrast are set to minimum and saturation one notch above minimum. You may need to experiment using your own camera.

shoot for a wide-screen aspect ratio of 16:9 (1920 x 1080 pixel frame size) typically shot at a frame rate of 24 fps (frames per second), or 30 fps for a smoother effect.

To get good, smooth-looking video footage with “natural” motion, you need to match up your shutter speed and frame rate. This means using a shutter speed of 1/50th if shooting at 24 fps, 1/60th when shooting at 30 fps, or 1/125th when shooting at 60 fps, if your camera is up to it.

You can break these rules if you want to. For example, shooting at slower shutter speeds will add more blur to your footage and can make it look more “dreamy,” while using faster shutter

IMAGINEERING | 7

speeds can give it a hectic feel. Note that AE l (automatic exposure) lock is required to prevent the camera changing exposure dynamically – again look to your own camera manual for specific instructions.

Custom picture control

Most DSLRs can take still photos in RAW format, but generally only JPEG for video (which is essentially a series of JPEG images). This means you have less digital information in each video frame, and to get maximum clarity, you'll want to shoot using a custom profile [2]. This can result in a dim image, but the detail is “locked in” and you can use video editing tools (gamma, gain, contrast, and brightness) to pull out that detail. An over-exposed or washed-out shot is very difficult, if not impossible to recover.

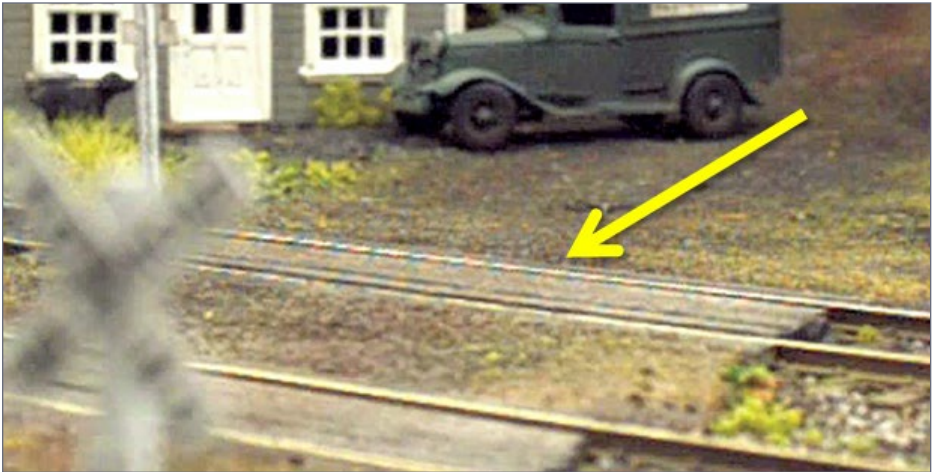

3. Moiré occurs when a scene contains repetitive details (such as lines, dots, etc.) that exceed the camera's sensor resolution. Changing the distance from the subject or the angle of the shot will cure this

Zooming

Unless you are using a camera that has constant-aperture zoom lens, the camera aperture will change when you use zoom, and this can affect your exposure. As you zoom in, things get dim! You need to set your aperture (f/stop) to the smallest aperture that keeps your shot in focus when you finish the zoom. Alternatively you can use post-production software (see later) to zoom (and pan) within the limits of the frame size you have shot.

ISO and video noise

Noise is the grainy effect you get when the camera sensor is struggling to collect digital information because of low light levels.

You want to shoot with the lowest ISO (“film speed”) setting you can get away with, but because you have to fix the shutter speed to match your desired frame rate, your range is restricted.

Your camera should allow you to limit the maximum ISO it uses – I get good results up to 1250. But the best answer is light and more light, so see the section on lighting. It’s worth taking some time to experiment with different ISO settings to get the best result for the lighting conditions you are working under. Rules are there to be broken!

Moiré

Moiré patterning occurs when the scene being photographed contains repetitive details (such as lines, dots, etc.) that exceed the camera’s sensor resolution. The result is a strange-looking wavy pattern.

Moiré is most common with man-made objects, and in our model world, the rail head is a strong candidate for this problem [3]. If you find moiré in your footage, it’s nigh on impossible to correct it in post-production, so you need to check your shot

as soon as you have taken it to ensure it's OK. The best way is to view on a laptop computer (see later).

If you have moiré, then you need to change the camera distance or angle to the subject.

Jello

DSLRs have a thing called a rolling shutter, which means the whole image isn't exposed at one time (professional video cameras have a global shutter and avoid this problem). This very slight time lag with a rolling shutter can cause subjects to appear to wobble in video footage if pans are made too quickly, and sometimes a vertical object can look like it is leaning.

To counter the "jello effect" when shooting with a DSLR, you need to slow down the camera movement. You may be able to counter some minor wobbles during post-production, depending on the software you are using, but best to avoid by panning smoothly.

Heat

Avoid taking very long shots. The sensor in a DSLR normally operates in very short bursts as the viewfinder mirror flips up. In movie (live view) mode, the mirror stays up and the sensor runs continuously, so it can overheat, possibly causing damage.

This shouldn't be an issue if you follow the shot-taking guidelines provided later in the "artistic" section of this article.

Memory card

It may seem like a small thing, but make sure you buy a good quality (read: fast) memory card for your camera. Ten megabytes-per-second is a good compromise between cost and performance.



4. You don't have to spend a fortune on a tripod, but remember, you get what you pay for. The picture is big because the subject is vitally important.



5. This fluid-damped head is affordable and pretty much guarantees smooth panning. It's also very pleasant to use for still photography, and is another all-round good investment.

Batteries

Movie mode on DSLRs eats battery power. Always have a charged spare available, and get into the habit of immediately putting your flat battery on charge. There is nothing more irritating than having a creative surge stopped by a dead camera.

Cleaning

Clean your lens before you shoot. With a still shot, you can Photoshop-fix a dust or hair blemish – not so with video!

The tripod

You need one, and consider this is an absolute must (Joey Ricard does an informative and amusing YouTube video on photography, with very relevant reference to tripods).

Nothing spoils a video more than wobbly shots. Chances are you will already have one if you are taking static shots of your railroad but if not, get one and as with anything, you get what you pay for [4].

IMAGINEERING | 12

My first purchase was a very cheap model, and this produced problems. Even just altering the focus during a moving shot resulted in a small amount of camera shake. The same rules apply to the tripod head. If you want to track a moving subject, then it's worth getting a higher specification head. It's quite possible to work without one, but be prepared for a few re-takes and a small amount of wobble. As mentioned earlier, it is possible in post-production to remove small amounts of wobble using a "stabilize" software plugin, but don't expect miracles.

I have recently upgraded to a fluid damped head and am much happier [5].

The specialist kit is out there if you want to spend the money, but we are going to ignore stabilizers, dollies, and camera sliders – this is an introductory article, and I don't use them anyway!



6. You need the maximum amount of light on your scene to avoid video noise. Daylight is great, but difficult to import into your railroad room, so try some spotlights.

If you really want a moving point of view, then shorten your tripod legs and pick up the camera by the tripod head when you shoot and move. The counterbalance of the tripod legs creates a damping effect, and your camera shot will appear much smoother as you move.

Light

You need lots of light – the more the merrier.

I use both the model railroad built-in lights and spotlights [6]. These are very economical (albeit bulky) “soft box” lights fitted with daylight-balanced, compact fluorescent bulbs. Similar “umbrella” variants can be purchased.

I’m lucky in that the color temperature of my railroad room and photography spot lights are close. It’s best not to mix different types of light (e.g., incandescent and fluorescent) because you can get some strange color tints due to your camera white balance being unable to cope.

You need at least two lights, and these should be arranged to avoid shadow (unless that’s an effect you want). Don’t get hung up about the theory, just position the lights obliquely and look at the scene. Does it look evenly lit? Move the lights around until you are satisfied. Try different heights as well. Trust your eyes!

Same rules apply as for static photography. What time of day? where is the sun? But bear in mind that a moving object may move from a well-lit area to a badly lit one if the shot is long enough.

I usually go for an even spread of light with no shadows anywhere, but that’s personal preference.

Monitoring your shot

The problem here is that you can’t use the camera viewfinder. When a DSLR is in movie mode, the mirror is retracted and

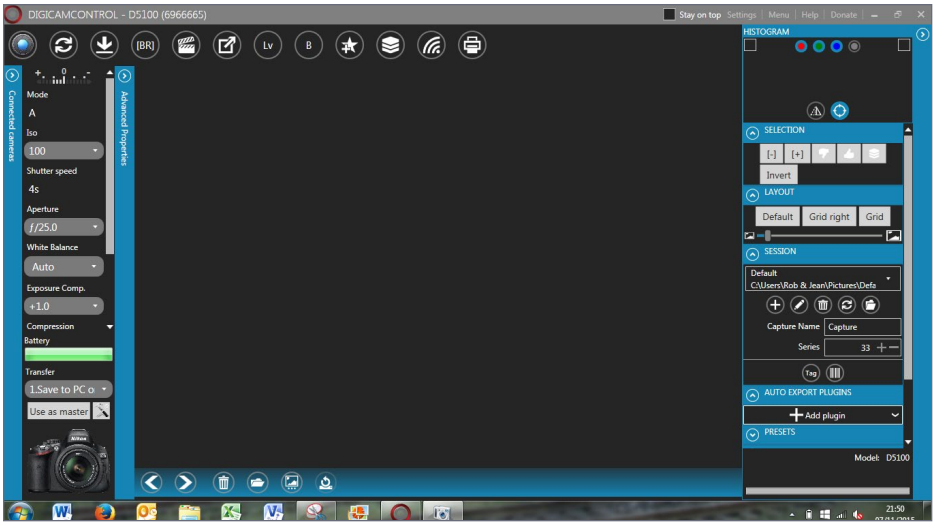

7a-b. (Top and bottom) Digicamcontrol is an example of software that allows you to control your camera from your laptop. It's also great for taking automatic multiple focus shots for still photography "focus stacking."

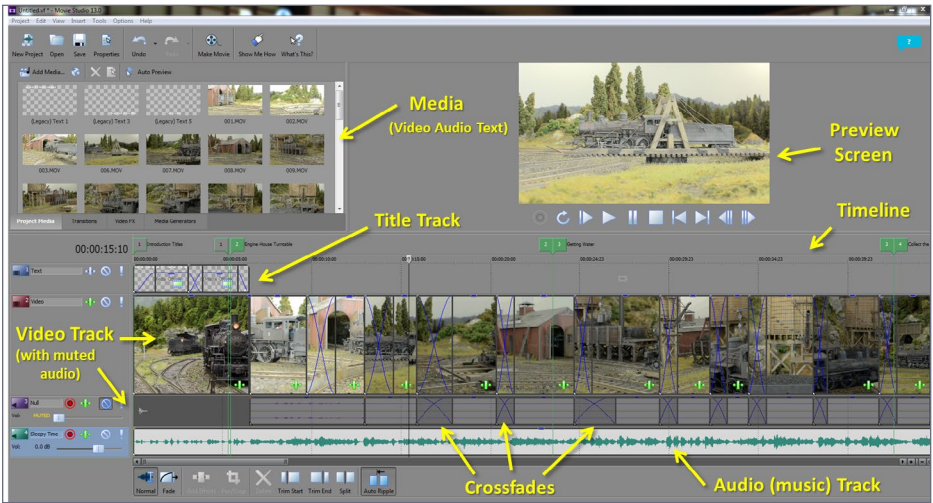

8. Video editing software provides the “workshop” where you assemble the final product. This is Sony Movie Studio 13, but many other good products are available and most operate in a similar way.

you see a “Live View” picture on the small screen on the camera. This is difficult to use when trying to focus accurately, especially if you have a moving object (front/back of shot). You can buy loupe devices to attach to your camera live view screen and convert it to a viewfinder, but I haven’t tried this so can’t comment on their effectiveness.

I prefer to use a laptop to view the image at a good size. You can just connect the camera to the laptop with an HDMI cable, but I prefer use a piece of free software called Digicamcontrol [7].

This provides (among many other useful features) a live view on your laptop/PC and full camera control so you can clearly see what you are recording, and also start/stop recording on a mouse click.

Post-production

You will need some software to assemble your video shots, integrate audio, and still photos, and add titles. As with every aspect of this hobby, you can spend as much or as little as you like.

The operating principle is much the same with all video editing products. You have a “timeline” working area, with separate video/audio/title channels and after importing your media (video, sound, still pictures) you drag and drop onto the timeline in the desired sequence [8].

You can trim the start and end of each shot to make things flow – add some cross-fade. Add some audio. Finally, render the movie with the best settings (resolution, aspect ratio format) for your desired output medium e.g. Internet video, big screen, or PC monitor.

Windows Movie Maker is free and has all of the basic features you need to make a fun movie. It’s a good way to ‘dip your toe in the water’ before you commit to any upgraded software purchase.

I use Sony Movie Studio 13 (Joe Fugate guided me on this choice) but lots of others are available. SMS 13 is a good compromise between features and cost, and is the little brother of the Sony professional VEGAS product. If you spend a little extra cash on software, you get lots of audio and video “plug ins” that can pay dividends in terms of finished quality. One of the particularly useful video features is the capability to zoom in or out and also pan (simultaneously if you like), and this can follow any pre-programmed speed or direction.

We don’t have time to go into the depths of video editing software here – it’s too broad a topic, so whatever software you use you will need to spend some time familiarizing yourself with its operation and features.



9. An external microphone is preferable to using the camera microphone. This directional condenser microphone was very inexpensive.

This is fun in its own right and pays off handsomely when you are making a movie for real, because you don't keep getting interrupted while hunting for a feature.

Sound

Your camera can record audio when you are taking the shot. I rarely use a soundtrack recorded this way because of quality problems. I recommend an external microphone [9] for best quality, and also being able to place the mike nearer the sound source (e.g. if you have sound equipped locomotives.) Again, you can spend as much money as you want!

If you need to add a music track then (free) software like Audacity provides everything you need to 'manage' the sounds [10].

One of its very useful features is the ability to cut and paste sections of music so that you can shorten or lengthen a piece (provided there is a clearly identifiable section that repeats).

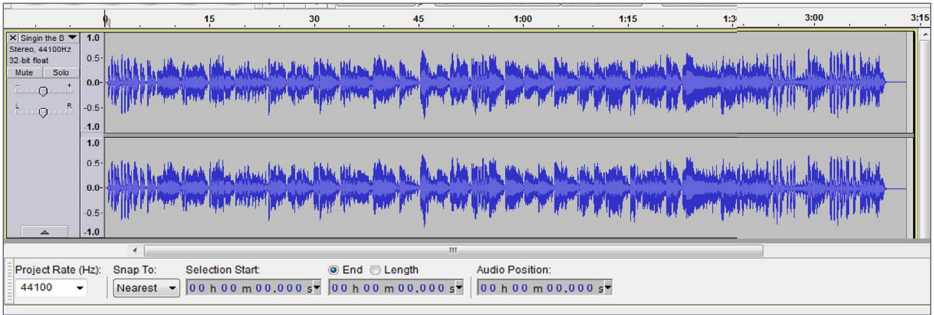

10. Audacity is a great (free) audio editor with a vast array of features. You can even use it to make your own cell phone ring tones.

The track waveform picture can be zoomed and this allows precise identification of the start and end of the clip you want. I used this feature to add 30 seconds to the music track on the C&A video in the Nov 2015 MRH. The audio join is seamless!

In all of this you have to be very mindful of copyright infringement, a topic which we will return to at the end of this column.

You can also ‘rip’ a sound sample from an audio source and then use it in your own video. This is very useful for locomotive sound effects.

SMS 13 also has impressive audio plug-ins. For example, pitch shifting, time stretching, reverb, and compression are useful if you want to simulate “Doppler” effect as a train goes by.

The artistic side

This is where the real fun starts. All the tools are in place and you “just” need to get creative.

Storyboard

There is a great temptation to take some shots and create a movie as fast as possible. I encourage this “dive in and splish about” approach for a first effort – you will have great fun and learn a lot, but the end result might be patchy.

If you want something a bit more professional, you need a story – no matter how short. Remember what we said about getting the “feel.”

First try to write down a sentence that describes the overall event that the movie attempts to portray. You’re OK to run to two or three if things are complicated.

- The Atherton Local is prepared in the yard and then takes a selection of cars to Cornhill.
- The freight has derailed and the ‘big hook’ is needed.
- Waiting for the west bound express in the center of town.

Think out what is happening and write a description of each scene to be photographed. You don’t have to draw all of the storyboard pictures like they do in the real movies. For one thing, you already have the ‘sets’ created.

You could also try setting up and photographing a series of storyboard stills and then view them as a slide show:

- Does the story flow?
- Are the views attractive?
- Do things appear in a logical sequence?

This can be a fun exercise in its own right!

At some point though, you need to commit everything to “paper.” As an example [11] is the first cut storyboard for my last video.

The movie ended up deviating somewhat from this initial plan, but it formed an invaluable “work-to” sheet to manage the process of scene taking.

Scene composition

This is similar in basic principle to still picture composition. We dealt with these composition techniques in the last C&A Imagineering column and they are also valid for videos.

IMAGINEERING | 20

However, the big difference is that unlike still photos where the composition is fixed, with a movie it can be constantly changing, both within a shot and between shots.

The local travels from Atherton to Cornhill” – 2 to 3 minutes in total

The journey stops visually when the train leaves Widows Veil trestle – nowhere else to go!

Opening static shots of engines at Mortimer (2-3 available).

Titles “The C&A RR” – “Imagineering the 1930s short line”.

- 1) Engine number 1 comes out of engine house and onto turntable (2 shots)
- 2) Turntable rotating (1 shot)
- 3) Leaving turntable (2 shots)
- 4) Travel to the water tower and stop (2 shots)
- 5) Watering scene with locomotive number 3 passing by number 1 (2 shots).
- 6) Number 1 moves off from water tank – (2 shots) - will need some scenery flats to block aisle shot.
- 7) Establishing shot of tank and flat at Spock’s with number 1 moving in the distance (1 shot)
- 8) Number 1 backing up to tank and flat (1 shot)
- 9) Coupling close up (1 macro shot)
- 10) Pulling away from Spocks (1 shot)
- 11) Backing onto caboose at Morocco tunnel (1 shot)
- 12) Pulling away from Morocco tunnel (1 shot)
- 13) Rounding the curve at Spangler Gap (1 shot)
- 14) Establishing shot of Mortimer with local approaching in the distance (1 shot)
- 15) Pulling into Mortimer (rolling shot)
- 16) Stopping in Mortimer showing Heisler waiting in siding (1 shot).
- 17) Heisler engine starting close up – (1 macro shot)
- 18) Logger pulling out of Mortimer (1 shot)
- 19) Local leaving Mortimer (1 shot)
- 20) Pulling round curve (1 shot)
- 21) Entering Matrimony Hill (1 shot)
- 22) Branum Pass – tunnel exit (1 shot)
- 23) Branum Pass - Tunnel entrance (1 shot)
- 24) Widows veil trestle – tunnel exit onto bridge (1 shot)
- 25) Widows Veil trestle - rolling by looking up (1 shot)
- 26) Widows veil trestle - tunnel entrance (1 shot)
- 27) Widows veil exit showing unfinished railroad (humour shot)
- 28) Final static shot – Panoramic Shakkei static view (1 panning? shot)

34 shots in total – at 4 second average = 136 seconds – trim to 2 minutes?

Jazz music on soundtrack – medium tempo, Possibly some muted sound effect

Consider moving camera dolly idea, Consider a moving camera car shot

11. A sample storyboard for the video that accompanied the November 2015 Imagineering column.

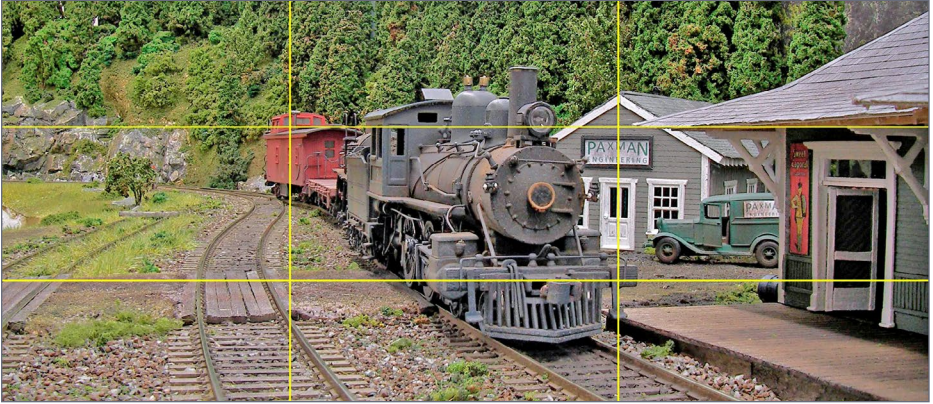

12. Rule of thirds: OK – it’s a fixed shot, but notice how the loco and caboose sit in the central third. The station roof and walls are neatly split between thirds, the road sits neatly below the lower third and the Paxman sign on the building almost hits an intersection point. It’s “easy on the eye,” folks.

The “rule of thirds” is a good yardstick [12] for something that is pleasing to the eye. Even when objects move in the composition they should start/end in a third/intersection or move in a “thirty” way.

As usual – you can break the rules, but at least understand them!

Synchronizing movement between scenes

I’m sure all of you have spotted continuity errors in movies. If you frequent Internet sites like IMDB (International Movie Data Base), you’ll see there is a community out there who delight in documenting every movie-making mistake they can find, and to be fair – it’s very interesting and educational.

You need to be very aware of how fast your train is running. Things are straightforward if your target train is moving at a fixed rate.

Just make sure that you have enough “leader” on your shot to get the locomotive up to speed – consider turning off momentum effects for the filming exercise, where the train is continuously moving between shots. Things get a lot harder when your train is changing speed and you have a few linked shots – pulling into a station and stopping for example.

You need to match the exit speed of the preceding shot to the entry speed of the current shot. You will be amazed at how easily a viewer (even those not “movie-savvy”) can instinctively spot a minor anomaly between shots. A trick I occasionally use is to overlap the shots (just drag one over the other in SMS 13) so that you get a crossfaded transitions. This hides some sins, but not all.

A crossfade is also a visually pleasant way to transition between still pictures, and I often use overlapping dissolves. While we are talking about crossfade options, there are many available: peeling pages, checkerboard dissolves, horizontal spin ...

In my personal opinion, the vast majority of them are horrible and scream “amateur” – avoid.

If your train is moving left in the first shot, then keep it moving left, or people will automatically perceive it as different train running in the opposite direction.

In a similar vein, try not to alter the vertical position of the train between shots. For example, if it exits the screen at the top, make sure it doesn't enter the screen at the bottom of the next shot. This isn't as dramatic an “error” as the left/right thing, but your viewer will still register a visual disconnect.

You can break this rule if there is some event (like entering a tunnel) that mentally breaks the link between one shot and the next.

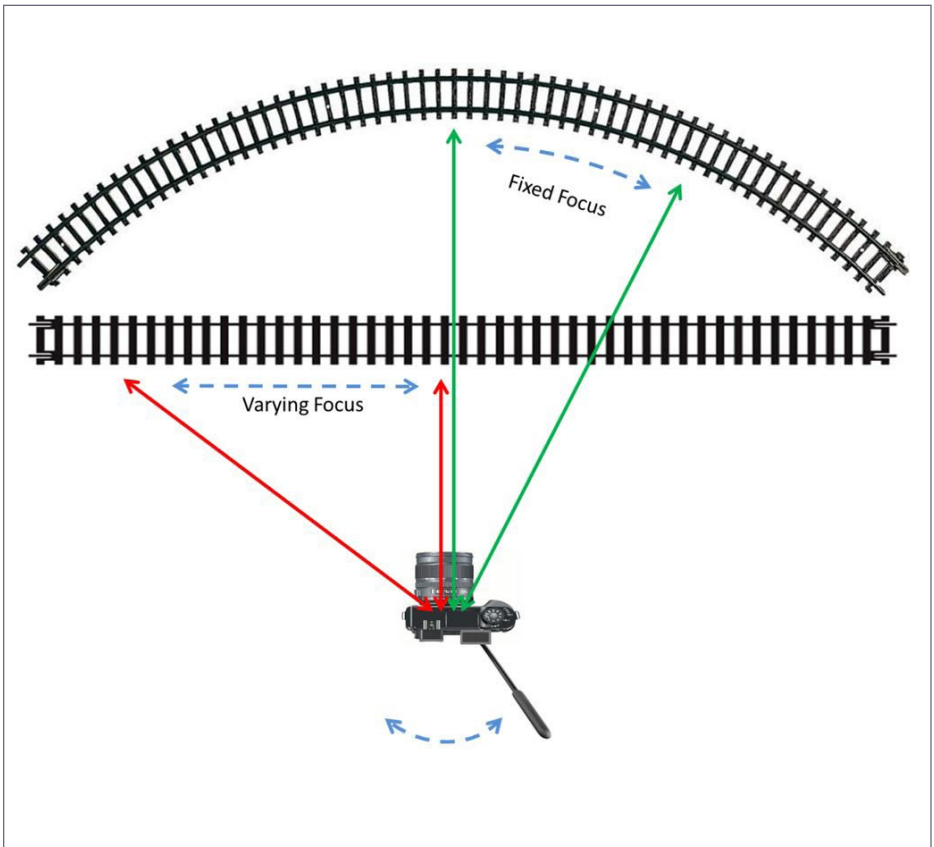

13. Panning is much easier when the target maintains a fixed distance to the camera. Otherwise you need to alter focus at the same time as you pan.

Panning

Panning (like focus) takes some practice. Pan speed should generally match that of the target, and even if it doesn't, it needs to be smooth. Panning also increases digital data collection issues for the camera sensor. A fast pan will introduce motion blur and possibly noise.

So try to keep train speeds slow or at least slower if the train is close to the camera, thereby reducing the need for a fast pan. A pan-related issue is changing focus [13]. If the train runs past on a straight track, you will need to simultaneously pan and alter the focus. All absolutely do-able, but only with practice.

You can reduce or even eliminate the need to change focus by taking your shot on the inside of a curve. Then a panning shot can maintain the same distance to your subject, reducing the risk of focus drift. Otherwise, just keep on practicing.

Zooming

Zooming (just like pan and focus) takes some practice. It needs to be smooth and slow, and above all, used with discretion.

I find zooming can disorient the viewer. I suspect because unlike panning and focus, the human eye doesn't zoom naturally.

We covered the technical issues of zoom in the previous section. It's a balancing act between getting as much depth of field as possible to hold focus, versus the dimming effect as you zoom-in.

As mentioned earlier you can use your video editing software instead of the camera to pan and zoom. SMS13 allows very precise control of simultaneous pan and zoom with user-selectable motion paths. The obvious advantage is that, if original shot was in focus, it will stay that way whatever motion effect you apply – very versatile.

However, zooming-in too much can produce picture resolution issues, and of course your original shot has to be wide enough to encompass your panning extremes.

Practice the shot – rehearsal mode: Length of shot

People get bored *very* quickly. I think 4-5 seconds is a comfortable average length in train videos, with a max of 8-10 seconds.



14. You need to practice each shot:- dummy run, then filmed run, view and check, adjust if necessary, another dummy run, confirm all good, then real take, final viewing, save to the film clip folder on your PC (in my case central workstation via network since Digicamcontrol keeps a local copy anyway). Finally write down your notes. Repeat as required. Phew..... anyone for a beer (or coffee)?

Videos of 100-car trains passing over a bridge are (in general) not riveting material. Conversely, don't disorient the viewer by jumping quickly between unconnected events, unless this is a specific requirement, like a summary montage of shots, which the viewer has seen, or will see later.

Overlapping crossfades can be used to "compress" a sequence. If you want to show all of the train moving past a point, then split the full length shot into multiple sections, trim each one down, and then "crossfade" the joins. I used this quite a lot in the November column's additional video. It maintains the continuity of the event without committing to the full elapsed time.

On a similar topic, avoid long introduction and credit sequences. People want to see the main feature, and will very

quickly get irritated waiting, with the risk that they stop watching altogether. The casual viewer is easily lost. If we are honest, most people really don't care that this is a "Robert Clark Production Company Epic" and that Ethel Perkins made the tea.

Subtitles (or not?)

A lot depends on the style of movie you are creating. A subtitle can be very useful if you are documenting a fact, whether it is technical or historical.

You will see me using subtitles on the videos that accompany this column because they are intended to be instructional, rather than purely entertaining. Also, I don't like the sound of my own voice attempting narration.

On the other hand, if you have a pleasant, clear, natural-sounding voice (or know someone who does,) then by all means add a narrative. If you have a narrator, you certainly don't need to repeat what they have said in a subtitle (unless of course you are supporting a hard-of-hearing audience).

In general I say avoid subtitles unless absolutely necessary – let the picture and the sound tell the story.

Pre-shooting "rules"

For every shot in the storyboard:

- Audit the location for obvious visual problems – glue splodges, stuff that's fallen over, dog hair (it happens) – anything that looks wrong.
- Perform visual checks on the train equipment you plan to use – paint scuffs, missing handrails?
- Clean the track and test reliable operation of the actual equipment you plan to use.

For each individual shot:

- Set up lights and confirm no shadows
- Calibrate white balance on camera
- Confirm all camera settings are correct for movie taking
- AE lock camera for correct shutter speed
- Dry-run everything

Shooting “rules”

- Annotate your shots correctly (sequence, storyboard number date/time, locomotive speed setting – whatever) and write everything down as you do it.
- Record the camera settings you used (Digicamcontrol is great here, because you get all the data in a sidebar).
- Don’t be afraid to re-shoot as many times as it needs to get it right. You will always regret the weakness of succumbing to a “shucks, that’ll do” moment.
- Always add some extra lead-in/lead-out time on each shot. It eases synchronization of shots, and gives you a few seconds to settle into “cameraman mode” and confirm everything looks OK in the frame.
- Make sure you don’t change the visuals of the train. The main continuity fluffs I have suffered are headlight on/off and speed differences.
- Perform a video quality check by viewing what you have just recorded, before you move on to the next set of scenes. It saves having to set everything up again.
- I’m going to say it again: There is a great temptation not to write notes – you will regret this.

This may sound like I’m barking a set of commands at you like a drill sergeant, but it’s actually based on my experiences/mistakes.

Soundtrack

I rarely use camera-recorded sound in a movie. You have way more control dubbing-in stuff afterward. If you have a sound-equipped locomotive, by all means record it, but be prepared to do some editing to get the best result. “Real” train sounds are usually more effective, but again be prepared to do some editing to get the best fit to your shot(s).

There are plenty of free sources of excellent sound effects on the net, often royalty-free. A credit to the original provider somewhere in your titles or credits usually covers permission for your use. Consider recording your own sound effects when visiting railroad attractions, or in fact anywhere with some good ambient noises.

ADVERTISEMENT

Lasercut kits and details *O, S, HO, TT and N scale*



New kit
“The Grove”
HO, N and
TT scales



Custom cutting, Scratch Building supplies
ASPEN Models N, Nn3 and Z scale

Rslaserkits



Music overdub

Pick something appropriate, or at least inoffensive. Just because you love a piece of music doesn't mean it fits the mood of your video.

I wince when a railroad clip starts with a heavy metal chord. Consider era, geographical location, and energy level of the video. Because my railroad is set in the 1930s, I like to use music recorded in that era and I find jazz/ragtime are very appropriate.

You can use changes of music/pace throughout the video to fit the mood. It helps to synchronize changes in the music with scene changes, although this can be tricky.

“Big movie” music is usually written to fit the story, but most of us will be using off-the-shelf stuff. At least try to synchronize the start-up titles with the introductory bars and make sure the music ends at the same time as the movie.

Copyright

If your movie is for personal use, or a very limited audience, then copyright isn't an issue. But take great care about using copyrighted video/audio material if you plan to publish your work. Obtaining permission to use copyrighted material is harder than it sounds, and probably not worth the grief.

If you use YouTube or Facebook as a delivery method for your work, you will find they do an automated audio copyright check when you upload. I have been astonished to find that the most obscure and ancient pieces of music are owned by “somebody.”

You may find that use of copyrighted music is permitted, but results in pop-up ads on your YouTube video.

IMAGINEERING | 30

Personally I think it's a small price to pay if you have a good soundtrack, but you will have to either mute it or find some non-copyrighted material if you are planning to earn money from your work ('monetize' is the term).

Just to re-iterate - If in any doubt about copyright (beyond personal use), avoid using the material!

Preaching and practicing

I've done a lot of talking about video so far, but video has to be "seen," so take a few minutes to look at these two offerings and see if I can practice what I preach.

Firstly we create a short movie [15] from a storyboard [16].

The movie was made with direct reference to the story, which remains in its original form. It's interesting to see the changes between the initial concept and what was finally delivered – see if you can spot the differences.



15. Shooting the video.

Theme is “Location shoot for a Movie”

Establishing shots of location

- Different shots of buildings ; nobody about ...
- Perhaps door closing or swinging in the breeze
- Car with idling engine with owner elsewhere?
- Camera crew waiting patiently

Peace and Quiet (bird song)

Train in transit but not yet here

- establish upcoming excitement

Train visible in distance

- build the tension (Camera crew point of view)

Whooshing through

- dramatic pan
- climatic point
- flying leaves/rubbish/dust (how????)

Disappearing into the distance

Re-establish calm

Final (un)establishing shot(s).

16. First-cut story board. Match it up with the movie and see what changes were made.

You should never be afraid to improvise or introduce extra elements when you get some “on set” inspiration. The key thing is to have enough material to get good ‘flow’ when you are editing.

The second movie is the ‘Bloopers reel’ where we see the majority of the things that can go wrong.

Making a mistake is like falling off a log. Deliberately making a mistake that looks accidental is much trickier than you might think. I spent as much time on the bloopers reel as the main feature!

The epilogue

We have skimmed over a vast array of topics here, and I make no apology for that. If you think that model railroad story-telling through the medium of a movie looks interesting, then try it out and spend as near to zero as you can. If the bug bites, then you can start searching for more detailed support information and spend some cash on equipment that helps eliminate the problems that are bugging you.

The technical side is a relatively small hurdle to overcome. You could pick up a smart phone and start!

The opportunities and pitfalls are in the artistic side. Try to tell a story and weave it round the spirit of your model world.

I can guarantee you will get better results with every attempt, and also learn more from your mistakes than anything I can tell you here. Practice, practice, practice. There really is no substitute, and you will have great fun trying. ✓



[Click here for
reader comments](#)



Playback problems? [Click here ...](#)



Playback problems? [Click here ...](#)

Important terms supplement

April 2016 Imagineering

BY ROB CLARK

.....

CAMERA FUNCTION & VIDEO TERMS

DSLR - Digital single lens reflex In a camera reflex design, light travels through the lens, then to a mirror that can send the image to either the viewfinder or the camera's image sensor. The alternative would be to have a viewfinder with its own lens, hence the term "single lens" for this design. By using only one lens, the viewfinder shows the user almost exactly the same picture that the camera is going to take. digital-slr-guide.com/what-is-a-digital-slr.html.

Autofocus - Autofocus is found in digital camera software and in smartphone camera modules, giving the device the ability to automatically focus on a subject correctly, without the need of manual intervention from the user. cambridgeincolour.com/tutorials/camera-autofocus.htm.

White balance - White balance is a camera setting that adjusts for lighting in order to make white objects appear white in photos. This is more difficult than it might seem due to the fact that light cast from different sources is different in color (technically called color temperature). That is to say, light is rarely truly white in nature. The light from an incandescent or halogen bulb, for example, is red/orange in color, while that from the sun is relatively blue. A proper white balance setting in a camera will prevent, for example, a white bed sheet in a photo from appearing orange in color when it is being illuminated by a candle. cambridgeincolour.com/tutorials/white-balance.htm.

Aspect ratio - Aspect ratio is the ratio of the width and the height of a picture. It is often expressed in the W:H format,

.....

where W is the width and H the height. For example, a 16:9 aspect ratio means that for a width of 16 units, the height must be 9 units. digitalcitizen.life/what-screen-resolution-or-aspect-ratio-what-do-720p-1080i-1080p-mean.

Frame rate - Movies create the illusion of motion by showing still images in rapid succession. Cameras expose a series of still images, and the number of images exposed per second is referred to as the frame rate, and is measured in frames per second (fps). The more frames recorded per second, the more accurately motion is documented onto the recording medium. At an FPS of 12 or less, your brain can tell that it's just a bunch of still images in rapid succession. Once the frame rate is faster than about 18 FPS, your brain is fooled into thinking that these individual images are actually a moving scene. gizmodo.com/why-frame-rate-matters-1675153198.

Shutter speed - speed is the unit of measurement which determines how long the camera shutter remains open as the picture is taken. The slower the shutter speed, the longer the exposure time. Shutter speeds are expressed in seconds or fractions of a second. For example 2, 1, 1/2, 1/4, 1/8, 1/15, 1/30, 1/60, 1/125, 1/250, 1/500, 1/1000, 1/2000, 1/4000, 1/8000. photographylife.com/what-is-shutter-speed-in-photography.

AE Lock - AE (Auto Exposure) lock “locks-in” the exposure setting so that subsequent photos have the same exposure. Without this applied, your video can brighten and dim as you move across a scene since the camera attempts to get the “best” exposure for every frame it shoots. all-things-photography.com/exposure-lock.

Camera RAW picture format - RAW files are created by storing every bit of data detected on the camera image sensor. This results in large image files, but allows flexibility in editing/correction. Overall exposure, color, hue, tone, and hues can be adjusted in a RAW file. photo.net/learn/raw.

Camera JPEG picture format - JPEG files are a common format for digital photos and other digital graphics. JPEG files use “lossy” compression, so image quality is lost as file size decreases. JPEG is the most common file type for digital images, and are widely used for images on websites yourdictionary.com/jpeg.

Aperture and f/stop - Aperture refers to the opening of a lens’s diaphragm through which light passes. It is calibrated in f/stops and is written as fractions such as f/1.4, f/2, f/2.8, f/4, f/5.6, f/8, f/11, and f/16. The smaller the number, the larger the diaphragm opening, and the more light that passes through the lens. The larger the number, the smaller the diaphragm opening, and the less light that passes through the lens. Smaller apertures increase the depth of field.

Depth of field - This is one of the most important elements in photography (still or movie). Depth of field is the amount of distance between the nearest and farthest objects that appear in acceptably sharp focus. Large lens apertures (f/2, f/2.8) yield a “shallow” depth of field, which emphasizes your subject and blurs the foreground and background. Small lens apertures (f/16, f/22) give you “deep” depth of field to keep everything reasonably sharp. digitalcameraworld.com/2016/01/25/what-is-depth-of-field-in-photography-how-aperture-focal-length-and-focus-control-sharpness.

ISO - ISO measures the sensitivity of the image sensor (or film in old cameras). Digital cameras let you set this to match your subject lighting. The higher the number, the more sensitive the

sensor is to light. For example, ISO 100 is a “slow” speed and will capture detail well, but a moving object may blur. ISO 1200 is a “fast” speed and can capture motion well, but with reduced detail. Depending on the camera, very high ISO settings may produce “grainy” images, that is, speckles across the entire image. photographylife.com/what-is-iso-in-photography.

Color temperature - Color temperature is a measure of a light’s color. Different light sources produce different colored light. For example, a candle emits a reddish light, while the midday sun’s rays have a blue tint. Color temperature is measured on the Kelvin scale, which is denoted by the letter “K” or the word “kelvin” after the number e.g. mid-day sun = 5500K and candle flame = 1800k. photographymad.com/pages/view/what-is-colour-temperature.

Audio “ripping” - This refers to the process of copying audio or video content from a compact disc, DVD or streaming media onto a computer hard drive for your own use. Care is required that you do not violate copyright! whatis.techtarget.com/definition/ripping-digital-extraction.

Doppler effect - This can apply to light or sound, but from an audio point of view is an increase (or decrease) in the frequency of sound as the source and observer move towards (or away from) each other. For example, the effect causes the sudden change in pitch noticeable in a passing fire tender siren. thefreedictionary.com/Doppler+effect. ■



**Click here for
reader comments**



MRH MARKETPLACE

STREAMLINED BACKSHOP

Sales
... Services
..... Solutions

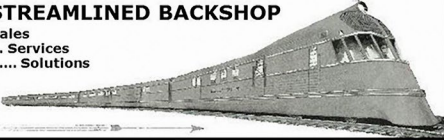

"SUGAR CUBE" SPEAKERS...

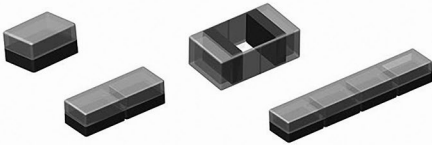

4 Sizes * 4 Baffles

... "Sweet" Speaker Options!



www.SBS4DCC.com

Don't settle for lifeless signals!

We've got signaling circuits!



LOGIC RAIL
TECHNOLOGIES

"Sophisticated
Model Railroad
Electronics"



Please visit our website and online store!

21175 Tomball Pkwy
Suite 287
Houston, TX 77070

Phone: (281)251-5813

<http://www.logicrailtech.com>

info@logicrailtech.com



Affordable built to order Benchwork
starting at only \$20 a Sq Ft.

FEATURING America's Historic Main Street Architecture



MAINSTREET HERITAGE

Your ad could be in this space for as low as \$112 a month.

Click to learn more ...

MRH MARKETPLACE | 2

clever
models LLC
Cardstock models & materials



Try one today!

www.clevermodels.net

The Pixel Depot™

Your favorite RR logos on:

- Mouse Pads
- Coaster Sets
- Vinyl Decals

CELEBRATE CONRAIL!
UP TO
19.76% OFF
EVERYTHING! [Click Here to Save](#)

www.ThePixelDepot.com

PRE-SIZE
MODEL SPECIALTIES

P.O. Box 6 Paonia, CO 81428

Ph. 970 527 4586

Made in The USA

Cast resin items for All Scales.

Tunnel portals, bridge piers, abutments, culverts, and retaining walls.

Trackside details and sage brush tree armatures.

"FREE SHIPPING see website for details"



ATSF Ex-48

JIM'S TRACK PLANS



EXPLORE HERE

New Designs Every Tuesday!

Yarmouth Model Works

HO scale resin kits and detail parts



..... U.S.A. MAILING ADDRESS

3560 Pine Grove Ave. Unit 617

Port Huron, MI 48060

Tel. 519-633-7574

pierre.oliver@start.ca

www.yarmouthmodelworks.com

..... CANADIAN MAILING ADDRESS

85 Hiawatha St.

St. Thomas, ON N5P 2T5



Miller Signs | Evan Designs | Iron Penguin
Ring Engineering | EZ Line | Tomar

LED lights & Animated Signs
for all your Modeling & Hobby needs

[Click Here](#)



Now Available Again
KIT #5761/5762 PRR GLA
Modernized Hopper

Check our Website For
List of Closeout Kits.
westerfieldmodels.com



Railroad Art-Prints,
Caps, Jackets,
Shirts and More ...
Jackets starting
at \$79.95

www.jelsma.com

1-904-221-3513 • Jacksonville, FL.



JEFF OTTO
TURNIN' it OUT

414-915-4671
ohrtracksupply.com
jeff@ohrtracksupply.com

N36W23431 Oak Hill Ln.
Pewaukee, WI 53072

LOOK
at what's new at
Black Cat this month

Click here for
our website

Northern Pacific
early Piggyback Trailer
various lengths in HO



Black Cat Publishing
(204)489-5005
ajfergus@mymts.net
blackcatdecals.com



Affordable Modular (**domino**)
Benchwork in 200+ sizes
Custom built to order benchwork also available!

KC's WORKSHOP
CRAFTSMAN MODEL KITS



WWW.KCWORKSHOP.COM

CLICK HERE



CANYON CREEK
SCENICS

PRECISION DESIGN CO

Chains
Flat Car loads
Joint Bars
Signs & Posts



FREE SHIPPING

Great Decals!™

FEC, Interstate, Virginian
Railway, & L&N Titles
After Hours Graphics Line
Coupler Gages and More
In O, S, HO, and N Scales



Your ad could be in
this space for just
\$58 a month.

Click to learn more ...

MOUNTAIN SUBDIVISION HOBBIES

www.modelrrsupply.com

FREE USA SHIPPING OVER \$29.00

NCE - SOUNDTRAXX - DIGITRAX - PECO - CIRCUITRON
DCC SPECIALTIES - INTERMOUNTAIN - CMX - ATLAS
BAR MILLS - BOWSER - KATO - MRC - TOMAR - RIX -
PIKESTUFF - LOGICRAIL - CENTRAL VALLEY AND MORE!

RULERS-of-the-WORLD

Scale Rulers \$4 each

Over 200+ scales!

Metric or Imperial

www.rulers-of-the-world.com

HO DIESEL SUPPLY

Are you serious about your HO Diesel fleet or just tinkering? Either way
You probably bought just the right parts you needed from us already

BACKSHOP HARD PARTS DIVISION

Now Direct Personal Service

www.hodieselsupply.com

email: TheBoss@hodieselsupply.com

Have you seen these
popular blogs on the
MRH website?



Tom Johnson's L&N

270,000 reads

CLICK TO READ IT NOW



Ken Glover's Shelf Layout

81,000 reads

CLICK TO READ IT NOW



Edendale Creek Diorama Part 1

**A trestle, some track, and
the equipment ...**

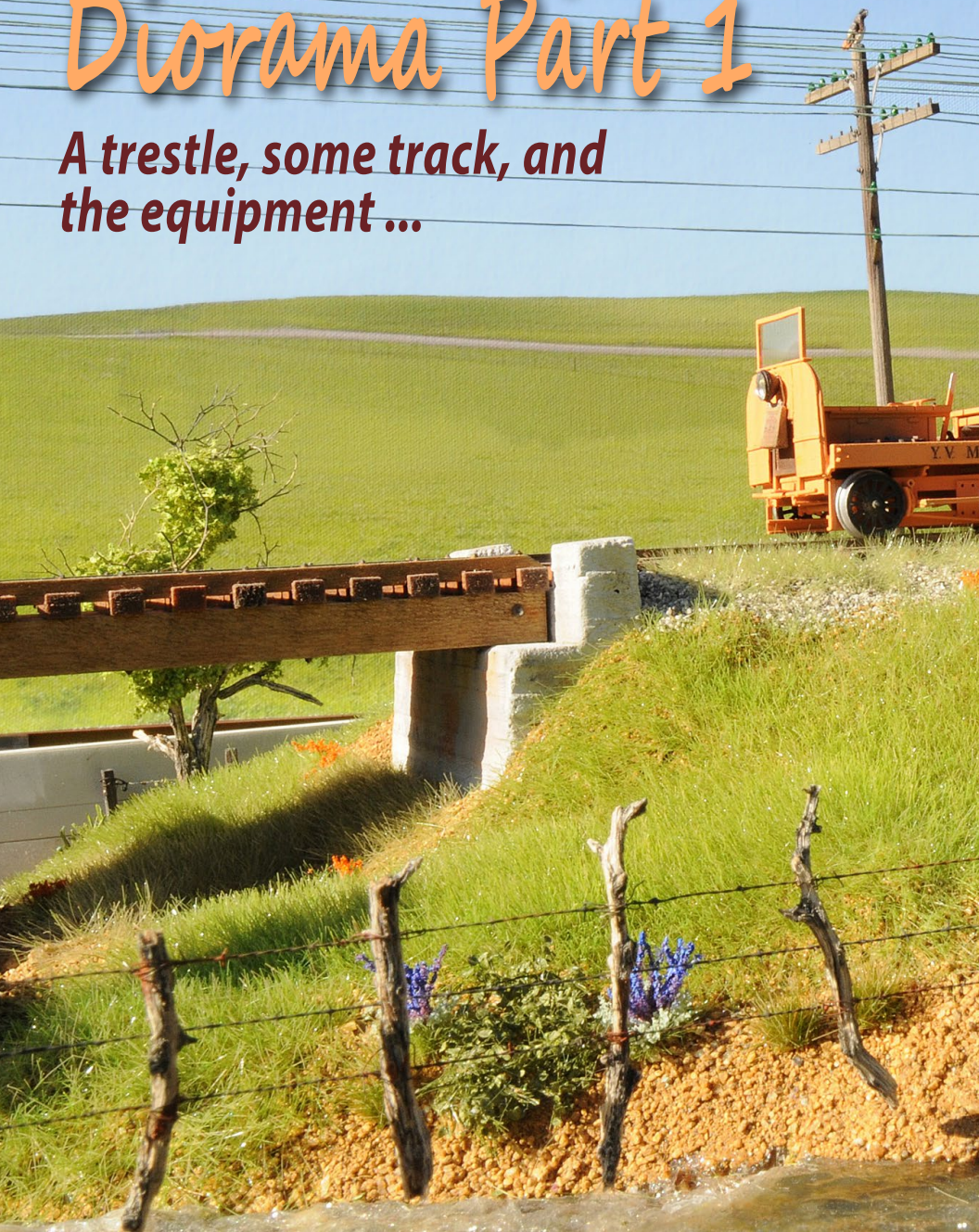

• INDEX

• TABLE OF CONTENTS



BY JACK BURGESS



[Click here for
reader comments](#)

HAVE YOU EVER THOUGHT OF WHAT YOU MIGHT

do if or when you finish your current layout? Of course, you could just tear it out and start a new layout. On the other hand, if your main interest is in operations, the answer is easy – continue to operate and maybe change a few things which aren't working as well as you would like. If you used “placeholder” buildings to populate your towns, you can spend time to replace them, along with other compromises made during construction.

But my interest in the hobby is building models, and not operations. Yes, my layout was designed to be fun to operate and also prototypically correct for duplicating the operations of the Yosemite Valley Railroad, circa August 1939. After 31 years of enjoyment, I completely finished my multi-deck YV layout in June 2011. But I wasn't worried about getting stagnate or searching for something else to do. While my stash of resin freight car kits exceeds 60 or so, I was looking for another modeling challenge, and that search actually started 35 years earlier.

For reasons I no longer remember, I wrote a letter to Fairmont Railway Motors, Inc. in 1976 asking about equipment purchased by the YV from Fairmont. I soon received a letter from them stating that the YV had purchased a Fairmont M-44-A-1 weed burner in October 1942 along with a T27-C-2 extinguisher car and a T28-A-1 trailer. The weed burner was used to burn weeds along the track while being followed by the extinguisher car and trailer

EDENDALE CREEK DIORAMA | 4

carrying additional water for the extinguisher car, putting out any lingering fires.

Included with that letter was a large-scale drawing of the weed burner and a sales brochure for the extinguisher car! A couple of

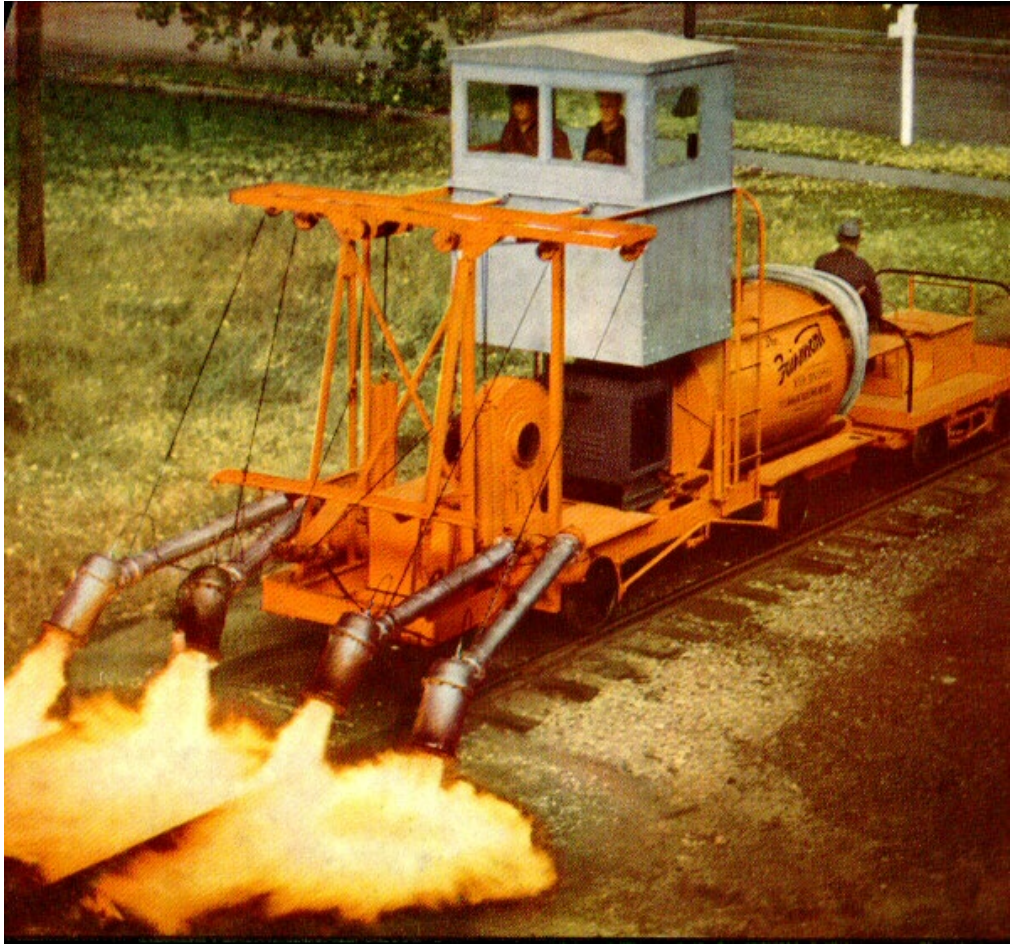

1. This publicity photo from Fairmont Railway Motors shows a weed burner in action. The two operators in the cab can swing the burners outward and raise and lower them, as well as control the amount of fuel fed to them.

EDENDALE CREEK DIORAMA | 5

months later, I wrote to them again about other YV purchases and received a letter back listing a number of section cars the YV bought together with photocopies of some catalog sheets for those cars.

The weed burner was an intriguing piece of equipment. It was 27"-4" long and stood 12"-5" above the rails. The four movable burners directed 3000° flames between the rails [1] and beyond, burning all of the weeds, which could dry up and catch fire from sparks once the California rains had stopped.

With my layout done, I remembered these plans and began thinking about building a model of that weed burner. I model 1939, and the YV didn't purchase the weed burner until 1942. If



2. The author's scratchbuilt O scale of a Fairmont M-44-A-1 weed burner.

EDENDALE CREEK DIORAMA | 6



3. Here is the entire diorama which is 36" long and includes the five pieces of equipment together with the trestle over Edendale Creek. The area along the track on the right has already been burned by the weed burner.

I built it in HO scale, it wouldn't be correct to display it on my layout, so I decided to scratchbuild it in Proto48.

The resulting model [2] was a very challenging but fun project. Before I even finished, I began thinking about a follow-up project. I initially thought about building the other Fairmont cars, but then decided to build a diorama [3] displaying them in an operational setting.

My plan evolved into building the diorama together with the Fairmont A6-C gang car used to pull the weed burner and the following "extinguisher" train composed of an ST2-D section car which pulled the T27-C-2 extinguisher car and T28-A-1 trailer. To add interest, I opted to set the scene near the YV trestle over Edendale Creek [4] northeast of Merced in California's San Joaquin Valley in April 1945. It also made sense that the YV would have the weed burner burning the grass between the rails and along the ballast line once the rains in California stopped for the summer (typically April) and before the grass turned golden yellow a couple of months later

EDENDALE CREEK DIORAMA | 7



4. This photo of the remains of the trestle over Edendale Creek was taken in the late 1970s, long after the rails had been removed. The bridge itself is now gone.

The diorama is 36" x18". I ultimately labeled it "Taking a Break - Edendale Creek April 1945." While friends questioned a foreman allowing his workers a break back in 1945, the lead weed burner operator is investigating a problem with the four-cylinder engine which powered the pumps and blower, giving the gang a "break." The workers are taking advantage of the problem by drinking coffee and talking among themselves.

The construction of these four additional pieces of equipment, the bridge, and the diorama took about a year to complete and provided some thoroughly enjoyable modeling. Building in Proto48 allowed me to include a number of details which would have been impossible or invisible in HO scale.

EDENDALE CREEK DIORAMA | 8

.....

In this part, I'll talk about building the trestle over Edendale Creek and the track incorporated into the diorama as well as the other Fairmont equipment built for the diorama. Next month I'll discuss the scenery and details.

Timber trestles

Timber trestles have "stringers" which are large timber beams which run parallel to the rails supporting the ties. The stringers are in turn supported by bents which extend from the under-sides of the stringers to the ground. They can consist of piles at right angles to the track and driven into the ground, or are built of framed members which rest on a foundation of some type.

ADVERTISEMENT



GLXSCALEMODELS.COM



**OIL LANTERN
KIT**

**1/48
SCALE!!!**

**\$19.99
+ S&H**

12 VOLT POWERED LED LIGHT



• INDEX

• TABLE OF CONTENTS

.....

EDENDALE CREEK DIORAMA | 9

Pile-driven trestles were very common when the YV was built, and consisted of from four to six round piles (four for the YV bridges) with the outer piles driven at an angle called batter.

After the piles were driven and cut level, caps, typically 12”x12” if the piles were 12” in diameter, were placed on top of the piles and held in position with round steel pins driven from above through the caps and into the piles. The cap supported the stringers. The end piles had sturdy boards, called “dump boards,” positioned on the dirt side to contain the fill.

A framed-bent trestle used field-built “bents” in lieu of driven piles. These bents typically consisted of square posts, usually 12” square timbers, with a horizontal sill, the same size as the posts, on the bottom. On the top of the posts were caps which, typically, would again be the same size as the bent posts. The size and number of posts depended on the span between the bents and the weight of the equipment running over them.

On steam railroads using coal, the exposed top of the caps and stringers would be covered with galvanized flashing to protect these parts from hot cinders. The YV engines were fired with oil, so this detail was not necessary. Guard rails, which consisted of used rail laid 8” to 12” inside the running rails, were not used on timber trestles on the YV although they were standard on some other railroads. The YV used guard rails only on steel truss bridges where the support structure was above the rails and could be damaged by a derailed car – the guard rails kept the car from striking the bridge itself.

On the other hand, a majority of railroad timber trestles, including the YV, had guard timbers. These were located at the ends of the ties and kept a derailed car from falling off of the bridge. One of the stringers on each side of the bridge was positioned



5. A current day view looking west shows an abutment and the pier for one of the trestle bents. The holes in the far side of the pier show that it was poured around the original driven-pile bent. That bent would have been sawed off after the new bent was in place.

under the guard timber to carry the weight of a derailed car. These guard timbers were “dapt” or “dapped,” meaning “notched,” to fit over the ties. The guard timbers were then secured to the ties with a combination of lag screws and long bolts and nuts. On the YV bridges, the guard timbers extended from one bent to the next, and were not continuous over the length of the bridge. Joints between the individual guard rails were lapped. Note that the ties were not connected in any way to the stringers, but instead were held in place by the guard timbers and spiked rails.

The Edendale Creek bridge

The bridge over Edendale Creek was about 10 miles east of Merced along Highway 59. When I first visited this area in the late 1970s, the bridge was still in place, although the rails had been pulled up in 1946. On that trip, I took a few photos (film and film developing was costly on my limited budget in those days) and measured the bridge and abutments. The wood portions of the bridge itself were eventually removed, but the concrete abutments remain today. If you are familiar with Google maps, copy the coordinates 37.430211 N, 120.507007W into that program and you'll be on the current-day highway bridge over Edendale Creek. Zoom in on the map and when you get close enough, Google will switch to a Street View and you'll be looking at the remaining abutments and bridge piers which once supported the railroad bridge over this creek. The fill supporting the tracks is also obvious. If you switch to the Satellite view and zoom in, you'll see the stringers and one of the bents lying on top of the original roadbed just south of the bridge site.

The first bridge built over Edendale Creek was a 96-foot-long pile-driven trestle constructed in 1906. A problem with pile-driven trestles is that the portion of the piles below ground are very susceptible to decay and rot. By the early 1920s nearly all of the original pile-driven trestles on the western half of the railroad were in need of serious repairs. As a result, the YV began a program of replacing the pile-driven trestles with framed-bent trestles on concrete piers.

A portion of the original pile-driven trestle was simply filled, extending the fill on each end of that bridge. The replacement bridge was most likely 48 feet long, and used end bents and dump boards along with concrete piers. The western concrete



6. This detail was included in the model bridge with a few California poppies providing some spring color.

pier was poured directly around one of the original pile-driven bents [5], a detail I included in the model [6]. Those end bents and dump boards were also susceptible to decay and were eventually replaced with concrete abutments in 1942. The resulting bridge was then 43 feet long.

Trestle abutments and footings

The concrete abutments for this bridge [7] were formed with 6"-wide boards. The concrete isn't very smooth but I also don't see wood grain from the wood used for the forms. After thinking about it, I realized that they would not be using old,

EDENDALE CREEK DIORAMA | 13

weathered boards with a lot of grain to build the forms, but would have used relatively new, rough-cut planks.

I used Mt. Albert Scale Lumber for all of the scale wood on this project mtalbert.com and their basswood is very smooth. I ripped some 6"x14" boards in half on my model table saw, giving me two boards 6" high and around 7" wide. That resulted in one rough side on each board also with a little variation in thickness. Even a very fine-toothed blade in this table saw produces a rough surface with some saw marks.

These planks were then used to build up forms for the two abutments and the two piers for the center bents. The wood was cut



7. The outline of the form boards is still evident on the west abutment 70 years after it was poured. The black and orange "stains" are forms of lichen.

EDENDALE DIORAMA | 14

and glued together with quick-drying white glue. The forms were built “upside down” so that the top of the abutments and shelves would be smooth. The concrete for them would have been floated to a smooth surface by the Bridge and Building (B&B) gang.

The forms were filled with Woodland Scenics Lightweight Hydrocal plaster. Vibrating the forms with a back massager, I made sure they filled completely and released any trapped air bubbles. Once the plaster dried, the forms were stripped and the castings colored with a diluted mix of black leather shoe dye and alcohol, resulting in a very light gray color. Lichen on the prototype abutments is replicated using Bragdon Enterprises rust and dark gray weathering powders [8].

Bridge construction

One of the challenges when constructing a framed-bent trestle is ensuring that inside

Combo Right Clamp™

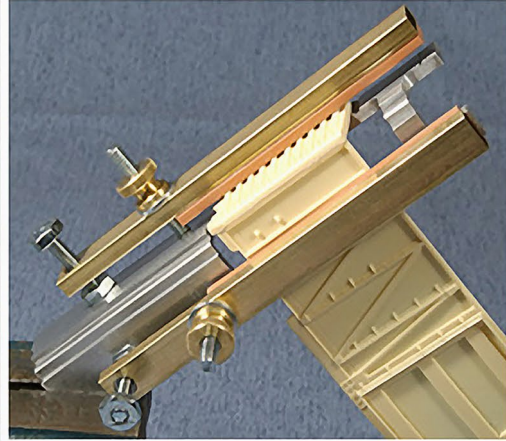

Combo Right Clamp™
with cast resin boxcar

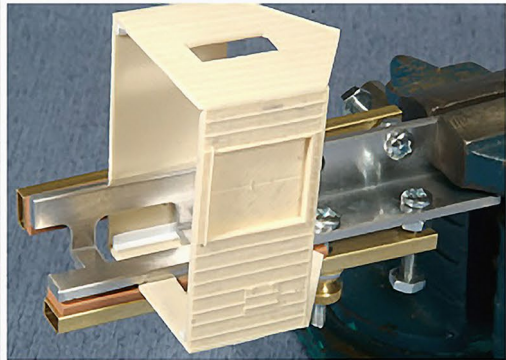

Combo Right Clamp™
with Wolf Design Pump House

**Click here for
all our products ...**

Tools for Modelers

Coffman Graphic Solutions Co.
1500 River Circle, Richmond,
KY 40475-7907



8. The form boards used to cast the model abutments are more pronounced in photos than on the model itself.

vertical posts and the angled outside posts are exactly the same length so they all fit between the bottom sill and top cap without gaps. In HO, you could mark cut lines on the pieces of basswood and use an NWSL Chopper to cut the pieces to length,

EDENDALE CREEK DIORAMA | 16

but cutting 12"x12" O scale posts is impossible with a Chopper. Using a Zona saw is another option, but is a challenge.

In 1981, I wrote an article about a solution to this problem for some HO trestles I was building. I built a jig which held all of the posts while they were sanded on a power sander to both the correct length and the proper batter angle. For the Edendale Creek trestle, I used the same approach, but built a simpler jig.

I built the jig [9] from a piece of .060" styrene that could be clamped to the table on my disc sander. I glued pieces of 1/8"

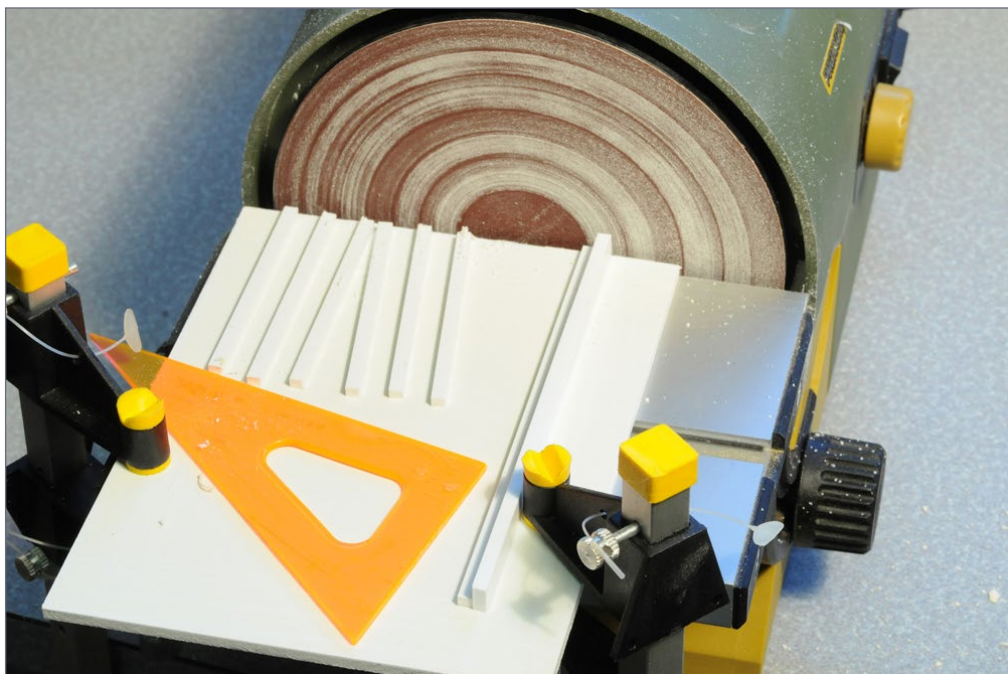

9. This simple jig makes it easy to produce a set of posts for a framed-bent trestle. The YV trestles used four posts and the jig has slots for two vertical posts and two battered posts. Putting the slots for similar posts next to each other saved room on the jig.



10. One end of each of the posts for one bent are first sanded square or angled.

styrene to the jig to hold the 12"x12" posts for a bent at either a 90° angle to the disc sander, or at the proper batter angle as taken from my scale drawing. (Plans for this wood trestle are a subscriber extra.)

With the jig built, I cut all of the posts needed for the two bents from Mt. Albert Scale Lumber Co. O scale 12"x12" basswood. I cut them slightly longer than needed, and then sanded one end of each post [10] to the proper angle using the jig. For my four-post bents, the two center posts were sanded square while the other two were sanded to the batter angle. All of the posts for each bent were then turned end-for-end and reinserted into the jig [11]. I then used a drafting triangle and pushed them all at the same

EDENDALE CREEK DIORAMA | 18

time toward the sander until they were the correct height while holding them tight to the jig [12]. This resulted in all of the posts being exactly the correct height, including the angled ones, and they all fit perfectly between the sill and the cap.

I cut the stringers to length next. Note that stringers are not single pieces of lumber from one end of the bridge to the other. Instead, shorter pieces of lumber are used and the joints staggered – every joint must be centered on a bent. I feel that including these joints and arranging the lumber so that the grain is different on each piece at a joint is an important detail. Therefore I cut the outside stringers to match the prototype but did not cut the inside ones, since that detail would be hidden on the finished bridge.



11. All four posts are then turned end-for-end and reinserted into the slots in the jig.



12. Pushing all four posts at the same time with the drafting triangle (or a square piece of styrene) results in them all being the same height. Note how the drafting triangle rests up against the end of the posts and it tight to the fence on the right. The strip of styrene to the left of the fence lets the drafting triangle rest of top of the styrene strips holding the posts in place.

Cutting the guard timbers was an interesting challenge – I wanted to cut notches in them so they would fit over the ties. I found an 11/64” end mill online at McMaster-Carr mcmaster.com which was just slightly wider than the 8”-wide bridge ties. Then I could use my milling machine to mill out the notches, using a simple holder for the ties built from a piece of 1”x 2” piece of pine. A plywood fence was glued on the rear, and

EDENDALE CREEK DIORAMA | 20

another secured on the front with a pair of long screws. Both fences were also “milled” as the ties were milled, as shown in the photo of this jig [13]. Once the notches were done, I added the lap joint between the individual guard timbers and tapered the ends [14] per the prototype.

Staining and assembly

The wood parts were stained after all of the parts for the bridge were cut to size. I incorrectly stained all of the HO trestle parts on my layout with a dark stain to represent creosoted components. But that was done three decades ago, long before I learned that the bridges on the YV were built using untreated Oregon pine. Using creosoted timbers probably would be unusual for a framed-bent timber trestle.

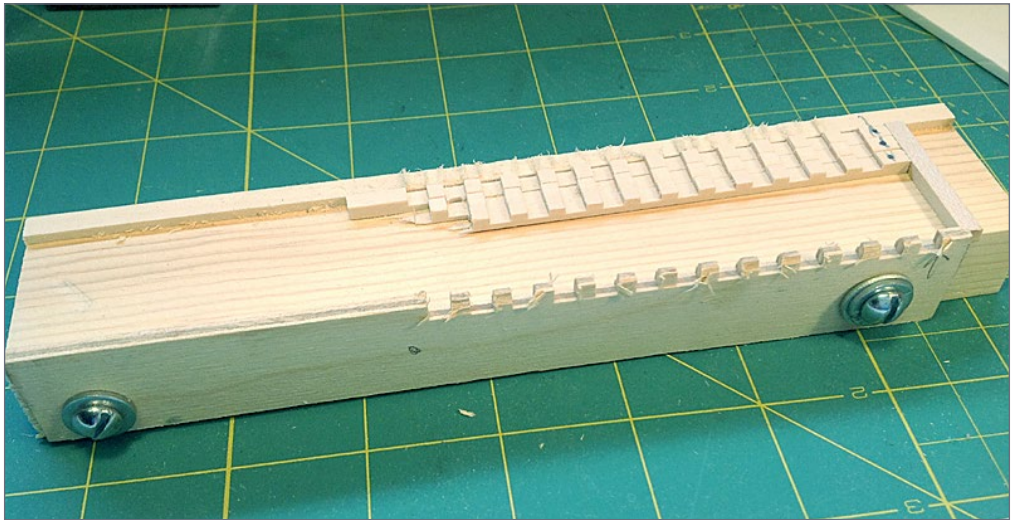

13. This wooden jig was clamped to a milling machine table so that notches could be milled into the guard timbers. All of the guard timbers were milled at the same time—four of them are still in the jig.

EDENDALE CREEK DIORAMA | 21

I never add grain to wood when modeling in HO scale, since I think grain isn't actually visible in HO scale. A timber bridge on an HO layout might be viewed from a foot away or so. That is equivalent to viewing a real piece of unpainted wood from 87 feet away. At that distance, you will see variations in the color of the wood but not the grain. In O scale, some grain might be visible, so I lightly dragged a Zona saw across the wood and then knocked down the fuzz with a coarse sanding stick. I believe the stringers were replaced in 1942 when concrete abutments replaced the end bents and dump boards, so I didn't add wood grain to those pieces.

Each piece of wood was first soaked in plain water for a few seconds. I then brushed on a full-strength coat of Com-Art Raw Umber tcpglobal.com/Airbrushing-Supplies/Com-Art, a

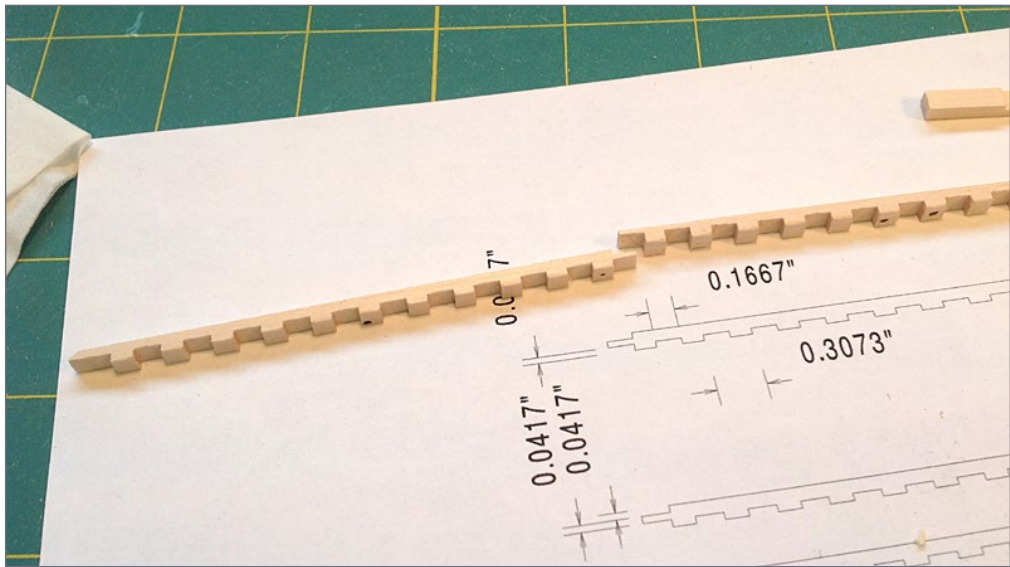

14. Two of the guard timbers after adding lap joints and tapering the ends.

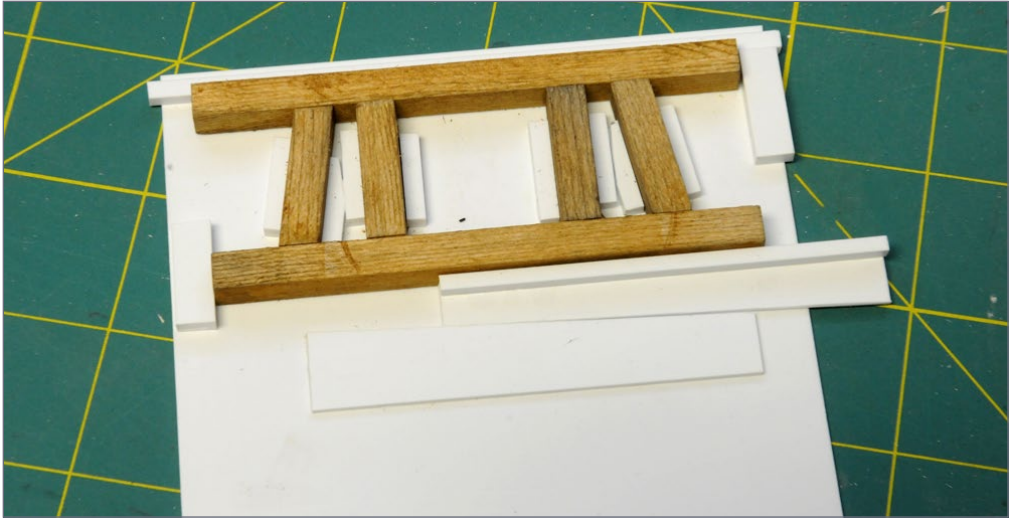

15. This styrene assembly jig holds the posts, cap, and sill all in alignment. The sliding wedge on the bottom holds the pieces tightly together while the glue is drying.

transparent, water-based stain. I let that dry for a while before brushing on some more water to dilute the next application of a heavily diluted coat of Com-Art Black stain. After the wood dried completely, a final light application with PanPastels pan-pastel.com Raw Umber finished the job. PanPastels are available online in different colors and sets. They are artists' pigments with a creamy paste consistency, and typically are applied with a foam sponge.

I used construction adhesive to assemble the bents using a jig similar to the one used to sand the bent posts to length. The jig [15] was built using a piece of .040" styrene with strip styrene glued to hold the posts in alignment. Two wedges, one glued to the jig and the other pushing against the bottom sill, hold the bent tightly together while the glue dries.



16. NBW castings were added after the ties and guard timbers were in place. The NBW castings which alternate side to side represent lag screws while those in the center represent bolt heads. Those bolts have corresponding nuts and washers on the underside of the ties.

The completed bents and stringers were drilled for nut-bolt-washer (NBW) castings which were added where appropriate. I also added NBW castings to the guard timbers to represent the lag bolts and through bolts. On the prototype, the long through-bolts were centered on the guard timbers while the lag bolts zigzagged from left of the centerline to the right, and back to the left, a detail I included on the model [16].

Getting the two piers and two abutments glued to the diorama base so the stringers were resting on the abutment shelves and the bents were resting on the piers wasn't difficult. I used pieces of stripwood as shims under the piers and abutment to adjust them to correct grade, sanding the stripwood as needed. The

stripwood shims were then glued to the plywood sub-base so that they wouldn't move.

I use construction adhesive to glue the castings in place, spreading it on slightly thicker than needed and letting the excess squeeze out as the castings are pushed down onto the stripwood shims. Since construction adhesive doesn't set up right away, I had plenty of time to make sure that the abutments and piers were centered under the bridge and everything was square and in alignment.

Track

Construction specifications issued in the early 1920s for the major realignment of a portion of the YV specified 6" x 8" x 8' redwood or cedar ties. Confirming those specifications today, nearly 100 years later, might seem impossible but salvaged YV ties have been used as fence posts along several areas of the now-abandoned roadbed. While it is certainly possible that some of these ties came from other railroads, the YV used unique three-hole tie plates, and I have found some of these ties with three-hole tie plates still spiked to them.

During a field trip before I started this project, I removed a sliver from one of these ties which confirmed that the ties were indeed redwood, and not cedar. From the tight grain, it looked like first-growth redwood which very possibly came from the redwood forests near Santa Cruz, the closest redwood lumber mills to the YV.

I cut my ties from Mt. Albert Scale Lumber 6" x 8" stripwood, adding varying amounts of grain to each tie with a Zona saw. In order to duplicate the dark reddish cast of old redwood, the ties were first dipped in a mixture of black shoe dye in alcohol. Once

EDENDALE CREEK DIORAMA | 25

dry, they were glued in place on the diorama. The following day, I brushed on a coat of Superdeck Semi-transparent Redwood deck stain. After this stain dried, I dabbed most of the ties with PanPastels Payne's Grey Extra Dark and followed with a brush-on coat of the black shoe dye stain.

I included a few "new" ties which didn't receive any Zona saw grain effects. After the coat of Superdeck Semi-transparent Redwood stain, I applied a coat of Miniwax Sedona Red, but skipped the PanPastels. However, they still received a final brush-on coat of shoe dye. The contrast of old ties to new ties is subtle but fun to do.

I have a YV three-hole tie plate in my collection. My copy of *Trackwork, and the Section Foreman*, copyrighted in 1929 and given to me by the children of a YV section foreman, makes three-hole tie plates possibly more common than I thought. It states,

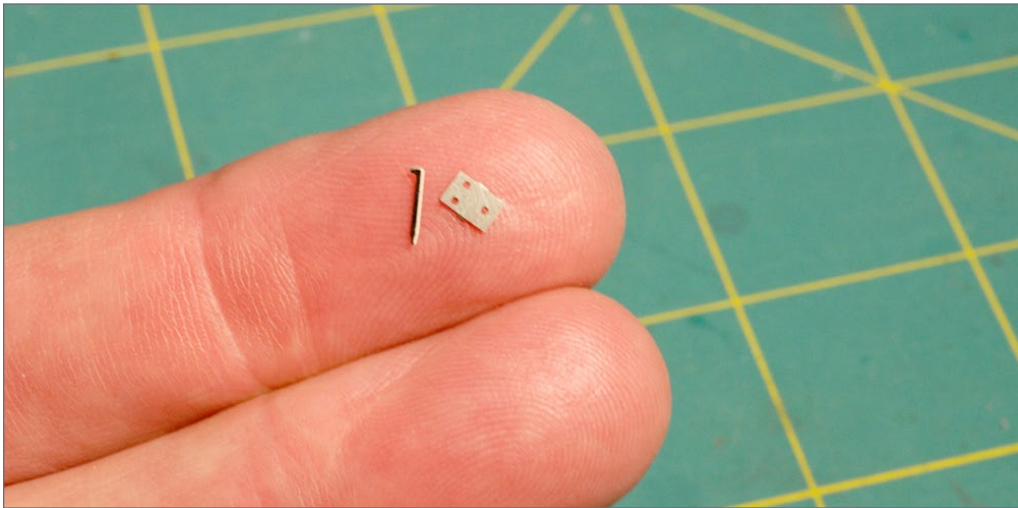

17. A custom photo-etched three-hole tie plate and a spike from Proto87 Stores.

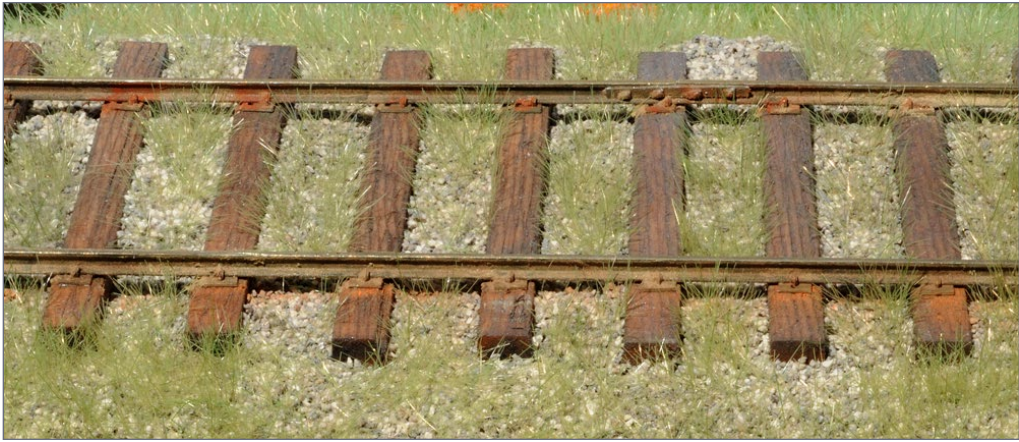

18. The finished track. Many of the ideas about weathering track came from Mike Gougill's book *Detailing Track*.

“Although only two or three spikes are used to fasten the rail to the tie, four holes are sometimes provided in the tie-plate in order that the spikes may be placed near either edge of the tie.”

The reference to “two or three spikes” obviously means “per rail.” In practice, there are always four spikes per tie except on curves where there may be six spikes per tie, with the additional spikes on the outside of the curve.

There are a number of sources of scale tie plates, but I quickly learned that all represent four-hole plates. Fortunately, a friend preparing drawings for some custom photo-etched parts had room on his drawing for enough tie plates for my diorama, and offered to include them in his order. The resulting stainless steel tie plates are to scale, and thus very small. To spike the rail in place, I used long photo-etched HO scale spikes from Proto87 Stores [17]. I discovered the need to pre-drill holes for these spikes, but they look very realistic when done.

EDENDALE CREEK DIORAMA | 27

I used pre-weathered Code 70 Micro Engineering rail and after spiking it down, airbrushed the rail and tie plates with Floquil Weathered Black. I followed with an application of Vallejo Pigments mixed with Vallejo Pigment Binder, which is basically matte acrylic medium. I primarily used Light Siena and Burnt Umber pigments, dipping an old brush in the matte medium and then in a bottle of pigments, and brushing the mixture onto the sides of the rails. This combination does a good job of duplicating mud and dirt which end up on the sides of the rails. A

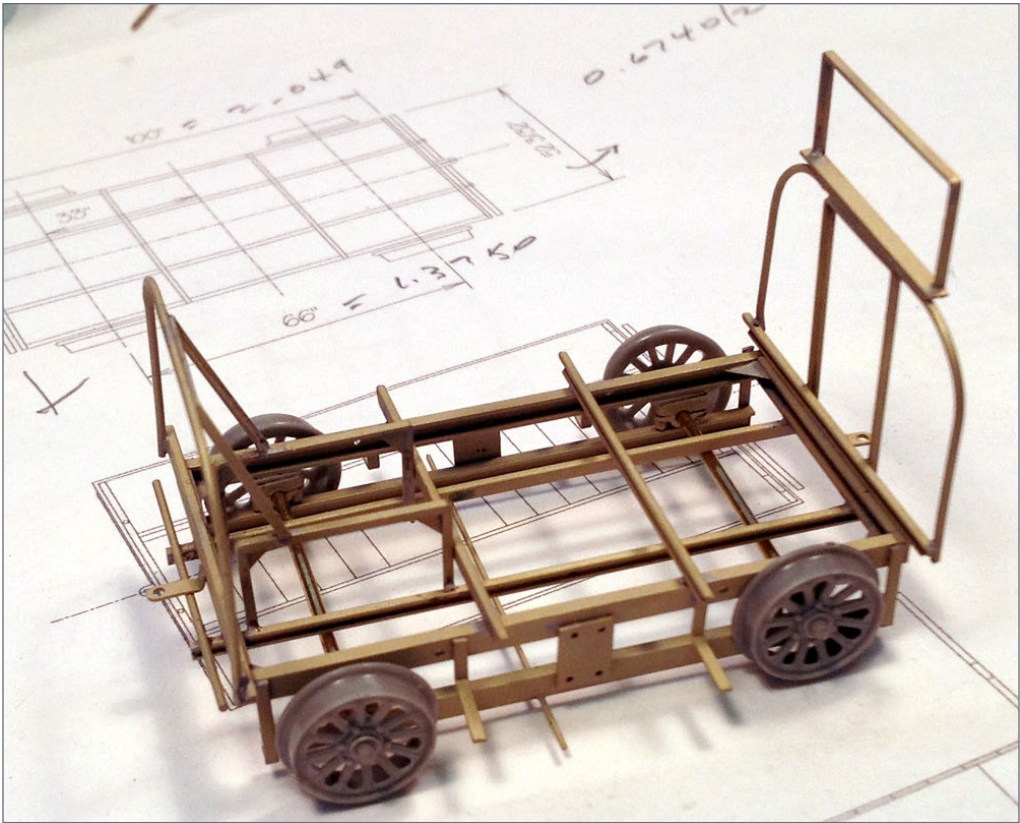

19. This is the frame for the A6-C gang car. The O scale model is just over 2" long.

EDENDALE DIORAMA | 28

touch of PanPastels Burnt Siena and Red Iron Oxide (both rust colors) on some of the spike heads finished the rail [18].

Equipment

I bounced back-and-forth between construction of the bridge, scenery, and equipment while working on this diorama. The same basic construction approach is used for the A6-C gang car which pulled the weed burner, the ST2-D section car, the T27-C-2 extinguisher car, and the T28-A-1 trailer. Frames are built up from brass shapes [19] soldered together with a resistance soldering unit. Wheels are from Grandt Line. The 48"-diameter water tanks on the T27 and T28 were made from 1" brass tubing with sheet brass ends. Weld seams were added with Archer resin decals. Wood boards on the prototype cars were duplicated with styrene to allow them to be easily bonded to the brass frames with CA.

Be the first
to **Spring to
Savings
Here!**

YD 
Yankee Dabbler.Com

Click **NOW!**
(while supplies last)

HO

DCC

ALL SCALES

- Kadee - NCE - SoundTraxx
- Digitrax - And more!



Some of the smallest parts on these cars, such as the Fairmont single-cylinder engines, pulleys, brake shoes, battery boxes, gasoline tanks, and even the Thermos bottles, lunch pails, and water bags, were drawn in 3D using SketchUp and 3D-printed [20-21] using rapid-prototyping technology.

The finished cars were airbrushed with lightened Floquil Reefer Orange. The decals were printed on my home computer and applied where appropriate. Weathering was added using Bragdon Enterprises weathering powders bragdonent.com. With the addition of some track and maintenance tools, the cars are ready to go to work. [22, 23, 24, and 25].

Next month I'll discuss building the scenery and details.

More photos follow



**Click here for
reader comments**



20. The Fairmont single-cylinder engine and radiator on the T27 extinguisher car were made using rapid prototyping technology. Together, they measure about 5/8" long. The same technique was used to make the vintage Thermos bottle and lunch box barely visible in the storage well to the left of the operator's leg.



[Click here for reader comments](#)



21. This Desert water bag measures about 1/4" square and is another detail made using rapid prototyping. Wire was added for the rope and the part painted before adding a decal made from a photo of a real Desert water bag found on the Internet.



22. The finished Fairmont A6-C gang car with the foreman walking back to get some tools. The track tools on the car are castings from Wiseman Model Services.



[Click here for
reader comments](#)



23. The gang car and weed burner. One of the weed burner operators is looking for a problem with it, giving the rest of the crew a short break.

**Want to help keep
MRH free?**

Then *click* on ads!



24. From left to right, the Fairmont ST2-D speeder, the T27 extinguisher car, and the T28 trailer. All of the figures are from Buffalo Landing.

***TrainMasters TV is part of
the MRH product family.***

***TMTV members not only get great network TV level
videos, they help pay for MRH and keep it free ...***



25. A closer view of the speeder and extinguisher car. The operator of the speeder is talking to one of the “hosemen” who ride on the extinguisher car or trailer, putting out fires from the weed burning operation. The wildflowers next to him are brush lupines.



[Click here for
reader comments](#)

END OF TRAIN DEVICE

NEW ORANGE CASE!



Bright Red Flashing Light!

Installs in minutes!
No freight car modification required!

RE RING™
ENGINEERING

Click Here to Learn More

Patented Technology - US Patent 7,549,609

Does not affect Load!

↓ Car without Load ↓



↓ Car with Load ↓



ADVERTISEMENT

ADVERTISEMENT



Archer

FINE TRANSFERS
PROUDLY SERVING MODEL BUILDERS SINCE 1989

**THE ORIGINAL
SURFACE DETAILS™**

**WE NOW HAVE MORE
THAN 100 SHEETS OF
RIVETS, LOUVERS,
TREADPLATE AND
MORE CAST ONTO
MICROSCALE CLEAR
DECAL FILM**

FREE SHIPPING:

- DOMESTIC USA ORDERS
\$50 OR MORE
- INTERNATIONAL ORDERS
\$100 OR MORE

▶ **CLICK HERE TO VISIT OUR WEBSITE!** ◀

"Archer rivets are easy to apply and look great. To me, they are now a vital tool in building railroad models."

Tony Thompson, Model Railroad Author/Historian



Archer Fine Transfers • PO Box 1277 • Youngsville, NC 27596 • USA
(919) 570-1026 • info@archertransfers.com • archertransfers.com

**TRINITY 3281
SUMMER 2016**

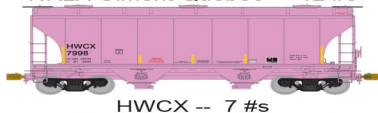

American Limited

www.americanlimitedmodels.com



FAST TRACKS

YOUR VERY OWN TRACK FACTORY

Make the most of your modeling experience.

Build perfect trackwork easily and inexpensively when YOU want it!



Check out our extensive (and growing!) online video library to learn how easy it is to hand lay your own trackwork with Fast Tracks tools and supplies.

Play Video 



shop online 24/7

1-888-252-3895

handlaidtrack.com

service@fast-tracks.net



YES, IT'S A MODEL

compiled by
DON HANLEY
.....



**Click here for
reader comments**



1. Southern 2427 is drifting toward a cut of cars on an overgrown industrial track. It's this mundane day-in and day-out task that keeps railroads in business. Nick Campbell built and photographed the model. It began as an Atlas Silver Series Southern MP15DC.

Nick added many details, including scratchbuilding the working light in the cage that is mounted to the front of the cab. A scratchbuilt cooler and stack of cups sit beside it on the porch. It was made from a leftover BLMA bridge support, and its handles are magnet wire. The weathering was done using a mix of acrylics and gouache.

► **MRH'S MONTHLY PHOTO ALBUM**

YES, IT'S A MODEL | 2

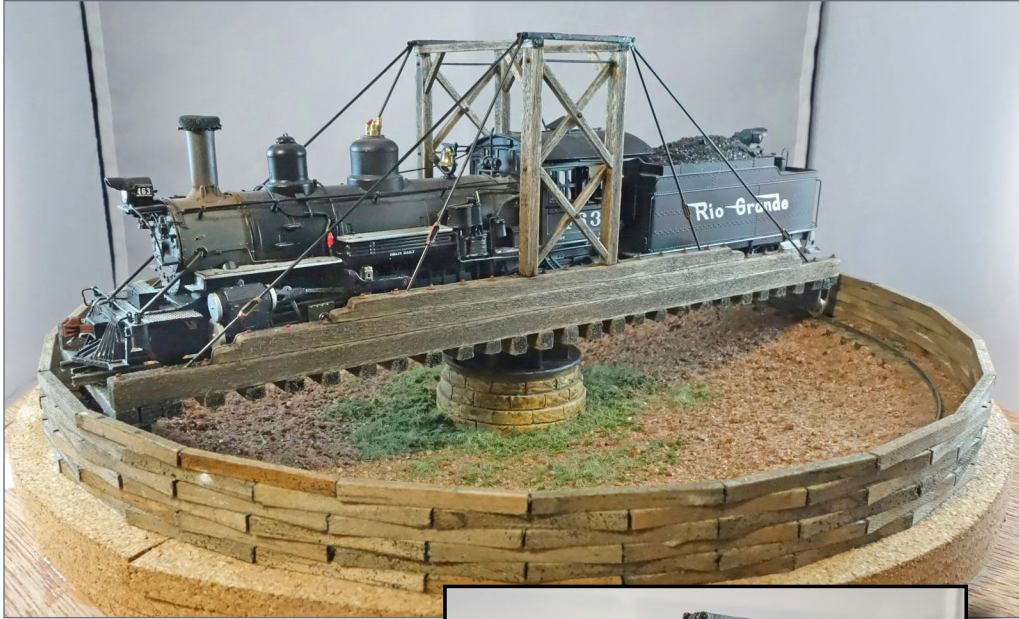

2. Here are a couple of photos of a Model Masterpieces D&RG 60' gallois turntable built by Michael Graff of Sweden. He has shared his experience in the MRH forum. There is more than just the turntable in this project. Follow the link and see much more. mrhmag.com/node/24924.

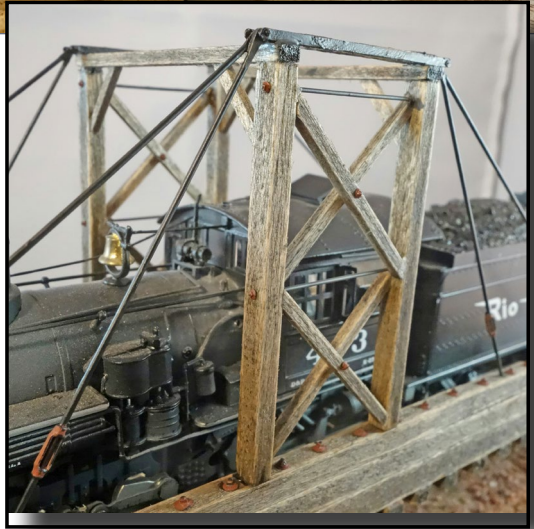

Check out the blog and pick up a few tips from Michael on building a turntable.

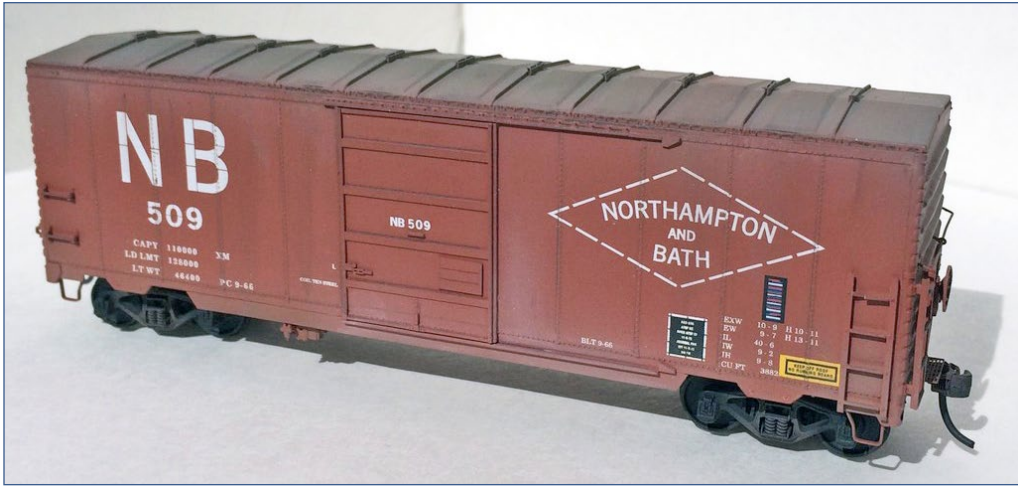

3. The Northampton and Bath is a six-mile short line that operated in the state of Pennsylvania beginning 1902. Tom Haag began with an Intermountain undecorated kit and added new doors and sidesills. The decals are from Mask Island. Great job modeling a little-known road.

.....

GET PAID FOR YOUR PHOTO

We pay \$40 per photo we publish. If you'd like to get your modeling in our photo feature, just start posting your photos on the MRH website, especially in the Weekly Photo Fun thread created each weekend.

See mrhmag.com/help for more on how to post an image. You need to be an MRH subscriber to post photos to our website, and becoming a subscriber is free, [just fill out this form here](#). ■

.....



4. It is the summer of 1976, and the shop forces of the newly formed ConRail are hastily applying new numbers and painting-out the previous road names. Yet it is clear that a former Reading unit is on the point of this freight heading to Buffalo NY on the former Erie Lackawanna line.



Neil Schofield posted this photo in the Weekly Photo Fun segment of the forum.



[Click here for reader comments](#)

One Module Challenge

Chama Division of the San Juan Extension, 1937



BY PETER VASSALLO

GRAND PRIZE WINNER of the MRH Contest!

THE SAN JUAN EXTENSION OF THE DENVER

and Rio Grande Western is, for many fans, the pinnacle of narrow gauge railroading. Even today thousands of people every year ride the Cumbres and Toltec Scenic Railroad, which is the last operating portion of this dramatic, scenic line. I rode it myself in 1998, loving every minute – the trains getting ready in Chama, climbing double-headed up 4% grades to Cumbres, winding along rocky ledges through Toltec, and eventually meandering along the relaxing foothills toward Antonito.

I always thought this would make a great model railroad, one that would offer high scenic and operating potential. For the contest, I originally planned to focus solely on Chama. Once I started, I couldn't stop, so before getting into detail on the



[Click here for
reader comments](#)

Chama module I'll present all the sections as a whole [1], including some prototype photos taken on my 1998 trip for inspiration [2-5].

I decided to set the layout in 1937, when a turntable existed in Chama to turn the engines, and when oil from the northern Gramps fields was being piped to Chama for transfer to Alamosa via tank cars. In this era, smaller locomotives were still being used, including class C-16 through C-25 Consolidations that face limitations when traveling upgrade, even for the shorter train lengths that better suit the compactness of a model railroad. After 1946, the engines in use were too long for the Chama turntable and were turned using the wye at the west end of the yard.

Chama was a division point yard used to sort cars, service engines and apply helpers for eastbound traffic. Trains were broken into manageable chunks for the move to Cumbres and multiple trips in a single day were necessary. From Cumbres, eastbound traffic traveled to Antonito and then to Alamosa.

The intent of the layout design is not to capture the precise track arrangement in each location but rather their spirit and functionality. For example, my Cumbres is similar but not exactly the same as the prototype. Some of the points featured are Chama, Lobato, Cresco, Cumbres, Osier, Toltec Gorge, and Antonito. The peculiar shape at the end of the Antonito section is necessary for an optional fit-up described later.

Construction could start at any of several points. If scenery is your thing, Toltec Gorge is a natural fit with dramatic rock faces,

ONE MODULE CHALLENGE | 3

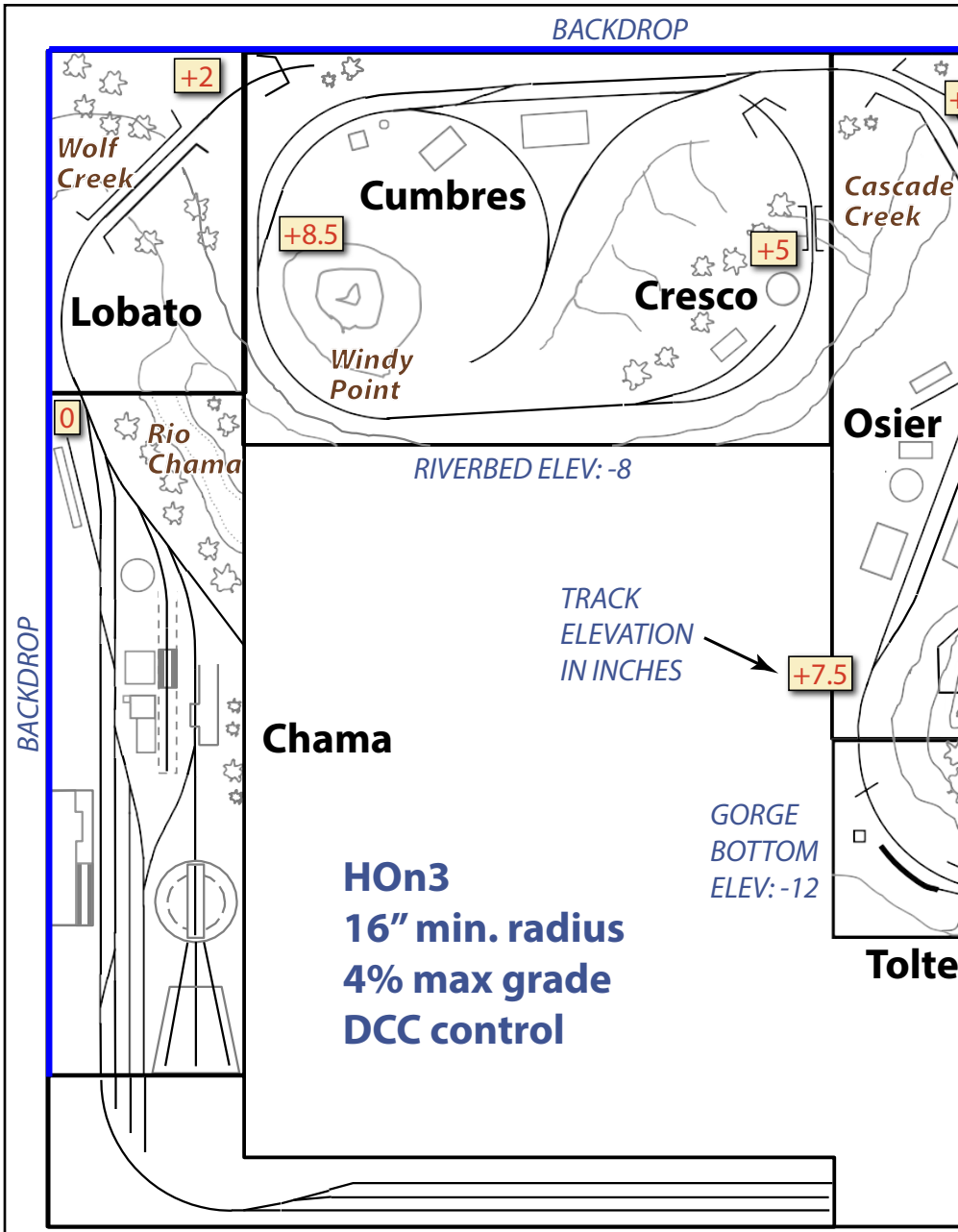

1. Track plan.

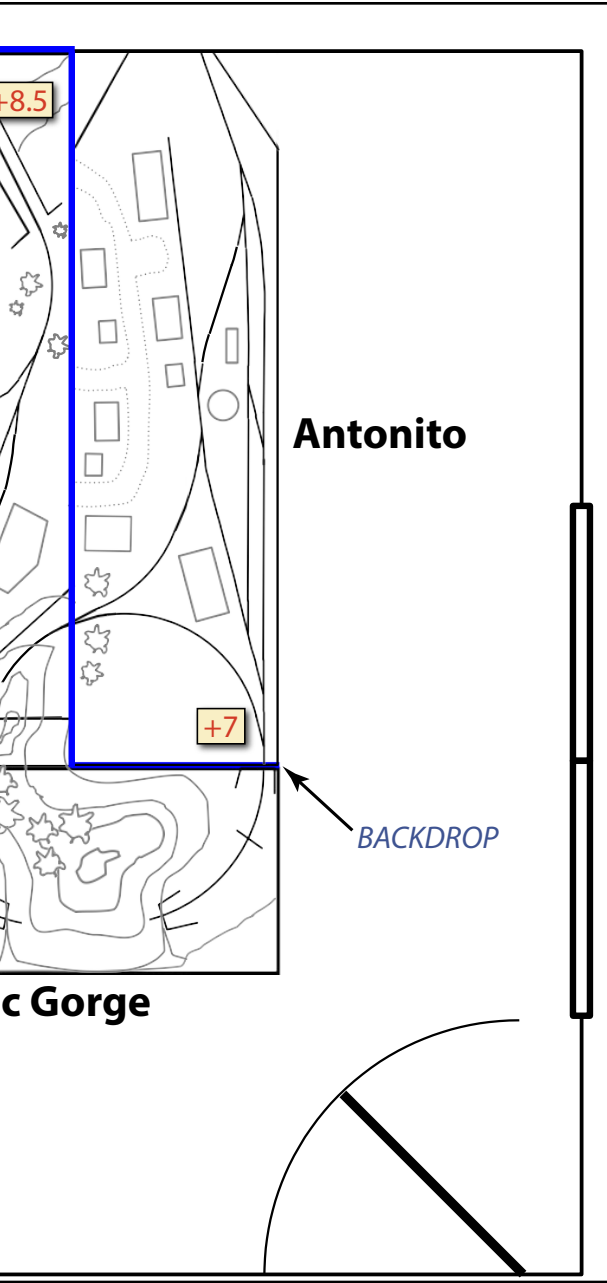

ONE MODULE CHALLENGE | 5

canyon walls and peaks along with towering pines, aspens and evergreens. You could model the telltales, Garfield monument, stone retaining wall and rock tunnel. A loop staging area could be built behind the module to hold two trains while a third runs in circles through the scene. The finished section would be a showpiece and if built from lightweight materials, could be transported for display at shows and conventions.



2. A mid-morning view of the Chama yard looking north-east. Directly to the left is a warehouse; further down are the sand house, coal tipple and water tank. Note the gondola on the elevated loading track behind the sand house. To the right of the picture, out of view, is the roundhouse. Beyond the trees is the Rio Chama. Our train will soon pass by on the near track as it departs Chama for Antonito.

ONE MODULE CHALLENGE | 6



3. Traveling near Coxo with Windy Point looming in the distance. Cumbres, and the highest point on the line at 10,015 feet, is just behind the peak.



4. Engine 463, a K-27 class 2-8-2, pauses at Osier while passengers disembark for lunch. This train has arrived from Antonito at the same time as our train from Chama. The dining hall can be seen at the upper right while stock pens are to the left.



5. The observation gondola slowly rounds the curve toward the west rock tunnel of Toltec Gorge. The Rio de Los Pinos runs along the bottom of the gorge 600 feet below, out of view to the right. The opposite rim of the canyon is 800 feet away.



[Click here for reader comments](#)

Chama module

Although the Toltec section is great for scenery, the Chama module, which constitutes my entry into the module design contest, is better for operation.

Boiling down the essential elements of Chama to fit into a 2x7 foot area is a challenge. Compromises had to be made, but I think the final design [6] offers a good balance between engine service/storage facilities, through train classification, and local switching within the yard.

A typical day's operation goes as follows: A freight train 12-14 cars long enters the yard from either the east or west, although the more interesting action is from the west. The head locomotive cuts off and goes to the roundhouse for servicing. During this time, the switcher, positioned in front of the water tank, breaks up the train into smaller units on tracks b & c, adding to the cars already there, and stores local cars on track d.

A main loco and helper engine take the first cut of cars, stopping for sand, coal, and water as needed while the switcher moves the local cars to the freight dock, oil rack, or coal loading track. A caboose is placed behind the helper engine at the rear of the train. After the train is brought to Cumbres, the engines return to Chama for servicing. Another pair of engines then takes the second cut of cars of the divided train up the hill.

The storage track is a good place to spot cabooses or maintenance-of-way equipment. The storage track can be curved over to the ash pit, to spot a gondola for ash removal as in the prototype. I decided to keep the storage track as is, to spread the tracks out a bit and offer more versatility.

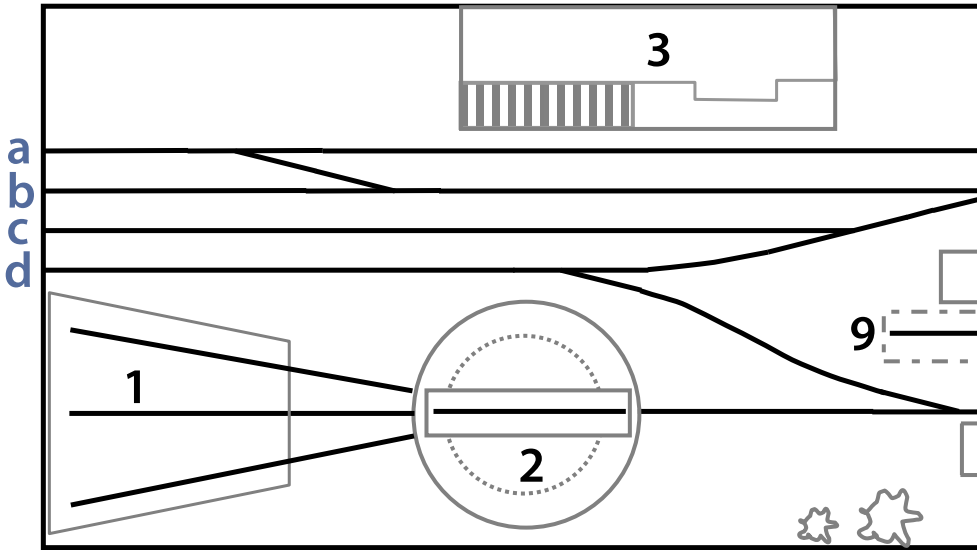

Structure List	
1	3-Stall Roundhouse
2	65ft Turntable
3a	Depot
3b	Warehouse (substitute for depot)
4	Water Tank
5	Coal Tipple
6	Sandhouse
7	Oil Rack
8	Ash Pit
9	Elevated Loading Track

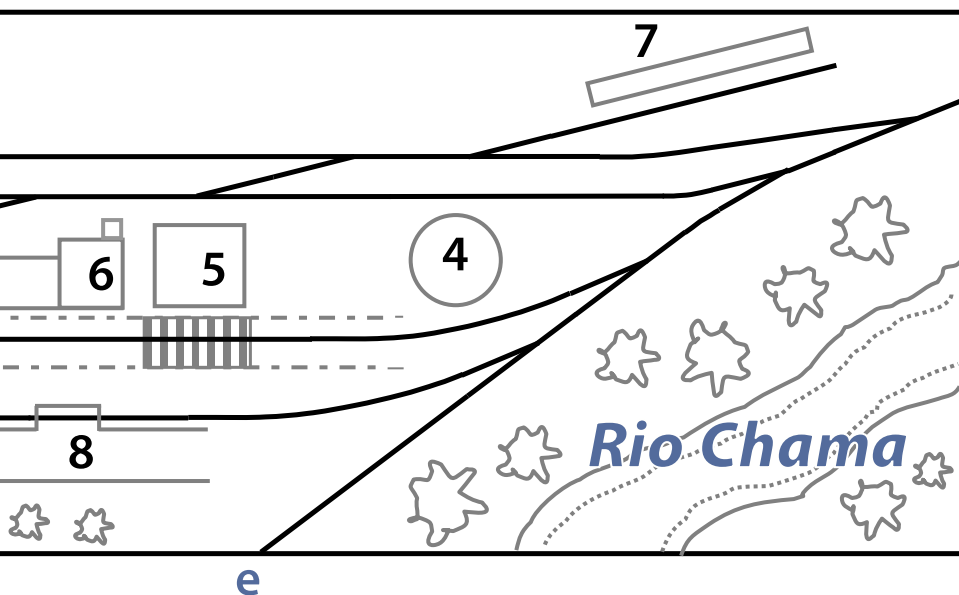

6. Schematic of Chama module with list of structures: Overall size: 24 x 84 inches.

ADVERTISEMENT

Backdrop Junction
Your Stop for Railroad Backdrops

Click Here →

**For the Finest in Custom
Designed backdrop**



www.backdropjunction.com

ONE MODULE CHALLENGE | 11

Benchwork Materials	Quantity	Purpose	Price
4 x 8 ft plywood, 3/8 inch thick	1	Sub-roadbed	\$15.00
4 x 8 ft Homosote, 1/2 inch thick	1	Roadbed	\$29.00
1x4 inch pine board, 10 ft long	3	Framing	\$27.00
2x2 inch pine, 8 ft long	2	Legs	\$8.00
1x2 inch pine, 8 ft long	3	Leg bracing, backdrop supports	\$6.00
Pink insulation foam ¾ inch x 2 ft x 8 ft	1	Basic terrain	\$10.00
4 x 8 ft Masonite 1/8 inch thick	1	Backdrops + control panel	\$12.00
Wood glue	8 oz.	Fastening	\$3.00
Wood screws	1 pkg.	Fastening	\$8.50
2 inch swivel casters with brakes	4	Mobility	\$12.00
Miscellaneous nuts/bolts	As needed	Legs and backdrop fastening	\$5.00
Total Price:			\$135.50

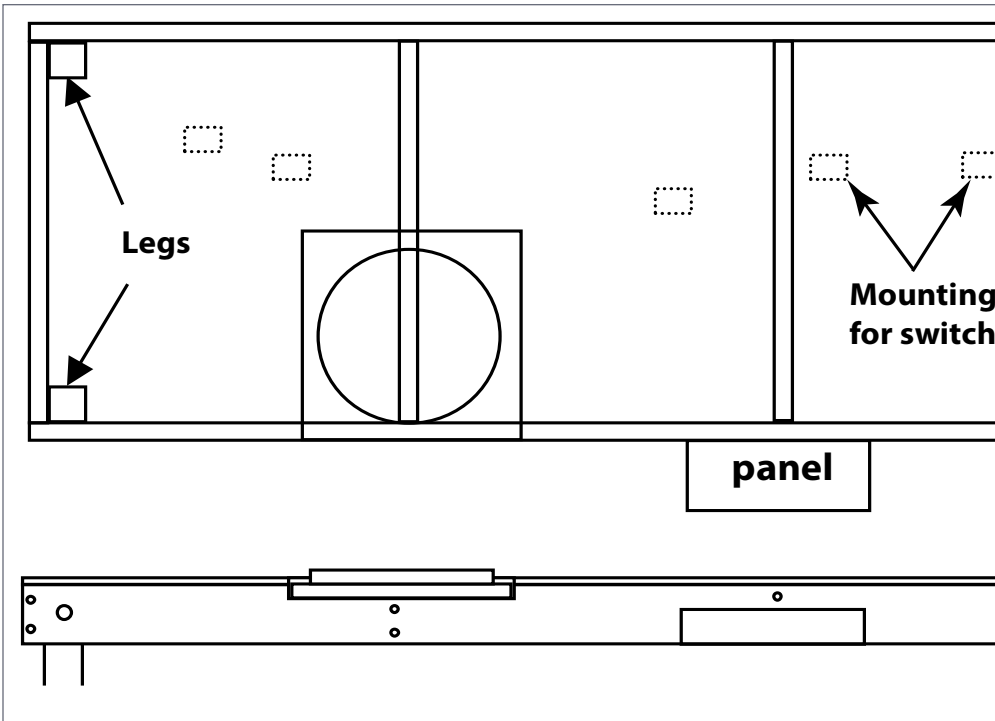

Module construction

The benchwork is a wooden grid with each cross joist glued and screwed to the lateral joists [7]. Plywood is then glued and screwed on top of this grid after sections are cut out for the turntable and the river (optional). If the river is modeled, a strip is cut out of the plywood and notches made in the joists to accept the cutout section.

The recommended turntable has a 12x12 inch wooden base for mounting. To accommodate the turntable, cut a one-foot square section out of the plywood at the appropriate location and cut notches for the base into the joists below. Homasote is cut tight around the turntable and the entire section is made to be removable. Screws hold the turntable to the lateral joist.

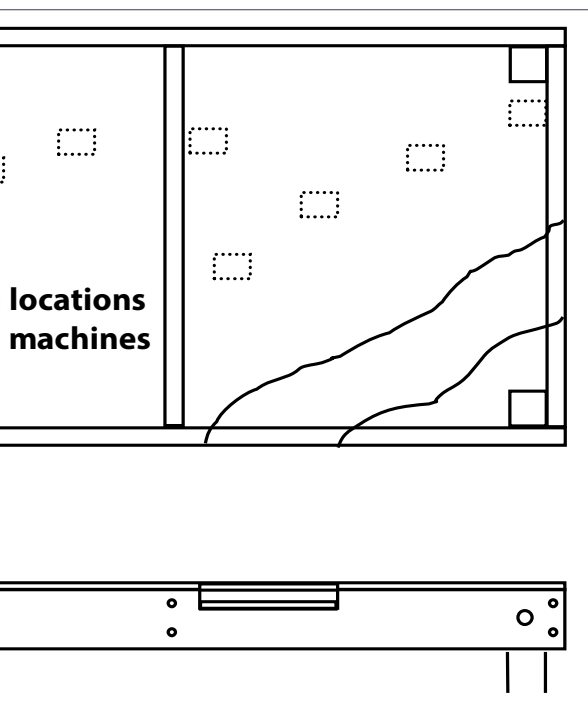

7. Benchwork, top and side views. Note notches for turntable and river.

ONE MODULE CHALLENGE | 13

A mixture of Homasote and foam is glued to the plywood top [8]. Homasote provides a good roadbed surface, accepts track nails, and can be cut out in places to form the coal and ash pits. The foam is shaped to form undulations and hills, offers good texture, and when painted and ground cover added, makes effective terrain that readily holds features like telephone poles and trees. The Homasote and foam may be cut using a sharp-edged utility knife or a jigsaw. The foam can then be shaped with a rasp or file.

Bolts are used to hold the four corner legs in place and are easy to remove for transporting of the module. I like the idea of

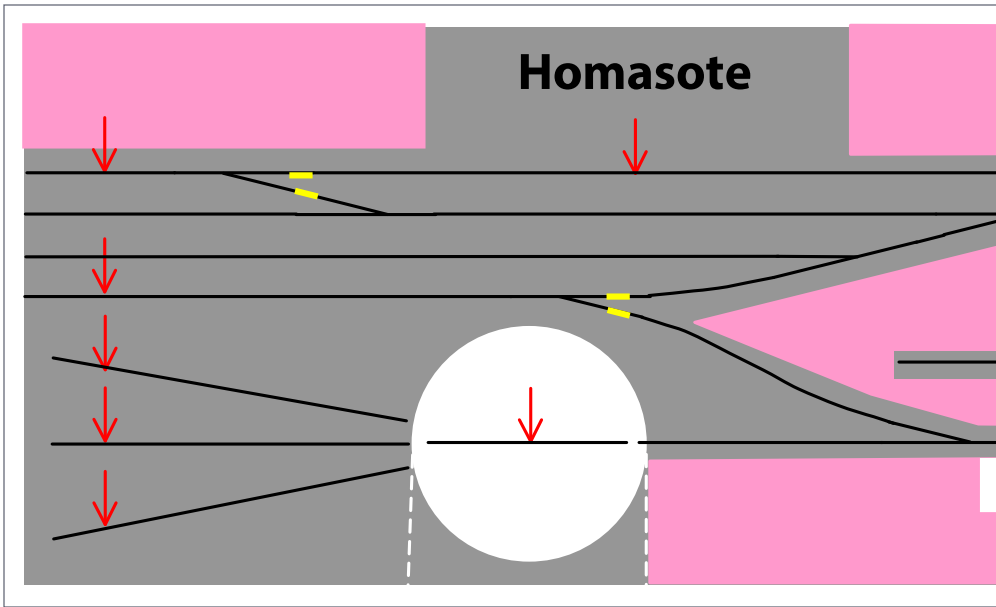

8. Homasote and foam sections are glued to plywood top, with white sections to be cut out. The track layout shown with insulated joiners noted for both rails at each location. Feeder wires for both rails are also noted.

ONE MODULE CHALLENGE | 14

casters with brakes on the bottoms of the legs for easy mobility. I recommend casters for all the sections to allow for later access behind them. The height of Chama above the floor is a personal preference; I like about 42 inches to balance the need for manual manipulation of turnouts and uncouplers with a reasonable viewing angle. Remember that Chama is the lowest point on the layout and Antonito is 7 inches higher. The control panel and backdrops are made from Masonite panels. To hold the backdrop in place, wooden supports glued behind the backdrop can be bolted to either the front or back of the module, depending on on which side is to be viewed.

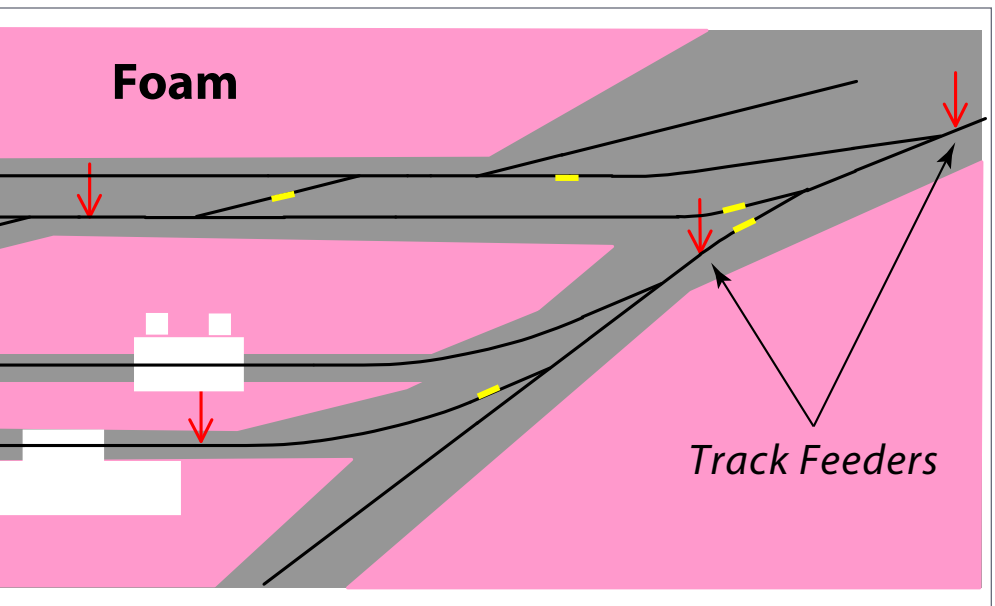

ONE MODULE CHALLENGE | 15

Track and Electrical	Quantity	Price
Shinohara HOn3 Code 70 flextrack, 40 inches long	10	\$76.00
Shinohara HOn3 Code 70 No. 4 left hand turnout	4	\$76.00
Shinohara HOn3 Code 70 No. 4 right hand turnout	8	\$154.00
Shinohara HOn3 Code 70 No. 4 wye turnout	1	\$19.00
Tortoise switch machines (optional)	11	\$200.00
Caboose ground throws	2 or 13	\$6.50 or \$43.00
No. 22 wire, 100 feet	1	\$8.00
No. 14 bus wire, 25 feet	1	\$8.00
Atlas N scale metal track joiners	1 pkg. (48)	\$5.00
Atlas N scale insulated track joiners	1 pkg. (24)	\$2.50
Miniature DPDT toggle switches (optional)	11	\$22.00
Atlas track nails	1 pkg.	\$5.00
Total price, powered switches:		\$582.00
Total price, manual switches:		\$396.50

Take care when laying the track since it's one of the major elements of the scene and good track is critical to smooth operations. Remove a few ties here and there, space some of them unevenly, and clip some of the ends of the ties to add character. Most of the turnouts will need to be trimmed back about an inch from the diverging end for proper fit-up and positioning. Make sure to maintain a minimum spacing of 1-3/4 inches between parallel track centers.

N scale metal joiners and insulated joiners can be used to fit the tracks and turnouts together. A thin layer of white glue and a few track nails here and there will hold the track in place. Feeder wires will need to be soldered to the track at various places, as shown in [8]. The insulators at the turnouts are necessary because the turnouts have live frogs and will short out

ONE MODULE CHALLENGE | 16

otherwise. Plug-type connectors between layout sections allow electrical continuity among the different modules.

You will need to decide how the switches will be controlled – manually or remotely. They can be manually controlled using Caboose Industries ground throws, but I think it's more convenient if they are thrown remotely. I have included suggested mounting locations in [7] for the Tortoise motors underneath the module.

The two turnouts closest to the panel can be manually operated since they are especially close and space is tight for switch motors. I suggest drilling holes for the Tortoise switch machines as the turnouts are being installed, even if the switch machines are not planned for immediate use. These can be installed later without removing the turnouts if the hole exists and is properly aligned.

Once all of the track is installed and operational, paint and weather it. First, airbrush a suitable brown base color over the entire track. Next, stain individual ties a variety of wood colors here and there to break up the uniformity. Apply a wash of India ink mixed with rubbing alcohol over the ties. Last, clean the track with a Bright Boy. Ballasting and other detailing will complete the trackwork.



[Click here for
reader comments](#)

ONE MODULE CHALLENGE | 17

Scenic material	Quantity	Price
Dirt	As required	N/A
Woodland Scenics ballast, gray	12 oz.	\$5.00
Woodland Scenics ballast, cinders	12 oz.	\$5.00
Woodland Scenics fine turf, burnt grass	18 cu. in.	\$4.00
Woodland Scenics coarse turf, burnt grass	18 cu. in.	\$4.00
Woodland Scenics foliage clusters, light green	45 cu. in.	\$11.00
Woodland Scenics fine leaf foliage, light green	1 pkg.	\$18.00
Acrylic paint: earth, black, blue, white	As required	\$20.00
Acrylic gloss medium	4 oz.	\$7.00
Sculptamold	3 lbs.	\$7.00
Total price:		\$81.00

Painting the track and foam goes a long way toward scenicking the module. The foam may be spray painted using a suitable acrylic earth color. Then add ground cover, first dirt, then a mixture of gray ballast and cinders over the tracks, and bury some of the ties. Follow up with burnt grass and shrubs, especially near the depot and river. Plant larger trees near the river and toward the front of the module near the turntable.

Many pictures of the Chama yard can be browsed online for inspiration and ideas. Take your time and keep adding details here and there. Telephone and utility poles are good examples.

In the engine service facilities, the scenery blends in with the structures. The elevated loading track can be made with foam and Sculptamold, creating a strip-like embankment behind the coal tipple and sand house with a steep ramp descending behind the water tank. Add dirt, weeds and small bushes to

ONE MODULE CHALLENGE | 18

the embankment, and place stones against the slopes to act as retaining walls [2, 10].

Paint the backdrop (about 18 inches high) sky blue color and airbrush cirrus clouds in near the top. Blend a horizontal line of earth color along the bottom to blend with the foreground. The Walthers Instant Horizons Whistle Stop scene provides a good model of how the horizon should look. As described earlier, the backdrop can be installed on either side of the module, providing a background for attractive photos from multiple angles.

The optional river can be made using any of several methods. Perhaps the simplest is that described by Dave Frary in the January 1984 issue of *Model Railroader*, in which he used acrylic gloss medium to simulate the water surface. In this approach, model and detail the banks (Sculptamold would be useful here), apply brown paint near the banks and black paint toward the center of the river. Brush acrylic gloss medium with colored tints in layers on top of the painted river surface until the right depth, color and texture is achieved.

Structure	Model	Price
Roundhouse	Banta Model Works or Scratchbuild	\$170.00
65ft Turntable	Diamond Scale	\$165.00
Depot	Banta Model Works	\$148.00
Warehouse (substitute for Depot)	American Model Works	\$45.00
Water Tank	Durango Press	\$55.00
Coal Tipple	Campbell Scale Models	\$95.00
Sandhouse	Campbell Scale Models	\$75.00
Oil Rack	Scratchbuild	\$15.00
Ash Pit	Scratchbuild	N/A
Elevated Loading Platform	Scratchbuild	N/A

ONE MODULE CHALLENGE | 19

The structure list reflects my own preferences. Cheaper or different models can be substituted or the structures could all be scratchbuilt. You will probably want to start with the turntable as that is integral to the operations of the yard. Beyond that, one could spend years carefully building up the module into a highly detailed operating diorama, buying kits and materials as your budget allows.



9. This picture of Chama yard was taken prior to 1924, when the current coal tipple was built to replace the 60-ton coal chute in the photo. At left, a boxcar sits beside the loading dock of the freight station, which occupies the left portion of the depot. The roundhouse, complete with smokestack, can be seen along the middle right. Many things have changed in the yard over the years, but one thing that hasn't is the mountains rising in the distance.

The roundhouse is based on one at Sargent CO which was a base for helper operations across Marshall Pass on the northern side of the narrow gauge circle. If the roundhouse is too pricey, one could be built from scratch at less cost. In any case, it is likely that even the kit will have to be modified slightly to get the tracks to fit into the limited footprint. Tolerances are tight everywhere on this module – pretty much par for the course on narrow gauge lines.

A model of the Chama depot is available from Banta Model Works kit BSC-2098. If you choose another option to forgo the depot and replace it with a warehouse, which was present in the yard near the depot. American Model Works offers a similar warehouse that could be used with a few modifications. Walthers makes an oil platform that could be modified to form the oil rack. If scratchbuilt, it will have to be shortened a bit to fit into the available space.

I've had good success with the high-quality Durango Press and Campbell kits. The sand house is based on a similar design at Durango; it would need to be rearranged a bit to form the configuration at Chama (refer to [2] for more details).

Search via Google using keywords like Chama ash pit, coal tipple, sand house, etc. for more information and photos. With these pictures, you can learn how the coal delivery system works, and how the ash-pit is cut below the track behind the sand house. If you choose to bend the storage track over to the ash pit, it would descend into the pit beside the engine track to facilitate easier shoveling of the ashes into gondolas [10]. Without the track, a truck could do the job of ash removal.

The service area, consisting of sand house, coal tipple and ash pit, forms an intricate array of structures that fits into the

ONE MODULE CHALLENGE | 21

surrounding terrain. A large grate over a concrete coal delivery pit directly behind the coal tippie cuts into the hill holding the elevated track. Coal from drop bottom gondolas would descend through the grate and into the two coal pits behind the tippie.

Building in stages

There are numerous advantages to building train layouts in sections.

1. Smaller sections are easier to work on at the workbench or in the train room.

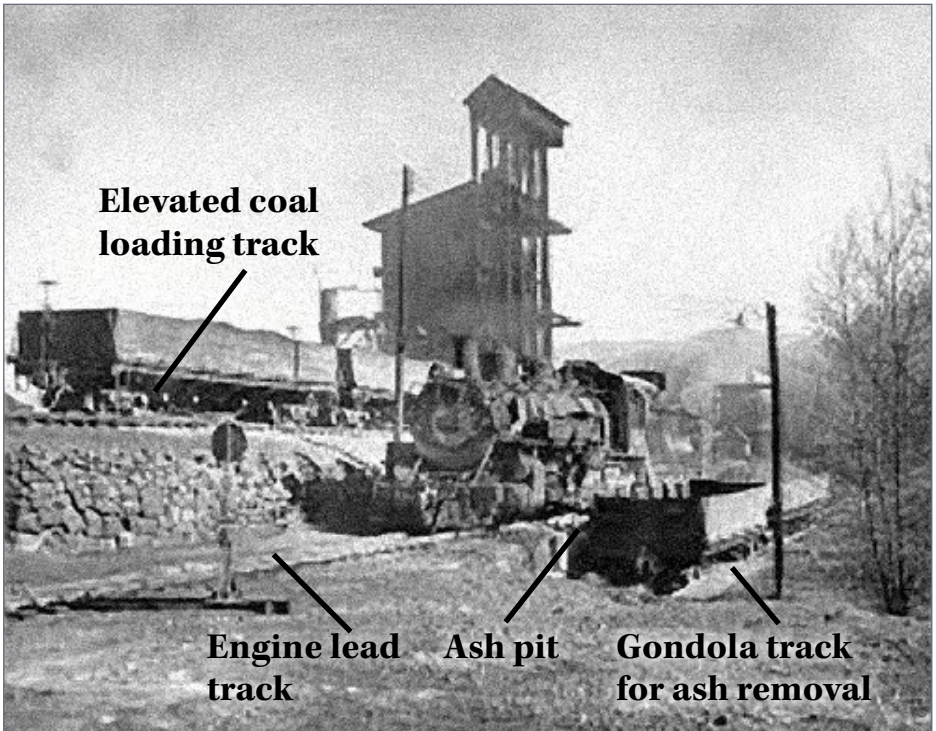

10. Photo of engine service facilities highlighting the ash pit and coal track. All three tracks pictured join up by the water tank in the distance.

2. The completed sections can be up and running as other sections are being built, so there is no rush to complete the entire layout.
3. The sections are generally portable, so they can be transported for display or operation at other locations, or all sections can be moved into a new room if the need arises.

Stage 1

The Chama division as I have planned it can be built in several stages [11]. First, the Chama module itself, with an 18-inch extender off the yard lead track for an engine and two cars, can allow operation on its own. A cassette of cars, or cars placed manually on the main track, begins the operating session. During the session, the cars are sorted and the yard switched. Cars set out include boxcars at the depot, drop-bottom gondolas behind the coal tipple, “Gramps” tank cars at the oil rack, and cabooses or equipment cars on the storage track. Engines are also serviced appropriately.

Stage 2

Add the three-track staging section to the west and the Antonito section to the east [12]. Take advantage of the room on the left staging module to extend some of the yard tracks. The Chama and Antonito sections are similar in design, so building them together allows for efficient construction. For example, Homasote for both sections can come from the same sheet. A 2nd sheet of plywood is recommended when building Antonito because Antonito and Osier fit together. (Osier is notched to accept the wye support piece from Antonito. The wye track is eventually covered by hill/mountain scenery built at the rear of Osier and spilling over to Toltec [1].

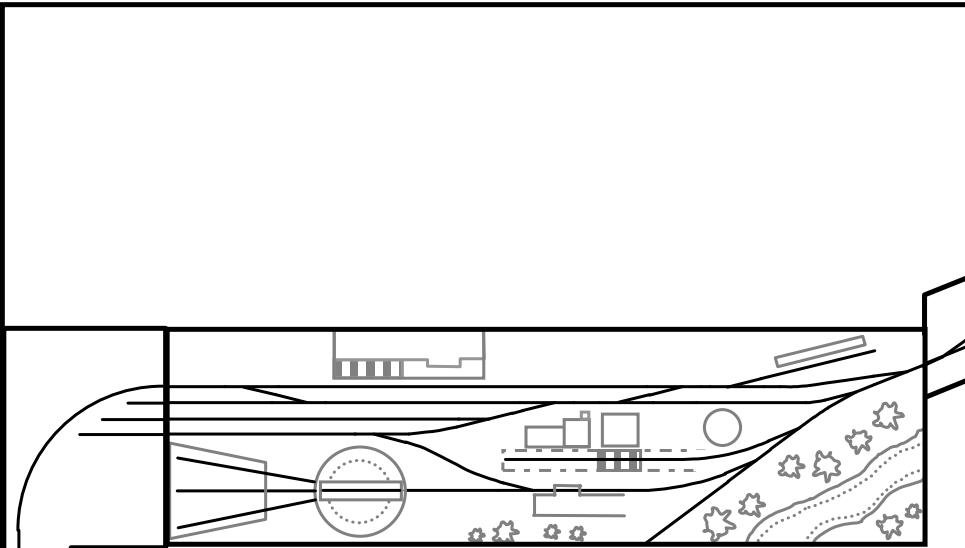

STAGE 1

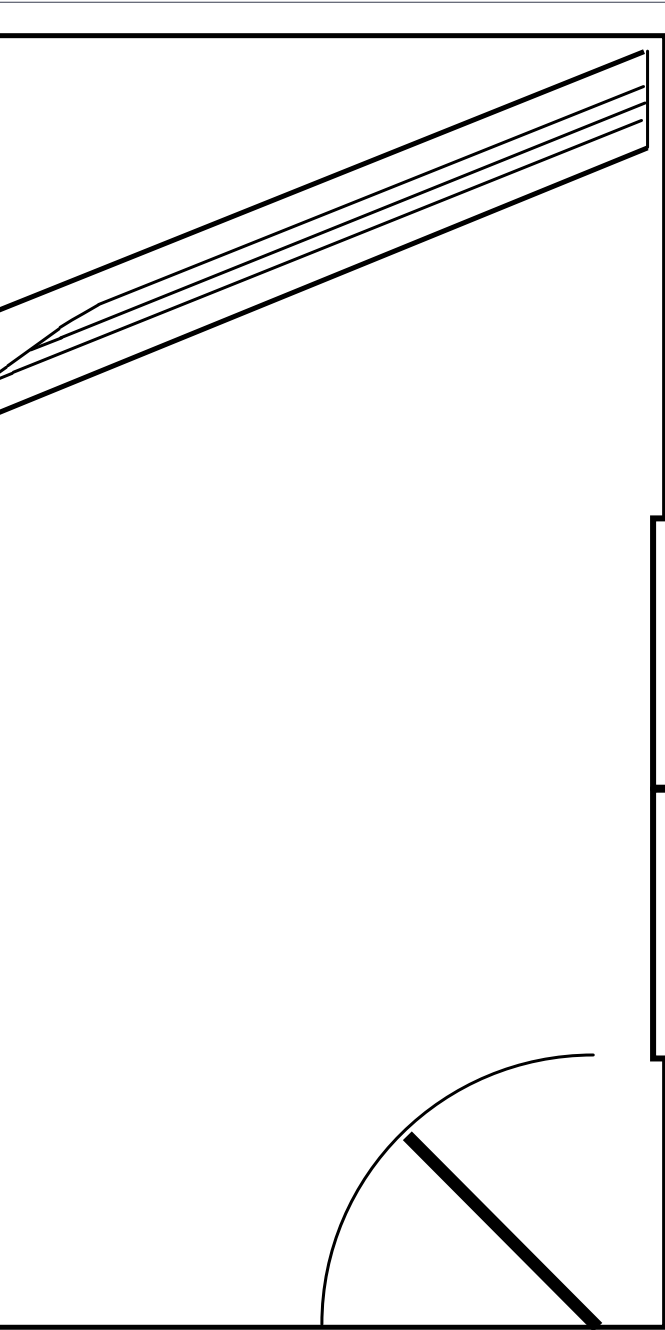

11. Stage 1
arrangement:
Western staging +
Chama + Eastern
staging.

Lobato (under construction)

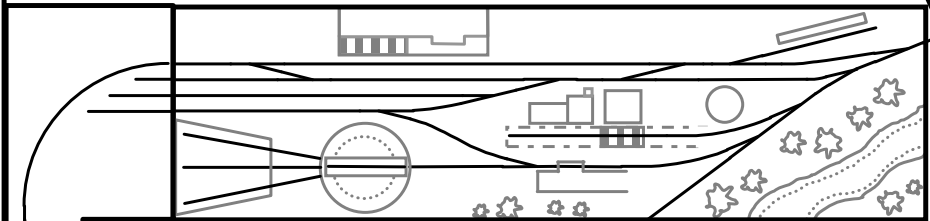

STAGE 2

Cumbres (un construction)

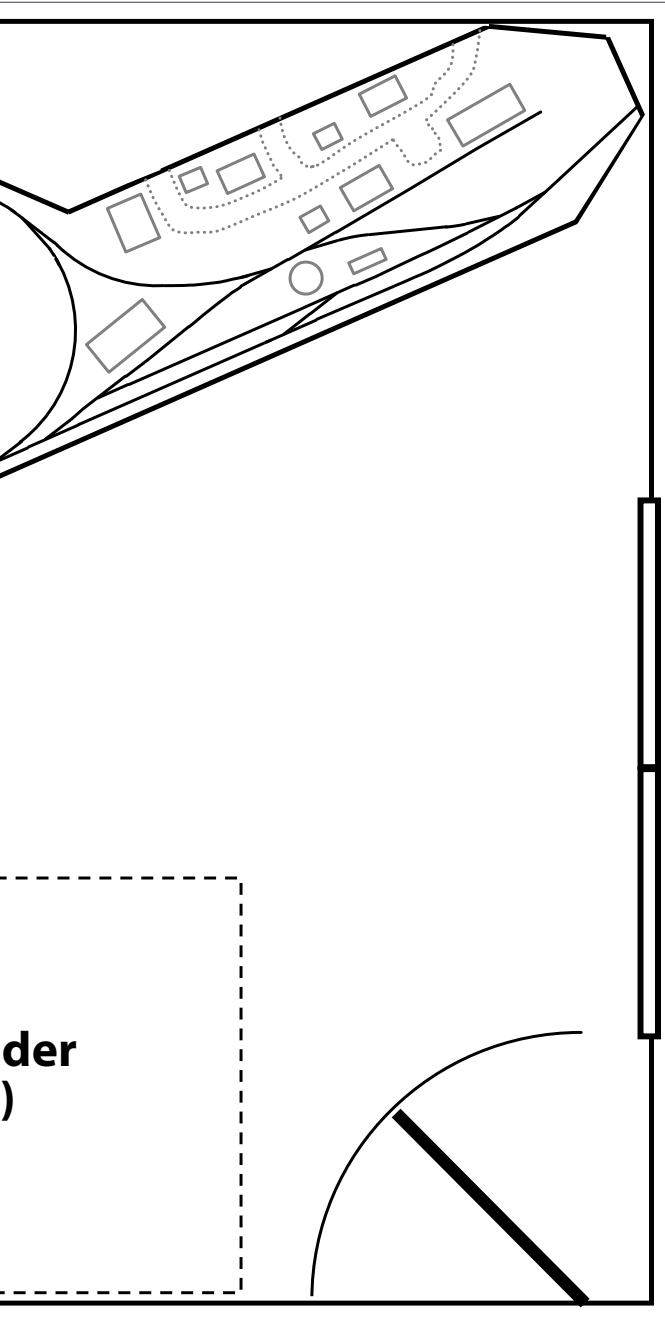

12. Stage 2 arrangement: Western staging + Chama + Antonito sections.

Stage 2 operation includes sending trains back and forth between the two modules with local switching added in.

Stage 3

Modules could be under construction in the room during Stage 2 operations. The Lobato corner section would be constructed first, then stored behind Chama. Space would be tight while Cumbres is being built, but there would still be about two feet of aisle in front of Chama [12].

I acknowledge that the configuration described in Stage 2 does not explicitly meet the contest requirements for staging; that is, three full trains of at least 70 inches long wouldn't quite fit the arrangement as shown. To meet the requirements, the western staging section could be lengthened by 9 inches. This would still be usable in the final Stage 4 configuration, and another similar section [12] could be built toward the east.

Once the Lobato and Cumbres sections are completed to the point of operation, you can move to Stage 3 [13]. Note that, except for Antonito, the sections assume their final positions in the room. Antonito is attached in reverse position using two short bridge and extender sections. Stage 3 operations allow helper action between Chama and Cumbres with the assembled trains being brought to Antonito for reclassification and staging. The engines are turned using the wye at Antonito and the trains are sent back to Chama as westbound freights.

A snowshed at Cumbres protects part of the wye from snow accumulations. I have not shown this on the plans to keep the view uncluttered but you could certainly model one if you choose.

Note on helper operations: I think there is a balance between weight of cars, locomotives and grade which would be required

Make it run like a

Dream

By Joe Fugate

EBOOK SERIES:

First time these methods all collected in one place

**PREORDER
SPECIAL**

\$12.99

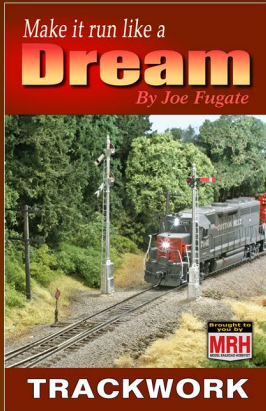

Est release: Jul 2016

\$12.99

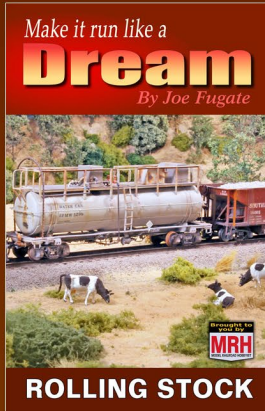

Est release: Jan 2017

\$12.99

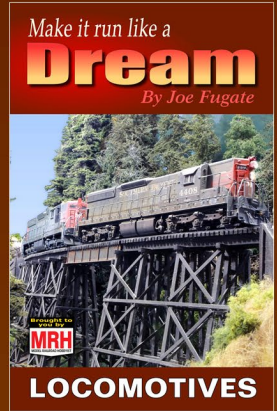

Est release: Jun 2017

Pre-order customers get regular sneak peeks at chapters as they're finished, and get exclusive access to video shorts ...

~~\$38.97~~

\$29.99

eBook ... hardcopy books
pre-order coming soon

PRE-ORDER EBOOKS TODAY >>



store.mrhmag.com

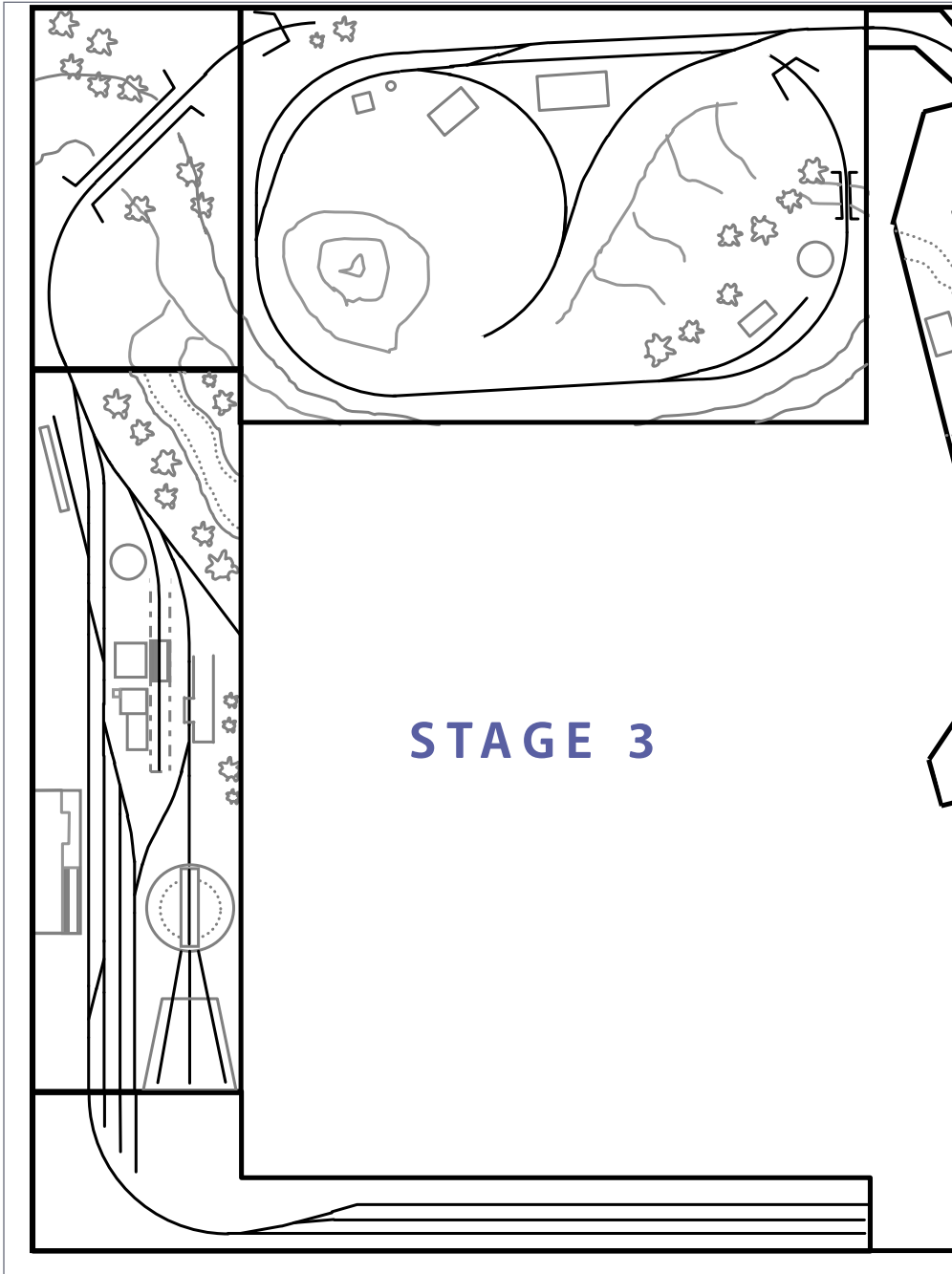

STAGE 3

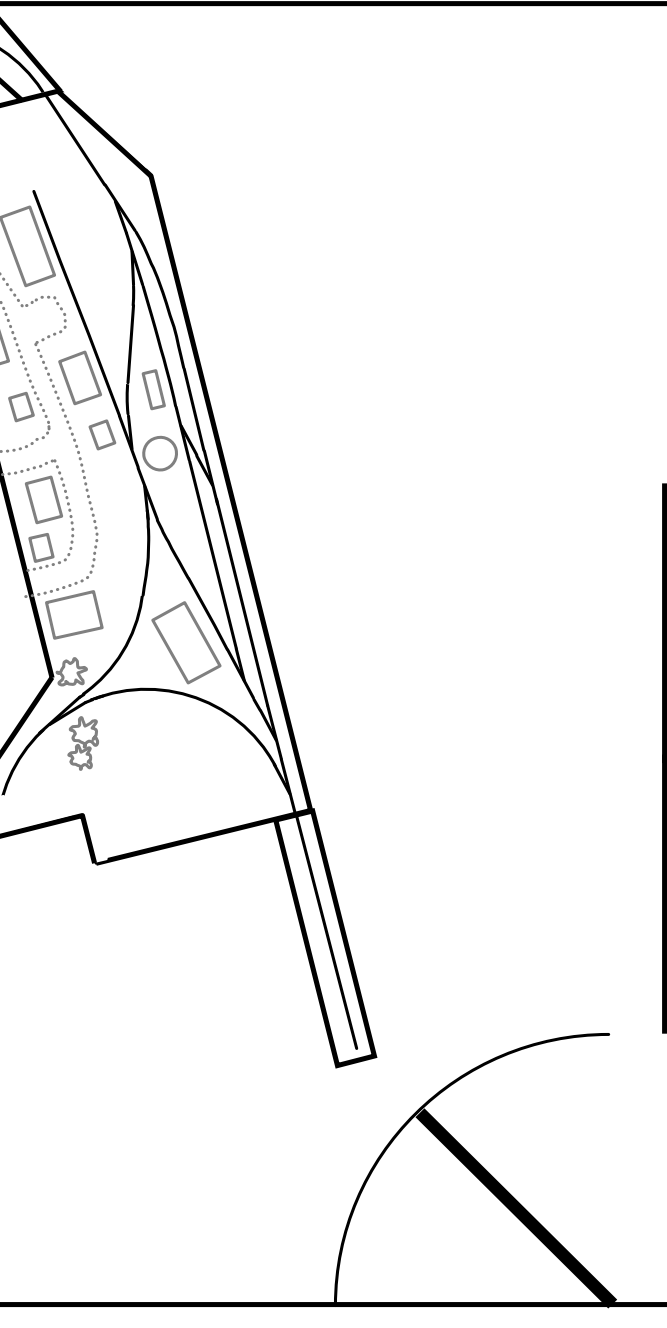

13. Stage 3 arrangement:
Western staging +
Chama + Lobato
+ Cumbres +
Antonito sections.

ONE MODULE CHALLENGE | 30

for effective helper operations using 7-8 cars (the limit of the passing tracks at Cumbres, assuming standard 30-foot car lengths). If the cars are too light, they are more likely to derail as the helper engine pushes from behind. For that matter, if the cars are too light only one locomotive would be necessary. Of course if the cars are too heavy, even seven cars might be too much for two locomotives. I suggest experimenting with the planned equipment before final build-up of the graded sections to determine the appropriate grade; it might be less or more than 4%.

I've included some sketches of the switching maneuvers at Cumbres when bringing two trains up the hill [14]. Part of the switching involves a pause for the engines at the waterspout for

Move sequences for helper operations at Cumbres. Follow the pictures on the next pages.

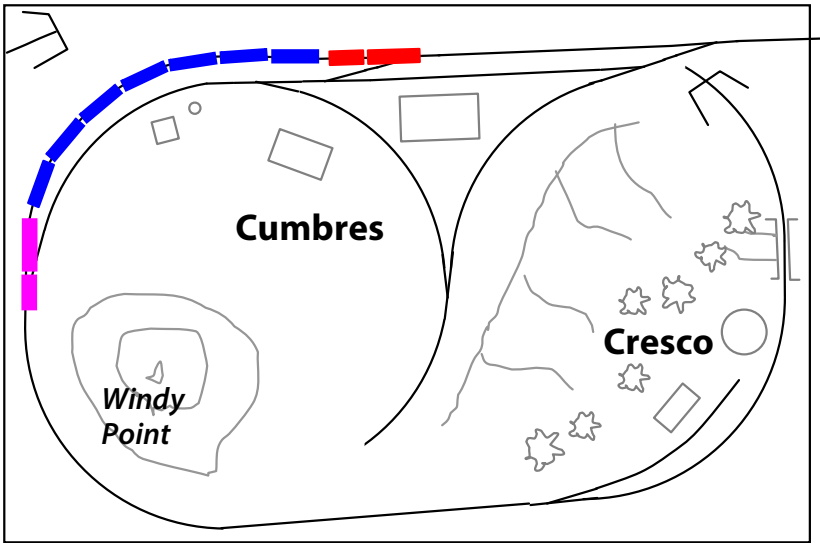

14a. Main and helper engines arrive at Cumbres with the first cut of cars, pausing on the main track.

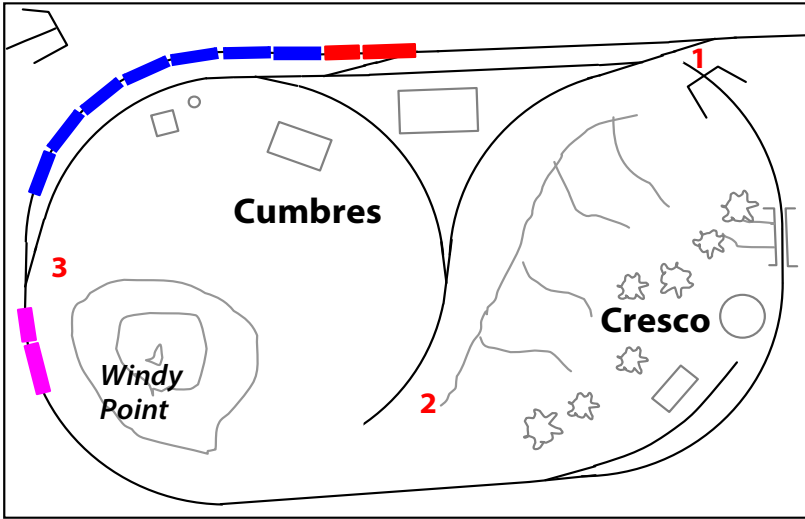

14b. Helper uncouples and turns using the wye as shown, stopping at the waterspout if necessary.

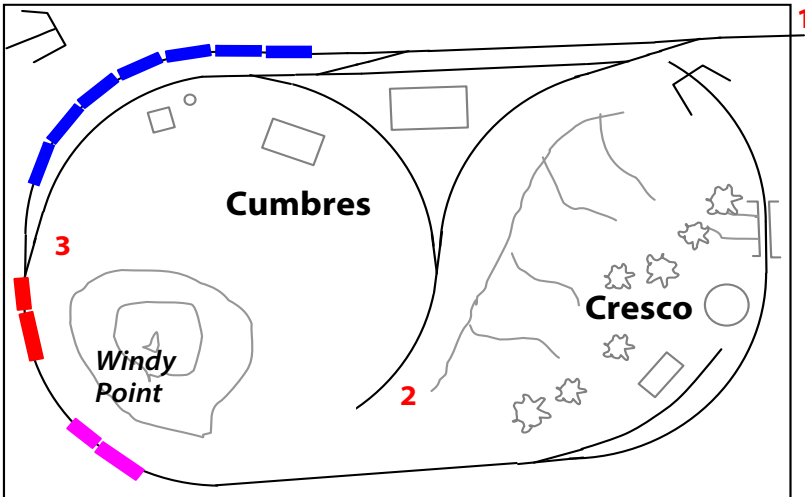

14c. Main engine uncouples and turns using the wye, again pausing for water if necessary. The two engines then make their way back to Cumbres.

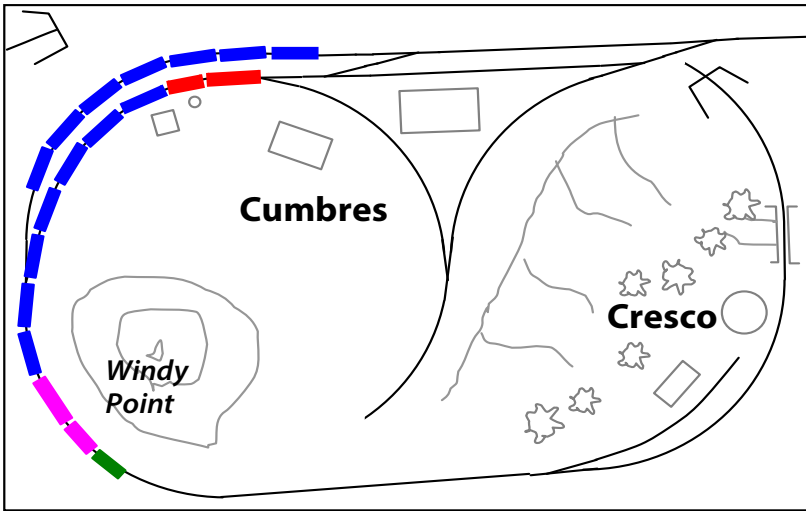

14d. Later another cut is brought to Cumbres, this time with a caboose behind the helper. If necessary, the main engine pauses for water on the passing track as shown.

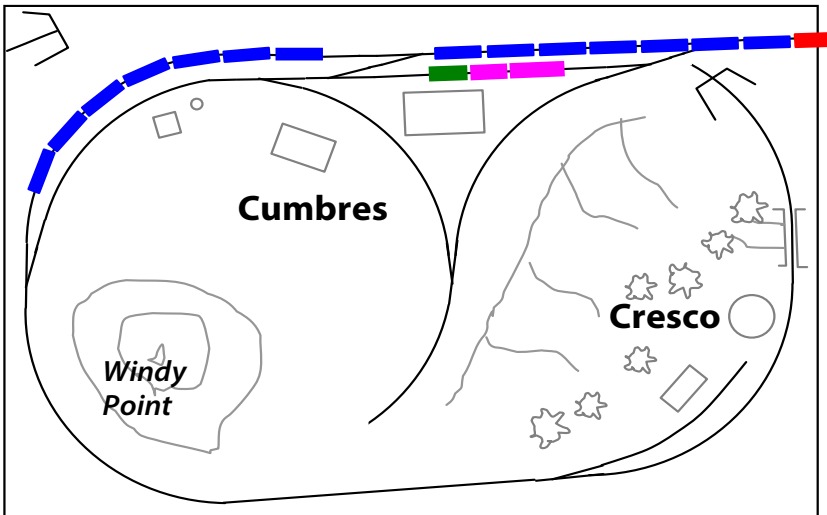

14e. Main engine pulls train onto mainline using crossover track and helper pulls forward to pause in front of the depot.

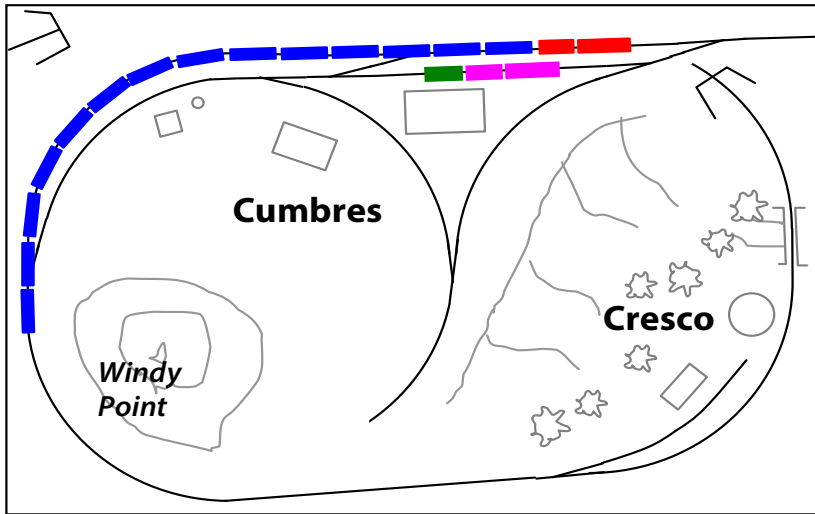

14f. The main engine backs up to couple onto the previous cut of cars and makes room for the helper to pull forward.

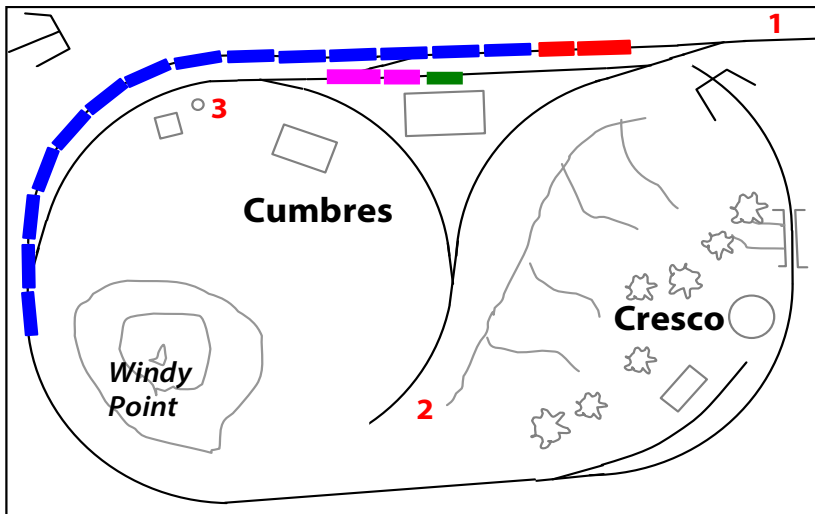

14g. The helper uncouples from the caboose, turns using the wye, then re-couples with the caboose on the opposite end.

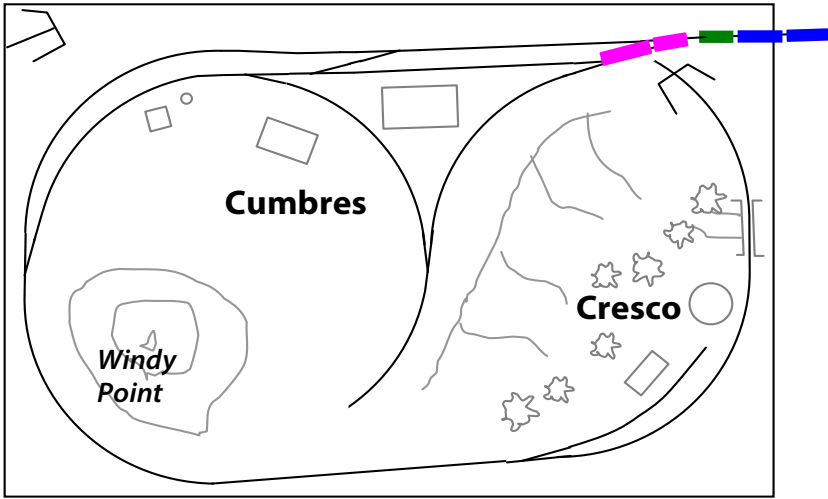

14h. The main engine pulls the train forward and the helper tacks caboose onto the train. The train continues eastward while the helper is free to return to Cumbres.

filling before returning to Chama or going onward to Antonito. Another set of moves involves switching the caboose into the final train. If Kadee uncouplers are used, you would probably need two uncoupling magnets — one just west of the crossover switch on the mainline and one in front of the depot — as it would be difficult to manually uncouple in those areas..

Stage 4

Adding the Toltec and Osier sections to the mix completes the layout [1, 15]. I think the final layout would be a pleasant place to run trains and get away from your daily troubles. Upon entering the train room, you'd be treated with a spectacular view of the Toltec Gorge. As far as the room itself, there are no duck-unders to deal with, and the closet is fully accessible.

Cloth skirting along the front of the sections would set off the layout nicely and the backdrop would also help frame the scenes. I've shown the simplest arrangement of backdrops with right-angle corners. With a little extra work, you could cover the corners for a nicer effect. Coving would be especially useful for Antonito, as it is largely open field near the left corner. All sections can be removed from the room without too much trouble. The trickiest move would be Cumbres, which would have to be placed on end to get through the door.

Scenery

There is high scenic potential here, particularly the vertical aspects of the terrain. The creeks and rivers are cut much lower than the track and are built to connect between sections. Similarly, the mountains rise above the tracks and are built to align between sections.

The site lifewastedchasingtrains.com showcases the superb photographs of John West, who has taken photos of the Denver and Rio Grande Western (among other railroads) since 1958. The sites www.drgw.net and www.ghostdepot.com are also good resources for understanding the history of the railroad.

The completed layout supports up to four operators, one each at Chama and Antonito, and two running the main line. As described earlier, eastbound operations move freight from the western staging tracks to Antonito via helper service to Cumbres. The consists include stock cars from the Oxford area west, refrigerator cars carrying beans and fruit from Farmington NM, and freight and lumber in boxcars. Among other freight customers, there was a lumber mill in west Chama and the Gramps oil facility.

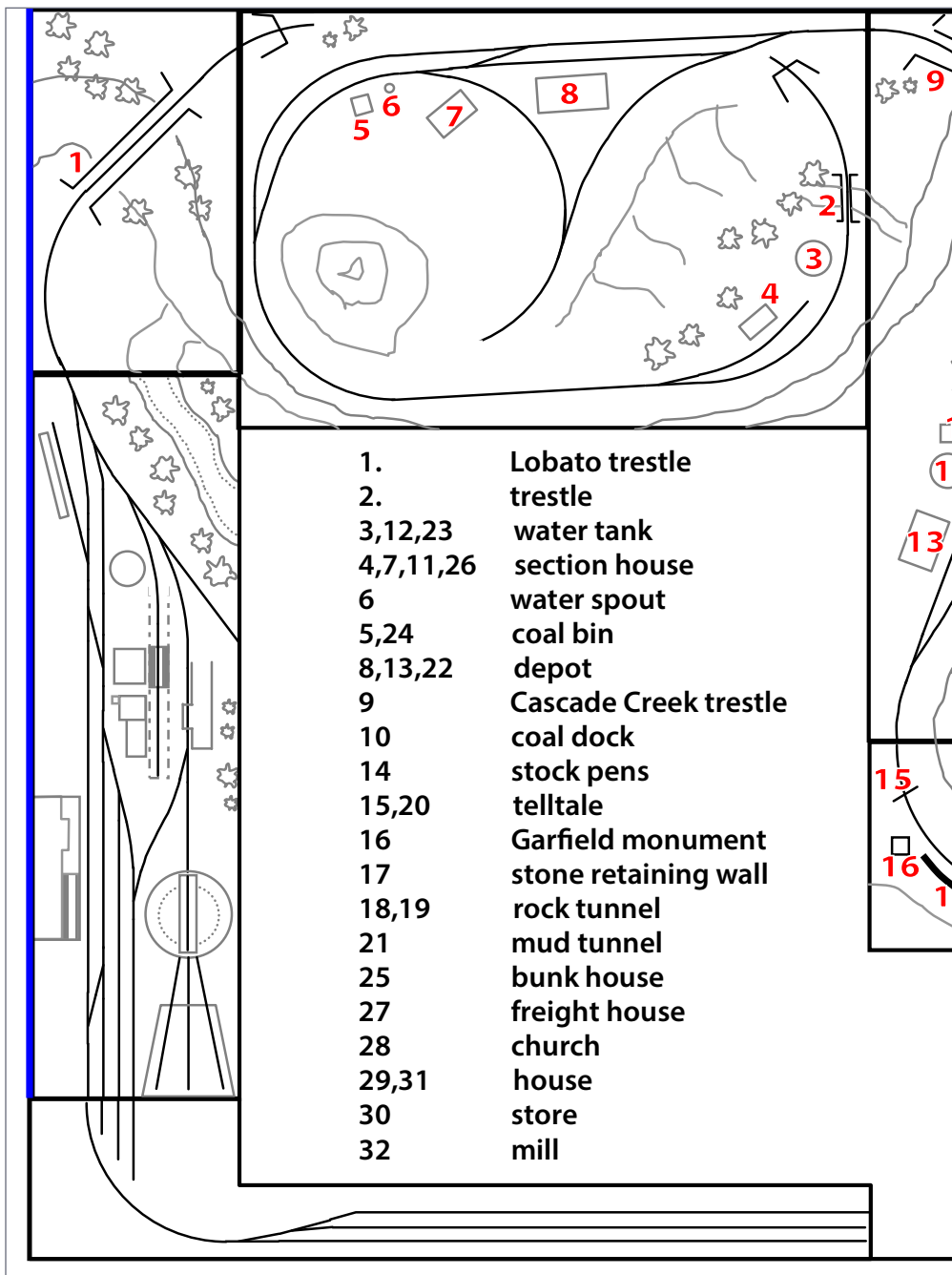

- | | |
|-----------|-----------------------|
| 1. | Lobato trestle |
| 2. | trestle |
| 3,12,23 | water tank |
| 4,7,11,26 | section house |
| 6 | water spout |
| 5,24 | coal bin |
| 8,13,22 | depot |
| 9 | Cascade Creek trestle |
| 10 | coal dock |
| 14 | stock pens |
| 15,20 | telltale |
| 16 | Garfield monument |
| 17 | stone retaining wall |
| 18,19 | rock tunnel |
| 21 | mud tunnel |
| 25 | bunk house |
| 27 | freight house |
| 28 | church |
| 29,31 | house |
| 30 | store |
| 32 | mill |

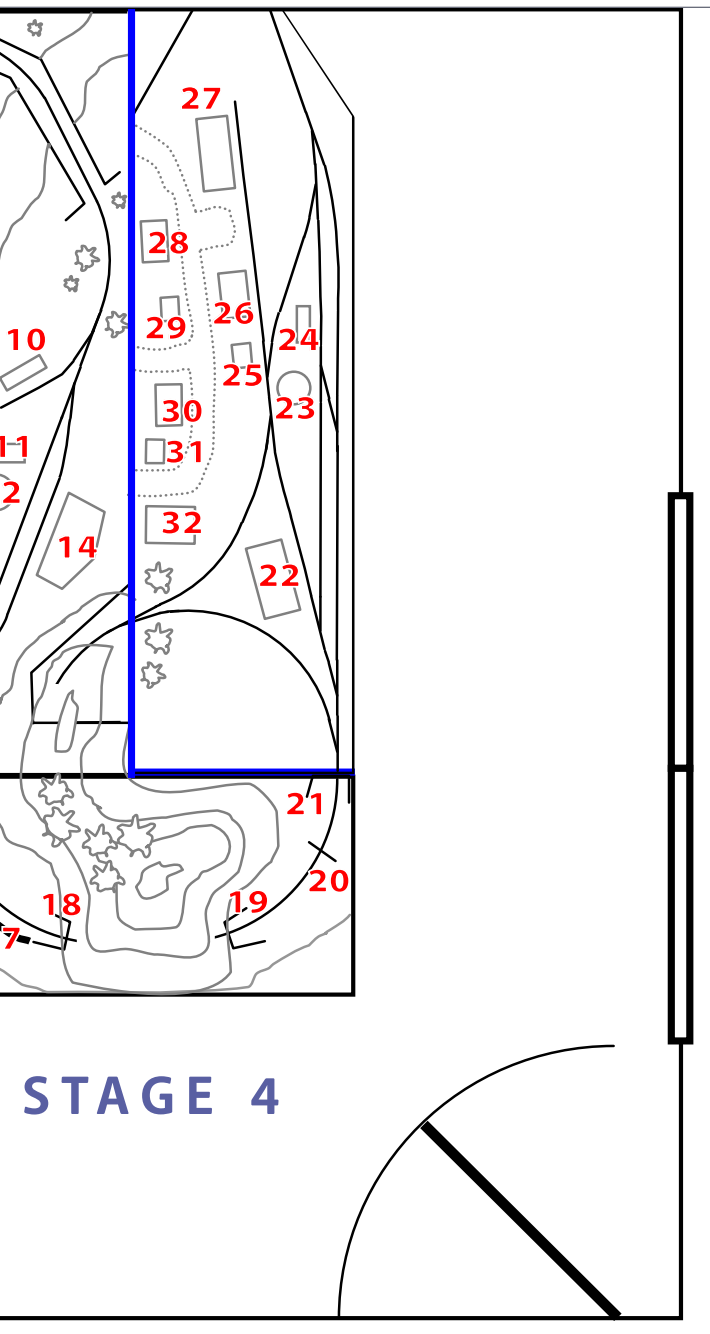

STAGE 4

15. Structures for Stage 4 layout, excluding Chama section (covered in the module one plan [6]).

ONE MODULE CHALLENGE | 38

Antonito can be used as a switching/staging module [16] where the eastbound train is accepted into the yard and cars switched as necessary. The engine and caboose must be turned to set up

16a-f. Converting eastbound freights to westbound freights at Antonito. See the following pictures.

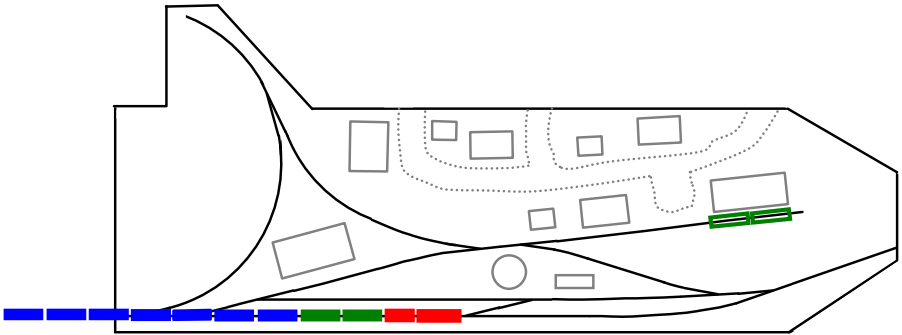

16a. A 14 car train (plus caboose) enters Antonito and pauses by the crossover. Cars in green are to be switched at the freight house.

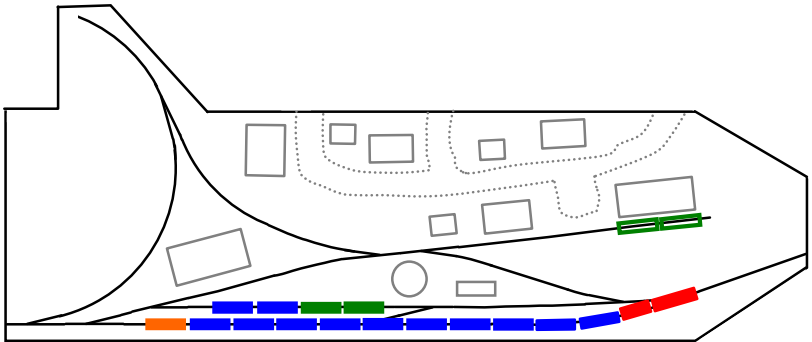

16b. To make room, 4 cars are set on the passing track. Then the rest of the train is pulled forward to clear switches.

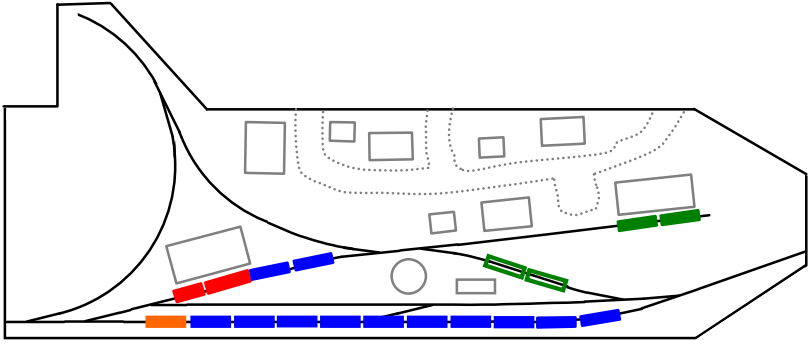

16c. Engine runs around train, picks up short section of cars, switches freight house.

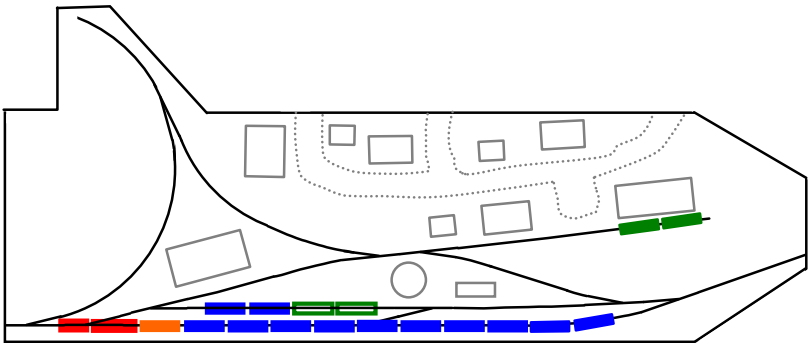

16d. Engine gathers cars, puts them back on passing track, then couples onto caboose.

a westbound train, Loads could now be empties and vice versa. Westbound freights originating from Antonito can support longer trains due to the decreased grade. These trains can also switch cars at Osier, Cumbres and Cresco on the way to Chama.

Even though I've shown how longer trains can operate on the layout, there is also ample opportunity to run shorter freights or passenger trains headed by a single engine. I imagine it

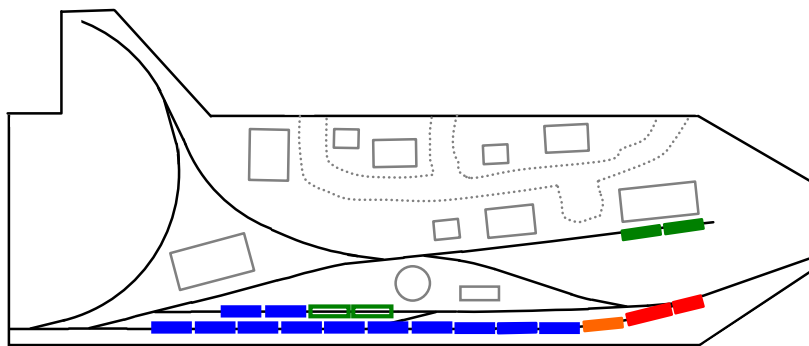

16e. Engine turns with caboose using the wye, then attaches caboose to opposite end of the train.

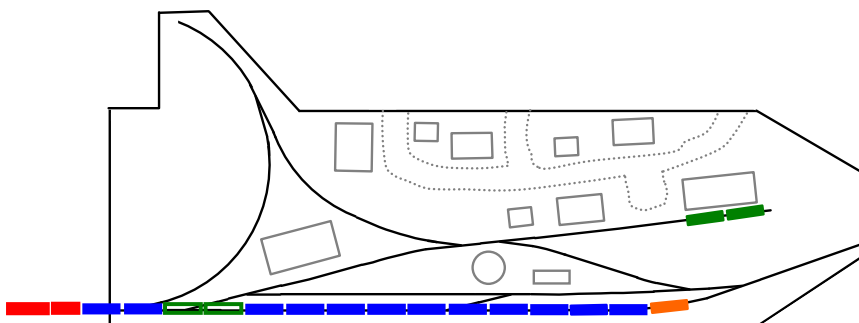

16f. Engine takes on water, attaches 4 cars to front of train and is ready to leave as a “new” westbound train.

would be quite a thrill to run a passenger train out of Chama, steaming through the mountain scenery across the trestles and around the Toltec Gorge before arriving at the depot in Antonito. It might even be better than the actual trip.

I'd like to thank *Model Railroad Hobbyist* for sponsoring this contest and for providing inspiration to revisit and further explore the Cumbres and Toltec. I've thoroughly enjoyed

ONE MODULE CHALLENGE | 41

designing the Chama module, and also the associated sections filling out the route to Antonito. Now if I only had a spare 12 x 15 foot room to build it in!



[Click here for reader comments](#)

PETER VASSALLO



Peter lives in Albany, NY and works as a mechanical engineer for Bechtel Marine Propulsion. His interests include golf, writing, photography and (naturally) trains. As a boy, he had an N scale layout that was inspired by his father, who also modeled in N scale. He currently lives in a one bedroom apartment and models HO standard and narrow gauge (small sections!). His particular interest lies in the narrow gauge railroads of Colorado and California. An article on one of his HO modules is scheduled to appear in Model Railroader later this year. ■

Esteban Martinez's

BNSF

BY ESTEBAN MARTINEZ
AND THE MRH STAFF



Also coming to
TMTV in April



**On tour at
this summer's
Indianapolis
NMRA
National**





[Click here for
reader comments](#)

On tour at this summer's Indianapolis NMRA National ...

MRH: Hello, Esteban! What is it you're trying to do here?

Esteban: I'm recreating a section of the BNSF Northern transcontinental railroad to the best of my ability. I'm modeling a 300-mile stretch between Wolf Point, Montana and Essex, Montana. I chose that section because it's a high traffic area, with a lot of container traffic, coal traffic, among other things.

MRH: Why the BNSF in particular at this location?

Esteban: I started out modeling the Burlington Northern. When 1996 came and the merger with the Santa Fe happened, I just kept up and started modeling the BNSF. Over the years, I have just have stuck with it.

I chose Montana because I like the coal traffic that comes from the Powder River Basin. There are also a lot of containers from the West Coast going through on the way to Chicago.

So this gives me two leading types of traffic – and it's the traffic I prefer to model.

MRH: So a good variety, then.

Esteban: That's it – a good variety.

ESTEBAN MARTINEZ's BNSF | 3



1. Esteban's BNSF mainline has concrete ties while the passing track is on wooden ties. Here #617 leads its train over the bridge at Nashua.



2. The BNSF engine service facility at Shelby, MT sees a variety of motive power passing through on this transcontinental route through Montana.

MRH: When did you get into the hobby?

Esteban: I got my first train set when I was six years old, down in Costa Rica. My parents went downtown and bought me a Tyco set. I ran that engine until the wheels fell off! I just kept going in the hobby through my teenage years.

I was able to get a job at the hobby shop, amazingly enough. As the years passed, I was able to get better equipment, get better cars, and better engines.

MRH: How did you develop this layout's track plan? Did you go through many versions before you got to this one?

Esteban: I've been into modeling for over 20 years, so it wasn't hard. When it came to designing this layout, I had a good idea already of what I wanted and how to make it work.

This track plan took me about six months to draw because I took my time. I went back and studied it repeatedly, and thought, "Well, if a train is at this place here, is it really going to work or have I missed something?"

I actually took the time to think of what the operation would be for each train.

MRH: Where is the layout located – and what challenges did you face building it here?

Esteban: I built this layout in my garage. The main challenge that I encountered right off the bat was the temperature variation in here.

I had to insulate the walls, the ceiling, and make it comfortable here in both the winter and the summer. That was my biggest challenge. I feel it's important to regulate the temperature

ESTEBAN MARTINEZ'S BNSF | 5

because of the wood and the rails. I do some hand-laid track, so it's important that it stays as uniform as possible in here.

Before we built a house, since I took drafting in high school, I drafted out exactly what I wanted to do. The formal final builder's plan actually used about 95 percent of what I drew!

MRH: How long have you been working on this layout?

Esteban: This layout, three years.

MRH: Three years – that's pretty impressive. Do you have a day job?

Esteban: I have a full-time job at Advance Auto Parts. I manage a store for them and I work 50-60 hours a week on top of having two children and a family. I can still make time to do this.



3. Today's eastbound Amtrak train is powered by a single GE P42DC loco. The train has stopped at Shelby, MT, and is about to depart.



4. Esteban filled the corner at Chinook with industries and a bit of photo backdrop.

MRH: What motivated you to try handlaying track?

Esteban: When I was 13 or so, I wanted to build a yard in the small layout I had then, with eight tracks. I needed like 20 turnouts all together for what I wanted to do and I didn't have the money at that age. My dad said, "Well, we could save for it, but it's going to take time."

When you're that age you're not as patient. I started playing with pieces of track by cutting and filing them and figured out how to build a turnout. The turnouts worked well enough that I still use them today. Handlaid track is nicer in my perspective.

MRH: Besides the handlaid track, it also looks like you're using some flex track with concrete ties?

Esteban: The first thing I did is when I chose this particular section of the BN is I went to look at pictures of the real thing.



5. BNSF #617 leads another “pumpkin” and an NS Dash-9 through Wolf Point on its westbound run.

I found that the BNSF uses concrete ties in this section, so I chose to do the concrete ties. The concrete ties are only on the main line. All the sidings, the passing sidings, spurs, everything else still use wooden ties. That’s why everything else is hand-laid.

On the prototype, the turnouts all use wooden ties.

MRH: You have quite a variety of trees.

Esteban: I have experimented with different ways of making trees. I wanted the scenery to look like it should in this area of Montana.

With trees, if you look out at nature, there is a lot of variety – different heights, and different styles, if that’s what you want to call it, of trees. No two trees are the same.

ESTEBAN MARTINEZ'S BNSF | 8

I've think I've used every technique there is to make trees, scenery, and bushes. I have aimed for a lot of variety to the foliage.

MRH:As for your backdrops, did you do the painting?

Esteban: For the most part, yes. My dad actually painted some of the mountains by hand. I painted the rest of the mountains, plus the clouds, and the sky itself – it's all painted by me.

There's a section over by the coal mine that I wanted to look a very specific way and I knew I couldn't paint it, so I showed my dad some pictures.

I asked, "Can you do this?" He said, "Yeah, I can probably put that together," and he painted that part for me.



6. Signal Peak Energy has a coal mine and load-out in Hinsdale. SD9 #6226 has just spotted more empties to be loaded.

ESTEBAN MARTINEZ'S BNSF | 9

MRH: Fantastic job. Your dad is pretty supportive now?

Esteban: Yes, very supportive. I pay for it all myself now, so he's quite supportive!

MRH: Do you consider yourself a lone wolf modeler or do you work with other modelers in the hobby?

Esteban: I know a decent number of modelers here in the Indianapolis area. However, I don't stay in constant contact with all of them – there are maybe of two or three that I consistently interact with.

They visit every so often, but I'm not involved in any club.



7. Dash-840BW #515 crosses Main Street in Glasgow, leaving town after a meet with a westbound.



8. A stack train slowly rolls through Shelby yard on track two while passengers detrain at the Shelby station on track one.

MRH: We've seen layouts with hidden staging like you have. How has that worked for you?

Esteban: This is probably my third attempt at hidden staging. My first attempt was a failure. The second try was a little bit better, but it still had some flaws. This third try is the one that came out the best, and by that time, I obviously had some practice!

Staging is perhaps the most important part of the layout, because real trains don't commonly park in the yard or places on the layout. Real trains come and go. The staging provides that place to actually "park" your trains and realistically have them all made up and ready to go.

ESTEBAN MARTINEZ'S BNSF | 11

The layout itself then provides you a place to run these trains and to break them down or make them up again.

MRH: What has worked for you and not worked for you with hidden staging?

Esteban: The biggest thing with hidden staging is to get your trackwork right. You have to *get it right!* It's not negotiable, because you cannot easily get at it to fix it. It's not like the layout.

Make sure that everything is electrically sound and operationally sound. You should be able to pull trains from any track and push them into any track without any problems.



9. Dash-840BW #580 eases down the siding in front of the Glasgow depot.

MRH: So you have 15 staging tracks that will accommodate 21-foot trains?

Esteban: Actually, a little longer. The sidings on the layout are 15 feet to 21 feet long. In staging, the shortest tracks are at least 21 feet long.

MRH: How does an operating session on your layout work?

Esteban: The layout needs to have plenty of industry to for cars to go to and to take cars from. And there needs to be plenty of through traffic. It's all a matter of organizing things so I could do a serious operating session.

Not every industry is going to be switched every session. Some industries like the coal mine probably get switches once or twice during an operating session. The yard has enough room to break up trains and make up new trains for without overwhelming the main line.

A serious operating session could look interesting.

I have 15 staging tracks. This wasn't in my original plan, I added this much staging later.

My wife was, "Do you really need all this track?" I answered, "Well, think about it. If I had five more tracks of staging, that gives me room for at least 125 more cars that I don't have right now." Then she said sarcastically, "Oh, of course! Because you need an extra 125 cars ..."

MRH: You're running pretty long trains, right?

Esteban: Yes, 21 feet long in HO, at least.

MRH: This railroad is really pretty much for you, then?

Esteban: Yes, I designed this layout to be able to run by myself.

ESTEBAN MARTINEZ'S BNSF | 13

I designed it so I can pull out a train and run it. Then I can leave the train on the siding and do some switching. Just whatever I feel like doing.

It doesn't really need a lot of rhyme or reason in that sense, operationally. The main thing is to enjoy it. I want to have fun.

I want to see my trains running. I want them to look real and go through scenes that look realistic. I especially like coal trains, so I want to see a coal train running around the layout without a flaw.

MRH: Some of the cars are weathered, but not many. Is that by design?

Esteban: If you notice, most of my industries are weathered. I find weathering an industry to be really easy. On cars, it's a bit more challenging.



10. Amtrak #13 picks up speed as it accelerates its passenger train through the truss bridge at Malta.

I'm careful when it comes to cars and I avoid touching them because I don't want to damage them in any way. I want to make sure when I weather a car that it will look nice. I don't like overdone weathering – it has to be right.

Weathering cars is one project that I'll do one every so often and one car will take me hours, because I want it to look right.

MRH: What have been your greatest challenges building the layout? Did you foresee them or were they a surprise?

Esteban: This layout has actually gone very smoothly. I haven't had many challenges or problems, mainly because I already had experience in the hobby already.

Perhaps the only thing is some of the temperature changes in the garage. Here in Indiana, most summers will be 80-90 degrees, but we've had some go well over 100 degrees. Even though the room has AC and heat, when it gets really hot or when like a couple winters ago the temperature is negative 30, those are extreme. These extremes do affect the layout and the performance.

Engines don't work as good on that kind of temperature extremes. The track tends to move around. The rails will have some variation. I can't control that as much as would like to.

MRH: What do you like most about the layout and what do you like least?

Esteban: I like that it has scenery on about 99 percent of it. Anywhere I run a train, I can look at a finished product. That's very exciting.

The thing I perhaps don't enjoy is a couple curves that have a tighter radius than I would have liked. It is by design, but the

ESTEBAN MARTINEZ'S BNSF | 15

tight radius does provide some challenges. Some trains have to run only one way or the other in order to keep them running without a problem.

MRH: Anything else you would like to do to this layout?

Esteban: Adding detail is a big thing for me. Putting a kit together, assembling a building is not enough. Once I put them together and paint them, I like to add details like wiring, electrical boxes, things like that. I want to break away from what came in the box and make it more real.

MRH: Why did you select the layout height you did?



11. Dash9-44CW #617 leads a stack train over the single track bridge at Malta.



12. Crews are prepping a new right-of-way near Glasgow for an expansion project that includes double tracking. Esteban says he periodically rearranges the gang and adds more to their progress.

Esteban: That's a good question. I have never liked the layout to be too low where all you see is roofs. Generally speaking, I always thought highest point of the layout shouldn't be past my chest and the lowest point should never more than 10 inches below that, at my belly let's say.

That feels about right. It's not too tall, it's not too low. It's just about right.

MRH: How do you motivate yourself to those things you don't like to do?

Esteban: The least favorite thing for me is the electrical. It's very tedious and there is no room for a mistake. It's also very time consuming and a lot of boring work.

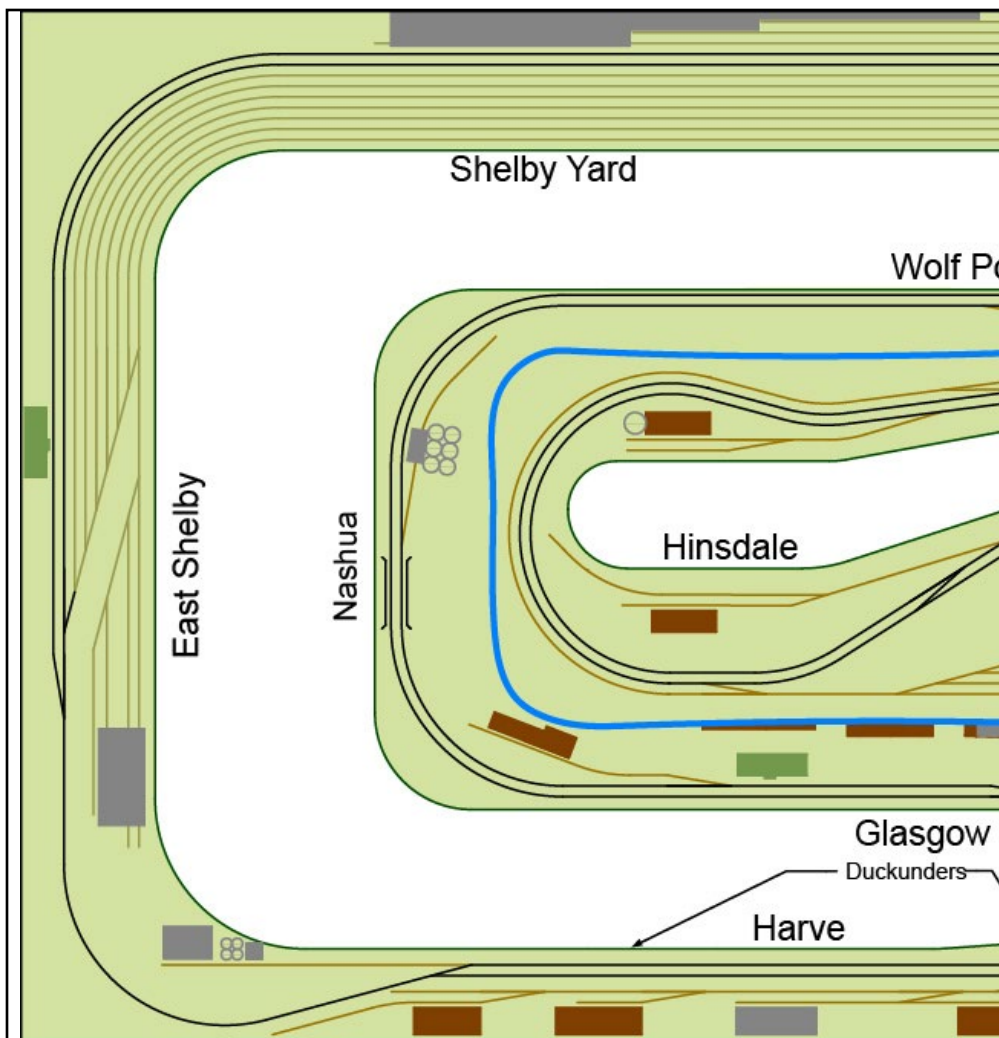

Esteban Martinez BNSF Wolf Point to Essex Layout.

Layout 16' x 30'

- Main line
- Yard tracks
- Industrial tracks
- Backdrop



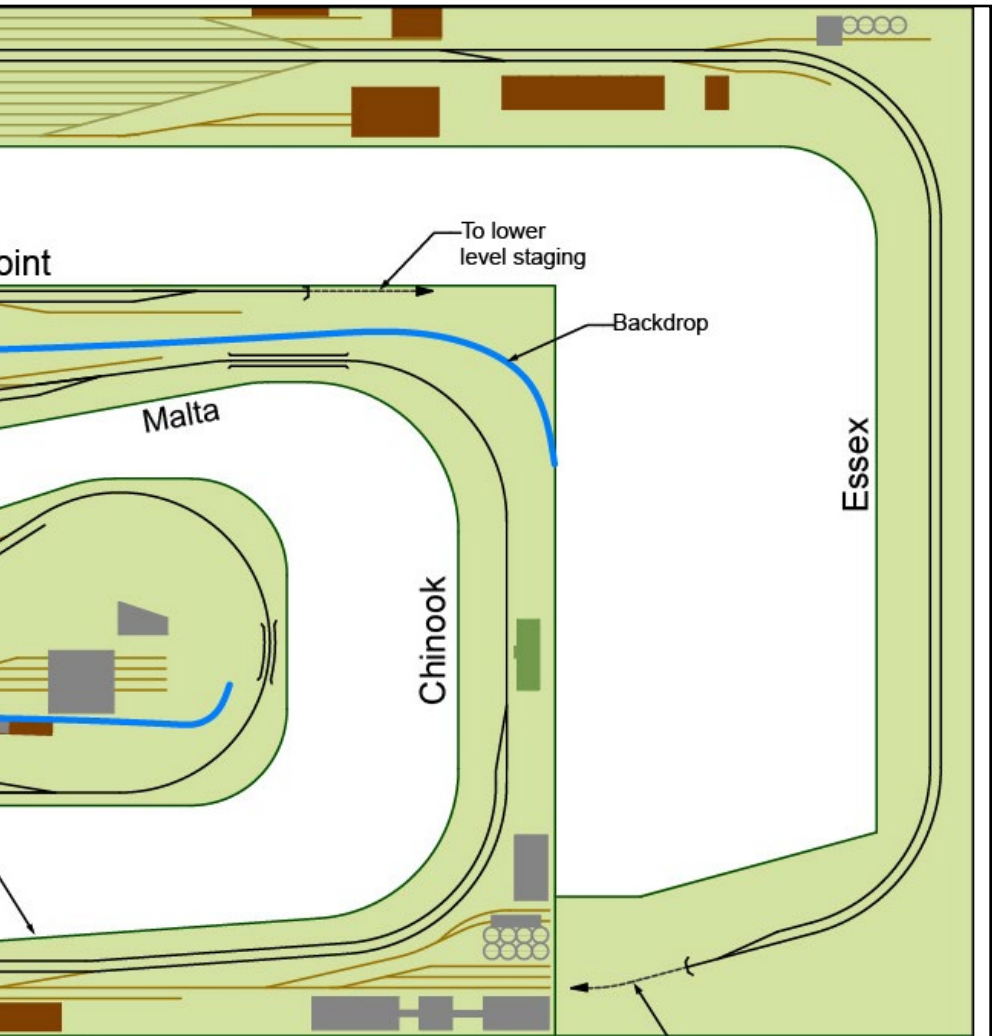

NOTE: For a fully zoomable track plan, see this month's [Subscriber Bonus](#) downloads.

To lower level staging



My motivation is to keep thinking about the end, when I'm done with all that work. The trains are going to run, the lights are going come on, or the signals will be working or whatever the project. That's the motivation: I keep thinking of the finished product.

MRH: Is HO always your scale? What about modeling in another scale?

Esteban: No, HO was always my scale. I think N scale is too small for me. Anything bigger than HO, even though it's bigger, I find it less detailed. That's just my opinion. HO has always been just the right size for me.

MRH: What advice would you give to someone starting out in the hobby?

Esteban: Have a lot of patience. Don't try to get everything accomplished overnight, take your time. You will make mistakes and that's okay, go ahead and make them. If you don't make those mistakes, you just won't learn.

You don't know what you don't know is the way to think. Only time gives you that. You have to go through phases of the hobby, we all do. You have to go through the frustrations, we all do. But that's really the only way to accomplish something meaningful.

MRH: Having fun with trains, right?

Esteban: Yeah, it's fun once you develop patience from hitting every rock on the way!

MRH: Where do you see this layout in another five years?

Esteban: In another five years, I want to add more detail to the layout. I can also see some of the kinks and flaws that still exist and I want to correct them. I hope to see the trains running smoother than they do today.

Maybe some industries will change, too. I have a project in mind to add a bridge where there isn't one, but this will be after the convention because it's going to be quite a project. Walthers just came out with this new bridge system and I really like it. I'll need to take an ax to part of the layout to incorporate a brand new bridge.

MRH: What do you hope the convention attendees get out of a visit to your layout?

Esteban: One of the things is the track work – when you see hand-laid track, it flows more naturally. I would hope people notice there are some track arrangements on my layout only because of the flexibility that comes from laying track by hand.

I also hope that they like my layout scheme. I want them to ask me questions: I'm not shy to share anything. Maybe I can give them that extra push into something they didn't know could be done.

MRH: What does this hobby do for you? What does it give you?

Esteban: It gives me a place to go and forget about the pressures of life, so to speak. I'll come out here and run my trains. I'm not thinking about my job. I'm not thinking about bills. I'm just running my trains and enjoying them.

It's a place where I can just do my thing.

MRH: Chill.

Esteban: Yeah. Just chill. I have this couch next to the layout because sometimes I'll just sit there and play on my phone. I could do that on the couch inside, absolutely, but there's something about sitting out here with the trains that I find really relaxing.

ESTEBAN MARTINEZ



Esteban got into the hobby at age six while living in Costa Rica, where his parents bought him a Tyco train set. As a teen, Esteban got a job at the local hobby shop, and among other things, was able to get a good price on his cars and engines!

Esteban has been doing the hobby now for over 20 years, first modeling the BN, and now the BNSF. Three years ago, he started his current layout, modeling the transcontinental line of the BNSF through Montana.

Esteban works for Advance Auto Parts as a store manager. He is married and has two children. ■



*Also coming to
TMTV in April*



[Click here for
reader comments](#)



TRAINMASTERS.TV

Esteban Martinez's BNSF



Non-members can watch for
only \$1.49 per episode



Coming
this
April!

Visit the TrainMasters TV website



SCRATCHBUILDING

With Monster Model Works Etched Wood – PART 2

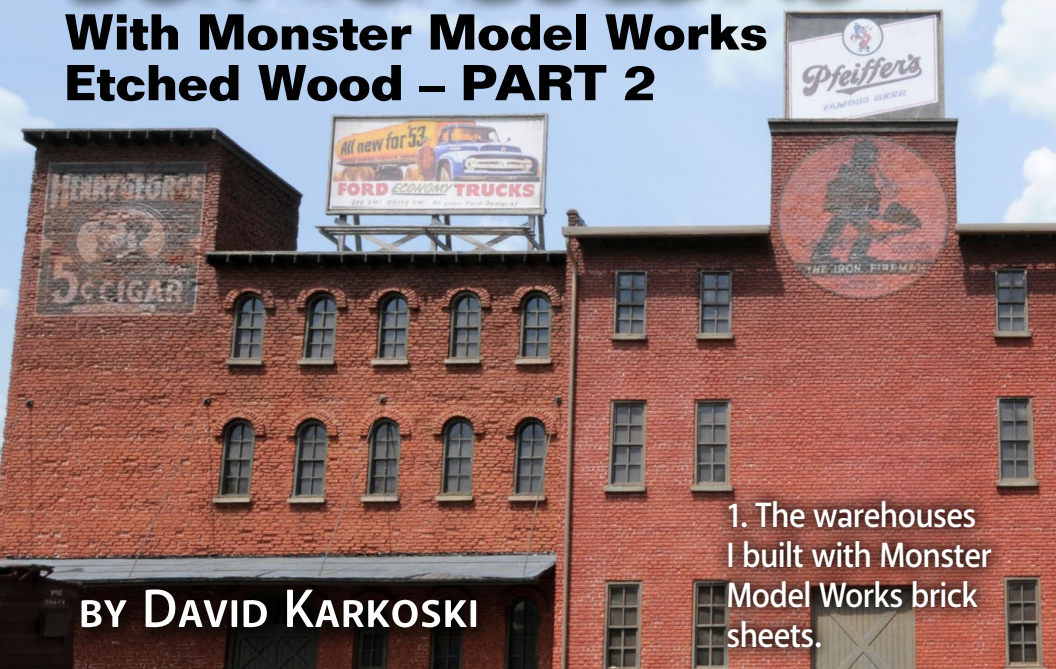

1. The warehouses
I built with Monster
Model Works brick
sheets.

BY DAVID KARKOSKI

Taking your brick structures to the next level continues with the roof ...

LAST TIME, I INTRODUCED YOU TO MONSTER MODEL WORKS' laser-etched basswood material and how I work with it to build brick structures.

This time, I continue with the techniques I use to model the roof and related details on my brick structures.



**Click here for
reader comments**



monstermodelworks.com

• INDEX

• TABLE OF CONTENTS

Roof detailing - Eaves



1-2. The rafter tails on the 1900 building [1] are boxed in with wood. The tails on the 1880 building [2] pass through the brick wall. The rafter tails are short 2x8 segments bonded to the overhang.

PART 2: SCRATCHBUILDING WITH MMW | 3

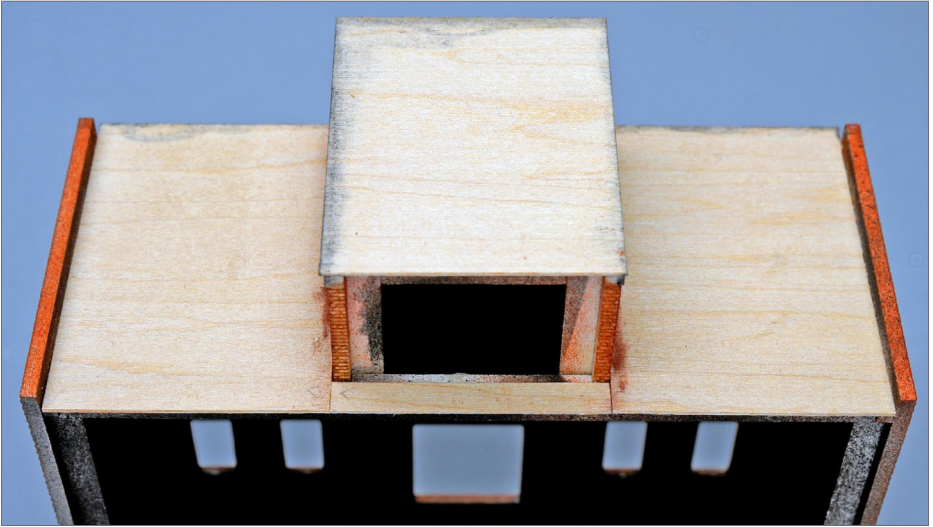

3. Roof sheathing for this style of roof is 1/32" basswood.

ADVERTISEMENT



Announcing
*Motrak Models New Coal Load
For Fox Valley 50' Coal Gondola:*

**CHECK
IT OUT!**



Phone number: 813-476-4784
Email: motrakmodels@centurylink.net

• INDEX

• TABLE OF CONTENTS

Roof detailing - surface

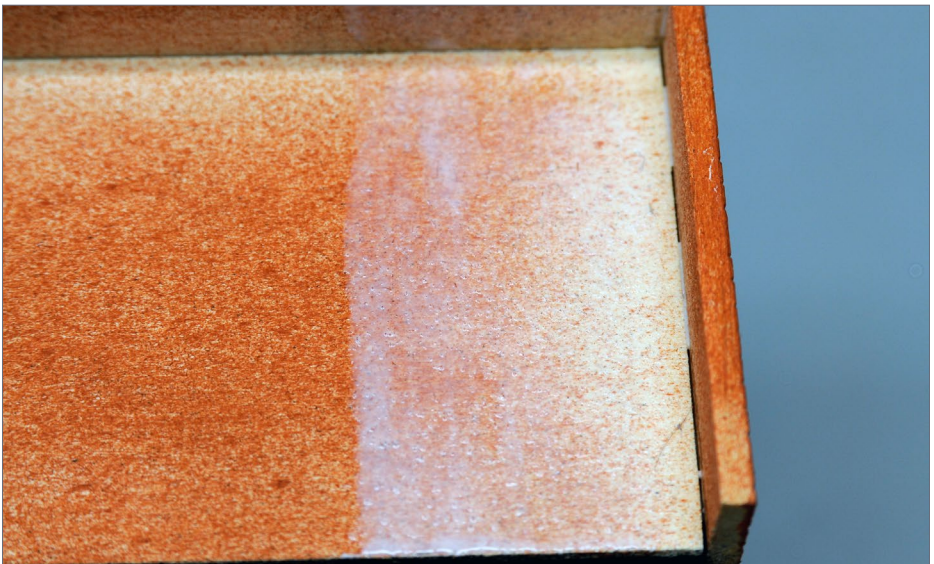

4-5. To simulate a tarred canvas roof, I used a single ply of facial tissue. Cut it into manageable size strips. Apply white glue to the roof surface and rear of wall.

PART 2: SCRATCHBUILDING WITH MMW | 5



6-7. Lay the tissue onto the glue and press it into place with an old brush. Shown in [101] is the completed roof. After it dries trim off the excess tissue.

PART 2: SCRATCHBUILDING WITH MMW | 6



8. The finished roof after painting it gray.

ADVERTISEMENT

WWW.TRAINMASTERMODELS.COM

**YOUR COMPLETE
MODEL TRAIN STORE**

TRUSTED FOR MORE THAN 18 YEARS!

Over **50,000** items daily from our
distributors, warehouse and retail store.

Layouts Are Not Built on Engines and Cars Alone.
Shop The Most Complete Selection of Items Available

**LOW
PRICES**

**BEST
SELECTION**



TRAINMASTER

Free Shipping On Orders Over \$75 to the Lower 48 States

• INDEX

• TABLE OF CONTENTS

PART 2: SCRATCHBUILDING WITH MMW | 7

Roof detailing - wall caps





9-11. Sheet metal flashing can be simulated using ordinary bond paper. Cut the paper into strips and bond it to the top edge of the wall. Allow a small amount to overhang the wall edges, and bend it downward with your fingers after painting. Paint the paper a metallic color, I chose Gunmetal in this case, and then weathered it. I find Gouache watercolors work well for weathering.

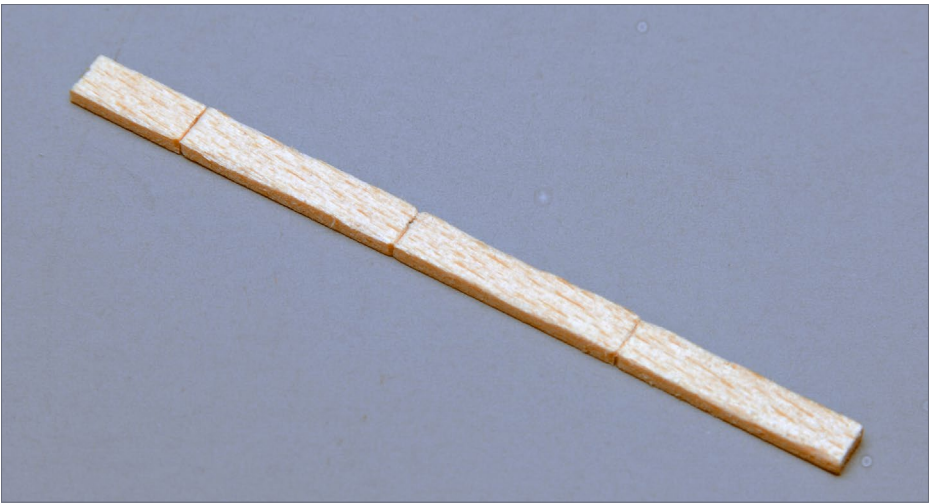
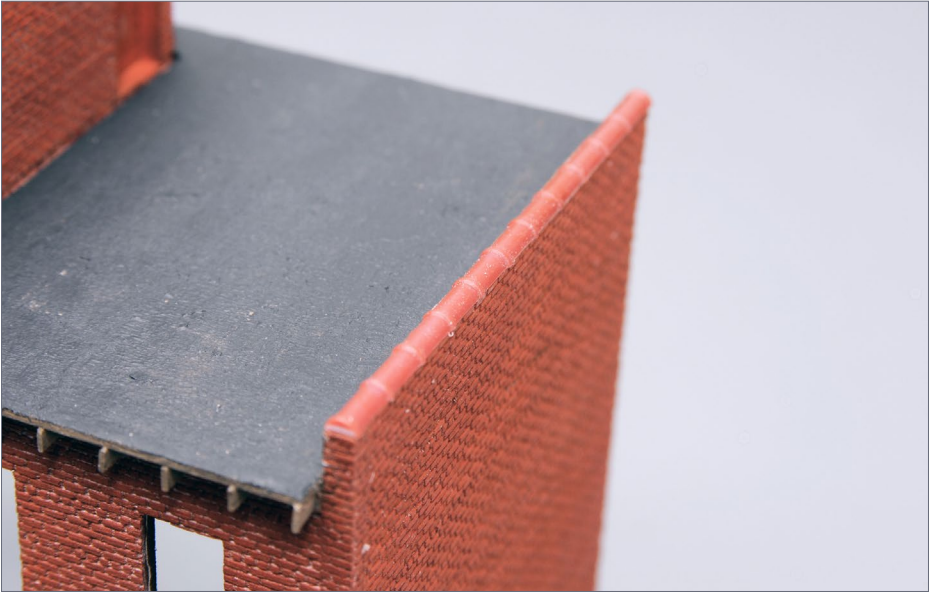

12-13. MMW recently introduced a tile cap. Pikestuff 541-1008 styrene tile cap castings can be substituted for the MMW part, as was done on the 1900 building. A limestone cap can be fashioned from scale 4x10 stripwood. Cut in joints approximately four feet apart, and create an irregular edge along the sides of the wood.

Other details - roll up doors



14. The modern roll-up door is built up from styrene. Scribe a piece of .020" sheet styrene at a scale 2' spacing, and attach it to the wall. Add segments of .015" x .100" strip around the sides and top. Add an additional .015" x .040" strip along the sides.

ADVERTISEMENT

MONSTER modelworks

Freight Depot
Background Flat Kit



N & HO Scales



www.monstermodelworks.com

Other details - loading dock

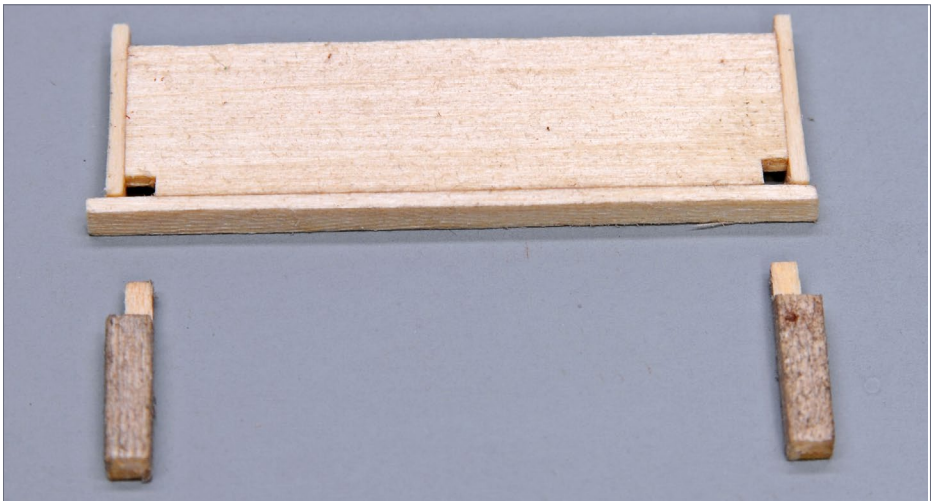
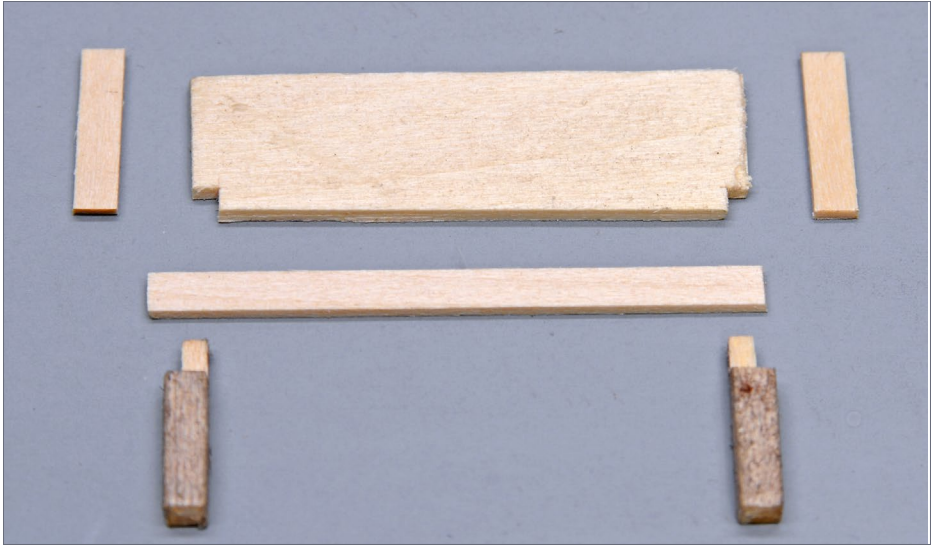

15-16. Platforms are built up from a 1/16" basswood core, scale 4x10 stripwood, and scale 10x10 posts. The 4x10 frame wraps around the core, the 10x10s are recessed to accept the 4x10s creating a tenon. The core is notched to accept the tip of the tenon.

PART 2: SCRATCHBUILDING WITH MMW | 12

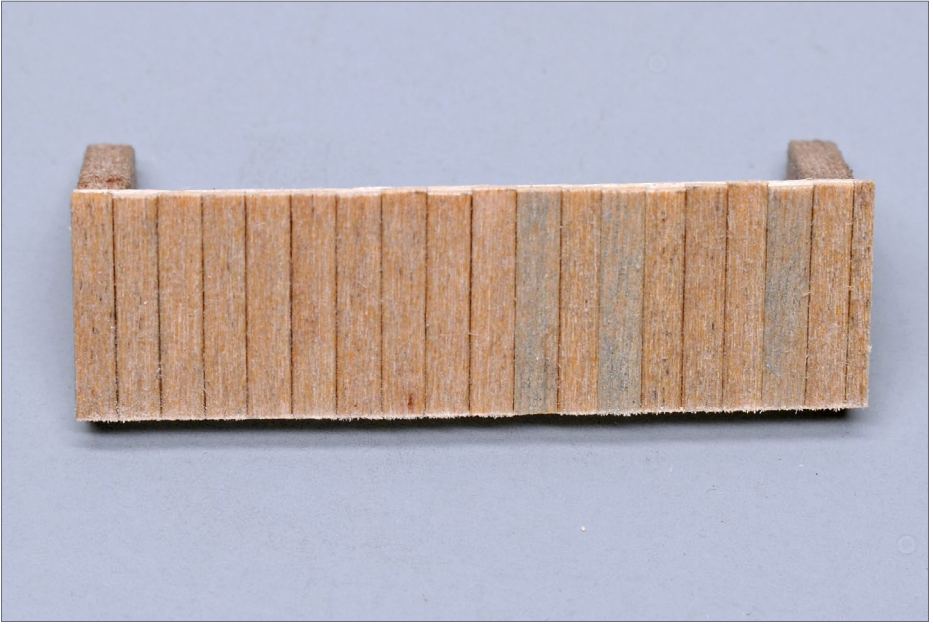

17-18. The decking is built up from pre-stained scale 2x8 strip-wood. To aid in supporting the deck install two .032" piano wire braces. Bond the platform to both the wall and the braces.

Other details - gutters

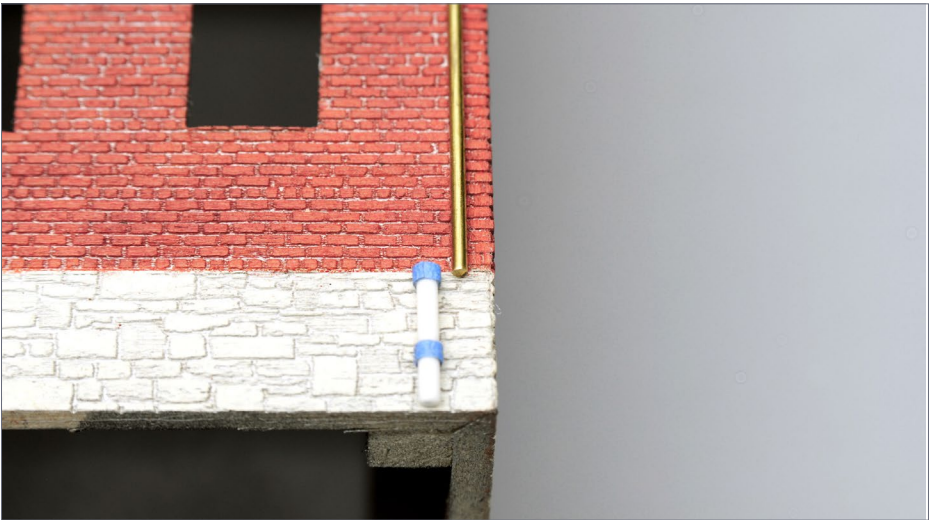

19-20. I used Micro Engineering 80-63 gutters on the 1900 building. The downspout is brass wire. The tile soil pipe is built up from 1/16" styrene rod that has been wrapped with narrow tape bands to simulate pipe joints.

Get the first 50 issues of
**Model Railroad
Hobbyist magazine™**

Save
yourself
endless
hours of
downloading

On a data DVD for \$10!

Send me one!

(Sold by Model Trains Video)

*Includes a coupon
good for \$20 off on
TrainMasters TV*

*Over 5000
pages of
how-to
information
on model
railroading*



Other details - chimney

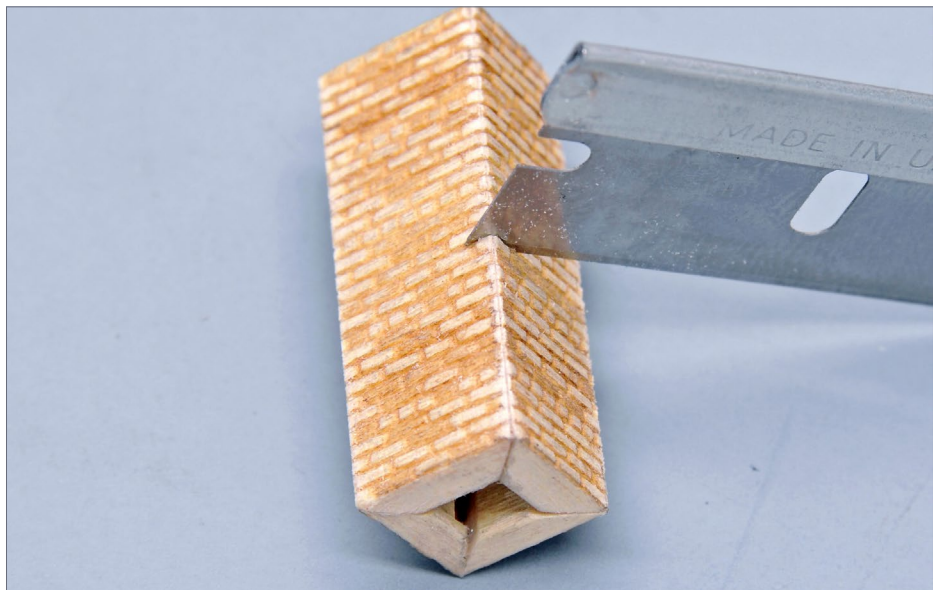
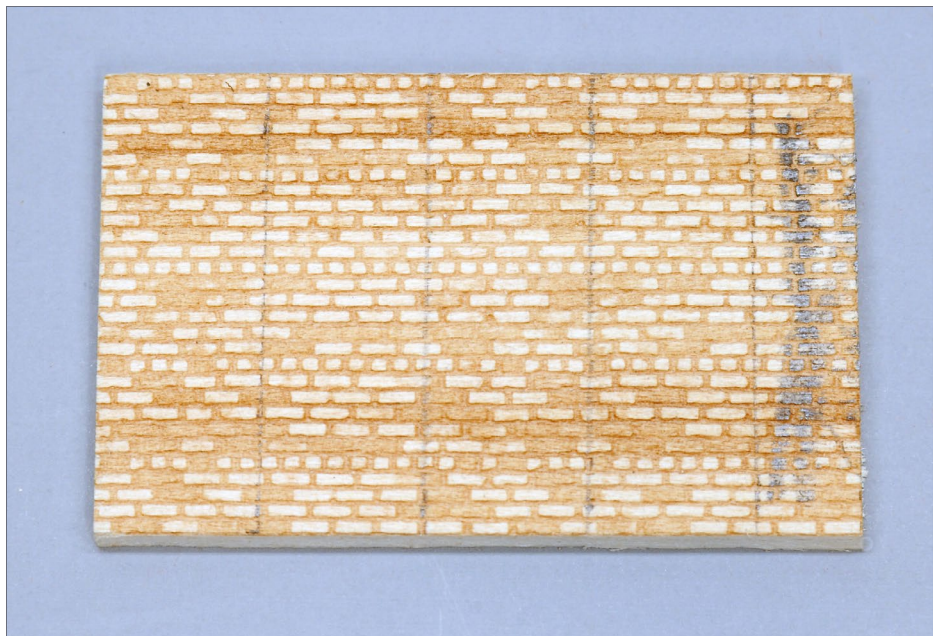



21-23. Lay out 3'-wide chimney sections on a brick sheet . Cut out each section, and taper the sides at a 45° angle. Assemble the chimney box, and then use a blade to emphasize the mortar lines at the corner joints. After painting, add scale 4x10 strip-wood segments to the top to simulate a cap.

PART 2: SCRATCHBUILDING WITH MMW | 16

Other details - loading dock roof

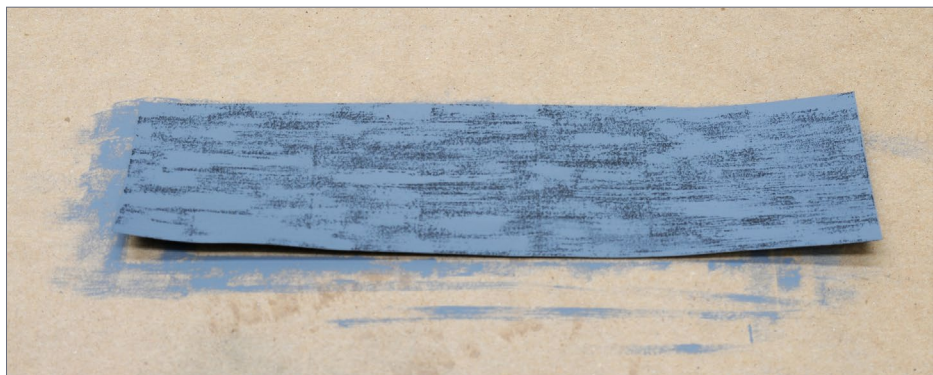

24-25. Stain and then attach a scale 4x4 to the wall. Use small tabs of tape to help maintain alignment on the wall. Ingres Drawing #50 Stygian Black paper is an excellent base to simulate roofing paper. Paint (dry-brush) or apply Pan Pastels to color the surface. Cut into 3'-wide strips for use on the roof.

PART 2: SCRATCHBUILDING WITH MMW | 17



26-27. Add piano wire braces to support the roof. Bend the braces down at a slight angle and then attach them to the wall. The roof is fabricated from 1/32" thick scribed wood. Add a 2x6 stringer down the center of the roof and form a channel with two 2x6 stingers on the outer edge. Use matte medium to bond the roofing paper to the roof. When dry glue the roof to the wall and wire supports. Paint and bond Grandt 5113 NBW castings to the wall. Drill the NBW to accept a .0125" wire tie rod. Bend the tie rods to meet the roof and then attach to the NBW.



28. Cut the tie rods so they rest on the roof. They do not need to be attached to the roof. Paint appropriately; Model Master Raw Umber is a good choice.

29-30. (Right-top, right-bottom) Using dark gray or black pigment, very lightly dust the upper portion of the wall to simulate accumulated city grime. This can easily be overdone so use an extremely small amount of pigment in the brush. Simulate a ghost roof by taping a strip of wood at the height of the former roof. Dab gloss black paint along the upper side and, when the paint is dry, dust some Aim Products 110-3107 Dark Earth below. Remove the wood strip and add some abandoned side braces.

Other details - weathering



Other details - window glazing



DAVID KARKOSKI

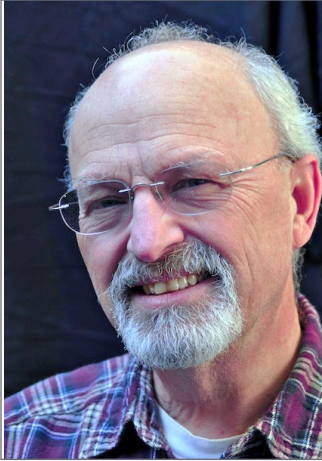

David Karkoski is retired and lives in Milwaukee, WI. His interest in model railroading stems from a color photo of Paul Larson's Mineral Point and Northern in the December 1959 *Model Railroader*. David also was inspired by articles on structure building by Jack Work and Al Armatage in the same issue.

David is currently building a DCC dead-rail sectional shelf layout that can be changed to depict various eras and railroads, in keeping with his ever-changing interests.. ■



monstermodelworks.com

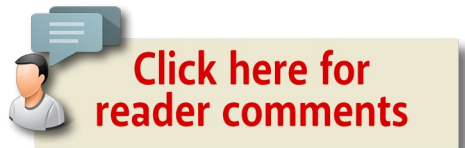

30-31. Window glazing is done using clear styrene held in place with Pledge Future floor wax. Dip glazing in the floor wax, tip off the excess, and apply to the window casting; allow to dry. Before mounting the window, dust the interior with Dark Earth pigment. Fit the window into its opening, and file the window casting if needed. Bond it in place from the rear using a bead of Canopy glue. Dust the exterior and sill with Dark Earth. ✓

Model Railroad Hobbyist *Store*

DVDs and downloadable videos from ...

TRAINMASTERS.TV



Titles include:

- Streamliners at Spencer
- Layout tours-1 & Layout tours-2
- Backdrop painting how-to
- Extreme weathering how-to
- Best of TMTV 2014



Most common comment in our video survey last summer:

"My internet bandwidth doesn't do streaming very well. Can I get TrainMasters videos on DVD or as a download instead?"

Our answer: *Yes, now you can! Available from the MRH Store*

Brought to
you by

MRH
MODEL RAILROAD HOBBYIST

Visit store.mrhmag.com



From the Model Railroad Hobbyist STORE

• INDEX

• TABLE OF CONTENTS



LOOK

column



[Click here for reader comments](#)

LES HALMOS

WIRELESS LIGHTING CONTROL WITH MRC'S NEW LIGHT GENIE ...

BACK IN THE DAY, IF I wanted to enhance a model or a layout, the solution was to use accent lighting. Adding a few lights, here and there, really made things come alive.

Back in those days, I used several different incandescent bulbs, grain of wheat, micro bulbs – all with varied voltages from 1.5V to 12 V.

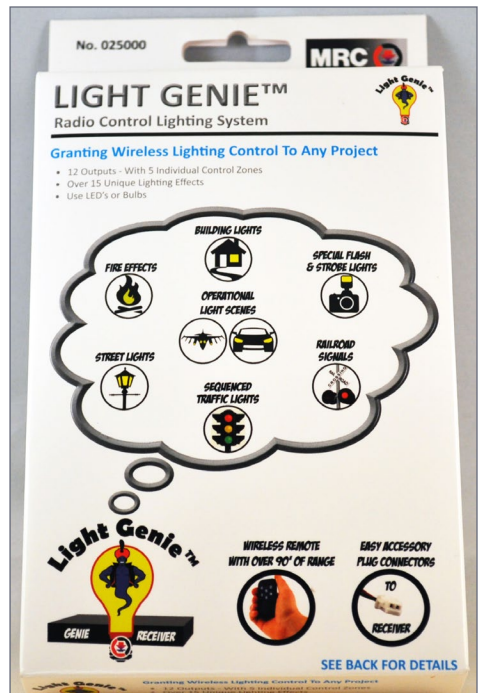

1. Here's the MRC Light Genie package, complete with some application ideas on the front.

▶ **NEW PRODUCT FIRST LOOK**

FIRST LOOK | 2

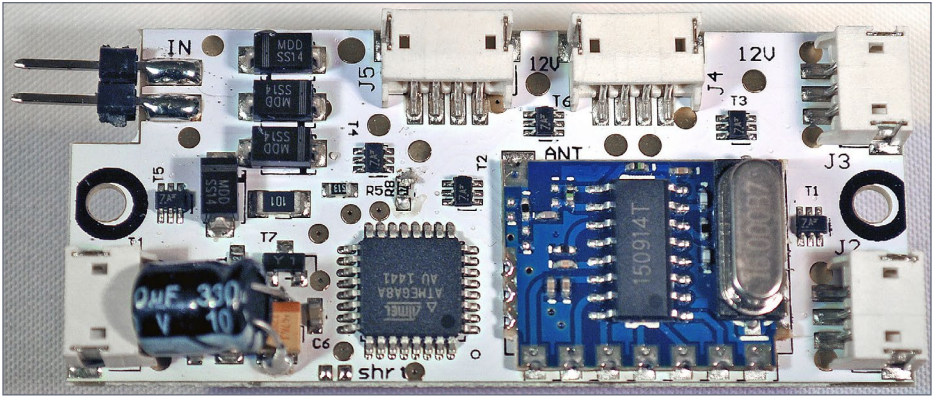

2. Light Genie receiver board.

Most of them required 30 mA to 50 mA of current, and when you added them all up, just 10 lamps on your layout could take ½ Amp (500 mA). And on a small layout, you could be looking at 100 bulbs with a whopping 5A current draw!

I had to build a power supply just for the lighting, so the best and cheapest solution I could devise in those days was to use a battery charger, since it was capable of supplying 10 amps at 6 or 12 VDC.

Then came LEDs, (Light Emitting Diodes) at affordable prices. With LEDs, the power requirement dropped to just .003 mA – quite a difference! Each LED needs a resistor, but with lower voltage power supplies.

MRC, Model Rectifier Corporation, already well known in the model railroad community as a supplier of throttles, DC and DCC controllers, DCC decoders and many other products, has a new product called the Light Genie.

What is Light Genie? It is a power and control source for incandescent bulbs or LED's and it has remote control as well!

FIRST LOOK | 3

LIGHT EFFECT CHART		
Effect #	Light Effect	Applications
0	On/Off	
1	Sequential flash with pause	Arrow lighting
2	Crossing signal / Traffic street light	Railroad crossing signal / Stree traffic lights
3	Alternating flash - always on	Police car - headlight/tail lights
4	Simultaneous flash	Warning lights, towers, runway lights
5	Sequential flash	Roadside flashers
6	Gyra light	
7	Gyra light on at the same time	
8	Oscillation	Cell phone towers / airplanes
9	Oscillation (Simultaneous)	
10	Stepped lighting	Dim-medium-bright lighting cycle
11	Stepped lighting (Paralleled)	
12	Single Strobe (Varied / alternating)	
13	Single Strobe (Simultaneous)	
14	Double Strobe (Varied / alternating)	
15	Double Strobe (Simultaneous)	
16	Rotating beacon	
17	Rotating beacon (Simultaneous)	
18	Flicker (Pattern 1)	Camp fire / fireplace / furnace / foundry
19	Flicker (Pattern 2)	Gas lamp / TV
20	Varied intensity	Arc welding

3. Table of Light Genie lighting effects.

Light Genie includes a 2.4 GHz transmitter and a 12 output receiver with 5 zones of control.

Each zone can be remotely turned on or off, brightness adjusted and you can set each one to 20 different lighting effects. I can select from: constant on, flashing, sequential lighting, flickering and several more. Among all the others, I particularly like the Traffic Light feature (Effect #2) – no need for an expensive circuit for realistic operation!

FIRST LOOK | 4

Basic Light Genie package has:

1. 1 x Genie Receiver
2. 1 x Genie Transmitter Remote
3. 1 x 2 Pin Power Connector w/Leads
4. 3 x 3 Pin Connectors w/Leads
5. 2 x 4 Pin Connectors w/Leads
6. 2 x Mounting Screws
7. 1 x Velcro Strip
8. 2 x AAA Batteries
9. 12 x Resistors for LED's and 3.5V Bulbs

MRC's Light Genie can also be controlled directly using a DCC Throttle.

With DCC, Light Genie operates like most standard NMRA decoders, but without speed control functions. The decoder can be controlled using the function buttons on your DCC controller.

Light Genie, like most DCC decoders, is pre-set with a default address of #3.

Light Genie uses short addressing (1-127). Programming can be done on the "program track" and/or "main track." Once I give my Light Genie decoder an address, I can use the accessory function to turn the light on and off, change lighting effects, change brightness, and light effect rate.

The Genie series of products from MRC advances the way to control lighting on layouts. MRC says there are more products in the series to come, so stay tuned.



4. Light Genie controller remote.

FIRST LOOK | 5



Playback problems? [Click here ...](#)

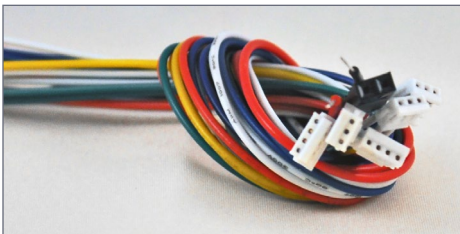

5. Light Genie connectors.

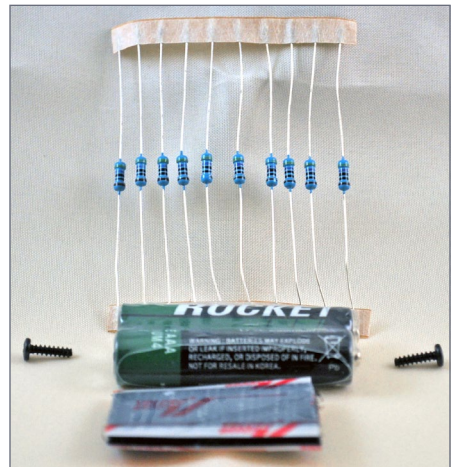
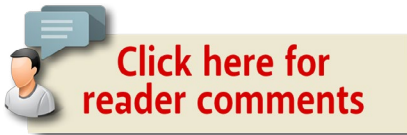

6. Resistors, screws, velcro, and batteries.

Links:

Modelrectifier.com/genieproducts/lightgenie.asp

[Light Genie operating manual.](#)

You're the kid.



Welcome to the candy store.

- 180,000 square feet of “candy”
- Over 250 manufacturer & retailer booths
- 44,000 square feet of modular layouts
- “Ask the Collectibles” appraiser
- Trains, accessories, collectibles & more
- Hands-on demonstrations

July 8 - 10, 2016
**Indiana Convention
Center**

100 S. Capitol Ave.
Indianapolis, IN 46225

**CLICK HERE
FOR ALL THE
DETAILS!**

www.nationaltrainshow.com

Sponsored by



We make it more fun!

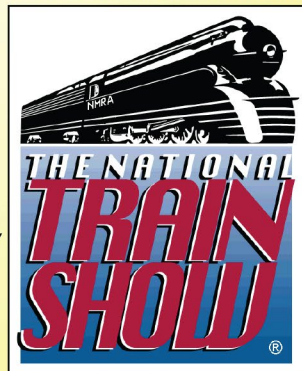

• INDEX

• TABLE OF CONTENTS

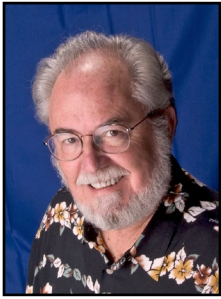

APRIL NEWS

column

RICHARD BALE *and* JEFF SHULTZ



[Click here for
reader comments](#)

Cyril Durrenberger 1942-2016



Master Model Railroader Cyril Durrenberger of Austin, TX succumbed to lung cancer March 4. He was 74 years old. Durrenberger was an enthusiastic modeler and scholar of railroad history. The focus of the native Texan was the railroads that once served the industries of central and east Texas. Several of Durrenberger's articles appeared in various hobby journals including *Prototype Modeler* and *Model Railroader*. As a consultant he provided critical prototype information to several model manufacturers including the freight car kits developed by Westerfield and Sunshine. Durrenberger was recognized nationally as an authority on environmental health issues. He was a member

▶ THE LATEST MODEL RAILROAD PRODUCTS, NEWS & EVENTS

of the Texas Air Control Board and served on the Texas Commission on Environmental Quality. Later he joined the University of Texas at Austin where he did research and lectured on the science of air pollution. Durrenberger served his country during the Vietnam War as an armor officer in the U.S. Army. He is survived by his wife Lynn, sons Carl and James, and two grandsons. ...

.....

NEW PRODUCTS FOR ALL SCALES

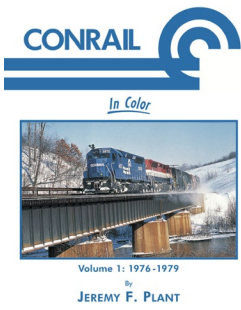

Morning Sun has released a digital reprint of *Conrail in Color 1976-1979*, by Jeremy Plant. New traditional hardback books now available include *Steel Mill Railroad Facilities and Equipment* by Stephen Timko, *Anthracite Railroads & Mining* by Chuck Yungkurth, *Western Maryland Power* by Robert Yanosey, and *Logging Railroads of the Pacific Northwest* by Gary Durr. Information on purchasing

Morning Sun books is available at morningsunbooks.com.

.....

The answer is **Wiseman Model Services**. The question is, whatever happened to some of those great detail items once offered by such firms as McKenzie Iron & Steel Machinery, National Motor Company, Back Shop, Railway Engineering Agency, SS Ltd, and Simpson?

During the past several years Keith Wiseman has been quietly buying tooling and manufacturing rights for many small companies that have seemingly disappeared. He has refurbished the tooling, updated some of the instructions and introduced new packaging to many of these old items.

Among favorites that are once again available are the Fordson farm tractor, Kleiber trucks and Willamette Straddle lumber carrier from SS Ltd; the 1929 Packard Victoria Convertible from National Motor Company; the Horseshoe Meadow Depot from Railway Engineering Agency; Simpson's decals for G, HO, S and O scale narrow gauge equipment, and the abundance of lost wax brass detail parts from Back Shop. All of these and many more similar items are now available from Wiseman. To view the current product lineup go to wisemanmodelservices.com.

.....

NEW CLUB PRODUCTS



The NMRA's Illinois Division is celebrating its 50th anniversary by offering two HO scale freight car kits custom decorated for Illinois

Valley. Available now is a twin-bay hopper car with offset sides.



The second kit is for a 50-foot boxcar with plug doors. Both cars have IVDX reporting marks and display a slogan that reads "50 Years of Service." The kits

were produced by Accurail and include trucks and Accumate couplers. Orders for multiple cars will be shipped with renumbering decals. The kits are available at \$20.00 each plus \$5.00 for is shipping and handling. Send orders with check payable to Illinois Valley Division, McLean Depot, 200 East Dixie Road, Box 262, McLean, IL 61754. For additional information contact Tom at agent@mcleandepot.com or call 309-244-5900.

.....

O SCALE PRODUCT NEWS



New models coming from **Atlas O** include this 40-foot wood reefer. The model is based on a car built in 1930 by Pullman for the Northern Refrigerator Car Company. Spotting features

include working roof-top ice hatches, a vertical brake shaft, and a USRA-style fishbelly steel underframe. In addition to the Joan of Arc scheme shown here, the O scale ready-to-run model will be available decorated for Monarch Brewing, Peoria Creamery, Puget Sound Butter & Eggs, Schlosser Brothers, and Stokely's Vegetables.



Additional new freight cars coming from Atlas O include a Trainman series RBL insulated boxcar with plug doors. Road

names will be CP Rail, Fruit Growers Express (PRR), Milwaukee Road, Mountain Pine Lumber, and Penn Central. All of the cars mentioned above will be available during the third quarter of 2016 for both 2-rail and 3-rail operation.

Atlas O has announced details on limited edition sets of California Zephyr passenger cars. The 12 distinctive cars come in three boxed sets with four unique cars per box. Set A for Chicago Burlington & Quincy is shown here. Hobbyists can create a complete prototypically correct 12-car California Zephyr by combining three boxes. In addition to CB&Q, road names will be available for Western Pacific and Denver & Rio Grande Western. The special California Zephyr passenger car sets will

APRIL NEWS | 5

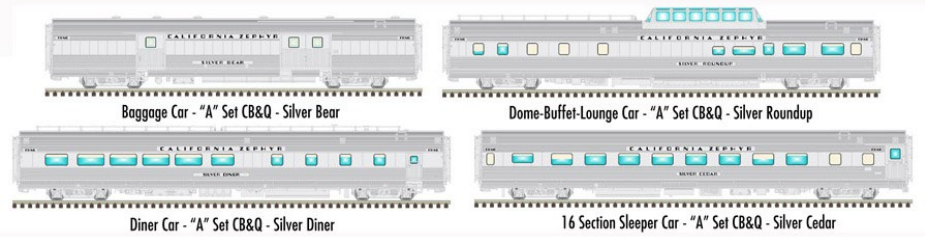

be available only through participating dealers. Advance reservations are required with delivery expected this December. To lead the trainsets, Atlas O is offering its EMD F3 diesel locomotive in the same three roadnames. For additional details and ordering information contact an authorized Atlas O dealer.



San Juan Car Company has On3/ On30 versions of Gramps frameless tank cars available at a reduced price. Availability includes Gramps cars decorated

in pre-1947 road numbers. Other road names include Pioneer Oil and UTLX. The ready-to-run models come with SJCC Evolution couplers and trucks equipped with On3 wheels. On30 wheelsets with blackened tires are included in the box. For additional information or to order visit sanjuancarco.com.

HO SCALE PRODUCT NEWS



Accurail is developing a new line of 36-foot double-sheathed wood boxcars. The HO scale

APRIL NEWS | 6

models are based on plans issued in 1920 by the Master Car Builders Association. Many of the prototypes remained in service through the end of WWII. Variations will include straight and fishbelly steel underframes, and both wood and steel ends. Production is expected to begin sometime during the second half of this year.



HO scale kits for 40-foot wood stock cars are available now decorated for Northern Pacific and Great Northern.

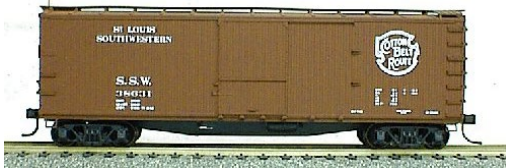

A 40-foot double-sheathed boxcar with a steel underframe is currently available decorated for SSW/Cotton Belt and Norfolk & Western.



Also new is a kit for this Detroit, Toledo & Ironton 40-foot insulated steel boxcar with a plug door.



Accurail's kit for this Baltimore & Ohio 50-foot steel boxcar features an 8-foot, 6-panel Superior door.



USRA ribbed-side twin-bay hopper cars are available in kit form from Accurail for Gulf, Mobile

APRIL NEWS | 7



& Ohio and Denver & Rio Grande Western.



Kits for 50-ton twin-bay hopper cars with offset sides are available for Santa Fe and Wheeling & Lake Erie.



All of the above Accurail kits have an MSRP of \$16.98 each. Completing Accurail's recent release is this Western Pacific triple-bay ACF covered hopper.

This kit has an MSRP of \$17.98. All Accurail kits include appropriate trucks and Accumate couplers. For additional information contact a dealer or visit accurail.com.



**A-Line
Division
of Proto
Power West**
offers a wide
selection
of compo-

ponents for upgrading or repowering HO scale diesel drive systems. Recent additions include a universal hex-drive coupling kit that is compatible with hex flywheels (above left). A-Line also offers a selection of miniature chain in several sizes and colors. Black, silver, and brass chain is available in 6, 13, 15, 27, and 40-links per inch. For more information visit ppw-aline.com.

APRIL NEWS | 8

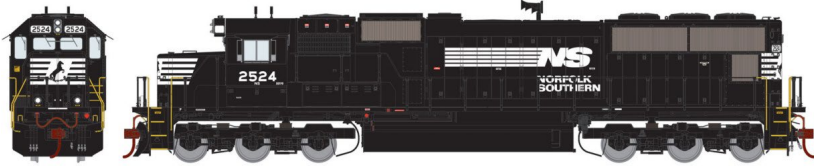

Heading the list of new models **Athearn** plans to release this December is a Genesis SD70 Series diesel locomotive. Road names will be Norfolk Southern, Union Pacific (with flag), Canadian National, EMD Lease, CSX, CSX-Spirit of Miami (also Spirit of Tampa and Spirit of Mulberry), and BNSF (warbonnet). The HO scale diesel locomotive will be available for standard DC operation and with factory installed DCC decoder and SoundTraxx Tsunami sound system.

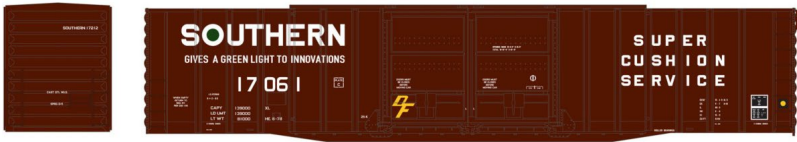

A second Genesis model due in December is a PS 60-foot auto parts boxcar. In addition to the Southern version shown here, decorating schemes will be Western Pacific, Union Pacific, Norfolk & Western and Louisville & Nashville , BN, and Chicago Burlington & Quincy.



Also expected late this year is an EMD SD40-2 locomotive. Road names for the locomotive will be Union Pacific, Missouri Pacific, Milwaukee Road, Illinois Central, Canadian National/GTW, and Soo Line. The Ready-to-Roll series model will be available for standard DC operation as well as with factory installed DCC and sound.



Freight cars on Athearn's December release schedule include a 2600 cu. ft. PS-2 covered hopper with a flush roof.

It will be available decorated for Wheeling & Lake Erie (patch over EL), SBD (patch over Monon), CSXT (patch over C&O), CSXT (patch over faded Chessie System), GLNX, Chicago & North Western, and Burlington Northern.

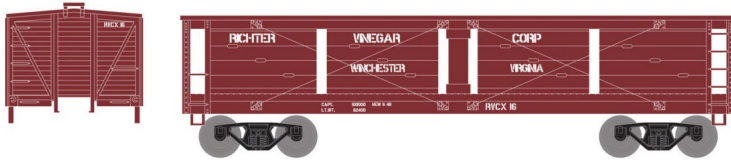

Also due in December is an HO scale

40-foot pickle car. Road names on the Ready-to-Roll model will be Richter Vinegar, Western Food Products, Soo Line, Squire Dingee Company, National Fruit Products, Green Bay Foods, Bloch & Guggenheimer, and Budlong Pickle Co.



Individual models of Athearn's 40-foot off-set

ballast hopper will be available as well as 4-packs, all with different road numbers. Decorating schemes will include Union Pacific, Northern Pacific, Great Northern, Santa Fe, MOW, and Milwaukee Road.



A 40-foot single-sheathed wood boxcar in Athearn's Roundhouse brand is

set for release in December. Road names will be Canadian Pacific, Rock Island, Great Northern, Southern Pacific, and Santa Fe.

APRIL NEWS | 10

.....

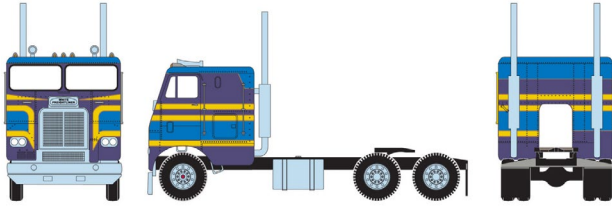

New HO scale vehicles coming from Athearn in December include two-axle and three-axle versions

of a Freightliner COE tractor. Owner-operator color schemes include blue/purple (above), black/purple, orange/brown, silver/green, and white/purple.



Fruehauf 40-foot Z-van trailers will be available decorated for Vermont Railway, Union Pacific, Southern Pacific, Rock Island, Missouri Pacific, Kansas City Southern, Burlington Northern, and Boston & Maine. For more information on all Athearn products contact a dealer or visit athearn.com.

.....



Atlas Model Railroad Company has scheduled the next production

run of its EMD GP38/40 diesel locomotives for the fourth quarter of 2016. The low nose GP38 with twin rooftop radiator fans will be available decorated for Maryland Midland, Alaska, BNSF, Iowa Interstate, Norfolk Southern, and North Shore.

APRIL NEWS | 11



Road names for the high nose GP40 with three rooftop radiator fans will be Pan Am and

Norfolk & Western.



GP40s with a low nose will be available for Paducah & Louisville, Wisconsin

Central, Richmond Fredericksburg & Potomac, and Burlington Northern.

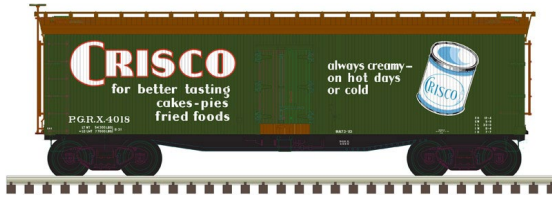

Atlas plans to release this 40-foot wood reefer during the second quarter of 2016. Features of the HO scale ready-to-run model include

separate grab irons, ladders, cut bars, and door locking rods. Road names will be Crisco, Grand Trunk Western, Marhoefer Packing, Morrell (bacon slogan), Morrell (canned meats slogan), Pacific Cooperative, Sinclairs, and White Rock Water.



Third quarter releases from Atlas include a 50-foot boxcar with Youngstown doors. The HO scale ready-to-run

model represents postwar cars that were based on the original 1937

APRIL NEWS | 12

AAR design but updated with Improved Dreadnaught ends and diagonal panel roofs. Many saw service well into the 1980s. Road names will be Atlantic Coast Line, Green Bay & Western, Illinois Central, Lehigh Valley, M-K-T, and New York Central.



Also due from Atlas in the third quarter of this year are HO scale versions of Norfolk Southern TopGon gondola cars. In

the early 1990s NS installed new gondola bodies on frames salvaged from old hopper cars. The successful rebuild program resulted in more than 18,000 TopGon coal haulers. Atlas' ready-to-run model of the NS car will be available in four decorating schemes: With conspicuity stripes, MW scrap tie loading, 263k GRL scheme, and as the celebratory 25,000th rebody car. For additional information on all Atlas products contact a dealer or visit atlasrr.com.



Broadway-Limited expects to release its HO scale version of the Pennsylvania Railroad's K4

steam locomotive late this month. The HO scale Paragon2 model replicates two versions of PRR's workhorse passenger steam locomotive. Both a pre-war model with slatted pilot and a 1950s-era iteration with a cast pilot are included in this production run.

Broadway Limited's HO scale version of this Texas & Pacific 2-10-4 steam locomotive is scheduled for release in June. In addition to its normal in-service livery as shown here, the locomotive will be

APRIL NEWS | 13

.....



available decorated for the American Freedom Train. The HO scale brass-plastic hybrid model comes with Paragon3 sound and control system. For

additional information on all Broadway Limited products contact a dealer or visit broadway-limited.com.

.....



Digital Fox is selling a kit for this HO scale Baltimore & Ohio PS 4750 cu. ft. triple bay covered hopper in six numbers.

The kit includes appropriate trucks with Delrin wheelsets and Accumate couplers. For additional information including ordering instructions visit digitalfox.com.

.....



ExactRail has released another production run of its HO scale 7315 cu. ft. high-cube waffle boxcar. Pullman-Standard

introduced the 65-foot 6-inch prototype with the distinctive sides in 1974. It was designed to handle automobile parts loaded on pallets and bins. The indentations along the inside provide space for load restraints to attach to internal rub rails. Road names on this release are Norfolk & Western with white top corners and yellow draft gear (above), Grand Trunk Western repaint scheme with GT logo,

APRIL NEWS | 14

Milwaukee Road in federal yellow paint scheme that includes end-of-car lettering, and Santa Fe in Gothic font.



Completing this production run is Union Pacific car No. 960872 with a widely spaced road name. ExactRail's ready-

to-run Platinum series model features 100-ton ASF Ride Control trucks with 36-inch machined metal wheels, Kadee #158 couplers, wire grab irons, and separately applied door tracks and door locking bars. For additional information including ordering instructions go to exactrail.com.

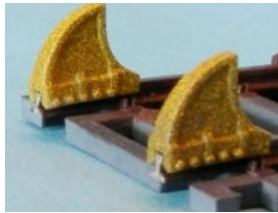

GLX Scale Models sells a variety of detail parts in various scales. All are produced using state-of-the art 3D printing equipment. A sample of HO scale items shown here include a caboose stove, CN-style car stops, and a fire hydrant. Additional items can be viewed at glxscale-models.com.



InterMountain is taking reservations for Tier 4 GEVO locomotives. General Electric Transportation's Evolution locomotives are designed to meet the U.S. Environmental

Protection Agency's stringent Tier 4 emission standards. InterMountain states their current HO scale model reflects updates that have been made to the prototype since its introduction almost a decade ago. Decorating schemes with road-specific details will be available for BNSF (new image ET44C4), Canadian National (EF-644T), CSX (ET44AH), and Union Pacific (C45AH). The ready-to-run model will be available for DC operation as well as factory equipped with ESU sound decoders. Delivery is expected in October or November.



Also coming from InterMountain next fall is a new release of X29 boxcars. These HO scale models will be produced

from Red Caboose tooling. Road names will be Baltimore & Ohio (13 states, class M-26D), Chicago Great Western (Corn Belt Route slogan), Nickel Plate Road, Norfolk & Western, Central of New Jersey, Lehigh & New England, Maine Central, Ferrocarril de Chihuahua al Pacifico, U.S. Army, and two Pennsylvania Railroad versions (circle keystone and shadow keystone). The model will be available ready to run with multiple road numbers, metal wheelsets, Kadee couplers and road-specific doors and ends. The production run will include undecorated economy kits with plastic wheelsets, no couplers and a choice of Dreadnaught or steel plate ends. For additional information contact a dealer or visit intermountain-railway.com.

.....

Kadee Quality Products is selling unpainted HO kits for both 40 and 50-foot PS-1 boxcars. Options on the 40-foot kit include 6, 7, or 8-foot Youngstown corrugated steel doors, and either narrow or wide side sill tabs. The 50-foot kit is available with either 9- or 10-foot P-S doors as well as 9-, 10-, and 15-foot Youngstown corrugated steel

APRIL NEWS | 16



boards, and brake steps. The combination plastic and diecast metal underframe comes partly assembled. The kits include Kadee metal couplers with delayed centering action, scale draft gear box, and Kadee HGC series self-centering trucks with non-magnetic RP-25 metal wheels.

doors. Side sill options include a slope type with a lip and a sharp sloping sill. Detail parts in each kit include separate grab irons, ladders (a choice of short or full height), stirrup steps, handrails, running



New HO scale ready-to-run models scheduled for release in June include this Peoria & Eastern 50-foot PS-1 boxcar with 10-foot door decorated in the

original 1964 Century Green.



Also scheduled for release in June is this Union Pacific 40-foot PS-1 boxcar with 8-foot P-S doors.



Kadee has added two new couplers to its extensive line of HO scale Magnetic knuckle couplers. Shown above left (item #146) is

APRIL NEWS | 17

a Whisker coupler with a long center set shank. On the right is item #451, a new body-mounted swing gearbox whisker coupler with an extended shank for passenger and long freight cars. Contact a dealer or visit kadee.com for additional information.. More info at kadee.com.

Rapido Trains has introduced a new category of HO scale models identified as Prime Movers. In announcing the new line, Jason Shron said the new series of products will be budget priced. While he is proud of the well-detailed models Rapido has brought to the market, Shron said he fully recognizes that museum quality comes at a price not everyone can afford. Rather than being simply a re-release of existing model with less detail, Jason said that Prime Movers by Rapido is an all-new line of models from new tooling. While they will be more than adequately detailed for most hobbyists, each model will include a bag of extra details that the consumer, at his/her own discretion, can install or leave off.



Rapido's initial Prime Mover model will be a General Electric Dash 8-40M with a four-window North American cab. The Dash 8-40M (also known as the

C40-8M) will have handrails installed but some other details such as grab irons, sun shades, and windshield wipers will be provided but not installed. For complete details on Rapido's new Prime Mover line, including pricing and reservation information go to rapidotrains.com/ho-dash-8-40cm.

RSLaserKits has introduced a new kit for an HO scale structure named The Grove. The three-story brick building features two store

APRIL NEWS | 18



fronts, and rear balconies for the upstairs apartments. The kit consists of laser-cut task board and windows, basswood walls, and signage. The assembled structure has a footprint of 4 x 6 inches. For additional information visit rslaserkits.com.



Resin Car Works has a limited quantity of HO scale resin kits for this Illinois Central coal hopper. The model is based on a 33-foot Enterprise design with twin bays and

offset sides. Between 1937 and 1949 about 12,000 of the prototype cars were built by several firms. The kits are \$36.00 plus shipping. Trucks and couplers are not included. For more details including ordering information go to resincarworks.com/kits.htm.

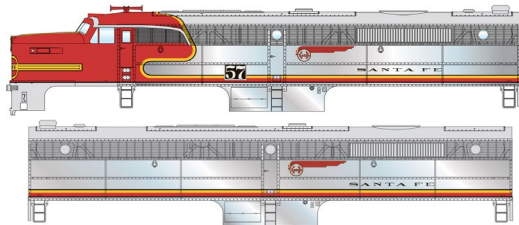

Walther's plans to begin to release of a new run of Alco PA diesel locomotives later this month. The HO scale Mainline series models feature the

same drive mechanism as the Walther's Proto series. Drill starter points for grab irons (sold separately) are molded into

APRIL NEWS | 19

the body shell. The PAs will be available for standard DC and with a factory-installed SoundTraxx decoder. Locomotives decorated for Santa Fe and Pennsylvania Railroad are scheduled for release in late April. Southern Pacific and Union Pacific models are expected to be ready by September. An undecorated version is included in the production run.



Also due from Walthers late this month is a Proto series 55-foot Evans 4780 cu. ft. triple-bay covered hopper. Road names will be

Archer-Daniels-Midland, Boston & Maine, Comet Rice-USLX, FMC Chemicals-USLX, and Farmer's Co-Op Company-USLX.



A new HO scale Mainline series model of an International bay-window caboose is scheduled for release in late April or early

May. Road names for the ready-to-run model will be Chessie System-B&O, Burlington Northern, Chicago & North Western, Conrail, Milwaukee Road, Missouri Pacific, and Union Pacific.



Walthers has scheduled the next release of its Proto series GP35 Phase 2 diesel for late May. In

addition to the Santa Fe scheme shown here, the HO scale model of the EMD locomotive will be available for Burlington Northern, Chesapeake & Ohio, Milwaukee Road, Southern Pacific, and undecorated. A video about Walthers GP35 including all of the

APRIL NEWS | 21

Chicago Burlington & Quincy. For additional information contact a dealer or visit athearn.com.

.....



New locomotives coming from **Atlas** during the third quarter include a General Electric U23B. Produced in the 1960s and early '70s, the

four-axle intermediate-sized road switcher was a direct competitor to EMD's popular GP38. Atlas's N scale version will be available both DCC-ready and with a factory installed DCC decoder. Decorating schemes will include Conrail, Chesapeake & Ohio, Milwaukee Road, Union Pacific, M-K-T, Erie Lackawanna, and two variations of Nacionales de Mexico.



Atlas plans to release this N scale 40-foot wood reefer during the third quarter of this year. The model is based on a car built in 1930 by Pullman for the Northern Refrigerator Car Company. The model features

roof-top ice hatches, a vertical brake shaft, and a USRA-style fishbelly steel underframe. In addition to the PFE car shown here, decorating schemes will be Fruit Growers Express, Marhofer Packing, Grand Trunk Western, Morrell Refrigerator Line (bacon slogan), Morrell Refrigerator Line (canned meats slogan), Sinclairs, and Pacific Cooperative.

New models coming from Atlas during the third quarter include an NSC 50-foot 6-inch plug-door boxcar. The model is based on a 100-ton prototype National Steel Car built during the late 1970s.

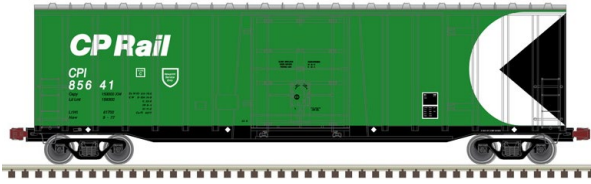

Most of the original production went to Canadian railroads for paper service. Road names on Atlas's N scale Master series version will be CP Rail, Ontario Northland, Quebec Central, and YARR-Youngstown & Austintown Railroad.

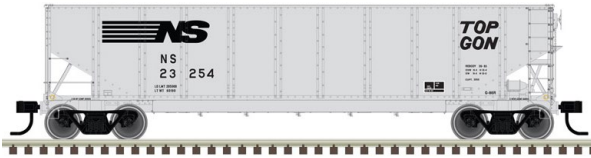

Also due from Atlas in the third quarter of this year are N scale versions of Norfolk Southern TopGon

gondola cars. In the early 1990s NS installed new gondola bodies on frames salvaged from old hopper cars. The successful rebuild program resulted in more than 18,000 new TopGon coal haulers. Atlas's ready-to-run model of the NS car will be available in four decorating schemes: With conspicuity stripes, MW scrap tie loading, 263k GRL scheme, and as the celebratory 25,000th rebody car. For additional information on all Atlas products contact a dealer or visit atlasrr.com.



Eastern Scale Models has scheduled another production run of its 40-foot XIH insulated plug-door boxcars

with delivery expected late this year. The N scale ready-to-run model is based on a 40-foot prototype built by Magor Car Company in 1950. The original buyer, Bangor & Aroostook,

APRIL NEWS | 23

ordered them with charcoal heaters and ventilators so they could transport potatoes in the winter and paper products in the summer. Cars of nearly identical design were built in 1953 by Pacific Car & Foundry.



The ready-to-run N scale models will have etched brass brake platforms and running boards, and

SF A-3 Ride Control solid bearing trucks fitted with Fox Valley metal wheels. Decorating schemes will include B & A's original 1950 red, white and blue design as well as a modified version from late 1955. Also New Haven's 1967 scheme, Canadian Pacific (four schemes), and two versions of CP Rail (yellow and black), and CP Rail's Mandarin Orange Express.



For additional information contact a dealer or visit esmc.com.



KatoUSA has announced a rerun of Amtrak Phase I baggage cars for release in August. The ready-to-run N scale models will be sold as a two-car set.

APRIL NEWS | 24



Additional new N scale releases include early Amfleet I cars with a door and vestibule at each. Many are still in use on some of Amtrak's shorter routes.



Here is Kato's version of Amfleet II cars with a vestibule and door at just one end. They joined the fleet in 1981.

Also new is Kato's N scale Viewliner sleeper in Amtrak Phase VI scheme. For additional information contact a dealer or visit katousa.com.



Micro-Trains Line has released several new N scale cars including a Southern Pacific 10-1-2 heavyweight sleeper and a Baltimore & Ohio 89-foot tri-level auto carrier.



Also available now from Micro-Trains is a Canadian Pacific NSC 65-foot 100-ton skeleton log car

with a log load, and a Sierra Railroad 50-foot rib-side boxcar with double doors.

APRIL NEWS | 25



Completing the list of new N scale items from Micro-Trains is a Pennsylvania Railroad 33-foot panel-side twin-bay hopper with a coal load, and a Navajo Lines 45-foot trailer.

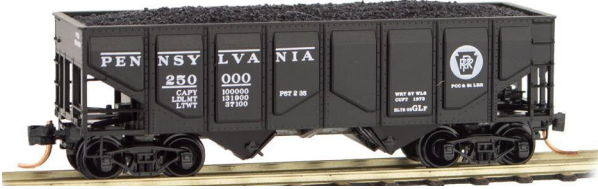

For additional information about all Micro-Trains Line products contact a dealer or visit micro-trains.com.



RSLaserKits has introduced a new kit for a structure named The Grove. The three-story brick building features two store fronts and rear balconies for the upstairs apartments. The kit consists of laser-cut task board and windows, basswood walls, and signage. The assembled N scale structure has a foot print of 2.25 x 3.25 inches. For additional information

visit rslaserkits.com.

Trainworx is booking reservations through the end of April for a third quarter release of its N scale 40-foot flatbed trailers. Decorating schemes will include Atlantic Container Line, Florida East Coast, Great Northern, L&N Family Lines, Northern Pacific, Rio Grande, Seaboard Coast Line, Soo Line, and XTRA Lease. This

production release also includes unlettered trailers painted red, black and silver. For additional information visit train-worx.com.

NEW DECALS, SIGNS AND FINISHING PRODUCTS

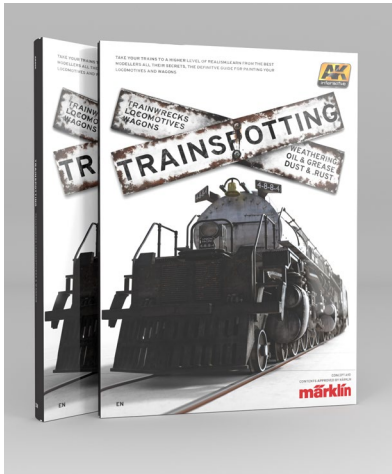

AK Interactive has release a new book on weathering titled Trainspotting. Many of the methods described are based on advanced techniques perfected by military modelers. The individual chapters are from a variety of authors/modelers. They are presented in three principal groups including: 1. techniques and materials, 2. achieving various effects on different types of locomotives and

rolling stock, and 3. weathering structures and ailway buildings. Although the examples shown are primarily on European trains they are fully applicable to North American equipment. A company spokesperson explained that AK Interactive has been targeting armored and military vehicle and aircraft modelers and are just now beginning to address train modelers. AK Interactive's principal products are weathering pigments and acrylic modeling paint available in a wide range of colors. The company was founded in 2009 by Fernando Vallejo. Although relatively new, AK Interactive has grown rapidly with its products now marketed in more than 50 nations. The 208-page book has an MSRP of \$46.00. For additional information contact a dealer or visit ak-interactive.com.

Mask Island Decals is selling HO scale decals for Southern TOFC flat car rebuilds, Rock Island 50-foot insulated boxcars, and Southern Railway cars for brick service. Each set has sufficient material to letter two cars. For more information including ordering details visit maskislanddecals.com.



Microscale Industries reports several popular decals are back in stock. Available now are HO scale decals for Union Pacific diesels and gas turbines (1947-1980), Southern Pacific/Cotton Belt

EMD E-unit and Alco PA diesels (1950-1958), and Pennsylvania Railroad steam locomotives pre-1948 with gold leaf lettering. Also available are O scale decals for Frisco/SL&SF cabooses (1960-1970). For additional information contact a dealer or visit microscale.com.



**Click here for
reader comments**

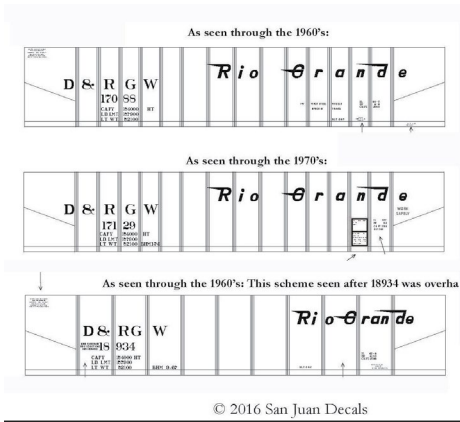

San Juan Decals has expanded into HO scale standard gauge decals with the introduction of a lettering set for D&RGW 17000 and 18000 Series 70-ton open-top hopper cars. Owner Dan Peterson says more HO standard gauge sets will be coming later this year. To order visit sanjuandecals.com.



SEND US YOUR PRODUCT ANNOUNCEMENTS

If you are a hobby manufacturer with a product announcement, just [click here](#) and submit your announcement to us. Our web site and free magazine reach continues to grow, so get on board this new media train! ■

DISCLAIMER

The opinions expressed in this column are those of the writer and do not necessarily reflect the opinion of *Model Railroad Hobbyist* or its sponsors. Every effort is made to provide our readers with accurate and responsible news and information, however, neither *Model Railroad Hobbyist* or the writer of this column can be held responsible for any inaccuracies or typographical errors that may inadvertently appear in this column.

BUILD THAT STEAM LOCO YOU CAN'T BUY!

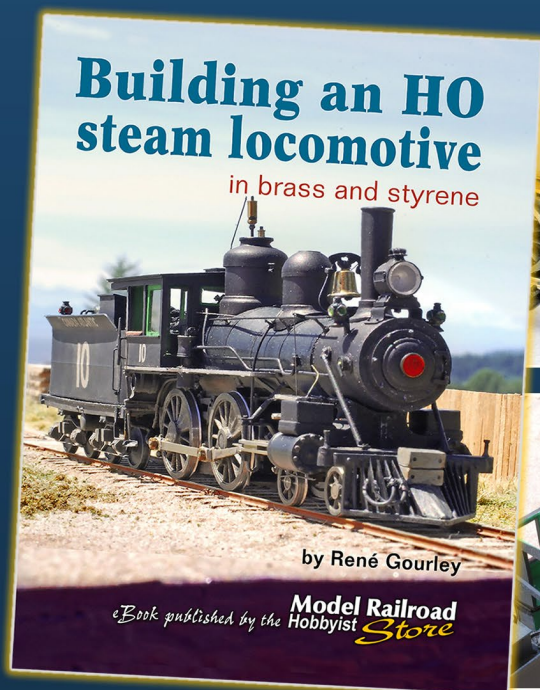

In this book, René Gourley shows you the step-by-step process he used to build an HO steam locomotive from brass and styrene. As René journaled this steam loco construction project online, many asked if he could make his writings and photographs available in published form. The result is this book, which tracks his methods and ideas, with step-by-step photos of the entire process.

Paperback

~~\$34.99~~

LIST PRICE

\$29.74

+ S&H

eBook

~~\$19.99~~

LIST PRICE

\$14.99

On special!

Preorder Paperback

STARTS SHIPPING APRIL 15

Order eBook

INSTANT DOWNLOAD

• INDEX

• TABLE OF CONTENTS



SELECTED EVENTS

April 2016

(Please note that many events charge a fee. Check individual info website for details.)

AUSTRALIA, CANBERRA, April 2-3, 28th Annual Model Railway Expo, hosted by Canberra Model Railway Club, at University of Canberra High School, 104 Baldwin Drive, Kaleen. Info at canberra-model-railway-club.webs.com.

CANADA, ALBERTA, CALGARY, April 16-17, Super Train, Canada's largest model train show, sponsored by Calgary Model Railway Society, at Glenmore Inn and Convention Centre, 2720 Glenmore Trail SE. Info at supertrain.ca.

CANADA, BRITISH COLUMBIA, NANAIMO, April 24, 31st Annual Nanaimo Model Railroad Show, sponsored by NMRA Pacific Northwest Region 7th Division, at Beban Park Recreation Center, 2300 Bowen Road. Info at bctrains.org/node/13.

CANADA, ONTARIO, LINDSAY, April 2-3, 42nd Annual Model Railroad Show, at Victoria Park Armoury, 210 Kent Street West. Info from Eric Potter at annualshow@ldmr.org.

CANADA, ONTARIO, LONDON, April 23, Home Layout Tours, sponsored by London & District Layout Tour Group. Info from Bob Shiell at shiellb@gmail.com.

CANADA, ONTARIO, TORONTO, April 9, Toronto Railway Prototype Modellers Meet, at Humber College, North Campus, Building B, rooms B201-B202, 23 Humber College Boulevard. Info at torontoprototypemodellers.wordpress.com.

SELECTED EVENTS | 2

CALIFORNIA, BELLFLOWER (metro Los Angeles), April 30, WPM Meet hosted by Western Prototype Modelers, at Encounter Christian Church, 10012 Ramona Street (new location). Info at railroadprototypemodelers.org/sbdmeet.htm.

CALIFORNIA, MODESTO, April 20-24, NMRA Pacific Coast Region/Feather River Rail Society Joint Convention, at DoubleTree Hilton Hotel 1150 9th Street. Info at pcrnmra.org/conv2016.

CALIFORNIA, OCEANSIDE, April 9, 2nd Annual Railroad Swap Meet, hosted by North County Model Railroad Society, at Heritage Park, 230 Peyri Drive. Info at ncmrs.org.

FLORIDA, LARGO, April 23-24, Train Show & Open House, hosted by Suncoast Model Railroad Club. Show at MINNREG Hall, 6340 126st Avenue N. Open house at 12355 62nd Street N. Suite A. Info from Jerry Bock at prrailfan@gmail.com.

GEORGIA, PORT WENTWORTH (Savannah area), April 1-2, Savannah RPM & Gun Shoot, at Port Wentworth Community Center, 103 Turnberry Street. Special rates available at Holiday Inn Express, 7210 Georgia Hwy 30. Info facebook.com/savannahrpm.

ILLINOIS, DANVILLE, April 16, 2016 C&EI Historical Societies Annual Meeting at the Danville Area Community College, 2000 E Main St. No charge, all welcome. Info from David Forbes at altamontc_ei@yahoo.com.

IDAHO, LEWISTON, April 3, Annual Train Show and Swap Meet sponsored by Lewis-Clark Train Club at Nez Perce County Fairgrounds, 1229 Burrell Avenue. Info from Dan Wise at wrails@cableone.net.

SELECTED EVENTS | 3

INDIANA, MARTINSVILLE, April 2, Spring Train Show, sponsored by NMRA Central Indiana Division, at 2182 Burton Lane, in Martinsville Plaza. Info from Dan Goins at santafedangoins@comcast.net or Trevor Jones at trevjn@sbcglobal.net.

MASSACHUSETTS, WALTHAM, April 3, Spring TRAINing Model Train Show, hosted by NMRA HUB Division, at Embassy Suites, 550 Winter Street. Info at hubdiv.org.

MICHIGAN, MUSKEGON, April 24, Spring Model Train & Hobby Show, at Veteran's Museum Ship LST 393, 560 Mart Street. Info at mrhs-online.org.

MICHIGAN, WYOMING, April 9, Spring Train Show, sponsored by Grand River Valley Railroad Club, at Home School Building, 5625 Burlingame Avenue SW. Info at grandrivervalleyrrc.org.

MINNESOTA, WOODBURY, April 16, Train Show & Flea Market sponsored by Newport Model Railroad Club, at Woodbury High School, 2665 Woodland Drive. Info from Ed Petry at 651-233-3310.

MISSOURI, SPRINGFIELD, April 16, 38th Annual Ozarks Model Train Show, at Springfield Expo Center, 635 St. Louis Street. Info at omraspringfield.org.

MISSOURI, ST LOUIS, April 6-7, 2017, Sn3 Symposium, at Marriott St Louis Airport. Info at 2017sn3symposium.com.

OHIO, DUBLIN (metro Columbus), April 28-May 1, Rails To The Capitol NMRA MCR Division 6 Regional Convention, at Embassy Suites Hotel, 5100 Upper Metro Place. Info at 2016convention.div6-mcr-nmra.org/home_B.html.

OHIO, MARION, April 28-30, Central Ohio RPM Meet, at Marion Union Station, 532 West Center Street. Request info from Denis Blake at dblake7@columbus.rr.com.

SELECTED EVENTS | 4

PENNSYLVANIA, MONACA, April 3, Spring Model Train Show, sponsored by Beaver County Model Railroad & Historical Society, at Center Stage, 1495 Old Brodhead Road. Info at bcmrr.railfan.net.

VIRGINIA, ROANOKE, April 2, O Scale Narrow Gauge Meet at Lions Meeting Hall, 4801 Merriman Road. Info from Rick Anderson at rickshobbyshop@verizon.net.

WASHINGTON, CHEHALIS, April 2-3, Spring Model Train Show and Swap Meet, sponsored by Lewis County Model Railroad Club, at Southwest Washington Fairgrounds, Blue Pavilion Building. Request info from tedstrains@lewiscounty.com.

WASHINGTON, LACY, April 30, Open House at Olympic Model Railroad Society, Thurston County Fairgrounds, 3054 Carpenter Road SE (basement of Heritage building-not wheelchair accessible). Info from Scott Nelson at westmilwaukees-hops@hotmail.com.

May 2016

CANADA, NEW BRUNSWICK, SAINT JOHN, May 19-22, Port City Rails 2016 Model Railroad Convention & Show, sponsored by Saint John Society of Model Railroaders, at Howard Johnson Fort Howe Plaza & Convention Center, 10 Portland Street. Info at portcityrails2016.org.

CANADA, ONTARIO, OTTAWA, May 6-8, NMRA Algonquin Turn, Niagara Frontier Regional Convention, at Algonquin College. Info at algonquinturn.ca.

CALIFORNIA, NORWALK, May 14, 15 and 17, Open House at California Southern Model Railroad Club, 12140 Firestone Boulevard. Info at californiasouthern.org.

SELECTED EVENTS | 5

CALIFORNIA, SANTA CLARA, May 5-7, 26th Annual O Scale West and 11th Annual S West meets, at Hyatt Regency Hotel. Info at oscalewest.com.

LOUISIANA, METAIRIE, May 14, Open House in celebration of National Train Day, sponsored by Crescent City Model Railroad Club, 601 North Lester Avenue. Info at ccmrc.com.

NORTH CAROLINA, SPENCER, May 13-15, Annual Convention, sponsored by Southern Railway Historical Association. Info at srha.net.

VIRGINIA, FISHERSVILLE, May 1, 30th Annual Shenandoah Valley Model Train & Railroading Show, sponsored by Augusta County Model Railroad Club, at Augusta Expo, 277 Expo Road. Info at acmrrc.org. acmrrc.org/%20.

Future 2016, by location

CANADA, BRITISH COLUMBIA, SALMON ARM, June 15-19, Selkirk Express NMRA Pacific Northwest Region Annual Convention & Train Show. HQ at Prestige Harbourfront Resort, 251 Harbourfront Drive NE. Show at Shaw Centre, 2600 10th Avenue NE. Info at selkirkexpress2016.ca.

CANADA, NOVA SCOTIA, TRURO, June 18, Maritime Prototype Modellers Meet, at Recreation Centre, 40 Douglas Street. Info at facebook.com/MaritimePrototypeModellers.

CANADA, ONTARIO, BRAMPTON, October 1-2, Model Railway Show, at Brampton Fair Grounds, 12942 Heart Lake Road. Info at bramptonmodelrailwayshow.com.

CALIFORNIA, LOS ANGELES, September 25, Self-Guided Tour of area layouts. Info at groups.yahoo.com/neo/groups/Model_Railroads_Of_Southern_California/info.

SELECTED EVENTS | 6

CALIFORNIA, RICHMOND, June 18, Bay Area Prototype Modelers Meet, at St. David's School Hall, 871 Sonoma Street. Info at bayareaprototypemodelers.net.

CONNECTICUT, ENFIELD, June 3-4, New England/Northeast Prototype Modelers Meet, at Holiday Inn, 1 Bright Meadow Boulevard. Info at neprototypemeet.com.

ILLINOIS, COLLINSVILLE (metro St Louis), August 12-13, 10th Annual St. Louis Railroad Prototype Modeler's Meet, hosted by John Golden, Lonnie Bathurst, Dave Roeder, and Dan Kohlberg. Co-sponsored by NMRA Gateway Division, at Gateway Convention Center. Info at icg.home.mindspring.com/rpm.

ILLINOIS, CHICAGO, October 1-2, Brass Expo, a juried show limited to pre-submitted items including brass models and items relevant to brass models. At The Westin Hotel (Chicago North Shore), 601 N. Milwaukee Ave. Wheeling, IL 60090. Info at brassexpo.com.

ILLINOIS, LISLE, October 20-22, RPM Chicagoland (formerly Naperville RPM), hosted by Mike Skibbe, at Sheraton Hotel. Info at rpmconference.com.

INDIANA, INDIANAPOLIS, July 3-10, NMRA National Convention and National Train Show. HQ at Westin Hotel, 50 South Capitol Avenue. Info at nmra2016.org.

INDIANA, INDIANAPOLIS, July 8-10, NMRA National Train Show, at Indiana Convention Center, 100 South Capitol Avenue. Info at nationaltrainshow.org.

INDIANA, MERRILLVILLE, Aug 11-14, Steel Mill Modelers SIG Meet, at Hilton Garden Inn, 7775 Mississippi Street. Membership in SMMSIG is required to attend. Info at smmsig.org.

SELECTED EVENTS | 7

KANSAS, WICHITA, June 22-26, Santa Fe Railroad Historical & Modeling Society 36th Annual Convention, at Wichita Marriott East, 9100 Corporate Hills Dr. Info at atsfr.com/convention/2016%20Wichita/Index.htm.

MAINE, AUGUSTA, Sept. 7-10, 36th National Narrow Gauge Convention. Info at nngc2016.org.

MISSOURI, JEFFERSON CITY, October 6-9, Missouri Pacific Historical Society Annual Meeting, includes modeling clinics and swap meet. Info at mopac.org/corporate-history/73-missouri-pacific-railroad.

NORTH CAROLINA, DURHAM, October 20-23, Mid-Eastern Region Fall Convention, sponsored by NMRA Carolina Piedmont Division, at Marriott at Research Triangle Park, 4700 Guardian Drive. Info at mer2016.org.

TENNESSEE, JOHNSON CITY, June 3-4, George L. Carter Railroad Museum Train Show, at East Tennessee State University, Memorial Center Mini-Dome, 1081 John Robert Bell Drive. Info from Mark Woomer at markwoo1969@hotmail.com.

VIRGINIA, FREDERICKSBURG, September 23-24, Mid-Atlantic Prototype Modelers Meet, at Wingate by Wyndham Hotel, 20 Sanford Drive. Info at marpm.org.

WISCONSIN, WAUPACA, June 18-19, 27th Annual Strawberry Fest Model Railroad Show & Model Contest, sponsored by Waupaca Area Model Railroaders, at Waupaca Recreation Center, 407 School Street. Info at wamrltd.com.

Future 2017 and beyond (by location)

AUSTRALIA, VICTORIA, GEELONG, April 14-16, 2017, 13th Annual Australian Narrow Gauge Convention. Info at austnar-rowgaugeconvention.com.

SELECTED EVENTS | 8

COLORADO, DENVER, August 30-September 2, 2017, National Narrow Gauge Convention, at Marriott Denver Tech Center Hotel.

FLORIDA, ORLANDO, July 30-Aug 5, 2017, NMRA National Convention.

MISSOURI, KANSAS CITY, August 5-12, 2018, NMRA National Convention. ■



**Click here for
reader comments**

ADVERTISEMENT

HO GP60M, GP60B AND GP60 Locos



NOW AVAILABLE !



DC OR DCC WITH SOUND!



www.foxvalleymodels.com

ADVERTISEMENT

NICK & NORA DESIGNS
Uniquely inspired craftsman kits



Craftsman Structure Kits,
Detail Parts, Shingles & More!
www.nickandnoradesigns.com

• INDEX

• TABLE OF CONTENTS

Clickable advertiser index – 1

[Accu-Lites](#)

[American Eagle Railroad Group](#)

[American Ltd \(San Juan\)](#)

[ANE Models](#)

[Archer Fine Transfers](#)

[Athearn](#)

[Atlas Model Railroad Co.](#)

[Bachmann](#)

[Bachrus](#)

[Backdrop Junction](#)

[Berrett Hill Trains](#)

[Black Cat Publishing](#)

[Blair Line](#)

[Bowser](#)

[Caboose Hobbies](#)

[Canyon Creek Scenics](#)

[Clever Models](#)

[Coastmans Scenic Products](#)

[Coffman Graphics](#)

[Credit Valley Railway](#)

[Digitrax \(2 page spread\)](#)

[ESU LokSound](#)

[Fast Tracks](#)

[Fifer Hobby Supply](#)

[Fox Valley Models](#)

[George's Trains](#)

[GLX Scale Models](#)

[Great Decals](#)

[HO Diesel Supply](#)

[Indianapolis National Train Show](#)

[Iowa Scaled Engineering](#)

[Iwata-Medea](#)

[Jelsma Graphics](#)

[Jim's Track Plans](#)

[KC's Workshop](#)

[Ken Patterson.com](#)

[Lights 4 Models](#)

[Litchfield Station](#)

[Logic Rail Technologies](#)

[Main Street Heritage Models](#)

[Micro-Mark](#)

[MinuteMan Scale Models](#)

[Model Railroad Benchwork \(1\)](#)

[Model Railroad Benchwork \(2\)](#)

[Monster Modelworks](#)

[Motrak Models](#)

[Mountain Subdivision Hobbies](#)

[MRH Store \(1\)](#)

[MRH Store \(2\)](#)

[MRH Store \(3\)](#)

[MRH Store \(4\)](#)

[MRH Store \(5\)](#)

[MRH Store \(6\)](#)

[Nano-Oil](#)

[NCE \(2 page spread\)](#)

[Nick & Nora Design](#)

[North American Railcar Co.](#)

[Oak Hill MRR Track Supply](#)

[Pre-Size Model Specialities](#)

[Precision Design Co.](#)

[RailMaster Hobbies](#)

[Rapido \(1\)](#)

[Rapido \(2\)](#)

[Ring Engineering \(1\)](#)

Clickable advertiser index – 2

[Ring Engineering \(2\)](#)

[RsLaser Kits](#)

[Rulers-of-the-World](#)

[Rusty Stumps](#)

[Scale Trains](#)

[Scotty Mason Show](#)

[Soundtraxx \(Blackstone\)](#)

[Southern Digital](#)

[Streamlined Backshop](#)

[TAM Valley Depot](#)

[The Pixel Depot](#)

[Tony's Train Exchange](#)

[TrainMaster Model Trains](#)

[TrainMasters TV \(1\)](#)

[TrainMasters TV \(2\)](#)

[TrainMasters TV \(3\)](#)

[Traintek](#)

[TSG Multimedia](#)

[Westerfield Models](#)

[Yankee Dabbler](#)

[Yarmouth Model Works](#)

Clickable “other” index

[Other – Cover](#)

[Other – Derailments](#)

[Other – Hobby Marketplace](#)

[Other – MRH Sponsors](#)

[Other – Staff Notes](#)

[Other – Table of Contents](#)

DOWNLOAD ISSUE



DOWNLOAD PORTRAIT



DOWNLOAD LANDSCAPE

• INDEX

• TABLE OF CONTENTS



REVERSE RUNNING

commentary

DON HANLEY
.....



[Click here for
reader comments](#)

THE RECLUSIVE LAYOUT

I WAS INVITED BY AN

acquaintance (whom I will call B.S.) recently to operate on a local HO scale layout. B.S. indicated the layout was off the beaten path, but well worth the 45-mile drive. B.S. warned the owner was reclusive and somewhat eccentric. I nodded while thinking that most people feel all us model railroaders are a bit eccentric, so how bad could this guy be?



My friend also mentioned a secret handshake to get into the layout.

“What?” I said. “I am with *you*, can’t you vouch for me?” “Nope,” said B.S. “You must know the secret handshake to get in. Let me teach it to you.” After five or six tries, I had it down, at least well enough – I hoped – to get me in.

I offered to drive, but B.S. said he would drive since it was best to go in his truck on the backroads. Near the edge of town, we exited

▶ [STEPPING OUTSIDE THE BOX WITH A CONTRARY VIEW](#)

the freeway to go, I assumed, to one of the subdivisions located in the foothills of the Sierras. B.S. continued past the subdivisions and soon we were bouncing along a Humboldt-Toiyabe National Forest road and then down an old logging road and finally driving up a creek through the water!

“Where in God’s green earth are we going?” I exclaimed to B.S. “Almost there” he said, and sure enough, a couple more bends of the creek and there it was, a beautiful home nestled in some trees.

Upon giving the secret handshake – which I almost forgot during the ride – the owner (whom I can’t name) said I would need to sign a non-disclosure statement. “A what?” I asked. He replied, “A non-disclosure saying you won’t tell anyone who I am, or where the layout is located.” I came this far to see the layout, so I signed it.

We walked to a separate building with an attached shop, the dream of most modelers. He showed us around the shop and the various projects that he was working on. Next, he took his time showing his large collection of railroad memorabilia. Everything was nicely presented, but I had come all this way to see the layout!

At last he opened the door to his layout and there it was in all of its glory. Two 4 x 8 sheets of plywood end to end with a loop of brass track and a few switches. Choking down my disappointment, I said some nice words and asked if we could operate it.

“No it’s not operating today” he said. I must have looked rather dumbfounded as he explained: “I am off the grid and the layout is solar powered. Since it’s been cloudy for the last week, I need to keep what power I have in the batteries for household needs.” I nodded my head in understanding.

We soon left and made the drive home in silence. I said my good-bye to B.S. and went on home. Upon arriving at my house, instead of pulling the car into the garage, I parked on the street, opened my garage door, and began operating *my layout*, letting anyone who wanted come on in, have a look, and run a train. ☑



DERAILMENTS

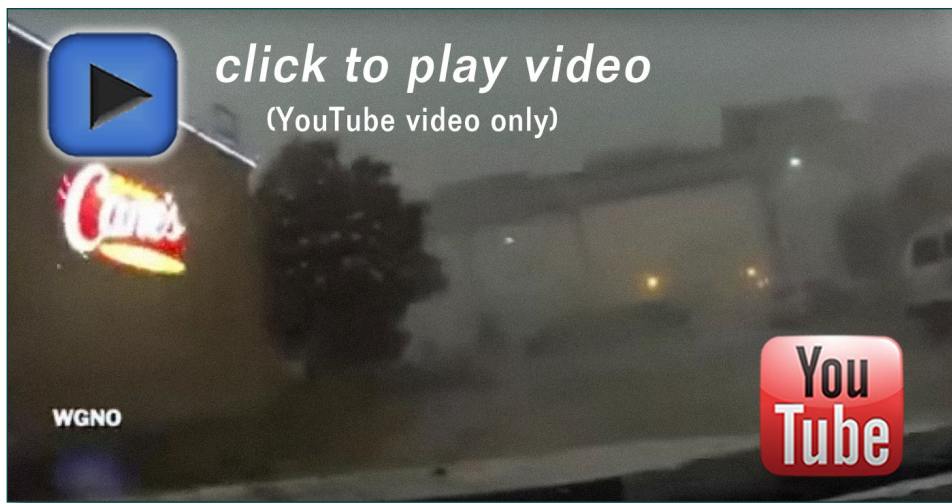

TRAIN BLOWN OFF BRIDGE IN STORM

A Norfolk Southern intermodal freight train succumbed to severe wind gusts from a massive thunderstorm, with several of the freight cars tossed off of the tracks to the street below!

On April 27, 2015, WGNO News, located in the New Orleans, LA area, got this footage from a news reporter who caught the Norfolk Southern freight being blown off of the Huey P Long Bridge during a heavy thunderstorm.

For more details on this startling event, visit this web link:

trainfanatics.com/breaking-news-freight-train-blown-off-huey-p-long-bridge

► BIZARRE FACTS AND HUMOR (SUPPOSEDLY)

YOU MIGHT BE A MODEL RAILROADER IF ...

- You talk about the merits of DCC versus DC at parties.
- You've refused to buy a model freight car because the tiny stenciled build date is a year off from your era.
- You feel three hours forming and mounting wire grab-irons on a caboose is time well spent.
- You've calculated your layout track in scale miles, and padded the number by adding the length of the sidings and spurs.
- You've ever traced the route of a wire by pulling on it. ■

GET PAID ...

If you're the first to submit a bit of good humor or bizarre facts and we use it, it's worth \$25! Just send to derailments@mrhmag.com ■

Coming next issue ...

- Rick Norris and his Rio Grande Southern layout
- Build a BC Rail CRS20
- Powering a turntable
- Model an oil dealer
- Another One Module Challenge winning layout design
- And lots, *lots* more!

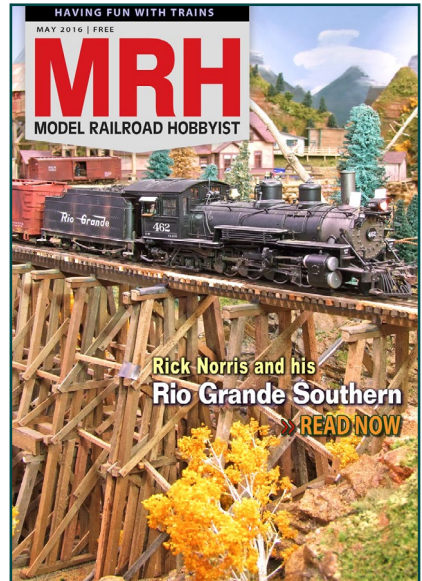

 [Click here for reader comments](#)