

HAVING FUN WITH TRAINS

JUNE 2016 | FREE

MRH

MODEL RAILROAD HOBBYIST

ALSO:

- Imagineering building design
 - Bashing a wood boxcab loco
 - Powering your DCC system
 - Bob Case's B&O layout
 - Building a layout in sections
- ... and lots more inside!*

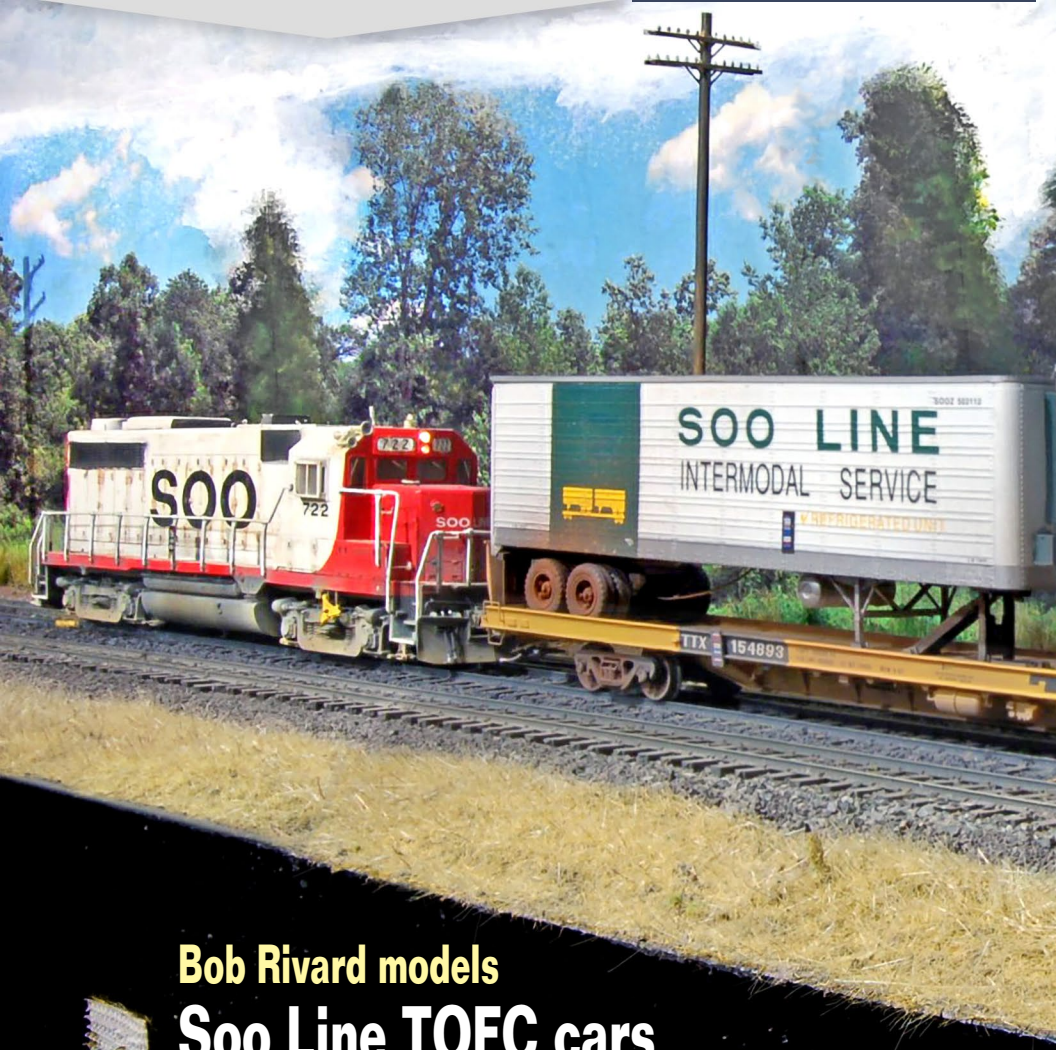

Bob Rivard models
Soo Line TOFC cars
» READ NOW

STANDARD EDITION | PORTRAIT



DOWNLOAD

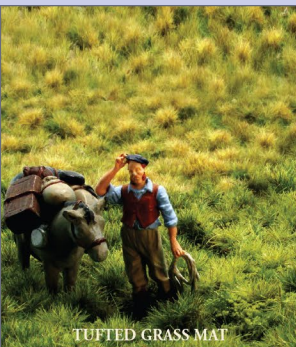

TUFTED GRASS MAT



2MM PULL-APART STATIC GRASS

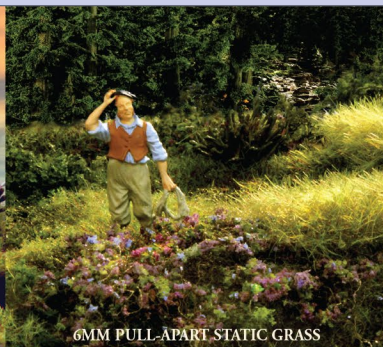

6MM PULL-APART STATIC GRASS

NEW SCENESCAPES® LANDSCAPING PRODUCTS

REALISTIC-LOOKING SCENERY HAS NEVER BEEN EASIER!

Bachmann's new *Scenesapes*® landscaping products let you quickly add distinctive details and natural-looking textures to any scale layout. Professional, realistic-looking scenery has never been easier!



Click for more info

TUFTED GRASS MAT (one 11.75" x 7.5" sheet)
MSRP \$28.95 each



LIGHT GREEN
Item No. 32921



MEDIUM GREEN
Item No. 32922



WESTERN RANGE
Item No. 32924



DRY GRASS
Item No. 32925

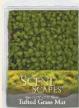

2MM PULL-APART STATIC GRASS (one 11" x 5.5" expandable sheet)
MSRP \$16.95 each



LIGHT GREEN
Item No. 31011



MEDIUM GREEN
Item No. 31012



DRY GRASS
Item No. 31014



GOLD
Item No. 31015



6MM PULL-APART STATIC GRASS (one 11" x 5.5" expandable sheet)
MSRP \$16.95 each



WILD GRASS
(medium green with gold highlights)
Item No. 31001

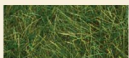

DARK GREEN
(dark green with subtle gold highlights)
Item No. 31002



ALPINE GREEN
(dark green with subtle gold highlights and blown leaves)
Item No. 31003



6MM TUFTS (100 pieces)
MSRP \$10.95 each



MEDIUM GREEN
Item No. 31031



DARK GREEN
Item No. 31032



TAN
Item No. 31033



YELLOW and RED
Item No. 31034



WHITE and BURGUNDY
Item No. 31035



10MM TUFTS (50 pieces)
MSRP \$12.95 each



LIGHT GREEN
Item No. 31041



MEDIUM GREEN
Item No. 31042



TAN
Item No. 31044



YELLOW and RED
Item No. 31045



Bachmann Industries, Inc. • 1400 East Erie Avenue; Philadelphia, PA 19124 • www.bachmanntrains.com
Click to learn more.



Model Railroad Hobbyist | June 2016 | #76

STAFF CREDITS

Front cover: Bob Rivard returns to the pages of MRH, this time to tell us how he models Trailer-On-Flat-Car (TOFC) intermodal on his Soo Line layout.

ISSN 2152-7423

Editorial Staff

Joe D. Fugate, Publisher and Editor
Don Hanley, Assistant Editor

Production

Patty Fugate, Pasteup and Layout
Joe Brugger, Copy Editing
Mike Dodd, Copy Editing

Technical Assistant

Jeff Shultz

Advertising

Les Halmos, Account Manager
Daniel Nava, Advertising Assistant
Jean-François Delisle, Marketing Assistant
Richard Bale, News and events



Columnists

Jeff Shultz, News and events
Les Halmos, Modular railroading
Larry Smith, Narrow Gauge/Shortlines
Bruce Petrarca, DCC
Ken Patterson, Reporter at large

Special Correspondents

Joe Brugger, Questions & answers
Charlie Comstock, Contributing editor

Issue password: Jun2016

Published for the glory of God. [What's this?](#)



MRH SPONSORS

A - E



acculites.com



onlinetrainauctions.com



americanlimitedmodels.com



railroadhobbyshow.com



anemodel.com



archertransfers.com



athearn.com

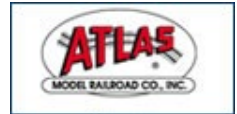

www.atlasrr.com



bachmanntrains.com



backdropjunction.com

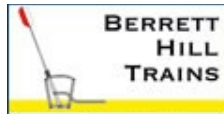

berrethill.com/trains



blairline.com



bowser-trains.com



caboosehobbies.com



coffmaneng.com



con-cor.com/website



cvcrc.com



www.digitrax.com



esu.eu/en

[Vendors: Get your clickable logo here ...](#)

MRH SPONSORS | 2

F - R



www.handlaidtrack.com



fiferhobby.com



foxvalleymodels.com



georgetrains.com



glxscalemodels.com



www.iascaled.com



iwata-medea.com



litchfieldstation.com



micromark.com



model-trains-video.com



monstermodelworks.com



stores.ebay.com/Motrak-Models



modelrectifier.com



nano-oil.com/Model%20Railroad.html



ncedcc.com



nickandnora.com



www.pwrs.ca/main.php



nationaltrainshow.org

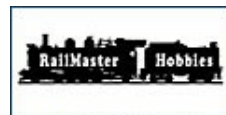

railmasterhobbies.com



rapidotrains.com



ringengineering.com



rslaserkits.com



rustystumps.com

[Vendors: Get your clickable logo here ...](#)

MRH SPONSORS | 3

S - Z



sanjuancarco.com



scaletrains.com



soundtraxx.com



sodigi.com



tamvalleydepot.com



tonystrains.com



trainmastermodels.com



trainmastermodels.com



trainteklc.com



tsgmultimedia.com



yankeedabblers.com

[Vendors: Get your clickable logo here ...](#)

Looking for something? Check the MRH Marketplace!

Take me there!

INTRODUCING THE...

Amtrak Downeaster

NPCU "Cabbage"
Downeaster in
Amtrak Ph.IV



HO
SCALE

DC/SILENT &
DC/DCC/SOUND
VERSIONS AVAILABLE

RAPIDOTRAINS.COM

• INDEX

• TABLE OF CONTENTS



TABLE OF CONTENTS

FEATURES

TOFC on the SOO Line

BOB RIVARD

Tips and tricks for modeling trailers on flat cars



How to bash a wood-N boxcab

M.C. FUJIWARA

Kitbash this rustic backwoods locomotive



Build a safe straight edge

MIKE DODD

Keep your ruler in place and your fingers safe



Bob Case's Baltimore & Ohio

BOB CASE and the MRH STAFF

This layout will be on NMRA Indy convention tours



One Module Challenge: Pembroke

RENÉ GOURLEY

Our first place TOMA layout design contest winner

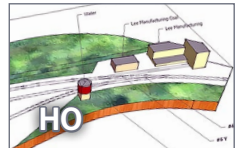

ALSO: MRH Marketplace | Bonus extras

TABLE OF CONTENTS | 2

COLUMNS

MRH Q-A-T: Solvaset, cork roadbed, ...

compiled by JOE BRUGGER

DCC Impulses: Getting power to my DCC system

BRUCE PETRARCA

What's Neat: iPhone vs DSLR, interlocking tower

KEN PATTERSON

Imagineering: Buildings on the In-ko-pah Railroad

RAY DUNAKIN

Photo feature: Yes, it's a model

compiled by DON HANLEY

MRH Staff Profile: My model railroad journey

BRUCE PETRARCA

Derailments: Bizarre facts & humor

compiled by the MRH STAFF

NEWS and EDITORIAL

Assistant Editor's Thoughts: Taking the long-term view

DON HANLEY

Staff Notes: Doing small layouts

compiled by the MRH STAFF

News & Events: June 2016

RICHARD BALE & JEFF SHULTZ

Reverse Running: The power of confinement

JOE FUGATE

THANK YOU

On March 15th, we received our second new product shipment. To our dismay, a forklift pierced two pallets plus a third was scattered on the trailer floor.

To ensure the models still met our high quality standards and were in new condition, we opened and inspected every Operator™ and Rivet Counter™ package – over 7500 tank cars.

During the evaluation process, we discovered a potential issue with the Rivet Counter die-cast double shelf knuckle couplers so we decided to replace nearly 9000 couplers as well.

When we shared what happened, the modeling community and our church immediately offered to help. Over 30 volunteers from across the country traveled to our small town in Southeast Tennessee.

Thank you cannot begin to express the level of our gratitude. Without your selfless gift of time and skills, our young company may have been short lived. We are truly humbled by your kindness. May God bless you like you have blessed us.

Chattanooga Modular Modelers

Chattanooga, TN

Dale B

Jim L

JoAnna L

Lloyd C

G M

Scott D

Mark M

Owen M

Roy M

Bill O

Ed T

Pat T

Community Fellowship Church

Ocoee, TN

Samuel B

Lily C

Carol H

Michael H

Meta H

Kevin K

Warren L

Shaney

Shaun M

Krystle M

Cadence M

Lylah M

Barrett M

Kim O

Bruce U

Amanda U

Kaytlin U

Iron Station, NC

Todd A

Megan A

Buford, GA

Russ G

Knoxville Area Model

Railroaders

Philadelphia, TN

Keith E

Moon Dog Rail Cars

Olney, IL

John O

Railroad Model Craftsman

Editor

Kansas City, MO

Stephen P

Westfield, IN

Jim S

Benton, TN

Brendan W

Lauren W

We're also grateful for the supportive e-mails, phone calls, Facebook posts, etc. Your encouragement helped motivate everyone.

Thanks to you, we were able to complete the evaluation and coupler swap over a couple of weeks instead of several months. We look forward to having the opportunity to return the favor by giving our time and skills to help others.

Sincerely,



The ScaleTrains.com Crew

Joe, Kimberly, Mike, Paul, Shane, Michelle

Visit Us At www.scaletrains.com

© 2016 ScaleTrains.com, Inc. ScaleTrains.com, Operator & Rivet Counter plus respective logos and slogans are trademarks of ScaleTrains.com, Inc. ScaleTrains.com, Inc. 7598 Highway 411 Benton, TN 37307 844-9TRAINS 844-987-2467



ASSISTANT EDITOR

editorial

DON HANLEY
.....



[Click here for
reader comments](#)

TAKING THE LONG TERM VIEW

WE CAN PRETTY MUCH AGREE WE LIVE IN AN instant-gratification society.

My grandmother was born in 1892 on a small farm near Merom, Indiana along the Wabash River. She saw a lot of changes in her lifetime: from horse and buggy, steam locomotives, and telegraphs; to airplanes, telephones, two World Wars, television, and man landing on the Moon. She died in 1987. She saw a huge change in technology in one lifetime, and technology is still changing.

Besides affecting our daily lives, technology changes also are affecting our hobby, from rapid prototyping, to controlling our trains with your smart phone, to dead rail power. Much of the new tech seems aimed at helping us “do more” in the 24 hours allotted to us each day, further fueling our instant gratification society.

Yet with all of these technological advancements affecting life and our hobby, model railroading is not an instant-gratification hobby.

Most of us dream of having a large layout along with the space and time to work on it, having friends over to enjoy it, and to admire and operate it. But every one of us will run into the reality that to

ASSISTANT EDITOR'S THOUGHTS | 2

build our dream layout takes more time and money than we ever thought it would.

While you can throw up the benchwork and lay the track rather quickly, if you want your railroad to run flawlessly, you need to spend time tweaking the turnouts, tuning the track, and making sure the electrical connections are all solid. Once you finally get the trains running, then you need to make sure the rolling stock and locomotives run reliably.

I have a small 20" x 24' switching layout and progress on it has been painfully slow. It's more work than I had anticipated, plus the demands of everyday life gets in the way of my hobby time. Now multiply this by ten to a hundred times if you want a large dream layout and have it running flawlessly!

ADVERTISEMENT



WHAT A STEEL!
ATLAS MASTER HO, N AND O 42' COIL STEEL CARS

BETHLEHEM, PENNSYLVANIA
BETHLEHEM STEEL
BSCX 170700

ATLAS
MODEL RAILROAD CO., INC.

Available for Pre-Order in June 2016 **CLICK HERE!**

For a copy of our latest All Scales Catalog, please call 908-687-0880 or visit www.atlasrr.com/catalog

(O scale model shown)

• INDEX

• TABLE OF CONTENTS

ARRIVING JUNE 2016



THE NEW ATHEARN® ROUNDHOUSE

Historically, the Roundhouse brand delivered quality pre-1940s era models while maintaining a terrific value. Building upon this tradition, Athearn® Roundhouse is now home to the hobby's best-loved models. No matter your era or favorite railroads, Athearn Roundhouse has a complete product selection for the beginning and experienced hobbyist.



RND87909



Check out the new Athearn Roundhouse line at Athearn.com.



HORIZON
H O B B Y

VISIT
Your Local Retailer

CLICK
Athearn.com

CALL
1.800.338.4639

SERIOUS FUN™

©2016 Horizon Hobby, LLC. Athearn, Genesis, Ready To Roll, Trains in Miniature, Serious Fun and the Horizon Hobby logo are trademarks or registered trademarks of Horizon Hobby, LLC. The Union Pacific mark and other marks owned by Union Pacific are made under trademark license from Union Pacific Railroad Company. All other trademarks, service marks and logos are property of their respective owners. Final models may vary slightly from photos shown. 4/9/2012



RAILROAD AUCTIONS
RAILROAD CROSSING
AMERICAN EAGLE
RAILROAD GROUP

Quality
Convenience
Variety
Pricing

www.onlinetrainauctions.com

THREE STORY STOREFRONT KIT
Custom Cornice Inscription

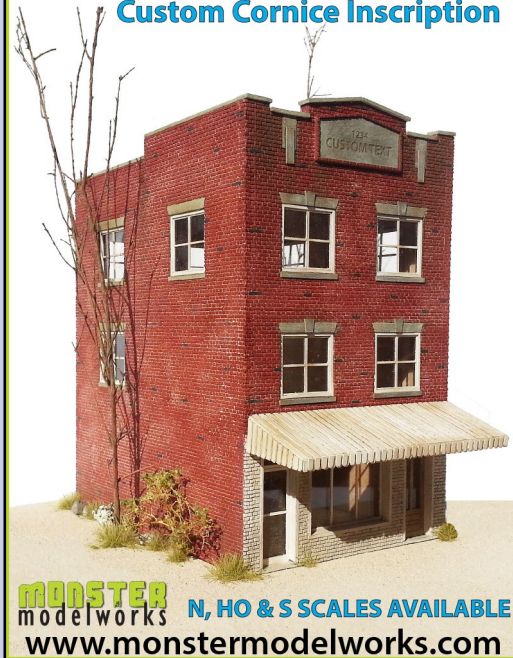

ASSISTANT EDITOR'S THOUGHTS | 3

This is where *The One Module Approach* (TOMA) we've been discussing demonstrates its value as a way to build a layout. We feature second place in our TOMA contest this month, and René Gourley makes an interesting point: even if you are doing a module at a time, plan for the future. This is an important concept.

Why plan for the entire layout if you are only building a module at a time? René says if you don't plan for the next phase(s), you might block yourself out of a desired alignment or operational feature you want. Does that mean you need to plan every little detail of every phase? No, I don't believe you do.

Other than the alignment of the track and its route in the room, you need fewer planning details for future modules. The first module built needs to be planned in detail so that you know what you are building, obviously.



Announcing our next Limited Run
PWRS / Micro-Trains® Car!!!

PWRS

Canadian National (CNA) 4-pk

50' Rib Side Box Car, Plug & Sliding Door, w/o Roofwalk



- Brown w/
Aluminum
Roof
- Lightly
Weathered



PACIFIC WESTERN RAIL SYSTEMS
SPECIAL RUN CAR



CLICK HERE FOR
CNA

COMING
December 2016

NORTH AMERICAN RAILCAR CORPORATION

**DO YOU MODEL ANY
OF THESE ROADS?**

**NEW TOOLING
COMING!!!**

**WE WILL SOON BE
TAKING ORDERS FOR
2 BRAND NEW, NEVER
BEFORE RELEASED
MODELS... FOR ALL
OF THESE ROADS.
STAY TUNED FOR
MORE INFORMATION
ON OUR FIRST 2
RELEASES.**



CLICK HERE FOR
NARC Teaser

NARC Cars are sold
exclusively through

Pacific Western Rail Systems

YD
Yankee Dabblers.Com



**SURE TO
FIT YOUR
BUDGET!**

HO

DCC

ALL SCALES

Click NOW!



**- Kadee - NCE - SoundTraxx
- Digitrax - And more!**

ASSISTANT EDITOR'S THOUGHTS | 4

One of the great features of TOMA is having a runoff track (that is, staging) on each end of the module. Why not plan these runoff tracks so they become the next adjoining modules?

This may require building the basic framework of the adjoining modules on each side, but that just puts you one step ahead for the next modules you want to work on.

In TOMA, we do recommend you finish one module at a time, and avoid working on the adjoining modules until the current module is finished.

Another great feature of TOMA is that you don't need to standardize the size of a module. You can choose to use a modular standard if you like, but you do not have to do so. Each module section can be a custom design to fit within an overall layout plan. Just be sure each section is not so big that you need a small army plus a small boy to handle it.

Building a layout step-by-step, but also thinking long-term

ASSISTANT EDITOR'S THOUGHTS | 5

with TOMA provides some advantages:

1. It increases your sense of accomplishment by making the initial scope smaller. This prevents being overwhelmed, and then feeling guilty because you are not making progress at the rate you desire.
2. You can test as you go. If your module is not working as you hoped it would, then no big deal. It only requires changing the module you are working on. Or perhaps the current module could work but

118,000 have seen this MRH video - *have you?*



Watch the
video now



Lasercut structures. Highway, storefront and billboard signs.



WHAT'S NEW?
HO-N-O scales
Blair Line

ADVERTISEMENT

Backdrop Junction

Your Stop for Railroad Backdrops

Click Here →

**For the Finest in Custom
Designed backdrop**



www.backdropjunction.com

ASSISTANT EDITOR'S THOUGHTS | 6

changing one of the connected modules you have not yet built will solve an issue.

3. You can control your budget with each step. Small projects cost less, and the expenses are more manageable when taken in small steps. If you find out later you need to use a different approach on something, you don't have a room full of partially completed layout to change over.
4. Instead of being committed to one phase of a large project that you later find you don't particularly like because your interests have evolved as you learn more, each phase is smaller. This allows your layout to keep step with your evolving interests.
5. As your skills increase, you will likely discover the first modules are not up to par with your skills and experience now. Because your layout uses individual module sections, you can easily replace or upgrade an older module with one that matches your current skill level.

As the old saying goes: How do you eat an elephant? One bite at a time.

And how do you build a dream layout? One module at a time, that's how.



[Click here for reader comments](#)



NOTE: Joe Fugate has updated his acrylic painting guide from previous months. You can get the latest version from this month's [Subscriber Bonus downloads](#).

Nano-Oil™

Made in U.S.A.

**New
Innovation**

Nano Technology Lubricants

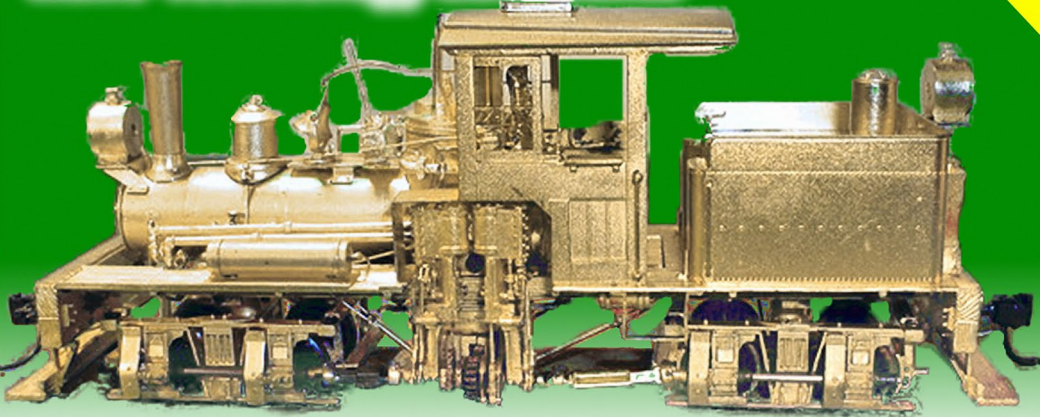

"After eight years of extensive testing, the only lubricants now used in my shop are Nano-Oils and Nano-Grease. The extreme reduction in power draw by mechanically minimizing friction is simply technologically superior."

- Phil Floyd, 'The Shay Fixer'

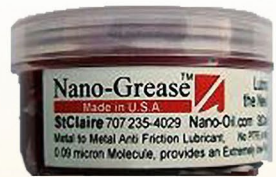
**Nano-Grease**

For more details click here ...

**THE SHAY FIXER** 

VISIT US AT...

SHAYFIXER.COM

Specializing in brass Pacific Fast Mail / United geared locomotives

• INDEX

• TABLE OF CONTENTS

WHAT'S NEW!

ON

TRAINMASTERS.TV



WIRELESS DCC BATTERY POWER

Miles Hale shows how to install and get the most from the Station S-Cab wireless battery-powered DCC locos.

Non-members: Watch for \$1.49 / episode!



INSTALLING BRAKE HOSES

Pierre Oliver shares his techniques for adding detailed air brake hoses to plastic freight cars on Notch 8.

Non-members: Watch for \$1.49 / episode!



RICK NORRIS' RIO GRANDE SOUTHERN

TMTV visits Rick Norris, who is modeling the picturesque Rio Grande Southern narrow gauge line.

Non-members: Watch for \$1.49 / episode!



BREAKING THE SOUND BARRIER

Matt Herman of ESU/LokSound does an in-depth demo of their innovative new FULL THROTTLE sound decoder update.

Non-members: Watch for \$1.49 / episode!



Watch these videos on TrainMasters.TV

(Non-members can now watch one of these videos for just \$1.49, or download-to-own for \$3.49)



• INDEX

• TABLE OF CONTENTS



STAFF NOTES



[Click here for
reader comments](#)

DOING SMALL LAYOUTS ... AND MORE

IF YOU RECALL LAST MONTH'S STAFF NOTES, we concluded, from our discussion of Nicholas Kalis' letter about the future of the hobby, that promoting smaller layouts is a good idea. To that end, Nick sent us his reading list for more info on creating a good small layout.

Here's Nick's small-layout friendly magazine list. Each magazine cover is clickable, so click a cover to learn more about that particular magazine. We do note, however, Nick's recommended magazines have a distinct narrow gauge bias!

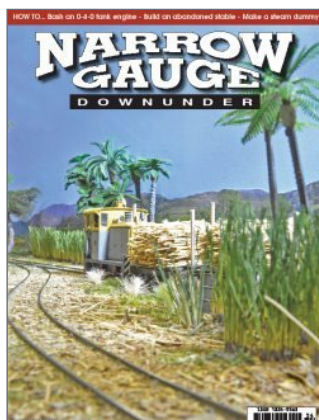
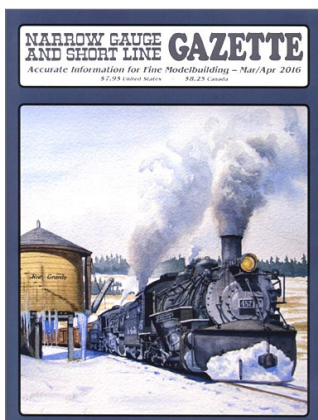
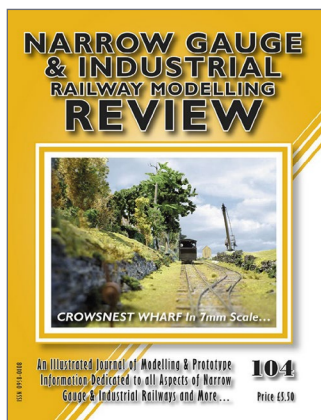

STAFF NOTES | 2

As for other places you can get small layout information, there's Carl Arendt's small layouts website (click on the website image here to visit the site). Carl is deceased, but his excellent website loaded with great small layout insights is maintained by devoted followers of his ideas.

Nick also lists a number of books. Nick says, *"If you are interested in building a small layout, there is much help at hand. While there are lots more books that cover the*

CARENOT.COM

SMALL LAYOUT SCRAPBOOK 4 JUN, 2015
PAGE 118: June 2015
And here is another Small Layout Scrapbook update for you to enjoy. How fun reading! High-C Daywell Tractor Factory The layout is built in On30 by Geoff Potter from Wamboral, NSW, Australia. ...

SMALL LAYOUT SCRAPBOOK 9 APR, 2015
PAGE 117 -- April 2015
After almost a year of silence, a new update! The first in a series of new, regular updates. As you might have read, I started a competition last year, to make a micro layout.

SMALL LAYOUT SCRAPBOOK 1 JUL, 2014
PAGE 116 -- July 2014

SMALL LAYOUT SCRAPBOOK 13 AUG, 2013
PAGE 115 -- August 2013

ADVERTISEMENT



CABOOSE HOBBIES
WORLD FAMOUS
MODEL TRAIN STORE
Since 1938!

The World's Largest Model Train Store!

Model trains G to Z, DCC, brass models, kits, RTR, collectable models, scenery, structures, books, magazines, DVD's, hobby tools & supplies and a full service repair department.



WWW.CABOOSEHOBBIES.COM

• INDEX

• TABLE OF CONTENTS

STAFF NOTES | 3

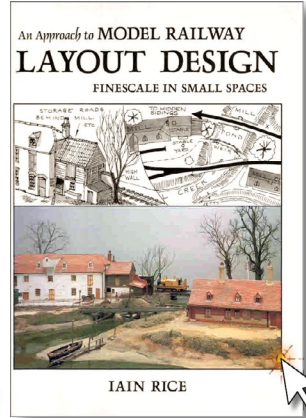
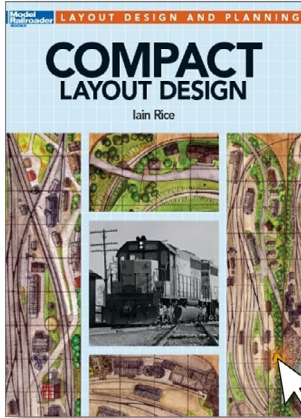
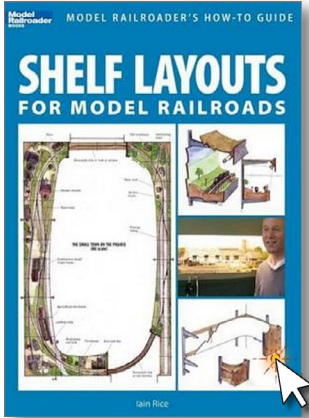

topic of small layouts, interested modelers can pick up these books and be well on their way. Notice that I lean heavily in favor of Iain Rice's approach."

Nick also lists a couple of books that cover the super small layout, known as micro-layouts. A micro-layout is typically less than four square feet, total. However, to qualify as being a micro-layout, it needs to also be operationally engaging. Any old four square foot chunk of track and scenery does not qualify as a micro-layout, it's just a diorama. Adding the *operational component* makes it a layout.

We find micro-layouts to be especially interesting – virtually anyone has four square feet they could devote to building an operational micro-layout. Time to get you out of your armchair!

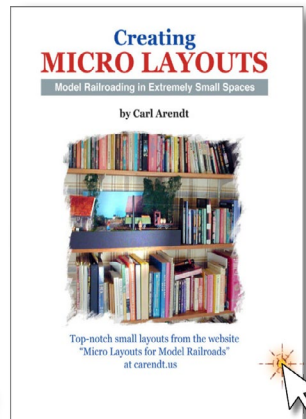
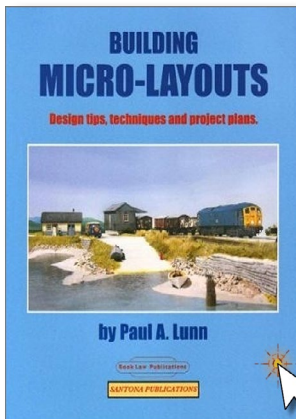

STAFF NOTES | 4

There are also some other great websites on small layouts. Lance Mindheim writes about small layouts a lot on his blog. One of my favorite blog entries from Lance recently is this post:

[How to play with trains \(Lance Mindheim blog\)](#)

Trevor Marshall (TMTV) has assembled a great collection of “achievable layout” designs on The Model Railway Show website:

[Achievable layout designs \(Trevor Marshall\)](#)

Finally, there’s a great small layout / shunting layout website called:

[The Model Railways Shunting Puzzles website](#)

Take a minute to check these resources out. Almost anyone can have a layout using these clever approaches.

**Please include
a phone
number when
emailing MRH
(in case your spam
filters eat our email
response)**

ADVERTISEMENT

NICK & NORA DESIGNS
Uniquely inspired craftsman kits



Craftsman Structure Kits,
Detail Parts, Shingles & More!
www.nickandnoradesigns.com

• INDEX

• TABLE OF CONTENTS



LAST ISSUE'S RATINGS

The five top-rated articles in the [May 2016 issue](#) of *Model Railroad Hobbyist* are:

4.8 Dan's Oil

4.8 Edendale Creek Diorama, part 2

4.7 DCC Impulses: Demystifying DCC CV 29

4.7 What's Neat: LED lighting strips, RC autos, and more

4.6 May derailments

Issue overall: **5.0**

Please rate the articles! Click the reader comments button on each article and select the star rating you think each article deserves. Thanks! ■

ADVERTISEMENT



Your Local **N Scale**
Online Hobby Shop

575-523-9743
fiferhobby.com

• INDEX

• TABLE OF CONTENTS

“Those MRH jerks won’t respond to my email!”

Many email providers now automatically filter out anything that comes from a business that even slightly smells like spam. Many modelers are now incensed with us because we don’t respond to their emails. Believe us, we’re trying!

When contacting MRH via email, if you absolutely require a response from us, ***then please include a phone number*** and possibly a second email address. There’s so much email spam these days that getting an email response from us just isn’t dependable any longer. We get blamed for being unresponsive, but we keep trying and nothing get through!

You just do not know how frustrating it is to get a nasty email from a party we’re trying to respond to when we have no way to get a response to them. Imagine what it would be like if someone left you voice mails, yet when you tried to return the phone call you could never get through. And then, people complain that you are an uncommunicative jerk.

If you add us to your contact list, most email providers will deliver emails from your contacts. To do that, add admin@mrhmag.com to your email contacts. But, a phone number works all the time. Tell us when to call.

MRH website: James McNab’s IAIS Grimes Line

James McNab, an MRH forum regular, has maintained an extensive journal on our website over the years. He’s now five years in on his layout project and he has made tremendous progress. Here are some of his more important blog posts:

Track plan: mrhmag.com/magazine/url/grimesplan

One year anniversary: mrhmag.com/node/8080

STAFF NOTES | 6

Meredith Drive Grade Crossing: mrhmag.com/node/8646

I-35/80 & Hwy 141: mrhmag.com/node/10157

Along the line at Clive: mrhmag.com/node/12058

Don't fence me in: mrhmag.com/node/14423

Car forwarding on the Grimes Line: mrhmag.com/node/17426

My five-year mission: mrhmag.com/node/26570

To see James' entire collection of blog entries, visit this link:

mrhmag.com/blog/jfmcnab

Have a nice June and a great start to the summer! ✓

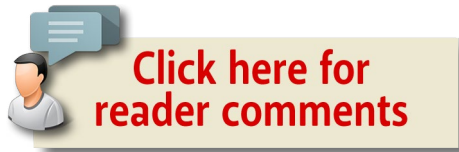

ADVERTISEMENT

HO GP60M, GP60B AND GP60 Locos



Now AVAILABLE !



DC OR DCC WITH SOUND!



www.foxvalleymodels.com

ADVERTISEMENT

George's Trains

EST. 1962

Canada's Greatest Model Train Store

PROTO-PAINT

20 NEW Colours
Just added!



ACRYLIC-Air Brush Ready
NOW OVER 45 Canadian Railway Colours!

Dealer inquiries welcome.

- | | | |
|------------------------------|-----------------------------|-------------------------|
| PP-001 CNR Green #11 | PP-020 TH&B Maroon | PP-038 TTC CREAM |
| PP-002 CNR Imitation Gold | PP-021 Primer | PP-039 TTC Maroon |
| PP-003 CN VIA Blue #16 | PP-022 Reducer | PP-040 Warm BLACK |
| PP004 CN Via Yellow #18 | PP-023 Flat Finish | PP-041 Grimy Black |
| PP-005 VIA Grey | PP-024 Stencil White | PP-042 Anti-Glare Black |
| PP-006 CN Red/Orange #11 | PP-025 Loco Black | PP-043 Slag Brown |
| PP-007 CN Lettering Grey #17 | PP-026 Flat Haze | PP-044 GO Green |
| PP-008 CN Grey #11 | PP-027 CNR LT BLUE | PP-045 GO White |
| PP-009 CNR Red #12 | PP-028 CNR DK BLUE | PP-046 CNRAIL Blue |
| PP-010 CPR Tuscan | PP-029 CNR YELLOW | |
| PP-011 CPR Diesel Grey | PP-030 CNR Post 2000 Yellow | |
| PP-012 CPR Diesel Yellow | PP-031 CNR GREEN | |
| PP-013 CPR Steam Grey | PP-032 BCR/PGE DK GREEN | |
| PP-014 CPR Mineral Brown | PP-033 BCR RED | |
| PP-015 CP Action Red | PP-034 BCR BLUE | |
| PP-016 CP Action Yellow | PP-035 BCR Yellow | |
| PP-017 CP Action Green | PP-036 BCR/PGE LL GREEN | |
| PP-018 CP Bright Red | PP-037 GTW Blue | |
| PP-019 TH&B Cream | | |

\$8.98 each
Canadian



550 Alden Rd. Unit 101 Markham, On, Canada L3R 6A8
Tel: 905-470-6200 Toll Free: 1-877-8TRAINS (887-2467)
www.georgetrains.com

Coming in June to TMTV! from TSG Multimedia ...

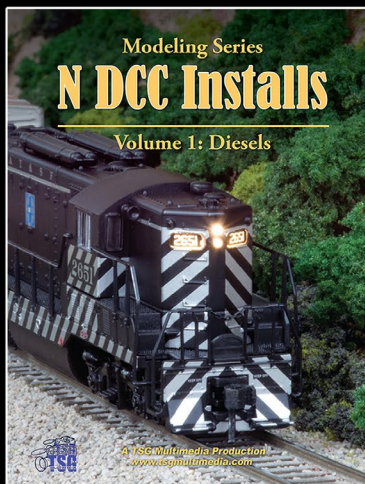

Kato EMD SD79ACE
Atlas EMD SD35
Kato EMD E9A
Micro-Trains EMD SW1500
Intermountain EMD FP7A
Atlas GEB40-8W
Fox Valley Models EMD GP60M
Kato Budd RDC-2
Atlas EMD GP7 (Torpedo)
Atlas EMD GP9 (not DCC-ready)
Minitrix Fairbanks-Morse (FM) H-12-44 (not DCC-ready)
Kato EMD SD40-2
Kato EMD SD45 (not DCC-ready)



Larger scales take NOTE: Loaded with tricks for fitting DCC and lighting into very tiny spaces!

Don't miss out ... become a TMTV member today!

(Click here)





Model Railroad Hobbyist | Jun 2016 | #76

MRH Q-A-T

column

compiled by
JOE BRUGGER
.....



[Click here for
reader comments](#)

QUESTIONS AND ANSWERS

Solvaset and Vallejo paint

Q. I almost had a disaster. I sprayed some Vallejo paint more than 48 hours ago. Tonight I used Microscale's Micro Set first, floated an old Champ decal over some rivet detail, and when I was happy with the placement, plastered it with Walthers Solvaset. I figured old school chemicals for an old school decal. I got a splot of Solvaset over to the side and used a Q-Tip to gently blot it up. The Q-Tip came up with a bunch of the Vallejo paint. People on the internet say they use the Microscale system with Vallejo paint with no difficulty. It seems Solvaset is too strong for Vallejo paint. I'm pretty sure I'm using an old formula Solvaset – I have the same bottle my father used when I was a kid and I'm 50 this year.

—GregW66

A. Tom Patterson: I have been using Vallejo Model Air paint for about two years now and have found the cured paint to be

▶ MRH QUESTIONS, ANSWERS, AND TIPS

• INDEX

• TABLE OF CONTENTS
.....



1. Walther's Solvaset is a fairly aggressive decal setting solution and can be thinned with distilled water.

old 50/50 water/Solvaset trick from the late 1980s. I used it back then with Microscale decals in order to keep from destroying them due to the thin film and the aggressiveness of the decal solvent. I imagine the formula has probably changed from those days, as I haven't had that problem in years.

By the way, the Vallejo paints are just incredible. My friends who are also military modelers have raved about them for years. Wish I had listened to them earlier!

BR GP30 2300 and MRH: Thinning Solvaset 50/50 with distilled water is a safe move when using Solvaset with any thin-film decal. Champ Decal Set was even more aggressive. Anyone willing to test that with Vallejo Air?

somewhat soft, and Solvaset will definitely take it off! I spray everything painted with Model Air with a light coat of Testor's GlossCote prior to applying decals. I then follow with the tried-and-true method of applying Microscale Micro Set followed by Solvaset. So far, this has worked extremely well.

I remember the

MicroScale Micro Sol is good at settling decals into cracks and around details. Even so, repeated applications can soften paint.

Read the thread on MRH forums at mrhmag.com/node/25861.

—MRH

Cork for yards

Q. I'm using Midwest Cork roadbed on ½" plywood on my HO layout mainline, but what should I use in yards and passing sidings? Should I use cork in the yards or mount track to the plywood? What thicknesses should I get if I decide on sheet cork and where's a good place to get it?

—Ian Ring

A. Steve in Iowa City: The Midwest stuff in my opinion is nice and tight and firm. I've also used two different thicknesses of sheet (roll) cork, and have spread it out as a base for a yard. From the start it was dry and crumbly, and if not thoroughly glued/caulked to the base plywood, would rise up if I tried to scenic the area with water-thinned white glue. I ripped up sections and replaced them because of this.

Ron Willson: Hobby Lobby has a weekly 40% off coupon for one item on their web page. If you have a smart phone you can have the coupon on your phone at checkout. The \$14.99 cork roll drops to \$9.00. They have two thicknesses in cork rolls: 3/32" and 5/32". The 3/32" is very fragile, but the 5/32" is much stronger and easier to lay.

Dimstar: Grainger sells 3mm (0.118") cork sheet (2'x3') for \$7.22 and has other sizes/rolls/thicknesses available.

Beachbum: I use thin roll cork. I think it's actually shelf liner. To my eye, the commercial MR cork roadbed is way too thick. Where necessary, I bevel cork sheet at 45 degrees with a matte cutter from Dick Blick.

MRH Q-A-T | 4

“Mountain Goat” Greg: Midwest sold sheets at one time that would be good for yards. Also check out your local art supply stores for large rolls or sheets of cork to use as a base. I would avoid the 100% natural cork and also the more open formed stuff. You want the look to be like the standard roadbed cork.

Russ Bellinis: Check for cork gasket material at auto parts stores. They may have a choice of thicknesses available.

Pat Miller: I am using HO scale cork roadbed on the main, N scale roadbed on the sidings, and cork sheets on the yard tracks. I didn't have trouble locating cork sheets, but the quantity I needed was going to cost a lot and all I could find were 2'x4' sheets.

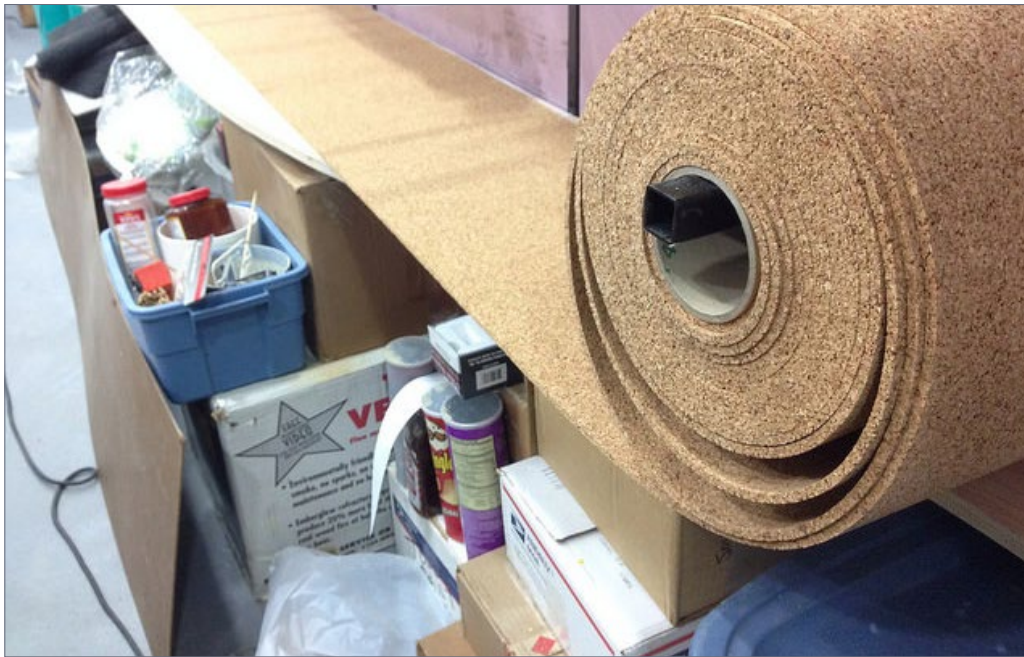

2. Randy Seiler used big rolls of cork cut to his needed width and rolled out. *Randy Seiler photo*

I got lucky and found an 18”x96’ roll on eBay for a good price. Finally, I found 12”x18” craft foam sheets about the same thickness of the cork sheets and less than a dollar per sheet! You should be able to find them at any craft supply store.

Ian Stronach: My 20-year-old main yard and a number of other areas are made with ¼” roll cork glued (100% of area) to ½” plywood using 3M or Lepage water-based (acrylic) contact cement. No toxic fumes. The cork was end rolls from a dumpster at a notice board manufacturing plant and was in perfect shape. Do not use solvent-based contact cement, unless you don’t care about your health. I tested white glue and found it took longer to dry than the contact cement and did not give as strong a bond.

MRH: A Google search for “cork sheet” turns up several suppliers, some like Jo Ann’s and Walmart with retail outlets, and some with online sales. One U.S. seller is corkdirect.com/underlayment.html which lists a variety of products.

Read more about using cork at mrhmag.com/node/26149.

Tell your friends about MRH!

**We depend on word-of-mouth to grow
... if you don't share us, we don't grow**



3. Ian Stronach's yard is built completely on cork, with recessed "wells" cut out for building bases, and drainage ditches cut out with a utility knife. *Ian Stronach photo*



4. Rob Spangler installed cork rolls with contact adhesive intended for laminate countertop material. Here's one area before ballasting. The cork provided a nice, smooth surface for laying track compared to plain plywood. *Rob Spangler photo*

Fiberglass and metal roof hatches

Q. Does anyone have info on what material is used for a particular hatch type on a covered hopper, and how to distinguish such hatch covers from each other? From what I understand there are both Fiberglass and stamped steel covers. It would make an interesting weathering feature. Fiberglass hatches would not rust, but stamped steel ones would. When did car builders start applying Fiberglass hatch covers?

—Mendell

A. Duckdogger: From my experience in the rail industry in the '70s and '80s, it was common for elongated and continuous hatches to be molded Fiberglas. Typically, these would be 4600 cu.ft. cars in grain service, although they could be specified by the customer for any size car in any service as far as that goes.

Round hatches for plastic pellet service for instance, would likely be 20" diameter cast aluminum. General purpose cars often came with 30" diameter stamped steel covers. My experience is with ACF but likely would also apply to Pullman during that same period.

Shane: To distinguish a Fiberglas hatch from steel hatch is typically easy. Fiberglas hatches are usually white or light gray with steel brackets that are typically the color of the hopper. Steel hatches are usually the same color as the hopper. Rust on hatch hardware and no rust on actual hatch will also typically indicate a Fiberglas hatch.

Dave Husman: Metallic-looking hatches may not be steel. A lot of them were originally aluminum. Back in the 1980s, when cars were sent to Mexico they tended to come back missing hatches. So car owners moved towards Fiberglas hatches which had no scrap/recycle value, and the cars tended to come back with hatches on them. So the comment about "steel" ones rusting may not be correct if they are actually aluminum.

Rob Spangler: New cars typically will have the hatches painted to match the car. A replacement hatch only needs to be for the same size of opening as the original. Cars with replacements can have every hatch a different type and color. This is more common with trough hatches than the individual circular or square types, which are less prone to damage that requires replacement. Metal trough hatches bend, and Fiberglass ones crack much more readily than the individual ones.

Find more information about fiberglass and metal roof hatches at mrhmag.com/node/25096.



5. A home-made spout makes it easy to decant contact or rubber cement into a small container from a large can.
Victor Roseman photo

TIPS

Contact cement made neater

I use “DAP-Weldwood contact cement” for many purposes in building models or layouts. This is a solvent cement (use only in ventilated areas and with care) intended to glue large surfaces, such as adding Formica to a tabletop or counter.

With contact cement, both sides are coated and left to dry for five to 15 minutes before the pieces are aligned carefully and then pressed together. A great advantage in this process is that the solvents in the cement are dry when the parts are assembled. Ordinary liquid styrene cements need air to dry and so have their solvents trapped between the parts and may soften styrene for days or even weeks until the solvents finally dry. DAP-Weldwood also remains flexible, and I use it to glue dissimilar materials that may have different coefficients of expansion and contraction as temperature changes.

There are a few problems with contact cements. While a three-ounce bottle with brush in cap is available, the brush is way too big for model work. I place a puddle of cement the size of a penny on a piece of scrap material and then apply this with a toothpick for small pieces. For slightly larger areas, small wooden coffee stirrers work well.

The second problem is that once applied, it is difficult, or even impossible to reposition the item. A very old graphic arts method called the “slip-sheet method” was devised to permit double coating for just this purpose. Let the contact cement dry thoroughly. It usually turns very glossy when dry. Place a sheet of wax paper (available in supermarkets) on one surface to be glued, leaving only a 1/8” or 3/16” strip of glue showing along one edge. Place the covering material on top of the wax paper and align it, holding the edge slightly above the uncovered glue strip. Once the piece is aligned correctly, just touch it down along the glued strip and pull out the wax paper gradually, pressing the top material down as you go.

Small bottles and tubes of contact cement are not easy to find, and cost far more per ounce than a pint can does. I keep one or two small bottles and refill them from a larger can. This has to be one of the messiest things to do in model railroading. The cement gets everywhere you do not really want this stuff.

To pour cement, or paint, from a metal can, carefully remove the lid by working a screwdriver around the edge a little at a time, prying slightly upwards as you go. When the lid comes off, form a sheet of aluminum foil

into a spout. Form this around the inside edge of the opening so cement or paint will not touch the actual opening or get into the trough around the top of the can.

Done correctly, all the contents will move slowly down the center of the spout (put a slight crease at the center) and eliminate the need for a funnel. Work over some old newspaper, for once this cement gets on a surface it is extremely difficult to remove. Lacquer thinner is one of the few solvents that will remove the cement from skin or worktables. Wear solvent-proof disposable gloves or kitchen rubber gloves.

I hope these tips will make using contact cement easier and neater for readers.

—Victor Roseman

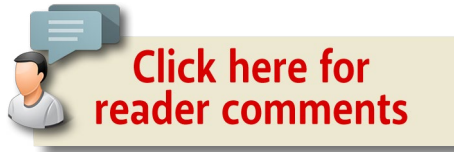

.....
 **GET PAID FOR YOUR TIP**
We pay \$25 per tip we publish, or \$40 each if the tip also includes a photo or finished drawing. [Click here and select article type TIP.](#) ■
.....

From first train set to railroad empire...

*Our complete line of DCC products
grows with you. Discover the fun!*

- Designed and manufactured in the U.S.A.
- Preferred for ease of use and ergonomic design
- Unlimited scalability for any size model railroad
- Plug-and-play means more time running trains
- Great customer service and excellent support



See your dealer



Visit our new and improved web site for all your DCC needs!

- Get the latest new product announcements
- Watch our detailed how-to videos
- Browse the all-new Information Station
- Enjoy secure online sales, day or night!

Visit **ncedcc.com**



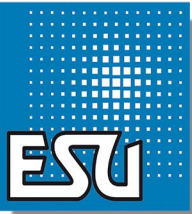

Tired of tearing apart valuable locomotives every time a new decoder is released?

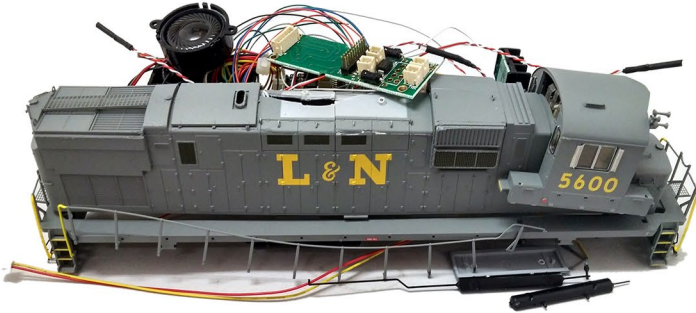

ESU decoders are re-programmable!

ESU LLC

23 Howard Street, Montoursville Pennsylvania 17754

Phone +1 570-980-1980, Fax +1 866-591-6440

(Office hours: Monday through Friday, 8AM to 4PM (EST))

WWW.LOKSOUND.COM

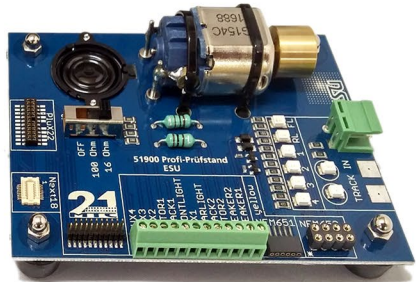

(June 1st - August 31st)

#53452 LokProgrammer - **SUMMER SALE** \$150 list!

#51900 - Decoder Tester - \$57.90 list

BUY IT ONCE & UPDATE IT FOR LIFE!



DCC IMPULSES

column

BRUCE PETRARCA MMR



[Click here for reader comments](#)

GETTING POWER TO MY DCC SYSTEM

THIS IS GOING TO BE A SHORT COLUMN, AS I have a feature article elsewhere in this issue. The reason for the other article is that, at the end of March, I completed the last items to qualify for the NMRA's Master Model Railroader recognition (#574).

This month we will talk about getting power to your DCC system. It can be as easy as plugging the power supply that comes with your system into the wall socket and running trains. DCC allows systems to become bigger and more complex. Added stuff can make for more stuff.

Power supplies

In my May 2012 column, "Anatomy of a DCC System" (mrhmag.com/mrh-2012-05-may/dcc_impulses), I discussed power supplies and transformers to get the power into your DCC system. Since then, transformer use has seriously diminished. I can see several reasons for this:

► DCC TIPS, TRICKS, AND TECHNIQUES

DCC IMPULSES | 2

- Power supplies [1] can operate on any power line anywhere
- Power supplies [1] are lighter to ship than transformers
- Power supplies [1], unlike transformers, keep current surges away from the power lines

However, the focus of this column is supplying AC power to the transformer or power supply. I recommend a read of the column referenced above if you are trying to size a power supply or transformer for your system.

A.C. power main needs

Lots of times I hear folks talking about a separate A.C. circuit for their DCC needs. For the most part that is not necessary. Lots of lights are more likely to need special A.C. runs than your DCC system.

Robust wiring on the track bus is necessary to have the booster (or circuit breaker) to trip in the event of a short on the rails. This may involve wiring as big as 12 AWG for reliable shutdown operation.

Wiring this robust is not needed on the A.C. side. Let's do the math in a simple manner. If everything is 100% efficient and the DCC track voltage is 12 volts and the A.C. supply voltage is 120



1. The NCE SB5 as it is being sold in Australia by DCC Concepts. The power supply (box on the right) is the same worldwide, just the cord changes.

DCC IMPULSES | 3

volts, the current required from the A.C. side will be 10% of the DCC current (100% x 12 / 120).

In real world numbers, it is somewhere between 10% and 15%. If your 5-amp DCC set is supplying full power to the track, it will need about ½ to ¾ amp of A.C. power at 120 volts. In most of the world where the power mains are a nominal 240 volts, the current is half again or ¼ to ¾ amp. This is similar to the power draw of a 60-watt bulb.

Folks think nothing of a floor lamp with three 60-watt bulbs in it. They turn one or two or all three on with impunity. They may even have two or three of these lamps on the same circuit. When each bulb comes on, that is roughly the same load on the power line as a DCC set going from zero output to full trip current.

ADVERTISEMENT

Make LocoNet wiring extremely simple!

ACCU-LITES, inc

Your DCC Center!

Dealer Inquiries Accepted

CELEBRATING
20
YEARS
ANNIVERSARY

PM42
breakout
board

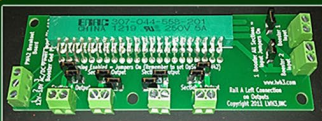

SE8C
breakout
board



BDL168
Multi-zone
breakout board

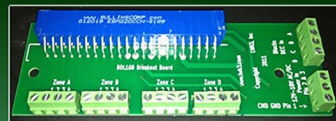

BDL168
Single-zone
breakout board



Now Offering SNAPS! in packs of 6 or 12 pieces! [CLICK TO LEARN MORE ...](#)

• INDEX

• TABLE OF CONTENTS

DCC IMPULSES | 4

Even the brute of DCC systems, the NCE Powerhouse system, rated at 10 amps, will draw less than 2 amps from the 120 volt A.C. line at full power and maximum voltage.

Surge protection

DCC command stations are basically computers. The decoders are computers, too. Sensitive electronics need to be protected from surges on the power lines. While lightning is the most frequent cause, power surges can occur for many reasons.

The minimum protection, in my opinion, is a good quality surge protector strip plugged into a grounded outlet. If the outlet is not grounded the surge protection is diminished.

A better solution is to use an Uninterruptible Power Supply (UPS) as designed for home computers. Here's my story about that:

ADVERTISEMENT



SOUNDTRAXX[®]

Fun Features for a Fraction of the Cost!

As the most versatile, feature-packed sound decoder, Econami redefines *value*. Starting at \$79.95 and available now!



Hear how you can get more for less!

• INDEX

• TABLE OF CONTENTS

TONY'S TRAIN XCHANGE

Committed to your DCC support!

Tony's Is Your Locomotive Price Leader!

Genesis SP MT-4



NOW IN STOCK!

Atheam Genesis
Southern Pacific MT-4 4-8-2 w Skyline
Casing in Daylight Colors or Black Tender

Many more steam locomotives available from
Atheam Genesis, Bachmann, Broadway Limited
Imports, MTH, Rapido, Rivarossi & More!

Starting at \$229.95

Order Yours

Atheam Genesis

**IN STOCK
SALE!**



Genesis level detail and
performance at an unbeatable price!
All In Stock Diesel Inventory ON SALE!

Includes B&M EMD GP7's, NH, PRR & UP GP9's,
BNSF & CSX & NS SD70ACe's, & UP GE ES44AC's
(Search our site by Atheam stock numbers)

Starting at \$134.95

Order Yours

New SoundTraxx Tsunami2

Expected June 2016

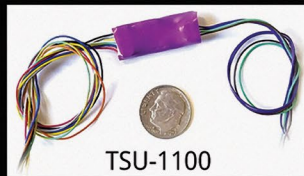

TSU-1100

Universal style 1 amp, 4 function sound
decoder, 13 Bells, 40+ Horns/Whistles

Available Sound Files:

EMD, GE, ALCo, Baldwin, Steam & More

\$103.95

View Stock

**Do you need a Sound or
DCC Installation done?**

Get a quote!



Providing unmatched person to person
DCC support for more than 25 years, the
kind of service that has made us #1 in DCC.

DCC questions? CALL US! 1-800-978-3472

We'll get you on the right track!

Mar 2016



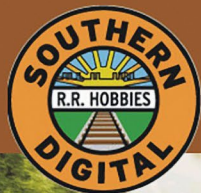

Southern Digital



**20% Discount
on most items!**

Specializing in DCC Since 1992



DCC Conversions, Service & Support

Orders Received by 3:00 pm EST ship the same day

WWW.SODIGI.COM

E-mail: sales@sodigi.com

(770) 929-1888

(Photo's are from our N-Scale layout)



2. DCC power switch and indicator light on the fascia at PebbleCreek Model Railroad Club.

Early on in the history of Litchfield Station, we had a summer place in the mountains near Flagstaff, AZ. That locale gets a lot of thundershower activity in the summer. I was using a Digitrax DCS100 system on my workbench. I had the Digitrax system and my computer (and a shop light) plugged into the computer's UPS. One evening, I was programming a loco for a customer. There was a huge lightning strike – the kind where you hear it before you see it. The house went dark except for the light in the workshop that was plugged into the UPS. It turns out that the strike hit the transformer on the pole outside our house, about 75 feet from where I was sitting. The transformer was so damaged that it failed about 12 hours later and the power company had to replace it.

None of the DCC or computer equipment was damaged. The decoder that I was programming during the strike was not even

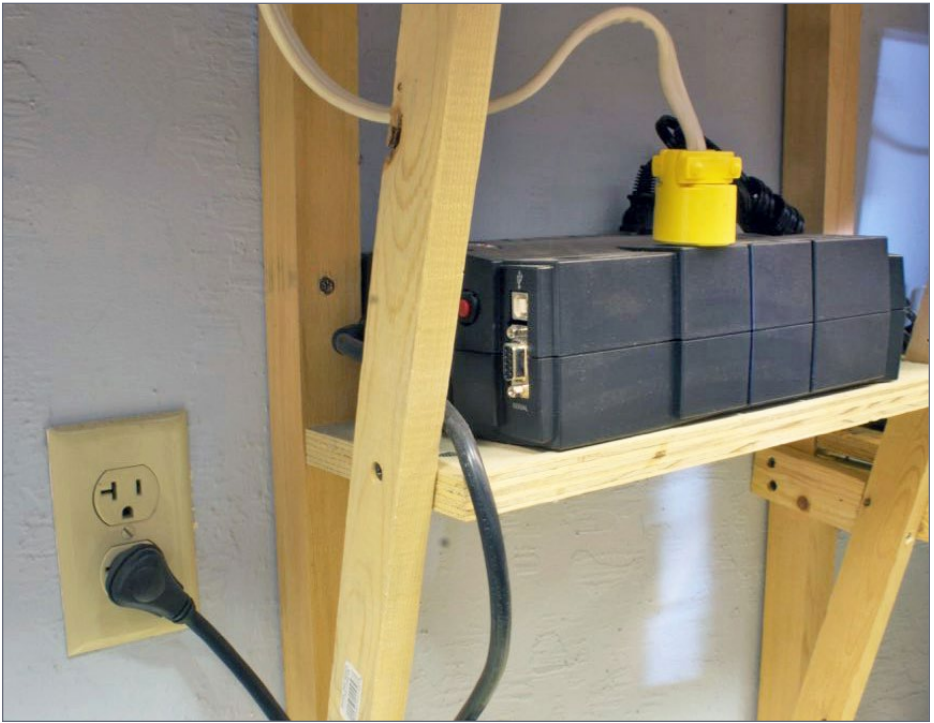

3. UPS on the PCMRC layout. Plugged into the wall and feeding the layout switch [2] through the Romex and (yellow) plug.

corrupted. I compared the decoder as programmed to what I was expecting and it was exactly the same.

Since then, I use a UPS on all DCC setups and recommend the same to everyone. Be sure to use the connections labeled something like “battery plus surge protection.”

“One switch” for everything DCC

It is nice to shut down your entire DCC system with one switch. That can be as simple as the power switch on the UPS. Or a power strip. It needs to be convenient but not too accessible. Don't want to shut things down unintentionally.

Great control in a tiny package



**Original
Touch Toggles**

- Touch Toggle™ plug in controls
- Bright clear indication
- Easy setup
- Flexible system

Stall Motors, Twin-coils,
Power, and Servos

Now for Tam Valley Depot
and MRservo too!



Made in the USA 

What will they think of next?

www.berretthillshop.com

ADVERTISEMENT

ADVERTISEMENT

IOWA SCALED ENGINEERING

Enhance Prototype Realism
Electronics for "Your" Model Railroad

- Switch Machines
- Time Lock Controllers
- Fast Clocks
- Sound Players
- Infrared Detectors
- Block Detectors
- And more!



open source
hardware

LEARN MORE >

TamValleyDepot.com

Great Electronics for Great Model Railroads

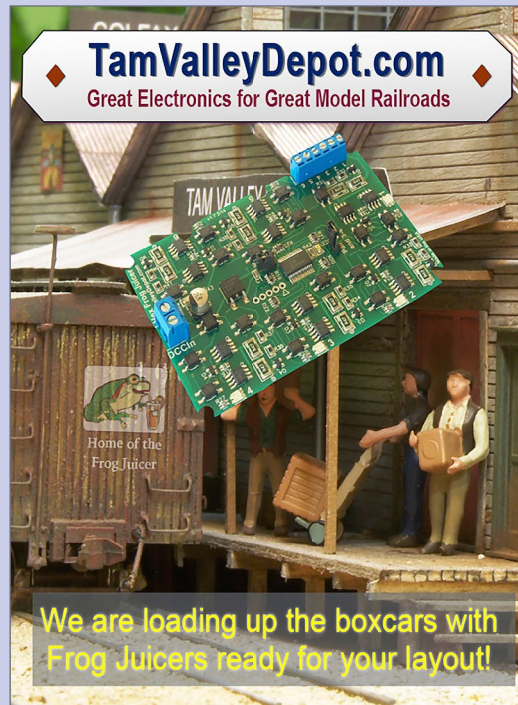

We are loading up the boxcars with
Frog Juicers ready for your layout!

• INDEX

• TABLE OF CONTENTS

Get Better Sound from your Locomotives

Can't get a good sound from your sound decoder?
Give our speakers a test drive with your ears.



RAILMASTER HOBBIES
9812 BELMONT
BELLFLOWER, CA 90706

Bass Reflex
Speakers



High Bass
Speakers



When it comes to speakers we have high quality speakers to fit many different applications.

We are also a full line hobby shop. Need anything? We are an authorized dealer for Soundtraxx, Digitrax, Athearn, Walthers and many others. We provide quality speakers for your DCC sound systems and quality service.

**Click here for
the answer ...**

DCC IMPULSES | 7

At the PebbleCreek Club (pcmrc.org), we have used a UPS for a decade now. But we want to be able to power up several boosters around the layout with one switch. So, we added a switch and an indicator [2] on the fascia.

Throughout the layout there are outlet boxes wired back to this switch. The wiring uses Romex and meets local wiring codes for a 15-amp circuit. These boxes are the only 120 volt outlets attached to the benchwork. The rule is that you don't plug into the benchwork sockets with anything but DCC stuff. If I were to do it again, I'd use different colored plugs and plates (like the red used for medical), making it easier for folks to not forget. Alternatively, you can paint the sockets and the plates any color you choose, say, purple.

ADVERTISEMENT



NEW TECHNOLOGY



Click Here to Learn More

For more information visit our Internet site: www.RingEngineering.com



RE RING ENGINEERING RailPro Power ON Main Page
Handheld Controller Model # HC-2

Control Locomotive (CO) [Battery Icon]

17.6% [Link Icon] Forward [Triangle Icon]

UP 5714 [Info Icon]

Frnt Light Dim Dilch Pop Off Next Page 1
Horn Bell Engine Back Light Exit Page



NEW Starter Kit \$399.99 MSRP

- Includes Wireless Color Touch Screen Handheld Controller and 56 Watt Power Supply
- Expandable to Virtually any Size Layout

NEW Locomotive Module LM-2 & LM-2S



- Direct Radio RF
- Sound and Non-Sound
- New Tiny Size
- 6 Light Outputs

DCC IMPULSES | 8

The input to the switch [2] comes from a UPS (uninterruptible power supply) sitting on a shelf [3]. The Romex and plug are sized to allow them to be plugged into the wall socket in the event of a UPS failure.

I like this method better than the switched circuit around the room wired into the walls, as it allows distribution of surge-protected power on the layout.

So, here are this month's ideas:

- Rarely is a special A.C. circuit needed for the DCC system. Most circuits in the USA are rated 15 or 20 amps. Even a 15-amp circuit would power 20 or more 5 amp DCC systems simultaneously, as long as nothing else is connected.
- Use an UPS or, at the very minimum, a surge protector on the A.C. line coming to all DCC systems.
- Check building codes if you are going to run A.C. circuits through your layout.

Folks always seem to have additional ideas to share. Just click on the Reader Feedback icon at the beginning or the end of the column. While you are there, I encourage you to rate the column. "Awesome" is always appreciated. Thanks.

Until next month, I wish you green boards in all your endeavors. ☑



[Click here for
reader comments](#)

END OF TRAIN DEVICE

NEW ORANGE CASE!



Bright Red Flashing Light!

Installs in minutes!
No freight car modification required!

RE RING™
ENGINEERING

Click Here to Learn More

Patented Technology - US Patent 7,549,609

Does not affect Load!

↓ Car without Load ↓



↓ Car with Load ↓



ADVERTISEMENT

WAY TO GO, TRAINTEK!

Already great prices and NOW ...

FREE SHIPPING ON ORDERS OF \$79 or more*



Start saving now



*some exclusions apply

ADVERTISEMENT

LC2xx series DCC decoder for HO scale



*High Performance
High Compatibility
Multi-lighting function output*



- Conforms with NMRA specifications and is certified by the NMRA DCC
- DCC standard decoder is suitable size for HO scale locomotives
- Offers 4 to 6 100mA function outputs with short circuit protect
- Includes Back-EMF with client motor control
- Operates on a 28 step adjustable speed table
- Supports long address and bit mode program



ZEPHYR xtra™

\$255 MSRP



All-In-One Throttle / Command Station /
Booster to run your layout!

Super EMPIRE BUILDER xtra™

\$355 MSRP



Super Empire Builder Xtra has everything you
need to get started in Advanced Digitrax
Command Control.



Complete Train Control

Digitrax Starter Sets for great operation!

View more at: www.digitrax.com

*Super Chief xtra*TM
\$455 MSRP



Maximum capacity, maximum features.
Take it to the Max with Super Chief Xtra!



STATION

Litchfield

**Making
DCC FUN
for 15 Years!**

**Everything Digital
Command Control
Decoders,
Command Systems
Layouts,
Accessories
& More!**

**We carry
12 volt LEDs!**

623-298-7355

www.LitchfieldStation.com



Model Railroad Hobbyist | June 2016 | #76

WHAT'S NEAT WITH KEN PATTERSON

KEN PATTERSON

column



[Click here for
reader comments](#)

IPHONE PHOTOS AND A MAGNETIC LIFT-OUT ...

THIS MONTH WE COVER FIVE SEGMENTS, WITH lots of runbys in between. For tool tips, we talk about the Touch-N-Flow glue applicator. John Tyson stops by with a scratchbuilt model of UD interlocking tower in Joliet, IL. We have two photo segments this month, one on the DSLR vs. iPhone 6 for shooting model photos, and one on a special train set shot for Horizon Hobby.

I also build a lift-out section for my layout with no wires, rail joiners, or hinges using simple magnets to hold it in place. Add to that some of the most elaborate runby scenes to date and we have a great video and written column this month.

▶ [PHOTOS AND VIDEO OF SUPERB MODELS](#)

• [INDEX](#)

• [TABLE OF CONTENTS](#)

WHAT'S NEAT | 2

Tool tips, Touch-N-Flow

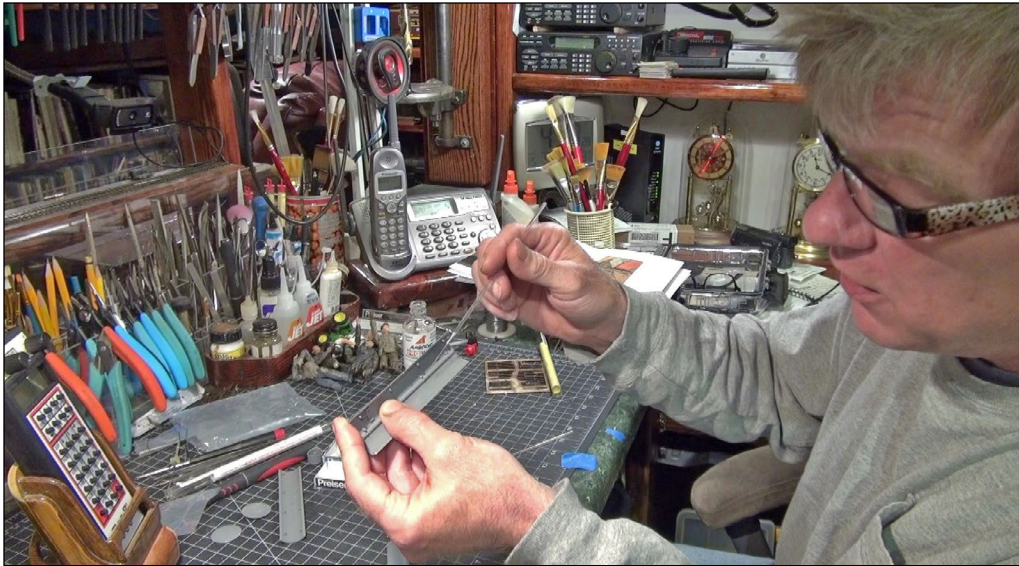
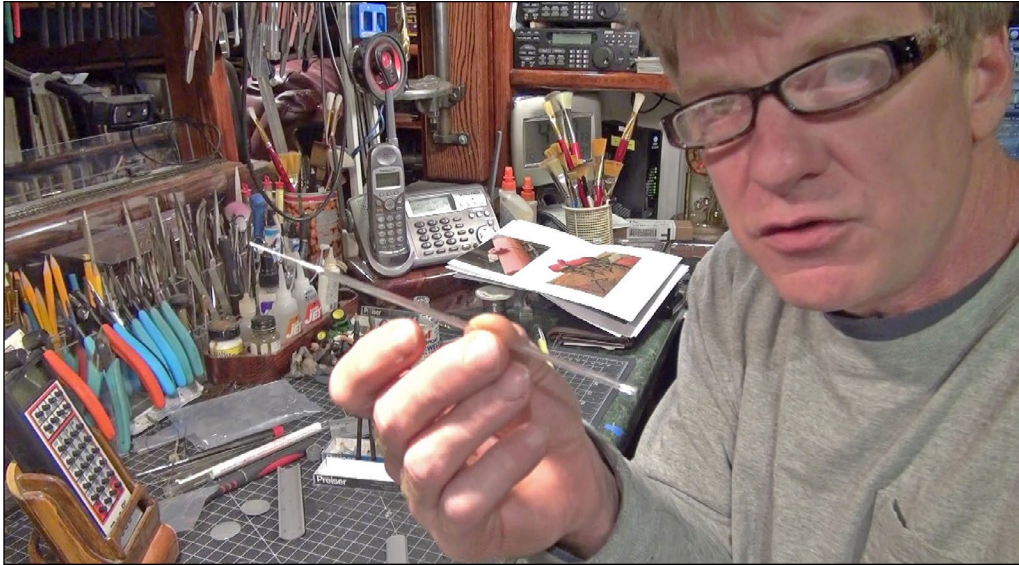

WHAT'S NEAT | 3

1-2. (Left) Let's start with the Touch-N-Flow glue applicator. There is no tool better suited for building clean models with no glue marks. The glass applicator is used with polystyrene cement like Pro Weld. This type of glue melts the plastic into a solid weld. The very thin glue flows through the needle and into the air gap between the parts. This capillary action glues the parts clean with no overflow to mar the plastic surface. It's great for gluing acetate to plastic window frames when building structures. If you have never tried this tool, I encourage you to check it out. It changed how my finished models look.



Playback problems? [Click here ...](#)

WHAT'S NEAT | 4

UD interlocking tower by John Tyson



3. John Tyson came by with a model of UD Tower located in Joliet IL. John is a perfectionist like no other modeler I have met. Well, John Hitzeman at American Model Builders ranks on that list. Not many do. John Tyson scratchbuilt this interlocking tower with a full interior including all 224 levers. The building was milled with a milling machine to achieve the crisp clean lines. The brick mortar color was painted first, then the brick stone color. Then John scribed each mortar joint for the mortar color to be exposed.

4-6. (Right) The windows are etched from brass, as are the exterior stairs. Study the photos to see the amazing detail in this structure. The prototype built by the Rock Island Railroad had 224 pistol grip levers to control the plant, but these jobs are now handled by microchips. Plans started in 2009 to turn the tower into a museum as part of a Joliet regional multi-modal transportation center. The governor at the time announced \$38 million in state funding for the development but that never came through. Because of financial problems on the state level the project has not advanced much. The tower was closed in April of 2015. John's model captures the prototype in every detail.

WHAT'S NEAT | 5



WHAT'S NEAT | 6

Horizon Hobby train set photo cover



7. I want to tell a story about a photo shoot project for a client the other week. I have a standard “train set” diorama, which you see in this photo, that can be changed into any type of scenery from desert to green country by simply sliding the hills around and replacing the vegetation. Most train sets come with E-Z track and that is what makes this the train set photo shoot platform.

**Want to help keep
MRH free?
Then *click* on ads!**

WHAT'S NEAT | 7



8-9. Here are two example shots of standard train sets, with different scenery on the same diorama. It was designed to be shot in this left to right set up.

Chris Palomarez from Athearn said that the Horizon art department needed a quick train set cover photo for a slot car/train set brochure. He suggested that I shoot the photo from right to left and email the shot of a Grand Trunk 1976 paint scheme.



10. Wanting to impress the folks in the Horizon Hobby art department with a dynamite shot, I felt handicapped by the request to use the train set diorama shot backwards. I shot the photo anyhow and this is the resulting photograph. It is not going to win any contest.



[Click here for reader comments](#)

*Learn to solder track, wiring and
brass models in this video!*

**CHECK IT
OUT!**



kenpatterson.com

click here to ...

Visit Ken's website

**Ken Patterson shows
you how to solder like
an expert!**

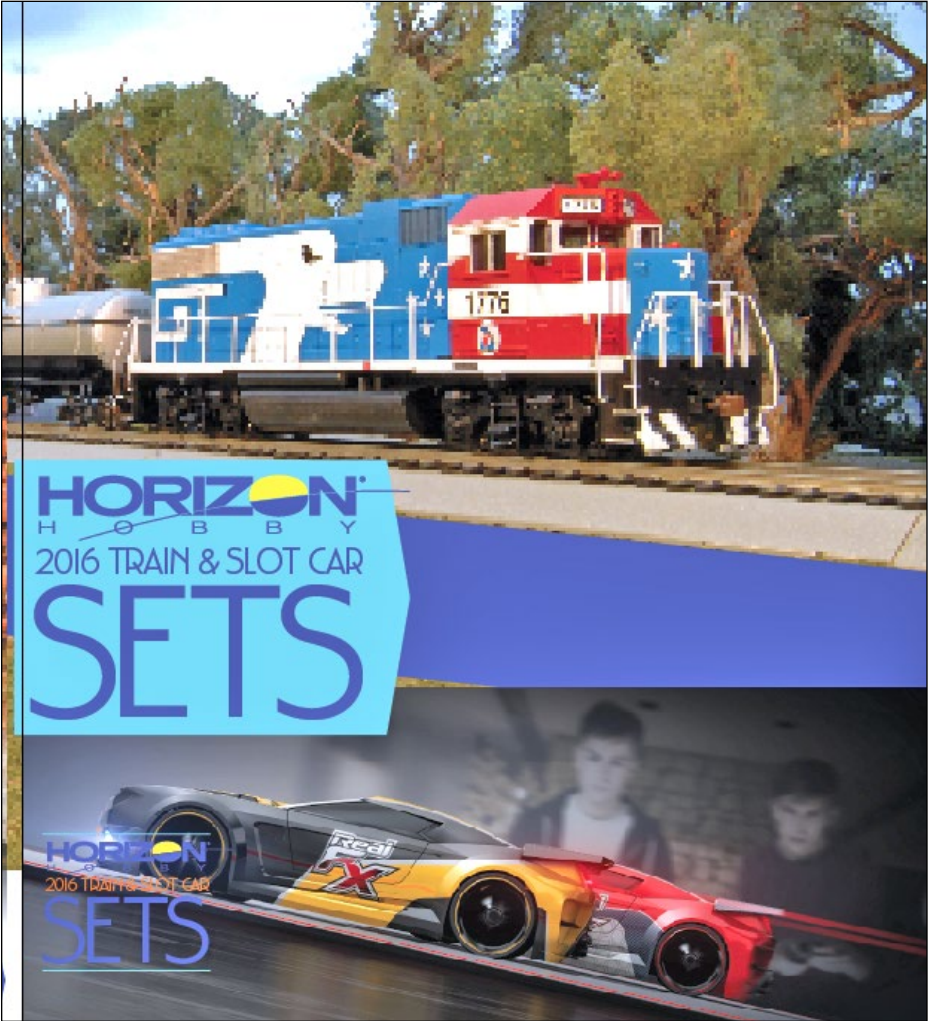

11. In an attempt to save the shot, I talked with the folks in the art department to find out how the photo was to be placed in the presentation. This is the mockup of that proposed cover shot. Now that I realized how the photo was to be used, I imagined a work of art in that space to influence the slot car guys into our train world. A yard shot, a city shot, maybe a river shot, anything but the train set diorama that looked so bland.



12. After thinking about the set-up for a few hours, I ended trying a river module from my home layout. With added trees and figures I created this simple but very nice shot that tells a story, with the father, the boy, and his dog watching the GT train set cross the bridge.

117,000 have seen this MRH video - *have you?*

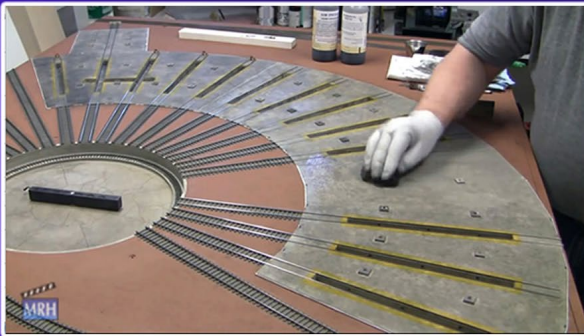

**Watch the
video now**



WHAT'S NEAT | 11

iPhone vs. DSLR camera for model photos



13. People often ask if a cell phone can make good model railroad photos. This month we look at the same photo set-up shot with a cell phone, an iPhone 6 with an 8 MP camera, and my Nikon D2xs, a 12 MP digital camera. Note the tripod in this photo with the iPhone tripod mount. I picked this up from bhphotovideo.com on line. This handy clamp holds the phone tight for still photos and time-lapse videos, and can be adjusted to any position.



**Click here for
reader comments**

WHAT'S NEAT | 12



14. This photo was made with the iPhone in fully automatic mode. Its resolution is soft closest to the lens but overall it's a good photograph worthy of publication in the model press.



15. This is the same scene shot with my Nikon D2. I used a 35mm lens stopped down to f/22 with a $\frac{1}{4}$ second exposure. It too is a great photograph. I will let you decide which photograph looks the best, but you can watch the whole process in real time in this month's video.

WHAT'S NEAT | 13

Lift-out section



16. This month I build a lift-out section. I use magnets to join the Blackstone II layout to my home layout with no wires, rail joiners, or hinges. This is a simple and easy to use functional lift-out on a curve. It needs to work right every time. After some thought, I cut a piece of $\frac{3}{4}$ inch plywood to a 4-inch wide piece, with a 24-inch radius curve centered on it. The width 2 inches of wood on either side of the center catch any rollover freight cars from hitting the floor.



[Click here for
reader comments](#)

WHAT'S NEAT | 14



17. The plan was to use these high-strength magnets to hold the lift-out into place.



18. I drilled holes through the lift-out ends and the plywood that was cut to match the ends and would act as a base in the foam. These holes ensured that the magnets would match up.

WHAT'S NEAT | 15

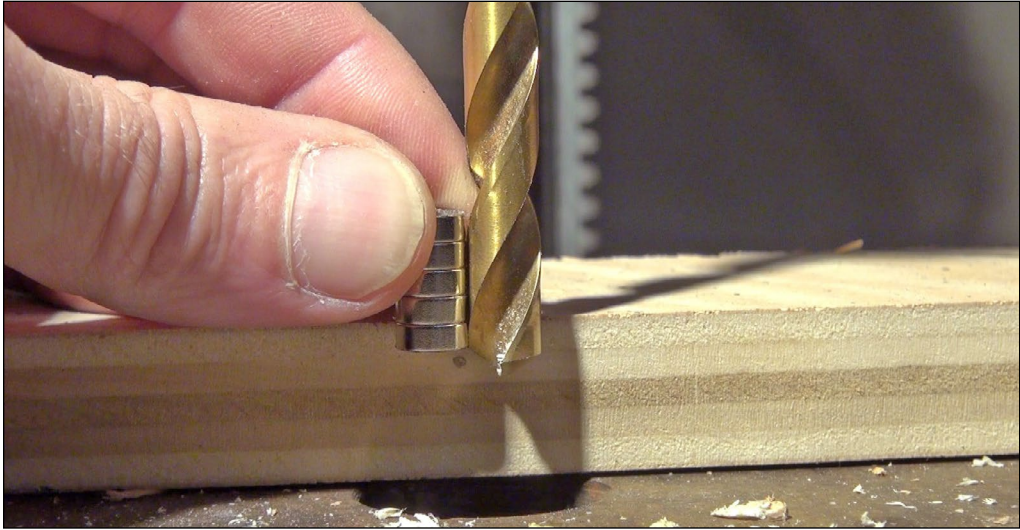

19. I set the depth of the feed on the drill press to match the magnets and drilled 16 identical holes in the plywood to accept the magnets.



20. Gorilla Glue holds the plywood base into the foam on both ends of the lift-out section. After a test fitting came the final carving of the form for a perfect fit.

WHAT'S NEAT | 16



21. After staining the wood and applying polyurethane, I mixed 5-minute epoxy and placed this in the holes where the magnets would be glued flush in the wood.



22. I also placed matching magnets in the base sections one magnet at a time, being careful to get the polarity right to avoid a levitating lift-out.

WHAT'S NEAT | 17



23. After letting the epoxy set for an hour, I tested the fit and the magnets' holding power. Everything worked. I added a fifth set of magnets to both ends for insurance because the curved piece weighed heavier on the outside of the radius. Operation was super strong, smooth, and functional. So far so good.



24. To build up the approach to make a smooth transition from the Blackstone II layout to the lift-out plywood, I built a dam from styrene and filled this area with a layer of Gorilla Glue, thinking this would expand into road bed. It did! Another new idea! I cut it smooth with a saw, making a solid base for laying track.

WHAT'S NEAT | 18



25. I glued Code 70 Micro Engineering track to the foam with Liquid Nails. I attached the track to the plywood lift-out with clear silicone caulk, using a painter's knife to spread the glues. The fact that Micro Engineering flex holds its shape after being curved made it easy to match the ends to where it would join my main lines on both layout approaches.



26. I cut the track on each end with a Dremel cut-off wheel. I left an overhang of 1/16 of an inch to ensure a clean lift-up.

WHAT'S NEAT | 19



27. A piece of 1/32 x 1/4-inch brass stock cut one inch long forms the power contacts to feed current to the rails in the lift-out section. These contacts were placed in a carved-out space to fit almost flush. I soldered wires to the contacts, then fed the wires through the plywood to the rails.

The Get the Latest Model Railroading News, Tips, Reviews & Opinions
SCOTTY MASON
S H O W
The Original Model Railroad Podcast

-Monthly Interviews

- Modeler's Spotlight: Top Modeler's Talk
- Narrow Gauge Modeling w/Chris Lane
- Contemporary Modeling w/ Mike Rose

-More Product Announcements & Reviews

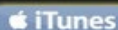

Our feed has changed! To get the latest shows,
Please search Scotty Mason and subscribe to the new feed!

www.TheModelRailroadPodcast.com

Scott Mason Jimmy Simmons Mike Rose Joe Duckworth

• INDEX

• TABLE OF CONTENTS

WHAT'S NEAT | 20



28. I also placed contacts in the base plywood in the end that adjoins my around-the-room home layout. These contacts were soldered to wires that pick up current from the rails.



29. After testing the contacts for power conductivity I ballasted the track and finished the scenery for the approach areas to the lift-out section. I then test ran the first train across it.

WHAT'S NEAT | 21



30. As soon as the last passenger car cleared, I lifted out the section and walked on through. Easy and fast with no problems. I would call this a successful build that works perfectly in every way. Watch the entire process in this month's video, with 42 how-to steps.

This month we have some of the best runbys filmed so far in HO scale. There are surprises in the runbys: see if you catch them.

Be sure to tell a friend about “What’s Neat” and leave your comments and vote in the Readers’ Comments section.

Next month we will look at the new Soundtraxx Tsunami 2 decoders. I started filming video back in April on this exciting new generation of decoders from Soundtraxx. We will show the installation process and will bring you all the information in depth as no one else can.

I have already experienced the learning curve and will help you understand the superb features these ground-breaking decoders offer in both diesel and steam. It’s a scoop that you only see on the “What’s Neat” show, the first to bring you the information you want about new products.



[Click here for reader comments](#)

THE UK'S FASTEST TILTING TRAIN!



THE CLASS 390 'PENDOLINO' IN N SCALE
5-car, 9-car & 11-car options
DC/DCC/Sound or DC/Silent
DEADLINE EXTENDED TO JULY 15th
rapidotrains.com/pendolino/

WEATHER

like a pro.

(No airbrush required!)

Go from this ...

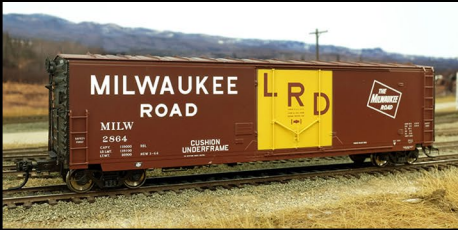

To this ...



Volume 1:
Freight cars

Volume 2:
Diesel locomotives

Click me to
LEARN MORE ...

“Simple, effective, and a lot quicker than an airbrush ...” - *Koos F.*

DVD or Digital download - From the MRH Store: store.mrhmag.com

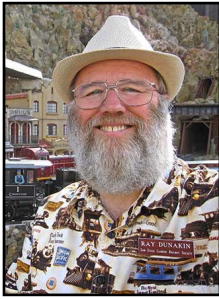

IMAGINEERING

column

RAY DUNAKIN
.....



[Click here for
reader comments](#)

BUILDINGS ON THE IN-KO-PAH RAILROAD. DESIGN REALISTIC STRUCTURES FOR A FICTIONAL RAILROAD...

BUILDINGS ARE AN ESSENTIAL PART OF RAILROADING. Besides the engine house, machine shops, depots, shanties, and sheds directly associated with the railroad, there are also the buildings of the industries served by the railroads. Then there are the cities and towns, shops and homes, barns and cabins, and all the other structures that make up the trackside environment.

On a model railroad, buildings give our railroads purpose, and a sense of place. They help us tell the story of the railroad, and bring our layouts to life. Together with the scenery, buildings transform a “model train” into a miniature world, transporting the viewer to another time and place.

▶ EXPLORING THE CREATIVE SIDES OF THE HOBBY

Creating realistic, scratchbuilt structures also happens to be one of the things I love most about this hobby. There is great personal satisfaction in building scale structures that look authentic, fit the scene, and fool the eye. The sight of a well-weathered, rustic or historic building warms my heart, and building models of such buildings is one way to capture that feeling and relive it at any time, just by looking at my layout.

In this month's column I'd like to share my thoughts on the process of creating structures for a fictional railroad, and then I'll discuss some of the buildings I've created.

Backstory

In my first column I talked about creating a fictional history, or “backstory” for my layout. This applies to buildings too, unless you are modeling a newly built structure. The fictional history of the building – what it was originally built for and how it changed over the years – is helpful for designing structures that show age in a logical and interesting way. The older the building, the more it will have changed, even if it's just the degree of weathering.

Know your prototype

This may seem like odd advice for anyone building a freelanced railroad rather than following a specific prototype. But the fact is, creating a believable model environment requires knowledge of the real world environment. You have to know what is appropriate for the period and locale. It doesn't matter that your railroad never really existed. Whatever you're modeling, whether it's a Louisiana sugar train, a logging railroad in the Pacific Northwest, a Maine two-footer, or a Midwestern short line, if you don't know your subject you can't model it accurately.

This is true not just for the trains and scenery, but also for the buildings. Although there is often some overlap, architectural

styles, construction methods, and building materials tend to differ from one region to another. Even places that are only a few miles apart may have different types of buildings depending on the local climate and availability of materials. Each type of material weathers differently, and different climates affect the way buildings age and weather.

The period you are modeling is also a factor. Is your railroad set in the 1880s? The 1930s? Post-war? Contemporary? The styles, varieties, and ages of your buildings must reflect that choice. Another factor is the age of the area you're modeling. A Nevada mining town that was first settled in the early 20th century will be younger, with different building styles and much less weathering, than a Colorado mining town that was built in the 1860s.

ADVERTISEMENT



Rusty Stumps

Scale Models

WE ONLY SELL WHAT WE MANUFACTURE

DETAILS IN HO, O, S & N SCALES

LASER CUT SHINGLES, DOORS & WINDOWS, FENCES, SIDING, CRATES. Also RESIN and WHITE METAL DETAILING CASTINGS.

CRAFTSMAN KITS IN HO, O & S SCALES

CHECK IT ALL OUT AT

WWW.RUSTYSTUMPS.COM

Send \$3.50 for Catalog - Specify Scale

RUSTY STUMPS SCALE MODELS

6785 Cherry Blossom W. Dr., Fishers IN 46038

Phone (317) 595-9489

Now, I'm not saying you have to become a rivet-counting fanatic. It isn't necessary to know everything about your subject down to the last nail. You just need to know enough to faithfully capture the essence of the structure. On the other hand, the more you know, the easier this will be, and you'll be better equipped to decide which details can be fudged and which are vital. As I like to say, you have to know the rules before you can bend them. This is true even if your layout is meant to be a caricature, with features purposely exaggerated for effect.

Unless you live in the area your models are based on, you'll have to do some research. If possible, visit the area and spend some time taking as many photos as you can. With modern digital photography you can shoot thousands of photos for next to nothing.

Google's image search is an indispensable tool for finding photos, and additional information can often be found simply by asking around on the various forums. The "American Memory Archives" of the Library of Congress is an excellent source of period photos. These archives are freely available online at memory.loc.com. Another good place to find high-resolution period photos is shorpy.com.

Of course, good old-fashioned books and magazines are helpful too! The more research, the better, especially if you can't travel, or are modeling an earlier era. Chances are you'll find researching your prototype is enjoyable – after all, you probably wouldn't be modeling it if you didn't have an interest in it.

Prototype, freelance, and everything in between

One of the great things about modeling a freelance railroad is that you have a high degree of flexibility in your choice of structures. You can include buildings that are replicas of real structures, from any number of sources, as long as they are



1. The stone cabin at the abandoned Monolith Mine.

appropriate to your layout's theme. You can also create models that are highly modified versions of real structures, or you can design original buildings from your imagination.

Modeling a prototype structure has several advantages. Chief among these is the fact that all you have to do is copy it. You don't have to try to come up with all the little details that give a building personality and make it interesting. You can also copy the weathering. The downside to prototype structures is that they are often much larger than we can fit into the limited space on our layouts. Vintage buildings may also have been considerably altered or remodeled over the years, taking them outside the bounds of the time period being modeled.

IMAGINEERING | 6

A few of my buildings were inspired by real structures, but with major changes to make them better fit my theme and/or space. Others borrow features from one or more prototype buildings, combined with original features. Some are original designs that follow typical construction practice for the region and era I'm modeling.

Now let's take a look at the buildings on my layout ...

The stone cabin at the Monolith Mine

The Monolith Mine represents an early abandoned mine and mining camp with an on-again, off-again history. A small wooden headframe stands over the mine shaft, with the ruins of a blacksmith's shack nearby. Across the track are the dilapidated remains of a one-room stone cabin. [1]

This cabin was only the second building I'd made for the layout, and was made with real stone and mortar. The "wood" parts such



2. This cabin in Rhyolite, NV provided inspiration for my model.



3. These buildings represent the town of Dos Manos.

as the roof, door frame, and window frames, were made from styrene. The design of the building was inspired by a large, two-room cabin in the ghost town of Rhyolite, NV. [2] When I first saw the prototype back in the 1980s, the roof was covered with crude shingles made from tin cans and random pieces of scrap sheet metal.

Besides reducing the size of the structure, I also changed the number and positions of the doors and windows. The windows were made to look broken, with only a single pane of glass remaining in one window. The hip roof was almost a direct copy of the roof on the Rhyolite cabin, including the random, rusty metal shingles.

The history I imagined for this building is that it was originally the office for the mine. After being abandoned for some time, the mine was reworked on a smaller basis, and the stone building was used as a cabin. Since the final abandonment, the cabin is sometimes used by hikers and campers.

The town of Dos Manos

This is the main town on my railroad. Although some mining has taken place here, it was mostly a supply point for outlying communities. Much of the town's business now comes from tourism.

Currently there are only five buildings here but eventually there will be many more. [3] Because I'm modeling outdoors, I've had to experiment with materials and methods to create structures that can withstand the elements. All the buildings here are original designs not based on any prototype. The buildings in Dos Manos were also test subjects, experiments in materials and methods for modeling outdoors. Except for the hotel, they all have developed issues (mostly related to the windows) and may have to be rebuilt someday.

The two-story house was one of my earliest structures. It has a ground floor made of real rock and mortar. The second floor is styrene, with siding textured and painted to look like weathered board-and-batten. As I imagined it, the building started out as a stone cabin, and later was expanded with the addition of a second floor.

The next two structures are Sam's Rock Shop and a bakery called Cora's Cakes. [4] The rock shop is housed in a small, false-front wood cabin that may have originally been a land office or saloon. The bakery is a two-story building with a residence upstairs. Both of these buildings are made of styrene.



4. The rock shop and bakery occupy two of the town's older buildings.

The fourth building is the Dos Manos Drug store, a two-story stone structure made with real stone and mortar. The second floor separates from the ground floor for access to the interior.

Lastly, there is the Hotel Torgo, built in the Mission Revival style that became popular in the late 19th century, and is still common throughout southern California. [5] My history for this building is that it was built during one of the town's brief boom times, replacing an earlier wooden structure.

The hotel was my first use of Sintra PVC foam board, and also my first attempt at simulating a stucco building.

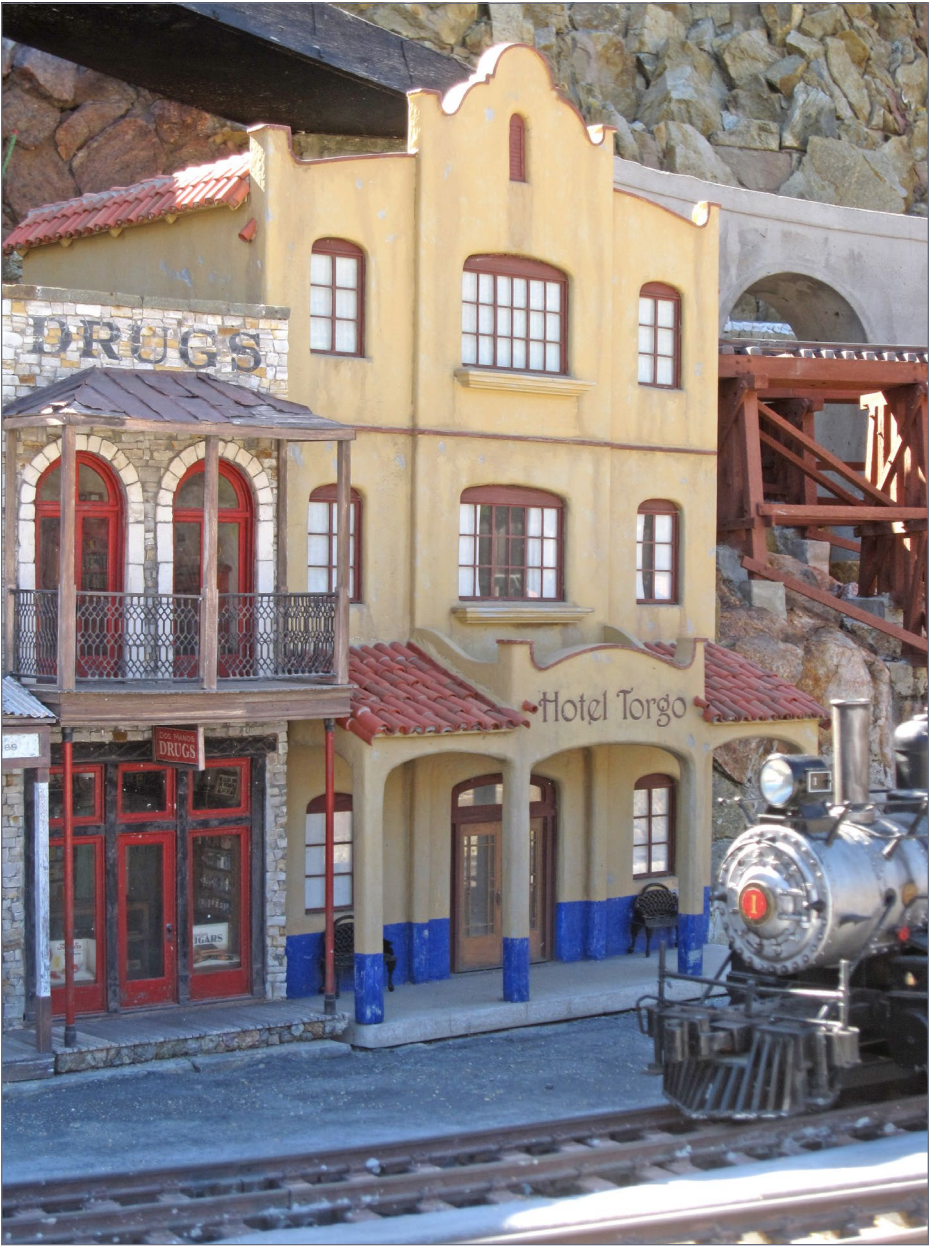

5. The Hotel Torgo represents a more recent structure of stucco and Spanish tile.



6. A former jail, this cast concrete building now provides storage for the railroad.

[6] On the outskirts of town there is an old, concrete jail that was abandoned when a larger facility was needed. Later the jail was acquired by the railroad and is now used to store tools.

The town of Mineral Ridge

One of the most recent additions to the layout, I envisioned this as a former boom town that was once flush but has fallen on hard times. After many lean years it is just starting to make a comeback, thanks to new gold strikes and growing tourism. Though rundown, many of the town's buildings are quite substantial, made of rock or brick. [7]

I made all the buildings here from Sintra, with styrene details. Sintra is a very versatile material that can be scribed and



7. Many of the buildings in Mineral Ridge are built on a steep slope.

textured to look like brick, stone, or wood. Currently there are three shops and a large mill. I have several more buildings planned for this town.

The basic design of my Miner's Bank building was from a photo I found online of a building in downtown Woodland, CA. The prototype has a sandstone face and brick sides, and spans almost a full block. The front of the building has six segments.

I reduced my building to one segment. [8] The depth of the building was also reduced significantly. The arched storefront and entry were altered to fit – on the original it spans two segments, with a second door off to one side. I also changed the sides from brick to random stone, in keeping with common practice on many early



8. The former Miner's Bank building is a highly compressed version of a real building.



9. Above the bank building are two brick structures – a hardware store and a former billiard parlor.



10. The former billiard parlor was loosely based on this prototype in Eureka, NV.

buildings in desert mining towns. The walls on the sides had to be carefully textured and painted to match the retaining wall above the town, which was made from real stone.

The bank building is not completely finished. I still have to add the interior details and lighting, plus some exterior signs. My history for this building is that it started out as a bank, and over the years has either been empty or used for various shops. I plan to turn it into a jewelry store, with a silversmith's shop upstairs.

The hardware store is an original design. [9] The heavily weathered signs and crumbling bricks were inspired by a building in Virginia City, NV. The interior hasn't been completed yet – I'm still trying to decide whether to model this as a hardware store, or to have some other business occupying the structure, but retaining the historic, original signs.

The building housing the radio repair shop and barbershop is loosely based on a general store in Eureka, NV. [10] I made several changes to it. My building is narrower and shorter at the front, and greatly reduced in depth. The openings for the windows and doors are narrower, and I changed the way they're framed. In addition, I wanted to divide the interior into two smaller shops, and converted one of the windows into a second door.

Despite these changes I managed to keep the look of the building very similar to the original. The height-to-width ratio is roughly the same, and so is the shape of the false front or parapet, and the brick ornamentation. The paint and weathering follows the prototype fairly closely, down to the cracks caused by settling, crumbling bricks, and the two holes in the wall filled with cement.

As I write this, only the radio repair shop has been fully detailed – I still have to detail the interior of the barbershop.

IMAGINEERING | 16

I imagined this building starting out as a billiard parlor before falling into disrepair. At some point the interior was divided so two small shops could occupy the same building. To accommodate this, one window was knocked out and replaced with a door. Concrete was used to reinforce an area between the doors where some bricks had decayed.

The mill was designed to fit the space, starting with a stepped foundation of concrete, cast in place. Like most of my buildings, I had to employ a substantial amount of “selective compression,” while still capturing the look and feel of a typical Nevada or California mill. A mockup of foam core art board was essential to creating this structure and making sure it would fit.



11. This unique miner's cabin in Lone, NV was the prototype for the cabin at Grandt Cliff.

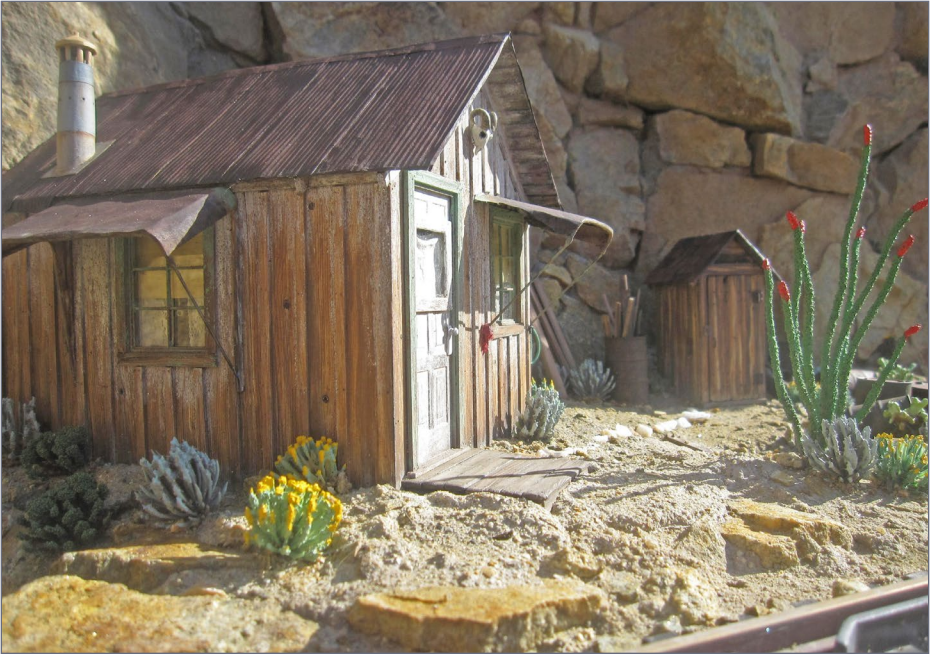

12. The miner's cabin at Grandt Cliff is the only true replica of a real structure on the In-ko-pah Railroad.

The town of Grandt Cliff

I imagined this town as a very small, decrepit mining community that is struggling to stay alive. So far I've only finished two buildings for this site, but there is room for two or three more.

The miner's cabin was patterned after one in a tiny central Nevada mining town called Ione. [11] The cabin itself is pretty standard, a one-room, 10' x 12' shack that started out as a wood-framed tent, and was later made permanent with the addition of board-and-batten siding and a corrugated metal roof.

The details are what make it unique – large, homemade metal awnings over the windows, a window crudely cut into the door,



13. Numerous signs help give character to Serenity's Sandwich Shack.



14. The sandwich shack will eventually be joined by other buildings here at Grandt Cliff.

and a large smoke jack with a decorative clay cap. These are what give the building character, and are the kinds of details that would be hard to come up with on your own. The only change I made was to add a third window. I also eliminated the trailer and other relatively modern junk from around the cabin, and replaced it with an outhouse, water tank and appropriate clutter. I used styrene to create this model, with brass for the awnings and corrugated metal. [12]

At the other end of the site is Serenity's Sandwich Shack, a colorful establishment catering to both miners and tourists. [13] This building, with its many hand-painted signs, is completely original, but was inspired by many vintage photos of rustic diners

and “tourist traps.” Except for the styrene details and corrugated metal, it was made from Sintra. [14]

Conclusion

So that’s the process I use in designing buildings for my fictional railroad. I hope it will be of use to you, whether you’re creating your own structures from scratch, or choosing and modifying kits to fit your layout’s theme.



[Click here for reader comments](#)

ADVERTISEMENT



GLXSCALEMODELS.COM



OIL LANTERN KIT

1/48 SCALE!!!

\$19.99
+ S&H

12 VOLT POWERED LED LIGHT



• INDEX

• TABLE OF CONTENTS

iwata

by ANEST IWATA

Be Realistic

From weathering broad areas to painting concentrated details, an Iwata airbrush gives you precision and reliable performance for a natural, smooth finish.



Iwata Eclipse CS

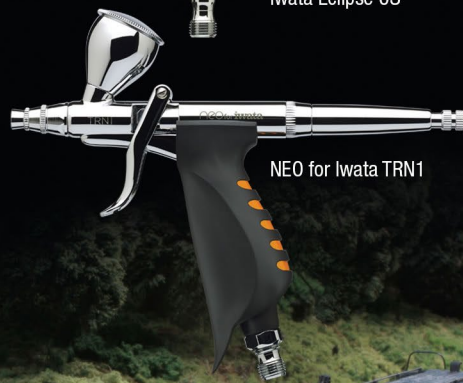

NEO for Iwata TRN1



iwata
MEDEA
ANEST IWATA-MEDEA Inc



Locomotive from Alan Houtz, North American Prototype Modelers

Click to see the entire line of Iwata Airbrush and Artool Products

• INDEX

• TABLE OF CONTENTS



MRH MARKETPLACE

STREAMLINED BACKSHOP

Sales
... Services
..... Solutions

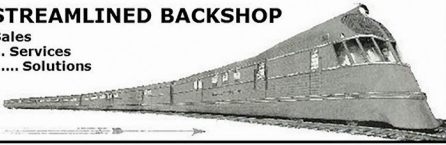

"SUGAR CUBE" SPEAKERS...

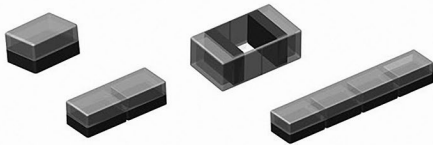

4 Sizes * 4 Baffles

... "Sweet" Speaker Options!



www.SBS4DCC.com

Your ad
could be in
this space
for as low
as \$112 a
month.

[Click to learn more ...](#)

LOOK
at what's new at
Black Cat this month

[Click here for
our website](#)

Canadian 1867/1967
Confederation Train in N scale



Black Cat Publishing
(204)489-5005
ajfergus@mymts.net
blackcatdecals.com



JIM'S TRACK PLANS



[EXPLORE HERE](#)

New Designs Every Tuesday!

MRH MARKETPLACE | 2

PRECISION DESIGN CO

Chains
Flat Car loads
Joint Bars
Signs & Posts



FREE SHIPPING

FEATURING

America's Historic
Main Street Architecture

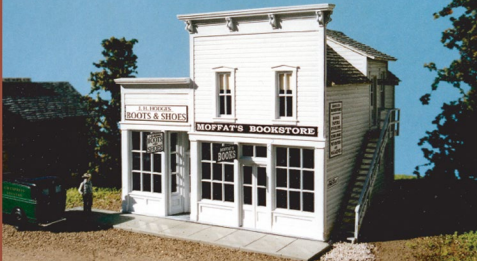

**MAINSTREET
HERITAGE**

www.mainstreet-heritage.com



**KC's
Workshop**

Craftsman Model Kits
www.kcworkshop.com
www.facebook.com/kcworkshop



ATSF Bx-48

CLICK HERE

**CANYON CREEK
SCENICS**



Yarmouth Model Works
HO scale resin kits and detail parts



..... U.S.A. MAILING ADDRESS
3560 Pine Grove Ave, Unit 617
Port Huron, MI 48060

..... CANADIAN MAILING ADDRESS
85 Hiawatha St.
St. Thomas, ON N5P 2T5

Tel. 519-633-7574
pierre.oliver@start.ca
www.yarmouthmodelworks.com

**LIGHTS 4
MODELS**



NEW !!!
SOUNDS FOR
YOUR LAYOUT
CHECK OUT OUR
WIDE VARIETY OF
SOUNDS

**FREE SPEAKER & SWITCH WITH
PURCHASE OF SOUND BOARD**

LED lights & Animated Signs
www.lights4models.com 614-296-8691

[Click Here](#)

**PRE-SIZE
MODEL SPECIALTIES**

P.O. Box 6 Paonia, CO 81428
Ph. 970 527 4586
Made in The USA

Cast resin items for All Scales.
Tunnel portals, bridge piers, abutments,
culverts, and retaining walls.
Trackside details and sage brush tree
armatures.

"FREE SHIPPING see website for details"

**WOOD RAILROAD
BenchWork**



**Affordable Modular (domino)
Benchwork in 200+ sizes**
Custom built to order benchwork also available!

MRH MARKETPLACE | 3

clever
models LLC
Cardstock models & materials

Try one today!

www.clevermodels.net

Don't settle for lifeless signals!
We've got signaling circuits!

LOGIC RAIL™ "Sophisticated Model Railroad Electronics"
TECHNOLOGIES

Please visit our website and online store!

21175 Tomball Pkwy Phone: (281)251-5813
Suite 287 <http://www.logicrailtech.com>
Houston, TX 77070 info@logicrailtech.com

MODEL RAILROAD
BenchWork
COM

Affordable built to order Benchwork starting at only \$20 a Sq Ft.

W GOLDEN AGE LINE
WESTERFIELD
MODELS, LLC

New Kits Coming:
NWP USRA Express Box

westerfieldmodels.com

Oak Hill
MODEL RAILROAD TRACK SUPPLY LLC

JEFF OTTO
TURN 'IT OUT

414-915-4671

ohrtracksupply.com
jeff@ohrtracksupply.com

N36W23431 Oak Hill Ln.
Pewaukee, WI 53072

AMERICA'S NUMBER ONE RAILROAD PRINT SOURCE

Jelsma
Graphics

...America's Railroad Embroiderer

Railroad Art-Prints,
Caps, Jackets,
Shirts and More ...
Jackets starting at \$79.95

www.jelsma.com
1-904-221-3513 • Jacksonville, FL.

Great Decals!™
FEC, Interstate, Virginian
Railway, & L&N Titles
After Hours Graphics Line
Coupler Gages and More
In O, S, HO, and N Scales

MOUNTAIN SUBDIVISION HOBBIES

www.modelrrsupply.com
FREE USA SHIPPING OVER \$29.00

NCE - SOUNDTRAXX - DIGITRAX - PECO - CIRCUITRON
DCC SPECIALTIES - INTERMOUNTAIN - CMX - ATLAS
BAR MILLS - BOWSER - KATO - MRC - TOMAR - RIX -
PIKESTUFF - LOGICRAIL - CENTRAL VALLEY AND MORE!

RULERS-of-the-WORLD

Scale Rulers \$4 each

Over 200+ scales!

Metric or Imperial

www.rulers-of-the-world.com

HO DIESEL SUPPLY

Are you serious about your HO Diesel fleet or just tinkering? Either way
You probably bought just the right parts you needed from us already

BACKSHOP HARD PARTS DIVISION

Now Direct Personal Service

www.hodiesupply.com

email: TheBoss@hodiesupply.com

**Your ad could be in
this space for just
\$58 a month.**

Click to learn more ...



**DID YOU KNOW
MRH SUBSCRIBERS
GET FREE BONUSES?**

**CLICK TO SUBSCRIBE
NOW - IT'S FREE!**

**Have you seen these
popular blogs on the
MRH website?**



Tom Johnson's L&IN

291,000 reads

CLICK TO READ IT NOW



Ken Glover's Shelf Layout

91,000 reads

CLICK TO READ IT NOW



TOFC on the SOO



***Build trailers and flat cars with
Con-Cor trailers, Microscale
decals, and Athearn flats ...***

• INDEX

• TABLE OF CONTENTS



BY BOB RIVARD



[Click here for reader comments](#)

IN 2001 I MODELED A HANDFUL OF SOO REFRIGERATED semi-trailers. Recently I decided it was time to model a few more. The decision to build some more was made easier because the trailers that are the starting point for this project were still available in 2015. The Con-Cor Star Glass company trailer can be ordered through them, or from Walthers. The other major challenge for any project can be the lettering. The lettering I need is still available from Microscale, set number 87-999.



1. My 1982 roster shot provided the inspiration for modeling these classic Great Dane reefer trailers.

TOFC ON THE Soo | 4



2. The starting point for this project is the Con-Cor 45-foot Star Glass Company tractor trailer, part number 4002019-E.

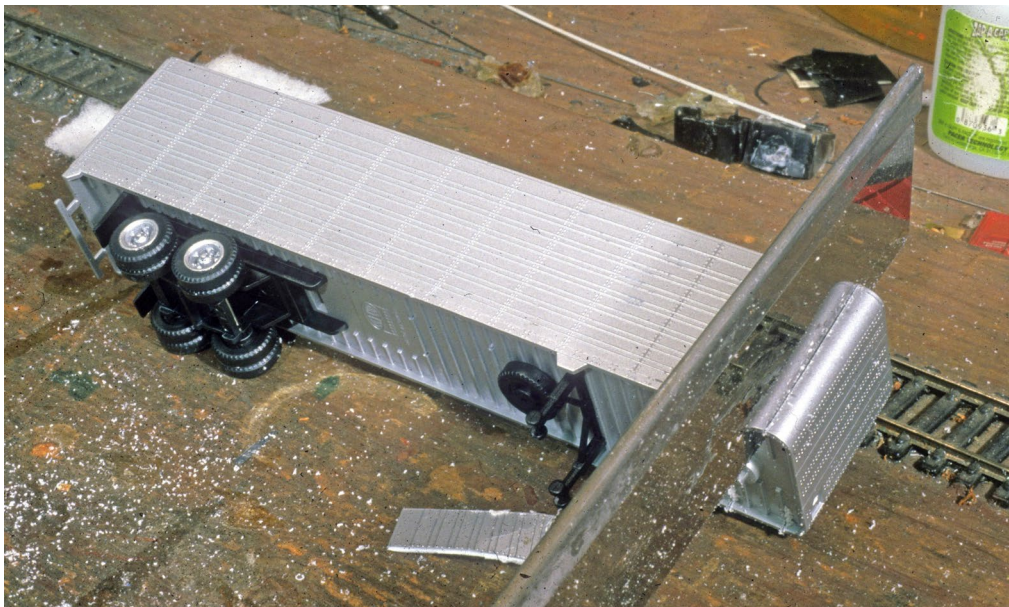

3. In order to correct the model's length to that of the prototype, remove one front section of the model using a razor saw. A nice feature of the model is how easily the roof separates from the body.

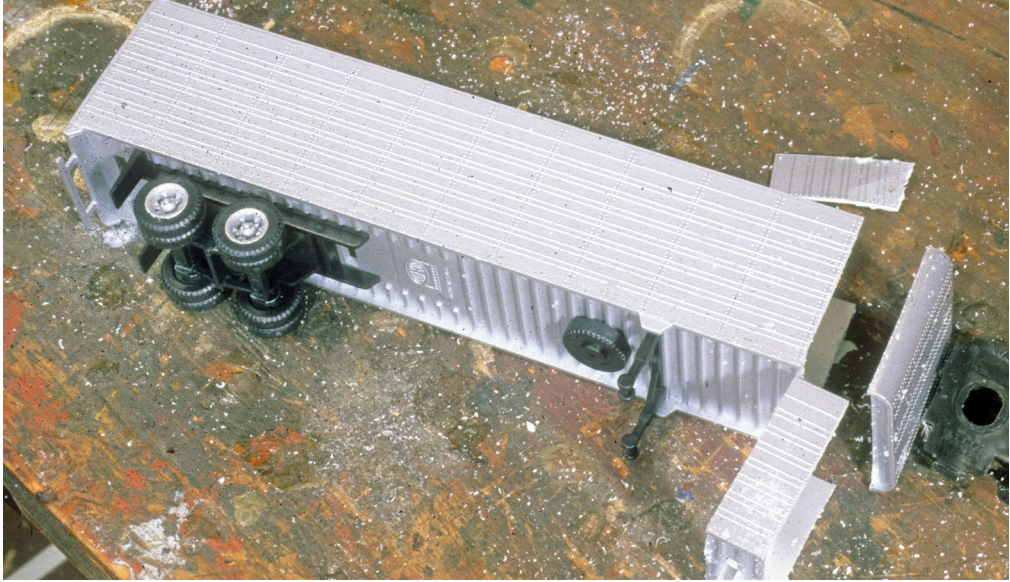

4. After removing this section, sand the edges for a square joint before using liquid cement to re-attach the body pieces.



5. Next, remove the same amount of material from the rear of the roof piece.



6. Airbrush Scalecoat II 2011 white onto the trailer. After allowing 24 hours for the white to dry, address the 12-inch aluminum strip along the bottom of the body. To do this, apply masking tape 12 inches up from the bottom edge and airbrush Testors silver paint. Micro Scale 87-999 decal set provides the correct lettering for the trailers. The decals are applied by using normal decaling practices.

**Want to help keep
MRH free?**

Then *click* on ads!

TOFC ON THE Soo | 7



7. Refrigeration units are needed since the Con-Cor Star Glass trailers are non-refrigerated units. Prepare the Thermo King refrigeration units for a coat of dark green paint. These are A-Line part #50136. Scalecoat II 2036 CNW green is a close match for the color for these units.



8. I use my airbrush to apply the paint to the refrigeration units.



9. Next come the underframe details. I use A-Line #50133 for the landing gear. The A-Line Thermo King units are supplied with fuel tanks that are too small for this project. I extend the tanks to more appropriately reflect the prototype tanks. To do this, I use a piece of 2'-6" inch long aluminum tube cut to length using a razor saw. Glue this between the two A-line parts.



[Click here for reader comments](#)

TOFC ON THE Soo | 9



10. At this point, the model is ready for a set of wheels. As I studied my model against photos of the prototype, I noticed that the space between the tires is slightly more than the prototype wheel spacing. With a razor saw, cut apart the leaf spring assembly and position the now separate pieces onto the chassis side rails to a closer spacing.



11. That's more like it. The space between the tires and the landing gear looks more appropriate!

TOFC ON THE Soo | 10

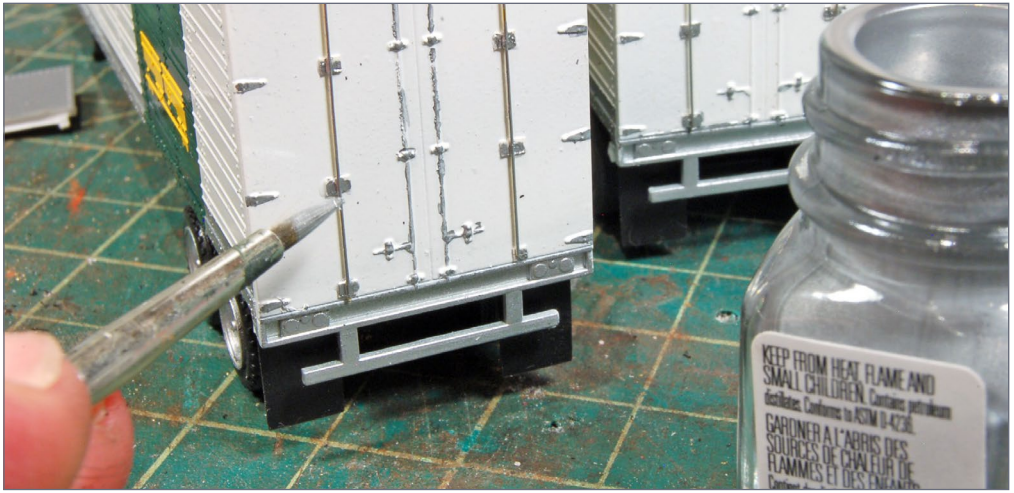

12. Before starting the weathering process, I need to address a minor detail item. The prototype photo shows the extra set of door latch rods on the rear doors required for trailers in TOFC service. To model these, cut .012-inch diameter brass rod and mount these to small styrene bits. Use a small brush to carefully paint the rods using classic Testors silver paint.



13. Here are my finished models before appropriate weathering.

TOFC ON THE Soo | 11



14. To start weathering, apply a coat of Testors Dullcote. This provides a nice dead flat finish and hides the decal edges.



15. I use my airbrush to paint the landing gear and fuel tank with Testors silver.

TOFC ON THE Soo | 12



16. Begin weathering the trailers with Floquil Grimy Black, and finish with some passes of Floquil Rust.



17. Apply some AIM Products weathering powders using a small brush to really force the powders into the wheel hub area. This step does a nice job to highlight the detail of the wheel area.



18. Here is my finished model. My trailer only needs an appropriate flat car to ride on! One thing leads to another.

Build Soo Line flat cars with the Athearn 85-foot piggyback flat car

Now I needed an appropriate flat car to transport my two Soo Line Great Dane reefer trailers. Because these trailers are equipped with the Thermo King refrigeration units, they are too long for a pair to fit on an 85-foot flat car. I decided that the best option for these trailers would be a stock Athearn Genesis BSC F89F flat car wearing the classic Trailer Train yellow paint scheme. A nice inspirational photo can be found on page 71 in the Morning Sun Piggyback Color Guide Vol. 2 by James Kinkaid. Because I had also modeled a few 40-foot trailers I decided these could be carried by the Athearn 85-foot flat car. Follow along as I describe how I transform the Athearn Trailer Train models into the Soo Line scheme.



19. I decided to model two 85-foot piggyback flat cars using the Athearn Trailer Train model as a starting point. These cars are from series 5575 through 5593, odd numbers only, built by Pullman Standard. A nice photo of Soo Line 5583 can be found on page 70 in the new Soo line Freight Car book by Ken So-roos. I also found a fantastic prototype photo of Soo Line 5593 taken by Ron Hawkins on the RR pictures archives.net web site.

 [Click here for reader comments](#)



20. Here is the out of the box stock Ahearn Trailer Train model.



21. I need to remove the factory lettering on my two models to convert them to Soo cars.



22. Remove the lettering using wet/dry 400 grit sandpaper.



23. Follow the prototype photo of Soo 5583 to install the hand-brake linkage detail. For this, use .015" brass wire. Solder this 30-foot length of wire to three short sections of wire which are glued into #76 holes. After soldering the horizontal length of wire to the hangers, cut the hangers flush. Soldering makes for a sturdy and realistic looking installation.

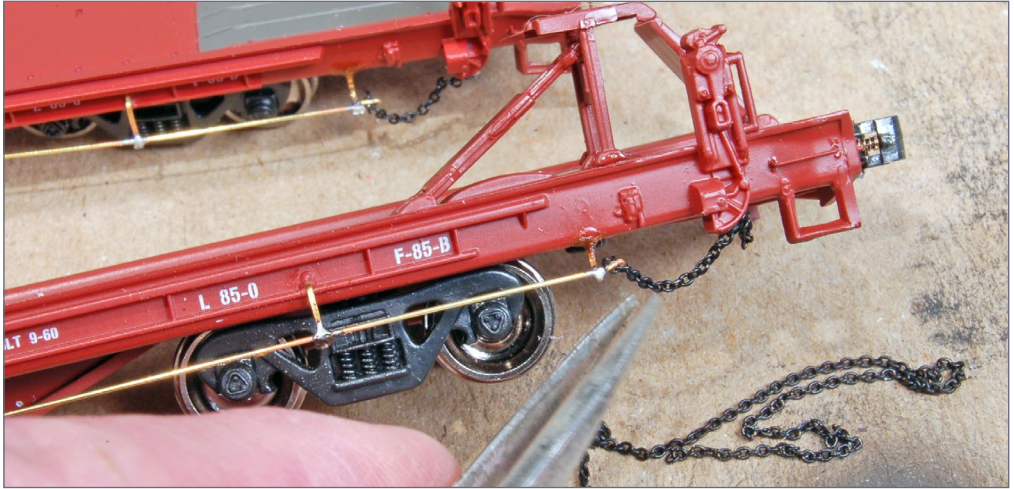

24. Finish the handbrake linkage detail by gluing a small piece of chain from the end of the brass rod over to the back of the hand brake.

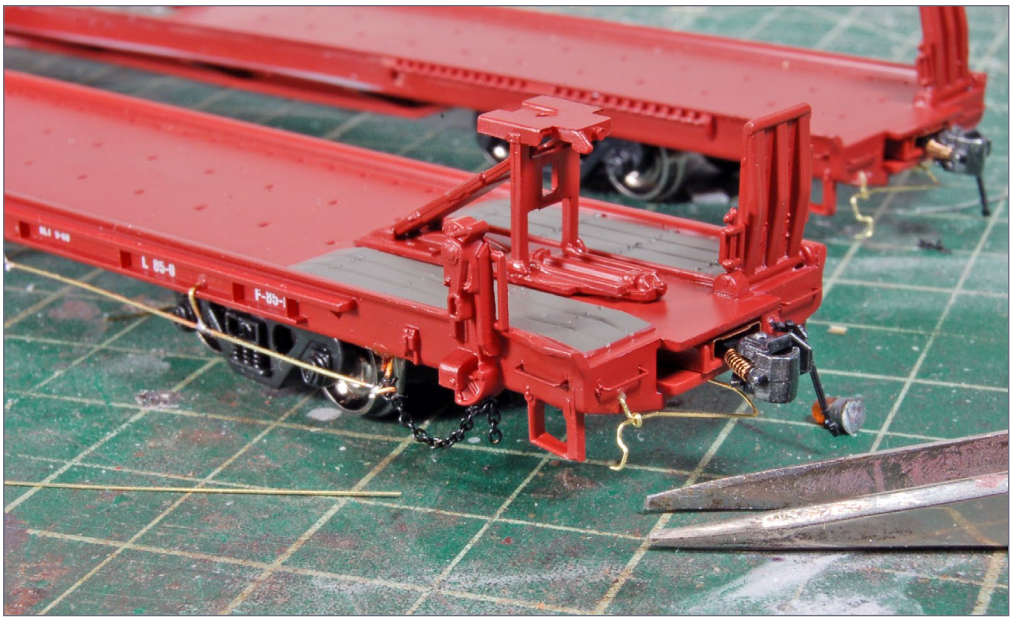

25. Use .012-inch brass wire and bend and cut coupler pin lifters.



26. Here my two models ready for a coat of boxcar red paint. An important detail for my 1977 modeling era is adding ACI label plates.



27. Scalecoat II Boxcar Red paint is the perfect paint for this project. When dry, the gloss finish provides the ultimate surface for applying decals.

TOFC ON THE Soo | 19



28. I am ready to decal the TOFC models. Microscale MC-4215 provides the lettering I need.



29. Study the photo of the 5583 and apply decals to match the prototype. To faithfully capture the correct look of the prototype car, I simulate the areas where data has been patched out and re-applied on these newly painted areas. Before attempting to capture this look, weather the cars.

TOFC ON THE Soo | 20



30. Airbrush some light passes of Floquil Grimy Black to the 5583.



31. Repeat this same process, applying Grimy Black to the 5593.

TOFC ON THE Soo | 21



32. Now apply freshly painted patches on the 5593 and on the 5593. On the 5593, I decided that Reefer Orange will best capture this look. Use an airbrush to paint a scrap of Champ decal material. Use a #11 X-Acto blade to cut out the right size patches and apply these as a decal.



33. Next, add the appropriate lettering to these patch areas.



34. Then, turn your attention to the trucks. Airbrush Grimy Black onto the wheels and side frames.



35. Next, apply weathering powders to the side frames and brush powders onto the wheels. The flat Grimy Black paint provides a great surface for the AIM weathering powders to bite into.



36. This process really captures that gritty grimy look of prototype trucks.



37. Here is the finished flat car along with a photo of the prototype 5583.



38. I had to place these two trailers onto the car!

TrainMasters TV is part of the MRH product family.

TMTV members not only get great network TV level videos, they help pay for MRH and keep it free ...



39. Here is my finished model of Soo Line 5593, the last car from this series, with some final weathering using AIM weathering powders, based on the prototype photo taken by Ron Hawkins. ☑



[Click here for
reader comments](#)

BOB RIVARD



Bob Rivard has been fascinated with trains since the age of 5 when he received his first train set, the proverbial Lionel.

He really enjoys his job at KARE TV and has worked there for 34 years as a broadcast technician. He runs the robotic cameras during the 10 p.m. news. ■

.....

ADVERTISEMENT

HIGHBALL TO INDY 2016



JULY 3 – JULY 10, 2016
INDIANAPOLIS,
INDIANA

You're the kid.



Welcome to the candy store.

- 180,000 square feet of “candy”
- Over 250 manufacturer & retailer booths
- 44,000 square feet of modular layouts
- “Ask the Collectibles” appraiser
- Trains, accessories, collectibles & more
- Hands-on demonstrations

July 8 - 10, 2016
**Indiana Convention
Center**

100 S. Capitol Ave.
Indianapolis, IN 46225

**CLICK HERE
FOR ALL THE
DETAILS!**

www.nationaltrainshow.com

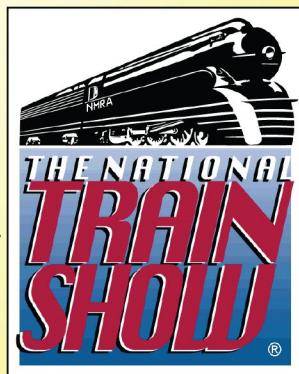

Sponsored by



We make it more fun!

• INDEX

• TABLE OF CONTENTS

**PREORDER
SPECIAL**

MAKE IT RUN

as good as it looks.



(Stock Athearn HO diesel weathered for Joe by Ralph Renzetti)

Click me to
LEARN MORE ...

Make it run like a
Dream

BOOK SERIES: *By Joe Fugate*

Preorder now and SAVE - From the MRH Store: store.mrhmag.com

• INDEX

• TABLE OF CONTENTS



YES, IT'S A MODEL

compiled by
DON HANLEY
.....

 [Click here for reader comments](#)



1. Jeff Whitney captured this roster shot of CR 631078 while he was out railfanning in early April. Jeff began with an ExactRail coil car, modifying it with semi-scale wheels and Sergent scale couplers. He added a very faint fade with thinned acrylics followed with oil and pastel powders, creating the well-used look seen on many freight cars.

▶ **MRH'S MONTHLY PHOTO ALBUM**

YES, IT'S A MODEL | 2



2. It has been a long time since the Texas Special ran these rails before becoming a part of Amtrak, but the Katy is still busy with its primary business, hauling freight. Here we see MKT 240 stuck in the hole waiting on a northbound out of Eureka Yard. Scott Sanders posted this photo on the *MRH* forum.



[Click here for
reader comments](#)



3. Terence Boardman captured this rust-streaked boxcar sitting on a siding on a cloud-free day. The model is an Athearn Ready-to-Roll model he purchased on eBay. Terence added ExactRail trucks with semi-scale wheels, new ladders, and modified the coupler boxes with HiTech hoses. He did the weathering completely with acrylic paints. Great job, Terence.

GET PAID FOR YOUR PHOTO

We pay \$40 per photo we publish. If you'd like to get your modeling in our photo feature, just start posting your photos on the MRH website, especially in the Weekly Photo Fun thread created each weekend.

See mrhmag.com/help for more on how to post an image. You need to be an MRH subscriber to post photos to our website, and becoming a subscriber is free, [just fill out this form here](#). ■



4. Under a threatening March sky, HRCX 2500 sets out an MOW flat for an upcoming maintenance project on the IAIS. With its high front hood, HRCX 2500 proudly shows off her N&W heritage. George Malcolm began with an Atlas SD35. The locomotive and rolling stock were weathered using weathering techniques of The Weathering Shop. The bridge is from Monroe Models with Tichy nut/bolt castings added. George did a great job of capturing that rural look found along much of America's railroads.



[Click here for
reader comments](#)



My Model Railroad Journey

An unconventional Master Model Railroader looks back ...

• INDEX

• TABLE OF CONTENTS



• INDEX

• TABLE OF CONTENTS

BY BRUCE PETRARCA, MMR



[Click here for reader comments](#)

WHAT A JOURNEY. IN THE SPAN OF LESS THAN TWO decades, I've gone from a non-modeler, to Mr. DCC, to Master Model Railroader #574. Preparing my short biography for the *NMRA Magazine* put me in a pensive mood. Here I'll share the rest of the story, as Paul Harvey used to say. I kind of stumbled into and over lots of things along the way.

Stories like this frequently revolve around things and events. People are the serendipity of my journey.

Some would say that the story began with the PebbleCreek Model Railroad Club (pcmrc.org) in 1998. But it really started on my first Christmas.

The early years

Home movies show I got a train squeeze-toy for my first Christmas. I was more fascinated by the wrapping paper than the train. For most of my life, I have lived amongst trains, not for them. Now I'd love to go back and re-live and photograph and document some of the places and times that I mostly ignored along the way.

There are O-27 Lionel and Marx trains in all of our Christmas movies, including the year that I was six and Santa brought me a new red Santa Fe Lionel NW2 [1]. But the trains didn't move to California with the family when I was in high school.

My early story is about electronics and Scouting. Because I had toy trains, I got the Model Railroading merit badge. I got the



1. Santa brought me a new Lionel NW2 when I was six. Remember what they say about Lionel trains and dads. Captured from an 8 mm movie.

Radio merit badge after I passed my novice class amateur radio [2] license.

To earn Eagle Scout, I needed 21 merit badges, with certain quantities from certain categories. I chose what I liked, but needed some that didn't necessarily interest me as a 12-year-old: for example, Book Binding. But each merit badge was an adventure. In later life, I've actually used some skills I learned for the Book Binding merit badge.

As a kid, I built plastic models, but my patience wouldn't last through a paint job. Squadron putty and sandpaper were not in my toolbox. I looked for models where the parts were molded in the correct colors for the final object. I usually got a fingerprint or two in glue on a prominent exterior surface.

MY MODEL RR JOURNEY | 5

Summer of 1963 found my family camping near Durango. As we headed home to Denver, Mom drove to Silverton, allowing Dad and me to take the D&RG. This was in one of the last years of their operation with cattle-car like open gondolas [3]. I was busy watching the scenery, not studying the ballast color and tie plates.

Being an only child, my parents were my friends, too. My Dad, Fred, was not a modeler or an electronics guy, but he has always supported my crazy hobbies.

Later, I dodged the street-running trains of the Santa Maria Valley (California) Railroad (smvrr.com) as I was trying to get to classes at



2. My amateur radio antenna farm (as KX0E), circa 1986, in Colorado Springs, CO.

MY MODEL RR JOURNEY | 6

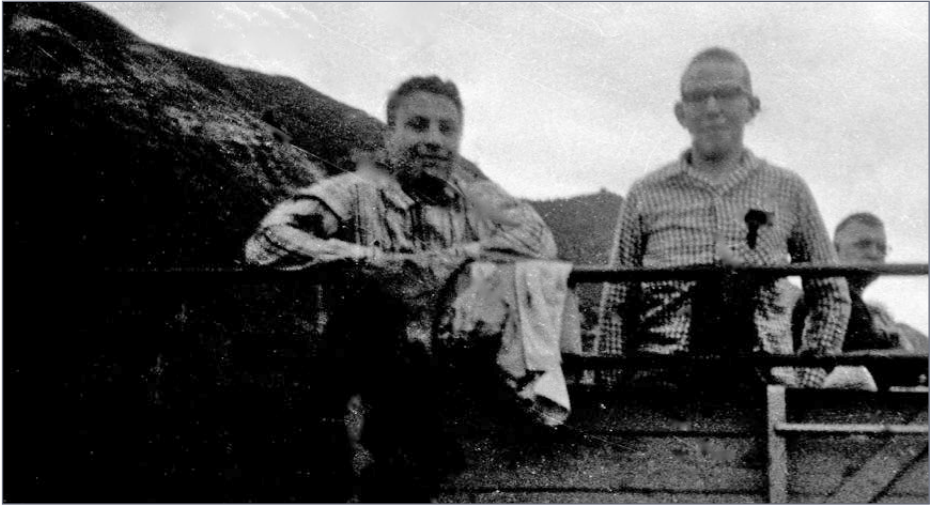

3. Dad and me in an open gondola on the D&RG leaving Durango for Silverton in August 1963.

junior college. Today, I'm working on an HO model (mrdccu.com/layouts/SMVRR) [11] of that railroad as it was in the early '60s, and I wish I had taken lots of notes and photos back then.

In the late '60s, I was a student at Cal Poly, San Luis Obispo (CA). The Southern Pacific wound through the sprawling campus and climbed about 1000 feet from the depot in San Luis Obispo to the high point on the coast route at Cuesta. The iconic Coast Daylight still ran on the horseshoe curve on campus, albeit with newer equipment than that shown in this vintage postcard [4]. There was a nuisance grade crossing on the way to campus. I was busy working on a degree in electronic engineering. I didn't look to see what was in the consists that occasionally made me late for class.

Next I lived in Santa Barbara. There, I overlooked literally and figuratively the SP coast route. I lived within 1000 feet of the tracks in three different apartments for a total of three years. Yup, I ignored the freight and (pre-Amtrak) passenger trains. I was too busy

MY MODEL RR JOURNEY | 7

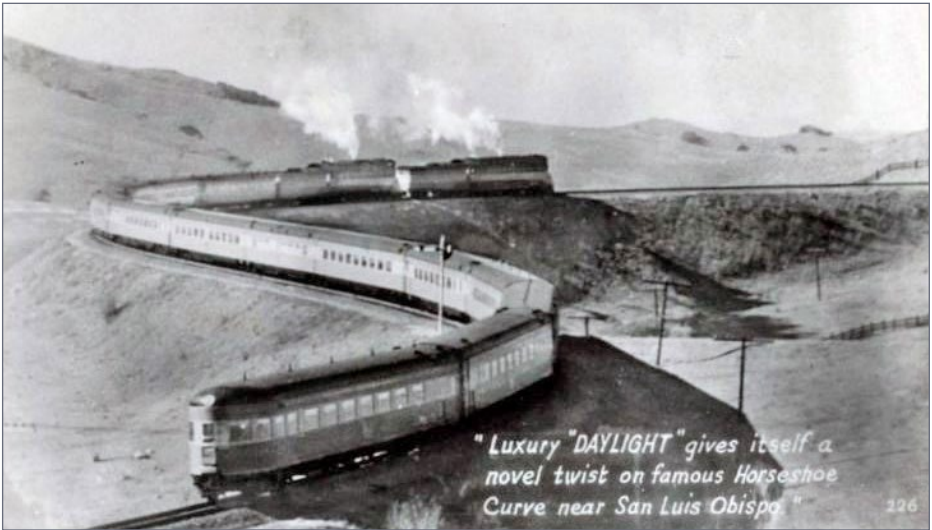

"Luxury "DAYLIGHT" gives itself a novel twist on famous Horseshoe Curve near San Luis Obispo."

4. Vintage postcard of the northbound SP Coast Daylight with a helper on the horseshoe curve on the Cal Poly campus.

working and getting an MS in engineering at UCSB and my private pilot's license.

Then came a career in the aerospace and computer industries. As that wound down, I became a business owner.

In the early '90s, I wanted a cheap train to run around the Christmas tree, so I went to a couple of local train stores. Nothing tripped my trigger. A toy store sold me an HO Bachmann steam set for about \$25. It made about a dozen loops of the Christmas tree before it broke.

Getting into model railroading

We moved to the PebbleCreek Resort Community (robson.com/communities/pebblecreek/overview) in 1997. Once again, I lived near a formerly SP main and branch line. In January 1998, our community newspaper advertised that a group of residents were

MY MODEL RR JOURNEY | 8

interested in starting a model railroad club. At that inaugural meeting we created the PebbleCreek Model Railroad Club (pcmrc.org) and I was the new club's secretary.

PCMRC's first layout was a sectional HO affair [5]. I was learning, asking questions, like "What is DCC?", and "What does '6 code 100 switch' mean?" I read a magazine I'd never seen before, *Model Railroader*, at the club meetings.

The HO layout was set up to run with DC and DCC. This DCC stuff interested me. It fit with my technical background

In 2000, I realized that most hobby shops didn't "get it" about DCC, so I started a part-time decoder installation business. I named it for the closest depot on the old SP mainline: Litchfield Station (litchfieldstation.com). A decade later, when I sold

ADVERTISEMENT



Announces their purchase of
BEST's
Laser-cut Structure Kits

CHECK
IT OUT!

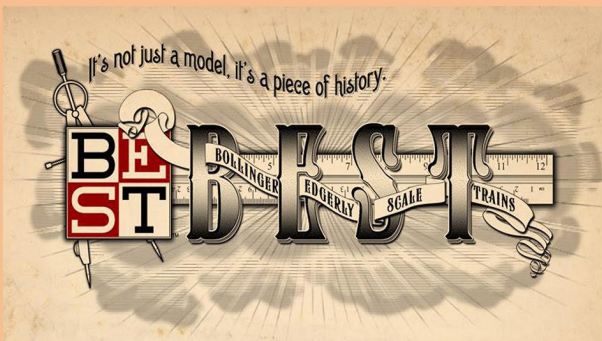

To order or get more information, please email Jeff at:
motrakmodels@centurylink.net



5. PCMRC's sectional HO layout in 2001.

Litchfield Station, it was arguably the second largest DCC dealer in the world.

Early on, I was showing Litchfield Station's wares at a local meet. I overheard a couple of folks discussing what it was going to take to put a decoder into a loco that was being offered for sale at the table next to mine. One of them said, "Let's go ask Mr. DCC" and pointed to me. The name stuck.

In 1999, without really knowing what it was, I attended the NMRA Pacific Southwest Region (PSR) convention in Flagstaff. I joined the NMRA and the Flagstaff Model Railroad Club (flagmrrc.org) shortly thereafter.

The NMRA Arizona division meets became important dates on my calendar. I used them and the NMRA conventions to promote Litchfield Station. At these meets, I saw Achievement Program (AP) certificates passed out, but had no interest in seeing what was behind them.

MY MODEL RR JOURNEY | 10

In 2000, Gary Gelzer moved to PebbleCreek and joined PCMRC. An NMRA OpSig member, Gary introduced me to operations. I worked with Gary converting his Great Northwestern Coastline (GNC) railroad to DCC. He got me invitations to operate on some of the local railroads and even one to the Prairie Rail weekend in Kansas City.

In 2001, PCMRC was asked if we would like to build a garden layout. That became PCMRC's first permanent layout [6] and introduced me to outdoor model railroading. One of the members had a huge 1:20.3 (Fn3) layout in Minnesota. As I became interested in 1:20.3 scale later, I wished I had learned more from him back then.

With a technical background and virtually no modeling experience, my approach to modeling has been unconventional, to be polite. I found things that worked and things that didn't work.

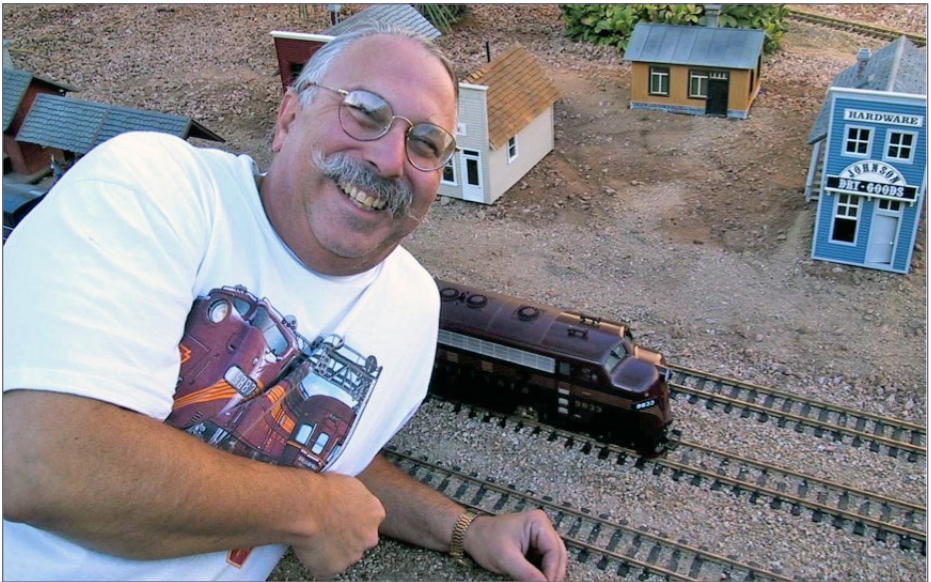

6. Gary Gelzer during the test of PCMRC's first permanent layout, a garden one, in October 2001.

MY MODEL RR JOURNEY | 11

I was like a 50+ year old kid. Folks would say that it should be done this way or that way and I'd ask, "Why?" For example, one of my favorite adhesives is clear caulk. I use it for attaching light pipes and scenery and temporarily attaching things, and to seal speakers, and numerous other uses.

I built my very first model railroad, about 2003. It is a shelf layout [7] based on the venerable Time Saver with an extra track added. It wound up 8-1/2 feet long and a bit over a foot wide. It has appeared in several of my columns. Gary Gelzer later did the scenery on it for me.

I got started giving sound and DCC clinics for clubs and NMRA events. In 2005 I went big time with two different clinics at the NMRA national convention. Many of my clinics were given to standing-room only crowds. After one clinic, an attendee came up to me and said, "I've done sound for Bob Seger on the road for years and I know the theory behind what you are doing, but I never thought of applying it to my model trains. Thank you."

In 2005, we learned that PCMRC would have a permanent (41 x 19 feet) room in about a year. A layout design committee was

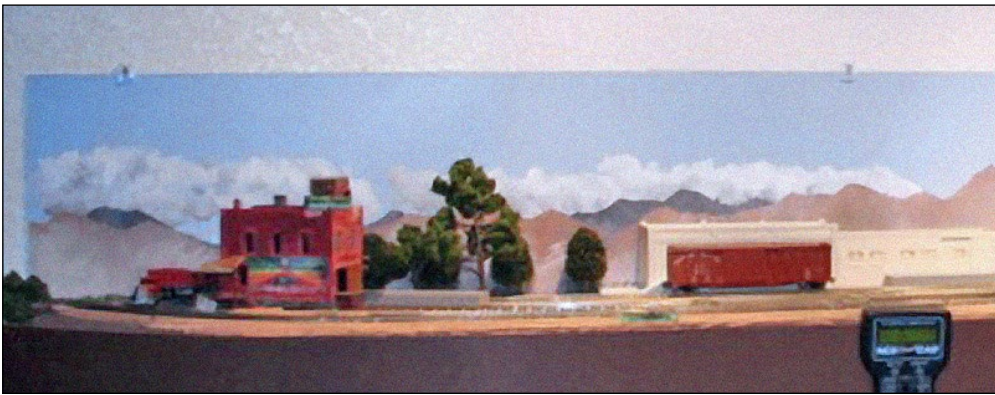

7. My first model railroad, a modification of the Time Saver design.

MY MODEL RR JOURNEY | 12

formed with me and Gary and another ops-oriented member, Dick Vogler. There is no better tutorial than working beside folks who have built many layouts. Discussing the “givens and ‘druthers,” and starting with a blank sheet of paper opens a neophyte’s eyes. We had to balance the desires of ops folks to spot cars with the need to run in circles for neighborhood open houses. The year’s planning culminated in a design [8] that survives today.

Our planning paid off. Within six weeks of getting the room in early 2006, we were running our first train on permanent track [9].

This is a good place to introduce my wife and best friend, Linda. She not only supports my hobby, she encourages it. She uses her artistic leanings and experience to enhance the layouts I work on. She also shares her ideas with other hobbyists by giving clinics and demos. Her first NMRA clinics were at a national convention. The business we built at Litchfield Station was due in no small part to her customer service expertise.

When Litchfield Station moved into a “brick and mortar” store in 2007, I wanted it to have a layout to demonstrate DCC. Since we

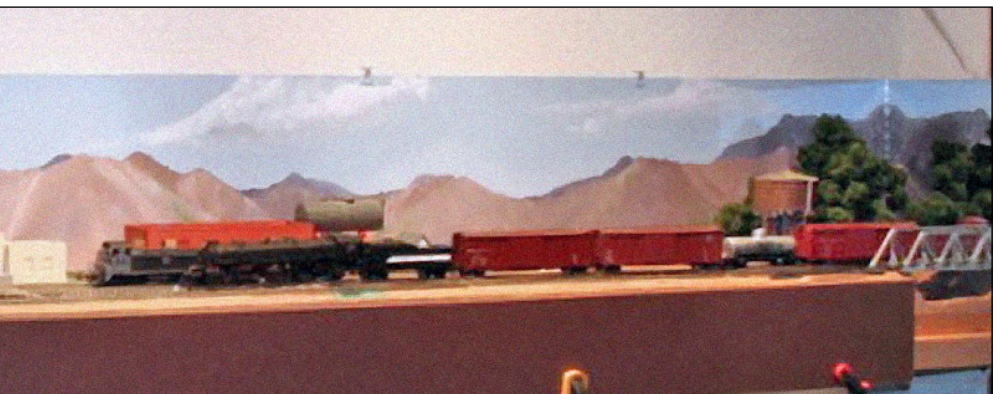

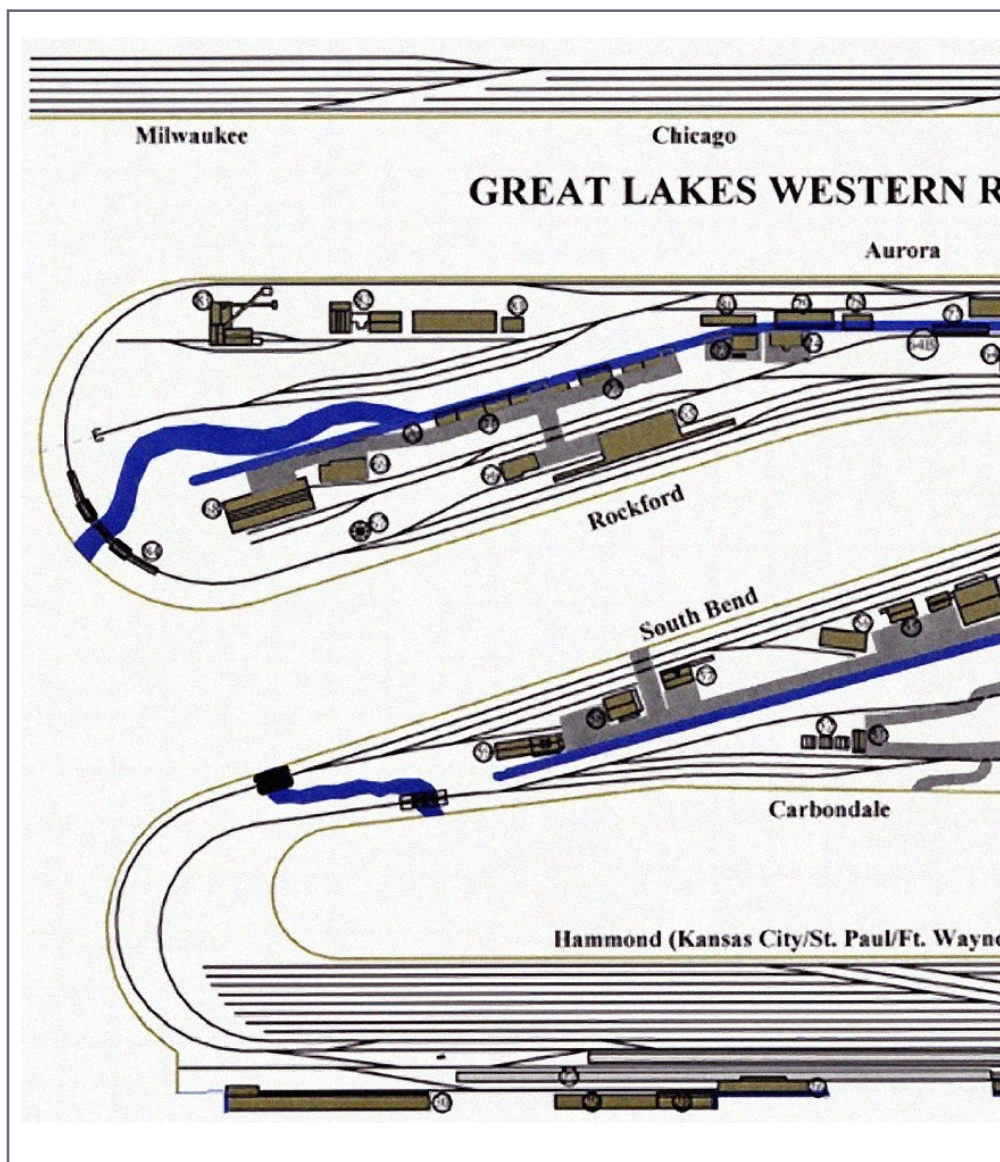

8. Track plan of PCMRC layout as designed in 2005.

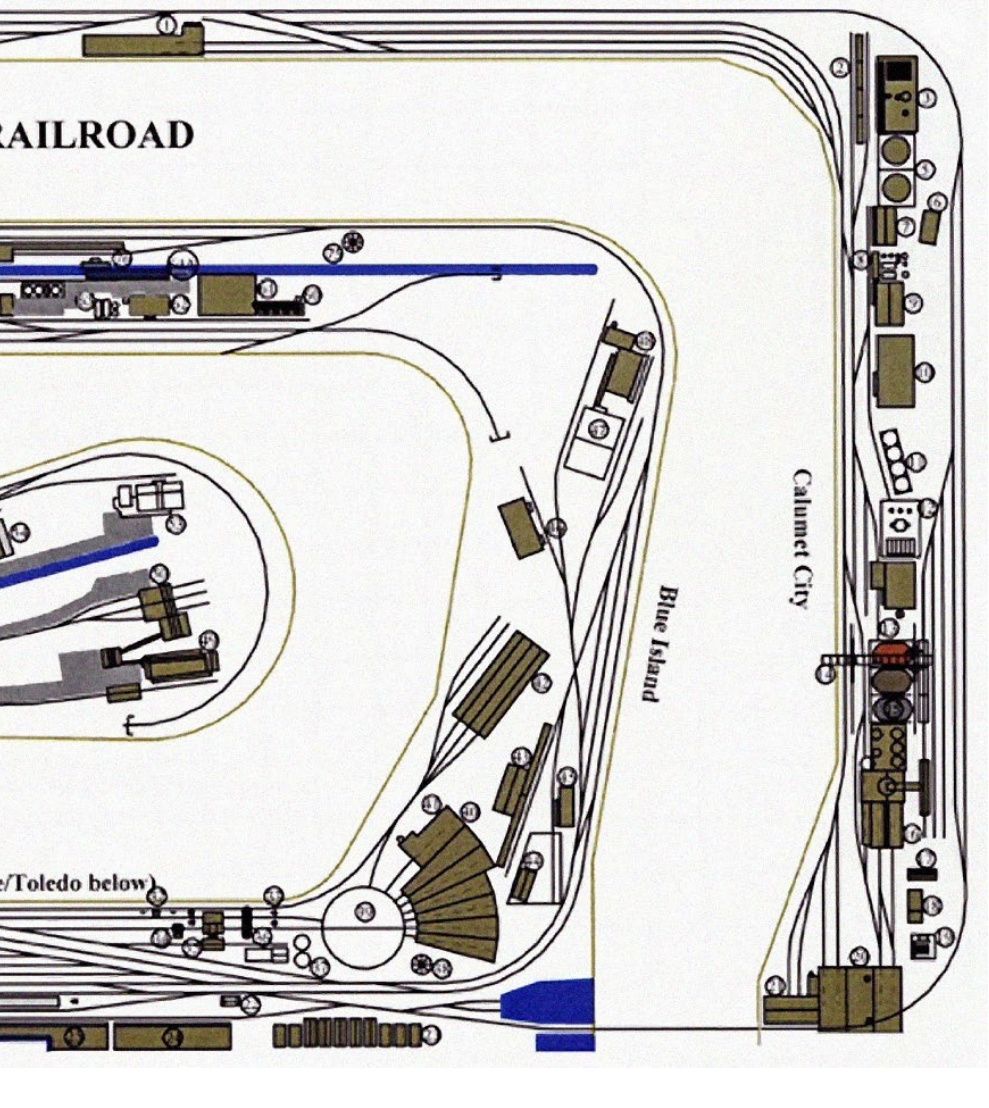

MY MODEL RR JOURNEY | 15

were going to sell the HO_n3 Blackstone products, it needed to be HO dual-gauge. This would be my second layout and was based on the Denver skyline that Linda and I knew from having grown up there.

Dick Vogler gave a track laying clinic for Litchfield Station in December 2008. In the course of a Saturday, the clinic attendees laid some of the track for the layout [10] as a way to hone their skills. I finished off the track and wired the layout - my second. Any of three DCC systems (Digitrax, Lenz or NCE) could operate it.

Late in 2009, Gary Gelzer suggested that I get my NMRA Chief Dispatcher AP certificate. My response was something like “Huh?”



9. PCMRC first run (left) on track in use today (near the background gondolas loaded with scrap metal).

MY JOURNEY | 16

What's that?" It turned out I had done most of the operating that was required and just needed the signatures. There is a requirement for setting up a time table and creating string diagrams to show that the trains can actually run as scheduled. Not too difficult after I reduced it to a spreadsheet.

While looking up the requirements for Chief Dispatcher on the NMRA web site (nmra.org/education/achievement-program), I realized that I was also qualified for Model Railroad Author. I had given the clinics and had the certificates and files, dating back as many as five years. I hadn't collected any signatures along the way. With some detective work, I got the signatures necessary and the paperwork submitted. The knowledge base from that Litchfield Station web site is now on my own site (mrdccu.com).

Contest models are eye candy. Since the hobby isn't a

Combo Right Clamp™

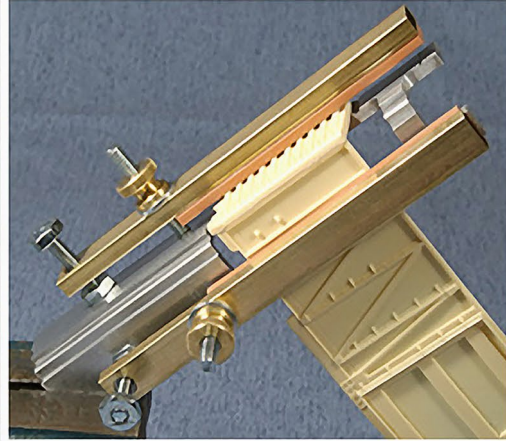

Combo Right Clamp™
with cast resin boxcar

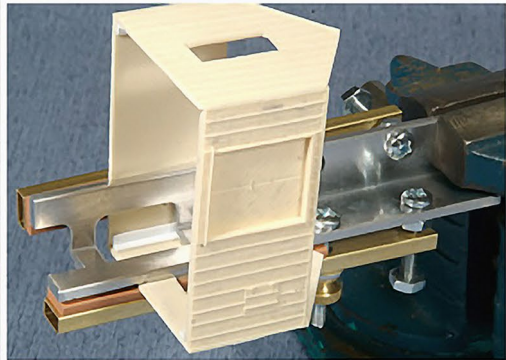

Combo Right Clamp™
with Wolf Design Pump House

**Click here for
all our products ...**

Tools for Modelers

Coffman Graphic Solutions Co.
1500 River Circle, Richmond,
KY 40475-7907

MY MODEL RR JOURNEY | 17

competitive sport to me, I volunteered as a judge partially to get a close look at nice models. I got to bounce ideas off the other judges and observe what entrants did.

Bringing it home

In 2010, we sold Litchfield Station. The layout that I had started there [10] had the possibility of qualifying for the Civil and Electrical Engineering certificates, as well as the Scenery certificate. I said a tearful goodbye to it.

I began work on a narrow gauge garden layout [16] (mrdccu.com/layouts/RMP) and a bedroom-sized HO layout [11] (mrdccu.com/layouts/SMVRR). I registered the garden layout with the NMRA with pike name Rocky Mountain Pacific (reporting mark RMP); that could also stand for Real Money Pit.



10. Litchfield Station layout: HO and HOn3 capable of using any one of three DCC systems.

MY MODEL RR JOURNEY | 18

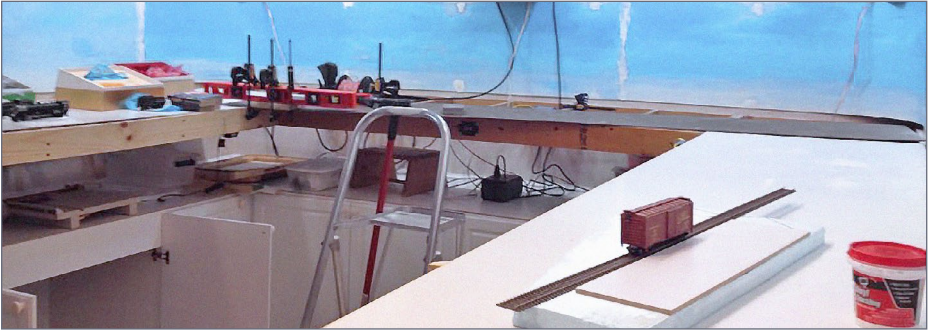

11. In 2010, I started on an HO model of the Santa Maria Valley Railroad in a small bedroom. Here is its status in October 2015.

In 2011, three events steered my journey.

The NMRA national convention in Sacramento had a “Modeling with the Masters” session building laser cut structures that included Fran and Miles Hale. Linda and I had met them at a prior convention. This was the first time I got to spend several hours with them on strictly technical issues. Discussions started then for them to come to Arizona to do a three-day structures clinic.

Remembering the heavy-handed modeling of my youth, I was not certain that I would have the patience to develop the skills to earn the “artistic” AP certificates. So, it was a major leap of faith when I publicly committed to working on my MMR at the NMRA PSR convention in Flagstaff that summer.

That fall, I started writing the “DCC Impulses” column for MRH. The first one was in the October 2011 edition (mrhmag.com/magazine/mrh-2011-10-oct/dcc_impulses). I worked forward from there as a form of a DCC handbook. Since then, I’ve written 53 columns and this is the second article for MRH.

In March of 2012, Fran and Miles Hale did a three-day structures clinic in Arizona. We had a dozen folks from two states

MY MODEL RR JOURNEY | 19

participate. Hales brought kits and materials for 12 structures per person. Most folks finished three to six.

The Hales introduced us to the difference in mindset between contest judging and AP evaluation. Judging is finding the best model amongst those submitted to a contest. Evaluation concerns how well the modeler achieved their AP goal with one particular model.

What I took away was the realization that simple items could earn (even if barely) a merit award in AP evaluation [13]. I also took away merit awards for five structures [12] and a good start on the sixth [15]. I finally started to believe that I could make good on my statement of the prior summer and earn my MMR without ever entering a contest.

Bob Libbey (one of the participants in the Structures weekend) and I began spending every Wednesday night working on the hand-laid track necessary for the Civil Engineering certificate. Changes in Bob's life resulted in his moving out of state before either of us could complete our MMR. I miss Bob and those Wednesday nights.

I started work on scenery for the South Bend portion of the PCMRC HO layout. I had never done serious scenery before. Dick Vogler showed me how to do layered rock outcroppings with wet plaster, then I added seeping water [14].

Arizona created its own OpSig weekend. Desert Ops (desertops.org) was coordinated amongst ten local layouts and scheduled to debut in October 2012. Three of the ten scheduled layouts were in our PebbleCreek community: PCMRC's, Gary Gelzer's and Dick Vogler's.

Gary, who was three weeks older than I, died less than two weeks before Desert Ops. He had appeared healthy when he left on

MY MODEL RR JOURNEY | 20

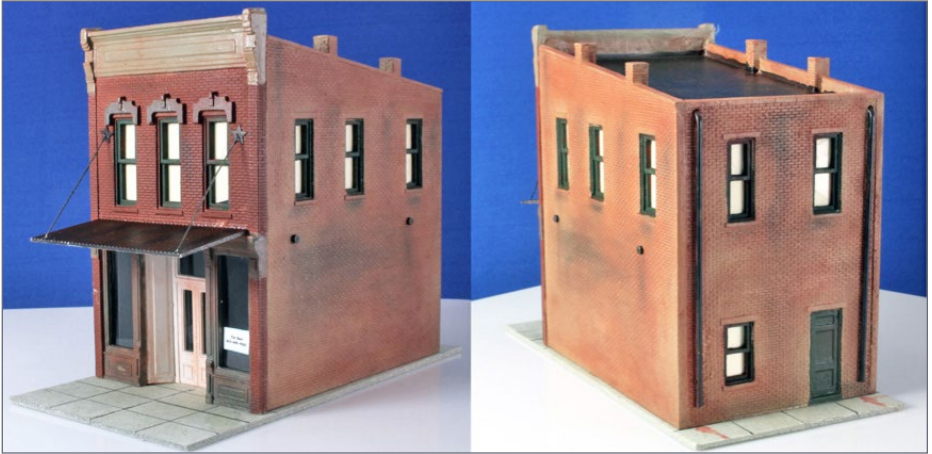

12. Kelly's Corners kit from the Structures weekend. Don't know if I'll ever have place for it, but I like it.



13. A cabin from the Structures weekend, now on the PCMRC layout. Enhancing the simple laser kit made it a Merit Award winner with added details including the paper roof and a foundation, with scratchbuilt items like the porch deck, supports and railing; and interior flooring with individual joists and floor boards.



14. Seeping water and hand-carved rock outcroppings set the PCMRC layout apart. The water seeps out of the rocks in the center right of the photo and runs down into the rubble beside the track. It flows to the left in this photo and empties into a river.

a 5-week cruise in July. Cancer took him two months after he returned. His departure was a shock and a loss to many communities, including PebbleCreek, local operators and OpSig folks.

At Gary's request, I hosted four Desert Ops sessions on his layout. I also hosted a couple of memorial sessions for local regulars on his GNC in the few weeks after Desert Ops.

Gary's death and lack of preparation contributed to the desire by Linda and me to write the article for MRH: "Slow Orders, Dangerous Track Ahead" (mrhmag.com/magazine/mrh-2012-12-dec/slow-orders-dangers-ahead). We gave a clinic based on that article at the 2015 NMRA national convention in Portland. It is being added to the NMRA's EduTRAIN library.

Focus on the target

My pursuit of MMR recognition became more scientific. I created a spreadsheet (mrdccu.com/curriculum/nmra-ap/mmr.xlsx) and tracked my progress. Many MMRs that I've talked with say that their path was vague and scattered until they reduced it to a spreadsheet. There is the satisfaction of coloring in boxes or watching percentages change. The sooner you start to plan the quicker your plan will come together.

The garden layout (mrdccu.com/layouts/RMP) [16] slowly started to take shape. What I discovered is that scale becomes elastic in the garden. Everything from 1:20.3 to 1:32 is run on 45 mm (gauge-1) track, with 1:24 and 1:29 being the most popular. Turns out that 1:20.3 is correct for 3-foot gauge and 1:32 corresponds to 4' 8-1/2" gauge. The whys and wherefores of all this could make another article.

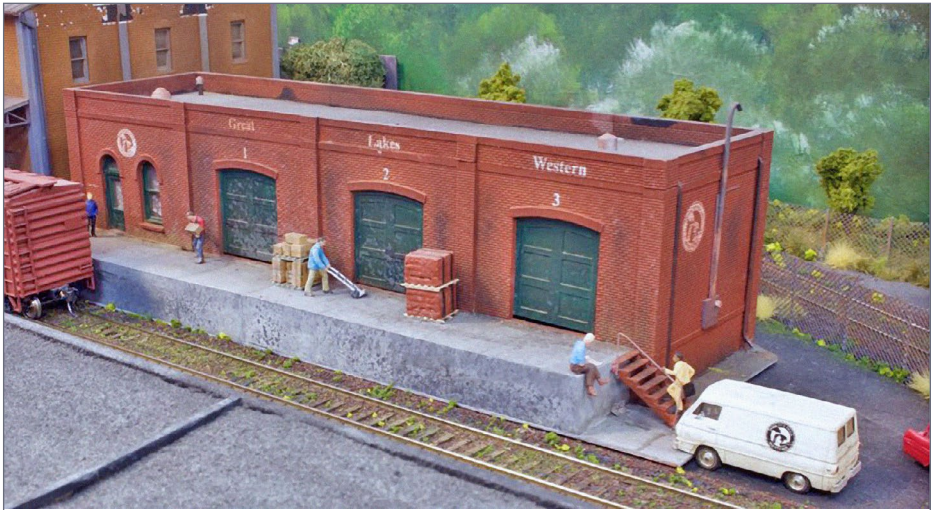

15. The GLW Freight House was my last of the six Merit Award structures needed for the AP certificate. Here it is in situ on the PCMRC layout in South Bend.

MY MODEL RR JOURNEY | 23

Finishing the Structures certificate required some scratchbuilt structures and the RMP needed a few bridges. So I scratchbuilt a small trestle [18], a concrete culvert and a wood culvert, as well as a MOW shack [17] in 1:20.3.

As I was building experience in areas of model railroading other than DCC, I felt a bit like Haley Mills or Patty Duke. Once one gets a reputation in one area (whether it's electronics or being a child star), it is hard to change folks' image of you. No matter what, I think I'll only be Mr. DCC to some folks forever.

I got another invitation to Prairie Rails for February 2016. This gave me an opportunity to focus on the Cars AP certificate. I took a couple of completed cars with me. There I used Miles Hale's shop and counsel to build another six cars [19]. The cars were evaluated and the certificate processed before I left. Also the week there let me rub elbows with many talented modelers and expand my ideas.

The Electrical and Civil certificates (the last two for my MMR) were completed at the end of March, 2016. The irony of it all is that the last certificates I earned were the engineering ones.



16. The Rocky Mountain Pacific narrow gauge garden layout in October 2015.

MY MODEL RR JOURNEY | 24

But what does that mean? I am, as another MMR said, “certifiably average.” Another calls MMR “Mediocre Model Railroader.”



17. Scratchbuilt MOW shack in 1:20.3. The door knob and hinges are from Linda's bead collection.

MY MODEL RR JOURNEY | 25

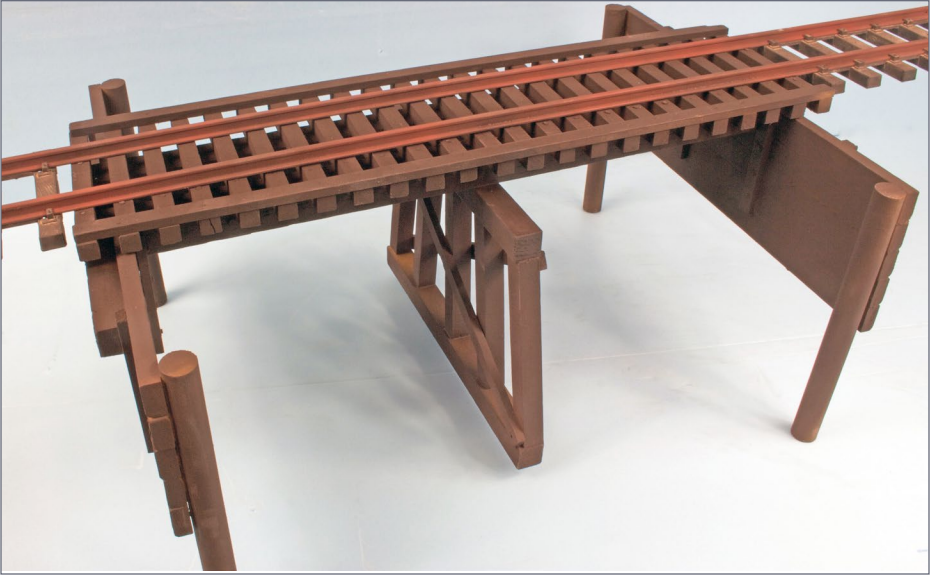

18. Single bent scratchbuilt 1:20.3 scale trestle.

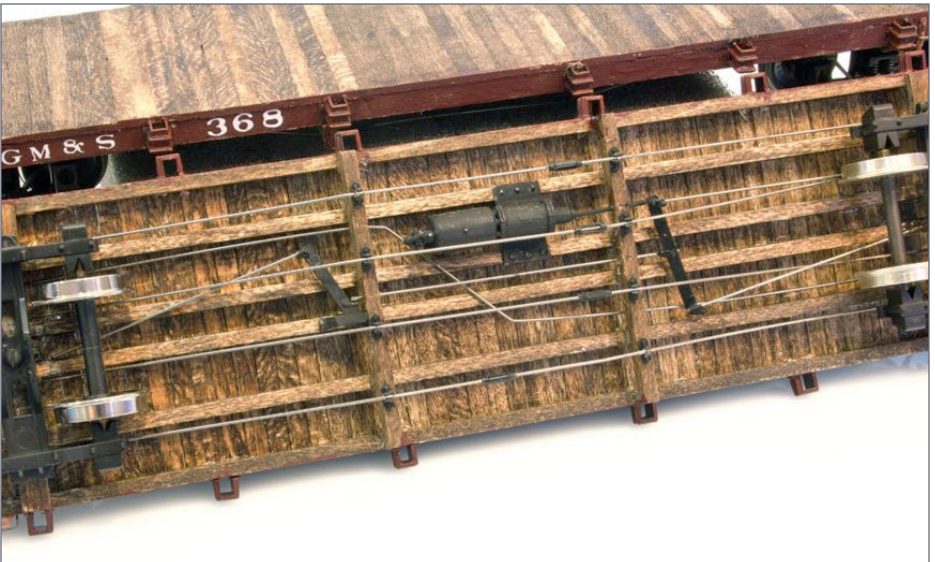

19. Top and bottom of two scratchbuilt On30 flat cars. Merit Award winners.

MY MODEL RR JOURNEY | 26

Yes, I marshaled a lot of items together to make up the whole. But each item by itself wasn't that big a deal.

Build a structure that gets at least 87-½ out of 125 points in AP Evaluation or a NMRA contest; that's 70%, a C- grade. Repeat as needed to have a total of 12 structures, half scratchbuilt and half merit award winners. Repeat for a total of eight cars. Judge a division contest. Repeat. Judge a regional contest and repeat. Go to an op session. Volunteer for a NMRA event. Do a clinic. Write an article. Get elected to a NMRA office. Wherever you go, get signatures "contemporaneously." That means "when you do it."

Where does my journey go from here? I feel as if I have just started. I have two personal layouts [11 and 16] to finish, and I'm working on the scenery in South Bend on PCMRC's GLW HO layout [14] [15]. There is still a Scenery certificate I can earn there. As I write this, I'm building a Bar Mills kit for the PCMRC O-gauge modular layout.

Becoming a MMR has opened my eyes to some aspects of our hobby that I didn't even know existed before my quest. I know now that I can be a decent modeler. I just need more practice and a generous shot of patience.

I got a fortune cookie that sums it up: "Perceived failure is often times success trying to be born in a bigger way." That hangs over my workbench.

Some parting thoughts

Be a positive influence on someone. There are lots of folks who would love to know something that you know. It will make their journey lighter. Share with them. Today. Learn something from them.

Look back on the events in your own life and think about those folks who influenced your thinking, concepts and life direction. Thank them, if you still can.

MY MODEL RR JOURNEY | 27

At the NMRA PSR convention last fall in Scottsdale, Dale Angell gave the keynote address ([youtube.com/watch?v=2Q4eEkTQYI](https://www.youtube.com/watch?v=2Q4eEkTQYI)). In that address (about 28 minutes into the video), he challenges folks to join the NMRA. Not just to pay dues to the organization but to get involved with the Achievement Program.

That fits into something I just read in a book: *More Iditarod Classics* by Lew Freedman (2003). He collected stories from Iditarod (sled dog) race participants in the early 2000s. Bruce Lee, who had, at the time, run seven times and never finished higher than 10th place said, “The people I feel most sorry for are the fans, because they really don’t get to be out there and see what we get to see.”

You can sit on the sidelines and watch others or you can get your feet wet. Go do it for yourself. If you don’t stretch yourself, you won’t know what you can really achieve.

I really like that I’ve been one who has been able to see the things that model railroading has shown me. Linda and I are thankful for the friends we have found along the way, only a few of whom could be mentioned in this article.



**Click here for
reader comments**

BRUCE PETRARCA, MMR



Bruce was raised in Colorado and Wyoming and moved to California in high school.

As an engineer in the computer and aerospace industries, he moved from coast to coast, but his heart remained in the southwest and the Rocky Mountains.

He and Linda, his wife of almost 40 years, encourage each other's hobbies and share an interest in aquatic creatures. They are both scuba divemasters. Bruce has studied and taught underwater photography (still and video). Some of his work is on his web site (petrarcas.com). ■



1. Hank waves to an oncoming engine as he waits to pull his own shop-built speeder out onto the Mt. Coffin & Columbia River RR mainline. M.C. Fujiwara scratchbuilt this signature backwoods boxcab as a removable shell that slips over a Bachmann 44-tonner mechanism.

How to bash **A WOOD-N BOXCAR**



• INDEX

• TABLE OF CONTENTS

BY M.C. FUJIWARA

Backyard shops way out in the wooded boonies built boxcab/speeder beauties and beasts – you should too. ...

MANY SHORT LINES CONSTRUCTED THEIR OWN speeders, boxcabs and other odd types of locos, giving the green light for modelers to make their own unique and plausible motive power. A friend and I started a “Build A Boxcab Challenge” thread on a forum, and I took the opportunity to scratchbuild a backwoods boxcab speeder that fit the early 1900s Pacific Northwest theme of my now-dearly-departed 2’x4’ Mt. Coffin and Columbia RR layout [*see Model Railroader* Sept. 2012, *Model Railroad Hobbyist* March 2013].

Using photos of turn-of-the-century urban boxcab steamers and diesel-electrics for inspiration and reference, I built my speeder shell using stained stripwood around a styrene frame that slips over a Bachmann 44-tonner chassis—a quality mechanism equipped with dual DC/DCC decoder and LED lighting.

The growing availability of good mechanisms – Bachmann’s 44-, 45-, and 70-tonners in HO and N and Kato’s NW2 and 11-105 “Kritter” chassis in N – provide solid starting points for creating your diesel-electric boxcab or steam-powered speeder. You can use interchangeable shells over the same mechanism, so it’s easy

WOOD-N BOXCAB | 4

to match equipment from various eras or lines with your layout's current theme.

While I share with you my own backwoods boxcab construction process, I also encourage and challenge your home shops to cobble together plausible and unique motive power that brings individual personality to your layout.



**Click here for
reader comments**

ADVERTISEMENT



**1st choice for model
railway supplies
and service.**

**Expedited mail
service available
across North America.**

Click to visit:
WWW.CVRCO.COM
1 800 464 1730



• INDEX

• TABLE OF CONTENTS

STEP 1: MAGICAL REMOVABLE STYRENE SHELLS

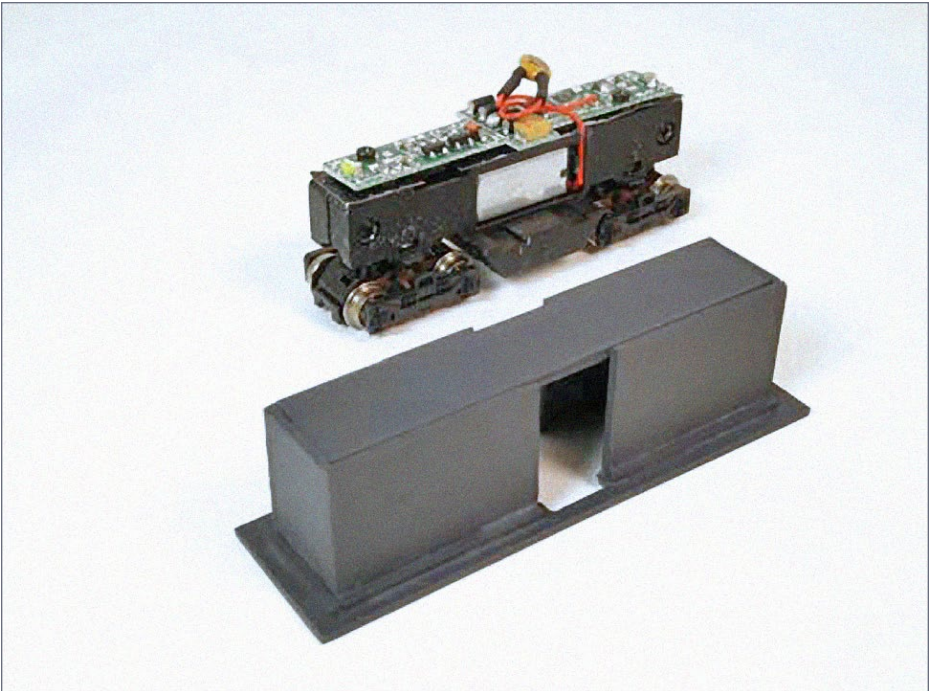

2. A simple shell of .040" and .060" styrene slips snugly over the top of a Bachmann 44-tonner mechanism, providing a sturdy structure for the couplers and the fragile stained stripwood wrap. The gap in the middle allows for airflow to prevent overheating. The styrene shell is spray-painted dark gray so it disappears behind the doors and windows of the outer structure.

STEP 2: FRAMING SIDES AND ENDS

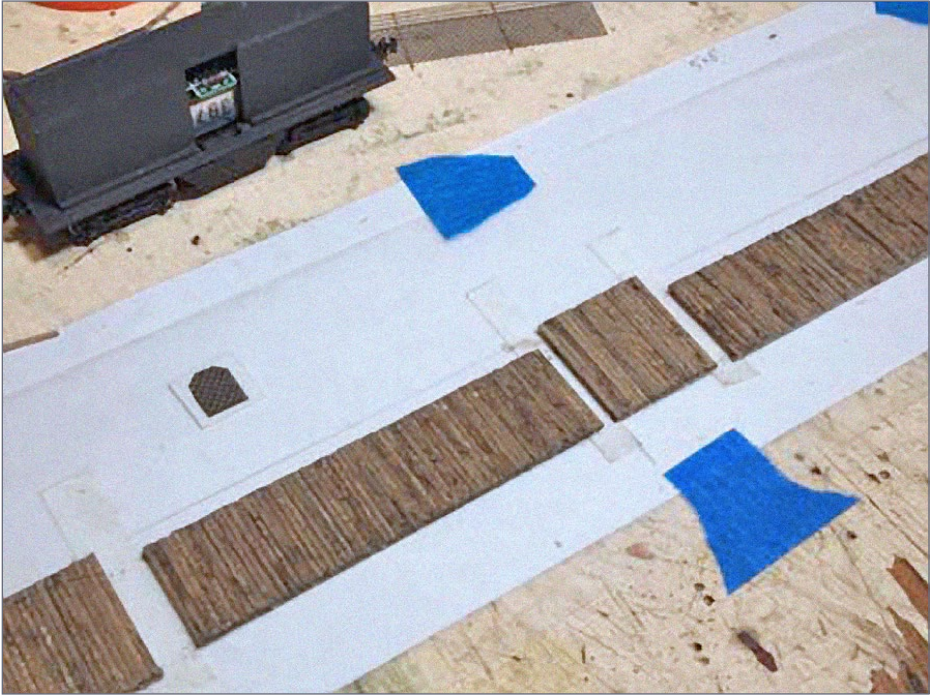

3. Once the styrene frame is finished and MTL Z-scale couplers are installed, draw a template for the sides and ends. Use prototype photos for reference and, while you don't need exact scale measurements, try to keep realistic ratios between doors, windows, and wall heights and widths.

I place wax paper over the scale drawings to protect them from glue. Use thin strips of double-sided tape to hold the horizontal stringers in place. Glue individual pieces of strip-wood, stained in a bath of 70% isopropyl alcohol and India ink, to the stringers using wood glue. Windows, doors, and the roof curve will be cut out after the glue has cured.

STEP 3: CAREFUL CUTS – WINDOWS AND DOORS

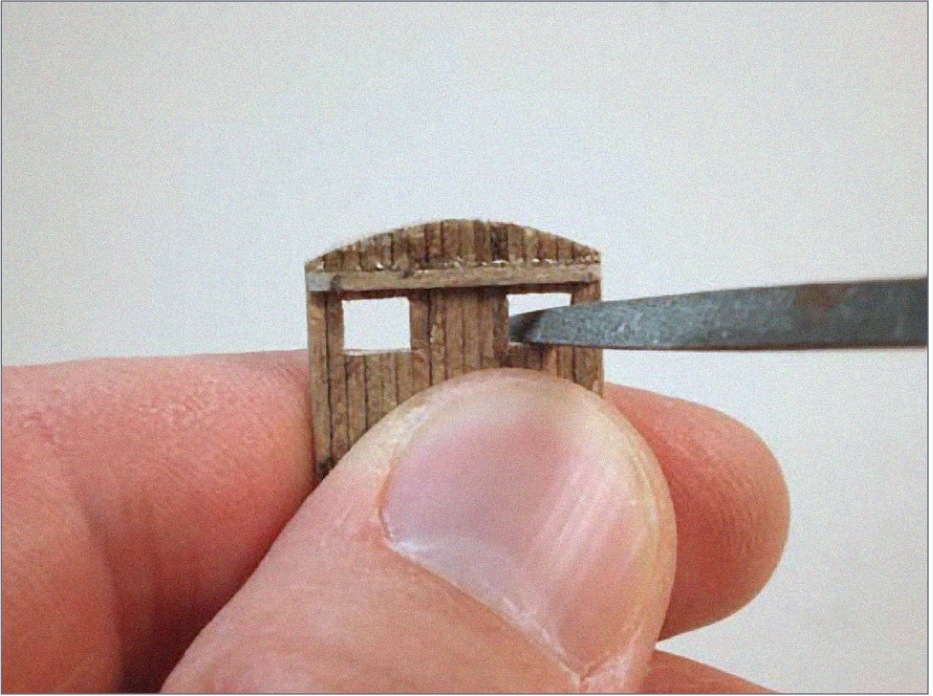

4. After the wood glue dries, use a sharp hobby knife to cut out both the windows and doors, as well as the arc of the roof. Making multiple light passes with a sharp blade along a slim straightedge works better than trying to cut through the stripwood all at once.

Apply more wood glue, CA, and stripwood from the back to help reinforce the sides. A small triangular file helps even out the lines within windows. Hold the piece close to the action (cutting or filing) to reduce accidents or breaking. It's always easier to take off more material later than adding it back after an "oops!"

WOOD-N BOXCAB | 8

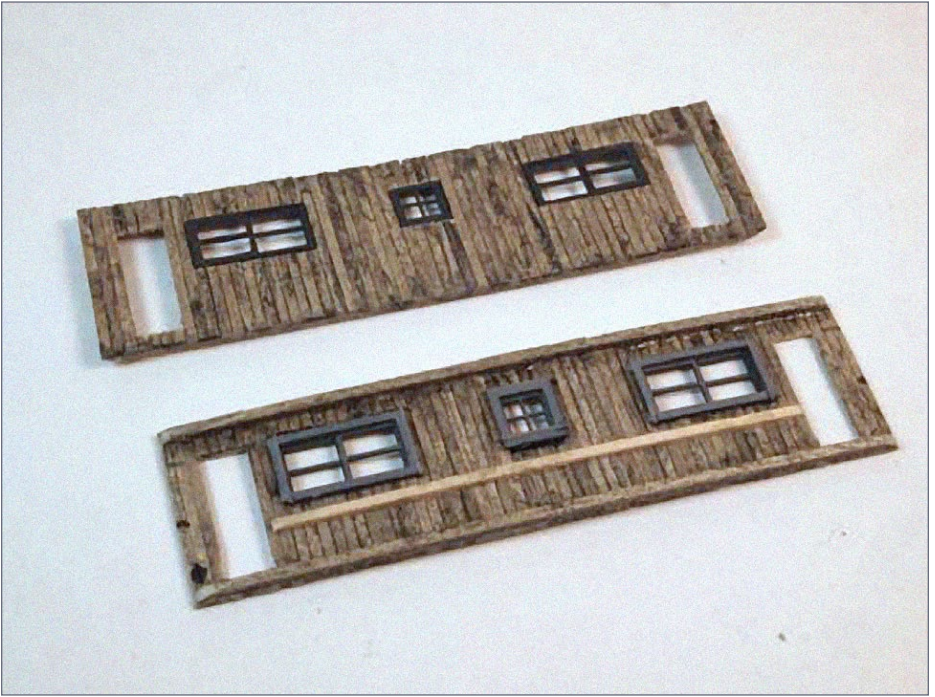

5. While the top cab section has the clean outside lines of the boxcab side, doors, and windows, the bottom section shows the ugly inside: Tichy and Grandt Line windows pressed into place backwards so their moldings don't overwhelm the outside, with extra pieces of stripwood for support. The stringers have edges beveled to fit with the ends.

Scrap pieces of clear plastic – I got mine from the MTL 905 Z-scale coupler package – are affixed with CA on the inside of the windows for glazing. The slight bowing of the side sections disappears when the sides are glued together around the shell.

STEP 4: THE FLAT TRUTH OF DETAIL INSTALLATION

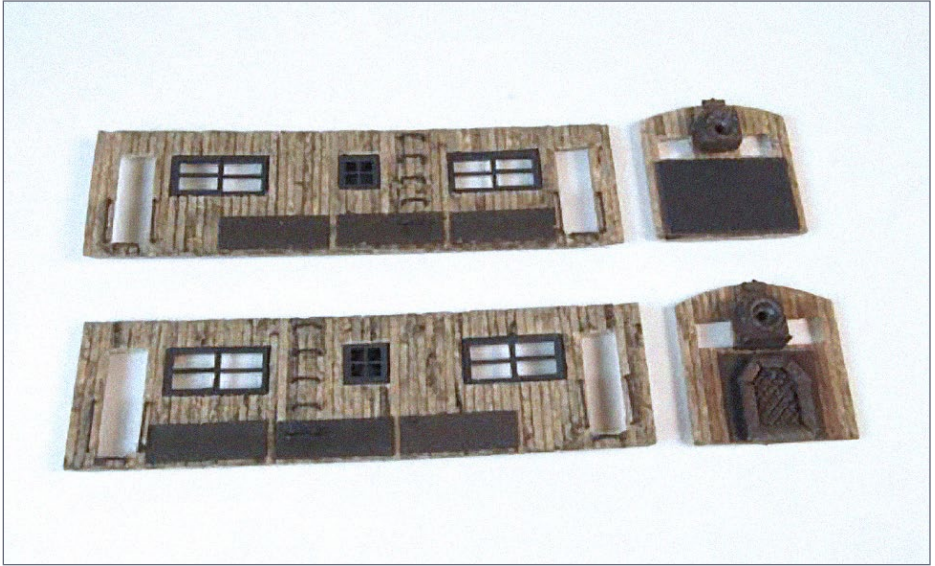

6. Add as many details as you can – grab irons, styrene skirts, grilles, and lamps – before gluing all four sides to the shell. All these details are much easier to install on the flat sections, than later when they are part of the shell.

Gold Metal Models provides a template to drill holes for grab irons of various widths. A pin vise usually works better than using a motor tool, but you can also just prick an indentation with a T-pin or needle and use CA to hold the grab iron in place.

I crafted the front grille from a section of scrap metal fence, cutting it to the desired shape. I framed it with Plastruct “L” beam sections, cutting and beveling them to fit. The lamps are HO metal castings from Detail Associates, and the panels and skirts are .010” styrene. I spray-painted all “metal” parts Floquil Grimy Black, then misted them with Scalecoat II Oil & Graphite before affixing them to the body with CA.

WOOD-N BOXCAB | 10

I drilled a hole through the center of both lamps for a section of fiber optic to reach the LED inside the styrene shell. It's much easier to drill while the section is flat rather than after shell assembly.



7. I used a large broad file to square the ends, then fit all four sections onto the styrene frame. Given all the delicate detail on the outside, fingers on all four corners make the best clamps to secure the sides. I had to hold the pieces in place for only 30 seconds or so with thick CA, and even with wood glue. Once the outer walls are set, you can reinforce the outer stripwood and inner styrene frame by slipping pieces of scrap wood or styrene between the two in the middle, and at the corners.

STEP 5: CURVED ROOFS & WELL-HUNG SKIRTS

A common practice of early 1900s inner-city motive power was to use skirts to protect people and horses from the wheels and working mechanism of the locomotive (see Thomas the Tank Engine's friend Toby for a good example). I installed styrene panels sprayed with Grimy Black and misted with Graphite to cover the trucks, replicating the prototype.



8. The roof is .010" styrene secured with CA. I bored a small hole with a round file for a short piece of tubing (metal or styrene is fine) to create the exhaust stack. I slipped a rectangular piece of black construction paper over the stack and glued it with CA. I used Bragdon Weathering Powders to blend everything together.

A short piece of fiber optic conveys the light from the LED to the locomotive lamps. I melted the outside tip of the fiber

WOOD-N BOXCAB | 12

.....

optic to mushroom the end. This is easier to do with the fiber optic out of the lamp casing. The other end is secured near the LED. The Bachmann 44-tonner stock light board uses a very light-blue LED, so by painting the fiber optic tip super yellow and/or gray I created a warmer, gas-lit color.

Scrap stripwood and small L-girder strips make four steps, one for each door. Hank, a graduate of the Woodland Scenics Engineer Academy, steps into the boxcab, bringing this contraption to life.



9. Hank hauls medicinal merchandise into Mt. Coffin, showing the back of the boxcab. Much of the “metalwork” – skirts, coal storage bunker, access hatches – was crafted out of .010” styrene. Exactly what mechanical magic makes this Frankencab move, only Hank truly knows, but it can pull four to six cars on tight curves through the Pacific Northwest mountains to the Columbia River-side cannery town of Mt. Coffin, and that’s a lot of medicine.

.....

Additional photos



10. Mt. Coffin, Oregon, early 1900's: On the banks of the Columbia River, Hank waves to a passing Climax-led coal train before leading his home-shop-built boxcab out onto the Mt. Coffin & Columbia River RR mainline. While the 18-Ton Climax is a Randy Gustafson resin kit over a Kato 11-105 chassis, and the 20-ton coal cars are Chris Schmuck / Republic Locomotive Works kits, M.C. Fujiwara's scratchbuilt speeder shell (snug on a reliable Bachmann 44-tonner mechanism) is a one-of-a-kind character running on the layout stage.

WOOD-N BOXCAB | 14

Reference photos

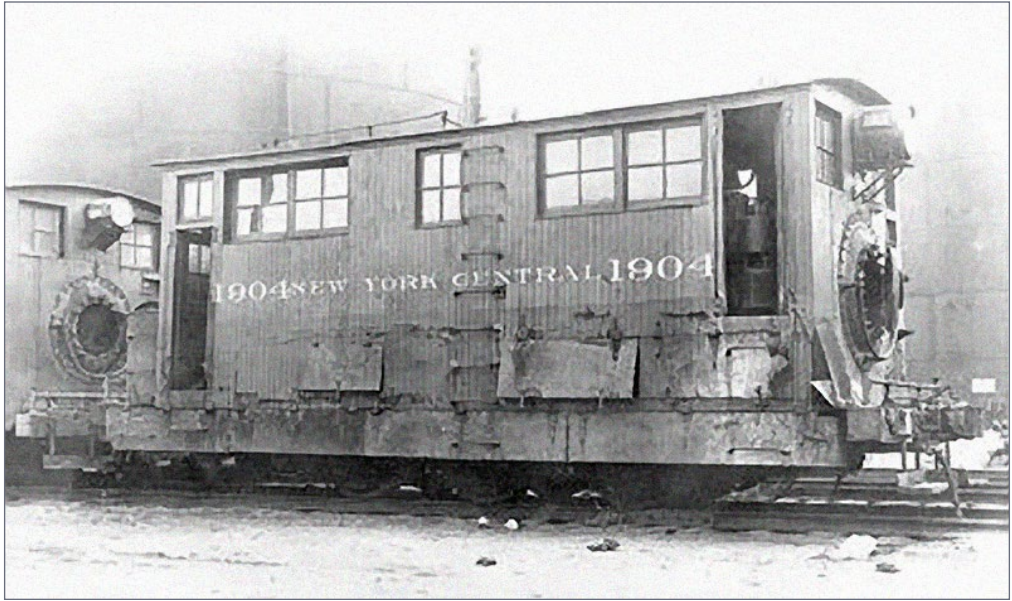

Continued on next page ...

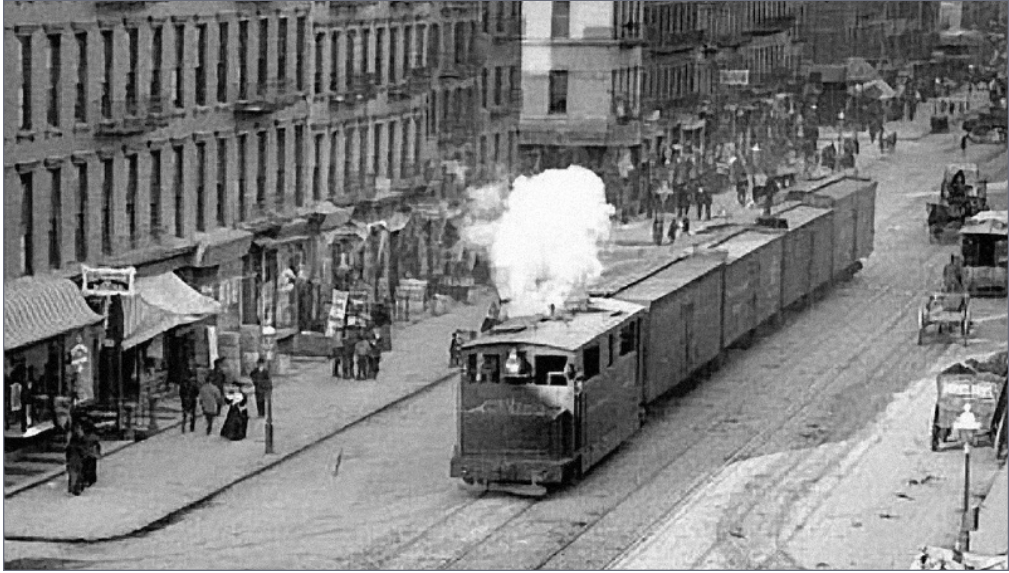

11-13. Turn-of-the-Century NYC street runners.



[Click here for
reader comments](#)

**Want to help keep
MRH free?**

Then *click* on ads!

WOOD-N BOXCAB | 16

M.C. FUJIWARA



A San Francisco Bay Area native, M.C. has modeled N scale since the mid '80's. Currently, raising his two teens and his more-than-full-time work as Communications Coordinator for the non-profit Legal Services for Prisoners with Children (prisonerswith-children.org) displace any model railroading, but many of his personal and Silicon Valley Free-moN projects ([facebook.com/SiliconValleyFreeMoN](https://www.facebook.com/SiliconValleyFreeMoN)) are still featured on his archived Yardgoat Layout Design website (web.archive.org/web/20151226225414/http://yardgoatlayoutdesign.com/5.html) or on his YouTube Channel ([youtube.com/user/mcfujiwara925](https://www.youtube.com/user/mcfujiwara925)).

.....

• INDEX



Fire Cracker Sale!
June 6th Through
Sept. 30th 2016



N Powered PA-1 from \$77.77 each*
 *(See Website for Prices for Non-Powered A/B Dummy's)



NEW HO Gondolas from \$20.77 each



N Freight Cars From \$9.97
 with Micro Train Couplers

LabelleTM

"If it moves, Lube It!"

Don't Forget to Maintain Your
 Train Collection with
 Labelle Lubes and Conditioner.



New Items
Added Monthly

www.Con-Cor.com/website

888-255-7826



• TABLE OF CONTENTS

BUILD A SAFE STRAIGHTEDGE



BY MIKE DODD

Keep your ruler from slipping and your fingers safe ...

HOW MANY TIMES HAVE YOU READ A MODELING article that says to cut or score something with a hobby knife and a straightedge?

I'm nervous every time I do this. Holding down the straightedge puts my fingers too close to the sharp blade for comfort. Plus, I've had the straightedge or the material slip, ruining the cut.

• [INDEX](#)

• [TABLE OF CONTENTS](#)



[Click here for reader comments](#)

Four years ago I laid 400 square feet of floor tile in my workshop. Cutting the tiles presented these same issues, but on a much larger scale. No way was I going to hold a yardstick and draw a utility knife past my fingers!

To work more safely, I built the straightedge shown here, and it works great. Even though it was made for cutting floor tile, I find it useful for modeling tasks like scoring sheet styrene for model structures or trimming paper signs and labels.

The concept is simple: Add a handle to keep fingers out of harm's way. Other benefits include:

- Two metal straightedges rest flat on the material being cut, decreasing slippage for better cutting accuracy.
- A large handle affords a solid grasp and allows firm downward pressure.
- Can be scaled to meet special requirements. Check out the small version shown in [4].
- Inexpensive – less than 10 bucks, assuming you have a piece of wood.

Construction

I'll describe how I build my large and small straightedges. Feel free to customize the design to your own needs or for the materials you have at hand.

BUILD A STRAIGHTEDGE | 3

THE WOOD BODY: I used a 16" length of oak 1x6 ($\frac{3}{4}$ " x $5\frac{1}{2}$ " actual size). This straightedge actually is a do-over. I used $\frac{3}{4}$ " plywood for the original, but it warped slightly after several years, and wouldn't securely hold thin materials like paper. I had the oak board on hand, but a pine 1x6 would work as well. You could even use a 2x4 – nothing is magic about the $5\frac{1}{2}$ " width.

THE HANDLE: My handle came from a ceramic floor trowel purchased at Lowe's for \$2.48. The handle on this trowel is attached from underneath with two screws – exactly what we need for this project. Avoid trowels with handles that are welded to the blade.

Remove the handle from the trowel and use the holes in the blade as a template for drilling the wood body. Angle the handle on the body to provide a comfortable grasping angle.

Drill two holes for the mounting screws, then turn the wood over and use a $\frac{3}{8}$ " Forstner bit to counter-bore two $\frac{1}{4}$ "-deep holes to recess the screw heads [2], so they don't scratch the material being cut. If you don't have a Forstner bit, a regular $\frac{3}{8}$ " drill bit makes a similar hole, but without the Forstner's flat bottom.

The straight edges

I used a spare aluminum yardstick from the workshop, but you can buy a new one for about \$3 at many hardware stores. Double-check that the yardstick actually is straight – two of mine were not. Nobody wants a crooked straightedge. Sight along the edge, or lay it on a known-flat surface like a kitchen counter or office desk top.

Cut the yardstick with a hacksaw, then file smooth all burred edges and sharp corners. This is, after all, a SAFE straightedge. One yardstick yields two 16" lengths – one on each side of the body – plus a 4" piece for the small straightedge.

BUILD A STRAIGHTEDGE | 4



1. Overhead view showing the handle and the two 16" aluminum yardstick sections.



2. One of two screws holding the handle to the body. It is recessed to prevent marring the material being cut.

BUILD A STRAIGHTEDGE | 5

Four short pieces of double-side foam tape affix each 16" edge to the wood body. The edges extend about $\frac{1}{4}$ " beyond the body



3. Side view showing the handle and the double-side foam tape that affixes the yardstick sections to the body.

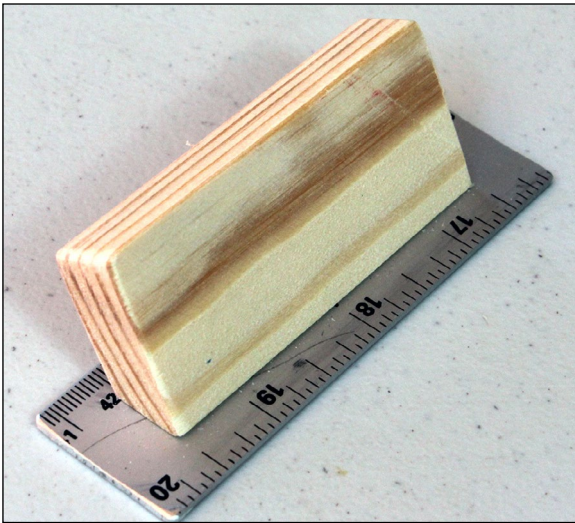

4. Small version of the safe straightedge.

so the measurement markings can be seen – a handy ruler for a quick check before cutting. [1] shows both visible rulers and the handle, and [3] is a side view showing the foam tape.

THE SMALL STRAIGHTEDGE:

A simple handle glued to the 4" leftover yardstick section is all it took to make the small version of this tool [4].

Bevel one edge of a pine scrap for the handle, and glue it to the aluminum with Goop adhesive. The aluminum is too thin to recess screw heads, so the handle must be attached with adhesive.

The pine handle works OK, but I plan to replace it with a



FAST TRACKS

YOUR VERY OWN TRACK FACTORY

Make the most of your modeling experience.

Build perfect trackwork easily and inexpensively when YOU want it!



Check out our extensive (and growing!) online video library to learn how easy it is to hand lay your own trackwork with Fast Tracks tools and supplies.

Play Video 



shop online 24/7

1-888-252-3895

handlaidtrack.com

service@fast-tracks.net

BUILD A STRAIGHTEDGE | 6

metal cabinet pull, which will provide a much better grip. Home improvement stores sell a huge variety of cabinet pulls. Shop carefully and don't over-pay for a fancy model. Lowe's sells the pull shown in the parts list for \$4.09.

Summary

Adding a handle to a straightedge keeps fingers away from sharp blades, and allows applying pressure to hold the material in place. Two straightedges on the wood body provide a wide base and additional holding power. You can tailor the basic design to your individual needs.

PARTS LIST

- 16" length of wood, such as 1x6 pine, oak, or a 2x4
- Aluminum yardstick. [lowes.com/pd/123911-1099-AE141-0/?productId=1007805&Ntt=yardsticks&pl=1¤tURL=%3FNtt%3Dyardsticks&facetInfo](https://www.lowes.com/pd/123911-1099-AE141-0/?productId=1007805&Ntt=yardsticks&pl=1¤tURL=%3FNtt%3Dyardsticks&facetInfo).
- Handle from 9" ceramic tile trowel. [lowes.com/pd/464712-1255-2631PS-0/?productId=4717321&Ntt=tile+trowel&pl=1¤tURL=%3FNtt%3Dtile%2Btrowel&facetInfo](https://www.lowes.com/pd/464712-1255-2631PS-0/?productId=4717321&Ntt=tile+trowel&pl=1¤tURL=%3FNtt%3Dtile%2Btrowel&facetInfo).
- Two-sided foam mounting tape, 6'. [lowes.com/pd/394734-98-110/DC4294729388/?productId=3715096&Ns=p_product_qty_sales_dollar](https://www.lowes.com/pd/394734-98-110/DC4294729388/?productId=3715096&Ns=p_product_qty_sales_dollar).
- Cabinet pull for small straightedge. [lowes.com/pd/362554-81227-1429774294777203/?productId=3470389&Ns=p_product_qty_sales_dollar](https://www.lowes.com/pd/362554-81227-1429774294777203/?productId=3470389&Ns=p_product_qty_sales_dollar).



[Click here for reader comments](#)

MIKE DODD



Mike Dodd was given with an American Flyer train set at age 6, and within a few years had built a simple layout that consumed half his bedroom.

As an adult, Mike built a couple of HO scale layouts, but didn't become interested in modeling a specific railroad until 1994, when he started building his HO scale Virginian Railway. After eight years of timetable & train order

operating sessions, the layout was dismantled and given to a frequent crew member.

In 2011 Mike and his wife, Louise Kurylo, built a new house with a large train room where Mike plans to build a new Virginian Railway.

Mike is a retired computer programmer/analyst. When he is not modeling, he enjoys woodworking, metalworking, photography, astronomy, amateur radio (N4CF), and programming computers. He also copy edits many of the articles published in *Model Railroad Hobbyist*.

Mike and Louise live in central Virginia, and have two grown daughters.



[Click here for reader comments](#)

Bowser

EXECUTIVE LINE

GMD SD40-2 Locomotives

Features on All models:

GMD Steps, Air Hoses, MU Hoses, Cab interior, Metal grab irons, Brass bell and bracket, Brass horn, Drop Steps, Window Glass, Wind Shield wipers, ESU LokSound Select, DC versions have 21 pin DCC socket, Flywheels, Can motor, 40" wheels, RP25 flange, KD® couplers, each classification light is individually controlled.

Delivery January 2017

Pre orders due 6/1/16

Available with or without Sound
MSRP \$199.95 With Sound \$299.95

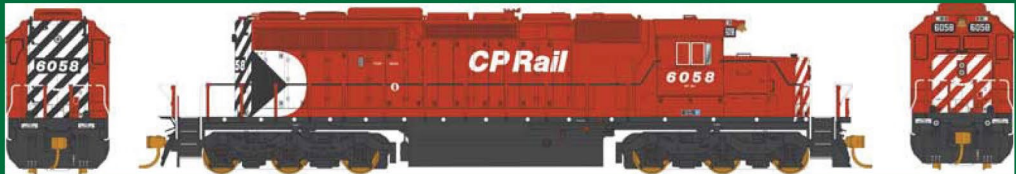

Click here to check out the details for these and other great Bowser products!

• INDEX

• TABLE OF CONTENTS

Your Complete Model Train Store

WWW.TRAINMASTERMODELS.COM

TrainMaster Buys, Sells & Trades Model Trains!

We have over 50,000 items to chose from!

Visit us to shop the most complete selection of items available!



TRAINMASTER MODEL TRAINS HAS BEEN TRUSTED FOR MORE THAN 18 YEARS!



ADVERTISEMENT

ADVERTISEMENT



Archer

FINE TRANSFERS
PROUDLY SERVING MODEL BUILDERS SINCE 1989

THE ORIGINAL
SURFACE DETAILS™

WE NOW HAVE MORE
THAN 100 SHEETS OF
RIVETS, LOUVERS,
TREADPLATE AND
MORE CAST ONTO
MICROSCALE CLEAR
DECAL FILM

FREE SHIPPING:

- DOMESTIC USA ORDERS
\$50 OR MORE
- INTERNATIONAL ORDERS
\$100 OR MORE

CLICK HERE TO
VISIT OUR WEBSITE!

*"Archer rivets
are easy to apply
and look great.
To me, they are
now a vital tool
in building
railroad models."*

Tony Thompson, Model
Railroad Author/Historian



Archer Fine Transfers • PO Box 1277 • Youngsville, NC 27596 • USA
(919) 570-1026 • info@archertransfers.com • archertransfers.com

TRINITY 3281 SUMMER 2016

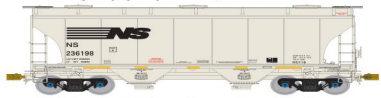

Norfolk Southern -- 12 #s

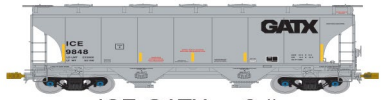

ICE-GATX -- 8 #s



Winchester & Western -- 12 #s



NRLX Ciment Quebec -- 12 #s



HWCX -- 7 #s

American Limited

www.americanlimitedmodels.com

**On tour at
this summer's
Indianapolis
NMRA
National**





BOB CASE'S BALTIMORE & OHIO



Also coming to
TMTV in June

BY BOB CASE AND
THE MRH STAFF

PHOTOS BY CHRIS THOMPSON

• INDEX

• TABLE OF CONTENTS



1. Engine 7133, an EL-3a 2-8-8-0, departs Hardman and immediately digs in to start the ascent with a long train in tow.



[Click here for reader comments](#)

MRH: HI, BOB. WHAT IS IT YOU'RE DOING HERE?

Bob: I'm recreating the west end of the Baltimore and Ohio railroad because it's the most difficult piece of terrain the railroad had to deal with. I've always found the history of that line to be an amazing story.

The B&O in 1827 felt threatened by the surrounding cities that were getting good canals leading to them. The B&O wanted to leap beyond the canal technology, so they went to railroad technology, which at that time was an unproven technology. Remember, we're talking 1827.

The B&O was determined to go across the mountains to Ohio, hence the name Baltimore *and* Ohio. But they didn't know how they were going to finance it. They didn't know how to get the locomotives over the mountains because no one had ever crossed mountains before with a railroad. It was a very bold move.

MRH: Was this actually the first section of the B&O?

Bob: No, but it was the first to cross the mountains.

MRH: How did you decide exactly what parts of this section to model?

Bob: Basically, I model the western end, which goes from Cumberland, MD to Grafton, WV. These were division points on the B&O, separated by about 100 miles. This section included the worst grades, which at points reached 2.8%, along with numerous curves. It became difficult for them to lay much straight track on this part of the railroad.

For over 20 years, I made field trips to West Virginia to see this B&O route first hand. For the first few years, I walked the tracks for long

distances because in a lot of these places, there's not much in the way of roads. To get to some of the areas you have to walk in. After years and lots of walking, I thought there's got to be an easier way.

I used to be a teacher, and one day, one of the kids in my class brought some mountain bicycles to a hobby show we had. He insisted they'll go over stones like you're riding on a sidewalk. He told me to take it out on the playground and try it. I did and thought: Now I know how I'm going to explore the B&O! I bought myself a mountain bicycle.

This particular bike was called the Rock Hopper. It was made with resilient steel that you could feel flex when it went over bad bumps. It had special tires with self-sealing tubes in case you got a flat.

The self-sealing tires were important because I didn't want to be stranded out in the middle of nowhere. This bike turned out to be just excellent. Everything about the bike was designed for this sort of rough backwoods use.





2. B&O #61, an EMD E6A leads a passenger train past abandoned beehive coke ovens near Austen.

I made many photos, then took them and made a long list at first using the photos as a guide. Then I kept cutting things down. Which areas and scenes would I be willing to give up?



3. To add depth to a narrow scene, Bob used a photo backdrop for the far side of this underpass at Austen, making it look like the road actually exits the other side and curves left.

One of them I knew I wanted to keep was Tray Run viaduct, a nice stone arch bridge going across a valley. I planned carefully to make that scene work. I also wanted Grafton, WV, which is dear to my heart, and also Cumberland, MD. Those formed the end points of my layout.

Then, I picked other scenes such as the Irish Graveyard, then Hardman where they had a helper engine house, plus Tunnelton and Terra Alta – both scenic little West Virginia towns. These became the scenes that I *had to have*.

MRH: Tell us about the station and the hotel at Grafton and Cumberland. How did you model them?

Bob: I did a lot of experimenting. What I ended up doing was first, I built what I call a “white model.” I built it out of foam core to the rough shape. Then, I would play around with it until I got just the right size.

For the Cumberland station, I ended up reducing it about 15% to make it fit. I also pushed it back a bit more from the tracks, because I wanted the building to look like it was a little further back. I’m aiming for the proper illusion, which is all important in model railroading.

Once I finally had the real dimensions, I made a box of foam core, then I used Plastruct brick sheeting to do the outside, and used a lot of scratch building for the details. On the Cumberland station, the tower was a lot of work. It’s an octagon domed tower that just looks magnificent on the station. I scratch built many things like that.

Likewise, the chimneys were elaborate. I started with a wood core and added pieces of card stock and Plastruct brick sheeting to make this elaborate set of chimneys.

MRH: Some of your scenes are quite deep and look photo realistic. How did you do that?

Bob: I have gotten into using photos, they add lots of little details to the scene. Lately I’ve really gotten into using photos to extend the backdrop, and make it seem even further away. I prefer to use a scene from the actual spot I’m modeling.

With this layout, I want to walk in on a winter’s day and feel like I had just dropped into spring in West Virginia. I want it to evoke the emotions from when I was at that real spot in West Virginia.

MRH: How do you get your photos sized and proportioned properly?

Bob: I got some help from a friend. He has a super copy machine. We would make the photos as large as full page size. Then, I would cut them out carefully and take a green marker to color the foliage edges so you didn't see any white edges.

I would use other markers if there were holes in the trees where sky was peeking through to disguise the edges so that the photo would fit into the model scene. I want it to look like it's a real scene.

MRH: Your tree-covered slopes feel realistic without looking too much like the forced cliffs you see on a lot of model railroads. How did you do that?

Bob: I use bigger pieces of poly-fiber at the bottom and as I work my way up the mountain, I use smaller pieces to give the illusion of depth. I also distract you by putting in detailed foreground trees such as the Woodland Scenics fine leafed trees. Using those in the foreground draws your attention to them more than the poly-fiber trees in the back.

MRH: It looks like you're into realistic signals on this layout.

Bob: Yes. I've always felt special about signals. They look so neat when they're off in the distance. I wanted to do proper B&O signals, but it turned out to be way more difficult than I originally thought. Once I got it into the middle of it, there was no turning back.

I got some excellent help from friends who did technical stuff that I could not have done. I am so grateful to them for the help they gave. It was a many years process. We used five miles of wire and 4,500 lines of code to get the signaling program to finally work.



4. EMD E6 #61 winds its passenger consist through the crossovers at Austen to maintain right-hand running.



5. Loco 7133 has just exited the Carrothers Tunnel and will soon cross the Tray Run viaduct. Bob adds detailed foreground bushes and trees guide the viewer's eye away from the less detailed background trees.

To do this, I had to sit down with a retired electrical engineer who wrote the code and we had to go over the B&O rules. What would happen if a train is coming to a junction? Who gets the right-of-way? What kind of a signal is correct for both of them?

We went through lots of scenarios with many long hours of discussion. He would write the program, then we would try it and see how it worked with the trains. If it wasn't quite right, then he would modify it. Determining all the right signal behavior, debugging it, and getting it right was a very long process.

MRH: You're the first person we've ever seen who has mini versions of CTC panels. What prompted that approach?

Bob: I wanted to have panels that would fit my railroad and were small enough. I wanted to break things into three CTC or



6. During construction Bob uses photos such as this to capture the “feel” of the modeled area. With the mood set like this, exact details aren’t as important.

centralized traffic control panels. I used plywood for the panels and used components that I could get either at local stores or hobby switches that would give the semblance of the proper look.

I simply used white tape from an automotive store to do the track diagram, then used markers to make some of the little markings needed to make it look authentic.

MRH: What’s inside of the panel box?

Bob: A nightmare! When you open it up, it’s scary how many wires there are. Fortunately, my electrical engineer friend made a schematic of everything he did so that we can trace problems. Fortunately, there have been very few problems. His work was very precise, so I credit him with this.



7. Bob uses localized CTC-like control panels for switch routing and occupancy indication.

MRH: What does an operating session look like? Your track plan does not look linear.

Bob: Underneath the layout, I have built my version of the English fiddle yard on which I put various trains. When a train comes into Grafton, to the big yard, we can move that train off and replace it with one from the fiddle yard underneath.

It's as if we're a train watcher and we're getting to see all these trains, sort of like a parade. Meanwhile, there can be switching going on in the yards.

MRH: It doesn't sound like your typical operating session. It sounds more like a design for a railfan's layout.

Bob: Yes, I wanted to do something a bit different that way. If we have a full bunch of people, we have three tower operators plus the engineers, and we'll have a dispatcher – and run trains in a more typical fashion, but more as a sequence rather than to a timetable. It won't be minute to minute – it will be more running through a list of trains.

MRH: The description we saw of your layout for the convention said that it was 98% complete.

Bob: My wife, in looking around the layout this morning, said, “I think you're 100% now.” In the last two weeks, I've done a flurry of activity getting ready for your visit.

I have done about 50 small projects to complete little areas that either weren't quite finished or we hadn't quite put everything in. It's been very satisfying over the last couple weeks to see things coming together.

MRH: What do you hope people visiting the layout get out of it?

Bob: I hope they get inspired. I have done more with scenery and small details than most people do with a layout because I'm trying to capture this feeling that you're back in West Virginia in 1948.

I want it to feel like a beautiful spring day. I want the vehicles, the people, the way the people are dressed to all say it's just after World War II and before the 1950s.

I hope they find I've created something magical and they get inspired to research it and do something like it also.



8. As #61 takes the crossovers at Austen, the B&O position signals drop to indicate the track is occupied to any other approaching trains. Bob is a big fan of operating signals – he and friend Mike Bailey worked hard to develop his working signal system.

MRH: What is next for you?

Bob: Right now, we want to get good at operating the trains. I kid some of the guys in the model railroad group and I said my trains don't run without scenery.

Some think that once you have the track, if it's on plywood, it doesn't matter. I think it does matter – I wanted that feeling of really being in a certain location, and for that it takes scenery.

What we're going to concentrate on now is operating the trains in a fun way, you could say.



9. A B&O EM-1 2-8-8-4 leads its train through the interlocking at Tower K and under a wooden highway bridge.

MRH: How did you develop the track plan?

Bob: For the track plan, I wanted it to be like the scenic modules that Tony Koester talks about [Tony calls them *Layout Design Elements* or LDEs – ed.] where you have a scene of a particular location. I wanted to divide the layout up with an approach like that.

I made the inside of the layout with a peninsula down the center that is high enough you can't see over it. You really felt like you were traveling with the train as you went along and coming to new scenes as you walked around the layout. It's designed with walk around being a main part. I wanted separate scenes with a transition from urban to rural, to enhance the feeling of going somewhere.



10. We catch up with the passenger train again crossing the spectacular Tray Run Viaduct.

My layout main line basically uses 30 and 32 inches radius curves. The distance around the inside part of the layout is 122 feet, so it's two scale miles of running length. I built it as plywood on L-girder and I've put styrofoam with Sculptamold over that.

MRH: Did the plan turn out the way you expected?

Bob: It's even better. That's one of the lessons I have learned about layout planning versus layout building. You can make the best track plan you think could be made, and yet when you actually start building it, you will see new possibilities that you didn't see on paper because now you're working in three dimension, not two dimensions.

So jump in and start building. Then listen to your friends and they will give you fresh ideas as well. You'll end up with something even better than you thought you were going to get.

MRH: What were your greatest challenges and did you foresee any of them?

Bob: Mainly, the painful part was the signaling. I thought maybe some of the construction would be, but I've thoroughly enjoyed the construction. L-girder is just wonderful.

There's many good how-to books on benchwork. I looked at those, read them and re-read them, then really got into the layout building. I knew scenery was something I would really enjoy although it's been a constant process to refine my methods, but I've enjoyed that too. And the buildings, I love doing the buildings.

MRH: That's the thing about L-girder, or any benchwork, it goes fast. It gives you a real boost.

Bob: L-girder is so flexible and believe me, I made changes. Just pop some screws and move a joist over. Even changing the elevation is easy to do.

MRH: What do you like most about this layout? And what do you like least?

Bob: Wow, that's hard. There's so many things I like about this layout. It's one of the more satisfying things I've done in my life. I get immense enjoyment out of the various scenes and the many details. It's fun to walk around and let your mind wander back to when I really was at that location. It's a time machine as well as a travel machine for me.

What I least like, I suppose it's the standard model railroaders' complaint: I could use more room. But realistically, even a layout



11. The Gorman Mine #3 at Blaser prepares to load another 12 hoppers with black diamonds.

this size has a good amount of maintenance. If the layout was twice as big as this, I'd be doing a lot more maintenance than I would want to do.

MRH: How did you set the layout height?

Bob: I wanted to see the switches easily. Part of me likes looking at track as if you were a little scale figure, 3/4 of an inch tall. But when looking at the layout ordinarily, I don't like not being able to see the track easily to work on things. So it's better to make the track lower than the railfan level. I set things to about 55 inches with some of it down to about 52 inches. I found that to be a comfortable height to run trains.

MRH: How do you motivate yourself to work on the layout?

Bob: I make a list of things that need to be done. Often, I'll think about those things before I go to bed and tick off the different projects I'd like to do the next day. When I get up in the morning, I find I'm excited about doing those things. I'm eager to see how they're going to turn out.

MRH: Have you ever considered changing scales?

Bob: I have thought about it some. I have an Englishman friend, Trevor Jones, and he has an N scale layout. I paint figures and vehicles for him and I've done scenery on his layout. I've thought if I did an N scale layout, it's incredible what I could do in a couple square feet. I like that part about N scale.

However, I don't get the same feeling of train mass like I do in HO. That's what has stopped me so far, but I am thinking about making some N scale modules. I would like to do something like an 1870 B&O where you would have camelback locomotives. I would have to do a lot of scratchbuilding, but the result would be some very different looking trains along with buildings that looked quite different as well. I've thought that would be fun.

I might even make some modules and take them to a train show just to encourage people to do more historic modeling.

MRH: What advice would you give to someone who's just starting out in the hobby?

Bob: Planning is a good thing to do, but don't let planning make you just an armchair modeler. There is so much joy in actually doing it and learning along the way. If you're not comfortable at first, then do mock-ups. Use cardboard boxes to represent buildings or mountains.

Take a Sharpie marker and make some marks for windows and doors on the cardboard. Whatever you need to get something started. Play around and try to imagine what a scene could be like with just a mock-up.

Invite your friends over and ask what do you think if we did this? Get going. Enjoy it.

MRH: You have a whole crew of people behind you on this. Do you want to say anything about that?

Bob: Yes! First of all, I am very grateful to Mike Bailey, who is the electrical engineer I spoke about earlier. He spent countless hours and helped when we had temporarily given up on this signaling system. We had run into a dead end and he came through in a wonderful way.

I mentioned my Englishman friend, Trevor Jones, already. He started out as an artist in college. His artistic ability shows in so many scenes.

Paul Surburg has helped so much in the planning. When I was doing the original drawings, we went through drawing after drawing. He gave me many good ideas. Putting Cumberland and Grafton on the outside of what I had first built was his idea. I didn't think there was enough room to do those two towns, but he convinced me it could be done. It has turned out to be among the most wonderful parts of the layout.

Also, Alan Heuer has been a great inspiration. He's given me encouragement all along.

Robert Sharp comes over. Kyle Reagan comes over. They have done a zillion small jobs and helped get so many little details right.



12. A few military troops waiting for their train on the Terra Alta platform aren't distracted by the huge articulated steamer blasting by with a freight train.

There are other people, but those are the people that I want to especially thank for just helping me get to this point. We did it all in ten and a half years.

Then there's my wife Marilyn who has encouraged me from day one. Marilyn, from the very beginning, understood that this was an artistic thing I was trying to do. She jumped right in and painted the blue sky of the backdrop. She painted the fascia. She often comes in to look at scenes and will make suggestions or praise things that have been done. I always feel her encouragement. ☑

See Bob's layout at the Indianapolis NMRA Convention this July ...

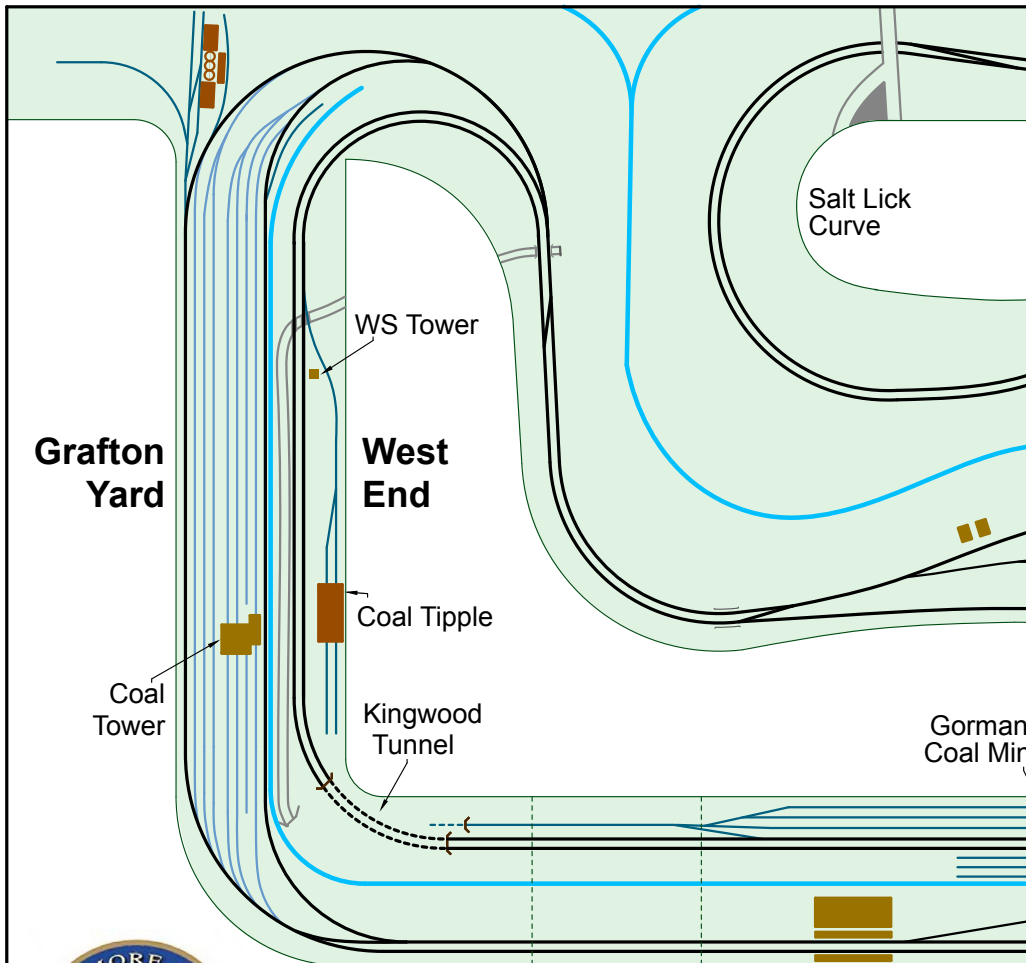

Bob Case's B&O
Layout 36 x 20
Min Radius 30"

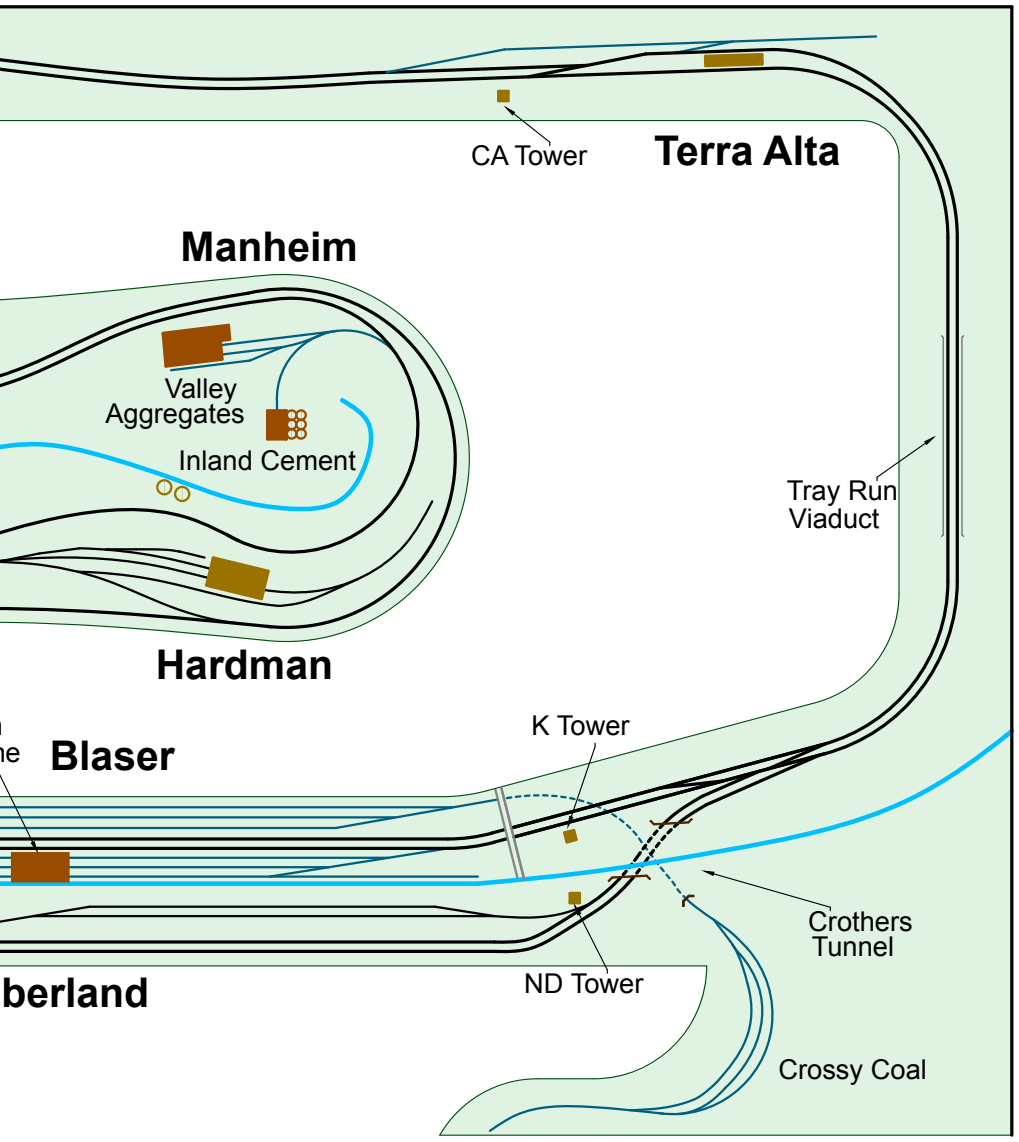

BOB CASE

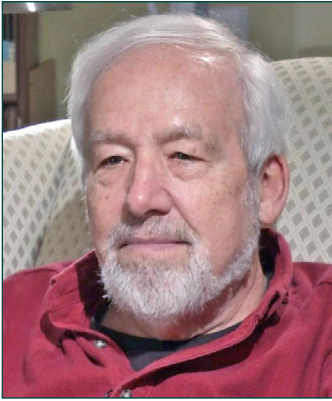

Like many modelers Bob started out with a Lionel train layout. In high school, Bob transitioned to building HO models.

As an adult, Bob continued modeling HO railcars and buildings, but a busy career and family kept him from building his dream B&O layout.

When Bob retired from teaching, that 40 years of pent up frustration led him to building his present layout like a madman. After three years of working by himself and completing much of the benchwork and track laying, Bob got a call from a group of local model railroaders.

These modelers had noticed that Bob was making rapid progress and they offered to come over and help. That started the “Wednesday afternoon group” and they have been meeting at Bob’s house for 8 years now. As Bob says, “I call this my Field of Dreams: ‘If you build it , they will come.’ Out of this group has come a beautiful layout and a wonderful set of friends.” ■



**Also coming to
TMTV in June**



**Click here for
reader comments**

TRAINMASTERS.TV



Bob Case's Baltimore & Ohio

Non-members can
watch for only \$1.49



Coming this June!

Brought to
you by

MRH
MODEL RAILROAD HOBBYIST

Visit the TrainMasters TV website 

• INDEX

• TABLE OF CONTENTS



One Module Challenge: First place winner
Pembroke: One module at a time

BY RENÉ GOURLEY

Planning the TOMA way avoids unpleasant surprises and organizes construction ...

READERS OF THE *MODEL RAILROAD HOBBYIST* forum are likely familiar with Pembroke (mrhmag.com/blog/2760), the slice of the Canada Atlantic Railway that I am modeling in Proto:87. What they may not know is that it has always been part of a larger building program, or that this is the second version.

I've been interested in the Canada Atlantic Railway (CAR) since being inspired in high school by Niall MacKay's book, *Over the Hills to Georgian Bay*. The railroad stretched over 400 miles from Parry Sound, Ontario to Swanton, Vermont, running near my boyhood home in Ottawa. It survived as a separate corporation from 1882 until 1905, when it was absorbed into the Grand Trunk Railway.

As a modeler, to me the CAR presents both challenges and opportunities. Operationally, the mainline was incredibly busy. Contemporary reports speak of trains every fifteen minutes.



[Click here for
reader comments](#)

However, because there are few who model it, there is virtually nothing available off the shelf – not even decals.

Modeling all that mainline traffic may never be feasible, but there were some quieter branches off the mainline that are a good place to start. Of course, “quieter” is relative. These are not sleepy once-a-week operations, dodging closure in annual appearances before the Board of Railway Commissioners. That pattern is for a later time, after cars and trucks came along wrecking everything. No, as we will see, the branch lines prior to the age of the automobile were going concerns, with plenty of traffic for a fun, albeit small operating layout.

The town of Pembroke is about 100 miles west of Ottawa on the Ontario bank of the Ottawa River. It was the terminus for one such quiet branch that connected with the Canada Atlantic, 20 miles to the south at Golden Lake. Technically, the branch was its own railroad, the Pembroke Southern, but the CAR operated it from the day it opened.

The end of the branchline, Pembroke, requires only one or two engines to operate. I anticipate that it will entertain me for years while I develop equipment for mainline operations. Once I have sufficient equipment, I will extend the line down to Golden Lake and connect with the mainline. As my skills improve, I expect that Pembroke itself will get old, and will be replaced with more mainline.



1. The station area of Pembroke, along the bank of the Muskrat River. The roundhouse is about $\frac{1}{4}$ mile down the track around the bend in the river. *Author's collection*

Pembroke I

I built the first version of Pembroke in the 10'x10' bedroom of a rented townhouse in Burnaby, B.C. I had minimal tools and even less skill. However, "Pembroke I" did prove the resilience of the One Module Approach in the face of household moves. Indeed, the modules moved with me several times.

Being in a rented townhouse, Pembroke I was initially free-standing. It sat atop a pair of L girders wedged against the walls. I built ladder-shaped legs for it that incorporated shelves for the myriad books, tools and materials we model railroaders accumulate. In the second installation, I was less concerned about making holes in the wall, and the layout was mounted on sturdy shelf brackets..

ONE MODULE CHALLENGE | 4



Unfortunately, my skill gaps made for real gaps between the modules. Even worse, during my research information surfaced that showed I had taken too many liberties with the track plan and scenery. I was never satisfied with the inaccuracies, and wound up starting over before much track was ever laid.

Pembroke II

Pembroke II resides in our 15'x16' rec room. The room is not only a train room, but also a home office, guest room, playroom, and occasionally a home gym. The layout occupies a shelf above two cabinets and two desks

2. Pembroke I just before its trip to the dump.

that I made to support the office and train activities. Staging is built onto a wide windowsill.

My friend Andrew and I built the two sections of the layout in the garage. They were wired and turnout controls were partially completed before installation day. With shelves full of printers and books under the layout, working beneath it is a nuisance. So, I am happy that most of that work was completed when I could turn the layout on its side or its end.

I chose not to complete the scenery in the garage because I wanted to be sure I was happy with operations. Besides, I was getting impatient to see trains actually running!

ONE MODULE CHALLENGE | 5



3. Building the benchwork for Pembroke II in the garage kept all the dust and noise out of the house.



4. I completed the wiring and turnout controls while Pembroke II was still in the garage and could be easily stood up on its end or side.



5. Installation day, July 27, 2014. Left to right, the author, Scott Calvert, Ken Catlin, Andrew Hutchinson; the author's children are in the front row.

Pembroke TOMA - Phase 1

At 16'x15', my room is quite similar to the TOMA Challenge room. However, for Pembroke II, I did not restrict myself to 84" in length. Pembroke TOMA was designed with HO in mind, rather than Proto:87. As such, it has a minimum radius of 30".

The good news is that it's 1905, and 72" or 84" is plenty of room to run around the half- dozen or so 36-foot cars that a 4-4-0 can be expected to pull. So, this initial module along with staging is a complete operating layout by itself!

ONE MODULE CHALLENGE | 7

In Pembroke I, I started with the station end of the line. Knowing what I know now, in the One Module Approach, I will start with the engine shed area because Pembroke's 50-foot turntable is critical to its operation.

Both in Pembroke II and Pembroke TOMA, the engine house area is in a broad corner. This keeps the town of Pembroke on one wall, and that will be important if future phases are built. The prototype was, of course, as straight as an arrow; also, the engine house was slightly north of the quarter-mile siding. By

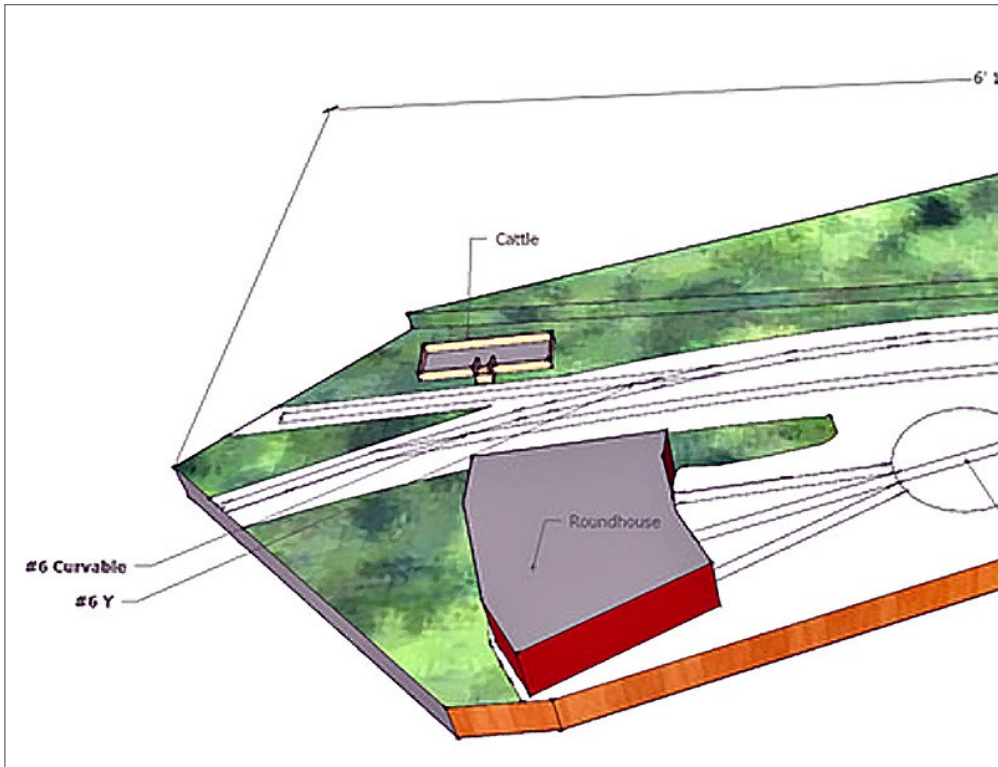

6. Pembroke TOMA - Phase 1 is a seven-foot corner module incorporating a turntable, passing siding and two spurs.

ONE MODULE CHALLENGE | 8

moving the siding to overlap with the engine house it shortens the whole of Pembroke so it can fit in a room.

The module contains five turnouts. However, the corner location means that they are all the more expensive curved ones. To save money, you could substitute straight turnouts, but the curved ones flow more nicely.

There are four or perhaps five car spots on the module:

- Lee Manufacturing receives coal and shipped incubators

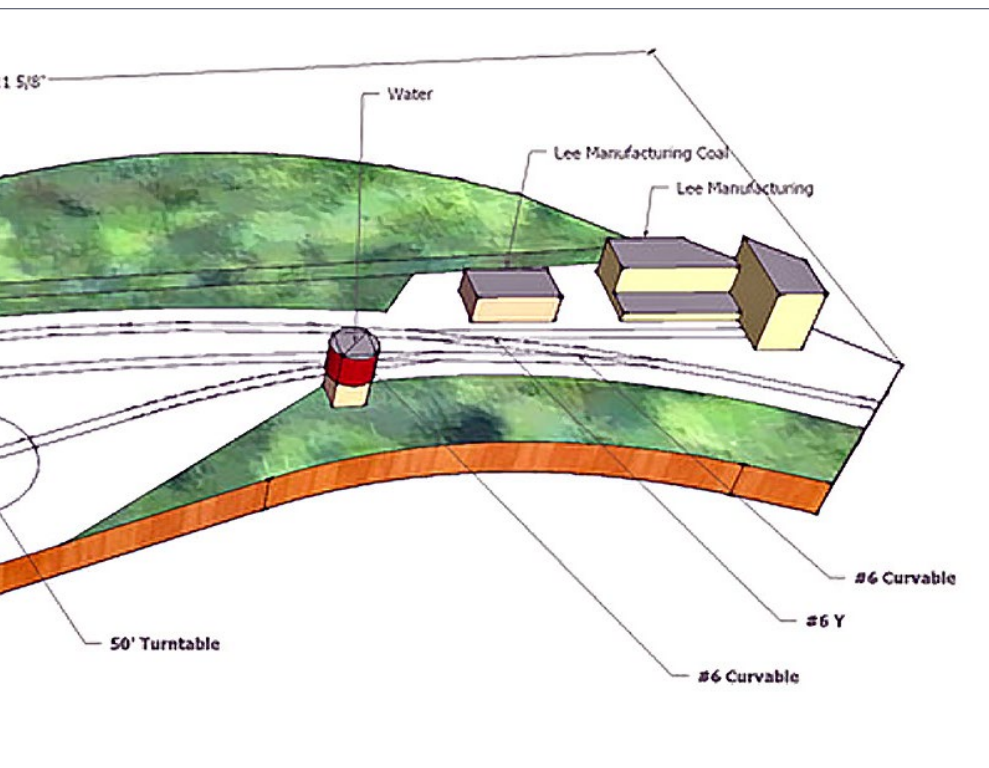

- The cattle pen
- An unknown, small building at the end of the cattle track may have been a car spot
- Only two of the three stalls in the engine shed were used for engines. The last stall may have been used for engine coal.

Because building staging yards is itself akin to layout construction, Phase 1 employs a single long track to represent the town of Pembroke itself. By Phase 2, Golden Lake staging will require a surprising five tracks to support the full operation of Pembroke, and we may as well build them now. The staging yard itself is quite short, but again, we are dealing with short trains. You can go to my post on the forum to see how I came up with the operations plan using Brio Trains. mrhmag.com/node/15589.

In future phases, the lead into the staging will need to assume different radii. And so, we will only tack it in place, rather than gluing it down permanently. Notice also that the staging yard is not the full length of the wall. This short configuration will be required in Phase 4.

The first module is designed to be cut from a single piece of 2-inch extruded polystyrene insulation. There has been some excellent discussion in the *MRH* forums on using this material for modular display layouts. Pembroke TOMA is not meant to be trucked from one exhibition to the next, and so, I am confident that similar construction methods will be sufficient for our purposes.

Shinohara turnouts and Micro Engineering flex track provide the bulk of the track. To keep things simple, Caboose Hobbies ground throws align the turnouts. The short turntable will have to be scratchbuilt, and I see this as a finger-strong manual

ONE MODULE CHALLENGE | 10

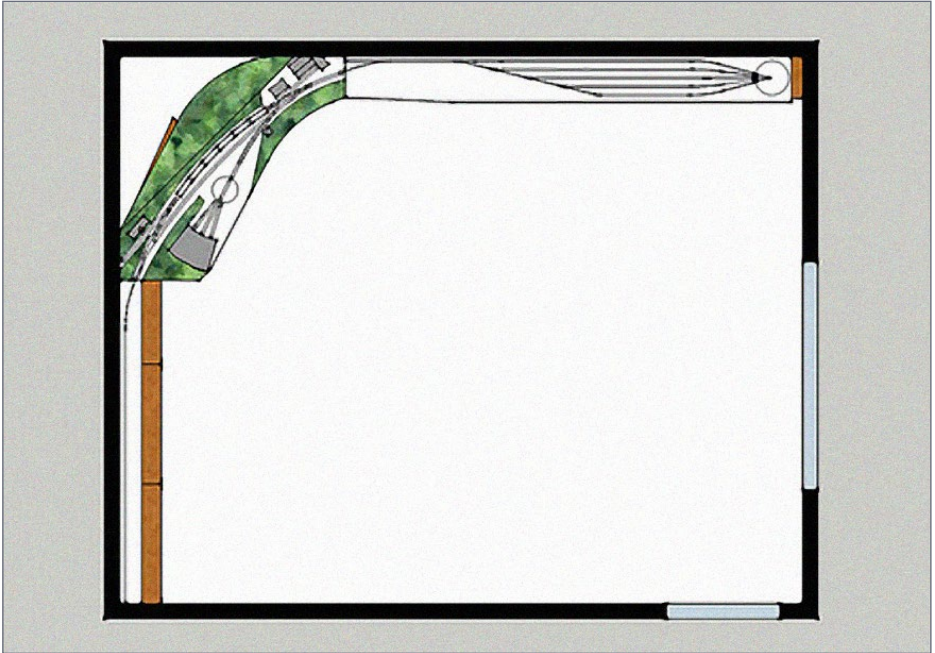

7. The town of Pembroke itself is represented by a single track, while a five-track staging yard represents points south.

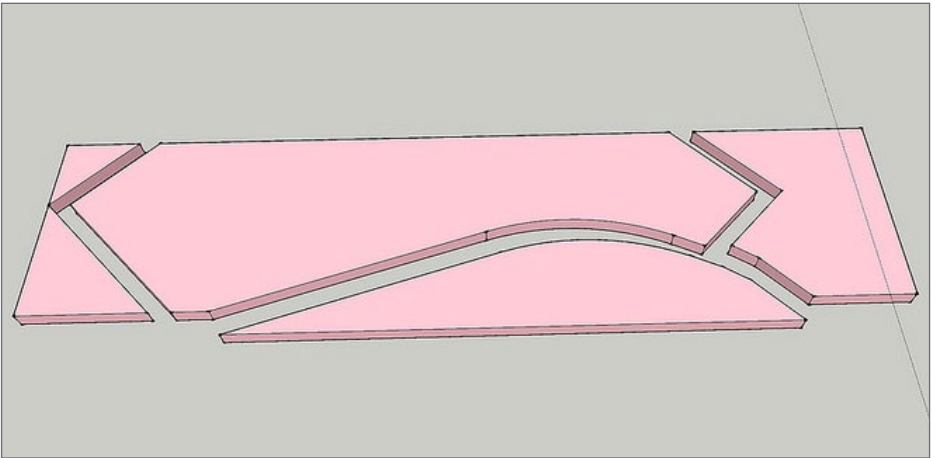

8. The module can be cut from a single piece of 2" insulation.

ONE MODULE CHALLENGE | 11

turntable. Being HO rather than Proto:87 it can be aligned by eye. See my blog about building the turntable mrhmag.com/node/21332.

All the buildings can be scratchbuilt, although there is only one murky photograph of Lee Manufacturing that I am aware of, and the roundhouse appears only in the background of a few photos. So, here is a place where your creativity can really shine.

I suggest mounting the initial module on Ikea cabinets, such as the Billy series. The lower bookcases are 41 3/4" high and a 13 5/8" extension can be added for 55 3/8" height. Including the 2" foam, this gives a track height of just over 57", which is a nice height for watching trains, but a difficult height for construction. However, remember that the modules will be built on the workbench, not at their installed height, so the 57" inches is a great height for me.

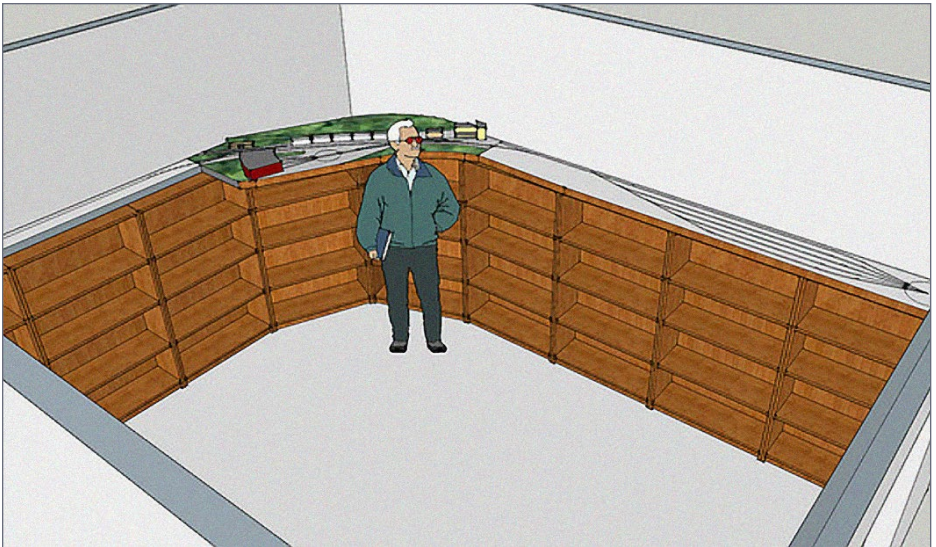

9. The layout in place atop extended Ikea Billy book cases. The figure is 6' tall. The door and closet are both in the near corner.

MIDDLE DIVISION

Southbound Trains. Pembroke Branch. Northbound Trains

1st Class			2nd Class			Time Table No. 91 Effective Oct. 4, 1903		1st Class			2nd Class			
45	43	51	STATIONS			STATIONS			52	44	46			
Mixed. Daily Ex. Sunday	Through. Daily Ex. Sunday	Passenger. Daily Ex. Sunday	Leave			Arrive			Through. Daily Ex. Sunday	Passenger. Daily Ex. Sunday	Mixed. Daily Ex. Sunday			
A. M.	P. M.	A. M.							P. M.	A. M.	P. M.			
8:40	1:00	7:45	Pembroke			Pembroke			7:50	11:45	6:00			
8:58	1:11	7:56	Lockport			Lockport			7:39	11:34	5:42			
9:13	1:19	8:04	Wolke			Wolke			7:31	11:26	5:37			
9:40	1:25	8:20	Golden Lake			Golden Lake			7:15	11:25	5:00			
A. M.	P. M.	A. M.	Arrive			Leave			P. M.	A. M.	P. M.			
Daily Ex. Sunday	Daily Ex. Sunday	Daily Ex. Sunday							Daily Ex. Sunday	Daily Ex. Sunday	Daily Ex. Sunday			

Southbound Trains will have absolute right of track over trains of the same class running in the opposite direction. See Rules 384 and 385A. All trains will register at Pembroke and Golden Lake. Standstill Clock at Pembroke. Branch Trains when using Main Line at Golden Lake must protect against Main Line Trains.

Dispatcher's Office, Ottawa. Telegraph Cell, N. A.

10. The Pembroke Branch schedule in 1903. Author's collection

Smaller layouts benefit more than you might expect from DCC when the operations support two engines. While I can delay that purchase until I have a second engine, I did not skimp on wiring now. The module and staging yard should get feeders to every section of rail, connecting to heavy bus wires. To connect the buses, terminal strips mounted to the backs of the module end plates should be sufficient.

From an operating perspective, Phase 1 *could* support the full Pembroke schedule, especially with the addition of a second track in the north staging. However, I will save that for Phase 2. In Phase 1, I will have only a single engine, which operates trains 43, 44, 45, and 46.

An operating session begins with pulling the engine out of the engine house and turning it to face south toward Golden Lake.

ONE MODULE CHALLENGE | 13

Then after watering, it backs down onto the daily mixed, which is parked on the north staging, and pulls it down to Golden Lake. We stop to pick up any outbound cars from the cattle dock, Lee Manufacturing or the engine house.

At Golden Lake, the engine disconnects from its train, turns on the turntable and runs around the train, picking its combine off the rear before returning to Pembroke. The little train passes right across the module and into north staging, where it pauses to drop off passengers before reversing to the siding on the module.

Any inbound traffic was brought in on yesterday's evening train and some cars will have been left at the end of the north

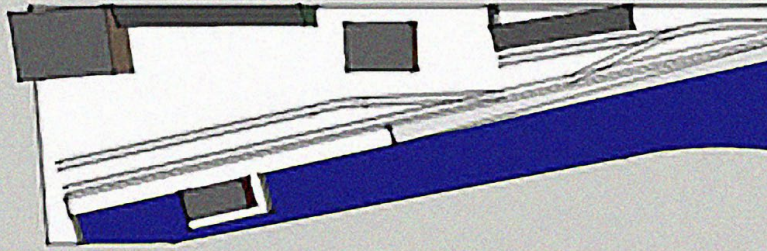

11. Comparing the second module with photo [1], we can see all tracks except the distant spur to the milling company warehouse appear on the layout.

ONE MODULE CHALLENGE | 14

staging. The engine retrieves them and distributes the cars among the industries. Hopefully there is not too much, as our little yard will quickly get crowded!

At the end of the day, we gather our combine and head back for Golden Lake to pick up any passengers as well as cars that may have been dropped by mainline trains during the day.

Pembroke TOMA - Phase 2

That could be the end of Pembroke TOMA. Operating the little layout with a two-person crew could be quite a bit of fun, but remember the goal is to get to Golden Lake and model the action of the Canada

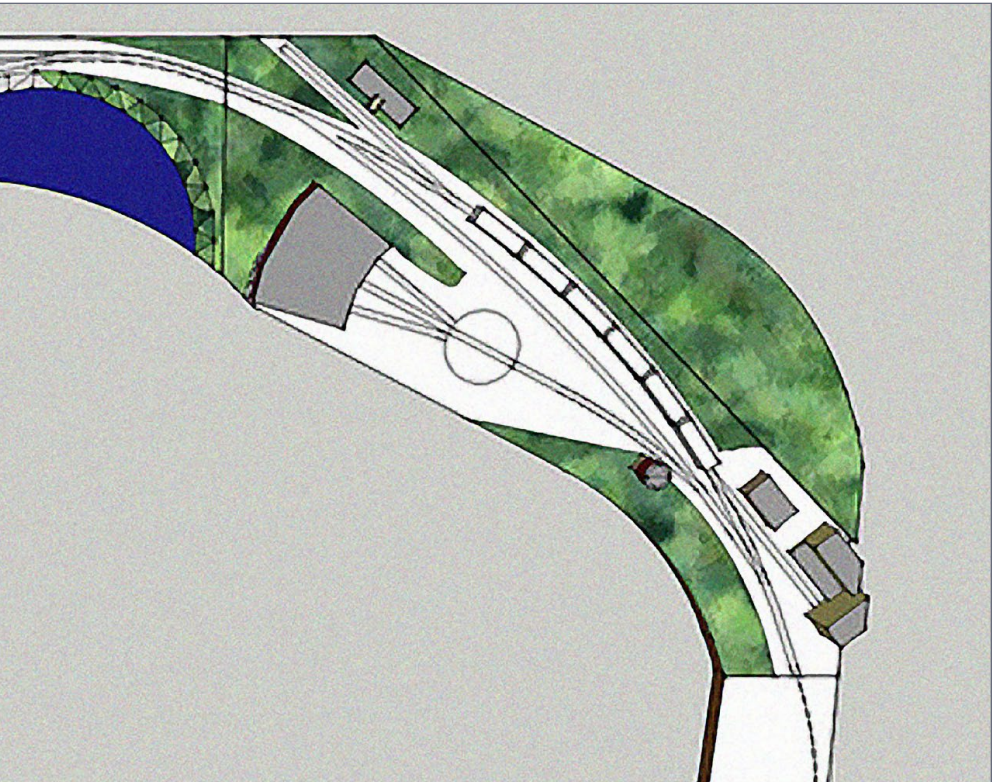

ONE MODULE CHALLENGE | 15

Atlantic mainline. So, I continue to build locomotives and rolling stock, starting with another 4-4-0.

Once the second eight-wheeler is ready, space for a second crew to operate can be made in Pembroke by building the town site itself. With this second module I have all but one of the tracks that were in Pembroke until the station was substantially rebuilt in 1912. What's more, they are only slightly compressed to fit on the 7'1" module.

This second module provides a freight shed, coal dock, carriage factory, and team track, as well as the depot itself. More importantly, it provides space for train 51/52 to hide while the local engine busies itself around the station.

Trains 51 and 52, the daily through service to Ottawa, would not be enough work to keep a second crew fully occupied. In order to make an enjoyable operating session for two crews, a mid-day extra could be added -- either a passenger excursion or a freight extra.

Phase 3

The next phase is a simple section of the branch line. The key here is to avoid painting ourselves into a corner. So, it is important to plan the subsequent phases to ensure there is enough room for them.

In this phase, the staging yard moves to cover the closet. If this is a problem, the branch could be further curved, almost to the branch turnout of Phase 4. The staging yard would then angle into the middle of the room, allowing access into the closet.

Phase 4

With phase 4, it is tempting to dream big, and consider a double-deck layout, with the branch descending to a mainline

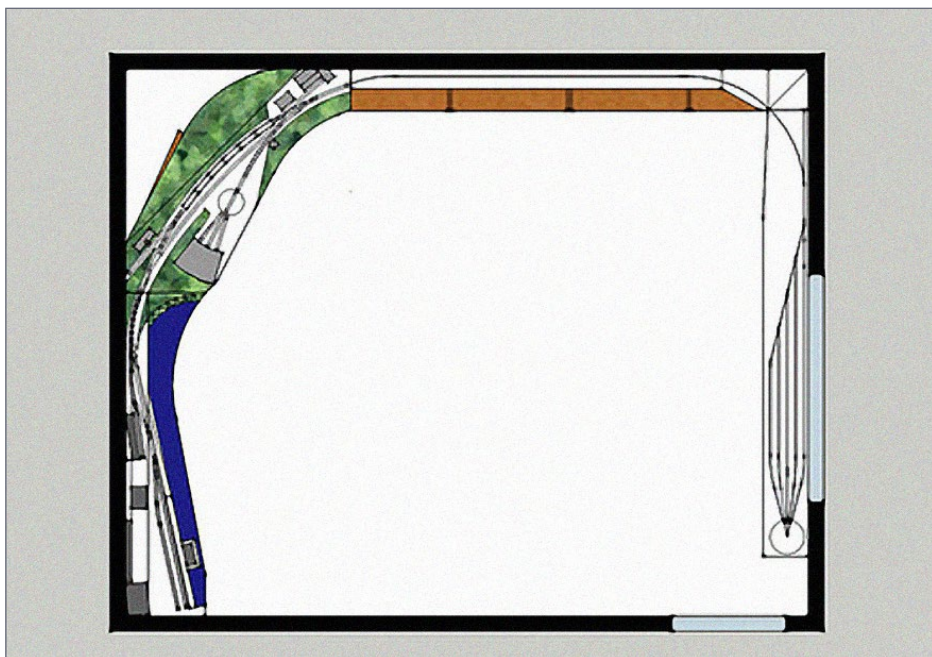

12. Phase 3 adds a length of branch line. The staging yard could be further rotated into the room if access to the closet must be maintained.

beneath Pembroke. However, the branch motive power is all 4-4-0s, and they are slippery on hills. A 1% grade is probably okay, but 2% is asking for trouble. So, phase 4 is pretty much the end of Pembroke.

The original southern staging yard continues to migrate clockwise around the room, except it now represents Ottawa and points east. A new staging yard, representing the westward line to Lake Huron, tucks up against the branch line modules, and Golden Lake fills the middle of the room.

Sadly, the real Golden Lake included the bane of all model railroad planners - a wye for turning locomotives. Fortunately,

ONE MODULE CHALLENGE | 17

it seems that the prototype turned only the locomotive on the wye, rather than the whole train. So, I have replaced the wye with yet another turntable. Trains 51 and 52 are not affected by the loss of the wye as they can proceed straight through the branch line switch, into the eastern staging beside the door to the room. There were three tracks at Golden Lake, but that is just about the only resemblance this rough sketch has to the real place.

While Phase 3 has no operational impact other than a lengthened run, Phase 4 is exciting! Trains 43, 44, 45 and 46 now terminate and originate on the layout, completing the run into

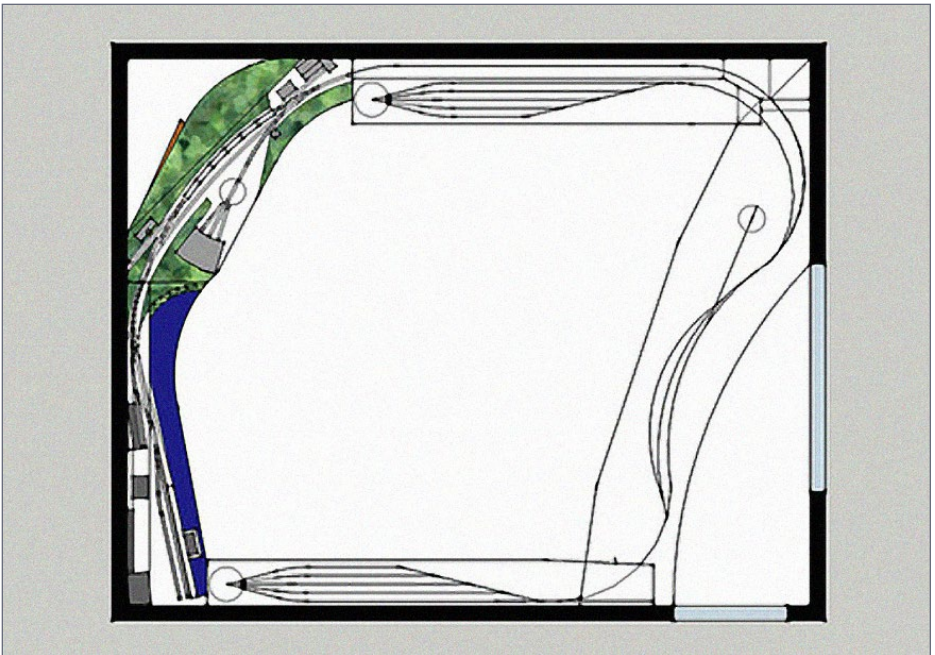

13. Phase 4 finally completes the goal with a representation of the Canada Atlantic mainline.

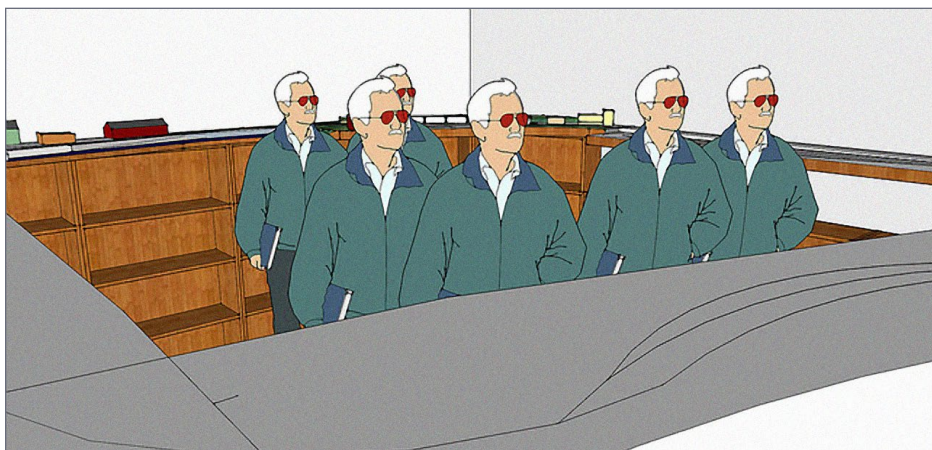

14. With the middle of the room wide open, there is even room for three two-person crews.

Golden Lake, turning and reversing. Trains 51 and 52 make their runs all the way into eastern staging (Ottawa).

We also have enough staging tracks to represent a small amount of mainline traffic without fiddling new trains together during the operating session. This mainline traffic could either keep a third crew busy, or it could provide entertainment for the crew of 51/52, rather than forcing an extra train up the branch.

Conclusion

Reconsidering Pembroke under the lens of The One Module Approach (TOMA), has been an interesting exercise. TOMA not only provides an incremental approach to layout construction, but also an incremental approach to developing an operating scheme and equipment roster.

Starting with the engine house module surprised me because my natural inclination would have been to start at the end of track. However, with the turntable module, I can begin

ONE MODULE CHALLENGE | 19

operating right away. I was fascinated that the single module not only allowed operations with a very small collection of rolling stock, but that it constrained the operation to a single engine as well.

Reaching forward to think about Phases 3 and 4 also yielded some unexpected results. In order to swing the staging modules around into new positions, they needed to be shorter than allowed by Phases 1 and 2. This realization implies that anyone planning to follow TOMA would want to develop a full plan for the whole railroad before beginning construction of the first module.

The One Module Approach has numerous benefits from a construction and momentum standpoint. If we consider prototypes that naturally ran smaller equipment such as the golden age of railroading, the approach yields interesting and lively operations from a very early stage, even in HO scale.



[Click here for
reader comments](#)

***TrainMasters TV is part of
the MRH product family.***

*TMTV members not only get great network TV level
videos, they help pay for MRH and keep it free ...*

ONE MODULE CHALLENGE | 20

Bill of Materials for Module 1

Manufacturer	Item	Qty	Each	Cost
Shinohara	Code 70 Nickel-Silver Track -- #6 Turnout - Left-Hand	1	21	21
Shinohara	Code 70 Nickel-Silver Track -- #6 Turnout Rt-Hand	1	21	21
Shinohara	Code 70 Nickel Silver -- Curvable Left Hand Turnout	2	31	62
Shinohara	Code 70 Nickel Silver -- Curvable Right Hand Turnout	1	31	31
Micro Engineering	Code 70 Standard Gauge Flex-Track(TM) pkg(6)	2	36	72
Caboose Industries	Turnout Rigid Ground Throw Operating .280in Travel	5	3	15
Scratch built	50' Turntable			50
Various	Extruded Polystyrene Rigid Insulation - 24 Inch x 96 Inch x 2 Inch	1	30	30
Various	Plywood for end plates, wire, terminal strips			30
Estimated Total:				332

**Want to help keep
MRH free?**

Then *click* on ads!

RENÉ GOURLEY



René lives in North Vancouver B.C., Canada, with his darling wife, Laura, their children and a lively English Springer Spaniel.

He has enjoyed railroad modeling since the age of five, and cycling from about that time too. He works in the software industry, chairs his local community association, and also leads a local annual railroad modeling meet. ■

**Did you know
there's an
MRH index
available?**

CLICK TO FIND OUT MORE

BUILD THAT STEAM LOCO YOU CAN'T BUY!

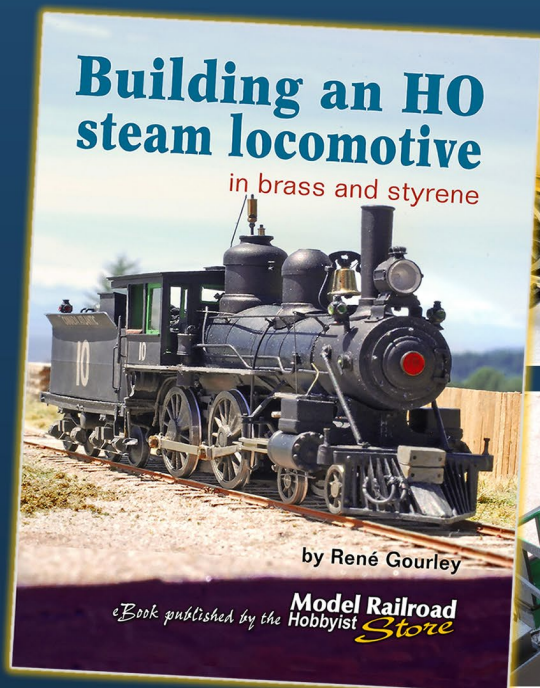

In this book, René Gourley shows you the step-by-step process he used to build an HO steam locomotive from brass and styrene. As René journaled this steam loco construction project online, many asked if he could make his writings and photographs available in published form. The result is this book, which tracks his methods and ideas, with step-by-step photos of the entire process.

Paperback

eBook

~~\$34.99~~

\$29.74

LIST PRICE

+ S&H

~~\$19.99~~

\$14.99

LIST PRICE

On special!

Order Paperback

100-PAGE PERFECT BOUND BOOK

Order eBook

INSTANT DOWNLOAD

Order now and SAVE - From the MRH Store: store.mrhmag.com

• INDEX

• TABLE OF CONTENTS

**A CLASSIC NARROW GAUGE CONVENTION
IN A VERY SPECIAL PLACE**

VISIT MAINE IN 2016

AUGUSTA, MAINE — SEPTEMBER 7-10, 2016

- 4 MUSEUMS OPERATING 2-FOOT STEAM
- OVER 15 MODULAR & DISPLAY LAYOUTS
- DOZENS OF CLINICS
- CONTESTS
- VENDORS
- LAYOUT TOURS

**\$115 INCLUDES SPOUSE
REGISTER ONLINE OR BY MAIL**



SCENERY, SHOPPING, LOBSTER, AND MORE - A VACATION FOR THE WHOLE FAMILY

VISIT WWW.NNGC2016.ORG FOR FULL DETAILS

**PO BOX 1406 – GRAY, ME – 04039 – INFO@NNGC2016.ORG
CO-SPONSORED BY SEACOAST DIVISION, NER, NMRA**

• INDEX

• TABLE OF CONTENTS

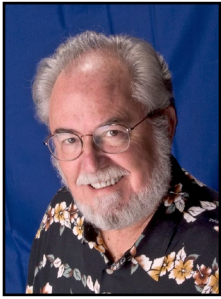

JUNE NEWS

column

RICHARD BALE *and* JEFF SHULTZ



[Click here for reader comments](#)

Charles Robert Yungkurth 1929-2016

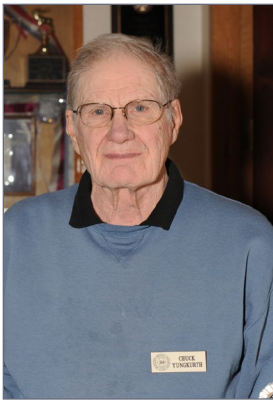

Chuck Yungkurth died of undiagnosed cancer in Louisville, CO on May 7. He was 87 years old.

Yungkurth was born and raised

in Scranton, PA, where he developed his life-long affection for trains. He graduated from Pennsylvania State University with a degree in mechanical engineering. Among the many projects he worked on during his 37-year career with IBM were state-of-the-art computers for NASA's Space Shuttle program. During the

▶ THE LATEST MODEL RAILROAD PRODUCTS, NEWS & EVENTS

Vietnam War he served in the U.S. Army as a project engineer at a military test center at Fort Belvoir, VA.

An accomplished draftsman, Yungkurth pioneered the development of accurate drawings of railroad equipment for use by historians, model manufacturers, model builders and publishers. He frequently served as a consultant to manufacturers and helped develop several railroad models. Combining his photographic skills with his love of trains, he built a collection of some 10,000 color slides and black & white negatives which he made available to the railroad community through Rail Data Service.

Yungkurth relied on his personal collection for several books he authored, including *Trackside Around Scranton PA, Delaware & Hudson Steam in Color, The Steam Era of Lehigh Valley, Lackawanna Railroad Facilities in Color, and Anthracite Railroads and Mining*. Seventeen of his articles appeared in *Model Railroader* magazine including a construction article about the Gumstump & Snowshoe Railroad, a small portable switching layout that continues to inspire model railroad hobbyists throughout the world.

Yungkurth retired in 2000 and moved to Colorado where he became a volunteer in the research library at the Colorado Railroad Museum in Golden. Chuck Yungkurth was predeceased by his wife Mary in 2012. He is survived by four children and six grandchildren ...

Hands-On Workshop at Fos Studio

Doug Fos, the creative mind behind Fos Scale Models, has scheduled a special hands-on workshop in his Connecticut studio on June 11. This year's program will focus on modeling mini scenes including street and cobblestone, seawalls and low tide scenes, coal bins, stone wall carving, loading docks, overgrown track,

JUNE NEWS | 3

and trackwork in pavement. Participation is limited to eight adult modelers.



The all-day schedule includes building and learning. Fos will share modeling techniques, short cuts and philosophy. Special discounts will apply to Fos Scale kits and DVDs purchased at the studio. For complete details

visit fosscalemodels.com/products/modeling-mini-scenes-all-day-workshop-june-11-2016.htm ...

Monster on the Move

Monster Modelworks has relocated. The new postal address is PO Box 2269, Valley Center, CA 92082. Sales inquiries should be directed to support@monstermodelworks.com. The company's web address remains monstermodelworks.com.

.....

NEW CLUB CARS



The Illini Chapter of the Professional Car Society is offering two versions of a wood boxcar decorated for The Eureka Company, an early manufacturer of automobile bodies. The HO scale kits are based on Accurail 40-foot USRA double-sheathed

JUNE NEWS | 4

boxcars. The kits are available at \$19.98 each plus \$6.80 shipping for one car or \$9.50 for two or more cars to domestic U.S. locations, or \$15.50 for shipping any number of cars to Canada. Mail check or money order payable to Illini Chapter PCS, 918 W. Colfax St., Palatine, IL 60067.

.....

NEW PRODUCTS FOR ALL SCALES

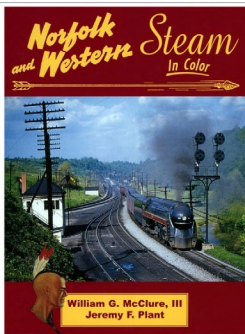

Morning Sun has released a digital reprint of *Norfolk & Western Steam in Color*. This system-wide tour of the N&W offers great terminal scenes as well as stunning action photography. Traditional printed hardback books new from Morning Sun include *Louisville & Nashville Color Guide Volume 2*, by Steven Johnson, and *Penn Central Color Guide*, by James Kinkaid. For additional information

visit morningsunbooks.com.

.....

O SCALE PRODUCT NEWS



Atlas O has scheduled another release of its popular USRA 50-ton single-sheathed boxcar during the third quarter of this year. Depending on the

prototype being followed the O scale models will have either Murphy 7-8 or 5-5-5 corrugated steel ends and simulated steel or wood doors. The ready-to-run model of this classic prototype will

JUNE NEWS | 5

be available decorated for Duluth, Missabe & Northern; Grand Trunk Western, Maine Central, and Richmond, Fredericksburg & Potomac. Previously released road names included in this production run with new road numbers will be Southern Pacific and Pennsylvania Railroad.

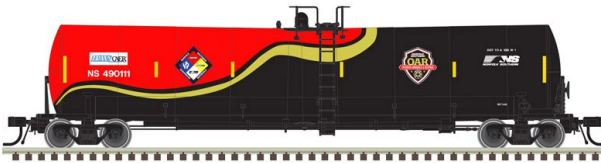

Also coming from Atlas O during the third quarter is another production run of Trinity

25,500 gallon tank cars. Previous road names included in this release with new numbers are ADM-Molecule, AGP-Refined Oil, Cargill-Vegetable Oils, and GATX-BASF. All-new paint schemes include DPRX, XTRX-First Union Rail, and NS First Responders. Undecorated models of both the USRA boxcar and the Trinity tank car will also be released. Both 2-rail and 3-rail versions are available for all Atlas O models. For more information contact a dealer or visit atlaso.com.

.....



Rusty Rails has released several new O scale detail items including two different styles of old gas pumps. The masters for these items were developed on a CAD program then created on a 3D printer. For additional information visit rustyrail.com.

.....

Morgan Hill Models is selling a stone locomotive ash pit. The open side of the pit facilitates loading to a gondola car on an adjacent track. Although designed for On30 track, the one-piece cast Hydrocal model could be adapted to other scales. For additional information visit morganhillmodels.com.

.....

HO SCALE PRODUCT NEWS

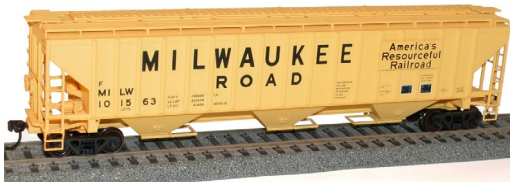

New HO scale freight car kit releases available from Accurail include this Milwaukee Road 4750 cu. ft. triple-bay covered hopper.

The model and paint scheme are based on a prototype car built by Pullman-Standard in 1975.



This Norfolk Southern triple-bay covered hopper represents a car built by ACF in 1969 and rebuilt in 1984.



Accurail has released a pair of USRA twin-bay coal hoppers including this Gulf, Mobile & Ohio car. The Chicago & North Western version is available in a

three-car set with different road numbers.

Also new from Accurail are kits for 40-foot wood stock cars. In addition to the Great Northern version shown here, a similar



car is available decorated for Northern Pacific. All Accurail HO scale kits include appropriate trucks and Accumate couplers. For additional information contact a dealer or visit accurail.com.

.....



American Model

Builders has a kit for an HO scale wind turbine blade. The kit includes a 102-foot long cast resin blade, a cast resin end frame, and a laser-cut H-frame with a shipping

sling. The load can be carried by an 89-foot flat car or it can be straddled between two 60- or 89-foot flat cars. Idler flat cars will be required on each end of the loaded flat cars.

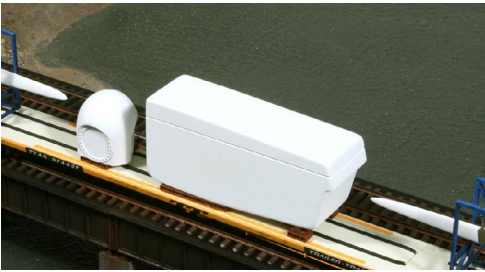

Also available are a cast resin nacelle and cone with blocking fixtures. They can be carried on a single 60-foot flat car. An interesting arrangement for transporting two wind turbine blades would

utilize three 89-foot flat cars with the middle car carrying the nacelle and cone while functioning as an idler. For more interesting load ideas and ordering instructions visit laserkit.com.

.....

ANE Model is selling a Lococruiser decoder for HO applications with a 21-pin socket and four outputs. Features include



back-electromotive-force (BEMF) control with silent motor running, 28-step adjustable speed table that supports long addresses, advanced consist address setting, and an adjustable braking function. The

decoder is designed to handle 1.5 amp continuous (2 amp peak) motor current. The device measures 1.1 x 0.6 x 0.2-inches. For additional information visit anemodel.com.

.....

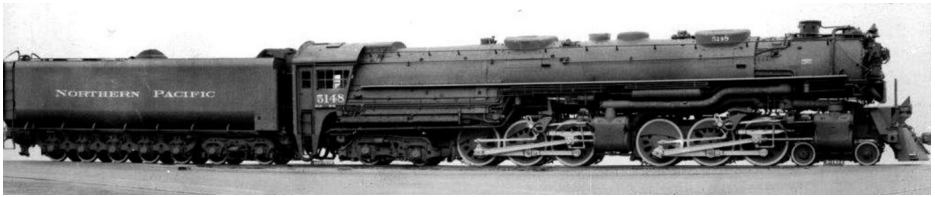

Athearn is preparing tooling for an HO scale 4-6-6-4 class Z-8 Challenger steam locomotive. Delivery is planned for September. Both Northern Pacific and Spokane, Portland & Seattle versions of the Genesis series model will be available.



Notable features include cast pilot with a fold-down coupler, an enclosed cab with side entry doors, a simulated cab diaphragm, twin air pumps mounted on the front of the smokebox, unique four-wheel trailing truck with

two sizes of wheels, a seven-axle welded tender, individually

JUNE NEWS | 9

applied piping, operating eccentric cranks, and directional light change on headlight and number boards. The Northern Pacific model will have the unique expansion link that NP favored to support the heavy valve gear. The NP locomotive will have a coal tender while the SP&S model will come with an oil tender. The model will have an onboard DCC decoder with a SoundTraxx Premium sound system.



Athearn has scheduled a February release for a Genesis Series Canadian National GP40-2L diesel repainted in CN's modern liveries including the short-lived North American map scheme shown here. Spotting features include a late CN body with a comfort cab, snow shields, CN-style pilot plow, ribbed anti-climber, and Blomberg-M trucks.

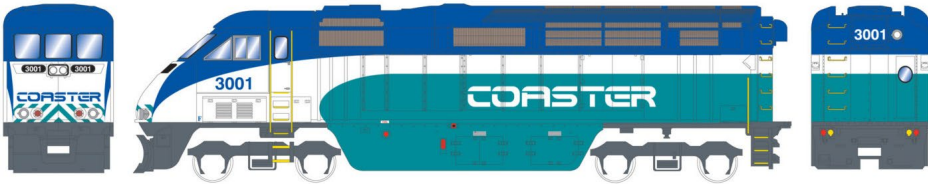

Also coming next February is a run of F59PHI diesels and Bombardier commuter cars. Although originally designed and built by EMD for the California Department of Transportation, the lightweight, high-speed F59PHI can now be found in service throughout the US and in eastern Canada. Athearn's HO scale Ready-to-Roll models will be available with factory installed DCC SoundTraxx Econami Sound System. They will also be available for standard DC operation with 8- and 9-pin Quick Plug connectors for installation of an after-market decoder (not supplied).

JUNE NEWS | 10

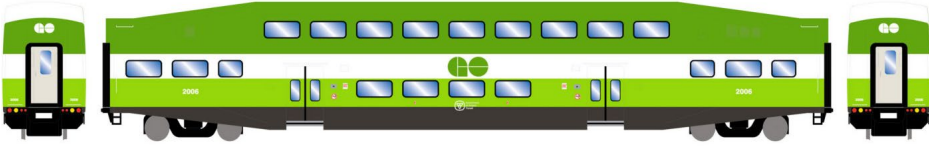

The F59PHI locomotive and Bombardier cars will be available decorated for Coaster, GO Transit, Amtrak Surfliner, Amtrak California, Caltrain, Northstar, and Metrolink.

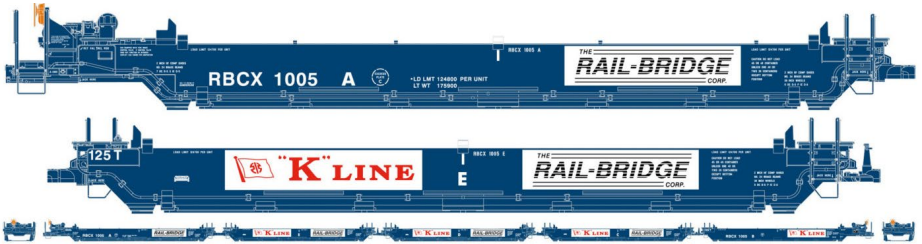

Athearn's February 2017 schedule includes five-unit MAXI I well cars that feature etched walkways and separate wire grab irons. In addition to the K-Line scheme illustrated, road names will be Maersk (early scheme), Southern Pacific, TT (early scheme), TTX (late version), and TTX (late version with red logo).

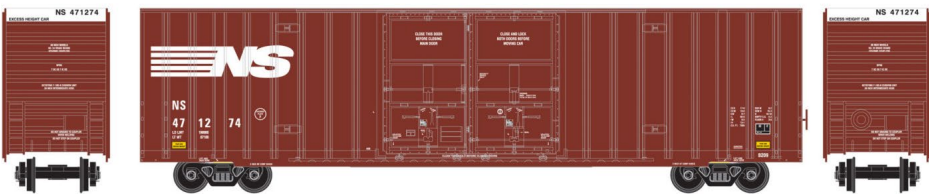

Athearn also plans to release this 60-foot Gunderson boxcar with double plug doors next February. This is the first release of this popular car since spring 2012. Road names on the Ready-to-Roll model will be Burlington Northern Santa Fe, Canadian Pacific, Canadian National, Norfolk Southern, Railbox (brown), Railbox (yellow), and Union Pacific.

JUNE NEWS | 11

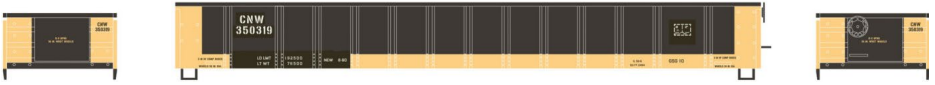

Also due next February is a 52-foot 14-panel mill gondola with separately applied wire grab irons and etched end platforms. In addition to the Chicago & North Western scheme shown here, the HO scale Ready-to-Roll model will be available decorated for Detroit, Toledo & Ironton; Amtrak, Santa Fe, Golden West Service, Golden West Service patch, and Norfolk Southern.



Athearn will include a group of 60-foot bulkhead flat cars in its February 2017 product release. Road names on the Ready-to-Roll cars will be Burlington Northern/Colorado & Southern, Burlington Northern Santa Fe, Trailer Train, BC Rail, Canadian National, Canadian Pacific, Northwestern Oklahoma, and Union Pacific.



Athearn Roundhouse models due next February include ribbed offset-side

ore cars that will come with a removable load. Road names for the 24-foot cars will be Duluth, Missabe & Iron Range; Bessemer & Lake Erie, Chicago & North Western, Union Pacific, Great Northern, and Milwaukee Road. The models will be available individually and in two four-packs for a total of nine different road numbers.

JUNE NEWS | 12



Also due next February is an Athearn Roundhouse Chemical tank car decorated for Domino Sugar, Dow of Canada, GATX-General American Transportation, GATX-Kodak, and Montana Rail Link.



Scheduled for a Roundhouse release this month is a selection of 36-foot truss-rod reefers. Paint schemes on the

old-time wood cars will be Atchison, Topeka & Santa Fe; Pennsylvania Railroad, Southern Pacific, and American Refrigerator Transit.



Completing the run is a red, white and blue SRLX-Swift car with a Buy War Bonds slogan. For additional information on all

Athearn and Athearn Roundhouse products contact a dealer or visit athearn.com.

Heading a list of new models coming from **Atlas** during the third quarter of this year is a group of heavyweight steel coaches. The HO scale models were developed by Branchline. Atlas ready-to-run Master Series models will have full interior detailing,

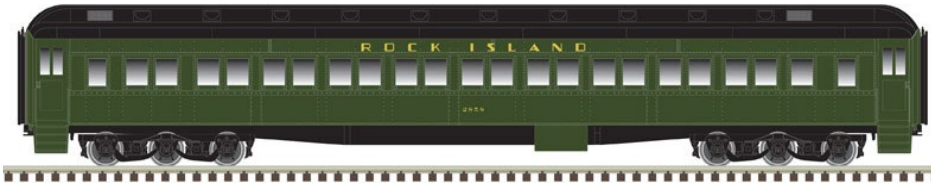

operating diaphragms, separately applied underbody detail, and appropriate trucks with metal wheels. A minimum radius of 24 inches is recommended. Cars with paired windows follow a prototype originally built for the Chesapeake & Ohio. Atlas will offer the car decorated for Gulf, Mobile & Ohio; Canadian National, Wabash, and Rock Island.

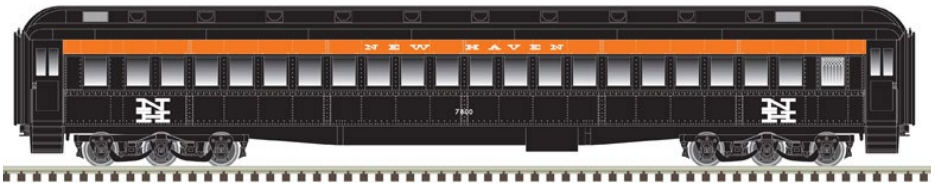

Single window coaches will be available for Richmond, Fredericksburg & Potomac; Boston & Maine, Burlington, and New Haven. The HO scale model is based on a New York Central prototype. Undecorated versions in both window styles will be available.



Also due in the third quarter is another production run of Atlas Master Series Trinity 25,500 gallon tank cars. Previous

road names included in this release with new numbers are ADM-Molecule, AGP-Refined Oil, Cargill-Vegetable Oils, and GATX-BASE. New paint schemes will be DPRX, Flint Hills Resources, GATX-ADM, TCBX-AIG Rail Services, TILX, XTRX-First Union Rail, and NS First Responders.



Atlas is quoting a fourth quarter release for a Berwick 50-foot boxcar. The HO scale Master Series model

is based on a prototype introduced in 1972 by Berwick Forge & Fabricating Co. The design featured an overhanging X-panel roof and corrugated non-terminating steel ends. Road names for the ready-to-run model will be Bangor & Aroostook, BNSF (Swoosh scheme), CSX, Kansas City Southern, Mississippi Delta, San Luis Central, Union Pacific, and Railbox (original scheme). For additional information on all Atlas products contact a dealer or visit atlassrr.com.

.....



A new craftsman-style structure kit named the Green Door Lounge is coming soon from **Blair Line**. The laser-cut kit assembles into a two-story store-front building with a foot print of 2x5 inches. Key components in the kit include laser-cut

tab and slot wood walls with etched nail holes in the sides, and a laser-cut floor that includes front and rear sidewalks with randomly etched cracks. The laser-cut peel and stick windows can be positioned open or closed. Additional details include a trash barrel, roof-top TV antenna, brick chimney, downspouts, a wall fan, two different wall vents, and non-working exterior lamps. Signage includes several billboards and three billboard frames plus a hanging front sign. In addition to Green Door Lounge, business name signs include Dew Drop Inn and Calico Cat

JUNE NEWS | 15

Lounge. Availability of the HO scale kit is projected for late July. For additional information contact a dealer or visit blairline.com.

.....

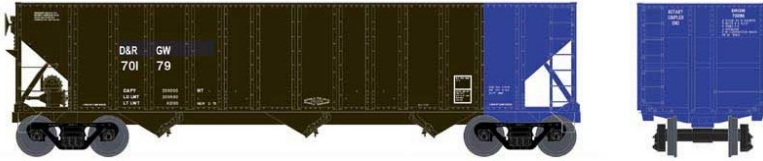

Bowser is working on a new 100-ton 45-foot triple-bay open hopper car for release next February. Reservations for the ready-to-run model are being accepted through the 20th of this month. The HO scale model replicates a prototype developed in 1960 for the Norfolk & Western Railroad. Distinctive features include roping eyes with integral end buffers, end slope sheets that are at a steeper angle than the hopper sheets, and 13 riveted side posts with the two wider panels in the middle of the car. Additional features include full-height side ladders, Wine hopper door fixtures, interior slope sheet bracing, and roller bearing trucks with 36-inch metal wheels.



The model will be available decorated for Denver & Rio Grande Western (blue rotary end), Bessemer & Lake Erie (baby blue scheme), B&LE (black with conspicuity stripes), BNSF (Swoosh), Canadian National (ex-C&O), PPLX (yellow end), PPLX Reddy Kilowatt, Pennsylvania Railroad (yellow dot), Reading, Western Pacific (blue rotary end), WP (white rotary end), and Wheeling & Lake Erie. For additional information contact a dealer or visit bowser-trains.com.

.....



Broadway Limited Imports has announced plans to release this big Class A Norfolk & Western 2-6-6-4

this summer. The HO scale model replicates prototype locomotives built between 1936 and 1950. One Class A is preserved in Roanoke at the Virginia Transportation Museum. The ready-to-run locomotive model and class 22i tender comes with Paragon3 Sound for DC or DCC operation. Features include puffing smoke synchronized with each exhaust chuff, traction tires, and an engineer and fireman installed in the cab. The model is composed of ABS plastic superstructure with a die-cast metal chassis.

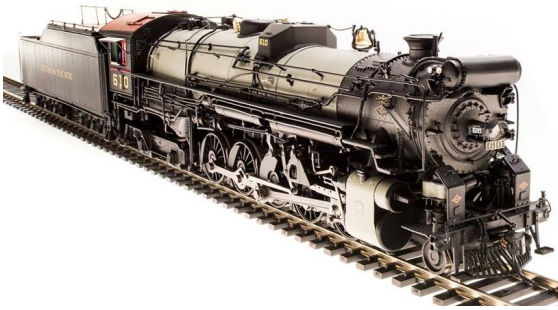

BLI plans to release a HO scale version of a Texas & Pacific 2-10-4 steam locomotive early next year. The brass-hybrid model is based on a prototype built by Lima in 1925. The model will be fitted with BLI's new

Paragon3 Rolling Thunder sound system. For more information on all BLI models contact a dealer or visit broadway-limited.com.



Classic Metal Works has several new HO scale vehicle models set for release this summer including a Greyhound Scenicruiser decorated in the red, white

and blue Pepsi scheme that appeared briefly in the early 1970s.

JUNE NEWS | 17

The model will be available with unique numbers and destination signs for New York, Chicago, Los Angeles, and a blank. Also coming this summer is a group of WWII-era military trucks and a group of 1960 Ford utility trucks with hi-rail wheels for railroad maintenance duty. Completing CMW's summer release is a 1936 Ford Fordor sedan that will be available in green and blue, and the iconic Checker Taxi Cab scheme of yellow over green. For additional information visit classicismetalworks.com.

.....

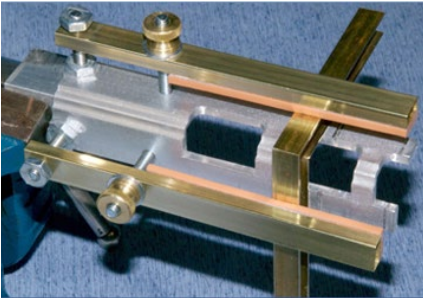

Among the newest products from **Coffman Graphic Solutions** is a combination

clamp suitable for both soldering and gluing applications. Features of the combo clamp include heat resistant silicon rubber pads to withstand soldering temperatures, a heavy 1/8-inch aluminum base that functions as a heat sink, alignment grooves to help secure round material, convenient thumb screw adjustments, and a base extension to facilitate securing the clamp in a vice. For additional information visit coffmaneng.com.

.....

Fox Valley Models will release another production run of its HO scale Baltimore & Ohio class M-53 wagon-top boxcar late this year. Four cars in this release will be decorated in standard B&O schemes representing prototypes from their introduction to 1962. An additional five schemes will cover variations of the late billboard scheme. For additional information contact a dealer or visit foxvalleymodels.com.

.....



boxcar with 8-foot doors. The model follows L&N's 1952-era decorating scheme..



The HO scale ready-to-run model is painted in the original gray scheme applied to the prototype when it was built in 1957. For additional information on all Kadee products contact a dealer or visit kadee.com.



Union Pacific. The SP models and DC version of the UP diesel are available now from factory stock in two different road numbers.



New HO scale freight cars coming from **Kadee** late next month include this Louisville & Nashville PS-1 40-foot

Also coming from Kadee this summer is a PS-2 Northern Pacific twin-bay covered hopper with eight round roof hatches.

KatoUSA has announced a new release of its HO scale General Electric C44-9W locomotives decorated for Southern Pacific and

DCC versions of the UP locomotive are built to order which can be arranged through an authorized Kato dealer

or direct. For additional information contact a dealer or visit katousa.com.



Rapido Trains has added a Downeaster scheme to the previously announced

line-up of NPCU Cabbage units (see mrhpub.com/2016-03-mar/online). Extended negotiations with the Northern New England Passenger Rail Authority accounted for the delay in announcing the Downeaster version. Tooling for Rapido's NPCU (non-powered control unit) is nearing completion and preliminary test shots are expected to be completed early next month. Unlike the prototype, Rapido's HO scale NPCU will be fully powered. The order deadline is July 1 with delivery anticipated this fall. A complete listing of F40PH and NPCU units is available at rapidotrains.com/ho-amtrak-npcu.



Resin Car Works has introduced a pair of cast resin boilers that make an interesting as well as authentic flat car load. Etched brass tie-down straps are included. The prototypes were built and

used throughout the 1900s making the loads appropriate for many railroad eras. For additional information visit resincarworks.com/scene.htm.

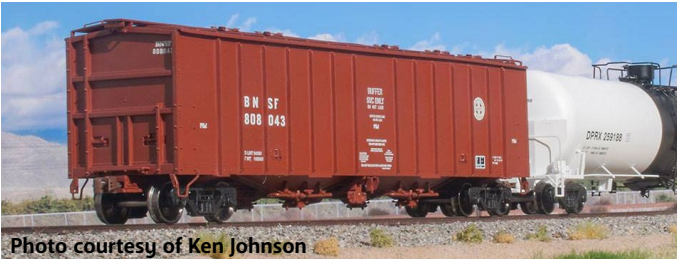
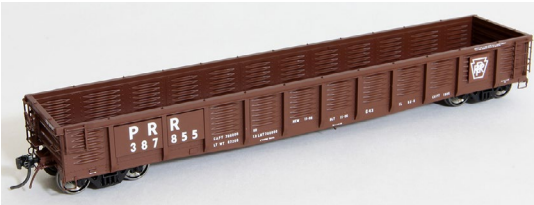

Photo courtesy of Ken Johnson

ScaleTrains.com unveiled a preview sample of its new 4180 cu. ft. covered hopper at the Western

Prototype Modelers meet held recently in Bellflower, CA. The project has been licensed by GATX and to ensure prototypical accuracy ScaleTrains.com developed the HO scale model from copies of the builder's original blueprints. As an economy-priced Operator Series model, the 4180 will have minimal details and basic lettering. An upgrade kit with grab irons, coupler cut levers, train-line hoses and other details including decals will be sold separately. Availability of the model is expected late this summer. For additional information visit scaletrains.com.

.....



The newest HO scale freight car from **Tangent Scale Models** is an all-new Pennsylvania/Penn Central class G43 100-ton 52-foot 6-inch corrugated side gondola.

The PRR and its successor PC built a total of 3,750 of these at the Sam Rea Shops. Many of these tough gondolas still serve NS and CSXT in both revenue and MOW services. To accurately replicate variations in the prototype, Tangent has produced three side configurations including interior details, two end configurations, different underframes, and four different floors including two with coil racks. The ready-to-run models come with 100-ton trucks with 36-inch machined wheels and Kadee couplers. Models available now include Pennsylvania Railroad class G43 with plain keystone (above).



This Penn Central class G43C gondola in 1970s-era PC green with “worms” logo and steel floor (above) is available now in multiple road numbers. A similar car is available with wood floor for general service.



This Conrail version represents the G43 gondolas CR modified with special racks to transport uncovered steel coils. A set of eight steel coils painted in

the color of galvanized sheet steel with black steel banding is sold separately. In addition to the above ready-to-run models, undecorated kits for six different versions of the G43 gondolas are also available now. For more information on these beautifully rendered models visit tangentscalemodels.com.



TSN Design is selling a finely-detailed kit for the Johnson House – a typical Craftsman-style house of the 1920s.



This beautifully executed kit is composed of laser-cut acrylic for the siding and roof, laser-cut embossed shingle roofing material, and cast resin detail parts

including doors and windows. The instructions provide information on assembling three different versions of the house. For more information visit tsndesign.com.

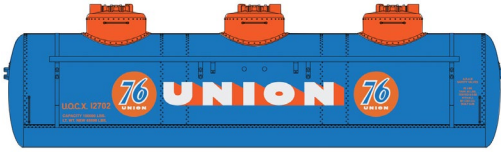

Walthers plans to release a new series of road names for its 36-foot triple-dome tank car in September. The Mainline series model will

be available in two numbers each for SHPX-Gulf Oil, SHPX-JM Huber, GATX-General American, NATX-Prichard Oil, SCCX-Shell, and UOCX-Union 76. (910-1123)



Scheduled for release in November is a steel bay-window caboose based on a prototype manufactured by International Car

Co. The HO scale ready-to-run Mainline Series car is an economy priced model with a limited number of details. For example, there are no grab irons on the caboose, but starter points are molded into the body to conveniently indicate where grabs can be installed. Road names on this run will be Santa Fe, CSX, Great Northern, Norfolk Southern, Southern, Southern Pacific, and New York Central.

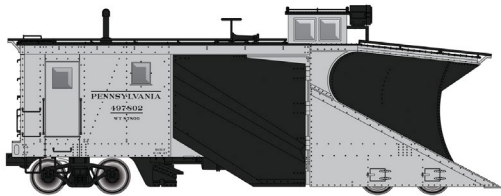

Walthers plans to deliver a new run of Russell snowplows this December. The HO scale ready-to-run Proto Series model will be available decorated for

Ontario Northern, Canadian Pacific, Northern Pacific, New Haven, and Pennsylvania Railroad. The placement of running boards,

headlights, and horn will vary depending on the practice of the prototype road being modeled. For additional information on all Walthers products contact a dealer or visit walthers.com.

.....



Yarmouth Model Works is offering a resin kit for an HO scale Northern Pacific 1937 AAR 40-foot boxcar. Features include a one-piece body with correct lower door track, a laser-cut running board,

and ladders with correct 15-inch rung spacing. Appropriate trucks from Tahoe Model Works are included along with custom decals from Speedwitch Media.

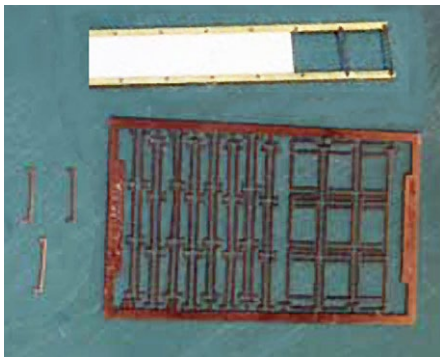

Freight car ladders came in a variety of widths, depending upon manufacturer and end user. To fill this need for HO modelers, Yarmouth offers a variety of etched rungs and side rails. Each fret includes enough rungs to build four ladders plus some spares. Extra-long side rails are included for those who

wish to use the rails as pins to further secure the ladder to the car. Rungs are available in half-inch increments from 14 inches to 18-1/2 inches. For more information visit yarmouthmodelworks.com/details.php.

.....

N SCALE PRODUCT NEWS



American Model Builders has introduced a laser-cut body kit for an N scale Northern Pacific 1200 series wood caboose. The kit features laser-cut underframe and end platform and laser-cut body components using custom

laser-scribed birch plywood for the sides, end walls, and cupola. Additional details include end railings, hand grabs, ladders, cast platform steps, smoke jack, window glazing, brake wheels, and peel & stick material for the windows, doors, and trim. Optional details include both wide and narrow ladder arrangements. The illustrated assembly instructions provide guidance on painting and decaling the model. Trucks, couplers, and decals are not included. AMB recommends Micro-Trains Line body-mounted couplers, Atlas solid-bearing caboose trucks, and Microscale decals #60-184.



Also new from American Model Builders is a kit for a load of generators for a flat car. The N scale kit includes seven cast resin generators, a laser-cut wood shipping frame, and deck blocking. When assembled the load will fit comfortably on a 50-foot flat car (not supplied). For more information on all AMB products visit laserkit.com.

.....

JUNE NEWS | 25



Athearn is quoting a February release date for a group of F59PHI diesels and Bombardier commuter cars. Although originally designed and built by EMD for the California Department of Transportation, the lightweight, high-speed F59PHI can now be found in service throughout the US and in eastern Canada. Athearn's N scale locomotive will be available with a factory installed DCC SoundTraxx Econami Sound System. They will also be available for standard DC operation with 8- and 9-pin Quick Plug connectors for installation of an after-market decoder (not supplied).



The F59PHI locomotives and Bombardier cars will be available decorated for Coaster, GO Transit, Amtrak Surfliner, Amtrak California, Caltrain, Northstar, and Metrolink.



Also due next February is a 52-foot 14-panel mill gondola. Road names will be Detroit, Toledo & Ironton; Amtrak, Santa Fe, Chicago & North Western, Norfolk Southern, Golden West Services patch, and Golden West Services. For additional information about all Athearn products contact a dealer or visit athearn.com.



Atlas Model Railroad Company has scheduled another release of its popular USRA 50-ton single-sheathed boxcar during the third

JUNE NEWS | 26



(above) doors. The ready-to-run model of this classic prototype will be available decorated for Duluth, Missabe & Northern; Grand Trunk Western, Maine Central, and Richmond, Fredericksburg & Potomac. Previously released road names included in this production run with new road numbers will be Canadian Pacific, Chicago & North Western, Southern Pacific, and Pennsylvania Railroad.

quarter of 2016. Depending on the prototype being followed, the N scale models will have either Murphy 7-8 or 5-5-5 (above) corrugated steel ends and simulated steel or wood



gallon tank car. Previous road names included in this release with new numbers are ADM-Molecule, AGP-Refined Oil, Cargill-Vegetable Oils, and GATX-BASF. New paint schemes for the model include DPRX, Flint Hills Resources, GATX-ADM, TILX, XTRX-First Union Rail, NS First Responders, and TCBX-AIG Rail Services.

Also coming during the third quarter is another production run of Atlas Master Series Trinity 25,500



available for standard DC operation as well as with a factory

Atlas has announced a fourth quarter release date for a selection of EMD GP7/GP9

installed NCE DCC decoder. Road names for the GP7 version will be Central of Georgia, Chattahoochee Industrial Railroad, Southern, and Wabash.



The higher horse-powered but otherwise identical GP9 will be available decorated for

Baltimore & Ohio, Great Northern, Metro North, Northern Pacific, and New York Central. For additional information on all Atlas products contact a dealer or visit atlasrr.com.

.....



The latest craftsman-style structure kit coming soon from **Blair Line** is the Green Door Lounge. The N scale laser-cut kit assembles into a two-story store-front building with a foot print of 1.1- by 2.7-inches. Key components

in the kit include laser-cut tab & slot wood walls with etched nail holes in the sides and a laser-cut floor that includes front and side-walks with randomly etched cracks. The laser-cut peel & stick windows can be positioned open or closed. Additional details include a trash barrel, roof-top TV antenna, brick chimney, downspouts, a wall fan, two different wall vents, and non-working exterior lamps. Signage includes several billboards and three billboard frames plus a two-sided hanging sign at the front of the building. In addition to Green Door Lounge, business name signs include Dew Drop Inn and Calico Cat Lounge. Availability of the kit is planned for late August. For additional information contact a dealer or visit blair-line.com.

.....

Fox Valley Models will release another production run of N scale Baltimore & Ohio class M-53 wagon top boxcars during the fourth quarter of this year. Four cars in this release will be decorated in standard B&O schemes representing prototypes from their introduction to 1962. An additional five paint jobs will cover variations of the late billboard scheme. For additional information contact a dealer or visit foxvalleymodels.com.

.....



Kato Japan is celebrating its 50th anniversary as an international producer of N scale models with the release of a specially packaged Japanese C50 steam locomotive. The

anniversary package includes the operating N scale model, a full-color hardback booklet, and a DVD that presents a gallery of models throughout Kato's history. A release date is planned for late July. A limited quantity of the anniversary model will be available in North America through KatoUSA. For additional information on this special model visit katousa.com/Zcart/index.php?main_page=product_info&cPath=166&products_id=1681.



KatoUSA has scheduled an early summer release for an N scale EMD SDP40F Type 1 diesel. The model represents the first locomotive

JUNE NEWS | 29

designed and built specifically for Amtrak. Amtrak's Phase I (above) and Phase II paint scheme will both be available on the initial release. DCC models with ESU LokSound are scheduled for release later this summer.



KatoUSA is selling a bookcase set of N scale models composed of a Siemens ACS-64 City Sprinter electric locomotive and four Amfleet I cars.



The passenger cars are decorated in Amtrak's Phase VI scheme and include three coaches and the café cars shown here.

For more information on all Kato products contact a dealer or visit katousa.com.



Micro-Trains Line has released N scale 53-foot corrugated containers decorated for CSX and AX Sun Group.

JUNE NEWS | 30



for CB&Q-Burlington. The diner is also available in the colorful Ringling Brothers Circus scheme.

New heavyweight steel passenger cars from Micro-Trains include a dining car decorated



Canadian Pacific open-platform observation car.

Completing this month's release of N scale passenger equipment is a



hopper and a Soo Line 61-foot bulkhead flat car.

New N scale freight cars coming from Micro-Trains Line include a CSX/C&O 100-ton triple-bay coal



Additional new ready-to-run N scale models include a Denver & Rio Grande Western 60-foot boxcar with double plug doors, and a 50-foot rib-side boxcar decorated for Union Railroad of



Oregon. The UO car has non-terminating steel ends and double Youngstown sliding doors.

JUNE NEWS | 31



For more information about Micro-Trains Line products contact a dealer or visit micro-trains.com.



Train Control Systems is selling a drop-in decoder for Kato's ACS-64 electric locomotive and Electro-Motive Division SDP40F units. Identified as TCS item K7D4, the decoder includes built-in forward and reverse light-emitting diodes, two solder pads for additional lights, auto-adjusting back-electromotive-force control, and Quiet Drive. For additional information visit tcsdcc.com.



New N scale models coming from **Walthers** late this year include these Thrall 48-foot well-cars. Like the prototype, these ready-to-run N scale models can accommodate 20-,

40-, and 48-foot containers. Road names will be CP Rail, Florida East Coast, Santa Fe, and both early and late TTX schemes. The models will be available as individual units or in five car sets with different numbers. For additional information contact a dealer or visit walthers.com.

NEW DECALS, SIGNS AND FINISHING PRODUCTS



Black Car Decals is selling Northern Pacific monad decals for water towers. The HO scale decal is 10 feet in diameter. Each package contains four decals.



Also new are HO scale decals for Grand Trunk Western single-sheathed boxcars

in GTW's 581000-581999 series. Also decals for GTW 585203-585885 series 40-foot steel double-door boxcars. For additional information visit blackcatdecals.com.

.....

MinuteMan Scale Models continues to expand the selection of railroad colors in its Scalecoat brand of hobby paint. The latest addition is EMD Demonstrator Blue in a two-ounce bottle. Railroad colors recently made available in six-ounce spray cans include Oxide Red, Tuscan Red, and Smoke Box Gray. For additional information visit minutemanscalemodels.com.

.....



Dan Kohlberg at **ICG Decals** has released two new sets of silk-screened decals suitable for

Tangent's new class G43 gondola. ICG set #SE-15 will accurately

JUNE NEWS | 33

decorate one Pennsylvania Railroad class G43 52-foot gondola in the 1966-era scheme as shown in the prototype photo.

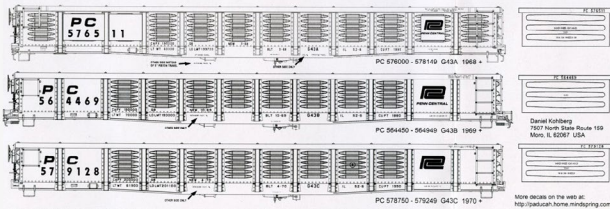

ICG set #SE16 will decorate three Penn Central 52-foot class G43a, G43b, and G43c gondolas in the 1968+ scheme.

For more details including photos and prototype information visit home.mindspring.com/~paducah.

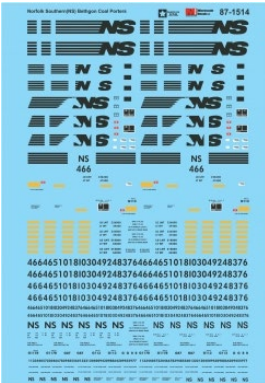

New water slide decals available from **Microscale** include HO, N, and O scale decals for Norfolk Southern Bethgon Coal Porters. The set includes extra striping and five paired stripes to match both early logos and later horse head logos. Also

new are HO and N scale decals sets for Gulf, Mobile & Ohio 40- and 50-foot boxcars, and FGEX-Fruit Growers Express. Additional new HO decals include sets with yellow letters for Northern Pacific passenger cars in NP's original two-tone green scheme.



[Click here for reader comments](#)



O scale decal lettering sets are available for Gulf, Mobile & Ohio diesels 1966-1972; Canadian Pacific/

Canadian Pacific hood diesels 1998+; and Baltimore & Ohio F, FA, FB-2, F7 and Alco FA-1 and F-3 cab units. Microscale has also released O scale lettering sets for CB&Q Burlington Route with yellow lettering for heavy weight passenger cars circa 1950-1970, and a three-sheet set for Pennsylvania Railroad pre-1948 steam locomotives. For more information contact a dealer or visit microscale.com.



SEND US YOUR PRODUCT ANNOUNCEMENTS

If you are a hobby manufacturer with a product announcement, just [click here](#) and submit your announcement to us. Our web site and free magazine reach continues to grow, so get on board this new media train! ■

DISCLAIMER

The opinions expressed in this column are those of the writer and do not necessarily reflect the opinion of *Model Railroad Hobbyist* or its sponsors. Every effort is made to provide our readers with accurate and responsible news and information, however, neither *Model Railroad Hobbyist* or the writer of this column can be held responsible for any inaccuracies or typographical errors that may inadvertently appear in this column.

Trainfest®

NEW
**2 DAY
TICKETS**

AVAILABLE JULY 1
THROUGH NOV. 11

AMERICA'S LARGEST
OPERATING MODEL
RAILROAD SHOW

Saturday & Sunday
Nov. 12 - 13, 2016

9:00am-
5:00pm

WI State
Fair Park
Milwaukee (West Allis), WI

Ticket discounts and show details at **Trainfest.com**

EXPANDED TRAINFEST CLINICS

FREE

Join us for **2 full days of clinics** presented by expert modelers and model railroading manufacturers. Choose from a wide range of modeling topics at any of our **56 total clinics!** Space is limited, register for clinics today at www.Trainfest.com.



60 MODEL RAILROADING MANUFACTURERS

Come to see all **major model railroading manufacturers** at Trainfest and many **cottage industry** businesses offering unique and interesting products for your layout. Don't miss any of the exciting announcements scheduled to be unveiled at Trainfest!

NEW PRODUCT ANNOUNCEMENTS

**OPERATE
THE
TRAINS!**

70 OPERATING LAYOUTS

Make Trainfest your annual destination to meet with other modelers and find inspiration for your own layout at more than **70 operating model railroads**. Experience the camaraderie of the model railroading hobby and even **operate the trains** on participating layouts!

CELEBRATE
A
RAILROAD



CELEBRATING THE MILWAUKEE ROAD

In 2016 Trainfest will partner with the Milwaukee Road Historical Association to celebrate the Milwaukee Road. Look for the Milwaukee Road throughout the show and don't miss the museum quality historical photo display, Celebrate-a-Railroad clinic series, and much more!

**FREE
RIDE THE
MLES
TRAIN!**

Sponsored by the Wisconsin Southeastern Division, Inc.
of the National Model Railroad Association



BRIEFLY NOTED AT PRESS TIME ...

Archer Transfers has introduced 3D rivets for a variety of patterns commonly used on heavyweight steel Pullman cars. Prototype modelers can be assured of the authenticity of the patterns since they were developed for Archer by Pullman experts Tom Madden and Larry King. The decals are available in N, HO, S and O scales. Details are at archertransfers.com.

Con-Cor is selling an HO scale 36-foot wood stock car that represents prototype equipment used to transport cattle and sheep from the late 1800s through the 1920s. The ready-to-run models are available in multiple road numbers decorated for Denver & Rio Grande Western, Pennsylvania, Atlantic Coast Line, Chicago & Illinois Midland, Union Pacific, Norfolk & Western, Santa Fe, Seaboard, Southern Pacific, and Florida East Coast. More information can be found at con-cor.com.

KatoUSA, headquartered in Schaumburg IL, has a job opening for a full-time position with the corporate sales team. Responsibilities include working with distributors and dealers, handling customer phone support, attending trade and dealer shows, and some light warehouse work. For more information visit katousa.com/career.html.

Monroe Models of St. Cloud, MN, has acquired **AIM Products**, a long-time producer of weathering stains and cast tunnel portals, retaining walls, and bridge abutments. Monroe is also announcing the release of a new laser-cut kit for a diesel engine house. The single engine facility is available now in N scale with HO and Z scale versions expected to be announced soon. Additional details on the acquisition as well as the new model are available at monroemodels.us.

Rapido Trains has released a video that documents the progress of its forthcoming Alco/MLW FA-2 and FPA-2 diesel engines. Featured are some beautifully decorated hand-finished pre-production models. The video can be viewed at rapidotrains.com/ho-alco-mlw-fa2.

ScaleTrains.com has announced plans to deliver an HO scale GATC 4566 cu. ft. Airslide covered hopper this September. The car is similar to but taller than the previously-announced 4180 cu.ft. counterpart. The initial production of the 4586 is expected in September. They will be decorated as buffer cars for ScaleTrains.com's Trinity crude oil tank cars. Features of the Rivet Counter series model include see-thru etched metal walkways and crossover platforms, separately applied detail parts including formed wire grab irons, Barber S-2 100-ton trucks with rotating bearing caps, and metal Type E knuckle couplers. Four additional variations of the 4180s will be available later in the year. For complete details visit scaletrain.com.

Motrak Models, best known for its extensive line of loads for open-top freight cars, has purchased Bollinger Edgerly Scale Trains, aka BEST Models. According to Jeff Adams of Motrak the acquisition includes all prototype-based models BEST had acquired over the past several years from Precision Lasercraft, Crow River Products, and Sheepscot Scale Products. Adams told MRH that freelance-based models are not included in the acquisition. Motrak products will be available through a net work of distributors and dealers. Within the next few weeks the expanded line of products will be ready for viewing on the firm's new web site at motrak-modelsusa.com.



SELECTED EVENTS

June 2016

(Please note that many events charge a fee. Check individual info website for details.)

CANADA, BRITISH COLUMBIA, SALMON ARM, June 15-19, Selkirk Express NMRA Pacific Northwest Region Annual Convention & Train Show. HQ at Prestige Harbourfront Resort, 251 Harbourfront Drive NE. Show at Shaw Centre, 2600 10th Avenue NE. Info at selkirkexpress2016.ca.

CANADA, NOVA SCOTIA, TRURO, June 18, Maritime Prototype Modellers Meet, at Recreation Centre, 40 Douglas Street. Info at facebook.com/MaritimePrototypeModellers.

ALABAMA, HUNTSVILLE, June 10-11, NMRA Southeastern Region Convention, Rocket City Rails, at Huntsville Marriott, 5 Tranquility Base. Info at midsouthnmra.org/convention.htm.

CALIFORNIA, PASADENA, June 5 and June 7, open house at Slim Gauge Guild Model Railroad Club, 300 South Raymond. Info at slimgaugeguild.com.

CALIFORNIA, RICHMOND, June 18, Bay Area Prototype Modelers Meet, at St. David's School Hall, 871 Sonoma Street. Info at bayareaprototypemodelers.net.

CONNECTICUT, ENFIELD, June 3-4, 14th Annual New England/Northeast Prototype Modelers Meet, at Holiday Inn, 1 Bright Meadow Boulevard. Info at neprototypemeet.com.

SELECTED EVENTS | 2

FLORIDA, TALLAHASSEE, June 25, Model Railroad Show & Sale, North Florida Fairgrounds, 441 Paul Russell Road. Sponsored by Big Bend Model Railroad Association. Info at bbmra.org.

KANSAS, MERRIAM (Metro Kansas City), June 11, 13th Annual KCNG Meet sponsored by Kansas City Area Narrow Gaugers, at Johnson County Library, Antioch Branch, 8700 Shawnee Mission Parkway. Info from Larry Alfred at captlalfred@gmail.com.

KANSAS, OVERLAND PARK, June 29-July 3, National N Scale Convention hosted by N Scale Enthusiast at Sheraton Overland Park Hotel Convention Center, 6100 College Boulevard. Info at nationalscaleconvention.com.

KANSAS, WICHITA, June 21-26, Santa Fe Railroad Historical & Modeling Society 36th Annual Convention, at Wichita Marriott East, 9100 Corporate Hills Dr. Info at atsfr.com/convention/2016%20Wichita/Index.htm.

OKLAHOMA, ENID, June 18-19, Trainfest 2016, at Oakwood Mall, 4125 West Owen K. Garriott Avenue. Info from randylutz01@gmail.com.

TEXAS, ARLINGTON, June 22-25, NMRA Lone Star Region Daylight Express Convention, at Sheraton Arlington Hotel. Info at mainlinetrains.com.

UTAH, SALT LAKE CITY, June 18, NMRA Northern Utah Division has moved the location of its monthly meetings to Discovery Gateway Children's Museum, 444 West 100 South. Future meetings will be held at the new location on the third Saturday of each month. For additional information visit northernutahnmra.org.

SELECTED EVENTS | 3

WISCONSIN, WAUPACA, June 18-19, 27th Annual Strawberry Fest Model Railroad Show & Model Contest, sponsored by Waupaca Area Model Railroaders, at Waupaca Recreation Center, 407 School Street. Info at wamrltd.com.

July 2016

ARIZONA, PHOENIX, July 23, Cactus Summer Swap Meet hosted by Grand Canyon Model Railroaders, at North Phoenix Baptist Church, 5757 North Central Avenue. Info at gcmrr.org.

CALIFORNIA, SANTA CLARA, July 4-10, 32nd Annual National Garden Railway Convention, at Santa Clara Convention Center adjacent to Hyatt Regency Santa Clara (headquarters hotel), 5101 Great America Parkway. Info at ngrc2016.org.

INDIANA, INDIANAPOLIS, July 3-10, NMRA National Convention and National Train Show. HQ at Westin Hotel, 50 South Capitol Avenue. Info at nmra2016.org.

INDIANA, INDIANAPOLIS, July 8-10, NMRA National Train Show, at Indiana Convention Center, 100 South Capitol Avenue. Info at nationaltrainshow.org.

MARYLAND, TIMONIUM, July 9-10, Great Scale Model Train & Railroad Collectors Shows at Maryland State Fair, 2200 York Road. Info at gsmts.com.

Future 2016, by location

CANADA, ONTARIO, BRAMPTON, October 1-2, Model Railway Show, at Brampton Fair Grounds, 12942 Heart Lake Road. Info at bramptonmodelrailwayshow.com.

CALIFORNIA, CULVER CITY, September 21-24, NMRA Pacific Southwest Region LA Junction Convention, at Double Tree Hotel LA Westside, 6161 West Centinela Avenue. Info at psrconvention.org/lajunction.

SELECTED EVENTS | 4

CALIFORNIA, LOS ANGELES, September 25, Self-Guided Tour of area layouts. Info at [groups.yahoo.com/neo/groups/Model Railroads Of Southern California/info](http://groups.yahoo.com/neo/groups/Model_Railroads_Of_Southern_California/info).

CALIFORNIA, SAN PEDRO, October 15-16, Open House & Swap Meet, sponsored by Belmont Shore Railroad Club, at 3601 South Gaffey Street, Building 824. Info at belmontshorerr.com.

MAINE, AUGUSTA, Sept. 7-10, 36th National Narrow Gauge Convention. Info at nngc2016.org.

CALIFORNIA, TEHACHAPI, August 13-14, Tehachapi Train Show sponsored by Tehachapi Loop Model Railroad Club, at Tehachapi Valley Parks and Recreation West Park Gymnasium, 410 West D Street. Info at tlrc.club/model-train-shows.

FLORIDA, THE VILLAGES, August 20-21, Summer Train Expo, at Savannah Center. Info at villagerailclubs.blogspot.com.

ILLINOIS, COLLINSVILLE (metro St. Louis), August 12-13, 10th Annual St. Louis Railroad Prototype Modeler's Meet, hosted by John Golden, Lonnie Bathurst, Dave Roeder, and Dan Kohlberg. Co-sponsored by NMRA Gateway Division, at Gateway Convention Center. Info at icg.home.mindspring.com/rpm/stlrpm.htm.

ILLINOIS, CHICAGO, October 1-2, Brass Expo, a juried show limited to pre-submitted items including brass models and items relevant to brass models. At The Westin Hotel (Chicago North Shore), 601 N. Milwaukee Ave. Wheeling, IL 60090. Info at brassexpo.com.

ILLINOIS, LISLE, October 20-22, RPM Chicagoland (formerly Naperville RPM), hosted by Mike Skibbe, at Sheraton Hotel. Info at rpmconference.com.

INDIANA, INDIANAPOLIS, September 22-24, 48th National O Convention, at Wyndham Indianapolis West Hotel, 2544 Executive Drive. Info from Kimberly Ryker at kim.ryker@yahoo.com.

SELECTED EVENTS | 5

INDIANA, MERRILLVILLE, Aug 11-14, Steel Mill Modelers SIG Meet, at Hilton Garden Inn, 7775 Mississippi Street. Membership in SMMSIG is required to attend. Info at smmsig.org.

MISSOURI, JEFFERSON CITY, October 6-9, Missouri Pacific Historical Society Annual Meeting, includes modeling clinics and swap meet. Info at mopac.org/annual-convention/110-2016-jefferson-city-mo.

NORTH CAROLINA, DURHAM, October 20-23, Mid-Eastern Region Fall Convention, sponsored by NMRA Carolina Piedmont Division, at Marriott at Research Triangle Park, 4700 Guardian Drive. Info at mer2016.org.

TEXAS, FOREST HILL, October 8-9, Texas Western Train Show, at Forest Hill Civic Center, 6901 Wichita Street. Info at twmrc.org.

VIRGINIA, VIRGINIA BEACH, October 8-9, 27th Annual Train Show & Sale, at Virginia Beach Convention Center, 1000 19th Street, sponsored by Tidewater Division Model Railroaders. Info at nmra-mer-tidewater.org.

VIRGINIA, FREDERICKSBURG, September 3 - October 1, Mid-Atlantic Prototype Modelers Meet, at Wingate by Wyndham Hotel, 20 Sanford Drive. Info at marpm.org.

Future 2017 and beyond (by location)

AUSTRALIA, VICTORIA, GEELONG, April 14-16, 2017, 13th Annual Australian Narrow Gauge Convention. Info at austnarrowgaugeconvention.com.

COLORADO, DENVER, August 30-September 2, 2017, National Narrow Gauge Convention, at Marriott Denver Tech Center Hotel.

SELECTED EVENTS | 6

FLORIDA, ORLANDO, July 30-Aug 5, 2017, NMRA National Convention.

MISSOURI, KANSAS CITY, August 5-12, 2018, NMRA National Convention. ■



**Click here for
reader comments**

***TrainMasters TV is part of
the MRH product family.***

*TMTV members not only get great network TV level
videos, they help pay for MRH and keep it free ...*

Clickable advertiser index – 1

[Accu-Lites](#)

[American Eagle Railroad Group](#)

[American Ltd \(San Juan\)](#)

[ANE Models](#)

[Archer Fine Transfers](#)

[Athearn](#)

[Atlas Model Railroad Co.](#)

[Bachmann](#)

[Backdrop Junction](#)

[Berrett Hill Trains](#)

[Black Cat Publishing](#)

[Blair Line](#)

[Bowser](#)

[Caboose Hobbies](#)

[Canyon Creek Scenics](#)

[Clever Models](#)

[Coffman Graphics](#)

[Con-Cor International](#)

[Credit Valley Railway](#)

[Digitrax \(2 page spread\)](#)

[ESU LokSound](#)

[Fast Tracks](#)

[Fifer Hobby Supply](#)

[Fox Valley Models](#)

[George's Trains](#)

[GLX Scale Models](#)

[Great Decals](#)

[HO Diesel Supply](#)

[Indianapolis NMRA Convention](#)

[Indianapolis National Train Show](#)

[Iowa Scaled Engineering](#)

[Iwata-Medea](#)

[Jelsma Graphics](#)

[Jim's Track Plans](#)

[KC's Workshop](#)

[Ken Patterson.com](#)

[Lights 4 Models](#)

[Litchfield Station](#)

[Logic Rail Technologies](#)

[Main Street Heritage Models](#)

[Model Railroad Benchwork \(1\)](#)

[Model Railroad Benchwork \(2\)](#)

[Monster Modelworks](#)

[Motrak Models](#)

[Mountain Subdivision Hobbies](#)

[MRH Store \(1\)](#)

[MRH Store \(2\)](#)

[MRH Store \(3\)](#)

[Nano-Oil](#)

[National Narrow Gauge](#)

[NCE \(2 page spread\)](#)

[Nick & Nora Design](#)

[North American Railcar Co.](#)

[Oak Hill MRR Track Supply](#)

[Pre-Size Model Specialities](#)

[Precision Design Co.](#)

[RailMaster Hobbies](#)

[Rapido \(1\)](#)

[Rapido \(2\)](#)

[Ring Engineering \(1\)](#)

[Ring Engineering \(2\)](#)

[Rulers-of-the-World](#)

[Rusty Stumps](#)

[Scale Trains](#)

Clickable advertiser index – 2

[Scotty Mason Show](#)

[Soundtraxx \(Blackstone\)](#)

[Southern Digital](#)

[Streamlined Backshop](#)

[TAM Valley Depot](#)

[Tony's Train Exchange](#)

[Trainfest 2016](#)

[TrainMaster Model Trains](#)

[TrainMasters TV \(1\)](#)

[TrainMasters TV \(2\)](#)

[TrainMasters TV \(3\)](#)

[Traintek](#)

[Westerfield Models](#)

[Yankee Dabbler](#)

[Yarmouth Model Works](#)

Clickable “other” index

[Other – Cover](#)

[Other – Derailments](#)

[Other – Hobby Marketplace](#)

[Other – MRH Sponsors](#)

[Other – Staff Notes](#)

[Other – Table of Contents](#)

DOWNLOAD ISSUE



DOWNLOAD PORTRAIT



DOWNLOAD LANDSCAPE

• INDEX

• TABLE OF CONTENTS



REVERSE RUNNING

commentary

JOE FUGATE
.....



[Click here for
reader comments](#)

THE POWER OF CONFINEMENT

ONE OF THE GREAT

unsung ways to do the model railroading hobby well is to embrace putting limits on yourself. I call it the power of confinement.

I think it's a myth that no limits is the most liberating. A good analogy is



being on a ship at sea. So called "total freedom" would be to just point the ship any direction and then "sail away". Who needs a compass and charts? If we get the impulse to change direction, then hey, we change direction! Total freedom and no confinements whatsoever.

But what's likely to happen? Sooner or later, because we don't know where we are (we threw out the compass and charts, remember), we may run aground. Or worse yet, we may shipwreck in the night,

▶ [STEPPING OUTSIDE THE BOX WITH A CONTRARY VIEW](#)

crashing into some rocky seashore and losing the ship, the crew, and the cargo to the murky depths.

By letting the compass and the charts confine and direct our movements, we now know where we are and where we are going. By limiting our freedom of choice and letting it be restricted by the guidance of the compass and the charts, we're actually more free because we're now confined to exploring the globe more safely.

As for being a model railroader, consider limiting the era and prototype you're modeling. This can actually be more liberating because you'll have a greater sense of where you're going, just like the compass and charts give you in the example.

By knowing the era and prototype you are doing, you can now focus your resources. No longer are you broke ten minutes into a train show because you bought whatever caught your fancy. Now attending a trainshow becomes like a fascinating treasure hunt. You're looking for just the specific era and prototype of interest.

When you're doing research online, you can now focus your efforts on much more specific topics, making your searches more productive. Rather than flailing around with little sense of direction online, you now know exactly what questions to ask. How liberating!

There's also the use of your most precious resource: time. By focusing your hobby pursuits based on era and prototype, you can spend your limited time working on specific projects aimed at modeling this era and prototype well. Instead of being the Generic Central, your layout can develop a specific purpose and a well-defined story that excites the imagination of your model railroading buddies. Time well spent!

By getting a lot more specific in your modeling, you may also find your passion for the hobby increases a few notches, too. Nothing like infusing some fresh excitement into your hobby pursuits!

Don't see putting limits on what you model as a bad thing. It could be the most liberating thing you've done for your hobby in a long time. The power of confinement – you might be surprised how fun it is!



DERAILMENTS

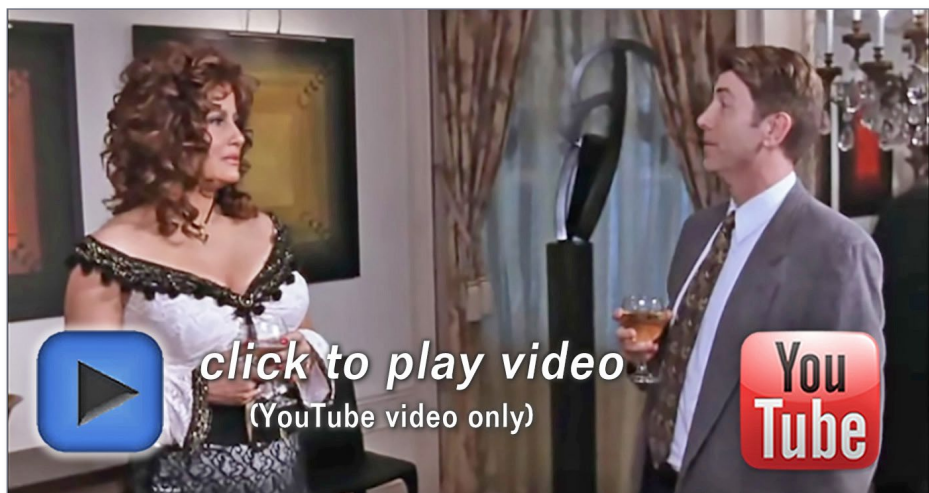

“I’M A MODEL TRAIN ENTHUSIAST ...”

In this clip from the documentary-style comedy, “A Mighty Wind”, actor Jim Piddock remarks to a lady at a party that he’s into model trains. The lady’s response is unexpected, to say the least. The plot of this 2003 docu-comedy is based on three folk groups from the ‘60s who reunite for a memorial concert in New York City.

The subtly wacky jokes in this movie are good for many chuckles – we couldn’t resist sharing this “I’m a model train enthusiast” moment from the movie!

► BIZARRE FACTS AND HUMOR (SUPPOSEDLY)

THE DENT TRAIN STATION

A lady was travelling to Dent, a station on the famous Settle to Carlisle railway in the UK. Upon arrival at Dent, she got off the train and seeing nothing but countryside around her asked the attendant “Where is the village of Dent?” The attendant replied it was about 3 miles away, down the hill. The lady then asked “Wouldn’t it have been better to build the station near the village?” to which the attendant replied, “ Well madam, we thought it better to build it near the railway.” ■

💰 GET PAID ...

If you're the first to submit a bit of good humor or bizarre facts and we use it, it's worth \$25! Just send to derailments@mrhmag.com ■

Coming next issue ...

- Modeling SP operations in CA
- Naptown & White River Club layout
- Modeling tricks for a small city space on your layout
- Kitbashing rail transfer facility
- Doing the Arizona & California in N scale
- And lots, *lots* more!



**Click here for
reader comments**

