

Tim Dickinson models The Burlington Northern » **READ NOW**

ALSO:

- Realistic creosote wood coloring
- Loading sounds into DCC decoders
- Better hopper coal loads
- Joining dissimilar rail heights
- Build a DCC test station

... and lots more inside!





ALL ABOARD THE ATLAS HO MODERN COMMUTER TRAIN



CLICK HERE!



Multi-Level Trailer

Multi-Level Cab Car



Multi-Level Trailer with Safety Slogan

Multi-Level Trailer with Toilet

*Products bearing NJ TRANSIT marks are made under trademark license from NJ TRANSIT.



Model Railroad Hobbyist | Aug 2016 | #78

STAFF CREDITS

Front cover: In this issue, Robert Schleicher (editor emeritus of *Railmodel Journal*) reviews Tim Dickinson's HO Burlington Northern layout and the principles he used to model this prototype well.



ISSN 2152-7423

Editorial Staff

Joe D. Fugate, Publisher and Editor
Don Hanley, Assistant Editor

Production

Patty Fugate, Pasteup and Layout
Joe Brugger, Copy Editing
Mike Dodd, Copy Editing

Technical Assistant

Jeff Shultz

Advertising

Les Halmos, Account Manager
Daniel Nava, Advertising Assistant
Jean-François Delisle, Marketing Assistant

Columnists

Richard Bale, News and events
Jeff Shultz, News and events
Les Halmos, Modular railroading
Larry Smith, Narrow Gauge/Shortlines
Bruce Petrarca, DCC
Ken Patterson, Reporter at large

Special Correspondents

Joe Brugger, Questions & answers
Charlie Comstock, Contributing editor

Issue password: Aug2016

Published for the glory of God. [What's this?](#)



MRH SPONSORS

A - F



acculites.com



americanlimitedmodels.com



railroadhobbyshow.com



anemodel.com



archertransfers.com



athearn.com



www.atlasrr.com



bachmanntrains.com



bachrus.com



backdropjunction.com

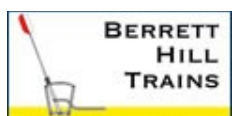

berretthill.com/trains



blairline.com



bowser-trains.com



caboosehobbies.com



coffmaneng.com



cvrco.com



www.digitrax.com



esu.eu/en



www.handlaidtrack.com



fiferhobby.com



foxvalleymodels.com

G - R



georgestrains.com



glxscalemodels.com



www.iascaled.com



iwata-medea.com



litchfieldstation.com



micromark.com



moloco.biz



store.mrhmag.com



monstermodelworks.com



stores.ebay.com/Motrak-Models



mtalbert.com



modelrectifier.com



nano-oil.com/Model%20Railroad.html



ncedcc.com



nickandnora.com



www.pwrs.ca/main.php



nngc2016.org



railmasterhobbies.com



rapidotrains.com



ringengineering.com



rustystumps.com

[Vendors: Get your clickable logo here ...](#)

[Vendors: Get your clickable logo here ...](#)

MRH SPONSORS | 3

S - Z



sanjuancarco.com



scaletrains.com



soundtraxx.com



sodigi.com



sbs4dcc.com



tamvalleydepot.com



tonystrains.com



trainmastermodels.com



trainmastermodels.com



traintekllc.com



tsgmultimedia.com

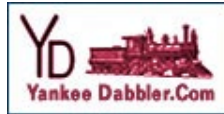

yankeedabblers.com

[Vendors: Get your clickable logo here ...](#)

Looking for something? Check the MRH Marketplace!



Take me there!



PWRS

Announcing our next Limited Run
PWRS / Micro-Trains® Cars!!!

Procor (PROX) w/Optimiser Logo • 4-Packs

54' General Service Tank Car

Pack #1

- yellow Procor logo
- yellow reporting marks

Pack #2

- white Procor logo
- yellow reporting marks



NEVER DONE BEFORE PAINT SCHEMES!

- Black w/yellow reporting marks
- Optimiser logo
- Vertical reflective tape
- Light weathering



COMING February 2017

CLICK HERE FOR **Procor tank**

Canadian Pacific Railway (CPR) • 6-Pack

40' Despatch Stock Car w/Cattle Chute

COMING February 2017

1ST TIME IN N-SCALE!



- Mineral Brown top & ends w/white lettering, high position
- Railroad name on plate, high right
- White slats
- Light weathering



PACIFIC WESTERN RAIL SYSTEMS
SPECIAL RUN CAR

CLICK HERE FOR **CPR stock car**

Pacific Western Rail Systems



TABLE OF CONTENTS

FEATURES

Tim Dickinson's Burlington Northern

ROBERT SCHLEICHER and TIM DICKINSON

Modeling a prototype railroad more effectively



Realistic coal loads made easy

MIKE HOLLY

Make coal hopper loads that look totally real



One Module Challenge: 3rd Place

SHAWN BECHER

An early 1900s modular layout plan

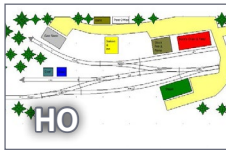

Build a DCC decoder testing station

ERIC WARHOL

Make sure that decoder is good *before* you install it



First Look: Scale Trains

JOE FUGATE

Closeup look at new releases from ScaleTrains.com



TABLE OF CONTENTS | 2

COLUMNS

MRH Q-A-T: Alco sounds, creosote coloring, ...

compiled by JOE BRUGGER

Up the Creek: Joining dissimilar track

CHARLIE COMSTOCK

DCC Impulses: Loading sounds into DCC decoders

BRUCE PETRARCA

Getting Real: Ozark mountain scenery, part 2

NICK MUFF

What's Neat: Train Show, Tsunami2 ...

KEN PATTERSON

Photo feature: Yes, it's a model

compiled by DON HANLEY

Derailments: Bizarre facts & humor

compiled by the MRH STAFF

NEWS and EDITORIAL

Publisher's Musings: Investing in your hobby satisfaction

JOE FUGATE

News & Events: August 2016

RICHARD BALE & JEFF SHULTZ

Reverse Running: Limited run model frustration?

JOE FUGATE

ALSO: MRH Marketplace | Subscriber extras

Finally... The Definitive HO SD40-2



Also available in...



Preorder Now

Scene and photography by Ken J Johnson
First test model shown

© 2016 ScaleTrains.com, Inc. ScaleTrains.com, Operator, Rivet Counter, and respective logos are trademarks of ScaleTrains.com, Inc. ScaleTrains.com, Inc. 7598 Highway 411 Benton, TN 37307 844-9TRAINS 844-987-2467 International 423-299-3689

WWW.SCALETRAINS.COM

WWW.SCALETRAINS.COM



Model Railroad Hobbyist | August 2016 | #78

PUBLISHER'S MUSINGS

editorial

JOE FUGATE



[Click here for
reader comments](#)

INVESTING IN YOUR HOBBY SATISFACTION

I ATTEND A NUMBER OF SHOWS EVERY YEAR

and I take in interesting clinics by hobby experts from all over. Some of these clinics contain excellent insights. When I can I approach those modelers about doing an article for MRH, getting on TrainMasters TV (our web video channel), or both.

Some of the hobby insights I have gained from these clinics have done a lot to increase my hobby satisfaction, at times dramatically. As a leading hobby publisher, I feel it's important for us bring you these insights whenever possible. Sometimes though, an article in MRH just isn't enough – so we will put the information into a book or a video – which means it won't be free like MRH¹.

Even though the books and videos are not free, we can bring you this powerful insight for a lot less than the price of a plane ticket and hotel stay! I realize many people have a tight hobby budget, but don't overlook an occasional investment in your hobby satisfaction. Let me pass along one example recently posted on the MRH website.

¹ We have two business models we use – products that are free but loaded with ads (MRH mag), and products like our books and videos with no ads and a modest price. Sites like YouTube that are free are now loaded with ads. We prefer to avoid the “ad junkyard” look with our books and videos.

PUBLISHER'S MUSINGS | 2

"For about two years, resistance soldering was a huge frustration. How could I go wrong? I bought the biggest and best Hot Tip machine P-B-L offered. Boy, was I in for a surprise when I still could not get a decent solder joint with either the tweezers or the probe and ground!

"The solution was staring me in the face: P-B-L offered a video on how to solder, called The Art of Soldering. I was skeptical. A review of that video said it was dated but excellent and very helpful. I [finally] ordered one and watched it. I realized right away that I was using too much flux, too much solder and heating the wrong area. It wasn't long before I got the hang of it ... now 99% are good, up from about 15%!" - herronp (mrhmag.com/node/27033?page=9#comment-249506)

This has been my experience as well from seeing these clinics at shows or from watching videos or reading books. At shows, I

ADVERTISEMENT



1st choice for model railway supplies and service.

Expedited mail service available across North America.

Click to visit
WWW.CVRCO.COM
1 800 464 1730



ADVERTISEMENT

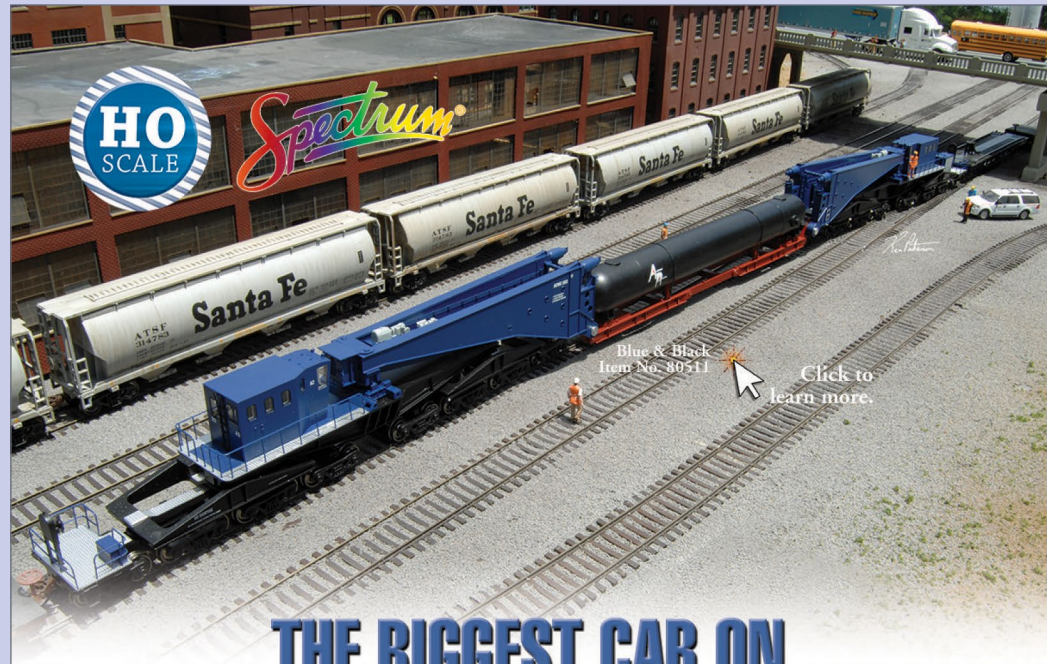

THE BIGGEST CAR ON THE RAILS JUST GOT BIGGER!

Bachmann takes enormous delight in introducing the 380-Ton Schnabel Transformer Car with Retort/Cylinder Load. The Schnabel car's unique design allows it to carry extremely heavy or oversized loads, such as generators and transformers for power stations, by making the load an element of the car. A whopping 32.5' long and meticulously detailed, see why our new Schnabel is the biggest thing in HO modeling!

Features include:

- 16 sets of 125-ton roller-bearing trucks
- prototypically correct 36" metal wheels
- RP25 wheel contours
- 8 span bolsters

- retort/cylinder load
- molded hydraulic lines and pumps
- 32.5" long
- performs best on 22" radius curves or greater



Gray & Black
Item No. 80512



Red & Black
Item No. 80513

Shipping now! • MSRP \$349.00 each



Bachmann Industries, Inc. • 1400 East Erie Avenue • Philadelphia, PA 19124 • www.bachmanntrains.com

Click for more information.

Checked us out lately?

- ✓ HO/N and now O scale products too!
- ✓ Laser-cut Structures & Bridges.
- ✓ Advertising & Storefront Signs.
- ✓ Highway Signs, vintage & modern.
- ✓ New Detail Items.
- ✓ Laser-cut Grade Crossings.
- ✓ Billboards, roadside & rooftop.
- ✓ Laser-cut Graffiti Decals
- ✓ 1000's of satisfied customers.

WHAT'S NEW? Established 1993...
 **Blair Line**

NICK & NORA DESIGNS
 Uniquely inspired craftsman kits



Craftsman Structure Kits,
 Detail Parts, Shingles & More!
www.nickandnoradesigns.com

PUBLISHER'S MUSINGS | 3

carefully cherry-pick the clinics I attend, looking for the ones that are the best topics by the most intriguing modelers. When I find a good one, we try to get that information into your hands via MRH, the MRH Store and TMTV.

Some techniques and methods are best demonstrated on camera rather than explained in text. Reading about some techniques doesn't create the aha moment like the soldering example above shows. That's where video comes in.

Speaking of aha moments, we'll be starting up a new series on TMTV with these little-known insights from various expert modelers, such as Mike Confalone. The aha moment format is short and meaty – in less than seven minutes we show you killer tips for solving various hobby frustrations or challenges. If you've seen the new MRH Acrylic Painting Guide and the tips in there (we're even

3800



*It's, like, even the
 right length, eh?*

BEAUTY GOAL!

SO, AH, CLICK HERE, EH?



WOW!
What scale is this?

Click for the answer ...

MISSOURI LOCOMOTIVE COMPANY

ADVERTISEMENT



Archer
FINE TRANSFERS
PROUDLY SERVING MODEL BUILDERS SINCE 1989

THE ORIGINAL
SURFACE DETAILS™

WE NOW HAVE MORE THAN 100 SHEETS OF RIVETS, LOUVERS, TREADPLATE AND MORE CAST ONTO MICROSCALE CLEAR DECAL FILM

FREE SHIPPING:

- DOMESTIC USA ORDERS \$50 OR MORE
- INTERNATIONAL ORDERS \$100 OR MORE

CLICK HERE TO VISIT OUR WEBSITE!

Archer Fine Transfers • PO Box 1277 • Youngsville, NC 27596 • USA
(919) 570-1026 • info@archertransfers.com • archertransfers.com

"Archer rivets are easy to apply and look great. To me, they are now a vital tool in building railroad models."
Tony Thompson, Model Railroad Author/Historian

MADE IN THE USA

PUBLISHER'S MUSINGS | 4

getting longtime experts in the hobby telling us these tips rock), then that's the kind of insights we'll be bringing you from various modelers via the aha moments TMTV series.

Even though your hobby budget is limited, don't overlook the chance to make the hobby more satisfying by investing in some how-to materials beyond MRH. Compared to the price of a plane ticket and hotel stay, these insights we're finding and bringing to you in book and video form are a bargain.

MRH SURVEY RESULTS: HOW MUCH DO YOU SPEND ON THE HOBBY?

We've concluded our 2016 MRH reader survey, so periodically I will share some of the results.

My editorial above talks about hobby spending, so let's look at the survey results for how much our readers spend on the hobby.

We ask this question so we can tell advertisers how

PUBLISHER'S MUSINGS | 5

much our readers spend. We don't record who said what, so you're safely anonymous. We only care about the aggregate.

(The survey results chart is on the next page.)

From this survey feedback, we can estimate that our 33,000 subscribers, as a group, spend about \$5 million per month on the hobby, or about \$60 million per year.

Extrapolating out to our almost 90,000 total readers, that's about \$15 million per month or approaching \$200 million per year in business MRH readers generate with their model railroading hobby.

I also note that almost half our readers spend less than \$100 per month on the hobby, so spending money on a how-to product could be a hard choice.

It's tempting, when your budget is small, to spend your limited funds mostly on the hobby core products: locos, rolling stock, track, and controllers (DCC or DC). Deciding

Combo Right Clamp™



Combo Right Clamp™
with cast resin boxcar

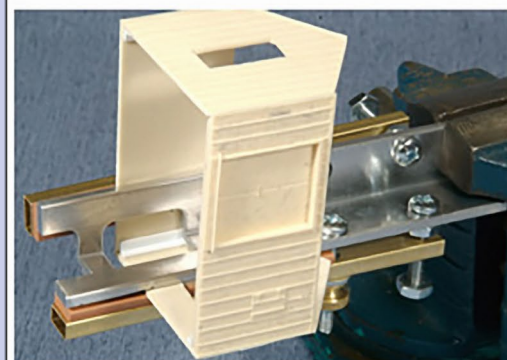

Combo Right Clamp™
with Wolf Design Pump House

Click here for all our products ...

Tools for Modelers

Coffman Graphic Solutions Co.
1500 River Circle, Richmond,
KY 40475-7907

How much do you spend on the hobby each month?

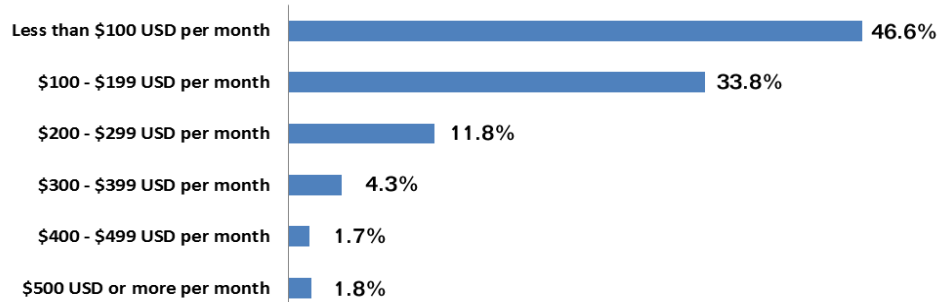

to spend money on non-core hobby products like structures, scenery details, or tools versus on another loco can be a tough choice, especially if you're worried another "must have" limited run loco might be in the wings.

It's even more difficult to spend some of your limited hobby budget on how-to material when things like MRH and YouTube are available for free.

Yet, it may be these extra insights that will help you the most with saving time and avoiding costly mistakes.

At the end of the day, remember we're modelers too, and we're trying hard to bring you the insights that have helped us to better achieve our hobby goals. When it fits within an article format then we'll bring it to you here in MRH. But if it demands a more in-depth treatment, then we will target a book or video – which we might call an "extra-curricular" product.

However, like the soldering story, some occasional "extra-curricular" spending just might be the best investment you've made in your hobby recently.



[Click here for reader comments](#)

MRH SECOND ANNUAL "ONE MODULE" CHALLENGE CONTEST

ENTRY DEADLINE: January 31, 2017

Goal: Design the first "module section" for a sectional home layout design.

Hypothetical room is 10' x 14' – 2'x'8' closet can be used; window can be covered.

Note: This is a sectional home layout design, no modular standard required.

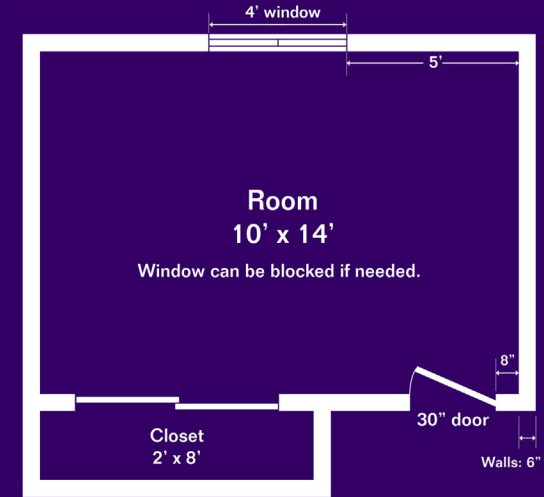

CONTEST RULES

- Modules can be any size or shape but must fit through the room door (7'-6" tall and 30" wide) without damage or pinching your fingers.
- Scale: From Z to O, using any track gauge combination.
- Module section must connect to a temporary staging yard module at each end. Staging yard must have at least three yard tracks.
- Rough in the outlines of the other layout module sections to be built for the entire room. No track plan required, just an outline of the modules in the room is sufficient. Bonus points awarded for [showing a module construction progress plan](#).
- Modules can follow a standard or not. Custom sections are okay.
- Module support method / height up to you, but please describe.
- Innovative approaches get extra points: please describe and illustrate if possible.
- Include a cost estimate for the module. There is no need to actually build anything, this is a design contest only. Do be as comprehensive as possible in the cost estimate: the hypothetical goal is a completely finished, operational module.
- The best submissions will be published, so extra points are awarded for quality text, illustrations, photos and captions. Winners get a bonus payment rate.

SUBMIT ENTRY (Choose "Contest Entry")

Other notes

We received this “Letter to the editor” from NMRA President Charlie Getz, in response to Don Hanley’s editorial in July on the future of the NMRA and the resulting discussion thread that accompanied it.

A Response to the MRH Editorial on the NMRA

I would like to respond to the recent editorial on the role of the NMRA in the hobby as published in the July issue of MRH. I appreciate all of the points made and especially, many of the posts following those comments. Some of those posts were very constructive offering great ideas for improving the NMRA but I start by correcting a major mis-statement wrongly attributed to me.

At no time have I ever said Millennials will abandon their computers and devices, which is a ridiculous proposition on its face! Rather, I have said, based upon many studies of that particular generation, that given their preferences and traits, recruiting them for model railroading is a big challenge. I also said that I held out great hope for the post-Millennial generation since all generations reject the excesses of the prior one. We baby boomers did so with the conformity of our 50’s era parents and perhaps that youngest generation will be less enamored with the digital world and more open to what we offer.

We would love to attract the younger generations in the NMRA but no one has yet demonstrated how to do so. All studies indicate that his generation does not embrace hobbies, particularly analog hobbies such as ours, and those activities with delayed gratification. It is fine to employ digital platforms for our message and we do so, but it is the message that is the challenge.

We embrace social media nonetheless and will embrace digital publication when it makes economic sense. Right now it does not and we have studied it extensively. No publisher of model railroad magazines reports more than a 5% digital participation by their readers. Digital is not free and its costs must be covered by income.

MRH is a fantastic magazine and I am proud to be a subscriber. But MRH is also free.

The NMRA is the oldest scale model railroad organization in the world. Since 1935, we have promoted model railroading and set standards that are widely utilized. The NMRA is why you can use trucks, couplers and track from different manufacturers and have them work together. Try charging you iPhone with a Samsung charger. In fact, some years back, we were contacted by an internet group of modelers in China asking to partner with the NMRA in order to insure our standards were applied in China.

And our standards work continues with Power on Board (battery powered wireless DCC) and Layout Command Control. We continue to offer education and skill improvement to members through our conventions, both local and National. We promote the hobby worldwide. I ask you to name any harm the NMRA has done to the hobby.

The editorial cited our leadership and conventions as potential problems. In fact, we have a very lean National leadership: 9 Board members, 5 officers, maybe 10 Department heads and a professional staff of 3. Hardly “top-heavy”! It is our 18 Regions and 156 Divisions where the rubber meets the road and where members receive services. Are we “out of touch”? Well, I never say “never” but our members are probably best to answer that one. I do not think so as we spend a lot of time listening to our members and trying to better our association and ourselves.

The National Convention can be expensive. So is Comic-con. The better question is whether you receive value for the money spent. There, the answer is easy. With dozens of clinics, Modeling with the Masters (hands-on clinics), hundreds of layouts (many open to self-guided tours), a world-class contest, one of the largest Train Shows in the country, silent auction, operations possibilities and a special interest room along with fellowship, it is a week packed with Model Railroading on steroids. But there are also Regional conventions at a far less cost and periodic local events.

PUBLISHER'S MUSINGS | 9

Joining the NMRA is a vote for the future of model railroading and a vote of confidence in what we do and stand for. Some suggest Joe Fugate run for President of the NMRA. Well, we have one prominent magazine editor on our BOD, so why not?

More importantly, I urge any MRH reader to get involved. For \$9.95, you can try us out for six months. Get involved and if change is needed, become a part of that change. Don't like the NMRA? Then join and help us change for the better. You can join us or stand outside and complain. I welcome your comments and invite you to join us. I also thank Joe for a wonderful magazine, his support of the NMRA and his fairness in encouraging all viewpoints.

Charlie Getz
NMRA President

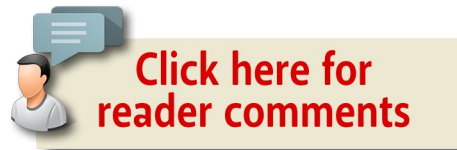

ADVERTISEMENT

Floquil/PollyScale stash running out?



MRH has mapped the old familiar colors to new readily-available acrylic paints.

ADVERTISEMENT

Your Complete Model Train Store

WWW.TRAINMASTERMODELS.COM

TrainMaster Buys, Sells & Trades Model Trains!

We have over 50,000 items to chose from!

Visit us to shop the most complete selection of items available!

TRAINMASTER MODEL TRAINS HAS BEEN TRUSTED FOR MORE THAN 18 YEARS!



MRHMAG.COM

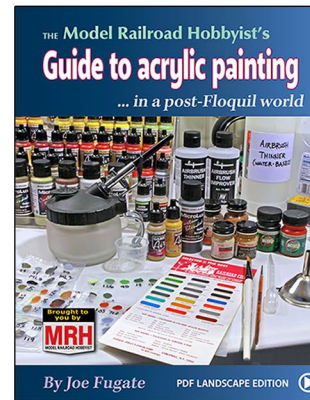

MRH's Floquil / PollyScale Paint Equivalents Conversion Chart - 1

Floquil/PollyScale Color	Color Name	Model Master	Valley Model	Woods	Notes
Primer Gray		MM 4763	VMA 71500	16-12	
Engine Black		MM 4888	ML 30098 VMA 71521	16-01	
Steam Power Black		MM 4795	VMA 71657	16-44B	
City Black		MM 4792	VMA 71601	16-44F	
Weathered (Charcoal) Black		MM 4790	ML 39023 VMA 71654	16-05	
Reflex Gray		MM 4887 MM 4793	VMA 71045	16-04	
Reflex White		MM 4873	ML 39024 VMA 71491	16-02	
Gring Black		MM 4887 MM 4831	ML 39025 VMA 71491	16-03	
Colosse Red		MM 4887 MM 4831	ML 39025 VMA 71491	16-08	MS 100 4831 with 20% Water/100% Floquil/100% PollyScale

MRH's Floquil / PollyScale Paint Equivalents Conversion Chart - 2

Floquil/PollyScale Color	Color Name	Model Master	Valley Model	Woods	Notes
Tuscan		MM 4650*	VMA 71036	16-15	
Reflex Orange		MM 4682*	VMA 71083	16-09	
Reflex Yellow		MM 4679	VMA 71078	16-10	
Rail Brown		MM 4681	ML 39009 VMA 71249	16-19B	
Railroad Tan Brown		MM 4685	ML 39003 VMA 71479	16-40F	Clear match... See MRH 10-04
Rail Brown		MM 4687*	ML 39001 VMA 71239	16-19A	
Rust		MM 4625	ML 39005 VMA 71037	16-10Z	
Concrete		MM 4676	VMA 71491*	16-10*	Clear match... See MRH 11-12
Appl Concrete		MM 4676	ML 39007 VMA 71491	16-09*	Clear match... See MRH 10-15

*Indicates a close but not exact match. All Model Master paints are a sample finish. Valley Model Acrylics, Woods, and Model Master paints are from various sources. 1 Glass finish. 2 Sample finish. 3 Wood finish. 4 Model Master Acrylics. 5 Clear match... See MRH 10-04. 6 Clear match... See MRH 10-04. 7 Clear match... See MRH 10-04. 8 Clear match... See MRH 10-04. 9 Clear match... See MRH 10-04. 10 Clear match... See MRH 10-04. 11 Clear match... See MRH 10-04. 12 Clear match... See MRH 10-04.

MRH Subscribers: Download your FREE Post-Floquil acrylic painting eBook

Want a hardcopy version? Post-Floquil acrylic painting guide: \$15.99 (MRH Store)

• INDEX

• TABLE OF CONTENTS

★ LAST ISSUE'S RATINGS

The five top-rated articles in the [July 2016 issue](#) of *Model Railroad Hobbyist* are:

- 5.0 Derailments
- 4.9 Noti switching puzzle
- 4.7 Modeling Quisling, CA
- 4.6 Getting Real: Ozark mountain scenery, part 1
- 4.6 What's Neat: HO RC autos, Tsunami2, and more

Issue overall: 4.3

Please rate the articles! Click the reader comments button on each article and select the star rating you think each article deserves. Thanks! ■

ADVERTISEMENT

MT. ALBERT SCALE MODELS
SCALE LUMBER CO.

**COMING SOON
IN HO SCALE!**

SCALE PILOT MODEL SHOWN

We plan to produce an HO Scale version of our very popular Mt. Albert Lumber Yard kit later this year. Please watch our website and Facebook page for more details.

MRHMAG.COM

ADVERTISEMENT

New Product Release
OLD COBBLESTONE SHEETS

MONSTER modelworks

HO & N SCALES AVAILABLE

www.monstermodelworks.com

ADVERTISEMENT

Bowser

N Scale Cylindrical Hopper Cars

Ready to Run. Features: Crisp details and sharp painting and printing. Roller bearing trucks with Fox Valley Models metal wheels and body mounted knuckle couplers.
\$19.95 each

Road Names:

French's Southern Pacific Great Northern	Burlington Northern Union Pacific CSX	Grace/Davidson Chemical Co. Toledo, Peoria & Western Maypo	Pillsbury B&O Chessie Ajax
--	---	--	----------------------------------

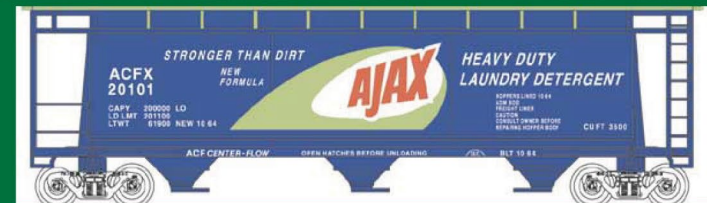
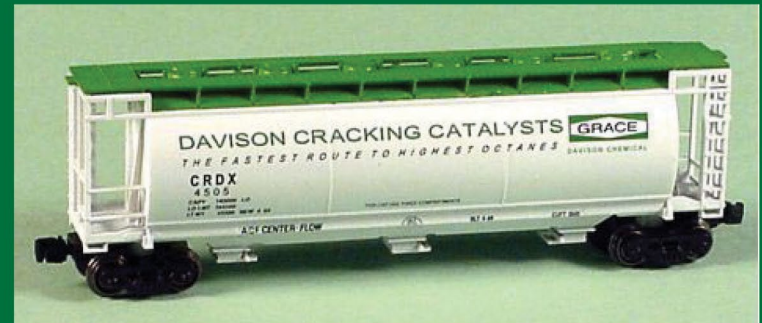

Click here to check out the details for these and other great Bowser Products

• INDEX

• TABLE OF CONTENTS



HO models shown



N-SCALE ROLLING PIPELINE

ANNOUNCEMENT

Loading and unloading individual tank cars is a time consuming process, so GATX developed a unique solution—the TankTrain. The TankTrain is literally a pipeline on wheels. Sets of up to 13 cars are interconnected with a transfer hose so they can be loaded and unloaded from one end at a rate of 3,000 gallons per minute. Based upon GATX diagrams, as well as photos and field measurements, these new N-scale models faithfully replicate the differences between the 282-number series and 486-number series. For the first time ever, these models make their debut in N-scale exclusively by Athearn®

\$84.98 3-PACK

- ATH14991 N TankTrain A/B Ends & Intermediate Car Set, GATX/Early (3)
- ATH14992 N TankTrain Intermediate, GATX/Early #1 (3)
- ATH14993 N TankTrain Intermediate, GATX/Early #2 (3)
- ATH14994 N TankTrain Intermediate, GATX/Early #3 (3)
- ATH14995 N TankTrain A/B Ends & Intermediate Car Set, GATX/Late (3)
- ATH14996 N TankTrain Intermediate, GATX/Late #1 (3)
- ATH14997 N TankTrain Intermediate, GATX/Late #2 (3)
- ATH14998 N TankTrain Intermediate, GATX/Late #3 (3)



Down to the Last Detail
Accurately represented flexible soft vinyl transfer hose with characteristic sag that easily bends as the cars negotiate curves.



Accuracy Counts
Details specific to both the 486xx and 282xx series including different tank saddles, uncoupling lever and bracket, top walkway and supports, and transfer piping and gas purge lines.



Find us on: YouTube®
Facebook® and Twitter®

HORIZON
H O B B Y

VISIT
Your Local Retailer

CLICK
Athearn.com

CALL
1.800.338.4639

SERIOUS FUN™

©2016 Horizon Hobby, LLC. Athearn, Genesis, Ready To Roll, Trains in Miniature, Serious Fun and the Horizon Hobby logo are trademarks or registered trademarks of Horizon Hobby, LLC. All other trademarks, service marks and logos are property of their respective owners. Union Pacific Licensed Product. Final models may vary slightly from photos shown. Model photos by Tom Bacarella. 55593



Model Railroad Hobbyist | August 2016 | #78

MRH Q-A-T

column

compiled by
JOE BRUGGER



[Click here for reader comments](#)

? QUESTIONS AND ANSWERS

Alco turbo sounds

Q. I am really tempted to buy a couple of the Alco RS-1 units for the SP&S that Atlas is bringing out. It is the closest prototype to what I am modeling. My question is about the turbocharger sound. I downloaded the manual from the ESU website but was unable to find anything about turning down the volume of the turbo sound.

All the sound samples I have listened to from ESU and other manufacturers for the 539T make me think the whining is too much. Sort of like the bells. After a very short time they can get annoying.

So has anybody done this? Turn down the turbo on a 539T? The RS-1 is one of my favorite locos, but the available 539T sounds leave something to be desired.

—Stevie

▶ MRH QUESTIONS, ANSWERS, AND TIPS



1. Smoking Alco video example #1: Spruce Falls ALCO (MLW), does his switching chores, and finishes just in time.



2. Smoking Alco video example #2: After winter hibernation, ex-Eastman Kodak Company ALCO RS-1 #9 starts up.

A. JC Shall: I think you'll have to agree that the turbo whine is fairly pronounced on a 539T. Maybe you would be happier with a model of an S-1 or S-3 switcher which uses a non-turbocharged 539 prime mover. Or perhaps an RS-2, RS-3, or RSD-4 or -5. These use the 244 engine which, though turbocharged, doesn't have the pronounced whine of the 539T.

Nelson Beaudry: Most all decoder manufactures have the 539T sound dead-on. Even the MRC decoders have the 539T dead-on! I have the sound value Bachmann S2, and it sounds very good. The RS-1 has turbo whine that sounds almost like a whistle at times. Wait until you do some switching with it, especially if you have some momentum cranked up so you can spool up the prime mover when pulling or pushing a string of cars.

MRH: Bell sounds can be turned on and off, and the ringer rate changed. Turbo whine on the 539T is not listed among the separately adjustable sounds. The LokSound news, forum, and videos are at esu.eu/en/news. Sound effect levels for the diesel engine and some accessories are individually adjustable, and ESU LokSound and LokSound Select manuals can be downloaded at esu.eu/en/downloads/instruction-manuals/digital-decoders.

We posted your question at esu.eu/en/forum/forums-overview/topic/loksound_lokpilot_support-1/alco_539t_sounds/#pid but have not received any response.

See more smokin' Alco videos in the MRH Forum thread at mrh-mag.com/node/25670.

1. At top left see and hear a great-sounding Spruce Falls Alco (MLW) doing its switching chores.
2. At bottom left, some nice sounds while switching with a remotely controlled Alco S-2.

Creosote paint colors

Q. I would like to use inexpensive craft acrylic paints to paint a styrene trestle a creosote color to make it look like wood. Any suggestions what colors to mix and what ratio?

—Ken L.

A. Dave B.: A wide range of colors can be used depending on the age, type of wood, maintenance, weather, etc. Even on a single trestle, the colors can vary a lot. This one [3] at Capitola, CA ranges from shiny black dripping creosote to dry gray and brownish tones. Find color photos of trestles in your modeled location to get the best results.

JC Shall: I agree with Dave on this one. In March of last year a friend and I took a drive down a highway paralleling a mainline. We

ADVERTISEMENT

GLX SCALE MODELS.COM

OIL LANTERN KIT

3D PRINTED MODEL

1/48 SCALE!!!

\$19.99 + S&H

12 VOLT POWERED LED LIGHT



3. This old creosoted-timber trestle at Capitola CA has weathered to a silvery gray, but notice the brownish horizontal stringers, and the faded warning strips on the base level to the left. *Dave Branum photo*

stopped at every trestle we passed (quite a few), and I took detailed photos at each location. I don't think any two piles or timbers had exactly the same coloration.

I think it best to apply several layers of paint of various colors/shades, streaking them here and there to simulate the look seen in photographs you've taken or perhaps found on the internet. Here are just a few of the photos I took that day: lacentralrr.com/Blog/2015/03/10/a-field-trip.

Joe Fugate: Make sure you distress the styrene in advance to add wood grain. Use coarse sandpaper (like 40 grit), the blade on a razor saw, and a hobby knife to get wood grain. Go in a consistent direction that the wood grain would actually go.

Build up the color in thin layers. You are staining the trestle, not painting it. Start with a light gray paint, and add just a touch of silver to give it a weathered wood sheen. This is an undercoat.

Next, apply a thin black stain to bring out the grain. Let the stain settle down into the grain. Once this is dry, if needed dry-brush on some black to add wood grain streaks. Keep your brushstrokes going in the direction of the grain.

Next, mix up some very light gray and very lightly dry brush that on in the direction of the grain to create subtle highlights.

If you want to go further, mix up some black-brown paint and thin it to make a stain. Flow that on inconsistently, allowing some pieces to be more weathered than others. Depending on how weathered you want the trestle to look you can thin the black-brown paint a lot or just a little. You don't want it to cover things completely, so even the thickest mixture should be no more than 50% color to 50% thinner. More often, you will want more like 20% color to thinner.

My preference is to err on the side of less paint and more thinner, and to build up the creosote color with two or more thin coats of black-brown stain. If you like, mix up a thin stain using some yellow-orange or red-brown paint to stain a few pieces and add some more color to your wood.

Lastly, hit the trestle with some flat finish like Dullcote and add some dry weathering powder to give the trestle more of a dusty-dirty look. To protect the final weathering, add one light coat of flat finish.

Some notes on thinner

For best results, use thinner for the paint brand you're using – Aztek universal thinner for Model Master acrylics, or Vallejo thinner for Vallejo/MicroLux, for instance. Or you can use distilled water with some dish soap added. Armor All Auto Glass cleaner is a superb cheap thinner straight out of the bottle for acrylic paint washes.

Armor All Auto Glass Cleaner also thins craft acrylics – it feels more like working with a solvent than working with plain water. The odor is very mild and it's environmentally friendly.

Avoid using isopropyl alcohol to thin acrylics because it chemically reacts with many modern acrylic resins, weakens them and sometimes causes the pigment to coalesce into clumps.

ADVERTISEMENT

HO GP60M, GP60B AND GP60 Locos



9747
Southern Pacific

NOW AVAILABLE !



9889
COTTON BELT

DC OR DCC WITH SOUND!



www.foxvalleymodels.com

ADVERTISEMENT

Backdrop Junction
Your Stop for Railroad Backdrops

Click Here →

For the Finest in Custom
Designed backdrop



www.backdropjunction.com

MRH Q-A-T | 8

PollyScale seemed to thin OK with isopropyl alcohol, but not Model Master, Vallejo, ModelFlex or cheap craft paints, because it can cause a chemical reaction with the acrylic base and mess up your project.

Armor All Auto Glass cleaner is acrylic resin-safe (so it cannot attack the acrylic tint film on windows), plus it's inexpensive and readily available.

See more about creosote, timber trestles, and working with acrylic craft paints at mrhmag.com/node/26760.

Retarders for plaster

Q. I've tried adding baking powder to plaster when mixing, but it still seems to start hardening within about 10 minutes or less, making it difficult to work with. My wife mentioned vinegar. Will that work as well, or more effectively?

—Jim Fitch

A. Joe Fugate: Yes, make sure it's baking POWDER ... baking soda will not work. It needs to say baking powder on the can.

Try some tests if you're not getting it to work. Get six small Dixie cups and put two tablespoons of plaster in each. Mark the Dixie cups 1 through 6. Then ...

Put 1/8 teaspoon of baking powder in cup #1

Put 1/4 teaspoon of baking powder in cup #2

Put 3/8 teaspoon of baking powder in cup #3

Put 1/2 teaspoon of baking powder in cup #4

Put 5/8 teaspoon of baking powder in cup #5

Put 3/4 teaspoon of baking powder in cup #6

Mix each of them thoroughly as a dry mix. Add water to each until you get a mixture that flows like cake batter. Now set an egg

Seriously?

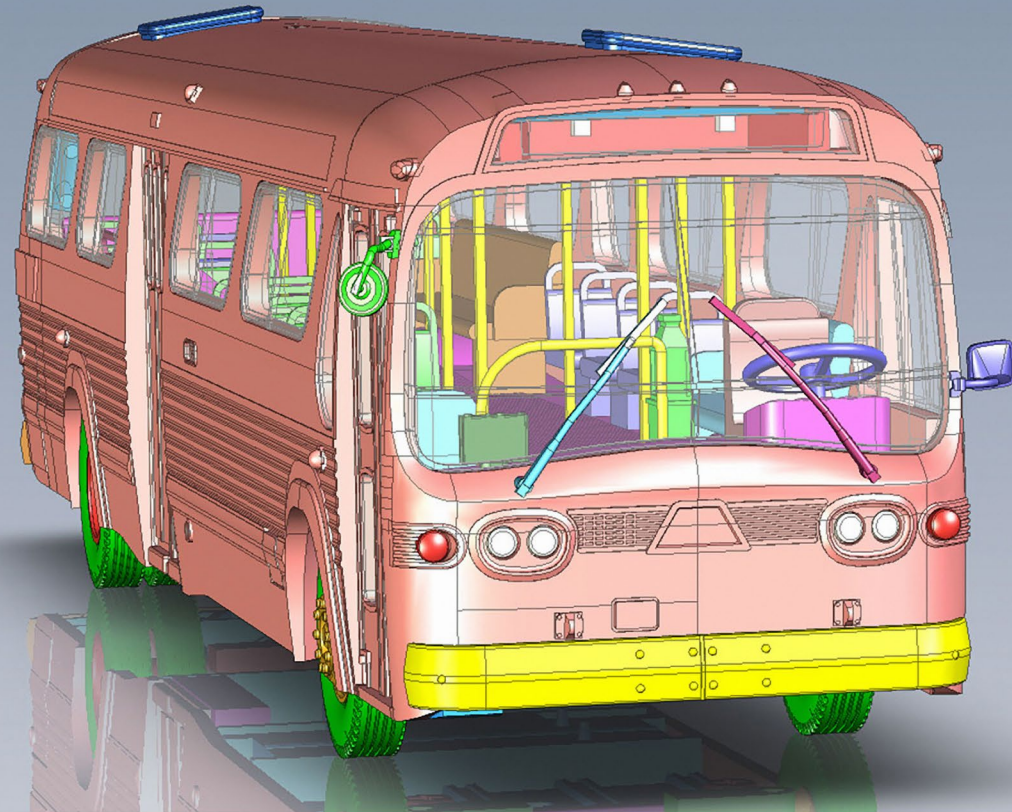

Click here
to watch the video.

timer for five minutes ... when it dings, check each mix and reset timer for another five min. Repeat every five minutes until the last Dixie cup of plaster hardens. You may find the last Dixie cup or two simply foams like whipped cream and still isn't hard after an hour ... If so, then the experiment is done – you don't want to use that much baking powder in the mix.

You want to aim for about 30 minutes of working time.

There are 48 one-eighth teaspoons in two tablespoons. There are also 48 teaspoons in a cup. So whichever Dixie cup mix gives you the desired hardening time, that's how many teaspoons of baking powder are needed per cup of plaster. If it's Dixie cup 2 (1/4 teaspoon ... or 2/8 teaspoons) then that's two teaspoons of baking powder per cup of plaster. For me, a half teaspoon per cup of

plaster was good enough, but you may need to do this experiment to find out how much works for you.

The nice thing about baking powder over vinegar is you can pre-mix it with the plaster. I empty out the 25 lb. plaster of Paris bag into two big buckets with lids. One is marked FAST PLASTER and is straight plaster of Paris. The other is marked SLOW PLASTER and has the baking powder thoroughly mixed in.

For each given project, I use the plaster I want. If I want something that sets up somewhere between the fast and slow plaster, I just mix the FAST and SLOW plaster 50-50.

What I do to get a really smooth surface is ...

1. Test retarder mixes to get a batch that won't set up for at least 30 min
2. Get a full spray bottle of wet water (water with a few drops of dish soap) ready
3. Mix it to the consistency of very thick cake batter (pourable, just barely)
4. Apply the plaster over my scenery base with a brush
5. Spray the area with water and smooth with my bare fingers

This last trick is what gets an ultra-smooth plaster finish. Spray the water while you smooth the plaster with your bare fingers and you'll get a watery thin layer on top of the thicker stuff and you can get the plaster very smooth this way. Rinse your hands in a nearby bucket of water to keep plaster from clumping on them.

If the plaster sets up and shows brush marks, go over the plaster with some fresh plaster. Soak the set-up plaster first until there is standing water on the surface, then put down a blob of plaster. Start spraying some more, and use your bare fingers with plenty of wet water to spread out a thin, ultra-smooth

ADVERTISEMENT



Announces their purchase of
BEST's
Laser-cut Structure Kits

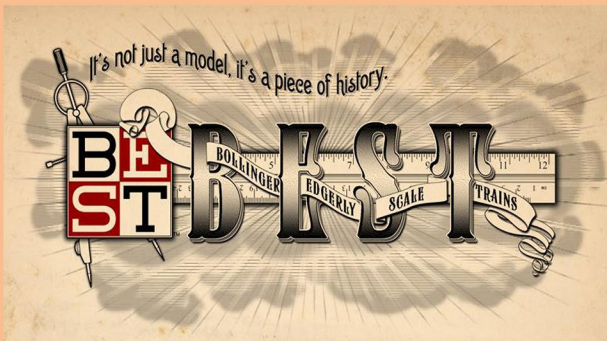

To order or get more information, please email Jeff at:
motrakmodels@centurylink.net

CHECK IT OUT!

layer of plaster. A plastic drop cloth will protect the floor or junk stored under the layout.

Bottom line – don't be afraid to get your hands dirty. Your fingers are the most controllable tool you have, and the direct feedback you get from using them on the plaster surface will enable you to get a surface that looks better than any you can get with a brush or spatula.

For more on working with plaster, joint compound and other materials, read the complete thread at mrhmag.com/node/26712.

TIPS

Paint shaker

Having just purchased a large stash of squeeze bottle airbrush paint from the clearance section of my neighborhood Hobby Lobby, I found myself in need of a paint shaker to revitalize the separated acrylics.



4. John Tabler turned workbench clutter into a paint mixer for bargain acrylics.

Not wanting to pry open my wallet to buy another tool, I decided to make one from whatever I might find in the pile on my workbench.

What I came up with, as seen in the accompanying photo [4], is a plastic childproof pill bottle, attached with strapping tape to a short piece of stiff metal rod. Strapping tape, also called filament tape, has fibers that run the length of the tape, and it cannot be torn by hand. The metal rod is then attached to a jigsaw, in place of a saw blade. It's important to use a metal rod that is stiff, but still small enough to fit into the saw.

CAUTION: Be sure the metal rod is firmly secured, and the area is clear when using the shaker.

Place a securely sealed paint squeeze bottle inside the pill bottle, and add some tissue to keep it from bouncing around inside. It takes just a few seconds to thoroughly mix the paint. "Securely sealed" is very important. I made a second tool for larger paint bottles. I have found this larger unit useful for reviving some decade-old Floquil paints.

This paint shaker should be treated with the same respect as a jigsaw, and as with any paint shaker, be used only where a spill would not be a catastrophe.

—John Tabler

GET PAID FOR YOUR TIP

We pay \$25 per tip we publish, or \$40 each if the tip also includes a photo or finished drawing. [Click here and select article type TIP.](#) ■

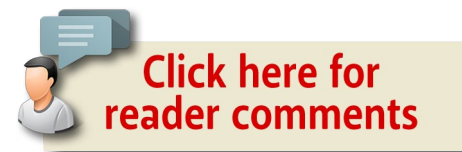

Model Railroad Hobbyist Store

CHECK OUT OUR NEW VISUAL CATALOG:

click here

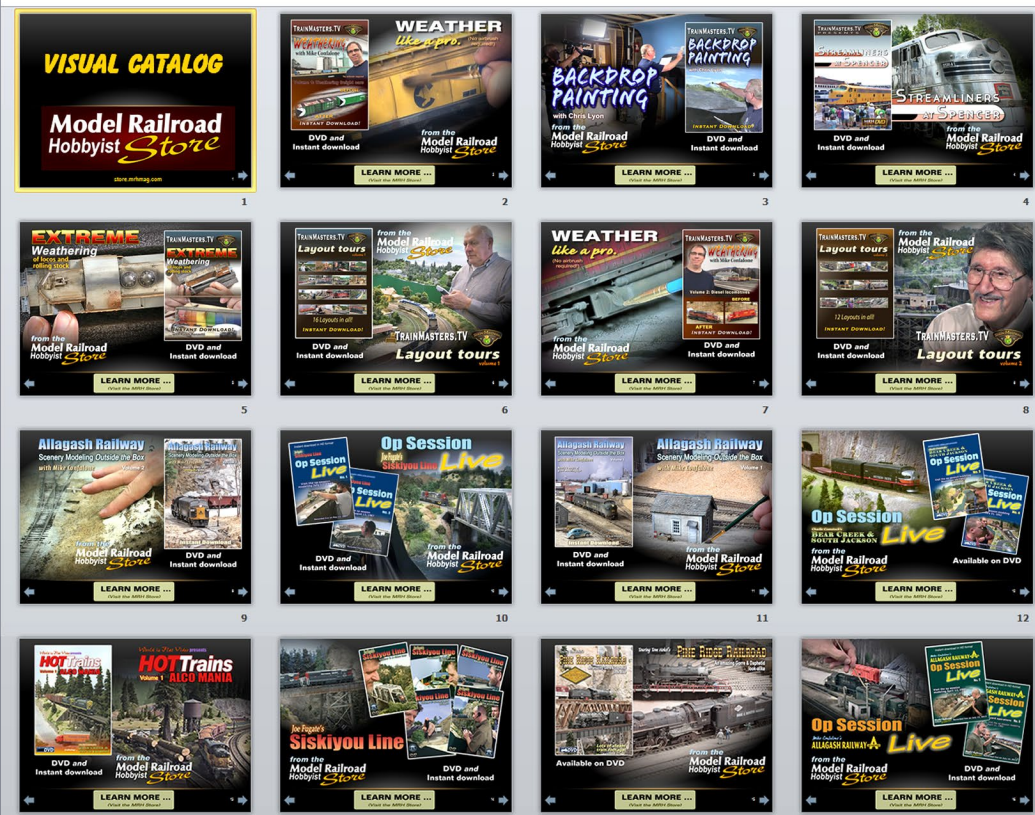

CHARLIE COMSTOCK

Model Railroad Hobbyist | August 2016 | #78

UP THE CREEK

column



Click here for reader comments

JOINING DISSIMILAR TYPES AND SIZES OF TRACK

PROTOTYPE RAILROADS USE DIFFERENT WEIGHTS of rail. Busy mainlines get heavy rail to better stand the pounding of frequent, long, and fast-moving trains. Spur tracks are traversed infrequently and at low speeds, so they typically receive lighter weight rail. I use code 83, code 70, and code 55 rail to represent the different rail weights. Referring to [1], the mainline (lower right) is laid with code 83 rail. The loco is riding on code 70 track. The track under the box car and the spur (far left) is diminutive code 55 rail. If you look carefully you can see the joint between the code 70 siding and the code 55 spur track just beyond the turnout frog. I'll show a couple of ways I connect different sizes and brands of rail and flex track.

Joining different brands of rail

Different rail heights aren't the only way the sizes of rail are different. If two pieces are different enough in size, it can be bit tricky

► DCC TIPS, TRICKS, AND TECHNIQUES

UP THE CREEK | 2



1. Different rail sizes in use on the author's Bear Creek & South Jackson railroad.

UP THE CREEK | 3

joining them. A while ago a friend emailed me a question – he's been using Atlas code 83 flex track and Walthers code 83 turnouts, but for his new layout he wanted to use Micro Engineering code 83 flex track (I'll refer to Micro Engineering as ME). The cross sections of Walthers and ME rail are quite different.

There are several vendors that make model railroad track components, and they do a good job, but their rail cross sections are not necessarily the same. In particular, while Atlas and Walthers code 83 tracks are similar, ME track is different, and mating them can be tricky. The rail head and rail base widths of ME are smaller. This makes it difficult or impossible to use ME code 83 rail joiners with Atlas or Walthers track – a situation a bit like Cinderella's step sisters trying on the glass slipper. Enough force is required to split the joiners.

ADVERTISEMENT



WE ONLY SELL WHAT WE MANUFACTURE

DETAILS IN HO, O, S & N SCALES

LASER CUT SHINGLES, DOORS & WINDOWS, FENCES, SIDING, CRATES. Also RESIN and WHITE METAL DETAILING CASTINGS.

CRAFTSMAN KITS IN HO, O & S SCALES

CHECK IT ALL OUT AT WWW.RUSTYSTUMPS.COM

Send \$3.50 for Catalog - Specify Scale

RUSTY STUMPS SCALE MODELS

6785 Cherry Blossom W. Dr., Fishers IN 46038

Phone (317) 595-9489

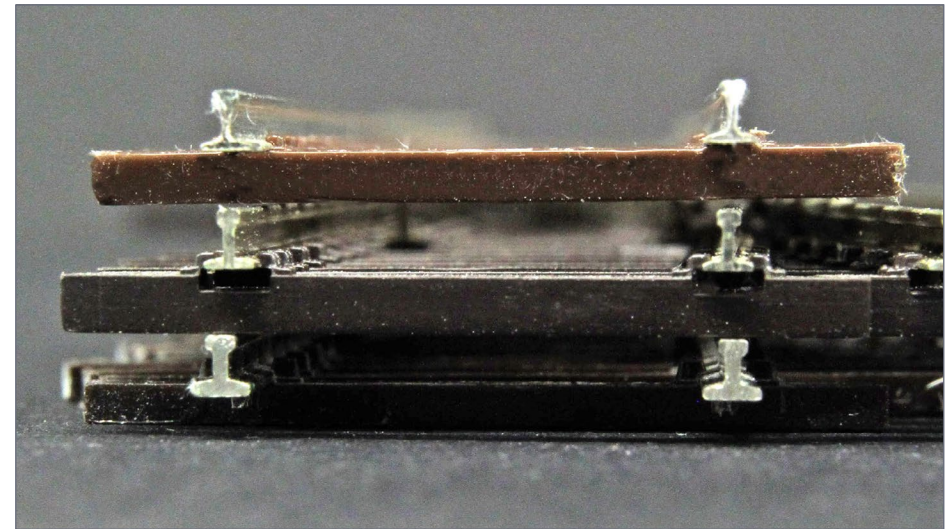

2. This photo shows the cross sections of three brands of code 83 track. Micro Engineering (top), Peco (middle), and Walthers (bottom). Both Micro Engineering and Peco have a finer cross section than Walthers.

Dimensions of different brands and sizes of rail

Rail type	Rail head width		Rail base width	
	Inches	Scale inches	Inches	Scale inches
Atlas code 83	.039"	3.39"	.079"	6.87"
Walthers code 83	.039"	3.39"	.079"	6.87"
Peco code 83	.029"	2.52"	.066"	5.74"
Micro Engineering code 83	.032"	2.78"	.068"	5.92"
Micro Engineering code 70	.030"	2.61"	.069"	5.52"
Micro Engineering code 55	.026"	2.26"	.054"	4.70"
Prototype 140lb AREA (code 84)	n/a	3"	n/a	6"
Prototype 110lb AREA (code 70)	n/a	2.78"	n/a	5.5"

Table 1: Comparison of different brands of rail to the prototype.

While larger rail joiners work well with Atlas or Walthers rail, the smaller ME rail tends to swim around inside the joiner. This causes two potential problems:

- The rails may not be perfectly lined up
- If you, heaven forbid, depend on unsoldered rail joiners to conduct track power, the loose connection will make this even less reliable than it usually is.

Each brand of track has advantages and drawbacks. Atlas code 83 flex track easily bends into smooth curves and is strong – you’ll seldom pull the rail out of its spike heads. Micro Engineering track looks great with its more delicate ties and spike heads, but curving it requires careful finagling. In my opinion, it looks better than other brands.

I could have told my friend he should sell his good Walthers turnouts and use Micro Engineering turnouts instead, but that would be neither cost-effective nor practical - ME makes only #6

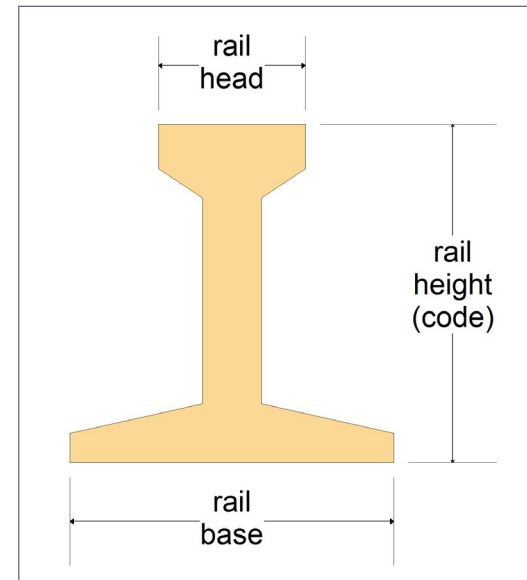

3. Rail cross section and basic dimensions.

ADVERTISEMENT

The advertisement features a model train on a track. Below the train are two product images: 'RUNNING STANDS' and 'SPEEDOMETER For Speed in Real Time!'. The speedometer section also includes the text 'Analogue or digital' and a 'Tell me MORE' button. The Bachrus Inc. logo and website information are at the bottom.

Bachrus inc
RUNNING ON QUALITY

www.bachrus.com
Hannon, ON Canada

UP THE CREEK | 6

straight-leg turnouts while Walthers has a vast selection of turnout sizes and configurations.

I suppose that with enough careful filing it should be possible to make Walthers or Atlas rail compatible with ME rail joiners. But the amount of work required for each joint would be ridiculous, especially when there's a much simpler solution for mating ME and Walthers rail.



4. From left to right: Peco code 100 joiners, Atlas code 83/100 joiners, Micro Engineering code 83 joiners, ME code 70 joiners, ME code 55 joiners. Note that the Table of Rail Dimensions shows ME code 83 and 70 rail base widths are nearly the same, explaining why the ME code 83 and 70 rail joiners are hard to tell apart. For practical purposes they may be interchangeable. This also explains why a code 83 Fast Tracks turnout assembly jig also works with ME code 70 rail. Walthers make code 83 rail joiners, too, but they are several times more expensive, so I don't use them.

UP THE CREEK | 7

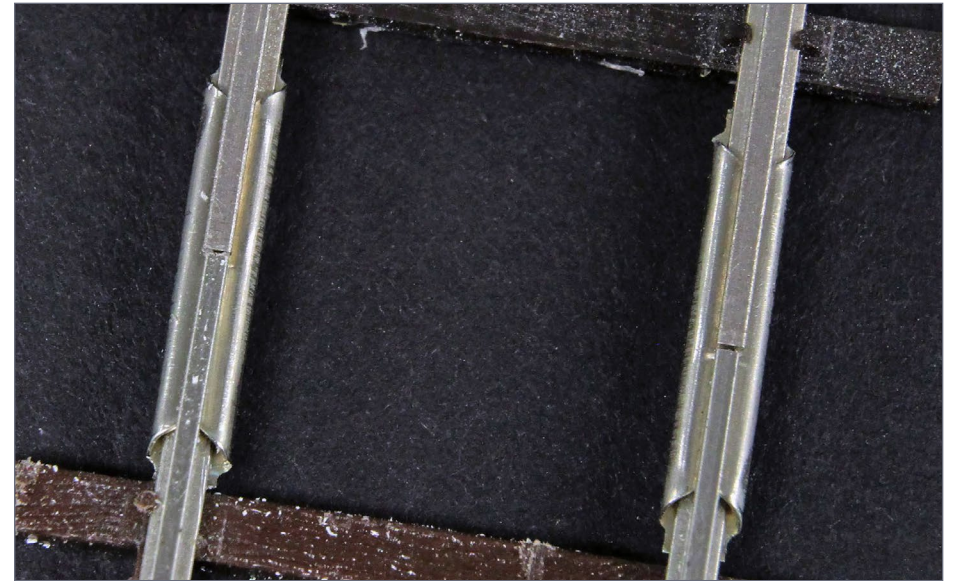

5. The ME code 83 rail (bottom) is a loose fit in the Atlas code 83/100 rail joiners. Note the different rail head widths in the close up. If the inner edges aren't kept smooth/flush through the joint wheels might derail at such a joint. Filling the joint with solder holds the ME rail firmly in place.

A simple solution

Fortunately, the solution is for joining Walthers and ME rail is simple. I use Atlas code 83/100 rail joiners [4], insert the Micro Engineering track into the joiners, and fill the rail joiner with solder.

Once both rails are soldered I reheat the joint and, using sturdy tweezers or a small pair of pliers I tweak the rail alignment until the inside rail edges (the ones the flanges touch) are absolutely smooth with no bumps, rough edges, or burrs. I go over the joint lightly with a small file and presto – a solid joint that won't come out of alignment.

UP THE CREEK | 8

I try not to get too much solder in the joiner; it can result in strange-looking bulges at the joints! And it seems to result in more solder getting on the rail heads and needing to be cleaned up. After soldering the joint, cleanup with a small file finishes the joint.

As a test, if you can run your finger over the inside edges of the joint and can't feel a bump, then you've done it right.

Joining different size rails

As I previously mentioned, there are three different rail sizes on my Bear Creek and South Jackson. I use ME code 83 for the heavier rail found on the mainline, code 70 for sidings and branchlines, and code 55 for industrial spurs.

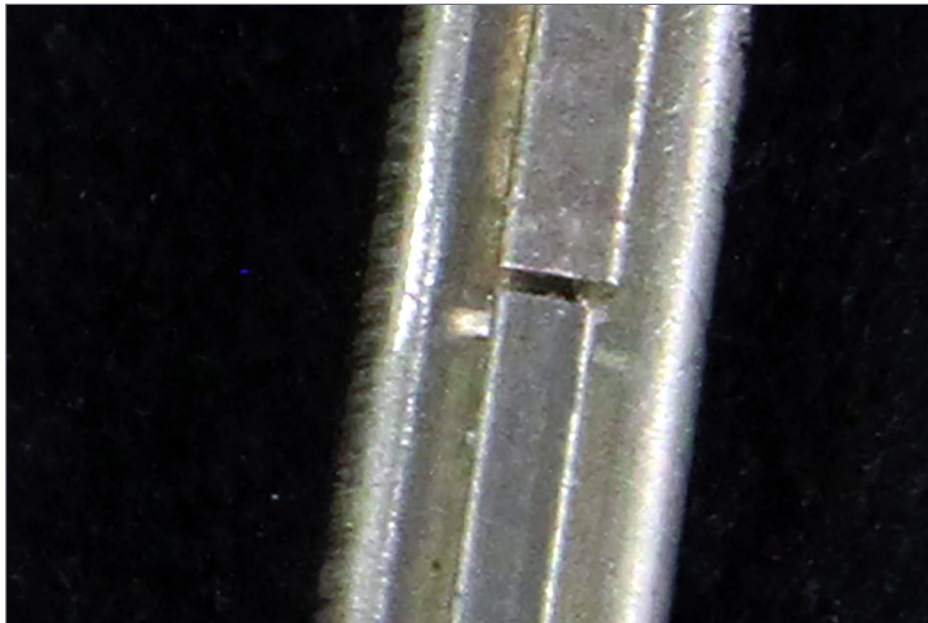

6. Close up of previous photo – the difference in rail head width is clearly visible. Walthers code 83 above, Micro Engineering code 83 below.

UP THE CREEK | 9



7. Close up of ME code 83 (near) soldered to a Walthers code 83 turnout. I was careful to keep the amount of solder used low, wire brushed excess flux off the joint, and gently filed the top and inside of the rails to eliminate bumps.

ADVERTISEMENT

**TRINITY 3281
SUMMER 2016**

Norfolk Southern -- 12 #s

ICE-GATX -- 8 #s

Winchester & Western -- 12 #s

NRLX Ciment Quebec -- 12 #s

HWCX -- 7 #s

American Limited

www.americanlimitedmodels.com

ADVERTISEMENT

George's Trains EST. 1962

Canada's Greatest Model Train Store!

20 NEW Colours Just added!

PROTO-PAINT

ACRYLIC-Air Brush Ready

NOW OVER 45 Canadian Railway Colours!

Dealer inquiries welcome.

PP-001 CNR Green #11	PP-020 TH&B Maroon	PP-038 TTC CREAM
PP-002 CNR Imitation Gold	PP-021 Primer	PP-039 TTC Maroon
PP-003 CNVIA Blue #16	PP-022 Reducer	PP-040 Warm BLACK
PP004 CNVIA Yellow #18	PP-023 Flat Finish	PP-041 Gimmy Black
PP-005 VIA Grey	PP-024 Stencil White	PP-042 Anti-Glare Black
PP-006 CN Red/Orange #11	PP-025 Loco Black	PP-043 Slag Brown
PP-007 CN Lettering Grey #17	PP-026 Flat Haze	PP-044 GO Green
PP-008 CN Grey #11	PP-027 ONR LT BLUE	PP-045 GO White
PP-009 CNR Red #12	PP-028 ONR DK BLUE	PP-046 CONRAIL Blue
PP-010 CPR Tuscan	PP-029 ONR YELLOW	
PP-011 CPR Diesel Grey	PP-030 ONR Post 2000 Yellow	
PP-012 CPR Diesel Yellow	PP-031 ONR GREEN	
PP-013 CPR Steam Grey	PP-032 BCR/PGE DK GREEN	
PP-014 CPR Mineral Brown	PP-033 BCR RED	
PP-015 CP Action Red	PP-034 BCR Blue	
PP-016 CP Action Yellow	PP-035 BCR Yellow	
PP-017 CP Action Green	PP-036 BCR/PGE LL GREEN	
PP-018 CP Bright Red	PP-037 GTW Blue	
PP-019 TH&B Cream		

\$8.98 each Canadian

ORDER NOW!

550 Alden Rd., Unit 101 Markham, On, Canada L3R 6A8
Tel: 905-470-6200 Toll Free: 1-877-8TRAINS (887-2467)
www.georgetrains.com

Code 83 rail is .013" taller than code 70, which is .015" taller than code 55. Some people mix code 100 rail with code 83 rail, a .017" difference in size. ME code 83 and 70 rail head widths are very close to each other. Their code 55 rail is noticeably narrower.

Special rail joiners

Specialty rail joiners are available for joining certain rail size differences. In particular, Atlas makes them [7] for joining their code 100 and code 83 rail.



8. ME code 83 rail to code 70 rail joints using squished ME code 83 rail joiners, compared to a standard code 83 to code 83 joint.

CAN I CHANGE RAIL BRAND AND RAIL SIZE AT THE SAME JOINT?

I don't do this. Too many things changing at once. There are places on my layout where I transition from code 83 Atlas track to code 70 Micro Engineering track. I do this in two steps:

- Connect Atlas code 83 to Micro Engineering code 83
- Connect Micro Engineering code 83 to Micro Engineering code 70

Otherwise that code 70 would really be flopping around in the larger rail joiners. Of course if you're going from Peco code 80 to ME 70, that would be more reasonable because the rail cross-sections are more compatible.

These tend to a bit more expensive than standard joiners, they're not particularly strong, and they work best with the larger cross section of Atlas and Walthers code 83 rail.

I use a different technique when mating different sizes of Micro Engineering rail, but it should work when joining different sizes of most brands of rail.

Connecting ME code 70 and code 83 rail

Let's assume I'm connecting code 70 to code 83 rail. I start with a code 83 rail joiner. I mash down on half of the rail joiner using small pair of pliers, trying to make it as flat as possible and reducing its post-squish height. I do some filing on the code 70 rail, then solder the two together.

UP THE CREEK | 12

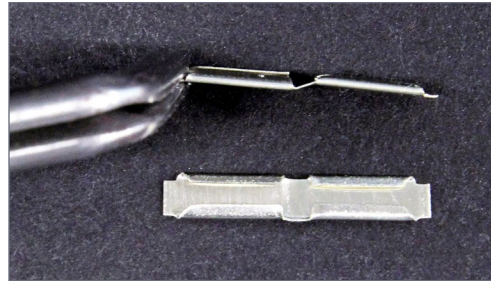

9. Specialized rail joiners from Atlas to connect code 100 to code 83 track.

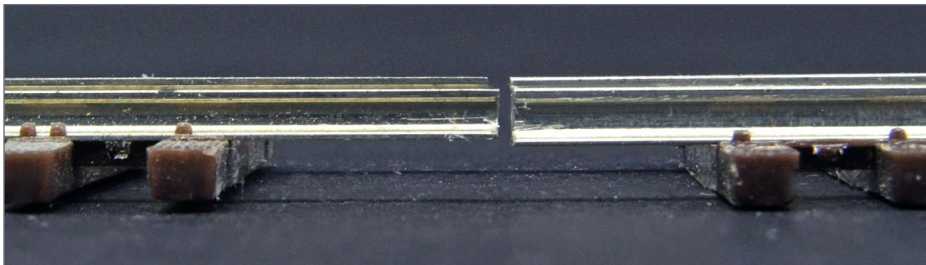

10. This photo shows the differences in rail height of the ME code 70 (left) and code 83 (right) rail. It appears the code 70 track has slightly thicker ties leaving the tops of the rails fairly well aligned. Although both code 70 and 83 ME track have very similar rail base width, it should be obvious that using a standard rail joiner in such a situation will result in trains lurching as they transition this joint. If the ties are the same thickness so the smaller sized rail ends up below the level of the other one, shimming of the smaller flex track may be needed.

UP THE CREEK | 13

Yes, the code 70 is not inserted in a rail joiner, instead it sits on top of it. But if your track is well-mounted and the solder joint is good, this shouldn't become an issue.

Then I prepare the code 70 (smaller) rail by filing a bevel in its end and removing a bit of the rail base. This is necessary because the squishing operation doesn't yield a perfect result and the smaller rail would otherwise sit higher than its code 83 mate.

I solder the joiners to the larger, code 83, rails and tin both the flattened spot and the bottom of the smaller, code 70 rail.

Then using the tweezers or a small pair of pliers, I position one of the code 70 rail ends on the flattened rail joiner taking care to align it both vertically and horizontally and solder it in place. Because I'm using one hand to hold everything in place, I pick up a bit of solder on the tip of the iron by touching a piece of



11. I modify a standard ME rail joiner by squishing one end of it with a pliers making it as flat as I can get it.

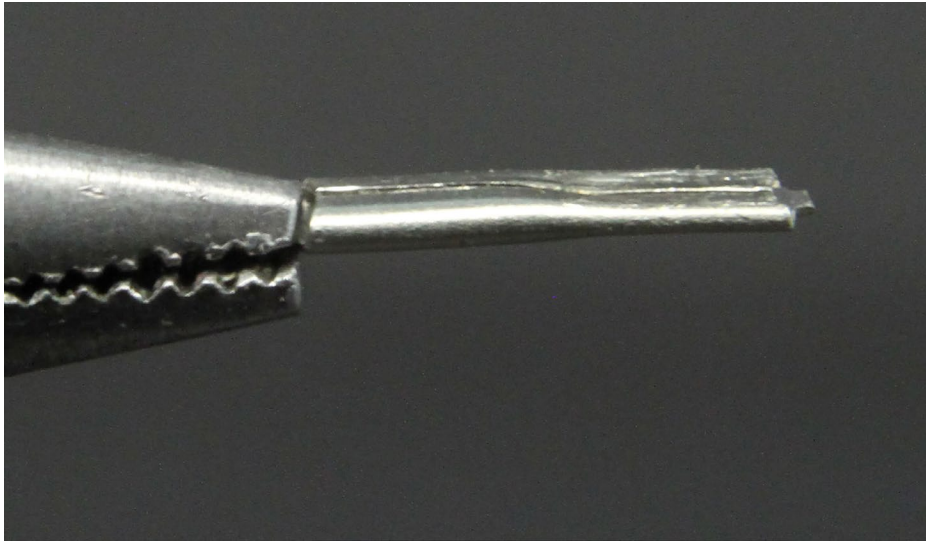

12. Here's what the joiner looks like after it's been squished.

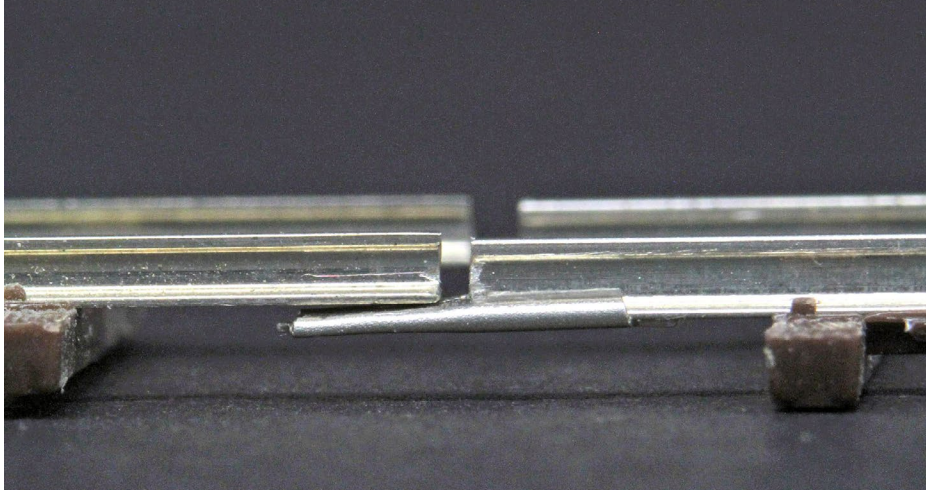

13. Oops! Here you can see the squished rail joiner doesn't sit low enough. The code 70 rail (left) is just too high and there's no practical way (that I know of) to squish the rail joiner further.

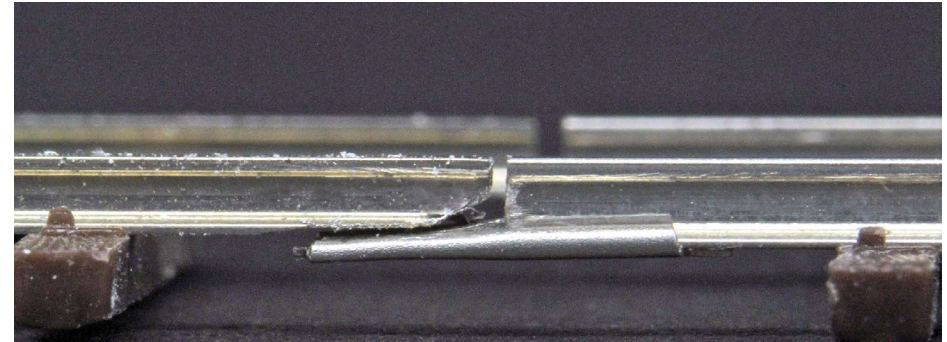

14. If the rail joiner can't easily be modified further to make the rail head heights match, the solution is to file away material from the bottom of the code 70 rail. I filed a bevel in the end to allow for the rail joiner swelling between the code 70 and code 83 rails. I also removed a bit of material from the bottom of the rail. Now the rail head heights match.

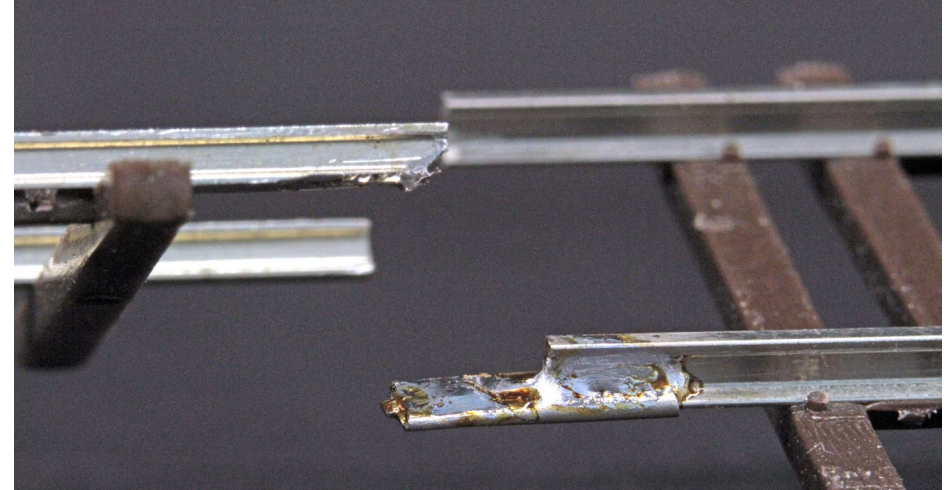

15. It's easier to solder the code 83 to 70 rail joint together if the squished joiner and filed rail have generously tinned.

UP THE CREEK | 16

solder with it, then touch the joint with the solder-bearing iron's tip. Because the work pieces were previously tinned, the solder should leap to make the connection.

After soldering, carefully check the alignment. The rail head should be smooth across the joint. If you can feel a lump, try reheating it and nudge the rails into better alignment. If it's a tiny bump, I will often use a small file to remove it – but only if it was small to start with. Don't get carried away with the file, lest you remove the entire rail head and leave the rail web showing.

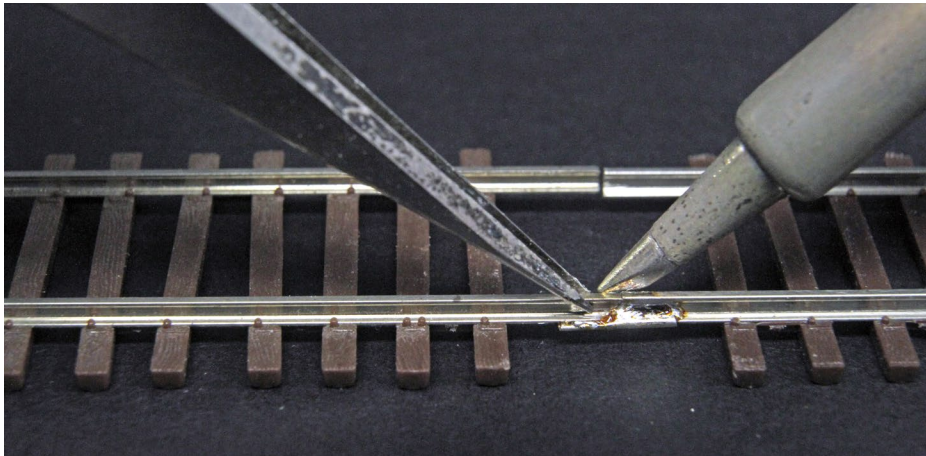

16. Place the two rail ends into alignment and hold them in place. Because the ends have already been tinned, all that is needed to solder them is to apply the tip of the soldering iron to join. The solder quickly melts and forms a joint. I use tweezers to help hold the code 70 (smaller) rail in place while this is happening and until the solder solidifies. Double check the joint making sure the rails are properly aligned both horizontally and vertically. If there are problems, reheat the joint and use the tweezers to move the rails into proper position. Once satisfied clean off the excess solder flux and dress the joint with a small file.

UP THE CREEK | 17



17. An inexpensive solder sucker. Cock it by pushing on the yellow tipped plunger. Place the white tip on the solder to be removed. Heat the joint and press the yellow button. Ker-suck! Instantly the solder is removed from the joint. Got too much solder in a joint? No problem!

Of course, when connecting different code rails, shimming will be required. I find that business cards are often about the right thickness. Styrene sheet is available in thicknesses of .010", .015", and 0.20" and can make good shim stock.

Practice makes perfect

If you're not an experienced hand with a soldering iron, this may seem difficult. Keep at it though. If you mess up a joint suck the solder out of it and try again.

It's not that hard

You'll likely be amazed at how quickly you pick it up and at how easy joining different types and sizes of rail can be. There's no need to stick to one brand and size of rail.

UP THE CREEK | 18

If you like the idea of different size rail for different types of track, give it a try. It makes a world of difference in photographs and, while the effect may not be completely obvious in person, it still can add to realism. ✓



[Click here for reader comments](#)



DID YOU KNOW MRH SUBSCRIBERS GET FREE BONUSES?

(LIKE THE 40 PAGE MRH PAINTING GUIDE eBook)

CLICK TO SUBSCRIBE NOW - IT'S FREE!



FAST TRACKS

YOUR VERY OWN TRACK FACTORY

Make the most of your modeling experience.

Build perfect trackwork easily and inexpensively when YOU want it!



Check out our extensive (and growing!) online video library to learn how easy it is to hand lay your own trackwork with Fast Tracks tools and supplies.

Play Video ▶



HELPING THE WORLD
BUILD BETTER RAILROADS

shop online 24/7
1-888-252-3895

handlaidtrack.com
service@fast-tracks.net

Digitrax



\$375.00 MSRP

Introducing
DCS240
 LocoNet® Advanced
 Command Station



- **400 Loco Addresses**
- **400 Throttle Support**
- **5 or 8 Amps of Power**
- **For Serious Operation!**

Find out more at:

www.digitrax.com



Southern Digital



**20% Discount
on most items!**

Specializing in DCC Since 1992



DCC Conversions, Service & Support

Orders Received by 3:00 pm EST ship the same day

WWW.SODIGI.COM

E-mail: sales@sodigi.com

(770) 929-1888

(Photo's are from our N-Scale layout)



Model Railroad Hobbyist | August 2016 | #78

DCC IMPULSES

column

BRUCE PETRARCA MMR



[Click here for
reader comments](#)

LOADING SOUNDS INTO DCC DECODERS

THIS MONTH WE ARE GOING TO DISCUSS SOUND decoders. See “Mr. DCC’s Workbench” at the end of this column for an insight into new firmware for LokSound Select diesel decoders.

There are two basic forms of DCC sound decoders. Those that allow you to load sounds into them and those that don’t. In this column, I’m going to look at those that do, what you can do with them, and what it takes to customize them to your liking.

There has been a long-standing discussion about sound loading. Some folks, such as SoundTraxx, have taken the view that the sound recording and editing are essential to their product. They have chosen to keep their sounds close to the vest. They do not provide for user sound installation. This viewpoint is great for non-technical folks who want to install a decoder, do a modest amount of personalization of the loco, and run.

As this column was being written, SoundTraxx announced the Tsunami2 series of flagship decoders, without user-loadable

► **DCC TIPS, TRICKS, AND TECHNIQUES**

DCC IMPULSES | 2

sounds. This shows their commitment to this business plan. Ken Patterson has a first look in this month's "Getting Real".

If the user is able to download software into the decoder, then a bunch of options open up:

- Changing the functional software as much as the hardware will allow
- Changing the sound set to a newer or different recording
- Installing your own sounds
- Mixing and matching sounds – this whistle with that horn and the other motor sound
- Fixing software bugs in the field without the need to remove the decoder from the loco and send it back to the factory

Another discussion surfaced along the way: allowing folks to record and mix and install their own sounds might reflect poorly on a specific brand of decoder.

If a modeler shows up with a loco with sounds that he loaded into an XYZ brand decoder and the horn has a dog barking in the background, the result would be a derogatory view of XYZ decoders. My argument is: whatever we modelers present is a view of

"If I do a poor job of recording and mixing and loading sounds into a decoder, it is not the fault of the decoder manufacturer."

DCC IMPULSES | 3

our work, not the manufacturer behind it. If I do a lousy job of weathering an Atlas car, it reflects on me, not on Atlas.

Similarly if I do a poor job of recording and mixing and loading sounds into a decoder, it is not the fault of the decoder manufacturer. But I'm sure not all modelers will see it that way

The roster

Quickly, before we begin, I want to talk about having a roster of your locomotives. Whether you spend minutes or hours per loco getting them set up just the way you want them, it is nice to have your work saved outside the loco. For this, I recommend **DecoderPro**.

ADVERTISEMENT

RailPro™
RE RING ENGINEERING
NEW TECHNOLOGY
DIRECT™ RADIO

RE RING™
ENGINEERING
NEW Starter Kit
\$399.99 MSRP

- Includes Wireless Color Touch Screen Handheld Controller and 56 Watt Power Supply
- Expandable to Virtually any Size Layout

NEW Locomotive Module
LM-2 & LM-2S

- Direct Radio RF
- Sound and Non-Sound
- New Tiny Size
- 6 Light Outputs

Click Here to Learn More

For more information visit our Internet site: www.RingEngineering.com

DCC IMPULSES | 4

To fully utilize **DecoderPro**, (jmri.org) you will generally need an interface between your computer and your DCC command station. I discussed some options in a prior column (mrhmag.com/magazine/mrh-2012-07-jul/dcc_impulses). Once the computer connection is functional, install the free JMRI suite of programs (jmri.org), which includes **DecoderPro**.

Even if you don't want to make the computer connection, you can install **DecoderPro** on your computer and use it to customize your locos. Just tell **DecoderPro** what you want the decoder to do. Let it calculate the corresponding CV values and store them on your computer. Manually punch the resulting CV values into the DCC system to set up the loco. It is the hard way to go, in my opinion, but some folks don't want to deal with the computer connection.

Older DCC systems may need a Programming Track Booster (PTB) to read from some sound decoders. See my website for more information about PTBs (mrhmag.com/url/mrdccu-ptb).

The sound loader packages that I'll be discussing here do not handle a roster at all well unless every decoder is their brand.

When talking to hobby vendors,
please remember to mention
MRH.

DCC IMPULSES | 5

That's why I use the sound loaders for their intended purpose and let DecoderPro track my CV customization.

Windows and drivers

A program runs under an operating system (such as Windows). However, there is a bit of software, known as a driver, which allow the program to talk to hardware outside of the computer.

These drivers tend to be very operating system-specific. Having the wrong one won't degrade performance; it will bring it to a complete halt.

Microsoft has been encouraging third-party software developers to submit their driver packages for review. If they were

ADVERTISEMENT



SOUNDTRAXX®

Fun Features for a Fraction of the Cost!

As the most versatile, feature-packed sound decoder, Econami redefines *value*. Starting at \$79.95 and available now!



Hear how you can get more for less!

DCC IMPULSES | 6

determined worthy, Microsoft would “sign” the driver. This sign is a secret handshake between the driver and the operating system that lets them both know that they are supposed to be friends. Rumor has it that money is exchanged for this approval, penalizing the small developers.

Signed drivers were encouraged for Windows 8. Microsoft has made it impossible for Windows 10 to automatically install a driver that is not signed. As you’ll see here, there is a work-around, but it isn’t pretty.

Let’s look at loadable sound decoders by manufacturer, alphabetically.

DCC IMPULSES | 7



1. Digitrax SDH166D sound decoder. *Digitrax photo*

Digitrax sound decoders

Digitrax offers their sound decoders [1] in many form factors for different installation options. They also offer a sound-only variant (Soundbug). The Soundbug is designed to plug into the Digitrax DH165 series of decoders. It can be hard wired to most other non-sound decoders, but may have some CV conflicts with non-Digitrax decoders. Thus, it may require a dual-decoder installation when mixed with non-Digitrax decoders. I discussed this sort of installation in a prior column (mrhmag.com/magazine/mrh-2012-07-jul/dcc_impulses).

The Digitrax decoders come with some sound sets pre-loaded. Exactly what is loaded varies by decoder model.

ADVERTISEMENT

An advertisement for Iowa Scaled Engineering. At the top, it says 'IOWA SCALED ENGINEERING' in a stylized font. Below that, it reads 'Simple electronics for extraordinary model railroads'. A central image shows a blue decoder component with a keyhole-shaped cutout. Below the decoder, there are three red question marks. At the bottom, a photograph shows several men in orange safety vests and hard hats working on a model railroad track. A 'LEARN MORE' button with a play icon is located at the bottom left.

ADVERTISEMENT

An advertisement for Tam Valley Depot.com. At the top, it says 'TamValleyDepot.com' and 'Great Electronics for Great Model Railroads'. The central image shows a green printed circuit board (PCB) with various electronic components, including a decoder chip. Below the PCB, there is a photograph of a model train car with a sign that says 'Home of the Frog Juicer'. At the bottom, a yellow banner reads 'We are loading up the boxcars with Frog Juicers ready for your layout!'.



2. Digitrax PR3XTRA programmer. *Digitrax photo*

Their initial products had 8-bit sound, offering sound quality similar to the old landline telephones. Newer products are offering 16-bit sound with the potential for much better sound quality. In some product categories, they offer both versions. The 8-bit version remains as an economical alternative, saving \$20 or so per decoder. There appears to be little or no physical indication of which version a specific decoder has. You might want to make your own notes on the decoder as you are removing it from the packaging.

Digitrax has always encouraged modelers to record, edit and load their own sound sets. They even have a page on their web

site (digitrax.com/sound-depot) for users to share their creations amongst themselves. This business plan has the users creating most of the sound files.

The PR3XTRA [2] is the current version of the Digitrax programmer for sound loading. The installation is simple: connect your Windows computer to the PR3XTRA with a USB cable. Load the software. Connect a stretch of track to the appropriate terminals on the PR3XTRA. Connect the power supply and go.

According to the Digitrax web site, their **SoundLoader II** software (digitrax.com/sound-depot/soundloader) is compatible with Windows versions from XP through 8. I asked Digitrax for the loan of a unit for this column and had not received it as of the

ADVERTISEMENT

ADVERTISEMENT

deadline. Thus, all I can report about current products is what information there is on their website. I worked with the predecessor hardware and software during my tenure at Litchfield Station, so my personal experience is dated.

Two functions of the PR3XTRA are not related to sound loading. It can provide a connection between a Digitrax DCC system and a USB-equipped computer for operation with programs such as **JMRI** or **Railroad & Co.** JMRI runs under Java on Windows, Mac OS X or Linux computers. The **JMRI** / PR3XTRA combination allows software updates to some of the Digitrax hardware.

Additionally, the PR3XTRA can be configured as a stand-alone programmer. Connect a computer via USB and a piece of track and power supply. Then you can use **DecoderPro** to adjust CVs and save rosters.

ESU LokSound

One of the pioneers of loadable sound decoders is ESU with its LokSound line. When these decoders were first imported to the USA, they offered a disappointing selection of American sounds. Since Matt Hermann has taken over the North American operations, lots of new sounds and options have been added to the LokSound lineup. See my December 2014 column (mrhmag.com/magazine/mrh-2014-12-dec/di_loksound-dcc) for more details.

Their current sound decoders come in two versions: LokSound V4.0 and LokSound Select [3]. Both versions are available in the “micro” size aimed at N-gauge installations and the more cost-effective “standard” size. The LokSound XL (O-gauge and larger) is only available in the V4.0 version. The difference between the two versions is that the less expensive Select allows the user to load pre-set packages. The V4.0 version allows complete user

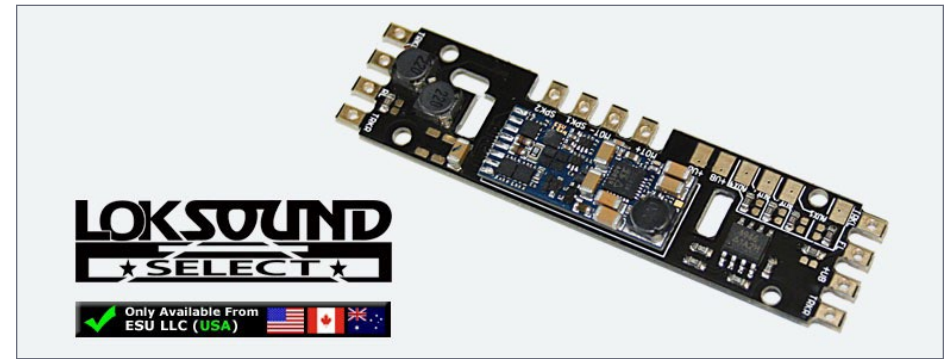

3. LokSound Select Direct decoder is designed to replace the factory light board in many HO-gauge locos. *ESU photo*

customization of all of the sounds and functions. ESU offers a wide variety of files to load into a Select or as a starting point for

ADVERTISEMENT



YD

**YD Specializes in DCC
Sales-Service-Installation**

YD provides the BEST for LESS

<p>Yankee Dabblor – Track 33</p> <p>DCS240</p> <p>Digitrax</p>  <p>\$375 Sale \$275</p>	<p>Train Control Systems</p> <p>Keep Alive WOWSound Audio Assist</p> 
<p>ESU / Loksound</p> <p>PROGRAMMER</p>  <p>\$199 Sale \$120</p>	<p>Soundtraxx</p> <p>Tsunami 2</p> 

CLICK AND SAVE TODAY!



NCE
The Power of DCC



YD installs DCC or RailPro in your engines
 Technical Coordination (727) 457-9227 9AM to 9PM EST
 Locations in NJ and FL / Visit our Web Site for Train Show Schedules

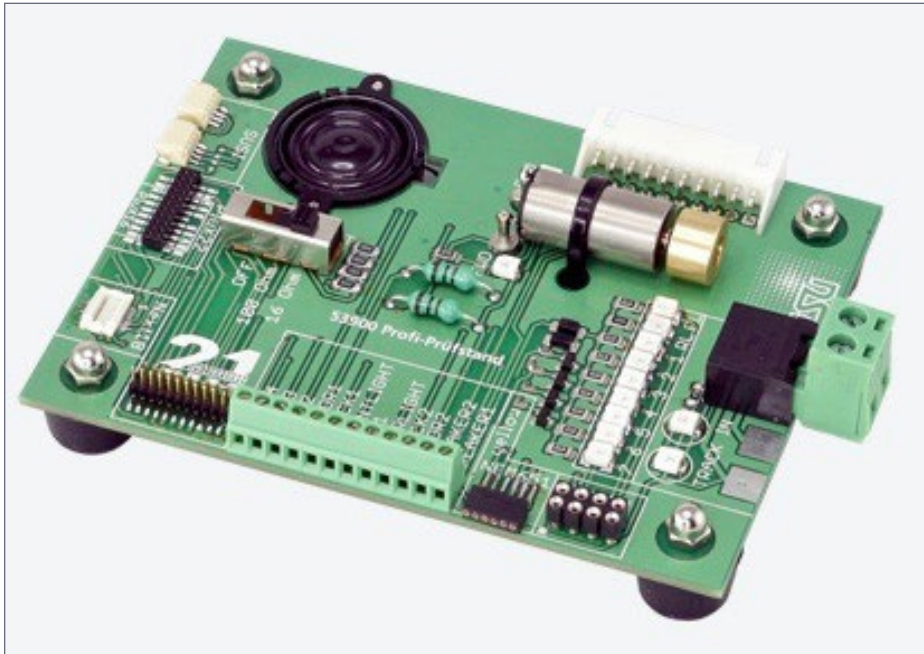

4. ESU Decoder Tester. *ESU photo*

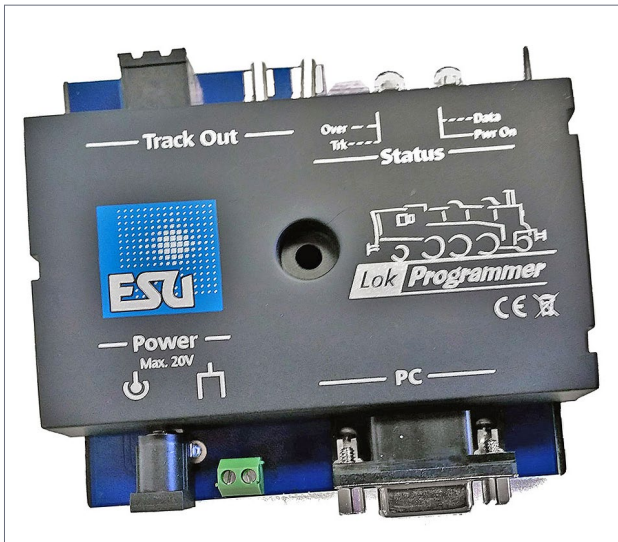

5. LokProgrammer from ESU will load sounds and automate CV programming for LokSound decoders. *ESU photo*

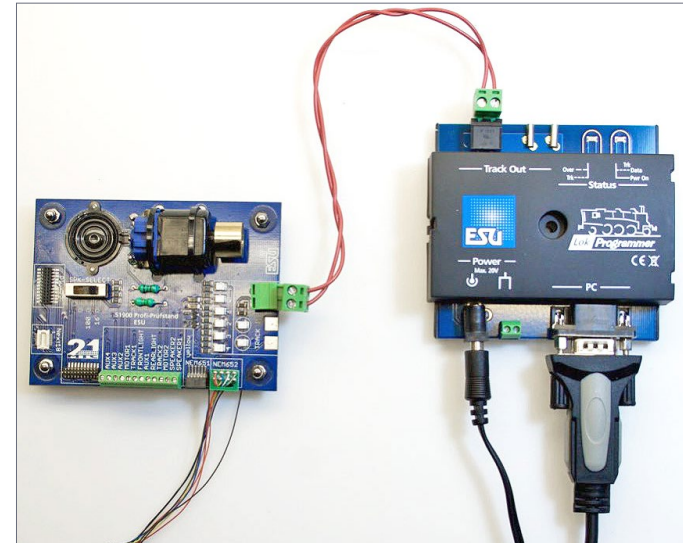

6. LokProgrammer and ESU Decoder Tester programming a LokSound micro V4.0 decoder.

customization for a LokSound V4.0. These files are on their website (esu.eu/en/downloads/sounds).

When it comes time to set up your decoder and load sounds, ESU has you covered with a really neat decoder tester [4] and their LokProgrammer [5].

I use the ESU Decoder Tester [4] all the time. This tester can be used with any DCC system or programming interface. It provides many different plugs and terminals to connect to the decoder under test. There are lots of loads to test the outputs of the decoder: 6 LED lights, a motor and a speaker (selectable for 100 or 16 ohm impedance or off). The decoder tester retails for about \$50.

ESU makes the LokProgrammer [5] to load sounds and program decoders. This unit has the old style (RS232) serial port for the

computer connection. However, ESU includes a serial to USB converter that works transparently with the LokProgrammer. Thus, the LokProgrammer will work with almost any PC ever built. Windows support is for all versions from XP to 10. The drivers are signed and included with the LokProgrammer software package. That way, the user doesn't have to jump through hoops and disable Windows safeguards to install the software or search around the internet for the correct driver.

I installed the unit on my notebook computer (running Windows XP). It was as simple as running the LokProgrammer installation program and selecting the option to install the drivers for the USB adapter. Once the software installation was complete, I plugged the LokProgrammer in. Windows XP automatically configured the package and I was up and programming decoders [6] in a few minutes.

I later updated the software from 4.4.22 to 4.4.23. It was easy and seamless.

Using the LokProgrammer software is not as intuitive as I'd like. Once you work your way around the software and hardware it is fine. It just took some trial and error and seat time for me to get comfortable. ESU comes to your rescue with a user's-forum (esu.eu/en/forum/forums-overview). Help can be had there. You only need to sign up to play in their sandbox. Discussion of the ins and outs of this system could easily fill a column.

The LokProgrammer will operate the decoder/loco combination for testing in between adjustments. The LokProgrammer and the power supply that comes with it will give about ½ amp at about 12 volts. An external supply as large as 20 volts and 3 amps will run almost any loco. The LokProgrammer doesn't have short circuit protection appropriate for operating on a full layout. Keep with just a test track.



4. QSI Quantum Programmer. *QSI photo*

QSI Titan

QSI offers sound and power decoders for HO gauge and “large” gauge locos. Their third version decoders, called Titan, feature what they call “stereo.” My initial reaction to their announcement was lukewarm. My concept was based on my idea of generating a stereo sound image right to left in front of the listener. I couldn't get my arms around how that was going to work out in a narrow model train heading down the track.

Once I played with one, I found that it is dual-channel audio and that is cool. There are two speaker outputs and you can use a pan control to move sounds between speakers. For example, put a small speaker in the smoke box of a steam loco and route the whistle, bell and dynamo sounds there. A larger speaker in the tender can get the deeper sounds, like the chuff. Or put most of

DCC IMPULSES | 16

the chuff in the heavier bass speaker and just a bit of it into the smaller speaker for more bite. This also allows the sound to be dispersed between the loco and tender. Yes, it can require more wires between the loco and tender to fully implement.

This dual-channel audio also creates more things to set up, making a computer-based system very helpful. The QSI Quantum Programmer is a very similar product to the ESU LokProgrammer. The Quantum Programmer hardware [7] is a small plastic tube with power and USB connectors on one end and track connector and status LEDs on the other.

The QSI software is Windows-based. They offer support for Windows XP through 10. The QSI drivers are not signed. QSI has step-by-step work-around instructions for Windows 8 and Windows 10 users to install them.

My XP computer has had the QSI software installed for many years. So, I chose not to uninstall and reinstall the software for this column. I went to their web site (qsisolutions.com/#!applications/cfvg) and downloaded the latest versions of **CV Manager** and **QSI Update**, the support software for the Quantum Programmer. The Windows USB drivers, from SI Labs, are also cached there.

There is a third piece of software, **Q1a Upgrade**, to update older QSI chips with more recent software. The affected decoders have not been available on the retail market for about a decade. Thus, the software is of minimal use now. I didn't check for a new version of my **Q1a Upgrade** software.

The installation of the updated software was seamless and didn't require (for my XP system) any changes in the USB driver. The QSI documentation (qsisolutions.com/#!quantum-programmer-documents/cevq) seems adequate for walking a knowledgeable

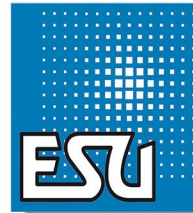

Tired of tearing apart valuable locomotives every time a new decoder is released?

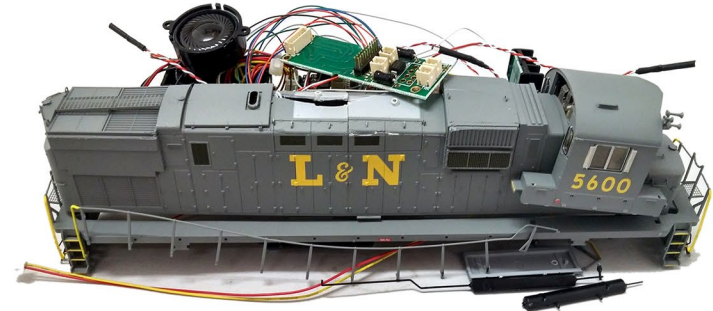

ESU decoders are re-programmable!

ESU LLC

23 Howard Street, Montoursville Pennsylvania 17754

Phone +1 570-980-1980, Fax +1 866-591-6440

(Office hours: Monday through Friday, 8AM to 4PM (EST))

WWW.LOKSOUND.COM

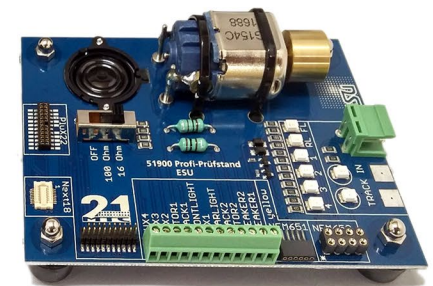
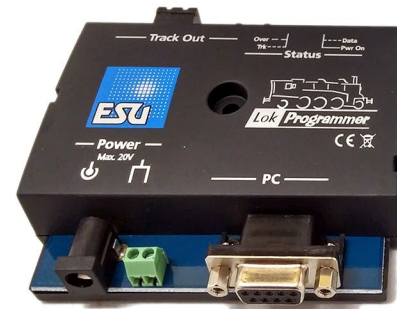

(June 1st - August 31st)

#53452 LokProgrammer - SUMMER SALE \$150 list!

#51900 - Decoder Tester - \$57.90 list

BUY IT ONCE & UPDATE IT FOR LIFE!

DCC IMPULSES | 17

user through the installation of the un-signed drivers on newer Windows systems.

Once you have the Quantum Programmer working with your computer, things are pretty peachy. No, it isn't perfect, but it is more intuitive to me than the LokProgrammer software.

The QSI Programmer will operate the decoder/loco combination for testing in between adjustments. The power supply will give about ¾ amp at about 15 volts. Again, this is not for running a layout, but for a simple test track.

The **CV Manager** software does a good job of programming and keeping track of the values stored in a fleet of QSI locos. But, unless every loco you have has a QSI decoder, a computer interface and **DecoderPro** are more versatile for keeping your roster.

ZIMO

Art Luescher, the North American importer for ZIMO, provided me some insight into their products. I haven't had my hands on them, so I must rely on his comments.

ZIMO sound decoders come with 6 steam and 1 diesel engine sound preloaded. The customer can chose amongst those sounds on the fly.

The MXULFA update-and-program module allows the user to update their own sound. The sounds can be loaded onto a USB flash drive and installed through the ZIMO command station.

ZIMO is promising a lot more U.S. diesel sounds coming this year.

ZIMO sounds come in three versions.

A second class of sounds are the "Free" sounds that can be downloaded from the ZIMO website and installed as desired.

"Pre-loaded" sounds are those that are loaded into the decoder at the factory. They can be used, removed and reinstalled at will.

Get Better Sound from your Locomotives

Can't get a good sound from your sound decoder?
Give our speakers a test drive with your ears.



RAILMASTER HOBBIES
9812 BELMONT
BELLFLOWER, CA 90706

Bass Reflex
Speakers



High Bass
Speakers



When it comes to speakers we have high quality speakers to fit many different applications. We are also a full line hobby shop. Need anything? We are an authorized dealer for Soundtraxx, Digitrax, Athearn, Walthers and many others. We provide quality speakers for your DCC sound systems and quality service.

**Click here for
the answer ...**

Sounds are available from the ZIMO website (zimo.at/web2010/sound/tableindex_EN.htm).

ZIMO also has third-party vendors who provide sounds through the ZIMO web site for a fee.

Whichever sounds you choose, the ZIMO MXULFA hardware and the associated software are your gateway to installing them.

Summary of hardware and software

I don't recommend the choice of sound decoder based solely on the sound loading hardware and software. Look at the total package, including:

- Sound quality
- Features
- Ease of loading and modifying sound files and decoder operation
- Cost of both the sound loader and the decoders

In the world of loadable-decoders, ESU's LokSound product stands head and shoulders above the rest, in my opinion. Their attention to sound quality and locomotive operation is exemplary, especially in the American diesel regime. While their sound loading and decoder management software is a challenge to get started with, it is solid and will work well for most users.

The somewhat higher price of the LokProgrammer (about double that of the Digitrax or QSI units) is a bit unhelping. However, you should only have to buy one unit for your pike, while you will probably be buying many decoders.

QSI's units are second in my book. Their pricing is good. The "stereo" sound has some fine uses. Their market share seems to have slipped recently and there seems to be little support for new sounds. Hopefully, this will change.

Mfr	Unit	MSRP	Input	Windows		
				Drivers	Signed	Program
Digitrax	PR3XTRA	\$84.95	USB 2.0	XP, Vista, 7, 8	No	SoundLoader
ESU	LokProgrammer	\$199.99	RS232 + adapter	XP, 7, 8, 8.1, 10	Yes	LokProgrammer
QSI	Quantum Programmer	\$89.95	USB 2.0	XP, 7, 8, 8.1, 10	No	Quantum Update / CV Manager
ZIMO	MXULFA	\$270.10	USB 2.0	?	?	ZSP (ZIMO Sound Programmer)

8. Sound loading hardware and software packages from various vendors.

ADVERTISEMENT

DCC and Sound in N Scale?

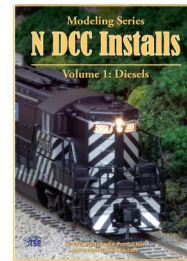

We'll show you how!
N DCC Installs
Examples with and without sound!

CLICK FOR DCC

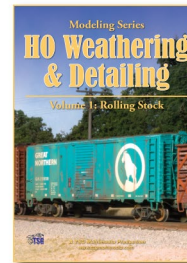

Want it now?
Our titles are now available in digital download format!

CLICK FOR DIGITAL

TSG Multimedia

ADVERTISEMENT

LC2xx series DCC decoder for HO scale



High Performance
High Compatibility
Multi-lighting function output



- Conforms with NMRA specifications and is certified by the NMRA DCC
- DCC standard decoder is suitable size for HO scale locomotives
- Offers 4 to 6 100mA function outputs with short circuit protect
- Includes Back-EMF with client motor control
- Operates on a 28 step adjustable speed table
- Supports long address and bit mode program



DCC IMPULSES | 20

I hear lots of good things from ZIMO users about their product. I didn't have the hardware to tinker with them and they are definitely the "high-priced spread."

Digitrax has never convinced me that their heart is in sound decoders. I feel as if they felt they needed to jump into a market that they didn't really understand and aren't seriously committed to. That said, I haven't experienced their 16-bit sounds, either.

Use one (or more) of these hardware and software combinations to load firmware and sounds into the decoder. Nothing here replaces a computer interface and **DecoderPro** to tweak your decoders and back up your work onto your computer.

One last thought. Unless you are going to tweak sounds as a hobby, you may not need a sound loader. Routine adjustments and additions may be programmed for you by your favorite DCC dealer. Even if they charge a modest sum for their work, you may be money ahead having them do the work for you.

Here is a chart [8] of the characteristics of the different programming units.

Please share your experiences, ideas and (especially) programming experiences. Just click on the Reader Feedback icon at the beginning or the end of the column. While you are there, I encourage you to rate the column. "Awesome" is always appreciated. Thanks.

Until next month, I wish you green boards in all your endeavors.

Coming up next is "Mr. DCC's Workshop" and a new LokSound project file.



[Click here for
reader comments](#)



SOUNDTRAXX

Digitrax
Complete Train Control



Custom Installation Available

We carry all your DCC Requirements!

623-298-7355

www.LitchfieldStation.com

MR. DCC's WORKSHOP

LokSound Full Throttle diesel sound decoders

In June 2016, ESU released the Full Throttle series of LokSound Select sound projects. These innovative products provide one of the most realistic sound sets in current decoder technology.

I had a LokSound Micro Select decoder kicking around the shop and was able to install the new version of the Full Throttle software package. I downloaded the package from the LokSound site (esu.eu/en/downloads/sounds/loksound-select/loksound-select-usa) and installed it using version 4.4.23 of the LokProgrammer software. Version 4.4.21 is the earliest version that will work with these new sound files. The files can be installed in any Select or V4.0 LokSound decoder.

This software was demonstrated on the MRH web site on Mike Confalone's layout. The video is referenced on the thread (mrh-mag.com/node/26536). If a picture is worth 1000 words, then a video is worth a million. I recommend you watch the video.

While this level of realism may not trip the trigger of operators enough to have them do the extra work to make it happen, some folks are raving. One of the members of the PebbleCreek Model Railroad Club – a railroader since the early 1950s – is extremely excited. His comment was something like, "That's EXACTLY how they should sound."

The new independent brake function works with the decoder to provide a realistic switching scenario, too. I doubt that many serious operators will want to follow the protocols to make it function prototypically, but it makes for good theater. ■

TONY'S TRAIN XCHANGE

Committed to your DCC support!

Jack Wabbit Quad

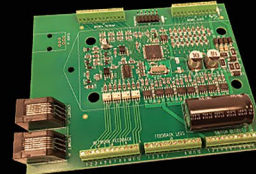

4 Output Stationary Decoder,
Compatible with Stall
Motors and Snap Coils,
Optional Loconet Interface

Starting at \$59.95

Order Yours

Locomotive SALE!

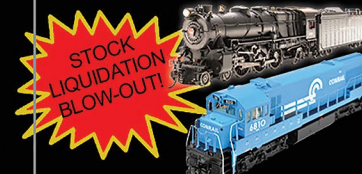

Get Fantastic Deals on a Huge Selection of
In Stock Inventory! Up to 50% Off MSRP!

Includes Diesel & Steam Locos from Athearn, Bachmann,
Broadway Limited Imports, Korea Brass, Rivarossi & More!
(Easily search our site by manufacturers stock numbers!)

Prices as low as \$99.95

Order Yours

New ESU LokSound Full Throttle Sound

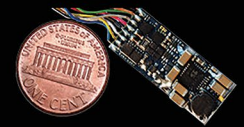

ESU's new Full Throttle sound files now
include Drive Lock "Cruise Control" and an
Independent Brake for exceptional
motor control and prototypical running.

Available on all Loksound Select
and V4.0 Sound Decoders

Starting at \$81.95

Order Yours

Do you need a Sound or
DCC Installation done?

Get a quote!



Providing unmatched person to person
DCC support for more than 25 years, the
kind of service that has made us #1 in DCC.
DCC questions? CALL US! 1-800-978-3472

We'll get you on the right track!

Aug 2016



From first train set to railroad empire...

*Our complete line of DCC products
grows with you. Discover the fun!*

- Designed and manufactured in the U.S.A.
- Preferred for ease of use and ergonomic design
- Unlimited scalability for any size model railroad
- Plug-and-play means more time running trains
- Great customer service and excellent support



Visit our new and improved web site for all your DCC needs!

- Get the latest new product announcements
- Watch our detailed how-to videos
- Browse the all-new Information Station
- Enjoy secure online sales, day or night!



See your dealer

Visit ncedcc.com



WEATHER

like a pro. (No airbrush required!)

Go from this ...



To this ...



**Volume 1:
Freight cars**

**Volume 2:
Diesel locomotives**

Click me to
LEARN MORE ...

“Simple, effective, and a lot quicker than an airbrush ...” - *Koos F.*

DVD or Digital download - From the MRH Store: store.mrhmag.com

Model Railroad Hobbyist | August 2016 | #78

GETTING REAL

column



NICK MUFF
.....



Click here for
reader comments

MODELING THE KANSAS CITY SOUTHERN RAILWAY | MAINLINE SOUTH – SCENERY FOR THE “OZARK MOUNTAINS” PART 2

IN THE JULY ISSUE, I STARTED THE PROCESS of adding vegetation and water to my Ozark Mountains scene, referencing scenery from the area (mrhmag.com/magazine/mrh2016-07-jul/getting-real). The topics covered in Part 1 include:

1. Bringing life to the rocks
2. Adding dirt and grass
3. Trees, trees and more trees
4. Waterfalls and pools
5. Stream side plants

This time, I continue to fill in the background with a prominent structure, add more distinctive trackside plants, and more trees with species correct for the area.

► MODELING REAL RAILROADS AND WHAT THEY DO

The Kihlberg Hotel and Baths

A distinctive feature of the Ozarks was its resort hotels. The early hotels catered to patrons who arrived by train from hot crowded cities such as Chicago and Kansas City to enjoy the cool mountain air and to take “The Baths.” Hot springs and hot baths were a popular way of treating many illnesses until the advent of antibiotics. Sulfur Springs in Arkansas had several resort hotels in those days. One was the Kihlberg Hotel, which I decided to feature on a distant hilltop.

Thanks to eBay I was able to obtain a vintage postcard of the hotel. I scanned this and printed it on cardstock. I then glued the cardstock to a sheet of 0.020” black styrene plastic. Next I cut out windows here and there which will be lighted. I tried to distribute them randomly and ensure that some of the windows were at the extremities of the image to help fill out its shape on the skyline at night.



58. Kihlberg Hotel vintage postcard.



59. Image glued to black styrene and some windows cut out.

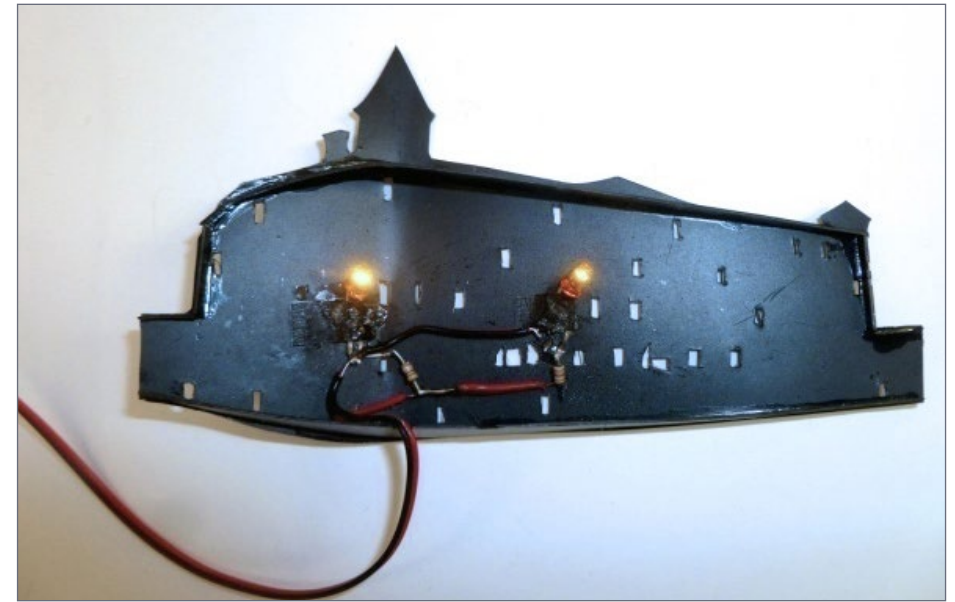

60. The backside of the hotel, light box, and LEDs.

GETTING REAL | 4

I attached a styrene tab to the backside of the hotel so that it could be taped into position on the backdrop. I use blue tape to do this and to dress the wires down to the bottom of the module so that the building and wires can be removed if needed at a future date for maintenance.

The Kihlberg Hotel's grounds

The land surrounding the hotel is landscaped in proportion to its diminutive size and supposed distance. Small bushes were planted at the base of the hotel using foam clumps. The tiny evergreen trees are pieces of green pipe cleaner with the tip trimmed to a point and the opposite end stuck into a hole drilled in the hardshell. The trees vary from about 1/4 inch to 3/8 inch high.

Even though the hotel is very small and very far away I wanted to create the feeling of a hotel garden by planting trees and shrubs



61. The Kihlberg Hotel lighted.

GETTING REAL | 5

around the building. To accomplish this in such a small scale I used small bits of ground foam at the base of the building to simulate bushes. This helps conceal the joint between the hotel and the hardshell. Then I used two different sizes of green pipe cleaners trimmed to a point and cut in short lengths to simulate conical evergreen trees. I drilled holes into the hardshell and inserted the base of these pipe cleaner trees into the whole using tacky glue.

Sumac bushes and distinctive trackside plants

As I prepared to add the rest of the trees to the mountains I studied photographs of the prototype right away. It was then that I noticed how prevalent sumac plants are in this area and particularly along

ADVERTISEMENT

Click Here

FIFER HOBBY SUPPLY LLC

**Your Local N Scale
Online Hobby Shop**

**575-523-9743
fiferhobby.com**

GETTING REAL | 6

the railroad right of way. It turns out the railroads planted sumac along the right away since is helpful in stabilizing erosion.

A manufacturer in the past offered etched brass sumac plants in HO scale. Unfortunately these are not currently available, so this was a chance to test the limits of my powers with the laser cutter. True, not everyone has a laser cutter, but they are becoming increasingly available and affordable.

The first step was to research sumac images with Google. It turns out that the long leaves or spikes vary from 3 inches to 12 inches long. For my HO scale versions I leaned toward the 12-inch length so that they would be visible and practical to construct.

Do ALL your model railroading friends know about MRH?

WE CONTINUE TO BE SURPRISED BY HOW MANY MODELERS STILL HAVE NEVER HEARD OF US - SO SPREAD THE GOOD WORD ABOUT MRH!

GETTING REAL | 7



62. Styrene mounting tab.



63. The hotel attached to the backside of the mountains.

Using an image of the leaves I drew branches in my CAD program and copied them down the page in medium and smaller sizes. I also created two sizes of flower/berry spikes. I chose Hewlett-Packard 48 pound brochure paper to create the leaves. This paper is one of my favorite products for many uses on the model railroad.

The leaves and spikes are then glued to 0.015-inch brass wire stems using canopy glue because of its flexibility. The branch structure of sumac consists of multiple Y-shaped junctions of stems. I take two leaf stems, bend them out at opposite 45-degree angles and solder them together. Then, solder these together in Ys to form the trunk. I spray paint the trunk grayish brown and then spray paint the leaves Testor's SAC Bomber Green.

The sumac spikes bend downward from the stem. Once the green paint is dry, use your thumb and forefinger to squeeze the spikes of each branch bending the spikes downward. This really improves the realism.



64. The diminutive hotel set on a distant hill.



65. KCS right-of-way with sumac plants highlighted.



66. Sumac branch structure, multiple Ys.

The last step is to add the berry spikes with canopy glue. These berry spikes come out of the sections where the Ys join. To achieve the reddish look of the sumac berries, dip the end of the spike in white glue and then in paprika. As you can see in the prototype photograph, sumac bushes may vary from three feet high to veritable trees at 30 feet high. Sumac bushes of any size can be created by combining these leaves and stems together.

Eastern red cedar trees

Prominent among the deciduous trees, even in summer and especially in the fall and winter are the eastern red cedar evergreen trees. They especially seem to grow along the top edge of the limestone bluffs. I'm uncertain whether this is due to more sunlight or the limestone in the soil but they are a prominent feature. I used Google's image search for eastern red cedar trees and came up with many great images showing the variation in shape, size, and color of these evergreens.

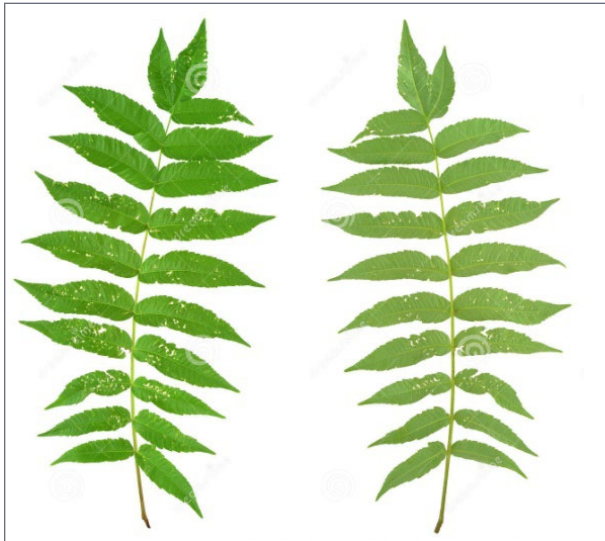

67. Sumac spikes and stems.

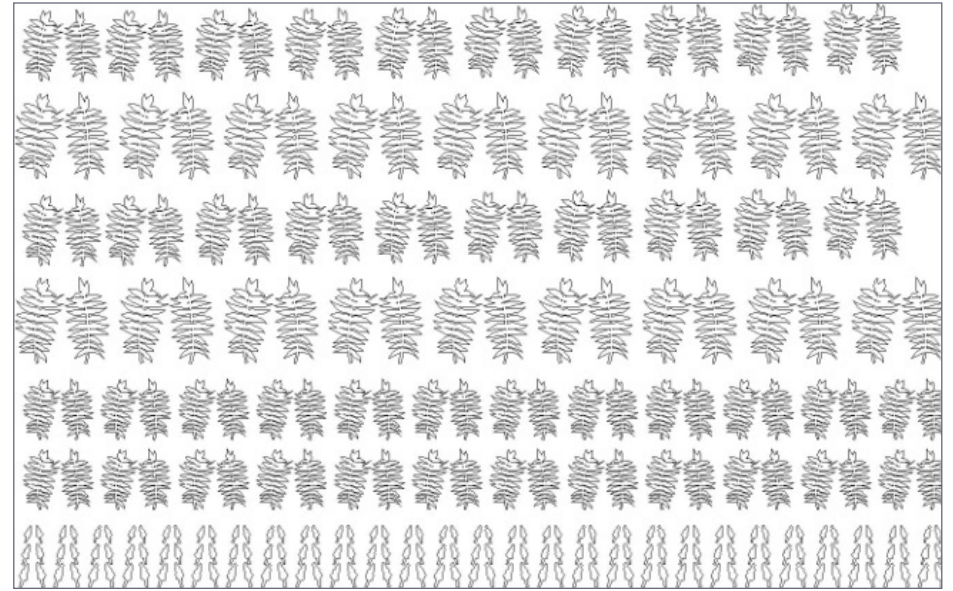

68. Sumac leaf CAD drawing. Get the full drawing in the [subscriber bonus downloads for this month](#).



69. Sumac leaves and flower spikes glued to brass wire stems.

GETTING REAL | 12

After looking over the various options, I chose cedar trees from Grand Central Gems which I purchased through Scenic Express (scenicexpress.com). Their number 295 – T3 includes 50 small trees. These simulate small pine trees and are more pointed than the eastern red cedar trees. To achieve a better representation, I clip off the top of the tree and use scissors to round over the branches. I also use scissors to trim and round the lower edge of the tree. When planted among the deciduous trees and along the tops of my bluffs, they capture the look of the prototype.

Creating a sense of distance

One way to help create perspective and distance for the Ozark Mountains is to make the trees in the distance smaller and

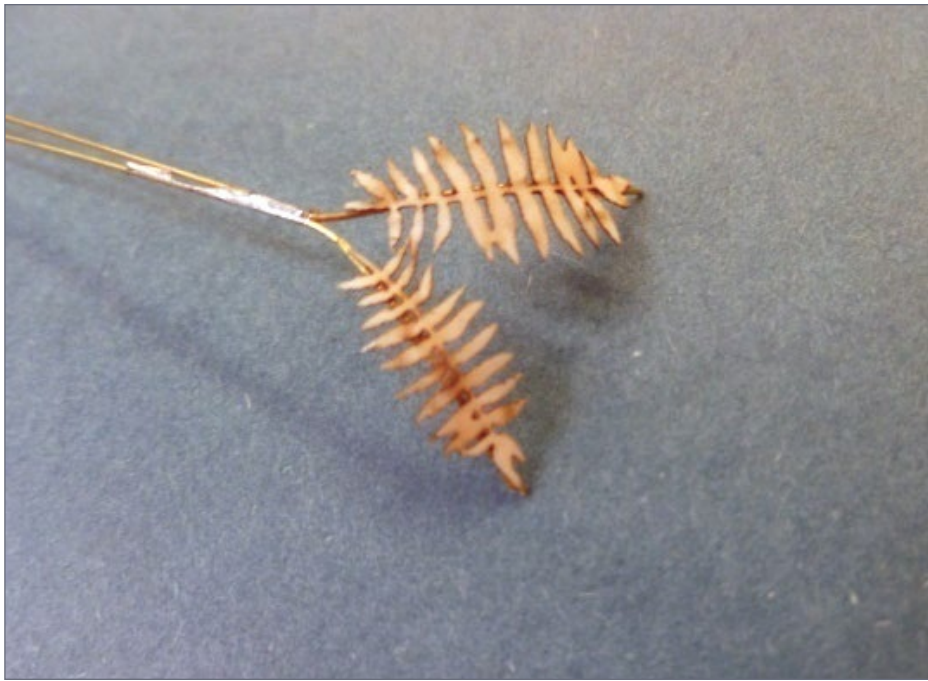

70. Sumac stems soldered together in Y-shaped pairs.

GETTING REAL | 13



71. Berry clusters made with white glue and paprika.



72. My first sumac plant with spikes bent downward.

GETTING REAL | 14

shorter. I needed to create a lot of really small trees. It turns out that the Super Tree scraps left over from trimming the armatures for the larger trees are just perfect. I toss them in a box and spray them with alternate colors of light gray, dark gray, and dark brown. I toss the pieces from time to time so that they are covered with the spray paint.

Then I take a small handful of the pieces at a time and dip them in the dilute matte medium for 30 seconds or so. Following this I pull them out with a disposable plastic fork and treat them with the small leaf material as I do the larger trees.

Next, I overspray them with hairspray and place them on a sheet of plastic sheeting to dry. One trick I discovered is to use my fingers



73. Sumac turns flaming red in the fall.

GETTING REAL | 15



74. Eastern red cedar trees along Butler Bluff.

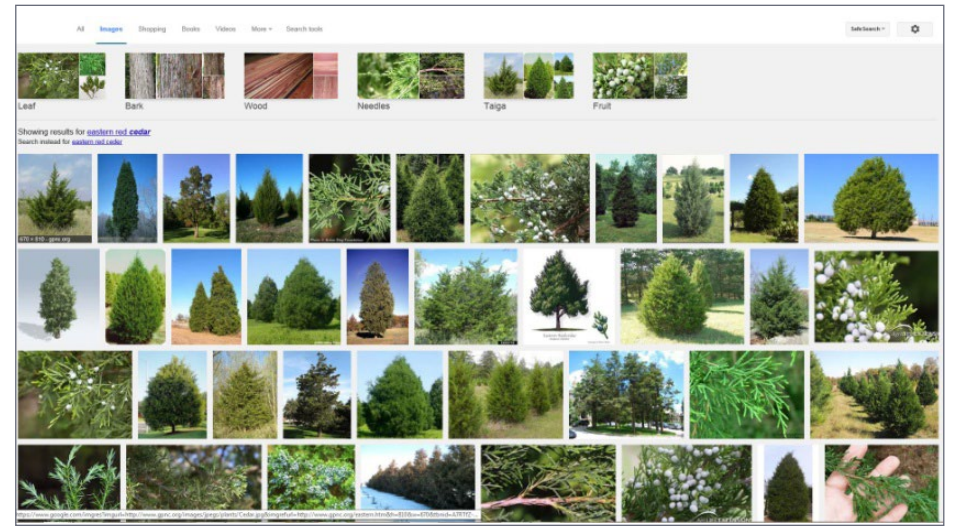

75. Google image search for "eastern red cedar."

GETTING REAL | 16

to tease the pieces apart on the plastic sheet before they dry so that they have a thinner, airier appearance. About an hour into the drying process I turn them over so the bottom side will dry.

When the pieces are thoroughly dry I pull them apart with my fingers or cut them apart with scissors and apply them to the distant hillsides using tacky glue. These trees vary from about 1/2 inch to 3/4 inch in height.

Conceal an access opening

I had hoped the access opening in the middle of the Ozark Mountains would not be visible because of its height, distance and location. But as I completed the project, I realized that it would be visible from certain viewing angles and for taller visitors. So a last-minute change in plans involve creating a piece of geodesic foam sheet to fit and cover the access opening. I used bath towels and rags to fill in that area and support the geodesic foam piece as it hardened.



76. Out of the package tree on the left. Shortened and rounded tree on the right.

AVOID COSTLY MISTAKES



Summer
special-Join
now and get
free bonus
months!

“I can’t imagine life before Trainmasters TV.
It is worth every penny.” – Guy E.

Let our experts
help you do it
right the first time.



trainmasters.tv – We help you
achieve your hobby dreams.

click to learn more

GETTING REAL | 17

With hot glue, I attached a cheap hardware handle to the bottom of the hatch to allow it to be raised and lowered from under the layout as needed. Once covered with trees, the access hatch is nearly invisible. The trees over the hatch are attached directly to the geodesic foam sheet with tacky glue instead of drilling holes for the trunks.

A final touch to create the sense of atmosphere or distance is to overspray the trees closest to the back edge of the mountains with a faint haze of light blue paint. I found Rustoleum 7722 Harbor Blue a close match for my sky color.

Final details

Where the double track heads for the helix down to Oklahoma, part of the mountainside covers a Tortoise switch machine. With



77. Pipe cleaner evergreens and small foam bushes surround the hotel and blend it into the mountaintop.

GETTING REAL | 18



78. Super Tree pieces sprayed brown and gray.



79. The painted pieces covered with leaf material. Don't forget the sun highlights.



80. Gluing the small distant trees in place.

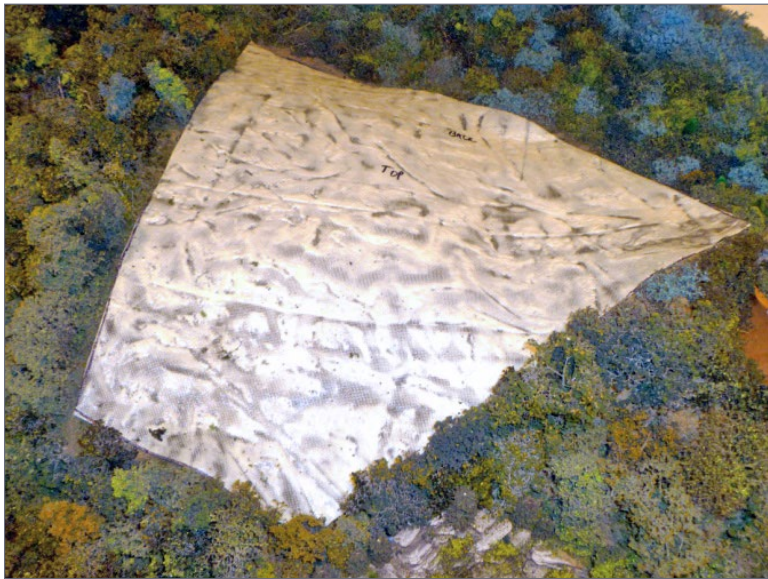

81. Geodesic foam access hatch cover.

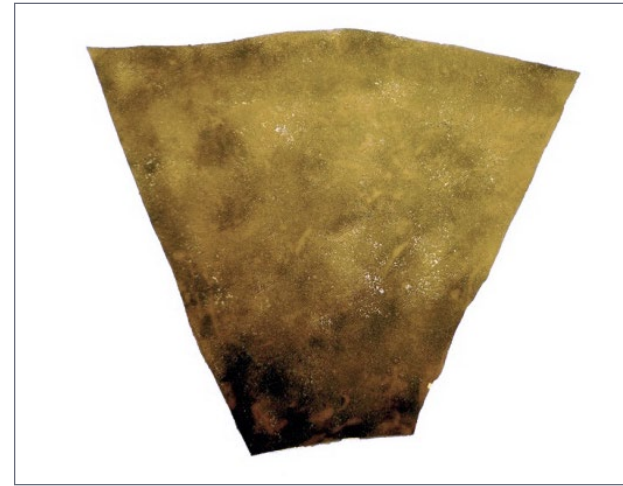

82. The access hatch with dirt and grass.

Please tell your buddies about MRH!

WE RELY ON WORD-OF-MOUTH TO GROW AND A BIGGER CIRCULATION MEANS MRH IS MORE LIKELY TO STICK AROUND FOR A LONG TIME TO COME!



83. Handle on the bottom side of the hatch.

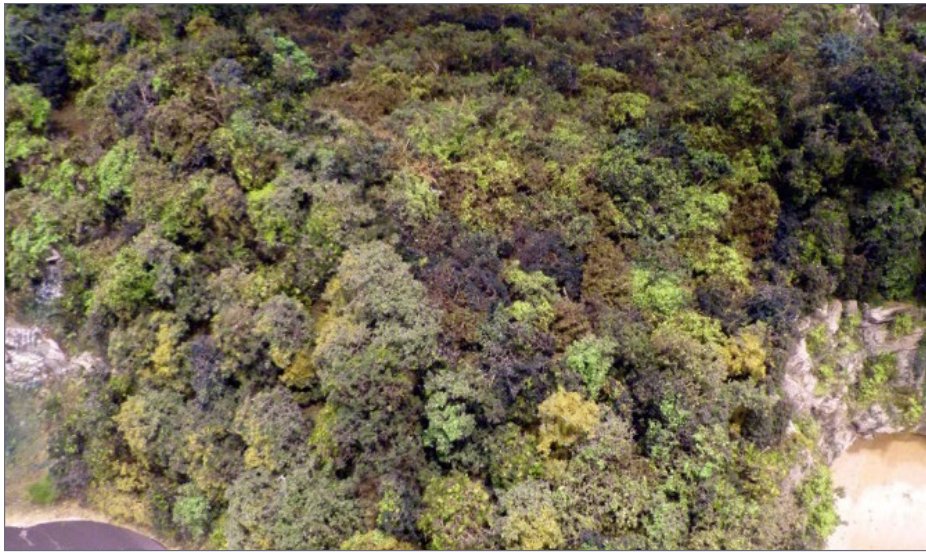

84. Covered with trees, the access hatch can no longer be seen.



85. The Ozarks viewed from the Noel, MO side.



86. The Ozarks viewed from the Siloam Springs, AR side.

GETTING REAL | 23

the half-inch foamcore base, geodesic foam hardshell, and rocks it is a simple matter to saw this piece loose for access to the switch machine for servicing.

Of course the large “canyon” by which the double tracks enter the helix has no counterpart feature on the prototype. But you can usually find a way to turn a problem into an asset. I did

this by adding a sign on the mountainside, pointing to the canyon. It is borrowed from the real world, proclaiming it as the “Arkansas Grand Canyon,” deepest in the Ozarks!

In my next column in a few months, I will create the first stop on my southbound mainline, Grandview MO. See you next time. ✓

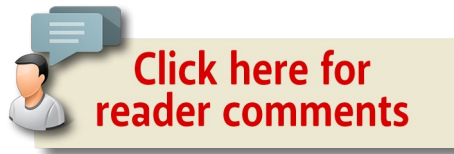

87. Tortoise access hatch.

GETTING REAL | 24



88. The “Arkansas Grand Canyon” sign.



89. The Kihlberg hotel at dusk.

We REALLY show you how!

- Network-quality video using multiple camera angles
- Closeups that let you SEE the action
- We ask probing questions of our expert guests
- In-depth model railroading topics by passionate modelers doing the hobby

Summer special-Join now and get free bonus months!

Click here and have a look!



KEN PATTERSON
.....

Model Railroad Hobbyist | August 2016 | #78

WHAT'S NEAT WITH KEN PATTERSON

column



KEN AT THE INDY NTS, TSUNAMI2, AND LOTS MORE ...

THIS MONTH, JOHN TYSON COMES BY WITH A NEW trick to shrink molds from larger scales down to HO scale. This process can be used to shrink any model. Jeff Meyer shows us a weathered locomotive project. We look at the new Tsunami2 Steam decoder from Soundtraxx. We look at the new Bachmann Schnabel car in HO scale. I try a new trick for making coal loads and we have a few moments from the NMRA National in Indianapolis plus some great runbys. All in this month's "What's Neat" column and video.



► PHOTOS AND VIDEO OF SUPERB MODELS

WHAT'S NEAT | 2



1. I just got back from the National Train Show in Indianapolis where I had to deliver a train layout to the Athearn trade show booth. This folding layout had a big makeover and will be featured in a future show.



[Click here for reader comments](#)

WHAT'S NEAT | 3



2. The show was wonderful to attend. Joe Fugate and Lionel Strang were manning the model Model Railroad Hobbyist booth and they gave a video interview for What's Neat. Overall, I got the feeling that the state of the hobby is good.



Playback problems? [Click here ...](#)

WHAT'S NEAT | 4



3. John Tyson and Mike Budde were visiting one Saturday evening when they started talking about model cars for the layout. John Tyson is working on an experimental method of shrinking 1/64 scale diecast cars down to HO scale. As Mike and John talked about it, the video camera was running to catch the conversation.

WHAT'S NEAT | 5



4. John is holding a 1/64 scale diecast model, stripped of the paint and filled with clay, ready for the mold-making process. In John's other hand is the finished cast HO scale car made from the 1/64 scale car.



[Click here for reader comments](#)

**Want to help keep
MRH free?**

Then *click* on ads!

WHAT'S NEAT | 6



5. John fills a container with silicone mold-making material, and you can see how the blue silicone mold has cured to become much smaller than the original container size. His trick is to mix in mineral spirits or NOVOCS Silicone Solvent while mixing the blue mold making silicone rubber. The silicone solvent is from a company called Smooth-On, at smooth-on.com. The mixture is 2 parts thinner to 1 part silicone rubber and the shrinking process takes 7 to 10 days as the silicone solvent evaporates. There is a tutorial on the Smooth-On web site on how to shrink molds by 18% to 22%. This is a popular technique among professional model builders.



**Click here for
reader comments**

Have you seen this?



**CHECK IT
OUT!**

kenpatterson.com

click here to ...

Visit Ken's website

Ken Patterson reveals his modeling secrets on video!

WHAT'S NEAT | 7



WHAT'S NEAT | 8



6-9. Here are a few examples of finished models in HO scale John made using this mold shrinking process. He finishes them with custom paint and Bare Metal Foil.

Car loads from foam



7. I was running my HO_{N3} models on the layout when I decided I wanted a car full of coal. Not actual coal, as this would weigh too much on the four percent grades. No, I needed a lighter load that looked like coal. After thinking about it for a few minutes I came up with an idea to solve the dilemma.

 [Click here for reader comments](#)



8. I use a plastic grocery bag to line the inside of the gondolas, then filled the cars with Great Stuff Foam Pro.

119,000 have seen this MRH video - *have you?*

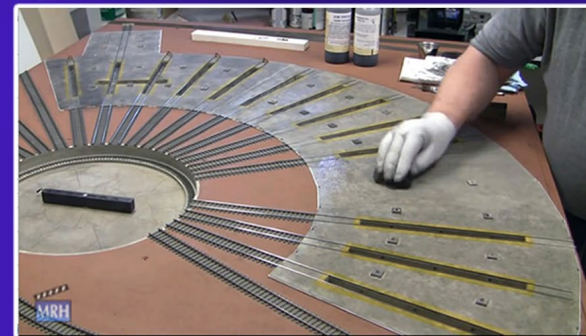

[Watch the video now](#)

WHAT'S NEAT | 11



9. After the foam cures – in about 45 minutes – I pull the plastic bag from the foam, leaving me with a foam casting the same size and shape as the inside of the car.

WHAT'S NEAT | 12

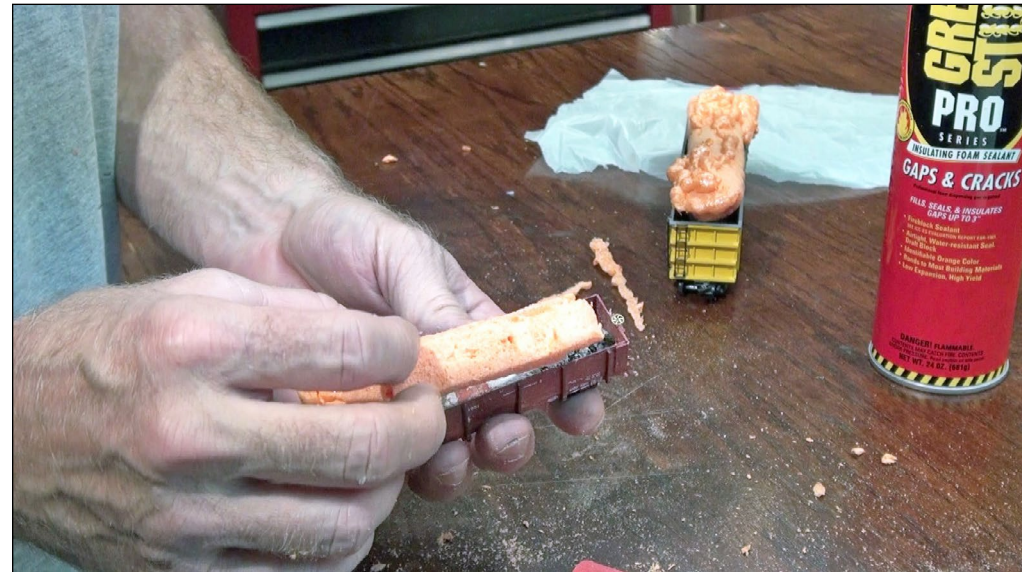

11. I test-fit this load in the car many times during this process of carving and shaping.



10. With 80 grit sandpaper, I carve the foam to give the look of a coal load as it would settle in the gondola.



12. I paint the top of the foam load with latex paint to act as glue to hold the coal in place atop the foam.

WHAT'S NEAT | 13



13. Then, I sprinkle on Woodland Scenics Cinder Black Ballast. This is pressed into the paint with a brush and my fingers and looks just like coal.

WHAT'S NEAT | 14



15. The end result is these two finished loads, made from lightweight foam in less than one hour.



14. I follow the same steps to make a load for this Athearn Thrall gondola: carve, paint and cover with cinders.

**TrainMasters TV is part of
the MRH product family.**

TMTV members not only get great network TV level videos, they help pay for MRH and keep it free ...

WHAT'S NEAT | 15

Bachmann Schnabel car in HO



16. This month I was photographing the new Schnabel car for Bachmann. At 32 inches long, with 32 sets of wheels, this car is a monster. I set up the model for a shoot in sunlight.



[Click here for reader comments](#)

WHAT'S NEAT | 16



17. After photographing the model, I ran it on the layout. Look at the overhang of an inch or so on a 48-inch radius curve. The model is very interesting to watch as it runs around the layout.

Did you know there's an MRH index available?

[CLICK TO FIND OUT MORE](#)

WHAT'S NEAT | 17

Jeff Meyer Locomotive



18. Jeff Meyer came by for the first time in seven or so months. He set up a photo shoot in my back yard of a locomotive weathering project he was finishing for a friend.



19. The model is weathered with small brushes and shades of oil paint to create a rust effect that just looks fantastic.

PREORDER
SPECIAL

MAKE IT RUN

as good as it looks.



(Stock Athearn HO diesel weathered for Joe by Ralph Renzetti)

Click me to
LEARN MORE ...

Make it run like a
Dream

BOOK SERIES: *By Joe Fugate*

Preorder now and SAVE - From the MRH Store: store.mrhmag.com

WHAT'S NEAT | 19

SoundTraxx Tsunami2 steam decoder



20. I videotaped most of the SoundTraxx Tsunami2 steam video outdoors in bright sunlight to make a better overall presentation of the models. The decoder was installed in this Bachmann steam locomotive for the demonstration.



[Click here for reader comments](#)

WHAT'S NEAT | 20



21. Here you see a photo of the hill test. The locomotive labors up the grade with deep chuff sounds, then crests the grade and becomes much quieter as the train rolls down the grade. The sound transition is all automatic as the decoder can sense the load on the motor.



22. I had to make an ash dump scene to demonstrate the ash pan cleaning and raking sounds and used cigarette ash to make the realistic pile under the locomotive. I also had to build a coaling scene to demonstrate the coal and fuel loading sounds. It's on function keys F17 and F18.

WHAT'S NEAT | 21

This month we look and listen to the NEW Soundtraxx Tsunami2 steam DCC decoder. I have just finished the corporate video for SoundTraxx on the steam decoder and this month show you a specially-edited cut on What's Neat, with its own introduction and additional text not in the SoundTraxx original video to help walk you through the function keys for various sound effects.

Soundtraxx says "Tsunami2 is a decoder that takes scale railroading to another level! Equipped with over 55 whistles, selectable bells, air compressors, couplers, and up to 10 exhaust chuffs that can be set up for a two-cylinder, three-cylinder, or articulated in each decoder, it makes matching your prototype easy."

"Fully redesigned and digitally remastered, these decoders are equipped with up to 6 lighting outputs, flexible 28 function support, Hyperdrive2, and over 50 individual sound effects. Available in many great board formats it is the perfect solution for any scale from N to G."

"Of the many great features and sounds found in Tsunami2, one of the most fun and prototypically correct is our next-generation SoundTraxx Dynamic Digital Exhaust and adjustable cutoff. Taking into account all of the factors of a locomotive, listen as the locomotive labors hard to bring the train up to speed and climb up the hill. Notice as the engineer runs the Johnson bar closer to center how the length of the chuff shortens. Finally, as we crest the grade, hear the engineer shut off the throttle and drift down the hill. Just like the real thing!

"Tsunami2 has two forms of actual functioning brakes available with different braking rates in both variations. Just like the prototype, you have access to the locomotive brake known as the independent brake, and the train brakes known as the automatic brakes. And "When used in conjunction with the Dynamic

WHAT'S NEAT | 22

Digital Exhaust and Johnson bar you can even simulate real power braking!"

"Tsunami 2 fun doesn't end in the yard, with the addition of Fireman Fred keeping your boiler hot, fuel and servicing functions."

"With so many new features and sounds focused on real railroad-ing fun, Tsunami2 is a new dimension in digital sound technology from SoundTraxx!"

Watch the video and hear the sounds. And with that, that ends What's Neat for August 2016. We just passed one million views last month for the What's Neat series of videos and we get an average of 22,000 views per month. That's Really NEAT! Thanks to all of you ...



[Click here for reader comments](#)



MRH MARKETPLACE

CLICK HERE

CANYON CREEK SCENICS

PRE-SIZE MODEL SPECIALTIES

P.O. Box 6 Paonia, CO 81428
Ph. 970 527 4586
Made in The USA

Cast resin items for All Scales.
Tunnel portals, bridge piers, abutments, culverts, and retaining walls.
Trackside details and sage brush tree armatures.

"FREE SHIPPING see website for details"

clever models LLC
Cardstock models & materials

Try one today!

www.clevermodels.net

MODEL RAILROAD BenchWork.com

Affordable built to order Benchwork starting at only \$20 a Sq Ft.

Don't settle for lifeless signals!
We've got signaling circuits!

LOGIC RAIL™ TECHNOLOGIES "Sophisticated Model Railroad Electronics"

Please visit our website and online store!

21175 Tomball Pkwy Suite 287 Houston, TX 77070 Phone: (281)251-5813
<http://www.logicrailtech.com> info@logicrailtech.com

PRECISION DESIGN CO

Chains
Flat Car loads
Joint Bars
Signs & Posts

FREE SHIPPING

Oak Hill MODEL RAILROAD TRACK SUPPLY LLC

JEFF OTTO TURNIN' IT OUT

414-915-4671
ohrtracksupply.com
jeff@ohrtracksupply.com

N36W23431 Oak Hill Ln. Pewaukee, WI 53072

Scale Photo Etch

Radio Tower with Blinking Lights

Fully painted and assembled, ready to be placed on your layout or diorama.
Kit includes 12V power supply.

www.scalephotoetch.com

AMERICA'S NUMBER ONE RAILROAD PRINT SOURCE

Jelsma Graphics
America's Railroad Embroiderer

Railroad Art-Prints, Caps, Jackets, Shirts and More ...
Jackets starting at \$79.95

www.jelsma.com
1-904-221-3513 • Jacksonville, FL.

MODEL RAILROAD BenchWork.com

Affordable Modular (domino) Benchwork in 200+ sizes
Custom built to order benchwork also available!

LIGHTS 4 MODELS

90DEG & GOOSE NECK
OUTSIDE INDUSTRIAL LIGHTS
O, HO, N, & S SCALE

LED lights, Animated Signs, & Sounds
www.lights4models.com 614-296-8691 [Click Here](#)

FEATURING
America's Historic Main Street Architecture

MAINSTREET HERITAGE
www.mainstreet-heritage.com

JIM'S TRACK PLANS

EXPLORE HERE

New Designs Every Tuesday!

Yarmouth Model Works
HO scale resin kits and detail parts

U.S.A. MAILING ADDRESS
3560 Pine Grove Ave. Unit 617
Port Huron, MI 48060

TEL. 519-633-7574
pierre.oliver@start.ca
www.yarmouthmodelworks.com

CANADIAN MAILING ADDRESS
85 Hiawatha St.
St. Thomas, ON N5P 2T5



New Kits Coming:
NWP USRA Express Box



westerfieldmodels.com



Craftsman Model Kits
www.kcworkshop.com
www.facebook.com/kcworkshop

RULERS-of-the-WORLD

Scale Rulers \$4 each
Over 200+ scales!
Metric or Imperial

www.rulers-of-the-world.com

LOOK at what's new at Black Cat this month [Click here for our website](#)

London & Port Stanley electric railway's Passenger cars and Freight Motors

Great Northern Passenger-pre empire builder in gold leaf & dulux gold

Black Cat Publishing
(204)489-5005
ajfergus@mymts.net
blackcatdecals.com



HO DIESEL SUPPLY

KATO EMD SD SPECIALIST-REPAIRS-UPGRADES

New and Rebuilt Locomotives
Powered Chassis-Trucks-Motors
Bodies and Parts-Handrails-Electronics

www.hodieselsupply.com

email:kato@hodieselsupply.com

Great Decals!TM

FEC, Interstate, Virginian Railway, & L&N Titles
After Hours Graphics Line
Coupler Gages and More
In O, S, HO, and N Scales

Have you seen these popular blogs on the MRH website?



Tom Johnson's L&N

297,000 reads

[CLICK TO READ IT NOW](#)



Quality DCC Equipment

- Digitrax • TCS • NCE •
- QSI • SoundTraxx •
- Lenz • LokSound •

Visit our website!

dcchobbysupply.com

MOUNTAIN SUBDIVISION HOBBIES

www.modelrrsupply.com

FREE USA SHIPPING OVER \$29.00

NCE - SOUNDTRAXX - DIGITRAX - PECO - CIRCUITRON
DCC SPECIALTIES - INTERMOUNTAIN - CMX - ATLAS
BAR MILLS - BOWSER - KATO - MRC - TOMAR - RIX -
PIKESTUFF - LOGICRAIL - CENTRAL VALLEY AND MORE!

Your ad could be in this space for as low as \$88 a month.

[Click to learn more ...](#)



DID YOU KNOW MRH SUBSCRIBERS GET FREE BONUSES?

[CLICK TO SUBSCRIBE NOW - IT'S FREE!](#)



Ken Glover's Shelf Layout

96,000 reads

[CLICK TO READ IT NOW](#)

Tim Dickinson's **Burlington Northern**

*How to model a
prototype by looking at
Tim Dickinson's example ...*

**Easy Real
Railroads** 
1 2 3



BY ROBERT SCHLEICHER
AND TOM DICKINSON
.....

 [Click here for reader comments](#)

MY 20 X 40 FOOT MULTI-DECK LAYOUT RECREATES the Burlington Northern's operations through the northwestern part of Washington State in 1976.

The layout is designed with enough staging tracks to run most of the trains that the BN operated then in Washington. Trains operate by Centralized Traffic Control (CTC) as did the prototype.

All locomotives are equipped with DCC/sound from various manufacturers such as LokSound, Sountraxx and TCS/WOW. The layout is wired with electrically-isolated blocks. The electrical blocks are not necessary for locomotive control but are needed to control the signaling system.

Construction is conventional open-grid benchwork with the roadbed supported by 5/8" plywood. Sheets of 1/8-inch cork are cemented to the plywood and topped by a layer of conventional cork roadbed.

Track is a combination of Railcraft by Micro Engineering and Central Valley's tie strip and rail system. Code 83 rail is used on the mainline, with Code 70 for the sidings, and Code 55 for yard tracks and spurs. The minimum mainline radius is 36 inches and most mainline turnouts are Central Valley #9 with Detail West modern-era manganese frogs. Yard turnouts are Walthers #6.

The scenery base is two-inch-thick sheets of blue Styrofoam covered with Sculptamold and plaster, and is painted earth brown with interior latex paint. The basic earth texture is real dirt dried and sifted through a tea strainer, with rocks cast in RTV rubber molds made from local rocks. Grass is Noch, applied with their Grass-Master tool, and I use Silfor grass mats from Scenic Express.



1. The gas station at West Summit is an SS Limited kit. The signal heads are from Sunrise Enterprises and the signal box is Details West. The cantilever is an NJ International model modified to match BN style with signal heads from Sunrise Enterprises. The lead locomotives are an ex-Great Northern EMD F45 and an ex-Burlington GE U25C, both Overland Model Imports brass diesels custom painted, with snowplows, horns, and working strobe lights from Details West.

There's a scratchbuilt farm with hog pens, and a livestock loading chute like the ones that were common in the area. Central Valley offers a kit to build the Northern Pacific's stock cars that were used frequently for hog transport.

Staging yard tracks fill a second deck about 12 inches below the visible deck. Trains enter the East staging yard just above the dispatcher's panel at A with a two-revolution helix bringing the track down to staging.

Tim Dickinson's 20 x 40-foot Burlington Northern Northern Layout

Only the upper deck is shown. The lower deck houses staging tracks. The layout is designed as a point-to-loop system. Trains run from the stub-ended West staging yard 12 inches below Fruitvale, up a helix around the dispatcher's panel area to Elliott Yard, and around the visible portion the layout to disappear into the East

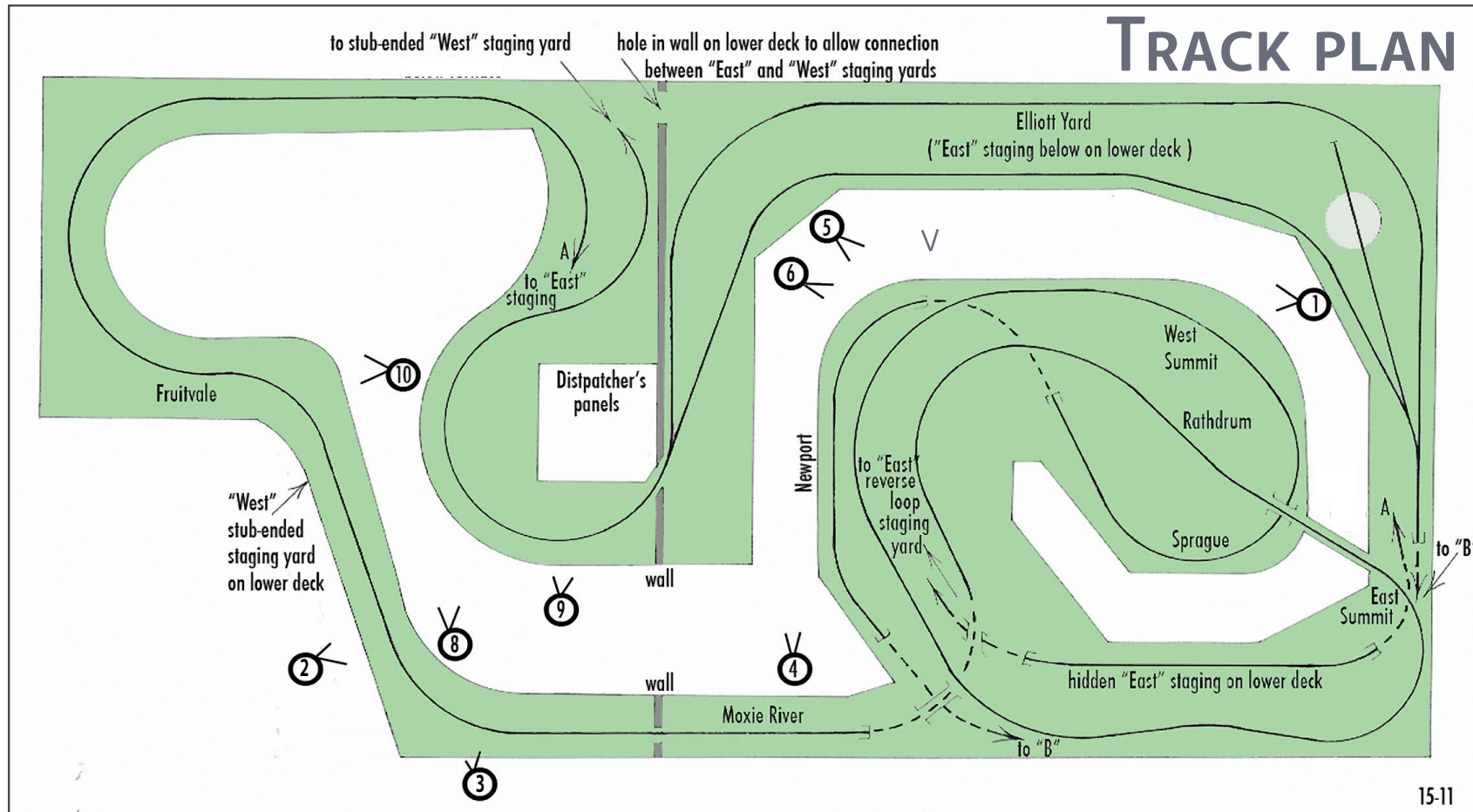

staging just beyond Fruitvale. They then travel around the massive staging track area hidden on the lower deck to a hidden reverse loop below West Summit.

Notes on the track diagram

The layout drawing is a single-line schematic diagram showing the route of each mainline, with no double track or other parallel tracks or sidings shown. If two railroads run side-by-side, those two tracks are shown. The track plan does not illustrate minor tunnels or bridges or any other scenic details.

The thick lines are track center lines; the thin lines are the exterior walls and the inner edges of benchwork. The circled numbers indicate where the photographs were taken. The individual capital letters in pairs identify where the track disappears and reappears, sometimes on another deck.

The thick lines are track center lines; the thin lines are the exterior walls and the inner edges of benchwork. The circled numbers indicate where the photographs were taken. The individual capital letters in pairs identify where the track disappears and reappears, sometimes on another deck.



2a. (Above) The view from the layout room entry with the track curving left to Fruitvale, and the dispatcher panels just visible at far right (2008).

2b. (Right) Same location in 2016.

A six-track yard extends clockwise around the larger layout room to “A” near East Summit and then enters a reverse loop below West Summit on the peninsula. The West staging yard is much shorter and is reached through the S-curves around the dispatcher’s panel to run around the walls of the smaller room to an eight-track stub-end yard beneath Fruitvale. ☑

Continued on the following pages ...





3a. (Above) Looking into the second layout room, the tracks at the west end of Elliott yard are on the far left, The mainline heading beneath the mountains to Rathdrum is on the far right (2008).

3b. (Right) Same location in 2016.





4a. (Above) The throat of Elliott Yard is on the far left, with a portion of the eastern hidden staging yard on the lower deck. Elliott Yard is in the upper center (2008).

4b. (Right) Same location in 2016.





5a. (Above) Elliott Yard is on the left, with the tracks leading across the flanks of mountains to West Summit on the right (2008).

5b. (Right) Same location in 2016.



BURLINGTON NORTHERN | 15



6a-7a. (Uppers) A panorama of the central portion of the layout, looking over the mountain range to East Summit in the upper left (2008).



BURLINGTON NORTHERN | 16



6b-7b. (Lowers) Same locations in 2016.





8. (Above) The late Leo Munson scratchbuilt the deck girder bridge, based on a prototype on the Southern Pacific near Mojave, CA. The crossbuck and signal box are Details West and the telephone poles are Rix.

9. (Right) The dispatcher uses the Centralized Traffic Control (CTC) panels to control the turnouts and signals on the entire mainline.

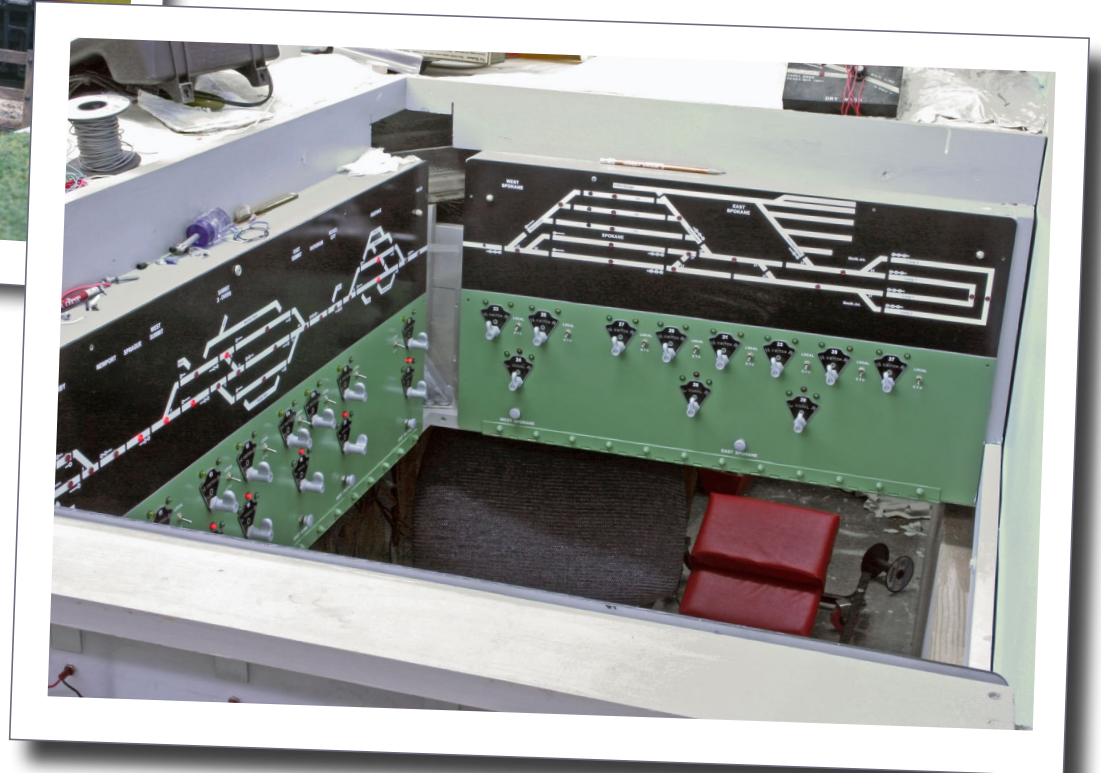



10. The grain elevator at Fruitvale is scratchbuilt from PVC pipe and styrene sheet. The grain train is headed by an Overland Imports brass Alco C425 (ex-SP&S), a Kato EMD GP35 (ex-CB&Q), and an Oriental Imports brass EMD GP30.

.....
Today, the simplest path to getting the most satisfaction from the hobby is to recreate a specific prototype railroad – modeling from the prototype, as opposed to creating fictitious railroads and places. Proto 2000, Spectrum, Genesis, Atlas and all have made it possible to accurately model a specific time and place, so that really is an easier and quicker path to creating a realistic model railroad than laboring to create a whole new world for a “random” model railroad. ■
.....



TRAINMASTERS.TV

WHAT'S NEW!

2016 National Train Show REVIEW

(Two episodes)

Summer special-Join now and get free bonus months!



click for more

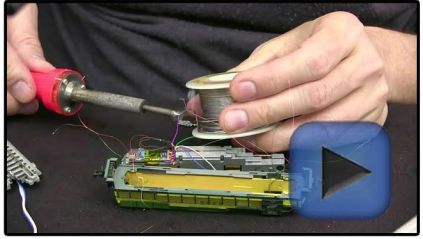

DCC decoder installs: HO & N



Airbrushing 101 and 102

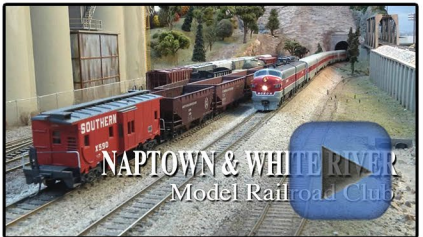

Naptown model railroad club



Making trees

Non-members: Watch each episode for \$1.49 each

Over 400 network tv quality videos on model railroading topics

QUESTIONS TO ASK

1. Why select this particular railroad?

A vacation in 1976 took me from southern California into the upper Midwest and I discovered the Burlington Northern Railroad. The unit coal train operations and solid trainloads of grain were the kind of railroading I wanted to recreate..

2. Why this region of the prototype?

The layout is based on the BN's operations in northwest Washington with one staging yard representing Seattle and the other Spokane. Original employee timetables were used to locate the towns along the line.

3. What era to model?

On the 1976 vacation, I followed the Burlington Northern east from Alliance, NE to Council Bluffs, IA. The pre-merger paint schemes were still visible with a rainbow of locomotive and caboose paint schemes. I was also fascinated by covered hoppers, particularly the 4750 cu. ft. capacity cars that came into service about 1973. During this period the BN was a funnel for grain shipments from the upper Midwest to the Pacific coast. I can also operate of some of my favorite diesels, including Alco RS-11s and EMD F-units.

4. Which freight and passenger operations to recreate?

Freight trains all operate as extras. Only the East yard (Spokane) has a reverse loop but trains can run through a connecting track between the two staging yards to reverse the train from east to west . The connecting track is also used to correct any imbalance between eastbound and westbound trains and for continuous operation of unit trains. Most trains have a four-unit set of diesels

and from 36 to 45 cars. I have created an employee timetable with useful layout information and basic operating rules. It is based on real BN timetables from the era and locale. The early Amtrak passenger trains run with the rainbow of different railroad equipment that it inherited.

The CTC dispatcher's area is inside the S-curve across from Fruitvale. The panels are Plexiglas boards with plates and levers from Rix Products. The circuitry for the system is from Logic Rail Technologies, and additional electronics by friend Barry Draper. The dispatcher activates toggle switches to throw the turnouts and light up the signals. Each turnout and signal has a Details West replica of the boxes that control them on the prototype. Signals are from Details West, BLMA Models and Sunrise Enterprises.

The rails are electrically insulated to divide the layout into about a dozen detection blocks allowing the signals to operate. They are actuated by the current that flows through the rails. The trains are all operated with DCC so engineers control the trains and the dispatcher controls the switches and signals.

The NCE hand-held throttles have a red emergency panic button, just like the real ones. If you push the "emergency stop" once it stops your train. Push it two times and it shuts down the entire system (which of course does not happen on a real railroad). Currently the layout operates with ten engineers, two yardmasters and one CTC train dispatcher. The engineers use two-way radios from Best Buy to communicate with the dispatcher. The entire operating system is designed to replicate what occurs on my day job as a Union Pacific locomotive engineer.

5. What were the most important design criteria?

To recreate the Burlington Northern's operations in 1976 as realistically as possible, we wanted enough aisle space for easy access to

QUESTIONS TO ASK CONTINUED...

all parts of the layout. The engineers walk around with trains using the hand-held controllers so it is important that they have enough aisle space to avoid crowding.

6. What are the defining structures?

The Great Northern and Northern Pacific railroads had distinct station styles and kits to build them are available from American Model Builders. Their Great Northern station is a copy of the one at Summit.

7. What are the signature scenes?

The foothills of the Cascade mountains in Washington state are a major challenge to the Burlington Northern in moving traffic east to west.

8. The locomotive roster?

Many of the locomotives are upgraded and superdetailed brass imports custom painted and lettered. Lots of great ready-to-run plastic models with additional super detailing added complete the locomotive roster. Nearly all of the diesels are exact matches for color schemes and numbers of units that operated in 1976 in the area.

9. How did I decide on the mix of cars in the freight car fleet?

The significant freight operations are defined by the time period and include the "Pacific Zip" intermodal trains, several solid trains of grain cars, and lumber traffic on bulkhead and flat cars (with removable lumber loads), and box cars of finished lumber. There also a number of insulated box cars to serve on-line industries that ship canned goods and frozen foods from Eastern Washington.

10. What research sources are most useful?

The internet, books and videos of the Burlington Northern are my primary research source supplemented with personal visits to the area I'm modeling. ■



ADVERTISEMENT

Great control in a tiny package



Original Touch Toggles

- Touch Toggle™ plug in controls
- Bright clear indication
- Easy setup
- Flexible system

Stall Motors, Twin-coils, Power, and Servos

Now for Tam Valley Depot and MRservo too!

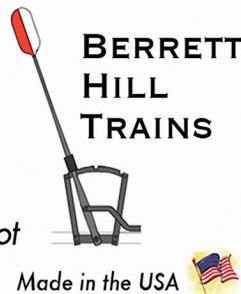

What will they think of next?

www.berretthillshop.com

YOUR RESOURCE GUIDE TO AN ACCURATE BURLINGTON NORTHERN MODEL RAILROAD

Books on the Burlington Northern:

- MBI Publishing, motorbooks.com
■ Four Ways West Publications, fourwayswest.com
■ Morning Sun Books, morningsunbooks.com
■ Burlington Northern Motive Power Annuals from the 1970s (out of print)

Videos on the Burlington Northern:

- Green Frog Productions, greenfrog.com
■ Pentrex, pentrex.com
■ Charles Smiley Presents (see MBI Publishing, motorbooks.com)
■ WB Video, railfanvideo.com.
■ Tim's Video, youtube.com/watch?v= 0pKOPngzgM&feature=youtu.be

Burlington Northern photo websites:

- Burlington Northern Railroad Photo Archive, trainpix.com
■ Fallen Flags photographs, rr-fallenflags.org
■ RR Picture Archives, rrpicturearchives.net
■ The NERAIL North American Railroad Photo Archive, naphotos.nerail.org
■ Burlington Historical Society, burlingtonroute.com

TIM DICKINSON



Tim Dickinson will be retiring from Union Pacific in 2017 with 40 years of railroad service in various capacities.

Tim started with a Lionel starter set as a young child. His first HO set came at age five. It's been HO scale ever since. As a teenager, Tim was interested in modeling the SP, but quickly changed to the Burlington Northern.

Tim's passion centers around prototype operations, including train operations, and acquiring and recreating time-period specific accuracy with his locos and rolling stock.

ROBERT SCHLEICHER

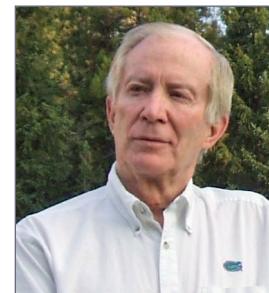

Robert Schleicher was editor of Railmodel Journal for 19 years and, prior to that, editor of Model Railroading magazine. He has also authored over a dozen model railroad books including the TYCO MODEL RAILROAD MANUAL, Bachmann's E-Z Track Book, THE BIG BOOK OF MODEL RAILROAD TRACK PLANS and three books for Lionel. Bob has

been a consultant to several manufacturers and helped to kick-start the Railroad Prototype Modelers concept. He is modeling the standard gauge Colorado & Southern in northern Colorado circa 1959 in HO scale.

iwata

by ANEST IWATA

Be Realistic

From weathering broad areas to painting concentrated details, an Iwata airbrush gives you precision and reliable performance for a natural, smooth finish.



Iwata Eclipse CS

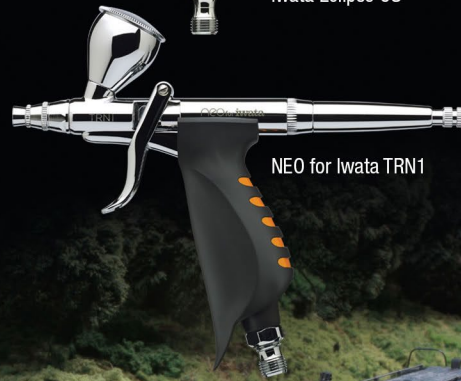

NEO for Iwata TRN1



iwata
MEDEA
ANEST IWATA-MEDEA Inc



Locomotive from Alan Houtz, North American Prototype Modelers

Click to see the entire line of Iwata Airbrush and Artool Products



Model Railroad Hobbyist | August 2016 | #78

YES, IT'S A MODEL

compiled by
DON HANLEY
.....



Click here for
reader comments



1. While waiting for the train to approach, Eric Barney took this photo of the DRG&W's narrow gauge Chili line bridge over the Chama River as it joins the Rio Grande in northern New Mexico.

Eric modeled the scene using 1" blue foam over a plywood base. The foam was used to simulate the river and then sealed with a thick coat of gloss polyurethane. Small rocks and paver sand were used to create the sand bars and river banks, with static grass and other materials added for vegetation.

► MRH'S MONTHLY PHOTO ALBUM

YES, IT'S A MODEL | 2



2. The crew of ONR 1732 is busy switching the siding at Maple Leaf Trading Co in Moose River Ontario. As soon as they finish, they will take a quick break for beans and then head up the line to their next pickup.

Steve Juranics took the photo outside on his diorama and used Helicon Focus to get all of the elements in focus. The locomotive is an Intermountain SD40 that he detailed and weathered, along with the Athearn GATX hopper that began as an undecorated kit.

YES, IT'S A MODEL | 3



3. A Milwaukee Road Fairbanks-Morse H10-44 switches the Schlitz grain elevator on the road's "Beer Line."

John Dick built the grain elevator from scratch using a foam-core base that was covered with .040" styrene, with numerous scratchbuilt and commercial detail parts added. John's layout was a stop on this year's NMRA bus tour in Indy.

💰 GET PAID FOR YOUR PHOTO

We pay \$40 per photo we publish. If you'd like to get your modeling in our photo feature, just start posting your photos on the MRH website, especially in the Weekly Photo Fun thread created each weekend.

See mrhmag.com/help for more on how to post an image. You need to be an MRH subscriber to post photos to our website, and becoming a subscriber is free, [just fill out this form here](#). ■



4. East Deerfield, Massachusetts has always been a favorite destination of railfans across New England, but during the 1980s it became a cornucopia of color when Delaware and Hudson along with Maine Central motive power began run-through operations in the early days of Guilford. Custom-detailed Atlas U33C

number 758 rests at the steam-era sand towers after bringing in a freight from Mechanicsville, NY. Meanwhile a former Reading GP 39-2 adds a splash of color at the terminal.

Neil Schofield modeled the scene and took the photos.

YES, IT'S A MODEL | 6



5. Finally something a little different. Yes it is a model, but it's 1/3 scale live steam. The Swanton Pacific Railroad was born out the Panama-Pacific International Exposition of 1915 in San Francisco, CA. In 1914 Louis MacDermot built the 19" gauge railway for the fair as an attraction to transport the visiting public around the fair grounds.

Enjoy the video trainfanatics.com/big-boy-replica-train-steam-like-real-thing.



**Click here for
reader comments**

**A CLASSIC NARROW GAUGE CONVENTION
IN A VERY SPECIAL PLACE**

VISIT MAINE IN 2016

AUGUSTA, MAINE — SEPTEMBER 7-10, 2016

- 4 MUSEUMS OPERATING 2-FOOT STEAM
- OVER 15 MODULAR & DISPLAY LAYOUTS
- DOZENS OF CLINICS
- CONTESTS
- VENDORS
- LAYOUT TOURS

\$115 INCLUDES SPOUSE
REGISTER ONLINE OR BY MAIL



SCENERY, SHOPPING, LOBSTER, AND MORE - A VACATION FOR THE WHOLE FAMILY

VISIT WWW.NNGC2016.ORG FOR FULL DETAILS

PO BOX 1406 – GRAY, ME – 04039 – INFO@NNGC2016.ORG
CO-SPONSORED BY SEACOAST DIVISION, NER, NMRA

REALISTIC LOOKING COAL HOPPERS MADE EASY



BY MIKE HOLLY

Make convincing coal loads that you can remove ...

WHAT IS YOUR PREFERENCE? THIS QUESTION generally is asked when it comes to the appearance and appeal of rolling stock. With a closed car like a boxcar or tank car, you are almost done, convincing your operators that “the car is loaded” by pulling out a waybill showing some kind of lading for this car. However, looking at an empty hopper marked as “pull loads from coal tipple” seems somewhat strange, at least for me. So I need coal loads – removable coal loads, because my N Scale hoppers are viewed both loaded and unloaded.

Model Railroad Hobbyist | August 2016 | #78

Preparations



[Click here for
reader comments](#)

I don't like spending time trimming foamcore boards to look like piles of coal. Instead I use piles of real coal, blended down to a size to match the overall dimension of egg-sized coal (approximately 3" in diameter) in 1/160 scale. With a household coffee grinder and some analytic sieves, I got the size coal I was after.

If you don't have the equipment at hand, you can try some kitchen sieves or buy scale coal loads from various distributors. If you are going to crush the coal at your home, work outside and wear some protective gloves, glasses, and dust mask.

Layout tours – Trackwork – Structures – New
Plann...
– Humor – Contributor Opinions – News
DCC...
Ballast – Multi-deck designs – Small layouts
ering – First looks – Rolling stock
guidelines – Clickable ads links – Video – Operat...
Prototype modeling – Lighting – MRH forum – In...
active reader feedback – Questions Answered
– Upcoming events – Freight liners – Build...
signs – Model...
Scenery...
tuning – The Tool Shed – Layout owner interv...

Model Railroad Hobbyist magazine™

YES, subscribing MATTERS!
(even though it's free)

**It helps MRH get more
advertisers**

[Click here to subscribe!](#)

STEP 1: MAKING THE COAL



1. I began with a lump of coal and broke it into small chunks, then ground the chunks into fine coal sand with an ordinary household coffee grinder.



2. To sift out the right size I used several fine analytic sieves. For my coal loads, I went with a size of 0.4 – 0.6 mm but kept the finer coal and set it aside.

STEP 2: MAKING THE INSERTS

To get a sturdy base for the coal loads, I cut a 4mm (5/32") sheet of plywood into strips matching the openings of the various hopper types.

Since I am modeling some smaller coal tipples on my layout, I wanted the loads to resemble those typical of smaller batch loaders. Browsing the internet, I found several photos showing the look of different loading types. A hopper loaded with a flood loader looks different than a hopper loaded from a truck dump.

I used a funnel to apply the coal on top of the inserts. For easy removal and additional weight of the loaded hoppers, I add some hex nuts underneath the inserts.



3-4. I cut strips of the plywood to fit into the opening of a hopper, such as this two-bay 55-ton hopper. The piece of plywood needs not to fit in tightly – a little gap around the edges makes removing the load easier .

STEP 2: MAKING THE INSERTS *CONTINUED...*



5. (Above) To hide the color of the plywood pieces, I painted the top side and edges of the inserts flat black, using straight acrylic paint.
6. (Right) After the paint dried, I applied thinned white glue to the insert. I used a ratio of 1 part white glue and 1 part water and some drops of 70% isopropyl alcohol to reduce the surface tension of the mix. While the glue was still wet, I sprinkled fine sifted coal on the insert. This creates teeth for the coarse coal to lock into. I turned the plywood pieces upside down to remove excess coal, using a plastic container to capture it and reduce material loss.



**TrainMasters TV is part of
the MRH product family.**

TMTV members not only get great network TV level videos, they help pay for MRH and keep it free ...



**Click here for
reader comments**

STEP 2: MAKING THE INSERTS *CONTINUED...*

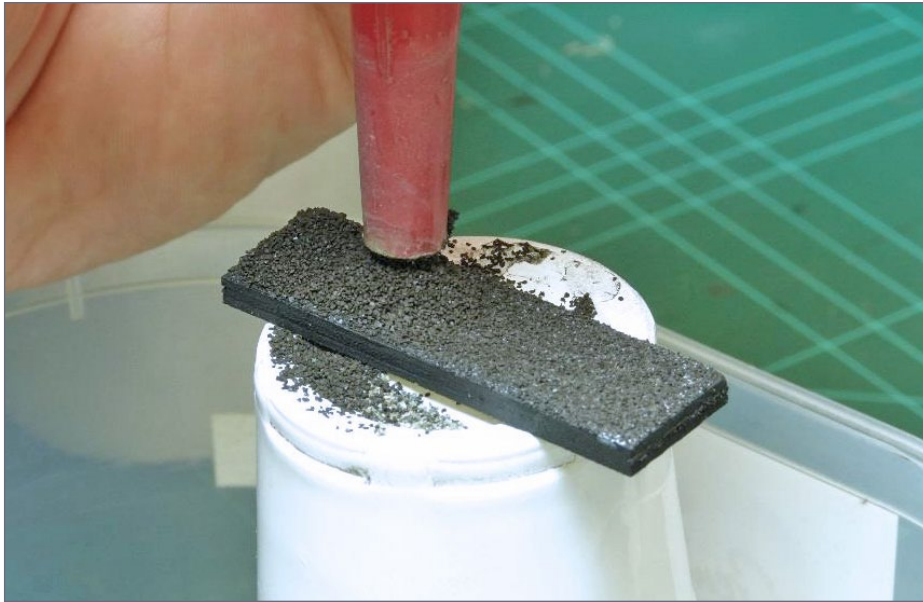

7. Next I applied several piles of coarse coal on top of the plywood, using a funnel. I added only a teaspoon of coal at a time to create the piles.



[Click here for reader comments](#)

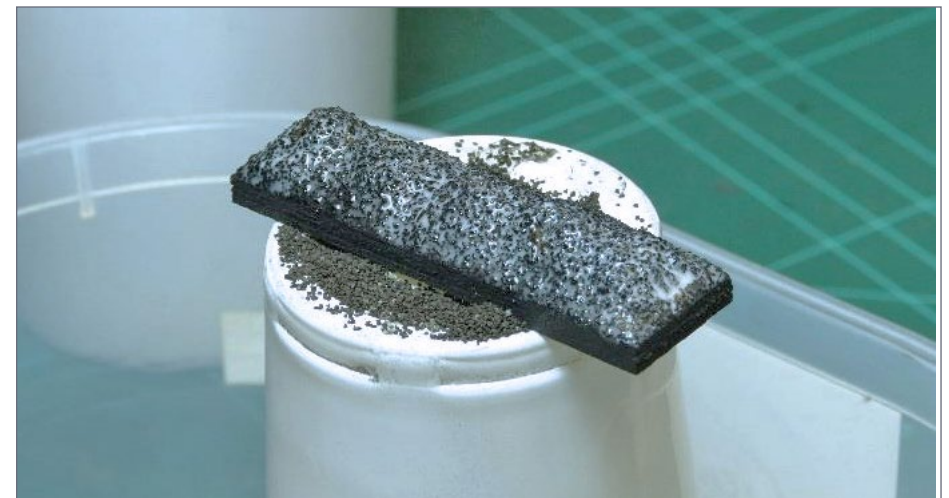

8-9. With the piles in place, I applied some drops of diluted water. I used a mix of 7 parts distilled water mixed with 3 parts 70% isopropyl alcohol, followed by a 50:50 ratio of white glue and water, with some drops of 70% isopropyl alcohol to kill the surface tension. With all the white glue soaked in, I let the coal load dry for at least 24 hours.

STEP 2: MAKING THE INSERTS *CONTINUED...*



10. After the glue dried, I test-fit the coal load into several different hopper cars of the same type. When needed, I used a wood file to adjust the width and length of the insert. I beveled the edges of the insert and cut notches into the base where needed. The notches are needed only where braces inside the hopper interfere with the insert.

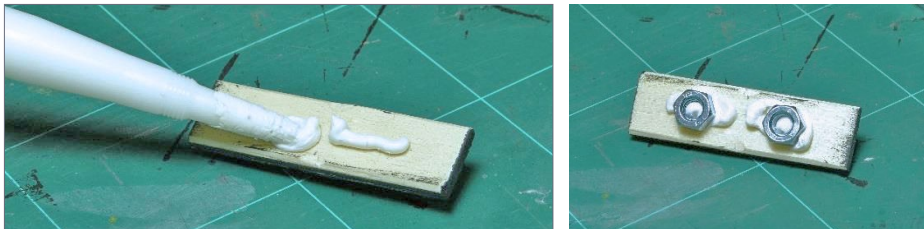

11-12. I used multi-purpose glue to affix additional hex nuts to the bottom of the insert. This increased weight improves handling of the loaded hopper.

STEP 3: EASY WEATHERING

One can invest a lot of time weathering individual coal hoppers get a realistic appearance. I try to do this as well as possible, but also without spending too much time.

To start, first disassemble the hopper, removing the trucks and wheels from the body. I use stock acrylic artist paint and mix my needed colors, in this case two colors, rust and dark gray. For the rust color, I mix equal parts of brown with ochre, and add two to three drops red and black. For the dark gray color, I mix two drops of black with white until I get the tone I am after.

All colors are thinned to a watery consistence by adding straight 70% alcohol. Final touches are applied with powdered pastel chalks.



13. I start with over-spraying the plastic wheels with several layers of rust. To get the color layers instantly dry, I blow air from the airbrush straight onto the wheels.

The wheel clamp is made of a cardboard strip, folded in half. With scissors, I cut triangles in to hold the axles.

STEP 3: EASY WEATHERING *CONTINUED...*

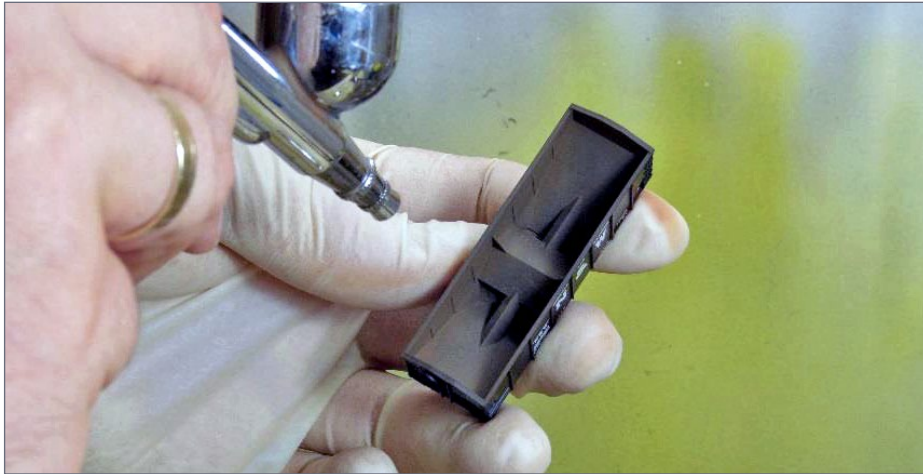

14. With the rust color loaded to the airbrush, I apply several alternating layers to the inside of the hopper. A uniform paint job looks unnatural.



16. With all parts airbrushed I reassemble the trucks. They are also airbrushed with dark gray paint. The overall lighter colors will be toned-down with powders in the next step.

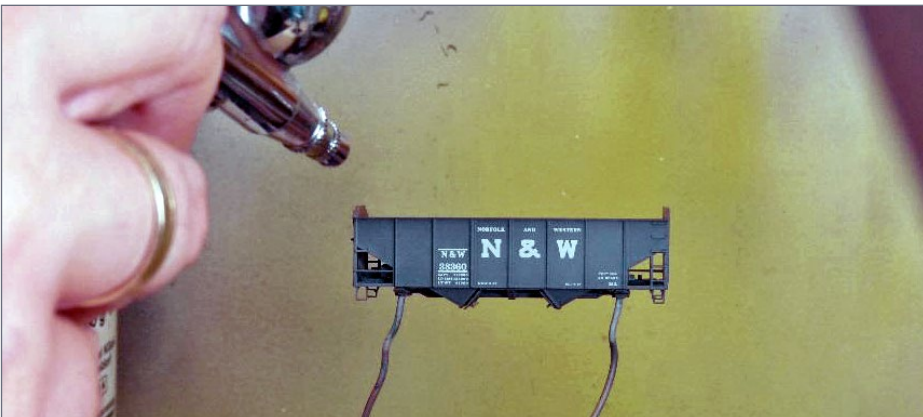

15. On the outside of the hopper I apply the gray tone until it starts to fade the white lettering. On brown hoppers, I use a light brown instead of gray.

**Want to help keep
MRH free?
Then *click on ads!***

STEP 3: EASY WEATHERING *CONTINUED...*

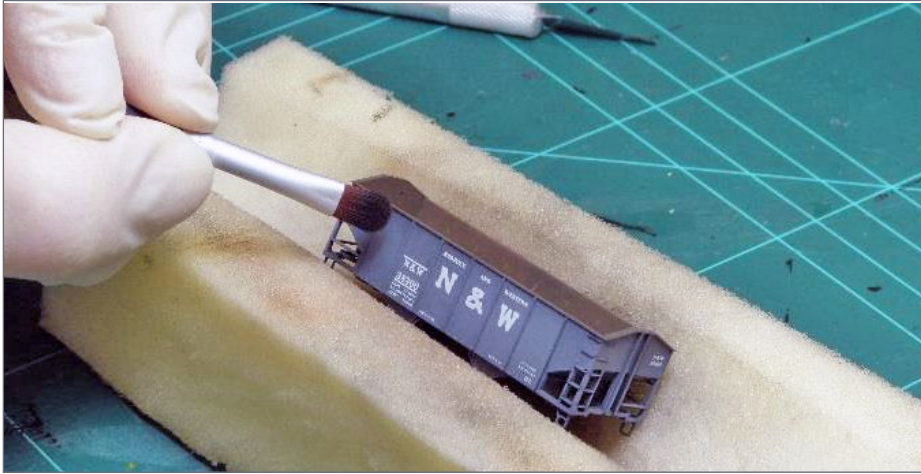

17-18. After leaving the hopper to dry for a few minutes, I start applying black powdered chalk with a soft makeup brush, starting at the top of the hopper and moving the brush straight down to the bottom.

I add more layers of powdered chalk to the hopper body. For some rust effects, I brush on a light layer of dark brown chalk.

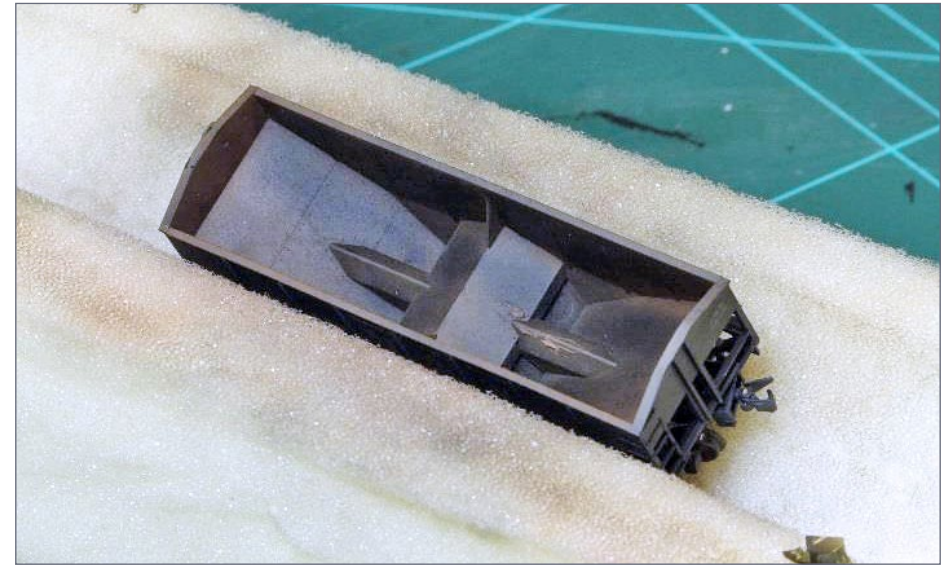

19. With outer body finished, I apply black powders on the inside of the hopper, trying to get the overall look of coal residue on the sides. For a stronger rust effect, I also apply dark brown chalks.



20. With all weathering done, I spray the empty hopper with clear flat finish to fix the powders.

STEP 4: A WORD ON WEIGHTING

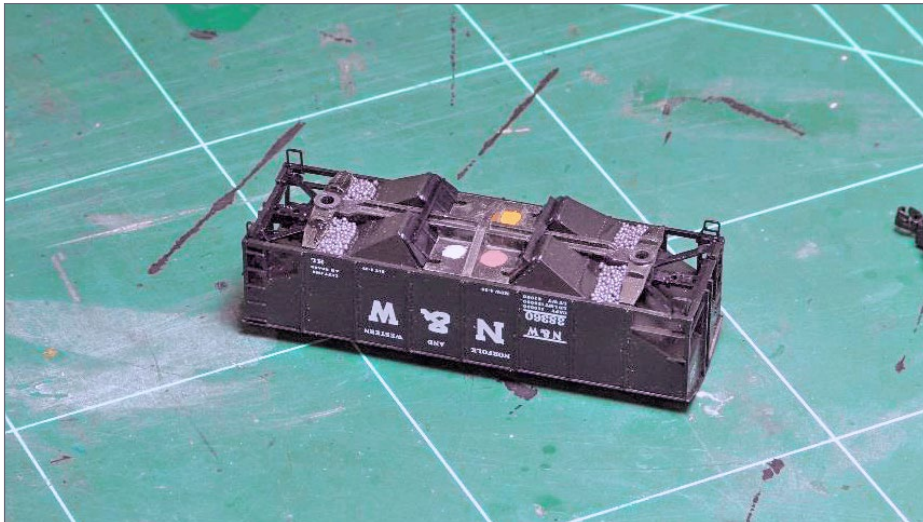

21. I try to match all cars to nearly the same weight per car length. The NMRA recommendations give a good starting point with RP 20-1. However, I took it a little farther and began to weight my cars as many modelers do.

 [Click here for reader comments](#)

Performing load tests on the practical side of what is possible, I settled with 4.3 grams per centimeter or .15 oz per 0.4 inches of car length. This is only an approximation, and can easily be achieved for closed rolling stock like boxcars or tank cars. However, this limit is hard to achieve on hoppers, so I tried to fill every spot on each car's bottom with fine lead sand. The previously described hex nuts glued to the bottom side of the coal inserts help raise the original weight of 10 grams (3.5 oz) up to 24 grams (.85 oz) for this 55-ton hopper shown. With the 24 grams, the over-weighted hopper performs a lot better than its out-of-the box sister. ☑

ADVERTISEMENT

END OF TRAIN DEVICE

NEW ORANGE CASE!

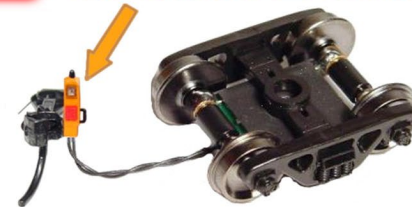

Patented Technology - US Patent 7,549,609

Bright Red Flashing Light!

Installs in minutes!
No freight car modification required!

RE RING ENGINEERING

Click Here to Learn More

Does not affect Load!

↓ Car without Load ↓



↓ Car with Load ↓



MIKE HOLLY

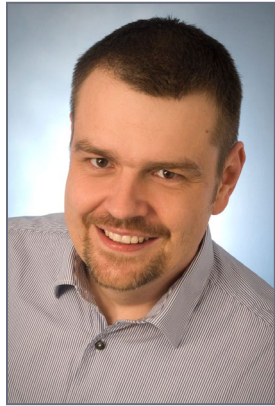

Mike received his first train set at the age of 10 and started two German-themed layouts. After visiting a local U.S. model railroad convention a couple of years ago Mike was infected by the U.S. model railroad virus.

While planing their house near Wiesbadn, German, Mike convinced his wife to add a dedicated room in the basement for a model railroad. After moving in, he began the planning process for current U.S.-themed

proto-freelanced “Elizabeth Oaks Branch Line” operated by the fictional Cleveland & Eastern Railroad Company set in northeast Ohio and Pennsylvania. Construction of the layout started in 2011. Today Mike is planning to extend the layout to add more operation spots.

Mike has a Bachelor of Engineering degree in (road design and construction.) In 2015 he joined the National Model Railroad Association (NMRA) – European Region, and was awarded with the Golden Spike Award in November 2015.

Mike and his wife Nicole have a four-year-old daughter who loves railfanning. ■

 [Click here for reader comments](#)



Trainfest®

NEW 2 DAY TICKETS
AVAILABLE JULY 1 THROUGH NOV. 11

AMERICA'S LARGEST OPERATING MODEL RAILROAD SHOW

Saturday & Sunday
Nov. 12 - 13, 2016

9:00am-5:00pm

WI State Fair Park
Milwaukee (West Allis), WI

Ticket discounts and show details at **Trainfest.com**

EXPANDED TRAINFEST CLINICS

Join us for **2 full days** of clinics presented by expert modelers and model railroading manufacturers. Choose from a wide range of modeling topics at any of our **56 total clinics!** Space is limited, register for clinics today at www.Trainfest.com.

FREE

60 MODEL RAILROADING MANUFACTURERS

Come to see all major model railroading manufacturers at Trainfest and many cottage industry businesses offering unique and interesting products for your layout. Don't miss any of the exciting announcements scheduled to be unveiled at Trainfest!

NEW PRODUCT ANNOUNCEMENTS

OPERATE THE TRAINS!

70 OPERATING LAYOUTS

Make Trainfest your annual destination to meet with other modelers and find inspiration for your own layout at more than **70 operating model railroads.** Experience the camaraderie of the model railroading hobby and even **operate the trains** on participating layouts!

CELEBRATE A RAILROAD

THE MILWAUKEE ROAD

CELEBRATING THE MILWAUKEE ROAD

In 2016 Trainfest will partner with the Milwaukee Road Historical Association to celebrate the Milwaukee Road. Look for the Milwaukee Road throughout the show and don't miss the museum quality historical photo display, Celebrate-a-Railroad clinic series, and much more!

FREE RIDE THE MLES TRAIN!

Sponsored by the Wisconsin Southeastern Division, Inc. of the National Model Railroad Association

One Module Challenge

Third place winner



BY SHAWN BECHER

Stocktown on the Ferryville & Eastern – an early 1900s modular plan ...

WHEN I FIRST SAW THE ANNOUNCEMENT FOR the One Module Contest, I thought to myself, “That’s a really neat idea, but I’m not going to enter. I’m working six days a week, and I have a kitchen/bathroom remodel to finish. I don’t have time to put anything else on my plate.”

It’s funny how things change. Going to TrainFest in Milwaukee really got me wanting to start planning a layout. I haven’t had one for about 10 years. The weekend after TrainFest, the local bunch had our 2nd Annual National Model Railroad Appreciation Month Open House on the Milwaukee North



**Click here for
reader comments**

Western at the Oconomowoc Historical Society Museum ([facebook.com/milwaukeenorthernwestern](https://www.facebook.com/milwaukeenorthernwestern)).

After our open house, I acquired and read two books, “Compact Layout Design” by Iain Rice, and the second edition of “Model Railroading in Small Spaces” by Mat Chibbaro. Combining the knowledge I gleaned from those two works, and adding that to all the reading I’ve done in *Model Railroad Hobbyist* and *Model Railroader* about LDEs (layout design elements), I started planning a module that I could start on and operate now, and incorporate into my layout when I finally have the space to build it.

I worked on the design during my lunch hours. Then it hit me, as I was reading the next issue of MRH. I re-read the design criteria, and realized I could modify my existing plan a little and use that as my contest submission.

History of Stocktown

Welcome to Stocktown, established just one year ago, in 1901. It is a couple miles inland of the Mississippi River, through the woods and around the hills. The only way to get here with heavy freight is by rail and when the weather turns bad, the railroad is the only way in and out of town. Why here? Well, the timber is plentiful, and the soil is rich. We have lots of farming in and around the bluffs, with plenty of natural resources to support their operations. The farmers barter their excess timber from the land they are clearing with the railroad for transportation of goods and livestock. The railroad is using

ONE MODULE CHALLENGE | 3

the timber for ties and trestles as it expands eastward towards Lone Rock, where they want to connect with the Chicago, Milwaukee, St. Paul, & Pacific.

Right now the railroad follows the Stocktown Creek up from Ferryville on the Mississippi River. It continues a few miles east of town, where construction continues. The Ferryville & Eastern Rail Road (the FERR line) has a small engine service facility here with a stub track, coal tower, and a water tower – the essentials for the end of the line town, unless you're involved in the construction. They set up a quaint little depot on the east side of town.

The FERR line also set up a general store, and was a big help in getting the post office, the bank, and Buck's Grain & Feed, established. Of course the construction workers all needed a place to stay, and a place to blow off steam, so there is the Stocktown Saloon and Inn in the middle of town. Then there is the livestock pen and ramp next to Buck's, and the timber loading winch, at the east end of town.

It's a nice little town, which continues to grow with more farmers wanting a piece of land, and from the growing construction crew as the railroad builds eastward. You could come visit, but you'd have to find a farmer to take you in since the construction workers have the Inn overbooked for the foreseeable future [1].

The FERR line has one locomotive right now – a 4-4-0 and it calls Stocktown home for now. The crew grabs what cars need to be pulled from town in the morning and any passengers headed west, and head down to Ferryville where they meet the Chicago, Burlington, and Quincy trains. Then they head back up to Stocktown, tender first, and drop the passenger coach at the depot. They set out cars from the CB&Q in town, and then head east to drop off construction supplies and personnel. Then the crew heads back to Stocktown and ties down on the service

ONE MODULE CHALLENGE | 4



1. SCARM 3D layout view.

track. On weekends, the FERR line runs a second train, consisting of only the passenger coach, down to Ferryville and back for folks heading into or out of town for the weekend.

Now that you know the history

Even when I do have a room to build my model railroad empire in, it won't be very big. I'll be taking the second smallest bedroom in our house, once the kids are grown up and out on their own. I'll have an almost unobstructed 8' by 12' space. I'm going to have tighter curves and steeper grade than would make sense for a modern railroad.

The books I mentioned talked about how running shorter trains will make your layout seem larger. The further back you go in time, the shorter the trains were. Couple that with the fact that my family loves horses – I wanted to find some way to feature them on the layout, and it seemed like a no-brainer. Go back in time to when there weren't really any automobiles. Now we suddenly have lots of horses, short trains, shorter rolling stock, tighter curves, and steeper grades. It just fits, both figuratively and literally!

ONE MODULE CHALLENGE | 5

Since I am incredibly limited on space, my starting module can't be too big. However, it has to be big enough to support stand-alone operations. It also has to be easily movable and storable since it will be stored somewhere safe, away from the cats who seem to think any platform is theirs to perch upon. To make it light enough to be easily portable, I will be using the modified L girder design illustrated in Rice's Compact Layout Design.

The design uses the L girders made with 1x2-inch boards, adding end caps to the L girders for added strength and rigidity. I wanted to design simple legs to fold up under the module, but with only 1 ¾" of height available inside the frame, I figured I would wind up with wobbly chicken legs. Instead, there will be pockets in each corner of the framework for a set of legs to slide into. I will use carriage bolts, washers, and nuts to connect this section with other modules.

When looking for pricing and availability of lumber and hardware for the benchwork, I turned to my favorite home improvement store, Menards. The following pine boards are necessary for construction of the frame:

- 4 - 5' x 1" x 2" for the L girders
- 6 - 18" x 1" x 2" for the cross members
- 3 - 16 ½" x 1" x 2" for the end caps and a center support under the L girders
- 4 - 16 ½" x 1" x 2" for braces between the legs
- 4 - 42" x 2" x 2" for legs

This can be accomplished by purchasing 2 10', a 12', and a 6' 1" x 2", and 2 8' 2" x 2". I will also need:

- 1 - 2' x 4' x ½" Homasote for roadbed
- 1 - 4' x 8' x ½" foam insulation board for scenery base
- 1 - 4' x 8' x 1/8" Masonite for backdrop and fascia (will have leftovers)

ONE MODULE CHALLENGE | 6

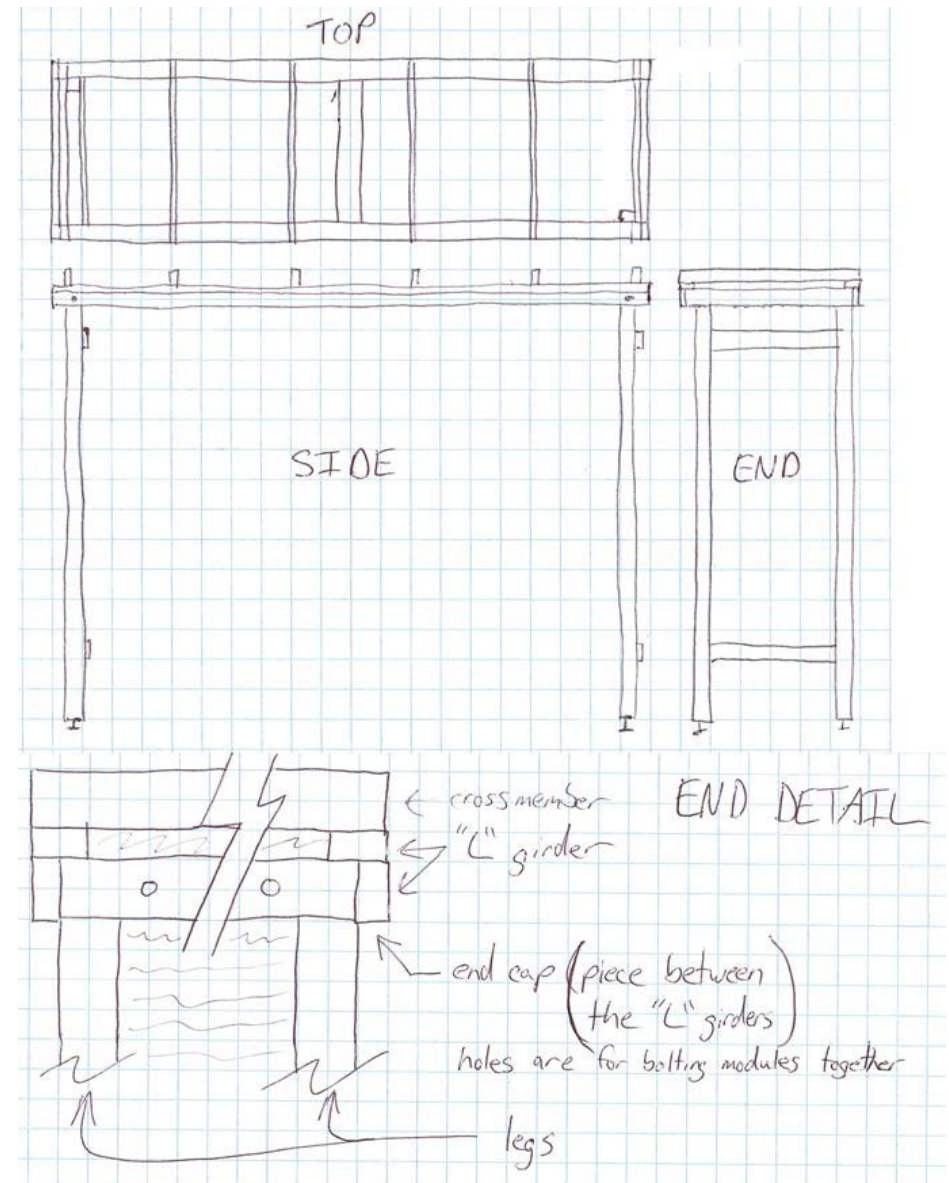

2. Benchwork drawings.

ONE MODULE CHALLENGE | 7

- 32 oz. wood glue
- 1 lb. 1 ¼” multi screws
- 1 package of tee nuts for putting adjustable feet on legs
- 1 package of 3/8” x 4” carriage bolts for adjustable feet (left-overs could be used to further secure legs to framework)

My total build price from Menards comes to \$66.69. Not bad, but then again, benchwork always seems to be the cheapest part of model railroading.

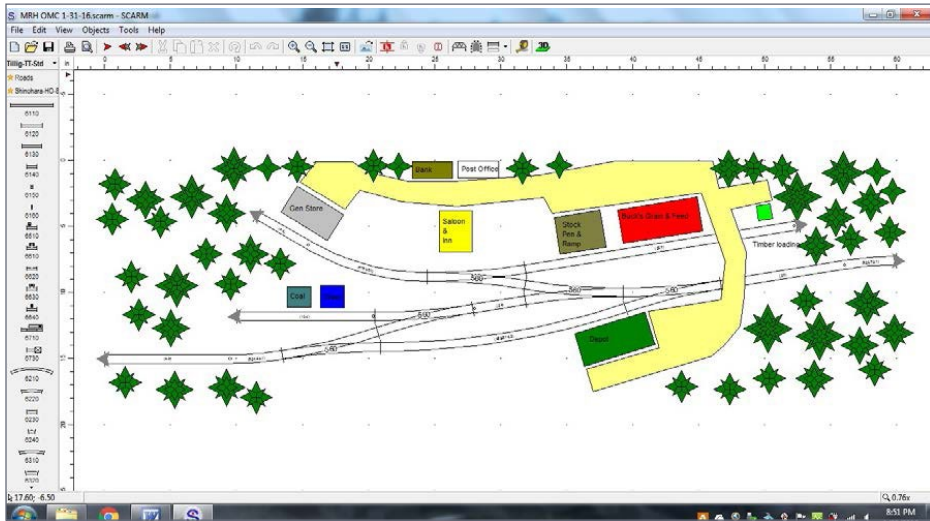

3. SCARM 2D module design

ONE MODULE CHALLENGE | 8

I had originally decided to go with an 18” by 48” module, but was having a really hard time fitting my track plan onto it. Well, that’s not entirely true. The track plan fit, but I didn’t have enough head room for the locomotive and tender to clear the switches on either end of town. The easy solution came to me after re-reading the contest guidelines – just add another 6” to each end of the module. So now we are up to 18” by 60”.

You’ll notice that every turnout on this module is a wye turnout. That was another tip I picked up from my reading. The wye turnouts offer more clearance between tracks in less distance with wider curvature. If I had tried this track arrangement with standard turnouts, I’d probably be closer to an 84” long module. The module design was done using a free program called *takes a big breath* Simple Computer Aided Railway Modeller, or SCARM for short. SCARM is available here: scarm.info and is a powerful tool, complete with a huge track library, a blog, and a video tutorial series.

With SCARM, you can print a 1:1 copy of your track plan. I plan to do that and lay the plan out on my sheet of Homasote. Obviously I’m not going to be able to do it all in one continuous piece since the module is 12” longer than the Homasote. However, the Homasote is 6” wider than the module. The track

MRH OMC 1-31-16.scarm

Parts List

No.	Image	Number	Name	Scale	Producer	Pcs.	Note		
1		500	Flex/Wood	HO	Atlas	7	Covered by 3 pcs. full-length Flex/Wood (500)	\$6.75 ea from Hiawatha Hobbies	Sub total \$20.25
2		560	560	HO	Atlas	5		\$21.75 ea from Hiawatha Hobbies	Sub total \$108.75
								Grand Total \$129.00	

4. Track list and pricing.

plan will be split, and then I will mark those centerlines on the homasote. I'm going to mark off a right of way, 2" either side of the centerline, and use my jig saw to cut out the Homasote. This will be mounted atop my risers, and will be my road bed.

The rest of the module framework will be covered in two layers of 1/2" sheet foam that will be my scenery base. Once the depression is cut in for the coal bunker at the engine service track, the base will be painted a dirt brown color. I do not plan on using any cork or foam roadbed. I want the tracks to be level with their surroundings. After all, I am modeling a start-up branch line with less emphasis on maintenance, and more emphasis on cost cutting and construction to get to the next town.

I am going to try an approach I have not seen or heard about anywhere else yet. I will pin my tracks to the roadbed, making the necessary cuts and joints. Then I will solder every rail joint, and add feeder wires, drilling holes in the necessary locations.

I am going to wire this module for DCC, even though I will probably start out running it in DC. Then I will remove the completed trackwork, and paint on layer of white glue where the track will sit. I will reinstall the track, pinning it back in place, and then sprinkle some ballast on the white glue right away.

Once the ballast is worked in where it needs to be, and out of where it shouldn't be, I will work the feeder wires back through their holes, add a dab of white glue, and a little more ballast to make them disappear. Now if it seems odd that I'm ballasting before doing anything else, it is, but there is a method to my

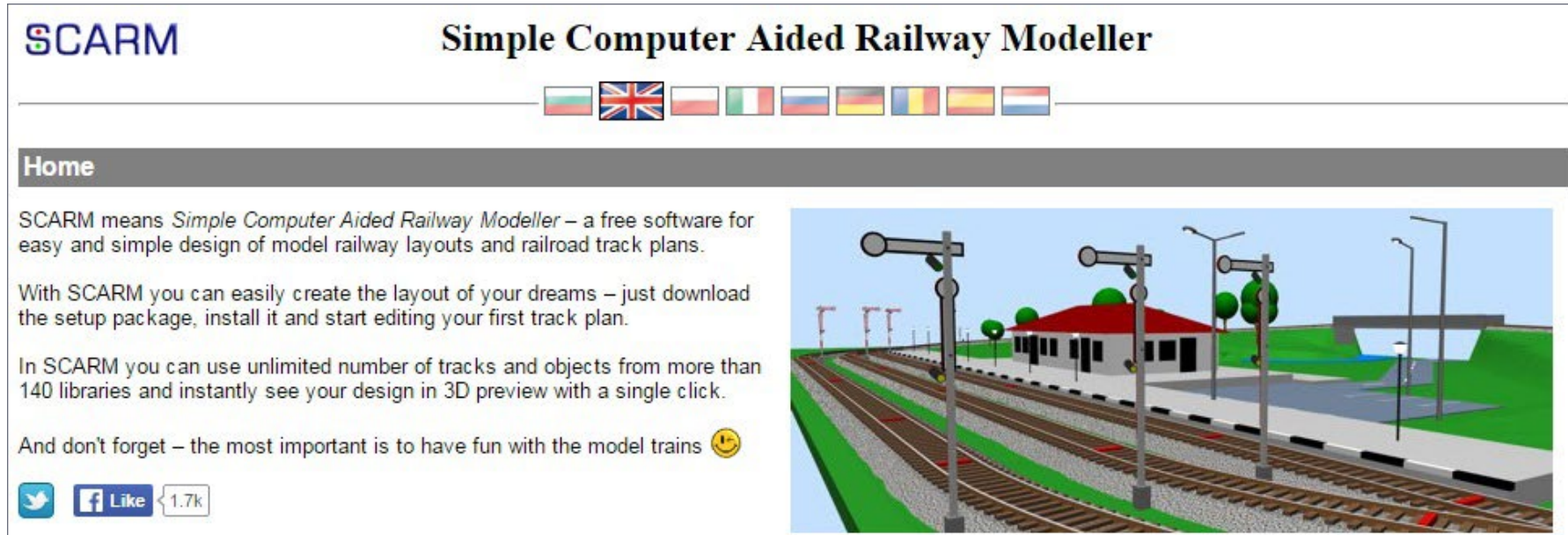

5. SCARM website screen shot.

ONE MODULE CHALLENGE | 11

madness. When I start laying other ground cover, I want it to partially cover the ballast – again, less emphasis on maintenance by the railroad.

Back to the wiring for a moment, my feeders are 20AWG red and black wires, acquired from my local hobby store, Hiawatha Hobbies (hiawathahobbies.com) in 50' rolls for \$9.95 each. That should be enough feeder wire for my whole layout hopefully. The feeder wires will be soldered to my bus wires. My bus wires are 12AWG red and black wires, acquired from my favorite home improvement store, Menards, in 50' rolls for \$9.67 each. I might be able to make that work for my whole layout if I plan carefully.



6. DuraTrax Powerpole electrical connectors.

ONE MODULE CHALLENGE | 12

For quick and easy connect/disconnect to the other modules, I am digging back into another hobby I enjoy – radio controlled cars. I haven't had one of these in forever either, but I do remember that the battery connectors we serious racers used were the real deal - extremely low resistance and quick and easy connections. Part of the reason I chose 12GA for the bus wire is because most of the connectors I've found don't go bigger than 12AWG. My connector of choice is the DuraTrax Powerpole [6], which can be acquired from Tower Hobbies (towerhobbies.com) for \$3.99 for a quantity of 4, or enough to wire up each end of one module.

Call me crazy, but I plan to scratchbuild all of the buildings for this module. I plan to use packs of assorted sizes of basswood

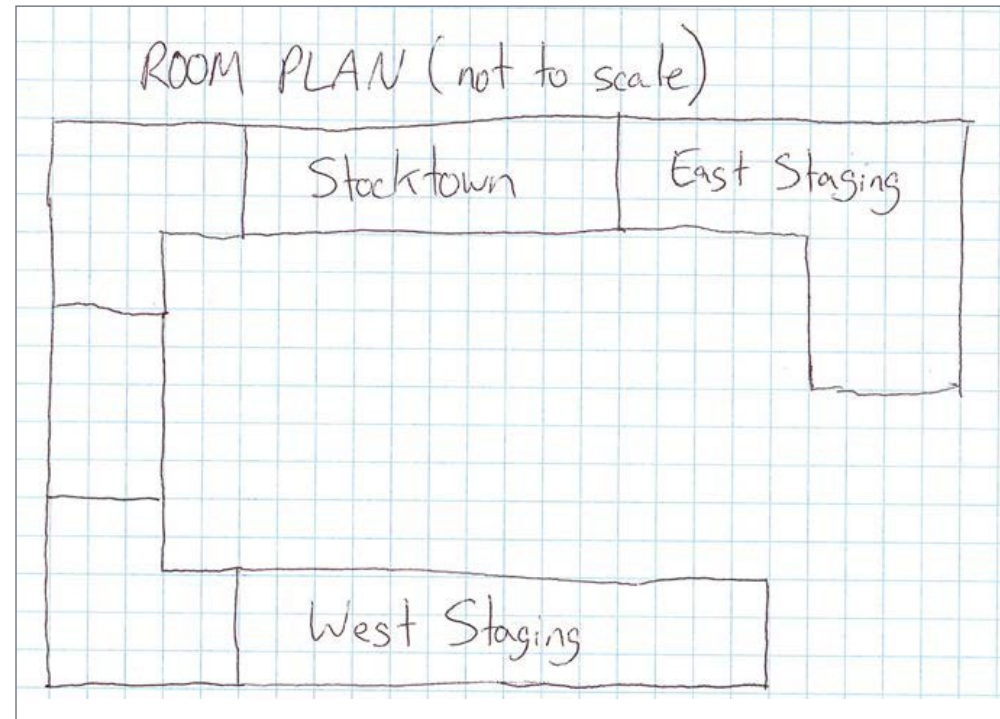

7. The rough drawing of the room plan.

ONE MODULE CHALLENGE | 13

that you can pick up at Hobby Lobby for \$8 each. I haven't nailed down exact designs for most of the buildings yet, but I'm also not worried about that until I get to that phase of the building process.

Once I have my building footprints, I will mark off their placement on the module, and then cover the rest of the module, except for the tracks, with a layer of diluted, painted on white glue, and sprinkle sifted dirt on that, going heavier where my roads will be. Once that dries, I will gently spritz on some more diluted white glue in the areas that will receive ground cover, including on the edges of the ballast around the tracks. I prefer to use Woodland Scenics ground cover in a mix of colors. Another light spritzing of diluted white glue to help hold the ground cover in place, and then I will affix the buildings into their permanent homes on the module, adding ground cover around the foundations as necessary with some white glue.

At this point, I will consult my painter (my wife is quite the artist) on the backdrop that will be attached to the back of the module, and turn that over to her because I'm not nearly the artist she is. While she is working on that, and my eldest daughter is busy painting the horses for the farmers, I will cut and paint the fascia. I don't think I can screw up a one color painting that badly, can I? Once those pieces are in place, I will set to work on the trees. I haven't yet decided if these will be purchased or constructed. I guess we'll see what is available commercially and material-wise when I get that far in the process.

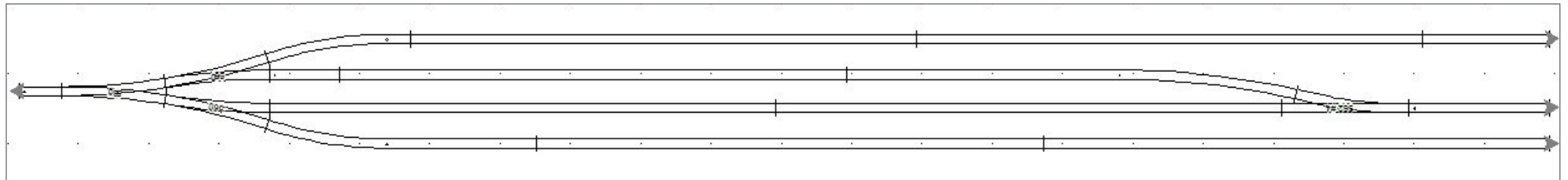

ONE MODULE CHALLENGE | 14

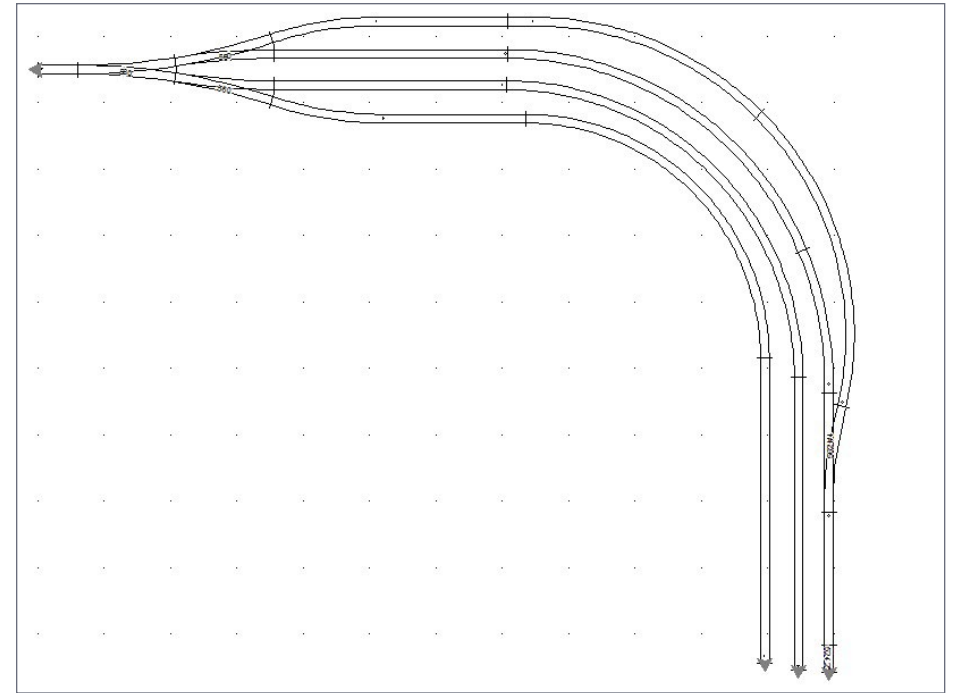

8. (Above) East staging.

9. (Below) This is the west staging yard, which will be completely finished, and will represent a portion of the CB&Q yard near Lacrosse.

ONE MODULE CHALLENGE | 15

My staging yards are not anything fancy. They also employ using wye turnouts to save on space. [8] is the east staging yard, which is curved to try to save a little space for the layout, and will be left bare. It will be hidden from the rest of the layout by a backdrop between it and the Stocktown module, and will represent points east on the FERR line, still under construction. ☑

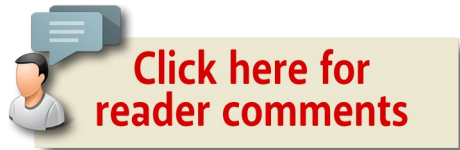

ONE MODULE CHALLENGE | 16

SHAWN BECHER



Shawn has lived in southern Wisconsin for all of his life, and has had a love of trains for most of it. He got his first train set at age 12.

While he hasn't had a home layout for the last decade, he has been a club member on the Milwaukee North Western, which is an exhibit at the Oconomowoc Area Historical Society Museum, for the last two years.

Shawn also enjoys railroad photography ([facebook.com/shawn-srailphotos](https://www.facebook.com/shawn-srailphotos)), racing (NASCAR, Indycar, and Formula 1), golf, and most importantly spending time with his family. Shawn currently resides in Oconomowoc, WI, 600 feet away from the Canadian Pacific mainline. ■

The Get the Latest Model Railroading News, Tips, Reviews & Opinions

SCOTTY MASON

S H O W

The Original Model Railroad Podcast

- Monthly Interviews
 - Modeler's Spotlight: Top Modeler's Talk
 - Narrow Gauge Modeling w/Chris Lane
 - Contemporary Modeling w/ Mike Rose
- More Product Announcements & Reviews

Our feed has changed! To get the latest shows, please search Scotty Mason and subscribe to the new feed!

www.TheModelRailroadPodcast.com

Scott Mason Jimmy Simmons Mike Rose Joe Duckworth

Want to help keep MRH free?

Then click on ads!



[Click here for reader comments](#)



Build a DCC DECODER TESTING STATION

BY ERIC WARHOL

An easy-to-build station for testing DCC goodies

1. I began with: Speakers, pink Styrofoam insulation, decoder programmer, LEDs, resistors, terminal strip, old Athearn motor, cooling fan (needed with a 10-Amp decoder), decoder, and a piece of wood.

ONE OF THE GREATEST FEATURES OF DCC FOR me is the ability to add sound to locomotives and rolling stock. Every time I buy a new engine I try to buy a sound decoder shortly after. I find that sometimes life gets busy (especially with three young kids), and that months pass by before I'm able to install the new decoder. I've had some decoders sit for almost a year before they get installed. By having the decoder sit for so long I've exceeded some 90-day

warranties from date of purchase, and been close to some one-year warranties expiring.

It occurred to me one day that I should test my decoders upon purchasing them. This way, I know they work and are not in need of warranty repair if I need to store them for a while. So I built a portable DCC decoder testing station.

Most of my engines are set up the same for lighting/sound features, motor control, etc. I initially program all sound, lighting, and motor functions. Once the decoder is installed in the engine I may go back and fine-tune things.

Now, if life gets too busy or I'm sidetracked with other projects, I know my decoders function properly. This setup also works with motor-only (no sound) decoders.

2. I marked the dimensions of the speakers I commonly use. Then I used a drywall saw to cut the foam. I added slots for the wires to pass through. It's not a perfect speaker baffle, but it's better than leaving the speakers out in the open.

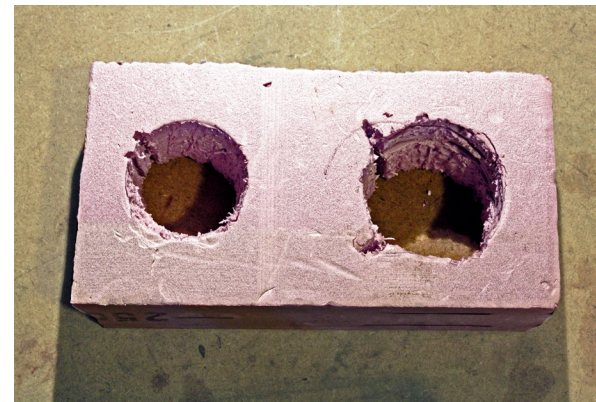

DECODER TESTING STATION | 3



3. I use mostly QSI Titan decoders for my large scale engines. I marked the decoder mounting slots and cut styrene tubing to 3/8" length for elevating the decoder.

DECODER TESTING STATION | 4

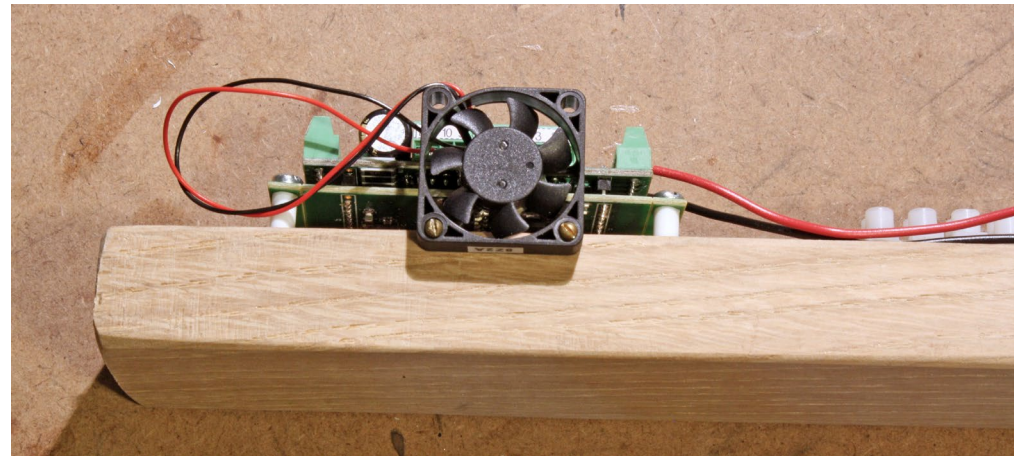

5. The cooling fan keeps the decoder cool. This is required by QSI for their 10-amp decoders.

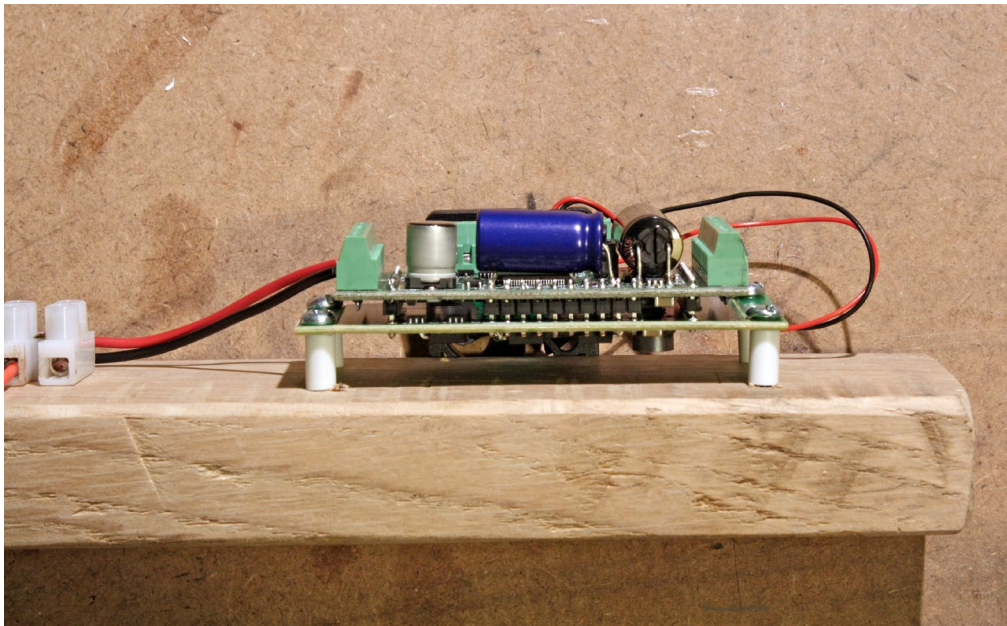

4. I drilled holes in the wood for screws I had on hand. Here is a profile picture of the mounted decoder.

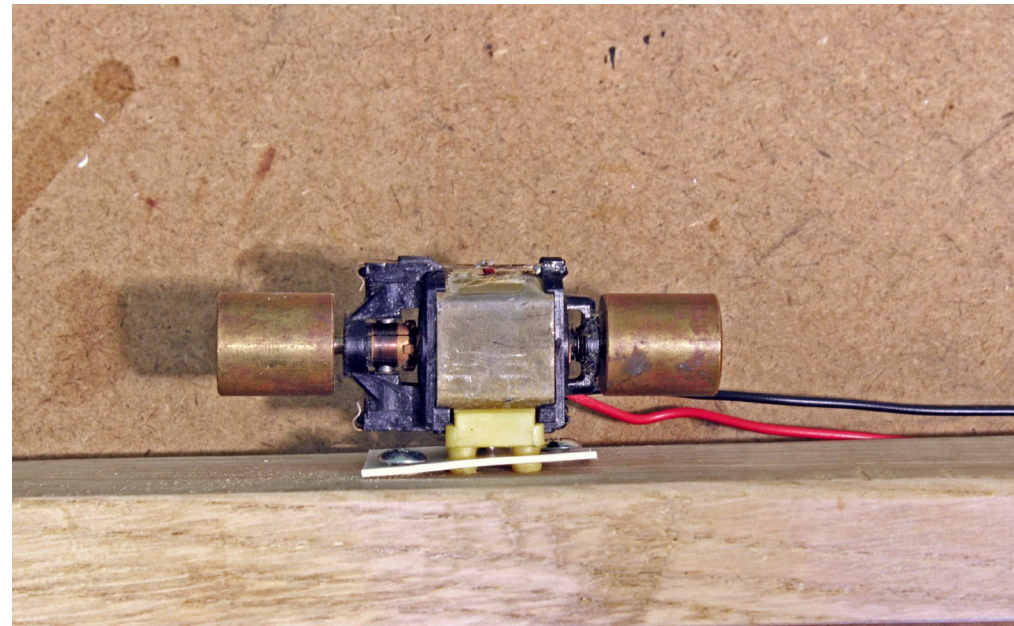

6. I drilled holes in a piece of styrene for the mounting tabs on an old Athearn motor. I screwed the styrene to the wood.

DECODER TESTING STATION | 5

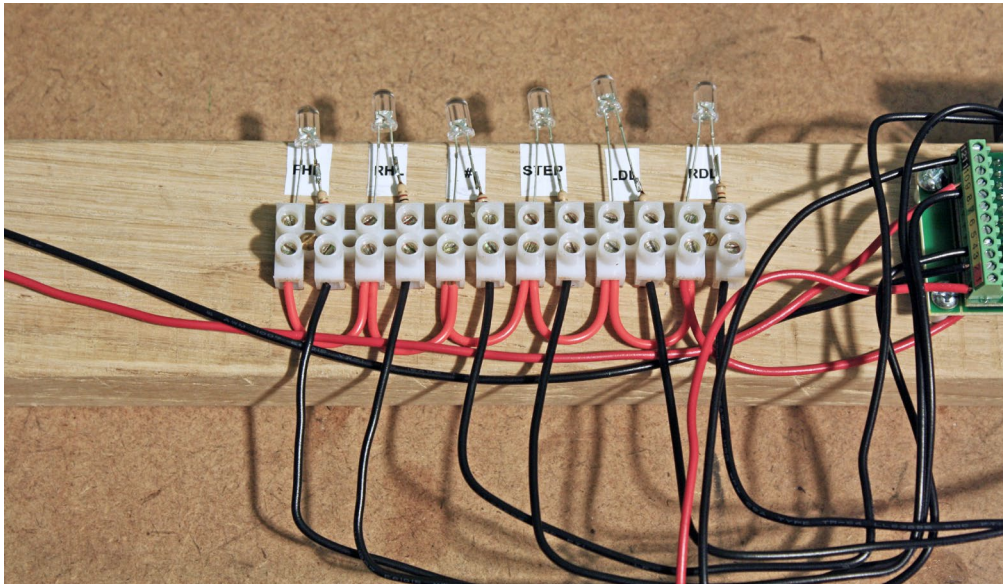

7. Forward/reverse headlights, number board lights, step lights, and ditch lights are the most common lights I use. The QSI Titan decoders have a +5v common for lighting. I daisy-chained the common terminals together. I soldered a 100 ohm 1/4 watt resistor to the negative lead on each LED. I then installed the LEDs into the terminal strip. The negative wire goes to its respective place on the decoder circuit board. Labels show the function of each LED.

DECODER TESTING STATION | 6

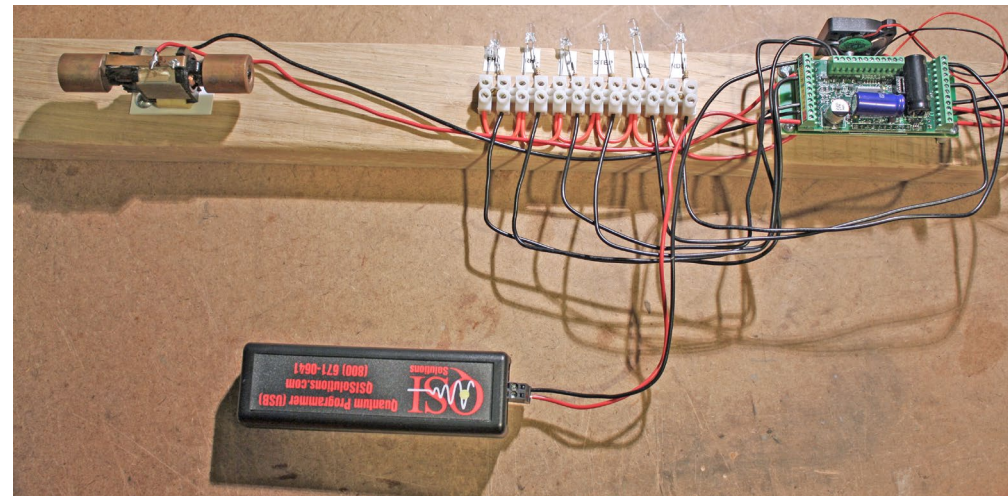

8. The completed decoder testing station. Now I can hook my computer to the Quantum programmer, program the sound file, adjust CVs, and test the decoder.

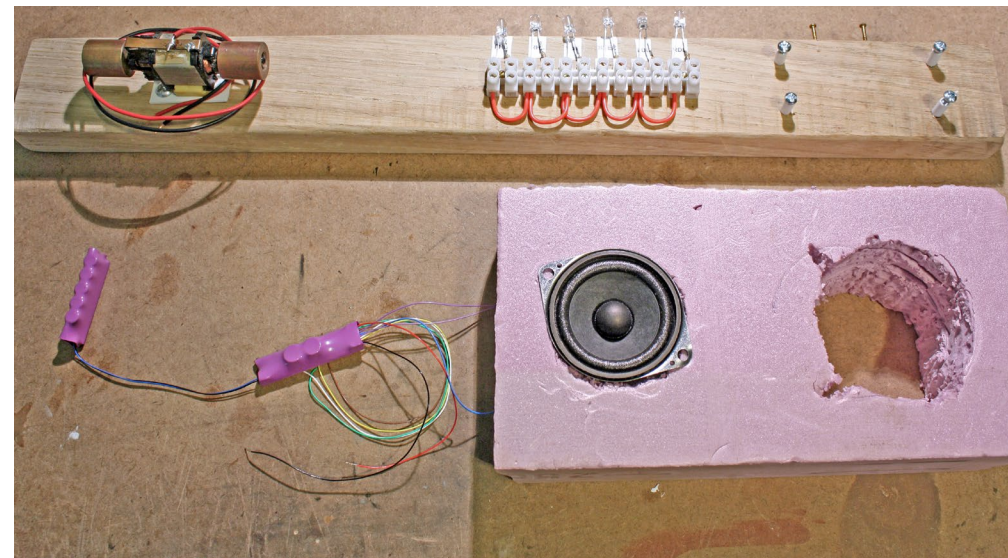

9. I have some rolling stock with Soundtraxx Soundcars. My rolling stock does not use the lighting features, but if it did I would have hooked the appropriate wires to the corresponding LEDs.

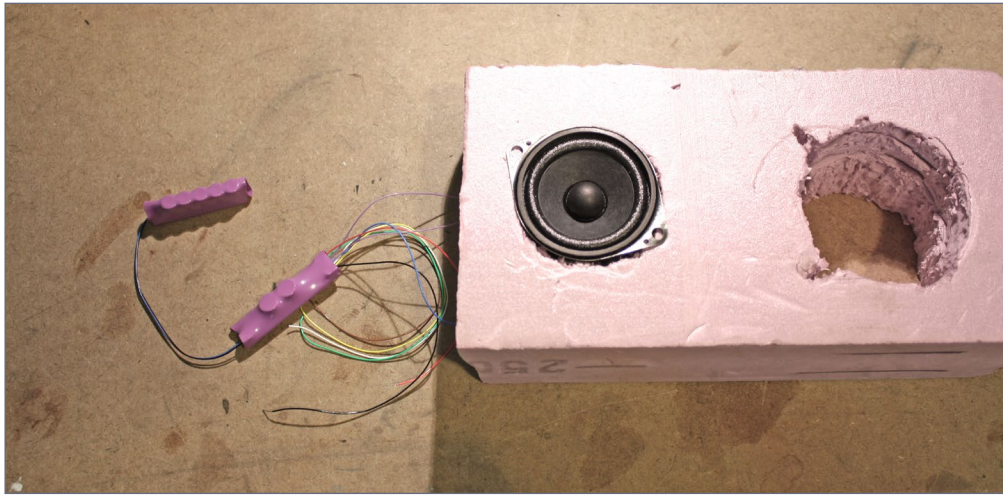

10. Since I am not using the lighting features of the Soundcar, this is all that I needed for testing that decoder. I hooked the red and black wires to the programming track, and used JMRI's DecoderPro to program the Soundcar.

ERIC WARHOL



Eric Warhol lives in Becker, MN with his wife, Joni, and their three children Matthew (9), Nathan (6), and Katherine (2). Eric has been into model railroading for most of his life. While HO scale held his interest most of those years, large scale modeling has recently become his favorite. Eric is a member of the Minnesota Garden Railway Society (MGRS). He plans to build an indoor large scale layout themed after Minnesota railroads, and named The Greater Minnesota Railroad (GMRR).

PARTS LIST

- Piece of wood 2" x 18"
- Speaker(s)
- Pink Styrofoam insulation
- Saw for cutting insulation
- Terminal strip
- Old locomotive motor
- Misc. wood screws
- LEDs with resistors
- A way to program a decoder (program track, Quantum programmer, or DecoderPro)
- Hookup wire
- Decoder (with or without sound) and cooling fan if needed.



[Click here for reader comments](#)

ADVERTISEMENT

Make LocoNet wiring extremely simple!



**Suitcases belong in your baggage cars,
not under you layout!**

**Introducing the DCC Vampire II ...
this guy does the job of two suitcase
connectors!
And really holds the connection good
too!**

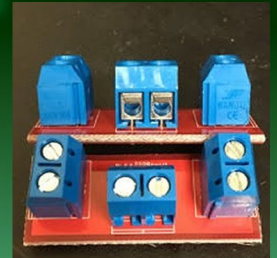

CLICK NOW TO DISCOVER THE AMAZING VALUE!

Dealer Inquiries Accepted

Nano-Oil™

Made in U.S.A.

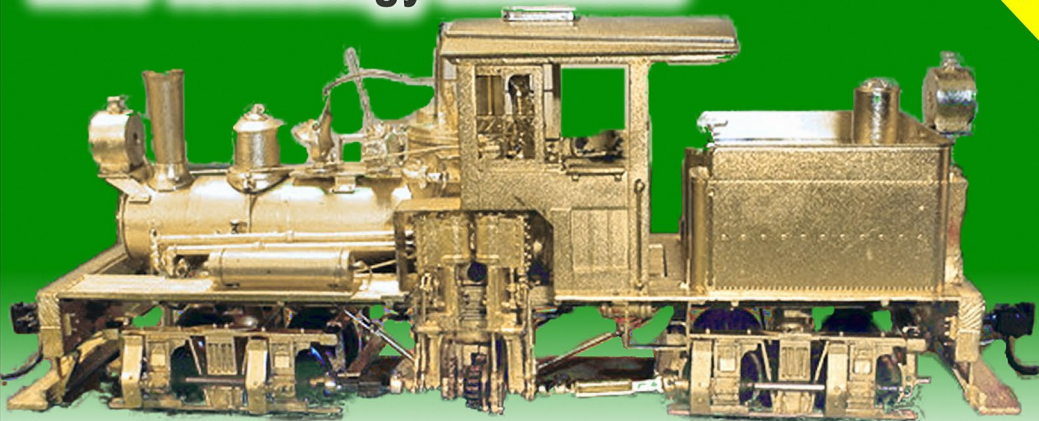
**Nano Technology Lubricants****New
Innovation**

"After eight years of extensive testing, the only lubricants now used in my shop are Nano-Oils and Nano-Grease. The extreme reduction in power draw by mechanically minimizing friction is simply technologically superior."

- Phil Floyd, 'The Shay Fixer'

**Nano-Grease**

**For more details
click here ...**

**THE SHAY FIXER**

VISIT US AT...

SHAYFIXER.COM

Specializing in brass Pacific Fast Mail / United geared locomotives



Model Railroad Hobbyist | August 2016 | #78

LOOK
column

**Click here for
reader comments**

JOE FUGATE

1. Scale Trains Kit Classics HO Evans 5100 RBL boxcar, decorated for their company. I replaced the kit knuckle couplers with Kadee #148 whisker couplers on this car – they drop right in.

**MRH LOOKS AT SCALETRAINS.COM AND
THEIR NEW ROLLING STOCK PRODUCTS ...**

Last November at the TrainFest show in Milwaukee, a major new model railroad manufacturer made their debut: ScaleTrains.com.

Based in Benton, TN, four industry-savvy friends: Shane Wilson, Mike Hopkin, Paul Ellis, and Joe Olvera founded Scale Trains with

▶ NEW PRODUCT FIRST LOOK

FIRST LOOK | 2

the goal of developing innovative new HO and N scale models at competitive pricing. Scale Trains has started shipping the first of their HO models. Let's take a look and see what the first of these new models from Scale Trains looks like!

Kit Classics

Modelers have bemoaned the loss of the affordable Athearn Blue Box kits, with only a few firms remaining that still make low cost rolling stock kits ([Accurail](#) and [Branchline](#) [owned by Atlas] still sell HO kits, for example).

We can add Scale Trains to the list of new manufacturers helping the hobby retain an entry-level way to build up a rolling stock fleet with their new Kit Classics line.

Scale Trains' first Kit Classics offering is the Evans 5100 RBL boxcar. This kit goes together easily: you just install the couplers and trucks to the underframe and snap it into the body shell.

The stock assembled ScaleTrains car weighs 5.6 oz. The NMRA recommended practice for car weight says about 5 oz for a circa 55 foot car over the coupler pockets, so this car is 12% overweight. With so many kit cars being underweight, it's interesting to find this one is ever-so-slightly *overweight*.

The kit includes plastic scale knuckle couplers with a metal jaw spring and stamped metal spring for the coupler box. The coupler box lid screws on, making for a coupler that won't fall out easily during operation. If like me, you want to replace the kit plastic couplers with metal Kadees, Kadee whisker couplers drop right in.

I decided to take one of their Evans kits lettered for the UP and prepare it for service on my Siskiyou Line. I researched the road numbers on the Fallen Flags website to find an equivalent prototype car. I found one here: rr-fallenflags.org/up/up451319.jpg.

FIRST LOOK | 3



2. Kit Classics HO UP Evans boxcar, ready for service on my Siskiyou Line.

Notice this car is pretty clean, so I wanted to make my car likewise fairly clean and only lightly weathered similar to the prototype. But I did do a black "shadow shade" wash on the doors, ladders plus on the car ends and roof. This black wash shadowing really brings out the details and makes the model look a lot more realistic, I think.

I added ACI decals and black COTS double-panel decals to each side to match the prototype photo. I also replaced the couplers with Kadee #148's.

Finally I weathered the couplers, wheels, trucks and underframe with a bit of Vallejo ModelAir Dirt (71.133) and some PanPastels.

You can see my finished UP Evans RBL car ready for service on the Siskiyou Line, above. I think it fits in nicely.

For more Evans car paint schemes, see the following pages.

FIRST LOOK | 4



3. Kit Classics HO C&O “Chessie” Evans boxcar.

Introduced during the late 1960s, the Evans 5100 cubic foot Insulated Double-Plug-Door boxcar uses heavy interior insulation and optional internal load restraints.

The Association of American Railroads (AAR) classified these cars as “RBL” - **R**efrigerator, **B**unkerless, with **L**oad restraining equipment. As designed, these cars protect cargo from the elements and extreme temperature swings without the use of mechanical refrigeration or heating equipment.

The 16’ wide door opening made loading and unloading easier. Inside the car, the closed double-plug-doors created a smooth, sealed opening. Because these cars included cushioned underframes, they were popular with shippers of delicate items like canned goods, bottled products and foodstuffs.

FIRST LOOK | 5



4. Kit Classics HO Willamette Industries Evans boxcar.

Shippers of finished lumber such as wood veneers also found these cars useful to protect their delicate products while in transit. The Evans 5100 cu. ft. boxcar helped prevent warpage and other damage that sometimes came from shipping via plain boxcars or flatcars.

This freight car kit represents a typical Evans-built 5100 cubic foot RBL boxcar or USRE “clone.” “Clones” were built to Evans specs in USRE facilities. Lasting from the late 1960s well into the 2000s, the Evans 5100 has served a variety of railroads and private owners.

These cars will be at home serving industries including canneries, beverage bottlers or distributors, food distributors, lumber mills, and lumber distributors. [Available online at \\$13.99 each.](#)

FIRST LOOK | 6



5. TrinityRail black crude oil tank cars (Operators brand).

Trinity tank cars (Operators/Rivet Counters)

Scale Trains also has their Operators line of ready-to-run cars, as well as their Rivet Counters line.

The Operators line provides equipment built for modelers who enjoy running realistic trains at an affordable price. Operator models have fewer factory-applied parts and simplified printing.

The Rivet Counter line strives for highly accurate detailed models. Scale Trains researches the real-world counterpart to ensure prototype fidelity. Each model features numerous factory applied parts including roadname and road number specific details when possible.

The first to appear in these new lines are some modern era Trinity crude oil tank cars.

FIRST LOOK | 7



6. TrinityRail black crude oil tank cars (Rivet Counter brand).

Since 2012, TrinityRail has built thousands of 31,000 Gallon Crude Oil Tank Cars to meet the growing needs of the oil industry. Mile-long unit trains with 100+ cars crisscross the United States and Canada daily to deliver crude from the oil fields of North Dakota, Wyoming and Montana to refineries on the East, Gulf and West Coasts.

The TrinityRail tank car is easy recognizable by its unique trapezoid-shaped end shields.

Operators brand: These cars come in 12 different road numbers and they come with details such as plastic end shields with hazmat placards, finely detailed manway cover and protective housing, plastic top and end platforms and detailed one-piece ASF Motion Control Super Service 110-ton trucks with 36” machined metal wheels. [Available online at \\$22.99 each.](#)

FIRST LOOK | 8



7. Deep Rock Refining crude oil tank cars (Operators brand).

Rivet Counters brand: These cars come in 24 different road numbers with etched-metal head shields for realistic thin profile as well as the correct body mounted metal semi-scale SE Type double-shelf knuckle couplers.

Additional details include finely detailed manway cover and protective housing details, see-through top and end photo-etched metal platforms, sturdy metal anti-personnel rods, and detailed tank saddles with defect card holders.

The car also includes separately-applied metal corner and end sill grab irons, underbody outlet valve and chain detail, FRA-224 yellow conspicuity striping, printed hazmat placards, Barber S-2-HD-9C 110-ton trucks with 36" machined metal wheels and rotating blue bearing caps.

FIRST LOOK | 9



8. Deep Rock Refining crude oil tank cars (Rivet Counter brand).

This tank car sports a handbrake housing with a finely-detailed wheel and chain along with underbody braking details including brake beam, control valve, air reservoir, brake cylinder and brake.

The car paint is color-matched to Tru-Color Paint colors. The finely applied printing and lettering on the tank body is quite legible even under magnification.

The trucks include printed reporting marks and road number with an accurately profiled .110" wide wheel tread. In addition, the cars have coupler cut levers, trainline hoses, and intricate brake plumbing.

This car weighs 5.3 oz, which is just over the NMRA recommended weight of 5 oz. [Available online at \\$38.99 each.](#)



9. Union Pacific water tender 814 "Joe Jordon."

UP Water Tender Set (Rivet Counters)

Scale Trains also issued a UP Water Tender set in their Rivet Counters brand.

Originally built as Union Pacific 800-class steam tenders in 1937, UPP 809 and UPP 814 have both undergone significant changes over the years. They were used as fuel tenders for the GTEL 8500 Horsepower "Big Blow" Turbines in the 1960s, as fuel storage tanks in the 1970s and finally entered water service for the Heritage steam fleet in 1989.

UPP 809 "Jim Adams" and UPP 814 "Joe Jordan" have been extensively modified since their Turbine Fuel Tender careers. Changes include removing the fuel oil heaters and squaring-off the top corners to increase their water carrying capacity. UPP 814 was



10. Union Pacific water tender 809 "Jim Adams."

rebuilt in July 2006 followed by UPP 809 in August 2008. Both tenders regularly operate together and are pulled behind FEF-3 #844, Challenger #3985 and eventually Big Boy #4014.

You can buy these tenders online [for \\$119.99 per set of two.](#)

Links:

[ho-evans-usre-5100-rbl-8-double-plug-door-boxcar](#)

[ho-trinity-31k-crude-oil-tank-car](#)

[ho-rivet-counter-union-pacific-steam-excursion-post-2006-water-tender-set](#)





The Amherst Railway Society Railroad Hobby Show

Our 2017 Show will be

January 28 & 29, 2017

Save the dates!

**Click
to learn
more ...**



About The Show

Every year late in January or early in February, the Amherst Railway Society holds its Railroad Hobby Show at the Eastern States Exposition Fairgrounds (The home of The Big E) in West Springfield, Massachusetts. More than 25,000 railfans and public attended the Show each of the past three years.

The event features real life railroads and scale model railroads, historical societies, travel agencies, art shows, flea market dealers, importers, manufacturers and photographers. You have to see it to believe it!

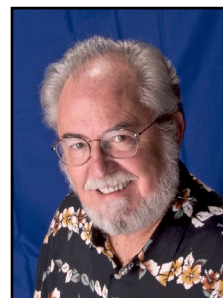

Model Railroad Hobbyist | August 2016 | #78

AUGUST NEWS

column

RICHARD BALE *and* JEFF SHULTZ



**Click here for
reader comments**

Daniel Stephen Kirlin 1956-2016



Well-known Canadian railroad hobbyist Dan Kirlin suffered a fatal heart attack on June 23 at his home in Kitchener, Ontario. Dan was an expert on Canadian rolling stock and motive power. He enthusiastically shared his extensive knowledge with fellow hobbyists. At one time he imported brass models of Canadian Pacific passenger cars under the name Kirlin Models.

Dan is survived by his wife Deidre ...

National Train Show

The National Train Show (NTS) was held in July in Indianapolis, IN. The event is conducted in conjunction with the annual National Model Railroad Association convention. Manufacturers

► THE LATEST MODEL RAILROAD PRODUCTS, NEWS & EVENTS

AUGUST NEWS | 2

and suppliers of model railroad equipment utilize NTS as an opportune time to introduce new products to the hobby world. Several MRH staff members attended the show and we are happy to pass along to our readers many of the products announced at this year's NTS ...

CLUB CARS



The **Mid-Continent Region of the NMRA** is offering a limited-edition Accurail St. Louis Refrigerator Car Company Reefer

as a Region freight car project. Six road numbers are available, with the lettering, white body, and brown roof and ends based on photos and prototype data. The prototype cars were in nationwide service with Anheuser Busch. For more information or to order, contact Whit Johnson at wjohnson@westec-inc.com.

NEW PRODUCTS FOR ALL SCALES

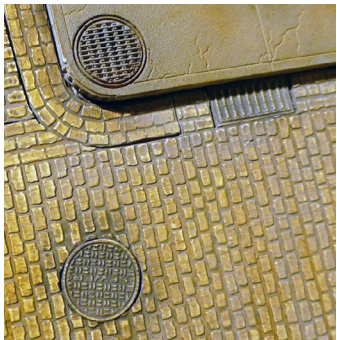

Chooch Enterprises has expanded its selection of peel-and-stick flexible textured vinyl material to include cobblestone paving. The new design includes manhole covers, storm grates, and curves. The peel-and-stick material is available in 3.75 x 12-inch sheets in three sizes of paving suitable for N, HO, S, and O scale applications. For additional

information contact a dealer or visit choochenterprises.com.

AUGUST NEWS | 3



Dr. Ben has introduced two styles of tarpaper roofing material that is approximately 3 scale feet wide. Available now in lengths of 10 to 12 scale feet is Pitched Tarpaper with ragged tarred seams and shading variations, suitable for patch roofs. Rolled Tarpaper is available in scale 50-foot rolls. Both types are produced on peel-and-stick material and are available in red oxide,

worn gray, and dirty black. The tarpaper roofing material is available for N, HO, S, and O scale. For additional information visit debenllc.com.



Railroad Line Models is selling a laser-cut kit for Pete's Garage. It is available in N, HO, S, and O scales. The kit features laser-etched concrete stonework over heavy cardstock. For more information visit railroadlinemodels.com.

Rails Unlimited has added three new publications to its assortment of reprinted shippers guides. Each publication lists all the industries and team tracks in a given territory. The new guides are *New York Central/Pittsburgh & Lake Erie Delivery Circular I-E* (covers Illinois and Missouri to the east coast including Ontario and Quebec. 1963, 376 pages), *Reading Company Freight Shippers Guide No. 1*. (includes Cornwall and Ironton railroads, Pennsylvania-Reading Seashore Lines, and Delaware River Piers. 1954, 256 pages), and *Official Freight Shippers Guide and Directory of the New York, New Haven, and Hartford* (1915,

AUGUST NEWS | 6



based the kit on a prototype built in 1955.



Another HO kit is this Baltimore & Ohio 70-ton triple-bay hopper car with offset sides. Cars of this basic AAR design were built in the thousands from the late 1930s until the early 1960s.



Also new is a kit for this triple-bay center-flow covered hopper decorated for Atchison Topeka & Santa Fe. It follows a prototype built by American Car & Foundry in the early 1970s.



Accurail's kit for this Central of Georgia 55-ton twin-bay hopper car is based on a wood side prototype built before World War I. After decades of service it was rebuilt in 1945.



This West India Fruit & Steamship 40-foot steel refrigerator car is decorated for a prototype built in 1957. Note the Dreadnaught ends, ice bunker hatches, and swing doors.

AUGUST NEWS | 7



Accurail's 40-foot Spokane, Portland & Seattle steel boxcar is based on AAR cars built from the late 1940s through the early 1950s. This one was built in 1948 and rebuilt ten years later. Features include steel Dreadnaught ends and Youngstown 6-foot sliding doors.



Development work nears completion on Accurail's soon-to-be-released 36-foot double-sheathed wood boxcars. The prototype cars were built in large numbers before, during, and after World War I. Their steel roof and underframe extended the useful life of the cars well beyond the 1928 ban on cars with wood underframes. Accurail will offer four versions of the car: with wood or steel ends, and with fishbelly or straight steel center sills. For additional information on all Accurail products contact a dealer or visit accurail.com.

.....



Athearn showed this pre-production sample of their Genesis Northern Pacific/Spokane Portland & Seattle 4-6-6-4 class Z-8 Challenger at the National Train Show. The NP version of the locomotive includes several road-specific details and a newly tooled coal tender. The SP&S version includes an oil tender. Athearn says the HO scale steam locomotive is scheduled for release in September.

AUGUST NEWS | 8

Additional future products on display at NTS included a Genesis GP40-2 in Southern Pacific gray and red scheme, and a very preliminary 3D printed sample of a Genesis SDP40F.



Athearn's production scheduled for next May includes another release of its Genesis series EMD GP7/GP9 with new road names. The GP7 will be decorated for Chicago, Burlington & Quincy and the GP9 will be decorated for Florida East Coast and Western Pacific. DCC-ready versions of the HO scale model will feature Quick Plug technology with both 8- and 9-pin connectors. DCC models have a factory-installed SoundTraxx Tsunami2 sound decoder.



Also coming next May is a Pullman-Standard 50-foot steel boxcar. In addition to the GATX car shown here, the Ready-to-Roll model will be available decorated for Boston & Maine, CP Rail, Delaware & Hudson, East Erie Commercial, Illinois Terminal, Norfolk Southern, and Vermont Railway. Features include separately applied wire grab irons, etched metal end platforms and 33-inch machined metal wheelsets.

This Chicago & North Western covered hopper car represents a 4700 cu. ft. triple-bay car built between 1965 and 1985 by the Gunderson Division of FMC. Athearn's HO scale Ready-to-Roll model features see-through end cages, etched metal platforms, and 100-ton trucks with 36-inch nickel silver wheelsets.

AUGUST NEWS | 9



Additional road names will be Dakota, Minnesota & Eastern; Burlington Northern, BNSF Railway, Canadian Pacific (ex NAHX), First Union Rail, SSW-Cotton Belt, and Wisconsin Southern.



Athearn also plans to release this Thrall high-side gondola next May. The Ready-to-Roll model will be available decorated for Santa Fe, Yankeetown Docks, Commonwealth Edison, Burlington Northern, Denver & Rio Grande Western, and Union Pacific.



Athearn's HO scale 57-foot 70-ton spine cars are based on a Trinity-built prototype that first appeared in the 1990s. The cars can be configured to accommodate trailers of varying lengths from 28-foot pups to 53-foot high-capacity units. With the trailer hitches collapsed, 40-, 45-, 48-, and 53-foot containers can also be loaded. The model is scheduled for release in May decorated for Trailer Train, Burlington Northern Santa Fe, and Florida East Coast.

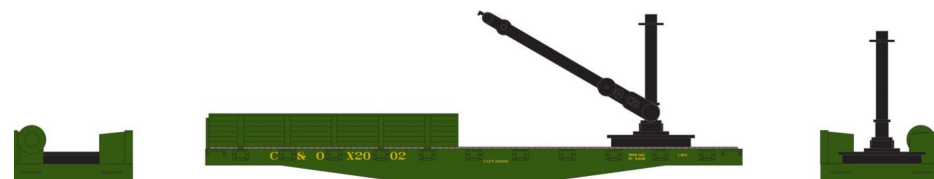

Athearn's May production schedule includes a 40-foot flat car fitted with a derrick and abbreviated sideboards. Road names

will be Alaska Railroad, Canadian Pacific, New Haven, Rock Island, Union Pacific, Western Pacific, Maintenance of Way (gray), and Chesapeake & Ohio as shown here. The fully assembled model comes with Bettendorf-style trucks with 33-inch machined metal wheelsets.



Vehicles in Athearn's May release include a 53-foot utility reefer trailer produced from upgraded A-Line tooling. The trailers will be available for Alliance, JB Hunt, Werner, XTRA, and GO2 Logistics. Special features include fuel tank and mud flaps, sliding rear bogie, rubber tires, a separately applied tractor-trailer refrigeration unit, and landing gear assembly. Three different fuel tank sizes will be applied as appropriate to the practice of the prototype carrier.



Athearn-Roundhouse brand models scheduled for release in May 2017 include EMD F7A diesel units decorated for Soo Line, Northern Pacific, Amtrak, Alaska Railroad, Western Maryland, Central Railroad of New Jersey, Santa Fe (yellow bonnet), and VIA Rail Canada. The powered A units will be available for DC operation only. Matching non-powered B units will also be available.

Streamlined passenger equipment suitable for the F7A will include cars decorated for Amtrak, Alaska Railroad, Santa Fe, Canadian National, Northern Pacific, VIA, and Southern Pacific as shown here. The release will include RPO cars, baggage, coach,



diner, a dome car, and a round-end observation car. All of the cars will be equipped with four-wheel passenger car trucks with machined metal wheels. For additional information contact a dealer or visit athearn.com.



Atlas Model Railroad Company showed this pre-production sample of an HO scale GP7 at NTS. The model was originally announced

last summer, but has been retooled with a new diecast metal frame and sill, with new fuel tanks in several road-specific sizes. Road names will be Toronto, Hamilton & Buffalo; Erie Lackawanna, Denver & Rio Grande Western, Santa Fe (yellow bonnet), Seaboard Air Line, Canadian National, MKT, and Rock Island. Both DC and DCC units with an ESU LokSound Select sound decoder will be produced.

Other pre-production models on display in Atlas' NTS booth included a New Jersey Transit ALP-45DP locomotive with working pantograph, Bombardier bi-level commuter cars, a high-nose FEC GP40-2 with dual horns at both front and rear, and Master series GE U33 and U36B diesels with correct head and Mars lights. The GE locomotives are scheduled for release late this year. For additional information contact a dealer or visit atlasrr.com.

Bachmann's NTS display included an engineering sample of a PCC car that randomly sparks at the end of the trolley pole. The effect was quite realistic. Plans call for the model to be released this December decorated for Pacific Electric, Allegheny Transit,



and the city transit lines in Chicago, New Jersey, Philadelphia, and San Diego. The HO scale model will be available with a SoundTraxx Sound Value sound decoder for bell, and three different horns.



Also on display in Bachmann's NTS booth was an Alco 2-6-0 steam locomotive. The HO scale model is scheduled for release in November with

an optional DCC Sound Value decoder on board. Road names will include Atchison, Topeka & Santa Fe; Louisville & Nashville, New York Central, Pennsylvania Railroad, and Union Pacific. A USRA 4-6-2 light Pacific was also shown at NTS. For additional information contact a dealer or visit bachmanntrains.com.



Bar Mills has added to its collection of the Cundy Harbor structures with the release of Cundy Cannery. The HO scale limited-edition craftsman-style kit features laser-cut components. For additional details including ordering information visit barmillsmodels.com.

Bowser Trains is developing an Alco RS-3 phase 3 locomotive and several subsequent versions. Bowser previously offered RS-3 body kits for use on Stewart mechanisms. Pre-production samples of a Canadian Red Barn SD40-2F were shown at NTS with a note

indicating the HO models will be ready for release early next year. Current Canadian models on display included MLW M636 diesels. Noting that his company is currently collecting data on eight new locomotives, Bowser owner Lee English said he is very optimistic about the future of model railroading. For more information on Bowser products contact a dealer or visit bowser-trains.com.



Broadway Limited is scheduled to deliver a group of Baldwin Sharknose diesel units late this year. Individual units as well as A/B sets will be included in

the release. The HO scale models will be equipped with Paragon3 Sound for DC/DCC.



Road names will be Pennsylvania Railroad single stripe, New York Central lightning stripes, Baltimore & Ohio (blue and gold scheme), Elgin, Joliet & Eastern (orange and green with a single stripe); MRY-Monongahela Railway (cigar band scheme), and a red and white Baldwin demo unit. For more information contact a dealer or visit broadway-limited.com.

Digital Fox Services is selling a kit for an HO scale Pullman-Standard three-bay covered hopper decorated for Norfolk Southern. The HO scale model is based on a 4,750 cu. ft. prototype built during a decade-long production run that began



in 1972. The kit is sourced from Accurail and includes Barber S-2 100-ton roller bearing trucks and Accumate couplers. Three differ-

ent road numbers are available. For additional information visit digitalfox.com.



Digitrax has introduced a new decoder designed to fit HO scale locomotives equipped with the 21MTC interface. Identified as DH126MT, the new decoder offers six functions. It is rated at 1.4 amps (2 amp peak) and measures .805 x .64 x .17-inches.

Also new from Digitrax is the DCS 240, a LocoNet advanced command station. The DCS 240 is rated at 5 or 8 amps of power and can handle up to 400 throttle and locomotive addresses. Capability includes full read/write programming, USB connectivity, and separate programming output that permits simultaneous running and programming. For additional information contact a dealer or visit digitrax.com.



Fos Scale Models is selling an HO scale flat background kit for Mathias Spring & Wire Co. The kit features laser-cut walls, plastic windows, metal and plastic details, NorthEastern Scale lumber, and detailed assembly instructions. The completed model stands 5.5 inches tall. The footprint is 1.5 x 9-inches. For

additional information including ordering instructions visit fos-scalemodels.com.

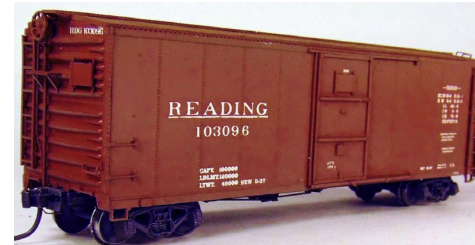

Funaro & Camerlengo is selling HO scale resin kits for Reading automobile cars built in the late 1930s. Class XMv single door cars and Class XAe double-door cars are available.



F&C kits include cast resin detail parts, a one-piece cast resin body, wire for air lines, Tichy grab irons, cast styrene brake components, and appropriate decals.

Trucks and couplers are not included. For additional information including a list of stocking dealers visit fandckits.com.

InterMountain Railway plans to release another production run of Pacific Fruit Express class R-40-10 refrigerator cars in



October. The HO scale model is based on prototype steel ice reefers built in 1936 with swing doors and Dreadnaught ends.



Decorating schemes will be PFE (double black and white herald, above), PFE (Overland herald), PFE (double herald), Ferrocarril

del Pacifico, and Illinois Central. For information on all InterMountain products contact a dealer or visit intermountain-railway.com.



New cars due next month from **Kadee** include a PS-1 40-foot steel boxcar decorated for the Chicago & Illinois Midland Railroad.

The fully assembled HO scale model has 6-foot, Five-panel Superior doors. It is painted in the as-new 1952 green paint scheme.



Also coming from Kadee next month is a Reading 50-ton AAR twin-bay open hopper. It is decorated in the as-built scheme of 1951.

Kadee ready-to-run models come with Kadee couplers and two-piece self-centering trucks. For additional information contact a dealer or visit kadee.com.

Lionel has returned to the HO world with the introduction of a 1:87 scale Polar Express train. The announcement came as a



surprise to both attendees and exhibitors at the National Train Show. The company already offers the popular train in S, O, and G scale.



The HO scale Polar Express train set includes a 2-8-4 Berkshire steam locomotive, two coaches, and an observation car with an unusual round platform. The set is intended primarily for the



juvenile market, and accordingly many of the details are somewhat coarse. The locomotive comes with Lionel RailSounds. It can be operated on conventional DC or DCC with the LionChief remote control system. An app is available for downloading to allow operation using a smart phone or tablet. For more information contact a dealer or visit lionel.com.



MOLOCO has released another run of its highly regarded GA RBL boxcars. New road names for the HO scale ready-to-run models

include a Conrail car as repainted in 1987-1988. Note the third arm at the top center of the plug door.



Rock Island repainted their cars to this Route Rock

scheme in 1979. The double third arms on the plug doors were mandated about the time of the repainting.



Also new is a Missouri Pacific RBL with graphics indicating cushion car, load divider, and Keystone 20 underframe. Cars decorated

for Milwaukee Road and Wabash are also in this production release. For additional information including ordering instructions visit molocotrains.com.



Monster Modelworks is selling a textured Lazerboard that models old cobblestone streets. The manufacturer states that sheets can be joined together with virtually no visible seam, creating a street as long or as wide as needed. Sheets measuring 7.4 x 3.7-inches come in packs of two. Installation tips and painting suggestions are included

with each pack. For additional information visit monstermodelworks.com.



Here is a preliminary computer graphic of an HO scale General Motors transit bus currently under development by **Rapido Trains**.

Between 1959 and 1986 GM produced more than 44,000 New Look transit buses of which some 11,000 were built in Canada by GM Diesel Division. About 70 percent of those built were 40 feet

long, although 29- and 35-foot designs were also built. The New Look bus gained the nickname Fishbowl for its six-piece front windshield. Rather than a traditional ladder frame, the New Look used airplane-like construction in which an aluminum riveted skin supported the weight of the bus.

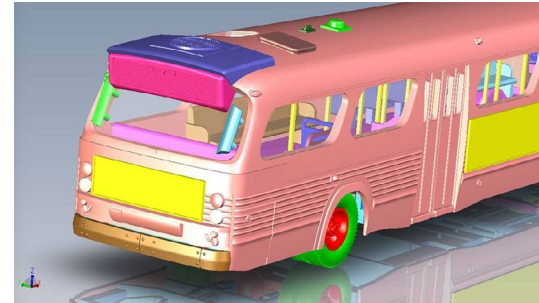

A wood floor maintained the bus's shape. The engine cradle was hung off the back of the roof, resulting in a weight significantly less than competitive city bus designs. Most were powered by Detroit

Diesel 71-series two-stroke engines. A video introduction to the model can be viewed at youtube.com/watch?v=pxF91Sjiz-c.



Also under development at Rapido is a 100-ton 3800 cu. ft. cylindrical hopper with four discharge bays. The HO scale model represents a common Canadian prototype that traveled throughout North America.

They were built with both round and trough loading hatches. Road names on the initial release will include Canadian National (four schemes), Canadian Pacific (three schemes), two Procor schemes, and a single Toronto, Hamilton & Buffalo version. Delivery is expected late this fall.

Rapido has entered the modern intermodal era with the announcement of a Gunderson 53-foot single-unit double-stack well car. At 74 feet in length (over strikers) the well car can carry 20- to 53-foot containers in the well with 40- to 53-foot



HAND PAINTED PRE-PRODUCTION SAMPLE

containers in the top position. The HO scale model is based on a prototype built at Trenton Works, Nova Scotia. The model features a diecast body with injection-molded

plastic running boards, end handrails and brake detail, and metal Macdonald-Cartier knuckle couplers. The trucks are a new 70-ton design with visible springs, separate in-line brake shoes, and 33-inch wheelsets. Six numbers each will be offered for the following road names: BNSF/Hub Group, CN Intermodal (three schemes), Canadian Pacific, CSX Intermodal, J.B. Hunt, Schneider National, and undecorated. Delivery is planned for early 2017.

Each well car will come with two new 53-foot Hyundai high-cube containers with riveted sheet/post sides and optional heater box/fuel tank. Road names on the containers will be randomly selected.

For information on all Rapido products contact a dealer or visit rapidotrains.com.



ScaleTrains.com showed early samples of their forthcoming EMD SD40-2 diesel locomotive at the National Train Show. The HO scale ready-to-run model will be available in the Rivet Counter series as well as their modestly priced Operator series. Both series use body components and basic mechanism from the same tooling, however, the level of factory-applied details is quite different. The Operator series SD40-2 will have LED

headlights and number boards, sectional walkway tread plates, and pre-drilled locations for grab irons, uncoupling levers, and MU cables. The detail items may be purchased in a separate upgrade package to be applied by the modeler.

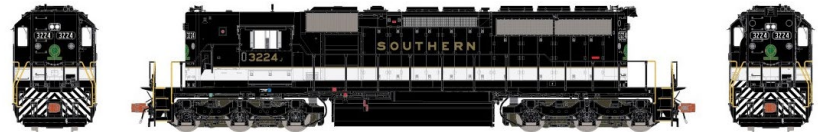

The Rivet Counter SD40-2 has all of the above-mentioned features plus LED class lights and directional headlights, installed wire grab irons, wire lift rings, windshield wipers, snowplows, horns, and trainline hoses. The models will also have see-through steps, traction motors and air ducts, underbody frame rails with separate plumbing, and traction motor cables. Either Hyatt or rotating Timken bearing caps will be applied to the trucks depending on the practice of the prototype road being modeled.



Rivet Counter road names are Burlington Northern, Chessie System, Union Pacific, Southern (with a high hood) and Norfolk Southern. Operator road names are BNSF, CSX, Norfolk Southern

(Horsehead), and Union Pacific. Availability is expected early next year. ScaleTrains.com official Paul Ellis said the first release would be the Rivet Counter version of a Norfolk Southern unit with an Admiral cab. Other road names will follow quickly. For additional information visit scaletrains.com.

Spring Mills Depot is preparing to release an HO scale ready-to-run model of a Baltimore & Ohio class N-34 wagontop covered hopper car. Features include wire grab irons, metal wheelsets,



and Kadee couplers. The thoroughly researched and well-detailed model will be available in six lettering schemes including early- to late-1940 Kuhler (left), late-1940

to mid-1945 wartime Kuhler scheme, 13 Great States scheme, 1953-1955 early billboard scheme, mid-1950s billboard scheme, and 1957-1962 late billboard scheme. Eight road numbers will be available for each scheme. For additional information visit springmillsdepot.com.



Summit USA has released a kit for a small Amtrak station. The HO scale model is based on a prototype structure in Lake Charles, Louisiana. The principal components in the kit are of milled styrene. Additional parts include laser-cut

acrylic, self-adhesive plywood, and illustrated assembly instructions. For additional information visit summit-customcuts.com.



Sylvan Scale Models is selling a cast resin kit that assembles into an HO scale 1946-1951 Seagrave fire truck with an aerial ladder. For additional information

visit sylvanscalemodels.com.



Tangent Scale Models has released a 40-foot PS-1 4900 cu. ft Mini-Hy Cube boxcar as built by Pullman-Standard primarily for hauling home appliances. The accurately detailed HO scale ready-to-run model is produced from all-new tooling.

Special features include correct Barber S-2-A 70-ton roller bearing trucks with 33-inch turned metal wheelsets. Road names include Milwaukee Road with the original 1968 DF2 slogan as seen above.



This photo shows the Burlington road name in the original CB&Q Chinese-red paint scheme from late 1967. These cars were initially built to transport Admiral appliances and lasted into the 1990s in

newsprint paper service on BN. Additional road names include Denver & Rio Grande Western and Illinois Central. An undecorated kit is also available.



Tangent has completed a second production run of its HO scale General American 4180 cu. ft. Airslide covered hopper car. Road specific details

include different roofs, alternate roofwalks, different side post profiles, high and low brake positions, and different ladder and grab iron arrangements. The dimensionally accurate model is available in eight new authentic paint schemes plus an undecorated version and an undecorated kit.

AUGUST NEWS | 24



Road names include Santa Fe in the original 1978 gray, C&O in the road's original Chessie yellow scheme, and a GACX car displaying Brach's Candy.



A car decorated for GACX Westvaco Carbon is also available along with four variations of BNSF buffer cars. Tangent's GA 4180 cars come with appropriate roller

bearing trucks with 36-inch machined metal wheelsets. All Tangent ready-to-run models feature wire grab irons and coupler lift bars, see-through crossover panels and brake platforms, separate air hoses, and Kadee couplers. Three undecorated kits in primer gray are available for cars representing iterations from three eras. For additional information visit tangentscalemodels.com.

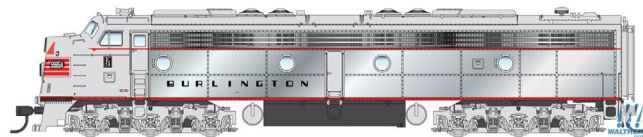

Walthers is booking advance orders for delivery in late January of an EMD EA

passenger diesel. Road names for the ready-to-run Proto series model will be Chicago, Burlington & Quincy (above) and Santa Fe in the red, yellow, and silver warbonnet scheme. Standard DC models will be available, as well as DCC units equipped with SoundTraxx Tsunami sound.



Walthers plans to release a group of

Mainline-series 89-foot channel-side flat cars next month. The newly tooled HO scale ready-to-run model is based on F89F flat cars with C-shaped steel channel side sills. Like the prototype,

AUGUST NEWS | 25

the models will accommodate trailers from 28 to 53 feet in length. The model is equipped with swing couplers that permit operation on 18-inch radius curves, however broader curves are suggested for more reliable operation. Road names will be TTX (brown), TTX (yellow), KTTX, and JTTX.



This 50-foot 100-ton quad open hopper car is scheduled for release this

November. The Walthers Mainline series model will be available decorated for Chicago, Burlington & Quincy; CSX, Denver & Rio Grande Western, Missouri Pacific/Union Pacific, Soo Line, and CRR-Clinchfield. The model comes with appropriate trucks with 36-inch turned metal wheelsets.



Walthers plans to release this Plymouth ML-8 industrial switch engine before the end of this year. The new model has a diecast metal underframe and hood, an etched metal see-through radiator grille, and directional

lights. It will be available for standard DC operation as well as with a SoundTraxx DCC decoder (no sound functions) and CurrentKeeper. In addition to the Santa Fe unit shown here, the Mainline series locomotive will be available decorated for Union Pacific and the U. S. Army Transportation Corps. Unlettered models will be available in black, blue and yellow. For additional information on all Walthers products contact a dealer or visit walthers.com.

Yarmouth Model Works is getting ready to release a kit for this Semet-Solvay AC&F Type 103 tank car later this month.



Components for the HO scale craftsman model include cast resin frame, tank, expansion dome, and detail parts. The dome platform, ladders,

sill steps, and tank anchors are of etched metal. Various wire sizes and plastic details are also included, along with custom decals created for this kit by Black Cat Publishing. Truck frames are included, but not wheelsets or couplers. The kit will be available for sale this month at the St. Louis RPM meet (August 12-13, see Selected Events). For additional information visit elgincar-shops.blogspot.ca/2016/07/ready-for-st-louis.html.

N SCALE PRODUCT NEWS



Athearn is preparing new tooling for an N scale version of the GATX TankTrain. The model will feature photo-etched walkways, manways, and loading apparatus including soft vinyl transfer hoses. The models will be equipped with prototypically accurate 100-ton roller-bearing trucks with 36-inch machined metal wheelsets. Both early and late decorating schemes will be available. Delivery is planned for May 2017.

Additional N scale models coming from Athearn next May include Thrall high-side gondola cars. In addition to the Burlington Northern car shown here, road names will be Santa Fe,



Yankeetown Docks, Commonwealth Edison, Denver & Rio Grande Western, and Union Pacific.

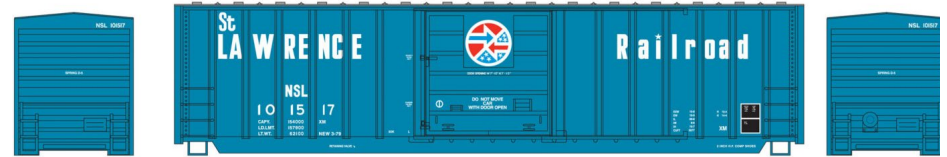

Completing Athearn's May 2017 release of N scale models is a 50-foot Berwick boxcar. Road names will be Detroit, Toledo & Ironton; Bangor & Aroostook, Canadian Pacific, CSX, Grand Trunk Western, Maine Central, Railbox, Wisconsin Central, and St. Lawrence Railroad as shown here. For additional information about Athearn products contact a dealer or visit athearn.com.



Atlas has scheduled the release of an N scale GP35 locomotive during the last quarter of this year. Two road numbers each will be available for Erie Lackawanna, Missouri Pacific, Wabash, Burlington Northern, Pennsylvania Railroad, and Santa Fe. Both standard DC and DCC-equipped models will be available.

Also due late this year is a new release of a twin-bay hopper car with offset sides. Two road numbers will be available for Central of Georgia, Delaware & Hudson, Interstate, CRR-Clinchfield,

AUGUST NEWS | 28



Chesapeake & Ohio, Jersey Central, and Milwaukee Road. The N scale ready-to-run models come with a removable coal load.

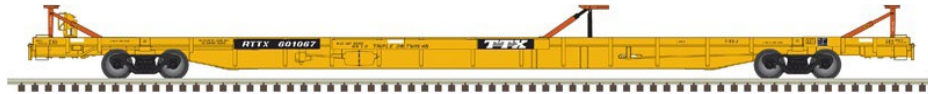

Atlas has set a 2016 fourth-quarter date for the release of N scale F89F 89-foot flat cars. The models feature a diecast metal frame, and BLMA 70-ton trucks with metal wheelsets. Six road numbers each will be available for TTX cars with a choice of deck risers, mid/end hitches (two schemes), or triple hitches, for a total of 24 numbers.



Bachmann Trains showed several new items at the National Train Show including this N scale Baldwin 2-8-0 Consolidation steam locomotive. The ready-to-run model is scheduled for release this December, decorated for Western Pacific (above), New York Central, Norfolk & Western, Western Maryland, and Union Pacific. The locomotive will be available with a SoundTraxx Sound Value decoder.

Bachmann demonstrated this new Pennsylvania GG1 electric locomotive with working pantographs at the National Train Show. The N scale model is scheduled for release late this year. For more

AUGUST NEWS | 29



information on all Bachmann products contact a dealer or visit bachmanntrains.com.



Bluford Shops showed a test shot of a newly tooled 33-foot 8-panel twin-bay open hopper car at the National Train Show.

Features of the N scale ready-to-run model include injection-molded plastic sides, ends, and hopper doors; diecast slope-sheet-hopper bay-center-sill assembly, molded brake tank, valve and air lines; body-mounted brake hose detail, removable body-mounted knuckle couplers, and appropriate trucks with Fox Valley Models metal wheelsets. Three road numbers each will be available for Chesapeake & Ohio, Baltimore & Ohio, Southern Railway, New Haven, PDSX-Penn-Dixie Cement, Pittsburg & Shawmut, and CRR-Clinchfield. A black car with white data circa late-1960s will also be available. Preorders are being accepted now for delivery in the first quarter of 2017. For additional information visit bluford-shops.com.



Fox Valley Models showed test samples of a new N scale Soo Line seven-post boxcar at NTS. The models are based on a

unique prototype Soo Line built at their Fond du Lac Shops beginning in the mid-1960s.



Although the final selection of road names is pending, it is likely that the new ready-to-run model will be available in four different Soo Line schemes.



Additional road names under consideration are Wisconsin Central (they acquired 50 cars from Soo in 1984), Great Northern, Burlington

Northern, BNSF, and Montana Rail Link. For additional information contact a dealer or visit foxvalleymodels.com.

Kato USA plans to release N scale versions of EMD's SDP40F late this year. The model represents Amtrak's first purpose-built diesel locomotive. Based on the framework of the SD40-2 freight engine, the SDP40F was geared for speed and equipped with a pair of steam generators to supply heat and hot water for the passenger trains it would pull.



Kato's EMD SDP40F type I, shown here in Amtrak Phase I paint, represents the locomotive as built in 1973-1974 without front railings and other accoutrements added

when converted to freight service. Kato will also offer this version in Amtrak Phase II paint scheme.



Santa Fe bought and converted several Amtrak SDP40Fs to freight service in 1984.

Modifications included the addition of front porch railings, notched nose, nose/cab headlights, additional roof antennas, cab air conditioning units, and rear-mounted three-chime air horns. They were repainted in the yellow-and-blue version of Santa Fe's famous warbonnet paint scheme, and continued in service for another 15 years. Kato will offer this locomotive in three road numbers.

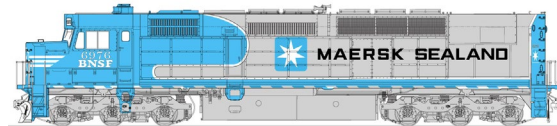

BNSF painted a single SDP40F in a pale-blue warbonnet scheme with a salute to Maersk

Sealand, a global shipping firm and major customer served by BNSF. Kato's production schedule includes BNSF/Maersk No. 6976. For additional information contact a dealer or visit katousa.com.



Micro-Trains Line has announced several new N scale ready-to-run cars including a five-pack of 40-foot Santa Fe boxcars. In addition to the El Capitan slogan shown here, the other four cars in the set are decorated for The Scout, Chief, Super Chief and Grand Canyon. The B side on all of the cars has the Santa Fe straight-line system map.

AUGUST NEWS | 32



Micro-Trains also has a four-pack of black Chesapeake & Ohio 50-foot boxcars. Designed for hauling automobiles, the cars were built with double side doors and a vehicle loading door in the end.



A four-pack of N scale Ortner triple-bay open top hopper cars decorated for Florida East Coast has also been released by Micro-Trains.

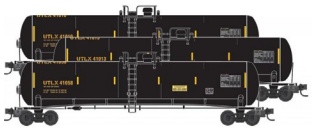

Completing this month's listing of Micro-Trains N scale models is a 56-foot general service tank car decorated for UTLX-Union Tank Car. The models are available in a three-pack. For more information on Micro-Trains Line products contact a

dealer or visit micro-trains.com.



N-Scale Laser is selling kits for 53-foot containers. The six sides of the model are MDF material that has been engraved and laser-cut to size. The insulated smooth-side container shown above with an integrated Carrier refrigeration unit is available with a choice of decals for Maersk Sealand, Crowley, Oceanex, and Evergreen.

Also available is a kit for a fixed pair of 53-foot double-stacked containers. For additional information visit nscalelaser.com.



AUGUST NEWS | 33



weathered brown, and rust (right).

RSLaserKits is selling laser-cut paper for N scale corrugated metal siding and roofing. The paper material is available pre-colored in weathered gray (left),



New N scale structure kits introduced by RSLaserKits include a small stone freight warehouse called S. J. Supply. Components include a pre-colored laser-cut shingle roof, laser-engraved task board walls, and a Tichy chimney. The assembled structure has a footprint of 2 x 6 inches.

Also new is Harris Door Manufacturing, a shallow N scale background structure with a footprint of 1.5 x 8.75 inches. Components include walls and sub-roof of laser-cut task board and micro plywood. Also

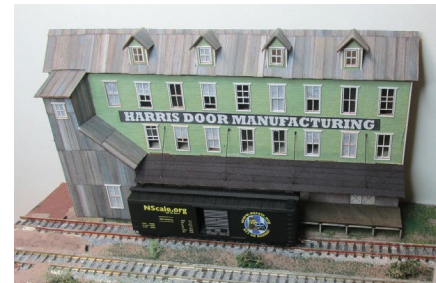

laser-cut paper corrugated roofing and siding, and scribed wood and engraved brick for the lower section of the structure are also included. For additional information visit rslaserkits.com.

Trains By Randy Brown is selling an N scale kit for Tiny's Diner. Components for the kit are cast resin. The assembled kit



has a footprint of 2.2 x 1.43 inches. For more information visit trainsbyrandy-brown.com.



At the National Train Show, **ScaleTrains.com** unveiled their first N scale locomotive; a Union Pacific GTEL 8500 horsepower turbine. Known to railfans and hobbyists as "Big Blow," the three-part

8500-horsepower prototype consists of a leading control A unit, a turbine B unit, and a 24,000-gallon fuel tender. Details on the Rivet Counter series locomotive include factory-applied windshield wipers, wire grab irons and uncoupling levers, and photo-etched metal grilles and walkways. Six road numbers will be available with several road-number specific details. A delivery date is expected to be announced soon. For additional information visit scaletrains.com.



Showcase Miniatures has released several new N scale trucks including the liquid propane gas truck shown here.



Also new is a GMC wrecker. In addition to this short-hood version, the wrecker is available with a long hood. For more information visit showcaseminatures.net.



Walthers plans to release a group of Thrall 48-foot articulated well cars in late November. The N scale models will be available individually and as five-unit sets. The intermodal cars can

carry 20-, 40- and 48-foot containers. Road names will be Santa Fe, CP Rail, SFLC and TTX. For information on all Walthers products contact a dealer or visit walthers.com.

Z SCALE PRODUCT NEWS



Atlas Model Railroad Company has introduced Z scale Super-Flex track. The track uses code 55 rail and is compatible with Atlas N scale rail joiners. Each section is 24 inches long. For more information contact a dealer or visit atlasrr.com.

NEW DECALS, SIGNS AND FINISHING PRODUCTS

New HO scale decals from **David Kohlberg** include a lettering set for Chicago, Burlington & Quincy twin-bay cement hoppers. Also new is a lettering set for Illinois Central Gulf 40-foot Hy-Cube boxcars. The black-and-yellow lettering is intended for an orange car circa 1973. More information, including prototype photos, is available at home.mindspring.com/~paducah.

Rails Unlimited has decals for HO scale Milwaukee Road smooth- and rib-side boxcars. Sheet #1 (above) is designed for 40-foot rib-side boxcars. Sheet #2 covers 40 and 50-foot rib-side and 50-foot smooth-side cars with double doors. For more information visit railsunlimited.ribbonrail.com/Models/decals.html.

Microscale has issued new water-slide decals for Canadian National's E9A Executive Heritage scheme. Also new is a lettering set for Reading Company twin-bay open hopper cars circa 1944-1976. For more information

contact a dealer or visit microscale.com.

Speedwitch Media has HO scale decals for a rare Pacific Fruit Express class R-30-9 reefer rebuilt in 1948. The SP medallion is the usual black and white. The UP shield is also black and white rather than the standard red, white, and blue design. For more information visit speedwitchmedia.com.

San Juan Decals is now selling HO and O scale decals for standard gauge Denver & Rio Grande Western rolling stock. The newest edition is for D&RGW 17000 and 18000 series 70-ton open hopper cars. For more information visit sanjuandecals.com.

i SEND US YOUR PRODUCT ANNOUNCEMENTS

If you are a hobby manufacturer with a product announcement, just [click here](#) and submit your announcement to us. Our web site and free magazine reach continues to grow, so get on board this new media train! ■

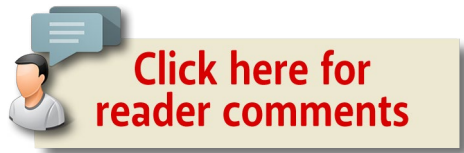

DISCLAIMER

The opinions expressed in this column are those of the writer and do not necessarily reflect the opinion of *Model Railroad Hobbyist* or its sponsors. Every effort is made to provide our readers with accurate and responsible news and information, however, neither *Model Railroad Hobbyist* nor the writer of this column can be held responsible for any inaccuracies or typographical errors that may inadvertently appear in this column.

! BRIEFLY NOTED AT PRESS TIME ...

Caboose Hobbies, holder of the Guinness World Record for the world's largest model train store, has been given notice to vacate their long-time home at 500 South Broadway, Denver Colorado. The property has been sold, and a major development is planned for the area. Although details have not been announced, Caboose Hobbies reports it will reopen in a new, perhaps smaller location, this fall ...

Mask Island has released new HO scale decals for a Rock Island wide-vision caboose and a 40-foot SSW Cotton Belt boxcar with Blue Streak Fast Freight slogan. Also new are decals for diesel switch engines for the Kansas City Terminal and the Northampton & Bath railroads. Details are available at maskislanddecals.com ...

Morning Sun Books has released a digital version of *Trackside Along the Baltimore & Ohio 1957-1958 with Edward P. Griffith*. The book was originally published as a hardback in 1990. Details are available at morningsunbooks.com.

ScaleTrains.com has released a new 24-page catalog that covers the firm's latest HO and N scale items. A printed version is available for \$5.00 including shipping within the contiguous United States. A free online version can be viewed at cdn.shopify.com/s/files/1/0642/8107/files/SXT80255-ST-Catalog-Vol-2.pdf?utm_campaign=Newsletter+07-19-16+2016+HO+%26+N+Scale+Catalog%2C+Volume+2+%28yHbb4n%29&utm_medium=email&ke=cmhiYWxlQGFvbC5jb20%3D&utm_source=Newsletter&7350691731115937440 ...



SELECTED EVENTS

August 2016

(Please note that many events charge a fee. Check individual info website for details.)

CALIFORNIA, BUENA PARK, August 7, California Express Railroadians & Transportation Show at UFCW Hall, 8550 Stanton Avenue. Info at [facebook.com/calexpressbuenapark](https://www.facebook.com/calexpressbuenapark).

CALIFORNIA, SIMI VALLEY, August 27, Santa Susana Depot Swap Meet, 6503 Katherine Road (exit Simi Valley Freeway at Kuehner Drive). Info at santasusannadepot.org.

CALIFORNIA, TEHACHAPI, August 13-14, Tehachapi Train Show sponsored by Tehachapi Loop Model Railroad Club, at Tehachapi Valley Parks and Recreation West Park Gymnasium, 410 West D Street. Info at tlrc.club/model-train-shows.

FLORIDA, THE VILLAGES, August 20-21, Summer Train Expo, at Savannah Center. Info at villagerailclubs.blogspot.com.

ILLINOIS, COLLINSVILLE (metro St. Louis), August 12-13, 10th Annual St. Louis Railroad Prototype Modeler's Meet, hosted by John Golden, Lonnie Bathurst, Dave Roeder, and Dan Kohlberg. Co-sponsored by NMRA Gateway Division, at Gateway Convention Center. Info at icg.home.mindspring.com/rpm/stl-rpm.htm.

INDIANA, MERRILLVILLE, Aug 11-14, Steel Mill Modelers SIG Meet, at Hilton Garden Inn, 7775 Mississippi Street. Membership in SMMSIG is required to attend. Info at smmsig.org.

OHIO, MARION, August 13, Summerail 2016, annual railroad themed multimedia exhibition jointly sponsored by Marion Union Station Association, Cincinnati Railroad Club and Miami Valley Railfans. Info at summerail.com.

PENNSYLVANIA, ALTOONA, August 20-21, 12th Annual N-Scale Weekend, at Jaffa Shrine Center, at Broad Avenue and 22nd Street. n-scaleweekend.com.

September 2016

CANADA, QUEBEC, MONTREAL, September 24-25, Montreal Model Train Exposition, at Sun Youth Organization Centre, 4251 St. Urbain Street. Info at montrealmodeltrainexposition.com.

CALIFORNIA, CULVER CITY, September 21-25, NMRA Pacific Southwest Region LA Junction Convention, at Double Tree Hotel LA Westside, 6161 West Centinela Avenue. Info at psrconvention.org/lajunction.

CALIFORNIA, LOS ANGELES, September 25, Self-Guided Tour of area layouts. Info at groups.yahoo.com/neo/groups/Model_Railroads_Of_Southern_California/info.

INDIANA, INDIANAPOLIS, September 22-24, 48th National O Convention, at Wyndham Indianapolis West Hotel, 2544 Executive Drive. Info from Kimberly Ryker at kim.ryker@yahoo.com.

INDIANA, NOTRE DAME, September 30-October 1, NMRA Michiana Division Modeling Like a PROTOTYPE Education and Training Conference, at Morris Inn & Conference Center on Notre Dame campus. Info at michiana-nmra.org.

MAINE, AUGUSTA, Sept. 7-10, 36th National Narrow Gauge Convention. Info at nngc2016.org.

MICHIGAN, HASTINGS, September 17, 3rd Annual Hastings Train Show and Swap Meet, Barry Expo Center, 1350 N. M-37 Highway. Info at bcmrrc.net.

SELECTED EVENTS | 3

MISSOURI, WARRENTON, August 6, Train Show and Swap Meet sponsored by Central Missouri Railroad Association, at Warrenton Elks Lodge, 1101 East Veterans Memorial Parkway. Info at cmrraclub.com.

NEW JERSEY, HILLSBOROUGH, October 1, NMRA Garden State Division Fall Meet, at Hillsborough Township Municipal Building. Info at nergds.com/upcoming.html.

NORTH CAROLINA, DENVER, September 23-25: HO modular layout display by The Sipping & Switching Society of North Carolina. Salem United Methodist Church, 378 N. Pilot Knob Rd, Denver NC 28037. Info at groups.yahoo.com/neo/groups/SandSSofNC/info.

VIRGINIA, FREDERICKSBURG, September 30-October 1 (Dates changed), Mid-Atlantic Prototype Modelers Meet, at Wingate by Wyndham Hotel, 20 Sanford Drive. Info at marpm.org.

Future 2016, by location

CANADA, ALBERTA, EDMONTON, October 22, Great Edmonton Model Train Show, sponsored by the Mainline Model Railroaders Fellowship, at Central Lions Seniors Recreation Centre, 11113 113 Street. Info at mmrf.ab.ca/events.shtml.

CANADA, BRITISH COLUMBIA, VANCOUVER, November 5-6, 34th Vancouver Train Expo, at PNE Forum, 2901 East Hastings Street. Info at vancouvertrainexpo.ca.

CANADA, ONTARIO, BRAMPTON, October 1-2, Model Railway Show, at Brampton Fair Grounds, 12942 Heart Lake Road. Info at bramptonmodelrailwayshow.com.

CALIFORNIA, SAN PEDRO, October 15-16, Open House & Swap Meet, sponsored by Belmont Shore Railroad Club, at 3601 South Gaffey Street, Building 824. Info at belmontshorerr.com.

SELECTED EVENTS | 4

ILLINOIS, CHICAGO, October 1-2, Brass Expo, a juried show limited to pre-submitted items including brass models and items relevant to brass models. At The Westin Hotel (Chicago North Shore), 601 N. Milwaukee Ave. Wheeling, IL 60090. Info at brassexpo.com.

ILLINOIS, LISLE, October 20-22, RPM Chicagoland (formerly Naperville RPM), hosted by Mike Skibbe, at Sheraton Hotel. Info at rpmconference.com.

IOWA, HAMPTON, October 30 5th Annual North Central Iowa Model Railroad Show & Sale, at Franklin County Convention Center, 1008 Cental Avenue West. Request info at eastsidetrains@gmail.com.

MASSACHUSETTS, WAKEFIELD, October 8-10, Model Railroad Show & Open House, sponsored by the North Shore Model Railroad Club. Show October 8 at American Civic Center, 465 Main Street. Club open house Oct 9-10 at 404 Main Street (rear). Info from Joe Greene at info@nsmrc.org.

MICHIGAN, SALINE, November 27, Southeast Michigan Model Train Show and Sale, sponsored by Rails on Wheels, at Washtenaw Farm Council Grounds, 5055 Ann Arbor-Saline Road. Info from Jeff at wab2ndops@yahoo.com.

MISSOURI, JEFFERSON CITY, October 6-9, Missouri Pacific Historical Society Annual Meeting, includes modeling clinics and swap meet. Info at mopac.org/annual-convention/110-2016-jefferson-city-mo.

MISSOURI, SEDALIA, October 29, Sedalia Rails Train Show, sponsored by Pettis County Historical Society, at Liberty Park Convention Hall, 1500 3rd Street at Highway 65. Info from Ken Bird at klbird@embarqmail.com.

NORTH CAROLINA, DURHAM, October 20-23, Mid-Eastern Region Fall Convention, sponsored by NMRA Carolina Piedmont Division, at Marriott at Research Triangle Park, 4700 Guardian Drive. Info at mer2016.org.

SELECTED EVENTS | 5

PENNSYLVANIA, ALLENTOWN, November 12-13, First Frost Train Meet Show and Sale, at Allentown Fairgrounds, Agricultural Hall. Info at allentowntrainmeet.com.

TEXAS, FOREST HILL, October 8-9, Texas Western Train Show, at Forest Hill Civic Center, 6901 Wichita Street. Info at twmrc.org.

VIRGINIA, VIRGINIA BEACH, October 8-9, 27th Annual Train Show & Sale, at Virginia Beach Convention Center, 1000 19th Street, sponsored by Tidewater Division Model Railroaders. Info at nmra-mer-tidewater.org.

Future 2017 and beyond (by location)

AUSTRALIA, VICTORIA, GEELONG, April 14-16, 2017, 13th Annual Australian Narrow Gauge Convention. Info at austnarrowgaugeconvention.com.

COLORADO, DENVER, August 30-September 2, 2017, National Narrow Gauge Convention, at Marriott Denver Tech Center Hotel. Info at 37nngc.com.

FLORIDA, ORLANDO, July 30-Aug 6, 2017, NMRA National Convention. Info at nmra2017.org.

MISSOURI, KANSAS CITY, August 5-12, 2018, NMRA National Convention. Info at kc2018.org.

SOUTH CAROLINA, EASLEY, February 10-11, 2017, Annual Train Show, sponsored by Central Railway Model & Historical Association at (new location) Impact Center, Rock Springs Church 207 Rock Springs Road. Info at crmha.org. ■



**Click here for
reader comments**

Get the first 50 issues of
**Model Railroad
Hobbyist magazine™**

On a data DVD for \$10!

Send me one!

(Sold by Model Trains Video)

*Includes a coupon
good for \$10 off on
TrainMasters TV*

*Over 5000
pages of
how-to
information
on model
railroading*



**Save
yourself
endless
hours of
downloading**

Clickable advertiser index – 1

[Accu-Lites](#)
[American Ltd \(San Juan\)](#)
[Amherst Railway Society](#)
[ANE Models](#)
[Archer Fine Transfers](#)
[Athearn](#)
[Atlas Model Railroad Co.](#)
[Bachmann](#)
[Bachus](#)
[Backdrop Junction](#)
[Berrett Hill Trains](#)
[Black Cat Publishing](#)
[Blair Line](#)
[Bowser](#)
[Canyon Creek Scenics](#)
[Clever Models](#)
[Coffman Graphics](#)
[Credit Valley Railway](#)
[DCC Hobby Supply](#)
[Digitrax \(2 page spread\)](#)
[ESU LokSound](#)
[Fast Tracks](#)
[Fifer Hobby Supply](#)
[Fox Valley Models](#)
[George's Trains](#)
[GLX Scale Models](#)
[Great Decals](#)
[HO Diesel Supply](#)
[Iowa Scaled Engineering](#)
[Iwata-Medea](#)
[Jelsma Graphics](#)
[Jim's Track Plans](#)

[KC's Workshop](#)
[Ken Patterson.com](#)
[Lights 4 Models](#)
[Litchfield Station](#)
[Logic Rail Technologies](#)
[Main Street Heritage Models](#)
[Missouri Locomotive Co.](#)
[Model Railroad Benchwork \(1\)](#)
[Model Railroad Benchwork \(2\)](#)
[Monster Modelworks](#)
[Motrak Models](#)
[Mountain Subdivision Hobbies](#)
[MRH Store \(1\)](#)
[MRH Store \(2\)](#)
[MRH Store \(3\)](#)
[MRH Store \(4\)](#)
[Mt. Albert Scale Lumber](#)
[Nano-Oil](#)
[National Narrow Gauge](#)
[NCE \(2 page spread\)](#)
[Nick & Nora Design](#)
[North American Railcar Co.](#)
[Oak Hill MRR Track Supply](#)
[Pre-Size Model Specialities](#)
[Precision Design Co.](#)
[Railmaster Hobbies](#)
[Rapido \(1\)](#)
[Rapido \(2\)](#)
[Ring Engineering \(1\)](#)
[Ring Engineering \(2\)](#)
[Rulers-of-the-World](#)
[Rusty Stumps](#)

Clickable advertiser index – 2

[Scale Trains](#)
[Scale Photo Etch](#)
[Scotty Mason Show](#)
[Soundtraxx \(Blackstone\)](#)
[Southern Digital](#)
[Streamlined Backshop Services](#)
[TAM Valley Depot](#)
[Tony's Train Exchange](#)
[Trainfest 2016](#)

[TrainMaster Model Trains](#)
[TrainMasters TV \(1\)](#)
[TrainMasters TV \(2\)](#)
[TrainMasters TV \(3\)](#)
[Traintek](#)
[TSG Multimedia](#)
[Westerfield Models](#)
[Yankee Dabblers](#)
[Yarmouth Model Works](#)

Clickable "other" index

[Other – Cover](#)
[Other – Derailments](#)
[Other – Hobby Marketplace](#)
[Other – MRH Sponsors](#)
[Other – Contents](#)

DOWNLOAD ISSUE



DOWNLOAD PORTRAIT



DOWNLOAD LANDSCAPE



REVERSE RUNNING

commentary

JOE FUGATE



[Click here for reader comments](#)

LIMITED-RUN MODEL FRUSTRATION?



I RECENTLY ASKED MRH FORUM MEMBERS TO SHARE some of their greatest hobby frustrations. One frustration that came up frequently was limited-run models. While I understand the frustration of missing out on a model you want, let's explore what is needed for manufacturers to end limited-run models.

For it to be practical to make a given model forever, each model needs to as generic as possible, to allow making the model ad

▶ **STEPPING OUTSIDE THE BOX WITH A CONTRARY VIEW**

infinitum at a profit. This means more cast-on parts and fewer details overall. These generic models might even be cheaper, in that case!

Let's not forget one very road-specific type of rolling stock: cabooses. Because cabooses tend to be so specialized by road, to do cabooses that always sell, manufacturers will need to drop the road-specific details and do generic cabooses that always sell instead.

In short, for manufacturers to stop making limited-run models, we need to go back to the "Blue Box" days with fewer specific models available and less-detailed generic models always on the shelf. By the time you invest in dozens of road-specific detail parts and likewise spend a few weeks adding all those details (and likely doing a repaint, too), that generic model is not so cheap any more.

Sure, it's not fun when the specific model comes out but you're flat broke. Or worse yet, you just miss the release entirely. However, going back to days of generic models always on the shelf isn't the answer, because that means a lot fewer small-run specific models.

There is nothing stopping you from kitbashing models *that are readily available* – that hasn't changed, even with more road-specific limited runs being done. Ending limited runs and going back to always-available generic models means kitbashing would likely become your only choice again for many models.

Remember today we have things like eBay or the HO yard sale on the web, so you may still locate one of the limited-run models for sale later.

Look at the lead photo to this month's Reverse Running. That is essentially a "stock" limited-run HO Athearn SD40T-2, weathered by Ralph Renzetti for me. I can't imagine a generic "Blue Box" tunnel motor looking this good, even with Ralph's fabulous weathering.

Be careful what you wish for. If we ditch the limited-run concept, then kiss many of today's highly detailed models goodbye. Get out your kitbashing tools and supplies: you're going to need them in a world without limited-run models. ☑



DERAILMENTS



THE GREAT STEAMPUNK RACE

Here is a somewhat fantastic futuristic video about two hopped-up steam locos that race each other. Talk about steam speed with an amazing course that will curl your toes ... here's the situation set up:

“Only the best two of the racing steam trains have reached the final. Red Arrow accepts a challenge from Iron Shark. The black villain is ready to do almost anything just to cross the finish line first. But has he underestimated his opponent?”

► BIZARRE FACTS AND HUMOR (SUPPOSEDLY)

YOU MIGHT BE A RAILFAN IF ...

- On your train-chasing outings, your four food groups are: McDonalds, Taco Bell, Pizza Hut, and Mr. Donut.
- The sound of a K5LA airhorn off in the distance does more for you than a double-shot of Prozac and Red Bull.
- You have these great moments in your personal history: Learning to ride a bike, graduating from high school, and your first photograph of foreign road motive power.
- Your cat's name is “Chessie.” ■

💰 GET PAID ...

If you're the first to submit a bit of good humor or bizarre facts and we use it, it's worth \$25! Just send to derailments@mrhmag.com ■

Coming next issue ...

- Neil Schofield kitbashes a Bowser Conrail C636
- Tools: Pliers and cutters
- Making photographic backdrops
- Building a C&EI boom car
- Track cleaning the easy way
- And lots, *lots* more!

 [Click here for reader comments](#)

