

HAVING FUN WITH TRAINS

NOVEMBER 2016 | FREE

MRH

MODEL RAILROAD HOBBYIST

ALSO:

- Actor Michael Gross interview
 - Build a wood pumphouse
 - Kitbash an SP switcher
 - 2016 Narrow Gauge Conv. report
 - High-tech scratchbuilding
- ... and lots more inside!*

Andy Rubbo's Pennsy: New York Division » **READ NOW**



STANDARD EDITION | PORTRAIT



DOWNLOAD

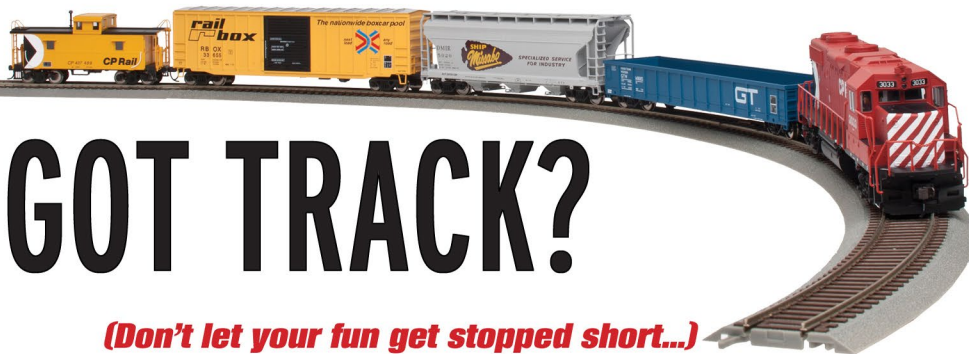

GOT TRACK?

(Don't let your fun get stopped short...)

ATLAS HAS PLENTY!

N SCALE TRACK



N Code 80



N Code 55

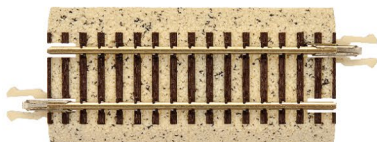

N True-Track®

H0 SCALE TRACK



H0 True-Track®



H0 Code 83



H0 Code 100

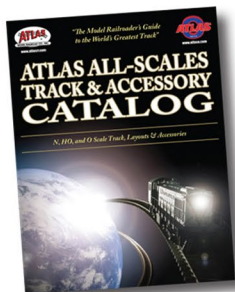

**FIND A
DEALER NOW!**

For more information visit
www.atlasrr.com, or call
 1-800-872-2521 and request an
 Atlas All Scales Track and
 Accessory Catalog.





STAFF CREDITS

Front cover: In this issue we take an in-depth look at Andy Rubbo's Pennsy New York Division layout and how you too can build a realistic prototype-based railroad.



ISSN 2152-7423

Editorial Staff

Joe D. Fugate, Publisher and Editor

Don Hanley, Assistant Editor

Production

Patty Fugate, Pasteup and Layout

Joe Brugger, Copy Editing

Mike Dodd, Copy Editing

Technical Assistant

Jeff Shultz

Advertising

Les Halmos, Account Manager

Daniel Nava, Advertising Assistant

Jean-François Delisle, Marketing Assistant

Columnists

Richard Bale, News and events

Jeff Shultz, News and events

Les Halmos, Modular railroading

Larry Smith, Narrow Gauge/Shortlines

Bruce Petrarca, DCC

Ken Patterson, Reporter at large

Special Correspondents

Joe Brugger, Questions & answers

Charlie Comstock, Contributing editor

Issue password: Nov2016

Published for the glory of God. [What's this?](#)



MRH SPONSORS

A - E



acculites.com



americanlimitedmodels.com



railroadhobbyshow.com



anemodel.com



archertransfers.com



athearn.com



www.atlasrr.com



bachmanntrains.com



bachrus.com



backdropjunction.com

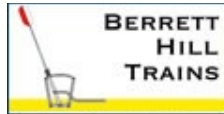

berrethill.com/trains



blairline.com



bowser-trains.com



coffmaneng.com



cvrco.com



www.digitrax.com



esu.eu/en

[Vendors: Get your clickable logo here ...](#)

MRH SPONSORS | 2

F - R



www.handlaidtrack.com



foxvalleymodels.com



glxscalemodels.com



www.iascaled.com



iwata-medea.com



litchfieldstation.com



micromark.com



moloco.biz



model-trains-video.com



modelrectifier.com



monstermodelworks.com



stores.ebay.com/Motrak-Models



mtalbert.com



ncedcc.com



nickandnoradesigns.com



nwhs.org



www.pwrs.ca/main.php



railmasterhobbies.com



rapidotrains.com



ringengineering.com



rustystumps.com

[Vendors: Get your clickable logo here ...](#)

MRH SPONSORS | 3

S - Z



sanjuancarco.com



scaletrains.com



selectmodelrailroads.com



signaturepress.com



soundtraxx.com



sodigi.com



sbs4dcc.com



tamvalleydepot.com



sbs4dcc.com



tonystains.com



trainmastermodels.com



traintekllc.com



tsgmultimedia.com



tsgmultimedia.com



yankeedabblers.com

[Vendors: Get your clickable logo here ...](#)

Looking for something? Check the MRH Marketplace!

The screenshot shows the MRH Marketplace website interface. At the top, it says "MRH MARKETPLACE | 2". Below this, there are several vendor listings and advertisements:

- Westerfield:** "New Available Again KIT #5761/5762 PRR GLA Modernized Hopper. Check our Website For List of Chosen Kits. westerfieldmodels.com"
- Did you know MRH subscribers get FREE BONUSES? Click to see more now - it's free!**
- OPEN HOUSE PORTES OUVERTES:** November 16-17, 26-27 November. www.mrh.com
- Click here for more information:** NCLP # 20165 box car. www.clevertmodels.net
- TAM Industries:** America's Historic Main Street Architecture. www.tamindustries.com
- MAINFREET:** www.maintreet.com
- CLEVER:** www.clevertmodels.net
- Yankee Dabblers:** yankeedabblers.com
- Yarmouth Model Works:** www.yarmouthmodelworks.com

Take me there!

MAKE MODEL RAILROADING *Come Alive*

— AMTRAK TRAIN SET —



NEW PAINT SCHEMES

FROM VINTAGE TO MODERN ERA, WE HAVE THE RIGHT SET FOR YOU

Atheam train sets return in 2016 as part of our new Roundhouse line. A wide variety of eras and railroads will be offered with an emphasis on fun. We are creating products for both beginners and experienced modelers alike.

TRAIN SETS: \$219.⁹⁹

- RND14750 HO Streamliner Train Set, Amtrak
- RND14751 HO Streamliner Train Set, PRR
- RND14262 HO GP38-2 Iron Horse Train Set, CN Web Address
- RND14263 HO GP38-2 Iron Horse Train Set, KCS Retro Belle (New Road Name)
- RND14266 HO GP38-2 Iron Horse Train Set, CSX "How Tomorrow Moves"
- RND14267 HO GP50 Iron Horse Train Set, UP

TRAIN SETS: \$239.⁹⁹

- RND14265 HO GP50 First Responder Train Set, BNSF Fire Train, Firetruck Included
- RND14264 HO GP38-2 First Responder Train Set, NS Safety Training, Firetruck Included



Visit atheam.com for more details!

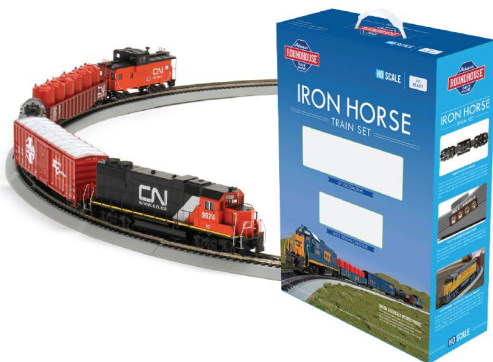

HORIZON
H O B B Y

VISIT
Your Local Retailer

CLICK
Atheam.com

CALL
1.800.338.4639

SERIOUS FUN[™]

©2016 Horizon Hobby, LLC. Atheam, Genesis, Ready To Roll, Trains in Miniature, Serious Fun and the Horizon Hobby logo are trademarks or registered trademarks of Horizon Hobby, LLC. The Union Pacific mark and other marks owned by Union Pacific are made under trademark license from Union Pacific Railroad Company. All other trademarks, service marks and logos are property of their respective owners. Final models may vary slightly from photos shown. 53395

• INDEX

• TABLE OF CONTENTS



TABLE OF CONTENTS

FEATURES

Pennsylvania RR, New York Division

ROBERT SCHLEICHER and ANDY RUBBO

A great prototype-based layout example

.....



Supplement: Easy real railroads how-to

ROBERT SCHLEICHER

Learn the ropes on doing a proto-based layout

.....



Build a 19th-century pump house

DAVID KARKOSKI

Model this turn-of-the-century wood structure

.....



Kitbash an SP SW900E switcher

KOOS FOCKENS

A new stack and lighting cluster for a rebuild

.....



2016 National Narrow Gauge convention

JOHN HUNTZINGER

Highlights from the narrow gauge convention in Maine

.....



ALSO: MRH Marketplace | Subscriber extras

TABLE OF CONTENTS | 2

COLUMNS

MRH Q-A-T: Handling grain, car spots, ...

compiled by JOE BRUGGER

Getting Real: Building Bagby Hotel

JACK BURGESS

What's Neat: Michael Gross interview, shaking paint, ...

KEN PATTERSON

Imagineering: Collaborative design

ROB CLARK

Photo feature: Yes, it's a model

compiled by DON HANLEY

Derailments: Bizarre facts & humor

compiled by the MRH STAFF

NEWS and EDITORIAL

Publisher's Musings: What would I do different?

JOE FUGATE

News & Events: November 2016

RICHARD BALE & JEFF SHULTZ

Reverse Running: Learning too much about modern

JOE FUGATE

ADVERTISEMENT

HEAR THE DIFFERENCE... IN N SCALE



WWW.SCALETRAINS.COM



- Road Number Specific ScaleTrains
- All-new locomotive
 - Road number specific details
 - Numerous separately-applied detail parts including grab irons
 - LED headlights and numberboards
 - Both "A" and "B" units powered
 - Photo etched metal grilles and walkways
 - And much more...

Watch Now

SCALETRAINS.COM

AVAILABLE LATE 2016

Preorder Now



Scene and photography by Ken J Johnson
First test model shown

© 2016 ScaleTrains.com, Inc. ScaleTrains.com, Rivet Counter, and respective logos are trademarks of ScaleTrains.com, Inc.

Scaletrains.com, Inc. 7598 Highway 411 Benton, TN 37307 844-9TRAINS 844-987-2467 International 423-299-3689

• INDEX

• TABLE OF CONTENTS



PUBLISHER'S MUSINGS

editorial

JOE FUGATE



Click here for
reader comments

WHAT WOULD I DO DIFFERENTLY ON THE NEXT LAYOUT?

MRH AND TRAINMASTERS TV HAVE STARTED a new layout project to be a featured video series on the 2017 season of TMTV. There will also be several construction projects for this layout coming to the pages of MRH in 2017 as well. It's turning out to be a fun project: see this issue's [Reverse Running](#) for how it might actually be *too* fun!

Working on this project and building a new layout from the ground up using TOMA (The "One Module" Approach) methods has got me thinking about how I would approach building my Siskiyou Line layout if I were starting over.

A lot has changed in the methods and approaches to building a layout since I started my Siskiyou Line 25 years ago. I thought it might be helpful to discuss some of what I would do differently the next time I built a layout.

But before I get into that, let me add that if I were starting over, I would still model the SP Siskiyou Line in the 1980s. While I do mention in this issue's Reverse Running column that modeling modern era railroading has turned out to be great fun (and pretty tempting),

PUBLISHER'S MUSINGS | 2

I still am very sold on my chosen prototype and era for my own home layout.

I have to credit the Layout Design Special Interest Group (LDSIG: see ldsig.org for more) with helping me focus on a layout subject that has turned out to be deeply satisfying. The LDSIG recommends you go back to what got you interested in trains in the first place if you want to determine what drives your passion for the hobby and what is likely to be the most satisfying.

In my case, growing up next to the SP Siskiyou Line in Southern Oregon was it for me. Once I decided to model the prototype that got me interested in trains to begin with, I've found my passion for the hobby has not waned, even though I also do model trains as my full time job too.

ADVERTISEMENT



1st choice for model railway supplies and service.

Expedited mail service available across North America.

Click to visit:
WWW.CVRCO.COM
1 800 464 1730



• INDEX

• TABLE OF CONTENTS

MRH SECOND ANNUAL "ONE MODULE" CHALLENGE CONTEST

ENTRY DEADLINE: January 31, 2017

Goal: Design the first "module section" for a sectional home layout design.

Hypothetical room is 10' x 14' – 2'x8' closet can be used; window can be covered.

Note: This is a sectional home layout design, no modular standard required.

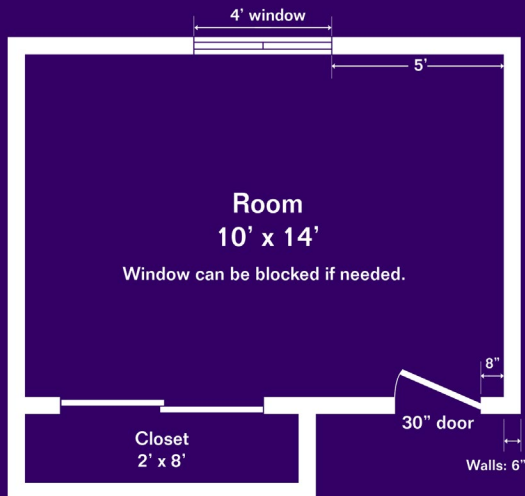

CONTEST RULES

- Modules can be any size or shape but must fit through the room door (7'-6" tall and 30" wide) without damage or pinching your fingers. Plan can have any number of modules.
- Scale: From Z to O, using any track gauge combination.
- Module section must connect to a temporary staging yard module on at least one end. A staging yard must have at least three yard tracks.
- Rough in the outlines of any other layout module sections to be built for the entire room. No track plan required, just an outline of the modules in the room is sufficient. Bonus points awarded for [showing a module construction progress plan](#).
- Modules can follow a standard or not. Custom sections are okay.
- Module support method / height up to you, but please describe.
- Innovative approaches get extra points: please describe and illustrate if possible.
- Include a cost estimate for the module. There is no need to actually build anything, this is a design contest only. Do be as comprehensive as possible in the cost estimate: the hypothetical goal is a completely finished, operational module.
- The best submissions will be published, so extra points are awarded for quality text, illustrations, photos and captions. Winners get a bonus payment rate.

SUBMIT ENTRY (Choose "Contest Entry")

www.SBS4DCC.com

DCC specialties
INNOVATION FOR DCC

MRC
Model Recifier Corporation

ACCUTRACK II
SPEEDOMETER

SPROG DCC
the DCC Programmer and Control Family

Digital plus
by Lenz

TAM VALLEY DEPOT
Great Electronics for Great Model Railroads

TEAM DIGITAL, LLC
Improving the world of DCC

N - HO - HO3 Scale Trains



**COMING SOON
IN HO SCALE!**



We plan to produce an HO Scale version of our very popular Mt. Albert Lumber Yard kit later this year. Please watch our website and Facebook page for more details.

PUBLISHER'S MUSINGS | 3

Given that I would still do the 1980's Siskiyou Line again if I were starting over on a new layout, what would I do different, then?

The "one module" approach we're using on the new "Start small, THINK BIG" TOMA video series has great appeal to me. I'm approaching retirement age and the topic of downsizing to a home that's totally paid off (with no house payments) is sounding good.

With TOMA, you can upsize easily, and you can downsize easily too. With a monolithic layout built using L-girder benchwork, it pretty much all would come out if we were to sell our current house. Unfortunately, houses with layouts don't sell well.

What I also really like about TOMA is being able to build a layout at the workbench in comfort. I can build an A-frame (or rotisserie as it's now being called) that allows rotating the module to any angle while working on it. As I get older, not having to crawl

CANADA 150



NORTH AMERICAN RAILCAR CORPORATION КОМПАНИЈА ЗА ПРОИЗВОДСТВО И ПРОЈЕКТИРАЊЕ РАЈКАРА



In 2017, Canada will celebrate the 150th anniversary of Confederation.

**Canadian National
(CNWX)
1867 - 2017**



**Government of Canada 4-Bay Cylindrical Hoppers
Two Car Commemorative Sets** (Officially Authorized)



CANADA 150
1867 - 2017



**Canadian Pacific
(CPWX)
1867 - 2017**

**COMING
Spring 2017**



CLICK HERE FOR

HO Scale

CLICK HERE FOR

N Scale

CLICK HERE FOR

Auth. Dealers

* NARC Cars are sold exclusively through

Pacific Western Rail Systems

* To celebrate Canada's 150th Anniversary, PWRS will make these cars available in select hobby stores across Canada.

• INDEX

• TABLE OF CONTENTS

PUBLISHER'S MUSINGS | 4

around under the layout to wire it or install switch machines sounds really nice.

I also like the idea of building one module to “completion” at a time rather than doing all the benchwork first, then all the track, then all the wiring, etc. The completion level doesn't have to be every little detail, but I can see great value in going through the scenery stage enough that the messy work is done.

I've been giving TOMA construction some thought as well. I'm thinking that using lightweight methods would have a lot of advantages so the TOMA sections can be moved later without needing a fork lift. Thinking light covers everything from benchwork to using very lightweight plaster for the scenery.

Finally, jig-built turnout fixtures (or ties like the Central Valley turnout ties for my poor man's jig method) were not commonly available when I started my layout in 1991. A new layout would use all jig-built turnouts.

These are just some of my thoughts on what I would do different the next time. There's more – maybe I'll discuss that in a future editorial.

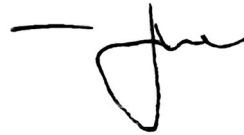

MRH staff note: Bruce Petrarca's father passed away recently and we gave him the month off to focus on more important family needs. His DCC column will be back next month.



[Click here for reader comments](#)

Publisher's Musings continue on the next page with some additional notes ...

ADVERTISEMENT

WORKING HIGH DITCH LIGHTS ON A BUDGET MODEL



CLICK HERE FOR MORE INFO.

• INDEX

• TABLE OF CONTENTS

Other notes - MRH 2016 Survey, modeling scales

Here are the scale preferences of our readers from our recently concluded 2016 reader survey. The statistical validity is +/- 2.5% with a 95% certainty.

MRH 2106 Survey: Readership by scale

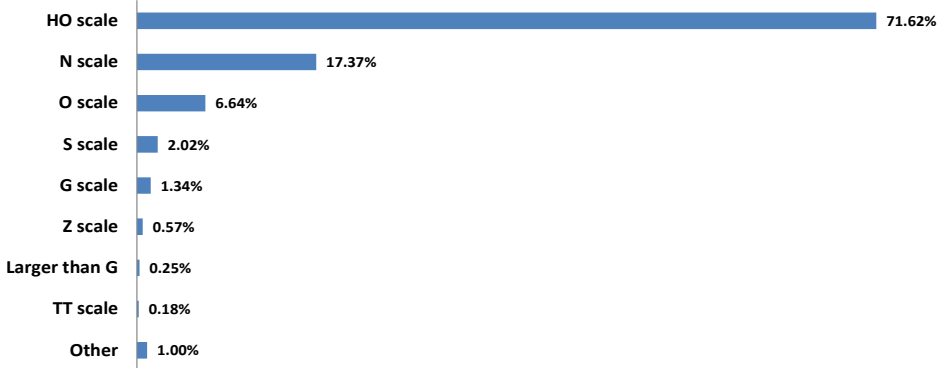

Common other responses: OO (1:76), 2mm finescale (1:152), HOn2-1/2 (1:80), Number 1 scale (1:32)

MRH 2016 Survey: Readers' other scales of interest

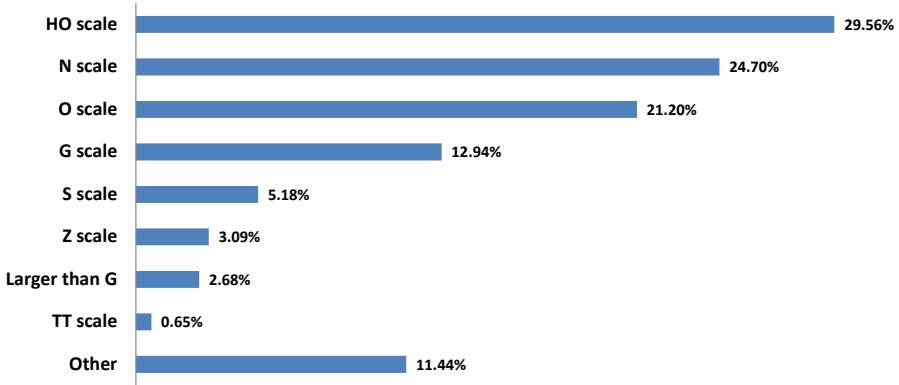

Common other responses: No other scales, build plastic cars/planes/tanks/ships, computer train simulators, OO scale (1:76)

In addition to their primary scale of interest, we also asked if they had any secondary scale interests. Interestingly, the secondary scale interest (second chart) is strong for HO, N, O, and G – with a fancy to S, Z, and G present too. ■



Click to learn more

READING COMPANY #1067
Item No. 66008



NOW WITH DITCH LIGHTS!

EMD SD70ACe IN FIVE NEW ROADNAMES

Bachmann has completed its collection of Norfolk Southern's 30th anniversary commemorative SD70ACe diesels with five new heritage paint schemes. Our DCC Sound Value-Equipped SD70ACe features the Sound Value *SoundTraxx*® diesel sound package with prototypical prime mover, 3 air horns, and bell—all in 16-bit polyphonic sound. These new paint schemes have been updated with operating ditch lights. Visit your favorite hobby dealer to see and hear what make these heritage SD70ACe engines a Sound Value!

Features include:

- DCC sound-equipped
- dual-mode NMRA-compliant decoder
- NEW! operating ditch lights
- can motor with dual brass flywheels
- all-wheel drive and electrical pickup
- operating headlights with dimming function
- E-Z Mate® Mark II couplers

SHIPPING NOW! MSRP \$319.00 each



ILLINOIS TERMINAL #1072
Item No. 66006



PENN CENTRAL #1073
Item No. 66007

Click to learn more



SAVANNAH & ATLANTA #1065
Item No. 66009



DELAWARE, LACKAWANNA
& WESTERN #1074
Item No. 66010

Click to learn more



Bachmann Industries, Inc. • 1400 East Erie Avenue • Philadelphia, PA 19124 USA • www.bachmanntrains.com

Click to learn more.



LAST ISSUE'S RATINGS

The five top-rated articles in the [October 2016 issue](#) of *Model Railroad Hobbyist* are:

- 4.7 What's Neat: St. Louis Railroad Prototype Modelers Meet
- 4.6 Cleveland Flats switching module
- 4.6 Getting Real: Hot boxes
- 4.6 Tricks with SMD LED headlights
- 4.5 DCC Impulses: Five years of columns

Issue overall: **4.5**

Please rate the articles! Click the reader comments button on each article and select the star rating you think each article deserves. Thanks! ■

ADVERTISEMENT

WAY TO GO, TRAINTEK!
Already great prices and NOW ...
FREE SHIPPING ON ORDERS OF \$79 or more*

Start saving now

*some exclusions apply

ADVERTISEMENT

Backdrop Junction
 Your Stop for Railroad Backdrops

Click Here ↓

For the Finest in Custom Designed Backdrops

www.backdropjunction.com

Bowser

HO Ready to Run 53' "RAF53C" Spine Cars

The spine cars are one of the most recognizable freight cars on the rails today. Named after their simple, spine-like appearance, these versatile cars carry anything from highway trailers, to international, corrugated containers. Built in late 1997 by Trinity Rail for TTX, these 5-Unit Spine Car's feature TTAX reporting marks. While very similar to other 53' Trinity Spine Cars, the "RAF53C" class boasts nearly 250, 5-car sets on the TTX roster.

Features

- Ready-To-Run
- Die-Cast Metal & Plastic
- Fine-Scale Detail All Around
- Chemically Etched Walkways
- Accurately Painted/Printed
- Collapsed or Raised Hitches!

Trinity "RAF33"
3 Unit Spine Car Set

- MSRP \$99.95
- #41575 road #355006
 - #41576 road #355085
 - #41577 road #355088
 - #41578 road #355062
 - #41579 road #355112
 - #41580 road #355133

Trinity "RAF53C" 5 Unit Spine Car Set
MSRP \$169.95

- #41581 road #555003
- #41582 road #555018
- #41583 road #555065
- #41584 road #555101
- #41585 road #555109
- #41586 road #555127

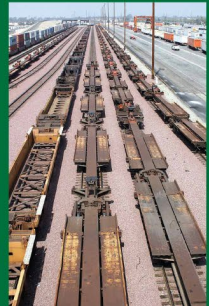

RAF53C 5 Unit
Trinity Spine car

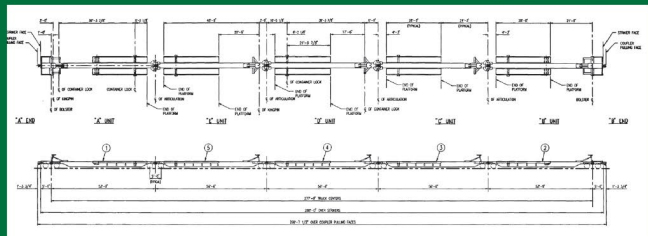

RAF33 3 Unit
Trinity Spine car

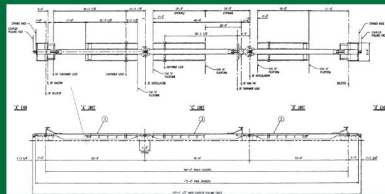

Click here to check out the details for these and other great Bowser Products

Not an MRH Subscriber?

Here's what you're missing ...

- ➔ 10% off on EVERYTHING in the MRH Store
- ➔ 10% off on TMTV Membership
- ➔ Free 40 page MRH Acrylic Painting Guide eBook **HOT**
- ➔ Unlimited access to back issues & bonus downloads
- ➔ Enhanced MRH website features
- ➔ Weekly emails with tips, tricks and new products
- ➔ Regular new product announcements (average of a couple times per month)

Subscribe to MRH today ➔

Go ahead, it's free!

THE SMALL PRINT: With more subscribers we get more advertisers. Becoming a subscriber is your vote of thanks for the 20,000+ pages of FREE model railroading info we've given you -- and helps ensure MRH stays forever free.

DON'T DELAY: SUBSCRIBE TODAY



MRH Q-A-T

column

compiled by
JOE BRUGGER
.....



[Click here for
reader comments](#)

QUESTIONS AND ANSWERS

Handling grain

Q. How can I simulate grain loads, namely corn or wheat, in HO scale? I want to detail boxcars for grain loading and would like to show loads in cars with operable doors. How do I create grain doors in both paper and board forms? I also want to show uncovered loaded farm trucks, spilled grain on the tracks, and possibly outdoor storage piles.

—Sancho Murphy

A. Corn, wheat, barley, rye, milo and other grains you might find at an elevator are pretty small. Corn meal, sawdust, finely ground foam, or sand will work if sifted down to small pieces – the trick is to create a pile that shows some texture but doesn't have such large pieces it will look like a pile of turnips or potatoes. Check photos for color. Some wheat shows up a yellowish-beige; other varieties tend more toward golden brown.

▶ MRH QUESTIONS, ANSWERS, AND TIPS

MRH Q-A-T | 2



1. Great Lakes Models makes laser-cut wood grain doors in several scales, including HO.

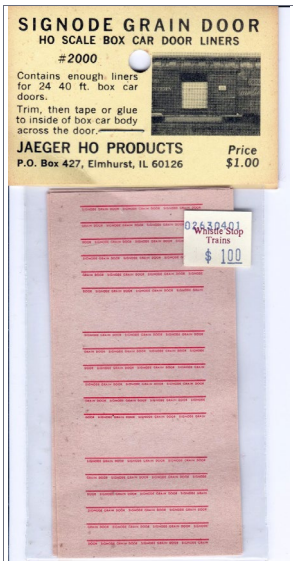

2. Jaeger HO Products markets heavy paper Signode box car door liners, "grain doors" used to prep box cars for grain service.

Rusty Dezel: My “rusty” memory being what it is, I question how you would actually show a loaded car. I worked at several grain elevators at the start of the 1970s. When loading a sliding door boxcar, whether it had wood or paper grain doors, the car would have the door opposite the loading side (elevator side) closed. Further, the grain doors extended most of the way up the door opening. When finished loading, the boxcar door would be closed and the tin serialized securing lock would be put in place. So once the car was away from the elevator, you would never see the grain until unloading.

For photos, just use Google image search. Not a lot of prototype images, but a number of images of models. It’s always amazing how people want to see things that back in the day were considered so mundane that no one considered taking pictures of them, and now that they’re gone ...

A detail you might consider is having some boxcars prepared for viewing after unloading. The broken boards and cardboard were usually tossed back into the boxcar with the doors left open, and the trash would then be removed back at the yard where a crew would then install new wood doors for the next load. I saw boxcars loaded with wheat even in 1973.

I worked at two major terminal grain elevators in the heart of Kansas. We received various grains, including milo, plus other products by rail. The one elevator had an associated hog farm, and bought “disaster” grain, such as what was picked up after a grain elevator burnt down (it happens) and also at the time there was a dog food manufacturer in Topeka, so they’d buy loads of “reject” dog food to feed the hogs.

Rail cars at the larger of the two elevators (32 million bushels) (c2.staticflickr.com/2/1130/1352778888_19977a2fda_b.jpg)

were unloaded by gravity, for covered hoppers, and by using a “boxcar shaker” for boxcars where a single car was wedged on a platform, then the doors were opened, a wedge shaped “plow” inserted to get the grain out the door, and then the entire assembly rocked back and forth while the grain poured out.

The smaller (10 million bushels) elevator (c2.staticflickr.com/2/137/4/1468139357_71e4643762_b.jpg) unloaded boxcars by first opening the doors, then using a hydraulic ram to break out the wood slats. Then a track-mounted horizontal auger would be used to get much of the grain out while workers used brooms and shovels to move grain from the corners of the cars to the auger.

Grain trucks always arrived with covers. Back in the early 1970s, gravity-fed hopper-floored grain trucks weren't usually found. Semi-trailers were flat-bottomed. Most farm trucks did not have hydraulic lifts either, so grain elevators had a lift mechanism (wheatfarm.com/journal_04/images/image14.jpg) to raise the truck and empty it. Some places still use them in America, and in other parts of the world.

Loose grain generally didn't stay around long. The farmer got paid for it, or credit for it, and the elevator didn't want to lose any, so workmen would quickly sweep any residue into the pit, whether the truck pit or the track pit. Grain that was lost was usually from spillage after loading a leaking box or hopper car, or from the soaked grain that was removed from the under the elevator tunnels where it had flown off the conveyor belt.

I don't ever remember outdoor storage. That's a “modern” thing, as far as I can tell. Now wheat production was making steady increases of bushels per acre from the 1960s onward, as genetically engineered varieties became more common. Also, the methods of handling types of wheat, meaning winter wheat or summer wheat, also varied.

Note: Storage on the ground occurred as elevators lagged behind the upswing in production, and was usually a temporary situation at the start of the harvest. Stored wheat develops a crust that protects the grain beneath, at least for the few weeks until the grain can be shipped or stored.

Read the ongoing discussion at mrhmag.com/node/27435.

Extras:

See a grain elevator in operation at nfb.ca/film/grain_elevator.

The website ourgrandfathersgrainelevators.com collects stories and photos of grain elevators. One group of individuals has documented a number of slip-form concrete grain elevators designed and built by several companies their “grandfathers” owned.

The Signode paper grain door models made by Jaeger are in stores and at walthers.com/exec/productinfo/347-2000.

Other producers are:

modelerschoice.com

greatlakesmodels.com

enginehouseservices.com/categories/HO-Scale/FREIGHT-CAR/Signode-Grain-Doors

Car spots

Q. I set up a car card and waybill system for my layout, but sometimes we get too many cars in one place. For example, a furniture factory only has two loading doors but sometimes three or four waybilled cars will show up at the same time. How do I fix this? If I only use two waybills, the siding is frequently completely empty.

—Rick A.



3. A spot card can be added to car card and waybill paperwork to control the flow of cars to an industry.

A. Well-known modeler Lee Nicholas and his friends invented “spot cards” to control this kind of traffic on his Utah, Colorado & Western.

Print one spot card for each car spot on the layout. The spot cards are held at the local yard which makes up trains for a particular destination – for example, at the Willamette Model Railroad Club in Clackamas OR, Redmon Homes in Mount Angel [3] is on the Woodburn Branch and trains for the branch are made up in Albany.

When the yardmaster in Albany has cars billed to Redmon Homes, he will look in Mount Angel’s spot card pigeonhole to

see if spot cards are available. If they are, he inserts the spot card into the car card slot, along with the waybill, and builds the car into an outbound train.

If this doesn't sound very prototypical, think of it as a phone call from the railroad's freight agent to the industry: "I have five loaded flats for you. Can you handle that?"

On its arrival at Redmon Homes, the paperwork goes into the "Set Out" box. The Willamette modelers use the Set Out/Hold/Pickup cycle and the spot card stays with the car until it is ready to go. Between sessions, if the clerk marks the car for pickup, the spot card is removed and returned to its pigeonhole in Albany.

In real-world practice, customers sometimes do receive more cars than they can handle at one time. The extra cars are placed nearby and switched into the loading or unloading spots as space and a switch crew are available. You can simulate this by adding more spot cards than there are spots.

The yellow-tabbed card in [3] simply lists the industry, which receives cars of inbound materials but doesn't ship by rail. It would be easy to add a door number or loading track.

An advantage of the system is that it's a simple mechanical way to keep tabs on which tracks are filled or empty once the spot cards are made up and put into operation. A disadvantage is that the spot cards have to be picked up and moved to the right yard to keep cars circulating.

Scale rule

Q. I got one of these steel model railroad reference rulers to make measuring a bit easier. I'm modeling in HO. I don't know how to read it exactly. Can anyone explain how to read it? I'm looking for feet in HO scale.

—Steel Rails PDX

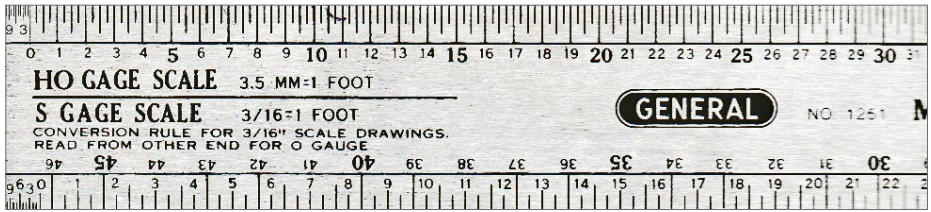

4. This is the top left-hand corner of General's popular 12" scale rule for model railroaders. The complete ruler includes markings for O, S, HO and N.

A. Pelse: Place the ruler so the words "HO Gauge Scale" are right side up, and use the scale at the top.

Note that the zero point is not at the end of the scale as on most rulers. That's a famous source of inaccuracy, as cheap rules are seldom cut at the right place.

The space to the left of the zero is marked in scale inches. If you want to cut a board at 12' 6", you line up the end at the 6" mark that is left of the 0, and cut at the 12' even mark. To measure the length of a board, place one end of the board left of the zero, then slide the ruler so an even foot mark lines up with the other edge of the board – that's your feet length, and you read the inches from left of the zero. It's a lot easier to do than describe.

That particular ruler is not the easiest to read--- in fact it is an excellent example of how not to make a ruler.

- The labels are confusing. I usually line it up wrong at least twice before I get it sorted.
- The width makes it awkward on a crowded bench, as does the fact that the scale you want is only on one edge. Half that width would be about right. **Note:** General also sells a 6" scale steel ruler with HO and O (1/4 inch/foot) markings.

- The charts on the back are handy, but too small for me to read without a magnifying glass. I have the same information posted on my shop wall.
- How often do you need to know the formula for 75% depth of thread?
- There is little reason to combine four scales on the same rule. I suspect that even multi-scale wizards like DaveB only work in one scale at a time.

I'd happily toss it for an HO rule that was marked on both edges of both sides.

On the positive side it is nicely etched steel, with marks finer and more accurate than a paper rule can provide.

Dave B.: The HO, N, and O parts of this rule work fine. The S scale is not marked well so I use a 3/16 architects scale or just calculate the dimensions on a calculator when working on S stuff. For O and HO scales I'd recommend this one. For N I'd probably look for a smaller size scale as the N scale markings only go part way along this one.

See more discussion at mrhmag.com/node/26688.



TIPS

Inexpensive rail bumpers

I am building a hidden storage yard and needed several bumpers to close out each section of storage track. Since it is hidden, I did not need an elegant solution. During one pilgrimage to my local hardware store I found some one-inch square felt pads that looked perfect for the job.



These pads have self-stick bottoms so they are easy to install. You can stack them as high as you want and can even offset them to minimize damage to rail car components if desired.

The final product provides an effective bumper with the added benefit of having a soft landing for any car you might push onto that siding with a little too much force.

—Ed Robinson

5. Self-stick felt pads can be stacked as necessary to form end-of-track bumpers in staging.



[Click here for reader comments](#)



GET PAID FOR YOUR TIP

We pay \$25 per tip we publish, or \$40 each if the tip also includes a photo or finished drawing. [Click here and select article type TIP.](#) ■

TONY'S TRAIN XCHANGE

Committed to your DCC support!

Accessory Decoder/ Tortoise Combos

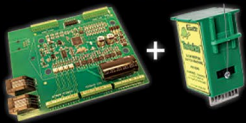

Get exceptional savings when you purchase Tony's Combo Packs!

Jackwabbit/Tortoise
Wabbit/Tortoise
Hare/Tortoise

Starting at \$39.95

Order Yours

CMX Cleaner Car



Superior, All-Brass
Build Quality, Super
Easy To Use & Cleans
Exceptionally Well!

N, HO, S, O, & G Scales

Starting at \$149.95

Order Yours

NCE DCC Systems Super Sale!



Get a great sale price on all
the impressive NCE DCC
Starter Systems

Order Yours

**Do you need a Sound or
DCC Installation done?**

Get a quote!



Providing unmatched person to person
DCC support for more than 25 years, the
kind of service that has made us #1 in DCC.

DCC questions? CALL US! 1-800-978-3472

We'll get you on the right track!

Nov. 2016





S T A T I O N

Model Railroad Technologies
Accutrack Speedometer 2



- Click here to visit our website -

www.LitchfieldStation.com
623-298-7355



JACK BURGESS
.....

GETTING REAL

column



[Click here for
reader comments](#)

BUILDING THE BAGBY HOTEL | MESHING SCRATCHBUILDING WITH NEW TECHNOLOGIES

IN THE EARLY 1990S A BROTHER AND SISTER in their 60s visited to see my Yosemite Valley Railroad layout. They had lived in Bagby (a station stop on the YV) in the late 1930s, including 1939 – the year I model. The Bagby station had become a non-agency station (one without a station agent) seven years earlier in 1932. Their father was a YV section foreman, and they were thus able to live in the upstairs living quarters in the Bagby station.

It was a fascinating visit for me since they remembered so much about the small community of Bagby. Bagby included the YV station, a water tank and water plug, a store/post office, a garage, a single house (possibly for the store owner), and a two-story hotel. The dwellings were bisected by the railroad as well as California State Highway 49 which runs the length of the historic Gold Country.

▶ [MODELING REAL RAILROADS AND WHAT THEY DO](#)

GETTING REAL | 2

As they studied the buildings and details in my slightly compressed HO version of Bagby on my layout, they continued to compliment me but also asked questions ... “That’s good” and “where is the loading platform for the station?” and “wasn’t the retaining wall behind the hotel taller?” Regarding that last comment, I fibbed that I didn’t have room for a taller retaining wall but, in truth, I didn’t have enough information on the hotel when I had scratchbuilt my model several decades earlier.

That model of the hotel was based on the few photos of the prototype hotel I had at the time I built it. In addition, my modeling skills in those days were also not up to my current-day efforts.



1. This two-story hotel was built in 1900 in the community of Bagby prior to the arrival of the Yosemite Valley Railroad. It was situated on the slope down to the Merced River, providing patrons a nice view from the rear porch.

GETTING REAL | 3

Although I declared my layout complete in mid-2011, I finally decided my earlier model of this iconic hotel exhibited a number of compromises which were no longer acceptable. Since I love scratchbuilding models, I decided it was time to replace this earlier model of the hotel at Bagby.

Research first

In order to build a more accurate model, my first step was to draw the hotel in CAD (computer-aided drafting) as I studied my photos and tried to understand what I saw. An official YV railroad route map of Bagby included the plan for the hotel, which gave me the overall width and length of the building. With that information, I was able to scale a good photo I had of the east

ADVERTISEMENT



GLXSCALEMODELS.COM

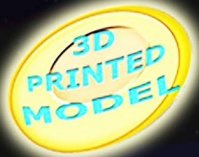

**OIL LANTERN
KIT**

**1/48
SCALE!!!**

**\$19.99
+ S&H**



12 VOLT POWERED LED LIGHT

• INDEX

• TABLE OF CONTENTS

GETTING REAL | 4

elevation of the building, which let me determine the size and spacing of the windows as well as the roof slope. [2] I was then able to start drawing up the other elevations given that all of the windows in the building were the same size.

Some details shown in these photos were easy to understand while others led to more questions, but eventually provided a better understanding of other building itself. For example, photos of the front of the building showed it only had two smoke stacks protruding through the roof close to the ridge. That meant those stacks were for the heating stoves on the two floors. But in



2. This photo provides a good view of the east end of the building. Stairs from the rear porch lead to the two-story building on the south/river side of the building. It also shows the building was well maintained, and the lack of weathering. Knowing the width of the building, I was able to use Photoshop to remove the minor skewing, and then scale the photo to use to determine the size of the windows, window spacing, and other details.

1900 when the hotel was built, the proprietor also needed to provide meals to overnight guests since there were no other options in the community. (Keep in mind that, in that era, horse-drawn stagecoaches had to stop before dark each day.) So where was the kitchen for the hotel, since the only two smoke stacks were for heating purposes?

Lacking enough photos when I built my first model of the building, I didn't realize the entire hotel, except for the front portion, overhung a steep slope down to the adjacent Merced River. In studying my expanded collection of photos, I noticed a ramshackle structure under the rear of hotel itself. [3] That had to be the kitchen, and it was confirmed when I noticed the stove pipe running from this structure to above the eave of the hotel. But

ADVERTISEMENT



WE ONLY SELL WHAT WE MANUFACTURE

DETAILS IN HO, O, S & N SCALES

LASER CUT SHINGLES, DOORS & WINDOWS, FENCES, SIDING, CRATES. Also RESIN and WHITE METAL DETAILING CASTINGS.

CRAFTSMAN KITS IN HO, O & S SCALES

CHECK IT ALL OUT AT
WWW.RUSTYSTUMPS.COM

Send \$3.50 for Catalog - Specify Scale

RUSTY STUMPS SCALE MODELS

6785 Cherry Blossom W. Dr., Fishers IN 46038

Phone (317) 595-9489



3. Most of the photos I have of the Bagby Hotel are from the opposite side of the Merced River like this one. This photo of the south (or rear) side of the building provides a good view of the kitchen under the porch. I never determined the purpose of the two-story building on the left (closer to the river). My best guess is that it housed family members and maybe the stagecoach driver and his side-kick overnight. *Library of Congress photo*

if that was actually the kitchen, how were meals moved to the upstairs dining area in the hotel? Photos showed some outside stairs which led down to the level of the kitchen from a rear porch. But that would mean carrying bowls of food out the door from the kitchen and up these stairs, rain or shine, day or night. Although not visible in any photos, I decided there had to be an enclosed stairway under the building from the kitchen directly up to the dining area, the only viable alternative.

I also questioned a small structure on the west side of the hotel. [4] It was on the outside of a walkway, and that walkway or porch circled the entire hotel. The structure was fairly small with a

GETTING REAL | 7

simple sloped roof. What was its purpose? I finally realized that it was a two-hole outhouse, since the hotel was built long before indoor plumbing. The walkway around the hotel allowed guests to reach the outhouse from the front or rear doors of the hotel and also access the rear porch from either side of the building.

But that outhouse was positioned about five feet above an area served by a stairway down the slope to the river. Once I noticed this fact, I questioned my conclusion that this was an outhouse! But from a Google search of outhouses, I learned that there were also outhouses where waste was collected in pails under each “seat” rather than holes dug in the ground. Those pails were emptied as needed, and that helped confirm my conclusion. There is certainly a lot you can learn from model railroading.

ADVERTISEMENT

Your Dream,
Our Ambition!



www.anemodel.com

ADVERTISEMENT

New Product Release
BRICK YARD TOWER

SPECIAL PRICING!



HO SCALE

MONSTER
modelworks

www.monstermodelworks.com

• INDEX

• TABLE OF CONTENTS



4. A view from the opposite side of the river was taken sometime between 1912 and 1925 when the YV station in the upper-right corner was replaced by a two-story station. The two-hole outhouse for the hotel is visible on the west side of the building. *Todd Pederson collection*

As with many other scratchbuilding projects, I spent a long time refining my CAD drawings for this building. Drawing plans for a building based essentially on period photos is an interesting challenge as one tries to date when photos were taken and what changes occurred over the years. I also like to incorporate all of the details I see in the photos into these plans, since drawing the plans also allows me to mentally “build” the model as I develop the plans. Those CAD plans for the Bagby Hotel are available as a subscriber-only extra. Rather than describe the actual construction of the hotel, I will instead share some techniques which can be used with many other structure projects.

Taking advantage of technology

One of my first steps when scratchbuilding a new structure is to find available styrene windows and doors which match those of the building. Unfortunately there weren't any for the Bagby Hotel. While I could scratchbuild all 23 identical windows for the hotel, that option wasn't very attractive, since I abhor unneeded, repetitious work.

The most obvious option was to cast the windows in resin using a rubber mold of a styrene master. However casting the double-hung windows with their very thin mullions would have been difficult. So I started by making a master for just the window frame and making a rubber mold of that master. But I had

ADVERTISEMENT

HO GP60M, GP60B AND GP60 Locos



Now Available !



DC or DCC with Sound!



www.foxvalleymodels.com

ADVERTISEMENT

NICK & NORA DESIGNS
Uniquely inspired craftsman kits



Craftsman Structure Kits,
Detail Parts, Shingles & More!
www.nickandnoradesigns.com

problems getting castings without air pockets or short casts. Rather than spend more time on this option, I decided on a different approach.

I had already drawn up this window in a free 3D drafting program called SketchUp to help me better understand how to build the styrene master for casting the parts in resin. So I uploaded this 3D file to a service bureau such as Shapeways, which “prints” parts in 3D.

(Producing parts using 3D printing is an up-and-coming technology which has numerous applications for our hobby. Basically, one draws a part in a computer program such as SketchUp and then uploads that file to a service bureau which “prints” the part using rapid prototype technology. The cost of that part is currently \$5.00 plus the cost of the materials used to print the part together with a \$5.00 shipping fee.)

Ten days later my single window frame arrived in the mail and was perfect. However, that single window cost me \$5.30 plus the \$5.00 shipping fee. Based on that price, having 23 windows “3D-printed” would cost \$127! But that \$5.30 cost of a single window meant the material cost for that single window was only \$0.30, so the material cost for 23 for them would be only \$6.90. Since I needed 23 of these windows, I used SketchUp to make a sprue with 25 of them (always good to have a couple of spares) and uploaded that file to Shapeways. [5] Those 25 windows cost just over \$12.00 plus the \$5.00 shipping charge. That is less than the cost of plastic windows from Grandt Line or Tichy. And they matched my prototype exactly.

But 3D printing couldn't reproduce the window mullions or the window sashes for these double-hung windows. Including them was important since I wanted to model most of the windows

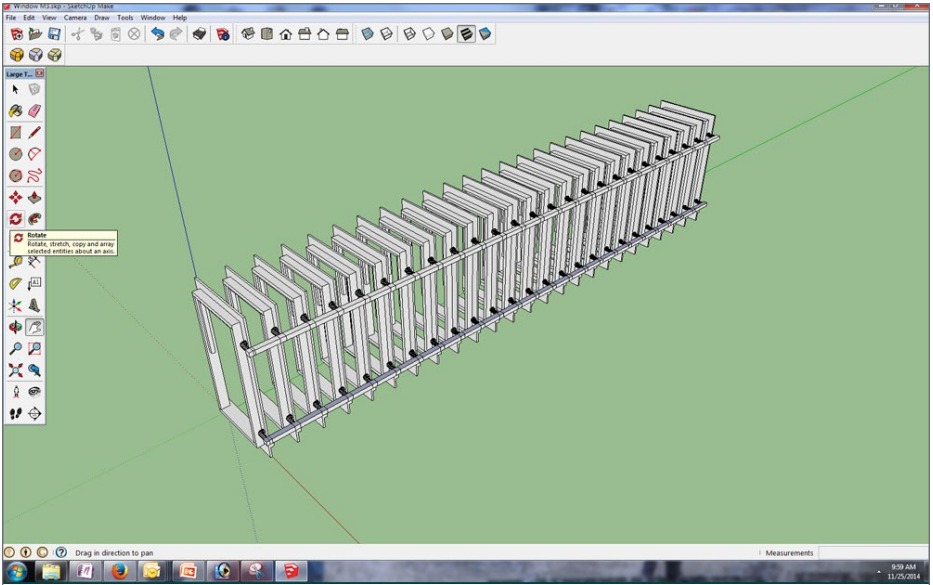

5. A SketchUp computer screen grab of 25 window frames for the building connected with two sprues. The sprues are attached to the inside of the window frames where they are easy to cut free without the need for cleanup. Even though there are 25 window frames, connecting them with sprues results in a single part as far as Shapeways is concerned.

open – I model August when daytime temperatures can easily reach the mid-90s or higher in Bagby and most of the windows might be open to let in any breeze.

To make the window sashes and mullions, I turned to laser cutting. I drew one set of these parts in CAD and then used the copy/paste function to produce a fret of 25 sets. I then contacted the owner of Monster Modelworks (monstermodelworks.com), who does custom laser cutting. He not only cut my 25 window frames, he also cut clear styrene window inserts which fit my 3D-printed window frames perfectly.

Making templates

With the problem of the needed windows and doors solved, my next step was to cut out the four sides of the building and the window and door openings. For the past 40 years, I have used styrene for nearly all the buildings on my layout. A couple of decades ago I realized that, while I could draw the outline of the sides of a building on a sheet of styrene with a pencil and then cut them out, it is much more accurate to use the CAD drawings of the building to create templates. Even if you don't draft complete plans for a planned structure in CAD, it is much easier and accurate to draw templates for the sides of the building in CAD. I took that approach even further and drew templates for not only the sides of the main building but also the sides of the kitchen and outhouse, and the roof pieces.

Using building templates makes it easy to allow for the thickness of the front and sides of the building. (For example, if a building is 20 feet square and you are using .040" styrene to build it in HO, two of the sides will be 20 feet long and the other two sides will be 19 feet 8 inches wide since .040" styrene is close to 4 scale inches thick.) For buildings such as this project, I always have the peaked sides or ends overlap the front and back sides, since that makes the roof pieces fit tight. The width of the front and back sides were thus narrowed by the thickness of the peaked ends. Since I wanted to apply the templates to what would become the inside face of the styrene and the sides were not symmetrical around the centerline of the side, I made mirror images of each side to accommodate windows and doors.

If you don't use a CAD computer program, you can still make your own templates. Drawing the sides of a building with a .5mm pencil on paper is easier than laying them out on styrene. Be sure

to allow for sides overlapping the front and back. If one or more sides of the building are not symmetrical, be sure to draw up a mirror image of that side.

For the Bagby Hotel, I simply substituted the required opening for each door and window based on my 3D-printed parts. I printed these templates on Avery 4383 Clear Sticker Project Paper, which is available from Amazon. The templates were then applied to the reverse side of the styrene and the sides cut out. If you are using scribed styrene, cut the template along the bottom edge and apply it to the reverse/non-scribed side of the styrene, aligning the bottom of the template with the bottom of the styrene. This will ensure the bottoms of the window openings are parallel to the bottom of the side. This Avery material is repositionable and won't leave residue after it has been removed.

An alternative option is to print the templates on regular paper and spray them with repositionable spray glue. Do not use regular spray adhesive or you will never be able to remove the template! Again, apply the template to what will become the inside wall of the structure.

Once the templates have been applied, use a straightedge and scribe along the edges of the template, then snap and remove the excess. Next cut out all the openings for the doors and windows using the templates. I used a nibbler, and described the process in my "Tool Shed" article in the June 2014 *Model Railroad Hobbyist*. Since this building had horizontal siding, I was careful to make sure that the bottom of all of the windows on the each floor were either on a groove or the same distance from the same groove. Having all the windows exactly in horizontal alignment is very important when using scribed styrene for a structure, since any variation in height is readily apparent.

Gluing the building sides together

For very small buildings, I use the method described in my “Tool Shed” article on “Vises, Clamps, and Angle Plates” in the April 2013 *Model Railroad Hobbyist*. That method uses angle plates and a drafting triangle to hold the sides of structures at right angles to each other while bonding them together. I used a different and better approach to bond the four sides of this large structure together.

I bought a Coffman 4” Right Clamp (see my article on these clamps in the March 2011 *Model Railroad Hobbyist*). when they

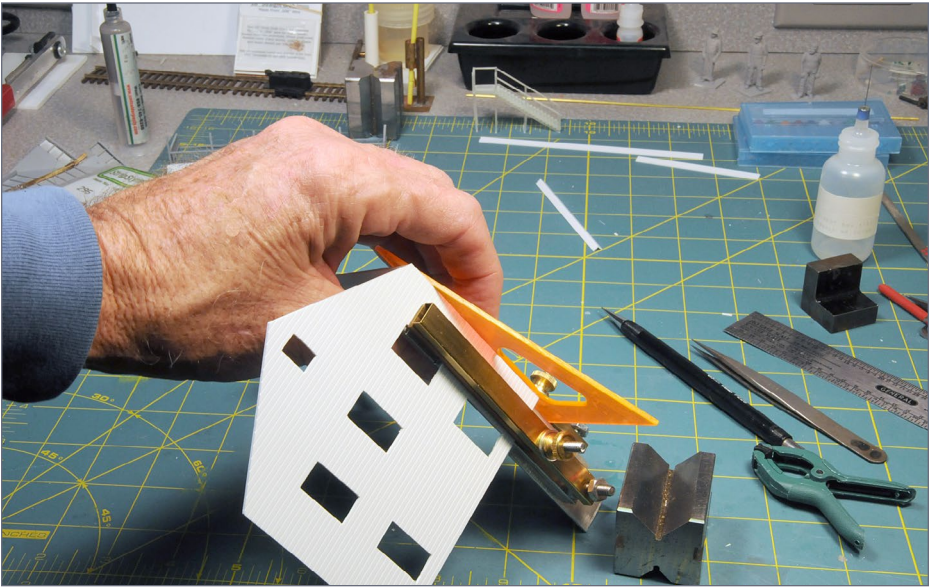

6. The west side of the building is held loosely in the Coffman Clamp and the joint checked with the flat surface of a drafting triangle to make sure that edge of the end is tight to the south side. The clamp was then tightened to hold the two sides in position.

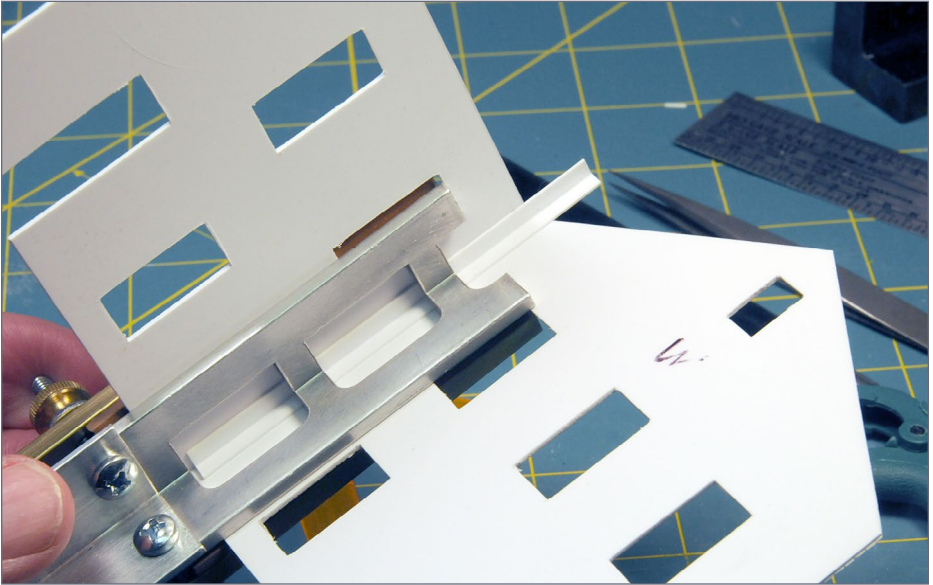

7. This photo was taken after I glued a piece of Evergreen .156" angle inside the corner to strengthen the joint. I put the clamp back in place just for the photo.

first became available, but I hadn't found a need for it until this project. This hotel was the perfect opportunity to use it. Not only is this clamp longer, it also has milled "cut-outs" in the aluminum angles which hold the sides of the building at right angles to each other and also aligned to each other. These cut-outs let me glue the pieces together without worrying about gluing the clamp to the sides themselves. [6-7]

I always glue one side (the front or north in this case) to the side on the right (east) and then glue the back (south) to the side on to the right of it (west). These two assemblies are then glued together. I use the same technique for resin box cars, and it seems to work better than gluing things in a simple clockwise orientation.

Taking full advantage of 3D printing technology

While I used 3D printing to produce the windows for this building as described earlier, I also used this technology for a number of other parts for this project. They included all the exterior hotel doors, the attic and kitchen windows, the stairs from the rear porch, and the railing around the front of the second-floor balcony. While there are commercial castings for some similar railings, they weren't exactly the same, and it was simple to model them in 3D.

The hotel also included roof overhangs over the front second-story balcony and the rear first-floor porch. I wanted to include the rafters and 4x4 top plates which rest on the vertical support posts. Drafting these roof overhangs in 3D was more difficult than I had expected, but the efforts resulted in learning more about 3D drafting. [8] Upon receiving my first roof overhang from

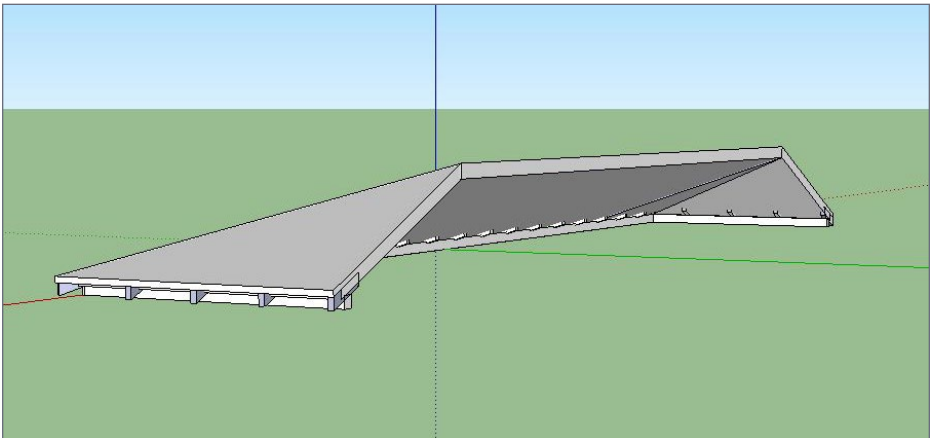

8. This computer screen grab shows the roof overhang as drawn in SketchUp. Note the rafter tails extending beyond the top plates.

Shapeways, it was obvious my scale part was too thin, since the overhang arrived already warped. I then redesigned the parts with a thicker roof, which solved the problem.

An additional design issue with these roof overhangs arose when I began figuring out how to attach them to the front and rear sides of the building. These roof overhangs extend about a real inch from the face of the building, which meant they would be very vulnerable to damage until the building was installed on the layout. Since I had an extra roof overhang (the warped one), I glued it to a piece of styrene using five-minute epoxy. After curing for 24 hours, it easily broke off. The epoxy wasn't sticking to the styrene or the 3D print or both. Another approach was needed.

My solution was to make a pair of braces using two pieces of .032" brass which would be attached to the building wall and the roof overhangs. I used a jig to hold a 1/2"-wide piece of brass up against a piece of 1/4"-wide piece of brass at the correct angle and soldered them together. That brass roof support was then drilled and the holes tapped for 2-56 screws to attach it to the building from the inside of the building. [9] Screws work better than glue in this situation, since they can be adjusted to make sure that the overhang is parallel to the top of the building by simply enlarging the clearance holes in the side of the building.

I then bonded the 3D-printed roof overhangs to the brass supports using industrial-strength double-sided tape. The double-sided tape that I use is Bron Tapes (brontapes.com) Killer Red 3/4"-wide tape. They have a minimum order of \$100, so I put together an order for myself and several other modelers a number of years ago to meet that minimum order requirement. I have used this tape numerous times on different projects. Rolls of the same tape in what appears to be 1/2"-wide rolls is available online

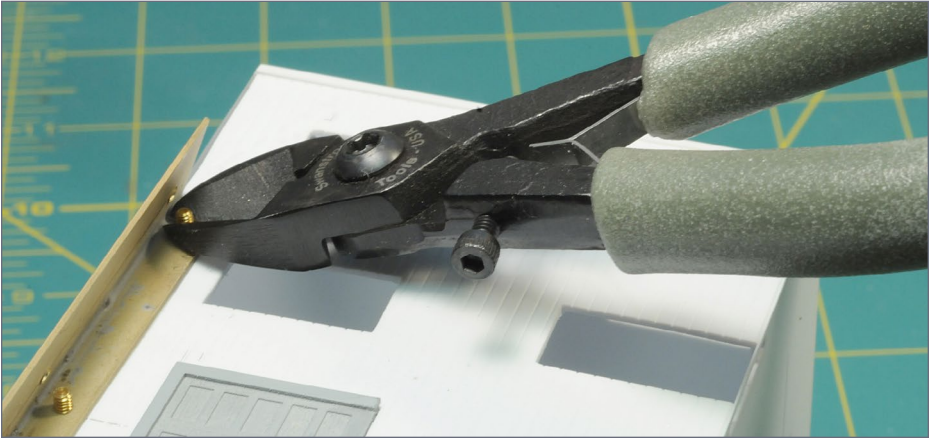

9. In this photo, the excess length of one of the 2-56 screws is clipped off the brass roof overhang support. The screws were screwed into threaded holes in the brass support from the inside of the building.

(only) through TAP Plastics (tapplastics.com). Search for “clear double-sided permanent bond tape”. This is a great modeling tape – it has a lot of modeling applications including bonding scale corrugated siding in place on structures. Once you have it, you will continually find instances where it is perfect for a particular project.

Front doors

Historic photos did not provide a good view of the front door (and most likely, also a similar rear door). But a circa-1961 B/W photo in my collection provided a very good view of this unique front door. [10] While it is possible the original door was replaced sometime after construction of the building in 1900, that would have been a significant expense without an equal increase in income. So I am fairly confident the original door was not replaced.

GETTING REAL | 19

This photo suggests that the clear glass center portion of the door was surrounded by cut glass. But what colors were used? Does it matter? No, but the answers can be out there.

I shared that B/W photo with members of our Yosemite Valley Railroad Yahoo chat list. An architect on the list responded with a color photo of a door with a very similar design which had been salvaged from a building being demolished. I converted his color photo to B/W in Photoshop Elements, which let me compare glass colors from my B/W photo of the prototype Bagby Hotel doors to his color photo. [11]

My model doors had been drawn in SketchUp and 3D-printed. So I then drew the stained glass using the CAD drawing of the front elevation of the door.



I exported that file as a regular graphic file and added the colors based on the later-day color door. It was then printed onto photo paper. The center “clear” section was cut out of the photo, and a sandwich of the

10. Here is a 1961 view of the front door of the Bagby Hotel. The fact that the screen door is propped open with the door mat suggests this photo was taken to document that door.

color photo and .005” clear styrene was inserted into the cavity from the inside of the door. That gave me a fairly good replica of the actual door with its colored glass. (12)

Interior details

The windows on the Bagby Hotel were quite large, and several of them would be in view on the layout aisle side of the building, since it would be installed only an inch or so from the fascia.



11. A color photo of the similar door salvaged from a building demolition, and the B/W version of the same photo. Comparing the B/W version of the door with the historic door from the hotel let me “best guess” the colors needed for my model door.



12. My model of the front door of the hotel and one of the 23 windows. All the doors and windows were 3D-printed. The colored tiles in the front door were replicated with a photo print produced from my CAD drawing.

While it would be easy to simply add curtains to those windows, I decided to model the simple furniture that might be in such a room circa 1939. I guessed it would be limited to a bed and chest of drawers for the bedrooms on the second floor. While there might be commercial castings for these items, I decided to draw them in SketchUp and print them in 3D.

But first I needed to develop a floor plan for the second floor in order to understand where all the walls were located. The hotel was described as a “fourteen-room, two-story” building. That

could mean fourteen bedrooms for rent or fourteen rooms total. For the second floor, a corridor was needed to provide access to each bedroom and the double doors leading to the front balcony. It also needed a set of stairs between the second and first floors. The center windows on the east and west elevations of the building suggested this corridor was arranged along this line of the building. Based on window arrangements, I concluded that eight bedrooms were on this floor, even though the resulting rooms would be very small.

After drawing up a bed and chest of drawers in SketchUp, I created a sprue of them and had them printed in 3D. I painted the bed headboards and chests of drawers using Vallejo Saddle Brown acrylic followed by a coat of brush-painted Pledge Floor Care Multi-Surface Finish to give them a gloss finish, typical of waxed furniture. The mirrors on top of the drawers were made by gluing silver Mylar foil from the inside of a small potato chip bag to some thin styrene, and then bonded that to the back of each mirror frame.

I initially planned to paint the bedspreads on the beds some basic color (red, blue, etc.), but then I thought they might actually be handmade quilts. But realizing that the owner's wife probably wouldn't have the time to make them, I moved on to another option.

After downloading some images of period bedspreads from the Internet, our 6-year granddaughter came in to my shop (she had been following my progress) with an 8x10 sheet of paper she found in a box of my wife's scrapbook supplies. She told me that it looked like a bed spread. She was right! The pattern was large, but I resized it in Photoshop Elements for an HO bed and then "stitched" copies together to form a single pattern about 8" square. But I was at a loss of how to cut it so that it would fit the

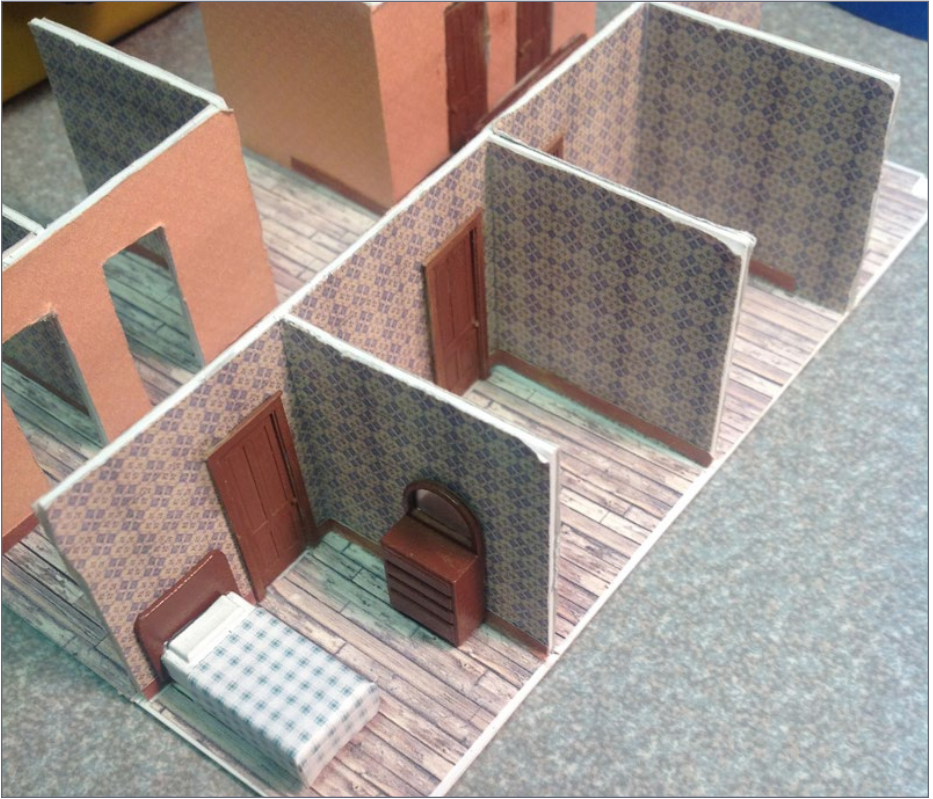

13. This is the second floor “insert” with interior walls, wallpaper, and furniture in a corner room before the furniture was added to the other rooms. These rooms were very small and the twin bed and dresser drawers just fit the space available

bed and overlap on the two bottom corners. My solution was to draw a pattern in CAD to cut the bedspreads to shape and then print that on the back side of the bedspread pattern. After painting the bed pillow and sheet white, I cut out the bedspreads and “made the beds.”

I also used Photoshop Elements to “produce” wallpaper for the rooms. These days wallpaper tends to be cosmetic, but before lath

and plaster became common, it was used as a simple way to cover interior walls to finish them off and also to prevent drafts from room to room or even the outside. I found some period wallpaper examples online and “stitched” them into larger patterns which I used to cover all the interior walls of the building. [13]

Shingles

From the beginning of this project, I planned on using laser-cut wood paper shingles from Paper Creek. These are a great product but, unfortunately, Paper Creek is no longer in business. However I had enough shingles left for this building. There are other sources of similar products.

I prefer to apply paper shingles to a roof using Scotch Quick-Dry Adhesive, which is much like regular white glue but it sets much quicker. That lets you to continue to apply shingles without the need to stop and let regular white glue dry. But the roofs on this and other buildings that I’ve built are sheet styrene, and white glue obviously won’t work to bond paper shingles to styrene.

The solution is simple. I added guidelines for applying the shingles (based on the shingle exposure, which is how much of each row of shingles is exposed to the sun) to the templates that I drew to cut out the roof pieces. These shingle templates were printed on regular bond paper and then bonded to the roof sections using a permanent spray adhesive. Don’t try to spray the roofs themselves since you cannot control the overspray. I always wear latex gloves to handle the sprayed roof templates, since it is nearly impossible to avoid getting the adhesive on your fingers. You can also just bond blank paper to the roofs and then draw up lines based on the shingle exposure. [14]

The Paper Creek laser-cut shingles don’t include “ridge shingles”. These are the “shingles” that cover the last row of shingles at the

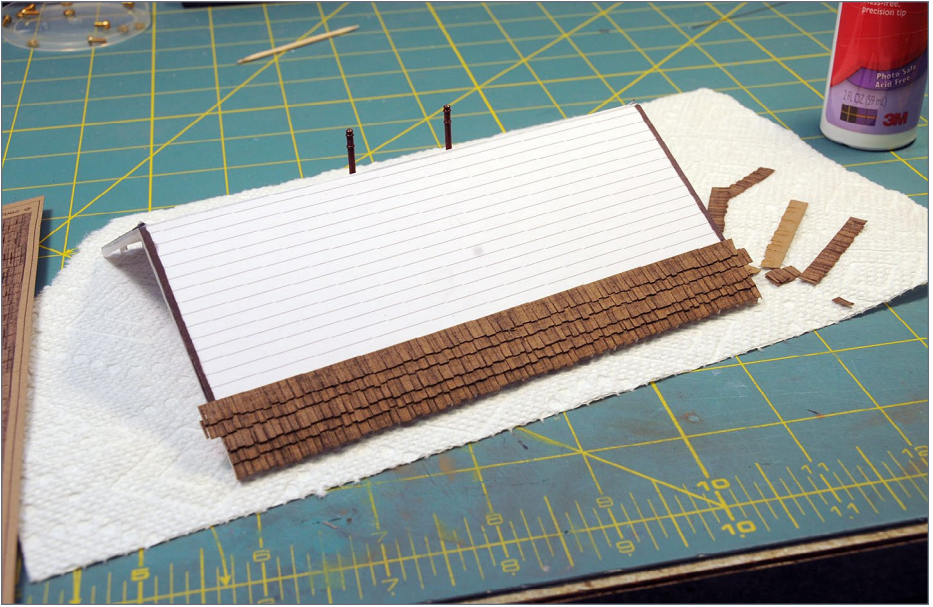

14. Laser-cut shingles are applied to the main roof of the building using guidelines on templates glued to the styrene roof assembly.

ridge line. I cut strips of Paper Creek material into strips about a scale 8” wide and about 12” long and glued them to the ridges, overlapping adjacent shingles.

Weathering

Pan Pastels (modelingcolors.com/index.html) have been around for a couple of years now, but are not well-known yet. They are actually a relatively new artist medium consisting of soft pastel colors packed in a unique soft binder. Although designed for artists, they are well suited for weathering freight cars and structures for model railroaders. Packages of colors have been specifically developed for model railroaders such as their “Rust & Earth” and “Greys, Grime, & Soot” weathering kits. They are typically applied

GETTING REAL | 26

with a sponge (rather than a brush) and can produce the effects of pastel chalks. But unlike pastel chalks, they are not easily removed once applied. I used them primarily on the support posts under the building after first airbrushing them with Floquil Earth. A light application of some Pan Pastel grays gave the painted styrene posts a look very close to weathered, unpainted wood.

Based on historic photos, this was a well-maintained structure—not unexpected since the owner wanted to appeal to travelers. Weathering of the exterior paint was thus limited on the main building to some minor rain streaking from window corners. [15] But photos show that the kitchen building below the rear porch didn't get the same attention from the owner, and it has a higher level of weathering. It and the roof were streaked with Bragdon chalks. (bragdonent.com)



15. This closeup of the west side of the completed building shows the double-hung windows which are composed of 3D-printed frames and laser-cut sashes and mullions.



16. The north side of the building includes a second-floor balcony which was accessed via double doors from the second-floor corridor. The two-stall outhouse is along the walkway on the west side of the building. The two stove pipes for heating the building are visible on the roof. The wires leading away from the front corner of the building are for the lights in the bedrooms.

The unpainted walkways around the Bagby Hotel were initially airbrushed with Floquil Earth. But they also needed some color variations. For these effects, I used some products that are more popular in the plastic modeling world than model railroading. I have been using Vallejo Model Color acrylics for a couple of years now and really like them for brush painting figures. Vallejo also makes a line of dry “pigments”. These are somewhat like chalks but are used very differently. Instead of being applied dry, they are used with a Pigment Binder, which is an acrylic medium. For

weathering the walkways, I dipped a small brush in the binder and then into a jar of pigment and brushed the combination onto the walkways. The colors I used included Light Sienna (close to the Floquil Earth) and Light Yellow Ocher (much lighter than Floquil Earth). Those applications resulted in very subtle color variations in the individual planks used for these walkways.

Final details

A couple of weeks after finishing the project, I realized hotel patrons would need some places to sit on the rear deck to enjoy the warm summer evenings. I found some plans online for



17. The front porch continued around the east side of the building. This view illustrates the slope down to the river, and also the enclosed stairs under the building from the kitchen to the first floor.

building Adirondack chairs. I drew them in SketchUp and had a sprue of six chairs 3D-printed. (This effort is typical for those who start working with SketchUp and 3D printing since, once you understand the power of this process, you begin looking for



18. The elevated walkway on the south side of the building provides access to stairs down to the ground level. I do not have room on my layout for the two-story outbuilding visible in prototype photos on the river side of the hotel which was connected to the hotel via another raised walkway. I therefore built only a portion of those stairs. The kitchen with its tall smoke pipe for the cooking stove and another stove pipe for the heating stove is under the porch. Note that the Adirondack chairs on the porch are the children's chairs and not the second attempt, adult chairs.

more parts to draw and have printed.) After painting them a nice dark green, I tried to put an HO figure in one of them and realized I apparently used some online dimensions for children's chairs rather than adult chairs. A second attempt was successful and, once the replacement Adirondach chairs were in place on the rear deck, I declared the building finished. ☑



[Click here for reader comments](#)

See the plans on the following pages ...

ADVERTISEMENT

DCC and Sound in N Scale?

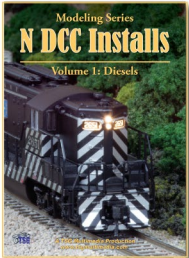

We'll show you how!
N DCC Installs
Examples with and without sound!

[CLICK FOR DCC](#)

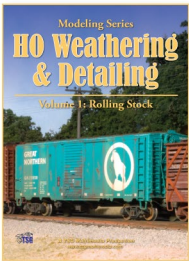

Want it now?
Our titles are now available in digital download format!

[CLICK FOR DIGITAL](#)



TSG Multimedia

• INDEX

ADVERTISEMENT

Select MODEL RAILROADS

Design & Build Services For Discriminating Modelers



[CLICK HERE FOR OUR WEBSITE](#)
www.SelectModelRailroads.com

(844) 872-4670

• TABLE OF CONTENTS

In September, with your help,
Fast Tracks raised over \$4000
to help people struggling against cancer.



Thank you Lionel Strang.
Your courage and grace will never be equaled.



FAST TRACKS

HANLAIOTRACK.COM

shop online 24/7

1-888-252-3895
service@fast-tracks.net

• INDEX

• TABLE OF CONTENTS



NORTH - Original

19. Plans of the Bagby Hotel, page 1.



SAGBY HOTEL
SEMI-DETACHED HOUSE
SEMI-DETACHED HOUSE
SCALE 1:87
J. A. BURGESS 8/14
Revised 4/1/15

or
nts





TEL
RAILROAD

14

EAST - Original





BAGBY HOTEL
YOSEMITE VALLEY RAILROAD
HO SCALE 1:87
© J. A. BURGESS 8/14
Revised 4/1/15

SOUTH - Original

21. Plans of the Bagby Hotel, page 3.



22. Plans of the Bagby Hotel, page 4



[Click here for
reader comments](#)

WEST - Or



ginal

From first train set to railroad empire...

*Our complete line of DCC products
grows with you. Discover the fun!*

- Designed and manufactured in the U.S.A.
- Preferred for ease of use and ergonomic design
- Unlimited scalability for any size model railroad
- Plug-and-play means more time running trains
- Great customer service and excellent support



See your dealer



Visit our new and improved web site for all your DCC needs!

- Get the latest new product announcements
- Watch our detailed how-to videos
- Browse the all-new Information Station
- Enjoy secure online sales, day or night!

Visit **ncedcc.com**



Get Better Sound from your Locomotives

Can't get a good sound from your sound decoder?
Give our speakers a test drive with your ears.



RAILMASTER HOBBIES
9812 BELMONT
BELLFLOWER, CA 90706

Bass Reflex
Speakers



High Bass
Speakers



When it comes to speakers we have high quality speakers to fit many different applications.

We are also a full line hobby shop. Need anything? We are an authorized dealer for Soundtraxx, Digitrax, Athearn, Walthers and many others. We provide quality speakers for your DCC sound systems and quality service.

**Click here for
the answer ...**



WHAT'S NEAT WITH KEN PATTERSON

column

KEN PATTERSON
.....



[Click here for
reader comments](#)

SHAKING PAINT, TALKING TO MICHAEL GROSS, AND NEWS FROM ESU ...

THIS MONTH WE LOOK AT AN INTERESTING WAY to shake paint with an oscillating sander. For layout construction, we give a new face to an existing trade show display layout. Famous actor and fellow model railroader Michael Gross stops by and talks about his passion for the hobby. Matt Hermann from ESU Electronics shows how the ESU line of sound decoders can add to our model railroad operating experience. Pour a hot cup of tea as the November winds blow outside and enjoy this month's "What's Neat" video presentation.

▶ PHOTOS AND VIDEO OF SUPERB MODELS

Tool tips



WHAT'S NEAT | 3



1-3. For this month's Tool Tips I found a fast way to shake all the paint on my paint rack to keep it fresh and usable. Using the flat plate of an oscillating sander, I attached a Floquil paint bottle using Gorilla Duct Tape. Clip this shaker to the sander and proceed to shake the bottle using varying speeds for a very short period. The vibration stirs the paint very quickly. Even this very old square bottle of Floquil paint was stirred to a usable state in less than 30 seconds. I believe this is a new product idea for the craft hobby for some manufacturer to follow up on. Just a simple idea that seems safe and works fast.



[Click here for
reader comments](#)

Michael Gross visits



4. Hollywood actor Michael Gross was in St. Louis for the RPM meet. After the show he visited my studio to hang out on the bluff and run some trains. He was very familiar with my layout from watching the show and felt right at home operating the controls. Later he sat down and we ran video and talked for a few minutes about his passion for the hobby, as a child and on through adulthood. It makes for an interesting and fun interview in this month's video.



[Click here for
reader comments](#)

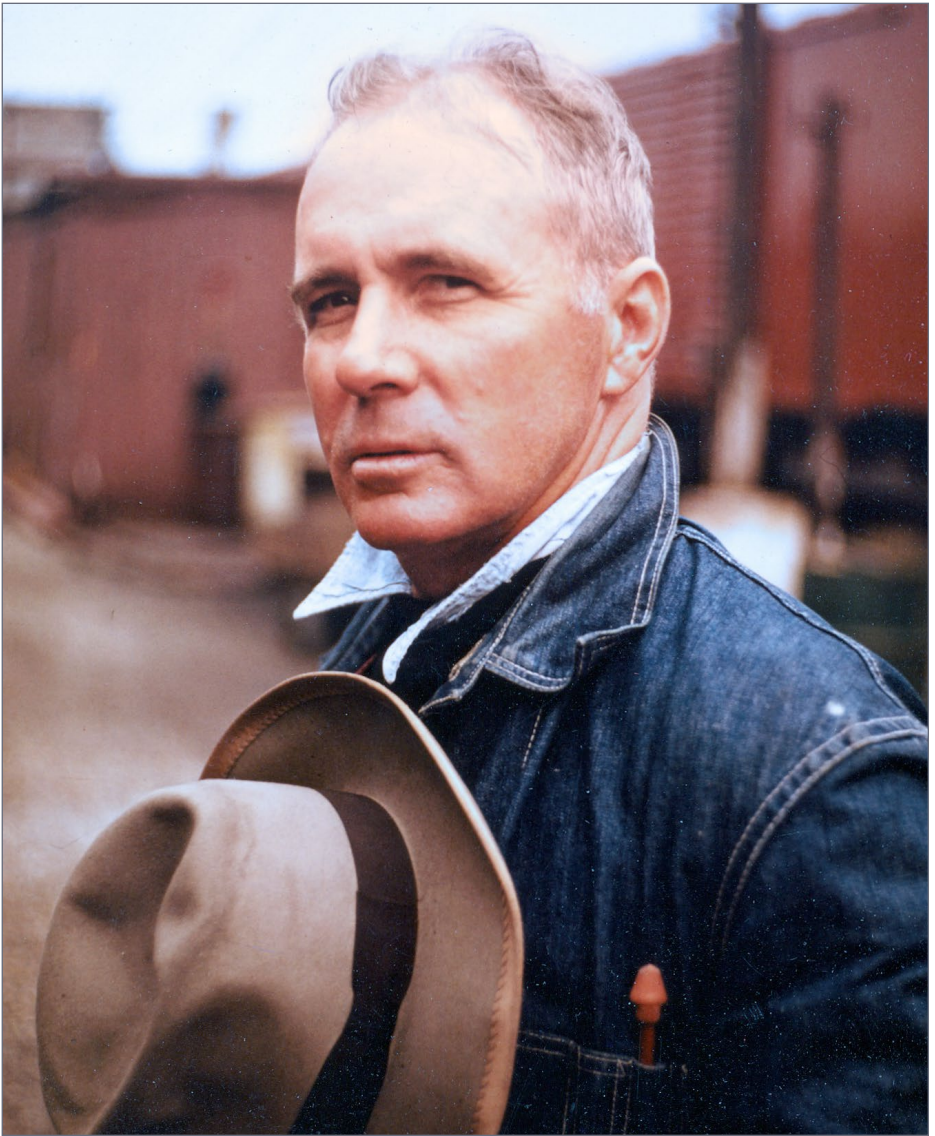

5. Michael describes his close relationship with his grandfather, Chester S. Gross, photographed at work, above, as the inspiration for his love of model trains. Chester worked for the railroad for 53 years and shared his wisdom and love for the railroads with Michael. *Photo courtesy of Michael Gross*



6. Michael Gross worked his way through college as an engineer for the Chicago & North Western. Michael is standing with his mother in front of the train he was running that day. What a neat photograph. Thank you, Michael, for sharing it with us.
Photo courtesy of Michael Gross



Playback problems? [Click here ...](#)

ADVERTISEMENT



Fun Features for a Fraction of the Cost!

As the most versatile, feature-packed sound decoder, Econami redefines *value*. Starting at \$79.95 and available now!

SOUNDTRAXX®



Hear how you can get more for less!

Layout construction



7. We featured this folding Athearn trade show layout on the show last year. It's back for a makeover. We will recolor the wood, refresh the ballast, and install a new power feed wire system to make show set-up fast and easy.

**Want to help keep
MRH free?**

Then *click* on ads!



Southern Digital



**20% Discount
on most Items!**

Specializing in DCC Since 1992



DCC Conversions, Service & Support

Orders Received by 3:00 pm EST ship the same day

WWW.SODIGI.COM

E-mail: sales@sodigi.com

(770) 929-1888

(Photo's are from our N-Scale layout)

WHAT'S NEAT | 9



8. I began the project by sanding the clear coat off the oak sides with an oscillating sander. This kept dust at a minimum and did not damage the scenery.



9. Using a straightedge painters mask to protect the fake fur scenery from the stain, I applied Minwax High Gloss Black polyurethane to the sides of the layout. This gave the layout a very different and professional look.

WHAT'S NEAT | 10



10. I also applied two coats of the black polyurethane to the outside of the folding layout to seal the wood and give it a finished look when folded up for transport.

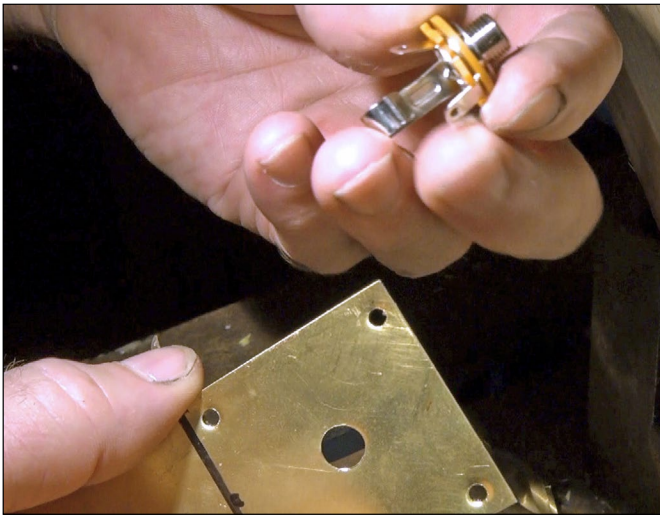

11. Using a thin piece of brass stock, I made a face plate to hold a guitar jack mount. The jack allows the layout to have power when set up.

I drilled five holes in the brass plate, four for mounting screws and the center hole to hold the female jack.

WHAT'S NEAT | 11



12. I drilled a hole in the corner of the layout to pass the wires from the mounting jack to the surface of the layout.



13. I then snaked the power feed wires from the corner of the layout under the fake fur to the track, using a piece of bent code 70 rail as a wire snake.

WHAT'S NEAT | 12



14. Power wires soldered to the female microphone jack connect to the outside of the rails on the Bachmann EZ Track. Note how I use clamping tweezers to hold the wire in place on the rails during soldering.

ADVERTISEMENT

Make LocoNet wiring extremely simple!



Suitcases belong in your baggage cars,
not under you layout!

Introducing the DCC Vampire II ...
this guy does the job of two suitcase
connectors!
And really holds the connection good
too!

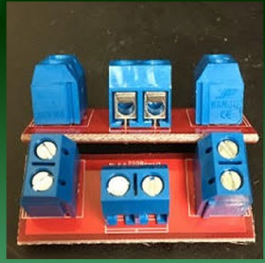

CLICK NOW TO DISCOVER THE AMAZING VALUE!

Dealer Inquiries Accepted



15. Using a buffing wheel and some fine buffing compound, I polished the brass face plate to a reflective shine. I then attached this plate to the bottom corner of the folding layout with four black wood screws. I attached eight feet of blue speaker wire to the male microphone jack, which simply now plugs into the layout's face plate during set-up.

ADVERTISEMENT

END OF TRAIN DEVICE

NEW ORANGE CASE!

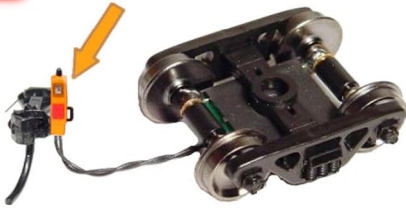

Bright Red Flashing Light!

Installs in minutes!
No freight car modification required!

RE RING™
ENGINEERING

Click Here to Learn More

Patented Technology - US Patent 7,549,609

Does not affect Load!

↓ Car without Load ↓



↓ Car with Load ↓



Great control in a tiny package



**Original
Touch Toggles**

- Touch Toggle™ plug in controls
- Bright clear indication
- Easy setup
- Flexible system

Stall Motors, Twin-coils,
Power, and Servos

Now for Tam Valley Depot
and MRservo too!



**BERRETT
HILL
TRAINS**

Made in the USA



What will they think of next?

www.berrethillshop.com

IOWA SCALED ENGINEERING

Exciting and
affordable
sound player
for your model
railroad



LEARN MORE >

TamValleyDepot.com

Great Electronics for Great Model Railroads



Home of the
Frog Juicer

We are loading up the boxcars with
Frog Juicers ready for your layout!

WHAT'S NEAT | 14



16. Because EZ Track reacts to temperature and humidity differently than Woodland Scenics ballast, a few cracks formed over the past two years.



ADVERTISEMENT



Announces their purchase of
BEST's
Laser-cut Structure Kits

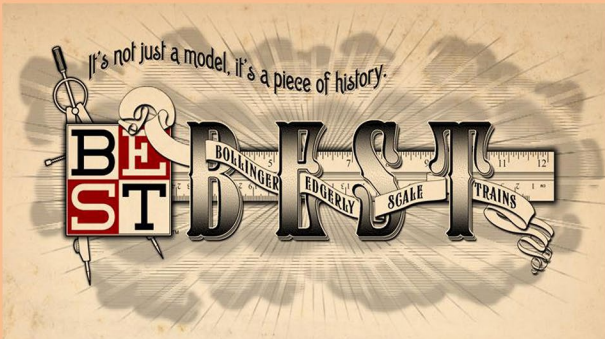

To order or get more information, please email Jeff at:
motrakmodels@centurylink.net

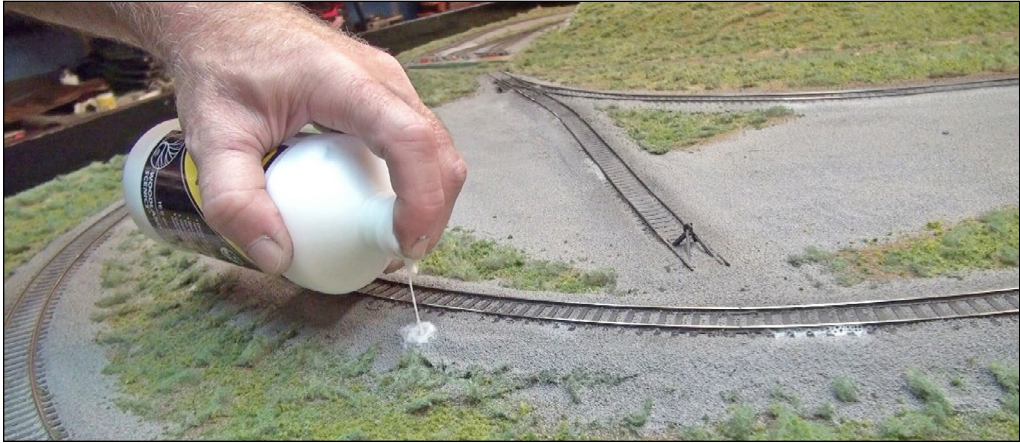

17. I added new ballast to fill the cracks and soaked the area with Woodland Scenics Scenic Cement which remains a little flexible, and may solve further cracking in the future.

ADVERTISEMENT

Imagine that!
Laser Art Products



ITLA Scale Models



*Precision Laser
Cut Wood Products*

*Cooper's Alley
HO Scale Laser
Cut Wood Kit*

CLICK HERE FOR MORE INFORMATION
www.itlascalemodels.com

WHAT'S NEAT | 16



18. After test-running the layout, it went into the truck on a soft blanket for transportation to the Athearn trade show booth, for its debut at the NMRA National in Indianapolis, IN.



19. Upon unfolding the layout at the show, things were set up quickly and the first locomotive was running in 10 minutes.



20. The layout had a new look and ran well. The wonderful attendees of the National Train Show got to see and hear Athearn locomotives pulling freight hour after hour for two days.

21-22. (Right, upper and lower) Matt Hermann from ESU Electronics came by the studio to share some of the features of the LokSound sound decoders. Matt brought a lot of nice sound-equipped locomotives to run on the layout. See and hear them in this month's video.

Matt demonstrates how the ESU line of sound decoders allows independent control of the locomotive prime mover RPM and the speed of the locomotive, allowing the modeler to match the sound of the engine to how heavy the train is, and how hard it works to pull the train. The effect looks and sounds neat! Some LokSound decoders allow the modeler to upload sounds from the ESU website to match the type of locomotive and its prime mover to your specific model. Matt explains a complicated subject in a simple, straightforward, and interesting way. For more information on ESU LokSound decoders, visit loksound.com.

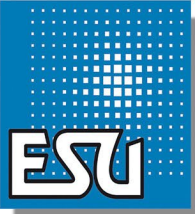

Tired of tearing apart valuable locomotives every time a new decoder is released?

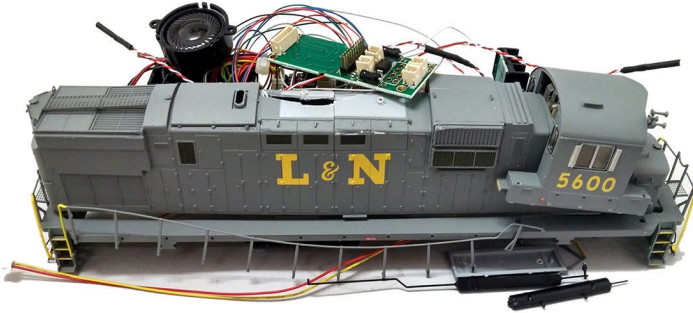

ESU decoders are re-programmable!

ESU LLC

23 Howard Street, Montoursville Pennsylvania 17754

Phone +1 570-980-1980, Fax +1 866-591-6440

(Office hours: Monday through Friday, 8AM to 4PM (EST))

WWW.LOKSOUND.COM

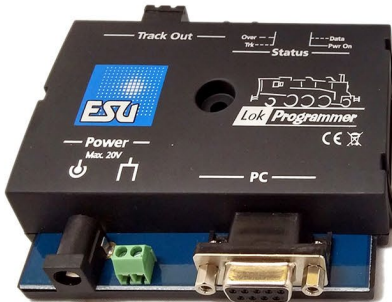

Programmer

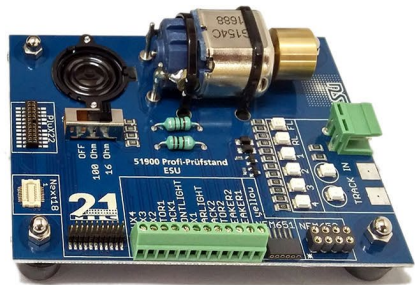

Decoder Tester

#53452 LokProgrammer - \$150 list

#51900 - Decoder Tester - \$57.90 list

BUY IT ONCE & UPDATE IT FOR LIFE!

WHAT'S NEAT | 18

Matt Hermann for ESU LokSound



Don't forget to click on Reader Comments to rate this month's "What's Neat" column and video.



[Click here for reader comments](#)

Digitrax



\$375.00 MSRP

- **400 Loco Addresses**
- **5 or 8 Amps of Power**



Introducing

DCS240

LocoNet[®] Advanced
Command Station



- **400 Throttle Support**
- **For Serious Operation!**

Find out more at:

www.digitrax.com

iwata

by ANEST IWATA

Be Realistic

From weathering broad areas to painting concentrated details, an Iwata airbrush gives you precision and reliable performance for a natural, smooth finish.



Iwata Eclipse CS

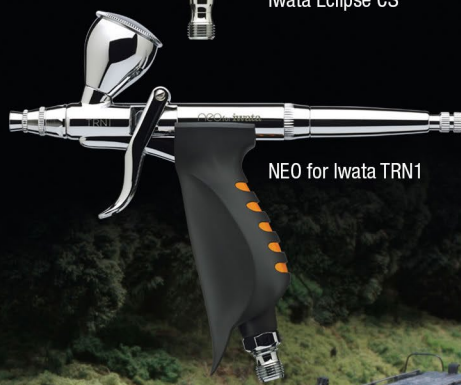

NEO for Iwata TRN1



iwata
MEDEA
ANEST IWATA-MEDEA Inc



Locomotive from Alan Houtz, North American Prototype Modelers

Click to see the entire line of Iwata Airbrush and Artool Products

• INDEX

• TABLE OF CONTENTS

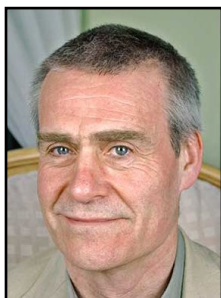

ROB CLARK
.....

IMAGINEERING

column



[Click here for
reader comments](#)

COLLABORATIVE DESIGN FOR MODEL RAILROADERS | SHARING KNOWLEDGE ON THE INTERNET

I'M BUILDING A 1930S FREELANCE US SHORT line railroad called the Cornhill and Atherton and, as all free-lancers will know, it is a difficult path to follow. Because there aren't specific prototypical guidelines, the opportunities to create something "wrong" are manifold. As a UK-based "Imagineer" I face some extra challenges, not helped by the fact that I have not even visited the US. Everything has to be researched or guessed, and this means I rely heavily on others to keep me on a sensible path.

This has evolved into a way of working I think qualifies as collaborative design, and I would like to share my very positive experiences of this approach in a model railroading situation.

What is collaborative design?

Collaborative design, very simply put, is a group of people working actively together on an initiative. It has its origins in software

▶ EXPLORING THE CREATIVE SIDES OF THE HOBBY

engineering, but from our modeling perspective, it's a way of utilizing people's knowledge through shared information.

Ideas can be discussed and refined, and hopefully a better model is constructed as a result.

The internet provides a powerful collaboration tool, since it allows dialogue between many people across the planet, with these dialogues visible to a potentially huge audience. Questions can result in many answers that then spark more questions and more answers. It's possible to tap into a huge pot of experience that is absolutely relevant to the area that you are working in.

Google is great for research, but it's a short conversation. Answers are provided, but you may have asked the wrong question, or may misinterpret the answer – there's no “sense check” or feedback loop.

Past workplace experience has shown me that you cannot beat a group of focused and knowledgeable individuals discussing a topic in front of a white board. Questions are defined, ideas discussed, decisions and direction established – “job done.”

The internet allows anyone to easily do this on a grand scale. It may not be in real time, but it's close enough. Pictures can be shown and annotated, ideas presented, and links to other topics reviewed.

One of the best ways of achieving meaningful conversations is through the use of internet forums, which allow the posting of a question or topic to which others can add comments.

Model Railroad Hobbyist magazine's forum is an obvious example of this – certainly my tool of choice. However there are many other model railroad forums, including those that support SIGs (Special Interest Groups) which can be useful if you have a very specific area of interest.

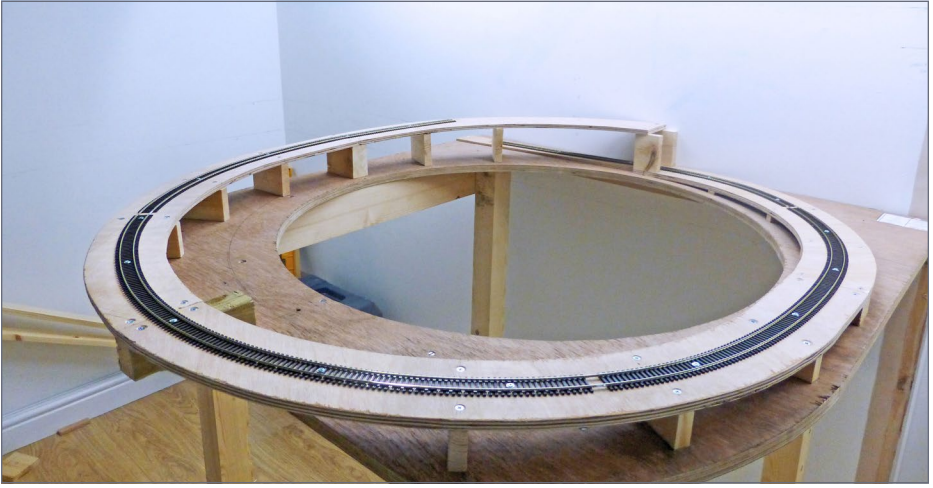

1. When I was building my helix I posted that it had a 3% gradient. Some swift advice was forthcoming so I “tried” the lower levels to see how trains actually performed and as a result, I redesigned it to include an extra turn between the two decks. That got the helix grade down from 3% to 2%, avoiding a disastrous error.

Don’t dismiss Facebook or similar social networks, because, used with care, they can connect you with like-minded individuals and provide good feedback.

How is it relevant to model railroading?

In my case, I have no experience of, or direct access to, American prototype railroad practices, so I have to rely on research material to get some kind of realism in my model world. However, model railroading is essentially an art form, and art is a very imprecise science, which means it’s easy to create things that are unlikely.

We all benefit from the experience of others, and to do this we need to be able to show what we are doing and discuss the pros

and cons. People can often see things you miss. It's easy to get too close to the problem, and often others can draw your attention to the obvious.

Even in the internet age, face-to-face contact is still the best way to communicate, but it's not always cost-effective, and in the case of our model railroads, mostly impractical. Your experts may be spread across the nation – even the planet – and they have no inclination to visit you at a set time and place. However, they will joyously assist if asked sensible questions they can read and answer when it suits them.

Collaboration is the key and we just need a way of getting everyone in touch.

ADVERTISEMENT

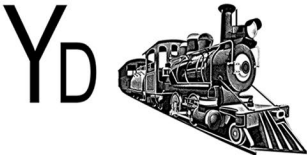

Yankee Dabbler – Track 33

**FREE SHIPPING
ON ORDERS OVER
\$100.00**

**YD Specializes in DCC
Sales-Service-Installation
YD provides the BEST for LESS**



CLICK AND SAVE TODAY!



YD installs DCC or RailPro in your engines

Technical Coordination (727) 457-9227 9AM to 9PM EST

Locations in NJ and FL / Visit our Web Site for Train Show Schedules

Visit YD at Trainfest
Booth 2220
Milwaukee 11/12 & 11/13



2. A blank doorway with a need for some dramatic scenery in the background. Alan B. had already suggested a photo backdrop to make the background mountain look like a range.



3. He followed it up quickly with this Photoshop mock-up which I loved, but thought too powerful for my small train room. Perhaps I need more like a New Hampshire look?

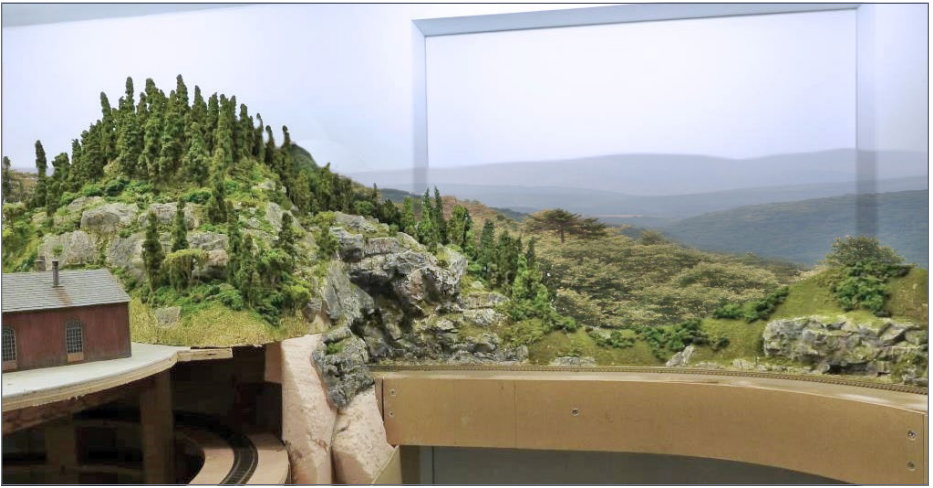

4. Alan duly gave me another option which I thought much more in keeping. He even sent me the image he used, but it proved of too low a resolution to be useful, which was probably just as well.



5. Suitably inspired, I sourced my own images and combined them with lots of 3D trees to end up with this (“real”) solution, which I think is a good compromise offering manageable grandeur.

How do we go about it?

The first time you embark on a bit of collaborative design you need to be brave, but it soon becomes familiar.

Essentially, you “post” your question on an internet (web) forum. Let’s assume for the purposes of this exercise that we are using *Model Railroad Hobbyist*. Take a look at the “Make a web post” link on the right-hand side of the *MRH* home page.

Here you have the choice of a topic or a blog (a “web log”). A topic is good for a question about a specific issue, whereas a blog can be used for a larger construction project that may cover many issues over time.

I recommend preparing your question/ issue in advance by just writing it down or using a word processor. Make sure you are clear, concise, and error-free, and then type or copy and paste into the forum text box.

Images are vitally important to clarify what you are talking about. They also get people interested and more likely to read what you have posted. So please add pictures to your post. Most forums require you to upload the images from whatever device you are using. You usually have some control over their final size.

After posting, you have to wait to see if there is interest. Patience is required because people are not sitting at their keyboards poised to comment. After posting a question, you need to walk away and wait for the first replies. This gives time for others to:

- a) see the question and respond (they may be in a different time zone)
- b) have the opportunity to see other replies and then provide contrary views, or add support to an existing view.

It’s all about “pacing” so that the conversation runs smoothly and productively. Waiting a little before replying also avoids



6. This image I found on Google was the inspiration for the look of the company housing at Atherton. Dave S. drew my attention to the stones that had been thrown onto the roof by kids, and also the swing lying loose below its chains.



7. Adding the stones to the roof and the swing (second house) are small details, but help with the believability of the scene and also connect the model to (a long-gone) reality in a satisfying way.



8. When I proudly posted a picture of a crow I made for the engine house roof, Dave B. pointed out in a most amusing way that the crow did not really look like a crow. So I tried again (very hard) and achieved the result you see here, which even has tail feathers.



9. You can see the original effort on the right. As Dave pointed out, with a pair of back legs it could pass for a ferret. What was I thinking of !

you stopping the information flow, or committing to a course of action on your railroad before getting all the options.

Conversely, don't wait too long before replying because people can lose interest. Be prepared for a few iterations if things are going well. Too much information is usually better than too little.

An important care point relates to posting a photograph of something that is "work in progress" rather than the finished article. You are deliberately doing this to get advice about how to proceed, but you have to be prepared for people to comment (you may think harshly) about the unfinished aspects of your work. The possibility that you may take exception to this negative feedback leads us nicely into the subject of etiquette.

ADVERTISEMENT



Archer
FINE TRANSFERS
PROUDLY SERVING MODEL BUILDERS SINCE 1989

THE ORIGINAL
SURFACE DETAILS™

WE NOW HAVE MORE THAN 130 SHEETS OF RIVETS, LOUVERS, TREADPLATE, WELD SEAMS AND MORE CAST ONTO MICROSCALE CLEAR DECAL FILM

LOW SHIPPING:
DOMESTIC USA ORDERS \$2.80
INTERNATIONAL ORDERS \$9.95

CLICK HERE TO VISIT OUR WEBSITE!

Archer Fine Transfers • PO Box 1277 • Youngsville, NC 27596 • USA
(919) 570-1026 • info@archertransfers.com • archertransfers.com

"Archer Fine Transfers 3D decals have revolutionized kitbashing and scratchbuilding. Putting rivets or other low-relief details like louvers or weld seams on your models is now as easy as applying decals."

Joe Fugate, Publisher/Editor Model Railroad Hobbyist



MADE IN THE USA

ADVERTISEMENT

**TRINITY 3 2 8 1
IN STORES NOW**



Norfolk Southern -- 12 #s



ICE-GATX -- 8 #s



Winchester & Western -- 12 #s



NRLX Ciment Quebec -- 12 #s

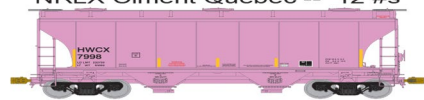

HWCX -- 7 #s

American Limited

www.americanlimitedmodels.com

Forum etiquette – politeness

The dynamic of digital communication requires as much, if not more, care than that of a face-to-face communication. With electronic communication, you cannot see facial expressions, hear vocal intonations or read body language, so extra care is required to avoid misunderstanding.

As the post owner and leader of the collaborative group, you have a responsibility to keep things professional, productive and polite.

As a starting point, make sure you present your question clearly. Carefully review what you have typed before posting – bad spelling or poor grammar doesn't do much for your credibility.

Take care how you word your questions and how you deal with replies. The written word in the electronic age is notorious for being hastily drafted and hastily read, resulting in, at best, the end of the conversation or, at worst, a messy conflict. You need to imagine the person you are messaging is seated right in front of you, and is someone you respect.

Remember, you are asking folks for help. If you don't like what they are saying, then that's unfortunate and you have to "take it on the chin" or better still, explore in more detail their point of view.

Never be offended, never reply with "smart" comments, and never lose your temper. Silence is better than a negative response. If you are unhappy with a reply written on your post, take a break and read it again slowly and carefully. You may well find that you misread it first time and perceived a negative that wasn't really there. I have done this on a number of occasions, and been pleased I didn't make a hasty retort. If, even after careful consideration, you still take exception to what was written, reply politely and factually (the next day if you feel you need to cool off). Never put fingers to the keyboard when you are in a bad mood.



10. Jim D. (ex-roofing professional) spotted the flashing overlapping the upper tiles on this smoke ventilator – roof leaks highly likely!



11. I reworked the flashing so that it tucks neatly under the tiles above the stack, providing a much more accurate representation.

IMAGINEERING | 13

Sometimes “conversations” can develop between individuals who are posting in your thread. This is useful and sometimes entertaining.

If things are going well, you may well end up with many different (possibly conflicting) answers and opinions. You can utilize one or more of these ideas, but remember that you don't have to follow any of them, because it's your railroad and you have to live with it. It may be that alternative ideas just cement your original thoughts.



12. Alan R. (an architect) made reference to the arched top and depth of the windows on this engine house being out of place on a board-and-batten building. I shortened the windows since a kick hazard would have been a real problem. However I retained the arched top (I and others just liked it) and applied a back story that the shop construction guys reclaimed the windows from a demolished building in town.



13. Rick R. printed a picture I posted of the bare helix I was struggling with. After drawing some ideas with a pencil crayon, he photographed the result and posted to my blog.

However, when you action a decision, it's polite to explain why, or more importantly, why you haven't taken a suggestion. If someone has taken the time to try to help you, you owe them some thanks and feedback.

Keeping things going – patience

You may have to keep “stoking the fire.” The more questions you ask and the more you reply, the more responses you will get.

Leaving a ‘conversation’ for a few days is not the end of the world, but the interest of the group may wane, and you might have to accept some time lag on information flow when you return to a topic.

Don't be upset if you get very few – sometimes zero – responses. It's nothing personal, and people have their own lives to lead. The

IMAGINEERING | 15

law of averages is controlling who takes the time to read your posts, and sometime people are just doing other stuff. Be patient and try again later, perhaps approaching the issue from another angle.

Be prepared for your posts to be diverted into other topics. Going off-topic can often be entertaining, and people appreciate humor and general interest.



14. I didn't follow Rick's picture ideas exactly, but they certainly had a big influence on the final result you see here. Widows Veil trestle is a signature scene on the C&A, and the helix-hiding exercise was successful.



15. When I was looking for some backdrop direction, Dave S. Photoshopped and posted this excellent scene. He even kindly offered to prepare it as a fully printable backdrop for me!



16. This is how the scene looks so far; after the 3D trees are added, things will have been heavily influenced by the input of Dave and others.

When you first embark on this collaboration process, you are pretty much guaranteed some responses, but initially things may be a bit thin. We are social animals, and trust has to be earned. Some of that trust is obtained through how you ask your questions and deal with answers, but is also comes with time. The number of people who are prepared to assist you will grow as this mutual trust develops.

Also, take the time to post without asking questions. Entertain a little by showing how things are going. Your blog should be a fun place to visit, so the more pictures, humor (and of course useful information) the better.

However, you need to remember the end game, which is creating a satisfying model railroad. Sitting at the computer and interacting with others who share your interest can become an addictive pastime. Take care not to become too wrapped up in the process of getting the information, at the cost of delivering the thing that started you out in the first place.

Conclusion

Personally I find collaborative design a fascinating process; here is a blog quote from me back in 2014:

“Seeing finished stuff is great, but I personally get a bigger kick out of sharing my often amusingly imperfect journey. I just love the criticisms. Seriously – even the ones I might not agree with – educate me and often make me re-examine my approach, now or in the future.”

The Cornhill and Atherton, although built by me (ably assisted by Jean) is the product of many people’s input. There is no question that it would have looked considerably different without this support, and certainly would not have been as successful. I have taken many wrong turns over the last few years but been steered back to

!MAGINEERING | 18

sensibility by the “group,” and I expect to make many more wrong turns and get lots more friendly advice in the future.

So go ahead and ask questions, have fun, be communicative, patient, polite, and most of all, be productive. ✓



[Click here for reader comments](#)

ADVERTISEMENT

TamValleyDepot.com
Great Electronics for Great Model Railroads

Home of the Frog Juicer

We are loading up the boxcars with Frog Juicers ready for your layout!

ADVERTISEMENT

WOW!
What scale is this?

Click for the answer ...

MISSOURI LOCOMOTIVE COMPANY

NEW!

TMTV Season 2 DVDs and downloads



TRAINMASTERS.TV Layout construction series

Miles Hale goes ...

Back To the Basement

All nine episodes following the layout from concept to completion

MRH DVD

DVD
\$29.99
~~\$36.99~~

DVD
2 disks

Download DOWNLOAD
\$14.99
~~\$19.99~~ 9 files

TRAINMASTERS.TV Layout construction series

Layout tours
volume 2

12 Layouts in all!

MRH DVD

DVD
\$29.99
~~\$36.99~~

DVD
2 disks

Download DOWNLOAD
\$16.49
~~\$21.99~~ 12 files

TRAINMASTERS.TV Module construction series

Trevor Marshall hosts ...

THE ROADSHOW

All ten episodes following two Free-mo modules from concept to completion

MRH DVD

DVD
\$31.99
~~\$44.99~~

DVD
3 disks

Download DOWNLOAD
\$19.99
~~\$24.99~~ 12 files

TRAINMASTERS.TV Layout construction series

the BEST of Season 2

MRH DVD

PREORDER
DVD
\$33.99
~~\$49.99~~

DVD
4 disks

Download DOWNLOAD
\$22.99
~~\$29.99~~ 16 files

Est. delivery:
Late Nov.

SHOP NOW >>

**Model Railroad
Hobbyist Store**

store.mrhmag.com



MRH MARKETPLACE



Now Available Again
KIT #5761/5762 PRR GLA
Modernized Hopper

Check our Website For
List of Closeout Kits.
westerfieldmodels.com

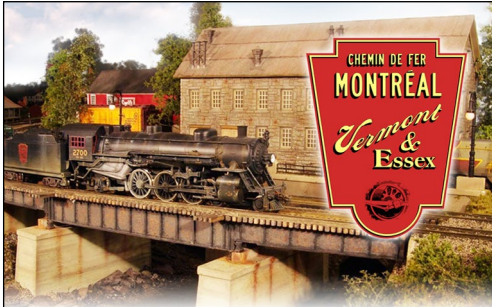

OPEN HOUSE

PORTES OUVERTES

November 26 & 27
26 et 27 Novembre

CLICK FOR DETAILS



DID YOU KNOW
MRH SUBSCRIBERS
GET FREE BONUSES?
CLICK TO SUBSCRIBE
NOW - IT'S FREE!

LOOK
at what's new at
Black Cat this month

Click here for
our website

ACL# 24165
box car



Black Cat Publishing
(204)489-5005
ajfergus@mymts.net
blackcatdecals.com



MRH MARKETPLACE | 2



TAM Industries

"Preserving the Romance"

The highest quality in Display Cases for sharing your excitement of Model Railroading. We manufacture Display Cases for all gauges of Model Railroading, from "G" to "N". Custom Sizes are available for some styles.



Visit us today at: www.TAM-IndustriesOnline.com

FEATURING America's Historic Main Street Architecture



O-Scale model shown (HO available)

**MAINSTREET
HERITAGE**

www.mainstreet-heritage.com

clever models LLC

Cardstock models & materials



Try one today!

www.clevermodels.net

MP THE LAND OF PERFECT SCALE SCENERY AND TREES



ATSF Bx-48

Yarmouth Model Works

HO scale resin kits and detail parts

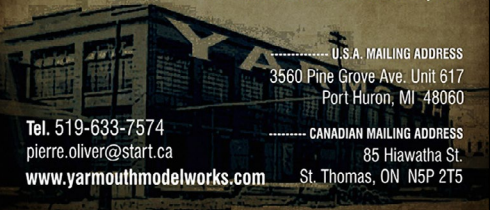

..... U.S.A. MAILING ADDRESS
3560 Pine Grove Ave. Unit 617
Port Huron, MI 48060

..... CANADIAN MAILING ADDRESS
85 Hiawatha St.
St. Thomas, ON N5P 2T5

Tel. 519-633-7574
pierre.oliver@start.ca

www.yarmouthmodelworks.com

P R E C I S I O N D E S I G N C O

Chains
Flat Car loads
Joint Bars
Signs & Posts

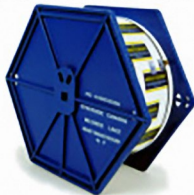

FREE SHIPPING

MRH MARKETPLACE | 3



Affordable Modular (domino) Benchwork in 200+ sizes
Custom built to order benchwork also available!



KC's Workshop
Craftsman Model Kits
www.kcworkshop.com
www.facebook.com/kcworkshop

CLICK HERE



CANYON CREEK SCENICS

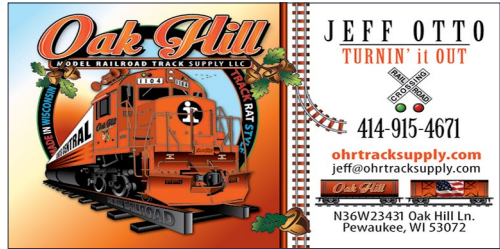

JEFF OTTO
TURNIN' IT OUT
414-915-4671
ohrtracksupply.com
jeff@ohrtracksupply.com
N36W23431 Oak Hill Ln.
Pewaukee, WI 53072

NEW! Fusee Pro/M **LOGIC RAIL™ TECHNOLOGIES**

The /M means it's **Mobile!** Track-powered; move it wherever you need it!

"Sophisticated Model Railroad Electronics"

Please visit our website and online store!

21175 Tomball Pkwy Suite 287 Houston, TX 77070 Phone: (281)251-5813 <http://www.logicrailtech.com> info@logicrailtech.com

JIM'S TRACK PLANS



EXPLORE HERE

New Designs Every Tuesday!

The B BUILDING & STRUCTURE Co.

banta modelworks



Chama Depot
in HO scale all laser cut wood
#2098 \$148

421 Hopkins Road, Dummerston, VT 05301
800-653-8214

see all of our fine products from HO to F/G scales at:
www.bantamodelworks.com

Trees



coastmans.com HO

LIGHTS4 MODELS 

 **FIND US ON FACEBOOK**

NEW PRODUCTS
ADDED MONTHLY

LED lights, Animated Signs, & Sounds [Shop Now](#)

www.lights4models.com 614-296-8691

PRE-SIZE
MODEL SPECIALTIES

P.O. Box 6 Paonia, CO 81428
Ph. 970 527 4586
Made in The USA

Cast resin items for All Scales.
Tunnel portals, bridge piers, abutments,
culverts, and retaining walls.
Trackside details and sage brush tree
armatures.

"FREE SHIPPING see website for details"

MODEL RAILROAD
BenchWork.com



Affordable built to order Benchwork
starting at only \$20 a Sq Ft.

RULERS-of-the-WORLD

Scale Rulers \$4 each
Over 200+ scales!
Metric or Imperial

www.rulers-of-the-world.com

Great Decals!TM

FEC, Interstate, Virginian
Railway, & L&N Titles 

After Hours Graphics Line
Coupler Gages and More
In O, S, HO, and N Scales

CROW RIVER PRODUCTS

O Scale Kit 333 Portable Conveyor \$ 25.00
A Resin & Metal Kit with Laser Cut Wheels



We Specialize in Machinery, Derricks,
Engines, Hardware & Waterfront Models
Pawtucket, RI 02861 Tel 401-723-0065
www.crowriverproducts.com
We Accept Visa Master Card- Discover and PayPal

**Your ad
could be in
this space
for as low
as \$112 a
month.**

[Click to learn more ...](#)

Have you seen these popular blogs on the MRH website?



Tom Johnson's L&N

305,000 reads

CLICK TO READ IT NOW



Ken Glover's Shelf Layout

102,000 reads

CLICK TO READ IT NOW



MOUNTAIN SUBDIVISION HOBBIES

www.modelrrsupply.com

FREE USA SHIPPING OVER \$29.00

NCE - SOUNDTRAXX - DIGITRAX - PECO - CIRCUITRON
DCC SPECIALTIES - INTERMOUNTAIN - CMX - ATLAS
BAR MILLS - BOWSER - KATO - MRC - TOMAR - RIX -
PIKESTUFF - LOGICRAIL - CENTRAL VALLEY AND MORE!

HO DIESEL SUPPLY

KATO EMD SD SPECIALIST-REPAIRS-UPGRADES

New and Rebuilt Locomotives

Powered Chassis-Trucks-Motors

Bodies and Parts-Handrails-Electronics

www.hodieselsupply.com

email:kato@hodieselsupply.com

Your ad could be in
this space for as low
as \$28 a month.

Click to learn more ...

2017 Trolley Calendar

Color cover, 13 B&W photos with
descriptive captions from mid-
Atlantic area:

PTC, PST, LVT, D.C., NY, PSCT and
others.

\$10 +\$2 S&H

To order the calendar by check or
money order (payable to East Penn
Traction Club), please send to:

East Penn Traction Club

c/o Charles Long

227 Locust Road

Fort Washington, PA 19034-1425

[click HERE to learn more](#)

Trainfest®

NEW
**2 DAY
TICKETS**

**AVAILABLE JULY 1
THROUGH NOV. 11**

**AMERICA'S LARGEST
OPERATING MODEL
RAILROAD SHOW**

**Saturday & Sunday
Nov. 12 - 13, 2016**

**9:00am-
5:00pm**

**WI State
Fair Park**
Milwaukee (West Allis), WI

Ticket discounts and show details at **Trainfest.com**

EXPANDED TRAINFEST CLINICS

FREE

Join us for **2 full days of clinics** presented by expert modelers and model railroading manufacturers. Choose from a wide range of modeling topics at any of our **56 total clinics!** Space is limited, register for clinics today at www.Trainfest.com.



60 MODEL RAILROADING MANUFACTURERS

Come to see all **major model railroading manufacturers** at Trainfest and many **cottage industry** businesses offering unique and interesting products for your layout. Don't miss any of the exciting announcements scheduled to be unveiled at Trainfest!

NEW PRODUCT ANNOUNCEMENTS

**OPERATE
THE
TRAINS!**

70 OPERATING LAYOUTS

Make Trainfest your annual destination to meet with other modelers and find inspiration for your own layout at more than **70 operating model railroads**. Experience the camaraderie of the model railroading hobby and even **operate the trains** on participating layouts!

**CELEBRATE
A
RAILROAD**



CELEBRATING THE MILWAUKEE ROAD

In 2016 Trainfest will partner with the Milwaukee Road Historical Association to celebrate the Milwaukee Road. Look for the Milwaukee Road throughout the show and don't miss the museum quality historical photo display, Celebrate-a-Railroad clinic series, and much more!

**FREE
RIDE THE
MLES
TRAIN!**

Sponsored by the Wisconsin Southeastern Division, Inc.
of the National Model Railroad Association



Photo by Andy Rubbo



The Pennsylvania Railroad

BY ROBERT SCHLEICHER
AND ANDY RUBBO

*Photos by R. Schleicher unless
otherwise credited*

1: Andy Rubbo selected an era near the end of the life of Pennsylvania Railroad when the electric GG-1 locomotives still headed most passenger trains. This view is looking east along the Elizabeth S-curve, just west of downtown. The track superelevation is evident with the train canting from left to right as it traverses the reverse curves. The mail and express train is pulled by double headed GG-1s, a common practice presumably to increase reliability. The PRR and other railroads relied heavily on postal contracts to supplement revenue for their passenger trains. Soon though, many of these contracts would be cancelled, hastening the demise of many passenger trains and leading to the eventual formation of Amtrak.

Easy Real Railroads



[Click here for reader comments](#)

HOW COULD ANYONE POSSIBLY COMPRESS

into a basement the busiest mainline in North America, with 300 and more trains a day rushing up and down a four-track main? How? By recreating only the significant scenes, trains, and operations. By focusing on the “signature” sights and actions, it is possible. I am recreating a portion of the Pennsylvania Railroad’s New York Division on my 13 x 37-foot HO scale layout.

I am focusing on the Pennsylvania Railroad’s tracks and scenes from Penn Station to Sunnyside yard in New York (as a hidden staging yard), through the west portal of the Hudson River tunnel into Metuchen, New Jersey and then into the west hidden staging. The area from New York through Newark is on the lower deck, and the stretch from Elizabeth to Metuchen is on the upper deck.

The staging tracks and reverse loops are in a separate 7x13-foot room. The mainline is four tracks wide, with six in some areas in addition to sidings. The mainline run is over 300 feet on the layout, enough to include the scenes that are important and still operate 15-car passenger trains close to the prototype’s length. The finished layout will fill two complete decks but, so far, only the track on the upper deck is complete.

The layout is built on conventional open-grid benchwork with plywood beneath track, and Homasote roadbed. The flex track is Micro Engineering, with Walthers turnouts. The layout is con-

THE PENNSYLVANIA RAILROAD | 4



2. The westbound Broadway Limited GG1 on track #4 meets an eastbound CNJ train from Jersey Shore on track #2.

trolled by a Digitrax DCC “Super Chief” system with radio walk around throttles.

Double, triple, and quadruple-track mainlines have crossovers so trains can cross from one line to another, as well as places where trains can cross all the tracks. On the Pennsy, these were referred to as interlocking plants. There are three interlocking plants: Elmora, Union, and Lincoln on the upper deck. There will be four more interlocking plants on the lower deck.

Lincoln is a true universal interlocking plant that can cross a train from any track to any other track traveling in either direction. Elmora and Union are limited interlocking and serve in conjunction with each other to funnel traffic to and from the shore branch line, known to many as the North Jersey Coast Line.



3. Looking west at the big “S” curve leading into Lincoln interlocking (Metuchen) in this photo taken 8 years ago.

This segment of the PRR is home to the heavy electrics that were a part of the PRR’s fleet. I scratchbuild all of the catenary. The supporting masts and bridges are made from brass strips and angles. Brass and nickel silver strips and wire are soldered together for the catenary poles and bridges. Phosphor bronze wire is used for the overhead conductor wires and tensioning cables.

The catenary is based on descriptions in the Pennsylvania Railroad Historical Society’s online modelers’ magazine, the Keystone Modeler in issues 50, 52 and 56.

A simpler method, although slightly less realistic, is to use etched metal kits and materials from Model Memories modelmemories.com. They offer kits to recreate the Pennsylvania system and the somewhat different New Haven towers and bridges, along with the catenary wires and supports.

THE PENNSYLVANIA RAILROAD | 6

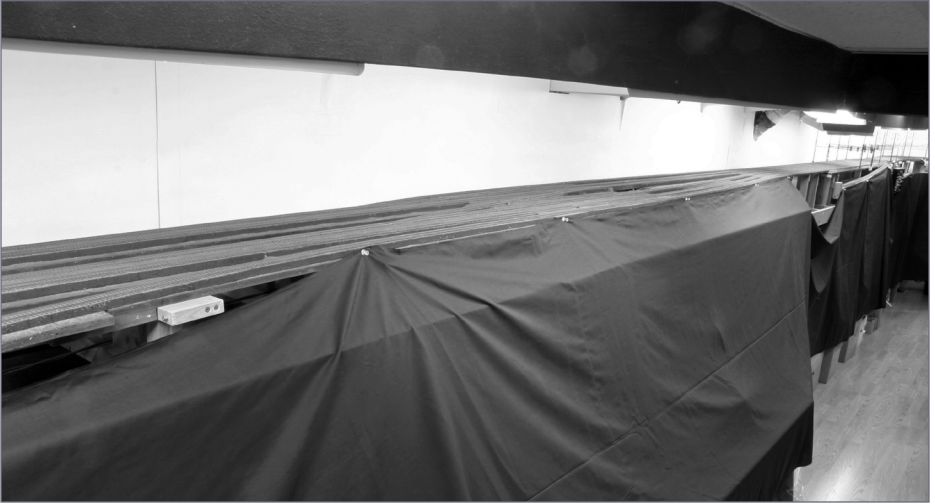

4. In this photo taken 8 years ago, we're looking east along the six-track main toward Elmora interlocking, where the two outer most tracks (A and B) will converge back into tracks #1 and #4.



Photo by Andy Rubbo

5. Here is the same location as [4]. Boxes on lower benchwork contain all the track and turnouts for future lower level.

THE PENNSYLVANIA RAILROAD | 7



6. In this photo taken eight years ago, we're looking westward at the six-track main toward Union interlocking. Rahway is on the right. On the left is the curve into Lincoln interlocking.



Photo by Andy Rubbo

7. A view of the concrete arch bridge over the Rahway River today, just east of the Rahway station. In the background is the Wheatena factory, with its unusual square water tower resembling the company's cereal box. The bridge is entirely scratchbuilt from styrene, as is the factory building. The water tower base is a modified Korber Models kit, with a scratchbuilt square tank on top.

THE PENNSYLVANIA RAILROAD | 8

Walters imports the Vollmer line of catenary and Euro Rails, in Canada, imports the European-prototype Sommerfeldt catenary system that is very close to scale thicknesses and proportions. Marklin also offers a simple to install but somewhat bulky European catenary system. These European systems may or may not be an exact match for American catenary but they are simple to install.

Ten Significant Factors

Here are ten significant factors that led me to model this portion of the Pennsylvania mainline:

1. Why select this particular prototype railroad?

I grew up in central New Jersey in the late '60s and early '70s when the Pennsylvania Railroad was running a steady parade of passenger and freight trains on the four-track mainline. Though



Photo by Andy Rubbo

8. Close-up of painting and weathering of Rahway River bridge [5] and [7].



9. Looking west from the east end of Elmora interlocking, as it looked eight years ago.

the Central Railroad of New Jersey (CNJ) ran through Elizabeth and Plainfield, NJ, my hometown, the Pennsy was my first love. Modeling Elizabeth allows me to incorporate both the CNJ and the Pennsy. The two roads interchanged passengers but not equipment at Elizabeth.

2. How did I determine which portion of the prototype to model?

My passion is watching the trains run through recreations of real world scenes. Super-detailing both the trains and the scenes to a high standard makes it difficult to tell the difference between the prototype and the model. The area also happens to be one of the rare portions of the Pennsylvania Railroad where there are more than dozen different prototype railroads running an incredible variety of passenger equipment. This was also one of the busiest portions any railroad in America, with hundreds of trains every

THE PENNSYLVANIA RAILROAD | 10



Photo by Andy Rubbo

10. The southbound "Afternoon Congressional" enters the El-mora interlocking. The observation car "George Washington" is positioned backwards behind the locomotive to facilitate turning the consist in Washington, D.C. On the return trip the car will be in its proper position on the rear of the train. This is the same location as [9], only how it looks today.

day. I recreate only about 10 percent of these trains, focusing on the most representative or "signature" trains. Living in the area makes prototype research much easier.

3. How did I decide on the era?

The era is the summer of 1967, the last year before the Penn Central merger. In 1967 the locomotives and passenger cars were still Pennsy. After some experiments with more colorful markings, the traditional Pennsylvania, New York Central, and New Haven colors and markings on the diesel and electric locomotives would be obliterated with black paint and white lettering by the Penn Central. The

merger did, however, provide a much broader mix of locomotives. The choice of 1967 also allows me to run a mix of 40-foot boxcars from the 1930s alongside modern hi-cube auto parts box cars and piggyback freight cars, and with modern diesel locomotives.

4. What type of freight and passenger operations are recreated?

There is a large staging yard to set up most of the trains that run through this portion of the Pennsy and just watch 'em run. There is a lot more operation possible than simply watching the trains go by. I use the real railroad's employee timetable to send the trains through the scenes in the sequence and match the arrival times of the prototype.

The passenger fleet is a near-recreation of at least a sample of cars that ran through this portion of the Pennsy, as recorded in the Pennsylvania Railroad's employee timetable number 23 for April 1, 1967. The trains include the Spirit of St. Louis, Broadway Limited, Silver Meteor, Silver Comet, Congressional and Senator, and Pennsy's unique "Keystone" tubular train. Passenger equipment from 10 or more railroads ran regularly behind GG1s through the Northeast Corridor.

Even at this late date there are still some heavyweight passenger cars in service. Videos help me recreate the cars and consists of these trains because the video often pans the entire train. Still photos are not quite as useful for entire consists but indispensable for getting the details and weathering correct on individual cars.

5. What are the most important factors to consider when designing the layout to fit the space?

I planned a layout that one person can run, but large enough to accommodate up to ten trains at once and keep ten or more operators busy matching the operations of the Pennsylvania Railroad.



11. This is a Broadway Limited model pulling the westbound “Broadway Limited” crossing the CNJ main line at Elizabeth.

In addition to an engineer for each train, operators can be kept very busy at the interlocking junctions controlling the signals and turnouts for the seven towers. The operating challenge for the dispatcher, the interlocking tower operators, and the engineers is integrating the traffic. Some of the branch lines had to cross the four mainline tracks.

The problem was similar to designing Interstate highway off ramps, with some ramps exiting the number 1 lane, some exiting the number 4 lane. There are six stub-ended industry sidings. Most of the freight traffic from the branch lines comes as complete trains. There is enough mainline action that I plan to operate only one or two local freights.

6. What are the defining (signature) structures?

The Pennsylvania Railroad stations, the CNJ station with its clock tower, the catenary system with the truss type signal bridges, and



12. Icons of railroading in Central New Jersey in the late '60s - observation car Mountain View brings up the markers on the westbound Broadway Limited, passing the clock tower of the CNJ station. The car is an Oriental Limited brass model with added details, including a scratchbuilt tail sign using Micro-Scale decals and illuminated with battery-powered LEDs.

many small track-related details are important visual signatures. All of these are scratchbuilt from photographs and data gathered on personal visits to the prototypes. I use reverse engineering to discover the correct size and proportions of the structures, often with only photographs as a guide. I buy the doors and windows from firms like Grandt Line or Tichy, as close as possible to those on the structure. The proportions of the rest of the building are then made to fit around the available doors and windows.

7. What are the defining (signature) scenes?

The signature scenes include the PRR/CNJ crossing at Elizabeth and the nearby curve, the six-track main line, the triple



Photo by Andy Rubbo

13. The scratchbuilt Elmora interlocking tower, which controlled this critical location where the PRR four-track main fanned out to six-tracks wide.

track burrowing junction with the Shore Branch and, of course, the forest of towers and web of wires that portray the catenary system. The lower deck trackage is still being planned but the scenes will include a vertical lift bridge and two swing bridges, the Waverly Freight Yard and the Kearny intermodal yard and Newark station.

8. How did you decide on the locomotive roster?

The Pennsylvania locomotive rosters, and photographs of the time and place limit the choices to E44 and a few GG1 electric locomotives for freight, and GG1s for all passenger trains except the MP54 commuter trains. The diesel fleet includes first-generation diesels like E-units, Alco road switchers, and EMD SD40, SD45 and GP30 units. The employee train phone antenna system that was a signature element on the Pennsylvania Railroad was removed in the late '60s and early '70s, replaced with modern solid-state electronics. Small decals appeared on locomotives to identify them as being "Radio Equipped," so a decal replaced the antennae. The program apparently started in the mid-sixties, and

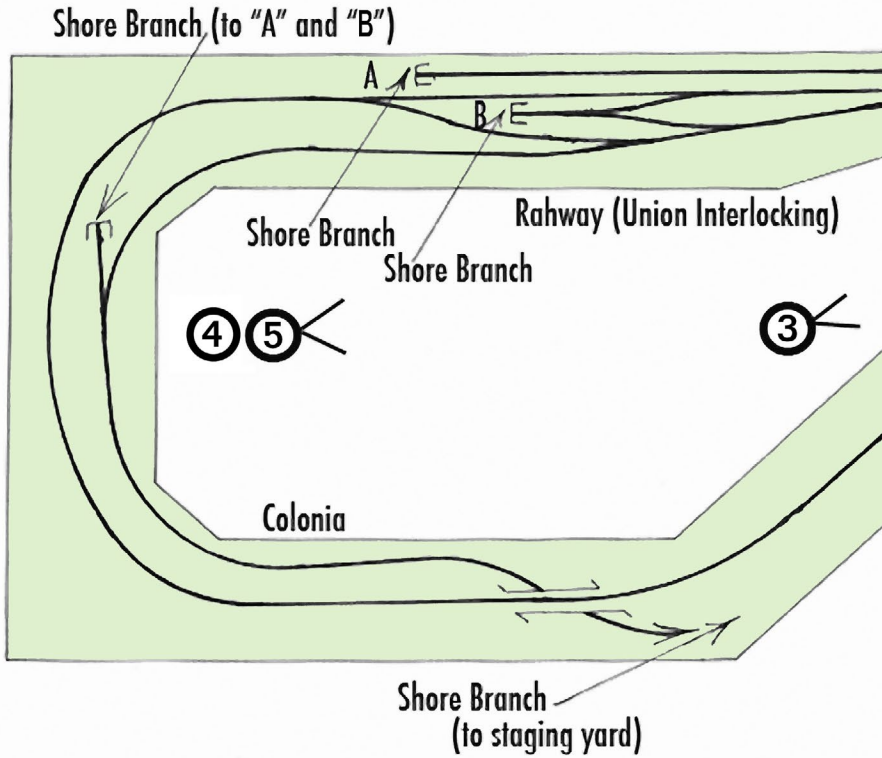

Andy Rubb
Pennsylvania RR: New

13 ft x 37 ft, ap

Track plan shows main
Circles indicate photo

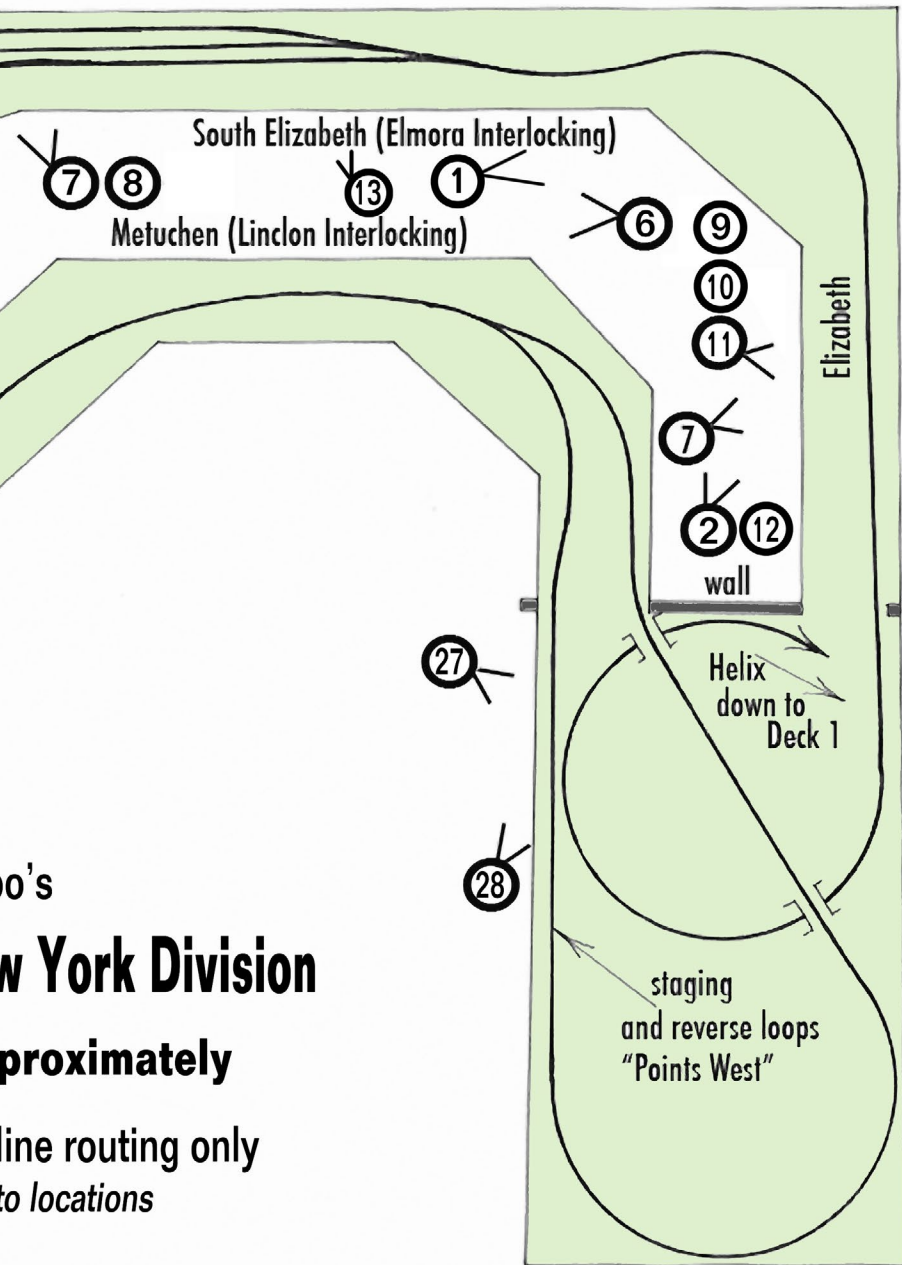

o's
New York Division
approximately

line routing only
to locations



14. Andy kitbashed a replica of the Pennsylvania Railroad's class BM85 Railway Post Office cars for the Broadway Limited from an Eastern Car Works baggage-dormitory kit.



15. The New Haven, Seaboard, ACL, RF&P, C&O, Southern, L&N, and other roads used the Pennsylvania Railroad as their connection to New York. This tavern-lounge-observation from Walthers is a replica of a car from the Seaboard's Silver Meteor. Andy repainted the model with Alclad chrome lacquer to get that reflective metal finish cleanliness, then weathered it to avoid the brand-new look.

THE PENNSYLVANIA RAILROAD | 18

by 1967 nearly all the train phone equipment was removed from the cabooses and locomotives.

9. How did you decide on the mix of cars in the freight car fleet?

The mixture of cars is based on what was needed for industries served by some part of extensive Pennsy system, especially auto parts, unit coal trains, piggyback flats, chemical and petroleum tanks, and mixed freight. I determine the mix of foreign road freight cars based also on prototype videos and photos.

10. What research sources were most useful?

■ Books

- *PRR Color Guide to Freight and Passenger Equipment*, by David R. Sweetland et al. [amzn.com/1878887076](https://www.amazon.com/dp/B000000000)
- *Pennsylvania Railroad Facilities In Color Vol. 1 and 2*, Morning Sun Books, [morningsunbooks.com/collections/the-pennsy](https://www.morningsunbooks.com/collections/the-pennsy)
- *Triumph V - Philadelphia to New York 1830 - 2002*, by David, W. Messer et al., [amzn.com/0934118272](https://www.amazon.com/dp/B000000000)
- *By Streamliner New York to Florida*, by Joseph M. Welsh, [amzn.com/094411914X](https://www.amazon.com/dp/B000000000)
- *Pennsylvania Railroad Color History*, by Mike Schafer, [amzn.com/0760303797](https://www.amazon.com/dp/B000000000)
- *Pennsylvania Railroad Passenger Train Consists and Cars, Vol. 1, East-West Trains*, by Harry Stegmaier, [amzn.com/1883089816](https://www.amazon.com/dp/B000000000)

■ Videos

- A & R Productions, [classicrailroadvideos.com](https://www.classicrailroadvideos.com)
- Green Frog Productions, [greenfrog.com](https://www.greenfrog.com)

THE PENNSYLVANIA RAILROAD | 19

■ Websites

- Pennsylvania Railroad Technical & Historical Society, prrths.com
- The Keystone Modeler, the online modeling publication of the PRRT&HS prrths.com/Keystone
- The NERAIL North American Railroad Photo Archive naphotos.nerail.org

■ Employee timetables

- The Pennsylvania Railroad Historical Society has discovered some train consists. They are available from Chuck Blardone, 2886 Wimbelton Lane, Lancaster, PA 17601-1454.

ADVERTISEMENT

TCS WOWSound

Come meet us at one of the upcoming train shows listed below, bring your engine, and **get WOWSound installed** for the bargain **show price** of **\$97**.

Learn from the best as **we perform your WOWKit installion** 1-on-1 and return home with a tested WOWSound equipped engine ready to go.

[Click here to learn more and register for a spot at an upcoming show](#)



Trainfest® Trainfest
Nov. 12th & 13th, 2016



Oklahoma City Train Show
Dec. 3rd & 4th, 2016

WOWKits provide the only true turn-key sound conversion solution.

www.TCSDCC.com

ROBERT SCHLEICHER



Robert Schleicher was editor of *Railmodel Journal* for 19 years and, prior to that, editor of *Model Railroading* magazine. He has also authored over a dozen model railroad books including the *Tyco Model Railroad Big Book of Model Railroad Track Plans* and three books for Lionel. Bob has been a consultant

to several manufacturers and helped to kick-start the Railroad Prototype Modelers concept. He is modeling the standard gauge Colorado & Southern in northern Colorado circa 1959 in HO scale.

ANDY RUBBO



Andy Rubbo has always lived in central New Jersey in close proximity to the Pennsylvania and Jersey Central railroads. His Pennsylvania Railroad New York Division layout is an attempt to re-create the railfanning experiences he had growing up and witnessing the transition from classic passenger and freight

railroading to the era of consolidation which we have today.

He is an airline pilot who lives in Metuchen, NJ where his backyard borders on Amtrak's Northeast Corridor, the former Pennsylvania Railroad main line.



[Click here for reader comments](#)

Easy Real Railroads



1 2 3



16. Andy Rubbo's Pennsylvania Railroad in the Northeast Corridor is a simple around-the-room shelf layout that attempts to duplicate a real prototype.

SPECIAL SUPPLEMENT!



[Click here for
reader comments](#)

MRH STAFF NOTE: *Andy Rubbo's Pennsy is a great example of a model railroad that's patterned closely after a real railroad. Robert Schleicher (we call him Bob) has studied what modelers who pattern their layout after a prototype do, and he's distilled his findings into some concise guidelines and best practices.*

Using Andy's layout (and a couple others) as examples, we're including this Easy Real Railroads supplement this issue to help you see how you too can choose to do a prototype-based model railroad. Here's Bob!

Easy Real Railroads supplement

You have probably already built and become bored with your first model railroad – that one where you crammed as much track as possible into the least amount of space. For your next model railroad, there are alternatives to consider that can make it far more realistic than you might have thought possible.

When you build a model railroad, you are creating a complete new world, including the action of the trains that occupy that world. You are truly an artist, sculpting in three dimensions as well as color and texture.

You likely thought it would be easier to “invent” your own model world than to try duplicating scenes from real life. For most modelers, however, it is far easier to use a real scene as the pattern for everything from the placement of the track and structures to the color of ballast, dirt, foliage and rocks.

From “no space” to “open space”

Each of the hundreds of the layout builders I have spoken with has his or her secret that they feel makes their model railroad so realistic. The obvious secrets include: real scenes with proportions, placement, colors, texture, and train action recreated from reality.

The most significant secret is that all of these modelers have the courage to leave open areas in nearly every scene. Model railroaders often have the cram-it disease, attempting to squeeze as much of everything possible into just too little space.

The truth is that every model railroad layout has too much in too little space. That’s because we just cannot spread things out for miles like the prototype.



17. This is Andy Rubbo’s recreation of the corner of Broad and West Grand Streets in Elizabeth, New Jersey. The structures are modified Design Preservation Models kits.



18. Andy made the twin arch bridge over North Broad Street from a modified Model Railroad StoneWorks cast plaster kit. These two arches were sandblasted clean (presumably as part of a downtown sprucing up project) in the spring of 1967. That's why the twin arch is a lighter color than the others. The cigarette ad on the billboard also dates the scene.

When you model a real scene, you are forced to place structures much farther from one another than you might like. Modelers who are recreating specific prototypes usually go a step further and eliminate a few of the background structures that would clutter the scene.

Great layouts have one thing in common; there is less clutter than on the usual freelanced model railroad. It is heartbreaking to leave out structures, scenes, and even complete trains. There is no way



19. Andy modified these kits and painted them to closely match the actual structures at the corner of Broad and West Jersey streets in Elizabeth, NJ.



you will ever get everything you might want in the confined space of a layout.

Leaving out some things is an easily learned discipline, especially when you discover that the reward of more open space is more realism.

The bare minimum space for prototype model railroads

The unavoidable problem with recreating a real railroad scene is space. Railroads locate yards where there is room for a mile or more of straight track or, at worst, a gentle curve. In HO scale, such a curve would be about a 100-foot

radius. That small town mile condenses to a whopping 60 feet in HO scale.

That is, unless you are willing to settle for recreating just a portion of a scene, which is what about 99% of even the most skilled modelers do. You will have to condense the scene to include only the significant structures or scenery but maintain most of the space between the structures.

In most instances, the largest structures must be compressed. A large locomotive shop may be 200 feet long with a series of ten 20-foot wide windows. By removing sets of windows, you can reduce the length by a fourth without much change in the visual effect of a massive locomotive shop.

Major railroad stations are too long for most model railroaders: the Cheyenne, WY station is too long, for example. But by shortening the ends, the station can be made about half the length of the prototype and it's not that apparent when comparing it to photos of the original.

What, you don't have a 30x40 foot basement?

It is almost impossible to create a realistic layout with an oval of track on a 4x8-foot tabletop. The tight curves needed to swing the track inside a 4-foot width are out of the question unless you are recreating a quarry or a streetcar route through a city.

If that's all the space you have, there are some choices:

1. Use the 4 feet or so of straight track to recreate a small portion of some real world scene on one or both sides – or use one side as a staging area to hold trains that will appear in the modeled scene.
2. Cut the 4 x8 plywood sheet into two pieces and join them to make a 2 x16-foot shelf layout. The shelf can go around a corner of the room if needed. No, you cannot run trains continuously

around that shelf but you can park a mainline train while a second locomotive performs switching chores.

If you build a shelf layout to conform to the standards of the local modular model railroad club, you can use the layout for display and switching at home. Join it to other modules and your layout can be the stage for 50-car freight trains and 15-car passenger trains during the modular club's sessions.

You can run through freights and passenger trains on a railroad in an area as small as 9' x 10' by running the tracks around the walls on 2' - 3' wide shelves (or narrower).

Given a few more feet, there might even be room for a peninsula to extend into middle of the room so you could include a

ADVERTISEMENT

Checked us out lately?

- ✓ HO/N and now O scale products too!
- ✓ Laser-cut Structures & Bridges.
- ✓ Advertising & Storefront Signs.
- ✓ Highway Signs, vintage & modern.
- ✓ New Detail Items.
- ✓ Laser-cut Grade Crossings.
- ✓ Billboards, roadside & rooftop.
- ✓ Laser-cut Graffiti Decals
- ✓ 1000's of satisfied customers.

WHAT'S NEW?



Established 1993...

Blair Line

ADVERTISEMENT

2016 Con-Cor Annual Christmas Collectors Cars
(Since 1975 for "N", Since 1976 for "HO")



2016 Donner Reindeer Car (Thunder)



"HO" 0001-00016H \$28.98 + S/H
Kit with working Knuckle Couplers

"N" 0001-00016N \$28.98 + S/H
R.T.R with Micro-Trains Couplers

Click Link To See This
Years Bonus Christmas
Add-on Cars!



Sign-up for Con-Cor Newsletter
Get Free Shipping on your 1st Order*
of \$75.00 or more if you sign up for
our eMail News letter
(Can be up to a \$15.00 value).



or Order by eMail at Orders@con-cor.com

reversing loop. *The Big Book of Model Railroad Track Plans* by Robert Schleicher has examples of how to condense prototype themes into small spaces.

Feeding trains onto shelf layouts

If you have room for just a single 8- or 12-foot shelf, there are ways to feed short trains on and off of the layout and provide places to store them.

British modelers are especially adept at selecting individual scenes and recreating them on 2x8 or 2x12 shelves, with another two or three feet at each end for hidden trackage. The trains run from one hidden yard to the opposite hidden yard.

These yards are just straight pieces of track arranged on a sliding drawer so four or five trains can be stored. These staging yard devices are similar to the transfer tables used in locomotive repair shops. Walthers sells one in the Cornerstone locomotive servicing facility series.

The transfer tables on the portable British layouts are often just a piece of plywood mounted on drawer slides with 4 to 8 pieces of straight track on the top. When a train arrives it is parked on the shelf. The shelf is slid in or out to align another track so the next train can be slid into alignment with the visible track.

Between operating sessions, the trains are rearranged to be ready to head back onto the layout from the opposite direction. The British refer to these as fiddle yards. You could easily work this type of scene with three-foot fiddle yards on each end of a 2x12 set of modules, with six feet of visible scene between the two fiddle yards.

This fiddle yard concept is really only practical if you have a 12 foot or longer wall. American modelers usually have enough space in a room for a five-foot deep shelf. With that space, you can arrange the

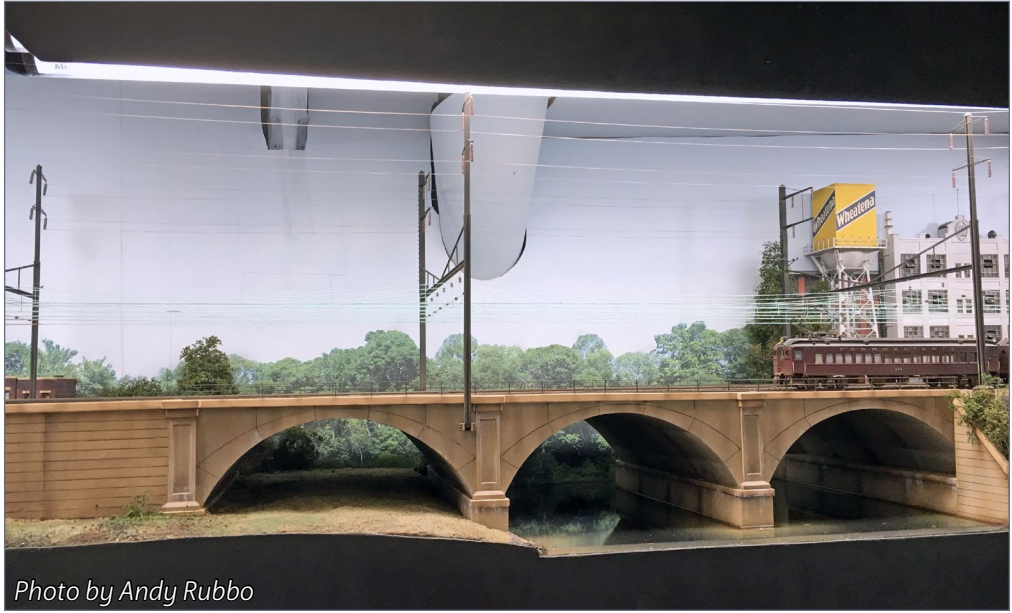

Photo by Andy Rubbo

20. Andy's layout fills his basement, but this scene could be recreated on a 1 x 4-foot diorama.

layout as a simple oval with 30" and 33" radius double track curves on each end.

A typical 6 x12 layout then would have six feet of visible straight track. The six feet on the other side can be arranged into four or five double-ended sidings capable of holding six-foot-long trains.

Match the prototype to your prescribed space

You probably already have a favorite prototype railroad, so the first decision to be made in creating a realistic model railroad is to determine just how much space you have available.

Yes, you can model the Union Pacific Railroad in as little as 2'6" x 12'. Select a small portion of the Union Pacific and settle for only being able to see 40-car freights when the modular club gets

together for an operating session. But you can create an accurate replica of a scene on the Union Pacific on shelves that could fit in any bedroom.

If you have more space, say 12x12 feet, the decision becomes more difficult. That's enough room for eight-car trains. Some modelers compress the train lengths, imagining that each car actually represents five or 10 cars.

If you want to focus on mainline operations in a small space, that's one way to do it. Charles Carrangi, with a four-shelf replica of the busy Northeast Corridor, is one of the most active model railroad operators in the Eastern U.S.

But in place of 15-car passenger trains, Charles operates trains of four or five cars using the same action-packed timetable as the real railroad with a dozen or more trains in an hour. The operations are dead nuts realistic; the model railroad not so.

Getting a realistic model railroad in just 12x12 feet is difficult. You can come close with N scale, but for HO scale, that 12x12 is enough room for a branch line but most railroads had dozens of those.

A friend once planned to recreate the Saratoga and Encampment Valley Railroad in southeastern Wyoming with six- to eight-car trains pulled by a 4-6-0. The locomotive was much like the Bachmann Spectrum model with Vanderbilt tender. The line served only two very small towns, Saratoga and Encampment, and a simple interchange with the Union Pacific at Walcott, WY.

21. At Elizabeth, NJ in July 1967, Pennsylvania Railroad Train 25, "The Duquesne," crosses the CNJ main line on its daylight trip to Pittsburgh. This is another scene from Andy Rubbo's layout that could be recreated on a 1x4-foot diorama.

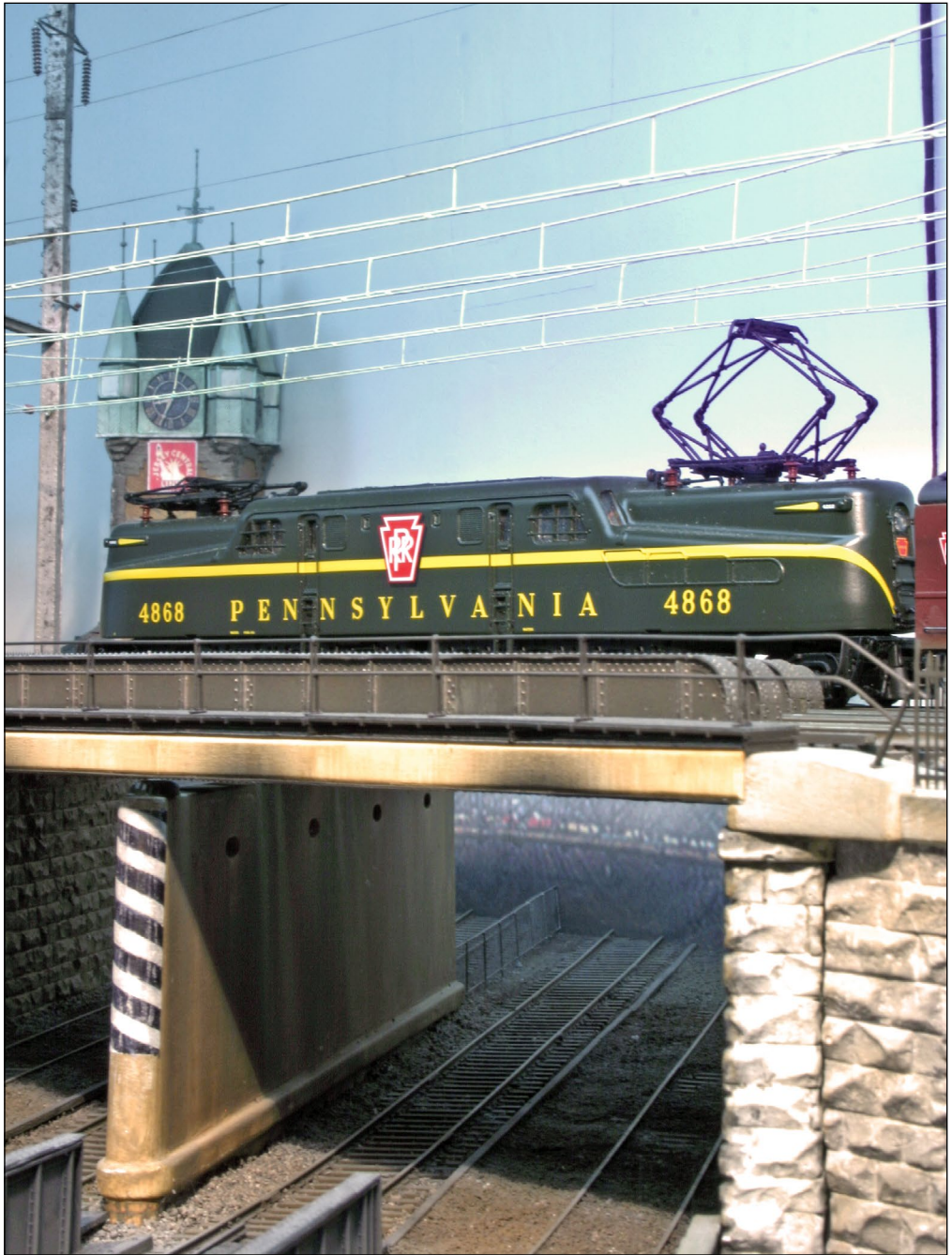

With a two-foot-deep shelf around four walls, he could have put a town per shelf on three walls of the room and used the fourth side for open meadow and sagebrush scenes along the North Platte River to show off Wyoming's open spaces.

There are hundreds of similar branch lines and dozens of small short line railroads, like the Sierra Railway, that you can recreate with short trains in a small a space.

Taking an eye-opening look at the reality of your available space might send you back to square one to decide on a different prototype, perhaps one that interchanges with your Class 1. The result could be a more credible choice than running a 4-8-8-4 articulated around 24-inch radius curves.

The dream of 100-car trains in 2x6

There's a compromise you can make: include an interchange with a Class 1 Railroad on a 12x12 or smaller layout. In the Union Pacific example, I was going to recreate the town of Walcott where the Encampment Branch of the Union Pacific (formerly the Saratoga and Encampment Valley Railway) joined the Union Pacific mainline.

I knew the area because my dad took me fishing there as a youngster. I have memories of short steam-powered trains that captured my interest far more than waiting for fish to take the bait or for mosquitoes to bite me. That does not magically expand the room or leave space for a 15-car recreation of the City of San Francisco streamliner. But it would allow me to park a Big Boy or to run a deadheaded locomotive or two as long as the big stuff disappears into tunnels or onto hidden staging tracks.

There is a better way: build the interchange yard at, say, Walcott, so it matches the standards of the local modular model railroad club.

SUPPLEMENT | 14

You can remove a 2x6-foot section of your permanent layout, stuff it in the back of your SUV or station wagon, and join it with a dozen others. Then you get to watch those 100-car freights and 15-car streamliners roll across your "layout" too. If you have a group of model railroaders, you are all set to create a modular club.

Dave Trussell formed a group of about a dozen model railroaders and created one of the country's largest modular model railroads, with a 300-foot mainline that can fill a 40x80-foot space at an exhibition hall.

The advantage of creating your own modular club is that you can set the standards for the scenery, structure colors, which railroads are being modeled, where, and in what era, so every module blends into the next. This avoids the patchwork quilt appearance of many modular layouts, where one member might be modeling the Mojave Desert and the next the Newark docks.

Combo Right Clamp™

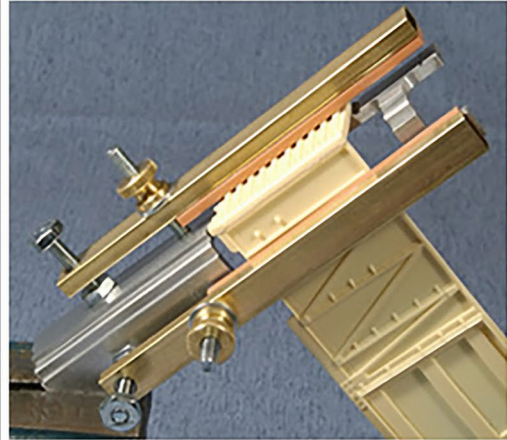

Combo Right Clamp™
with cast resin boxcar

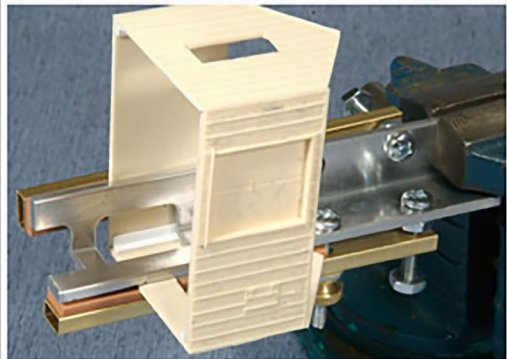

Combo Right Clamp™
with Wolf Design Pump House

[Click here for
all our products ...](#)

Tools for Modelers

Coffman Graphic Solutions Co.
1500 River Circle, Richmond,
KY 40475-7907

There are dozens of opportunities to set up a modular layout, including fairs, hobby shows, and even inside the larger malls. A few clubs rent or buy long-empty stores or small industrial buildings as a place to operate their modular layouts between public exhibits.

Determining your trains' lengths

Space is always the first constraint for any model railroader. Even Ken McCorry, with his massive 31x79-foot building and his four-deck recreation of Conrail's Buffalo Division, had to eliminate about 90 percent of the trackage he would have liked to include on his layout.



22. The significant portion of Elizabeth on Andy Rubbo's Pennsylvania Railroad only occupies a 3x1.5-foot area of the layout.



23. Even though Ken McCorry has a massive 31' x 79' building and uses up to four decks for his HO scale Conrail Buffalo Division, he could only model about a tenth of the prototype locations on his layout. Selective compression of the prototype is a fact of life, regardless of how much space you may have for a layout!

Train length governs the length of any town or yard you recreate. If, like Ken McCorry, you have space for 40-car trains (in the Conrail era these would be about 50 feet long in HO, including the locomotives) then the length of any yard or town can be as much as 50 feet. For most model railroaders, finding the space for a 10-foot long train is all that's possible. If that's your minimum train length, then you need enough space to fit a town or yard at least 10 feet long. You can always wrap a portion of either end of the town around a curve, but you will never enjoy operating 20-foot trains through yards or towns with just 10 feet of train-passing capacity.

Adapting existing layout plans to prototype model railroading

When most model railroaders search for a published track plan, it is because they want to fit a layout into a relatively small space, something between 9x10 and 20x20. You can, however, lift individual segments of any model railroad plan and transplant them into the space you have available.

When you are designing the track arrangement for your model railroad, the first consideration must always be “How much space



24. The CNJ station at Elizabeth, at the far left, and the stone arch bridge are the signature structures in this scene. Andy Rubbo heavily modified a Model Railroad StoneWorks product for the bridge and he scratchbuilt the CNJ station using Plastruct brick-texture styrene sheet.

is available?” The second consideration should be “How you intend to operate the layout?” On a short shelf layout, you may be limited to a few sidings and perhaps a staging or fiddle yard to hold a few trains. If you have space for even a simple oval, you will want to consider how the trains will operate over the tracks you are planning. If you are recreating a specific real railroad scene, you can condense the track arrangement that the railroad used. You will still need to plan the tracks that extend beyond that scene so they can accommodate the rail traffic you desire.

One scene at a time

One of the many advantages of recreating an actual scene or series of scenes from a specific railroad is that the track design is mostly done for you. However, few modelers have the space to recreate the full length of the tracks, even in small towns, so the length of the scene will nearly always have to be condensed.

You are the only one that can decide how much to condense any given scene. Some modelers try to include the just one scene at full length, perhaps running the layout 40 feet along a basement wall, while others will compress that same scene into six feet or so. Generally, structures define a town and significant signature buildings can usually be included in a relatively short scene.

If you are still waiting for the space to build a complete model railroad, consider a drop-in diorama as a head start on building that layout. Many modelers have spent ten years or so assembling and detailing structures and their surrounding scenes so major portions of their new model railroad would be complete.

These scenes are usually displayed, like the works of art they are, on bookshelves until space is located for a complete model railroad. Remember that these drop-in scenes can be built on a 2x6 module if you want to combine switching operations with

portability. That module can eventually become part of a layout large enough to run your longest trains.

The simple way to duplicate a prototype railroad, with recreations of signature scenes and some recreation of the parade of freight and passenger cars, is to start with an existing layout design.

If you have less than about 12 x 12 feet, there is little hope of including any prototype town or yard. The option here is to select just a portion of the scene and leave the rest to the viewer's imagination. There are many track plans available in the dozens of books on track planning, and in designs in the Layout Design Special Interest Group's Design Journal.



25. Andy scratchbuilt the station and waiting room at Elizabeth from styrene strip and sheet to match the prototypes, but he did compress them slightly to fit the scene.



26. Staging yards, such as this double-ended staging yard on Dick Elwell's New Haven layout, make it easy to feed complete trains onto the layout and accept complete trains coming off the layout.

These can provide a variety of choices for wrapping the tracks around the space you have available. Find a design that is a foot or less in each dimension than your available space and use it. Adjust specific turnouts and spurs to match the railroad you want recreate, and you are on the way to creating the layout of your dreams.

Drop-in track planning

You can go directly to the real world for the track arrangements of the towns you are modeling. Again, you will not likely have space for full-length sidings and spurs, but you can often include many of them, with signature railroad and industrial buildings in their proper positions.

EASY REAL RAILROADS SUPPLEMENT | 21

Modern-era maps and aerial photographs are available on the internet in things like Google Maps. A few historic topographic maps are available and you may be able find Sanborn insurance maps from many earlier eras for towns and cities you are recreating.

Some books on specific railroads also include maps. Some railroad historical societies have maps in their archives that they can reproduce to provide actual track maps of specific areas.

State historical societies usually have period photographs available and some may have early editions of telephone books and other documents that can provide track arrangements for specific towns.



27. The left end of the “staging room” on Andy Rubbo’s layout houses the helix and upper deck staging loop. Total storage area is about 150 feet of track, with the longest track approximately 30 feet long.

Staging yards

Most model railroaders have far more cars and locomotives than they can possibly operate at once on their layout. Building a larger layout is not the answer.

Most model railroaders simply store their excess cars and locomotives in boxes or, in some cases, on display shelves or in cabinets. It is possible, however, to store nearly all of the extra equipment you want on the layout itself on tracks in a yard that may or may not be part of the visible operating portion of the layout.

These hidden yards are referred to as staging yards, and they are far more than just places to store equipment. The staging yard is also the place where the trains disappear when they leave the portion of the world you have created. And the staging yard is the place where trains appear from where ever and enter your portion of the world.

There are a few cardinal rules about staging yards that experienced layout builders have learned in their decades of learning by trial and error, and you would be wise to heed them. You will want have hidden staging tracks either at both ends of the mainline or, with a through-oval design, somewhere in the middle.

If you possibly can, find the space to arrange staging yards with double-ended sidings so you can run trains right on through. Yes, you can rearrange trains one car at a time on stub-ended staging, but it can add more overhead to operating the layout.

When you design a staging yard, think carefully about how many trains you want to operate at any given time. You will need enough staging tracks to hold at least half that many trains, minus one or two trains that can be stored on a passing siding or yard on the visible portion of the layout.

EASY REAL RAILROADS SUPPLEMENT | 23

Andy Rubbo expects to operate just nine trains on his recreation of the Northeast Corridor on the Pennsylvania Railroad. Those nine trains, however, will represent both eastbound and westbound versions of 18 trains. Andy can get by with just four through tracks in the “east” staging yard and four more in the “west” staging yard. Andy must, however, plan his operating sessions carefully so there is a balance of four trains in each direction during each operating session.

If other modelers’ experience applies, Andy may wish he had planned for at least five tracks in each yard, because there always seems to be the need for at least one more. If there is much difference in the train makeup of an eastbound train compared to its



28. Andy Rubbo’s helix stretches from wall to wall in a seven foot wide room. The outer two tracks are the ascending (westbound) grade. With an outer curve radius of slightly more than 40 inches, the grade figures out at roughly 1.5 percent.



29. The angled twin arch viaduct over Broad and Jersey streets is one of several signature scenes that define the area as Elizabeth on Andy's Pennsylvania Railroad.

westbound counterpart, you most certainly will need to provide more than an even balance of “east” and “west” staging track.

Wide open spaces

The second mistake that model railroaders make in designing their layouts is failing to provide operating aisles that are wide enough. Yes, you can get by with just 30 inch wide aisles if there are 48 inch wide places for two operators to pass. Virtually every layout builder I have talked to -- unless they operate their layout all by themselves – has regretted a decision to do narrow aisles. Consider 30 inches to be the minimum aisle width and consider even 60 inches in some areas.

Using all this space sounds great if you have a 30x40 foot empty basement to fill but, for most of us, there is not much space to spare. If you have just a 12x12 room, it's possible to squeeze in a center peninsula but the operating aisles are going to be 24 inches wide or less and the shelves around the wall might have to be as narrow as 12 inches.

You will be far happier if you drop the notion that you can have the tracks loop out onto a peninsula in the center of room and just settle for a nice 30-inch shelf layout around three or four walls.

The other "wish-I-woulda" thought of experienced model railroad layout builders is providing a bit more space at the front of the layout to leave some room for scenery between the forward edge of the benchwork and the tracks.

Even if your layout is designed so the edge of the benchwork represents the shore of a lake or river, most railroads allow a few dozen feet from the edge of the ballast to the shoreline – consider six inches the minimum for an HO scale layout.

Where to get help

Layout design can be a hobby unto itself. Thousands of model railroaders never get beyond the design stage of building their dream layout. That's a pity because building a layout is really the best way to learn how to design one. The concepts of 36-inch aisles, staging yards, and extra scenery at the forward edges are all lessons learned by trial and error.

You will need to draw the track plan to a precise scale. You can use the time-proven drafting compass, straight edges, and pencils, or purchase one of the computer design programs like Cadrail, R-Track, 3rd Planit or Empire Express.

There are dozens of books on track planning and books on track layout design. Perhaps the best book on layout design is



30. Andy used photo murals of scenes from Elizabeth to capture the accurate appearance of the prototype scene. The building on the left is Walthers Cornerstone #3031 Bailey Savings and Loan. The arch bridge is a modified Model Railroad StoneWorks cast-plaster kit.

the late John Armstrong's classic *Track Planning for Realistic Operation*. Believe him! Be wary, though, of published track plans, even of existing layouts, because the designers may have made mistakes that Armstrong warns against.

Most frequently the designers and builders have not left enough space for ample aisles or the critical hidden staging tracks. Up to date design information is offered in the *Layout Design Journal*, the quarterly magazine that is included with a membership in the Layout Design SIG.

Other special interest groups can provide useful information for specific areas. The Operations SIG publishes the quarterly *Dispatchers Office* magazine that can be very helpful in designing layouts to be operated like the prototype.

The Railroad Industry SIG publishes the quarterly *Lineside* magazine that features specific railroad-served industries. If you are modeling either coast, the Gulf of Mexico, or the Great Lakes, you will find the Rail-Marine Information Group's quarterly magazine *Transfer* very helpful with the design and operation of rail and ship interfaces.

You can also find some incredibly accurate information by talking to other modelers and railfans at conventions. Most of the railroad historical societies that are listed here have annual



31. Andy selected an era near the end of the Pennsylvania Railroad when the GG-1 locomotives still headed most passenger trains. This is the westbound Broadway Limited crossing the CNJ main line at Elizabeth.

EASY REAL RAILROADS SUPPLEMENT | 28

conventions where both modelers and railfans gather to share information. Most have clinics on specific railroad subjects that pertain to that specific road.

In addition, most of these conventions also have sale areas where vendors offer original and reprinted timetables, rule books, railroad paper work, and original photographs from all eras. There's a very good chance that clinic presenters and some members of the audience are current or retired employees of the railroad.

At Railroad Prototype Modelers meets, you will also meet modelers who are recreating a variety of real railroads. These meets are prime sources for one-on-one information about your railroad as well as sources of books, railroad publications, paperwork, and railroad photographs.

ADVERTISEMENT

RailPro™

NEW TECHNOLOGY



Click Here to Learn More



RE RING™

ENGINEERING

NEW Starter Kit \$399.99 MSRP

- Includes Wireless Color Touch Screen Handheld Controller and 56 Watt Power Supply
- Expandable to Virtually any Size Layout

NEW Locomotive Module

LM-2 & LM-2S



- Direct Radio RF
- Sound and Non-Sound
- New Tiny Size
- 6 Light Outputs

For more information visit our Internet site: www.RingEngineering.com

• INDEX

• TABLE OF CONTENTS

It all starts with a prototype-inspired track plan

You may find, as have many modelers, that modeling real scenes is far more interesting than imagining your own. Of course, there is a compromise; you will likely find that you must accept some constraints, especially if you're trying to squeeze too much track, too many buildings, and too much scenery into too little space.

Five quick questions to help maximize your satisfaction from model railroading:

1. Will you be the only one to operate our layout, or do you want to provide for multiple operators?
2. Is the operation of a dozen or more trains more important than recreating realistic scenes?
3. Are you willing to restrict your locomotives and rolling stock to fit the space you have available?
4. Would a modular layout that could be integrated into a 200-foot mainline satisfy your desire to operate long trains?
5. Are you willing to allow other modelers to help in the planning, construction, and operation of your railroad?



**Click here for
reader comments**

**Easy Real
Railroads**



1 2 3

A holiday feast for you ...

One year membership ...

60+ *new* all-original videos coming in 2017 ...

But THAT'S not ALL!

ALSO get unlimited access to ~200 videos from three prior seasons of TMTV ...

AND unlimited access to dozens of MRH Store videos in high definition too.

Talk about a feast!

\$55 - 1 yr (~17 cents a video)

~~MONTHLY \$83.88~~ MRH Subscriber? Save another 10% using the [coupon code here](#). WOW!

Get this deal now 



TrainMasters TV Winter Promotion

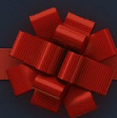



TRAINMASTERS.TV

WHAT'S NEW!



Building curved turnouts



PowerCab accessories



3D printing at home



Lubing locomotives

Non-members: Watch an episode for \$1.49; become a member for unlimited access
In-depth videos like MRH articles, except without ads



YES, IT'S A MODEL

compiled by
DON HANLEY
.....



**Click here for
reader comments**

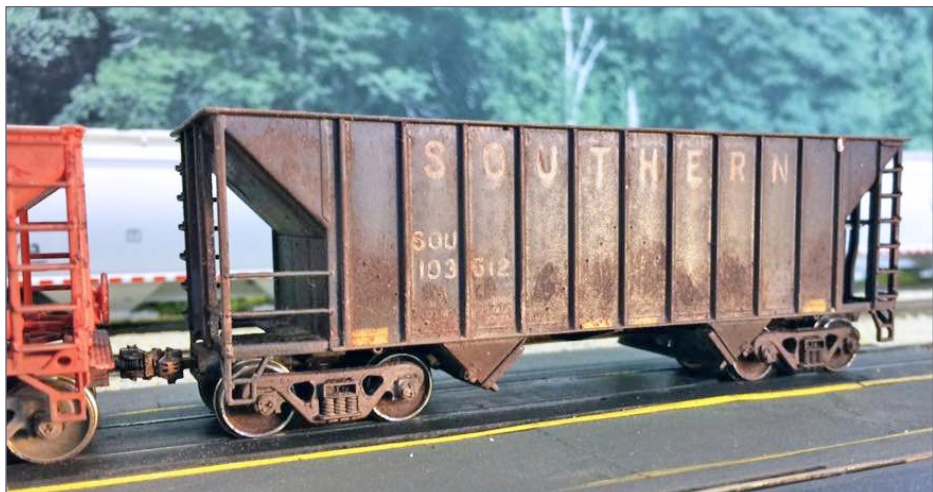

1. Just off the RIP track is Southern 103612 aggregate hopper. This is one of six hoppers found in service running ballast to be unloaded at a pit used by the maintenance-of-way forces doing spot work along the Seaboard Central. Tim Garland modified the car with scale Kadee #158 couplers and code 88 metal wheels. He added safety stripe decals and weathered the car with Testors Dullcote and artists oils, along with Pan Pastels. Tim used techniques he learned from watching Mike Confalone's weathering series.

► **MRH'S MONTHLY PHOTO ALBUM**

YES, IT'S A MODEL | 2



2. Cornhill & Atherton #54 is sitting in front of the station as the crew finishes up the necessary paper work to head out of town. Meanwhile in the background Mr. Knox is investigating a bad tire for a traveler who stopped at his service station while passing through the town of Atherton.

A little later in the day we see C&A #1 drifting down the hill by Vezmar mine, while the Glanton Lumber switcher is busy picking up a load from the mine. The shots are from our imagineering columnist Rob Clark. To see more of his work visit his web site cornhillandathertonrr.blogspot.co.uk.



3. The darkest and stormiest part of the night has passed, and the moon is starting to break through the clouds. BN SD60Ms 9228 and 9284 rest in the yard while their brethren hustle a stack train east. Paul Mack duplicated in HO a photo he took at Balmer Yard in Seattle. The models are Proto 2000 shells on Atheran Genesis frames and motors. Paul corrected most of the Proto 2000 dimensional errors in the long hood with styrene and Cannon and Co. parts.



[Click here for
reader comments](#)



4. During the recent RPM meet in St Louis, Jeff Youst took some time to visit MMR Pete Smith's, gorgeous Sn3 West Side Lumber Company layout. Here we see workers busy loading ice into a couple of reefers. The two reefers in the foreground have been taken off their trucks and relegated to ice storage. The layout



includes a complete crew lounge area with all of the requisite furniture.



[Click here for reader comments](#)



5. Railroads need many service vehicles to keep the road running. Steve Hurt recently posted this photos of a Dodge A-100 hi-rail truck. The model is 1/25th scale and includes all the correct motor wiring, brake lines, and electrical wires. The paint is Krylon yellow, and the decals were 40-plus-year-old Champ decals! For weathering, Steve wanted a very muddy look like driving through mud puddles after a rain. To achieve the effect he masked the shape of the windshield wipers first and then splatted the truck by gently flicking off acrylic paint from a toothbrush. The rest of the weathering is oils. The bare metal look is Rub N Buff silver and graphite.



.....

GET PAID FOR YOUR PHOTO

We pay \$40 per photo we publish. If you'd like to get your modeling in our photo feature, just start posting your photos on the MRH website, especially in the Weekly Photo Fun thread created each weekend.

See mrhmag.com/help for more on how to post an image. You need to be an MRH subscriber to post photos to our website, and becoming a subscriber is free, [just fill out this form here](#). ■

.....



6. Model railroaders' paradise!

The FREMO, Friend Circle of European Railway Modelers, had its 35th anniversary this year, and it was a milestone celebrated with a large meeting. It's not easy to find a hall large for such an event, but the "SACHSENarena" in Riesa, 30 miles northwest of Dresden, Germany, with 7000 square meters of space was available. The first members arrived Wednesday afternoon, and by Thursday evening, all the layouts were set up. Overall, 14 groups participated, with HO Europe placing the largest layout, occupying almost 2000 square meters. Other participating groups were HO USA, TT, AmicaN, HOe, 1, HOFine, O, HOn3 USA, N, OO, Fremo87, HOm and Om. Almost



[Click here for reader comments](#)

700 members and guests participated in the non-public event. Besides people from Germany, members came from Austria, Poland, Czech Republic, Hungary, Slovakia, Luxembourg, Denmark, and some with a 1200 km one-way journey from Sweden. Typical for FREMO meetings, the main focus was not just running trains, it was prototypical operations with engineers, dispatchers, telephones, timetables and clocks. Some operating sessions lasted until midnight, and all participants had a lot of fun. Michael Kreiser of Dresden, Germany posted the photo on the *MRH* forum.

BUILD A 19TH CENTURY PUMPHOUSE



BY DAVID KARKOSKI

*Try this simple pumphouse
for your layout ...*

WIND AND STEAM WERE THE PRIMARY MEANS of powering the pumps used for filling water tanks in the 19th century. Windmills were most common where the consumption of water was low, such as at rural stations. At engine facilities water consumption was great enough to require a more consistent source of power for pumping water. A steam-driven pump met that requirement.

• [INDEX](#)

• [TABLE OF CONTENTS](#)



[Click here for
reader comments](#)

My engine facility will use a steam-powered pump to fill the water tank. The prototype pumphouse that I chose to model was used on the Wabash Railroad. The plans were published in the July 1986 issue of *Mainline Modeler*. If you have access to the plans, by all means review them. I will give prototype dimensions during the construction. These and the photos of the completed model should provide enough information to allow you to replicate the prototype even without the plan.

A structure like this would be appropriate on any steam-era railroad. In a more modern setting, the boiler and steam pump could be replaced by an electrically motorized pump. In that case the smoke stack and steam exhaust would be gone. It is also likely that the shingle roofing would be replaced with some type of rolled roofing.

This HO scale model is constructed from basswood. Styrene castings are used for the doors and windows. The castings are modified to more closely resemble the doors and windows on the prototype. The primary tools required for construction are single-edge razor blades, #17 and #18 hobby knife blades, scale ruler, files, emery boards, and paint brushes.

I hope you will find this an interesting project, learn a few construction tips, and be inspired to build the model. Remember, model is the first word in model railroading.

Photos on the following pages ...

BUILD A PUMPHOUSE | 3

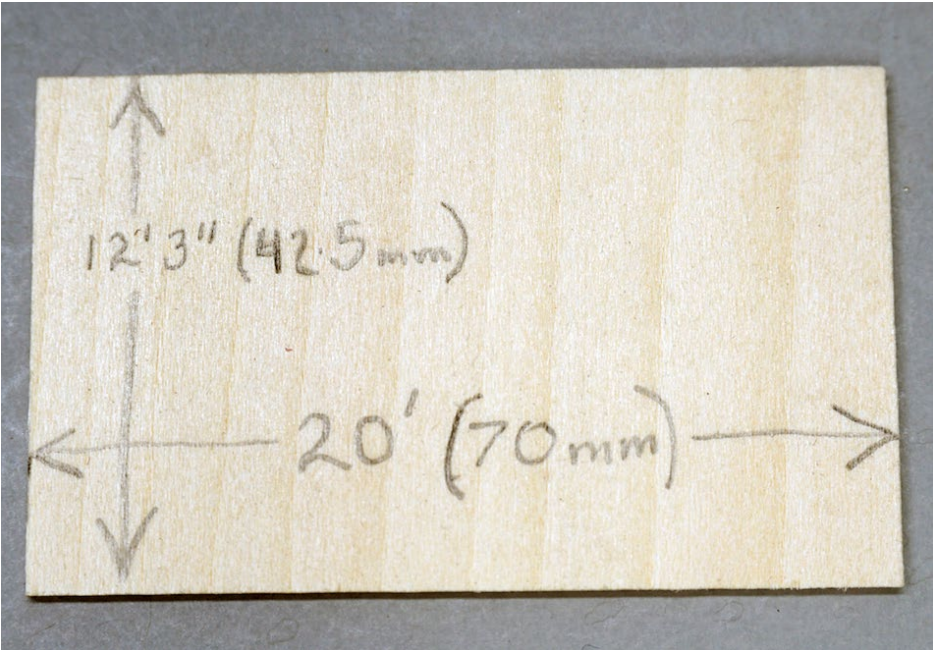

1. I used Northeastern 3/32" board-and-batten sheathing for the walls on this model. When working with board-and-batten, the visual appeal of the siding is enhanced when there is a uniform spacing of boards and battens along a side or end. In this case, a sidewall should be cut such that it starts and ends with a batten. The sidewalls on this building are identical. Cut out two walls 20' (70mm) long and 12'-3" tall (42.5mm).

BUILD A PUMPHOUSE | 4

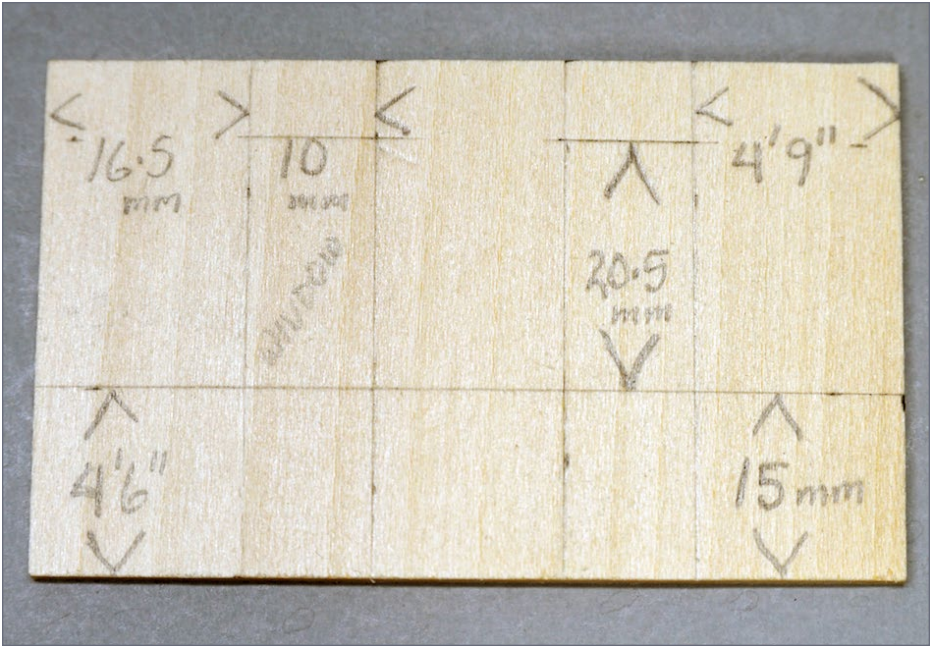

2. There are two windows on each side. They are 4'-9" (16.5mm) in from each end and 4'-6" (15mm) above the bottom. The window openings are 5'-10" (20.5mm) tall and 2'-10" (10mm) wide. To minimize tearing of the wood when cutting out the windows, lay out the cut lines on the face of the sheathing. For this build, I worked from the rear to improve the legibility of the measurements in the photographs.



[Click here for reader comments](#)

BUILD A PUMPHOUSE | 5

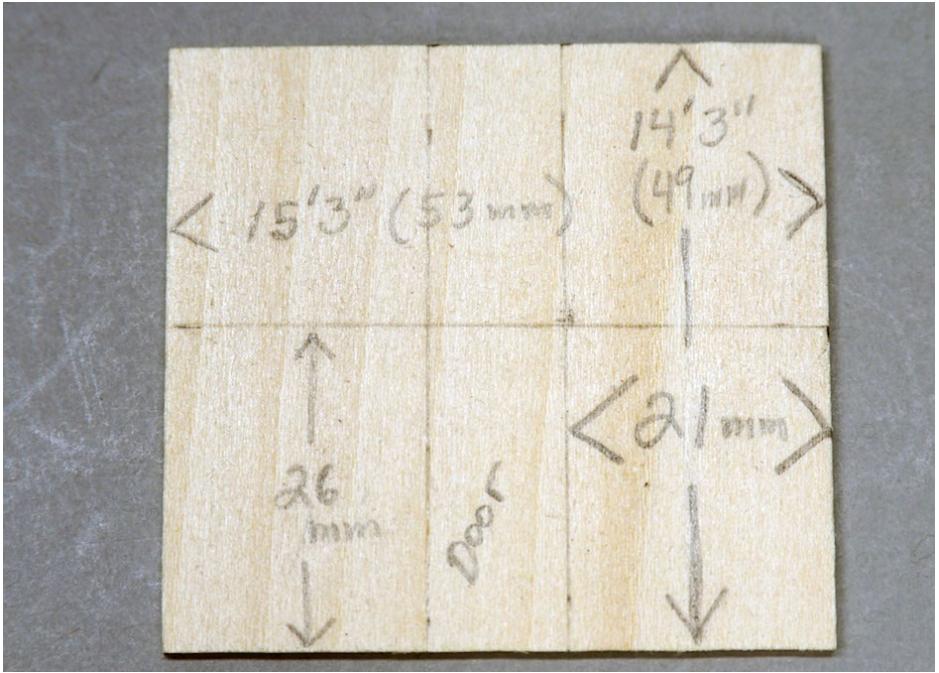

3. The width of the end walls is adjusted to account for the thickness of the sidewalls. The result is that the ends do not terminate at battens, but at the midpoint of boards. This is the layout for the single-door end. The wall is 15'-3" (53mm) wide and 14'-3" (49mm) tall. The single door is a Tichy #8049 four-panel door. Its opening is centered on the end. The edges are 6'-0" (21mm) from each side, and it is 12'-3" (26mm) tall.

BUILD A PUMPHOUSE | 6

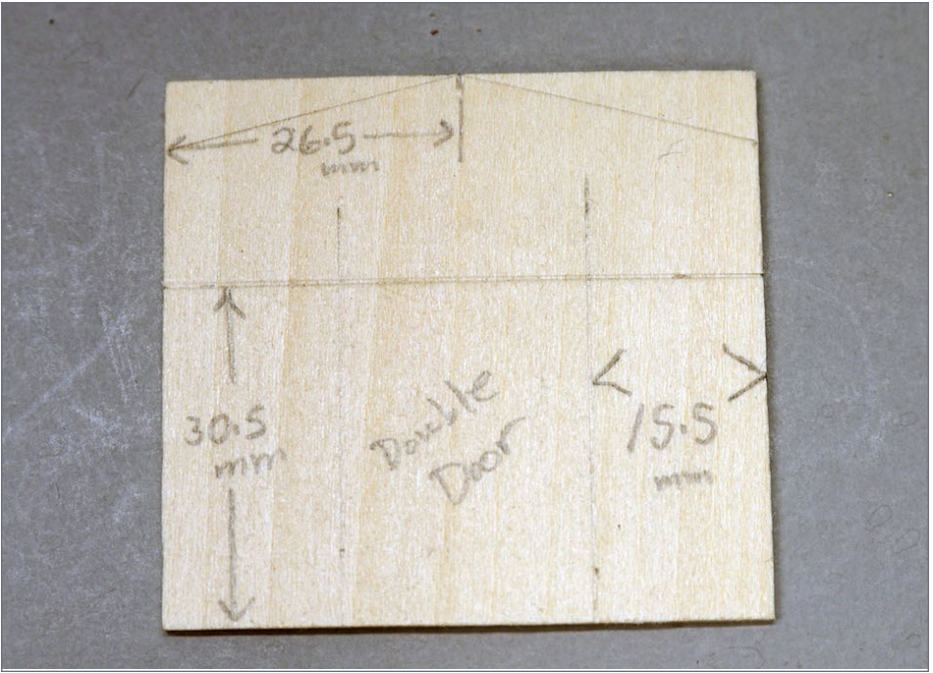

4. This is the double-door end. The door opening is centered on this side as well. Its edges are 4'-5" (15.5mm) from the sides and 14'-5" (30.5mm) tall. The peak center is marked at 7'-6" (26.5mm) from the edge.

**Want to help keep
MRH free?**

Then *click* on ads!

BUILD A PUMPHOUSE | 7



5. To draw the gables, butt the side against the end, aligning the bases. The gable ends fit between the sides. Lay a straight-edge against the top of the side passing over the peak center mark. Draw the cut line. This arrangement creates a slight gap at the top of the sidewall joint. For a shallow roof pitch, the gap is negligible, but steeper pitches result in a more obvious defect that would need to be filled.

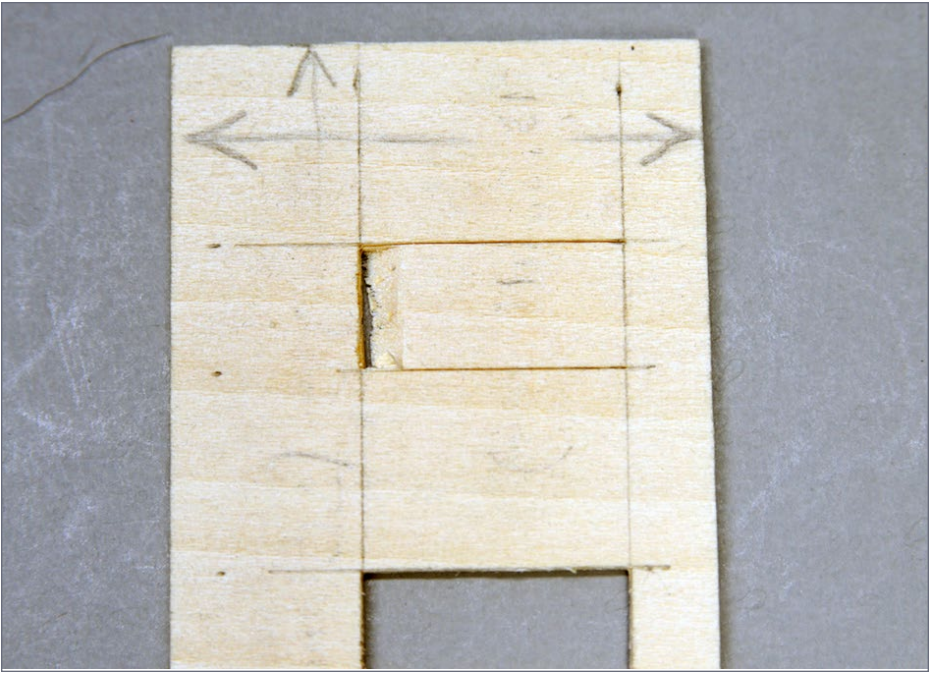

6. I used a razor blade and a #17 hobby blade to cut out the windows. To avoid splitting the narrow wood above each window opening, create a relief notch along the sill end of the window opening. Use the #17 blade to punch through the sheathing along the sill line. Again use the #17 blade make an angle cut toward the sill, creating a gap of about 3" (1mm). Use the single-edge razor to cut along the sides of the window opening.



[Click here for reader comments](#)

BUILD A PUMPHOUSE | 9

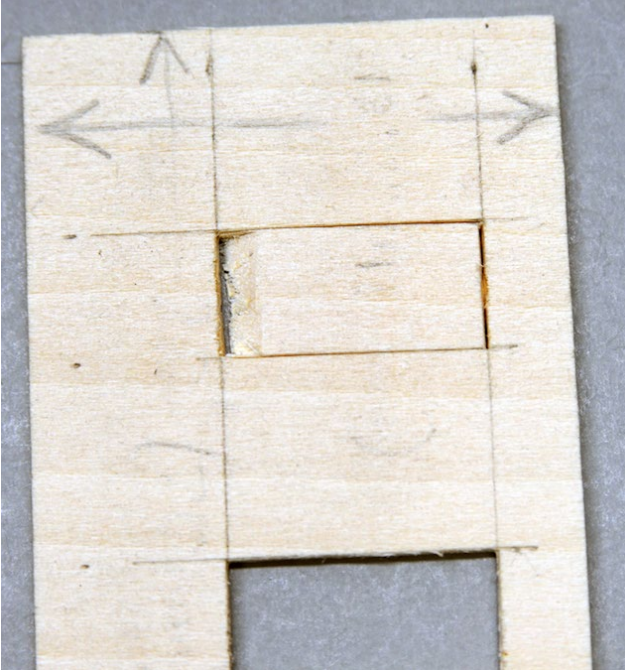

7. Using a few light punches with the #17 blade, cut along the top. As the blade punches through the wood, the waste will slide toward the gap at the sill.

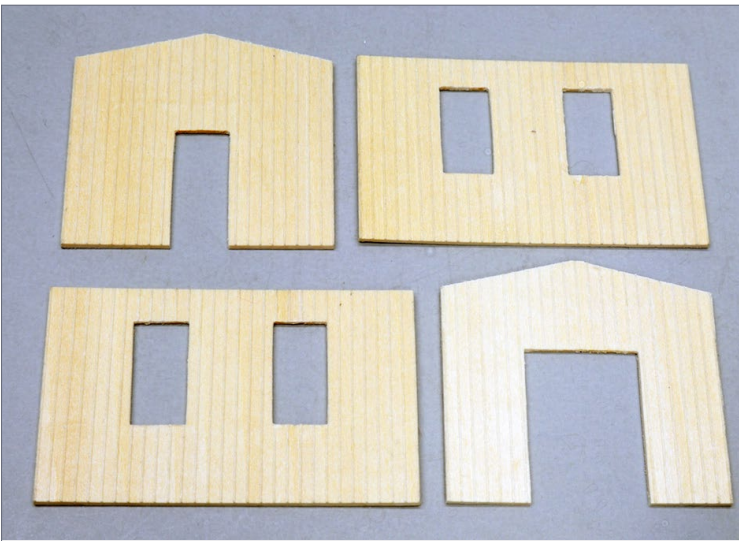

8. These are the walls at this stage of construction. Note the pattern of the board-and-batten siding on the ends and sides.

BUILD A PUMPHOUSE | 10



9. The Tichy #8153 windows need to be modified for use on this building. On the left is the stock window. Next right, the ears on the head casing are trimmed even with the side casings. Third right, the window is placed face-down, and the apron below the sill is cut off even with the inner frame. On the far right is the completely modified window.



10. The transom needs to be removed from the Grandt 5073 double door. Cut along the edge of the transom window frame.

BUILD A PUMPHOUSE | 11



11. Remove the top of the side door frame material to accommodate a new header. On the left, the frame has been cut to the depth of the transom frame. On the right, the frame has been sliced away down to the prior cut.



12. Bond a new .015 x .040 styrene strip door header across the top of the double doors. I used MEK.

BUILD A PUMPHOUSE | 12



13. The prototype building has an 8" trim board along the base of each wall. Using a scale 1" x 8" as a reference, mark a cut line along the base of each wall. Lightly cut through the battens. Shave away the battens from the wall below the scribed line.



[Click here for
reader comments](#)

BUILD A PUMPHOUSE | 13

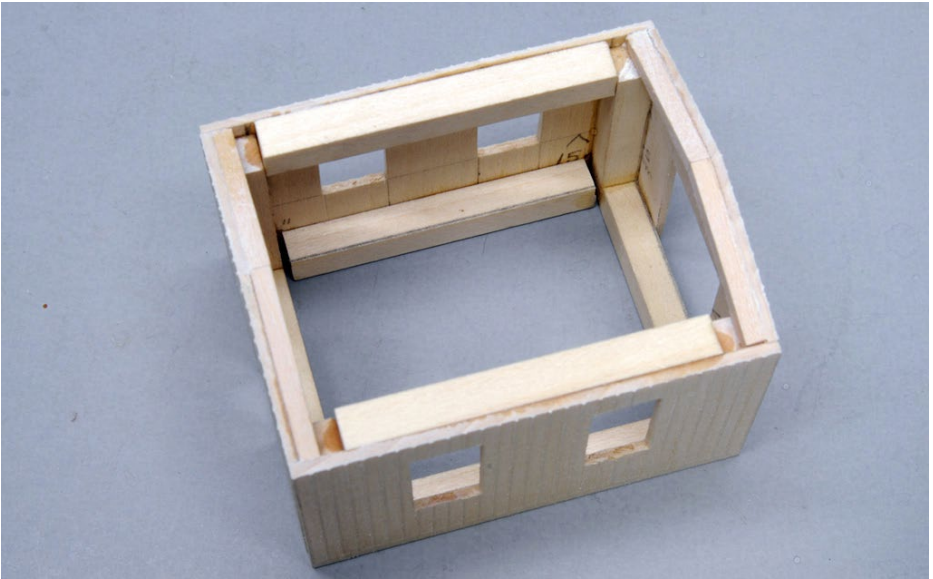

14. Assemble the box. I brace my wooden structures heavily; in this case I used $\frac{1}{4}$ " square stripwood. Start with the end walls. Bond a $\frac{1}{4}$ " square strip aligned flush with each side of the end wall. This is the corner support. Now add a strip across the bottom of the end between the corner supports. To provide an attachment for the roof, bond $\frac{1}{8}$ " square stripwood along the gables. Bond $\frac{1}{4}$ " strips along the top and bottom to reinforce the sidewalls. Make sure these are set back at least $\frac{1}{4}$ " from the ends, enough to clear the corner braces.

BUILD A PUMPHOUSE | 14

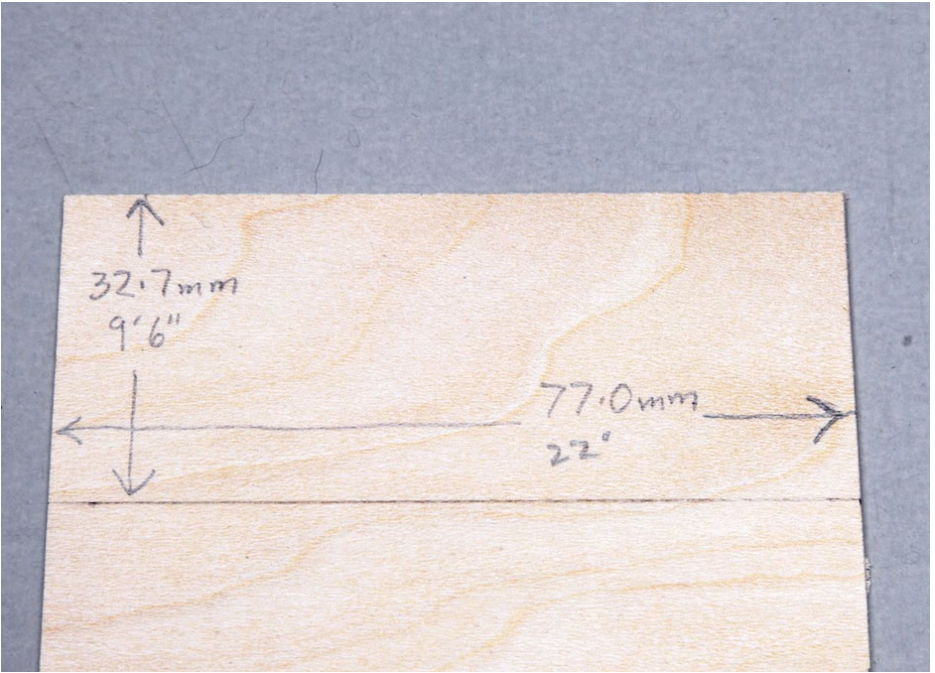

15. Measure your model to determine the dimensions required for the roof. On my model, each half was 9'-6" (32.7mm) wide and 22' (77mm) long. This provided a 12" overhang on all sides. The roof is made from 1/32" basswood sheet.



[Click here for
reader comments](#)

BUILD A PUMPHOUSE | 15

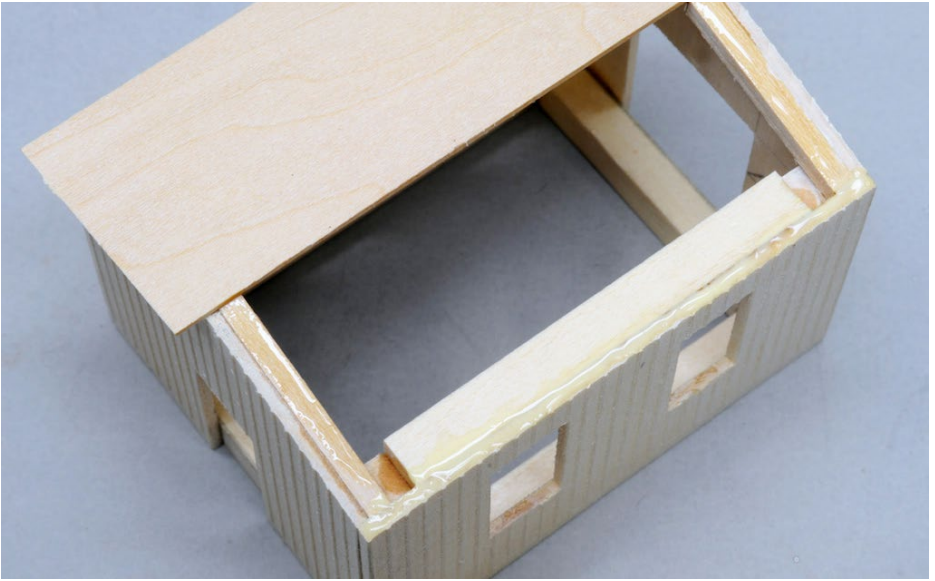

16. Apply CA along the 1/8" square gable braces, and carpenter's glue along the top of the side. When the roof is clamped down, any carpenter's glue that seeps out from the eave can be washed off with water. The CA is far enough back from the edge of the gable that it will not squeeze out onto the surface of the end, affecting painting.

BUILD A PUMPHOUSE | 16



17. When the glue joints for the roof are dry, sand the edges of the eaves parallel with the walls. This will provide a flat surface for attaching the trim boards.



[Click here for
reader comments](#)



18. I painted the interior of the building black, and stained the exterior prior to painting. I used diluted solutions of DEBenLLC Instant Age and Weathered Rust.

I also stained lengths of scale 1" x 6" (roof trim) and 1" x 8" (base trim). When the stain dried I painted the model. This model represents a building that is about five years old and in good repair, so weathering is minimal. I applied several coats of diluted paint from the eaves downward. My favorite paint has been discontinued, so I will not give details on its use other than to say that applying diluted paint gives more control over the final finish.

BUILD A PUMPHOUSE | 18

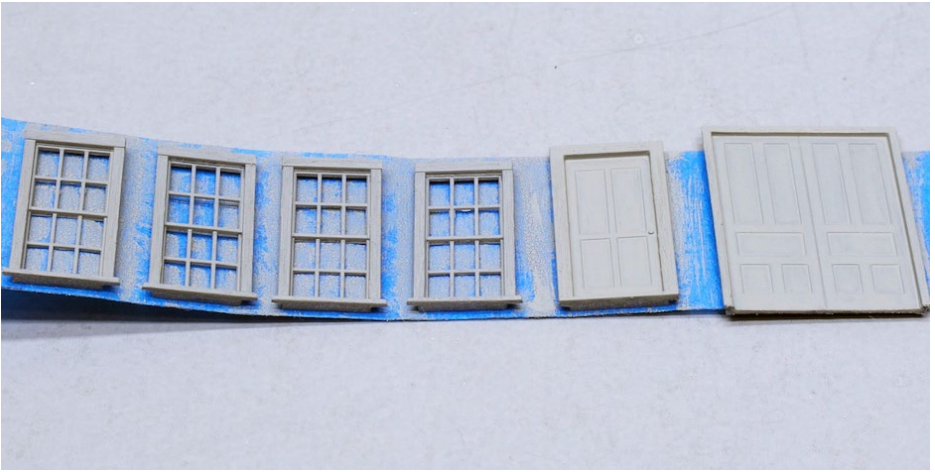

19. Next I primed the windows and doors with a light gray color.



20. While painting the building, paint the windows, doors, and trim boards. The windows are glazed with .005" clear styrene. I use Pledge Future floor wax to bond the glazing into the window openings. Dip the glazing in the wax and allow the excess to drip off, then position the glazing in the window. At this point attach the base trim boards and the fascias around the roof.



21. To allow the windows to fit flush with the wall, you must remove the battens at the top of the openings. Place a window in position and scribe a line along the head casing.



22. Use a hobby knife chisel blade to slice off the battens. Repeat this process for the doors. Bond the windows and doors in place. Using a small brush, apply a few dabs of Woodland Scenics Hob-e-Tac around the opening, and position the casting. I only recently started using this glue to fix castings in place. It holds well, does not fog the glazing, and has no sheen. The only down-side is that it remains tacky for an extended period.

BUILD A PUMPHOUSE | 20

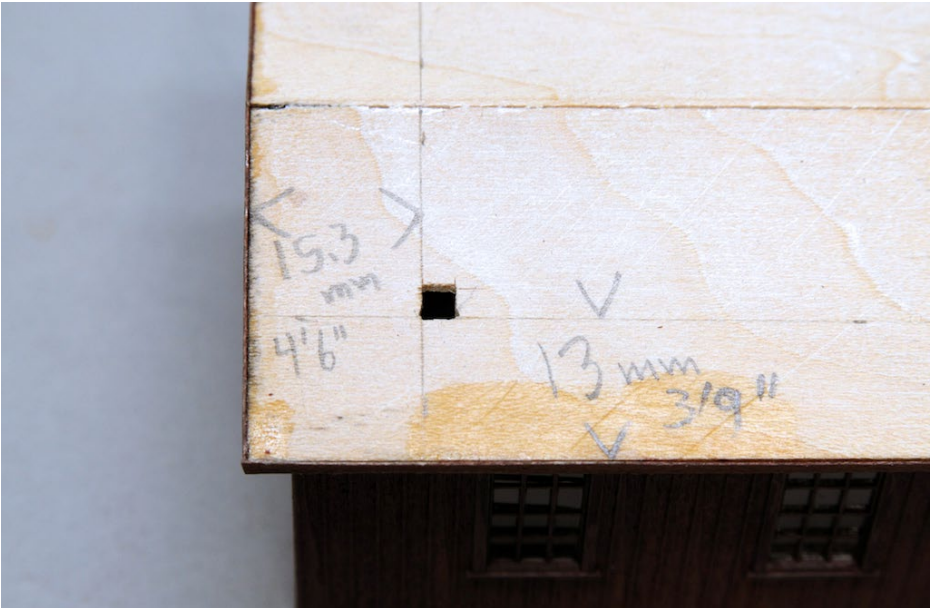

23. A unique feature of this pumphouse is the head frame. Cut two holes, located as shown, one on each side of the roof. The holes should allow an 8" x 8" to pass through at an angle. Cut out two head frame posts 30' long from 8" x 8" stripwood.



[Click here for reader comments](#)

BUILD A PUMPHOUSE | 21

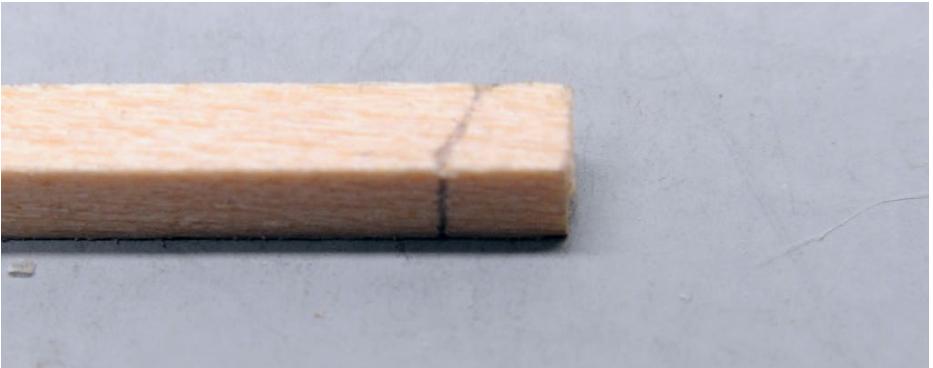

24. I like to do mortise-and-tenon construction when building any type of timber construction such as bridge piers, loading docks, etc. The side posts are angled, so the tenon base needs to be cut at an angle. In this case I used a 2" offset between sides. The short side is 6" from the end the long side is 8".

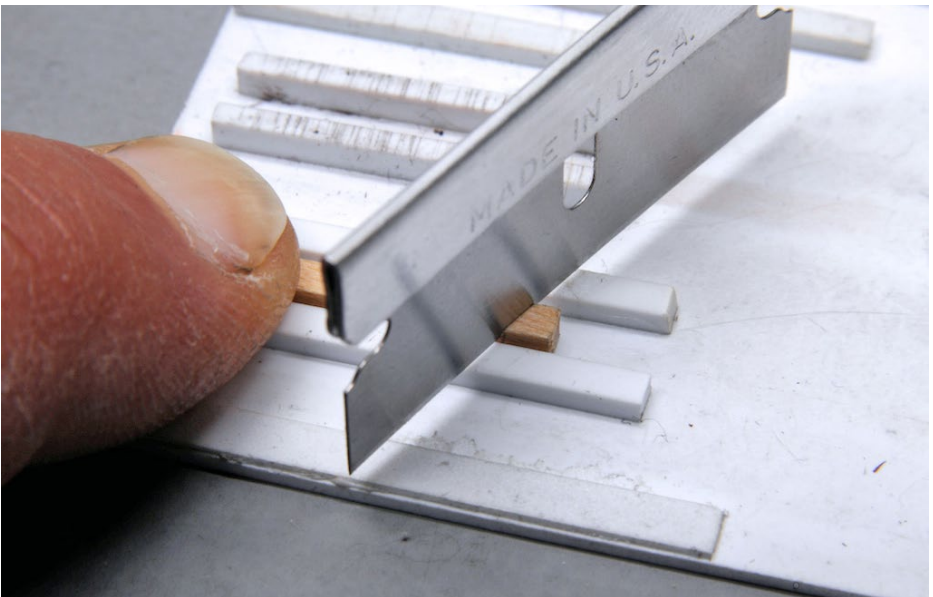

25. I built a cutting jig from scale 6x6 styrene. Press the razor blade into the wood until it hits the 6" x 6".



26. Resting the razor on the 6" x 6", push the blade into the post end until the wood is sliced away. Stop at the previously made vertical cut. Rotate the post and repeat these two steps on each side.



27. When done, you will have a 4" square tenon. Trim it to about 4" long.

BUILD A PUMPHOUSE | 23

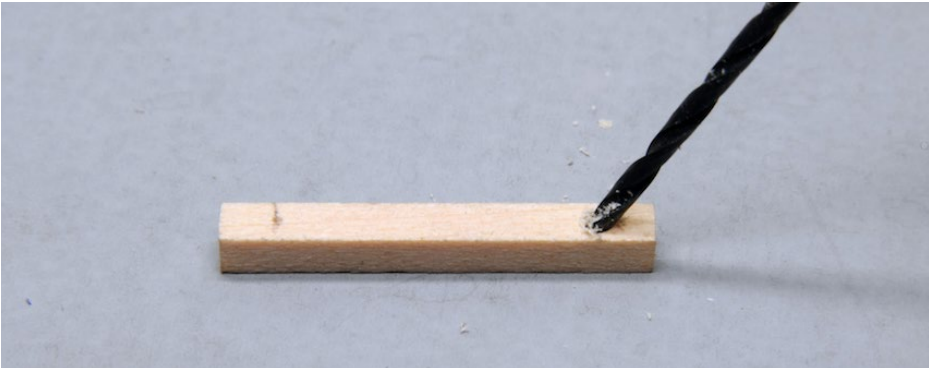

27. Cut a 8" x 8" top timber 6' long. Mark centers 9" in from the ends. Select a drill the size of the tenon. Holding the drill at an angle, bore a mortise in the top timber to the depth of the tenon. Do not drill through.



28. Test-fit the head frame. Adjust the angle of the mortise and tenon joint if necessary. The corners of the tenon need to be rounded to fit in the mortise. Cut the posts to length so that the top of the head frame is 15' above the roof peak.

It is necessary to cut a notch in the upper sidewall brace to clear the head frame post. Also note that the post rests

on the lower sidewall brace. Stain the head frame components at this time.



BUILD A PUMPHOUSE | 25

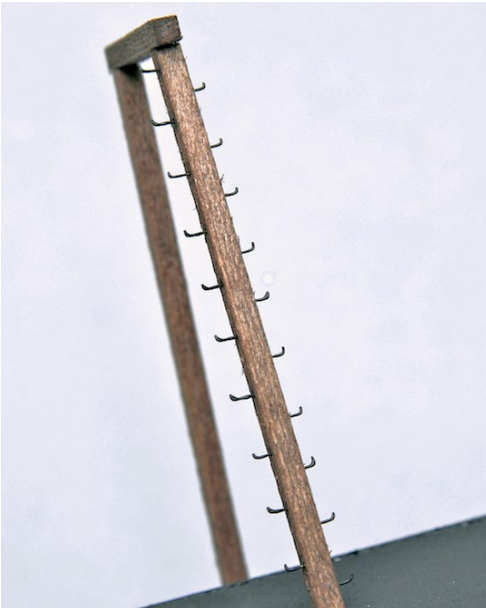

30. A detail worth including on the head frame is the climbing irons along one post. These irons are spaced 18" apart, and are offset by 9" on opposite sides of the post. I fabricated them from .008 brass wire.

31. To drill .008" holes in the post, I created a drill from .008" brass wire. Cut the end of the wire with a nipper to make a flat burr that acts as a cutter. Drill holes along each side of the post, using very light pressure, as the wire will bend. Shape the iron, apply a tiny amount of CA on the end, and place the part in the hole. The irons extend six inches away from the timber. After the irons are attached, set the head frame parts aside; they will be assembled after the roof is completed.

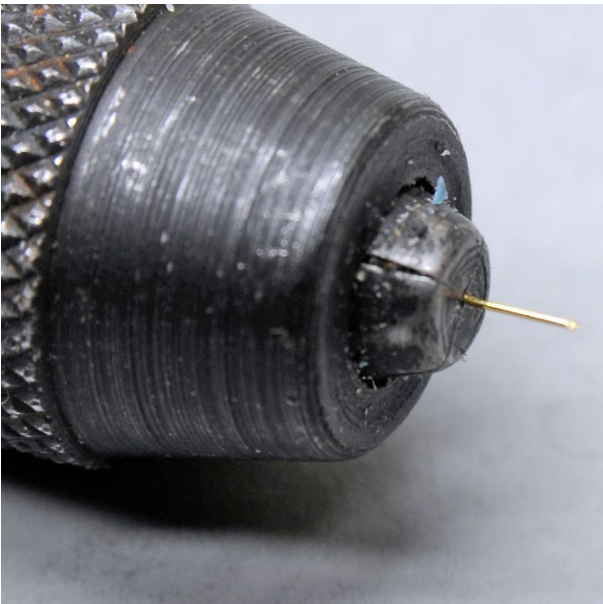

BUILD A PUMPHOUSE | 26



32. Paint the roof black. The building houses a steam boiler requiring the addition of a smoke stack. Create a stack shield from $\frac{1}{4}$ " styrene tube. Use a blade to scrape a bevel on the end of the tube. Drill a hole in the roof and epoxy the tube in place. It should extend about 12" above the roof.

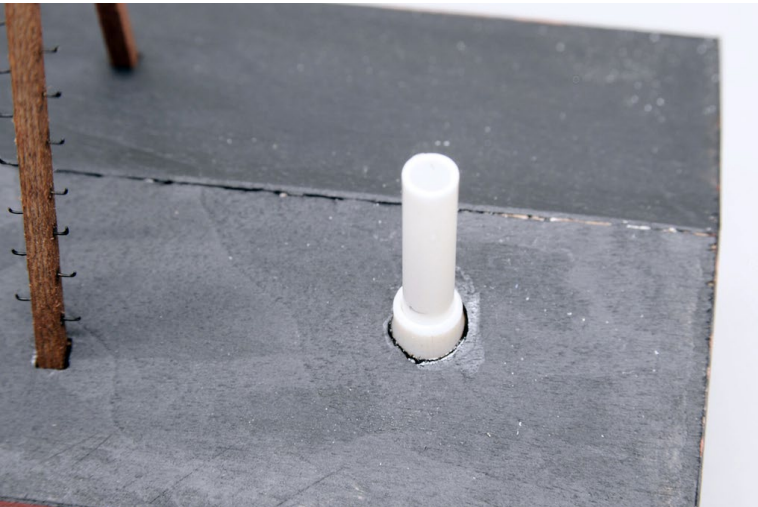

33. The stack is formed from a $\frac{3}{16}$ " styrene tube epoxied into the shield. It should extend 5' above the shield.

BUILD A PUMPHOUSE | 27

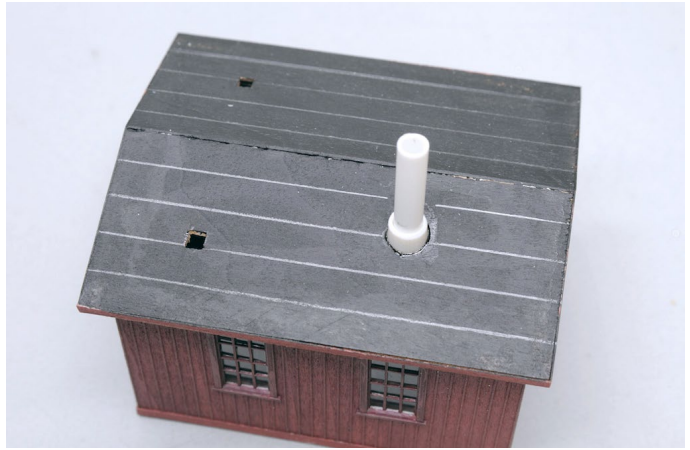

34. To aid in aligning the shingles, draw lines $\frac{1}{4}$ " apart. I used a piece of $\frac{1}{4}$ " square stripwood as a spacing guide.

I used American Model Builders self-adhesive shake shingles. I pre-colored them with my weathering stains, then separated them from the sheet. Apply the shingles starting at the eave and work up the roof. Use the guidelines to keep the courses straight.

BUILD A PUMPHOUSE | 28

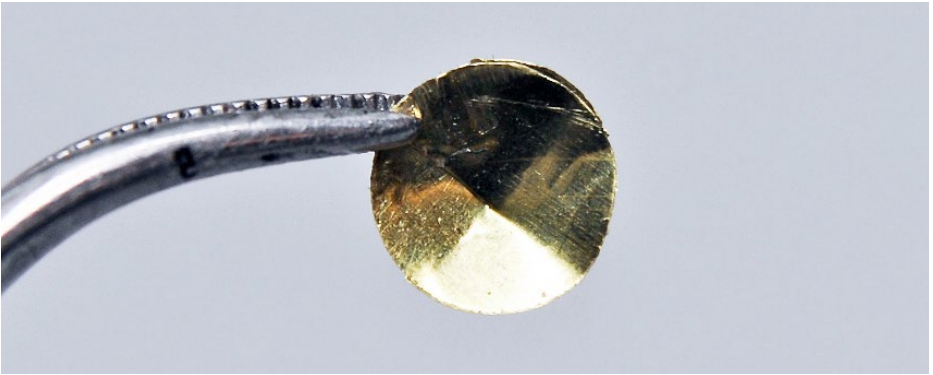

35. Create a smoke stack cap by paper-punching a disk from .002 brass sheet. Cut a slot in the disk and overlap the ends slightly to form a cone, then solder the seam. *Tip:* use a small piece of water-soaked cotton batting placed along the seam and around the first leg to act as a heat sink when soldering on the last leg.



36. Fabricate two cap legs from .010" x .018" brass bar. Make a slightly greater than 90-degree bend about 3" from the end of a 2' piece of brass bar. Solder the bar to the cap as shown. The legs should be on opposite sides of the cap.



37. Insert the smoke stack cap legs into the stack, leaving a 9" opening, and bond it in place. Position and secure the head frame components. I used scale 1" x 10" stripwood to form the ridge cap. Add the steam exhaust pipe made from 3/64" styrene tubing. It extends 4' above the roof. Paint the stack and steam vent grimy black. Apply a wash of mineral spirits and artists Van Dyke brown oil paint to the roof in a random manner to simulate weathering. The mineral spirits will soften the shingle adhesive, allowing you to lift up individual shingles to create a more aged roof. Apply a small amount of artist acrylic black paint around the roof penetrations and add some soot to the boiler stack. ✓

PARTS LIST

Detail Associates

- .010" x .018" Brass Bar #2522
- .008" Brass Wire # 2502

Northeastern

- 3/32 spaced board and batten siding
- 1/32" thick plain basswood sheet
- 1/4 " square stripwood
- 1/8" square stripwood

Scale Lumber

- 1x6 HOSCAL1611
- 1x8 HOSCAL1811
- 1x10 HOSCAL11011
- 8x8 HOSCAL8811

American Model Builders

- Shake Shingles # 335

Tichy Train Group

- # 8153 6/6 Double Hung Window
- #8049 Four Panel Single Door

Grandt

- #5073 Double Door

Evergreen Styrene

- 1/4" Tube # 228
- 3/16" Tube # 226
- 3/64" Rod # 221
- .015" x .040" Strip # 112
- .005" Clear Sheet # 9005

K&S

- .002" Brass Sheet # 6005

DAVID KARKOSKI

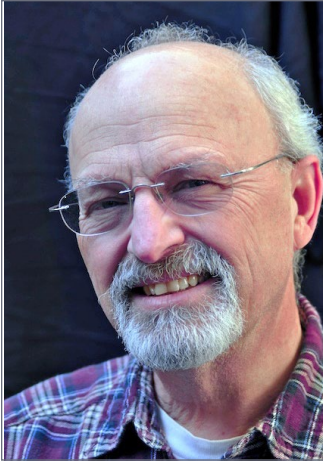

David Karkoski is retired and lives in Milwaukee, WI. His interest in model railroading stems from a color photo of Paul Larson's Mineral Point and Northern in the December 1959 *Model Railroader*. David also was inspired by articles on structure building by Jack Work and Al Armitage in the same issue.

David is currently building a DCC dead-rail sectional shelf layout that can be changed to depict various eras and railroads, in keeping with his ever-changing interests. ■



[Click here for reader comments](#)

THIS

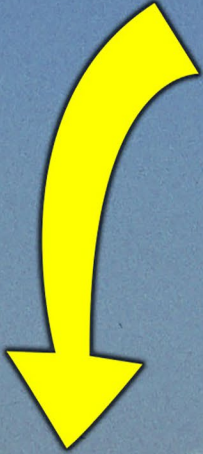

IN N SCALE. CLICK HERE.

Kitbashing a

SOUTHERN PACIFIC SW900E LOCO



BY KOOS FOCKENS

1. This is Southern Pacific SW900E 1193 in San Jose, CA, circa October 1974. Koos used this specific prototype loco as the basis for his project. *Steve Sloan photo*

Detail parts and scratchbuilding recreate a rare switcher ...

THE PROTOTYPE SW900E EMERGED FROM A locomotive series EMD originally built for the Southern Pacific as the SW900. After a relatively small rebuild/modernization program in the early '70s, they emerged from the SP Houston shops designated SW900E.

Compared to the SW900, they could be recognized by a single tall oval exhaust stack, a modified light package resembling the

• INDEX

• TABLE OF CONTENTS



**Click here for
reader comments**

arrangement on the SW1500s, new access doors on the cab walls underneath the road number, a different style number board from other switchers, and the Houston shop's signature stacked Southern Pacific lettering.

The SP used these locomotives as switchers until roughly 1986 to 1988, and deployed them mainly in California. Most were sold for scrap after retirement but to my knowledge there is at least one survivor, 1197, currently in the possession of the Niles Canyon RR. It was owned for a while by what is now called the Richmond Pacific RR, and is in its blue and white colour scheme. I'm hoping they'll one day restore it to SP colors. The locomotive otherwise shows few changes from the way it left the shops, other than having a roof beacon added.

I've owned a Life-Like SW1200 model for several years, and in fact painted it in a freelance color scheme, but I never really finished it. Recent technical problems with a DCC decoder that I had installed in the locomotive encouraged me to work on the loco. I settled on kitbashing an SW900E locomotive, mainly because there are a couple of details that differ from the standard SW1200 shell, and I thought it would be a nice project. This one was going to be a little more involved than my earlier commuter GP9, which you can read about in the September 2014 issue of *MRH* magazine at mrhpub.com/2014-09-sep/land/#104.

Research

All SW900Es were retired before I realized I liked American railroads, so I had never seen one in the flesh. This is further complicated by the fact that I live in Europe and didn't travel to the US until 1995. The only SW-style locomotive I have seen in action was actually parallel to the Panama Canal, when I transited the canal during my time as a seafarer. Before I go too far off topic, back to the SW900E.

Several pictures of SW900Es exist and they can be found on several photo websites. Facebook proved to be a good source. I am a member of some Southern Pacific groups, and people regularly share their photos. Since I don't own those photos, I cannot share them with you here with the exception of the intro picture of 1193, kindly authorized by Steve Sloan.



2. Koos built this SW900E #1193 by kitbashing a Life-Like SW1200 model.

SP SW900E KITBASH | 4



3. The original shell is disassembled on the workbench.

Suffice to say, if you type “Southern Pacific SW900E” in Google Search, several images and search results will point you in the right direction. I compared the model I had with these photos and was able to determine which parts I needed.

I soon discovered that some of the detail parts are currently not available, most notably the exhaust stack and the light packages of both long hood and cab, so some scratchbuilding is necessary. I wanted sound, and almost a fully working light package. A parts list is included, and most of the commercial detail parts are by Detail Associates.

Preparation

First, disassemble the model for paint stripping. Taking pictures of the process is always a good idea. First, you get yourself a nice guided tour on how it came apart, and second, you automatically get pictures to illustrate an article. Taking it apart took about 10 minutes.

As soon as it was apart, I noticed the rather poorly detailed cab interior. It not only shows the age of the model, it also gave me another opportunity to do a little more detailing. I did not want to go overboard with the cab interior, as you'll barely see it, but I aimed to improve a bit on what was there.

I started checking on the internet to see if there are any interior kits that might be useful. I came across a substitute thin-wall cab kit made by Cannon & Co., complete with new interior floor. Not quite what I had in mind, but I decided to get one anyway. It was out of stock at most places I checked, but I found one and ended up using it.

For this project I decided to try isopropyl alcohol as a medium for paint stripping. I recently managed to obtain some of the 91 percent industrial grade stuff and I wanted to try it out. Now, this particular model was originally an undecorated Life-Like Proto 2000 locomotive which I had airbrushed with Floquil paint several years back. Since then the formula of the paint has changed, partly due to environmental reasons. While that is a good thing, manufacturers often overlook the quality side, and, in my opinion, Floquil was never as fine or smooth afterward.

I had no idea how this old paint would react to the alcohol so it needed to be tested. I carefully applied a little bit of alcohol to a Q-tip cotton swab, and applied it to a section of the shell interior

SP SW900E KITBASH | 6

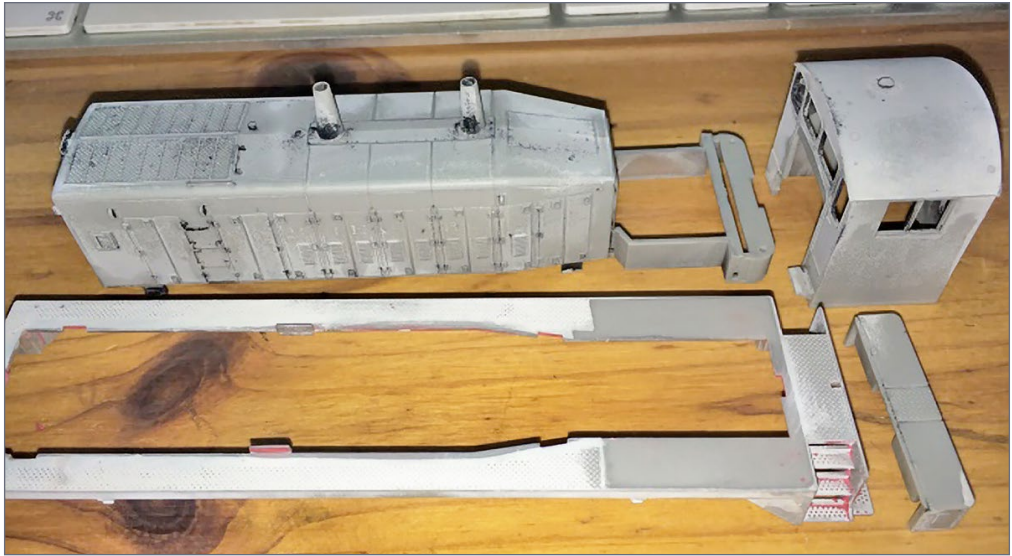

4. With the original paint stripped, the model is almost ready to start the kitbash. Koos soaked these parts again one more time in the isopropyl alcohol bath (15-20 minutes) and gave the shell one more good scrub to remove every last trace of the old paint.

that showed some overspray. I let it soak for a little while and then carefully rubbed the paint. I was in luck. It started to lift and the shell appeared undamaged. I therefore soaked the shell in a glass dish with alcohol and using an old toothbrush, scrubbed the shell clean.

Considering the color scheme and the quality of the original paint, I could have left it alone and used it as a primer. Since I decided to add several detail parts, I felt it was better to start with a clean slate, or shell.

About 15 to 20 minutes soak time was sufficient to release the paint from the shell. I had not used any primer previously, and perhaps this helped in its release.

SP SW900E KITBASH | 7

Here is the result [4] after the initial stripping process. A second soaking in 91 percent isopropyl alcohol and a bit of scrubbing will ensure the rest of the paint is removed.

Detailing the body

With the preparation out of the way, the fun part can begin. To turn this SW9/1200 shell into an SW900E, a couple of things need to be removed. Most obvious are the exhaust stacks. The front exhaust stack needs removing because the new SP version is oval, not the standard round tapered shape of most original SW series locomotives.

In addition, the frame overhang gussets directly behind the steps originally had a triangular shape. The SP modified these in a more angled shape for reasons unknown to me, perhaps for a clearance or access issue. In any case, it certainly is a spotting detail that needs modeling. To make sure I'd make all of the gussets symmetrical, I made a template from a piece of scrap styrene. I sort of "eyeballed" the shape from several pictures[5]. I used that to mark each gusset with a 0.5mm pencil, and then scribed the gusset with a sharp X-Acto knife, using the same

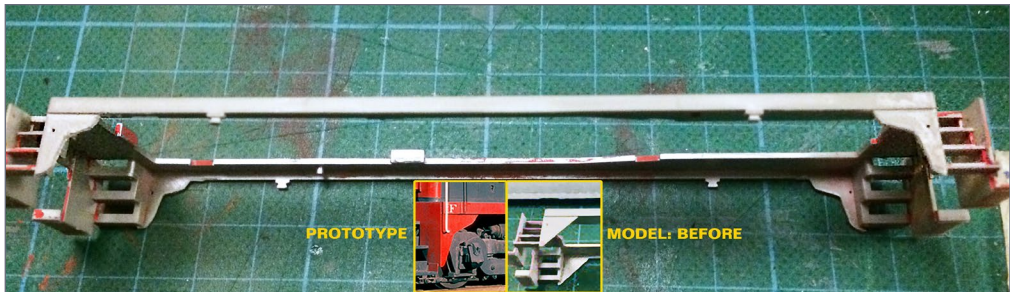

5. The original model sill (before) had a straight taper, but the prototype has a more complex angular shape. Koos modified the model sill taper to match the prototype.



6. Koos built a new replacement exhaust stack using a core of styrene wrapped with a soda straw.

template for support. I went very slowly and took care to not damage the template. Several passes were made until the gussets were cut through.

With the original exhaust stacks cut off, the holes can be filled with scrap pieces of sprue, and the shell sanded smooth. The new exhaust was made by glueing a few pieces of scrap styrene together to make the core of the new stack. I then fitted a soda straw over the top, squeezed it together, and glued it to the core.

The result is a nice oval stack approximating the prototype dimensions [6]. Comparing it to the photos I found it reasonably close; perhaps a little oversize, but I can live with it. The drinking straw had a diameter of 5mm, and the styrene core is 2mm thick. The top of the stack is in line with the cab roof.

SP SW900E KITBASH | 9

Next are the radiators. While there's nothing wrong with the existing radiators for most modelers – I was happy with them, too – I found some Detail Associates replacement radiators which feature a see-through etched grille. These are available both for the front and the top of the hood. I decided to go all out and replace these, and it really elevates the super-detail level of the model.

I carefully removed the cast-on front radiator grille with an X-Acto chisel blade. Work slowly and use sharp new blades. The model, and more importantly your finger tips, will be grateful. The top radiator was a little more involved. I used a hobby knife and carefully scribed the edges of the cast-on screen until I cut through the body.

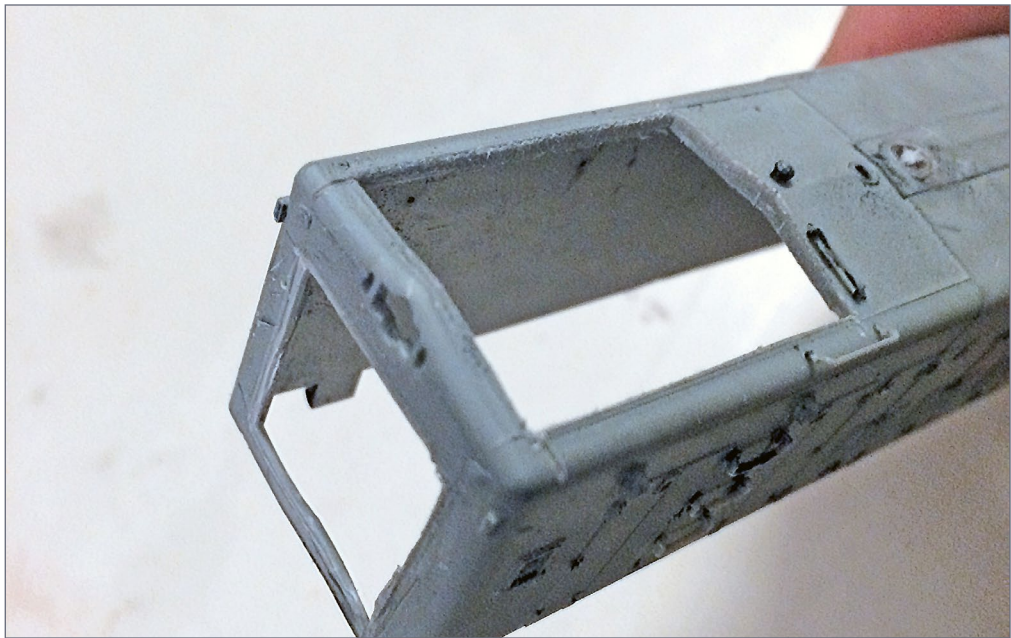

7. Koos decided to go “all out” and do see-through radiators on this model. To accommodate this, he removed the original cast on radiators.

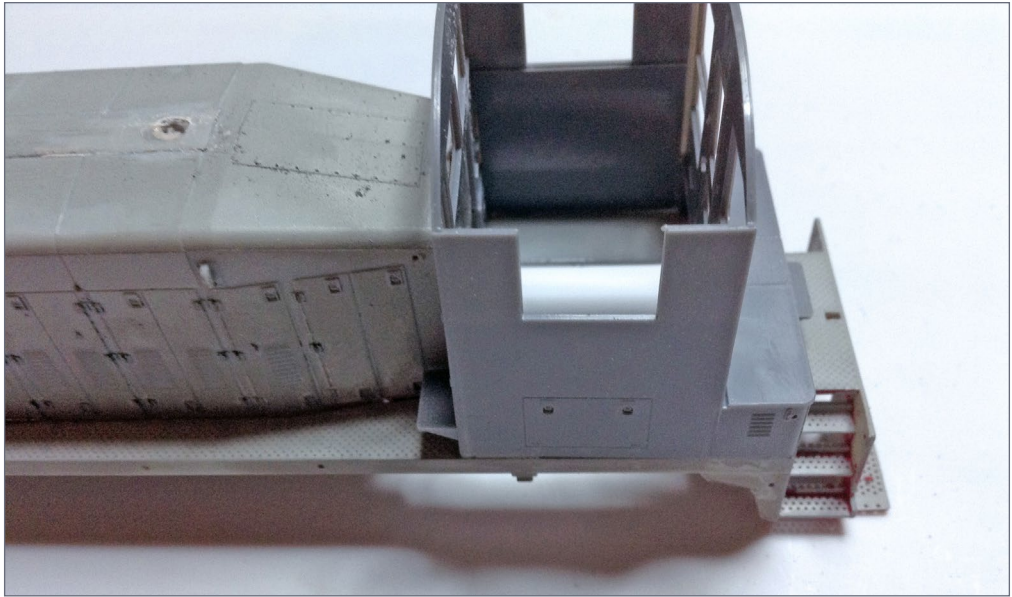

8. Koos replaced the stock Life-Like cab with a Cannon cab.

Installing the cab and lights

With all the major work done, the next step is to add the details.

The first, and by far the biggest, is the new cab. I used a Cannon & Company cab. The Life-Like cab is nice, but the Cannon cab is nicer still. While the locomotive was dismantled, I figured I may as well go the whole nine yards (or 8.23 meters since I'm a metric guy). I was a little disappointed with the interior floor Cannon provided. It was better than what came with the model, but I felt it wasn't that much of an upgrade. For the time being, I left it out to see what would happen once all of the wiring was in place. If there was room left, I might install it or the original Life-Like interior. As it turned out, I used the space for extra weights and an LED resistor board.

SP SW900E KITBASH | 11

I discovered that the prototype unit I was copying actually had compartment doors of similar shape and size on both fireman's and engineer's side. This was not the case on all SW900Es. Others had vents in them. Don't you love the SP? No two units seem alike. As the Cannon kit only includes one cab side with the compartment door, I managed to get a second cab, and borrowed the wall from that one. Now I can build another cab with two plain sides if I want to. I need to find a subject loco for that some day.

With the cab constructed, I test-fitted the radiators to the hood. The front one is important because I use it as a reference for the size of the light package. The SP 900E had a unique light

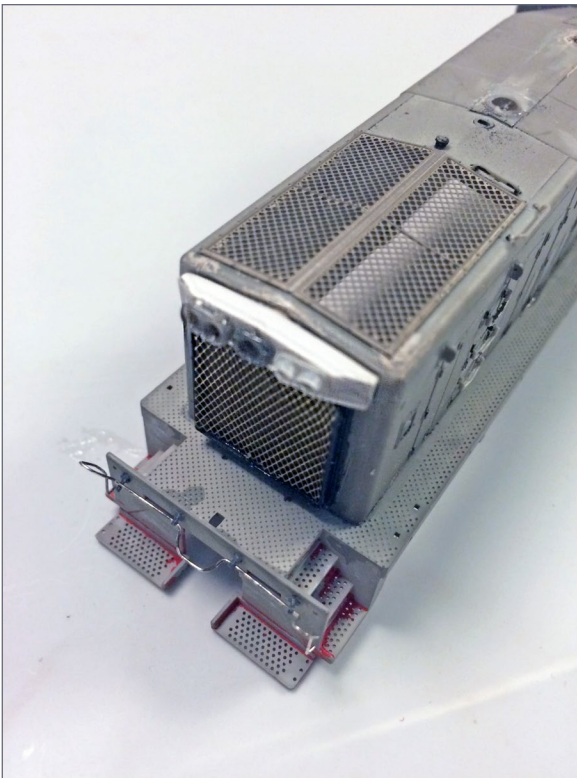

package. While it housed all the typical SP lights, they were packaged in a purpose-made housing.

Unlike some engines, such as the SW1500 where the lights are mounted to the front of the hood and others where the Pyle Gyalite

9. Here are the new see-through radiators mounted in the hood. They do look nice!

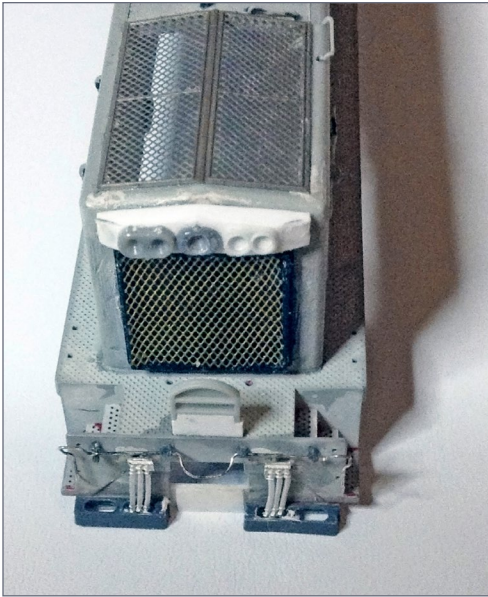

10. Koos had to build a custom SP light housing for the front of this loco, as well as make modifications to the front pilot.

protrude outwards, the SP seemed to have designed the the 900E arrangement such that the Gyalights are mounted flush with the other lights. I later found this design used on some SW1500s, but I am not certain if it is exactly identical, due to the SW900E hood which is a little wider.

The whole light housing assembly protrudes outward quite a bit farther than the radiator frame. It was angled to match the hood, and has beveled corners for the marker lights. There doesn't seem to be a detail part like this around, so I had to scratchbuild mine. That was part of the appeal of this project for me.

I did not have any dimensions but found enough photos on the internet. With others sent to me via friends in the US, I could "guesstimate" the dimensions. I had Pyle Gyalite detail parts on hand so I had a reference on how thick the assembly needed to be.

SP SW900E KITBASH | 13

I started by cutting a piece of scrap Evergreen .100 x .188 (#178) to the right size. All dimensions are eyeballed, but I ended up with the following dimensions:

- width overall 6'
- height in center 1'-6"
- width of the flat area with the lights 4'-6"
- thickness at center 8"
- the top angle is 160 degrees, and the sides with marker lights angle back at 30 degrees

Looking at various photos, it appeared that the front and rear light packages are identical, so I made two. I used hobby knives, emery boards, and sandpaper to get the two assemblies to look like those



11. Koos used Smokey Valley handrail stanchions and brass wire for the handrails on this loco.

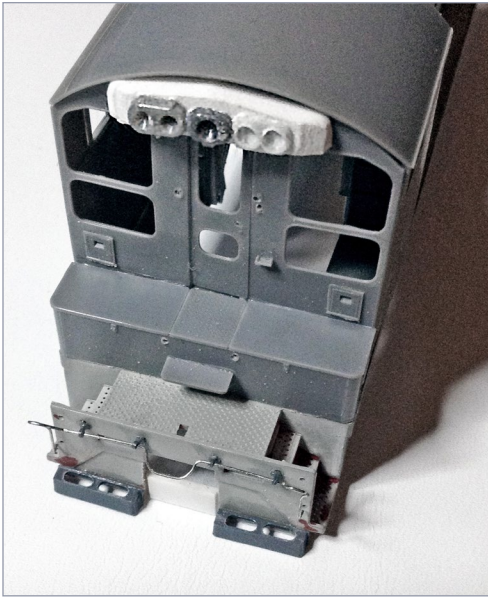

12. Koos also had to modify the rear of the loco by adding a custom light bar, and kitbashing the pilot.

in the pictures. I found the whole process rather unnerving. It was certainly new territory for me, and it took me a long time to get the first one shaped to my liking. I don't own an extensive array of tools and gadgets that would make the job easier.

I managed with the tools I have on hand and I'm quite pleased with the appearance.

The handrails are made with Smokey Valley stanchions, and brass wire, formed to the proper size and shape [11]. Again, the spacing and dimensions are derived largely from eyeballing prototype photos and the model, but I found some dimensions that made sense. Now, even this small series of switchers, 10 units in total, had some variety. Front and rear handrails on earlier units are different than those on the later ones, The same goes for some of the pilot details. It is therefore important to choose a unit, and model it as faithfully as possible. I chose 1193, since I

SP SW900E KITBASH | 15

had the best pictures of it, and photos of 1195 seem to confirm it was nearly identical.

I needed to cut off the original pilot footboards and replace them with MU hose holders. I closed the gap underneath the coupler with scrap styrene sheet. Coupler lift bars and MU and air hose details are fitted on the pilots.

I scratchbuilt the number boards on the long hood to resemble the uniquely shaped number boards of the SW900E. They look a bit like those on Alco units but are not the same, hence the need to scratchbuild the parts once again.



13. After painting the finished parts with primer, Koos sprayed the SP Scarlet Red areas. As the final step shown here, he masked the scarlet areas in preparation for the final spray with SP Dark Lark Grey.

Paint and final finish

Once all details are added, it is time to paint. I used Tamiya Light Gray acrylic primer from a rattle can to apply the primer undercoat. Next, I airbrushed SP Scarlet Red in two coats for good coverage. Once that had dried for 24 hours, I masked the areas to remain red, and applied Lark Dark Gray paint in two light coats to get a nice even coverage. When that was dry, I sprayed the entire loco with Tamiya acrylic gloss. This provides a nice smooth surface for the Microscale decals. I use both MicroSol and MicroSet to set the decals down around the details of the body. Once the decals are in place, I secure them by spraying on some satin clear coat.

Last, I installed the windows and glued the roof to the cab. I had left the roof off to provide easy access for the window installation. I then added the windshield wipers and finally some subtle weathering. I went very sparingly as most pictures show these locos to be well-maintained and kept clean. Friends of mine who saw them in action confirmed this impression.

Sound and motor

I wanted sound in this locomotive.

I am very pleased with the sound performance of some of my other locomotives, so I decided to use the same decoder family. I chose a 'micro' version of the Loksound Select decoder I wanted.

To make sure that I had enough space for the speaker, and to get as much performance out of it as possible, I decided that more space was needed. I found it by removing the stock motor. I've heard horror stories about the old Life-Like motor, but I have to say I have had no issues with them so far, and it's a smooth and quiet runner.

SP SW900E KITBASH | 17

That said, I replaced the original motor with a Mashima motor that has a smaller profile. To keep the shaft at the same elevation I had to build a new cradle for the motor. I used wheel balancing weights to fill the space below the motor. A few pieces of double-sided tape secure the motor in place and insulate it from the frame at the same time.

Warning: *Lead is potentially dangerous for your health, so handle it with protective gloves. I use nitrile powder-less gloves to handle lead and paint. A good alternative is to wash your hands properly.*

The reason for lead is two-fold. It adds weight to the loco, and it's easy to shape. If you don't use wheel balance weights as I did, use layers of lead sheet glued together.

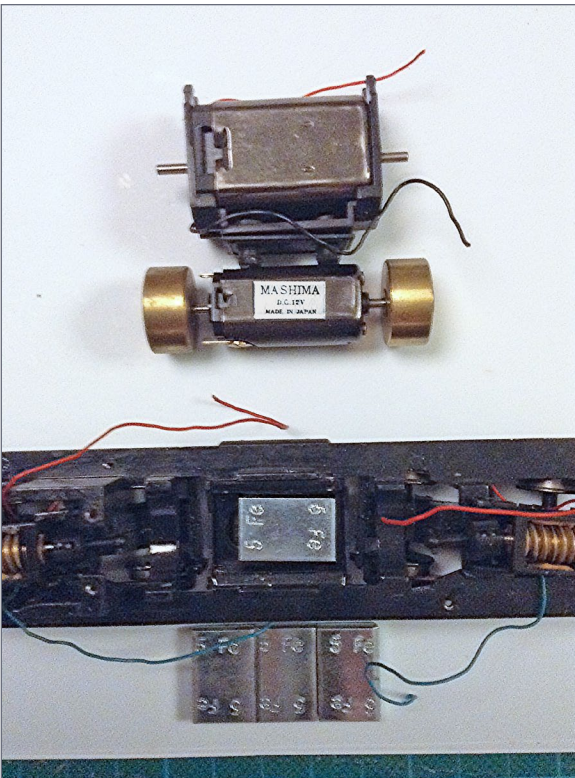

14. To get more room in this small switcher for sound, Koos replaced the Life-Like motor (top) with a much smaller Mashima motor (just below the original motor). This also allowed Koos to add more weight to the loco in the old larger motor cavity.

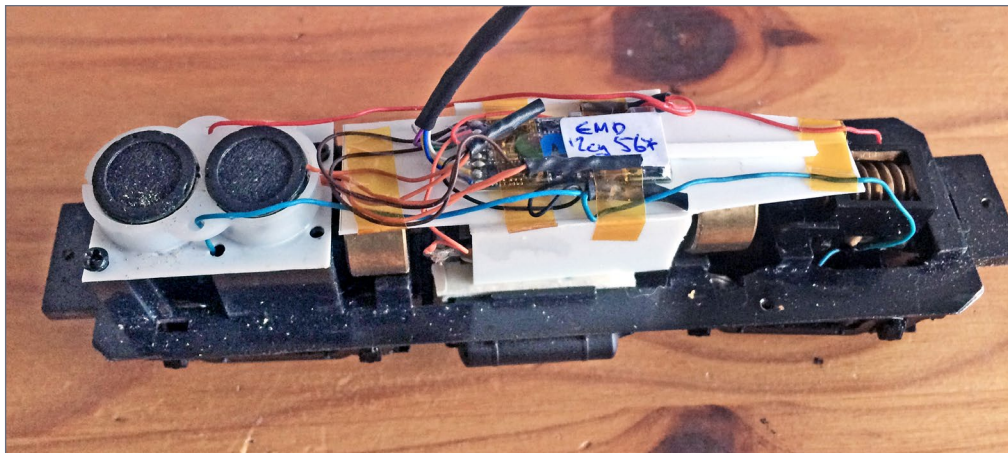

15. Here is what the sound install looks like inside this loco. By going to a much smaller Mashima motor [14], Koos got enough extra space to easily fit sound into this loco.

This let me remove the weight at the front of the long hood and use that space for the speaker. I also glued lead on the inside of each cab wall below the windows, to add extra weight at the rear of the loco.

The lighting is provided by micro LEDs supplied by Express Models in the UK. These warm white LED's are more than bright enough, and are small enough to fit one each in the individual light openings. I wire two in parallel per light unit.

Thanks

I would not have been able to build this model without some people who helped me identify the correct parts, and confirmed certain features were a good fit. They helped me with photos of the prototype, as well as supplying parts.

SP SW900E KITBASH | 19

Thanks to Jim Lancaster for his article and website on citrus packaging houses which show SW900E 1197 switching. His images inspired me to find a destination for my Life-Like locomotive. John Cockle supplied many pictures of the Parr Terminal, then-Richmond Pacific 1195. Steve Sloan provided additional prototype information and a picture of 1193. Robert J. Zenk supplied additional detail shots of the ex-1195, now at Niles River Canyon. Harry Wong confirmed parts suitability. Mike Rose of Mike Rose Hobbies helped me obtain needed detail parts; and many others.



[Click here for reader comments](#)

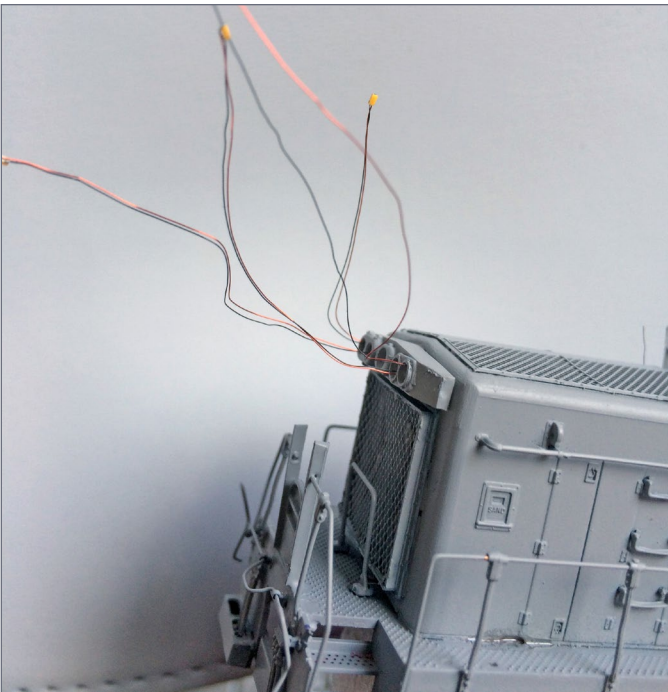

16. Koos installed micro-LED lighting in this loco, to give it a full set of working lights.



17. Finished loco, conductor side.



18. Finished loco, engineer side.

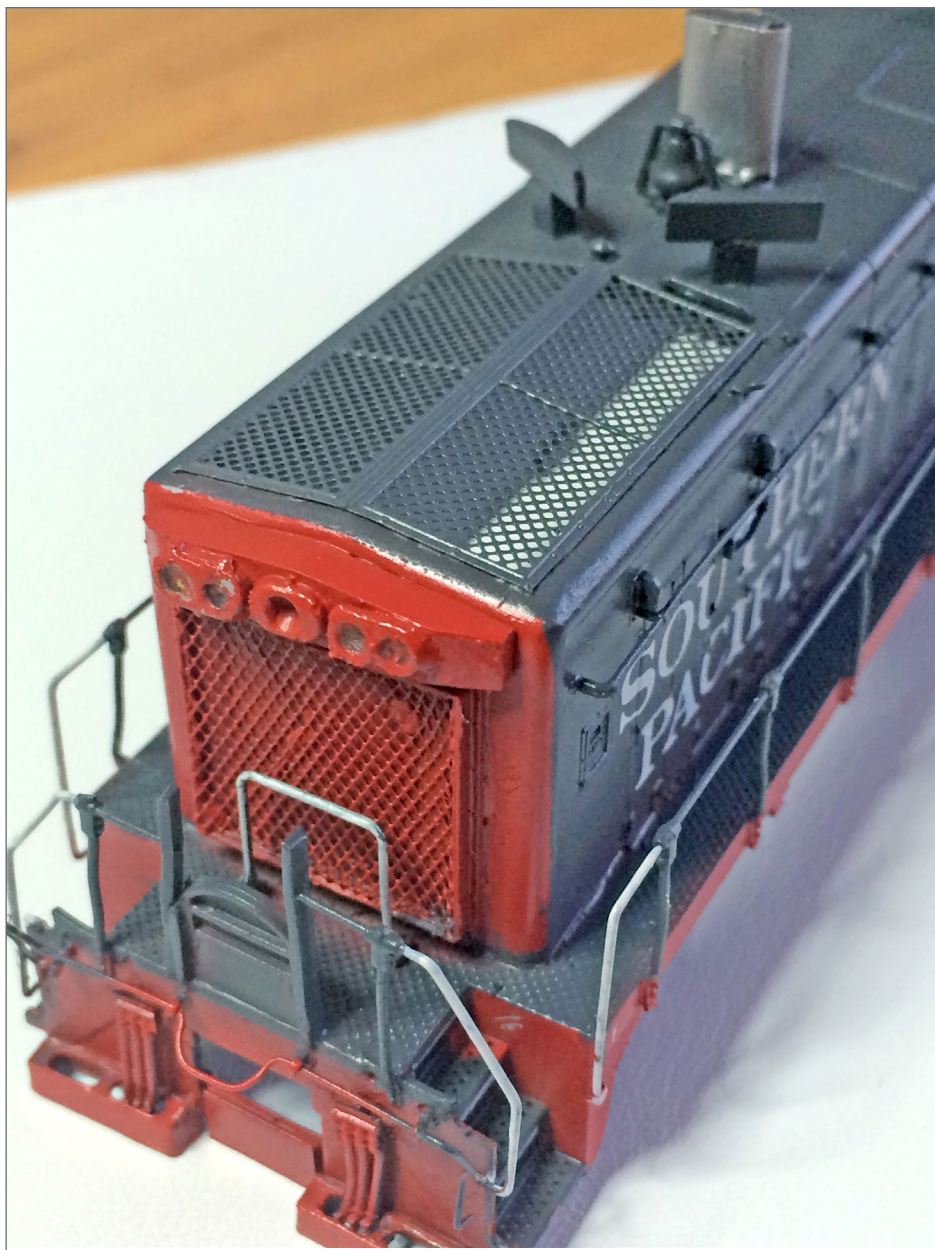

19. Finished loco, front pilot closeup.

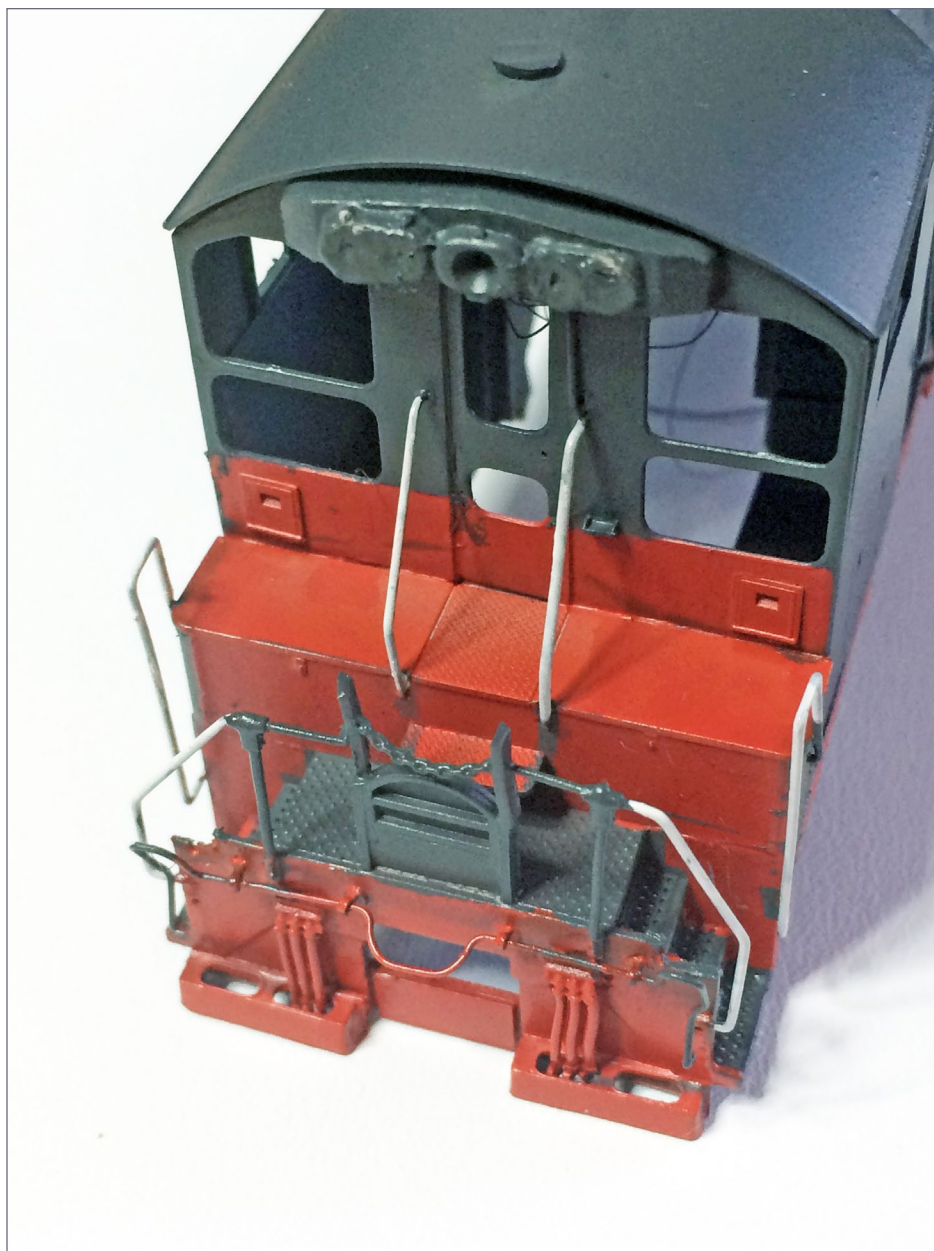

20. Finished loco, rear pilot closeup.





21. Finished loco, rear view.

DETAIL PARTS LIST

- Handrail stanchions EMD Precision Scale 3985
modern with 0.22” hole
- Brass wire Details Associates 229-2507
- Light clusters front and rear Details Associates 1001, 1002,
and 102
- MU hoses and pilot details Details West 235-265
- Horn Nathan PS 3 chime Details West 235-175
- SP style number board Scratchbuilt
- Thin wall cab EMD switcher Cannon and Co. 1504
- Coupler liftbars Details Associates 229-2211
- MU sockets Details Associates 229-1502
- Raised drop steps Details Associates 229-1401
- Arm rests Details Associates 229-2302
(not used)
- Cab air vent Details Associates 229-1901
- Radiator front SW engine Details Associates 229-2709
- Radiator top grille Details Associates 229-2727
- Windshield wipers A-Line 29201
- Styrene rod for light cluster Evergreen no 178
- Red emergency lens MV Lenses LS 281
- Sunshades (From scrap supply, any suit
able will do)

ELECTRONICS PARTS LIST

- Replacement motor Mashima MH1628
- LED lights, warm white 0.8mm Express models UK EX/
MICRO(WW)
- DCC Sound decoder..... ESU Loksound Select Micro
73800
- Sound file for decoder EMD 567 non turbo

PAINT LIST

- Testors Floquil SP Scarlet Red, and SP Dark Lark Gray. (Floquil is now discontinued but may still be found in some cases. TruColor paint is a good alternative, or mix your own.)
- Tamiya Light Gray primer
- Tamiya gloss varnish (for decalling purposes)
- Testors clear coat (final finish)

Staff note: Also see the free 40-page MRH Acrylic Guide [[link: mrhmag.com/subscribers-only/painting/acrylics](http://mrhmag.com/subscribers-only/painting/acrylics)] for good alternatives for all these paint colors. You need to be an MRH subscriber to get access to this free guide.

DECAL LIST

- Microscale SP locomotives, 87-447 and 87-1069



**Click here for
reader comments**

KOOS FOCKENS



Koos (pronounced as “coast” but without the “T”) Fockens is a Dutch model railroader who lives in the southwest of the United Kingdom. He’s married to Vicki, and has two children. Sadly, neither of them share his enthusiasm for U.S. model railroads.

He got the bug at the age of 3. Exploring the parental house in an unguarded moment, he bumped his head against a wooden table, which turned out to be a model railway built

by his late father. He never recovered from that knock on the head. His wife argues it explains a lot else, too. After starting out in Dutch HO scale, he switched to N scale, modelling German railways. He switched to North American HO in his late teens when he was introduced to the NMRA by a friend. After an active working life at sea, he picked up the hobby again when a change of career meant he has more time to set aside for it.

A member of the NMRA-British Region, he joins fellow members when possible at their monthly modular division meet in Plymouth. His main interests in modeling are the SP and the California Northern in 1993-94. He particularly enjoys loco building and detailing, and scenery, as both give such a dramatic change to the overall appearance of a model railroad.

NEW!

TMTV Season 2 DVDs and downloads



PREORDER

DVD

\$39.99

~~\$59.99~~



6 disks

Est. delivery:
Early Dec.

GET THEM
BOTH FOR ...

DVD

\$67.77

~~\$119.98~~



12 disks

All of season 2 ...
30 min / day: will
take 46 days to
watch it all



PREORDER

DVD

\$39.99

~~\$59.99~~



6 disks

Est. delivery:
Early Dec.

SHOP NOW >>

**Model Railroad
Hobbyist Store**

store.mrhmag.com

2016 NARROW GAUGE CONVENTION HIGHLIGHTS



BY JOHN HUNTZINGER

Augusta, Maine, September 7-10, 2016 ...

THIS YEAR'S NATIONAL NARROW GAUGE CONVENTION was in fabled two-foot narrow gauge country, Augusta, Maine's capital city.

I found this convention's format of clinics in the morning and evening, with the afternoon set aside for layout and prototype

• [INDEX](#)

• [TABLE OF CONTENTS](#)



[Click here for
reader comments](#)

tours, makes a lot of sense. The 2016 convention continued that format. My wife and I find this format allows us to attend almost all the clinics we really want to see and still go on tours!

The weather was quite warm for Maine in September, which meant the live steam layouts had to put up with more sun and heat than expected for this time of year.

One part of this year's convention that caught my eye was the contest room, and the layouts of all scales throughout the convention center. One thing I especially appreciate about the narrow gauge convention is the quality of the modeling and the layouts.

I kept getting drawn in by the amount of detail and workmanship exhibited by so many of the contest models and layouts. What follows are photos of the things that caught my eye.

**Want to help keep
MRH free?**

Then *click* on ads!



1. Jim Burchell's 1:24 Gobbler's Knob Maple Sugar Line is scratchbuilt. It's a 3 by 3-foot micro layout with animation. It depicts a maple sugar mine in operation.



[Click here for reader comments](#)



2. Sam Swanson's module of Windes Inlet in HO scale depicts a typical New England lobster boat scene. The detail is phenomenal and the module was the basis for his clinic on modeling seacoast structures. Even the mooring lines for the lobster boat are correct.



3. Jim Burchell built his contest diorama in G_n15 scale. “Cavan Junction & Nellie” is a kitbash project based on the English cartoonist Rowland Emmett’s very imaginative cartoons. “Nellie” is constructed from a resin kit, powered by a Hornby “Thomas” chassis, and heavily weathered. The station is scratchbuilt.



[Click here for
reader comments](#)

Debug trackwork *like an expert.*

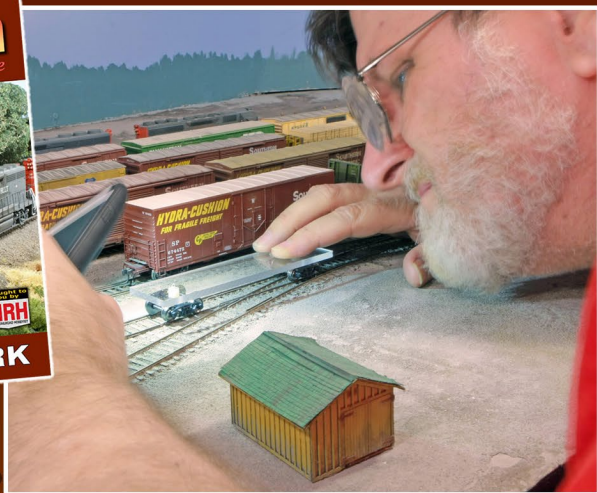
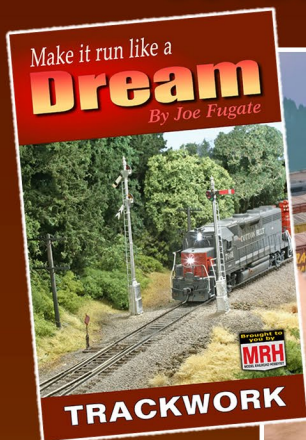

\$12.99

\$11.49

eBook

Also in
paperback

Click me to
LEARN MORE ...

Make it run like a **Dream**

TRACKWORK: *By Joe Fugate*

From the MRH Store: store.mrhmag.com

Other books in this series: *ROLLING STOCK* (Mar 2017) and *LOCOS* (Sep 2017)

• INDEX

• TABLE OF CONTENTS



4. This third place in the diorama category is a kitbash of Christmas in the “good old days” built by David Zolnierdk. The town of Red Mountain is all set for a very merry Christmas.





5. Sam Swanson scratchbuilt the Reed Brothers Boatworks in HO scale and took second place in the structure category. The longer you look, the more you see.





6. Jim Kulcher scratchbuilt a 1:20.3 model of a 40-foot engine shed. All five doors operate. The dog and cat are small details.



[Click here for reader comments](#)



7. Pete Wilson scratchbuilt this 1:20.3 backwoods engine house. This interior shot begins to show the interior detail. It boasts "knob & tube" wiring, hand carved wiring and hand-carved details.





8. (Left) Pete Wilson also built the interior of the backwoods engine house from scratch. Dozens of hand-carved and hand-cast items make up the scene.

9. Jerry Bohlander won first place in logging rail equipment with his scratchbuilt 1:20.3 scale Surry Parker log loader.



10. Sandy Alonzo placed third in Maintenance of Way with a highly kitbashed On30 MOW flatcar built on a Bachmann flat car. I'd like to think it's the end of a long, hard day and everything's been picked up except us.



11. Allen Littlefield won second place honors in the Favorite Train contest with a delightful On30 kitbash. The engine is a chopped Bachmann On30 Forney with a Mt Blue wood cab. A wooden work gondola with a scratchbuilt shed is followed by a scratchbuilt wood box car. Out of sight is a Mt Blue bashed work caboose.

12. (Right) Allen Houghton took first place in the animation category with this scratchbuilt model of the "Por Nada Mine Tram." Nada comes out of that mine! The loco is On30 and has sound and lights. All buildings are scratchbuilt and are lighted. The loco and cars are Bachmann. The C&S coal car is scratchbuilt on a Bachmann flat car.

B2016 NARROW GAUGE CONVENTION | 12





13. Rob Teates won second place in the freight car category with a scratchbuilt Fn3 stock car. The upper body is hand cut with shiplap decking and end walls. It features laser-cut doors and door frame. It has built-up draft gear, body, and truck brakes.

14. (Right, top) Tom Bowdler took 3rd place in the geared locomotive category with this 1:20 kitbashed Shay. It started as an Accucraft live steam open cab engine in 2005 and was freshened in 2016. Looks like the crew has taken everything for the day's operations and possible repairs.

15. (Right, bottom) Gerald Styles won first place in the geared locomotive category with this scratchbuilt On30 baby Heisler. He primarily made it out of brass, it is DCC equipped, with sound. Looks like it's ready to earn it's keep another day.



[Click here for
reader comments](#)



16. Chris Thompson's 1:20.3 logging loco is simply magnificent. It's scratchbuilt using Mt. Albert wood, ABS plastic pipe for the boiler, a small plastic funnel for the boiler top, Ozark detail castings, Bachmann trucks and cylinders, LED lighting (with boiler flicker), and Christmas tree branches for the firewood. It's easy to see why this took second place in the Gearing Locomotive class.



17. Ted Alexander kitbashed a 45-ton body to HOn3 by narrowing the walkway and cab. He then mounted it to an Atlas N scale drive.

TrainMasters TV is part of the MRH product family.

*TMTV members not only get great network TV level
videos, they help pay for MRH and keep it free ...*



18. Leslie Davis's first place diorama of the Rattlesnake & Dead End Mining Railroad is set in the Southwest. Lots of things going on, and lots of careful attention to those details.



[Click here for
reader comments](#)



Playback problems? [Click here ...](#)

19. Jim Burchall's 1:24 animated module is of the Experimental Steam Works. Rumor has it that the designer's next project after this failure has to do with submarines and screen doors.



**Click here for
reader comments**

JOHN HUNTZINGER



John is a retired US Air Force logistics officer and got his first train, a Lionel, for his first Christmas. He is currently working on a layout of the Pennsylvania Railroad in the mid 1960s on the DelMarVa peninsula.

He's a member of a local train club and participates in operating sessions at the club and on a friend's railroad. He's also a member of a modular railroad

club where he brings his modules of the Cape Charles, VA car float operation. John has also been on the Railroad Merit Badge staff at three Boy Scout National Jamborees.

He enjoys the Santa Fe, Bessemer & Lake Erie, and Montana Rail Link railroads, having lived near each of those. Being a member of a modular railroad club allows him to run trains from each of them.

His wife of 42 years, Margie, is a great supporter and has the better talent for scenery. His two grandsons call him BaPa Choo-Choo, and the oldest exhibited two cars at this year's Mid-Atlantic Rail Prototype Modelers Meet (MARPM).



The Amherst Railway Society Railroad Hobby Show

Our 2017 Show will be

January 28 & 29, 2017

Save the dates!

**Click
to learn
more ...**



About The Show

Every year late in January or early in February, the Amherst Railway Society holds its Railroad Hobby Show at the Eastern States Exposition Fairgrounds (The home of The Big E) in West Springfield, Massachusetts. More than 25,000 railfans and public attended the Show each of the past three years.

The event features real life railroads and scale model railroads, historical societies, travel agencies, art shows, flea market dealers, importers, manufacturers and photographers. You have to see it to believe it!

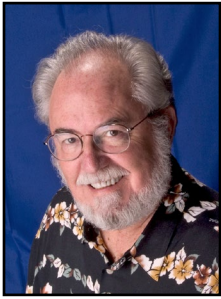

NOVEMBER NEWS

column

RICHARD BALE *and* JEFF SHULTZ

 [Click here for reader comments](#)

Caboose Hobbies to Reopen

Denver's Caboose Hobbies, which lost its lease and was in the process of being liquidated, has been purchased by Kevin Ruble. The new owner of the business, a store that once claimed the title of "the world's largest model railroad shop," immediately announced plans to reestablish the popular hobby outlet in the Denver area. Ruble bought the company from Duane and Joanna Miller, who last month announced plans to retire after efforts to find a suitable new location were unsuccessful. Caboose Hobbies was established in 1951 by Miller's father-in-law, Glenn Brazelton, who purchased Hobby House, a general line hobby shop. After a few years Brazelton changed the store name to Caboose Hobbies and focused exclusively on model train equipment and supplies. At its peak Caboose Hobbies occupied nearly 19 thousand square feet and supported a knowledgeable staff of almost 60 full and part-time employees. Information about a new location and opening date is expected to be announced soon ...

▶ THE LATEST MODEL RAILROAD PRODUCTS, NEWS & EVENTS

NEW CLUB PRODUCTS



The **Soo Line Historical Society** has an HO scale kit for a 40-foot six-panel single-sheathed wood boxcar. The model features

National doors, exterior braced wood ends, a wood running board, and a horizontal brake wheel mounted on a vertical shaft. The model follows a prototype rebuilt in 1950 from a car ACF originally delivered just prior to WWI. The kit includes appropriate trucks and Accumate couplers. Accurail produced the kit for SLHS. For additional details including ordering information go to sooline.org/Models.

.....

MULTIPLE SCALES



Digitrax has introduced a new super throttle that gives direct control of two locomotives. The throttle will work with any LocoNet compatible system. Selected features include dual throttle control, numeric keypad, soft on/off power switch, large multi-line LCD status display, and a built-in flash-

light. The new throttle is available with a standard tether (DT500, above left) or with radio duplex for wireless operation (DT500D, above right). Wireless applications require a

UR90 or UR92, sold separately. The DT500 series throttles are also included in Digitrax's new Evolution Starter sets. The Standard Set includes a DCS210 Advanced Command Station, the DT500 throttle, a UP5 Universal Panel, a PS615 6 amp power supply, LT1 LocoNet tester, and a 24-inch LocoNet cable. The Duplex Radio Set includes the DCS210, a DT500D, a UR92, a PS615, and the LT1 and 24-inch LocoNet cable. For additional information contact a dealer or visit digitrax.com.

.....

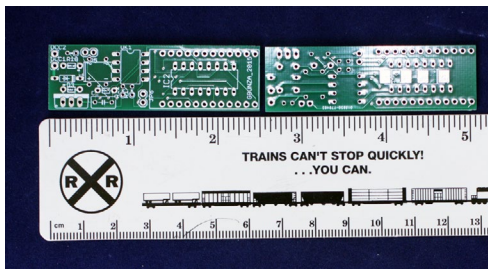

Model Railroad Control Systems (MRCS) is now stocking bare circuit boards for many of the electronic projects Geoff Bunza described in the pages of *Model Railroad*

Hobbyist magazine and in his blog on the MRH website. MRCS offers a convenient alternative to downloading a Bunza file and finding a circuit board fabricator willing to produce a small run of boards. Future projects will be coordinated with MRCS so that circuit boards will be available when a new article is published.

MRCS is also announcing a Servo Switch Motor Controller, based on a Mark Schutzer design. The controller includes all of the electronics needed to control one servo. It features easy choice of button control, slow speed operation, travel control in both directions for precise positioning, travel limits set by onboard potentiometers, and LED outputs (LEDs not included). For additional information visit modelrailroadcontrolsystems.com.

.....

NOVEMBER NEWS | 4

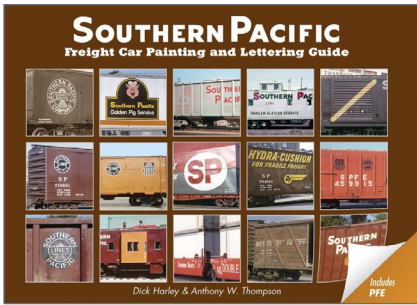

Southern Pacific Historical & Technical Society has released a 192 page book titled *Southern Pacific Freight Car Painting and Lettering Guide*. Authored by Dick Harley and Anthony Thompson, the book includes information on Pacific

Fruit Express, PMT trucking equipment used in TOFC service, and SP affiliates Evergreen and Golden West Services. The 11 by 8.5-inch format includes 291 photos and 122 diagrams. For additional information visit sphts.org.

.....

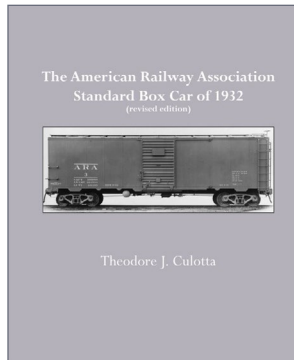
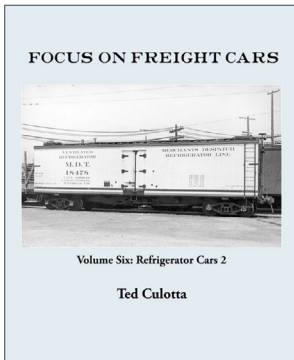

Speedwitch Media has released additional volumes in its Focus on Freight Cars series. Available now are volume 4, *Steel Box Cars*; volume

5, *Steel Automobile Cars*; and volume 6, *Refrigerator Cars Part 2*.

With exquisitely detailed photographs and knowledgeable captions, the Focus on Freight Car books provide modelers and historians a wealth of information about the prototype.

Also available is *The American Railway Association Standard Box Car of 1932 (Revised Edition)*, by Theodore J. Culotta. The 1932 ARA car was the watershed event in the

NOVEMBER NEWS | 5

design of house cars in North America. This revised edition covers all aspects of the ARA design with more than 50 new images and upgraded drawings. For additional information visit speedwitchmedia.com.

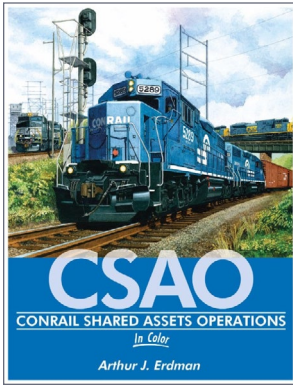

New hardback titles from **Morning Sun Books** include *CSAO-Conrail Shared Assets Operations in Color* by Arthur J. Erdman, *Illinois Central Through Passenger Service in Color* by Greg Stout, and *Steel Mill Railroads in Color* by Stephen Timko. Morning Sun has also announced digital reprints of several out-of-print hardback books. Digital books available now include *Chicago, Burlington & Quincy in Color Volume 4* by Michael Spoor; *New York Central Through Passenger Service in Color* by Geoffrey H. Doughty, *Rio Grande in Color Volume 1* by Ross Grenard, and *Western Maryland Color Guide to Freight and Passenger Equipment* by Jack Brown. For additional information visit

morningsunbooks.com.



Woodland Scenics has added three new shacks to its Built-&-Ready line of structures. Beginning at the left, the structures include a corrugated metal tin shack, a work

shack on a raised foundation, and a wood shack. Each building is hand-painted and weathered. They are available in N, HO and O scale. For additional information contact a dealer or visit woodlandscenics.com.

.....

LARGE SCALE PRODUCT NEWS



Bachmann has upgraded its 1:20.3 scale 2-6-0 steam locomotive with metal gears and a

nonproprietary plug-and-play electronic printed circuit board that will accommodate several options for control systems, including an aftermarket DCC decoder. The model comes with factory-installed optical sensors and a speaker with pigtail wires to ease installation of sound. Decorating schemes include Eureka & Palisade “Reveille”, D&RG “Raton”, Glenbrook, and Grizzly Flats “Emma Nevada.” Matching Jackson-Sharp passenger cars are also available. For more information contact a dealer or visit bachmann-trains.com.

.....

VCLCo is selling a set of plans and an illustrated booklet on building a large scale turntable from scratch. Author Jack L. Winegar uses numerous CAD drawings to illustrate step-by-step instructions for building a 60-foot turntable resulting in a 30-inch model in 1:24 scale. The plan set includes ten 13 x 9.5-inch sheets including a materials list, and painting suggestions. Electrical polarity factors are also reviewed. The twelve-page spiral-bound booklet includes 34 pictures

NOVEMBER NEWS | 7

and six additional turntable drawings. The drawings are based on the turn-of-the-century turntables built by the Lassig Bridge Co. of Chicago. Many Lassig turntables of varying lengths were still in operation in the 1940s. For additional information visit vclco.com.

.....

O SCALE PRODUCT NEWS



3rd Rail Division of Sunset Models is booking reservations for a trio of heavyweight US Army cars. The all-brass O scale

models include a Hospital car (above), a Surgery car, and a Communications car (below).



Features of the handcrafted cars include a fully detailed interior with overhead LED lighting, complete underbody details,

and six-wheel trucks with ball bearings on all axles. Both 2-rail and 3-rail versions will be available. For additional information contact a dealer or visit 3rdrail.com.

.....

Atlas O has included another run of 55-ton twin-bay hopper cars in its second quarter production schedule. In addition to the Kansas, Oklahoma & Gulf scheme shown here, the O scale

NOVEMBER NEWS | 8

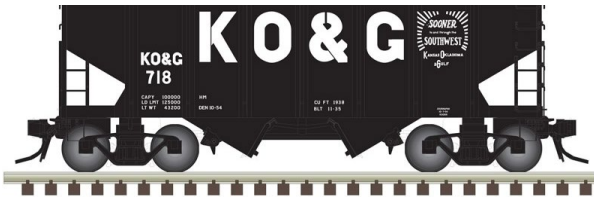

ready-to-run model will be available decorated for Boston & Maine, Canadian National, Virginian, and Westmoreland

Coal Co. The model features a die-cast center sill and chassis, wire grab irons, Andrews trucks, and operating hopper doors.

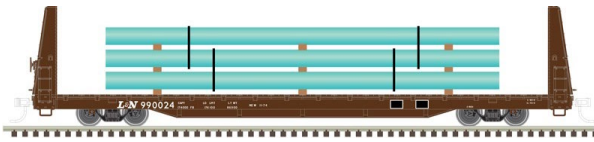

Two versions of a Trainman series flat car are also scheduled for release

during the second quarter. A 62-foot bulkhead car will be available for Burlington Northern, Illinois Central Gulf, TTX, and Louisville & Nashville.

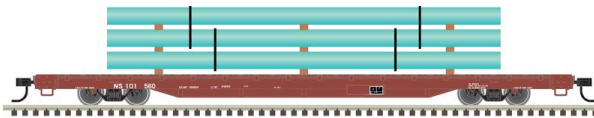

A 68-foot flat car without bulkheads will be decorated for Missouri Pacific

and Norfolk Southern. Both versions feature a pipe load with separately applied load tie-downs. All Atlas O cars are available for 2-rail or 3-rail operation. For addition information contact a dealer or visit atlaso.com.



Red Cliffs Miniatures has released modified versions of its 1/4" scale brass switch stands with the addition of LED lighting. The fully operating SS1 switch stand (left) now includes a lighted lantern, and the non-operating New Century switch stand kit uses the same LED to light a four-reflector

lantern. For additional information and photos see redcliffs-miniatures.com.



San Juan Decals has an O scale kit for a D&RGW standard bunk house. The kit consists of laser-cut basswood panels, basswood strip, 3-D printed windows and doors, and a chimney cast in white metal. Laser-cut wood shingles, instructions, and painting suggestions complete the kit. For additional information visit sanjuandecals.com.

HO SCALE PRODUCT NEWS



During this year's Trainfest, **Accurail** will offer a special three-pack of this HO scale 40-foot PS-1 boxcar decorated for Green

Bay & Western with a Packers slogan. This kit is a replacement for the previously announced 35-foot wood boxcars that have been postponed due to delays in completing new tooling.



New HO scale kits recently introduced by Accurail include this 40-foot NADX-Hormel steel refrigerator car with swing doors.



Also available now is a 3-pack of kits for this PS triple-bay covered hopper car decorated for Burlington Northern.

NOVEMBER NEWS | 10

.....



This 40-foot AAR steel boxcar with a Youngstown sliding door is available decorated for the Nickel Plate Road.



Accurail is selling a kit for 50-foot Penn Central boxcar with riveted steel sides and double sliding Youngstown doors.



This HO scale Bessemer & Lake Erie Pullman Standard 4750 cu. ft. triple-bay covered hopper is available as a kit from Accurail. All Accurail kits include appropriate trucks and Accumate couplers. For additional information

contact a dealer or visit accurail.com.

.....



Athearn has released its production schedule for next August. Heading the list are HO scale Genesis series EMD GP7/GP9 diesels. The ATSF GP7U shown above represents a group of locomotives Santa Fe upgraded in the mid-1970s. In addition to the obvious chopped nose, other modifications include installation of a Topeka cab, upgraded trucks, cab air conditioning, a

NOVEMBER NEWS | 11

four-stack exhaust manifold, and removal of the dynamic brake. Four road numbers will be available with additional details per the prototype.



High-nose versions of the locomotive include an Illinois Terminal GP7, a Burlington Northern (ex CB&Q) in Chinese red paint (above), and three different GP9 body phases decorated for Burlington Northern (ex-Great Northern).

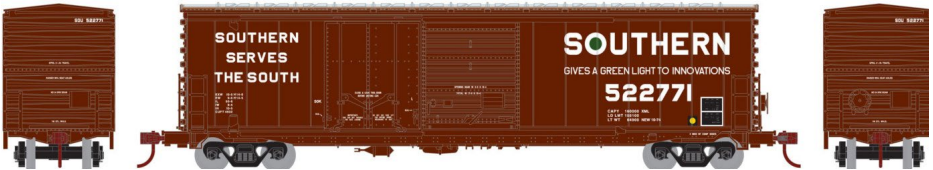

Athearn Ready-to-Roll models coming next August include this 1960s-era 50-foot 6-inch boxcar with a combination of two 8-foot doors. One is a Youngstown sliding door the other is a plug-door. Additional features on this HO scale car include separately applied side and end ladders. Road names will be Southern, Santa Fe, BC Rail, Burlington Northern, Canadian National, Western Maryland, and Rock Island.



A 40-foot Pfaudler milk car will be included in the August release. The fully assembled model will feature factory installed

NOVEMBER NEWS | 12

wire grab irons, metal stirrup steps, separately applied door closure rods, machined metal wheels and high-speed Commonwealth trucks with 7-foot wheelbase. Road names will be Boston & Maine, BFPX-Bordens, PFIX-Borden's, Canadian National, Central Vermont, Dairymen's League, Hoods, New England Cream, and Soo Line.



Athearn's August schedule includes this 2970 cu. ft. Centerflow round-body twin-bay covered hopper. In addition to the Rock car shown here, road names will be ACF Leasing, Burlington Northern, Chicago & North Western, Western Maryland (1984 re-weigh), CSX, and Norfolk Southern. The model will have photo etched metal roof walks, separately applied wire grab irons and stirrup steps, wire-formed brake rigging, machined metal wheels, and either round or trough hatches as appropriate to the prototype road name.



Husky Stack well cars are scheduled for release in August decorated for Arizona & California, Burlington Northern, Burlington Northern Santa Fe, Coe Rail Inc., Trailer-Train, TTX, TTX (red logo), and Northwestern Oklahoma. The 48-foot cars are designed to carry 20- to 48-foot containers on the lower level and up to 53-foot containers on the top.

A group of 45-foot containers will be available in three-packs with each container individually numbered.

NOVEMBER NEWS | 13



Decorating schemes will be Evergreen, K-Line, Maersk, Hapag-Lloyd, Hyundai, and Hanjin.



Forty-five foot rubber-tired container chassis designed to accommodate Athearn's 45-foot containers will be released in 2-packs next August. In addition to the Genstar trailer shown here road names will be CMA-CGM, Flexi-Van, Trac Leasing, Trans Pacific, and Hanjin.



Athearn Roundhouse models coming in August include this 50-foot auto loader. Road names will be Conrail, Burlington Northern, Burlington Northern Santa Fe, Baltimore & Ohio, Canadian National, Grand Trunk Western, Norfolk Southern, Pennsylvania, and Union Pacific.



Athearn's August 2017 production run will conclude with seven Roundhouse heavyweight passenger cars. Car types will be RPO,

NOVEMBER NEWS | 14

.....

baggage, round-roof coach, clerestory coach, diner, Pullman sleeper, and an open-end observation car. Each car type will be available decorated for Erie Lackawanna (above), Santa Fe (gray scheme), Canadian National, Canadian Pacific, Northern Pacific, and Union Pacific (gray).



Southern Pacific equipment will be limited to round roof coaches in three paint schemes: grey, two-tone grey, and green (above). For additional information on all Athearn and Roundhouse products contact a dealer or visit athearn.com.

.....

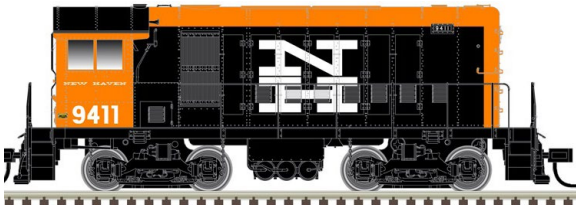

Atlas plans to release a new production run of its Alco HH600/HH660 diesel switcher during the second quarter of 2017. The

prototype 600 hp HH600 and 900 hp HH660 locomotives were externally identical. Features of the HO scale model include early Blunt trucks with separate brake cylinders, metal truck chains, separately-applied metal grab irons, lift rings, uncoupling lever and piping. Atlas will offer the ready-to-run model for DC operation, as well as DCC with a LokSound Select dual-mode decoder. Road names will be Central Railroad of New Jersey, Green Bay & Western, Milwaukee Road, New Haven, Penn Central (with NH patch), and Northern Pacific.

New Atlas Master Line models due in the first quarter of next year include a 40-foot postwar boxcar with seven-foot sliding doors and separately applied ladders and grab irons. Depending

NOVEMBER NEWS | 15



on the practice of the prototype road, the HO scale model will come in different end styles (4/4, early and late Improved Dreadnaught, and

“Dartnot”), two different roofs (straight or diagonal panel) and either Superior or Youngstown sliding doors. Three road numbers will be available for Buffalo Creek, Grand Trunk Western (Maple leaf herald), Jersey Central Lines, Western Maryland, Western Pacific, and Nickel Plate Road.

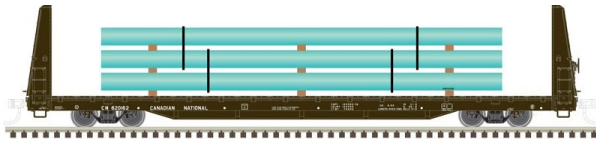

Two versions of a Trainman series flat car are also scheduled for release

during the second quarter. A 62-foot bulkhead car will be available for Burlington Northern, CAI Rail, Canadian National, Louisville & Nashville, TTX.

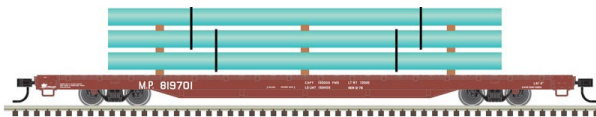

A 68-foot flat car without bulkheads will be decorated for Missouri Pacific and

Norfolk Southern. Both versions of the flat car feature a pipe load with separately applied load tie-downs. For addition information contact a dealer or visit atlasrr.com.

Bowser is completing new tooling for two versions of Trinity TTAX 53-foot spine cars. Both three-unit FAF33 and five-unit TRAF53C car sets are scheduled for release next March. The Executive series HO scale ready-to-run models feature diecast

NOVEMBER NEWS | 16

.....

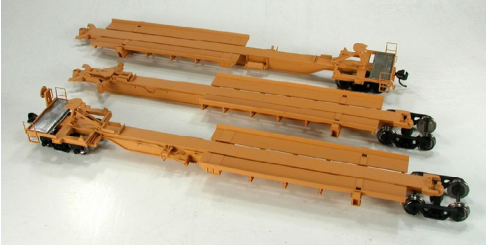

metal and plastic construction, chemically etched walkways, and positionable hitches. The cars come with 70-ton trucks with 33-inch metal wheels.

For additional information

contact a dealer or visit bowser-trains.com.

.....



Con-Cor has announced the availability of its annual HO scale ready-to-run Christmas cars.

The reindeer theme continues with the 2016 car featuring Donner on a Harley. A second car features Grandma. For complete details visit con-cor.com/website/product-category/concor-trains-annual-ho-n-christmas-cars.

.....



ExactRail is selling an HO scale Vert-A-Pac auto transport car. The ready-to-run model is available decorated for Merchants Despatch

Transportation, Baltimore & Ohio, and Rock Island. Future projects underway at ExactRail include several variations on a Southern 5277 cu. ft. waffle boxcar including one with a Hennessy door opener, more 64-foot TRINCool reefers, and a Greenville 7100 cu. ft. auto parts boxcar. For more information visit exactrail.com.

.....

NOVEMBER NEWS | 17

.....



InterMountain Railway is quoting a June release date for a group of 1937 AAR 40-foot boxcars with three types of steel ends. Cars with art deco waffle ends (left) will be available for Chesapeake & Ohio, C&O (Progress slogan),

and Baltimore & Ohio. Models with NSC-2 ends will be decorated for Canadian National and Ontario Northland. Cars decorated for Delaware, Lackawanna & Western; Chicago & Eastern Illinois, New York Central (jade green repaint), Louisiana & North West, Atlantic & East Carolina, and Copper Range will have Dreadnaught ends.



InterMountain has scheduled a late summer 2017 release date for this ACF 2927 cu. ft. triple-bay covered

hopper. In addition to the Denver & Rio Grande Western version shown here, the ready-to-run HO scale model will be available decorated for Santa Fe, Illinois Central, NAHX-Reynolds Metals, Louisville & Nashville (two versions), Rock Island (two versions), Missouri Illinois, and Wabash. For additional information contact a dealer or visit intermountain-railway.com.



ITLA Scale Models is selling a group of unique roof top items suitable for detailing any HO scale industrial structure. The collection of 19 items includes a water tank, rooftop staircase access and door, several air conditioning units, fans,

NOVEMBER NEWS | 18

exhaust vents, chimneys, and ducts. For additional information visit itlascalemodels.com.



Kadee plans to release an HO scale ready-to-run version of this B&O twin-bay covered hopper next month. The PS-2 8653 cu. ft. prototype was

built in 1957. It received the yellow paint job when it was shopped in 1977.

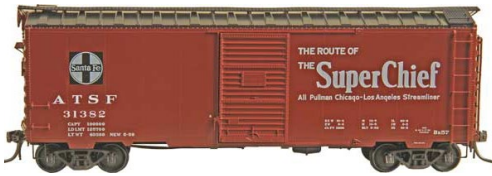

Kadee's January schedule includes an HO scale 40-foot ATSF boxcar with six-foot Youngstown doors. The sides of the PS-1 prototype were fabricated

from ten welded panels. For additional information on all Kadee products contact a dealer or visit kadee.com.



LASERKit, part of American Model Builders, has three new HO scale products available this month. The first is a Stationary Steam Engine Load (left), which includes the parts that would normally make up a 250 hp

steam engine. This model can be built to represent a new engine being delivered or a tired relic ready for scrapping. The load is also appropriate for S and O scale modelers as a smaller steam engine.

NOVEMBER NEWS | 19

.....



as well as peel and stick windows/doors/trim; rafter tails, dock height floor, tarpaper, battens, and roofing materials, and assorted white metal and cast resin detail parts. The assembled model measures 7" x 4.5" and is 4" high over the signboard.



The last model from LASERKit this month is the Northern Pacific 1700 series Wood Cupola Caboose. Originally produced by Pacific Car & Foundry in 1921, the 90 1700 series cabooses were based on the older 1200 series design.

The 1700s were equipped with steel underframes and were the last wood bodied cabooses the NP purchased. The 1200 and 1700 series were rebuilt in the 1940s with a common floor plans as well as other modifications including AB style brake gear. This model represents a postwar 1700 series caboose, with 100% laser-cut components and laser scribed plywood side and end walls. The model features tab & slot and peel & stick construction; laser-cut underframe, end platforms, end railing and brake wheels; cast resin platform steps and brake gear and a white metal smoke jack. The model can be constructed in one of three variations. Trucks, couplers, and decals are not included but specific ones are recommended. Further information can be found at laserkit.com.

.....

NOVEMBER NEWS | 20



Railroad Innovations is developing a Santa Fe boxcar with black roof and ends and authentic red sides based on Santa Fe color chip. Three road numbers will be available with different lettering on the side sill per the individual prototype numbers. Atlas is producing the car for Railroad Innovations. Final availability is pending. For additional information visit rr-innovations.com.

.....



Rapido Trains is producing a limited run

of RDC No. 6133 as a fund raiser to help restore the real No. 6133. The HO scale model will be offered in the two most recent decorating schemes that appeared on the prototype. They include the final scheme while the car was in service for VIA Rail Canada, as well as the future scheme it will wear in service for Rapido (above). Separate decals will be supplied for the VIA logo, wheelchair accessible logo, and the blue and yellow Rapido logo the RDC currently wears. Only 150 pieces will be produced. For additional information visit rapidotrains.com/ho-scale-absolute-rdc-project-exclusive.

.....

Tangent Scale Models has made another release of its HO scale Pullman-Standard PS-2CD 4740 cu. ft. covered hopper car. The ready-to-run model is available in 11 paint schemes including Great Northern, Illinois Central, Chicago Central (former IC

NOVEMBER NEWS | 21



re-stencil), Northern Pacific (pre-BN green scheme), Western Maryland (speed lettering scheme), and TLCX (red, white, and

black scheme with Columbus Ohio Elevator lettering).



Five additional schemes are available for TLDX cars including this Agland version. Details such as side ladders, jacking pads, center

sill supports, crossover platforms, and running boards (Morton or Apex) vary depending on the P-S production era represented by each road name. Additional features include wire grab irons and uncoupling bars, separate air hoses, 36-inch turned metal wheels, and Kadee couplers. Undecorated kits are also available.

Tangent is also releasing new road numbers for their HO scale PRR/PC Shops Class G43 corrugated side 52-foot 6-inch gondola. Four RTR paint schemes with six numbers each - PRR "Original 11-1966 G43," PC "Original 10-1969 G43B," PC "Original 4-1970 G43C," and CR "1988 G43 Coil Svc w/Rack" (coils not included). Additionally, there are six undecorated kit variations available, the PRR G43/PC G43A Early, PC G43B, PC G43C, PRR G43/PC G43A early with coil rack, PC G43B with w/coil rack, and the PC G43C w/coil rack.

To go with the coil rack equipped gondolas above, Tangent is also selling a pack of eight banded steel coils that are fully assembled and painted a sheet steel metal color with black

NOVEMBER NEWS | 22

banding. For more information or to order any of these products visit tangentscalemodels.com.



A 1956 Santa Fe Super Chief is the latest addition to Walthers selection of famous streamlined name trains. The HO scale ready-to-run models

will be available in two deluxe 10-car train sets. With the exception of factory printed car names and numbers, the consist in each deluxe set will be identical. Two cars in each set will be equipped with SoundTraxx Tsunami SoundCar and speaker. Features of the WalthersProto series cars include LED interior lighting, individual grab irons, tinted windows and gaskets, and more than 100 Preiser passengers and crew figures installed throughout the train. Production will be limited to 200 sets. An extended truck drawbar will be supplied for modelers wanting to operate on a minimum radius of 22-inches.

Budd-built prototypes in each 10-car set include a 63-foot RPO, a 73-foot baggage car, and two 10-6 sleepers, one with sound. Completing the 10-car consist are six 85-foot Pullman-Standard cars including a Pine-series 29-seat dormitory-lounge with sound, two Regal-series 4-4-2 sleepers, a 36-seat 600-series diner, a 500-series pleasure dome bar-lounge, and a newly tooled Vista-series blunt-end 4-1 sleeper-lounge-observation car.

Walthers will offer Proto Series F7 locomotives appropriately detailed to represent Santa Fe 300 class A and B units with post-1953 upgrades including Farr etched stainless side grilles,

NOVEMBER NEWS | 23

door-mounted headlight and Mars light, 36-inch dynamic brake fan, two single-chime air horns, and skirted fuel tanks. F7 A-B sets as well as individual A units will be available in both DC and with SoundTraxx Tsunami Sound and DCC decoder. Availability is expected in April 2017. For reservation information visit walthers.com/products/name-trains/1956-super-chief/dlx-super-chief-set-1.



Walthers has announced a late December release date for a 55-foot Trinity 30,145 gallon

tank car. The HO scale Proto series car will be available decorated for GATX.

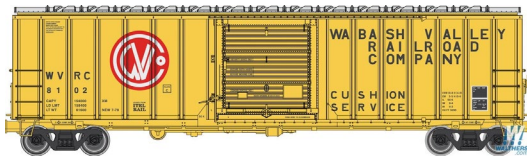

Also expected at the end of next month is a new run of WalthersMainline series 50-foot ACF Plate B exterior-post boxcars.

Road names on the HO scale ready-to-run cars will be Chessie System C&O, CSX, Detroit & Mackinac, Green Bay & Western, Greenville & Northern, Norfolk Southern, and Wabash Valley.



Walthers has three new styles of HO scale containers. Available now are 20-foot corrugated containers decorated for APL, CMA, Gateway, GE Seaco, K-Line, Wan Hai, Xtra, and Yang Ming.



Forty-foot corrugated containers with flat roofs are scheduled for release late this month. Road

NOVEMBER NEWS | 24

names will be APL, Columbus Line, Crowley, Genstar, Kein Hung, MOL, Nedloyd, TransAmerica, and Yang Ming.



A group of HO scale 53-foot Singamas containers are due for release in December.

Road names will be CN, Crowley, CSX, Hub Group, JB Hunt, Marten, Umax, and Universal.



A new production run of WalthersMainline 59-foot quadruple-bay cylindrical hopper cars is scheduled for

release in late January. Road names for the HO scale ready-to-run cars will be Canadian National, Canadian Pacific, Pillsbury, Potash Corp. of Saskatchewan, SKNX-Saskatchewan Grain, and SKPX-Saskatchewan Grain. For additional information on all Walthers products contact a dealer or visit walthers.com.

N SCALE PRODUCT NEWS

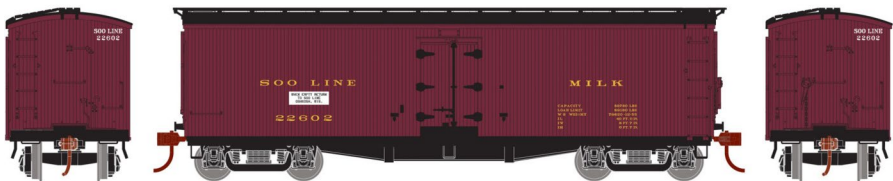

Athearn's August 2017 production schedule includes several N scale models. Leading the list is a 40-foot Pfaudler milk car. The fully assembled model will ride on high-speed Commonwealth trucks with machined metal wheels. Road names will be Boston & Maine, BFPX-Bordens, PFIX-Borden's, Canadian National,

NOVEMBER NEWS | 25

.....

Central Vermont, Dairymen's League, Hoods, New England Cream, and Soo Line.



Also coming to dealers in August is an N scale 2970 cu. ft. Centerflow round-body twin-bay covered hopper. In addition to the Chicago & North Western car shown here, road names will be Rock Island, ACF Leasing, Burlington Northern, Western Maryland (1984 re-weigh), CSX, and Norfolk Southern. Features include a photo etched metal roof walk and either round or trough hatches as appropriate to the prototype road name.



Husky Stack well cars are scheduled for release in August decorated for Arizona & California, Burlington Northern, Burlington Northern Santa Fe, Coe Rail Inc., Trailer-Train, TTX, TTX (red logo), and Northwestern Oklahoma. The 48-foot cars are designed to carry 20- to 48-foot containers on the lower level and up to 53-foot containers on the top. For more information see your dealer or visit athearn.com.

.....



New **Atlas** N scale models set for release during the first quarter of 2017 include this Trainman series beer-can tank car. Decorating schemes will be Eastman Industrial Chemicals, Dow

NOVEMBER NEWS | 26

Chemical, GATX (Service Driven slogan), Cargill, Exxon Chemical, and Southern Star Lard.



During the Second quarter of 2017 Atlas will complete another release of its Trainman series

GP15-1 diesel locomotive. The N scale version is based on a prototype EMD built between 1976 and 1982. The DCC ready model will be available decorated for Conrail, Conrail (Operation Life Saver slogan), CSX (YN3b scheme), California Northern, Puget Sound & Pacific, Ventura County Railroad, Norfolk & Portsmouth Belt Line, Chicago & North Western, and Union Pacific.



This PS 4000 cu. ft. triple-bay covered hopper is scheduled for release by Atlas during the second

quarter of 2017. The N scale ready-to-run model features etched brake platform and roof walks, and BLMA 100-ton trucks with 36-inch metal wheels. Road names will be Minneapolis Northfield & Southern, Baltimore & Ohio, Illinois Central Gulf, Norfolk & Western, Chessie System, and Southern Pacific. For more information on all Atlas products contact a dealer or visit atlas.com.



Con-Cor has announced the availability of its annual N scale ready-to-run Christmas cars. The reindeer theme continues with the 2016 car featuring Donner

NOVEMBER NEWS | 27

riding a Harley. A second car features Grandma. For complete details visit con-cor.com/website/product-category/concor-trains-annual-ho-n-christmas-cars.



ExactRail is selling N scale 33-inch and 36-inch metal wheelsets in 12 packs. Bulk packages of 100 wheelsets are also available.



ExactRail is selling an N scale ready-to-run model of an Evans 5277 cu. ft. boxcar. In addition to the St. Lawrence (NSL)

above, road names included in this release are Atlantic & Western, Delaware & Hudson, EEC, and Meridian and Bigbee. For additional information on all ExactRail products visit exactrail.com.



InterMountain Railway plans to deliver this ACF 2927 cu. ft. triple-bay covered hopper late next

summer. In addition to the Louisville & Nashville version shown here, the N scale ready-to-run model will be available decorated for Santa Fe, Illinois Central, NAHX-Reynolds Metals, (two versions), Rock Island (two versions), Missouri Illinois, Denver & Rio Grande Western, and Wabash. For additional information contact a dealer or visit intermountain-railway.com.

NOVEMBER NEWS | 28



Kato USA is selling a holiday-themed four-piece train set in support of Operation North Pole, a charity organization that supports several children's

hospitals in the Chicago area. Kato will contribute a portion of each sale of this equipment to the charity.



The N scale set includes a Chicago Metra F40PH locomotive, two bi-level coaches, and a bi-level cab-coach. A power pack and oval of Kato Unitrack is available separately.



Kato will release its 4-8-4 steam locomotive No. 4449 next March in two new decorating schemes. In addition to the original SP Daylight livery with Southern Pacific Lines lettering on the tender, the N scale GS-4 locomotive will also be available in black. BNSF repainted No. 4449 black to lead a Burlington Northern Santa Fe employee appreciation special in 2000.



Features of the ready-run model include operating Mars light and headlight, illuminated number boards, and a detailed cab

interior. The DC model is designed to accept Kato's EM13 motor function DCC decoder (not supplied). A Southern Pacific 10-car train set in Daylight colors will also be available in March.

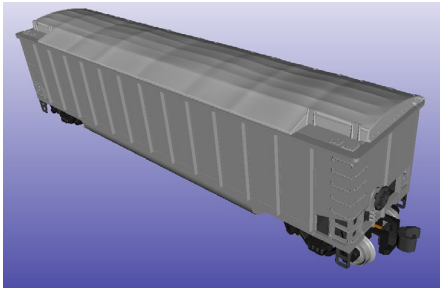

Kato plans to release a group of N scale Bethgon cars repurposed as protein gondolas. The cars differ from traditional Coalporters in that they have a roll-up tarp cover to protect the animal-feed lading. Two Burlington Northern eight-car

sets will be available in March. They will be followed in April with two additional eight-car sets decorated for SBTX. For additional information on all Kato products contact a dealer or visit katousa.com.

.....

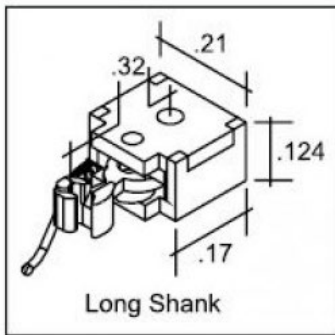

Micro-Trains Line has introduced True-Scale couplers, a new line of N scale couplers that are designed to more realistically represent the distance between cars as well as the size of prototype couplers. Both short and long shank versions are available. The True-Scale couplers are sold in packages of two pairs and 10 pairs. The

draft gear box is the same basic dimension as Micro-Trains #1015 body-mount coupler which should ease conversion to the new True-Scale series. Coupling is automatic. Uncoupling is accomplished using a pin or toothpick. These couplers do not work with the Magne-Matic or other coupler systems, so a conversion car with a True-Scale coupler at one end and a Magne-Matic at the other may be necessary.

NOVEMBER NEWS | 30



twin-bay Airslide covered hopper with enclosed ends.

New rolling stock available from Micro-Trains includes a 50-foot Norfolk Southern GATC

Two 40-foot wood refrigerator cars have just been released by Micro-Trains. The decorating schemes on the N scale

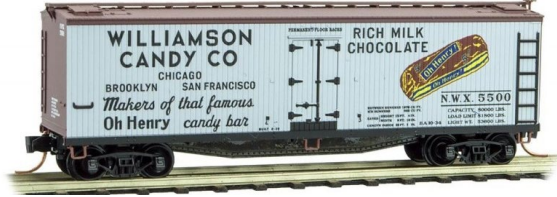

ready-to-run models are Williamson Candy and SFRD Santa Fe.

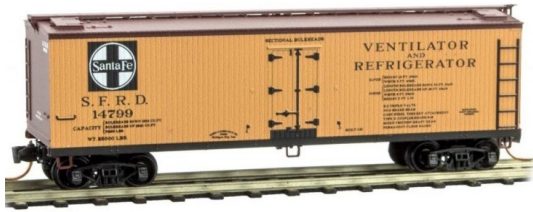

Completing our list of new Micro-Trains cars is this Canadian National 78-foot heavyweight paired-window coach.

For more information on all Micro-Trains Line products contact a dealer or visit micro-trains.com.



Rapido Trains has announced that lack of advance reservations for its NSC baggage-express car has placed several road names in jeopardy of being cancelled. At risk are Baltimore & Ohio, Central of Georgia, Erie, Missouri Pacific, Penn Central, and Southern Pacific. Paint schemes that are safe and will be produced include Amtrak, CB&Q (Shadowline scheme), Milwaukee Road (1950 scheme), Northern Pacific, and all Canadian schemes.

NOVEMBER NEWS | 31

.....



Cars with end loading doors decorated for New York Central and Great Northern are also safe. The N scale ready-to-run models come

with either outside swing hanger, inside swing hanger or 6-wheel cast trucks. Optional end doors can also be specified. The deadline for reservations is February 14 with production scheduled in March. Decorating, packing, transportation and distribution should put the cars in the hands of hobbyists by mid-2017. For additional information on all Rapido products contact a dealer or visit rapidotrains.com.

.....



Walthers plans to release this new steel water tank in December. The N scale kit is molded in black plastic and includes two water columns and an oil column. Also due from Walthers in December is a kit for the Prairie Co-Op Elevator. The structure includes four concrete silos and a cement block office with truck

scales. For additional information on all Walthers products contact a dealer or visit walthers.com.

NEW DECALS, SIGNS AND FINISHING PRODUCTS

After Hours Graphics sells a variety of HO and N scale Chesapeake & Ohio decal sets including 70-ton rib-side class HT hopper cars, and four sets of Pullman car names. For more information visit greatdecals.com.

Black Swamp Shops is selling a selection of decals for the Akron, Canton & Youngstown Railroad that were formerly available through the ACY Historical Society. For more information visit greatdecals.com.

Mask Island Decals has released new HO scale lettering sets for Elgin, Joliet & Eastern 50-foot boxcars with a cushion underframe as built by Pullman-Standard in 1964. The set includes material to correctly decorate two cars. For more information visit maskislanddecals.com.

Model Railroad Works of Dresden, Germany, is selling HO and N scale decals for American prototypes. Recent additions include BN scale monitor cars, BN scale test car, MARC HHP-8 electrics, Metro North P32AC-DM, Safety slogans for BN Pacific Pride unit #2085, and Seattle & North Coast switchers. All sales are processed through PayPal. For more information visit modelrailroadworks.de.

Mount Vernon Shops has HO scale decals for a class G22 Pennsylvania Railroad steel gondola. The set is correct for



craftsman kits produced by Westerfield and Funaro &

Camerlengo. The set includes data for up to four G22, G22a, G22b, or G22c cars. For additional information visit mountvernonshops.com.

.....



SEND US YOUR PRODUCT ANNOUNCEMENTS

If you are a hobby manufacturer with a product announcement, just [click here](#) and submit your announcement to us. Our web site and free magazine reach continues to grow, so get on board this new media train! ■

.....



[Click here for reader comments](#)

DISCLAIMER

The opinions expressed in this column are those of the writer and do not necessarily reflect the opinion of *Model Railroad Hobbyist* or its sponsors. Every effort is made to provide our readers with accurate and responsible news and information, however, neither *Model Railroad Hobbyist* or the writer of this column can be held responsible for any inaccuracies or typographical errors that may inadvertently appear in this column.



BRIEFLY NOTED AT PRESS TIME ...

Bowser is looking for drawings or detailed photos of the roof of Milwaukee Road F units. There were some unique fixtures on the top of these diesels including special cooling coils, muffler/spark arrestors, winterization hatches, and fan covers with side facing vents. Anyone with well-detailed photos they are willing to share is asked to contact Lee English at bowser@bowser.com ...

Eastern Seaboard Models will have two Canadian Pacific yellowbird covered hoppers ready for release before Christmas. Also coming next month are XIH boxcars with ASF A-3 trucks fitted with Fox Valley metal wheelsets. Decorating schemes will include the colorful Mandarin Orange Express ...

Fine Scale Miniatures has set a late February release date for a lineside coal yard called I.M. Dunn Co. The HO scale kit assembles into a complex that covers 11 x 13-inches. We'll have photos of George Sellios' pilot model next month ...

Kato USA is quoting a late January release date for custom painted N scale SD90/43MAC SLRG Iowa Pacific Holdings locomotives. See a dealer for details or go direct to katousa.com ...

Microscale has just released HO scale decals in the stillborn scheme of Southern Pacific Santa Fe. The set includes material to decorate hood diesels and switchers. Although SP and SF executives agreed on a merger and began painting selected locomotives in a scheme

NOVEMBER NEWS | 35

that resembled a package of Kodak film, the Interstate Commerce Commission nixed the marriage ...

Rapido Trains has announced plans to produce an HO scale New Haven EP-5 electric locomotive complete with double cabs and a working pantograph. Delivery is tentatively planned for late next year. For N scale hobbyists. Rapido will make another production run of its NSC 73-foot 6-inch express-baggage cars. Until recently, the smooth-side prototypes were still being used by Amtrak, VIA Rail, Ontario Northland, and Algoma Central. These and a long list of other road names will be available on this latest release. We'll have complete details, including photos, next month ...

The Get the Latest Model Railroading News, Tips, Reviews & Opinions

SCOTTY MASON

S H O W

The Original Model Railroad Podcast

- Monthly Interviews
 - Modeler's Spotlight: Top Modeler's Talk
 - Narrow Gauge Modeling w/Chris Lane
 - Contemporary Modeling w/ Mike Rose
- More Product Announcements & Reviews

 Our feed has changed! To get the latest shows, Please search Scotty Mason and subscribe to the new feed!

www.TheModelRailroadPodcast.com

Scott Mason Jimmy Simmons Mike Rose Joe Duckworth



SELECTED EVENTS

November 2016

(Please note that many events charge a fee. Check individual info website for details.)

CANADA, BRITISH COLUMBIA, VANCOUVER, November 5-6, 34th Vancouver Train Expo, at PNE Forum, 2901 East Hastings Street. Info at vancouvertrainexpo.ca.

CANADA, BRITISH COLUMBIA, VANCOUVER, November 3-6, Railway Modellers Meet, sponsored by NMRA, PNR 7th Division, at Atrium Inn, 2889 East Hastings Street. Info at railwaymodellersmeetofbc.ca.

CANADA, NEW BRUNSWICK, QUISPAMISIS (Saint John), November 5, 32nd Annual Model Train Show at Island View Lions Club, 8 Market Street. Sponsored by Saint John Society of Model Railroaders. Info at sites.google.com/site/sjsmrclub.

CANADA, ONTARIO, HAMILTON, November 5, 2016 Hamilton & District Layout Tour at 22 home and club layouts in N, HO, and O scales (G scale weather permitting). Guide books available at local hobby shops. Info at trainweb.org/homesclub.

CALIFORNIA, OCEANSIDE, November 19, Model Train Swap Meet sponsored by North County Model Railroad Society at Heritage Park, 220 Peyri Drive. Info from Rich Blankinship at rblankinship1@cox.net.

CALIFORNIA, ROSEVILLE, November 12-13, International Railfair, at Placer County Fairgrounds, 800 All American City Boulevard. Info at internationalrailfair.com.

SELECTED EVENTS | 2

CALIFORNIA, SACRAMENTO, November 12-13, Open House at Sacramento Model Railroad Historical Society, 1990 Grand Ave. Both HO and HO_n3 narrow gauge layouts will be operating. Info at smrhs.com.

MASSACHUSETTS and NEW HAMPSHIRE, November 25-27, 2016 Tour de Chooch Model Railroad Open House. Free self-guided model railroad open house tour in southern New Hampshire and northeastern Massachusetts. More information and locations can be found at tourdechooch.org.

MARYLAND, CHESTER, November 27, Queen Anne's Railroad Society Open House at Kent Narrows Outlet Stores, 61 Piney Narrows Road. Info at qarrs.org.

MICHIGAN, EAST LANSING, November 13, Lansing Model Railroad Club Show and Sale at Michigan State University Pavilion. Michigan's largest show, layouts, demonstrations, and 500+ tables. Info at lmrc.org.

MICHIGAN, SALINE, November 27, Southeast Michigan Model Train Show and Sale, sponsored by Rails on Wheels, at Washtenaw Farm Council Grounds, 5055 Ann Arbor-Saline Road. Info from Jeff at wab2ndops@yahoo.com.

NEW JERSEY, BURLINGTON, November 5, Model Train Show, at Burlington Masonic Lodge, 23008 Mt. Holly Road. Info from Carl Szathmary at cszathma@comcast.net.

NEW JERSEY, SCOTCH PLAINS, November 5, Third Annual Garden State RPM, at Union County Vocational School, 1776 Raritan Road. Info at gsrpm.org.

OHIO, DAYTON, November 5-6, Dayton Train Show, sponsored by NMRA Mid-Central Region, Division 3, at Upper Valley Mall, 1475 Upper Valley Pike. Info at daytontrainshow.com.

SELECTED EVENTS | 3

OHIO, VANDALIA, November 12-13, Annual Open House at Crossroads Railroad Club, 304 N. Dixie Drive. Info at crossroad-srr.com.

OREGON, CENTRAL POINT, Nov 26-27, Rogue Valley Railroad Show, at Jackson County Expo, 1 Peninger Road. Request info from Bruce at iwcr@charter.net.

OREGON, PORTLAND, November 12, 19, 26, Mt. Hood Model Engineers 38th Annual Open House, at 5500 SE Belmont. Info at mthoodmodelengineers.org/clubevents.html.

PENNSYLVANIA, ALLENTOWN, November 12-13, First Frost Train Meet Show and Sale, at Allentown Fairgrounds, Agricultural Hall. Info at allentowntrainmeet.com.

PENNSYLVANIA, MONACA, November 20, Beaver County Fall Model Train Show, at Monaca Turners, 1700 Old Brodhead Road. Info at bcmrr.railfan.net.

SOUTH CAROLINA, NORTH CHARLESTON, November 19-20, Charleston Area Model Railroad Club Annual Train Show, at Danny Jones Armory Park, 5000 Lackawanna Boulevard. Info at chamrc.com.

VIRGINIA, YORKTOWN, November 19-20, Chesapeake Bay & Western Fall Open House, at 110F Dare Road. Info at cbw-mrc.com.

WASHINGTON, KENT, November 12, 37th Annual Model Railroad & Railrodiana Swap Meet, sponsored by Boeing Employees Model Railroad Club, at Kent Commons, James & 4th Avenue. Info from Ed Sherry at swapmeet@bemrrc.com.

WISCONSIN, GREENFIELD, November 12-13, Trainfest at Wisconsin State Fair Park. Promoted as America's largest operating railroad show. Info at trainfest.com.

December 2016

COLORADO, LONGMONT, December 9-11, Model Railroad Exposition, sponsored by Boulder Model Railroad Club at County Fairgrounds, Nelson Road at Hover Road. Info at bouldermodel-railroadclub.org.

FLORIDA, THE VILLAGES, December 15-18, Christmas Train Show, at Colony Cottage Recreation Center, 510 Colony Boulevard, hosted by The Villages Railroad Historical Society.

INDIANA, JASPER, December 3, Model Train Show, at Dubois County Museum, 2704 Newton Street. Info at duboiscountymuseum.org.

MASSACHUSETTS, ROSINDALE, December 3-4, Holiday Open House, sponsored by Bay State Model Railroad Museum, 760 South Street. Info at bsmrm.org.

NEW JERSEY, OCEAN CITY, December 3-4, Train Show at Ocean City Sports & Civic Center, 6th and Boardwalk. Info at oceancityvacation.com/details/2036-train-show.html.

OHIO, LIMA, December 17, Train Town Train Show & Swap Meet, at Allen County Fairgrounds, Merchants Building, State Route 309 East. Info from Chuck White at railcarman@frontier.com.

OHIO, SANDUSKY, December 3, Open House at Erie & Mad River Model Railroad, 1309 North Depot Street. Request info from Robert Butler at robertbutler@bex.net.

OKLAHOMA, OKLAHOMA CITY, December 1-4, 21st Southern Plains N-Scale Convention, at Oklahoma State Fairgrounds. Convention hotel is Wingate Oklahoma City Airport, 2001 South Meridian Avenue. Info at oknrail.org/convention.

SELECTED EVENTS | 5

OHIO, SPRINGFIELD, December 4, Model Train Show, at Clark County Fairgrounds, 4401 S. Charleston Pike. Info at daytontrainshow.com.

OREGON, RICKREAL, December 3, Train Show & Swap Meet, at Polk County Fairgrounds sponsored by Willamette Valley Model Railroad Museum. Info at wvmrm.webs.com.

Future 2017 and beyond, by location

AUSTRALIA, CANBERRA, KALEEN, ACT, March 25-26, 29th Annual Model Railway Expo, hosted by the Canberra Model Railway Club, at University of Canberra High School. Info at cmrci.info.

AUSTRALIA, VICTORIA, GEELONG, April 14-16, 2017, 13th Annual Australian Narrow Gauge Convention. Info at austnarrowgaugeconvention.com.

CALIFORNIA, RIVERSIDE-SAN BERNARDINO AREA, February 25, 2017, Self Guided Layout Tour and Swap Meet. Request info from coordinator Bob Chaparro at chiefbobbb@verizon.net.

CALIFORNIA, SANTA CLARA, January 27-29, Bay Area Layout Design & Operations Weekend, sponsored by NMRA Pacific Coast Region Layout Design and Operations Special Interest Groups. Info pcrnmra.org/pcr/calendar/calendar.shtml.

COLORADO, DENVER, August 30-September 2, 2017, National Narrow Gauge Convention, at Marriott Denver Tech Center Hotel. Info at 37nngc.com.

FLORIDA, ORLANDO, July 30-Aug 5, 2017, NMRA National Convention. Info at nmra2017.org.

SELECTED EVENTS | 6

MARYLAND, TIMONIUM, February 4-5, The Great Scale Model Train & Railroad Collectors Shows at Maryland State Fair, 2200 York Road. Info at gsmts.com.

MASSACHUSETTS, WEST SPRINGFIELD, January 28-29, Railroad Hobby Show, sponsored by Amherst Railway Society, at Eastern States Exposition Fairgrounds. Info at railroadhobby-show.com.

MISSOURI, KANSAS CITY, August 5-12, 2018, NMRA National Convention. Info at kc2018.org.

MISSOURI, ST. LOUIS, April 6-8, 32nd Annual Sn3 Symposium, at St. Louis Airport Marriott, 10700 Pear Tree Lane. Info 2017sn3symposium.com.

OHIO, LIMA, December 17, Train Town Show & Swap Meet, at Allen County Fairgrounds. Info from Chuck White at railcarman@frontier.com.

OKLAHOMA, TULSA, June 21-25, Annual Convention of the Santa Fe Railway Historical & Modeling Society. Info from Marc Montray at m.montray@sbcglobal.net or visit atsfr.com/conventions/index.htm.

SOUTH CAROLINA, EASLEY, February 10-11, 2017, Annual Train Show, sponsored by Central Railway Model & Historical Association at (new location) Impact Center, Rock Springs Church 207 Rock Springs Road. Info at crmha.org.

TEXAS, STAFFORD, February 18, Greater Houston Train Show, at Stafford Center, 10505 Cash Road, sponsored by San Jacinto Model Railroad Club. Info at sanjacmodeltrains.org/GHTS/GHTS.html.

UTAH, SALT LAKE CITY, July 7-13, 2019, NMRA National Convention. Info at northernutahnmra.org/2019-nmra-national-convention.

SELECTED EVENTS | 7

WASHINGTON, MONROE, February 25-26, 2017, 26th Annual Washington State Train Show and Marketplace, at Evergreen State Fairgrounds. Event sponsored by United Northwest Model Railroad Club. Info at unwclub.org.

WISCONSIN, STEVENS POINT, January 21-22, 20th Annual Arctic Run Model Railroad Show, Holiday Inn Convention Center Hotel, 1001 Amber Avenue. Info at thecitypages.com/events/20th-annual-arctic-run-model-railroad-show--sale. ■



**Click here for
reader comments**

ADVERTISEMENT



TrainMasters TV Winter Promotion

What's coming
soon to TMTV?

Watch the video and see!



\$55 - 1 yr (~17 cents a video)

~~MONTHLY \$83.88~~

MRH Subscriber? Save another 10%
using the [coupon code here](#). WOW!

Get this deal now ➔

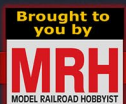
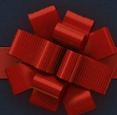

• INDEX

• TABLE OF CONTENTS

Norfolk and Western Historical Society

**Brand New
Video!**

**Feature
length DVD
or Blu-Ray.
The official
story of
611's 2015
restoration**

to operating condition.

**How can I add this great disc
to my collection?**



Click Here!

Clickable advertiser index – 1

[Accu-Lites](#)

[American Ltd \(San Juan\)](#)

[Amherst Railway Society](#)

[ANE Models](#)

[AQ Hobbies](#)

[Archer Fine Transfers](#)

[Athearn](#)

[Atlas Model Railroad Co.](#)

[Bachmann](#)

[Backdrop Junction](#)

[Banta Modelworks](#)

[Berrett Hill Trains](#)

[Black Cat Publishing](#)

[Blair Line](#)

[Bowser](#)

[Canyon Creek Scenics](#)

[Clever Models](#)

[Coastmans Scenic Products](#)

[Coffman Graphics](#)

[Con-Cor International](#)

[Credit Valley Railway](#)

[Crow River Products](#)

[Digitrax \(2 page spread\)](#)

[East Penn Traction Club](#)

[ESU LokSound](#)

[Fast Tracks](#)

[Fox Valley Models](#)

[GLX Scale Models](#)

[Great Decals](#)

[HO Diesel Supply](#)

[Iowa Scaled Engineering](#)

[ITLA Scale Models](#)

[Iwata-Medea](#)

[Jim's Track Plans](#)

[KC's Workshop](#)

[Lights 4 Models](#)

[Litchfield Station](#)

[Logic Rail Technologies](#)

[Main Street Heritage Models](#)

[Missouri Locomotive Company](#)

[Model Railroad Benchwork \(1\)](#)

[Model Railroad Benchwork \(2\)](#)

[Montreal Vermont & Essex](#)

[Monster Modelworks](#)

[Motrak Models](#)

[Mountain Subdivision Hobbies](#)

[Model Railroad Hobbyist magazine](#)

[MRH Store \(1\)](#)

[MRH Store \(2\)](#)

[MRH Store \(3\)](#)

[Mt. Albert Scale Lumber](#)

[NCE \(2 page spread\)](#)

[Nick & Nora Design](#)

[Norfolk & Western Hist. Society](#)

[North American Railcar Co.](#)

[Oak Hill MRR Track Supply](#)

[Pre-Size Model Specialities](#)

[Precision Design Co.](#)

[Rapido \(1\)](#)

[Rapido \(2\)](#)

[RailMaster Hobbies](#)

[Ring Engineering \(1\)](#)

[Ring Engineering \(2\)](#)

[Rulers-of-the-World](#)

Clickable advertiser index – 2

[Rusty Stumps](#)

[Scale Trains](#)

[Scotty Mason Show](#)

[Select Model Railroads](#)

[Streamlined Backshop Services](#)

[Soundtraxx \(Blackstone\)](#)

[Southern Digital](#)

[TAM Industries](#)

[TAM Valley Depot](#)

[Tony's Train Exchange](#)

[Train Control Systems](#)

[Trainfest 2016](#)

[TrainMasters TV \(1\)](#)

[TrainMasters TV \(2\)](#)

[TrainMasters TV \(3\)](#)

[Traintek](#)

[TSG Multimedia](#)

[Westerfield Models](#)

[Yankee Dabbler](#)

[Yarmouth Model Works](#)

Clickable “other” index

[Other – Cover](#)

[Other – Derailments](#)

[Other – Hobby Marketplace](#)

[Other – MRH Sponsors](#)

[Other – Contents](#)

DOWNLOAD ISSUE



DOWNLOAD PORTRAIT



DOWNLOAD LANDSCAPE

• INDEX

• TABLE OF CONTENTS



Model Railroad Hobbyist | November 2016 | #81

REVERSE RUNNING

commentary

JOE FUGATE
.....



[Click here for
reader comments](#)

LEARNING TOO MUCH ABOUT MODERN RAILROADING

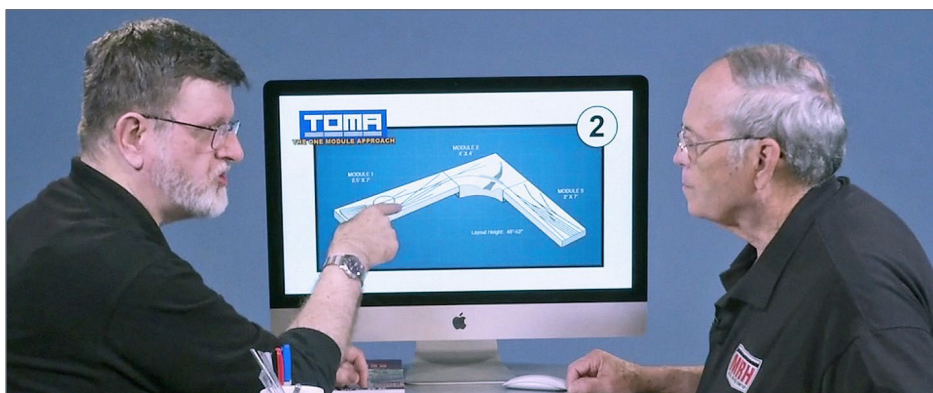

WHEN WE ELECTED TO DO A PROJECT LAYOUT using TOMA (The “One Module” Approach) for the 2017 season of TrainMasters TV, we went looking for a prototype to model. We decided to do something different for us: model a modern prototype, just to see what it might be like. That was our first mistake. After looking around a bit, we settled on modeling today’s Vermont Railway, a regional railroad. That was our second mistake!

▶ **STEPPING OUTSIDE THE BOX WITH A CONTRARY VIEW**

• [INDEX](#)

• [TABLE OF CONTENTS](#)
.....

As the publisher of MRH, I've had to pay attention to modern railroading and cover it in MRH, as well as in our MRH Store videos and books. That includes reading, editing, and checking out (via research) a lot of material about something we're going to publish.

So I'm hardly uninformed about modern railroading. But I've never been all that interested in modeling it myself.

As part of the TOMA project team, I had to step up and learn more about modern since I'm some of the staff helping out on this project.

I went into this thinking of it more like a job than something I was passionate about. There is a thread on the MRH forum called "Is modeling modern mundane?" at mrhmag.com/node/27967 and prior to my involvement on our TOMA project, I would have privately agreed, yes, modeling modern is pretty mundane.

But as part of this project, I'm not only helping plan the layout (see the lead photo where I'm talking design with the TOMA series host, Miles Hale), I also need to do some modeling for the project layout.

Now that I've started modeling a modern prototype, frankly, I'm having a ball. But I didn't go into this project all that willingly: I did it because I felt I *had* to.

Prior to this project, if I put on my modeling hat rather than my publishers' hat, I felt modeling modern was kind of dull and not for me. But once I actually started *modeling* modern, it has turned out to be a lot more fun than I ever expected!

Therein lies the danger: if you're modeling last-century railroading right now, beware! Do not underestimate how much fun it might be if you get hoodwinked into learning more about modern railroading.

And if you're not into modeling modern, steer way clear of modeling any modern railroading! Learn too much about modern railroading and you could find it's a total blast. Be careful, your historical layout modeling last century might be the next thing to go. ☑



DERAILMENTS

Being a model railroader ...



What my friends think I do.



What my mom thinks I do.



What society thinks I do.



What my boss thinks I do.



What I think I do.



What I actually do.

Being a model railroader sometimes means everyone else in your life doesn't quite get what the hobby is all about. We could not resist this somewhat humorous infographic someone posted recently on the MRH forum. While it's meant to be a bit tongue-in-cheek, there's also a lot of truth in it!

► BIZARRE FACTS AND HUMOR (SUPPOSEDLY)

ELECTION CAMPAIGN TRAIN DIRTY TRICKS

The story is told of a prankster in years past who was not a big fan of Richard Nixon and who used to follow him around during his political campaigns to pull disruptive practical jokes.

One day, Nixon was in the middle of a whistle-stop speech on his campaign train when it suddenly pulled out of the station. Apparently, the prankster had donned a rail worker's cap and signalled the engineer it was time to leave town ... ■

GET PAID ...

If you're the first to submit a bit of good humor or bizarre facts and we use it, it's worth \$25! Just send to derailments@mrhmag.com ■

Coming next issue ...

- Geoff Bunza presents a tutorial on Arduino circuits for model railroaders with many real examples
- Building a coal tippie
- Spicing up model photos
- Modeling gravel loads
- Ultra-tiny lights with fiber optics
- And lots, *lots* more!

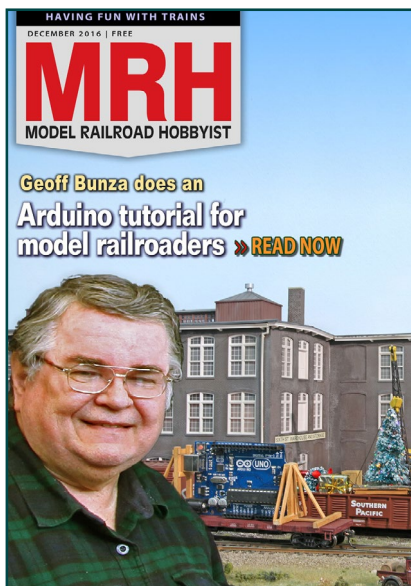

 [Click here for reader comments](#)