

HAVING FUN WITH TRAINS

FEBRUARY 2017 | FREE

MRRH

MODEL RAILROAD HOBBYIST

ALSO:

- Case for rolling stock standards
 - Turnout scratchbuilding journey
 - Model working ditch lights
 - Build N scale layout modules
 - Step-by-step sound decoder install
- ... and lots more inside!*

Bill Gill models

Realistic weeds along the right-of-way

» **READ NOW**



STANDARD EDITION | PORTRAIT



DOWNLOAD

GET ON BOARD!

Atlas HO Modern Commuter Trains are
Now Available!



Multi-Level Trailer



Multi-Level Cab Car



Multi-Level Trailer with Safety Slogan



Multi-Level Trailer with Toilet



CLICK HERE!

*Products bearing NJ TRANSIT marks are made under trademark license from NJ TRANSIT.



ATLAS MODEL RAILROAD CO., INC. • 378 Florence Ave., Hillside, NJ 07205 • www.atlasrr.com • www.atlaso.com

• INDEX

• TABLE OF CONTENTS



STAFF CREDITS

Front cover: We've all seen those flowering weeds along the railroad and roadway right-of-way. This month, Bill Gill shows how to model those weeds realistically from G to N scale.



ISSN 2152-7423

Editorial Staff

Joe D. Fugate, Publisher and Editor

Don Hanley, Assistant Editor

Production

Patty Fugate, Pasteup and Layout

Joe Brugger, Copy Editing

Mike Dodd, Copy Editing

Technical Assistant

Jeff Shultz

Advertising

Les Halmos, Account Manager

Daniel Nava, Advertising Assistant

Jean-François Delisle, Marketing Assistant

Columnists

Richard Bale, News and events

Jeff Shultz, News and events

Les Halmos, Modular railroading

Larry Smith, Narrow Gauge/Shortlines

Bruce Petrarca, DCC

Ken Patterson, Reporter at large

Special Correspondents

Joe Brugger, Questions & answers

Issue password: Feb2017

Published for the glory of God. [What's this?](#)





MRH SPONSORS

A - E



acculites.com



americanlimitedmodels.com

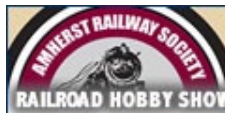

railroadhobbyshow.com



anemodel.com



archertransfers.com



athearn.com



www.atlasrr.com



bachmanntrains.com



bachrus.com



backdropjunction.com

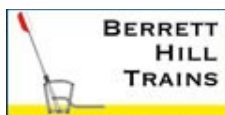

berretthill.com/trains



blairline.com



bowser-trains.com



con-cor.com/website



coffmaneng.com



cvrco.com



www.digitrax.com



esu.eu/en

[Vendors: Get your clickable logo here ...](#)

MRH SPONSORS | 2

F - R



www.handlaidtrack.com



foxvalleymodels.com



glxscalemodels.com



www.iascaled.com



lights4models.com



litchfieldstation.com



model-trains-video.com



modelrectifier.com



monstermodelworks.com



stores.ebay.com/Motrak-Models



mtalbert.com



ncedcc.com



nickandnoradesigns.com



nwhs.org



www.pwrs.ca/main.php



rapidotrains.com



ringengineering.com



rustystumps.com

[Vendors: Get your clickable logo here ...](#)

• [INDEX](#)



[SUBSCRIBE](#)
(free)

• [TABLE OF CONTENTS](#)

MRH SPONSORS | 3

S - Z



sanjuancarco.com



scaletrains.com



selectmodelrailroads.com



signaturepress.com



soundtraxx.com



sodigi.com



sbs4dcc.com

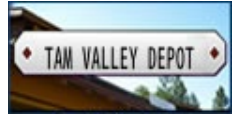

tamvalleydepot.com



tcsdcc.com



tonystrains.com



trainmastermodels.com



traintekllc.com



tsgmultimedia.com



tsgmultimedia.com



yankeedabblers.com

[Vendors: Get your clickable logo here ...](#)

Looking for something? Check the MRH Marketplace!

MRH MARKETPLACE | 2

Model Railroad Hobbyist | February 2017 #84

MRH MARKETPLACE

Yarmouth Model Works

LEARN to Make Trees FREE VIDEOS

GOODALL DCC

Benchwork

NEW 18 VOLTION DUAL GAGE LED VIBROTRUCK SETS

CINOW FEVER PRODUCTS

AMERICAN'S HISTORIC MAIN STREET ARCHITECTURE

VIBON - open top Hoppers

BRICKS TO BUILD WITH

WAINSTREET

Take me there!



Photo Credit: Craig Walker

GO WITH THE CENTERFLOW

THE ULTIMATE ACF 4600 3-BAY CENTERFLOW HOPPER IS NOW IN ATHEARN GENESIS

ANNOUNCING

The 3-bay CenterFlow covered hopper first entered service in the mid-1960s built by American Car and Foundry. The cars handle loads such as grain, corn and similar bulk commodities. The Centerflow relies on the car's rounded body to provide structural strength without the added weight of bracing, as well as making gravity unloading easier. This 3-bay car came in a 4,600-cubic foot capacity. The railroads looking to replace their aging 40' box cars in grain service needed a modern

hopper design. One that could operate within the tighter Plate B clearances for light branchline and industrial service. ACF's design won them many contracts from a plethora of railroads. One can find these cars still in revenue service today in grain trains and other similar service.

Athearn is excited to announce the brand new ACF 4600 cubic foot 3-Bay CenterFlow hopper exquisitely detailed in Genesis HO and in N-scale.

ON DISPLAY AT THE AMHERST TRAIN SHOW!

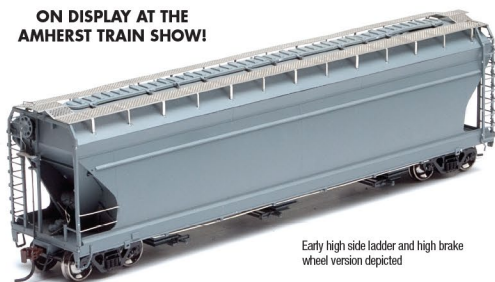

Early high side ladder and high brake wheel version depicted

- Early (High side ladder and brake wheel), Mid (low brake wheel), and Late/Post 1971 body variants
- Round or trough hatches
- Photo-etched metal roof walk
- Separately applied wire grab irons and stimpup steps
- Separate brake cylinder, valve and air reservoir with wire brake plumbing
- Detailed outlets
- Multiple road numbers
- Fully-assembled and ready-to-run out of the box
- Accurately painted and printed
- Highly detailed, injection molded body
- Separately applied brake wheel
- Genesis 100-ton trucks with 36" machined metal wheels and animated spinning roller bearing caps
- Screw mounted trucks
- Body mounted McHenry operating scale knuckle couplers
- Weighted for trouble free operation

VISIT ATHEARN.COM FOR PRICING AND COMPLETE SELECTION OF ROADNAMES!

HORIZON
H O B B Y

VISIT
Your Local Retailer

CLICK
Athearn.com

CALL
1.800.338.4639

SERIOUS FUN[®]

©2007 Horizon Hobby, LLC. Athearn, Genesis and McHenry are registered trademarks of Horizon Hobby, LLC. All other trademarks, service marks and logos are property of their respective owners. Final models may vary slightly from photos shown. 54462

• INDEX



SUBSCRIBE
(free)

• TABLE OF CONTENTS



TABLE OF CONTENTS

FEATURES

Weeds along the right-of-way

BILL GILL

Modeling more realistic weeds from G to N



Lighting up the ditches

MATTHEW NITKA

Model working ditch lights on your locomotives



My turnout scratchbuilding journey

TIMOTHY BARNUM

It all started with an MRH video on making turnouts

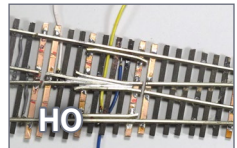

Designing & building Emey Falls

ROBERT KLARÉN

The process of creating an N scale module



Track marking gauge

BILL BRILLINGER

Making it easier to draw track centerlines for yards



ALSO: MRH Marketplace | Subscriber extras

TABLE OF CONTENTS | 2

COLUMNS

MRH Q-A-T: Team tracks, bells, and more

compiled by JOE BRUGGER

DCC Impulses: DCC decoder install example

BRUCE PETRARCA

Getting Real: Standards for model freight cars

TONY THOMPSON

What's Neat: Digitrax DCS-240, and more

KEN PATTERSON

Photo feature: Yes, it's a model

compiled by DON HANLEY

Derailments: Bizarre facts & humor

compiled by the MRH STAFF

NEWS and EDITORIAL

Asst Editors Thoughts: Remember relationships

DON HANLEY

News & Events: February 2017

RICHARD BALE & JEFF SHULTZ

Reverse Running: Eyes bigger than your stomach?

JOE FUGATE



ADVERTISEMENT

First HO Tier 4 GEVo Models

(Actual Model Shown)



Arriving **SUMMER 2017**

See All 7 Railroads and Preorder Now



Also available in...



© 2017 ScaleTrains.com, Inc. ScaleTrains.com, Operator, Rivet Counter, and respective logos are trademarks of ScaleTrains.com, Inc. ScaleTrains.com, Inc. 7598 Highway 411 Benton, TN 37307 844-9TRAINS 844-987-2467 International 423-299-3689

WWW.SCALETRAINS.COM

HO
1:87 SCALE

Scene and photography
by Ken J Johnson
Preproduction model shown

• INDEX

• TABLE OF CONTENTS



ASSISTANT EDITOR

editorial

DON HANLEY
.....



[Click here to rate or
comment on this article](#)

BUILD RELATIONSHIPS AS WELL AS MODELS

THE HOLIDAY SEASON IS OVER AND BY THE TIME you read this you are most likely back into the swing of your normal routine. Among the many holiday television commercials I saw, several included a model railroad. My favorite was the Lincoln commercial with a father and daughter operating a layout, with the train exiting a tunnel. The scene then transformed into the daughter being the engineer of the train while her father drove alongside the train in his new Lincoln.

I found the serious model detail fascinating, including the locomotive the girl was running. It was not your typical “make fun of the hobby” commercial. The hobby was presented as an engaging family hobby. What does this tell us?

I believe there is a shift taking place in our society. I am noticing more commercials that show healthy interaction and relationships between family members as well as placing value on the position of being a father. As a society, we seem to have realized the pendulum may have swung too far and it appears it’s beginning to return to the good fundamental values in our society’s heritage.



ASSISTANT EDITOR | 2

Society seems to be longing for a simpler life and a hobby is a good way to slow down. As many of us model railroaders know, you don't build a layout in a day. In fact, if we were to actually log the hours we spend working on our layout, I think we might all be surprised. An engaging hobby is a good way to slow down.

Here are a few of the things I am noticing:

- Society is remembering the importance of the family unit and the relationships within the family. Fathers are being shown less often as the fool of the family.
- The maker movement is gaining in popularity: Individuals want to get together and display things they have made.
- We're seeing more family-oriented entertainment.

ADVERTISEMENT



Announces their purchase of
BEST's
Laser-cut Structure Kits

CHECK
IT OUT!



To order or get more information, please email Jeff at:
motrakmodels@centurylink.net

Presenting the **WALTHERSPROTO****SANTA FE 1954 EL CAPITAN***An all-new version of a legendary name train*CLICK
HERE TO
LEARN MORE

Santa Fe's *El Capitan* was the first choice for travelers between Chicago and Los Angeles, reaching new levels of luxury as a conventional streamliner in 1954 when the first "Big Domes" arrived. Capturing the spirit of the 1954 *El Capitan*, our newest HO name train includes four new cars – six authentic models in all – that later served on other Santa Fe streamliners. New 300-Class F7s in full Warbonnet® colors will also be available for an authentic model from start to finish.

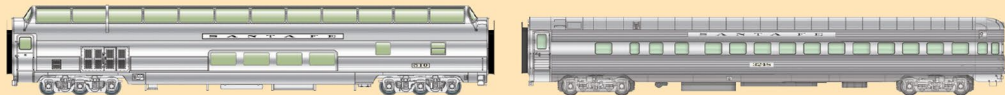
Santa Fe 300-Class F7 Diesels**Santa Fe 1954 *El Capitan* Passenger Cars****First car arrives in January 2017 - reserve now!****WALTHERS**Support your local hobby shop • visit walthers.com • call 1-800-4-TRAINS
Prices and delivery dates shown were accurate at press time, for updates please visit walthers.com. Photos show preproduction models for illustration purposes only, some colors and details may vary. The Santa Fe marks are licensed marks owned by BNSF Railway Company. ©2016 Wm. K. Walther, Inc.

• INDEX

SUBSCRIBE
(free)

• TABLE OF CONTENTS

Checked us out lately?

- ☑ HO/N and now O scale products too!
- ☑ Laser-cut Structures & Bridges.
- ☑ Advertising & Storefront Signs.
- ☑ Highway Signs, vintage & modern.
- ☑ New Detail Items.
- ☑ Laser-cut Grade Crossings.
- ☑ Billboards, roadside & rooftop.
- ☑ Laser-cut Graffiti Decals
- ☑ 1000's of satisfied customers.

WHAT'S
NEW?



Established 1993...

Blair Line

Select MODEL RAILROADS

**Design & Build Services
For Discriminating Modelers**



WE WILL:

**Complete Unfinished Railroads
Fix or Rebuild Bad Railroads**

OR

**Design & Build A Custom
Railroad Of Your Dreams**

CLICK HERE FOR OUR WEBSITE
www.SelectModelRailroads.com

(844) 872-4670

ASSISTANT EDITOR | 3

- More Christian-themed movies are appearing: *Miracles from Heaven*, the new *Ben Hur*, *Risen*, *Noah's Ark*, and others in which a key story focus is lasting relationships.

So what does this shift mean and how will it play out, I really don't know but I believe that it's an opportunity to grow the hobby. Relationships are the most important component of our lives. For me, they are in the following order:

- God
- Spouse
- Family
- Friends
- Coworkers

With the hobby, we have an opportunity to build relationships along with the models. I find that during our op sessions I enjoy

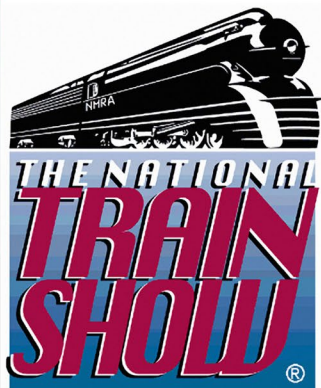

2017 National Train Show

August 4 - August 6, 2017

in **ORLANDO, FLORIDA**

Get the details >>

(click me)

Fun for the Whole Family

From your littlest engineer ...

To the most experienced Model Railroader



- The World's Best Known Manufacturers
- Over 180,000 square feet of exhibit space
- Hands-On Demonstrations
- 44,000 Sq. Feet of Modular Layouts
- Ask The Collectibles Appraiser
- The Incredible Lego® MiniLand

• INDEX



SUBSCRIBE
(free)

• TABLE OF CONTENTS

the comradery of the sessions as we work to move the trains over the layout every bit as much as the operation itself. Afterwards, we have a meal together and then discuss the session (as well as other topics). This retrospective remains a highlight for me.

The hobby also gives us the opportunity to work with our children and grandchildren. M.C. Fujiwara had a great article in the May 2012 issue of *MRH* – “Kids in model railroading”. He gives great tips for finding what they like best, keeping it interesting for the kids, and safety tips.

A while back, I took time to build a simple boxcar kit with my six-year-old grandson, keeping the work and time spent within his interest level. Yes, they *can* do the work. No, not to the skill level that we can, but that’s not the point. The point is to take the time and build the relationship first. The model is just the activity.

A key to making the hobby grow is to make it attractive to others. Since people prefer to spend time with their friends, take the time to build relationships and share the hobby with those who are our friends. Building relationships can be a complex, messy, dynamic, and time-intensive venture. Maybe that is why some of us prefer our models. They don’t talk back!

But think about it, there are very few who on their deathbed will wish they had spent more time alone with a hobby. With few exceptions they will wish they had spent more time with family and friends. In other words: spent more time building lasting relationships.

So let’s build relationships as well as models.



[Click here to rate or comment on this article](#)



Click to
learn more

SOUTHERN #2910 (double headlight)
Item No. 66602

CATCH BACHMANN'S NEW EMD E7-A IN DCC SOUND-EQUIPPED and DCC-READY VERSIONS

Designed for high-speed passenger service, the first "E" series diesel was introduced by GM in 1937 and became one of the most popular passenger engines ever made. Bachmann is proud to introduce a DCC sound-equipped EMD E7-A that includes our Sound Value *SoundTraxx*® diesel sound package with prototypical prime mover, 3 air horns, and bell—all in polyphonic 16-bit sound. There is also a DCC-ready model with an 8-pin socket for the DCC decoder installation of your choice. Both versions feature a precision motor with dual flywheels, die-cast frame, all-wheel drive, operating directional LED headlight per prototype, illuminated number boards, RP25 wheel contours, and *E-Z Mate*® Mark II couplers. Visit your favorite hobby dealer to catch one of these E7-A models for your high-speed passenger service.

DCC SOUND VALUE-EQUIPPED E7-A • MSRP \$299 each • SHIPPING NOW!



PRR - 5 STRIPE #5881
(single headlight)
Item No. 66601



CB&Q #99168
(double headlight with Mars light)
Item No. 66603

Click to
learn more



NYC #4028
(single headlight)
Item No. 66604



B&O #74
(single headlight)
Item No. 66605

DCC
ON BOARD

DCC-READY E7-A • MSRP \$199 each • SHIPPING NOW!

Item No. 66701 • PRR - SINGLE STRIPE #5876 (single headlight)

Item No. 66702 • UNION PACIFIC® #989 (double headlight)

Item No. 66703 • L&N #458 (double headlight)

Item No. 66704 • ATLANTIC COAST LINE #540 (double headlight with Mars light)

Item No. 66705 • MILWAUKEE ROAD #16 (double headlight)

Click to
learn more



Bachmann Industries, Inc. • 1400 East Erie Avenue • Philadelphia, PA 19124 USA • www.bachmanntrains.com

Click to learn more.

• INDEX



SUBSCRIBE
(free)

• TABLE OF CONTENTS

MRH 2016 Survey, prototype or freelance?

Here is our readers' response to our question about prototype vs freelance modeling from our 2016 reader survey. The statistical validity is +/- 2.5% with a 95% certainty.

MRH 2016 Reader Survey:
How much of a stickler are you for modeling the prototype?

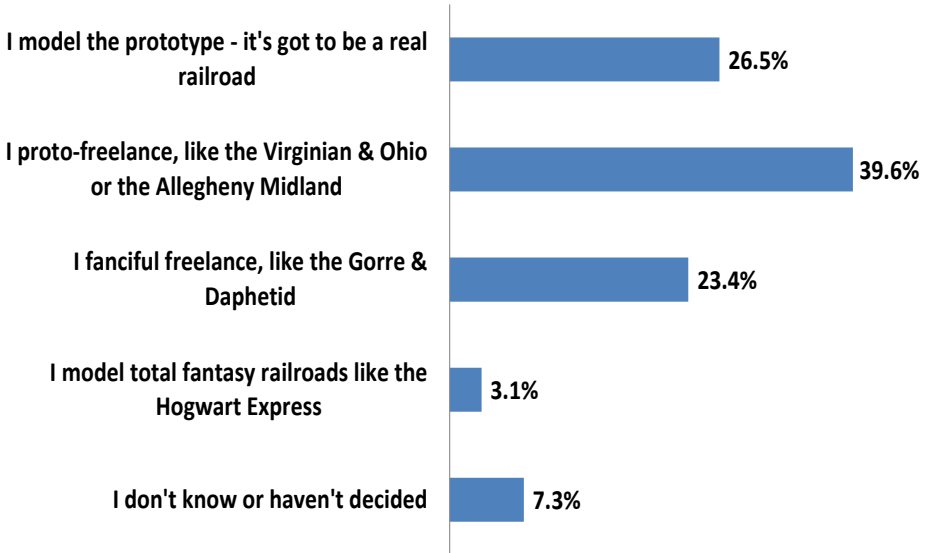

If we add together the prototype and proto-freelance groups, we get about 66% (two-thirds) of our readers who prefer something prototype-oriented. That leaves about a third of our readers who prefer pure freelancing, which is not an insignificant number.

Flipping this around, if we add the proto-freelance group to the fanciful and fantasy freelancing groups, we get 66% who appreciate freelancing. In short roughly two thirds of our readers will like prototype topics, and another two thirds will like some amount of freelancing coverage.



FINAL ORDER DEADLINE



VALENTINE'S DAY

CLICK HERE.

• INDEX



SUBSCRIBE
(free)

• TABLE OF CONTENTS



LAST ISSUE'S RATINGS

The five top-rated articles in the [January 2017 issue](#) of *Model Railroad Hobbyist* are:

- 4.8 Simple 3-step weathering
- 4.8 Imagineering: Scenic depth
- 4.7 Getting Real: Riding & modeling a prototype
- 4.6 Return to Allagash Country
- 4.6 Yes, it's a model

Issue overall: **4.6**

Please rate the articles! Click the reader comments button on each article and select the star rating you think each article deserves. Thanks! ■

ADVERTISEMENT

CRAFTSMAN KITS

Our instruction manuals are second to none!

CHECK IT ALL OUT AT

WWW.RUSTYSTUMPS.COM

THE QUALITY IS INSIDE BECAUSE OUR NAME IS OUTSIDE

ADVERTISEMENT

**COMING SOON
IN HO SCALE!**

We plan to produce an HO Scale version of our very popular Mt. Albert Lumber Yard kit later this year. Please watch our website and Facebook page for more details.

MODEL RAILROAD HOBBYIST MAGAZINE (MRH Media, LLC)

STATEMENT OF OWNERSHIP, MANAGEMENT, AND AUDIENCE¹

Title of publication: Model Railroad Hobbyist Magazine

- ISSN: 2152-7423

Date of statement: 3 February 2017

Frequency of issue: monthly

- Number of issues published annually: 12
- Lifetime subscription: No charge (just supply email)

Location of office of publication:

Woodburn, Oregon 97071

County, Marion

Names of publisher, editor:

Publisher: Joe Fugate

Editor: Joe Fugate

Owners: Joe and Patty Fugate

Known bondholders, mortgagees, and other security holders
owning or holding one percent or more: none

Extent and Nature of Audience² as of Feb 3, 2017

Total monthly unique device views: 119,615 (based on unique IPs)

Total monthly unique users: 90,668 (determined per [IAB guidelines](#))

Total monthly website visits: 263,186

Percentage of OS/devices used to visit:

Windows: 56.0%

iOS: 19.2%

Android: 14.2%

Macintosh: 8.9%

Linux: 1.0%

All others: 0.7%

Percentage of browsers used to visit:

Chrome: 41.3%

Safari: 21.8%

Firefox: 14.5%

Internet Explorer: 10.4%

Edge: 7.0%

All others: 5.0%

Total mailing list subscribers: 33,209

We certify that the statements made above are correct and complete.

Joe D. Fugate Sr., CEO and Publisher; Patricia C. Fugate, Co-owner

Model Railroad Hobbyist Magazine (MRH Media, LLC)

¹ Per the Alliance for Audited Media and the Interactive Advertising Bureau (IAB), a totally digital publication such as Model Railroad Hobbyist must measure "circulation" by tracking *Audience* per publishing cycle (monthly in the case of MRH) since there is no direct physical publication to count. The Audience statistics reported here follow the strict guidelines set forth in this document published by the IAB and endorsed by the AAMI: <http://www.iab.com/guidelines/iab-measurement-guidelines/#audiencereach>

² Computed and provided by Google Analytics (and can be independently verified by Google as correct and complete).



Announcing our next Limited Run PWRS / Micro-Trains® Car!!!



PWRS 

Union Pacific (UP) 4-packs

2 Bay ACF Center Flow®
Covered Hopper

**Building America
(MP) and (CNW)**



- 1 set MP and 1 set CNW road marks
- Light grey and lightly weathered
- Union Pacific herald with the Building America slogan

COMING
August 2017

PACIFIC WESTERN RAIL SYSTEMS
SPECIAL RUN CAR

Pacific Western Rail Systems

 **NORTH AMERICAN RAILCAR CORPORATION**

The newest in North American Railcar Corporation's fine line-up of high quality cars, as announced, Saturday, January 28th, at the Amherst Railway Society's Railroad Hobby Show in West Springfield, Massachusetts...

UNVEILED



CLICK HERE FOR
NARC - unveiled 

NARC Cars are sold exclusively through

Pacific Western Rail Systems

• INDEX

• TABLE OF CONTENTS



Model Railroad Hobbyist | February 2017 | #84

MRH Q-A-T

column

compiled by
JOE BRUGGER



[Click here to rate or comment on this article](#)

? QUESTIONS AND ANSWERS

Team tracks

Q. I know just about any type of car can show up at a team track sooner or later. But how common was it for covered hoppers to be unloaded at a team track in the mid '60s? What kind of off-line industry would use a team track in this way? What would have been the typical kind of load going in or out? And how would the hopper have been loaded or unloaded?

—pldvlk

A. David Husman: A team track doesn't really get every type of car. It can, but the purpose of a team track was to allow customers that did not have a private siding to ship and receive goods. A team track would only get the cars the customers in the area shipped or received and could load and unload.

To unload a covered hopper at a team track you would basically have to dump the commodity on the ground under the hopper

▶ MRH QUESTIONS, ANSWERS, AND TIPS

• [INDEX](#)



SUBSCRIBE
(free)

• [TABLE OF CONTENTS](#)

MRH Q-A-T | 2

and then auger/conveyor it up into a truck or whatever. Coal was unloaded all the time; grain wouldn't be a problem. Cement you would have to auger since it would blow away or be exposed to humidity on an open conveyor. Carbon black would be a huge mess, and flour would risk contamination.

Covered hoppers in the 1960s were still uncommon cars, especially lighter commodities like grain and plastic in the higher capacity cars (100 ton). They would have mostly been newer and



expensive cars, which means the railroad would want to maximize their utilization. A

1. This is a well-equipped team track with lighting and a concrete ramp. Some are as basic as a layer of compacted crushed rock. *Vander Borgh*
Jean-Pierre
photo

MRH Q-A-T | 3

single car shipment to a team track might not be the best utilization. Also, a covered hopper is a “specially equipped” car, not a general service car. A customer just can’t load it if it’s empty; the railroad has control over who gets to use it and where it goes.

One of the reasons that general service boxcars lasted so long was that many of the grain shippers and receivers did not have facilities that could load or unload a covered hopper. Grain was shipped to Mexico in boxcars until the 1980s because some Mexican destinations had facilities that could only unload a boxcar. Grain was shipped in boxcars in Canada and parts of the U.S. because track on many of the rural grain lines could not support a heavy covered hopper. In the 1960s, if you sent the customer a covered hopper, would they even have the capability to unload it? That was a real question.

I model the 1900 era so I have to do a lot of research to find stuff. That means looking at a lot of charts and data from other eras and working backwards.

One thing I have found is that industries changed names regularly, and tracks had different industries. Every 10-20 years, about half the smaller industries would be different or be under a different name. The bigger industries may turn over every 25-50 years. In the last 50 years or so, not only have the names been changing but the tracks and buildings have outright been disappearing.

Remember that a team track is for ALL the industries that do not have a private track. A team track can serve 100 different industries. If you lease the team track to a private company, then it’s no longer a public track. It now serves just that one industry.

sbird426: As a kid, I saw sand cars being unloaded on team tracks near my home in Georgia. Southern would shove in a couple of



cars at a time, and the trucks would park beside the cars, and the sand would be augered or conveyed up into the trucks.

I don't recall seeing grain cars being unloaded on a team track, but in the '70s I saw it being loaded on a team track. The process I saw was almost the reverse of the sand above. Trucks would come in from a local elevator that had lost its rail service. The trucks unloaded the cars onto the ground and the grain was then augered up into the railcars. I'm not sure how long this continued, but I know this took place for at least a couple of seasons.

Graham Line: In addition to team tracks, railroads will lease a spur track to a company for loading and unloading. Occasionally the railroad will provide a ramp or other facilities, but usually the lessee brings in the needed hoppers, conveyors, ramps etc.

Because the leases change or lapse periodically, a modeler can have hoppers unloading agricultural chemicals for several months, followed by a lumber reload, followed by an equipment dealer or whatever strikes their fancy. Unlike a team track, the leased spur is available to a single customer at a time.

In the '80s, for example, the Union Pacific was leasing a spur along its mainline in north Portland OR to an outfit unloading potash using a wheeled portable auger.

Charlie Duckworth: It was a seasonal move but I saw salt coming into team tracks in the Midwest where it was used on icy roads. Also saw a regular move of Christmas trees into St. Louis in boxcars from Canada billed to team track consignees.

Moe Line: In addition to cement, I have seen lime unloaded from covered hoppers into trucks with a conveyor.

Dave Branum: About the only thing unloaded regularly at the team track near me in the '60s was lumber and other building



Archer

FINE TRANSFERS
PROUDLY SERVING MODEL BUILDERS SINCE 1989

THE ORIGINAL

SURFACE DETAILS™

WE NOW HAVE MORE
THAN 130 SHEETS OF
RIVETS, LOUVERS,
TREADPLATE, WELD
SEAMS AND MORE
CAST ONTO
MICROSCALE CLEAR
DECAL FILM

LOW SHIPPING:

DOMESTIC USA ORDERS
\$2.80

INTERNATIONAL ORDERS
\$9.95

CLICK HERE TO
VISIT OUR WEBSITE!

"Archer Fine Transfers 3D decals have revolutionized kitbashing and scratchbuilding. Putting rivets or other low-relief details like louvers or weld seams on your models is now as easy as applying decals."

Joe Fugate,
Publisher/Editor
Model Railroad
Hobbyist



MADE IN THE USA

Archer Fine Transfers • PO Box 1277 • Youngsville, NC 27596 • USA
(919) 570-1026 • info@archertransfers.com • archertransfers.com

ADVERTISEMENT

HO GP60M, GP60B AND GP60 Locos



Now Available!



DC or DCC with Sound!



www.foxvalleymodels.com

• INDEX



SUBSCRIBE
(free)

• TABLE OF CONTENTS

TRINITY 3281
IN STORES NOW



Norfolk Southern -- 12 #s



ICE-GATX -- 8 #s



Winchester & Western -- 12 #s



NRLX Ciment Quebec -- 12 #s

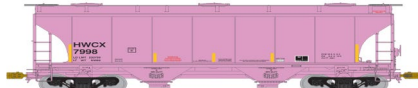

HWCX -- 7 #s

American Limited

www.americanlimitedmodels.com

ADVERTISEMENT



NICK & NORA DESIGNS

Uniquely inspired craftsman kits

Craftsman Structure Kits in HO & N

Detail Parts,

laser cut shingles,

HO Vehicles, Tru-Color Paints,
glues, tools & more!

www.nickandnoradesigns.com

products from boxcars or flat cars, some with end bulkheads and some regular flats. Occasionally there would be a load of machinery or other industrial stuff but not very often.

Some of the eastern roads shipped cement in canister-equipped gondolas, and I've seen photos of them unloading at team tracks. The trucks hooked up large hoses and sucked the cement out. I don't know if this still happened in the mid '60s or if they had switched to covered hoppers by then.

Rustman: Until last year or so, Cambridge, MD had a track that served a plastics manufacturer located off-line a few hundred feet away in a nearby industrial park. They had plastic piping underground that came up at the team track to offload pellets.

In Strasburg, PA there is a team track operated by the Strasburg RR. They have equipment to unload grain or corn of some sort using a purpose-built conveyor from this company www.rbtsi.com/MobileConveyors.asp.

Read the whole team track discussion at mrhmag.com/node/27583.

Bells, bells, bells

Q. My operations crew is driving me crazy with their sound-equipped locomotives. They have the whistle rules down pretty well and there aren't many grade crossings, but the bells go on and on. What are the rules?

A. Barry K.: Having retired as a locomotive engineer and railroad safety officer, here is generally what the bell is used for in the US.

When an engine/group of engines is moved after sitting for a period, the bell is rung to alert all that a movement is beginning. The bell is also used while moving to alert people that

ADVERTISEMENT

MONSTER
modelworks

New HO Scale Kit Release

Engineers Tool Shed



www.monstermodelworks.com

ADVERTISEMENT

ADVERTISEMENT

Backdrop Junction

Your Stop for Railroad Backdrops

[Click Here](#) ➔

For the Finest in Custom Designed backdrop



www.backdropjunction.com

ADVERTISEMENT

LIGHTS 4 MODELS



Miller Signs

Evan Designs

Iron Penguin

Ring Engineering

EZ Line

Tomar

ITT Sound Boards



Shop Now

Want it on Blu-ray?

Selected titles are
now available on
Blu-ray disc in
spectacular HD!

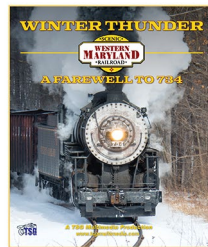
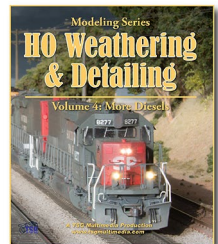
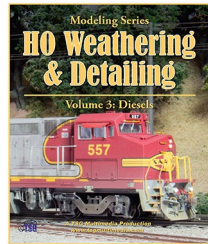

[CLICK FOR
BLU-RAY](#) ➔



TSG Multimedia

• [INDEX](#)



SUBSCRIBE
(free)

• [TABLE OF CONTENTS](#)

the engine is moving towards them, and is rung continuously, until moving past them. Most importantly, the bell is used in conjunction with the whistle for public crossing protection and begins at least 20 seconds before occupying the crossing, and continues until it is occupied.

In addition, the bell is rung when the whistle is not used traveling through a “quiet zone,” in which no whistle is allowed unless an emergency occurs, public crossings, or any other time the engineer feels it necessary to do so in communicating with crew members to get their attention, or as a general warning.

Chris van der Heide: Acquaint them with these, particularly Rule 32:

(1962 Uniform Code of Operating Rules)

30. The engine bell must be rung when an engine is about to move; while moving about stations; while passing a train standing on adjacent track; and 1/4 of a mile from every public crossing at grade (except within the limits of such towns or cities as may be prescribed in special instructions) until the crossing is occupied by engine or cars.

32. The unnecessary use of the whistle or the bell is prohibited. They will only be used as prescribed by rule or law, or to prevent accident.

For users of the General Code of Operating Rules, Rule 14 gives the same engine bell instructions.



[Click here to rate or comment on this article](#)

 TIPS

Paint stand for models

Upon nearing completion of two Funaro & Camerlengo resin kits, an H32 hopper and a high-platform tank car, I realized I was going to need some way to paint the two cars all the way around.

After thinking a bit, I created a paint stand that served my purpose well. Out of a scrap piece of plywood, I cut out a 3/4" wide strip about 10" long with a wide "handle" at one end.

Then I used two 4" lengths of 2-56 threaded rod and some washers and nuts to create a support for the cars that screw into the hole for

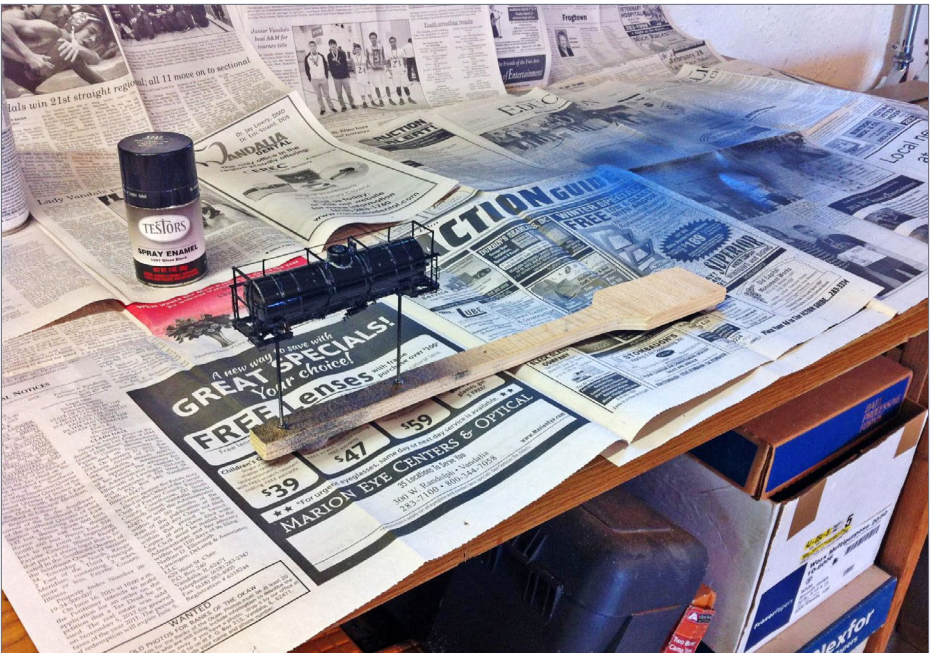

2. Douglas Dale Forbes' painting stand has a convenient grip at one end and allows access to all sides of the model.

MRH Q-A-T | 8

the trucks. I drilled holes just big enough for the rod. It works great and is adjustable All I need to do is drill a new hole for each car.

I don't have to touch the car at all between coats of paint and it is also great for decaling as well.

—Douglas Dale Forbes

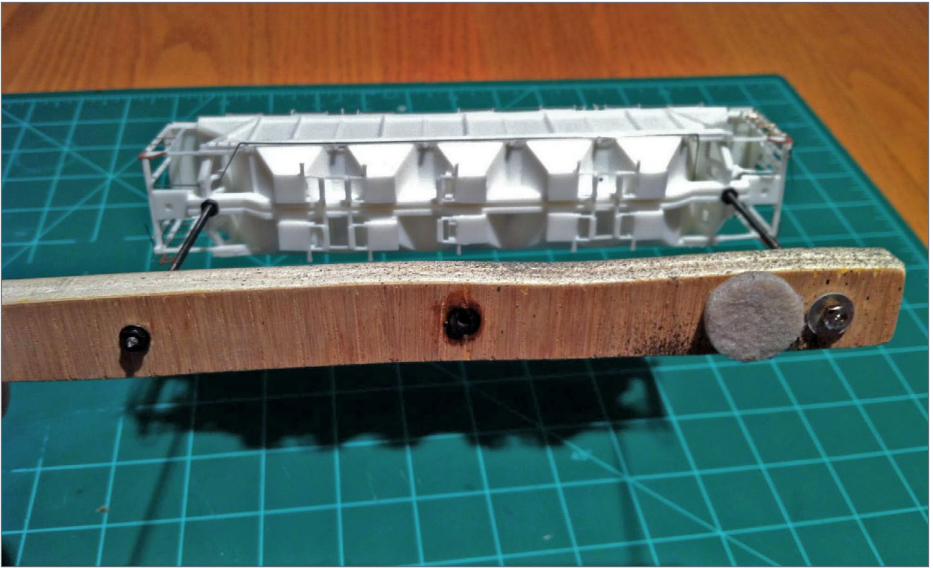

3. Threaded rods screw into the truck mounting bosses and can be spaced to fit different models by drilling new holes. The foam or fiber pad allows the holder to rest on the workbench.



GET PAID FOR YOUR TIP

We pay \$25 per tip we publish, or \$40 each if the tip also includes a photo or finished drawing. [Click here and select article type TIP.](#) ■

NEW!

TMTV Season 2 DVDs and downloads

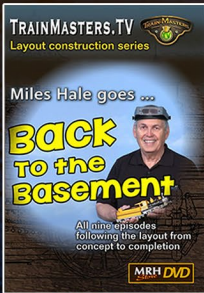

DVD

~~\$36.99~~

\$29.99



DVD

2 disks

Download

DOWNLOAD

~~\$19.99~~

\$14.99

9 files

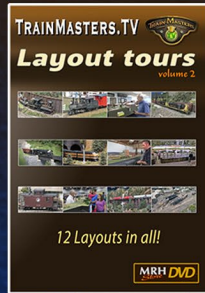

DVD

~~\$36.99~~

\$29.99



DVD

2 disks

Download

DOWNLOAD

~~\$21.99~~

\$16.49

12 files



DVD

~~\$44.99~~

\$31.99



DVD

3 disks

Download

DOWNLOAD

~~\$24.99~~

\$19.99

14 files



DVD

~~\$49.99~~

\$33.99



DVD

4 disks

Download

DOWNLOAD

~~\$29.99~~

\$22.99

16 files

ALSO: The Complete TMTV Season 2 DVD set, volume 1 and 2 are now shipping!

SHOP NOW >>

**Model Railroad
Hobbyist Store**

store.mrhmag.com

• INDEX



SUBSCRIBE
(free)

• TABLE OF CONTENTS

From first train set to railroad empire...

*Our complete line of DCC products
grows with you. Discover the fun!*

- Designed and manufactured in the U.S.A.
- Preferred for ease of use and ergonomic design
- Unlimited scalability for any size model railroad
- Plug-and-play means more time running trains
- Great customer service and excellent support



See your dealer



Visit our new and improved web site for all your DCC needs!

- Get the latest new product announcements
- Watch our detailed how-to videos
- Browse the all-new Information Station
- Enjoy secure online sales, day or night!

Visit **ncedcc.com**



• [INDEX](#)



[SUBSCRIBE](#)
(free)

• [TABLE OF CONTENTS](#)



S T A T I O N

Model Railroad Technologies
Accutrack Speedometer 2



Wow!
Only \$64.95



- Click here to visit our website -

www.LitchfieldStation.com
623-298-7355



DCC IMPULSES

column

BRUCE PETRARCA MMR
.....



[Click here to rate or comment on this article](#)

THINKING THROUGH A DCC DECODER INSTALLATION

GETTING STARTED IS THE PIVOTAL PART OF A decoder installation. But, before you heat up the soldering iron, there are a lot of things to think about and plan.

Some folks spend so much time thinking that they never start. Others jump in and find out halfway through that they should have considered some critical areas before they started. Sometimes, no matter how much you seem to think ahead, things conspire to complicate the installation.

In this column, I'm going to walk you through the concepts and ideas as I install a sound decoder in an older HO Atlas (Kato) RS3 [1] for MRH Assistant Editor Don Hanley. Most "installation" write-ups focus on what to do for a specific loco. I'm going to approach this from the point of view of what I'm thinking along the way. Hopefully, this will stir the creative juices in some readers.

▶ DCC TIPS, TRICKS, AND TECHNIQUES

• INDEX
.....



SUBSCRIBE
(free)

• TABLE OF CONTENTS
.....

DCC IMPULSES | 2

For those who aren't aware of the loco, it is one of the good runners from the early Atlas HO era, when they were importing and selling Kato locos under the Atlas name. They are readily identifiable by the "Kato" lettering on the bottom of the fuel tank and trucks. Don has tricked this Erie model out with (inoperative) marker lights and individually applied grab irons and has weathered it.

The interior is unique, too [2]. There is a light board mounted above the motor with a single bulb and light pipes in the shell to direct the light to each end of the loco. There is no directional lighting on this puppy as it was built. There are two weights, one above each truck, that are a friction fit into the shell.

Initial decisions

There are things to think about before the loco is even opened.



1. Atlas (Kato) RS3 before decoder installation started.



2. The interior of the Atlas RS3, showing the single centrally located bulb. The light pipes are inside the shell and not shown in this photo. The weights sitting on each end of the frame are not attached to anything. They are wedged into the shell when the loco is assembled. I call the assembly in front in this photo the “frame” and the one in back the “shell”.

Selecting a decoder can range from an easy choice to a totally vexing project. There are some “givens,” such as, “does it physically fit in the loco?” and “will it handle the current draw and the number of functions needed?” that need to be answered.

For sound installations, questions arise about the sound sets and quality in various decoders. Sometimes a simple “make a semi-appropriate noise” inexpensive decoder is desired. Other installations need “rivet-counter” accurate sound. Consider your needs and budget.



DCC IMPULSES | 4

Don wanted a LokSound decoder with the new Full Throttle sound package. A LokSound Select Direct is designed to mount directly on the Atlas motor and has six functions.

As explained on my website (mrdccu.com/curriculum/stall.html) I tested stall current to make sure that the LokSound Select Direct could handle the loco. With the bulb connected (increasing the test current), I measured 0.85 amps at 12 volts. The LokSound Select Direct is rated for 1.1 amps, so it fits, can handle the current and has more than enough light functions. It is a go.

To load the sound, I used the LokProgrammer, as discussed in my August 2016 column (mrhmag.com/magazine/mrh2016-08-aug/

ADVERTISEMENT

Make LocoNet wiring extremely simple!

ACCU-LITES, inc
Your DCC Center!

**Suitcases belong in your baggage cars,
not under you layout!**

**Introducing the DCC Vampire II ...
this guy does the job of two suitcase
connectors!
And really holds the connection good
too!**

CLICK NOW TO DISCOVER THE AMAZING VALUE!

Dealer Inquiries Accepted

• INDEX

• TABLE OF CONTENTS



3. LED mounted to a clear light pipe from Streamlined Backshop. Designed to fit Athearn openings, they work just perfectly in the Atlas/Kato. *SBS4DCC photo*

[dcc-impulses](#)). The Full Throttle Alco 244D V12 turbo sound set (73401) was loaded. The LokProgrammer software needs to be version 4.4.21 or newer to load the new Full Throttle sound package. With the Select Direct, the only connection needed for the LokProgrammer is the track, so I just used a set of clip leads to the track pads on the decoder.

“How to get the sound out?” is always a question. With similar locos, I’ve had good luck mounting the speaker on the weight and routing the sound out around the rear truck, such as shown on my website (mrdccu.com/install/hods/Atlas-RS-32-828044).

[html](#)). The floating weights in the Kato design won't work the the same way as those that are screwed down on later Atlas locos. Time to improvise.

There were two choices. The easy way would be to mount a sugar cube speaker with an enclosure or iPhone speaker in the shell and let the sound make its way out.

Don wanted the best sound possible and is willing to double head locos if necessary. So, we decided to remove weight and build a baffle that would direct the sound out the front truck from the front of the speaker. Sound from the rear (magnet) side of the speaker would be left to filter out the rear truck opening.

For more help with the sound design concepts, see my August 2012 column, "How Do I Get The Sound Out?" (mrhmag.com/magazine/mrh-2012-08-aug/dcc_impulses) and the accompanying YouTube video.

There won't be room for the light pipes and the speaker in the final installation. Besides, the single bulb design is dated. So I decided to install LEDs.

With the dual openings on each end of the loco and Don's investment in the looks of this loco, I decided to go with LEDs that are designed to mount in each hole. MRH advertiser Streamlined Backshop has just such a critter (store.sbs4dcc.com/SBS4DCC4-pkHOScaleAthearnHeadlightLEDAssembly-WarmWhite.aspx). While they are designed for Athearn locos [3], they fit perfectly in the Atlas/Kato shell. The 4-pack has just enough LEDs for this installation.

With these four LEDs mounted in the shell, there could be as many as eight wires between the shell and the frame. Ulrich Models made a board [4] to facilitate mounting the resistors in



4. Ulrich Models resistor board allows connection of eight LEDs to “track level” decoder outputs. It comes with 1KΩ resistors, as shown. *Ulrich Models photo*

ADVERTISEMENT

IOWA SCALED
ENGINEERING

Infrared sensors!

open source hardware

LEARN MORE >

The advertisement features a black and red model train on tracks. A red laser beam from an infrared sensor is directed at the train. A gear icon with a person silhouette is labeled "open source hardware".

ADVERTISEMENT

TamValleyDepot.com
Great Electronics for Great Model Railroads

Home of the Frog Juicer

We are loading up the boxcars with Frog Juicers ready for your layout!

The advertisement shows a model train scene with a boxcar. A large green PCB is being loaded into the boxcar. A sign on the boxcar reads "Home of the Frog Juicer" with a frog logo. A person is loading a box into the boxcar.

DCC IMPULSES | 8

the shell, which would reduce the wire count to three. Since I had a few of these boards in stock, I planned to use one.

A web search turned up the fact that Ulrich has gone out of business. They are currently selling out their stock on eBay.

MRH advertiser ACCU-LITES, Inc. sells what seems to be a functionally equivalent board, albeit in a slightly different design. I haven't yet worked with their board, but hope to do so soon. Check it out on their website (acculites.com/index.php?main_page=product_info&cPath=40_76&products_id=640).

An alternative method would have been to cut off the light pipes just inside the shell and mount one LED on each end of the frame such that it would shine on the light pipes. This would eliminate the need to bring wires from the frame to the shell. It would be less expensive, but more cumbersome.

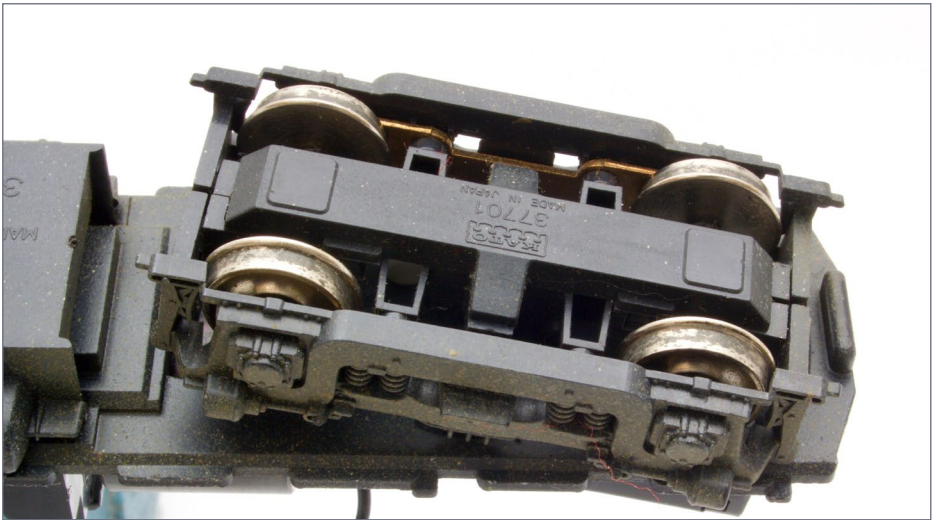

5. The wheels need cleaning, as can be seen in this close-up photo.



ESU

Why settle for sound that is close enough when you can have the exact sound for your locomotives?



[Click here for a complete listing of sound files and samples.](#) 

One size does NOT fit all!
Shown above are seven ALCO 12 cylinder 251's, all with slightly different sounds!

ESU LLC

23 Howard Street, Montoursville Pennsylvania 17754

Phone +1 570-980-1980, Fax +1 866-591-6440

(Office hours: Monday through Friday, 8AM to 4PM (EST))

WWW.LOKSOUND.COM

• [INDEX](#)



[SUBSCRIBE](#)
(free)

• [TABLE OF CONTENTS](#)



Southern Digital



**20% Discount
on most items!**

Specializing in DCC Since 1992



DCC Conversions, Service & Support

Orders Received by 3:00 pm EST ship the same day

WWW.SODIGI.COM

E-mail: sales@sodigi.com

(770) 929-1888

(Photo's are from our N-Scale layout)

The installation

Okay, we have made the design decisions. Here is how it all came together.

Check out the sidebar for the actual parts and some of the supplies used.

Before moving on to my methods, now is a good time to review tips and techniques I've discussed in prior columns. Specifically, I recommend the following links.

My first two columns on the basics in October and November 2011:

mrhmag.com/magazine/mrh-2011-10-oct/dcc_impulses

mrhmag.com/magazine/mrh-2011-11-nov/dcc_impulses

Also, check out my "17 Tips" column from June 2013:

mrhmag.com/magazine/mrh-2013-06-jun/di_17-dcc-tips

Preparing the loco

Before I install a decoder, I like to clean and lube the loco. The wheels on Don's had collected a bunch of crud over the years [5], which is typical for older locos.

In the process of cleaning the wheels, I noticed that the gears were cracked. This can be diagnosed by checking each axle separately.

Hold one wheel stationary (I use my thumb) and try to turn the opposite wheel. If they turn independently, frequently the gears that hold the metal axle shafts are cracked.

This situation is very common on Proto 2000 locos, especially those from the mid-1990s. The Atlas/Kato locos are less prone to this cracking, but not immune. I ordered four new axle sets (two wheels plus a gear per axle) from Atlas. They have a very good stock of replacement parts and are good folks.



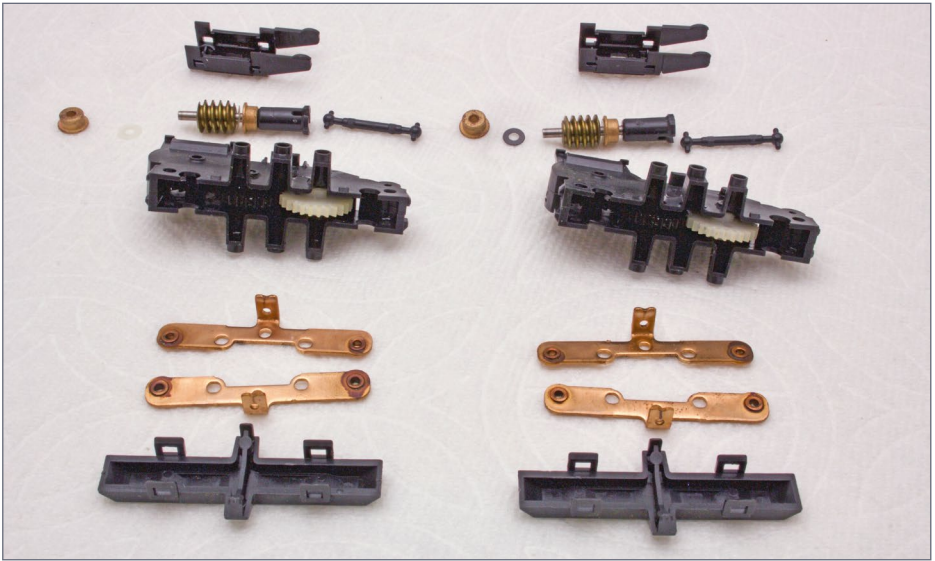

6. The parts of the loco drive train after cleaning. They are laid out drying on a paper towel and organized like an exploded view. Note the (new) black thrust washer near the right gear. There is an original (white to clear) one that is barely visible next to the left gear. These guys are easy to lose. That's why I ordered extras.

I ordered extra gear train thrust washers and a few other parts at the same time. I frequently loose the pesky little thrust washers, so having extras on hand is a blessing. Besides, they only cost a few pennies each. Thinking ahead here saves time and (postage) money.

While I was replacing axles, I decided to completely rebuild the trucks, cleaning out the old lubrication and replacing it with Nano-Oil. I disassembled the trucks as shown in [6]. I don't recommend taking apart the gear boxes any further unless you are very familiar with dismantling locomotives and reassembling them.

TONY'S TRAIN XCHANGE

Committed to your DCC support!

Accessory Decoder/ Tortoise Combos

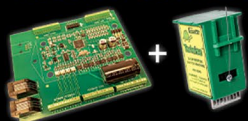

Get exceptional savings when you purchase Tony's Combo Packs!

Jackwabbit/Tortoise
Wabbit/Tortoise
Hare/Tortoise

Starting at \$39.95

Order Yours

CMX Cleaner Car



Superior, All-Brass
Build Quality, Super
Easy To Use & Cleans
Exceptionally Well!

N, HO, S, O, & G Scales

Starting at \$149.95

Order Yours

NCE DCC Systems Super Sale!



Get a great sale price on all
the impressive NCE DCC
Starter Systems

Order Yours

**Do you need a Sound or
DCC Installation done?**

Get a quote!



Providing unmatched person to person
DCC support for more than 25 years, the
kind of service that has made us #1 in DCC.

DCC questions? CALL US! 1-800-978-3472

We'll get you on the right track!

Feb. 2017



• INDEX



SUBSCRIBE
(free)

• TABLE OF CONTENTS

DCC IMPULSES | 11

I put all the parts in a stainless steel cup and filled the cup with my cleaning solution. I use 4 parts of 50% isopropyl alcohol to 1 part Simple Green degreaser. The easy way is to take a pint or quart bottle (liter or smaller) of 50% isopropyl and fill the empty space with Simple Green. I frequently find both at a “dollar store.”

I filled the ultrasonic cleaner (an inexpensive model from Harbor Freight) about half-way with water. Then I put the cup in the ultrasonic and ran a cycle or two. I used a stainless steel screen (“dollar store,” again) to separate the parts from the cleaner. I filtered the cleaning solution through paper towels back into the bottle so I could reuse it.

While the parts were still wet with the cleaning solution, I used an acid brush (cut off to about 3/8-inch bristles) moistened with more cleaning solution to work the old lubricant out. Once they were all clean, a clear water rinse made them ready to spread out for drying [6].

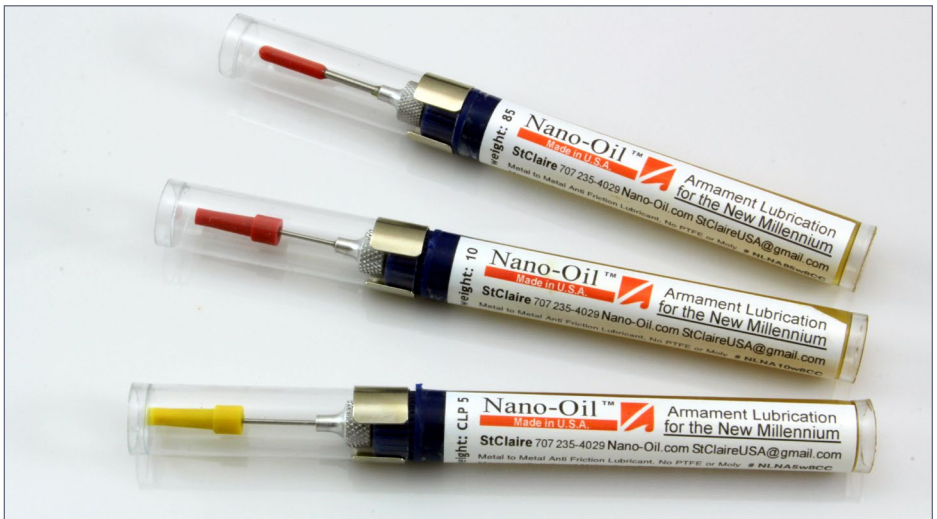

7. Nano-Oil in 5, 10 and 85 weight viscosities.

DCC IMPULSES | 12

After the parts dried it was time to reassemble the trucks. I lubricated them with Nano-Oil [7]. I own a kit of three weights: 5, 10 and 85. The 5 weight is used to penetrate small spaces and suck the 10 or 85 in behind it. So I coated all mating surfaces with 5 and then applied 10 to the bearing surfaces and 85 to the gear teeth.

Yes, I have found a major improvement in the smoothness and low speed running of locos when they have been cleaned and lubed in this manner. Is it worth the time and money? I firmly believe so.

I used a rubber-coated very flexible wire to run between the copper side frames and the decoder terminals. Northwest Shortline called this wire 2951 (29 AWG made of strands of 51 AWG wire). I

ADVERTISEMENT

TCS *WOWSound*

**Version 4 of WOWDiesel
NOW SHIPPING!**

**WOWDiesel Version 4 Introducing the
645 Non-Turbo Prime Mover**

All with Unmatched CD Quality Sound at
TRUE 16 bit Resolution that nobody else can
come close to!

click here

Learn why loco sound fans prefer WOWSound ...

Remember you "Rivet Counters", Sound has rivets too and TCS counts them better than anyone!

www.TCSDCC.com

• INDEX



SUBSCRIBE
(free)

• TABLE OF CONTENTS

DCC IMPULSES | 13

slipped a bit of shrink tubing [8] onto the tab after I soldered the wires to the side frames.

Whether you have rebuilt the trucks or not, now is the time to check the wheel spacing against a NMRA (or equivalent) gauge.

Time to work on the shell

I installed the Streamlined Backshop LEDs using MEK to hold them in place – applied *sparingly* inside the shell. I shoved them as far through the shell as possible [9]. When the MEK had set up, I clipped the light pipe off with cutters and sanded the end lightly. A drop of Faller Expert cement brought the optical surface back to top condition.

I slid a bit of shrink tubing over the four wires from each end of the loco to help dress them in place and keep them out of rotating components in the final assembly.

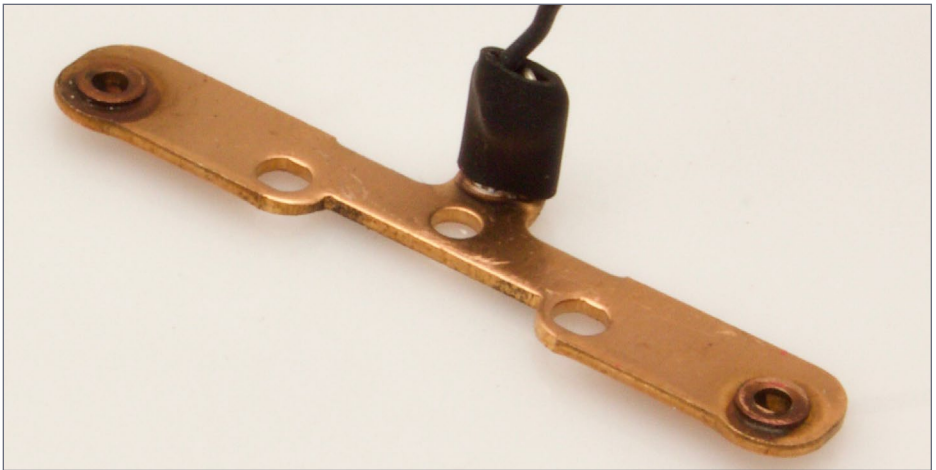

8. The truck side frames with wire soldered and shrink tubing providing some strain relief.

DCC IMPULSES | 14

The Ulrich Models resistor board [4] was installed in the shell with a bit of caulk and allowed to cure overnight. The next day, I wired it.



9. Detail of the installation of the LEDs in the long hood of the RS3.

DCC IMPULSES | 16

to assure this clearance will result in a loco that derails on curves and grades. Don't ask how I learned this. The story is too embarrassing.

Notice how I used two magnets to hold one angle block [10] with the flat side up. This gave me a magnetic surface that was level and raised by the three-inch thickness of the angle block.

Once the size was worked out with the thicker styrene, the "ears" were replicated in (thinner) 0.03-inch thick styrene and more of a baffle was built around the speaker [11]. The front was left open -- the shell will complete the baffle there. Some pieces were added to the rear (along with blue square parts to strengthen the corners). An opening for the drive shaft was left. While this will diminish audio quality a bit, it is necessary to allow the loco to run. Bits of square plastic were glued over the mounting holes to

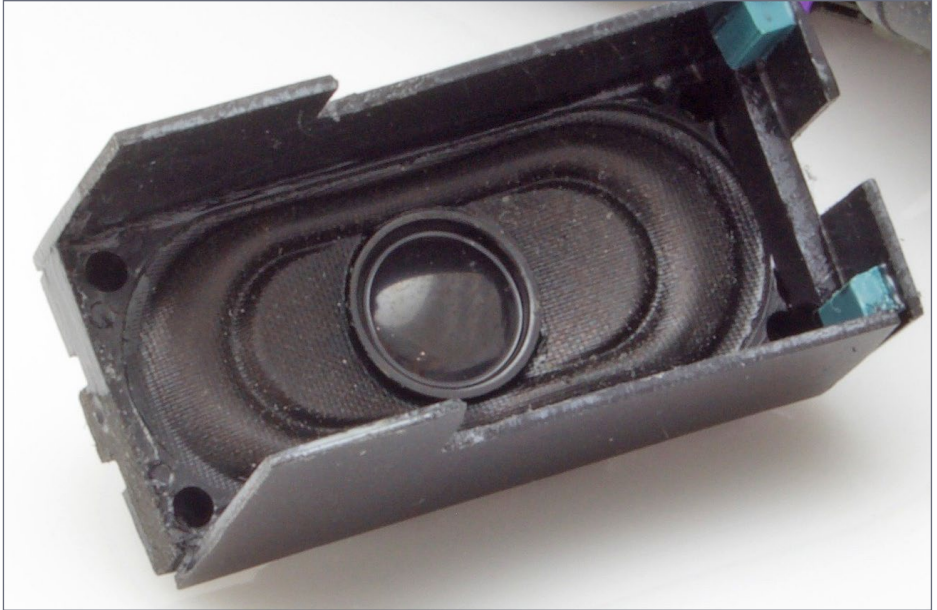

11. Close-up of the speaker baffle.

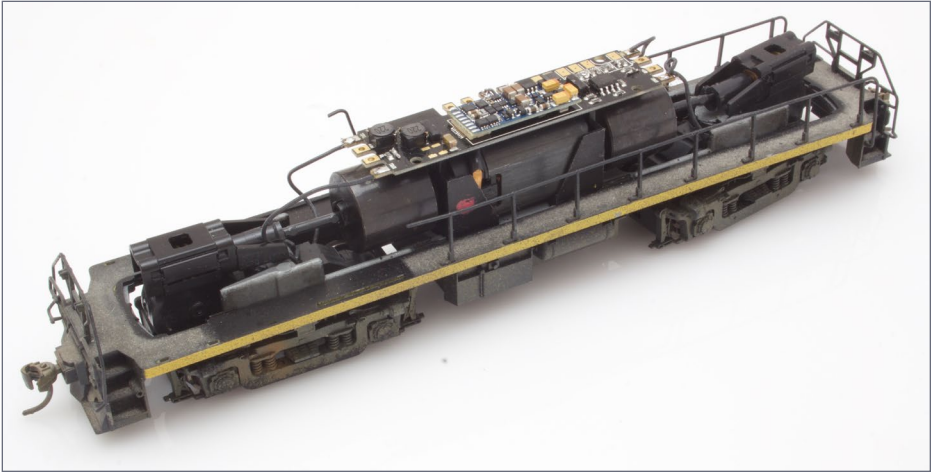

12. Decoder and motor wired. Now is the time to test the loco on the programming track.

ADVERTISEMENT

ANE Model
Navigator of Turnout & Digital control

LD101
Coming Soon

ANE model
www.anemodel.com

www.anemodel.com

ADVERTISEMENT

WAY TO GO, TRAINTEK!
Already great prices and NOW ...

FREE SHIPPING ON ORDERS OF \$79 or more*

Start saving now!

Traintek
LLC.COM

*some exclusions apply

DCC IMPULSES | 18

reduce air transmission front to rear. These bits of plastic are on the opposite side from the view in [11], so are not visible there.

Since I was using external resistors, the on-board resistors on the LokSound Select Direct decoder needed to be bypassed. Instructions for this modification are on the LokSound instructions. This is easiest to do on the decoder before installation into the loco.

The decoder was then snapped into position on top of the motor and wired to the motor and trucks [12].

It was time to test the basic installation. The loco was put on a programming track and the address was read (3) and new addresses were written (short = 14; long = 1014, with long address active). When the programming was done, the loco was run on address 1014 to verify operation.

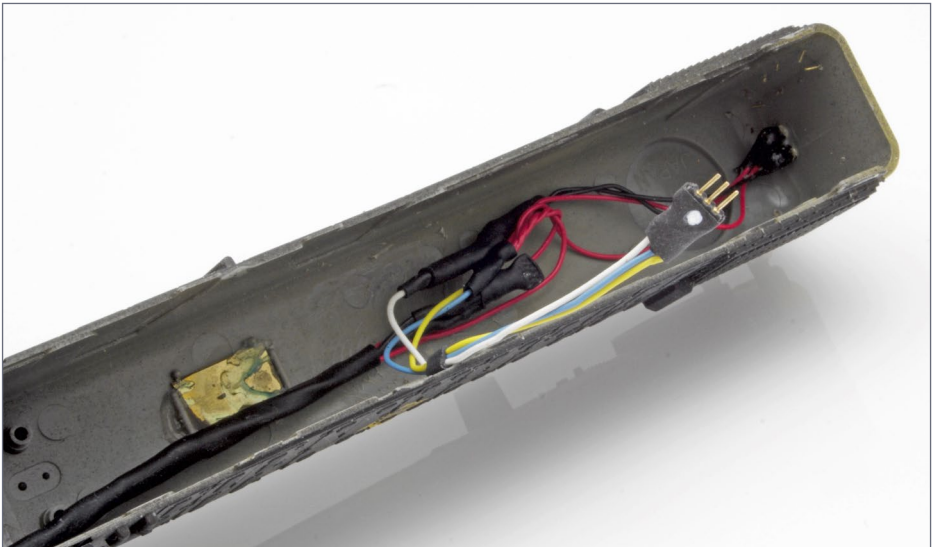

13. The wiring details inside front end of the shell. The brass plate is a heat sink from the original bulb installation.

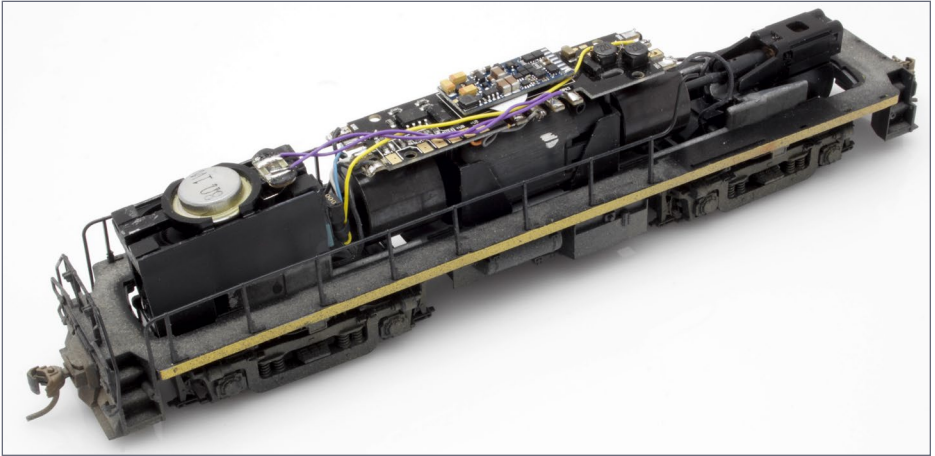

14. The finished frame, ready for shell installation. The lighting connector was plugged together with the white and yellow wires oriented to be together.

ADVERTISEMENT



NEW TECHNOLOGY



NEW Starter Kit
\$399.99 MSRP

- Includes Wireless Color Touch Screen Handheld Controller and 56 Watt Power Supply
- Expandable to Virtually any Size Layout

NEW Locomotive Module
LM-3 & LM-3S



- Direct Radio RF
- Sound and Non-Sound
- New Tiny Size
- 6 Light Outputs

Click Here to Learn More

For more information visit our Internet site: www.RingEngineering.com

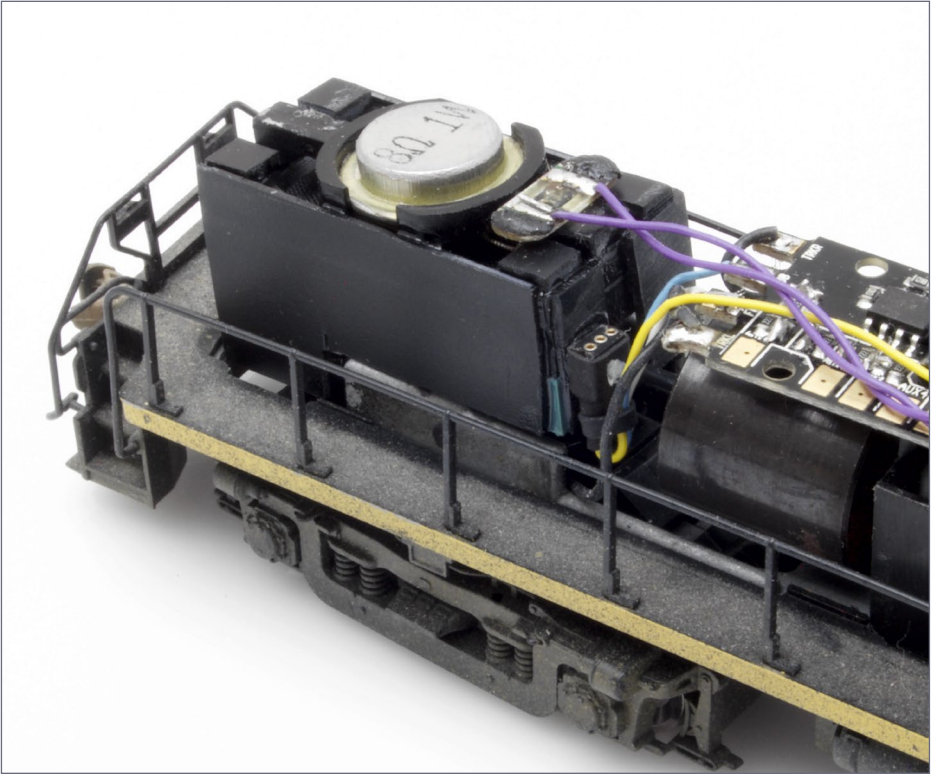

15. Detail view of left side of speaker baffle showing 3-pin lighting connector glued to the the side. The white dot on the side of the lighting (female) connector needs to be aligned with the similar dot on the male connector coming from the shell to get the correct lights on for the loco direction.

Next, I wired the LEDs to the Ulrich board and test fit the shell on the frame. It turns out that the LokSound design is a bit thicker than other similar decoders and there wasn't enough room to get the Ulrich board in the shell above the decoder.

No matter how much you plan, it seems that some gremlins can get you along the way. Time to rework the installation.

So, I removed the Ulrich board and wired all the LEDs together with 750 Ω resistors in the negative lead (between the black wire of each LED and the yellow or white wire, as appropriate).

These three wires were connected to a three-pin male connector created out of 50-pin headers, available from Litchfield Station (litchfieldstation.net/product/header-50-pin-inline-male-50-pin-575-500101). I wired the blue to the center pin. That way, if it is reversed in the socket, there will be no damage just the wrong light will be lit (reverse light when going forward).

This connector with the polarity dot is shown in [13]. Having a connector in the three light wires allows the shell to be totally removed from the frame.

ADVERTISEMENT

Fun Features for a Fraction of the Cost!

As the most versatile, feature-packed sound decoder, Econami redefines *value*. Starting at \$79.95 and available now!



Hear how you can get more for less!



Great control in a tiny package



**Original
Touch Toggles**

- Touch Toggle™ plug in controls
- Bright clear indication
- Easy setup
- Flexible system

Stall Motors, Twin-coils,
Power, and Servos

Now for Tam Valley Depot
and MRservo too!



Made in the USA



What will they think of next?

www.berretthillshop.com

www.SBS4DCC.com

Logos included: ESU, TCS, WOW Sound, OSI Solutions, ZIMO, SOUNDTRAXX, NCE (The Power of DCC), DiGiTrax, DCC Specialties (INNOVATION FOR DCC), MRC (Model Rectifier Corporation), ACCUTRACK II SPEEDOMETER, SPROG DCC (the DCC Programmer and Control Family), Digital plus by Lenz, TAM VALLEY DEPOT (Great Electronics for Great Model Railroads), and TEAM DIGITAL, LLC (Improving the world of DCC).

**When talking
to hobby
vendors,
please
remember
to mention
MRH.**

N - HO - HO_{N3} Scale Trains

• INDEX



SUBSCRIBE
(free)

• TABLE OF CONTENTS



16. Applying Never-Still lubrication to the rolling contacts on the loco trucks.

The wiring was finalized by connecting the speaker and the (female) socket for the LEDs, as shown in [14]. The speaker sits on the frame in a manner similar to the way the weight balanced previously.

I glued the light connector to the speaker baffle, as seen in [15]. This routes the wires away from the flywheel and keeps them below the shell when it is finally installed. The white dot to indicate polarity for the lights is on the side of the connector away from the speaker.

As you can see there is a lot to fit into this loco. I decided not to put the rear weight in. It just made the assembly too difficult.

As a final touch, I used Never-Still to lubricate the rolling contacts where the power transfers from the wheels to the side frames [16].

Now that Don Hanley has his NCE PowerCab controlled DCC layout, as detailed in the January 2017 MRH, he needs a switcher for it. Here it is. Having lost both weights, it won't pull quite as strongly as before the installation. However, his usage on a level switching layout will probably not tax its current capability. The sound is amazing. I imagine he will want to turn it down.

Please share your experiences and ideas. Just click on the Reader Feedback icon at the beginning or the end of the column. While you are there, I encourage you to rate the column. "Awesome" is always appreciated. Thanks.

Until next month, I wish you green boards in all your endeavors.

PARTS USED

LokSound Select Direct decoder

16 x 35 mm speaker

Styrene sheet (0.03 thick)

Styrene square (0.1 x 0.1 inch)

Athearn LED assemblies (kit of four) from Streamlined Backshop

750 Ω 1/8 watt resistors (4 each)

Replacement wheel/gear sets from Atlas

Replacement thrust washers from Atlas

50-pin male/female header stock

SOME SUPPLIES USED

MEK (Methyl Ethyl Ketone) solvent

Faller Expert styrene cement

30 AWG wire in several colors

2951 wire

50% Isopropyl alcohol

Simple Green degreaser

Clear caulk

Shrink tubing in several sizes



[Click here to rate or comment on this article](#)





Introducing

Complete Train Control

The next Evolution in Complete Train Control®

- Premium Advanced 5/8 Amp Starter Sets.
- Starter sets are available as standard tethered or duplex radio.
- The system features a DCS210 Advanced Command Station, DT500 series throttle, and includes a power supply to make getting started easier than ever.
- The DT500 series throttles can be purchased separately from the new Starter Set.

Find out more @ www.digitrax.com



E
St
DT
PS

E
D
DT
PS

the **EVOLUTION**™



Evolution (shown) | **\$450 MSRP**

Standard Set Includes: DCS210 Advanced Command Station, T500 Advanced Super Throttle, UP5 Universal Panel, 6615 power supply, and a LT1 LocoNet Tester.

Evolution Duplex | **\$660 MSRP**

Duplex Set Includes: DCS210 Advanced Command Station, T500D Advanced Duplex Throttle, UR92 Universal Panel, 6615 power supply, and a LT1 LocoNet Tester.

Bowser

In Stock at many dealers now!!

HO 53' Roadrailers



Road Names:
TC, Swift, Schneider \$25.95 each

HO Freight Car Kits



Road Names:
D&H \$15.95 each

HO F30a Flat Cars



Road Names:
Lehigh Valley, PRR,
UP, Conrail \$23.95 each

HO & N Scale N5c Caboose



Road Names:
PRR, PC,
Conrail With & Without
Antenna

HO H30 Covered Hopper Cars



Road Names:
PC, PRR \$29.95 each

HO Cal Scale

Drip Ribs, Window Shades, Cables,
Radiators, Horns, Steps, Whistles

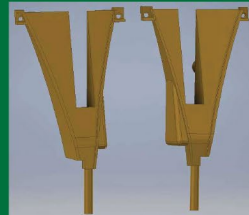
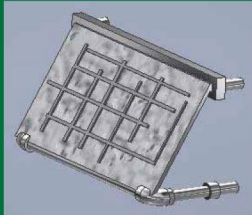

Click here to check out the details for these and other great Bowser Products

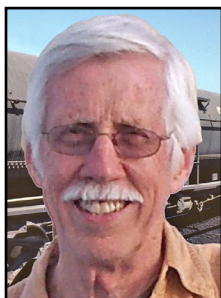

GETTING REAL

column

ANTHONY THOMPSON
.....



[Click here to rate or comment on this article](#)

STANDARDS FOR MODEL FREIGHT CARS | IMPROVE THEIR APPEARANCE AND PERFORMANCE BY SETTING SIMPLE GROUND RULES

OPERATION OF MODEL ROLLING STOCK REQUIRES minimum standards of performance. The standard may be implicit, as a “floor” under a certain level of dependability. Optionally, one may also add a standard for appearance, though not all modelers seem to do so. I like having explicit standards for consistency on my layout.

This column presents my standards for freight cars for the fleet that operates on my layout, which is a Southern Pacific branch line. I model in HO scale, though most of my standards are readily interpreted for other scales. I do divide my fleet into mainline and branchline cars. By “mainline” cars, I mean cars that may not have sufficient quality (accuracy and detail) for scrutiny when stationary or in switching moves, but are satisfactory in passing trains. But for all cars, there are some basic standards that I apply.

▶ **MODELING REAL RAILROADS AND WHAT THEY DO**



GETTING REAL | 2

These can be divided into three topics: Performance, Detailing, and Lettering plus Weathering.

Performance

The primary aspects here are trucks and couplers [1], as well as car weight. I will begin with trucks.

Trucks

Trucks need to have two qualities: they must be free-rolling, and they must be “in tram,” that is, with axles perpendicular to the side frames and parallel to each other. Any truck which can get out of tram not only will generate higher friction, but has a greater tendency to derail.

Both these criteria may depend on wheelsets of the correct length. An axle which is too long prevents free rolling, and one which is



1. As the ice deck crew prepares to start work, SP 1423 switches a loaded reefer to the deck for its initial icing before departing eastward. Dependability in operation like this demands good-performing trucks and couplers.

too short can allow out-of-tram behavior. Many of my freight cars still have Kadee wheelsets, which are fine for operation but are of a single length. My new cars and most upgrades now receive Reboxx wheelsets of appropriate length (see Sources at the end of this article). I regard their performance as outstanding.

I suspect most modelers by now recognize that plastic car wheels are troublesome with respect to track dirt. I have no idea why it's true, but these wheels really accumulate "gunk" in a way that metal wheels do not. I have not operated any plastic car wheels for many years.

A number of my older cars still have the relatively fat Code 110 wheels, that is, with wheel treads that are 0.110 inches wide. Nowadays a significantly narrower wheel is available, with 0.088-inch treads, called Code 88. I like the look of these, and they have operated perfectly well on my layout's Code 100 and Code 70 rail. It's worth remembering that a prototype car wheel has a tread width that scales to about 0.065 inches in HO scale, so even the Code 88 wheels are not truly prototype width.

Lastly, it is important that trucks swivel freely. A common cause of derailments, in my experience, is a truck which binds on a curve or through a switch. Over time, truck screws may tighten or loosen, so this is another of those maintenance issues which can require attention, even though that truck may have been fine when the car entered service.

Couplers

The standard coupler on my entire fleet at one time was the Kadee #5, and these are still in use on many older cars. But all new cars and many upgrades are receiving the "scale head" Kadee #58, or #78, or one of the whisker-sprung models. These interact acceptably with the #5 style but are best with other scale-head couplers, so I expect a gradual increase in the proportion of scale head heads in my fleet.



GETTING REAL | 4

Some ready-to-run cars come with other couplers nominally compatible with Kadee couplers but not always satisfactory. Recent freight cars assembled in China sometimes have a “copycat” coupler which only imitates the Kadee design, and though these work all right with others of the same design, I have found that they do not work as well with Kadee couplers as do other Kadees. I now routinely replace any “copycats” that show up.

I have tried the Accurail scale coupler and have not found it superior to the Kadee scale head. My instinct is to have one coupler type, so I am sticking to Kadees. Finally, I have not been happy with any of the plastic copies of the Kadee design, and routinely replace them with Kadee couplers.

With any coupler it is vital to ensure correct coupler height, and free operation of both the centering mechanism and the knuckle. I am careful about this with new cars, but do find that maintenance sometimes requires restoration of one or more of these qualities. In fact, any car which does not couple smoothly and dependably goes straight to the workbench for correction. The same is true of any trucks that do not perform as desired.

I am surprised when I hear modelers say that they know all about the Kadee height gauge but don't see the need to use it. This gauge is an excellent tool and reliance on it will make a car fleet far more consistent in performance. A sometimes overlooked feature of this gauge, on the back end, is that it indicates correct floor height [2]. Nowadays most kit cars and nearly all ready-to-run cars already have correct floor height, but if in doubt, I don't hesitate to check. This avoids lots of potential problems later.

Another thing I always check is height of the Kadee trip pin. Some modelers call it an “air hose,” but that's not the Kadee part name. The Kadee gauge gives you an easy check on this height also [3].



2. Here the back of the Kadee height gauge shows that the coupler pad on this car body is a little too low.

GETTING REAL | 6

Weight

One other aspect of performance is car weight. It is a topic which has received endless debate in the hobby. My own experience matches a number of published reports that *consistent* weight from car to car is more important than the particular weight value which is chosen. I tend to use the NMRA weight formula, half an ounce plus a half-ounce per inch of car length, which comes to 3.5 ounces for a 40-foot HO car. I don't have any serious grades on my layout, but if I did, I might standardize on a slightly lower car weight.

Detailing

This is a difficult area about which to generalize, given the differences among car types and the wide variety of commercial models

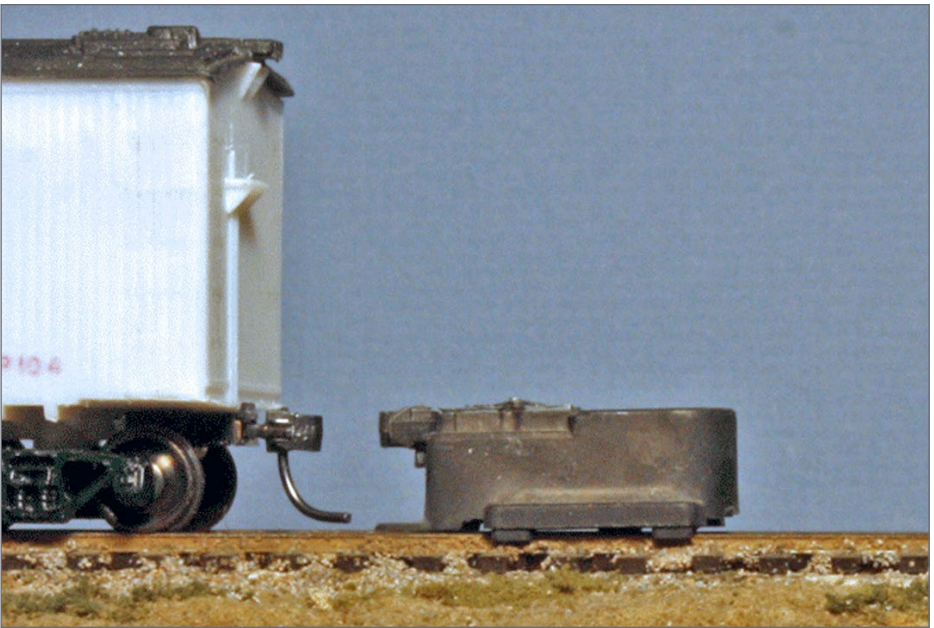

3. The Kadee gauge not only checks coupler height, but has a "shelf" below which checks height of the trip pin.

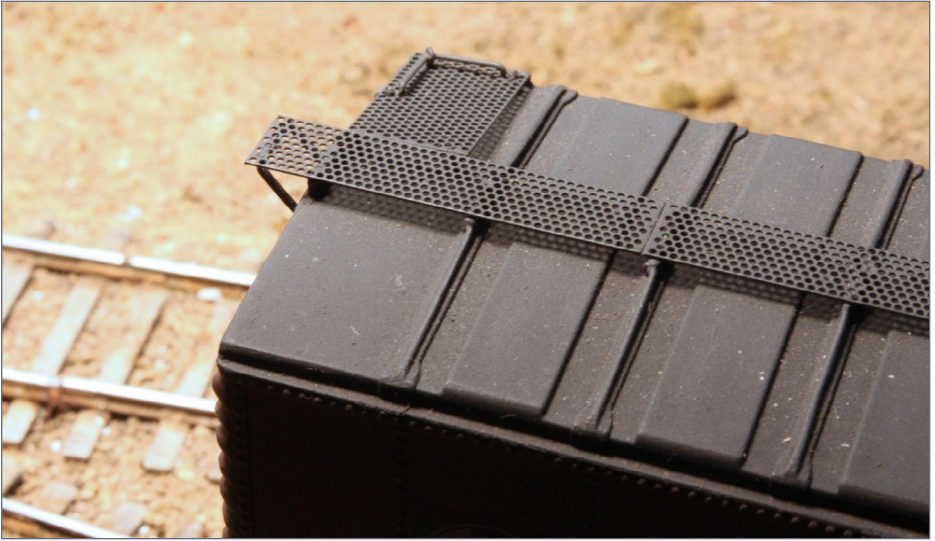

4. An example of a Morton etched metal running board, and wire corner grab iron.

that are available of each. But I can describe a few of the guidelines that I use. I should emphasize that these are *minimum* standards. I am not describing how good a model can be, only the minimum of quality I want it to have.

Car roofs are very visible on most layouts, given the common table heights we use, so I start with the running boards on house cars. The bad old days of terribly thick cast plastic running boards (so 20th century!) are fortunately behind us, but it's still essential to make sure running boards look right.

I model 1953, and prototype cars built new or extensively rebuilt since 1944 would have received steel running boards, as would many cars in shops for repair or upgrading. Etched metal boards are simply the best, in my opinion, though I think the Kadee plastic effort is impressive. I use model airplane canopy cement to attach the metal boards, since that adhesive remains flexible in the face of expansion and contraction of the metal part. An example is shown as [4].

GETTING REAL | 8

Wood running boards are readily modeled with wood or styrene strip. Corner grab irons need to be present, too. Though some of my mainline cars still have cast-on corner grab irons, they are being replaced. My “full standard” branchline cars all have free-standing corner grabs.

Nowadays most house car models have acceptable quality brake wheels, typically Ajax, but as more and more of the prototype specialties have become available including (Equipco, Superior,

Klasing, etc.), it's often possible to apply the correct brake wheel for a particular prototype car. I don't always do this, and sometimes it's not easy to find out which brake gear to use, but laying in a stock of the various prototypes permits doing it correctly when the information is available. My Sunshine model



5. The B or brake end of a Sunshine SP B-50-28 box car, with Kadee Equipco hand brake.



6. This Santa Fe box car shows bracket grab irons and a sill step, both of which are refined enough in size and shape to meet my standard. Note the reweigh paint patch.

of an SP Class B-50-28 box car illustrates this; it has a Kadee-made Equipco brake wheel [5].

For me, grab irons need to exhibit adequate refinement. Cast-on grabs are almost always replaced (except on a few of my main-line cars), and the heavy bracket grabs of early IMWX and InterMountain cars also fall short of modern standards. They can readily be replaced with the current InterMountain body parts, available for purchase as parts sprues (see Sources).

Modern kits and ready-to-run cars usually have acceptable sill steps, though often rather fragile. Cast-on ones are usually replaced with A-Line metal steps, as are damaged plastic ones. I still have some remaining stock of Tuttle steps, a slightly more refined part than the A-Line steps, and I tend to use them on models I regard as more important. To illustrate the kind of grab irons and sill steps I like, refer to [6].

GETTING REAL | 10



7. A California Dispatch Line insulated tank car, built for wine service, with National B-1 trucks. AC&F photo, *courtesy Ed Kaminski*



8. A Sunshine Models 8000-gallon tank car, lettered like the CDLX car shown in [7]. The National B-1 trucks are from Kadee.

GETTING REAL | 11

Underbody detail is not something I put a lot of work into, other than making sure that some brake rodding is visible from the side of the car. As Richard Hendrickson used to say, I intend my trackwork to be good enough that visitors will not get an inverted view of my freight cars. Hopper, covered hopper and tank cars are an exception, as their brake rigging is much more visible and needs to be correctly modeled.

Trucks are an important issue for some cars. Many transition-era freight cars used AAR-design trucks with sideframes only varying slightly from truck manufacturer to manufacturer. A fairly generic model truck may suffice for such cars. But there were some distinctive trucks in use, such as the National B-1. When such a truck was used on a car which I have modeled, I want the trucks to be correct. I show an example of such a prototype in [7], and the corresponding model in [8].

For a detailed description of HO scale trucks, the Hendrickson article cited in Sources is recommended.

Finally, I will mention route cards. Steel cars all have small (minimum 5.5 x 9 scale inches) boards to which a routing card could be tacked or stapled [9]. Older wood-sheathed cars, of course, could receive such cards anywhere on the car side. Tank cars with wood running boards often had route cards tacked to the edge of that board [10]. Customary locations were over the truck at the left end of the car, or sometimes just to the left of the center door on house cars.

Examination of prototype photos from the transition era shows that at least 80 to 90 percent of all cars in service exhibited such cards. Most were evidently manila or white in color, but color photos do show other colors, such as green, yellow, blue and red. It is easy to use ordinary paper of the desired color and cut out small rectangles, then glue them to the route boards or car siding with canopy glue. I would do the same with a tank car [11].





9. A clerk uses a hammer stapler to attach a route card to this box car. He is using the larger placard board; the "official" route card board is just visible behind his face. *Cotton Belt photo*

ADVERTISEMENT

END OF TRAIN DEVICE

NEW SAFETY GREEN

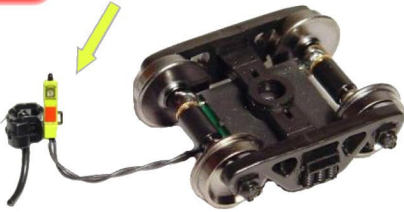

**Bright Red
Flashing Light!**

**Installs in minutes!
No freight car
modification required!**

Patented Technology - US Patent 7,549,609

Does not affect Load!

↓ Car without Load ↓



↓ Car with Load ↓



**Click Here to
Learn More**

**RE RING™
ENGINEERING**



10. This SP tank car has a route card board (the pale rectangle above the running board, to the right of the ladder and above the brake cylinder), but the last clerk who attached a route card put it on the edge of the wood running board, above the left truck. The car, incidentally, is in cottonseed oil service and apparently empty; note the outlet pipe cap hanging from a chain under the car (this should have been closed). *George Sisk photo at Kansas City, 1959, Charles Winters collection*

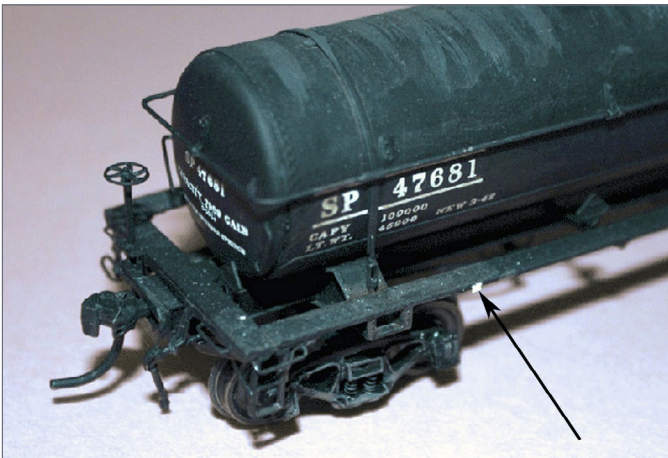

11. A model tank car with a route card (indicated by the arrow) on the edge of the "wood" running board, as was common prototype practice.

GETTING REAL | 14

Placards in place on placard boards on the doors of box cars, or on the side of refrigerator cars, are distinctly less common. I apply these to only a minority of my freight cars, but there certainly should be a few.

I should repeat here that I have not commented on my overall standards for accuracy of entire individual models. That is a more general topic than I address in this article, but of course has its own importance.

Lettering and weathering

The two topics of this section overlap in a sense, and could be presented in either order. Even the small lettering I will describe here



GETTING REAL | 15

might be applied prior to weathering, or after weathering. So my choice of order of presentation is a little arbitrary.

Lettering

By lettering here, I don't mean the major lettering that is on any freight car, the reporting marks and car number, railroad emblem



12. (Lower left) This superb photo shows a workman stenciling new weight data on a box car. Note that for this 50-ton car, the light weight and weight limit add up to 169,000 pounds, as was the rule. He is using a short-bristle brush, stiff white "stencil paste," and individual stencils for the numbers. It was natural that the spacing and alignment of individual digits might not be perfect. T&NO photo at Englewood Yard, near Houston. *California State Railroad Museum*

13. (Above) When a car was reweighed, a paint patch was applied, and in many cases only the last three affected digits were changed, and the place and date added.

if any, and all the dimensional data. I like to get as much of that lettering correct as is practical, and sometimes have spliced a lot of digits to get close to all the right values. But that's not what I mean to address in this section.

Instead, I want to emphasize the “lesser lettering” that should be there, because it is there on prototype cars. The major component here is the reweigh date [12]. I have consistently kept my freight car fleet correct on this point. After January 1, 1948, most cars had to be reweighed every 48 months. For a 1953 modeler, this means that any 1948 date is out of bounds, and only dates late in 1949 pass muster. My cars almost all have reweigh dates for 1950 to 1953 [13].

To read more about reweigh rules, you may wish to consult the article listed in Sources.

How is this modeled? I have made considerable use of the excellent reweigh data sets once sold by Sunshine Models, and am glad I laid in a good stock of these while Sunshine was still in business. You do see these on eBay and other on-line sales sites, and they are worth getting. Currently available decal sets from Speedwitch Media also include reweigh dates.

Second, I like to include repacking data blocks. On the prototype this lettering was placed over the right-hand truck [14]. It was normally one inch high, and thus pretty hard to read in HO scale. For that reason, I use repack decals that may not really be correct for date. Most cars with solid bearings were repacked around once a year. The principle here is that there should be some lettering above the right-hand truck on each side of a car [15]. Few could read it or would wish to, so lack of a correct date isn't essential, but I believe it is important to have something there.

Third, brake equipment was required to be cleaned and tested periodically. Eventually this was reported on a standard COTS

GETTING REAL | 17

stencil (Clean, Oil, Test, Stencil), but in my model year of 1953, that was many years in the future. Instead, the air reservoir would be stenciled, or if the reservoir was out of sight inside the side sill, the stencil was placed on the sill adjacent to the reservoir.



14. This Sunshine box car has fresh paint patches both for its reweigh data, and for its repack data over the right truck. Note in this case that all weight digits have been replaced, unlike [13]. Note also the route card on the door. The flat car at right has one too.

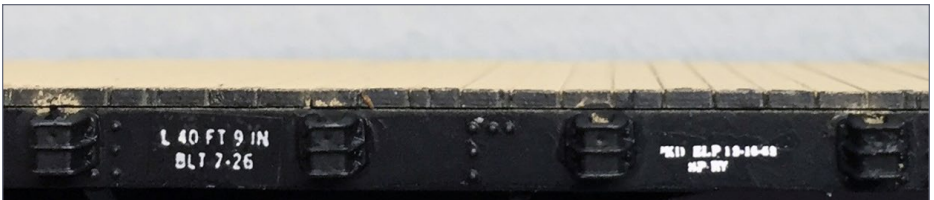

15. This Tichy flat car has a repack data group at the right of this photo. It happens to match the El Paso location of the reweigh on this car.

This is an unfamiliar lettering detail to most modelers, so I show [16] the AAR lettering drawing to show how lettering was supposed to be applied. But I should hasten to add that many prototype photos show other arrangements of lettering on reservoirs, so clearly the drawing was not rigorously followed. A prototype example of such lettering is shown in [17].

Here again, lettering was one inch high, so I simply use a small block of lettering so something is there, rather than try to reproduce actual stencil content. Looking at prototype photos, many cars accumulated enough dirt to make this lettering all but invisible, so I only apply it to a fraction of my freight car fleet [18].

Weathering

I do weather almost every single car. Photos of prototype cars only a month old already show some dust and dirt, so the myth of the “freshly painted car” really does not go very far. As I showed in my post on weathering Pacific Fruit Express cars (see Sources at the end of this article), one should attempt to create a wide range of levels of weathering, though most people (including me) don’t seem able to get there, particularly to the truly filthy dirt jobs. But at least a few cars should be so modeled, perhaps with a “wiped clean” area around the reporting marks and car number for those of us who operate with waybills and car cards.

My own weathering process emphasizes acrylic washes, as I have described in some detail in reference pages on my blog (you can access them at the links which are shown in Sources). I begin with acrylic tube paints [19], and mix up varying color batches to apply. There is no “formula” here, and I think it an advantage that there is probably never the exact match to any previous mix.

The process is to wet the model, add acrylic color, and use the brush to “stroke” and even out the tint as the drying process proceeds [20]. If this sounds daunting, trying it on some practice car bodies will quickly show what is needed and what works.

GETTING REAL | 19

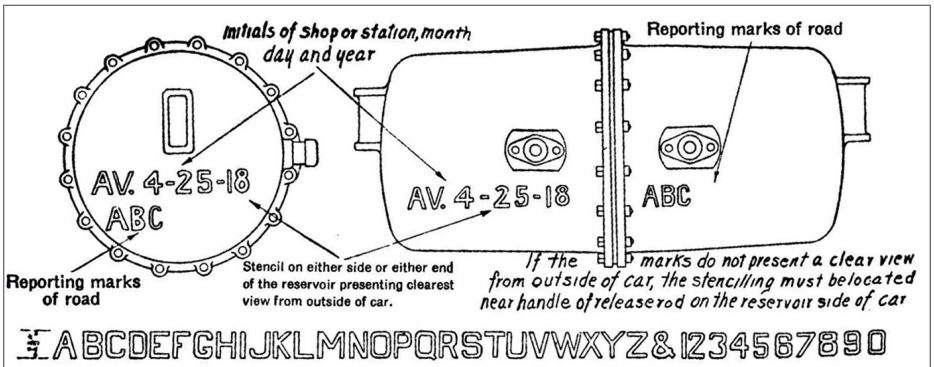

16. This is the 1952 AAR drawing showing arrangement and location of lettering on the reservoir to document date and place of brake servicing. Note that the reservoir end would be stenciled if more visible.



17. This detail from a photo of a Southern Pacific tank car with its reservoir readily visible shows the fresh stenciling for brake servicing. Tank cars often show brake stenciling very prominently because of the reservoir location. *Bruce Petty collection*



GETTING REAL | 20

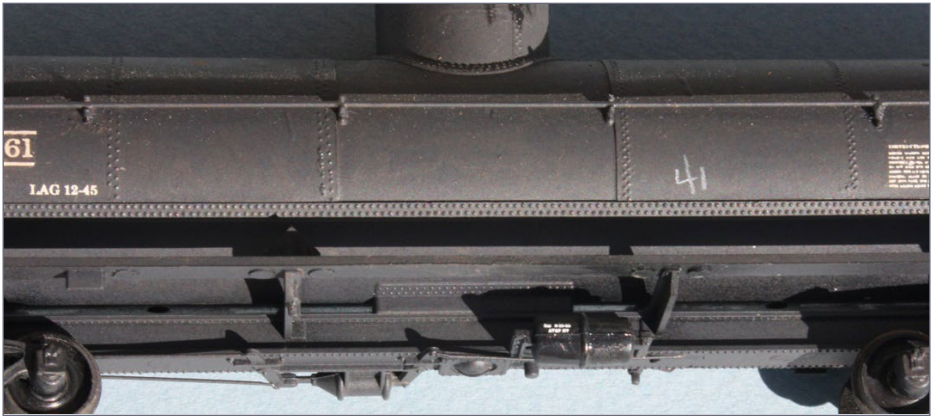

18. This model of an SP tank car has stenciling on its reservoir, as described in the text.



19. I use inexpensive tube acrylic paints in such colors as Neutral Gray and Burnt Umber, along with Black. A piece of cardboard can serve as a palette. The best brushes are relatively soft ones.

GETTING REAL | 21

My normal process is to do part of a car in one session and the remainder in another session, because that way there is something dry to hold on to. Some cars, like tank cars, can be a challenge to weather convincingly, because they really have to be entirely weathered in one session. A further challenge can be open-top cars like gondolas and hoppers, because the interior is usually at least partly rusted, if not entirely unpainted.

Once the car body is largely dry, some additional streaking with an almost dry brush can be effective [21]. Prototype photos are the best guide to where streaks develop, and what they look like. I am happy with my ability to use this method, but each person has to find the weathering method that works best for them, and then go to work.



20. This box car is showing dry areas toward the top of the car side. This is the last opportunity to smooth out any color blobs or streaks. In the photo, I am adding the wash to the trucks. I am holding the model by the roof and underbody that were previously weathered, and thus are now dry.

GETTING REAL | 22



21. In this photo, a streak descending from the end of the door track is being added. The brush size is evident here.



22. This box car has a wood running board. Note that it is made up of individual board lengths, not full car-length boards. Prismacolor pencils (available at any art store) were used to vary the shade of boxcar red from board to board, and to suggest a little gray showing up in the color as the underlying wood aged.

GETTING REAL | 23

There are of course other methods. I have seen superb weathering done with chalks, but even with the superior Bragdon materials, I am not always happy with the results I achieve. Others prefer oil paints or airbrushes, and fine work can certainly be done either way. I personally have found acrylic washes to be the most flexible and dependable to obtain what I want, so nearly all my cars are weathered that way. As I say, however, each person needs to discover what will work best for their particular needs and skills.

Of course, weathering does not end with car sides, roofs, and ends. One important challenge is any car part which represents wood, because wood tends to age and affect its paint covering differently from board to board. This is usually subtle, but can be represented with careful technique. I like to use artist's color

ADVERTISEMENT

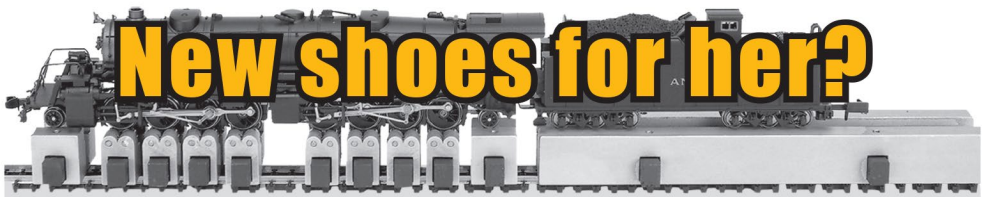

ROLLING ROADS

SPEEDOMETER For Speed in Real Time!



Analogue
or digital

One of these for you.

CLICK HERE

Bachrus inc
RUNNING ON QUALITY

www.bachrus.com
Hannon, ON Canada

• INDEX



SUBSCRIBE
(free)

• TABLE OF CONTENTS

GETTING REAL | 24

pencils for such challenges as wood car sheathing, wood roofs, or running boards, and have consistently found the Prismacolor pencils to perform best for me. An example of this technique on a running board is [22].

Another area of weathering challenge is the wood used for flat car decking, or wood floors in gondolas which were so equipped. With age, these wood areas tended to darken and tend toward a gray color. They are also severely gouged, scraped, dented and otherwise abused in service. Oil and other materials might be spilled



23. These flat car decks have all been modified from either “real wood” or painted plastic decks. All are Red Caboose SP Class F-70-7 models. Their appearance is now far more realistic than the out-of-the-box look. These cars were only a few years old at the time I model. Older cars would be darker and grayer.

on the wood. Some railroads did apply creosoted wood in these area, but most used other kinds of preservation treatments, so that the wood was not a blackish brown when brand new. Both acrylic washes and color pencils can be used in making a realistic wood appearance in these cases [23].

With the wood in gondola floors or flat car decks, it can be most instructive to take a look at prototype cars you may encounter. Contemporary cars are quite different from the transition-era equipment I model, but wood is wood, and you can certainly get some ideas from cars in service.

Lastly, I want to mention chalk marks. Certainly in the transition era, these were ubiquitous, and model freight cars without them definitely do not look like the cars in prototype photos. And remember, these marks by and large were *not* graffiti, but were deliberate marks made to convey information [24]. Many were merely letters and numbers. These might mean the track to which the car was destined, or the industry to which it was going, or the outgoing train it would join, or the day and time of loading, and so forth and so on. Every yard had its own codes and abbreviations, and most of the knowledge of those codes is now lost, but whatever they might mean, these marks are very visible.

For an even more vivid example than [24], a 1951 photo by Don Sims [25] shows a clerk writing on the cars during icing. To repeat, these marks are for information, and should not be called graffiti.

Here again, I use Prismacolor pencils, both white and light gray, to make chalk marks [26]. One can simply use the kind of letters and symbols seen in prototype photos to create these marks. The Monon box car of [26] is shown completed in [27]. The chalk marks have not been allowed to overwhelm the appearance of the overall model.

I want to conclude with a general comment about weathering. Heavy weathering is dramatic, and certainly in the transition era, with plentiful smoke from both locomotives and industrial plants,





24. This clerk in the 1920s is chalking some marks onto an automobile car using the standard one-inch diameter “rail-road chalk.” Note the paperwork in his left hand. What he is writing on the car conveys information to yard switch crews, or the crew of a local freight, or even to the switchmen at the car’s next destination. *Rob Evans collection*



25. (Top) This photo, taken at El Centro, CA in 1951, shows icing crews at work on these freshly loaded PFE refrigerator cars. Note the clerk at right holding a clipboard and writing with railroad chalk what appears to be date and time of icing.
Don Sims photo

26. (Bottom) A very fine point on a light gray or white Prismacolor pencil allows application of chalk marks to a finished model.

GETTING REAL | 28

many cars got seriously dirty. But a range is important too, to represent newer or repainted cars. And I always keep in mind that even a relatively recently built car shows at least a little dirt. Using my method of acrylic washes, I can readily create a light weathering look, and even that will contrast strongly with an unweathered car [28].

These are my most general standards. Beyond these, description becomes more intricate than is probably necessary here. But choices of good basic standards will help your car fleet look better and perform better. ☑



27. (Above) This Monon box car, the same one shown in [26], is well weathered, and shows only a modest number of chalk marks. This was commonplace. Note also the route card on the door and the paint patches for reweigh and repack data.

28. (Below) Initially, these two Red Caboose box cars were identical. But the one on the right has received light weathering and a reweigh patch. The contrast is striking. By itself, the one on the right would probably look fairly clean, but comparison to the out-of-the-box car shows the difference.

SOURCES

A-Line steps: ppw-aline.com/collections/freight-car-stirrup-sets

Article on PFE reefer weathering: modelingthesp.blogspot.com/2011/03/modeling-pfe-reefers-in-1953-2.html

Article on freight car reweigh: modelingthesp.blogspot.com/2011/03/reweigh-article-from-rmc.html

Chalk marks and route cards: modelingthesp.blogspot.com/2011/11/chalk-marks-and-route-cards.html and also following posts; search on “route cards”

InterMountain body parts: intermountain-railway.com/ho/hodetail.htm

Kadee products: kadee.com

Reboxx wheelsets: reboxx.com/wheelsets.htm

Richard Hendrickson on trucks: modelingthesp.blogspot.com/2013/07/another-update-to-richard-hendricksons.html

Speedwitch Media decals: speedwitchmedia.com/decals

Weathering reference pages. There are two parts: modelingthesp.blogspot.com/p/a-few-years-ago-richard-hendrickson-and.html

and:

modelingthesp.blogspot.com/p/weathering-with-acrylic-washes-specific.html ■



Click here to rate or comment on this article



WISH: Shadow expert home layout builders and learn their best tricks ...



MODULE 1
2.5' X 7'

MODULE 3
2' X 7'

30" at this end.



GRANTED: In the 2017 TMTV season, we do just that.



TRAINMASTERS.TV

Don't miss out: Click now and join in!



• INDEX

• TABLE OF CONTENTS



WHAT'S NEAT WITH KEN PATTERSON

KEN PATTERSON

column



[Click here to rate or comment on this article](#)

THE DIGITRAX DCS 240, ATHEARN SNOW SHOOT, A TRICKED-OUT BACHMANN 4-4-0, AND MORE ...

THIS MONTH, GEORGE BOGATIUK FROM SOUNDTRAXX stops by to show us a beautiful 4-4-0 that he tricked out using Bachmann's recently introduced model. The motor is no longer in the tender but is now in the boiler, opening new modeling possibilities.

We look at the new Digitrax DCS 240 and do a step by step installation of this. We also look at Bachmann's new streetcar with sounds and flashing sparking effects.

This month we build a trestle diorama for photography that will be covered with snow and icicles to create a beautiful image for Athearn featuring their new NP 4-6-4.

First, I want to follow up on last month's track cleaning tool construction story about using a breaker bar handle and wood block with attached track abrasive cleaner.

▶ [PHOTOS AND VIDEO OF SUPERB MODELS](#)



WHAT'S NEAT | 2



1. I have experimented further with this track cleaning tool concept by testing additional breaker bar handles of various types and shapes. Here you see a gun rack that I built holding the six sizes and types of track cleaners that have worked the best so far and are worth keeping. The gold breaker bar track cleaner with a dark varnished walnut head is simply a beautiful tool to see.



2. Last month I talked about tipping over the breaker bar with the higher center of gravity. It wasn't working very well with the two and a half inch long head. I suggested using a six-inch head instead, as this worked with the higher pivot point found on a lot of breaker bars on the market. Well, the six-inch head turned out to not be very functional on HO scale right of ways.

WHAT'S NEAT | 3



3. I had to redesign the tool to lower the center of gravity and did this by grinding down the square tip of the breaker bar to the spring-loaded ball. A belt sander or bench grinder will work for this. Keep a bowl of cool water on hand for this process.

HAVING FUN WITH TRAINS

MRH

MODEL RAILROAD HOBBYIST

February 2017 -
What's neat ...

Playback problems? [Click here ...](#)

• [INDEX](#)



SUBSCRIBE
(free)

• [TABLE OF CONTENTS](#)

WHAT'S NEAT | 4



4. I then cut a bigger hole in the wood block to accept the breaker bar's round head. This lowers the tool's high pivot point and moves its center of gravity closer to the track.



5. This worked really well, as you see in this photo with the gold breaker bar handle. This process lowered the center of gravity by half an inch, making it less top-heavy with the two and a half inch block of wood.

WHAT'S NEAT | 5



6. I also tried a breaker bar with a bent handle. It had a good feel to it in the switch yard between freight cars, but did not clear bridges past eight inches.



7. When you flip over the reversible head, the tool offers a very powerful feel. I can exert a lot of pressure on the track with the grip offered in this position, as the handle lines up well with the arm for accuracy and stability.



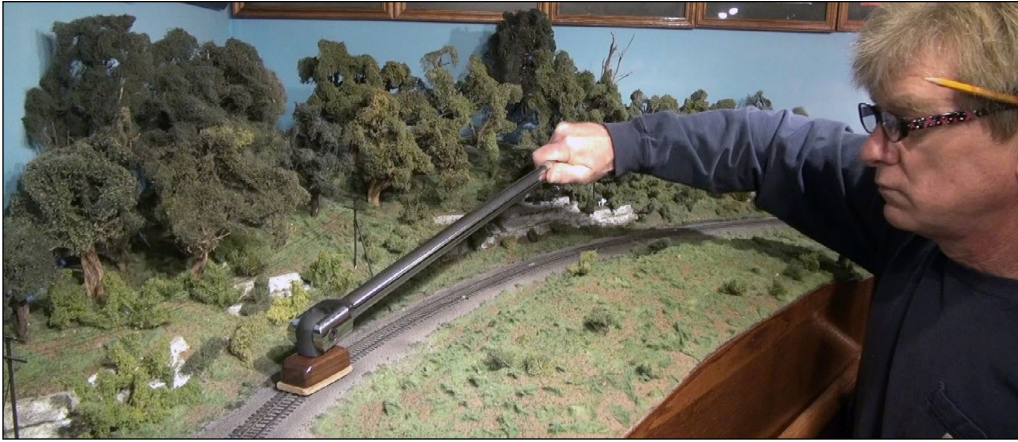

8. I used a three-quarter-inch breaker bar handle 25 inches long to make this polished chrome track cleaning tool, with 998 foot-pounds of torque (Ken may be stretching things here a little bit) and weighing in at five pounds. It worked great, but if handled improperly it could do a lot of damage to a right of way. This is an extreme track cleaning tool, more a conversation piece that would be fun to use at a train show cleaning a modular display layout.

**Want to help keep
MRH free?**

Then *click* on ads!

WHAT'S NEAT | 7

Digitrax DCS 240 Installation



9. This month we look at the new DCS 240 power command station. I really like the new features included in this unit, like the USB port which will allow me to eliminate my Digitrax PR3 and all the wiring associated with that. It also comes with a built-in power booster for the programming track and means I can eliminate my Soundtraxx PTB-100 programming track power booster and all the wires attached to that. It is also convenient to have three Loco-Net jacks on the front panel.



[Click here to rate or comment on this article](#)





10. My power system is located on my workbench where I spend most of my time. I can visually keep control of my layout as it runs slowly while I work all day. The system includes a DC power pack to switch the layout over to run analog trains but I plan to eliminate this. Everything that controls my DCC system is easy to get to and is always in clear view. All the wires do not look so nice, and today's project will clean this up. You can clearly see my PR3 computer interface and the PTB-100 programming track booster. Wood cradles hold the throttles firmly in place while pressing buttons and they are easy to see and access for radio control. The power supply is a three amp 30-volt system with digital readouts, along with my DCS 100 which works great and has for 17 years. I have added a Digitrax Zephyr to allow simple knob control. I will show you how to convert this DCS 51 Zephyr to a simple throttle connected to the LocoNet.



[Click here to rate or comment on this article](#)

Have you seen this?

**CHECK IT
OUT!**



kenpatterson.com

click here to ...

Visit Ken's website

**Ken Patterson
reveals his modeling
secrets on video!**





11. You will also notice the wood box with digital volt and amp meters. This was a project and article published in *Rail Model Journal* in December 2003. I built this box and added a Tony's Train Exchange RR-Amp meter and Digitrax face plates to have easy access to the LocoNet.



12. I also installed a Digitrax UR91 radio receiver in the wood box to allow good radio reception in that area of the layout room. I stained and varnished the control box to match the layout room decor.



13. To start the DCS 240 installation, I needed to un-wire and pull everything apart. I started with the Digitrax PR3 which was attached to my bench with wood screws. I moved the Digitrax face plate about eight inches to the left to open up more space.

Please tell your buddies about MRH!

WE RELY ON WORD-OF-MOUTH TO GROW AND A BIGGER CIRCULATION MEANS MRH IS MORE LIKELY TO STICK AROUND FOR A LONG TIME TO COME!



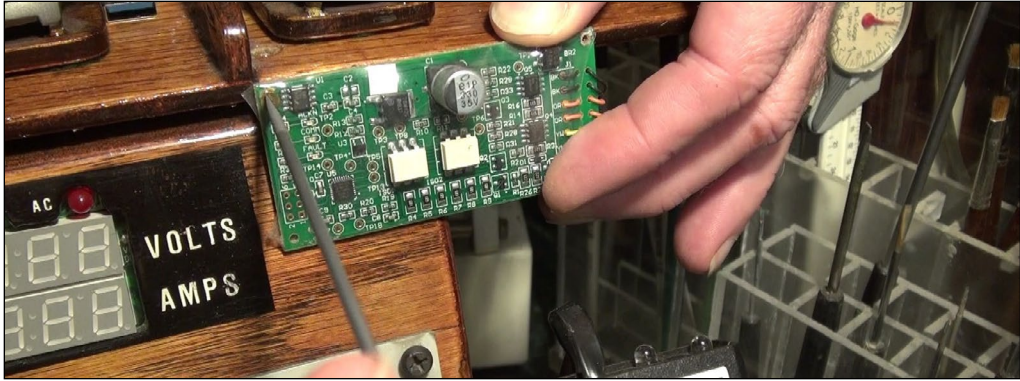

14. I removed the PTB-100 power booster for the programming track and the eight or so wires associated with that, making the wood power box look better without the electronics screwed to the front of it.



15. I pulled all the wires off the DCS 100's terminals. They included the Loconet six-wire connector, two track power leads, the two programming track wires and the two power supply wires. This unit will be programmed and used as a simple power booster to control another section of the layout as we add signals down the road.

WHAT'S NEAT | 12



16. I modified the Digitrax power harness, removing two of the four wires but keeping the inline fuse in place. I cut off the crimped-on wire connectors and replaced these with banana plug jacks.



17. These banana connectors plug in to the power supply's front power jacks. Matching the red to positive and black to negative is easy and fast.





18. I hid most of the power wires' length under the shelf. They emerge just where they attach to the DCS240 terminals with screws. You can also see the five-amp automotive inline fuse covered in black shrink wrap.

TrainMasters TV is part of the MRH product family.

TMTV members not only get great network TV level videos, they help pay for MRH and keep it free ...

WHAT'S NEAT | 14

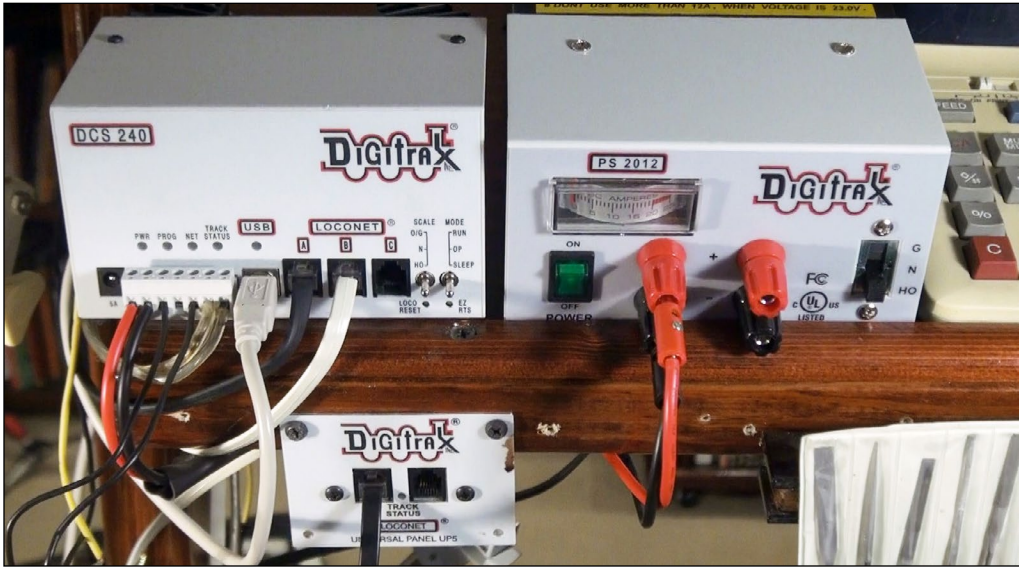

19. I attached the programming track wires, the LocoNet 6 conductor jacks, and the USB cable. That finished the hardware installation. With the power supply turned on, the DCS-240 lit up with colorful LEDs and sounds immediately started coming from my train on the main line. I turned the knob on my throttle and the train started running, just like that.



[Click here to rate or comment on this article](#)





20. The next thing I wanted to accomplish was to convert my Digitrax Zephyr power command station (DCS 51) to a simple throttle connected to the LocoNet so I could enjoy operating trains with a large power knob – I am old school and like it that way when I am just running slow laps around the layout. To do this, I pressed the program key, then pressed the switch key. I entered #2, the number of the option switch which needed to be set to “closed,” (C). Upon exiting the program mode, the -BR- was displayed, confirming that my Zephyr was now a simple throttle.



[Click here to rate or comment on this article](#)



21. The last step in the process was to connect the laptop computer to the DCS 240 through the USB cable. Upon launching Decoder Pro, I got a prompt that COM 3 Port was not found. Upon further investigation by checking my computer's device menu, I found the DCS 240 wanted communicate through the USB COM 5 Port.

**Did you know
there's an
MRH index
available?**

[CLICK TO FIND OUT MORE](#)



WHAT'S NEAT | 17

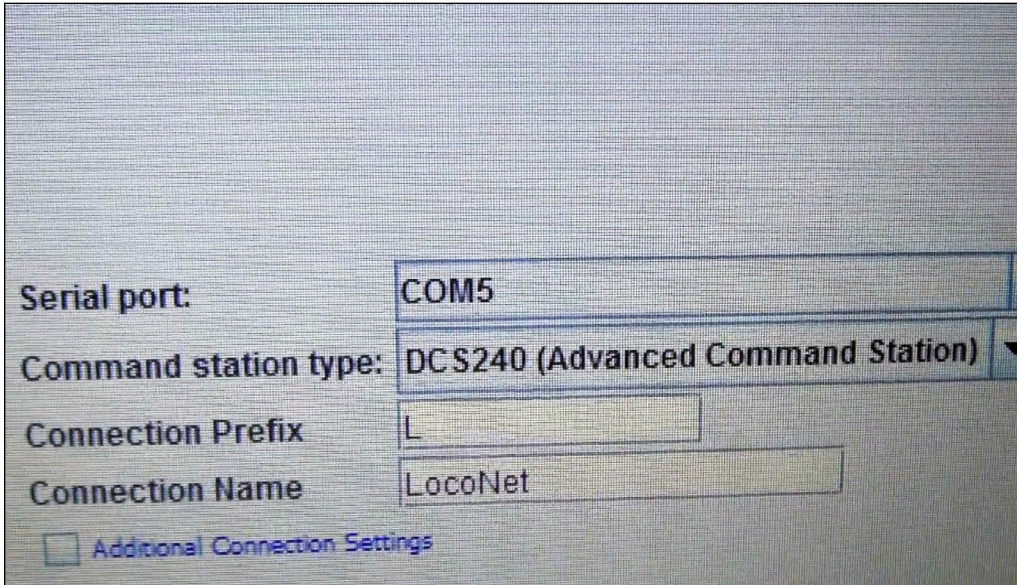

22. This meant I had to program the preferences setting in JMRI Decoder Pro to match the hardware. I did this using the multiple-choice dialog box in Decoder Pro's preferences settings. I set the serial port to COM 5 and the command station type to DCS 240 Advanced command station. Just like that, JMRI Decoder Pro program opened on my laptop with a green icon indicating that I can now program decoders and run trains using my computer interface.



[Click here to rate or comment on this article](#)

WHAT'S NEAT | 18

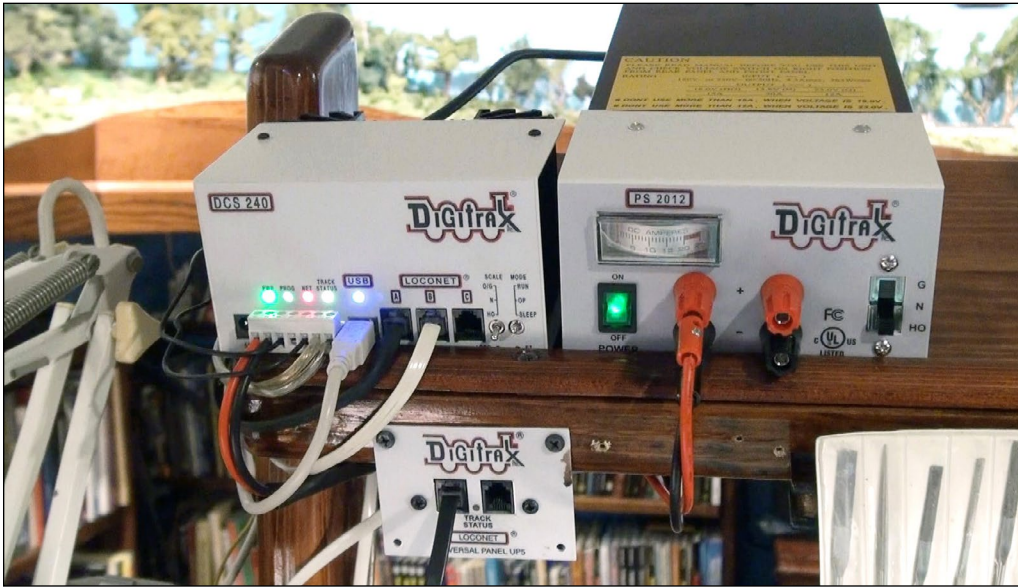

23. In a future month, we will separate the layout into 14 power districts for signaling, but for now I have made a good choice upgrading my DCC system with the new Digitrax DCS 240 and a new power supply providing my layout with a solid 14+ volts to the system, not to mention the pretty rainbow of LEDs lighting up the front panel of the Digitrax DSC 240. It should last me another 17 years of reliable use on my layout, as my DCS 100 did.



[Click here to rate or comment on this article](#)



WHAT'S NEAT | 19

The Athearn snowy trestle photo shoot



24. This month, Athearn asked that I design another photograph around a prototype photo to feature their new Northern Pacific Challenger locomotive running across a trestle in the snow. This

WHAT'S NEAT | 20



is a pretty amazing photograph and I will walk you through the process of creating it.

• [INDEX](#)



[SUBSCRIBE](#)
(free)

• [TABLE OF CONTENTS](#)

WHAT'S NEAT | 21



25. I started with a line drawing of the concept and how the final photo should come out, with the locomotive three-fourths of the way across the bridge with trees in various areas to fill the background.

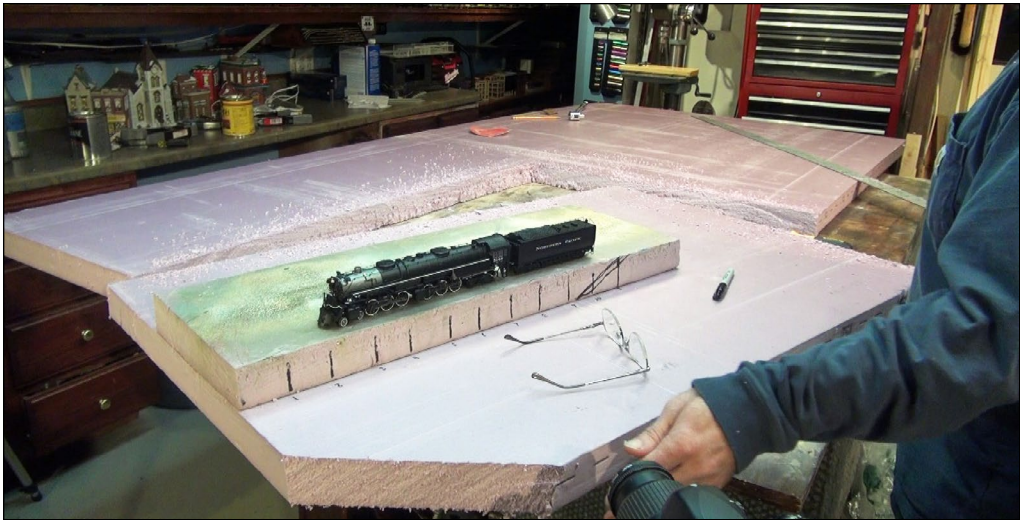

26. After plotting the scene on a 4x8 sheet of two-inch foam, I drew the placement of the bridge on the side of another sheet of foam and placed the locomotive on top of this. The finished cut out scene measured 40 by 28 inches.

WHAT'S NEAT | 22



27. I carved the topography on the foam scene using a pruning saw, a chainsaw and a Stanley Surform planer, working my way around the diorama and checking measurements for the bridge's placement until everything looked prototypically accurate to create a realistic looking scene.



[Click here to rate or comment on this article](#)



WHAT'S NEAT | 23

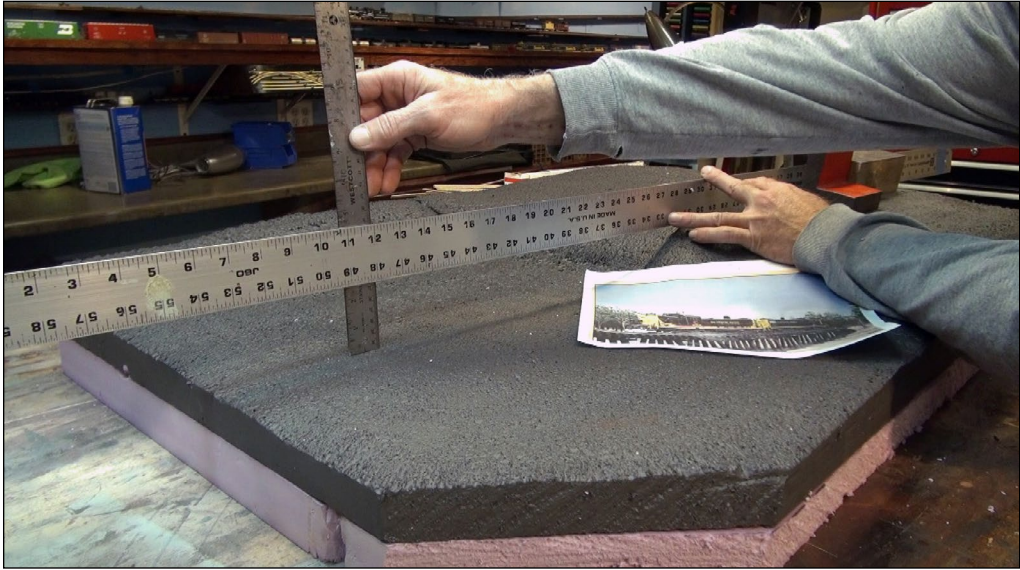

28. After painting the foam with dark latex paint, I measured from the bridge's deck location to the foam to understand how long the trestle bents needed to be. I figured I would sink the bents into the foam about half an inch.



29. Going through my dowel rod stock, I looked for poles with a scale diameter of 13 or 14 inches. 3/16th-inch dowel rods fit this bill. I sanded the poles lengthwise with 80 grit paper, cutting wood grain into the dowels and decreased their diameter to about 12 scale inches.

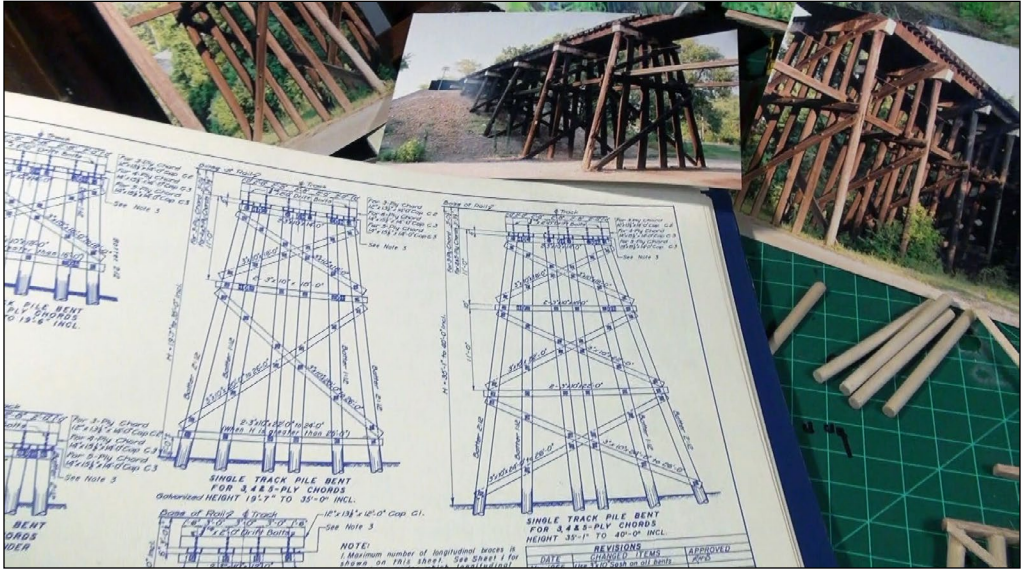

30. Checking through prototype photos and dimensions taken from prototype railroad standards books, I handbuilt the first trestle bent piece by piece. This first bent was used to make a trestle building jig.

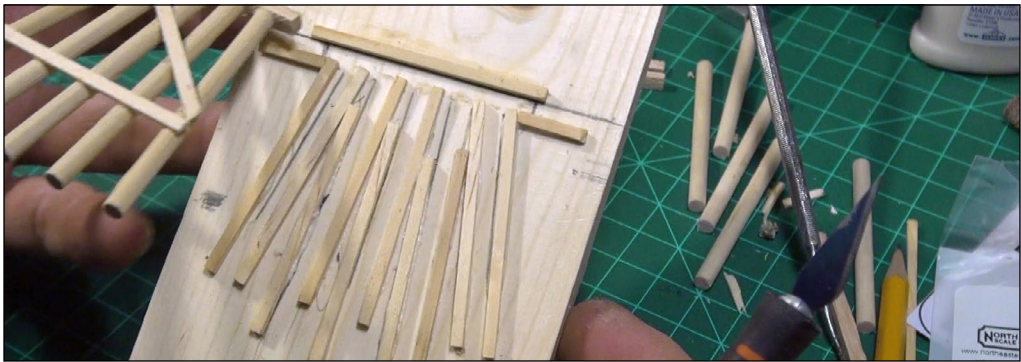

31. To build the jig, I glued HO scale switch ties to the jig surface, placing them on each side of the dowel rods leaving no space for movement or slippage. After the glue started to set up, I carefully removed the trestle bent from the jig, revealing my new trestle building tool.

WHAT'S NEAT | 25

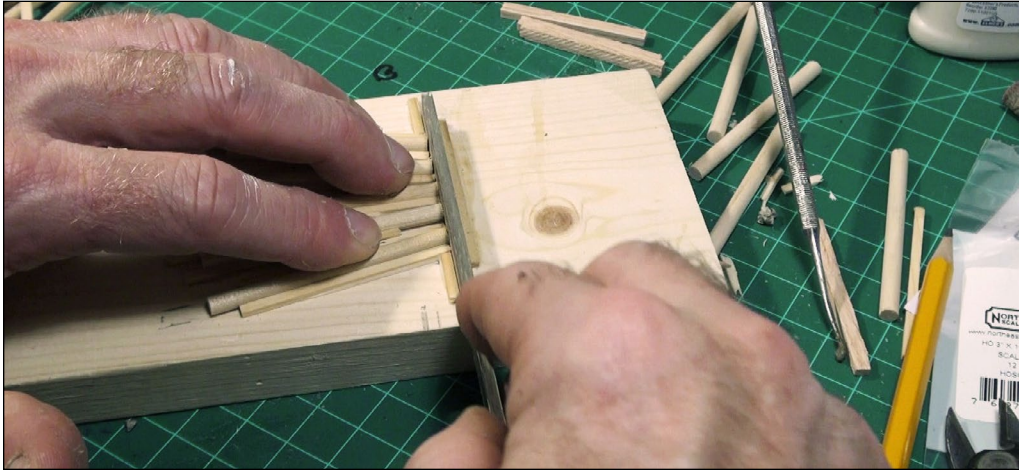

32. To build a trestle bent using the jig, I placed five dowel rods into the jig's grooves. I filed the tops of the poles so they would match up flush with the 14-foot-long top cap.



33. The building process moved faster after I built a few bents. The next step was adding 3x10 cross braces and 3x10 sway braces to both sides of each bent. I glued these in place with wood glue until I had 10 bents built.



34. If you study prototype photos of trestles, you will see they are not glued but instead bolted together. I wanted to capture this detail on the photo diorama model.



[Click here to rate or comment on this article](#)





35. Using a #65 drill bit in a drill press, I drilled holes in 11 locations on each side of the trestle bents where the bolts would hold the structure together. I then glued Grandt Line 2½ inch bolt castings into each of the bolt locations.

ADVERTISEMENT





36. To build the top deck of the bridge, I followed prototype standards. The deck is just under eight feet wide. I cut this part from a quarter-inch thick piece of oak plywood. It scaled out to 16 inches high, the same as a standard stringer, adding strength to our bridge without having to lay each stringer board individually. This saves a lot of time and adds a detail that will not look out of place in the final photograph. I glued scale bridge ties across our bridge deck, keeping everything square and evenly spaced.



[Click here to rate or comment on this article](#)



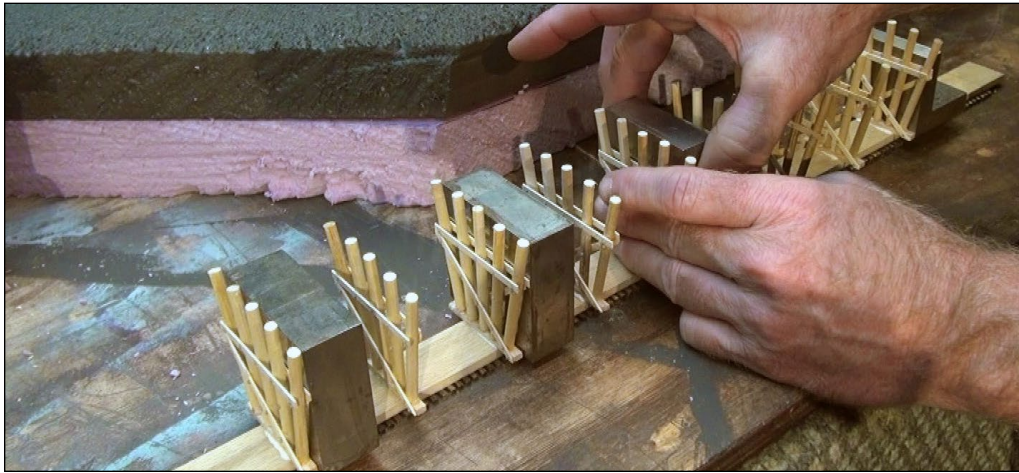

37. I glued the finished trestle bents to the bottom of the bridge deck on 14-foot centers using wood glue. I also used steel blocks to ensure everything was square as the glue dried.



38. I placed the bridge on the diorama and used a white marker to show where the bents would be sunk into the foam scene. I then cut these grooves out with a Dremel motor tool and a router bit attachment.

WHAT'S NEAT | 30



39. I test-fit the bridge into the foam, sinking it half an inch, making sure everything lined up perfectly and the bridge was level on both ends and in the middle. So far, so good: everything fits and the bolt castings look great with everything going together smoothly so far.



40. I painted the trestle with a can of Rustoleum Camouflage Brown spray paint. This will dry flat and be a good base coat as we color the bridge and add some weathering effects.



WHAT'S NEAT | 31



41. I filled the grooves in the foam with a bead of Gorilla Glue. I then placed the bridge on the scene, sinking it into the glue, and lining things up level and straight using a steel block on one end, and shimmed a little to make everything level.



42. I then clamped the bridge deck to the bottom of the level so it would hang level as I sprayed water into the grooves to activate the Gorilla Glue to start it expanding and promote a hard cure. I stayed with the glue during the curing process, pushing excess expansion back into the grooves with a dental pick so it would not creep up the bents and ruin my work. After the glue cured, I removed the clamps and sprayed the earth at the base of the trestle with more camouflage paint and let this dry flat.

WHAT'S NEAT | 32



43. I peeled the ties off of a piece of code 70 Micro Engineering track the length of the bridge. This rail will lay flat atop the bridge deck, giving a smooth transition from the land to the bridge.



44. I glued the track to the roadbed with Liquid Nails. I glued the rail to the bridge deck with contact cement keeping everything in gauge with Micro Engineering HO scale three-point track gauges. I further attached the rail to the bridge with scale track spikes pushed through the bridge ties with a pair of pliers. I attached 4x8 guard timbers to the outside of the rail, gluing these to the bridge deck.





45. I further painted the trestle with a fine spray of black paint, creating that creosote look. I then built a bridge abutment from scrap wood railroad ties and spread rip-rap around this area, working the rocks smooth with an artist's fan brush.



46. I ballasted the track with Woodland Scenics gray ballast. I covered the entire scene with an even coat of sifted dirt, then wet the entire diorama with two 16-ounce bottles of Woodland Scenics Scenic Cement and let this dry overnight.



47. I took my time, about two hours, planting trees and vegetation in the scene using wire trees and Super Trees. All were painted with matte camouflage paint before placing them into the scene. I looked through the camera each time I planted a tree to be sure the composition looked prototypically accurate and would balance well with the locomotive.



48. Because the photo was to be a cold February snow scene, Chris Palomarez from Athearn asked that I add icicles to the bottom of the bridge. I did this by dabbing silicone caulk in various areas under the structure. This effect will add just a little more magic to the final photograph.



WHAT'S NEAT | 35



49. Using a simple kitchen strainer, I sifted plaster over the entire scene minutes before the photo shoot. I cleaned the rails where the locomotive would sit to ensure a good DCC signal to light the headlight, markers and number boards of the model. I covered the freight cars with snow but kept the snow on the locomotive relatively light.



50. Everything was set up outside for the photo shoot. It was a cloudy, windy and very cold day, matching the scene's feel perfectly. I had to clean the windblown plaster off of the steam locomotive and my camera lens about every 30 to 45 seconds throughout the 20-minute photo shoot.



51. After the shoot was complete, I wanted to get the plaster off the scene before I brought it back inside, as the warm humid indoor air would cause the plaster to set up. I knocked most of it off into the grass, then finished the cleaning process with the garden hose, making the diorama clean and ready for its next photo shoot with desert scenery in a few weeks. The result is a very beautiful and realistic model photo of the new Athearn NP Challenger running across the bridge, with steam and smoke magic added in Photoshop by Chris Palomarez.



[Click here to rate or comment on this article](#)





52. (Above) George Bogatiuk recently traveled from Durango, CO to spend some time with us in the What's Neat studio. He was here to shoot some SoundTraxx videos covering the operating and programming features of the new Tsunami 2 sound decoders that will be featured in next month's show. While he was here, he wanted to share the beautiful Bachmann 4-4-0 that he superdetailed and gave a Soundtraxx Tsunami 2 sound system.

53. (Upper right) George added backhead detail that includes gauges and control levers. A crew sitting in seats makes the interior look complete.

54. (Lower right) George cut out the plastic wood load, creating space in the tender to install a Soundtraxx Tsunami 2 TSU1100 decoder and current keeper. He also installed a 20mm round speaker. The original circuit board was removed, along with the tender weights. George melted A-Line low melting point lead to add a little weight around all the electronics. Scale wood cut to represent the locomotive's fuel was then added to cover the decoder, current keeper and speaker. The sound passes through the wood load.

WHAT'S NEAT | 38



• [INDEX](#)



[SUBSCRIBE](#)
(free)

• [TABLE OF CONTENTS](#)



55. A new pilot/cow catcher was added to the model with link and pin coupler bar details attached. A detailed smoke-stack was attached to the boiler, along with flag posts.



56. George installed a new bell, whistle, water pumps and all the ropes along the boiler. It is a wonderful-looking model that runs smoothly and sounds fantastic. Watch this month's video to meet George on screen and witness this masterpiece running along the mainline.

WHAT'S NEAT | 40

Bachmann streetcar with special effects



57. In the final segment this month, we look at a night-time photo shoot. I was photographing Bachmann's new streetcar equipped with sound, interior lighting and a power pole with an arcing/flashing effect that corresponds with the electric sound of overhead wire sparking. A very bright LED on the streetcar's pole creates this effect from time to time as it is running. I demo this model real-time in this month's video.

That wraps up February's "What's Neat" features. Be sure to leave feedback by voting 5 stars in the Readers' Comments link if you like "What's Neat" and tell a friend about the show.



[Click here to rate or comment on this article](#)





MRH MARKETPLACE

Imagine that!
Laser Art Products

ITLA Scale Models

*Precision Laser
Cut Wood Products*

*Cooper's Alley
HO Scale Laser
Cut Wood Kit*



CLICK HERE FOR MORE INFORMATION
www.itlascalemodels.com

Port Costa RH

2 stall RH
in HO scale all
laser cut wood
#2097 \$170



421 Hopkins Road, Dummerston, VT 05301
802-258-3869

See all of our fine products from HO to F/G scales at:
www.bantamodelworks.com

CROW RIVER PRODUCTS

KIT 317 SOUTHWEST LEDGE LIGHT

An "O" Scale Victorian Lighthouse
For the Layout or the Display Shelf

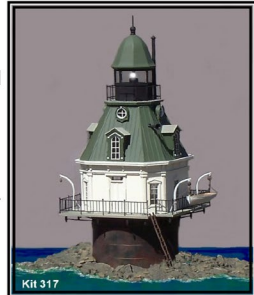

The model
is resin &
Pewter
castings
with laser
cut details.

Footprint
61/2" Sq.
14" High

Price
\$185.00

Made in USA

For adult
Hobbyist

HO & O

Scale

Machinery, Derricks,
Engines, Hardware & Waterfront Models
Pawtucket, RI 02861 Tel 401-723-0065
www.crowriverproducts.com

NEW #8 HO/HON3 DUAL GAUGE LEFT TURNOUT TEMPLATE



Anyone can
build track with
Oak Hill.

Template Kit comes with everything
cut, filed, gaped, and formed to make
5 turnouts, plus 1 free tube of Pliobond.

See Ken Patterson's What's Neat
to see just how easy it can be!

Click to see video

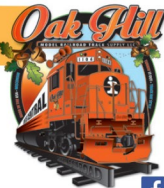

www.ohrtracksupply.com

MRH MARKETPLACE | 2



ATSF Dk-48



Yarmouth Model Works

HO scale resin kits and detail parts

U.S.A. MAILING ADDRESS
3560 Pine Grove Ave., Unit 617
Port Huron, MI 48060

Tel. 519-633-7574
pierre.oliver@start.ca

www.yarmouthmodelworks.com

CANADIAN MAILING ADDRESS
85 Hiawatha St.
St. Thomas, ON N5P 2T5

LEARN to
Make Trees
Watch FREE
VIDEOS

MODEL RAILROAD
BenchWork
Affordable built to order Benchwork
starting at only \$20 a Sq Ft.

GOODDEALSdcc
WWW.GOODDEALSdcc.COM

HOME OF THE
PROGRAMMER TEST TRACK SYSTEMS

DC & DCC COMPATIBLE
ALL SCALES AVAILABLE
CUSTOM ORDERS
DEALER INQUIRIES WELCOME

GARY COHN
106 CENTER STREET
FOX RIVER GROVE, IL 60021
GARY@GOODDEALSdcc.COM

FEATURING
America's Historic
Main Street Architecture

O-Scale model shown (HO available)

MAINSTREET
HERITAGE

www.mainstreet-heritage.com

LOOK
at what's new at
Black Cat this month

Click here for
our website

CNR
open top Hoppers

Black Cat Publishing
(204)489-5005
ajfergus@mymts.net
blackcatdecals.com



W GOLDEN AGE LINE
WESTERFIELD
MODELS, LLC

**New Kits Available:
S-40-1 Pressed Steel U/F
Stock, LA&SL, OSL,UP**



westerfieldmodels.com

clever models LLC
Cardstock models & materials



Try one today!

www.clevermodels.net

Looking for a signaling solution or fast clocks? Look no further!



LOGIC RAIL
SOPHISTICATED MODEL RAILROAD ELECTRONICS

"Sophisticated Model Railroad Electronics"

Please visit our website and online store!

21175 Tomball Pkwy Phone: (281)251-5813
Suite 287 <http://www.logicrailtech.com>
Houston, TX 77070 info@logicrailtech.com

P R E C I S I O N D E S I G N C O

Chains
Flat Car loads
Joint Bars
Signs & Posts

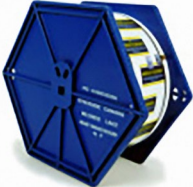

FREE SHIPPING

MOOSEY RAILROAD
BenchWork.com



Affordable Modular (**domino**)
Benchwork in 200+ sizes
Custom built to order benchwork also available!

PRE-SIZE
MODEL SPECIALTIES

P.O. Box 6 Paonia, CO 81428
Ph. 970 527 4586
Made in The USA

Cast resin items for All Scales.
Tunnel portals, bridge piers, abutments,
culverts, and retaining walls.
Trackside details and sage brush tree
armatures.

"FREE SHIPPING see website for details"

**HOBBY
MARKETPLACE**
ads are
economical and
effective.

Click HERE to learn more.

HO DIESEL SUPPLY

KATO EMD SD SPECIALIST-REPAIRS-UPGRADES

New and Rebuilt Locomotives

Powered Chassis-Trucks-Motors

Bodies and Parts-Handrails-Electronics

www.hodieselsupply.com

email:kato@hodieselsupply.com

Model Railroad Control Systems

Geff Bunza Project Boards

DCC Occupancy Detectors

CMRInet Compatible Nodes 

Layout Telephone Systems

RFID Switchlist Generator

Switch Machines and Drivers

MOUNTAIN SUBDIVISION HOBBIES

www.modelrrsupply.com

FREE USA SHIPPING OVER \$29.00

NCE - SOUNDTRAXX - DIGITRAX - PECO - CIRCUITRON
DCC SPECIALTIES - INTERMOUNTAIN - CMX - ATLAS
BAR MILLS - BOWSER - KATO - MRC - TOMAR - RIX -
PIKESTUFF - LOGICRAIL - CENTRAL VALLEY AND MORE!

RULERS-of-the-WORLD

Scale Rulers \$4 each

Over 200+ scales!

Metric or Imperial

www.rulers-of-the-world.com

Great Decals!™

FEC, Interstate, Virginian
Railway, & L&N Titles 

After Hours Graphics Line

Coupler Gages and More

In O, S, HO, and N Scales

Have you seen these
popular blogs on the
MRH website?



Tom Johnson's L&N

305,000 reads

CLICK TO READ IT NOW 



Ken Glover's Shelf Layout

102,000 reads

CLICK TO READ IT NOW 





Wild lichens stand in for goldenrod, asters and other invaders in scales from N to G ...

WEEDS

Along the right of way



Goldenrod flourishes along many rights of way across the country. Here it spreads near the abandoned freight house on William Gill's S. Troy, NY module. *William Gill photo*

• [INDEX](#)



[SUBSCRIBE](#)
(free)

• [TABLE OF CONTENTS](#)

BY **BILL GILL**
PHOTOS BY **BILL**
AND **WILLIAM GILL**



[Click here to rate or comment on this article](#)

THE SIMPLE NAME GOLDENROD (SOLIDAGO) COVERS more than a hundred plant varieties. Chances are railroads across Canada, the U.S., Mexico, parts of South America, Europe, Northern Africa and China have goldenrod lurking somewhere [2]. Flashy goldenrod unfairly takes the rap for allergies caused by plain jane ragweed, and its showy yellow blooms became the first specific weed I modeled [3]. My layout is HO scale but the same materials and methods work well for multiple scales because these plants vary from around four feet (1.2 m) to about six and a half feet (2 m) in height for the taller varieties [4].

Getting started

My modeled weeds begin with lichens. Not the commercial lichens used for modeling foliage and shrubbery, but wild unprocessed lichens found growing on deciduous trees in many areas [5]. These fruticose (bushy) lichens [6] are found in sizes that can be used for different scales. Let the lichens



1. Goldenrod blooms along a right of way in late summer. *Bill Gill photo*

WEEDS ALONG RIGHT OF WAY | 4



2. Individual stems of bright yellow goldenrod grow below a right of way. These are just over three feet tall. *Bill Gill photo*



3. Goldenrod flourishes along many rights of way across the country. Here it spreads near the abandoned freight house on Will Gill's South Troy, NY module. *William Gill Photo*



WEEDS ALONG RIGHT OF WAY | 5



4a. This display shows weeds made for three scales by starting with different lengths of lichen stalks.



4b. The first column is goldenrod blooming in late summer. The second column is wild asters and the last two columns are more generic tall weeds in fall coloring. *Bill Gill photo*



5. This twig is covered with a number of different kinds of lichens. The bushy looking one on the right end is the kind used to create the weeds in this article. These lichens can be found growing in large and small clumps and can be used for different scale weeds. *Bill Gill photo*

dry for about a week and they will shrink and look like miniature leafless bushes. I look for strands that have thin, straight stems about the right length, and pull them off the base of a clump with tweezers.

When you have a pile of 50 or so stems, submerge them for a few minutes in Pledge With Future Floor Care Multi-surface Finish – the liquid acrylic formerly known simply as Future [7]. The dried stems soak up some of the acrylic but will swell up less than lichens preserved with glycerin mixed with alcohol or water. The acrylic preserves, seals and slightly stiffens and strengthens the lichens, creating plants that can survive small mishaps on a layout. Blot the stems on a paper towel and dry them overnight on wax paper. The soaking softens the stems enough that slightly curved ones can be straightened before they dry.

Gardening the weeds

The next day, trim away most of the smaller bristles and branches on each stem as short as you can with small embroidery scissors.



WEEDS ALONG RIGHT OF WAY | 7

Work from the bottom of the stem almost to the top. The stubby remnants on the main stems represent leaves and the longer uncut bristles on top become the base for the blossoms [8].

Dab the longer bristles with thick CA. Use the tip of a fine needle to dab spots of glue only where flowers would bloom, and then dunk the top of the stem into very fine ground foam. I used Woodland Scenics Turf. Paint everything with a mix of greens and browns using craft acrylics. Hold the stem at the bottom with tweezers and turn it around and around on a disposable plastic lid while



6. The pale green lichen on the left was picked from a maple tree and dried for about a week. The pale ocher lichen on the right dried for over a year and is probably too old to absorb much acrylic preservative/sealer. The dark green lichen on the bottom is a commercially dyed and preserved sample. Notice how much thicker its stems are after being preserved with a glycerin mixture. They are also much softer and do not readily support their own weight standing vertically. *Bill Gill photo*



7. Pledge With Future Floor Care Multi-surface Finish is how this product is listed on the SC Johnson website. It used to be called simply Future. Pledge in the name confuses some people because that is commonly thought of as an aerosol wax/cleaner. Check the bottle for "with Future". *Bill Gill photo*

8. Tweezers hold a raw lichen stem so the lower bristles can be cut back with embroidery scissors. *Bill Gill photo*

liberally jabbing undiluted paint all over the stem. Use a short-bristled brush to thoroughly cover it [9].

Next, hold each piece on a paper towel and continue turning and jabbing with a dry brush to remove excess paint. The water-based paint softens the stems, so if needed straighten them again and spread the stems out on wax paper to dry overnight.

When dry, color the foam clusters yellow. Lightly touch the clusters with the tip of a tiny, stumpy brush barely dipped into yellow acrylic craft paint. Use wet but undiluted paint because thin



WEEDS ALONG RIGHT OF WAY | 9



9. Here are most of the materials and tools for making these weeds. Also used are a pair of small scissors for trimming stems, thick superglue and very fine ground foam like Woodland Scenics turf.



10. HO scale goldenrod stem seen in extreme close-up. The green showing through the blossoms enhances the realism of the model. *Bill Gill photo*

WEEDS ALONG RIGHT OF WAY | 10



11. New England asters, goldenrod, and other weeds grow in the rocky soil along the C&V branch line. *Bill Gill photo*



12 Goldenrod, wild asters and other weeds grow along the branchlike of the C&V. *Bill Gill photo*



13. Pale purple New England asters, about three feet tall, bloom by the side of a road. *Bill Gill photo*



14. Wild asters surround goldenrod in late August. These plants are about 30 inches tall. *Bill Gill photo*



WEEDS ALONG RIGHT OF WAY | 13

paint spreads, turning the green clumps into indistinct yellow blobs. A light touch is also important – the bits of green showing through the yellow gives these blossoms their convincing appearance [10][11][12].

In addition to goldenrod, many kinds of asters grow along tracks and roadsides across the country [13, 14]. They come in many varieties, ranging from around two to six feet tall. Their tiny flowers look like clusters of miniature daisies and vary from white to bright purple. I modeled these just like the goldenrod except the green clumps on the aster stems were more compact and got touched even more lightly with thick white craft acrylic tinted with a smidgen of warm purple. An extremely light touch left separate tiny dots of color mimicking the look of individual flowers of the New England asters on my layout [15]. By substituting browns, grays and tans on the stems, and off-white for flowers gone to seed, this method can model the same weeds in the fall, winter or very early spring [16][17][18].



15. HO scale wild asters seen in extreme close-up. The blossom colors were dabbed onto the stem with an extremely light touch to model individual blossoms. *Bill Gill photo*



16. Goldenrod in mid-December stands about four feet tall near a roadside. *Bill Gill photo*

Planting the weeds

Before planting the finished weeds I mist them with Krylon Clear Flat. That eliminates any shine from missed raw spots of CA and also helps to stick everything together. Plant the goldenrod and asters individually or in clusters. It takes only a few tall weeds scattered along the right of way to catch a viewer's attention [19].

Modeling a menace

Another weed crowding tracks and wetlands around the world is the common reed (*Phragmites*) [20][21][22]. This invasive plant was long considered a very recent arrival in America, but a smaller and less invasive native variety has been identified and has been growing in parts of the country for several thousand years. The taller *Phragmites* can reach nearly 20 feet (6m). It grows in very dense stands in wet areas, in water up to three feet deep, and even





17. Wild asters in November, about four feet tall.

WEEDS ALONG RIGHT OF WAY | 16



18. A mass of wild asters, about two and a half feet tall, hold together along a road in December. *Bill Gill photo*



19. Planting wild asters on William Gill's module of South Troy, NY. *William Gill Photo*





20. Amtrak's Acela Express streaks past phragmites crowding the Northeast Corridor shoreline. *Bill Gill photo*



21. Amtrak's Acela Express streaks past reeds spreading along a drainage ditch. *Bill Gill photo*



22. Amtrak's Acela Express streaks past phragmites taking over a small wet area. *Bill Gill photo*



23. Amtrak racing past large stands of reeds is a common sight on the Northeast Corridor and other parts of the country. Here Amtrak's Acela passes a large stand of phragmites along the shoreline. *Bill Gill photo*



in brackish water [23]. The shorter native variety reaches about 12 feet, and can be identified by its reddish tinged stems during the growing season. In general, though, both plants are similar, especially in the late fall and winter. I model the pale tan dead stalks rather than making thousands of green leaves for summer plants.

Christmas in August

Plastic needles hacked from an artificial Christmas tree branch form the reed stems [24]. The lengths on the branch I used varied from about three to twelve feet in HO scale. Branches with longer needles can often be found in craft stores starting in late summer. I prime the needles with flat white spray paint to give some tooth for later painting. For about half the stems, I dip the top six or so scale inches into CA and dunk them into brown foam turf to make the seed heads.

Next I cut a pile of tiny paper triangles to model the few remaining leaves [25]. The blunt ends are bent 90 degrees, dipped into thin



24. Plastic needles cut from the branch of an artificial Christmas tree are used for modeling reeds. *Bill Gill photo*



25. Tiny paper triangles represent the few leaves remaining on the dead reeds. The long pieces were trimmed after gluing them to the stems. *Bill Gill photo*



26. Model reeds after adding foam seed heads and paper leaves. *Bill Gill photo*



27. Very few leaves still cling to dried phragmites waving in an April breeze. *Bill Gill photo*



28. The reeds are finished by randomly streaking the stems with dilute raw sienna acrylic, dipping their bases in a dilute India ink-alcohol solution and then splattering them with more dilute ink. *Bill Gill photo*

CA with tweezers and the bent tab touched to the stems. I glue the leaves in pairs to match the prototype. Some were glued on the tops of bare stems; others were stuck randomly farther down [26]. Only a pair or two of leaves were glued to any stem and only about a third of all the stems got leaves.

I don't have an airbrush. I brush paint individual stalks and seed heads with a pale tan color, taking care to only lightly dab it onto the foam seed heads just like the colors are dabbed on the goldenrod and aster flowers. This gives the tips a feathery appearance closer to the prototype [27].

Next, randomly streak most stems with thin raw sienna acrylic. Some are then partially dunked into a very dilute ink-alcohol

WEEDS ALONG RIGHT OF WAY | 23

solution to gray the base of the dead stalks. A few are held in the solution longer to vary the graying. Splatter all the reeds with dilute ink-alcohol flicked off the bristles of an old toothbrush. These last steps improve the appearance a lot! [28]

Packing in the phragmites

The prototype photos show how densely the reeds grow and how tangled, bent and broken the stems get over time. The plastic Christmas tree needles are tough and won't break, but can easily be bent to mimic broken reeds. I use a fine sewing needle in a pin vise to poke holes for planting stems into an extruded foam base [29] [30]. Dip the stem bottoms in yellow glue and use tweezers to plant them in the holes, the denser the better. You might plan to cover a small area with these reeds unless you have lots of time, but even a small patch will create an attention-getting scene familiar to almost everyone. ✓



29. Reeds can look right at home in small wetlands on almost any layout. *Bill Gill photo*



30. A closer look at densely planted HO scale reeds. *Bill Gill photo*



31. Goldenrod is about to start blooming in late summer on the C&VRR. *Bill Gill photo*



32. Goldenrod is about to start blooming in late summer on the C&VRR. *Bill Gill photo*



33. Weeds take over the freight house on William Gill's South Troy, NY module. *William Gill photo*



[Click here to rate or comment on this article](#)

BILL GILL



Bill Gill is a member of the Rensselaer Model Railroad Society, builders of the New England Berkshire & Western RR. He is also working on a tiny HO scale home layout, the Connecticut & Vermont RR. Both layouts are set in approximately the same locale and time period, yet they are vastly different in size and scope. Each layout provides interesting projects and challenges that compliment one another. ■

ADVERTISEMENT



1st choice for model railway supplies and service.

Expedited mail service available across North America.

Click to visit:
WWW.CVRCO.COM
1 800 464 1730



• INDEX



SUBSCRIBE
(free)

• TABLE OF CONTENTS

Brought to you by
MRH
MODEL RAILROAD HOBBYIST

TRAINMASTERS.TV

WHAT'S NEW!



Narrow Gauge Niche

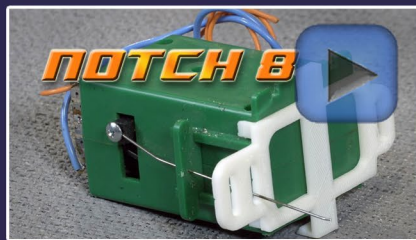

3D printing "accessories"



Installing a LokSound decoder



Jim Eudaly's C&O

Non-members: Watch most episodes for \$1.49; become a member for unlimited access

Our videos are in-depth like MRH articles, except without ads



YES, IT'S A MODEL

compiled by
DON HANLEY
.....



**Click here to rate or
comment on this article**



1. An Athearn Genesis Z-8, weathered to be a workhorse, drifts downgrade through Cascade siding on Mike McGinley's "Southwestern Pacific" freelance 18'x22' layout. The image is a Helicon Focus stack of exposures taken with a Canon XL resting on the track. The main line is 36" radius superelevated Precision Scale code 83 flex track, the rock formations are carved blue polystyrene insulation board, the trees are commercial products, and the sky is painted on the wall.

▶ **MRH'S MONTHLY PHOTO ALBUM**





2. Guilford's GP40 #310 hauls a short freight while GP9 #23 rests in the shed. This section of Michael Cawdrey's layout is modeled after the old Maine Central yard at Calais, Maine. Guilford closed down the line in the mid-1980s but it survives on Michael's layout. He scratch-built the structures and painted the backdrop with



acrylics. Snow is a mix of Woodland Scenics Flake and Curash baby powder which contains corn starch. Locos are by Atlas.





3. An INRAIL (Indiana Northern Rail) Erie Western RS3 is pulling a former PC transfer cabin. Also along for the ride come some loaded covered hoppers full of corn from the Farm Bureau Co-op in Kewanna, Indiana. Tom Johnson modeled this RS3 using a special run Atlas locomotive with a Loksound decoder on board. The transfer cabin is an NJ Custom Brass model and the hoppers are from Tangent. The elevator is kitbashed from Walthers kits and the grain bins are also from Walthers.



[Click here to rate or comment on this article](#)

.....

\$ GET PAID FOR YOUR PHOTO

We pay \$40 per photo we publish. If you'd like to get your modeling in our photo feature, just start posting your photos on the MRH website, especially in the Weekly Photo Fun thread created each week.

See mrhmag.com/help for more on how to post an image. You need to be an MRH subscriber to post photos to our website, and becoming a subscriber is free, [just fill out this form here](#). ■

.....

ADVERTISEMENT

A fine new history from Signature Press!

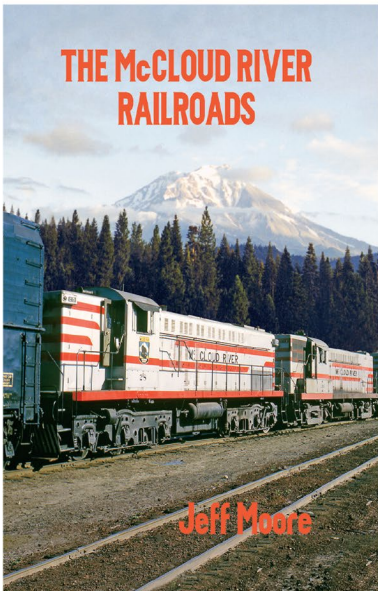

The *McCloud River Railroads* presents history and many photos from 1894 down to the present, of lumber rail-roading and a dinner train late in life. How can I learn more about this book? How can I buy it?

Click here for the answer ...

SIGNATURE PRESS



Norfolk and Western Historical Society

**Brand New
Video!**

**Feature
length DVD
or Blu-Ray.
The official
story of
611's 2015
restoration**



**to operating condition.
How can I add this great disc
to my collection?**

Click Here!

LIGHTING UP THE DITCHES

BY MATTHEW NITKA

Adapting, wiring, and lighting with LEDs ...

IN 1992, THE FEDERAL RAILROAD ADMINISTRATION (FRA) mandated that all locomotives have enhanced day and night visibility added. Railroads were given until December 31, 1997 to fully implement what we often refer to as ditch lights.

Earlier, Canadian railroads, specifically BC Rail, used ditch lights to give their train crews a better chance to spot fallen rocks and boulders on the track. Across other systems, ditch lights were much less common.

Until 2016, ditch lights were pretty scarce on my railroad. Thankfully, model railroads do not fall under FRA regulations, or I would have been shut down years ago!

• [INDEX](#)



SUBSCRIBE
(free)

• [TABLE OF CONTENTS](#)



**Click here to rate or
comment on this article**

Modeling the Wisconsin Central in the mid-'90s, I have been able to skirt the ditch light requirement as they could easily be “in the process of adding them to the fleet.” If a new diesel came with them factory installed, great! If not, “I’ll get around to them someday” became my standard answer.

Beginning in January 2016, I decided that “someday” is now.

The proliferation of tiny LEDs designated “0603” and the wide variety of color choices makes adding ditch lights a less-daunting task than it once was.

If you model the mid-'90s, you’ll find that many railroads installed ditch lights just below the locomotive anti-climbers on the pilot itself. This can add a bit of a challenge for a few reasons:

- The pilot area of a model diesel can be quite crowded with parts like MU hoses, air hoses, coupler pin lift bars, snow plows, and so on.
- The lack of the ditch light housing availability. Detail Associates has a ditch light housing, part #1022, that works quite well. I’ve had trouble locating them, due to short supply, so an alternative is needed.

Utilizing the *MRH* forum at mrh.com, I posted this conundrum and user CFNR 501 suggested using Details West HL-114 headlights. With some careful cutting and sanding, these are great substitutes. A quick rummage through my detail box revealed several of these left over from a previous project. The best part is, when I run out, they are readily available at most hobby shops.

LIGHTING UP THE DITCHES | 3



1. Various tools used for ditch light installation. Also needed are a soldering iron and multimeter.



2. Prototype photo of Wisconsin Central 3007.

First steps

Before cutting, gluing or soldering, I needed to establish a location for the ditch lights. The Railroad Picture Archive site at rrpicturearchives.net is a trove of great reference shots of rolling stock and diesel engines. After deciding to upgrade my Atlas GP40, I searched for photographs that would give me an idea where to mount the ditch lights.

My search found Wisconsin Central units with ditch lights mounted just below the top of the walkway on the front of the pilot. The ditch lights are mounted on the top corners of the pilot. It is difficult to tell from photographs if the stanchion for the front handrail was altered or if the ditch light is mounted in front of it. Exercising my modeler's license, I shifted them slightly inward to avoid cutting the stanchion.

Trimming the headlight casting

To begin installation, I needed to cut the headlight casting in half. Make many light cuts as these headlights are quite brittle. Once you have cut the headlight in half, sand down the area where the individual lights joined.

A light touch with a sanding stick helps preserve the hinges and latches. On the headlight these are represented by two small tabs. Be careful not to file these off.

I felt the ditch lights were a bit shallow and decided to back them with a piece of .020" styrene trimmed to the same size as the ditch lights. File a clearance groove into the backer board for the LED wires, so the housing can sit flush on the backer board.

Testing the LEDs

Remember to test as you go. There are very few things worse than getting the ditch lights onto the model, only to find out that

LIGHTING UP THE DITCHES | 5

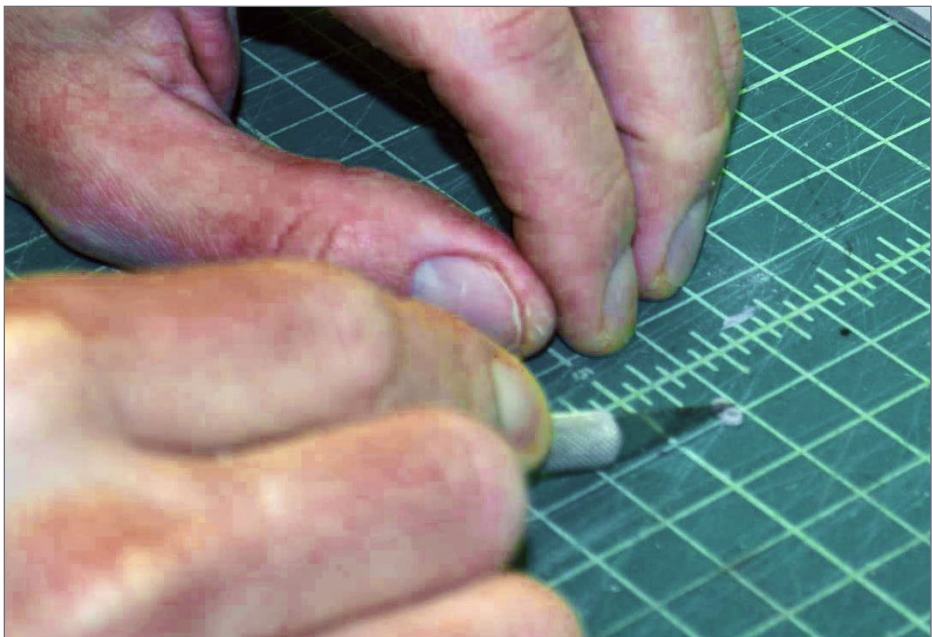

3. A delicate touch and many passes prevent cracking the modified light housings.

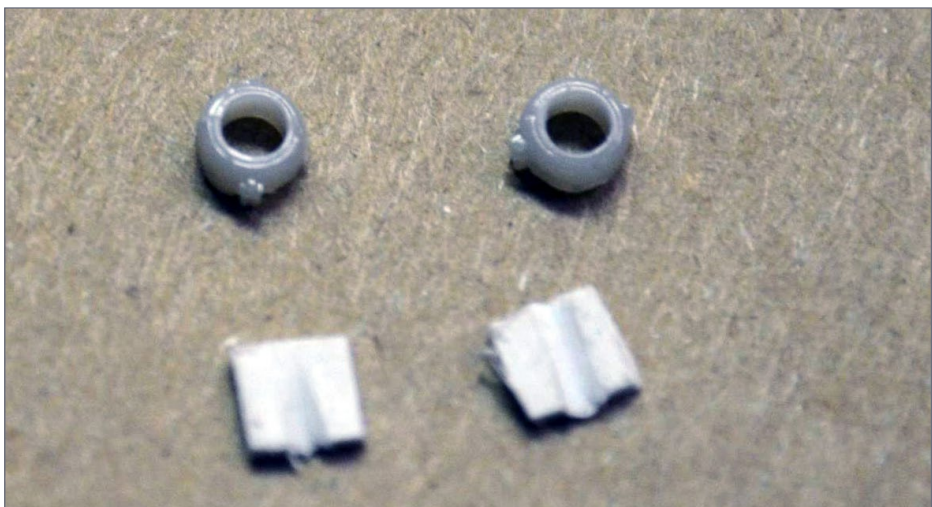

4. Trimmed headlights are now ditch lights.

something isn't right. Read the sidebar about working with LEDs so you know how to connect them and choose a current-limiting (series) resistor.

The LEDs I purchased had lead wires soldered on. I prefer this because 0603 LEDs are tiny and their solder pads are small.

As the sidebar illustrates, one LED wire connects to positive power, and the other wire connects to negative power. Often one wire will be longer than the other, to indicate the positive connection. Follow the steps in the sidebar "Connecting and testing an LED" to determine how to connect the LED, what value series resistor to use, and verify that the LED lights up.

Ditch light assembly

To hold the work, I use a paint stick covered with double-sided tape when working with small parts. I place the backer boards down on the tape first, then position the wires and LED onto the backer board. Gently pushing the wires onto the tape holds everything in place while you glue the ditch light housings together.

To glue the ditch light housing and backer boards together I use Tenax 7R or Micro-Mark's Same Stuff. Tenax 7R and Same Stuff are solvents, not traditional adhesives. They soften the styrene to form a weld of sorts between the two pieces. To secure the LED in place, I use Testors Glue for Windows. This glue goes on white, but dries clear and can form a nice lens inside the ditch light housing.

After all the parts are assembled and the adhesives are dry, I trim the corners of the backer boards to match the contour of the ditch light housings. A touch of sanding and everything is set for paint. I paint the backer boards flat black and use a Sharpie Silver Paint Marker to color the housings silver.

WORKING WITH LEDES

LEDs are everywhere, but not all modelers know how they work or how to use them. Let's find out.

An LED is a semiconductor that emits light when an electric current is passed through it. When an LED begins to conduct, it acts like a short circuit. An external resistance is needed to limit the current, or the LED will be destroyed. So ...

Rule 1. *Never* connect an LED directly to a power source. If you do so, you'll likely destroy the LED. It doesn't matter if your power source is a heavy-duty DC supply or a couple of AA batteries – the LED will burn out.

Rule 2. *Always* connect a resistor between your power source (e.g., a DC power supply and a toggle switch, or a DCC decoder function output) and one lead on the LED, as shown here.

The resistor in the diagram is in series with the power source's positive terminal and the LED's anode pin, and thus is known as a "series resistor." It limits the current through the LED. The resistor

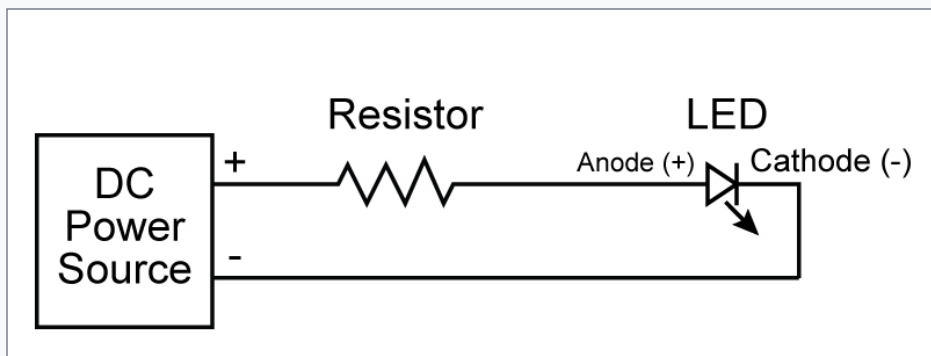

would limit the current exactly the same if wired between power source's negative terminal and the LED's cathode pin.

What value should the series resistor have? The simplest answer is, a value that lights the LED to the brightness you want (details below), but not less than a certain minimum value.

The minimum value depends on the voltage produced by your power source and the characteristics of your particular LED.

Measure the voltage produced by your power source, then look in this table for the recommended minimum resistor value to use for that voltage. These values limit the current to approximately 15 milliamps (mA), safe for any LED.

Power source voltage	Recommended minimum resistor value
5 volts	180 ohms, ¼ watt or 1/8 watt
6 volts	240 ohms, ¼ watt or 1/8 watt
8 volts	390 ohms, ¼ watt or 1/8 watt
10 volts	510 ohms, ¼ watt
12 volts	680 ohms, ¼ watt
15 volts	910 ohms, ¼ watt
24 volts	1.6K ohms, ½ watt

Connect and test an LED

In the diagram, the “anode” is the wire or terminal on the LED that connects to the positive side of the power source, and the “cathode” connects to the negative side.

Often it is difficult to determine which LED pin is the anode (positive), and which is the cathode (negative). Usually the

WORKING WITH LEDES CONTINUED...

longer LED pin or wire is the anode (positive), and the shorter is the cathode (negative).

Don't let that "usually" scare you. It's a starting point, and you can easily determine for yourself which pin or wire should connect to positive and negative power. Connect a resistor of at least the minimum value from the table to your power source's positive terminal. Connect the shorter LED wire to the power source's negative terminal. Touch the other LED wire to the resistor's non-connected wire. Does the LED light? If so, it's connected correctly. If not, swap the LED leads and try again. It will light one way or the other. Mark with red paint or marker which LED wire goes to the positive power source. Or mark with black paint or marker the LED wire that goes to the negative power source.

Choosing a resistor value

Nothing beats powering-on an LED and deciding if it's the right brightness for the intended application. Is it bright enough for a ditch light? For a headlight? For a marker light? Only you can evaluate the brightness.

You will need a selection of resistors ranging from your minimum value to two or three times that value. The plan is to try one resistor at a time, then evaluate the LED brightness. Start with a resistor that's 2X or 3X the minimum value. For example, if the minimum is 680 ohms, begin with a 1.3K ohm or 2.1K ohm resistor.

If the LED is too bright, try a higher value resistor. If it's not bright enough, try a lower value. Keep trying different resistors



greater than the minimum value until you find one that lights the LED to your preference. Once you find a good value. Use that value in your final installation, and note it for future reference with that particular type of LED.

It would be nice if all LEDs were the same, so one resistor value would produce the same brightness in them all. But that's not the case. A red LED might need a 560 ohm resistor to produce a certain brightness, but a warm white LED might need a different value to produce the same brightness. You just have to test until you find the best brightness for each type of LED.

What about built-in resistors?

Some DCC decoders have a built-in resistor in series with the function outputs intended for lights. Also, you can buy LEDs that have a built-in series resistor, and these may be connected directly to a power source.

How do you know what you have? Read the decoder user guide or LED data sheet. The decoder guide should tell you if it's OK to connect an LED directly to the function output. Such outputs will not light an incandescent lamp, and the instructions should mention this as well. An LED datasheet should state a range of voltages over which it will safely operate, and should include a diagram showing the LED connected without an external series resistor.

If you don't have documentation, follow the steps above under "Choosing a resistor value." If the LED lights only dimly when you reach the minimum-value resistor, either the LED or the DCC decoder probably has a built-in resistor. Go ahead and touch the LED without a series resistor, and see if it lights normally. If so, that's how you should wire the LED.

WORKING WITH LEADS *CONTINUED...*

Summary

Using LEDs is easy once you master the basics:

- Always use a series resistor to limit the current through the LED to a safe value.
- Never connect an LED directly to power without a series resistor.
- To determine an LED's anode and cathode, connect it to a power source through a series resistor to see if it lights. If not, swap the leads. Once known, make notes and/or mark the leads.
- Use a sequence of resistors to find an LED's best brightness for its intended use.
- If an LED or DCC decoder has a built-in series resistor, you don't need to use an external resistor. ■

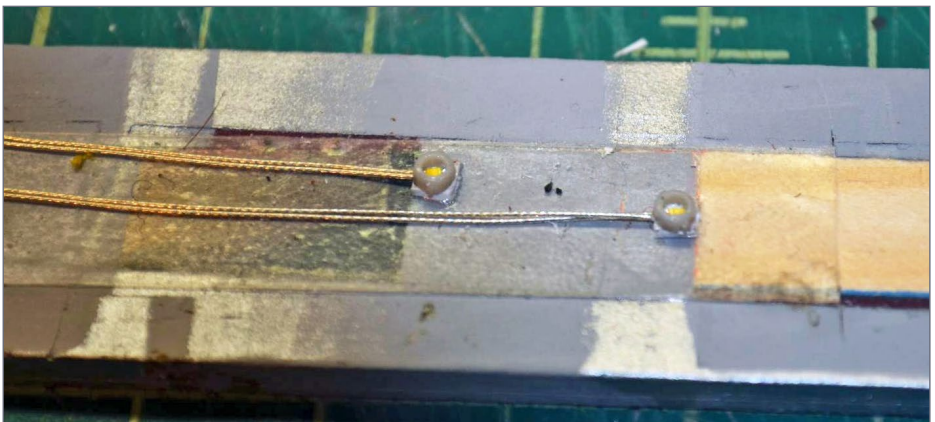

5. LEDs, backer boards and ditch light housings all in one piece.

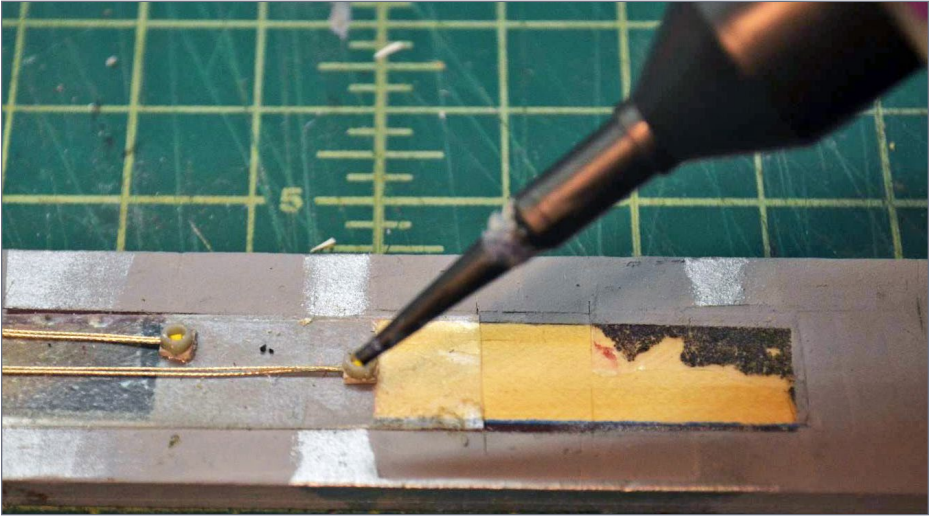

6. Testors Glue for Windows secures the LEDs in place.



7. Painted and ready for installation.

Test the LEDs again

Before installing the light assemblies, retest the LEDs to ensure that the assembly process did not damage

the connections. None of the adhesives used are corrosive but once the LEDs are installed, you will not be able to repair the connections.

Installation on the unit

The first step is to drill small holes for the wires in the pilot of the diesel. The wire size used will determine how large a hole you need to drill: I was able to drill a #75 hole to feed both wires through.

Before feeding the wires through and gluing the ditch lights in place, create a channel on the underside of the frame. This will allow the wires to run under the walkway without pushing it upwards – which will interfere with reinstalling the front coupler.



8. Drill holes for the wire leads.

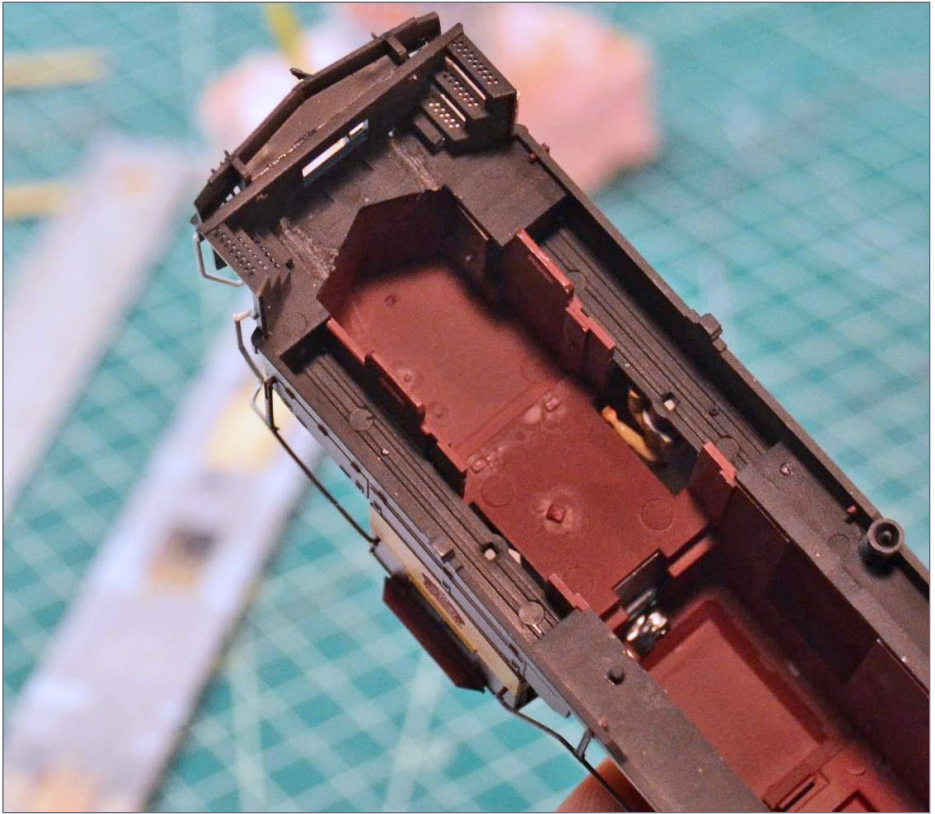

9. Channels created for LED wires.

I use a triangular file and slowly file a deeper and deeper groove. Too deep is not necessarily a bad thing but you do not want to break through or distort the walkway.

Creating the channels may take a few test fittings, but once the wires seat properly, you can install the ditch lights on the pilot.

I feed the wires through the hole in the pilot and position the ditch lights.. Tenax7r/Same Stuff works quickly to soften the plastic. The plastic hardens in a few seconds and the ditch lights are installed.

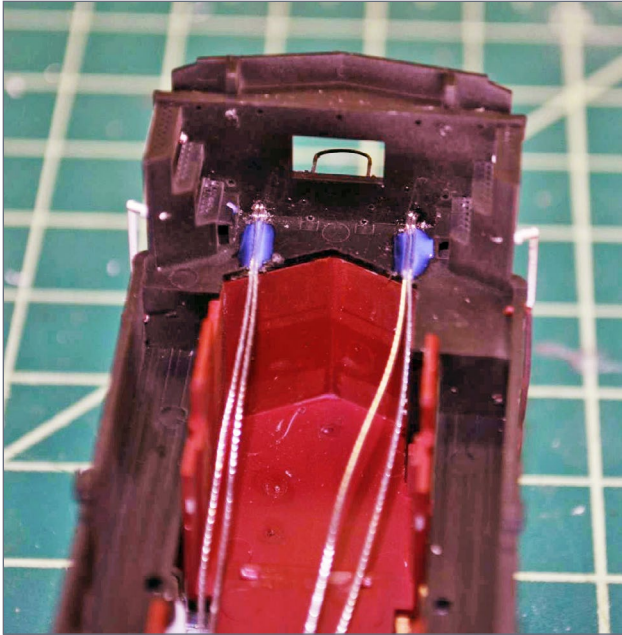

10. Wires routed and glued into their channels.



11. Installed ditch lights.

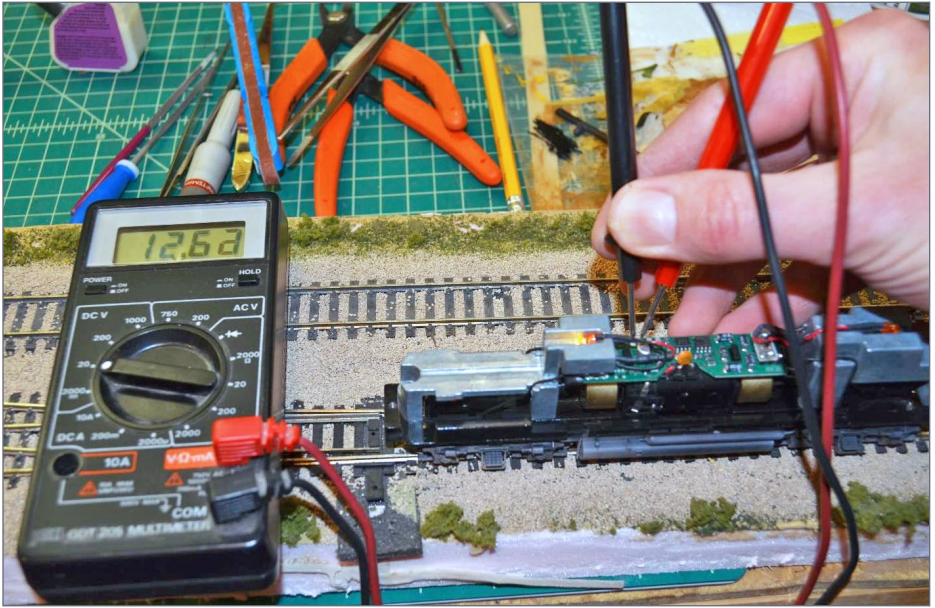

12. 12V on the function pads.

To position the wire leads in the newly formed channels I use a blunt object such as a toothpick or old piece of scrap wood. Bend the lead wires as soon as they come through the pilot, press them down to the underside of the walkway and into the channel. The blunt tool protects against accidentally clipping or nicking a wire. Testors Glue for Windows works very well to hold the lead wires in place.

Soldering LED wires to the decoder

Refer to the sidebar and determine if you need a series resistor between your LED and your decoder. If so, measure the voltage the function output produces, then choose a resistor that produces the desired LED brightness.

LIGHTING UP THE DITCHES | 17

For any lighting installation, refer to the product manual for the given decoder. On most decoders the function pads are easy to pick out, but they are not always uniformly located. If you have to use wires coming out of a shrink-wrapped decoder, refer to the manual to see which wires do what function. Since polarity is critical, you must determine which pad for the lighting function is positive and what pad is negative.

Tin the wires to be soldered

The resistor might be difficult to see at the end of the clamp tweezers. I dip the ends of the resistor leads in rosin flux to clean off impurities. When working with electronics, rosin flux should be used. Acid-based flux will corrode metals it comes in contact



13. Soldering tools.



14. One step closer to success!

with and leave you with a bad joint. I dip the LED lead wires and tin them as well as the resistor leads.

Tin the leads by flowing solder onto the wire lead prior to soldering the pieces together. When it comes time to solder them together, reheat the two pieces. The solder will flow and create a good solid joint. This also shortens the amount of time you need to hold the iron on the pieces being soldered. Overheated solder leads to a brittle joint that may break while you try to fit the wires into the shell. A good solder joint is bright and shiny. An overheated, or “cold,” solder joint will be dull.

LIGHTING UP THE DITCHES | 19

I put the resistor on the positive lead.

Once the joints are complete, I tin the pads of the decoder and solder the lead wires in place. The final step is to take a small piece of electrical tape and wrap the resistor leads and bare wires. This will prevent the wires from shorting to the decoder or frame once the locomotive is put back together.

Before reassembling the locomotive, I place the unit on my test track and enable the ditch lights. Breathing a sigh of relief, I'm almost done.



15. Final assembly complete, and successful test!

Bundle lead wires

I use some small pieces of electrical tape and wrap the leads into bundles to keep them tidy. This makes it easier to place the wires inside the shell without them interfering with the motor or getting caught on something.

Replace the shell

Replacing the shell onto the frame after completing the ditch light installation can be nerve-racking. Take it slow and look at each side of the locomotive to be sure wires are not getting pinched by the frame, weight, or shell. If you have made it this far, you don't want to shear a wire off while replacing the shell. Again, not saying I've done this . . .

I lead with the nose of the diesel. This allows the wires to be pushed into the upper part of the nose of the unit without snagging anything. After doing this a few times, the wires will begin to conform to the nose and you can slide the shell on normally.

Once the shell is back on the frame, you can either test the LEDs again or install the couplers to complete the reassembly. As you can see in [15], the ditch lights are a bit brighter than the original LED headlight. I may go back to replace the headlight with a new 0603 LED.

Decoder programming for ditch lights

Depending on the decoder in your model and the pads used, you may need to reprogram the function pads to activate them together. This is easily accomplished through JMRI but can be done by programming CV values on your hand-held throttle as well. I will refer to JMRI programming here. The CV values will need to be obtained from the decoder manual and updated accordingly.

LIGHTING UP THE DITCHES | 21

On the Function Mapping tab of JMRI's Programming window, I set both Function Pad 1 and Function Pad 2 to have a check mark under Function 1. I then uncheck the box for Function Pad 2. This allows both ditch lights to activate when Function 1 is pressed on the throttle.

This basic programming will allow you to toggle the ditch lights on and off independently of the headlights using Function 1. Further effects can be achieved with more advanced decoders. For instance, Wisconsin Central used ditch lights flashing alternately when signaling for a grade crossing. I really like this effect.

Using JMRI, under the Lighting tab you will see options for adding different effects to the ditch light functions. These options vary for each decoder. I selected left and right ditch lights for each function pad. This allows flashing when Function 2 is activated on the throttle.

Once you have mapped the ditch light functions, your diesel is ready to lead its next train to the closest grade crossing and be fully FRA compliant!



[Click here to rate or comment on this article](#)



MATTHEW NITKA



Matthew started model railroading when he was three years old. He was hooked instantly, and has been hooked ever since.

Growing up, he had many temporary layouts on 4'x8' sheets of plywood, but he was able to eventually convince his father to let him put up a more permanent layout that didn't need to be removed for holiday parties. Once he was

married and had a house of his own, it didn't take long for him to take over the basement.

Matthew currently models the Wisconsin Central Railroad in the mid to late 90s, prior to their being purchased by the Canadian National. His layout is based in Southern and Central Wisconsin, centered around the paper, aggregate and pulp industries that the Wisconsin Central served in the area.

Aside from model railroading, he is an avid cyclist, and races competitively in the Wisconsin Cycling Association Criterium Circuit. Married to his wife Eva, they have three children. His son has taken an interest in trains as well and enjoys trips down to Rochelle, Illinois to railfan at the Railroad Park.



[Click here to rate or comment on this article](#)

Make it run like a

Dream

ROLLING STOCK

PRE-ORDER

By Joe Fugate

First sneak peek now available!

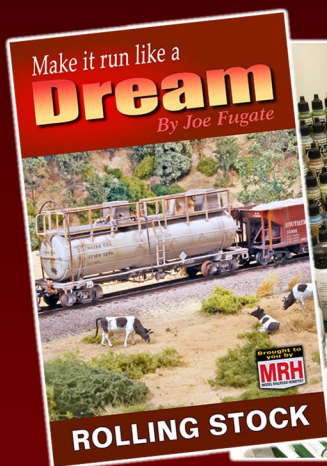

TOPICS INCLUDE: Setting standards • Building a test track • Wheelset/truck issues • Coupler issues • Carbody issues • Car weight considerations • Better maintenance procedures • Performance diagnosis & debugging • Special considerations

Click me to

PRE-ORDER eBOOK >>

~~\$12.99~~ \$11.49

Click me to

PRE-ORDER PAPERBACK >>

~~\$29.99~~ \$27.49 + S&H

Expected release: April 2017 - see the MRH Store: store.mrhmag.com

Other books in this series: *TRACKWORK* (available now) and *LOCOS* (Fall 2017)

• INDEX



SUBSCRIBE
(free)

• TABLE OF CONTENTS

MY TURNOUT SCRATCHBUILDING JOURNEY



BY TIMOTHY BARNUM

Learning to scratchbuild a turnout from an MRH video ...

BEFORE READING THIS ARTICLE, TAKE A good look at Charlie Comstock's MRH June 2012 companion video on YouTube, entitled "Scratchbuilding a turnout for your model railroad."

To see Charlie's video, go to [youtube.com/watch?v=F_POUtKO5qQ](https://www.youtube.com/watch?v=F_POUtKO5qQ)
This very helpful video is one of the best I've seen on this topic.

• [INDEX](#)

• [TABLE OF CONTENTS](#)



[Click here to rate or comment on this article](#)

You may wonder why such a good video would merit an additional article. Charlie is obviously a better modeler than I am, because I made some mistakes. I'm hoping that by including my missteps and corrections you will not only be encouraged to build your own turnouts, but also you will avoid making some of the mistakes I did!

The process is written in consecutively numbered steps so it can be used as a check sheet while the turnout is being built. After watching the video, I inadvertently jumped ahead in the process. This caused some problems, which I'll mention. Fortunately, it's easy to unsolder rail from the PC ties (ties made from printed circuit boards available cut to width) and to adjust a rail to correct misalignment. Jeweler's files can correct anything else. There is no need to give up on any turnout and start over.

I started model railroading after seeing a large HO railroad as a Boy Scout. I was helping the layout owner, who was doing fundraising for the scouts. That introduction to model railroading led to a career as a mechanical engineer and I've been returning to model railroading in HO, N or Z off and on since those days when I was 15 (I'm now age 75).

In spite of my engineering and model building experience, I managed to do some things wrong when building my first turnouts. Charlie implied that his was the first scratchbuilt turnout he'd made, and that is a tribute to his skill. I made some mistakes.

As a more average modeler, I'm hoping my experiences will be helpful to you. I originally purchased Atlas code 83 flex track and



TURNOUT SCRATCHBUILDING JOURNEY | 3

Atlas remote Snap Switches for building my current layout. Code 83 has narrower and more closely spaced ties than code 100; they look more realistic. The remote motors are very small, and could be easily camouflaged.

This layout was my first foray into DCC in a quest for better operation and to have sound. I came to regret my use of these switches, as they are difficult to modify and not especially DCC-friendly.

I naively thought that any configuration I could come up with for the Atlas code 83 remote turnouts would work well, but I but soon found that placing these switches at the start of an 18-inch radius curve created some derailments, even with my short wheelbase 2-6-2 Prairie loco. I hated to pay for a more expensive turnout and switch motor.

The Mighty Mole by Proto87 Stores, for \$12.95 per switch machine, was quite a bit less expensive than the alternatives. It includes a set of contacts I can use for frog powering. I thought the Central Valley switch kits at less than \$10 each would be the

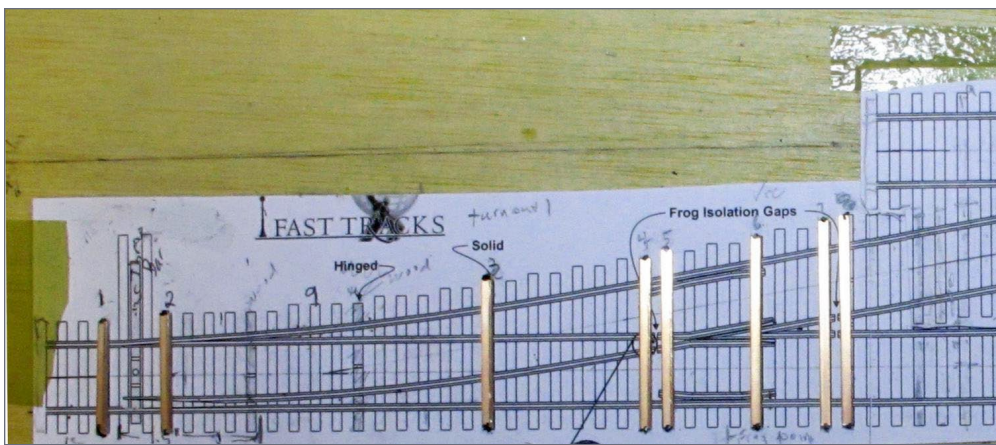

1. Crossover template with PC ties in place.

TURNOUT SCRATCHBUILDING JOURNEY | 4

answer for the turnout itself. Although I completed one kit and it is working pretty well, it required an inordinate amount of time. Partly due to my own inability, the plastic ties and CA glue made adjustments difficult. I kept breaking the beautiful but flimsy throw bar; the pivot for the points in the ties is plastic, which just was not very stable for me.

I've come to love the solid solder connections to printed circuit board (PC) ties, and the ease of adjusting the rail soldered to them slightly with a hot iron to obtain the optimum gauge. I still spent a lot of time because I've learned it's important to be precise with the points and how they contact the rails.

I believe I've learned enough to do it better – and hopefully this article will help others as well. Most of my pictures are from my second turnout where I corrected most of my mistakes in the fabrication and assembly process.

The effort required is well worth it: the turnouts look good and should perform as well as or better than any commercial ones. It's easy to make these turnouts DCC-friendly because the PC ties conduct between turnout parts without the need for wires. A

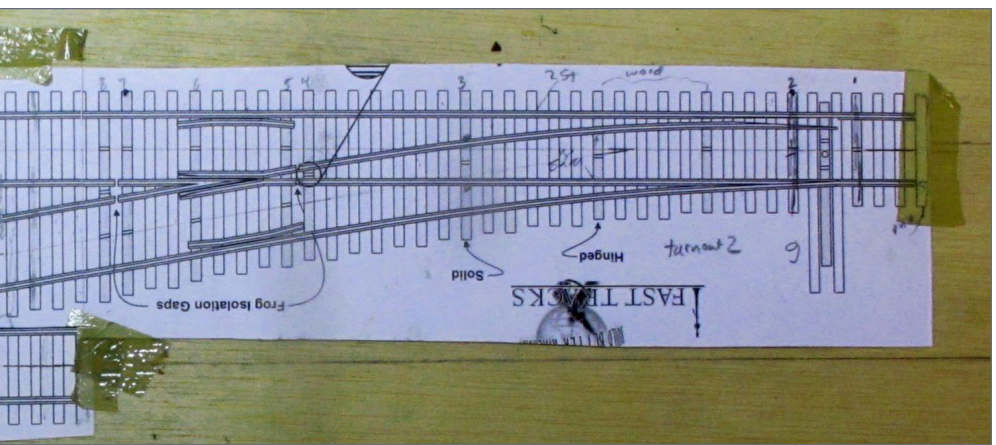

turnout can be constructed with only two power wires and a frog wire to be powered, without relying on contact at the points or from the stock rails leading into it.

I'm actually rebuilding my layout as a 5- by 9-foot plan with 24-inch radius curves and #6 turnouts. I've noticed most locomotives larger than a 2-8-2 require at least 22" curves. I may never build another layout, so my love of locomotives drove me to stop work on the smaller 4 by 6 layout with 18" curves, and to add enough framework for a larger layout with a bit broader curves.

Setting up the template

I started with the excellent templates available as free downloads from FastTracks. I printed these on 120# card stock. I was going to have a least two crossovers, so I cut a piece of 9" x 12" x $\frac{3}{4}$ " sanded plywood, assuming it might be easier to push spikes into than pine lumber.

I laid out two LH templates to create a crossover with 2.15-inch center-to-center spacing. Supposedly 2 inches is enough but I wanted a little cushion. This is a good point to review Charlie's video, as I used the same order of construction he used. [1] shows my PC tie locations on the crossover-arranged templates.

I used PC ties from Clover House like Charlie recommended. I purchased some of the modern HO ties in 0.62" thickness, and a pack of slightly wider throw bar ties. Clover House suggested these because drilling a hole in them for connecting to the switch machine does not weaken them too much.

Since I didn't have enough regular tie material, I ended up filing down some of the throw bar ties to complete my 10 turnouts. The holes are less than half the width of the standard tie, so I could have just bought two packs of regular PC tie strips.

TURNOUT JOURNEY | 6

The ties come in 12-inch lengths, ten to a package. The length allows for ties of different lengths in the turnout without much waste. For a #6, I found one or two additional turnout ties are required beyond what I could get out of a single 12" strip.

If you are building more than seven turnouts, buy two packs of the normal width ties. The folks at Clover House are great, and their shipping is very reasonable. I also purchased wooden turnout ties from them to fill between the PC ties.

Knowing that adding a few more things adds little or nothing to the postage, I studied the whole catalog and decided to buy some dry transfers as well.

Priority mail is quite fast and certainly cheaper than alternatives for packages weighing less than a few pounds.

I've noticed some how-tos online about how one can cut

Combo Right Clamp™

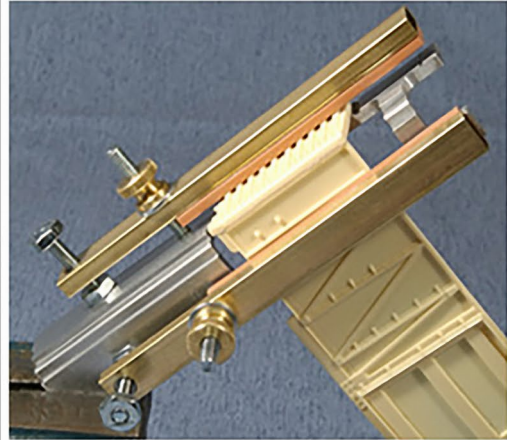

Combo Right Clamp™
with cast resin boxcar

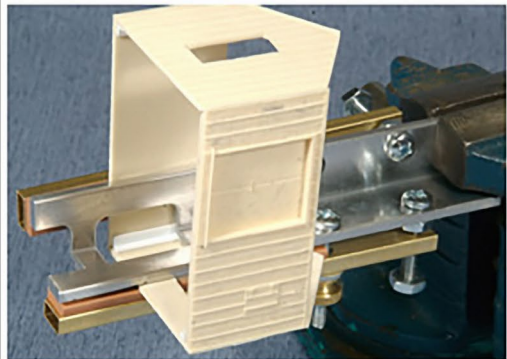

Combo Right Clamp™
with Wolf Design Pump House

[Click here for
all our products ...](#)

Tools for Modelers

Coffman Graphic Solutions Co.
1500 River Circle, Richmond,
KY 40475-7907



TURNOUT SCRATCHBUILDING JOURNEY | 7

your own PC ties from a PC board, but my table saw is too large and I'm sure I'd spend all my savings on the special blade!

Locating and cutting the PC ties

In contrast to Charlie, I wanted to build my turnout on the bench rather than in place on the layout. I also wanted them removable so I could use them again in a different place if my track plan changed.

As a result, my PC ties are in different locations on the turnout than what Charlie used. The Fast Tracks template shows the ties positioned differently from both of ours. To find the location of Charlie's ties, Fast Track's ties and my own ties, see the reference diagram [16] at the end of this article. This diagram also indicates the places on the PC ties and rails where electrical gaps are required.

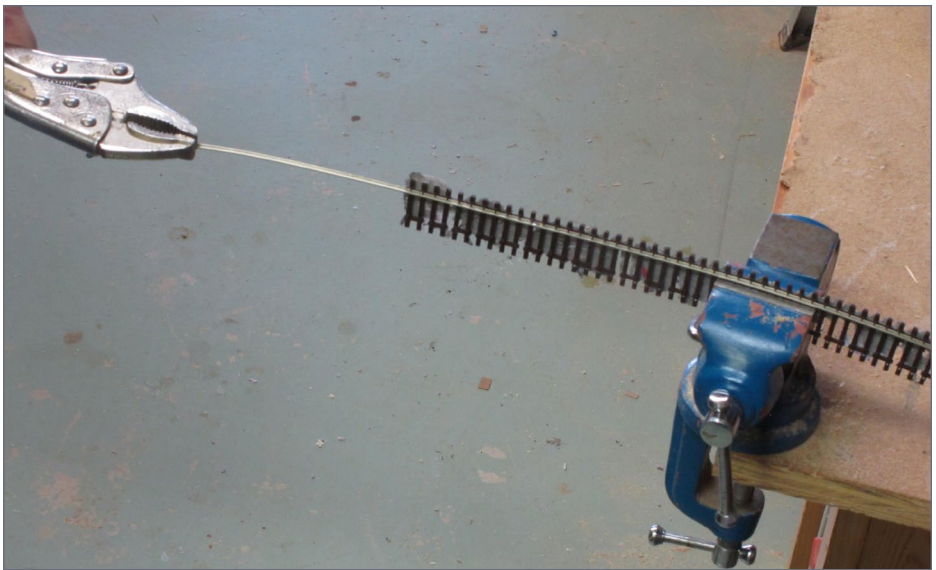

2. Pulling rail out of Atlas track.

TURNOUT SCRATCHBUILDING JOURNEY | 8

I had a very hard time trying to cut gaps in the frogs of my Central Valley Switch kits using a razor saw, file or a motor tool. Also the CA glue I had previously used for holding the rails to the ties came undone from the stress of cutting.

My new goal now for a PC tie turnout was to have the rail a gap locations be soldered to a PC tie on each side of the gap. I didn't do this for the rails after the last frog gap where the track goes at the two different angles, but I'll be using leftover Atlas ties at all three ends.

The points can either pivot at a hinge at the closure rail (as most commercial turnouts do) or they can be continuous having no break with the closure rail. Charlie's video uses the continuous form and I did as well. The Fast Tracks downloadable template shows the PC tie locations for both types – one location for continuous and another for hinged.

A YouTube video I found comparing the two choices recommended using the continuous form except for very short turnouts. The continuous type seems less likely to go out of alignment over time than the hinged type; continuous is also easier to make.

I quickly learned the sanded plywood *was* too hard to spike into, especially with the smaller spikes Charlie recommended. So I switched to a 5" x 14" scrap of 3/4" thick pine I had. Spiking into pine actually is a little easier. The tiniest spikes, however, are very fragile, and easy to bend when using pliers to insert them. I even tried filing down pushpins to create pilot holes, but I still bent a lot of the extra small spikes. (*NOTE: Charlie uses a tiny bit in a motor tool to drill a pilot hole.*)

In the second turnout, I used the larger spikes. They bend less often but still sometimes needed a pilot hole. With the larger head on these spikes, I could actually turn the spike slightly in its hole to align rail perfectly to the template prior to soldering. The standard spikes are also easy enough to insert in the sanded



TURNOUT SCRATCHBUILDING JOURNEY | 9

plywood. If you reuse the same paper template glued to the board, then the alignment spikes go in a lot easier for the second and subsequent turnouts.

I used the same Xuron cutter for cutting both the rails and PC ties. Charlie smoothed all of the PC ties with 600 grit sandpaper so that they wouldn't hinder movement of the closure/point rails over the PC tie underneath. He was also concerned with stray copper hairs from one side of the PC tie carrying electricity to the other.

I found it was faster to just quickly run a flat needle file at an angle on most of the tie to eliminate possible electrical contact issues. Then I concentrated on using 600 grit sandpaper just on the top side of the second tie just beyond the throwbar where the closure rails actually contact it. I also smoothed the top side of the throwbar.

In addition, I smoothed the bottom of the rails where the throwbar and points moved with the 600 grit sandpaper. I sanded an entire

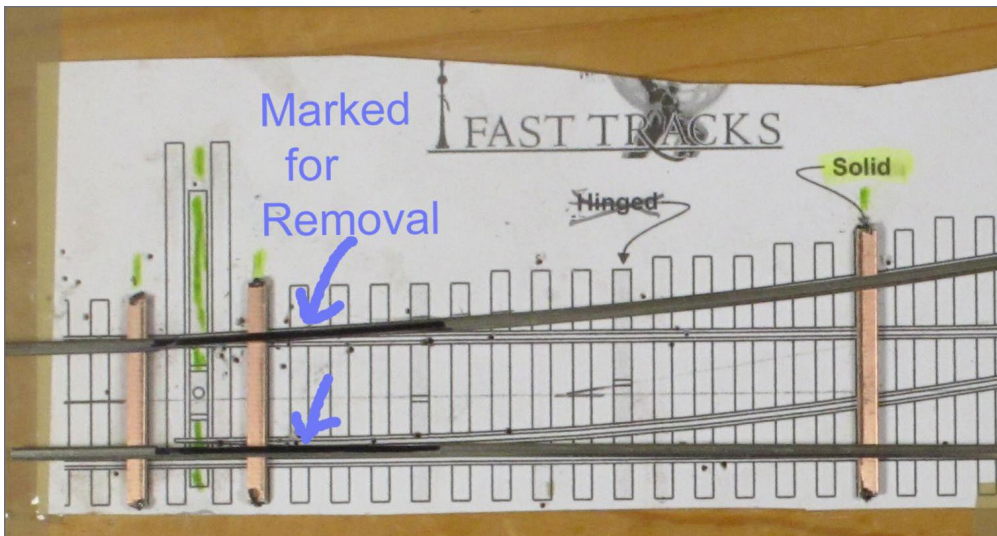

3. Stock rails marked for filing with a black marker.

TURNOUT SCRATCHBUILDING JOURNEY | 10

PC strip at a time before starting, since the cut ends won't be contacting the rails.

I started with cutting the long ties first from the 12-inch strip so I would not end up with an abundance of "too-shorts." I got a more accurate length by marking the cut on the PC board rather than trying to cut directly on the template.

On my later turnouts, I chose to make the gaps in the PC tie foil at this stage before any rails were soldered. In the video, Charlie did this after soldering, but I found it difficult to get a file in some places between the rails. For PC tie gap locations, see the reference diagram at the end of this article [16].

This is also a good time to check that all the gaps are really isolated by using an ohmmeter or other electrical continuity device to check each tie. Once the rails are soldered, it can be harder to find the bad gap.

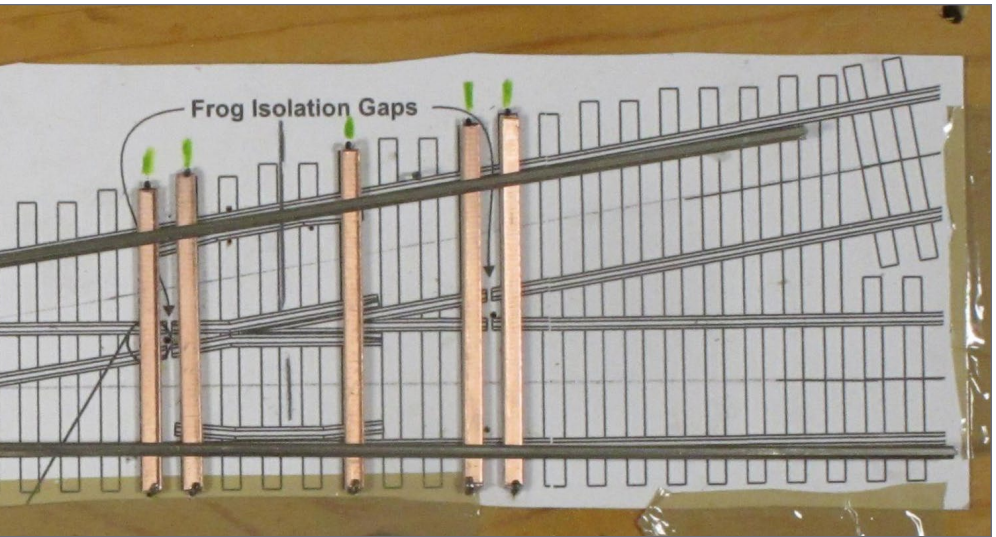

TURNOUT SCRATCHBUILDING JOURNEY | 11

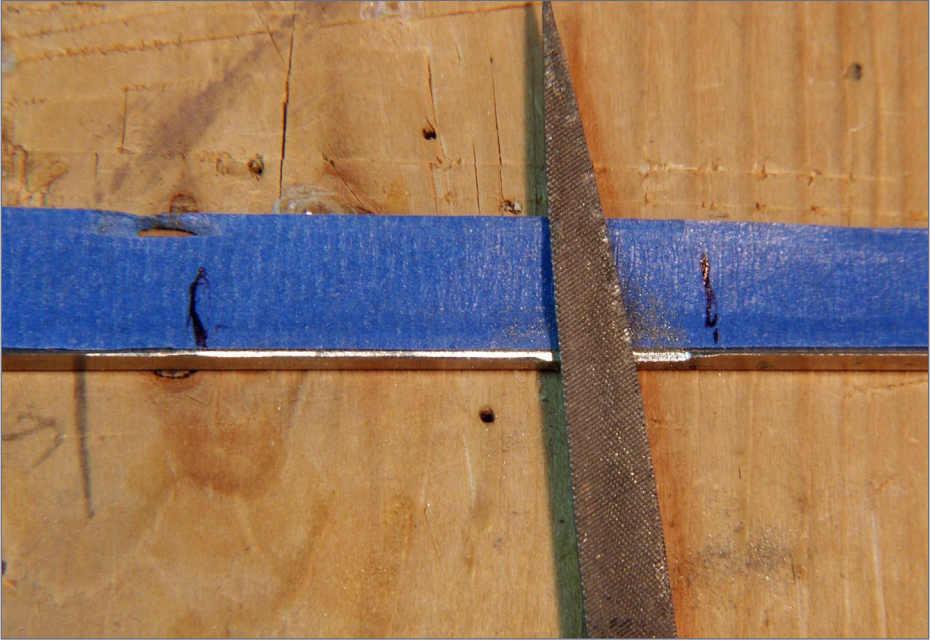

4. Final filing of the rail base in the stock rail.

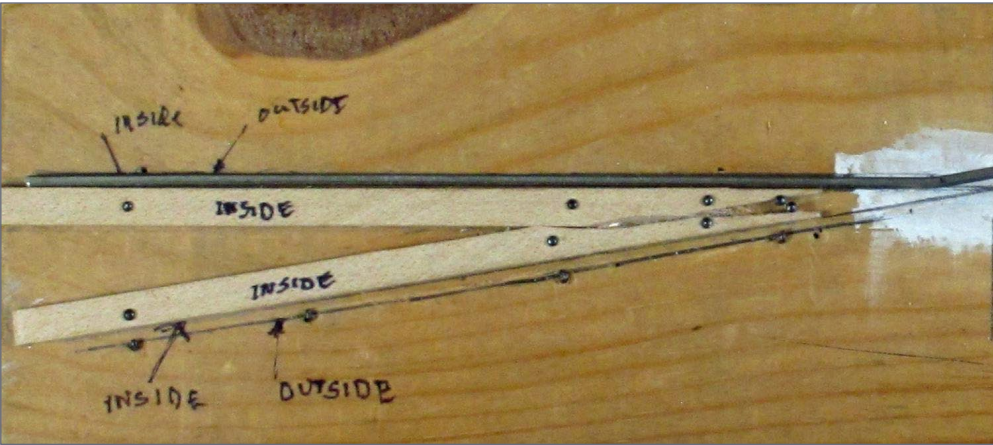

5. Frog assembly fixture with frog point and one closure-wing rail.

Scavenging rail from flex track

I already had some Atlas code 83 flextrack, and I expected to remove many pieces less than 36 inches long in rebuilding my railroad. Micro Engineering code 83 rail is available only in 33-piece bundles, but I only needed about 4 feet for each of my 10 turnouts, so I scavenged rail from my Atlas track.

Atlas track snaps back to its original shape and one rail just slips out. To remove the other rail, I clamped one end of the ties into a vise (only the ties, not the rail) and used pliers to pull out the rail as shown in [2]. The plastic ties are in sections of about six inches, so pulling the rail is a multi-step process but goes quickly.

The turnouts use various lengths of rail. Even a one-inch piece is usable as a guard rail. I used the Rollee gauges Charlie recommends to gauge the track. The code 100 HO gauges actually work on Atlas code 83 rail: it's a just right snug fit. Recently I got some ME code 83 rail which I measured, and it's definitely narrower at the railhead and base than Atlas code 83 rail.



TURNOUT SCRATCHBUILDING JOURNEY | 13

Follow the recommendation to use code 83 Rollee gauges if you are using ME rail.

Making the two stock rails

Cut rail to length for each of the outside stock rails. I went ahead and bent the curved rail pretty much to the template. I used a black marker to indicate the location where the stock rails need to have the base removed [3]. The template shows the point contact to be about an inch and a half toward the frog for a #6 turnout.

I marked only the inside of each rail so that I would not get confused using the disk sander in the next step. This step is needed to allow the point to sit flush up against the railhead of the stock rail. I did not make this stock rail base cutout long enough on my first turnout, but didn't realize it until I had soldered the point/closure rail assembly in place. It's a lot harder to file points and the stock rail after they are soldered in place!

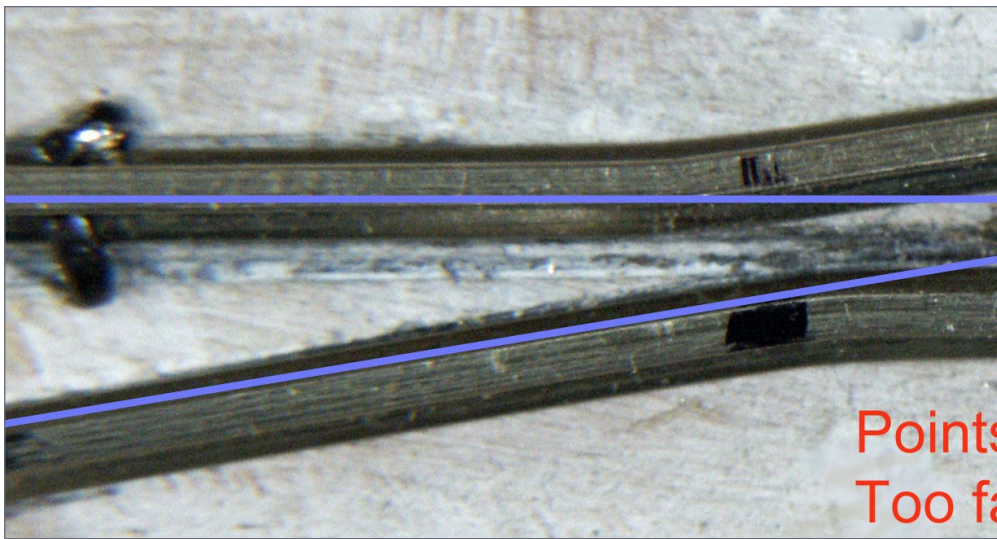

6. Correct point position.

Removing the stock rail base at the points

I used a six-inch fixed-disk sander like Charlie's, and it really goes fast; so watch out! I found it tricky to remove all of the rail base on the inside without removing any of the head. I did part of the job on the disk sander, being careful to tilt the rail at a slight angle so only the base was removed.

I went too far on the first turnout, and removed a bit of the inside of the rail head. On my second try I got close to the finished shape, then used files for the last bit. I put tape on the head to protect it when filing as shown in [4].

I also found laying the rail on a piece of wood kept the base higher than the head, which made the filing easier. I filed until the tape was disturbed. One could do all the filing without a disk sander, but if you have a sander it's certainly faster. Just be careful. It's easy to take off too much with the sander.

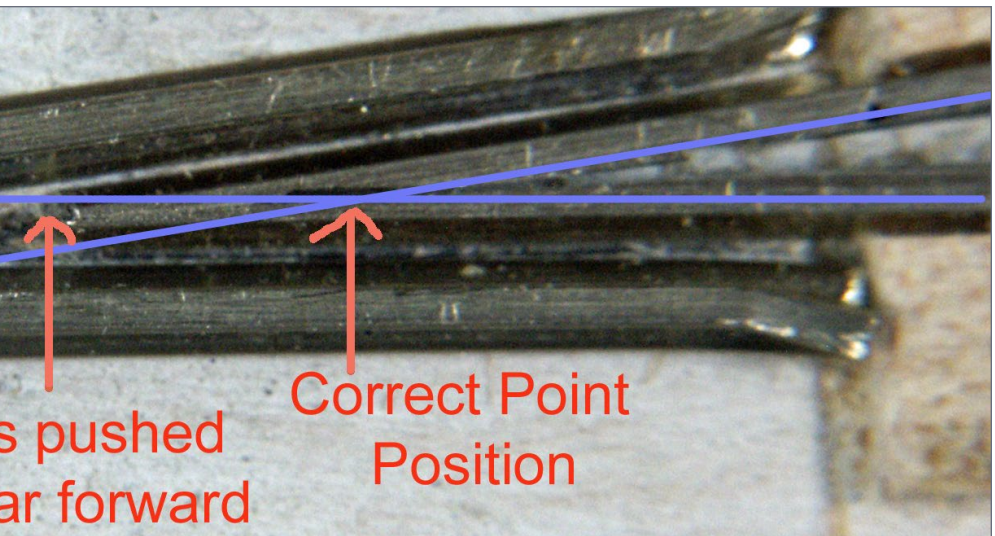

Creating the frog/closure rail assembly

In this step, four pieces of rail need to be cut. Two short ones form the inside frog point. Two much longer ones (about seven inches for a # 6) become the continuous point/closure rail, which ends in the wing rails around the frog point.

To build this part of the turnout, I spiked them onto a pattern drawn on another pine board. A 12-inch long 1x4 board works well for a #6 turnout. I'll refer to this as the frog/closure assembly, since it will be all one piece after this step.

Draw two lines which cross to form the required angle for the number of the turnout being built. For a #6, first draw a horizontal line. Then mark a point halfway along the horizontal line and measure six inches to the right and one inch up. A line drawn between

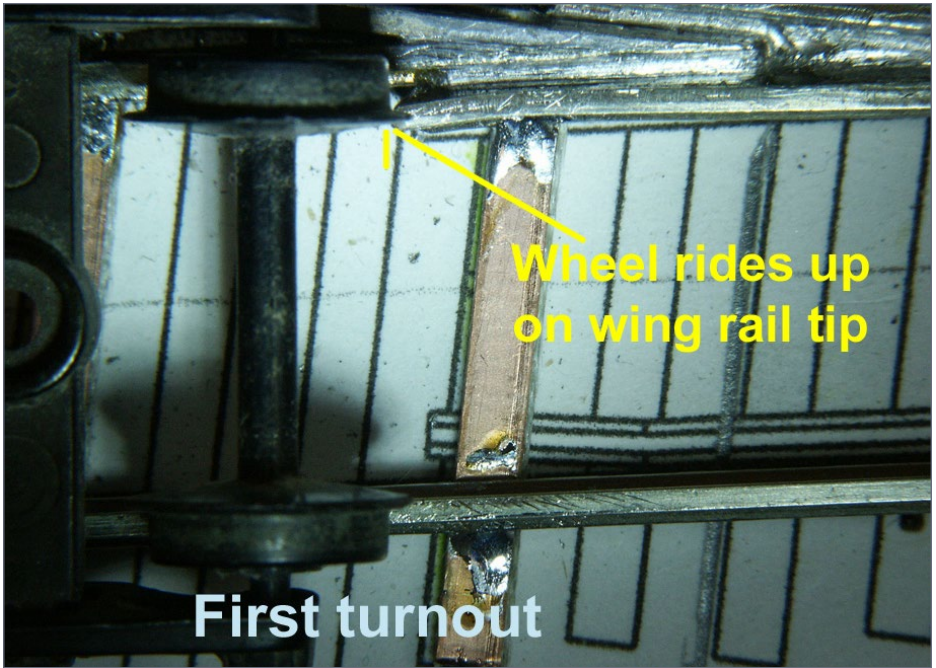

7. Wheel rides up on wing rail .

this location and the halfway mark on the horizontal forms the 1:6 angle of the turnout. By adding pieces of strip wood to this board, it becomes a reusable fixture for all turnouts of the same number. It works with both right hand and left hand turnouts.

Make sure the pieces of stripwood used to align the rail are inside of the rail for the moving point/closure rail portion and on the outside of the rail for the point of the “V” to the end [5].

The closure/wing rails should be made slightly long so the rail extends beyond where the moving point contacts the stock rails. These rails will be cut to length after the assembly is completed. I found it’s best to make the two rails forming the frog point a little long also. It helps to be able to file off more rail in case the angle of the “V” of the frog point isn’t correct at first.

The creation of this frog/closure assembly is one of the two critical parts of the turnout. The other is the moving rail points and their contact with the stock rails. I didn’t pay enough attention to creating this board fixture and in placing the rails or the frog/closure assembly on my first turnout. It required some tedious corrective filing of the nickel silver rail to fix.

My first turnout will be assigned to the back of the layout after running some trains through it to prove it doesn’t cause derailments. *(Editorial comment: We don’t recommend hard-to-reach locations at the back of the layout for iffy trackwork. Less-than-near-perfect early trackwork attempts should be stored where they belong: in the dumpster. Chalk it up as valuable experience and then move on – the frustration of iffy trackwork on the layout will cost more in the long run.)*

In making the second turnout, I rebuilt this fixture laying out the lines again. I thought Charlie hadn’t taken into account the thickness of the rail, so I drew and marked lines for the inside and outside of the rail. It proved that he was right.



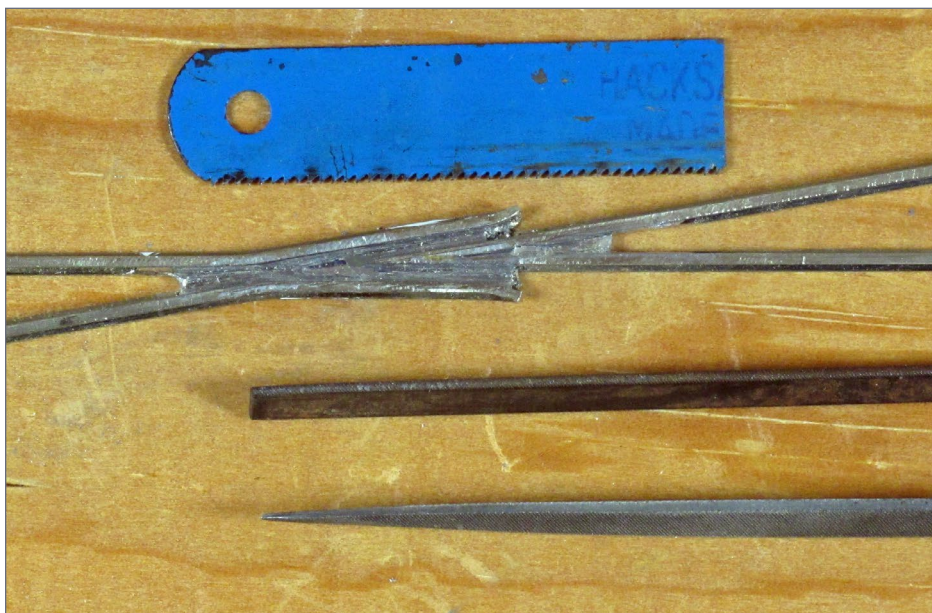

8. Hacksaw blade and files used for cleaning solder from the frog.

Remove some of the rail base on the inside of the “V” frog point beyond where the railheads meet at the point. The most important part of the frog point is the tip and its relation to the closure railheads. It’s best to leave any final adjustment to a jeweler’s file.

After disk sanding and filing down each frog rail to a very shallow point, the rails don’t have much strength at the end. Pushing too hard on them from the other end to get a tight fit actually forces the rail out of alignment. In the correct alignment, the frog point is back from the 1:6 line crossing point [6].

Keep picking up the frog/closure assembly fixture and sighting down one rail or the other until you are sure that there is a straight path through from the closure rail to the frog point. To see what happens when the frog points are pushed too far forward in the fixture, reference [6].

I actually took this photo on my second turnout so I could check whether the alignment was correct by drawing blue lines with my photo editing software. This picture showed they weren't aligned. I learned from the first turnout that filing to make up for poor assembly takes a lot more time than checking before soldering.

I saved myself a lot of unsoldering and re-filing if I waited to solder the stock rail to the PC ties until I completed the work on all the rails that make up inner parts of the turnout (except guard rails).

Care must be taken in bending the wing rails of the closure rails which surround the point of the frog. On the first turnout, I didn't bend the tip out far enough from the rail. Light finger pressure pushing a truck along the turnout showed that it could ride up at the wing rail [7]. I also checked that the rails were flat and not bending up or down from a flat plane – especially the wing rails. This had happened on my first turnout and I didn't catch it until I had the frog assembly soldered in place.

Another mistake I made on my first turnout was bending the curved closure rail to the template line before the frog assembly was complete. It's easier if the curved closure rail remains straight in the frog/closure fixture.

Be careful when soldering the frog. If you put too much solder on, more effort is required to remove the excess. I aimed to get the entire frog filled but not have excess. I initially used rosin core solder but as the flux melts, I had little control over where the solder would flow.

I bought a lifetime supply of rosin flux and used a piece of wire as Charlie did to apply the flux only on the bottom of the frog. The idea is to only apply it where you want the solder to go. The surface tension on melted solder makes it want to bead up. The



TURNOUT SCRATCHBUILDING JOURNEY | 19

separate flux was a definite improvement for subsequent soldering of rails even though my solder was also rosin core.

To clean up the frog assembly, I used a piece of a relatively fine hack saw blade as Charlie recommended. At first I tried a relatively coarse blade and it didn't work well. The blade, however did not remove the solder along the sides of the rail where the wheels contact. I used a very flat file to file the rail sides. The NMRA gauge flange tip is square and should fit all the way in until the gauge's top hits the railhead.

There is a tendency to have a "U" shaped path rather than a square one, which can also push the wheel flanges up and lead to derailments. After the hacksaw blade, cleaning with the files gets a clean square path through the frog [8].

While the inside of the frog point (outside railheads) is not contacted by the wheels, it looks better to clean it up with no blobs of solder showing.

The tops of the rails may also have some solder spots which need to be removed. Turn the assembly upside down and file the

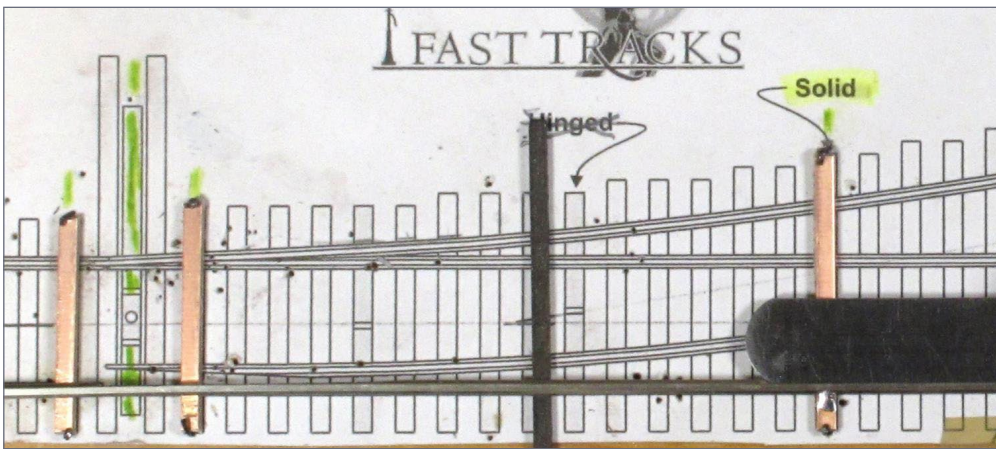

9. Soldering straight through rail to PC ties.

bottom flat. If the assembly is not flat from end-to-end, bend it by hand to get it as flat as possible. Soldering to the PC ties won't make up for it not being flat in the first place.

Soldering the straight stock rail onto the PC ties on the original turnout template

First check the stock rail base cutout where the points will contact to be sure sufficient base on the inside is removed. If there is a problem, fix it before soldering down the rails.

Dip a wire in rosin flux and apply the flux on each PC tie where the rail will contact the tie. Apply the soldering iron and solder to the outside of the rail so build-up does not interfere with the wheel flanges on the inside of the rail. If you can keep the solder spot small it will look better and less filing will be needed later.

Line up the straight stock rail and spike it on both sides at a tie in the middle. Solder only to this tie. After the one joint is complete, use a straight metal rule, as Charlie points out, to make sure this rail is really straight. I spike the rail at two places on the outside.

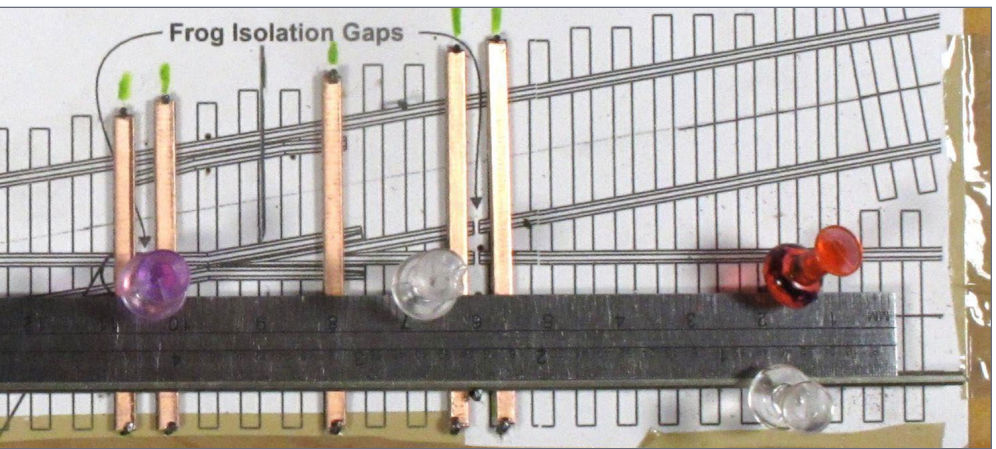

TURNOUT SCRATCHBUILDING JOURNEY | 21

Use push pins to hold the metal ruler in place. Double check to see that rail lines up with the template before soldering [9].

Finish the points & closure rails

This is a critical part of the turnout assembly, so I have broken it down into sub-steps.

Step A: Place the frog assembly on the full turnout template with the tip of the frog point in its proper location. To make sure everything is lined up properly before cutting the points to length, I use push pins and spikes to hold the frog assembly in position on the template. I also spike and pin the curved stock rail. Both the curved stock rail and the curved closure rail may now need to be bent more to fit properly on the template.

Mark the spot on each closure rail tip where it will contact the stock rail, about 1/16" past where the stock rail base cutout begins. I thought I needed to leave the stock rail base cutout a bit long, just in case.

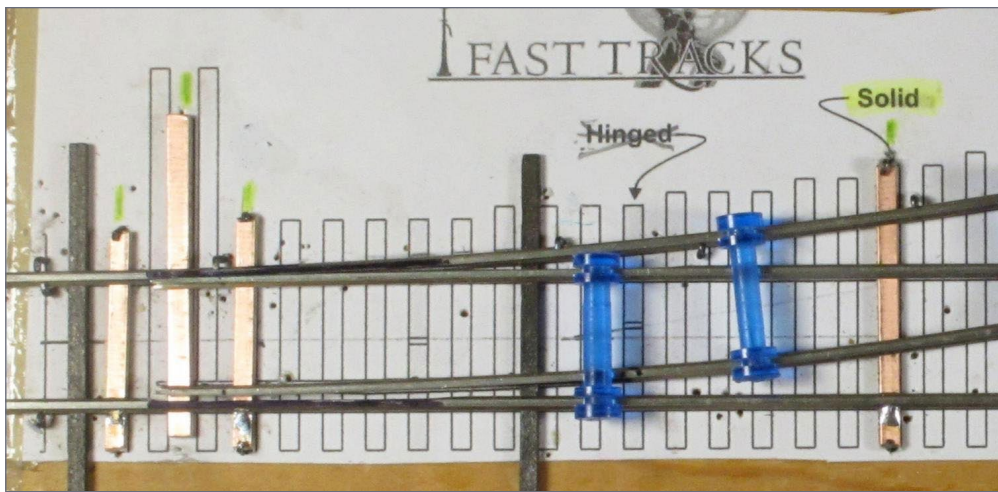

10. All rails in place with closure points partially finished.

TURNOUT SCRATCHBUILDING JOURNEY | 22

Step B: Cut the rail at the mark on the points with the Xuron rail nippers.

Step C: Bend just the tip of each closure point $3/8"$ back ever-so-slightly toward the inside. Bend it only far enough to get the inside edge of the railhead to align with the base of the rail. I had to double-check myself several times on the video to make sure I was doing this right. The video has diagrams, but the bend location looks a lot less than $3/8"$.

The amount of the bend is only the difference in thickness between the web and the railhead on the inside. The idea is to bend it only enough that when the top edge of the inside railhead is filed back to the web, it makes a straight line.

On my first turnout, I missed this slight bend step because I formed the closure rails and disk-sanded the points before watching this part of the video. I spent a lot of time later to correct for this and to get proper contact with the stock rail.

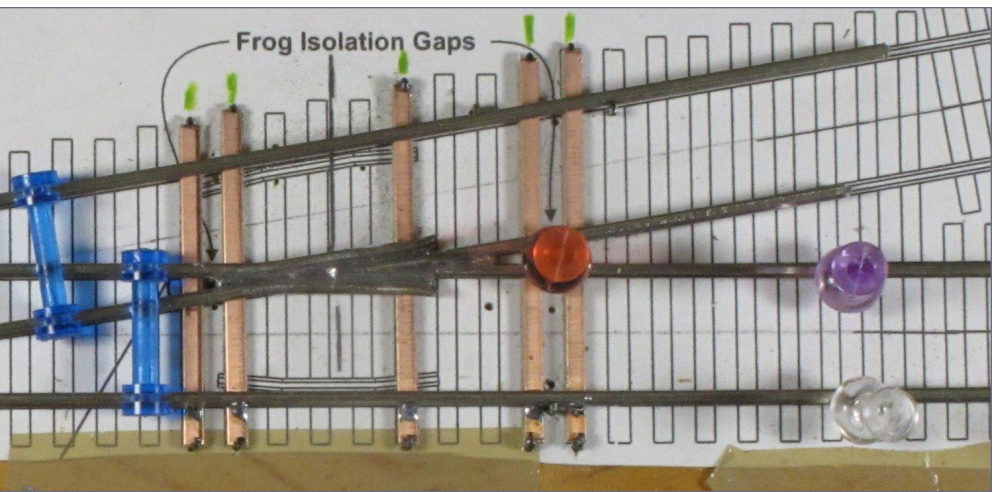

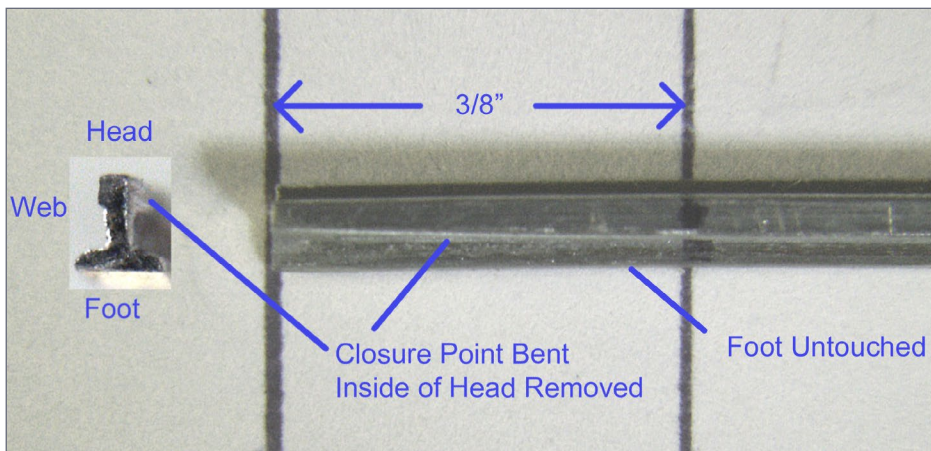

11. Closure point after Step D.

Step D: Using a flat file, remove the material only on the inside head of each railhead (but not the base). I tried using six-inch flat and triangular files, but found it too easy to start removing the top of the base. A small flat jeweler's file with the smooth side against the base worked best for me. If any of the base is accidentally removed, it will provide less contact for the solder joint with the throwbar.

Look closely at Charlie's diagram. The head is filed from flush to the web at the point end to normal railhead thickness $3/8$ " back from the point end. The photo above [11] shows what the inside of the closure point looks like when partially finished. The bend in this photo was not quite enough. The bend should be enough so the web (along with the railhead) is filed to a sharp vertical line, before any of the back side of the point is removed (next step).

Step E: Now that the inside of the point rails is complete, the back side must also be removed, but this time both the railhead and base are filed flush with the web. Use the stationary disk sander or a file to remove the outside of each of the closure rail

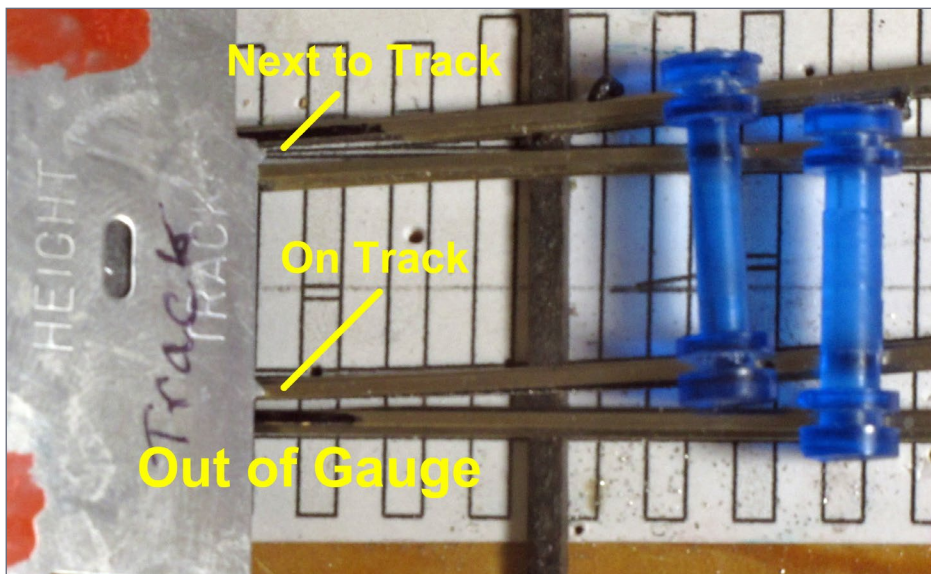

12. NMRA gauge at the points doesn't fit. Time for more adjustments: keep working until things are perfectly in gauge.

point at a narrow angle one inch or more from the point end. Again it is best to do the final shaping of the points with a jeweler's file. To get the best fit, you may have to remove more of the base of the stock rail. Use the Rollee Holders and NMRA gauge to get the proper gauge. This can be time consuming but it pays to get it right.

Make sure to sand with 600 grit sandpaper underneath the point rail bottom to polish it where it will slide across the ties.

Final check, before soldering

In [10] I have spiked all the rails in place to hold them for soldering. The straight stock rail is shown soldered, but in later turnouts, I didn't solder any rails until I had finished all the filing and fitting.

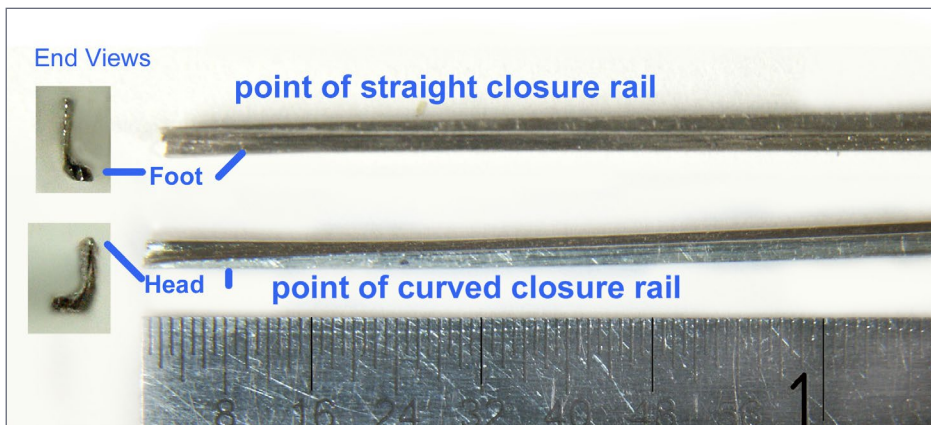

13. Top and end view of point closure rails before soldering.

The PC throw bar is shown in place but it's removed before any of the rails are soldered to the PC ties. I have placed a wooden tie (thicker than the PC ties so I sanded it down) under the rails halfway between the solid PC tie and the throwbar. Otherwise, spiking can force the rail to be pushed lower over this long unsupported area and cause a dip that can get permanently into the rails after everything has been soldered.

As Charlie recommends, I placed a slight kink in the curved stock rail (but not in the straight closure rail which meets it) where the stock rail base cutout begins. This helps to achieve a good fit with the straight point rail.

Do not rely on the Rollee gauges alone: they can't fit right where the point rails touch the stock rails, for instance. Before and after soldering, use the NMRA gauge to check the spacing between the stock and closure rails.

The photo on the previous page [12] shows that although the Rollee gauges are keeping the things in gauge very near the points, the NMRA gauge shows the point rails need further bending and filing to get the gauge correct.

According to Steve Hatch of Railway Engineering, the NMRA track gauge side is really a bit too wide for the NMRA wheel spacing standard and he recommends using the flange end of the gauge for turnouts.

The Rollee gauges fit well with the flange end of the NMRA gauge, so I use the flange end of the NMRA gauge as a final check. On Steve's website, see his Hints, Techniques and Answers on Tracklaying: railwayeng.com/rrhints.htm .

The photo [13] shows the top and end views of the closure points after final filing. I also had to take some slight bends out of the straight closure rail (which mates with the curved stock rail) as the filing tends to bend it. The mating of the closure points with the stock rails can be seen in later photos.

I had removed more of the inside base of each stock rail than I needed to. However, this is better than too little and assures the top of the point will be right against its stock rail. On the other hand, it's less rail base for soldering to the PC ties.

Soldering the rails to the PC ties

After doing all the checks with the NMRA gauge and the Rollee Holders still in place, the frog/closure assembly is ready for soldering. Always heat the rail so the solder flow. If the mass of the rail is hot enough, the copper of the PC tie surely will be hot enough too.

Since the straight stock rail had already been soldered (on my second and following turnouts, I left this for later), I used three of the Rollee gauges to make sure the straight closure rail was in gauge throughout its length. I used the fourth Rollee gauge to keep the proper spacing between the curved closure rail and the curved through rail.



TURNOUT SCRATCHBUILDING JOURNEY | 27

After soldering the closure rails to some PC ties, I noticed the frog point had moved and the closure points no longer aligned properly with the cutouts in the stock rail base. I had to unsolder, re-position and re-spike and finally re-solder. It didn't take long, but it made me be more careful on subsequent turnouts.

If you have to unsolder, remove as much solder from the PC ties as possible. When re-soldering, push down on the rail to make sure the resoldered rail is flat against the PC ties.

A few spikes kept the frog assembly in place the second time. Keep spikes close to the PC ties to avoid bending the rail out of gauge in between solder locations. Since the Rollee gauges are plastic, I keep them well away from the soldering location.

During soldering, remember to solder on the outside of the rail, not the inside. Excess solder may not look great on the outside of a rail, but at least it doesn't interfere with wheel flanges like solder on the inside of the rail might do. Just keep straight in your mind which is the inside and outside on the closure rails.

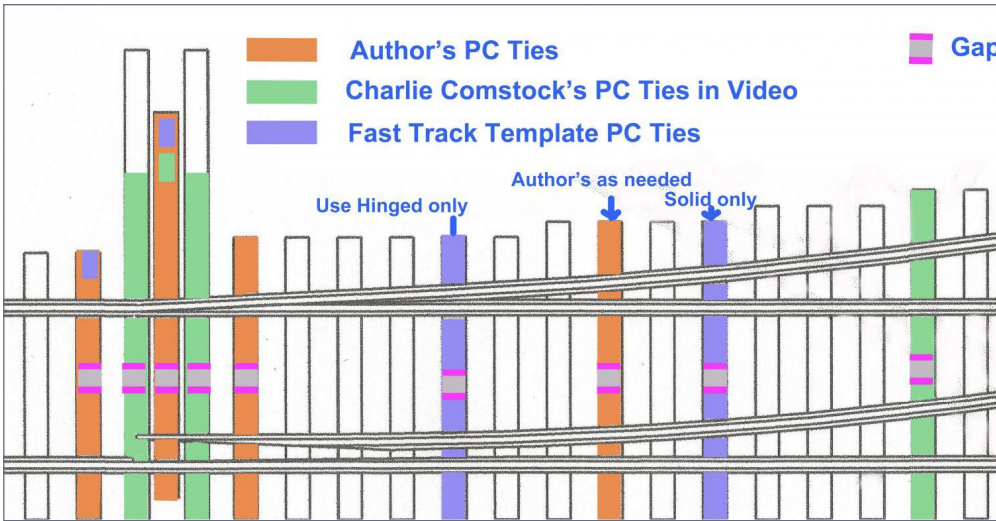

14. Three versions of PC ties with rail and tie gaps.

TURNOUT SCRATCHBUILDING JOURNEY | 28

Solder the closure rails only from the solid PC tie through the frog assembly. Do *not* solder the moving closure rail points to the PC tie that's next to the throw bar!

Use the Rollee gauges and spike down the curved through rail. Use the NMRA gauge to check alignment before soldering the curved rail near the points where the Rollee gauges don't fit.

Again check to see that the closure rail points are aligned with the base cutout on the curved stock rail. Even on the second turnout, I managed to move the curved stock rail slightly before soldering and the point didn't align with the cutout properly. I had to unsolder it and re-solder it, but I was more careful next time!

The span between the second tie next to the throw bar and the third PC tie toward the frog where the closure rails first get soldered, is quite large. On my first turnout, I added another PC tie between these two locations to keep the stock rails in gauge. Do *not* solder this tie to the closure rails, only to the stock rails.

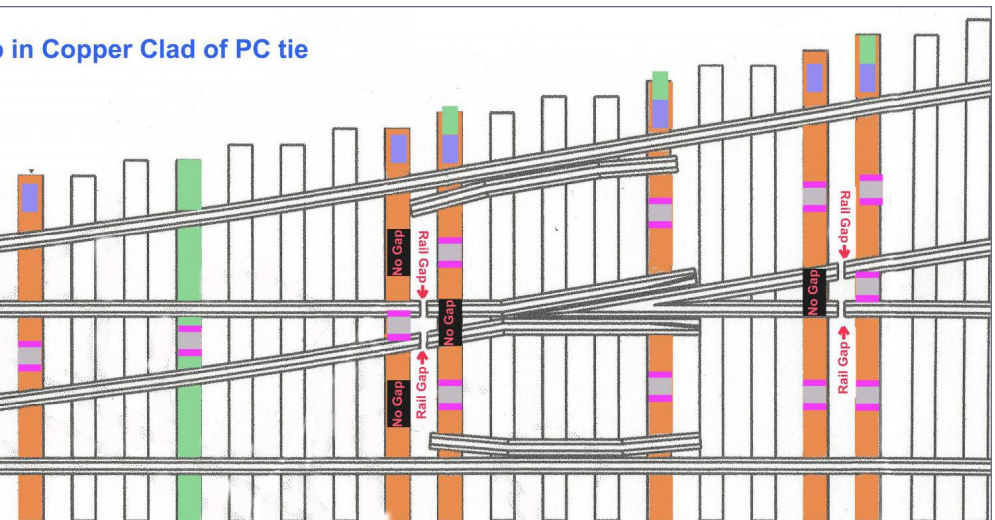

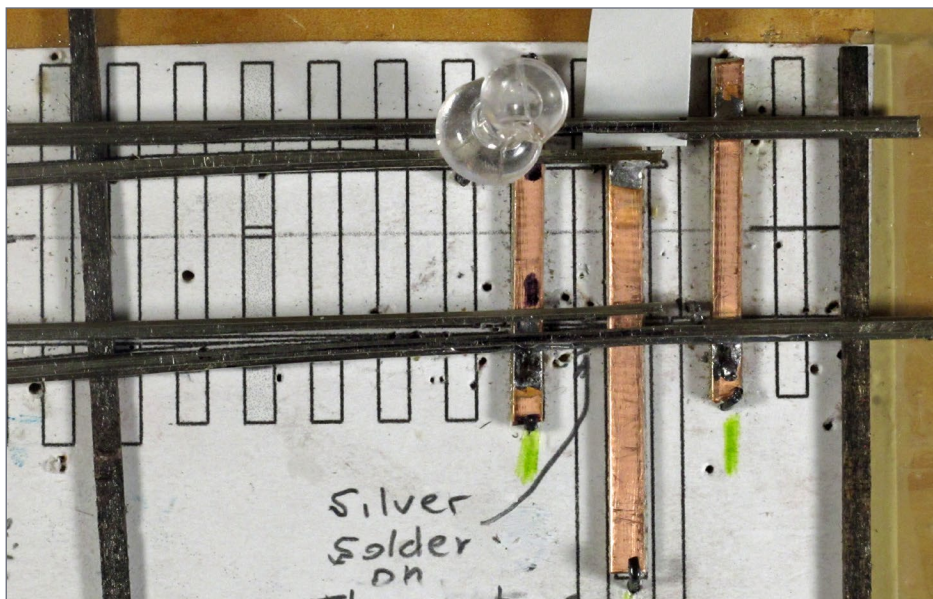

15. One point soldered to throwbar.

Soldering the points to the throw bar

The last critical step is soldering the points to the throw bar. Unlike Charlie, I followed the Fast Tracks template by planning for wood ties next to the throwbar, rather than Charlie's PC ties. Just to make it clear: starting at the throwbar end of the turnout the order of ties is: PC, wood, PC throwbar, wood, PC. I think both Charlie's and my own approach give more stability to the turnout in the point area than the Fast Tracks recommendation.

As Charlie does, I put a piece of strip paper between the stock rail and throwbar to assure that the throwbar wouldn't be soldered to the stock rail.

It's also important not to make the spacing between the point rail and stock rail on the open point side any wider than necessary. I used the flange end of the NMRA gauge to establish my

point spacing. I also double-checked the gauge between the point and the opposite stock rail for each direction of the throw.

Since continuous point/closure rails are stiffer than hinged, it's desirable to reduce the force and the stress on the solder joint as much as possible. Charlie recommends silver solder since it's stronger for this joint.

This is a good idea, as there is only 60% of the rail base left at the end of the point and there is extra stress as the points get forced to one side or the other when thrown. I found some silver solder at Home Depot for this critical solder joint.

Before soldering to the throw bar, gently bend the closure rails so the resting position of the points will be each equally far from the stock rail. This helps keep the force required by the switch machine to be the same in both operating positions. I also soldered each point in its open position as shown in [15].

Making final adjustments

After I completed soldering the points, I found the resting position of the throw bar was biased toward the curved rail side (straight path through the turnout). I bent the point rails slightly until they were centered. I did not bend them near the point, but near the soldered end of the closure rails. Nothing radical – just a little tweaking and checking with gauges throughout the process.

I also found it valuable to run a single truck through the turnout in each direction with my finger lightly holding it down. In the first turnout I built, this is how I found that the bend at the tip of the wing rail was insufficient and the lead wheel often rose up on it and derail. This is shown in [7].

Fortunately, using rail soldered to PC ties makes modifications easy. The gauges showed me the curved stock rail was wider than



proper gauge from the frog point. With the tip of the hot soldering iron and a nudge from a jewelers file, I corrected the track gauge. Also the last 1/8” of the wing rail was not soldered to the frog, so I was able to bend the tip out to eliminate the problem.

Making and installing the guard rails

Take two short pieces of rail at least 1¼” long and form guard rails. I bent the ends out as shown on the template.

Using the NMRA flange gauge end, I determined that the base of the guard rail should not be right up against the base of the stock rail. The photo [16] shows how I used spikes to hold down the guard rail, and push pins to give a slight spacing from the stock rail. I then soldered each guard rail in place.

Creating isolation gaps in the PC ties

The location of electrical isolation gaps needed on the PC ties are shown on the diagram in [16].

I show my PC tie locations in copper color. I use a small square file to make the gaps. Just make sure you can't see any copper “bridges” in the gap when done. Don't go too deep beyond the copper foil, to avoid weakening the PC tie.

Charlie Comstock's PC tie and Fast Track-recommended PC tie locations are shown in green and blue as a comparison to mine.

The locations of the rail gaps are also shown in [14]. These are designed to be DCC-friendly by isolating the frog. When these are completed, the closure/point rail assembly is electrically connected to its adjoining stock rail, and the frog assembly is electrically isolated. Power wiring to the turnout is now as easy as providing power to the stock rails. Powering the frog, however, takes some additional consideration.

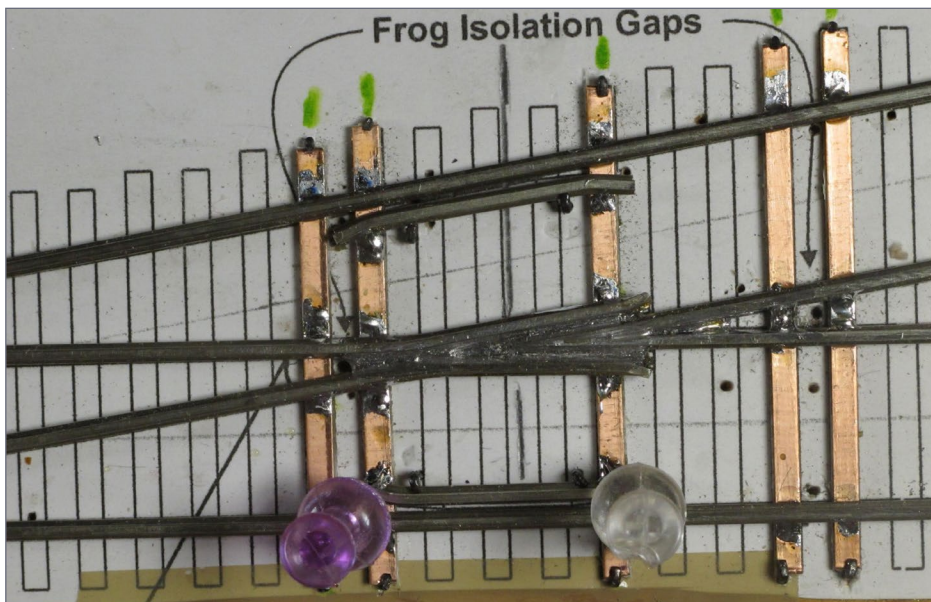

16. Soldering the guard rails in place.

The frog power gets switched, depending on which way the turnout is thrown. The Tortoise and Mighty Mole switch machines have contacts for this purpose. The closure rails' solid PC tie bridge means they do not need to rely on contact of the points with the stock rail for power, which makes running through the turnout more reliable. The isolated frog keeps shorts from happening at that location.

Remove the completed switch from the template and put it on a flat piece of wood for cutting the frog gap. I'd rather save the paper template as long as I can. I initially used a two-speed old Dremel motor tool but later switched to a Durabuilt with a a flexible shaft. This worked well for me.

Always wear protective glasses when using a cutoff wheel. They often break and send pieces flying.

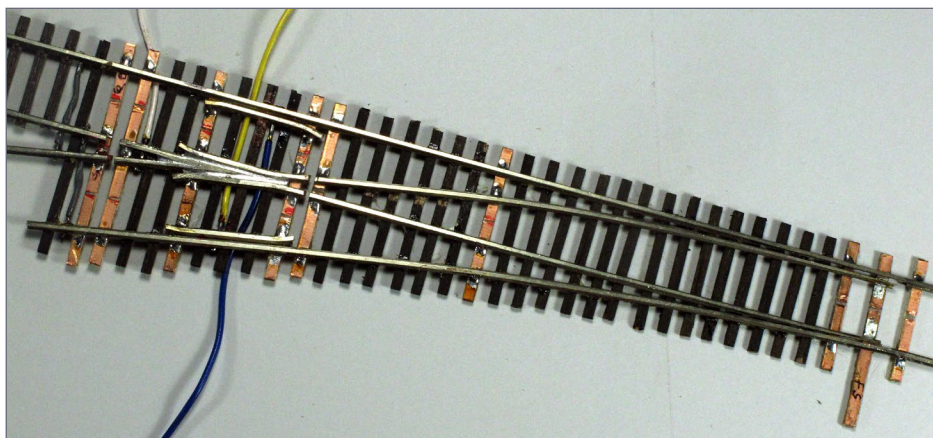

17. Wired turnout, ready to install on the layout.

Add power feeders to the turnout

I like to add feeders before installing the turnout on the layout. The curved stock rail gets a blue wire, the straight stock rail gets yellow, and the frog power feeder gets white [17].

I solder the wires so they lay flat while I am aligning the turnout on the layout but can be bent down into holes for the final install.

I learned the hard way not to solder the frog feeder to the frog underneath the solder-filled frog. The frog flangeway solder bulged out and had to be redone. After that I soldered the frog wire at the diverging end just before the last frog gap [17].

Both the Proto87 Mole switch machines which I'm using and the Tortoise have power routing contacts for powering the frog.

Finishing up

The final step is adding wooden ties to the turnout. Barge cement works well but I need more than a thin layer. I had to be especially careful gluing the ties around the moving points.

TURNOUT SCRATCHBUILDING JOURNEY | 34

In a couple of cases, the Barge cement (which seems to have strings everywhere) stuck to the moving points and had to be removed. I used my paper template rather than setting up a tie jig and my placement was not perfect. But Barge-cemented ties can be moved a bit to straighten them before the cement hardens.

Initially, I glued all the double-length ties to the rails full length. Then I cut them to length on the template. But I found they tended to come unglued. It worked better to cut them to length and *then* glue them on. The photo [17] shows a completed turnout (turnout, minus the switch stand or head block ties around the throwbar).

Before it is installed on the layout, the turnout needs a hole in the throw bar for a throw wire from the switch machine. I drill this hole at installation time to make sure I get it in just the right place.

I hope you will try making a turnout yourself from scratch. There is tooling available to make the job easier but it costs a lot more than the Rollee gauges.

A word from the MRH editor:

Much of the frustration Tim encountered with scratchbuilding his own turnouts and struggling with filing the rail inconsistently can be alleviated by investing in some Fast Tracks filing jigs. You don't necessarily need to buy the more expensive turnout fixture soldering jigs, but investing in just the filing jigs will save you a lot of headache and result in perfectly filed frog points, turnout points and stock rails every time. If you have more than a few turnouts to build, the filing jigs are worth every penny. There's nothing more valuable than these filing jigs to ensure consistent filing of the rails with your scratchbuilt turnouts.

– Joe Fugate





TIMOTHY BARNUM

Timothy Barnum has always loved trains big and small. As a child he wanted to be a train engineer and didn't know there was any other kind until high school. His interests in model trains plus math and science led him to become a mechanical and then systems engineer. Most of his career was spent in management of automation for the US postal service, from which he retired 16 years ago.

After retirement, Tim tried being an artist and a small boat designer/builder. While model railroading was his hobby off and on since childhood, it's now his major interest. The world's greatest hobby provides a chance for Tim to explore many technologies and build models. Tim also learned to play the bassoon and is a past president of Bay Winds Band.

Tim enjoys scratchbuilding turnouts based on Charlie Comstock's video, which led to this article. He thanks all of the modelers who share their ideas so that he could learn new things much more quickly! ■



[Click here to rate or comment on this article](#)

YOU DON'T HAVE TO BUILD IT...

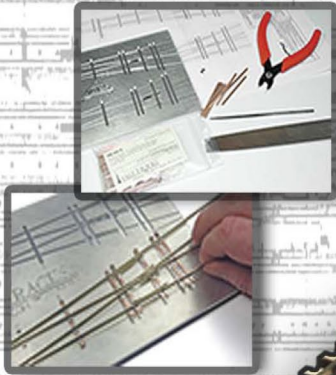

YOU GET TO BUILD IT!

With track building tools
and supplies from...



Visit HANDLAIDTRACK.COM and start today!

• [INDEX](#)



[SUBSCRIBE](#)
(free)

• [TABLE OF CONTENTS](#)

Introducing MRC's
Prodigy™ WiFi Module

Now, Run Your PRODIGY DCC Railroad Wirelessly From Your Smartphone*

All you need is an MRC Prodigy DCC system, MRC's WiFi Module and a Withrottle or Engine Driver App downloaded on your smartphone, and you're ready to run. Works with any brand loco or decoder.

The module acts as an interface between the two most popular smartphone apps: Withrottle for iPhone®, iPod®, iPod Touch® available on the App Store; Engine Driver® for Android™ devices, available on Google Play™

- Plug'n play simplicity. No complex JMRI software to navigate. No computer interface needed. No Bluetooth® connection. No wiring. No need for a home network to run your layout.



#0001530: MRC's WiFi Module
MSRP \$119.98

- Invite friends to run your railroad. All they need is a smartphone and to download the Withrottle or Engine Driver App to wirelessly control a loco. The MRC WiFi Module will run up to 8 smartphones.



For More Information Visit:
www.modelrectifier.com/wifi

*Use your Apple or Android smartphone, or other mobile device.
iPhone, iPad, and iPod touch are trademarks of Apple Inc., registered in the U.S. and other countries.
Android is a registered trademark of Google, Inc.



M O D E L R E C T I F I E R C O R P O R A T I O N
80 Newfield Ave. ■ Edison, New Jersey 08837 ■ Phone: 732 225 6360 www.modelrectifier.com

TECHNOLOGY. PERFECTED.

Model railroads Plastic model kits Battery chargers Radio control helicopters, planes, cars & boats Slot Cars Scenery Die cast

• INDEX

• TABLE OF CONTENTS

DESIGNING & BUILDING THE *EMEY FALLS* MODULE

BY ROBERT KLARÉN



[Click here to rate or comment on this article](#)

A two-meter-long module that was built in two sections ...

I AM MEMBER OF A SOCIETY BUILDING N SCALE modules in accordance to FREMO American standard. I had this idea of a two-meter-long module that would be built in two sections. The big challenge for me is I live in Sweden.

My first design I made, Emey Falls 1, had all tracks parallel. A friend of mine commented that if the first track is “bent” around the station building it would be more American, and that this track was often used for loading and unloading goods. I made the suggested change in Emey Falls 2.

• [INDEX](#)



SUBSCRIBE
(free)

• [TABLE OF CONTENTS](#)

Emey Falls American

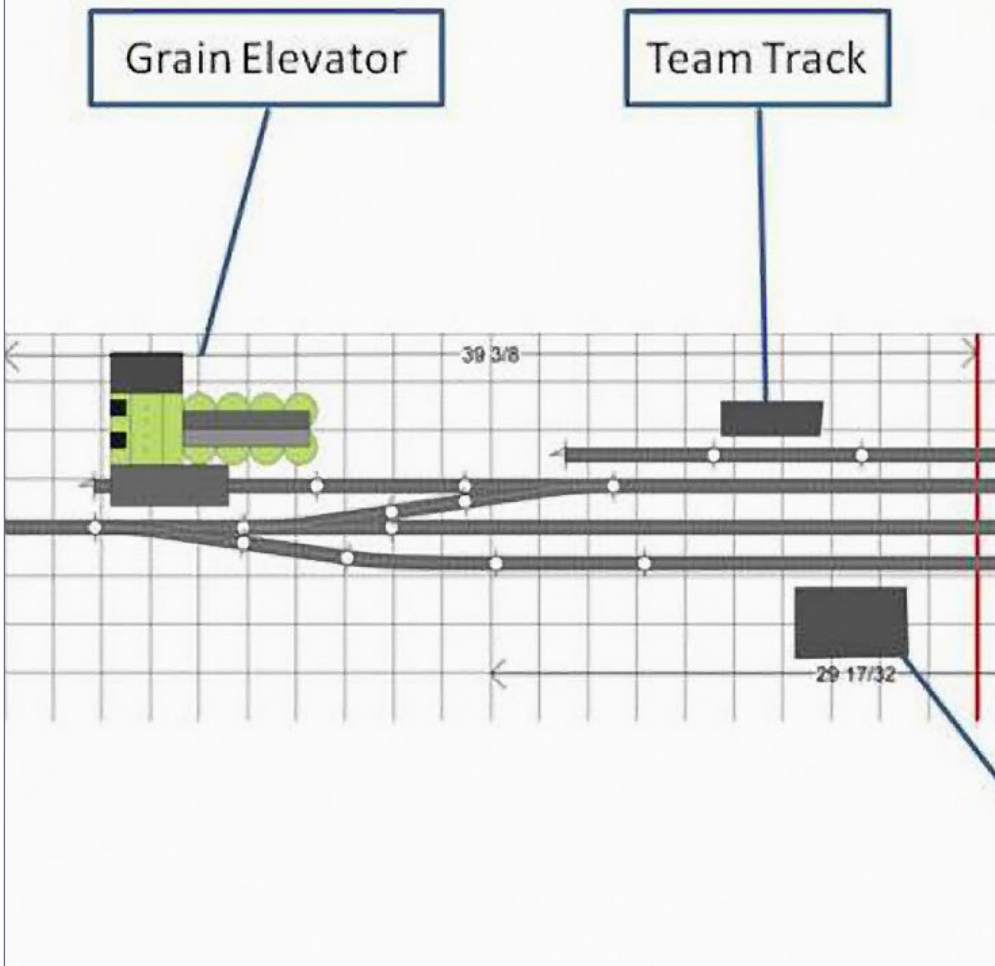

s 1

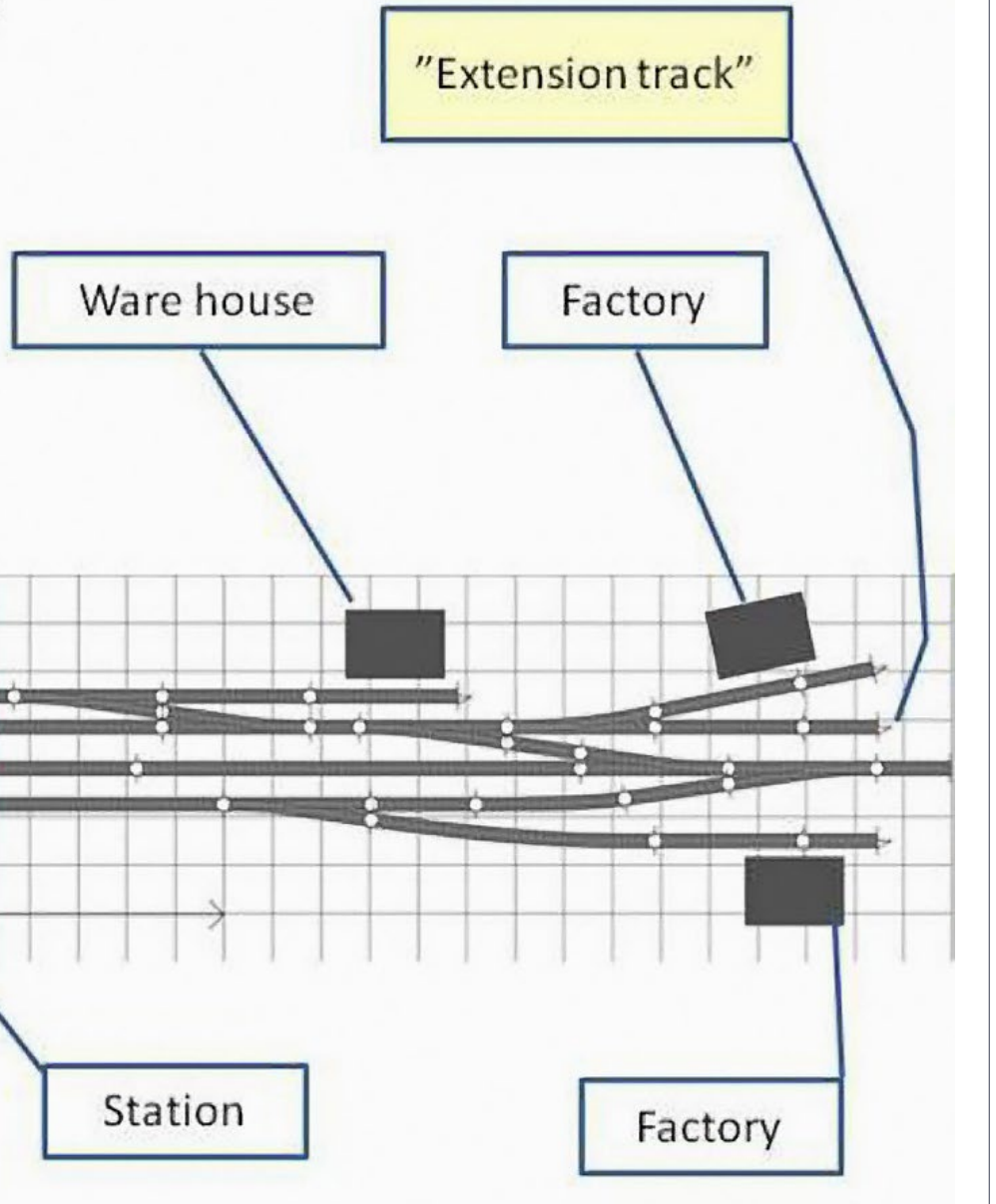

Emey Falls
American

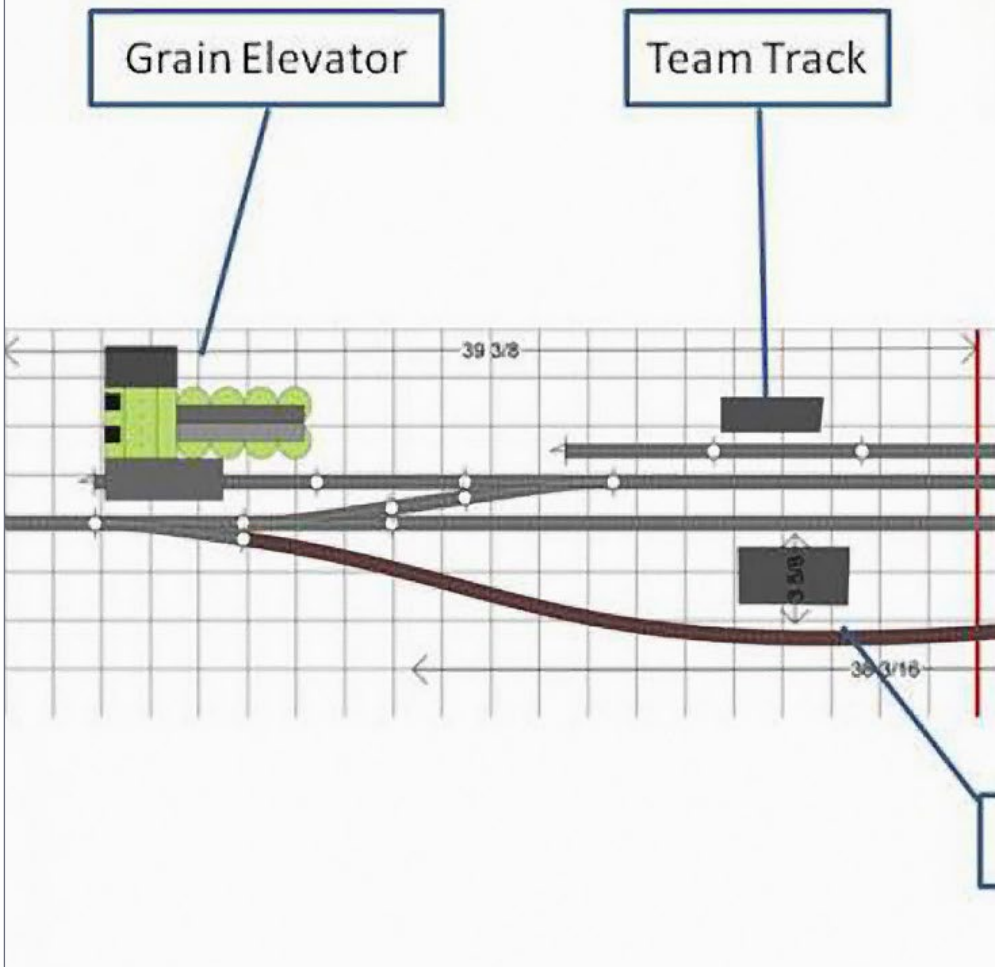

s 2

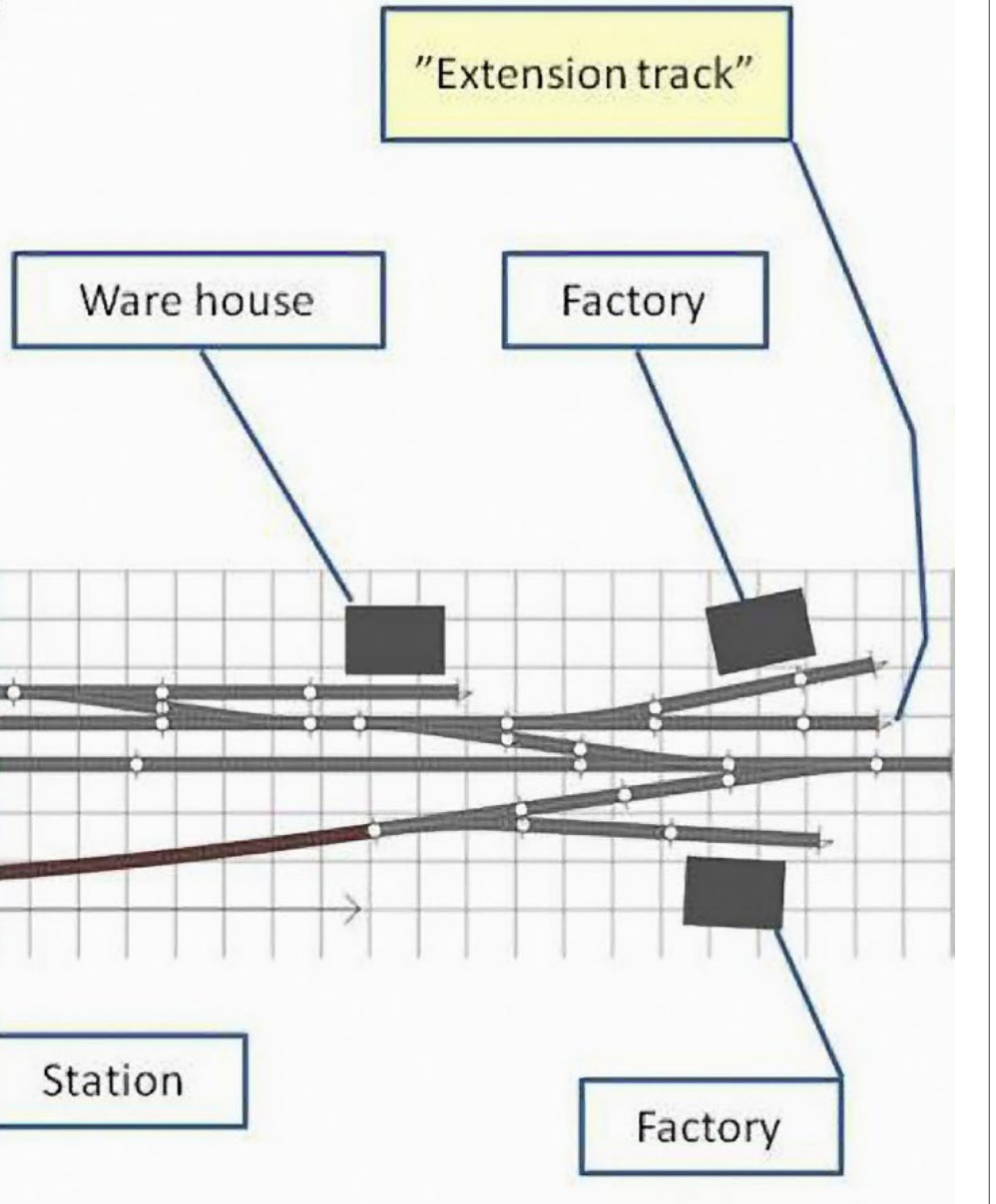

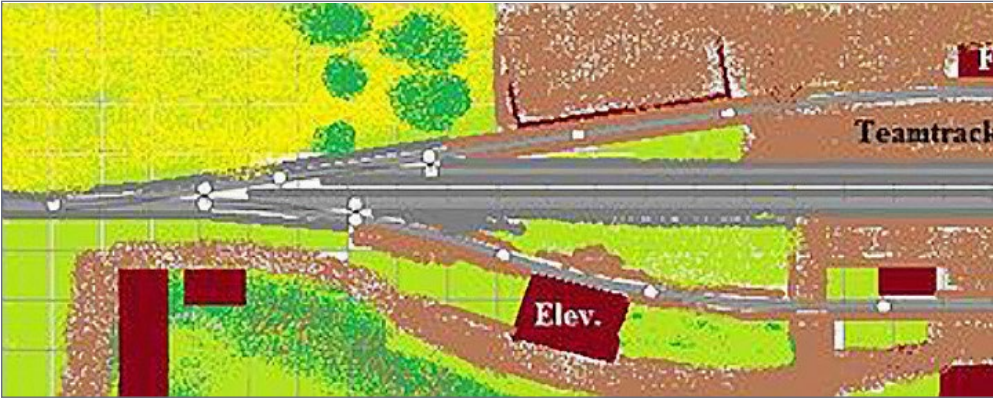

3. Emey Falls plan 3.

With these two plans, I posted my plans in the MRH Forum asking for comments. The next day I had received two comments regarding my plans, and learned a few things about American railroad terms. For example, the track behind the station is called a “house track” or a “team track,” and that an “industry track” is different from a “passing siding.”

I was also advised to make my passing track longer and to eliminate the extension track, since the local switching the town would be working it from the main. Finally, I learned that in my initial designs the elevator track was pretty useless since I could only load one car at a time. The American practice would be to have a track length of two times the number of cars I want to load plus one, and the loading point would be in the middle.

I also received some advice from a more experienced modeler who said “less is more,” so with that bit of advice and the comments I received, I came up with the following plan, Emey Falls 3

A few more adjustments, and I came up with Emey Falls 4. I expanded the module to three sections, and this is the plan I built. I would like to thank everyone in America who provided

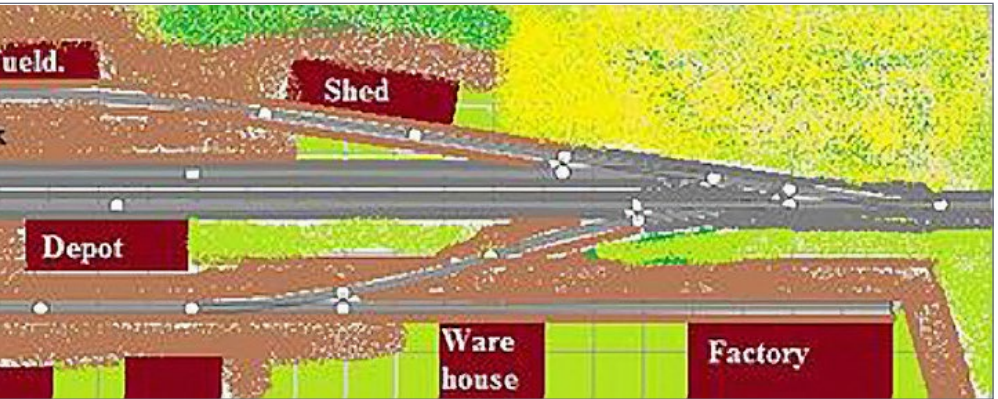

their input and advice. It gave me the opportunity to build a uniquely American module here in Sweden. ✓

See photos on the following pages ...

ADVERTISEMENT

YD



Yankee Dabbling – Track 33

**FREE SHIPPING
ON ORDERS OVER
\$100.00**

**YD Specializes in DCC
Sales-Service-Installation**

YD provides the BEST for LESS



CLICK AND SAVE TODAY!



2017
SOLD

YD installs DCC or RailPro in your engines
Technical Coordination (727) 457-9227 9AM to 9PM EST



Emey

By Robert
WetterN – Ha

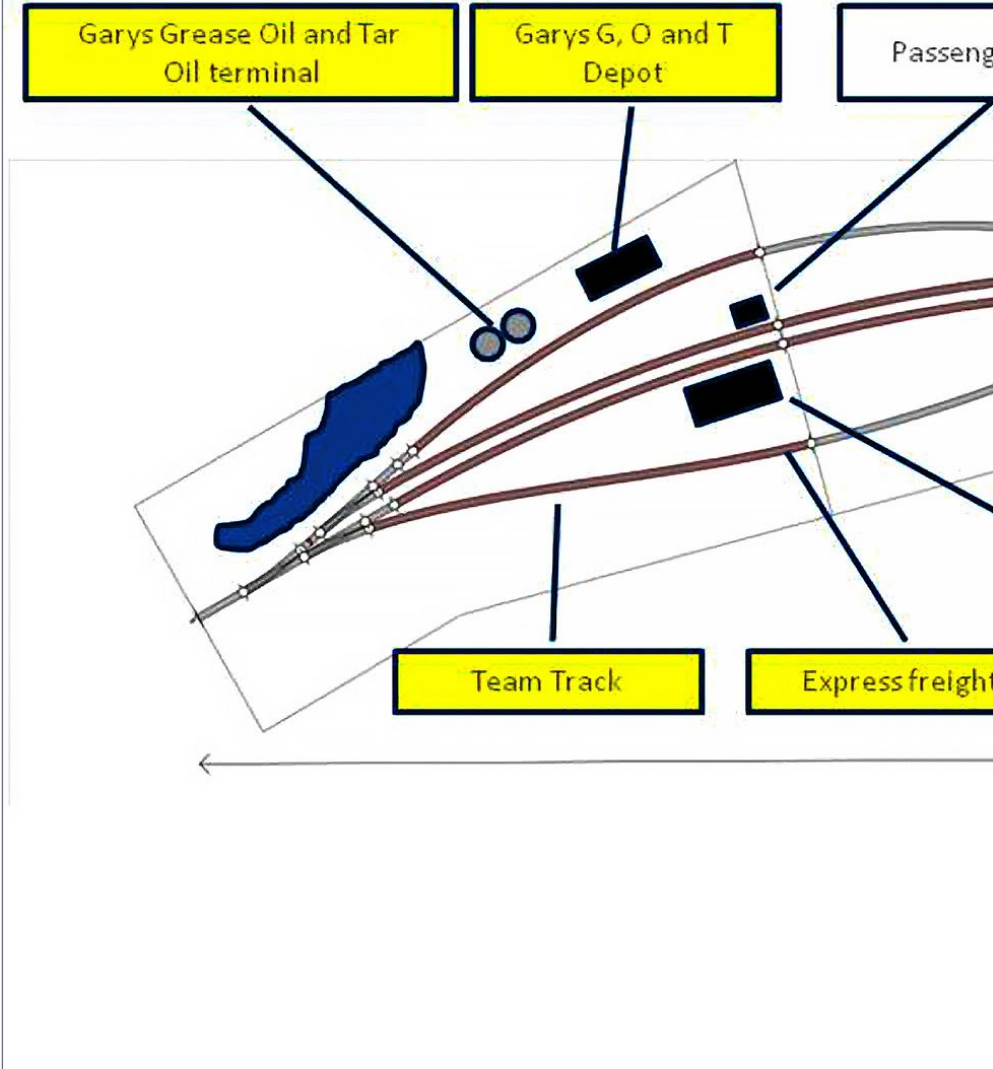

Falls

t Klarén
bo, Sweden

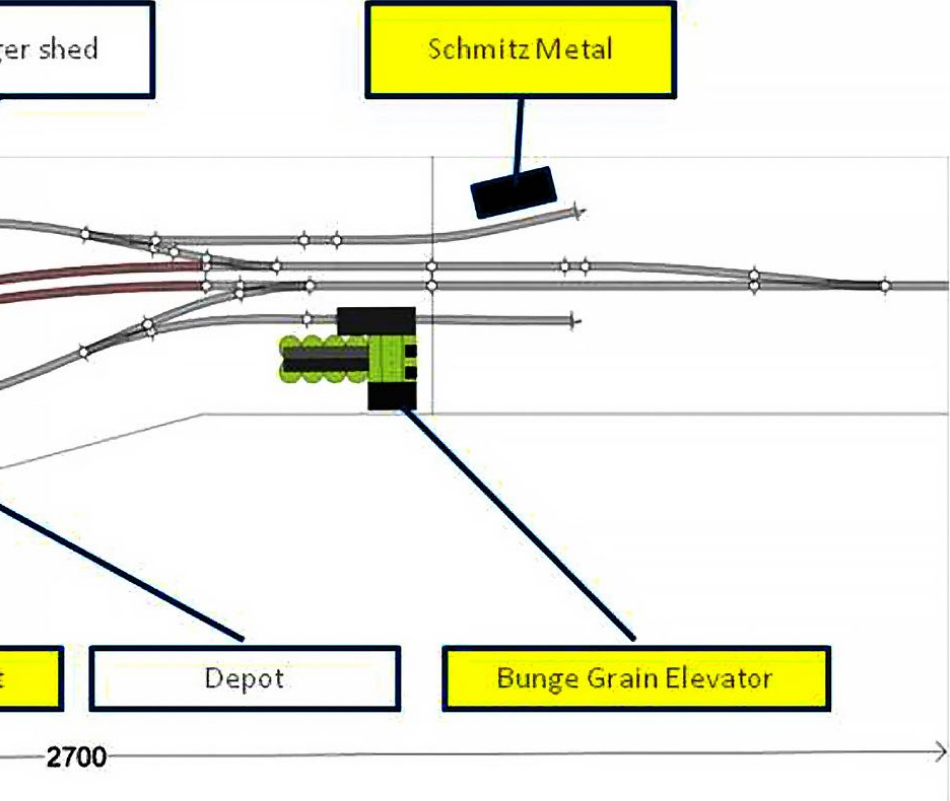

Inspiration from a photo published by *Model Railroader* magazine of Corning, Iowa

Jim Hediger, Senior Editor at *Model Railroader*, researched this photo of Corning, Iowa, and wrote about it. You can find the details on the *Model Railroader* website. Visit this weblink on the *Model Railroader* website for the details:

mrr.trains.com/how-to/prototype-railroads/2014/05/small-town-railroad-ing-in-the-early-1950s

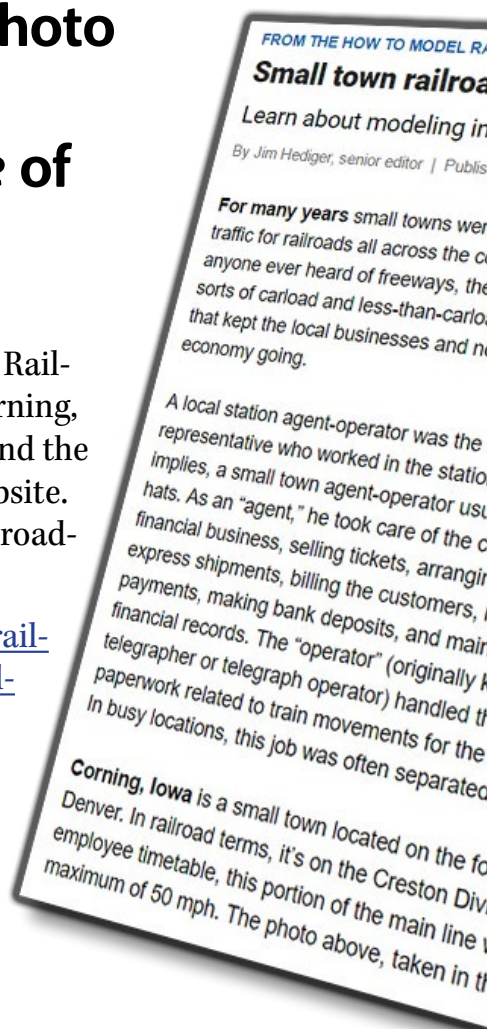

5. The bent shape of the module is inspired by a 1950s photo from Corning, Iowa, published by *Model Railroader* magazine. Click to visit the *Model Railroader* website and learn more.

RAILROADS OF THE 1950S ISSUE

anding in the early 1950s

h this era

hed: Friday, May 02, 2014

re a major source of
ountry. Long before
e railroads moved all
ad lot (LCL) freight
early agricultural

railroad's
n. As the title
ually wore two
ompany's
ng freight and
receiving
ntaining
nown as a
e operating
dispatcher.

into two positions.

former Chicago, Burlington & Quincy's main line between Chicago and
ision at milepost 413 east of Omaha, Neb. According to a 1955 CB&Q
was double track, with a passenger speed limit of 79 mph and a freight
the early 1950s, captured many typical features.



Coming, Iowa, is a small town that was served by the former Chicago, Burlington & Quincy's main line. This view looking east shows the wide curves that allowed the Zephyrs to speed through town at 80 mph. The crossovers helped the local freight do its switching.

Henry McCord photo



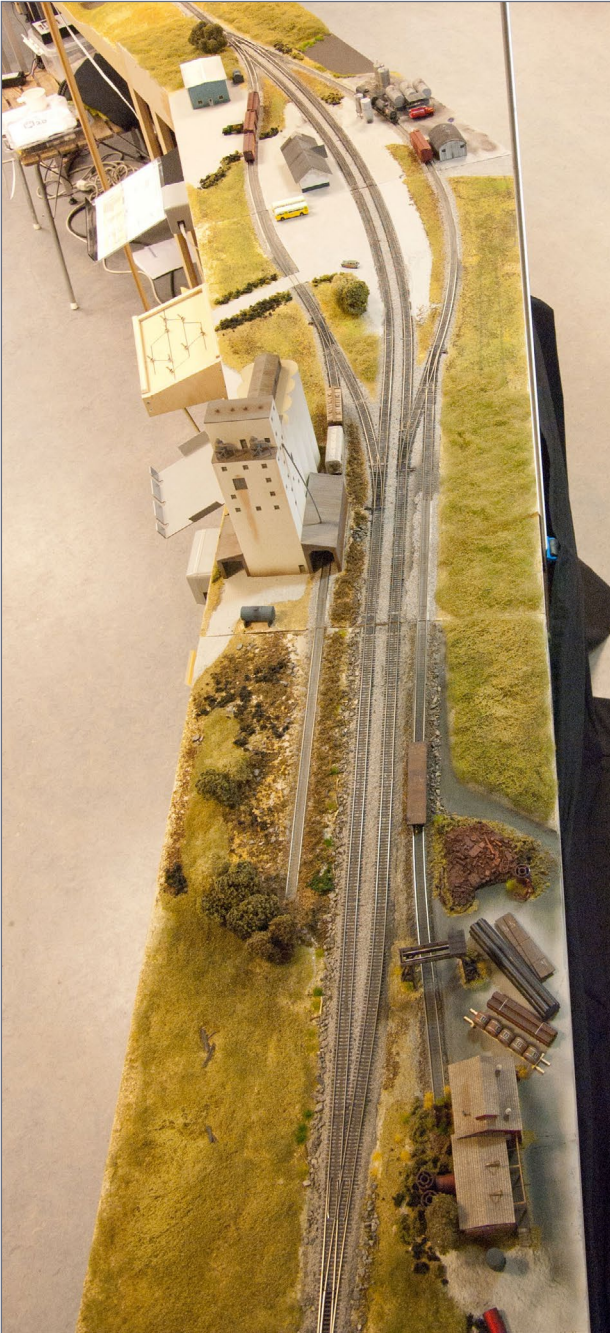

6. An overhead view of Emey Falls.



7. A flat car at Schmitz Metal waiting to be loaded.



8. A coal train passing Bunge Grain elevator while cars are being loaded.



9. The flowing curve through the two-module scene makes just about any train look dramatic.



10. All the “structures” you need for a team track are a few vehicles.



11. Cars being unloaded at the Bunge Grain elevator.



12. Boxcars are being unloaded on the team track.



13. The Schmitz Metal spur has a few rusting wheelsets sitting on it at the end.



Playback problems? [Click here ...](#)

ROBERT KLARÉN



Robert lives in Habo, Sweden, which is in the south of his country. He has been married to his wife Marita for almost 40 years, and has two grown children and one grandchild.

Trains have been a passion all his life, but when he first saw modules 5-6 years ago, his modeling really picked up speed. So far he has built 17 modules of different sizes, quality and complexity, and has traveled with these to gather-

ings in Sweden, Denmark and Germany at least four times per year. In addition to the modules, he also has a home layout called the Clarion RR, which is a point-to-point fantasy bridge line. On this railroad a person may see both massive coal trains and small locals.



[Click here to rate or comment on this article](#)



TRACK MARKING GAUGE



BY BILL BRILLINGER

Draw parallel yard track locations with ease ...

A LOT OF PARALLEL TRACKS MAKE UP THE typical staging yard. On my staging yard, I installed a 3/16" plywood fascia before laying the track. With the fascia installed, I had a nice smooth surface for sliding a track marking gauge.

I made my T-shaped gauge from plywood scraps. I glued and screwed the pieces together and allowed the glue to set overnight. I sanded the edges of the gauge so it would slide smoothly along the fascia. I drilled holes in the leg of the T to hold a pencil at the correct spacing as measured from the front fascia board.

With the pencil inserted, I simply slid the gauge along the length of the yard to mark the centerlines of each yard track.

On the next page is a diagram and a photo of the finished gauge.

The photo shows the gauge after I cut it down to work on a narrower part of the yard. The leg of the T can be as long as needed to provide a pencil hole for each yard track.



[Click here to rate or comment on this article](#)



1. Bill made this marking gauge, which is basically a homemade T-square using scraps of plywood he had on hand. Bill drilled holes in the leg of the T to hold a pencil at the correct yard track locations, as measured from the front fascia board.

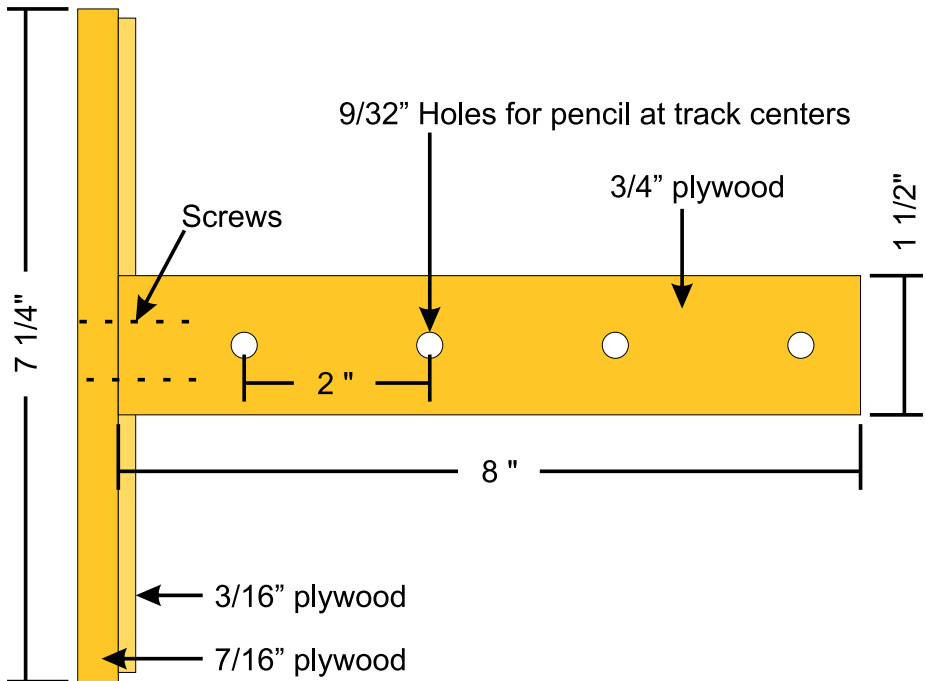

A message from
Joe Fugate
MRH Media Founder

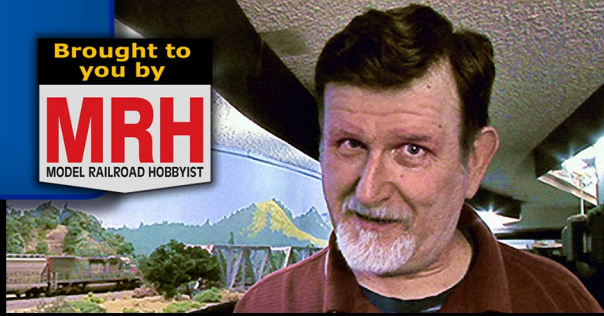

What topics does TrainMasters TV have?

TMTV has 400-some videos in nine categories, & we're adding 1-2 new videos per week ...



LAYOUTS



PLANNING



BUILDING



ELECTRICAL



MODELING



OPERATING



TOOLS/TIPS



PROTOTYPE



VENDORS/EVENTS

LOOKS GOOD, SIGN ME UP >>



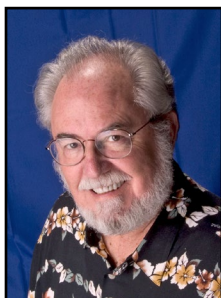

FEBRUARY NEWS

column

RICHARD BALE *and* JEFF SHULTZ



[Click here to rate or comment on this article](#)

Narrow Gauge & Short Line Gazette acquired by White River Productions

Kevin EuDaly, owner of White River Productions, has announced that his firm has purchased *Narrow Gauge & Short Line Gazette*. Robert W. Brown, founder and guiding hand behind the bi-monthly narrow gauge magazine since its inception 42 years ago, will continue as editor. Irene Brown, business manager of NG&SLG, plans to retire. The Browns' operating company, Benchmark Publications, will continue to sell its books and DVDs through Hayden Consulting, and will handle back issues of NG&SLG produced before the WRP takeover. Existing subscriptions will be honored by WRP. The first release of NG&SLG under the new ownership will be the March/April 2017 issue. According to EuDaly, readers will see few changes in the content or style of the Gazette. Other magazines currently published by White

▶ THE LATEST MODEL RAILROAD PRODUCTS, NEWS & EVENTS

• INDEX



SUBSCRIBE
(free)

• TABLE OF CONTENTS

FEBRUARY NEWS | 2

River Productions include *Railroad Model Craftsman*, *Railfan & Railroad*, *Model Railroad News*, *Passenger Train Journal*, *Trains & Railroads of the Past*, *Railroads Illustrated*, and *HO Collector*. WRP also publishes *On30 Annual* and *HOn3 Annual* ...

.....

NEW PRODUCTS FOR ALL SCALES

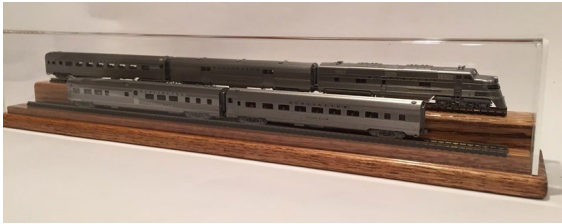

TAM Industries specializes in oak and acrylic cases to display and protect models from N through G scale. Standard single

and double tiered styles are available as well as custom designs. For additional information visit tam-industriesonline.com.

.....

Isle of the Kakapo software in Munich, Germany has released version 5.3 of their RailModeler Pro layout design software for MacOS. Included in this update is support for baseboards, allowing the modeler to quickly define the outline of their layout. RailModeler Pro includes more than 240 libraries of track and accessories from many model railroad manufacturers in scales from T (1:450) to G (1:22.5). Version 5.3 is a free upgrade from previous versions of RailModeler Pro and is available exclusively through the Mac App Store under Graphics and Design. More information is available from isleofthekakapo.com.

.....

Voltscooter Electronics has released a new Automatic Fuse for DCC. User settable to 3.8, 2.3, 1.5, or 0.8 amps, it will prevent shutting down an entire booster district or layout when a

FEBRUARY NEWS | 3

short occurs on a protected section. The fuse resets automatically when the short circuit is removed. More information on all Voltscooter products can be found at voltscooter.com.



New soft cover titles available from **Morning Sun Publications** include *Conrail-D&H-NYS&W*, *The Erie and DL&W in Hudson County, NJ*; *Amtrak Across America*, *Baltimore & Ohio – the Best of Bob Collins*, and *Southern California Rails 1941-1971*. Also new are *Lehigh Valley Best of Bob Wilt*,

Volume 1, the 1960s, *Pittsburgh & Lake Erie Railroad – The Last 30 Years*, and *Rio Grande – Best of Bob Davis*. For additional information on all Morning Sun products visit morningsunbooks.com.

O SCALE PRODUCT NEWS



Atlas O plans to release two boxcars with six new paint schemes during the third quarter of this year. The O

scale ready-to-run models will include a 50-foot modernized PS-1 boxcar with a single sliding door. It will be available decorated for Chattahoochee Industrial (above), Bangor & Aroostook, Boston & Maine, Great Northern, and Monon.

A Delaware & Hudson version of the car with a cushioned underframe and Pullman-Standard sliding door will also be available. The PS-1 models will have either 70-ton roller-bearing trucks



FEBRUARY NEWS | 4



with rotating bearing caps or 50-ton Bettendorf-style trucks as appropriate to the prototype being

modeled.

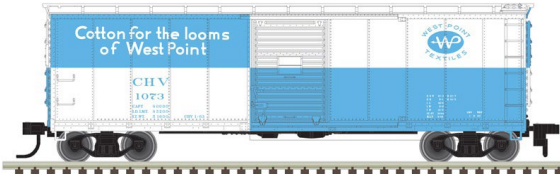

The second new boxcar scheduled for release later this year is a steel rebuilt version of a 40-foot USRA car

featuring a detailed brake system, Youngstown sliding doors, and either Andrews or Bettendorf-type trucks as appropriate to the prototype road being modeled. In addition to the Chattahoochee Valley car shown here, road names will be Grand Trunk Western, Great Northern, Soo Line, Western Railway of Alabama, and Union Pacific. Atlas O rolling stock is available with appropriate trucks for either 2-rail or 3-rail operation. For additional information on all Atlas O products contact a dealer or visit atlaso.com.



Crow River Products has an O scale kit for an open-air industrial operation. Although CRP designed this little structure to accompany its steam power plant, it is well suited for many uses such as a saw mill,

FEBRUARY NEWS | 5

wood shop, or any type of scene where it is desirable to show the equipment being used inside the building. Features include a one-piece cast resin base, pewter roof trusses, and pre-cut columns. The assembled structure has a footprint of 9 x 6.5-inches. For additional information, including ordering instructions, visit crowriverproducts.com.



Fos Scale Models has introduced an O/On30 kit for a small grocery store called Pop Gunns. As seen here, this craftsman style kit is loaded with details. The kit features laser-cut clapboard walls, laser-cut details and windows, strip wood, plastic detail parts, tar paper and corrugated roofing material, numerous metal detail parts, laser-cut soda crates, color signage and a laser-cut sign stencil, scale lumber, assembly

templates, and instructions. When completed, Pop Gunns has a footprint of 5 x 6 inches. For additional information including ordering instructions visit fosscalemodels.com.

S SCALE PRODUCT NEWS

San Juan Decals has introduced its first S scale structure kit. The model is based on a coal shed at the D&RGW Section House in Cumbres. The kit consists of laser-cut wood framing and wall planks for board by board



FEBRUARY NEWS | 6



construction. The roof panels, door and floor are cut, notched and scribed as one piece assemblies. Grandt Line door hinges are included. No roofing material is provided in the kit. Similar structures had tarpaper, sheet metal, and shingle roofs. The choice is left to the modeler. Detailed finishing suggestions and three laser-cut templates to aid in the assembly are included in the kit. For information on all San Juan Decals products visit sanjuandecals.com.

.....

HO SCALE PRODUCT NEWS

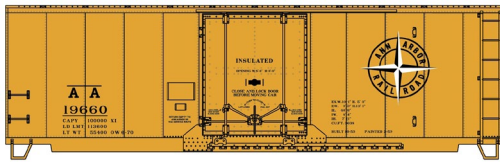

New HO scale car kits available from **Accurail** include this 40-foot Ann Arbor insulated plug-door boxcar. The model is based

on a prototype built in 1950 and rebuilt in 1970.



Also new from Accurail is a kit for a Burlington Northern triple-bay ACF covered hopper. The prototype was built in 1976.

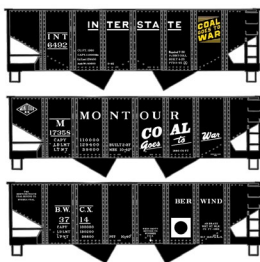

Accurail has introduced a 3-pack of hopper cars decorated for Interstate, Montour, and Berwind. The twin-bay hopper cars display the patriotic Coal Goes to War slogan from WWII.

This Great Northern 50-foot riveted steel boxcar with Youngstown sliding doors

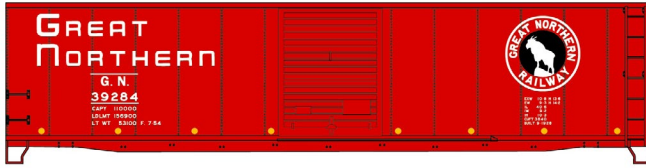

represents a car built in 1928 and rebuilt in 1954. The car is available now as

an HO scale kit from Accurail.

Also new are kits for a PRR ACF triple-bay covered hopper, a Gulf Mobile & Ohio 40-foot PS-1 boxcar, a Soo Line 50-foot plug-door boxcar, and a 40-foot plug-door reefer decorated for Chicago Great Western. All Accurail kits include appropriate trucks and Accumate couplers that are compatible with popular knuckle couplers. More information on these products can be found at accurail.com.



Athearn has announced its production schedule for November of this year. Topping the list are Genesis F7 diesel locomotives decorated for Burlington Northern (ex-Spokane, Portland & Seattle, above), Burlington Northern (brown freight/MOW scheme, below), Minneapolis & St. Louis (red and white freight scheme), Spokane, Portland & Seattle; and two Western Pacific schemes. F7A and matching F7A-F7B sets will be available for Santa Fe.

Athearn will be offering its F-unit powered mechanism later this year. Both standard DC and DCC with sound will be available. The chassis is suitable for Athearn and Highliner F2 through F9 body shells. Optional parts included will be fuel



FEBRUARY NEWS | 8



Western; Santa Fe, Wisconsin & Southern; and two versions of Utah Railway. Athearn's DCC-ready locomotive models feature Quick Plug technology with both 8- and 9-pin connectors. DCC models have factory installed DCC decoder with SoundTraxx Tsunami2 sound.



HO scale Ready-to-Roll freight cars due in November include a 50-foot FMC outside-post boxcar with Superior plug doors and box-corrugated non-terminating ends. Road names will be Burlington Northern Santa Fe, Norfolk Southern, Canadian

FEBRUARY NEWS | 9

National, Minnesota, Dakota & Western; New Orleans Public Belt Railway, and Santa Fe.

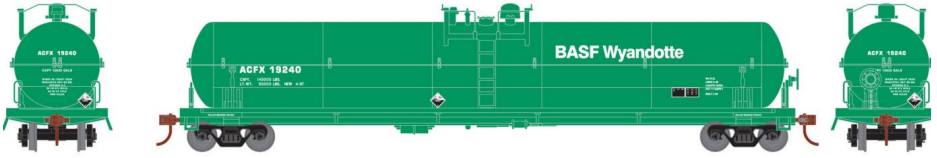

A 62-foot tank car decorated for BASF Wyandotte is included in Athearn's fall schedule. Additional road names will be American Car & Foundry Leasing; Burlington Northern, Coors Brewing, TEIX Eco-Energy, and Union Tank Car.



New HO scale intermodal equipment coming from Athearn in November includes 40-foot corrugated stackable containers. Decorating schemes will be Hamburg Sud, American President Line, China Shipping, Italia, Lloyd Triestino, PIL, and Seaco. The units will be available in 3-packs with the containers individually numbered.



Athearn will include a Ford C tractor with beverage trailer in its November product release. In addition to the Country Club scheme shown here, the beverage trucks will be available decorated for Double Line Soda, U. B. Schuiggenpeuken, Penguin Ginger Ale, and Jo-Jo Chocolate Flavored Drink. The HO scale models feature a detailed cab interior with separately applied steering wheel, clear window glazing, and rubber tires.



FEBRUARY NEWS | 10

.....



Athearn Roundhouse brand models coming in November include a wide-vision caboose decorated for Denver & Rio Grande Western; BNSF, CSX, Rock Island, and TTX Trailer Train.



A quadruple-bay ACF 5250 cu. ft. Centerflow covered hopper is also coming from Athearn- Roundhouse this fall. The HO scale model will have round roof hatches. Road names will be Union Carbide, Honeymead (American Car & Foundry Leasing), Wonder Bread, Continental Polymers, Denver & Rio Grande Western; Penn Central, SSW-Cotton Belt (with UP herald), and Wisconsin Central. For additional information on all Athearn and Roundhouse products contact a dealer or visit athearn.com.

.....



Atlas is set to release a run of 40-foot postwar boxcars during the first quarter of this year. Like the prototypes, the HO

scale ready-to-run models will have a variety of details such as three end styles (4/4 Murphy, early and late Improved Dreadnaught), two roof designs (diagonal and straight panel),

FEBRUARY NEWS | 11

and Superior or Youngstown 7-foot sliding doors. The model uses tooling Atlas obtained with the acquisition of Branchline Trains in early 2011. In addition to the Buffalo Creek car shown here, road names will be Grand Trunk Western, Jersey Central Lines, Nickel Plate Road, Western Maryland, and Western Pacific. An undecorated version will also be available.

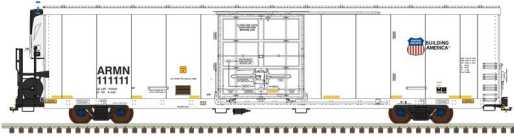

Atlas has scheduled a third quarter release for its HO scale 64-foot Union Pacific Trinity reefer. The ready-to-run model will be available in 22 road numbers plus an undecorated version. The model will feature a Carrier reefer unit, 100-ton trucks with 36-inch metal wheelsets, and body-mounted Kadee #156 couplers. Atlas took over this project with the acquisition of BLMA last February.



Atlas' third quarter schedule includes a 40-foot USRA boxcar rebuilt with 10-panel steel sides and Youngstown doors. Additional features include separately applied ladders and wire grab irons, and 7/8 or 5/5/5 corrugated Murphy ends. New road names will be Chattahoochee Valley, Grand Trunk Western, Great Northern, Soo Line, Great Northern, Western Railway of Alabama, and Union Pacific.



Atlas has scheduled a third quarter release for its HO scale 64-foot Union Pacific Trinity reefer. The ready-to-run

model will be available in 22 road numbers plus an undecorated version. The model will feature a Carrier reefer unit, 100-ton trucks with 36-inch metal wheelsets, and body-mounted Kadee #156 couplers. Atlas took over this project with the acquisition of BLMA last February.

Atlas' third quarter schedule includes a 40-foot USRA boxcar rebuilt with 10-panel steel sides and Youngstown doors. Additional features include separately applied ladders and wire grab irons, and 7/8 or 5/5/5 corrugated Murphy ends. New road names will be Chattahoochee Valley, Grand Trunk Western, Great Northern, Soo Line, Great Northern, Western Railway of Alabama, and Union Pacific.



FEBRUARY NEWS | 12

information on all Atlas products contact a dealer or visit atlasrr.com.



Broadway Limited Imports is preparing to release a group of HO scale USRA 2-8-2 Mikado steam locomotives next month. Both light and heavy versions of the

standard design will be in the release. Road names for the light Mikado will be Chicago, Rock Island & Pacific; Santa Fe (above), Chicago & Eastern Illinois; Canadian National, Grand Trunk Western, Pennsylvania Railroad, and Union Pacific. Also Southern Railway in both freight and passenger paint schemes.



Heavy Mikados will be available decorated for New York, New Haven & Hartford; Chesapeake & Ohio; Great Northern (above), Louisville & Nashville; Milwaukee

Road, New York Central, Nickel Plate, Wabash, and Missouri Pacific. Both versions of the HO scale ready-to-run locomotives will be equipped with Paragon2 sound and control system for DC and DCC including synchronized puffing smoke. For additional information on all Broadway Limited products contact a dealer or visit broadway-limited.com.

Bowser is selling kits for HO scale Pennsylvania Railroad X31 boxcars with a choice of either one or two Youngstown sliding doors. Both models display a large shadow keystone herald. The

FEBRUARY NEWS | 13

.....



kits consist of a one-piece plastic body, with separate underframe, brake wheel, air tank, brake cylinder, triple valve, and a car weight.



Appropriate PRR trucks come with metal wheelsets. For additional information on all Bowser

products contact a dealer or visit bowser-trains.com.

.....



Con-Cor International has launched a new HO scale collector series celebrating the presidency of Donald Trump. The first car in the

series marks the inauguration of Donald J. Trump on January 20, 2017 as the 45th President of the United States. The 40-foot plug-door boxcar is available as a stand-alone model as well as with a section of HO scale display track. For additional information including ordering instructions visit con-cor.com.

.....



ExactRail is selling four types of HO scale steel gondola cars. Leading the



FEBRUARY NEWS | 14

group is a Thrall 3564 cu. ft. 19-panel gondola. It is available in six road names including Southern Pacific, MHFX, LW, Canadian Pacific, CSXT, and COER.



Also available is a Greenville 65-foot mill gondola with distinctive corrugated side panels. Road names are Missouri Pacific, Chicago North Western, Southern Pacific, and Union Pacific.



This Thrall 52-foot 6-inch 2743 cu. ft. gondola is available decorated for CW

and UP/CTRN.



Completing ExactRail's quartet of steel gondolas is a Thrall 2244 cu. ft.

car featuring a heavy top chord. Road names are Chicago North Western, and Rock Island. All ExactRail ready-to-run models have individual wire grab irons, machined metal wheelsets, and Kadee couplers. For additional information visit exactrail.com.

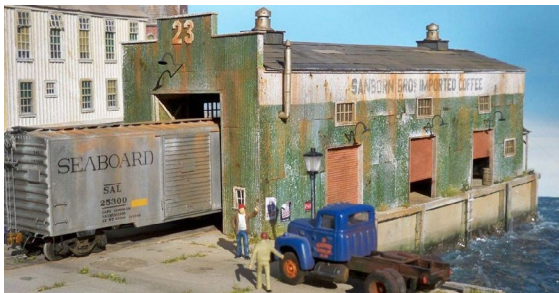

Pier 23 – Sanborn Coffee is the newest HO scale craftsman structure kit from **Fos Scale Models**. The wharf building is designed to extend into a harbor.

FEBRUARY NEWS | 15

Components in the kit include laser-cut walls, simulated metal corrugated panels, laser-cut roof trusses, Tichy windows, and numerous plastic and metal detail parts. Assembly instructions, templates, and suggested finishing techniques are all included. The assembled structure has a footprint of 3.75 x 11 inches. Figures, vehicles, and seawalls are not included. For additional information visit fosscalemodels.com.

.....



InterMountain Railway has launched an ambitious program to produce three differ-

ent versions of a PS2-CD 100-ton 4785 cu. ft. triple-bay covered hopper car. New tooling is currently underway to produce cars with both early and late end frame details, as well as a class H-100-21 version with three elongated roof hatches. Delivery is planned for the first quarter of 2018. Reservations are due by the end of this month.

Road names for cars with early style end frames will be available decorated for Monfort Feed, New York Central, Penn Central (green patch), Penn Central (green body), Staley, Paul Bimmerman, Transport Leasing, ADM, Conrail (red body, large logo), and Conrail (gray body, small logo).



Road names for cars with a late style of end frame will be Penn Central H54 (green



FEBRUARY NEWS | 16

.....

body), CSX, Milwaukee Road, Conrail (red body, large logo), Conrail (gray body, small logo), Conrail (gray body, quality logo), Central Soya, MKT, Norfolk Southern, and Lauhoff Grain.



Class H-100-21 versions of the car with three separate elongated roof hatches will be available

decorated for Golden West (patched, light blue body), Golden West (dark blue body), and SSW-Cotton Belt. The HO scale ready-to-run models will have etched metal roofwalks, metal wheelsets, and Kadee couplers. Undecorated kits will be offered for each of the three styles of cars. For additional information on all InterMountain products contact a dealer or visit intermountain-railway.com.

.....



Kadee plans to release a Chesapeake & Ohio PS-1 boxcar with 10-panel welded sides, narrow bolster tabs, and 8-foot Youngstown sliding doors

next month. The HO scale model is based on a 1950 prototype that had its running board removed and side ladders shortened when it was shopped in August 1977. For additional information on all Kadee products contact a dealer or visit kadee.com.

.....

Machine Shop is the name of the newest HO scale craftsman kit from **Monster Model Works**. The kit assembles into an early 20th century industrial building commonly used as a machine shop, blacksmith shop, or small factory. The kit is based on a

FEBRUARY NEWS | 17



1917 structure in Iowa at the old Milwaukee Road shops now known as the Sioux City Railroad Museum.

The craftsman-style kit is com-

posed of 3D engraved aged American Bond brick, brick columns, and iron wall anchors; basswood concrete foundation and sills, laser-cut windows and doors, and peel & stick tar paper roofing. The assembled structure is 4.25-inches high and has a footprint of 12 x 8.25-inches. For information on the complete line of Monster Models Works products visit monstermodelworks.com.

.....



Rapido Trains Inc. is booking reservations for HO scale Pullman-Bradley lightweight series fluted stainless steel cars decorated for New Haven and subsequent Penn Central and Amtrak schemes. This release will include a 36-seat parlor car and a River series 26-seat parlor/14 seat lounge car decorated in the McGinnis scheme (above) and in NH green. All New Haven versions will be offered with and without skirts.

Subsequent versions of the cars include a 72-seat coach without skirts decorated for Amtrak Phase I (above) and Penn



FEBRUARY NEWS | 18



Central. Features of the ready-to-run models include complete interior and underbody details, operating diaphragms with end gates, track-powered constant lighting for DC and DCC, 41-BNO-11 trucks with blackened metal wheels, and magnetic knuckle couplers. For additional information on all Rapido products contact a dealer or visit rapidotrains.com.

.....



Tangent Scale Models has an HO scale model of a Pullman Standard PS-3

2750 cu. ft. coal hopper. The 70-ton triple-bay open top car replicates a prototype Pullman Standard produced in both its Bessemer, AL and Butler, PA manufacturing plants. Tangent is offering the ready-to-run model decorated for CRR-Clinchfield, Great Northern, Louisville & Nashville; CR&IP-Rock Island; and Utah Railway. The exceptionally well-detailed model is also available undecorated in ready-to-run form or as a kit. For additional information on all Tangent products visit tangentscalemodels.com.

.....

Walthers has cancelled plans to produce the 1956 Santa Fe Super Chief due to lack of sufficient preorders. All preorders for 1956 Super Chief cars (920-9000 to 9008) and both deluxe edition trains

FEBRUARY NEWS | 19

(920-816, and 817) have been cancelled. Walther's Proto Santa Fe F7s from the 920-40900 series (DCC) and 920-47900 series (DC) locos will be produced, along with all of the cars for the 1954 El Capitan. In making the announcement, Walther's noted that the best way for hobbyists to ensure that a new product will actually be produced is to preorder with either their local hobby store or direct with Walther's.

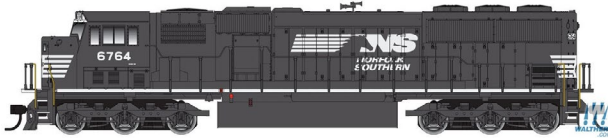

On a more positive note, Walther's will release a group of EMD SD60M diesel locomotives next

month. Road names for the HO scale ready-to-run model will be Burlington Northern, Burlington Northern Santa Fe, Conrail, CSX, Union Pacific, and Norfolk Southern.

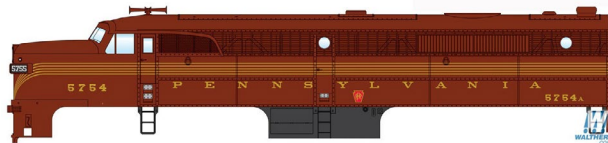

Walther's HO scale Alco PA and PA-PB locomotive sets decorated for Santa

Fe and Pennsylvania Railroad are scheduled for release in late April. Southern Pacific and Union Pacific versions are planned for release in September. The HO scale Mainline series models have the same drive mechanism as the Walther's Proto series. Drill starter points for grab irons (sold separately) are molded into the body shell. Both the SD60M and the PA locomotives will be available for standard DC operation or with factory installed SoundTraxx Sound and DCC. For additional information on all Walther's products contact a dealer or visit walther's.com.

.....

Yarmouth Model Works has introduced several new etched metal detail parts recently. The parts include a 40-foot Morton running board and brake step, six different arrangements of



Carmer cut levers, and an updated brake lever etching. For additional information on Yarmouth products visit yarmouthmodelworks.com.

.....

N SCALE PRODUCT NEWS



Athearn is planning to release another run of its N scale EMD F45 diesel in November. Road names will be New York, Susquehanna, &

Western; Santa Fe, Wisconsin & Southern; and two versions of Utah Railway.



Additional N scale models due in November

include this 50-foot FMC outside-post boxcar with Superior plug doors and box-corrugated non-terminating ends. Three road numbers each will be available for Minnesota, Dakota & Western; Canadian National, New Orleans Public Belt Railway, Santa Fe, Burlington Northern Santa Fe, and Norfolk Southern. For additional information on all Athearn products contact a dealer or visit athearn.com.

.....

Atlas plans to release its Trainman series N scale twin-bay Centerflow covered hopper with new paint schemes during the third quarter of this year. In addition to the Union Pacific version

FEBRUARY NEWS | 21

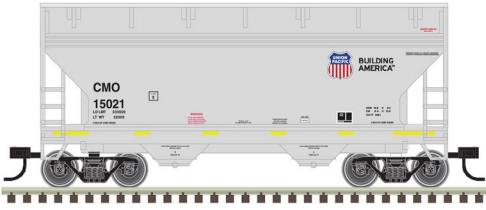

shown, the ready-to-run model will be available decorated for BNSF, The CIT Group, CSX, GATX, David J. Joseph Company, Southdown, and Excel Railcar.

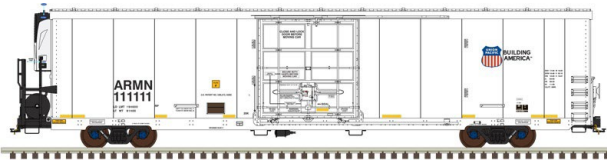

Also scheduled for release in the third quarter is a new production run of Atlas's 64-foot

Union Pacific Trinity reefer. The ready-to-run model will be available in 22 road numbers plus an undecorated version. Features include a Carrier reefer unit and BLMA 100-ton trucks with 36-inch metal wheelsets.



Atlas' third quarter schedule includes a 40-foot USRA boxcar rebuilt with 10-panel steel sides and 7/8 or 5/5/5

corrugated Murphy ends. New road names will Chattanooga Valley, Grand Trunk Western, Great Northern, Soo Line, and Western Railway of Alabama.



New road numbers for previously released roads will be available for PRR, Canadian National, and Chicago & North Western.



FEBRUARY NEWS | 22

For additional information on all Atlas products contact a dealer or visit atlasrr.com.

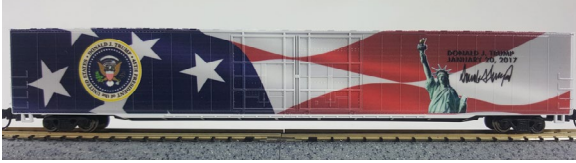

Con-Cor

International has launched a new N scale collector series cel-

ebrating the presidency of Donald Trump. The first car in the series marks the inauguration of Donald J. Trump on January 20, 2017 as the 45th President of the United States. The 85-foot plug-door box-car is available as a stand-alone model as well as with a section of N scale display track. For additional information including ordering instructions visit con-cor.com.



InterMountain Railway

has launched a major program to produce three different versions of

an N scale PS2-CD 100-ton 4785 cu. ft. triple-bay covered hopper car. New tooling is currently underway to produce cars with both early and late end frame details, as well as a class H-100-21 version with three elongated roof hatches. Delivery is planned for the first quarter of 2018. Reservations are due by the end of this month

Road names for cars with early style end frames will be available decorated for ADM, New York Central, Monfort Feed, Penn Central (green patch), Penn Central (green body), Staley, Paul Bimmerman, Transport Leasing, Conrail (red body, large logo), and Conrail (gray body, small logo).

FEBRUARY NEWS | 23

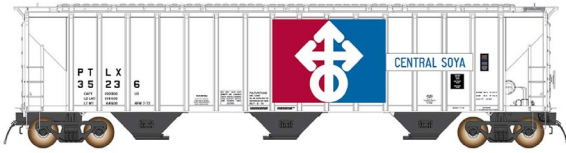

Road names for cars with a late style of end frame will be available for Central Soya, Penn Central (green body),

CSX, Milwaukee Road, Conrail (red body, large logo), Conrail (gray body, small logo), Conrail (gray body, quality logo), MKT, Norfolk Southern, and Lauhoff Grain.



Class H-100-21 versions of the car, with three separate elongated roof hatches, will be available

decorated for SSW-Cotton Belt, Golden West (dark blue body), and Golden West (patched, light blue body). The N scale ready-to-run models will have etched metal roofwalks and metal wheelsets.

Undecorated kits will be offered for each of the three styles of cars. For additional information on all InterMountain products contact a dealer or visit intermountain-railway.com.

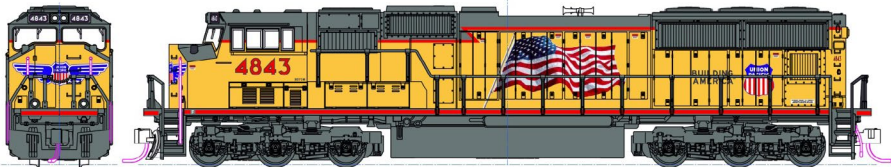

Kato USA plans to re-issue its EMD SD70M diesel locomotive this spring. The N scale model will feature a Phase II wide cab and flared radiators. The models will be equipped with all-wheel electrical pick-up and blackened metal wheels in trucks that replicate the HTRC Phase II prototypes. Road names will be Norfolk Southern and Union Pacific.



FEBRUARY NEWS | 24

.....

Kato USA is also re-releasing the GE AC4400CW in both Chicago & North Western's "Operation Lifesaver" and Union Pacific's "Lightning Bolt" paint schemes. The models feature Kato magnetic knuckle couplers and a DCC friendly mechanism for a drop-in decoder such as the TCS K1D4. For additional information on all Kato USA products contact a dealer or visit katousa.com.

.....



New ready-to-run N scale models recently issued by **Micro-Trains Line** include this Denver

& Rio Grande Western 89-foot tri-level closed auto rack car. The D&RGW rack is fitted to a TTX flat car.



This Shell Chemical 39-foot single-dome tank car is available now from Micro-Trains in two road numbers.



Also new is this Louisville & Nashville 50-foot auto boxcar in a unique yellow and white paint scheme. The car features double

side doors and an end door to facilitate loading automobiles.



Micro-Trains has released a 50-foot rib side boxcar decorated for Port Huron

FEBRUARY NEWS | 25

& Detroit. Note the non-terminating box corrugated ends, low side ladders, and lack of a running board.



New heavyweight passenger equipment released by Micro-Trains includes this

Canadian National 70-foot baggage car and a New Haven 3-2 heavyweight open observation car as rebuilt with air conditioning in 1943. Both cars ride on six-wheel trucks.

To ease transition into its new True-Scale couplers, Micro-Trains Line is selling an idler flat car with a Magne-Matic installed at one end and a True-Scale coupler on the other. The car is weighted and decorated for Southern Pacific. For additional information on all Micro-Trains Line products contact a dealer or visit micro-trains.com.

NEW DECALS, SIGNS AND FINISHING PRODUCTS

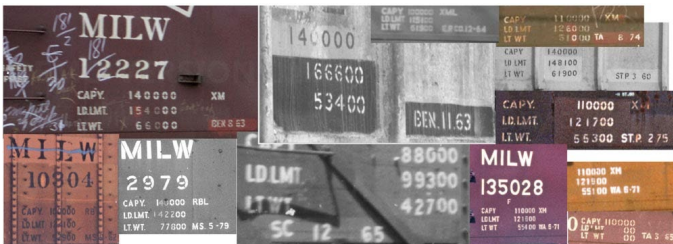

Dan Kohlberg has released new HO scale decal sets that provide a wide range of

Milwaukee Road reweigh data. The material covers 1959-1980 and is available in both black and white lettering. For additional information visit home.mindspring.com/~paducah.



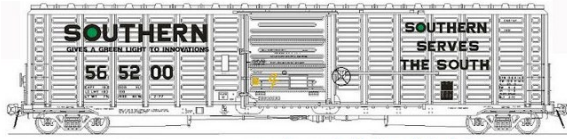

Mask Island Decals is selling HO scale decals for a Southern Railway 60-foot waffle-

side boxcar. This set will letter one car.

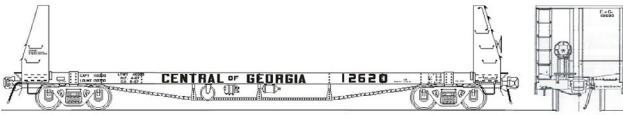

Also new is a decal lettering set for a Central of Georgia pulp wood car.

This lettering set has sufficient material to decorate two cars. For additional information visit maskislanddecals.com.



SEND US YOUR PRODUCT ANNOUNCEMENTS

If you are a hobby manufacturer with a product announcement, just [click here](#) and submit your announcement to us. Our web site and free magazine reach continues to grow, so get on board this new media train! ■

DISCLAIMER

The opinions expressed in this column are those of the writer and do not necessarily reflect the opinion of *Model Railroad Hobbyist* or its sponsors. Every effort is made to provide our readers with accurate and responsible news and information, however, neither *Model Railroad Hobbyist* or the writer of this column can be held responsible for any inaccuracies or typographical errors that may inadvertently appear in this column.



Click here to rate or comment on this article



BRIEFLY NOTED AT PRESS TIME ...

Athearn: During the Amherst Railroad Hobby Show held last week in West Springfield, MA, Athearn announced plans to produce both HO and N scale versions of a American Car & Foundry 4600 cu. ft. CenterFlow triple-bay covered hopper. Variations will include early high brake wheel position, early low brake wheel position and the post-1971 configuration. Both round and trough hatches will be available depending on the prototype being modeled. Additional features will include photo-etched roof walks, detailed discharge outlets, separately applied details, and 100-ton roller beating trucks with metal wheelsets. A release date is pending...

Bowser has announced a new production run of its class X32 50-foot wagon-top boxcars. The HO scale model is based on a 1932 prototype that saw service well into the 1950s. In addition to five PRR lettering schemes, road names will be D&H, D&M, DT&I, M.R.S., N&W, NP, OP&E, TAG, Virginian, and Wabash. The ready-to-run model will have knuckle couplers and PRR coil semi elliptical trucks with 33-inch Delrin wheels. Delivery is scheduled for October.

ExactRail has reissued its Greenville 7100 auto parts boxcar with new road numbers for Detroit, Toledo & Ironton; Western Pacific, Norfolk & Western, Conrail, CSX, and Penn Central. The HO scale Platinum series ready-to-run model comes with machined metal wheelsets and Kadee couplers.

Microscale Industries has released HO and N scale decal lettering sets for IC, ICG, and CN 50-foot boxcars. Each set contains material to correctly letter a 1990-era boxcar for



Canadian National, Illinois Central, and Illinois Central Gulf. Several sizes of IC logos are included...

ScaleTrains announced plans to produce a General Electric Tier 4 GEVo diesel locomotive at the Amhurst Show. Both Rivet Counter and Operator versions of the HO scale model are scheduled for release this summer. Railroad and road number specific features on the more detailed Rivet Counter model include three engine cab rooflines, high or low headlight, operating ditch lights, multiple versions of antennas and PTC antenna arrays, and two types of trucks. The initial production run includes seven roanames in 12 variations. DCC-ready versions with a 21-pin plug will be priced in the \$150 range. DCC equipped locomotives with ESU-LokSound Select DCC and Sound Decoder will be available in the \$220 range.

The basic body, motor, and drive train of the less expensive Operator series Tier 4 GEVo is the same as the Rivet Counter model. All Operator bodies share a common configuration with angled engine exhaust cab, walkway tread, non-operating ditch lights, snowplow, sunshades, LED headlights, and LED number boards. A DCC-ready Operator series locomotive with a 21-pin plug will be priced in the \$100 range. An upgrade kit with numerous modeler-applied detail parts will be available as a separate purchase. Availability on both the Rivet Counter and the Operator series models is summer 2017.

Tangent Scale Models has released another production run of its exceptionally well-detailed PRR class X58 box-car. Road names available now include PRR X58A original 1964 scheme, Lehigh Valley insulated X58 in 1965 scheme,

FEBRUARY NEWS | 29

.....

Penn Central 1974 X58A PRR paint out, Conrail 1978 X58A repaint, and Conrail 1979 X58 LV paint out. The HO scale ready-to-run model is also available painted but unlettered in PRR freight car red, PC green, and Conrail red.

WPM: Due to a conflict in scheduling the facility, the annual Western Prototype Modelers Meet scheduled in Bellflower, CA, on March 25 has been cancelled. According to spokesperson Joe d’Elia there are no plans for rescheduling this year.

.....

Get the latest Model Railroading News, Tips, Reviews & Opinions



**Our iTunes feed has changed search for
“Mike And Scotty Live” to receive the latest episodes!**

www.themodelrailroadpodcast.com

Hosts:
Scott Mason: www.scottymason.com
Mike Rose: www.mrhobby.com

**Don't Miss our Monthly Interviews
& Product Announcements**

• **INDEX**
.....



SUBSCRIBE
(free)

• **TABLE OF CONTENTS**
.....



SELECTED EVENTS

February 2017

(Please note that many events charge a fee. Check individual info website for details.)

CALIFORNIA, RIVERSIDE-SAN BERNARDINO AREA, February 25, 2017, Self Guided Layout Tour and Swap Meet. Request info from coordinator Bob Chaparro at chiefbobbb@verizon.net.

CALIFORNIA, WEST COVINA, February 4, Santa Fe Mini Meet, sponsored by Santa Fe Railway Historical & Modeling Society, at Christ Lutheran Church, 311 S. Citrus Street. Info from Charlie Schultz at (909) 596-5870 or Ctschult@aol.com.

FLORIDA, FORT MYERS, February 4-5, Annual Train Show, sponsored by Scale Rails of Southwest Florida, at Araba Temple, 2010 Hanson Street. Request info from Jim Overman at 239-272-6396.

KANSAS, WICHITA, February 4-5, Train Show & Swap Meet, sponsored by NMRA Chisholm Trail Division, at Cessna Activity Center, 2744 George Washington Blvd, Request info from Larry Gulick at legdag@cox.net.

MARYLAND, TIMONIUM, February 4-5, The Great Scale Model Train & Railroad Collectors Shows at Maryland State Fair, 2200 York Road. Info at gsmts.com.

SOUTH CAROLINA, EASLEY, February 10-11, 2017, Annual Train Show, sponsored by Central Railway Model & Historical Association at (new location) Impact Center, Rock Springs Church 207 Rock Springs Road. Info at crmha.org.

SELECTED EVENTS | 2

TEXAS, STAFFORD, February 18, Greater Houston Train Show, at Stafford Center, 10505 Cash Road, sponsored by San Jacinto Model Railroad Club. Info at sanjacmodeltrains.org/GHTS/GHTS.html.

WASHINGTON, MONROE, February 25-26, 2017, 26th Annual Washington State Train Show and Marketplace, at Evergreen State Fairgrounds. Event sponsored by United Northwest Model Railroad Club. Info at unwclub.org.

WEST VIRGINIA, CHARLESTON, February 18-19, 12th Annual Train Show at Lodge in Coonskin Park, sponsored by Kanawha Valley railroad Association. Info at kvrailroad.org.

WISCONSIN, MADISON, February 5, NMRA South Central Wisconsin Division Meet, at Zor Shrine Center, 575 Zor Shrine Place. Info at nmra-scwd.org.

WISCONSIN, MADISON, February 18-19, Mad City Model Railroad Show & Sale, sponsored by NMRA South Central Wisconsin Division, at Alliant Energy Center, Exhibition Hall. Info at nmra-scwd.org.

March 2017 by location

AUSTRALIA, CANBERRA, KALEEN ACT, March 25-26, 29th Annual Model Railway Expo, hosted by the Canberra Model Railway Club, at University of Canberra High School. Info at cmrci.info.

CANADA, ONTARIO, BOWMANVILLE, March 11, 8th Annual Bowmanville Model Railroad Flea Market, hosted by Soper Valley Model Railroad Association. New location at Clarinton Central Secondary, 200 Clarington Blvd. Send information request to sopervalley@gmail.com.

CANADA, ONTARIO, CAMBRIDGE, March 25, 34th Annual Self-Guided Tour, sponsored by Doubleheaders Model Railroad Club. Info at doubleheaders.org.



SELECTED EVENTS | 3

CANADA, ONTARIO, TORONTO, March 18, Annual Toronto Railway Prototype Modellers Meet, at Humber College, 205 Humber College Blvd, North Campus, Building B, rooms B201& B202. For more info visit qgryinhoscale.wordpress.com/2016/04/10/toronto-railway-prototype-modelers-meet.

LUXEMBOURG, JUNGLINSTER, March 4-5, Model Train Expo and NMRA European Region Convention, at Centre Polyvalent 'Gaston Stein'. Convention website at nmra.eu/conventions-meetings/junglinster-2017.

COLORADO, DENVER, March 4-5, Rocky Mountain Train Show, sponsored by Rocky Mountain TCA, at Denver Mart, 451 East 58th Avenue. Info at rockymountaintrainshow.com.

INDIANA, NAPPANEE, March 18, 2017, 13th Annual Train Show at Dutch Village Market. Info at trainweb.org/ew.

OHIO, GREENVILLE, March 5, Swap Meet, sponsored by Darke County Model Railroad Club, at Youth Building, Darke County Fairgrounds, 800 Sweitzer Street. Request info from Joe Worz at josephbw@embarqmail.com.

PENNSYLVANIA, GREENSBURG, March 24-25, RPM-East Prototype Modelers Meet, at Ramada Greensburg Hotel & Conference Center, 100 Ramada Inn Drive. Info at hansmanns.org/rpm_east/index.htm.

Future 2017, by location

AUSTRALIA, VICTORIA, GEELONG, April 14-16, 2017, 13th Annual Australian Narrow Gauge Convention. Info at austnarrowgaugeconvention.com.

CANADA, ONTARIO, April 8-9, Lindsay & District 43rd Annual Model Train Show at the Victoria Park Armory. For more information send inquiry to waynelamb@sympatico.ca.

SELECTED EVENTS | 4

CALIFORNIA, SANTA CLARA, May 25-28, 27th Annual O Scale West, at Hyatt Regency Santa Clara, 5101 Great America Parkway. Info at oscalewest.com.

COLORADO, COLORADO SPRINGS, April 29-30, TECO - Train Expo Colorado, at Mortgage Solutions Financial Expo Center, 3660 N. Nevada Avenue. For more info call 719-640-2076.

COLORADO, DENVER, August 30-September 2, 2017, National Narrow Gauge Convention, at Marriott Denver Tech Center Hotel. Info at 37nngc.com.

FLORIDA, ORLANDO, July 30-Aug 5, 2017, NMRA National Convention. Info at nmra2017.org.

ILLINOIS, COLLINSVILLE (St Louis area), June 23-24, St. Louis Prototype Modelers Meet, hosted by Lonnie Bathurst and John Golden, at Gateway Convention Center. Details at icg.home.mindspring.com/rpm/stlrpm.htm.

MASSACHUSETTS, HUDSON, April 2, New England 2 Rail & 3 Hi-Rail O Scale Train Show, Hudson Elks Hall, 99 Park Street, info at trainweb.org/metrowest.

MICHIGAN, MUSKEGON, April 23, Muskegon Spring 2017 Train and Toy Show, sponsored by the Muskegon Railroad Historical Society. USS LST 393 Veteran's Museum Ship, 560 Mart Street. More information available at facebook.com/muskegonrail.

MICHIGAN, WYOMING, (Grand Rapids area), April 8, Spring Train Show sponsored by Grand River Valley Railroad Club, at HSB Home School Building, 2625 Burlingame Avenue SW. Info at grandrivervalleyrrc.org.

MISSOURI, ST. LOUIS, April 6-8, 32nd Annual Sn3 Symposium, at St. Louis Airport Marriott, 10700 Pear Tree Lane. Info 2017sn3symposium.com.



SELECTED EVENTS | 5

OKLAHOMA, TULSA, June 21-25, Annual Convention of the Santa Fe Railway Historical & Modeling Society. Info at atsfrr.com/convention/index.htm.

WASHINGTON, CHEHALLIS, April 1-2, Spring Model Railroad Show & Swap Meet at Southwest Washington Fairgrounds, 2555 N. National Avenue, sponsored by Lewis County Model Railroad Club. Info from Ted at 360-985-7788.

Future 2018 and beyond, by location

MISSOURI, KANSAS CITY, August 5-12, 2018, NMRA National Convention. Info at kc2018.org.

UTAH, SALT LAKE CITY, July 7-13, 2019, NMRA National Convention. Info at northernutahnmra.org/2019-nmra-national-convention. ■



Click here to rate or comment on this article

**Want to help keep
MRH free?**

Then *click* on ads!



FINAL ORDER DEADLINE



VALENTINE'S DAY

[CLICK HERE.](#)

• INDEX



SUBSCRIBE
(free)

• TABLE OF CONTENTS

Clickable advertiser index – 1

[Accu-Lites](#)

[American Ltd \(San Juan\)](#)

[ANE Models](#)

[Archer Fine Transfers](#)

[Athearn](#)

[Atlas Model Railroad Co.](#)

[Bachmann](#)

[Bachrus](#)

[Backdrop Junction](#)

[Banta Modelworks](#)

[Berrett Hill Trains](#)

[Black Cat Publishing](#)

[Blair Line](#)

[Bowser](#)

[Canyon Creek Scenics](#)

[Clever Models](#)

[Coastmans Scenic Products](#)

[Coffman Graphics](#)

[Credit Valley Railway](#)

[Crow River Products](#)

[Digitrax \(2 page spread\)](#)

[ESU LokSound](#)

[Fast Tracks](#)

[Fox Valley Models](#)

[Good Deals DCC](#)

[GLX Scale Models](#)

[Great Decals](#)

[HO Diesel Supply](#)

[Iowa Scaled Engineering](#)

[ITLA Scale Models](#)

[Ken Patterson.com](#)

[Lights 4 Models](#)

[Litchfield Station](#)

[Logic Rail Technologies](#)

[Main Street Heritage Models](#)

[Model Railroad Benchwork \(1\)](#)

[Model Railroad Benchwork \(2\)](#)

[Model Rectifier Corporation](#)

[Monster Modelworks](#)

[Motrak Models](#)

[Mountain Subdivision Hobbies](#)

[Model Railroad Control Systems](#)

[MRH Store \(1\)](#)

[MRH Store \(2\)](#)

[Mt. Albert Scale Lumber](#)

[National Train Show Orlando](#)

[NCE \(2 page spread\)](#)

[Nick & Nora Design](#)

[Norfolk & Western Hist. Society](#)

[North American Railcar Co.](#)

[Oak Hill Track Supply](#)

[Pre-Size Model Specialities](#)

[Precision Design Co.](#)

[Rapido \(1\)](#)

[Rapido \(2\)](#)

[Ring Engineering \(1\)](#)

[Ring Engineering \(2\)](#)

[Rulers-of-the-World](#)

[Rusty Stumps](#)

[Scale Trains](#)

[Scotty Mason Show](#)

[Select Model Railroads](#)

[Signature Press](#)

[Streamlined Backshop Services](#)

Clickable advertiser index – 2

[Soundtraxx \(Blackstone\)](#)

[Southern Digital](#)

[TAM Valley Depot](#)

[Tony's Train Exchange](#)

[Train Control Systems](#)

[TrainMasters TV \(1\)](#)

[TrainMasters TV \(2\)](#)

[TrainMasters TV \(3\)](#)

[Traintek](#)

[TSG Multimedia](#)

[Walters](#)

[Westerfield Models](#)

[Yankee Dabbler](#)

[Yarmouth Model Works](#)

Clickable “other” index

[Other – Cover](#)

[Other – Derailments](#)

[Other – MRH Marketplace](#)

[Other – MRH Sponsors](#)

[Other – Contents](#)

DOWNLOAD ISSUE



DOWNLOAD PORTRAIT



DOWNLOAD LANDSCAPE

• INDEX



SUBSCRIBE
(free)

• TABLE OF CONTENTS



REVERSE RUNNING

commentary

JOE FUGATE
.....



[Click here to rate or comment on this article](#)

EYES BIGGER THAN YOUR STOMACH?

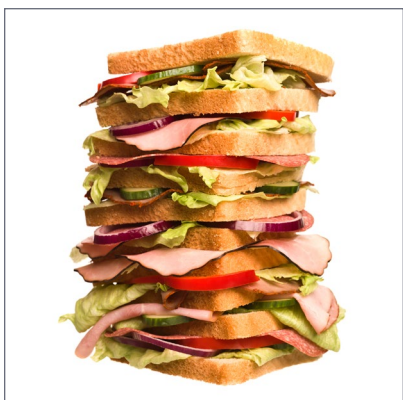

WHEN WE LAUNCHED [TrainMasters TV](#) in 2013, we did a video promo that likened doing the hobby with manipulating a sandwich. Continuing the analogy of doing the hobby to a sandwich, are your eyes bigger than your stomach?

More specifically, are you trying to do too much layout? Bigger is not

always better, you know. In fact, here's a quote made on a layout tour by the late John Allen (source, Richard Bale):

"I'd rather do it small and do it well ..." – John Allen

According to MRH staffer Richard Bale, the group was on a layout tour and one of the layouts was a large, poorly executed layout. In this case, the modeler's eyes were clearly bigger than his stomach. He was trying to do too much, and the result was a disappointing layout that just didn't cut it, leading to John's remark.

▶ **STEPPING OUTSIDE THE BOX WITH A CONTRARY VIEW**

I have a [comparison I often make](#) between what I call “quality of run” and “quantity of run.” I make this comparison because I have learned from nearly 50 years in the hobby that the greatest satisfaction in the hobby more often comes from things running well.

In other words, quantity of run (bigger layout) without quality of run (better looking and performing layout) generally doesn't cut it. Great performance is so important and so seldom covered well in the hobby press that I'm doing a book series called “Make it run like a Dream” to give much-needed equal time to getting better performance. (You can learn more about this series [on the MRH Store](#).)

Jim Six has had this epiphany recently, to the point he's downsized his layout plans to something a lot more achievable. Here's what Jim posted on the MRH forum a few months ago about his new layout:

“While this will not be a simple beginner's layout, it will not be an empire that is not achievable. I have evolved into a model railroader who does *not* believe that bigger is better or more is better.” – *Jim Six*

Jim has realized **quality** of run trumps **quantity** of run!

This problem is probably more common than a lot of modelers would like to admit. Sadly, the lights most often come on after you've filled the room with a Plywood Pacific. The benchwork and trackwork goes in fast – so fast, in fact, it can be beguiling.

It's often only after the real work in the hobby starts – the wiring, the ballasting, the scenery work, the bridges, the structures, and all the detailing that you realize you have a monster by the tail.

This is why MRH is beating the TOMA (The “One Module” Approach) drum so hard. TOMA allows you to do a layout in bite-sized chunks. Build a single module section from bare benchwork to a finished operational scene in months instead of years (or decades).

With TOMA, can find out sooner (rather than later) how much work doing a finished layout really takes. Downsizing your layout plan is easy with TOMA if you end up later having a reality attack!

Do you need to go look in the mirror and ask the hard question: Am I trying to build *too much* layout?





DERAILMENTS



click to play video
(YouTube video only)

BNSF Snowplow meets its match

Rotary plows are designed to be used when wedge snowplows no longer work because of snow depth. In this video, it is easy to see why a rotary was called upon. However, this rotary has all it can handle! ■

▶ BIZARRE FACTS AND HUMOR (SUPPOSEDLY)

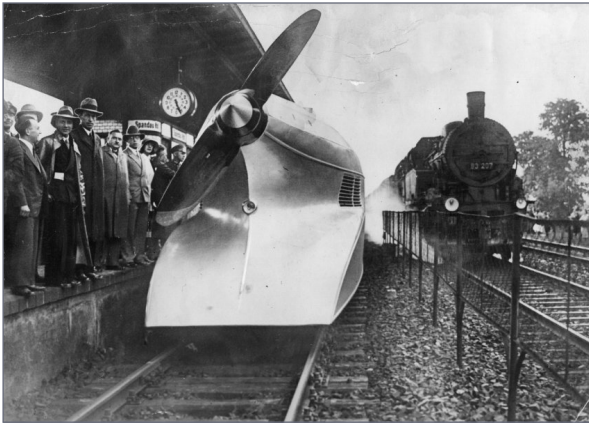

The Schienenzeppelin, was designed by German engineer Franz Kruckenberg in 1929. Made to look like a zeppelin, the Schienenzeppelin reached a world record speed of 143 mph. ■

💰 GET PAID ...

If you're the first to submit a bit of good humor or bizarre facts and we use it, it's worth \$25! Just send to derailments@mrhmag.com ■

Coming next issue ...

- Upgrading a plastic steam locomotive
- Modeling a B&O passenger car
- DCC with Arduino
- Layout tour surprise!
- Another prototype switching puzzle from Greg Baker
- And lots, *lots* more!



[Click here to rate or comment on this article](#)

• [INDEX](#)



[SUBSCRIBE](#)
(free)

• [TABLE OF CONTENTS](#)