

HAVING FUN WITH TRAINS

MARCH 2017 | FREE

MRRH

MODEL RAILROAD HOBBYIST

ALSO:

- Wireless battery-powered DCC
- Modeling B-27 baggage cars
- DCC Arduino projects
- Develop better modeling skills
- Solve this switching puzzle!

... and lots more inside!

Tom Hillebrant

Upgrade a plastic steam locomotive

>> READ NOW



STANDARD EDITION | PORTRAIT



DOWNLOAD



SUBSCRIBE
(free)

OUI! OUI! AMT!

Atlas HO Modern Commuter Trains Available for Order!



ALP-45DP Locomotive



Multi-Level Trailer Cab Car



Multi-Level Trailer

Atlas' foray into the world of modern commuter cars continues with the colorful and unique Agence métropolitaine de transport (AMT) paint scheme.

These trains are a common sight on the commuter lines in and around Montreal and the beautiful wave design on the cars has captured the hearts of passengers and railfans alike. Order yours today from your local Atlas dealer and bring these gorgeous models home to your layout.



CLICK HERE!





STAFF CREDITS

(Updated 3/9/2017)

Front cover: While there are some nice plastic steamers on the market these days, they may not fit your prototype. This month, Tom Hillebrant shows how he altered a plastic steamer to look more like his prototype.



ISSN 2152-7423

Editorial Staff

Joe D. Fugate, Publisher and Editor

Don Hanley, Assistant Editor

Production

Patty Fugate, Pasteup and Layout

Joe Brugger, Copy Editing

Mike Dodd, Copy Editing

Technical Assistant

Jeff Shultz

Advertising

Les Halmos, Account Manager

Daniel Nava, Advertising Assistant

Jean-François Delisle, Marketing Assistant

Columnists

Richard Bale, News and events

Jeff Shultz, News and events

Les Halmos, Modular railroading

Larry Smith, Narrow Gauge/Shortlines

Bruce Petrarca, DCC

Ken Patterson, Reporter at large

Special Correspondents

Joe Brugger, Questions & answers

Issue password: Mar2017

Published for the glory of God. [What's this?](#)





MRH SPONSORS

A - E



acculites.com



americanlimitedmodels.com

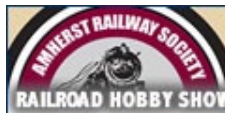

railroadhobbyshow.com



anemodel.com



archertransfers.com



athearn.com



www.atlasrr.com



bachmanntrains.com



bachrus.com



backdropjunction.com

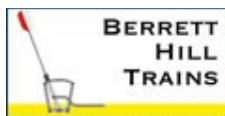

berretthill.com/trains



blairline.com



bowser-trains.com



con-cor.com/website



coffmaneng.com



www.digitrax.com



esu.eu/en

[Vendors: Get your clickable logo here ...](#)

MRH SPONSORS | 2

F - R



www.handlaidtrack.com



foxvalleymodels.com



www.iascaled.com



lights4models.com



litchfieldstation.com



model-trains-video.com



modelrectifier.com



monstermodelworks.com



stores.ebay.com/Motrak-Models



mtalbert.com



ncedcc.com



nickandnoraesigns.com



nwhs.org



www.pwrs.ca/main.php



rapidotrains.com



ringengineering.com



rustystumps.com

[Vendors: Get your clickable logo here ...](#)

• [INDEX](#)



[SUBSCRIBE](#)
(free)

• [TABLE OF CONTENTS](#)

MRH SPONSORS | 3

S - Z



sanjuancarco.com



scaletrains.com



selectmodelrailroads.com



signaturepress.com



soundtraxx.com



sodigi.com



sbs4dcc.com

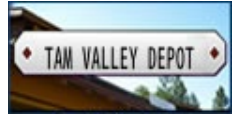

tamvalleydepot.com



tcsdcc.com



tonystrains.com



trainmastermodels.com



traintekllc.com



tsgmultimedia.com



walters.com



yankeedabblers.com

[Vendors: Get your clickable logo here ...](#)

Looking for something? Check the MRH Marketplace!

The screenshot shows the MRH Marketplace website interface. At the top, it says 'MRH MARKETPLACE | 2'. Below this, there are several vendor listings with images and text. Visible listings include:

- MRH MARKETPLACE** (Main header)
- WESTERFIELD** (New Risk Available: S-401 Pressed Steel UP Stock, LA&N, O&L, UP)
- CROW REVER PRODUCTS** (MR 225 1/2" HO Scale Locomotive)
- TAM Industries** (The "Golden Rule" of Model Railroading)
- AMERICAN HISTORIC MAIN STREET ARCHITECTURE** (Main Street Architecture)
- WALTERS** (HO & Scale Trains, Signals, Accessories)
- YANKEE DABBLERS** (YD)
- TRAM VALLEY DEPOT** (TAM Valley Depot)
- SELECT MODEL RAILROADS** (Select Model Railroads)
- SOUNDTRAXX** (Soundtraxx)
- SCALE TRAINS** (Scale Trains)
- SODIGI** (Sodigi)
- STREAMLINED BACKSHOP DCC** (Streamlined Backshop DCC)
- SBS4DCC** (SBS4DCC)
- TCS** (TCS)
- TONY'S TRAIN XCHANGE** (Tony's Train Xchange)
- TRAINFEST** (Trainfest)
- TRAINTEK** (Traintek)
- TSG MULTIMEDIA** (TSG Multimedia)
- WALTERS** (Walters)
- YANKEE DABBLERS** (Yankee Dabblers)

Take me there!

N
SCALE

NORFOLK & WESTERN
Item No. 14352

NORFOLK & WESTERN
Item No. 14252

NORFOLK & WESTERN
Item No. 14452

SMOOTH SAILING FOR YOUR PASSENGERS

BACHMANN'S NEW N SCALE SMOOTH-SIDE CARS

Bachmann's 85' Coach and Observation Cars feature lighted interiors so N scale passengers can ride in style, day or night. Available in your choice of five popular roadnames, all cars have E-Z Mate® Mark II couplers and metal wheels. Visit your favorite hobby dealer so your passengers can enjoy smooth sailing today!

72' SMOOTH-SIDE BAGGAGE CAR • MSRP \$49.00 each  [Click for more info](#)



PENNSYLVANIA RAILROAD
Item No. 14451



BALTIMORE & OHIO®
Item No. 14453



UNION PACIFIC®
Item No. 14454



NEW YORK CENTRAL®
Item No. 14455

85' SMOOTH-SIDE COACH with INTERIOR LIGHTING • MSRP \$59.00 each  [Click for more info](#)



PENNSYLVANIA RAILROAD
Item No. 14251



BALTIMORE & OHIO®
Item No. 14253



UNION PACIFIC®
Item No. 14254



NEW YORK CENTRAL®
Item No. 14255

85' SMOOTH-SIDE OBSERVATION CAR with INTERIOR LIGHTING • MSRP \$59.00 each  [Click for more info](#)



PENNSYLVANIA RAILROAD
Item No. 14351



BALTIMORE & OHIO®
Item No. 14353



UNION PACIFIC®
Item No. 14354



NEW YORK CENTRAL®
Item No. 14355

SHIPPING NOW!

Bachmann Industries, Inc. • 1400 East Erie Avenue • Philadelphia, PA 19124 USA • www.bachmanntrains.com

[Click to learn more.](#)



• INDEX



SUBSCRIBE
(free)

• TABLE OF CONTENTS



TABLE OF CONTENTS

FEATURES

Rework a plastic steam locomotive

THOMAS HILLEBRANT

Getting the locomotive you really wanted all along



Nickerson switching puzzle

GREG BAKER

Can you solve this prototype brain teaser?

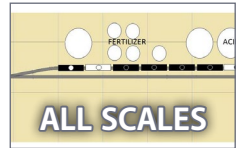

Modeling the B-27 baggage car

GREGORY LAROCCA

Methods to kitbash passenger cars for your layout



DCC projects using the Arduino

GEOFF BUNZA

More advanced DCC-compatible Arduino uses



LogicRail Fusee PRO/M

JOE FUGATE

Add operating realism with a mobile fusee board



ALSO: MRH Marketplace | Subscriber extras

TABLE OF CONTENTS | 2

COLUMNS

MRH Q-A-T: Electrical wipers, steam locos, and more

compiled by JOE BRUGGER

DCC Impulses: Wireless battery-powered DCC, part 1

BRUCE PETRARCA

What's Neat: Just Plug lighting system, and more

KEN PATTERSON

Imagineering: Developing modeling skills

RAY DUNAKIN

Photo feature: Yes, it's a model

compiled by DON HANLEY

Derailments: Bizarre facts & humor

compiled by the MRH STAFF

NEWS and EDITORIAL

Publisher's Musings: No more under-table turnout throws

JOE FUGATE

News & Events: March 2017

RICHARD BALE & JEFF SHULTZ

Reverse Running: Truly having fun with trains

DAVID EVANS





HO Tier 4 GEVo \$99⁹⁹

(Actual Model & Price)



Operating LED number boards



Operating LED ditch lights



Angled exhaust cabinet



HO
#87 SCALE

Preorder Now for Summer Delivery

Scene and photography by Ken J Johnson
Early Sample model shown

© 2017 ScaleTrains.com, Inc. ScaleTrains.com, Operator and respective logos are trademarks of ScaleTrains.com, Inc. ScaleTrains.com, Inc. 7598 Highway 411 Benton, TN 37307 844-9TRAINS 844-987-2467 International 423-299-3689 This product is made under trademark license from General Electric (GE).

• INDEX

• TABLE OF CONTENTS



PUBLISHER'S MUSINGS

editorial

JOE FUGATE



[Click here to rate or comment on this article](#)

NO MORE UNDER-TABLE TURNOUT THROWS?

IF YOU READ MY JANUARY EDITORIAL THEN

you know I've started dismantling my Siskiyou Line layout. My grand finale operating session was February 18th. At the end of the session, we held a little ceremony where I took the first screw out of the benchwork – so dismantling has now begun.

While I'm dismantling Siskiyou Line 1 (SL1), I'm not done with the Siskiyou Line or with having a layout. Not at all! I am planning to move, so the new Siskiyou Line 2 (SL2) will be a sectional module design using the concepts of TOMA (short for **The "One Module" Approach**) we've been discussing in MRH off and on for the couple years.

As I consider ways to do SL2, I am thinking of using "finger-flickable" turnouts. The idea is to use an "over-center spring" to make the points flickable from side to side with no under-the-table mechanism needed at all. I also won't need something like the Caboose Industries ground throw either.

On my current SL1 layout, I used doorbolt mechanisms on the layout fascia to throw the turnouts. These also needed a piece of



PUBLISHER'S MUSINGS | 2

L-girder under the turnout throw bar with stiff music wire to manage the point throw. The doorbolts are great because they're only about \$5 per turnout.

Technology has come far enough that it's now possible to have finger-flickable turnout points and have the frog polarity automatically controlled by a frog juicer circuit. That just was not possible back in the 1990s when I did the trackwork for SL1.

I'd like to devise a way to hide the over-center spring under a cover on the throwbar and on the first tie behind the throwbar. Then, only the part of the spring between the tie and the throwbar would be visible. If I use 0.020" spring wire painted a dark color, the wire should be very small and hard to see. By using a cover over the

ADVERTISEMENT



Announcing Motrak Models New Structure Kit HO Scale "The Tool Shed"



**CHECK
IT OUT!**

Website: motrakmodelsusa.com
Email: info@motrakmodelsusa.com



EMD 38 SERIES
DIESELS

ROOTS  BLOWER

200HP

Photo: Warren Calloway

ARRIVING BACK TO THE "ROOTS" WITH THE READY TO ROLL SD38

Featuring completely new body tooling with the proven Sound-Ready drive featured on the popular SD39/SD40/SD45, the Athearn RTR SD38 has been totally refreshed from the wheels up. The chassis incorporates the DCC Sound Ready components including using the Athearn Genesis® motor retrofit kit (ATHG63839) for simplified speed matching with our Genesis models. Beautiful attention to detail at a competitive price makes this model a must for yard switching.

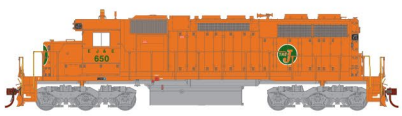

DCC-READY: \$134.⁹⁸ DCC+SOUND: \$184.⁹⁸

DCC-Ready	DCC+Sound	
ATH88473	ATH88573HO RTR SD38, B&E #861
ATH88474	ATH88574HO RTR SD38, B&E #862
ATH88475	ATH88575HO RTR SD38, B&E #863
ATH88476	ATH88576HO RTR SD38, CR #6938
ATH88477	ATH88577HO RTR SD38, CR #6949
ATH88478	ATH88578HO RTR SD38, CR #6954
ATH88479	ATH88579HO RTR SD38, CSX #2463
ATH88480	ATH88580HO RTR SD38, CSX #2466
ATH88481	ATH88581HO RTR SD38, CSX #2467
ATH88482	ATH88582HO RTR SD38, EJR&E w/J Logo #650
ATH88484	ATH88584HO RTR SD38, EJR&E w/J Logo #654
ATH88485	ATH88585HO RTR SD38, NS #3801
ATH88486	ATH88586HO RTR SD38, NS #3811
ATH88487	ATH88587HO RTR SD38, NS #3817
ATH88488	ATH88588HO RTR SD38, PC #6927
ATH88489	ATH88589HO RTR SD38, PC #6934
ATH88490	ATH88590HO RTR SD38, PC #6958

ATHEARN GENESIS HO EMD GP38-2

IN STOCK



The new fifth run Athearn Genesis GP38-2 models achieve an entirely new level of "As close to real as it gets" railroad specific detail including a precision drive make these models the top of the line for the most discerning modeler.

VISIT ATHEARN.COM
FOR MORE DETAILS



HORIZON
H O B B Y

VISIT
Your Local Retailer

CLICK
Athearn.com

CALL
1.800.338.4639

SERIOUS FUN™

©2017 Horizon Hobby, LLC. Athearn, Genesis, Ready To Roll, Trains in Miniature, Serious Fun and the Horizon Hobby logo are trademarks or registered trademarks of Horizon Hobby, LLC. All other trademarks, service marks and logos are property of their respective owners. Final models may vary slightly from photos shown. 514681

• INDEX



SUBSCRIBE
(free)

• TABLE OF CONTENTS



**CRAFTSMAN
KITS**



Our instruction manuals are second to none!
CHECK IT ALL OUT AT
WWW.RUSTYSTUMPS.COM
THE QUALITY IS INSIDE BECAUSE OUR NAME IS OUTSIDE



**COMING SOON
IN HO SCALE!**



We plan to produce an HO Scale version of our very popular Mt. Albert Lumber Yard kit later this year. Please watch our website and Facebook page for more details.

PUBLISHER'S MUSINGS | 3

throw bar and over the tie behind the throw bar, I can still get to the spring and service it from above if needed.

I've also seen the center-over spring method used on the underside of a turnout with a cover to hold it in place, but I'm leery of doing that and having a problem develop later. I prefer to plan that gremlins might cause some problems, and to have a way to deal with them without needing to rip out the turnout!

Some might be put off with reaching into the scene to flick the points and throw the turnout. That's not a problem for me because as an ops person I'm already used to reaching in to uncouple.

I've watched the prototype switch and they're always fiddling with the couplers to get things to couple up. I have no problem reaching into the scene and using a coupler pick: I just see myself as the guy on the ground working the coupler. It's the same with reaching into the



RESERVE YOURS BY ST. PATRICK'S DAY

CLICK HERE!

• [INDEX](#)



SUBSCRIBE
(free)

• [TABLE OF CONTENTS](#)

PUBLISHER'S MUSINGS | 4

scene to throw the turnout points. I'm just the switchman moving the points over.

I do like the sheer simplicity of finger-flickable points. One of the more tricky parts of learning to operate any layout I visit is figuring out how to throw the turnouts. You generally need to find something on the fascia or on a panel to throw the turnout points to the proper route. This is a big part of learning to operate on any new layout.

With finger-flickable points, there's nothing else to learn – you just reach in and throw the points of the turnout you need to throw. Done!

I also like the fact there's nothing under the layout to deal with: no Tortoise or other throw mechanism. That also means I won't have to fight benchwork members being in the way. I can't tell you how many times I've had to move joists and risers to make room for turnout mechanisms.

Back in the early days of SL1, I was good with dead frogs. But as the hobby has developed and I got into loco sound, I've come to really dislike dead frogs. Locomotive sounds often will cut out over a dead frog, even though a modern flywheel-equipped loco will roll over a dead frog just fine.

I've come to prefer live frogs, but I dislike having to install contacts to route the frog power. The advent of frog juicers for DCC has made using live frogs as simple as running a feed wire to the frog. The frog juicer will detect in milliseconds if the polarity is wrong when a loco rolls onto the frog and it switches the polarity so fast the loco rolls right on through just like nothing happened. Nice!

If any of you have used homemade over-center springs on your turnouts, I'd like to hear about it!

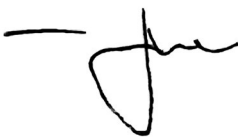

[Click here to rate or comment on this article](#)

FAST TRACKS BUYS MT. ALBERT SCALE LUMBER CO.

Fast Tracks is helping the world build EVEN better railroads with the addition of Mt. Albert Scale Lumber.

New Mt. Albert products and model kits coming soon.



Easy ordering • Live online support
Earn Waypoints with every purchase

shop online 24/7

handlaidtrack.com

1-888-252-3895

service@fast-tracks.net

• INDEX



SUBSCRIBE
(free)

• TABLE OF CONTENTS

MRH 2016 Survey, Are you building a layout?

Here is the response to our from our 2016 reader survey question asking our readers if they're building a layout. The statistical validity is +/- 2.5% with a 95% certainty.

Are you building a layout?

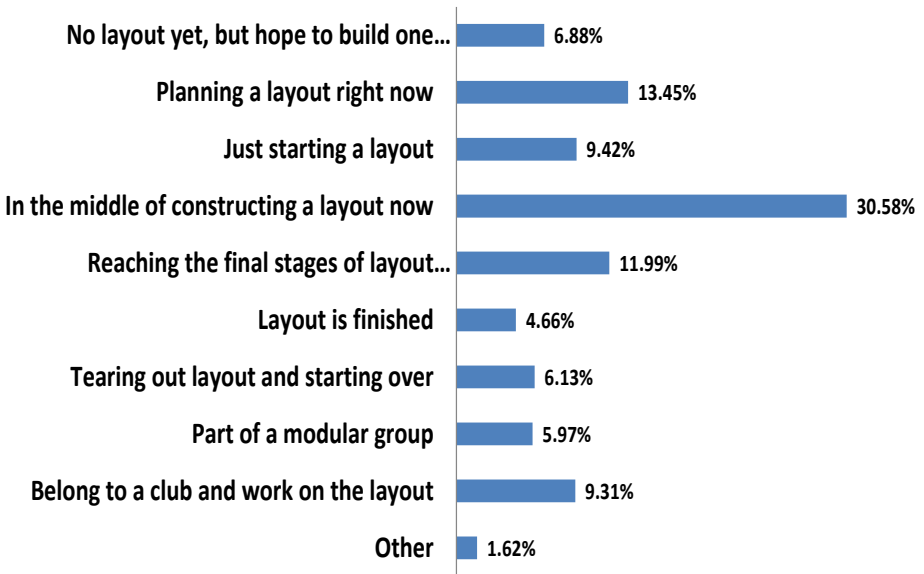

If we consider the first two categories to be no layout and the rest to be yes, building a layout, then we get 20% of our readers are not building a layout while the other 80% are building or otherwise regularly working on a layout.

The most common other response is “I’m working on a friend’s layout” so as far as we’re concerned, that counts too!

It’s gratifying to see 80% of our readers somehow engaged in building or working regularly on a layout (this means roughly one layout per 7000 people in the general population). A concern as a free web magazine would be it’s mostly armchair modelers who read us. Not so, based on this survey.

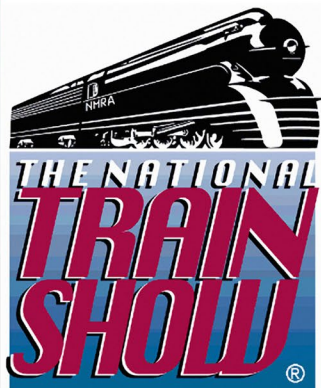

2017 National Train Show

August 4 - August 6, 2017

in **ORLANDO, FLORIDA**

Get the details >>

(click me)

Fun for the Whole Family

From your littlest engineer ...

To the most experienced Model Railroader



- The World's Best Known Manufacturers
- Over 180,000 square feet of exhibit space
- Hands-On Demonstrations
- 44,000 Sq. Feet of Modular Layouts
- Ask The Collectibles Appraiser
- The Incredible Lego® MiniLand

• INDEX



SUBSCRIBE
(free)

• TABLE OF CONTENTS



LAST ISSUE'S RATINGS

The five top-rated articles in the [February 2017 issue](#) of *Model Railroad Hobbyist* are:

- 4.8 Getting Real: Standards for model freight cars
- 4.7 Weeds along the right-of-way
- 4.6 DCC Impulses: DCC decoder install
- 4.6 What's Neat: Digitrax DCS 240, ...
- 4.5 Lighting up the ditches

Issue overall: **4.2**

Please rate the articles! Click the reader comments button on each article and select the star rating you think each article deserves. Thanks! ■

ADVERTISEMENT

HO GP60M, GP60B AND GP60 LOCOS



NOW AVAILABLE !



DC OR DCC WITH SOUND!



www.foxvalleymodels.com

ADVERTISEMENT



NICK & NORA DESIGNS

Uniquely inspired craftsman kits
Craftsman Structure Kits in HO & N
 Detail Parts,
 laser cut shingles,
 HO Vehicles, Tru-Color Paints,
 glues, tools & more!
www.nickandnoradesigns.com

Norfolk and Western Historical Society

**Brand New
Video!**

**Feature
length DVD
or Blu-Ray.
The official
story of
611's 2015
restoration**



**to operating condition.
How can I add this great disc
to my collection?**

Click Here!

• INDEX



SUBSCRIBE
(free)

• TABLE OF CONTENTS

Set for the new MRH: TMTV project layout series ...

Start small. THINK BIG.



Spring break

SUPER SALE



Get free bonus months!

TRAINMASTERS.TV

Don't miss out on the savings! **CLICK NOW**





Model Railroad Hobbyist | March 2017 | #85

MRH Q-A-T

column

compiled by
JOE BRUGGER
.....



[Click here to rate or comment on this article](#)

QUESTIONS AND ANSWERS

Material for electrical pickups?

Q. I am interested in making electrical wipers to pick up power from metal wheels on rolling stock. I have several design ideas, and my question is what to make them out of? I have heard of using stainless steel or phosphor bronze. Are these the best choices?

—Art

A. Mario & Bice: Definitely use phosphor bronze. It is used in similar industrial applications. Stainless steel passivates itself (this is why it resists corrosion), and the passivated oxide layer has a very high electric resistance.

Note: Passivate means making a metal or other substance nonreactive by altering the surface layer or coating the surface with a thin inert layer.

Also, phosphor bronze and all the copper-based alloys are non-abrasive. They are self-lubricating when running on a harder,

▶ MRH QUESTIONS, ANSWERS, AND TIPS

• INDEX
.....



SUBSCRIBE
(free)

• TABLE OF CONTENTS
.....

MRH Q-A-T | 2

dissimilar metal such as the nickel-plated metal wheels of model trains.

You can buy phosphor bronze in ready-made sheets and strips, or scavenge the material from old electro-mechanical equipment like relays and contactors.

Prof Klyzlr: +1 for phosphor bronze, either in the form of Tichy wire, or re-purposed Kadee #5 coupler centering springs.

1. Harold Minky makes phosphor bronze wipers which contact the backside fillet of the wheel flange. Note the sprung contacts on top of the pickup panel to transfer electricity to the car body. *Harold Minky photo*

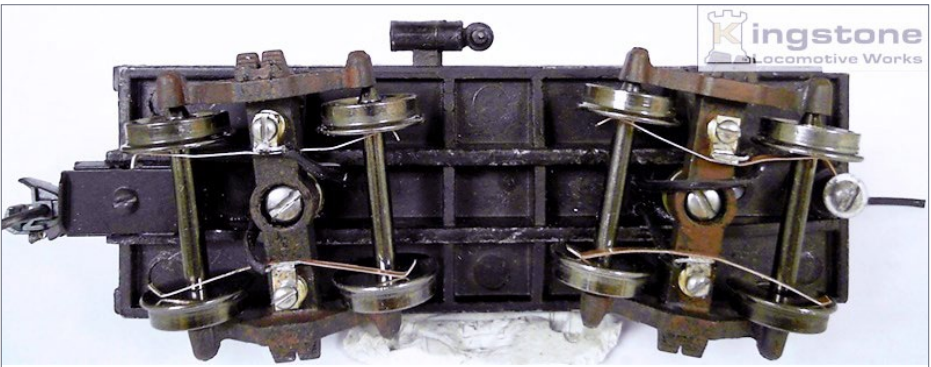
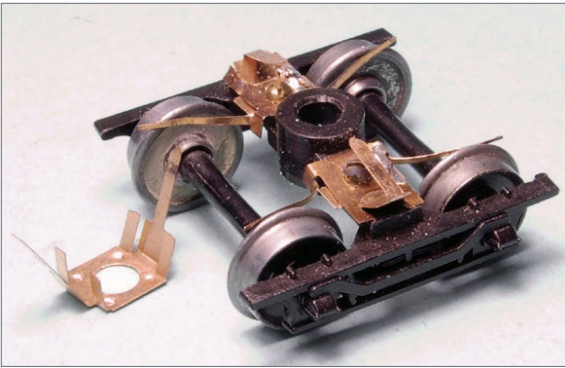

2. Bernd's design uses phosphor bronze wire and picks up directly from both wheels, creating a current path with as few wiping contact points as possible.

MRH Q-A-T | 3

Bernd: I use .015” dia. phosphor bronze wire rubbing on the back of the wheels. I did an engine upgrade for Bill Gill on his 0-4-0 Mantua engine a while back. I used wipers on both sides of the truck. This way you avoid the contact the wheel makes through the truck’s side frame and then through the truck frame to tender/engine frame connection. You get a more direct and positive electrical route if you can run wires directly from the wheels to the motor.

If you’re interested in seeing the whole project, here’s the link: mrhmag.com/node/15986.

Nelson Beaudry: I find that the best method to attach electrical pickups to trucks is to drill and tap for a 0-80 screw. Small enough for HO scale trucks, yet will retain the strength needed.

MRH: Phosphor bronze sheet is marketed by K&S and is available from hobby shops and online retailers. Wire is packaged by Tichy and other suppliers.

Condensed from the thread at mrhmag.com/node/28998.

Steam locomotive equipment

Q. I thought I knew what most of the equipment that hangs off a steam locomotive was, but this has me confused. Does anyone know?

—Rob Clark

A. Bob Battles: The SP Cab-Forwards all had stack lights, or “density lights” as the SP called ‘em, so the fireman could see how much smoke he was making at night. Bear in mind that the stack was about 60 feet *behind* him so he couldn’t just look up and out the cab window and see the smoke. The lights were on the engineer’s side behind the stack but shone up in the air and essentially through the smoke. In HO, a 1.5V “grain-of-rice” bulb is just about



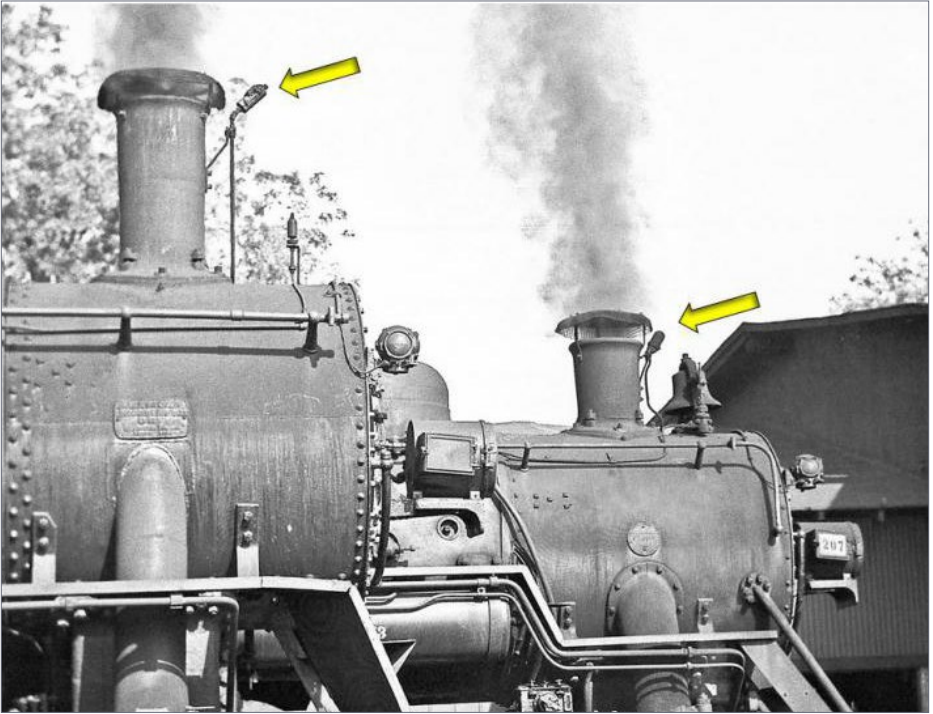

3. Steam whistles? Lambda sensors? What are the gadgets mounted to the front of these two smokestacks?

the right size for a stack light and I've installed them on both of my cab-forwards.

Sou1019x: While these lights were often seen on oil burners, I believe the photo is of two of the Gainesville Midland Railroad's 2-10-0s, which were coal burners.

John Garaty: When the fireman can see how much smoke he is making at night, based on the color/thickness of the smoke, he can then adjust either the amount of oil and/or the amount of air going to the burner in the firebox to get optimum combustion so that enough steam is being made for the locomotive's needs.

At various times during coal strikes some locomotives were converted to oil-burners, but most were converted back to coal once the strike was over. The exception in Australia was the NSWGR 59 class built by Baldwin/Lima /Hamilton in the US, based on the USRA Light Mikado design, but with a shortened tender to enable these locomotives to fit on a 60-foot turntable. These were delivered as oil-burners in the early 1950s. Most were converted to burn coal, but a few retained their oil burners until the end. They had that light in front of the stack throughout their working career. Even on some of the coal-burning conversions, the bracket to support the light was left in position.

BR GP30 2300: I thought it was a microphone ... to get DCC/sound recordings.

Thanks also for comments by JC Shall, NSWGR, AndreChapelon, Brownshoe Sailor, Benny, Laming, Bernhard, and SP 4284. Read the whole smoky thread at mrhmag.com/node/28591.

Flush-cutting pliers

Q. In the past year I have broken two Xuron flush-cutting pliers on Atlas code 100 nickel silver track. The pliers' metal is hard, maybe brittle, and one side just snapped off and flew across the room. Any suggestions for a brand of sturdier flush cutters?

—Doug L.

A. There's a possibility the problem is in the technique, and not the tool. Had you not specifically mentioned Atlas track, we would have suspected you ran into a batch of steel rail.

GregW66: We're helping a friend build a layout. We're using a very old and used pair of Xuron rail cutters. Bill uses the tool to cut the



rail from top to bottom. That is to say he places one edge of the tool on the rail head and the other on the base. He gets a rough cut that must be filed to allow a rail joiner on. He also uses a lot of force to make the cut.

I use the tool from side to side. I got a nice clean cut with no need to dress it with the file. The old tool cut like it was going through soft butter. Bill tells me I use the tool “wrong” but results don’t lie. This is on code 100 rail.

Yaron: Since I’m a Xuron noob and use a Dremel motor tool to cut my rails, I went to Amazon to see what different Xuron track cutters there are and seemingly there are two:

- the 2175B (semi flush) for cutting top-to-bottom of the rail (rail head to rail base)
- the 2175M (vertical cut) for cutting rail already laid, where you cut from side-to-side

I never knew the cutting edge of the tool would need to be different based on if you cut the rail top to the bottom vs. side-to-side.

Well, I learned something new!

JC Shall: I have a pair of the Xuron 2175 flush cutters. I later ordered



4. Xuron supplies 2175 flush cutters in two styles, with different grinds on the cutting edges. *Xuron photo*

a pair of the 2175B track cutters. When they arrived I noticed that the model number engraved in them was 2175. Naturally, I thought I had a pair of cutters identical to what I already owned.

A call to Xuron solved the mystery. The lady explained that the 2175B is indeed the same tool as the model 2175. However the grind applied to the cutting edge is slightly different on the 2175B track cutters, making it a better tool for cutting rail. The 2175B doesn't have the "B" engraved into the tool, so I marked the handle with a felt-tipped pen so as to not mix up the two tools.

Finally, the customer service lady advised me to NOT use the 2175B for cutting wire or other metals other than rail so as to not "disturb" the edge of the tool (which is optimized for rail).

Raymond Clifford: I buy excellent flush cutters from Micro Mark for about \$40; cheap for the job they do. I have probably used 20 in commercial work over the last 20 years. Most failed due to my carelessness cutting hard wire.

If you want to cut hardened wire, and not relatively soft rail, there are other tools.

Joe Fugate: Get these special music wire flush cutters designed to cut hardened music wire. As a bonus, they cut both sides flush! They work great – they're \$23 on Amazon and two-day shipping is free to Prime members. Search for Xuron 2193F "Hard Wire and Music Wire Cutter with Retaining Clips" or go to a.co/6EFkJ8y.

They are no good on rail, however. They assume a round profile on the material being cut and will mangle rail. But if you want to save your rail flush cutters from damage, get these babies and you will never be tempted to use (and damage) your rail flush cutters on music wire again.



Louix2: I'm a bit surprised your cutters broke. I've used Xuron products for decades with no problems. However, Xuron products have a lifetime warranty so you may want to contact them about a replacement at xuron.com/index.php/main/faq.

Doug L.: Thank you for the suggestions. I ordered the Xuron 2175B Semi-Flush Shear for cutting track from top to bottom – it was suggested at Amazon over the simpler model 2175.

For track in place, I ordered the Irwin angled-end cutter 1773600. Xuron also has an angle cutter, 2175M Vertical Cutting Track Cutter. Who knew NS track could be so tough? Code 100 track is like cutting 10 ga. wire.

I never cut piano wire. I either bend it back and forth or use an abrasive cutting wheel. If it had to be more accurate, the double-cutter expressly for piano wire would be the thing. (*Note: You can also score hardened wire with a file, and snap it*).

The original MRH Forum thread is at mrhmag.com/node/29047.



TIPS

Fix a broken clip on RJ cable plugs

If you have been frustrated with the constant breaking of the locking clip on top of your RJ12 connectors, then here is a cost-effective and permanent solution that doesn't require any special tools. All you need is some super glue and sandpaper.

Cut a small piece of sandpaper about the same size as the locking clip. Place a small quantity of superglue (CA) on top of the plug where the locking clip had been.

MRH Q-A-T | 9

Super glue the sandpaper on top of the plug, and let set for a few hours.

—Shelton D’Cruz

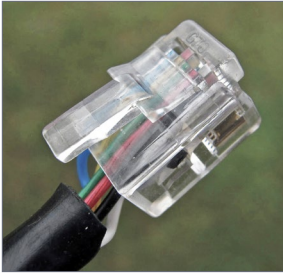

5. Connector plug with locking clip.



6. A damaged plug with the locking clip snapped off.



7. Attaching sandpaper holds the plug in place with friction and lasts much longer than the plastic locking clip.



[Click here to rate or comment on this article](#)



GET PAID FOR YOUR TIP

We pay \$25 per tip we publish, or \$40 each if the tip also includes a photo or finished drawing. [Click here and select article type TIP.](#) ■

• [INDEX](#)



[SUBSCRIBE](#)
(free)

• [TABLE OF CONTENTS](#)

From first train set to railroad empire...

*Our complete line of DCC products
grows with you. Discover the fun!*

- Designed and manufactured in the U.S.A.
- Preferred for ease of use and ergonomic design
- Unlimited scalability for any size model railroad
- Plug-and-play means more time running trains
- Great customer service and excellent support



See your dealer



Visit our new and improved web site for all your DCC needs!

- Get the latest new product announcements
- Watch our detailed how-to videos
- Browse the all-new Information Station
- Enjoy secure online sales, day or night!

Visit **ncedcc.com**



• [INDEX](#)



[SUBSCRIBE](#)
(free)

• [TABLE OF CONTENTS](#)

TONY'S TRAIN XCHANGE

Committed to your DCC support!

ESU LokSound DCC Decoders

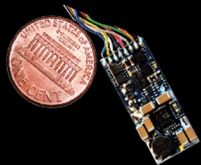

Accurate, Prototypical Sound
& Superior Motor Control.
All Select & V4.0 Decoders
N Scale through G Scale
Starting at \$85.95

Order Yours

NCE DCC Systems Super Sale!



Get a great sale price on all
the impressive NCE DCC
Starter Systems

Order Yours

New SoundTraxx Tsunami2 Decoders



TSU-21PNEM
21 Pin

TSU-24400
4 Amp (Large Scale)

The Excellent Tsunami2 Sound,
Motor Control and Features You
Expect. Now in Five Formats

Starting at \$87.96

Order Yours

**Do you need a Sound or
DCC Installation done?**

Get a quote!



Providing unmatched person to person
DCC support for more than 25 years, the
kind of service that has made us #1 in DCC.

DCC questions? CALL US! 1-800-978-3472

We'll get you on the right track!

Mar. 2017





DCC IMPULSES

column

BRUCE PETRARCA MMR
.....



[Click here to rate or comment on this article](#)

WIRELESS DCC: PART 1, THE RADIO SIDE

NO, THIS IS NOT ABOUT RADIO CABS FOR YOUR DCC system. I'm going to talk about removing the voltage from your track (dead track) and continuing to use DCC technology to run trains.

In the past, I've written about wiring my garden layout for DCC (mrhmag.com/magazine/mrh-2015-07-jul/di_dcc-garden-wiring-tips). I had been hoping to be able to run DCC in the garden with the brass track, since I live in the desert. That didn't happen without a lot of track cleaning.

My experiments were with what long-time garden railroader Stan Ames called hybrid drive: running the loco on track-supplied DCC but including a small battery to help it over the bad spots. This is an enhanced version of the energy storage capacitor schemes being marketed under various names by DCC decoder manufacturers.

Instead of a few seconds of running without track power, hybrid drive would keep locos running for minutes. But, if the loco derailed, it would keep running without a control signal.

► DCC TIPS, TRICKS, AND TECHNIQUES



DCC IMPULSES | 2

Not a good thing with water-filled ponds as part of the layout. Folks always said, “go radio and battery-powered and you’ll be happy.” Yah, but ... my garden layout is a switching layout based on southwestern Colorado narrow gauge in the Depression era: short 3- to 5-car trains with runs where every car would get switched out along the way. No room for a battery car that has to stay with the train. This is gonna take more than a quick fix.

Our club’s garden layout (pcmrc.org/garden.html) had one AirWire-equipped loco and a battery car, so I had a place to experiment. I kept looking at how to marry wireless DCC and battery power. Battery technology getting better increased my chances of fitting the batteries in the locos. This column isn’t the final chapter, but here’s how the story is unfolding.

ADVERTISEMENT

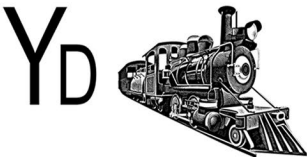

Yankee Dabbler – Track 33

**FREE SHIPPING
ON ORDERS OVER
\$100.00**

**YD Specializes in DCC
Sales-Service-Installation
YD provides the BEST for LESS**



CLICK AND SAVE TODAY!



YD installs DCC or RailPro in your engines
Technical Coordination (727) 457-9227 9AM to 9PM EST



• INDEX

• TABLE OF CONTENTS

DCC IMPULSES | 3

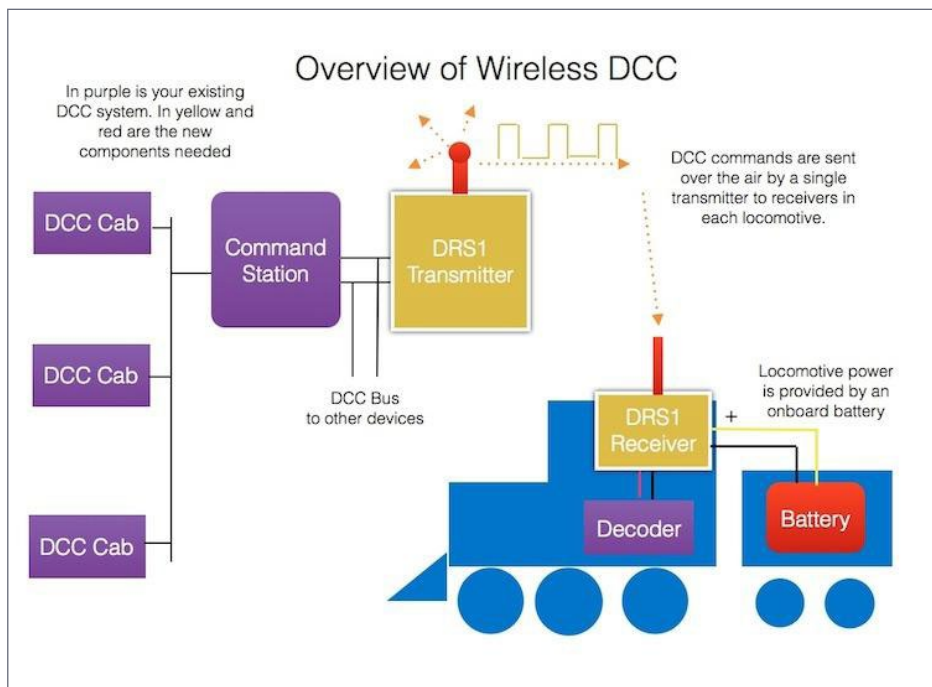

1. System diagram of the Tam Valley Depot DRS1 system. All the systems discussed here are similar. The AirWire and S-CAB systems combine the DCC Cab, command station and transmitter functions into a complete handheld module. The DRS1 is designed to leap-frog off an existing DCC system. *Tam Valley Depot drawing*

The solution has two parts: getting power to the locomotive and controlling its motion, sound and lights. Let's tackle the communication side first.

The trick with so much of this technology is adjusting battery size to fit the physical space available and still supply the needs of your locomotive to run a meaningful amount of time.

I have found methods which will yield reasonable run times for everything from HO to garden locomotives.

DCC over-the-air

To maximize my DCC investment: cash, knowledge, time and equipment, I wanted solutions that actually used the DCC packets delivered by radio. The Dead Rail Society was formed a few years back in southern California to bring like-minded modelers together. They have a nice web site (deadrailsociety.com). On their “suppliers” tab, they list only three systems that use DCC and support sound. So here is what I’ve found out about these systems:

Let’s step back and explain what this really means. Figure [1] shows the system diagram of the Tam Valley Depot DRS1 system. The boxes in purple represent an existing DCC system. The DRS1 system consists of the transmitter and receiver shown as

ADVERTISEMENT

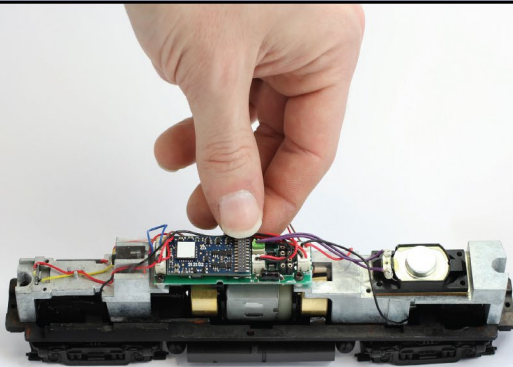

Compatible with Bowser, InterMountain, Atlas, Scale Trains, Rapido, Fox Valley Models, and other model manufacturers

SOUNDTRAXX™
www.soundtraxx.com

Easy Installation Amazing Sounds Tsunami²

Tsunami2 21PNEM digital sound decoders simply plug into models that are equipped with a 21-pin connector. With this decoder, you can have your model running with our massive sound library and top-of-the-line motor control in as little as 5 minutes!

Click now to watch the full install!

Watch Now ▶

the yellow boxes. The DCC control signal moves through the air from the transmitter to the receiver as shown by the dotted yellow arrow. Power coming from the battery (red) completes a totally wireless system.

There are several approaches to the receiver side of this DCC system:

- 1) Make the receiver a complete DCC decoder and provide motor and function outputs. Usually this solution works best in non-sound installations. It may also be the smallest version, as there are not two or three electronics modules to fit into the loco.
- 2) Make the receiver a DCC “booster” and have it drive an external DCC decoder. This way, whether the DCC decoder is a simple motor and lights version or the most exquisite sound, motor and lights decoder, the performance is determined by the decoder, not by the wireless system.
- 3) Build a DCC receiver that talks to the internals of a DCC decoder with low voltage signals. This necessitates the modification of the DCC decoder, but saves some size and heat in the process.

Let’s evaluate the three players listed on the Dead Rail Society website.

CVP: AirWire

CVP, the folks who bring you the Easy DCC system, are one of the pioneers in garden wireless command with their AirWire system (cvpusa.com/airwire_system.php). The garden superintendent of our PebbleCreek club (PCMRC.org) started using the AirWire cab and receiver packages for our garden layout. I have continued with that standard and added more cabs and locos for the club.

The operator side of the AirWire system has evolved to the T5000 [2] cab. The T5000 combines a DCC command station and a cab with a nice display and a radio transmitter into one package. Two versions are available, with or without backlight for the display.



DCC IMPULSES | 6

The backlight depletes the batteries when used, but makes the throttle usable at night. It also adds to the cab price. The venerable economy version T1300 cab is still available.

Batteries (2 x AAA) for the T5000 are user changeable. I normally use NiMh batteries in all my throttles. However, the T5000 seems to have been designed with alkaline batteries in mind. Fully charged NiMh batteries show almost completely dead on the T5000's meter. So, against my green side, I recommend alkaline for the T5000. The T1300 has built-in rechargeable batteries.

The AirWire system can operate on seventeen different frequencies within the 900 MHz band. For most reliable operation, I recommend putting each receiver on a separate frequency and using its own cab (on that same frequency) to control it. If you try to run two links on the same frequency there is a high probability of interfering with yourself. With all the choices, why gamble?

The locomotive side of the AirWire system uses either a receiver /motor driver [3] and [4] or a receiver / DCC booster board [5].

The current version of the receiver/



2. CVP AirWire T5000 cab. Bruce Petrarca photo

DCC IMPULSES | 7

motor driver board for the garden is called the G3 [3] and can operate on any of the 17 frequencies that the T5000 speaks. The G3 basically turns your battery voltage into pulse-width modulated DC to operate the motor (and any track powered sound unit). The G3 will supply up to 10 amps of output power.

I use G3 boards, for example, in our club's garden scale LGB locos that came with motion, sound and lights all driven off track DC power. A simple double-pole, double-throw (DPDT) toggle switch can be installed in the loco and switch from track power to AirWire control. Battery power can be installed in the loco or or a trailing car.

The G3 electronics are available in two additional form factors for easy installation into Bachmann G-gauge steamers and many USA diesels.

ADVERTISEMENT

TCS **WOWSound**

**Version 4 of WOWDiesel
NOW SHIPPING!**

WOWDiesel Version 4 Introducing the
645 Non-Turbo Prime Mover

All with Unmatched CD Quality Sound at
TRUE 16 bit Resolution that nobody else can
come close to!

click here

Learn why loco sound fans prefer WOWSound ...

Remember you "Rivet Counters", Sound has rivets too and TCS counts them better than anyone!

www.TCSDCC.com

• INDEX



SUBSCRIBE
(free)

• TABLE OF CONTENTS

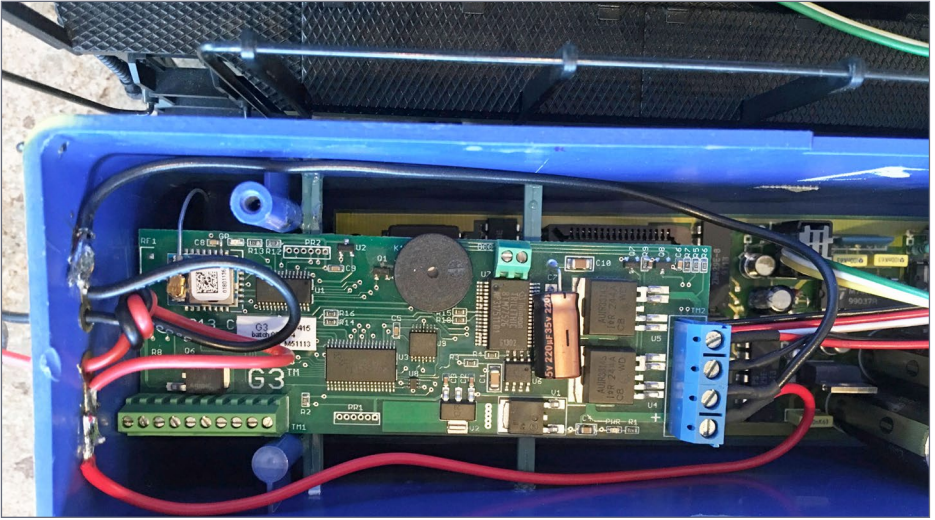

3. AirWire G3X external antenna board installed in LGB diesel. Battery power comes in from the left (red and black wires) and enters the G3X board on the lower screw terminals on the right side. The red and black wires from the upper terminals on the right connect to the LGB factory electronics where the track feed previously attached. The gray wire coming off the copper terminal in the upper left is the antenna, just routed up toward the roof of the shell and along the inside. *Installation and photo by Bruce Petrarca*

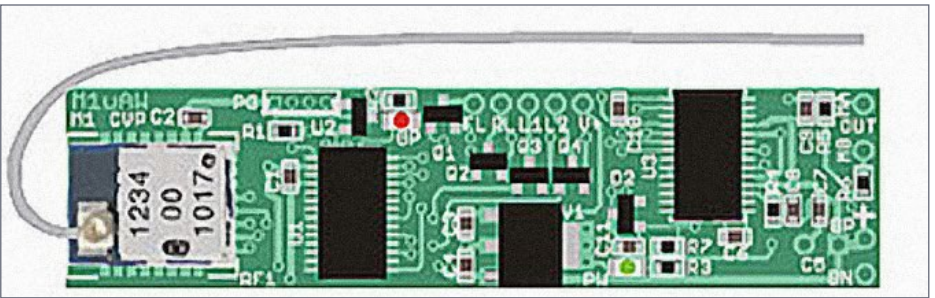

4. CVP's microDECODER interface board for AirWire control of smaller scale locos. *CVP photo*

DCC IMPULSES | 9

Of interest to the fans of the smaller scales, is the microDE-CODER [4]. This board, functionally equivalent to the G3, is small (0.6 x 2.4 x 0.25 inches) and will control 4 functions and a motor up to 1.5 amp running current. Coupled with the S-CAB BPS, discussed later in this column, it represents one of the solutions for HO and On30 dead track operations.

These AirWire boards are available with internal antenna boards (blue rectangles) or external wire (grey) antennas.

Okay, what's the DCC booster board story for AirWire? They offer three sizes of board in two versions. Their CONVRTR version boards house a receiver and DCC booster ready to drive your DCC decoder. These boards offer three current level outputs: 1.5, 2.5 and 6 amps running current with appropriately higher stall currents. The 2.5 amp version (CONVRTR-25) is shown in [5].

Thus, you can choose the power level you need and have the cost and board size adjusted accordingly.

In summary, the AirWire system offers a stand-alone DCC-over-the-air system:

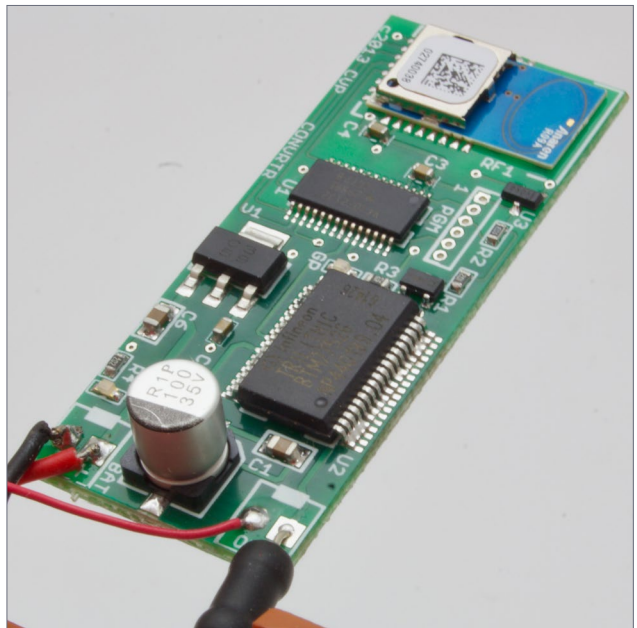

5. CVP CONVRTR-25 AirWire to DCC converter. The internal antenna is shown in the photo as the blue rectangle in the upper right. *Bruce Petrarca photo*

DCC IMPULSES | 10

handheld transmitters and loco-mount boards to drive your motor, lights and sound directly or through an installed DCC decoder. I am not wowed by the ergonomics of their rectangular-box cabs. But they have earned a reputation for reliability.

Tam Valley Depot: DRS1

Another system mentioned on the Dead Rail Society web site is the DRS1 from Tam Valley Depot (tamvalleydepot.com/products/drs1deadrailcomponents.html). Duncan McRee, the owner of TVD and a co-founder of the Dead Rail Society, has designed a system to piggyback on an existing DCC layout. This allows running some locos on track DCC and some on battery plus over-the-air-DCC on the same layout at the same time. The DRS1 is an easy way to transition from powered rails to dead track, one loco at a time.

ADVERTISEMENT

RailPro™

NEW TECHNOLOGY

DIRECT™ RADIO

RE RING™ ENGINEERING

NEW Starter Kit \$399.99 MSRP

- Includes Wireless Color Touch Screen Handheld Controller and 56 Watt Power Supply
- Expandable to Virtually any Size Layout

NEW Locomotive Module LM-3 & LM-3S

- Direct Radio RF
- Sound and Non-Sound
- New Tiny Size
- 6 Light Outputs

Click Here to Learn More

For more information visit our Internet site: www.RingEngineering.com

DCC IMPULSES | 11

The DRS1 uses the Linx radio board set on 916.48 MHz. The ease of use of these Linx boards has many unlicensed items using them and may cause interference, being on the same frequency: NCE radio cabs, for example. There is another frequency, aimed at the folks in Europe: 869 MHz. While it doesn't interfere with the NCE radio cabs, it is not legal to use in the USA.

The DRS1 transmitter [6] connects to the DCC bus from an existing DCC system. It simply takes the data stream on the DCC system and transmits it. Installation can be as simple as a couple of alligator clips connected to the rails of a layout. A more permanent solution would be to wire it to the rail outputs of your DCC booster. The transmitter draws a few milliamps of DCC power to operate, about the same as a DCC decoder sitting quietly waiting to go.

The DRS1 system has two sizes of receiver. The smaller version [7] is usable with battery voltages up to 18 volts (4 LiPo cells) and will supply 1.5 amps running current (2 amps peak). The larger version [8] will support up to 6 LiPo cells (28 volts) and deliver 3 amps running current (5 amps peak).

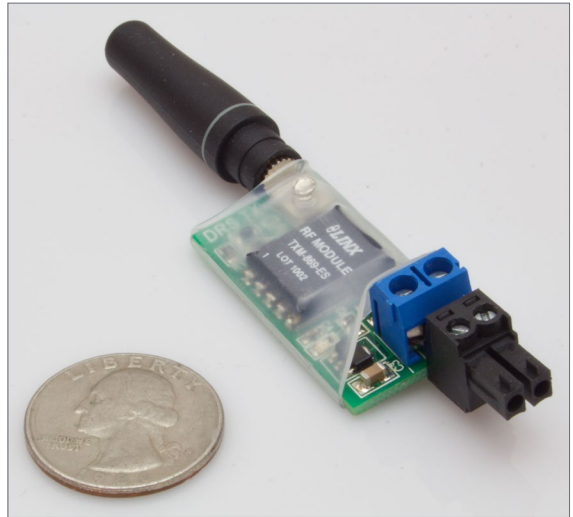

6. The simplicity of the DRS1 transmitter. Connect it to a basic DCC system with two wires connected to the (blue) terminal strip. Shown here close-wired to the terminal strip (black) for the NCE PowerCab. *Bruce Petrarca photo*

DCC IMPULSES | 12

On the Tam Valley Depot site there is an example where Duncan installed a high power version of the receiver and 4 LiPo cells in an HO scale dummy B unit. This provided a mobile DCC system to operate BLI sound and motor units, an A and a B, in a UP ABB City of San Francisco lashup.

The locomotive side of the installation consists of connecting the receiver module of choice to your battery and existing DCC decoder and routing the antenna (copper wire) away from motors, batteries and other electronics.

Let's see, who would best be served by the DRS1 system? Folks who were converting an indoor layout (HO or On30 are frequent choices) and already have an investment in a DCC system and cabs are well covered. Just remember the USA-legal system frequency (916.48 MHz) will not work and play well with NCE wireless cabs.

Stanton: S-CAB

In preparing this column, I hooked up with Neil Stanton on the phone. We discussed his S-CAB system ([S-CAB.com](#)). I heard some things that I liked and, hopefully, will have more information for you in a future column.

One of his innovative devices is the BPS [9] board (S-CAB.

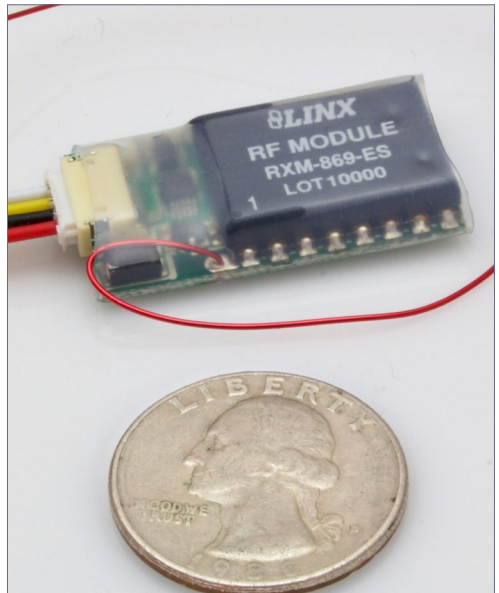

7. The DRS1 receiver, small size, usable up to 18 volts, will deliver 1.5 amps for continuous running. It fits many uses in a package barely larger than the Linx radio module. *Bruce Petrarca photo*

DCC IMPULSES | 13

com/battery-power.html) aimed at HO scale and similar sized locos. It connects between a Lithium Polymer (LiPo) battery and track power. When there is more than about 6 volts (DC or DCC) on the track, the battery will be charging. The BPS will convert the 3.7 volt LiPo battery voltage to 11 volts which can be connected to any DCC decoder to become the ultimate energy storage system. When fully charged, even the smallest of these batteries would run a modern loco for many minutes. A selection of battery sizes allows everything from stay-alive support to full dead track operation.

The S-CAB starter kit provides a way to send DCC commands to a receiver inside of a loco. This system consists of a Stanton radio CAB [10] and a radio receiver [11] combined with a DCC decoder [12]. In order to increase the efficiency of the system,

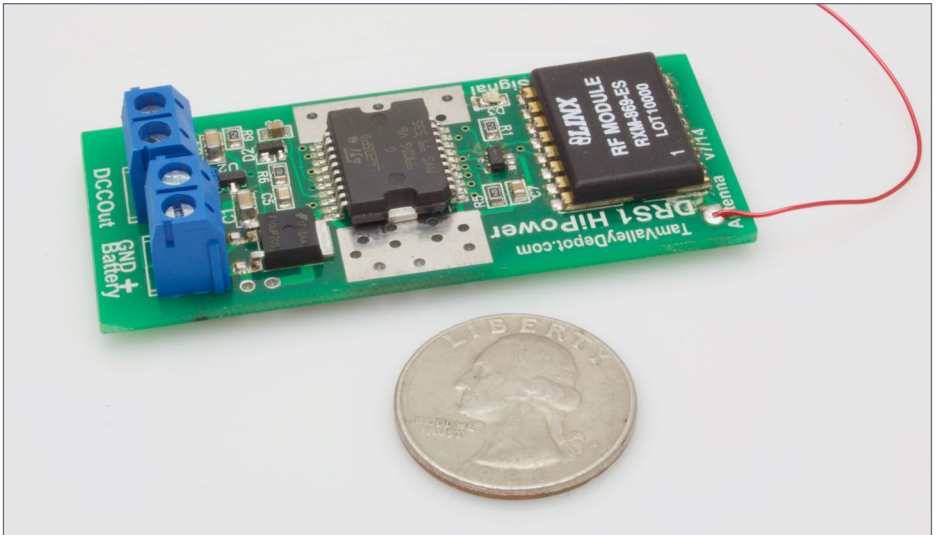

8. The DRS1 receiver, large size, has screw terminals and a bigger footprint than the smaller unit. This unit will supply up to 3 amps continuously (5 amps peak) with battery voltages as high as 28 volts (6 LiPo cells). *Bruce Petrarca photo*

DCC IMPULSES | 14

Neil connects the DCC signal out of the receiver directly into the decoder. This is why he supplies modified decoders, not just receivers. Don't worry about Neil's mod. Installation of the radio/decoder combo is exactly the same as a regular DCC decoder.

The Stanton Radio CAB is, like the AirWire, an entire DCC command station, cab and radio transmitter in a single unit. The S-CAB unit has built-in rechargeable batteries. See the charging jack next to the thumb in [10].

When working in the larger scales, you can to add a high capacity battery pack (connected via red and black wires of the decoder) for power. In the smaller scales, a BPS [9] system combines on-board battery charging from the track with a battery, all in one integrated package. Instead of using a battery pack, the BPS output (11 volts) connects to decoder red and black wires.

ADVERTISEMENT



ANE Model
Navigator of Turnout & Digital control

LD101
Coming Soon

ANE model
www.anemodel.com

www.anemodel.com

The advertisement features a white LD101 decoder with a digital display showing '8888' and several colored buttons. To the left is a cartoon character of a yellow and black train engine wearing a cap and boots. The background shows a model railway track in a landscape.

ADVERTISEMENT



WAY TO GO, TRAIKTEK!
Already great prices and NOW ...

FREE SHIPPING ON ORDERS OF \$79 or more*

Start saving now!

TrainTek

*some exclusions apply

The advertisement features a smiling man with a grey beard and a grey t-shirt. A purple speech bubble with a white mouse cursor points to the text 'Start saving now!'. Below the man is a blue train engine with a lightning bolt striking it. The background is white.

DCC IMPULSES | 15

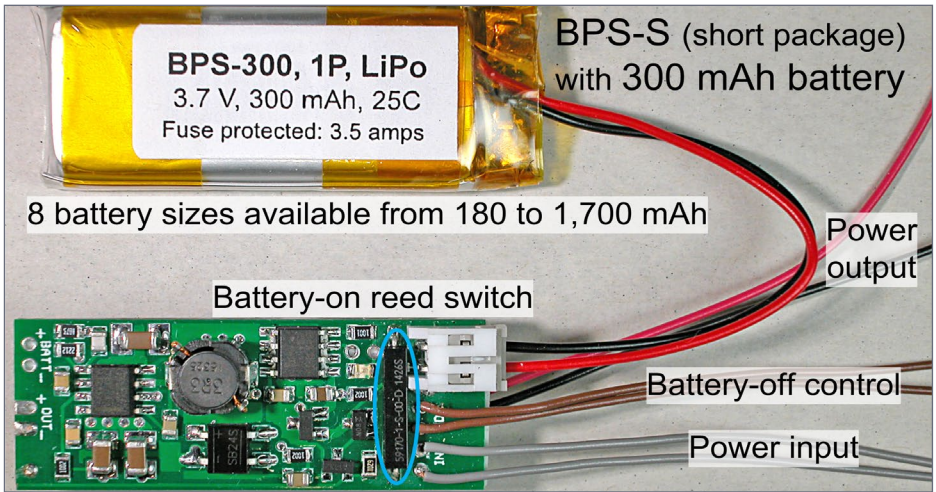

9. BPS-S (battery power supply) system with a 300 mAh LiPo battery. S-CAB.com photo

ADVERTISEMENT

Make LocoNet wiring extremely simple!



Suitcases belong in your baggage cars,
not under you layout!

Introducing the DCC Vampire II ...
this guy does the job of two suitcase
connectors!
And really holds the connection good
too!



CLICK NOW TO DISCOVER THE AMAZING VALUE!

Dealer Inquiries Accepted

• INDEX



SUBSCRIBE
(free)

• TABLE OF CONTENTS

DCC IMPULSES | 16



The S-CAB system operates on the 916.48 MHz frequency common to Linx boards. This makes for compatibility between the S-CAB system and others. For example the controller function could be from either an S-CAB Throttle or a TVD DRS1 transmitter. A CVP T5000 cab will work as well, using its channel 16 setting. Again, there is the interference issue with this frequency. However, the S-CAB

10. (Left) Stanton Radio CAB. *S-CAB.com photo*

11. (Bottom) S-CAB receiver uses the Linx RF module. *S-CAB.com photo*

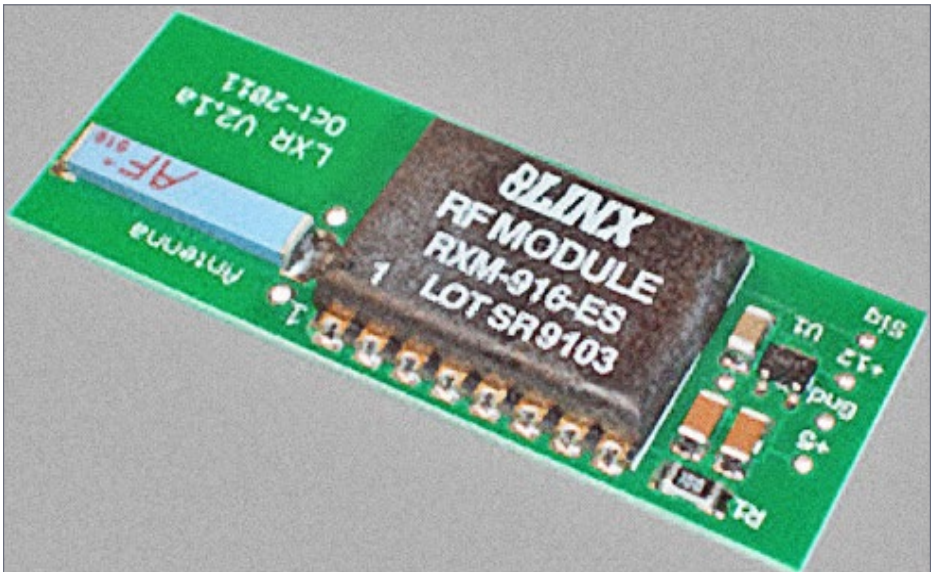



ESU

Why settle for sound that is close enough when you can have the exact sound for your locomotives?



[Click here for a complete listing of sound files and samples.](#) 

One size does NOT fit all!
Shown above are seven ALCO 12 cylinder 251's, all with slightly different sounds!

ESU LLC

23 Howard Street, Montoursville Pennsylvania 17754

Phone +1 570-980-1980, Fax +1 866-591-6440

(Office hours: Monday through Friday, 8AM to 4PM (EST))

WWW.LOKSOUND.COM

• [INDEX](#)



[SUBSCRIBE](#)
(free)

• [TABLE OF CONTENTS](#)

system doesn't rely on another DCC system to work. So, the NCE issue is less important here.

Neil also offers a Radio Programming Adaptor (RAPA) that functions very much like the TVD DRS1 transmitter. With this unit, you can use DecoderPro to customize your S-CAB equipped locomotive the same way that folks can with a wired system. The RAPA even allows read-back of the CV values programmed. I'm looking forward to experiencing this myself.

How do I proceed?

Selecting a communication system requires thought and planning.

The AirWire cab offers a selection of frequencies. The other two are stuck on one frequency with the possibility of interference. The individual cabs require one cab per loco, which can increase cost.

As I always recommend, it is best to try a cab yourself and insure that you can work well with it.

Once you have a transmitter style selected, then you can move on to selecting a receiver board and batteries. That will be the topic of my April 2017 column.

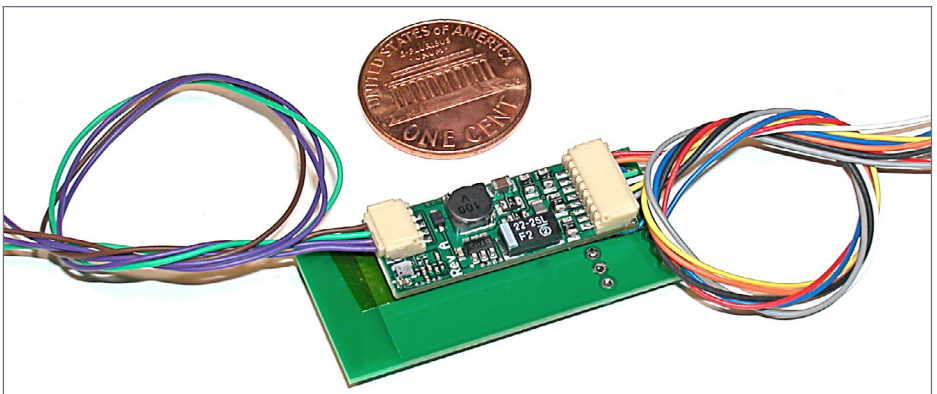

12. S-CAB receiver as mounted to a SoundTraxx ECO-100 Econami decoder. *S-CAB.com photo*

Great control in a tiny package



**Original
Touch Toggles**

- Touch Toggle™ plug in controls
- Bright clear indication
- Easy setup
- Flexible system

Stall Motors, Twin-coils,
Power, and Servos

Now for Tam Valley Depot
and MRservo too!



**BERRETT
HILL
TRAINS**

Made in the USA



What will they think of next?

www.berretthillshop.com

**IOWA SCALED
ENGINEERING**

Master clock



Remote clock



Easiest-to-use, most advanced
fast clock on the market

LEARN MORE >

TamValleyDepot.com

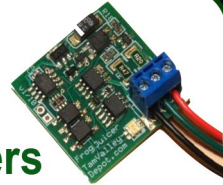

Frog Juicers

Automatic DCC polarity reversers for
frogs on turnouts and crossings.

Servo Switch Machines

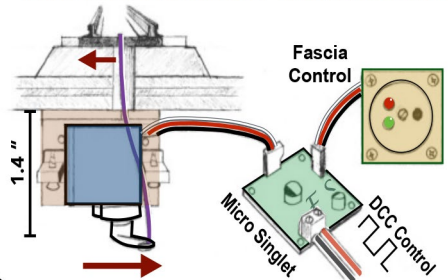

DCC IMPULSES | 18

Please share your experiences and ideas. Just click on the Reader Feedback icon at the beginning or the end of the column. While you are there, I encourage you to rate the column. "Awesome" is always appreciated. Thanks.

Until next month, I wish you green boards in all your endeavors. If you get stuck in the meantime, you may find your solution on the Dead Rail Society website (deadrailsociety.com).



Click here to rate or comment on this article

ADVERTISEMENT

www.SBS4DCC.com

TCS *WOW Sound*
ESU **OSI Solutions** **ZIMO**
SOUNDTRAXX
NCE *The Power of DCC* **DIGITRAX**
DCC Specialties **MRC** Model Rectifier Corporation
ACCUTRACK II SPEEDOMETER **SPROG DCC** the DCC Programmer and Control Family **Digital plus** by Lenz
TAM VALLEY DEPOT Great Electronics for Great Model Railroads **TEAM DIGITAL, LLC** Improving the world of DCC

N – HO – HO_{N3} Scale Trains

ADVERTISEMENT

LIGHTS 4 MODELS
10% Off HQ Sound Boards

GLITTER GULCH
CASINO
OPEN
OPEN

Coming in April
New signs from Miller Engineering

* orders with new signs get free shipping *

Shop Now



Southern Digital

**Digitrax Throttle Super Sale
while they last**



MSRP \$185.00
Your Price ~~\$148.00~~
Your New Price \$125.00



MSRP \$235.00
Your Price ~~\$188.00~~
Your New Price \$165.00



MSRP \$250.00
Your Price ~~\$199.95~~
Your New Price \$179.00



MSRP \$129.95
Your Price \$99.00



DCC Conversions, Service & Support

Orders Received by 3:00 pm EST ship the same day

WWW.SODIGI.COM

E-mail: sales@sodigi.com

(770) 929-1888

• INDEX



SUBSCRIBE
(free)

• TABLE OF CONTENTS



Introducing

Complete Train Control

The next Evolution in Complete Train Control®

- Premium Advanced 5/8 Amp Starter Sets.
- Starter sets are available as standard tethered or duplex radio.
- The system features a DCS210 Advanced Command Station, DT500 series throttle, and includes a power supply to make getting started easier than ever.
- The DT500 series throttles can be purchased separately from the new Starter Set.



Find out more @ www.digitrax.com

E
St
DT
PS

E
D
DT
PS

the **EVOLUTION**™



Evolution (shown) | **\$450 MSRP**

Standard Set Includes: DCS210 Advanced Command Station, T500 Advanced Super Throttle, UP5 Universal Panel, 6615 power supply, and a LT1 LocoNet Tester.

Evolution Duplex | **\$660 MSRP**

Duplex Set Includes: DCS210 Advanced Command Station, T500D Advanced Duplex Throttle, UR92 Universal Panel, 6615 power supply, and a LT1 LocoNet Tester.

WISH: Shadow expert home layout builders and learn their best tricks ...

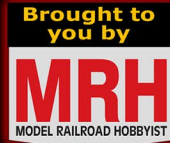

GRANTED! In the 2017 TMTV season, we do just that.



MODULE 1
2.5' X 7'

MODULE 2
4' X 7'

MODULE 3
2' X 7'

Free bonus months during our Spring Break sale!



TRAINMASTERS.TV

Don't miss out on the savings! CLICK NOW



• INDEX

• TABLE OF CONTENTS



WHAT'S NEAT WITH KEN PATTERSON

KEN PATTERSON

column

INSTALLING 'JUST PLUG' LIGHTS, LISTENING TO SOUNDTRAXX, AND REVIEWER JAMES WRIGHT ...

THIS MONTH, GEORGE BOGATIUK FROM SOUNDTRAXX stops by and gives us an overview of the new Tsunami 2 steam decoder. James Wright tells us about his success with his YouTube channel where he reviews various products in our hobby. We also look at the Woodland Scenics "Just Plug" lighting system and install the LED lights on my wharf scene.

Please remember to click the rating button and rate this column. It helps us see which topics you're most interested in us covering so I can go track down vendors or build more how-to segments to help you with your layout.

Also consider subscribing to the MRH YouTube channel so you won't miss any of our videos.

There's a lot to cover this month, so let's get into it!



[Click here to rate or
comment on this article](#)

▶ PHOTOS AND VIDEO OF SUPERB MODELS



WHAT'S NEAT | 2



1. (Above) I want to give a thank you to Jim Vail for giving us a mention in the *Narrow Gauge & Shortline Gazette*. He published an article on the lift-out section he built for his layout using magnets, as we did in the June 2016 *What's Neat* video. Thank you, Jim, and it's great to see how *What's Neat* is influencing what we see in the printed model press.

Woodland Scenics has created an LED lighting system for lighting our layouts called the "Just Plug" system. They manufacture are many types of lights, pole lights, cast ornamental lights, some with two heads. Modern street lights. Lamps for the sides of buildings, plus interior lights. I picked up eight or so different types of lights for this project, along with a wall plug power supply, a few light hubs, some expansion hubs and three power switches. The power supply produces 18.3 volts AC which feeds into the light hub and or the expansion hub to power the lights.

2. (Top right) The light hub has four output jacks to feed current to the lights. It is recommended that you wire three lights to each hub jack. That allows the light hub to power 12 street lights. There is a potentiometer for each of the four power

WHAT'S NEAT | 3

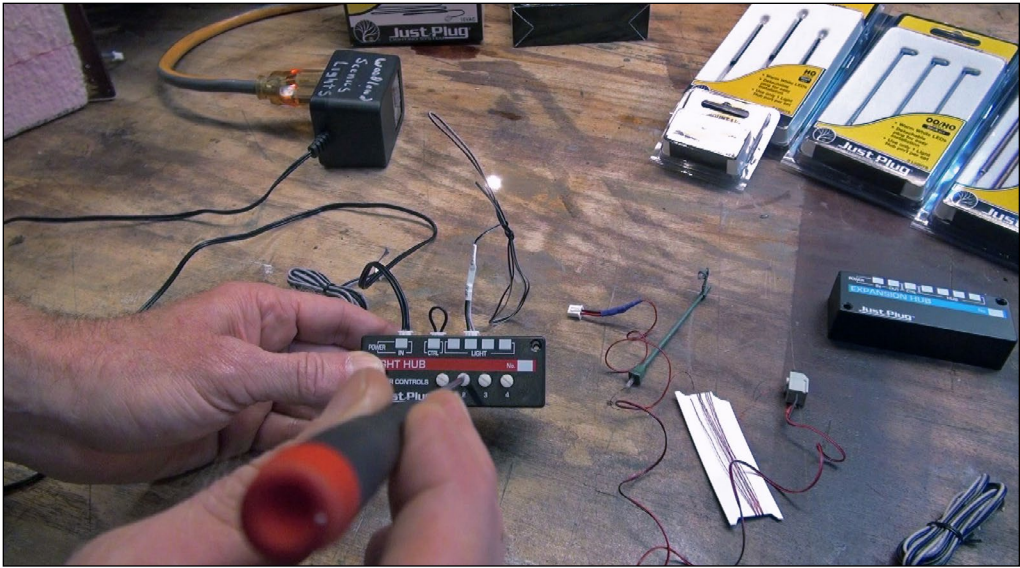

ports so the lights' brightness can be adjusted with a small screwdriver.

HAVING FUN WITH TRAINS

MRH
MODEL RAILROAD HOBBYIST

March 2017 -
What's neat ...

Playback problems? [Click here ...](#)

• INDEX



SUBSCRIBE
(free)

• TABLE OF CONTENTS

WHAT'S NEAT | 4

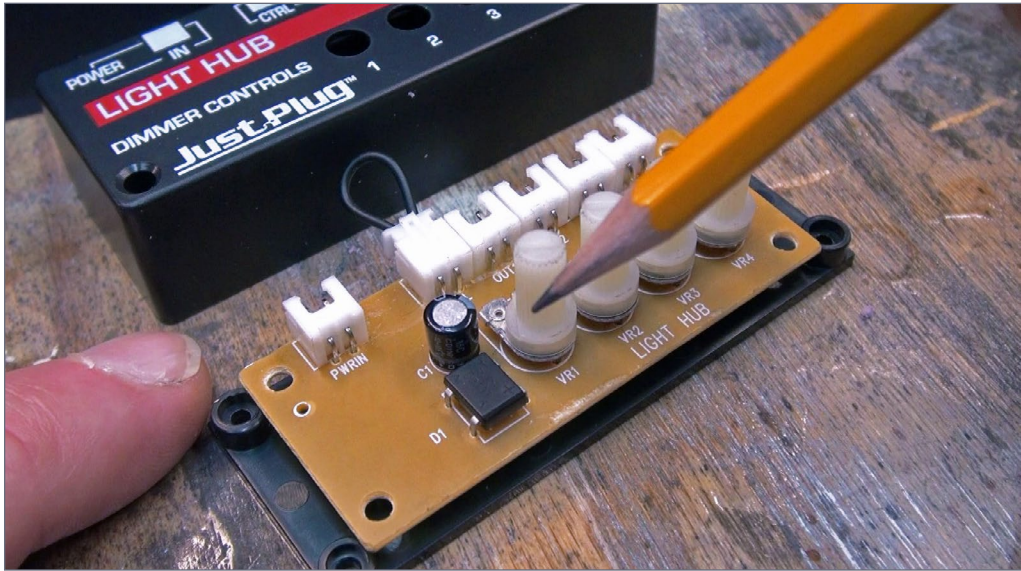

3. Looking inside the light hub I found a capacitor and a rectifier along with other well-thought out electronics which filter the current to the lights along with converting the AC power to a smooth DC current of 16.3 volts.

**Want to help keep
MRH free?**

Then *click* on ads!

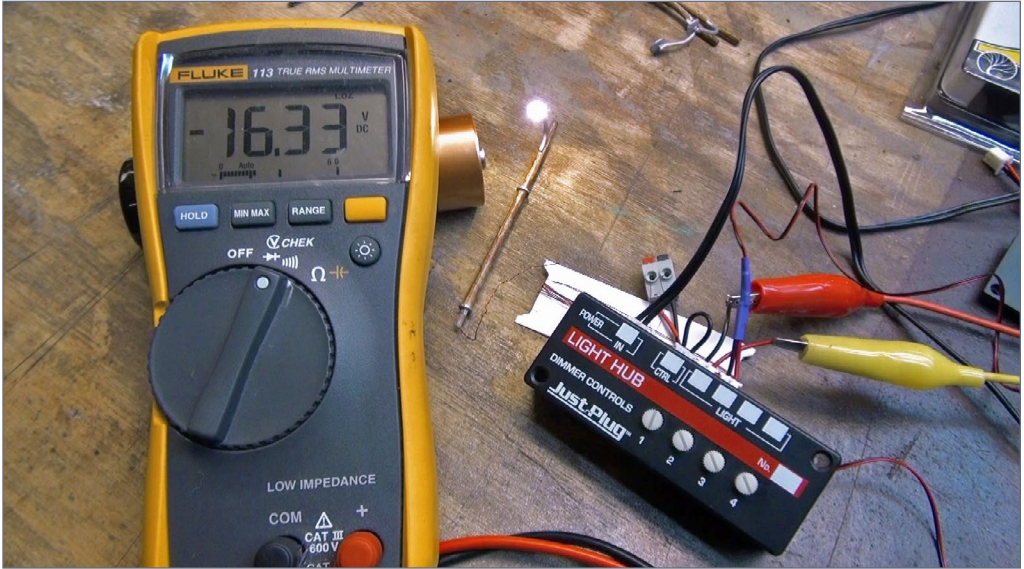

4. The exact output can be varied with the potentiometers. The lights come with a linker plug which allows you to connect the lights' wires to a push-button connector which holds the wires secure. The other end of the linker plug wires simply plug into the light hub with a white two-prong jack. This linker plug has a built-in resistor to drop the DC current from 16.3 volts to 3.1 volts which then powers the LED lights. It's all very well designed.



[Click here to rate or comment on this article](#)



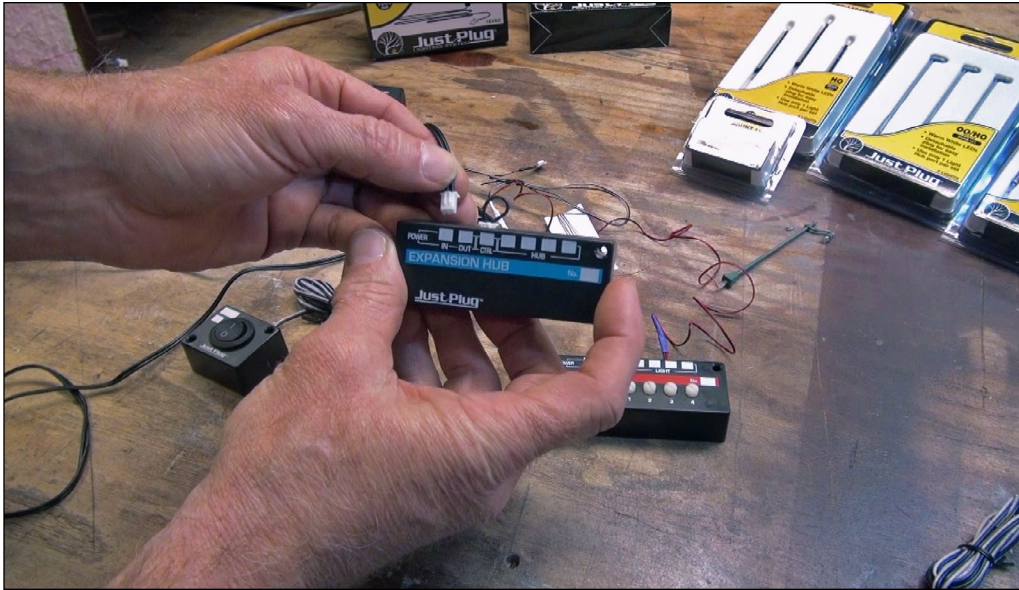

5. If I want to add more than 12 lights to my scene I use this expansion hub, which contains an electric circuit board that simply routes the AC current to 4 plug-in terminals. These four-hub jacks then can power four individual light hubs, bringing our possible light total to 48 LEDs. So, for every expansion hub you can power four lights. With two expansion hubs, you can light eight light hubs to light 96 bulbs in any given scene as long as you don't exceed the 1000 milliamps that the AC power supply puts out. It is easy to calculate this as every package of lights is clearly marked as to the milliamp consumption each set of lights. 30 milliamps, for example, is marked on the three-pack of cast iron single post lamps.

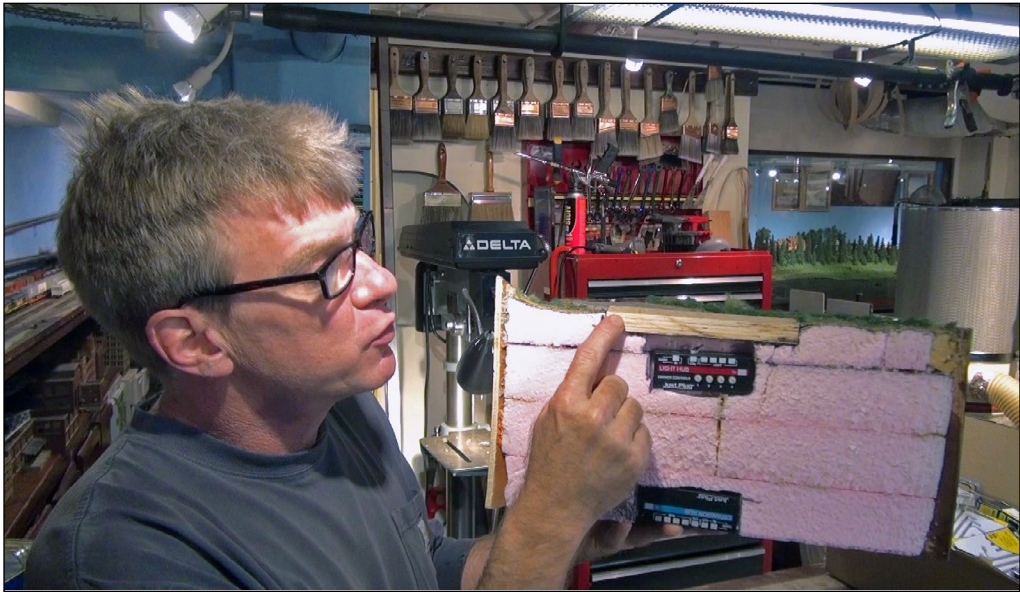

6. While trying to figure how I could incorporate this lighting system into my foam modular layout, I built this cross-section to illustrate how I planned to add this lighting system to my wharf scene. Installing the expansion hub in the bottom of the module would allow me to easily unplug the AC power from the system when moving the modules outside for photographs. I planned to feed the wires from the expansion hub up through the foam to the light hub which would be installed into the foam. It would sit just under the removable $\frac{3}{4}$ -inch plywood section acting as the foundation for the wharf buildings that we are going to light.



[Click here to rate or comment on this article](#)



WHAT'S NEAT | 8



7. I pulled the wharf module out of my layout to make it easier to access to the area from all three sides and the bottom to install the LED lighting system.

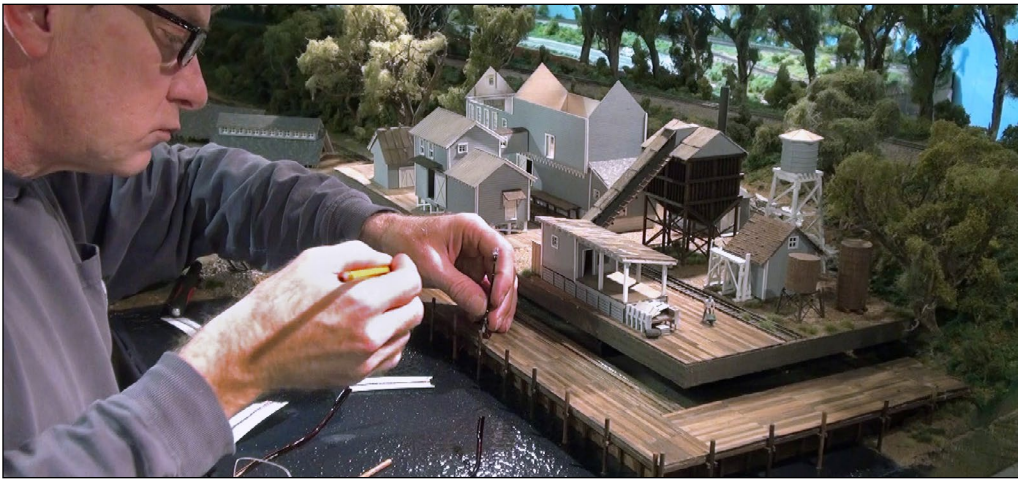

8. I started with the wood dock. This part of the water scene is not removable. I made marks with a pencil where the lights would be installed, working my way along the dock until I had seven light locations. Using a 3/16-inch bit, I drilled seven holes through the wood planks and the Plexiglas sub-base that make up the dock.

Have you seen this?

**CHECK IT
OUT!**



kenpatterson.com

click here to ...

Visit Ken's website

**Ken Patterson
reveals his modeling
secrets on video!**





9. Using a 10-inch-long 3/16 bit, I drilled horizontally through the foam under the dock, creating a channel to run wires. I pushed a 1/8-inch diameter brass tube through this hole as a temporary conduit to feed the wires through.

Please tell your buddies about MRH!

WE RELY ON WORD-OF-MOUTH TO GROW AND A BIGGER CIRCULATION MEANS MRH IS MORE LIKELY TO STICK AROUND FOR A LONG TIME TO COME!

WHAT'S NEAT | 10



10. The Woodland Scenics lights come with a generous length of wire attached, measuring over three feet long. I fed the lights' wires down through the wood dock and then through the brass tube where it will converge with the light hubs under all the buildings. Simply pull out the brass tube and the wires stay in the foam where we want them to be. I took my time on this, working my way along the dock installing and running the wires through the scene until I had seven lights installed along the dock.



[Click here to rate or comment on this article](#)



WHAT'S NEAT | 11



11. This is the auxiliary switch for the Just Plug lighting system. It connects to the hubs by removing the control port wire and plugging the switch's wire leads into the control port. This gives us an on and off control of the lights when everything is installed in the layout. The rocker switch matches the ones I already use to control my blocks on the layout, so I decided to disassemble this, removing the rocker switch from the housing and finding a place to mount this switch on the finished sides of the layout.



[Click here to rate or comment on this article](#)

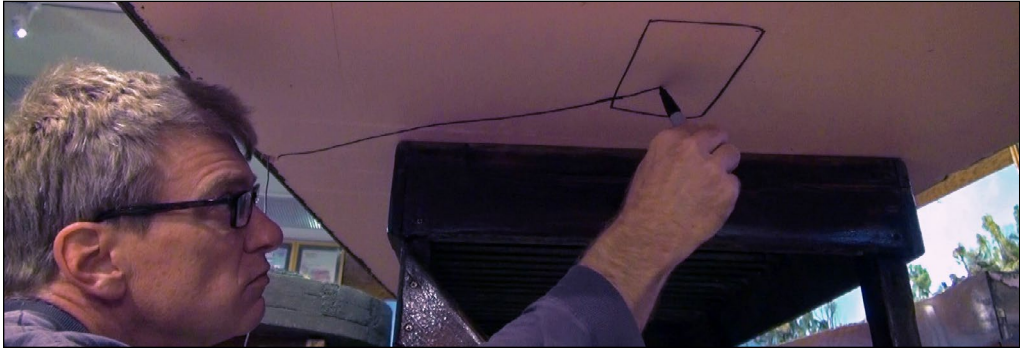

12. Underneath the layout, I used a Sharpie to draw a rectangle where the light hubs will be installed. I also drew a line from the auxiliary switch to the square where I will run the switch wires. Using a box knife, I cut a slot in the foam where the wire will run to the hubs. I used a screwdriver to press the wires into the slot, embedding them permanently in the foam.

ADVERTISEMENT

Want it on Blu-ray?

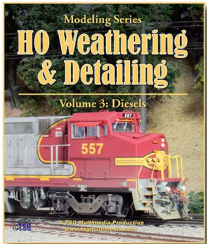

Selected titles are now available on Blu-ray disc in spectacular HD!

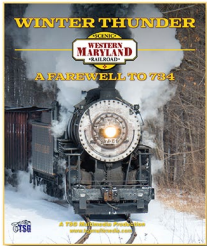
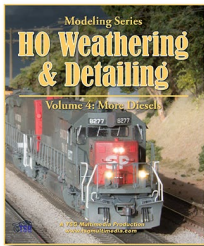

Please mention MRH when speaking with advertisers.

 TSG Multimedia

• INDEX



SUBSCRIBE
(free)

• TABLE OF CONTENTS



13. I used a hot foam cutter to cut a hole in the foam where the wires and light hubs will be installed. I also cut a hole in my plywood table top to match the area where the hole was cut in the foam.

***TrainMasters TV is part of
the MRH product family.***

TMTV members not only get great network TV level videos, they help pay for MRH and keep it free ...

WHAT'S NEAT | 14

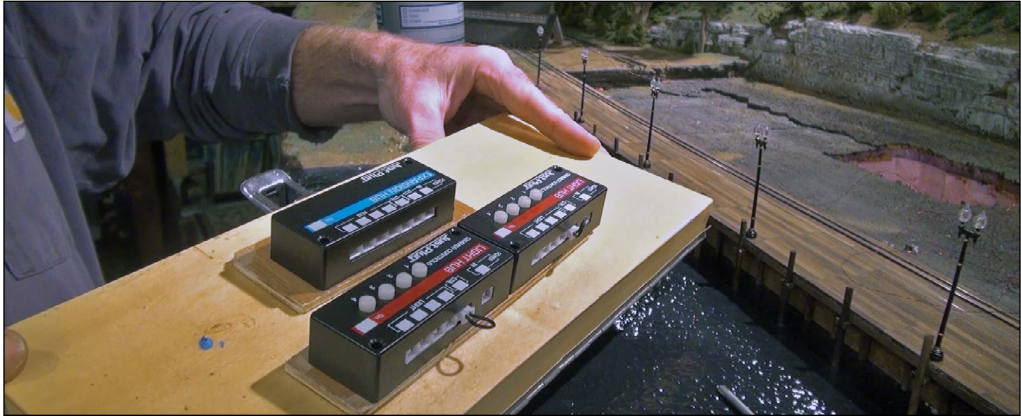

14. I used Gorilla Glue to attach two light hubs side by side in a piece of plywood. The expansion hub was also attached to its own piece of 1/4-inch oak plywood. I set this aside for 30 minutes until the glue cured.

ADVERTISEMENT

ADVERTISEMENT

MONSTER
modelworks
New HO & S Scale Kit Release
Placerville Store

www.monstermodelworks.com

Backdrop Junction
Your Stop for Railroad Backdrops

Click Here →

**For the Finest in Custom
Designed backdrop**

www.backdropjunction.com

• [INDEX](#)

 **SUBSCRIBE**
(free)

• [TABLE OF CONTENTS](#)

WHAT'S NEAT | 15



15. The two light hubs will be glued flush in the foam facing down so I will have access to the potentiometers with a long screwdriver when it comes time to adjust the lights' brightness.

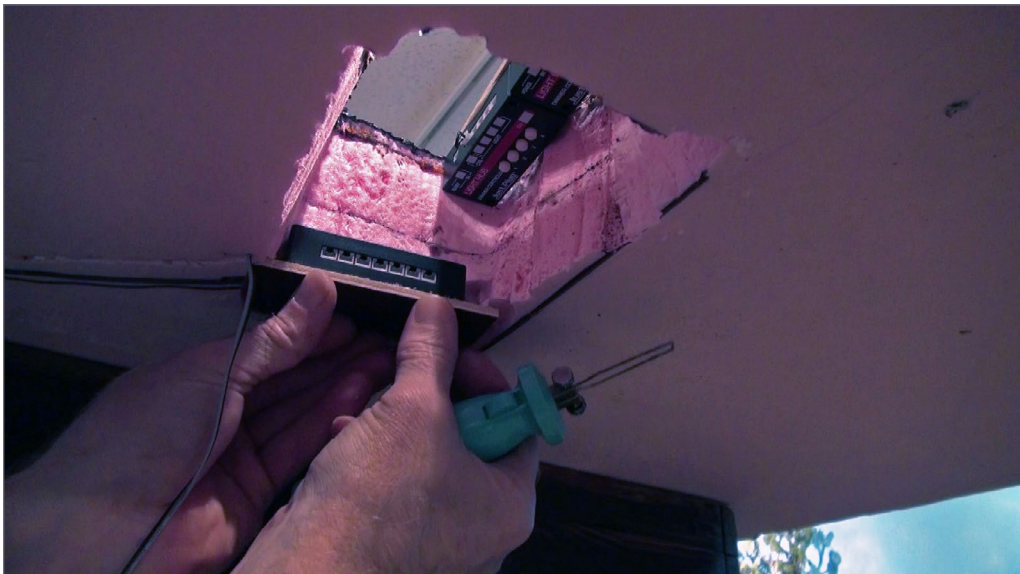

16. Using a hot foam cutter under the layout., I cut an additional space to install the expansion hub facing up, flush with the bottom of the layout.

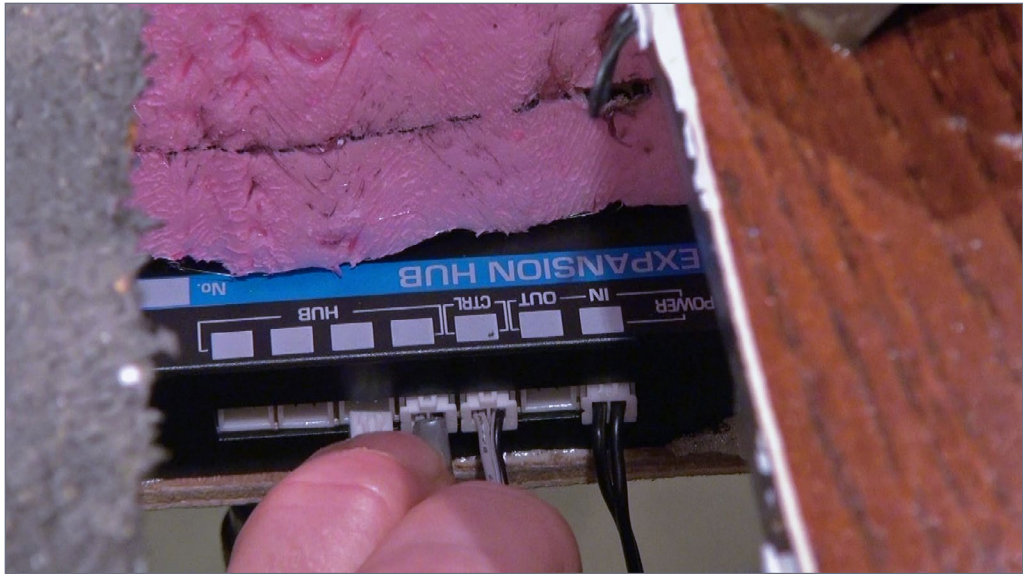

17. After the glue cured, I plugged the AC transformer in the expansion hub, along with the rocker switch connecting plug and two connecting cables that will run to each light hub.

**Did you know
there's an
MRH index
available?**

[CLICK TO FIND OUT MORE](#)



WHAT'S NEAT | 17

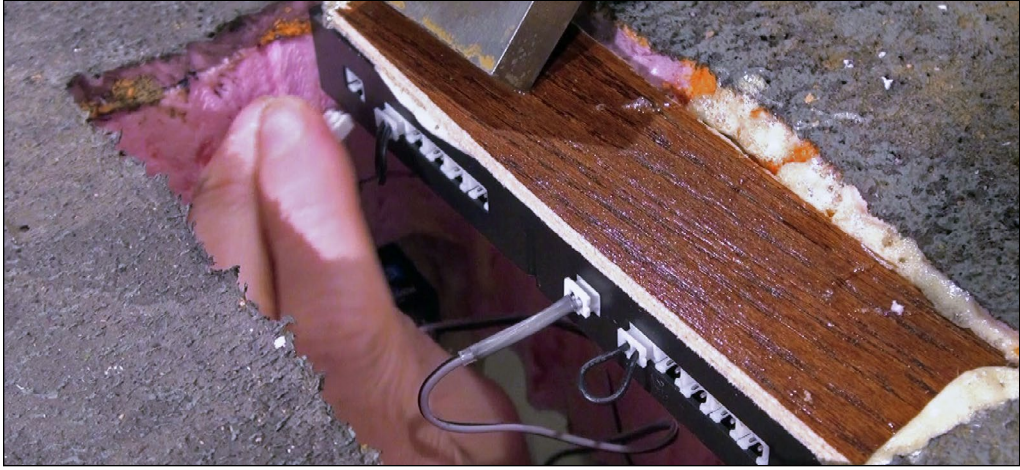

18. I plugged the other end of the connecting cables into each of the two light hubs. The hole in the foam provides plenty of room to squarely plug the jacks into the hubs along with great visibility to get the connectors in the correct hub plugs.



19. I twisted the fine wires, grouping three lights at a time and inserted these wires into the linker plugs supplied with the lights. Simply press down the buttons and insert the wires into the plug matching the color-coded polarity of red to red, and black to black.

WHAT'S NEAT | 18

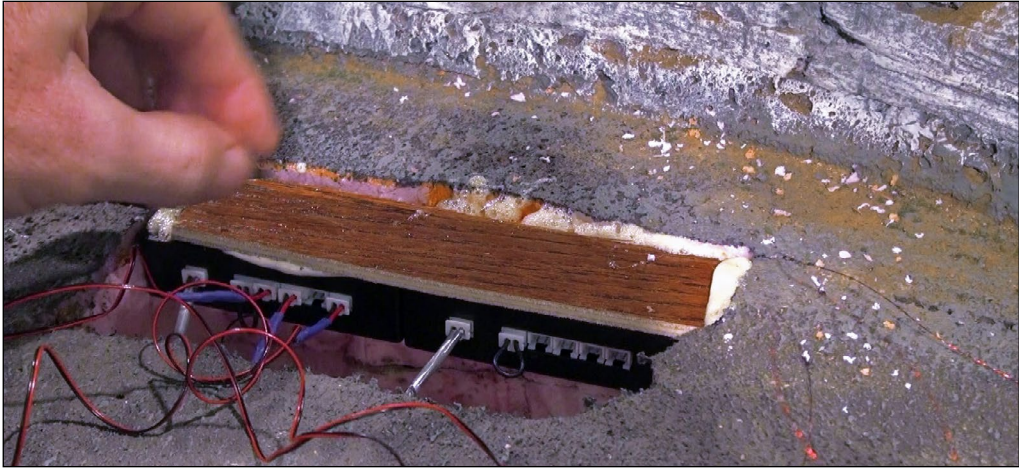

20. The linker plug wires get inserted into one of each of the four light hubs power output jacks. Pressing these in firmly ensuring a good connection to our diorama. And just like that, the wharf's dock lights are done.

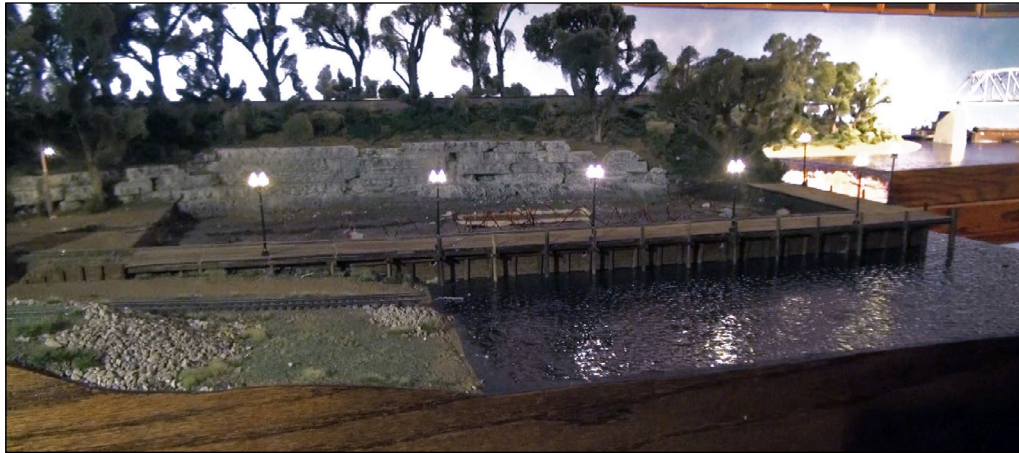

21. To test our progress to this point, I pressed the rocker switch and the lights turned on, giving a nice even glow on the scene. So far so good. Everything works. Now it is time to light the buildings and the areas on the lift-out plywood diorama.



WHAT'S NEAT | 19



22. I inserted the module back into the layout at this time as we now have good access to the light hubs from underneath and on top for the rest of the installation.



23. Turning my attention to the lift-out section of my wharf scene holding the entire B.T.S. Hyde Pulp Mill complex of buildings, I used a Sharpie to mark the placement of each light post. Because I am planning to convert this complex of models into restaurants, art galleries and gift shops, I planned to use a variety of different style lights on this scene and had this in mind when deciding the location of each light.

WHAT'S NEAT | 20



24. Using a 3/32-inch bit, I drilled eight holes through the 3/4-inch plywood base to accept the lamps. I also drilled 1/2-inch holes in the scene to feed the wires up to the buildings.



25. I fed the lights' wires through the small holes and pressed the lamps into place. The light posts are not brittle and in fact can be bent a little to keep them vertical and square to the scene.

WHAT'S NEAT | 21

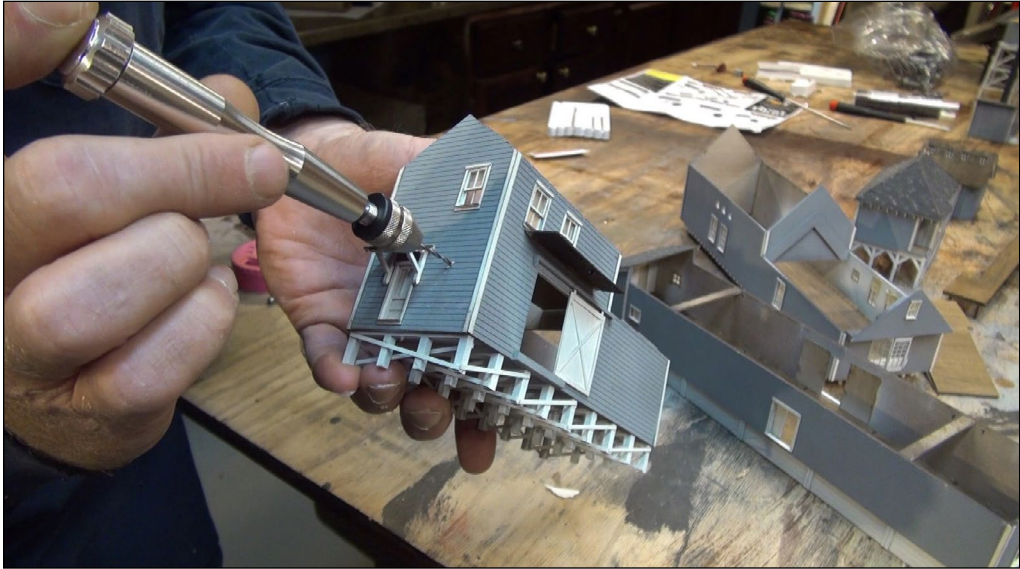

26. With a pin vise, I drilled 3/32-inch holes in two locations on the freight house walls.

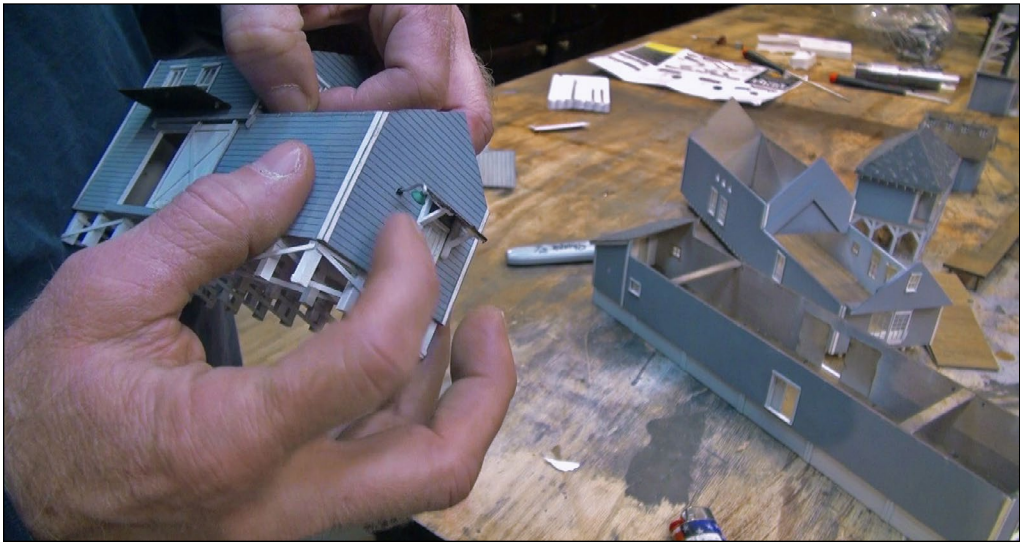

27. I then fed the wires through the holes in the walls and glued these goose neck lights into place with CA.

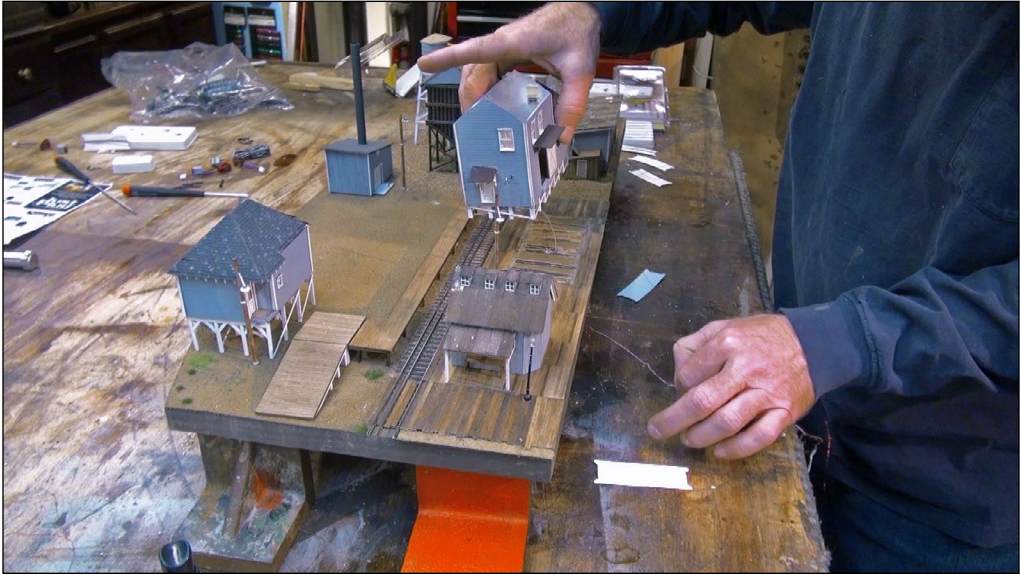

28. I placed one of the Woodland Scenics interior LED lights in the freight house, sticking it to a wall with two-sided tape in a way allowing light to be cast on both floors of this structure. I then pulled the wires from the building's bottom through the holes in the diorama. I kept them straight and separate to organize into groups for the next step in the process.



[Click here to rate or comment on this article](#)



WHAT'S NEAT | 23



29. I twisted the light wires into groups of three as before and inserted the wires into the linker plugs until all the lights were wired. Be careful to match the polarity by color, red to red and black to black. This created a total of five sets of wires with plastic jacks on the ends which will be plugged into the light hubs installed in the foam module.



[Click here to rate or comment on this article](#)



30. I placed the diorama about nine inches above the scene to give safe access. Then it was time to plug all the jacks into place and stuff the loose wires into the square hole in the foam.

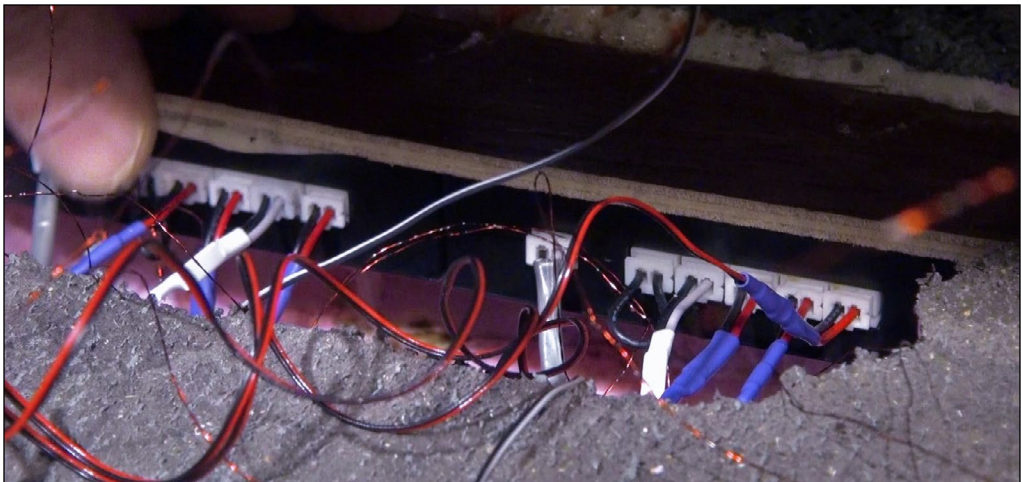

31. I plugged the five wired linker plug jacks into the open hubs on our light hubs one at a time, making sure they "clicked" when pressed in to ensure good conductivity of power for the diorama.



32. I then turned on the lights to make sure every one of them worked, and they did. The gooseneck lamps, the interior lights and all the iron lamp posts put out an even glow. At this point I felt a great sense of accomplishment as everything had gone smoothly so far on this project. I lowered the diorama back into the wharf scene making sure everything fit perfectly, and it did. A few days later I added an additional light hub under the scene to add lights along the road that parallels the yard's approach tracks.



33. With that done, the wharf has a whole new atmosphere created by these amazing LED lights from Woodland Scenics. I plan to install more of these lights on my layout over the next year as the finished effect is simply breathtaking. Someone at Woodland Scenics deserves a raise, as this lighting system is a real winner. Stunning magic in fact!



[Click here to rate or comment on this article](#)



James Wright interview



34. This month, James Wright from Omaha, NE came by to run some trains and shoot some video of my studio for his YouTube channel, jlwii2000. I know from talking with Bachmann Trains that James is respected in the industry for the product overviews that he performs real-time, starting with opening the box. His reviews are honest and thorough, pointing out details and special features about the model railroad products. The video editing is professional and his explanations are easy to understand. In this month's video, watch and listen as James describe his goal of providing educational overviews of products in our hobby through his 54-plus videos every year. Look on YouTube for jlwii2000.



[Click here to rate or comment on this article](#)

Make it run like a

Dream

ROLLING STOCK

PRE-ORDER

By Joe Fugate

First sneak peek now available!

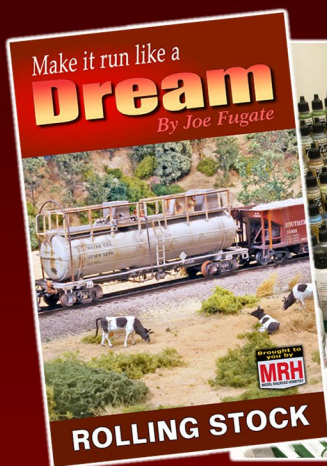

TOPICS INCLUDE: Setting standards • Building a test track • Wheelset/truck issues • Coupler issues • Carbody issues • Car weight considerations • Better maintenance procedures • Performance diagnosis & debugging • Special considerations

Click me to

PRE-ORDER eBOOK >>

~~\$12.99~~ \$11.49

Click me to

PRE-ORDER PAPERBACK >>

~~\$29.99~~ \$27.49 + S&H

Expected release: May 2017 - see the MRH Store: store.mrhmag.com

Other books in this series: *TRACKWORK* (available now) and *LOCOS* (Fall 2017)

• INDEX



SUBSCRIBE
(free)

• TABLE OF CONTENTS

WHAT'S NEAT | 28

SoundTraxx Tsunami 2 steam overview with George Bogatiuk



WHAT'S NEAT | 29



35-38. (Left top and bottom, and next page top and bottom) George Bogatiuk was in St. Louis recently to do a clinic at Mark Twain Hobby explaining the features of the new Tsunami 2 DCC sound decoder. In this month's video, George gives us the scoop on the Tsunami 2 steam decoder. It has amazing sound options available as long as you know how to set it up to enjoy all the features.

After writing articles for the model press for over 30 years, I can say the hardest thing to illustrate in text is sound features in decoders. With the advent of video editing programs available to anyone who wants to learn how to use them, I have taken advantage of this new medium to present DCC sound articles in video format. This makes it easy to hear and understand programming real time as you watch and learn. It is so much better than trying to describe sound effects in text and still photos.

George makes it look easy as he walks us through the various bell, whistle and chuff sounds the decoder has to offer: 63 whistles, 12 different bell types, and many various chuff sounds.

George then talks about setting up the Dynamic Digital Exhaust feature found in Tsunami 2 decoders. This is a well-developed system which senses weight and gear ratio of the locomotive at various speeds as the decoder forms an internal graph in its memory. With this data, the decoder then can create sounds that match the movement of the locomotive when pulling a load on flat track or up and down grades, changing the sounds of the prime mover to correspond to the locomotive's operating environment. It's really cool to hear and see.

This is set up by changing the value of CV 32 to 2, to allow you to program the page 2 level in the decoder. CV 2.503 is set to a value of 255 while the locomotive is moving forward at speed step 1. Then CV 2.504 is set to 255 while the locomotive is moving forward at speed step 30.



WHAT'S NEAT | 30



By following these steps, the decoder now understands the characteristics of the weight and strain on the motor without a load on level track. You can change the sensitivity to the changing load by setting CV 2.512 from 1 to 255. In the video, George sets this to 35. Then he sets CV 3 to 25 for startup momentum and CV 4 to 75 to slow the response when slowing to a stop.

Dynamic digital exhaust found in the Tsunami 2 creates the sounds and the locomotives move and respond as if you were working with a heavy load.

George also explains the various types of train brakes the decoder can replicate. The independent brake and the automatic brakes are available. Along with the sounds of charging the brakes in a train using the air pumps on the locomotive. It cycles though this process over a period of time. When the train is charged, release the brakes by pushing function 11 and away you go.

He also shows us the sound car with intelligent consist, where the sound car can detect your train's locomotive consist address and set its sound effects to correspond to your locomotive sets' movement when running in a consist. It is simply amazing to watch and hear in this month's video, as George makes us all experts in decoder programming.

Please comment on this article and give it a rating, using the 'Comment' tab below.



[Click here to rate or comment on this article](#)

WHAT'S NEAT | 31



• [INDEX](#)



[SUBSCRIBE](#)
(free)

• [TABLE OF CONTENTS](#)

WHAT'S NEW on TMTV!

Non-members: Watch episodes for \$1.49 ea, become a member for unlimited access



Start Small. THINK BIG.



AMHERST SHOW REPORT

What you missed at Amherst



THE BACKSHOP CLINIC

Modeling retaining walls



Weathering / detailing rolling stock



DCC DECODED

Installing a sound decoder

Free bonus months during our Spring Break sale!



TRAINMASTERS.TV

Don't miss out on the savings! **CLICK NOW**



• [INDEX](#)

• [TABLE OF CONTENTS](#)

IMAGINEERING

column

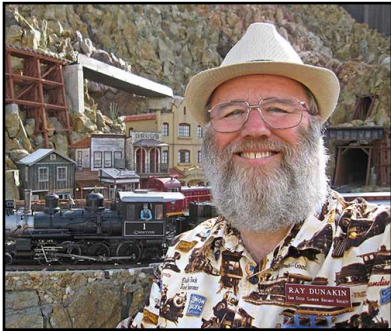

RAY DUNAKIN



[Click here to rate or comment on this article](#)

DEVELOPING MODELING SKILLS | ANYONE CAN LEARN TO CREATE CUSTOM MODELS

THE NEWEST ADDITION TO THE IN-KO-PAH Railroad is the Dos Manos depot. Because the depot will occupy a prime location for closeup viewing, I wanted something that would be attractive, interesting, and highly detailed. This free-lanced structure was inspired by the depot in the ghost town of Rhyolite, NV as well as by many other similar depots. It is built in a style known as “Mission Revival,” which borrows many features from the old Spanish missions, such as the distinctively shaped parapet, tile roofs, and arches. [1-2].

As with all the buildings on my layout, the depot was scratch-built. It was made from Sintra PVC board with styrene details. The exterior was textured to look like random blocks of light tan sandstone, with large rectangular blocks of banded sandstone along the base. I think it turned out very well. It looks great at night, too. [3]

▶ EXPLORING THE CREATIVE SIDES OF THE HOBBY



IMAGINEERING | 2



1. A narrow gauge RS-3 and a Model T railbus pose next to the Dos Manos depot. The depot and railbus were scratch-built, and the locomotive was heavily kitbashed.



2. Stone arches and a wooden phone booth grace the depot's waiting area.



3. Scale lighting brings the depot to life at night.

Now, you may be thinking, “What does this have to do with me? You’re modeling outdoors, in 1/24th scale. My layout is indoors and a much smaller scale.” Well, it’s true that some of the materials I use are different, and the larger scale allows a finer degree of detail. But this isn’t a step-by-step tutorial on building my depot. What I’m going to discuss is how one obtains the skills to create scratchbuilt or kitbashed models in any scale.

In the early days of the hobby almost everything had to be built from scratch. Thankfully that is no longer necessary, at least in the popular scales. There are a multitude of ready-to-run locomotives and rolling stock available. Many buildings and other structures can be purchased either in kit form or pre-assembled,

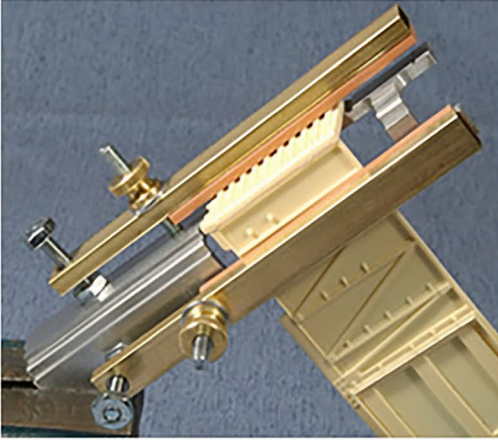

Combo Right Clamp™

Combo Right Clamp™
with cast resin boxcar

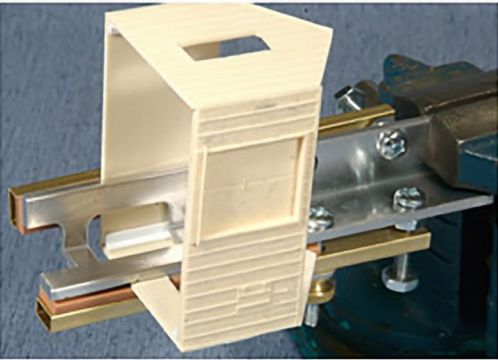

Combo Right Clamp™
with Wolf Design Pump House

**Click here for
all our products ...**

Tools for Modelers

Coffman Graphic Solutions Co.
1500 River Circle, Richmond,
KY 40475-7907

IMAGINEERING | 4

complete with weathering. The extensive supply of commercially-made locomotives, rolling stock, and structures has been a boon for the hobby, making it easier than ever to get your layout up and running.

In fact, you could probably to put together an entire layout without ever having to do one bit of traditional model-making. So why would anyone want to scratchbuild?

Well, there is a downside to using ready-to-run equipment and pre-assembled or kit structures: you are limited to only what's available. Despite the great variety of model railroad-ing products currently on the market, the manufacturers can't possibly offer models of every piece of equipment ever made, in every scale, all the time.

Even the equipment they do offer is rarely in continuous production, meaning there is only a finite period in which it is available. Out-of-production models can be rare, hard to find, and expensive.

When it comes to structures, the selection is even more limited. If your layout follows a specific prototype, you're unlikely to find kits or assembled models of all the structures along the right of way – and there may not be any that match. On a freelanced layout, you're not constrained by the need to match specific prototype structures. Yet if you use only commercially available structures, it becomes difficult to make your layout unique. How many times have you seen exactly the same structures on different layouts, varying only in their positions and placement?

So if you want a building or a piece of equipment that isn't available commercially, or you want to avoid having a layout that looks like everyone else's, then you'll have to do some scratchbuilding, or at the least, some kitbashing. (Kitbashing is the term for modifying kits, often extensively, and is a close cousin to scratchbuilding.) There is also great satisfaction in building something yourself, something that is uniquely yours.

Fortunately, kitbashing and scratchbuilding are not that difficult. A common misconception is that scratchbuilding requires innate artistic talent. Talent certainly helps. But what is needed most is skill, and skills are not inborn, they are learned. Anyone can develop the skills to create custom models.

How does one learn and develop scratchbuilding skills? Just like anything else – through observation, through trial and error, and most of all, through practice.

Observation

Wouldn't it be great if you could watch experienced modelers at work and learn all about their techniques and the materials they use? Well, you can! In addition to the great how-to articles in this and other magazines, you can also find a vast resource



of knowledge online. Many modelers post detailed step-by-step accounts of their builds on the various modeling forums. Most will be more than happy to answer questions, too.

Check out some of the work done in other scales besides your own, too. Many of the materials and methods will be the same. Even when they aren't, you can still be inspired and find ideas that can be adapted to your own modeling. I also recommend checking out some scratchbuilding projects on non-railroad forums too, particularly if you want to work in styrene. You can learn a lot of useful modeling techniques by seeing how someone scratchbuilt a vehicle or a piece of military equipment. It doesn't matter what the subject is, the methods can be used to build anything.

Don't be intimidated by the high level of work done by experienced modelers. They were beginners once, too.

Trial and error

Don't be afraid to make mistakes. Even the most expert modelers still make mistakes from time to time. Mistakes are part of the learning process, and almost any mistake can be repaired, corrected, or covered up. When I was constructing my depot, I accidentally scribed stones onto the wrong side of one wall. I had to redo the entire wall – but later I cut up parts of the botched wall to use elsewhere on the model.

Also, don't give up or get discouraged if your first scratchbuild isn't a museum-quality masterpiece. Nobody builds a flawless model the first time out.

In fact, I'd go so far as to say that perfection in modeling is unattainable. The better you get, the more critical you'll become. You'll see the tiny imperfections in your work that are invisible

to everyone else. So don't get hung up on not being able to build a "perfect" model. Let the imperfections push you forward to improve your skills with each new model, rather than letting it hold you back from ever developing the skills you need.

If you're not sure how well something is going to turn out, there's no need to risk ruining an entire model. Just try it on a test piece first. A test piece can be a scrap of wood, styrene, or other appropriate material. For instance, if you want to use styrene to create a weathered "wood" building, experiment with texturing and painting some styrene scraps first. When I first considered using Sintra PVC board, I made several small test pieces to see how easily it could be textured to look like brick or stone before committing to using it on a complete building. [4]

ADVERTISEMENT

ADVERTISEMENT



Archer
FINE TRANSFERS
PROUDLY SERVING MODEL BUILDERS SINCE 1989

THE ORIGINAL
SURFACE DETAILS™

WE NOW HAVE MORE THAN 130 SHEETS OF RIVETS, LOUVERS, TREADPLATE, WELD SEAMS AND MORE CAST ONTO MICROSCALE CLEAR DECAL FILM

LOW SHIPPING:
DOMESTIC USA ORDERS \$2.80
INTERNATIONAL ORDERS \$9.95

CLICK HERE TO VISIT OUR WEBSITE!

Archer Fine Transfers • PO Box 1277 • Youngsville, NC 27596 • USA
(919) 570-1026 • info@archertransfers.com • archertransfers.com

"Archer Fine Transfers 3D decals have revolutionized kitbashing and scratchbuilding. Putting rivets or other low-relief details like louvers or weld seams on your models is now as easy as applying decals."

Joe Fugate, Publisher/Editor
Model Railroad Hobbyist

MADE IN THE USA

TRINITY 3281 IN STORES NOW

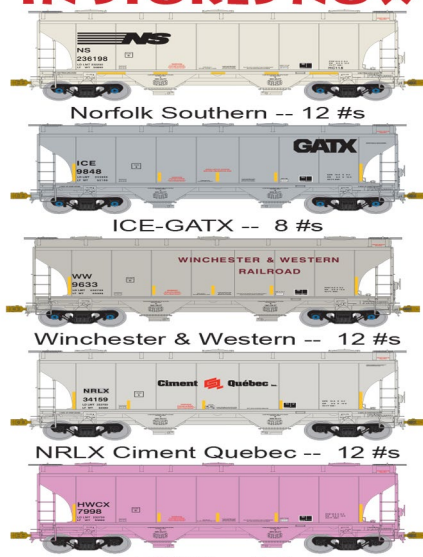

Norfolk Southern -- 12 #s

ICE-GATX -- 8 #s

Winchester & Western -- 12 #s

NRLX Ciment Quebec -- 12 #s

HWCX -- 7 #s

American Limited

www.americanlimitedmodels.com

IMAGINEERING | 8

Test pieces are especially helpful for learning how to paint and weather models. For more precise experimentation you can even practice on cheap “junk” models and second-hand rolling stock. Once you’re satisfied with the weathering on these, you can then work with confidence on your quality models.

Practice, practice, practice!

Practice is the most important element in developing modeling skills. The more you do, the better you will become. Start with simple projects to gain experience before tackling major projects. If you’re starting with zero experience, you may find it helpful to do some kit-building and kitbashing prior to attempting your first scratchbuilt project.

Starting with simple projects to gain experience is also helpful when switching to new materials or modeling methods.



4. I created this small section of stone wall when I was testing ways to texture and paint the walls of the depot.

When I started scratchbuilding, I was working in N scale. When I switched to HO, that wasn't a major transition for me because the materials and methods were still mostly the same. However, when I started modeling in 1/24th scale outdoors, almost everything was new to me. The materials I'd used indoors, such as balsa, basswood, cardstock, and foil, were useless for structures that would be exposed to the elements.

The Dos Manos depot was one of the first buildings I designed for the new layout. I had already built two small structures, and I had a pretty good idea of how I wanted to construct the depot. But I also knew it would be one of the most elaborate and challenging structures on the layout, so I decided to hold off



5. The depot was made from Sintra PVC board. Intricate stone detail was hand-scribed into the walls.

building it until I had a few smaller structures under my belt. I also used those smaller structures to try out various materials. Some were made with real stone and mortar, some were entirely styrene, and some were PVC with styrene details. [5]

The experience gained on those smaller buildings taught me a lot. By the time I was ready to take on the depot, I had already developed methods of simulating stone, brick, stucco, Spanish tile, and concrete. It also gave me time to see how various materials held up outdoors. And I'd experimented with different ways to access and detail the interiors of buildings.

In the end, the materials I used to create the depot were very different from what I had originally intended to use. And my skill at using these new materials was much more refined. This was especially important for a model that was meant to be a showpiece, located in a prime viewing position at the front of the layout.

[6] [7] When I was given a 1/29th scale standard-gauge RS-3, I wanted to convert it into a fictional narrow-gauge variant in 1/24th scale. The prospect of cutting up a brand new locomotive and attempting to rebuild it in a larger scale, with more details, was intimidating. There were also a lot of rounded shapes involved, which are trickier than flat walls and squared corners. But the experience I'd gained from working with styrene on structures gave me the confidence to try and the skills to succeed. This in turn helped when I decided to scratchbuild a Model T railbus. With each project I learned something new and gained skills to take on more advanced projects.



[Click here to rate or comment on this article](#)



6. To enlarge the RS-3 from 1/29th scale to 1/24th, I had to build a new cab. The rounded shapes of the window frames were a new challenge.



7. The RS-3 was extensively rebuilt, with a new cab, deck, pilots, handrails, and other details..

TOOLS FOR SCRATCHBUILDING

Scratchbuilding doesn't require a shop full of expensive tools and machinery. Specialized equipment such as a lathe or mill can speed up certain tasks and are helpful where great precision is desired, but usually such tools aren't essential. Some people have even built entire brass locomotives from scratch using only common hand tools. That's a bit extreme for most of us, but it shows what can be accomplished if you have the motivation.

Structures in particular can be easily scratchbuilt with a minimum of tools. The same is true of rolling stock, especially if you plan to purchase the trucks and/or wheelsets.

The most essential tool is a hobby knife, and plenty of #11 blades. For any kind of detailed work you'll need sharp, unbroken blades, so I buy them in packs of 100. Other necessary tools include a razor saw and hobbyist's miter box, a pin vise, a metal ruler,



8. A standard steel scribe has many modeling uses. Here I'm using it to scribe the mortar lines on a stone wall.

a steel scribe [8], and tweezers. Another type of scribing tool, called a panel scribe, is also very useful. The handiest power tool is a Dremel or similar power rotary tool, with a variety of bits and a large cutting disk.

One type of tool that is a little less common yet still inexpensive, is a set of steel machinist's blocks. The ones I use most are called "1-2-3 blocks," because they measure 1" x 2" x 3". You can find them online at Amazon and other sources. These blocks are indispensable for keeping corners square and holding parts in place for gluing.

[9] Occasionally I have made some simple custom tools for specialized tasks. For instance, I used a Dremel tool and cutting disk to cut a piece of razor saw about 1/4" wide by 1" long. This was mounted in the handle of a hobby knife, and used for scribing wood grain on styrene siding.

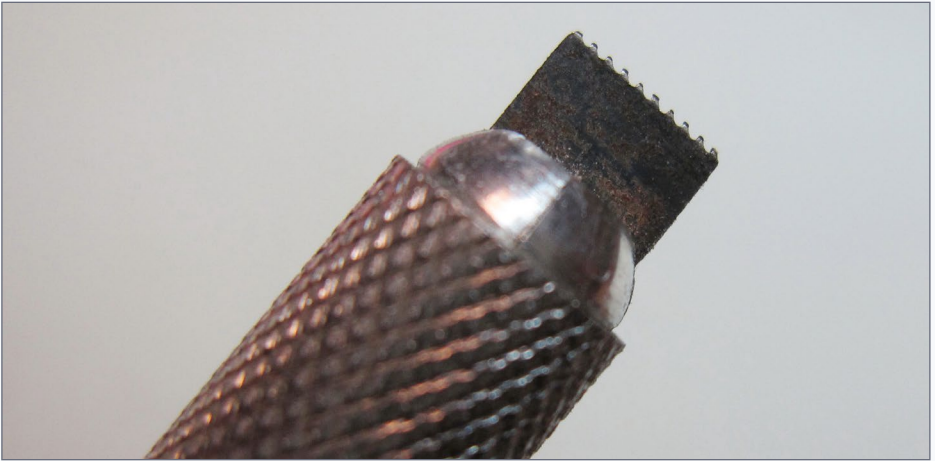

9. A 1/4" section of razor saw blade inserted in the handle of a hobby knife makes a great tool for creating wood grain in styrene siding.

Drawings and mockups

Before putting a knife to styrene or wood, you'll need to do some planning. How much planning, and in how much detail, will depend on your experience, your personal preferences, and the complexity of the project. Some people prefer to draft detailed technical drawings for every project, either by hand or with the use of CAD software. But in most cases, a crude drawing with basic dimensions will be sufficient – no artistic talent or technical software is necessary.

To start, you must first determine the dimensions of the structure you want to build. This includes the width, length, and height. Don't forget to allow for the thickness of the material. For instance, if the side of the building is to be 6" across, and the front and rear walls are each 1/8" thick, when you lay out the side wall you'll need to subtract 1/4". Once you have some experience you may be able to knock out simple buildings without a drawing, just by working out the dimensions on the raw material.

[10] [11] Often you'll find it helpful to create a mock-up prior to building the actual structure. Mock-ups are especially useful for complex structures, structures that must fit into a hillside, or any other situation that requires an irregular foundation or shape. The mock-up can be constructed from cardstock or foamcore art board. A mock-up can also help you get a feel for how well the building will fit in with its surroundings, and how much selective compression is needed.

The mock-up can be as simple as a building-shaped box. If you just want to get an idea of how it fits the scene, you may not even need to bother adding a roof. In other cases you may prefer to draw windows, doors, and other major details onto the walls. Some people even print their detailed drawings onto paper,



10. Before building the Hotel Torgo, I created a mock-up out of foamcore art board. Some of the windows were drawn on the computer, printed on

paper, and attached to the mock-up.



11. The mock-up helped me work out the size and shape of the hotel.

mount the paper on foamcore board, and then cut and assemble the mock-up. Such detailed mock-ups can even remain on the layout, standing in for the actual building until it is completed.

Tackling a big project

Taking on a large, complex structure can be daunting, even when you have experience with smaller structures. You may feel overwhelmed and not know how to begin. Take your time, think it through, and decide how to break it down into sections or stages. Often there is a logical sequence in which the model must be built.

[12] [13] When I built my Model T railbus, everything was dependent on the chassis. The motor and drive train had to fit into it, and the body had to fit onto it. So that is where I began. I worked out what wheels to use, how to attach them, and how to mount the motor. From there I could determine the size and shape of the body, and how to hide the battery and electronics.

Sometimes the location will affect the sequence of the build. For instance, my Cliffside Mine is located on a series of small ledges on a steep cliff. I had to build the shaft first, which determined the precise location for the head frame and ore bin. Those were built next, as a unit. Then I was able to figure out the placement for the hoist house. With these major components in place, I could then add the various stairs and walkways.

Modeling complex forms

Complex solid forms, such as an engine block, transmission, pump, or valve, may also appear tricky to model. But almost any complex form can be built up from basic shapes such as cubes, slabs, cones, rods, disks, and spheres. For example, even



12. The Model T railbus in progress. Building this vehicle helped me push the boundaries of my skills.



13. The finished railbus is now a distinctive feature of my railroad.

stripped of its external plumbing and other details, a steam pump would be pretty tough to carve out of a solid block of wood or styrene. But building up that same form a piece at a time is much easier.

[14] [15] This is how I created the control stand for the cab of my RS-3. The air brake and cut-off valves in particular look very complicated, but this hardware was built up from rounded blocks, disks, and other simple shapes. Another example is the early Fairbanks-Morse diesel engine I've been working on recently. [16] [17] [18] [19]



14. The complex shapes of the RS-3's controls were built up from bits of styrene blocks, sheets, rods, etc.



15. The cab interior features many scratchbuilt details.

Conclusion

Despite the proliferation of commercial products, scratchbuilding and kitbashing are still a vital and often necessary part of the hobby. More than that, there is great pride in creating something yourself, to fit your vision for your railroad. And it's not a "lost art" suitable for only a select few. Whether you've new to scratchbuilding, or have only limited experience, I hope this article will encourage you to develop your scratchbuilding skills as you build your railroad. ☑

More article photos on the next page ...



**Click here to rate or
comment on this article**



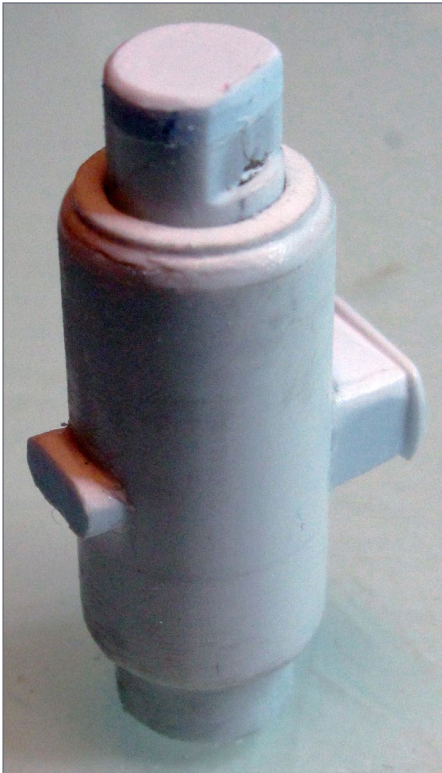
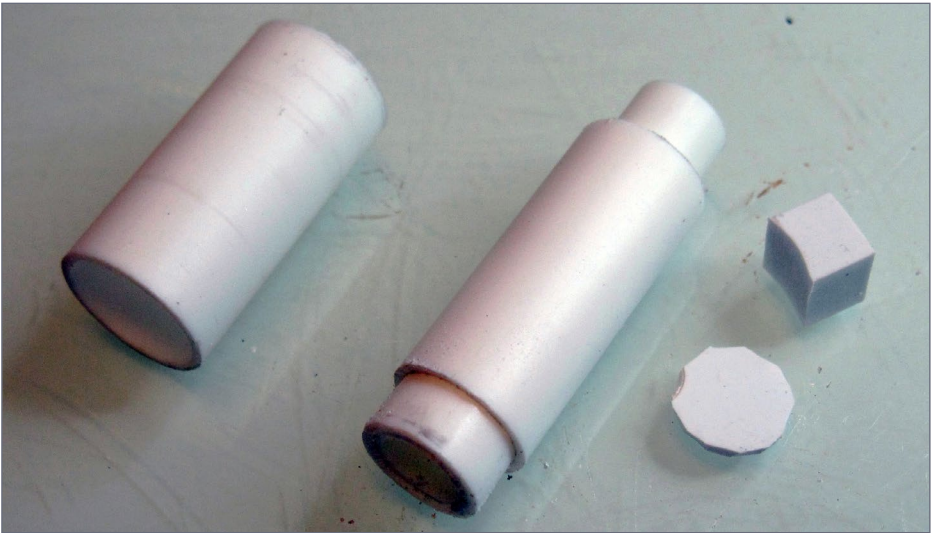

16-19. (Top and bottom left, and top and bottom right) Several telescoping sections of styrene tube, along with other basic shapes, were used to create the cylinder assembly for an early Fairbanks-Morse diesel engine. As construction progressed, additional parts were added, such as slices of hexagonal rod to represent bolt heads. In the final photo, the model has been sprayed with red primer. It will eventually be painted to look like a rusted relic.

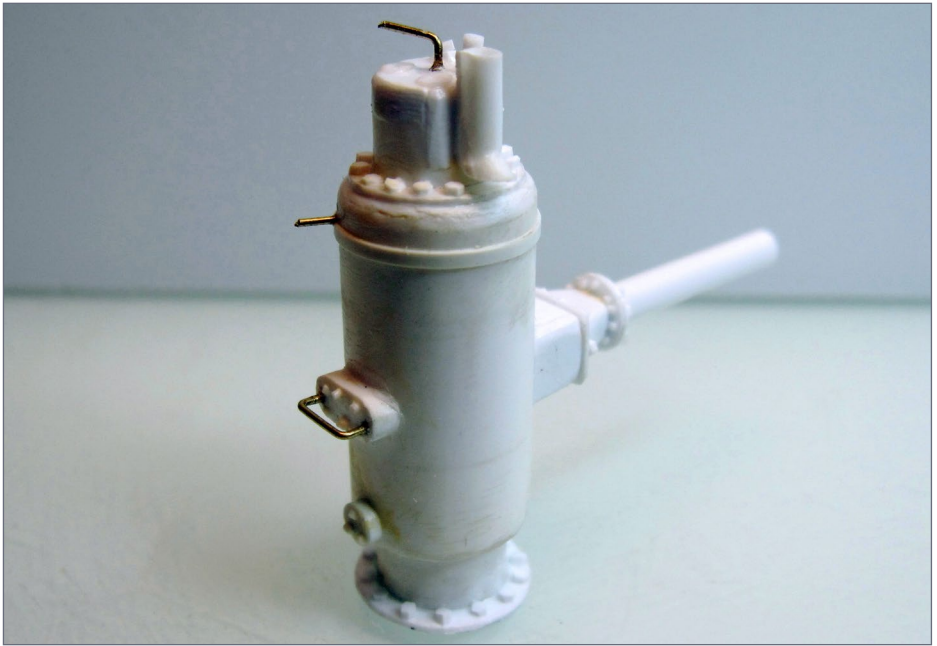



MRH MARKETPLACE

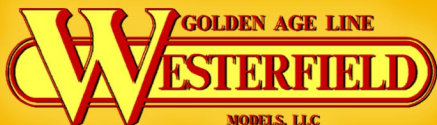

MODELS, LLC

**New Kits Available:
S-40-1 Pressed Steel U/F
Stock, LA&SL, OSL,UP**



westerfieldmodels.com

CROW RIVER PRODUCTS

KIT 225 SPARKPLUG LIGHTHOUSE

An "HO" Scale Pre-Fabricated Iron Lighthouse
This kit can be used to model numerous
three story Lighthouses of this design

The model
Is resin &
Pewter
castings
with laser
cut
Lantern.
Room
Parts



Footprint
7 1/2" base
Dia.
8" High
Price
\$150.00

Made in USA
For adult
Hobbyist

**HO & O Scale Machinery, Derricks,
Engines, Hardware & Waterfront Models**
Pawtucket, RI 02861 Tel 401-723-0065
www.crowriverproducts.com

We Accept Visa, Master Card, Discover or PayPal
For the Layout or the Display Shelf

Where the Rail Meets the Sea...



**CRAFTSMAN KITS & BUILT-UPS
HO - O - N Scale**



81' Buoy Tender Kit - H124-HO

www.seaportmodelworks.com

Click here for our website:

FEATURING America's Historic Main Street Architecture



O-Scale model shown (HO available)

**MAIN STREET
HERITAGE**

www.mainstreet-heritage.com

MRH MARKETPLACE | 2

NEW #8 HO/HON3 DUAL GAUGE LEFT TURNOUT TEMPLATE



Anyone can build track with Oak Hill.

Template Kit comes with everything cut, filed, gaped, and formed to make 5 turnouts, plus 1 free tube of Pliobond.

See Ken Patterson's What's Neat to see just how easy it can be!

Click to see video

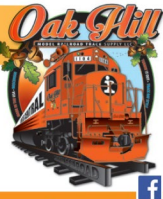

www.ohrtracksupply.com



TAM Industries

"Preserving the Romance"

The highest quality in Display Cases for sharing your excitement of Model Railroading. We manufacture Display Cases for all gauges of Model Railroading, from "G" to "N". Custom Sizes are available for some styles.



Visit us today at: www.TAM-IndustriesOnline.com



LOGIC RAILTM
TECHNOLOGIES

"Sophisticated
Model Railroad
Electronics"

Please visit our website and online store!

21175 Tomball Pkwy
Suite 287
Houston, TX 77070

Phone: (281)251-5813
<http://www.logicrailtech.com>
info@logicrailtech.com

P R E C I S I O N D E S I G N C O

Chains
Flat Car loads
Joint Bars
Signs & Posts

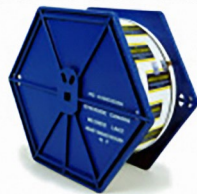

FREE SHIPPING



Affordable Modular (**domino**)
Benchwork in 200+ sizes

Custom built to order benchwork also available!

PRE-SIZE
MODEL SPECIALTIES

P.O. Box 6 Paonia, CO 81428

Ph. 970 527 4586

Made in The USA

Cast resin items for All Scales.

Tunnel portals, bridge piers, abutments,
culverts, and retaining walls.

Trackside details and sage brush tree
armatures.

"FREE SHIPPING see website for details"

Port Costa

R.H

2 stall RH

in HO scale all

laser cut wood

#2097 \$170

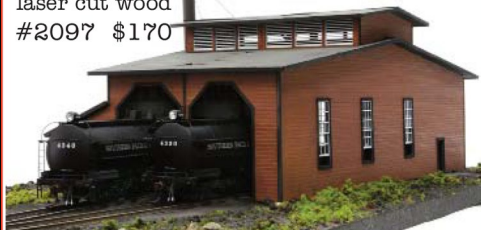

421 Hopkins Road, Dummerston, VT 05301

802-258-3869

See all of our fine products from HO to F/G scales at:

www.bantamodelworks.com

• INDEX



SUBSCRIBE
(free)

• TABLE OF CONTENTS

MRH MARKETPLACE | 3

CLEVER
models LLC
Cardstock models & materials

Try one today!

www.clevermodels.net

ATSF DL-48

Yarmouth Model Works

HO scale resin kits and detail parts

U.S.A. MAILING ADDRESS
3560 Pine Grove Ave. Unit 617
Port Huron, MI 48060

TEL. 519-633-7574
pierre.oliver@start.ca
www.yarmouthmodelworks.com

CANADIAN MAILING ADDRESS
85 Hiawatha St.
St. Thomas, ON N5P 2T5

GOODDEALSDCC
WWW.GOODDEALSDCC.COM

HOME OF THE
PROGRAMMER TEST TRACK SYSTEMS

DC & DCC COMPATIBLE
ALL SCALES AVAILABLE
CUSTOM ORDERS
DEALER INQUIRIES WELCOME

GARY COHN
106 CENTER STREET
FOX RIVER GROVE, IL 60021
GARY@GOODDEALSDCC.COM

Trees

coastmans.com HO

LOOK
at what's new at
Black Cat this month

Click here for
our website

**CNR Post '61
40' long Box cars**

10' & 10'6" IH

Black Cat Publishing
(204)489-5005
ajfergus@mymts.net
blackcatdecals.com

GREAT LOOKING
TREES
MAKE ALL THE
DIFFERENCE

**CANYON GREEN
SCENES**

MOORE RAILROAD

BenchWork
BenchWork.com

Affordable built to order Benchwork
starting at only \$20 a Sq Ft.

Imagine that!
Laser Art Products

ITLA Scale Models

Precision Laser
Cut Wood Products

Cooper's Alley
HO Scale Laser
Cut Wood Kit

CLICK HERE FOR MORE INFORMATION
www.itlascalemodels.com

HO DIESEL SUPPLY

KATO EMD SD SPECIALIST-REPAIRS-UPGRADES
New and Rebuilt Locomotives
Powered Chassis-Trucks-Motors
Bodies and Parts-Handrails-Electronics
www.hodieselsupply.com
email:kato@hodieselsupply.com

Model Railroad Control Systems

Geoff Bunza Project Boards
DCC Occupancy Detectors
CMRnet Compatible Nodes
Layout Telephone Systems [Click Here](#)
RFID Switchlist Generator
Switch Machines and Drivers

MOUNTAIN SUBDIVISION HOBBIES

www.modelrrsupply.com
FREE USA SHIPPING OVER \$29.00

NCE - SOUNDTRAXX - DIGITRAX - PECO - CIRCUITRON
DCC SPECIALTIES - INTERMOUNTAIN - CMX - ATLAS
BAR MILLS - BOWSER - KATO - MRC - TOMAR - RIX -
PIKESTUFF - LOGICRAIL - CENTRAL VALLEY AND MORE!

RULERS-of-the-WORLD

Scale Rulers \$4 each
Over 200+ scales!
Metric or Imperial
www.rulers-of-the-world.com

Great Decals!™

FEC, Interstate, Virginian
Railway, & L&N Titles
After Hours Graphics Line
Coupler Gages and More
In O, S, HO, and N Scales

DID YOU KNOW
MRH SUBSCRIBERS
GET FREE BONUSES?

CLICK TO SUBSCRIBE
NOW - IT'S FREE!



Re-rework a

PLASTIC STEAM



• INDEX

• TABLE OF CONTENTS

LOCOMOTIVE



The Washington, Idaho & Montana Ry. details an older plastic steam locomotive to help run its regional 1950s railroad ...

• [INDEX](#)



SUBSCRIBE
(free)

• [TABLE OF CONTENTS](#)

BY **THOMAS HILLEBRANT**
ALL PHOTOS BY THE AUTHOR



[Click here to rate or comment on this article](#)

THIS IS A STORY OF COMPROMISE, HOW ONE compromise may lead to more compromises, and how that's not always a bad thing.

My layout is based on the Washington, Idaho & Montana Ry. during its early diesel era, but I've always intended to operate one or two WI&M steam locomotives. This fits my prototype, since between 1950 and 1956, the WI&M operated with one diesel, Alco S-3 number 30, and two Alco-built steamers, 4-6-0 Number 1 and 2-8-0 Number 21. Then, in 1956, a secondhand Alco diesel joined the roster to replace the 21. Number 1 remained on the property in standby service until its 1961 donation to the city of Potlatch, ID for display in a park.

Modeling either of these steam locomotives would require some compromise, since no manufacturer produces exact copies of WI&M steamers, and I did not feel ready to start building one from scratch. Before I started planning my current layout, I had acquired two models that would make reasonable stand-ins for WI&M engines 1 and 21— a Model Die Casting 4-6-0 Ten-Wheeler kit and a ready-to-run Bachman Spectrum 2-8-0 Consolidation, respectively. This was compromise #1.

Compromise #2 cropped up during my layout's planning phase. To permit a longer siding at one location, I designed in a Peco "Setrack" curved switch, which has a 17" radius inside leg. I knew this would be tight, so I tested several models on mocked up 17" curves and didn't experience any trouble.

RE-REWORK A STEAM LOCO | 4



1. After reworking this plastic steam loco once, this is how it looked. As I describe in the article, I ended up reworking the loco a second time to add more detailing for my chosen prototype.

As you can guess, I gave no thought to my two steamers until after I laid, painted and ballasted the track in this spot. Sure enough, when I placed the 2-8-0 on the track and let it roll through the switch in question, it went “on the ground” immediately due to its eight flanged driving wheels.

After a couple more tries I gave up and unpacked the 4-6-0. The kit wasn't complete, but I had already assembled the running gear, so I placed it on the track and pushed it gently through. Still no go! The six drivers seemed to roll through with little trouble, but the tight radius pushed the four-wheel lead truck so far to the side that it hit the cylinder casting, causing a derailment.

Now I faced a dilemma. I could rip up and rebuild an entire section of layout or I could re-think my choice of steam locomotives.

RE-REWORK A STEAM LOCO | 5

I was in no mood for a major track project, so I began looking at other options. Since the two-wheel lead truck on the Consolidation successfully navigated the turnout, as did the six drivers on the Ten-Wheeler, what about trying a 2-6-0 Mogul? Compromise #3.

The plastic 2-6-0 imported by International Hobby Corp. back in the '90s received decent reviews. Plus, it was based on a series of Southern Pacific Alco Moguls built about the same time as the WI&M steamers. Once I removed the characteristic SP number boards and added a different headlight to the smokebox front, it would look like something the WI&M might have owned. Plus, I just happened to find an inexpensive used one at a nearby hobby shop!

The re-work

I placed my new acquisition on the rails and ran it carefully through the turnout several times. Success! . . . well, sort of. To make it work consistently, I modified the the lead truck's pressure spring to maximize its side play and I corrected the gauge of the drive wheels.

Now that I had a viable starting point for adding steam to my layout, I would need to make it run more reliably. The motor and drive train worked well enough despite not having a flywheel, but the electrical pickup was erratic. I had a good idea how to improve this, but I began working on the locomotive's outer appearance first. If I found out along the way I would not be satisfied with how it looked, then I wouldn't waste effort making it run better.

The IHC tender did not resemble WI&M tenders at all, but I had an old Model Die Casting "Santa Fe-type" oil tender that did, once I shortened it several scale feet [2]. The shell was simple enough – I made one cut a fraction of an inch ahead of the rear of the tank and another vertical cut approximately eight scale feet ahead of the first

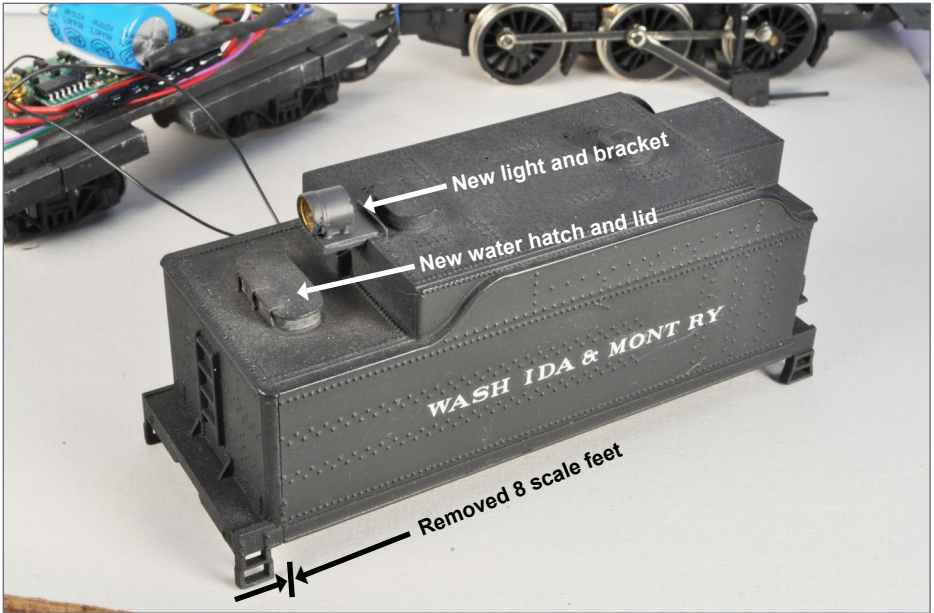

2. I shortened the IHC tender and added some new details.

cut. By sanding the back of the rear panel flush and squaring up the second cut, I could simply glue the rear panel onto the rest of the tender shell. This also left the cast rivet lines at the rear of the tender intact, which helps hide, or at least distract from, the slight seam at the glued joint.

I removed the oval water fill hatch from a tender body in my scrap box and cemented it to the rear deck with a lid and hinge details cut from 0.010" styrene. I added a rear headlamp from Cal-Scale (190-207), on a bracket cobbled up from a Kadee coupler box lid, and affixed it to the rear of the tender's oil bunker.

For the frame of the tender, I made six hacksaw cuts [3], to keep the truck bolsters evenly spaced from the ends of the tender. I did not take measurements to determine an exact location for the tender truck bolsters, since the tender length was only an

RE-REWORK A STEAM LOCO | 7

approximation. I just tried to get the trucks centered and close enough to each end to appear balanced. I then epoxied the four remaining frame pieces to a 0.080" piece of polystyrene, using the tender body to hold them in line until the epoxy cured.

I applied the same “close-enough” approach to the other cosmetic modifications I made. For instance, the cab sides; the configuration of tanks, air pumps and walkways along the boiler sides; and the incorrect style of cylinders (piston vs. slide) were all left “as is” for the sake of simplicity.

On the smoke box, I removed the centered headlight, and plugged the hole with styrene tube [4]. I didn’t need to do too neat a job of patching here, because a circular number plate (Cal-Scale 190-245) would cover most of the hole. I then attached a

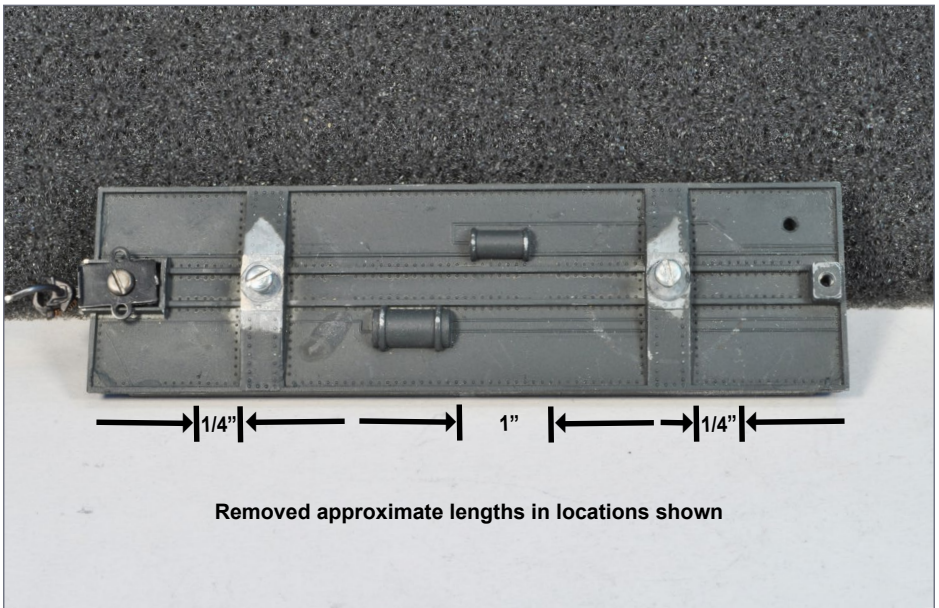

3. It took several cuts on the diecast tender floor to keep the bolsters placed appropriately on the shortened tender.

RE-REWORK A STEAM LOCO | 8

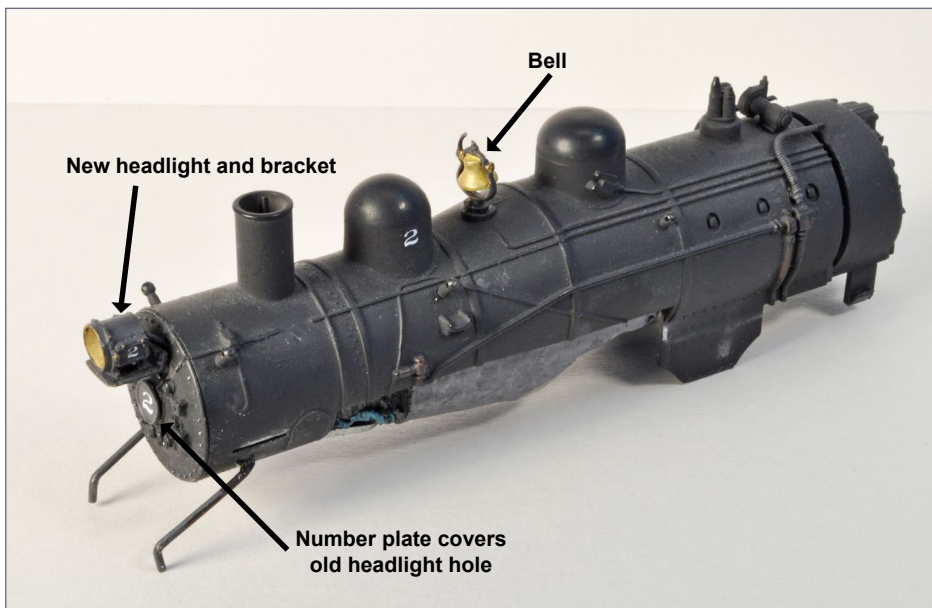

4. I upgraded a few details on the boiler, which included moving the headlight up higher on the front.

new headlight and bracket (Cal-Scale 190-202 and 190-246) and drilled a hole for the headlight wires to pass through. I left the smoke box front removable to access a micro connector to the headlight wires. And, I glued some lead fishing weights inside the smoke box for extra weight

To the lower boiler half [5] I attached two pieces of brass ladder stock to form steps from the walkways down to the pilot deck. And in the pilot [6], I installed a Kadee #22 overset-shank coupler. There was no easy way to fit in the whole Kadee draft gear box, so I simply glued the coupler in a fixed and centered position.

On the cab roof [7], I eyeballed the location of the vent and drilled a hole in that spot. With a hobby knife, I squared the corners for a tight fit on a short length of $\frac{1}{4}$ " square styrene tube.

RE-REWORK A STEAM LOCO | 9

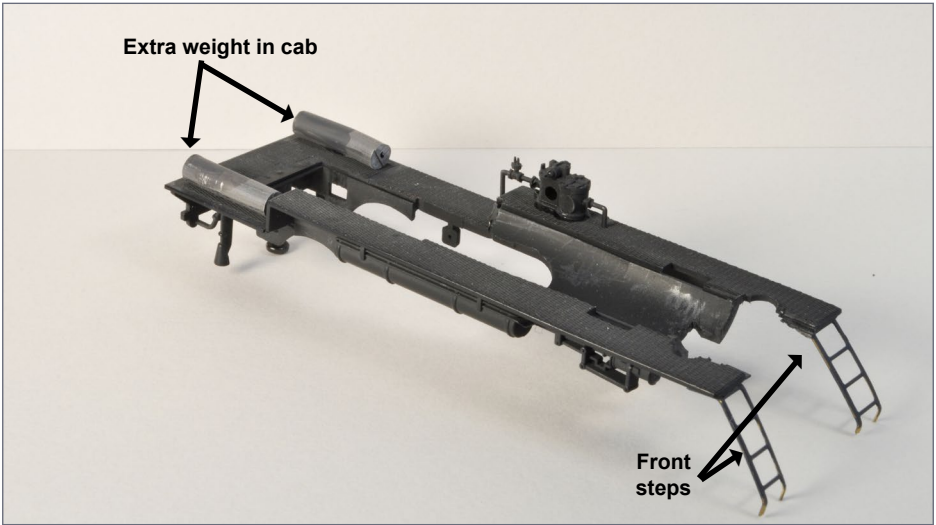

5. On the lower boiler/running boards, I added weights in the cab and some steps/ladders up front.

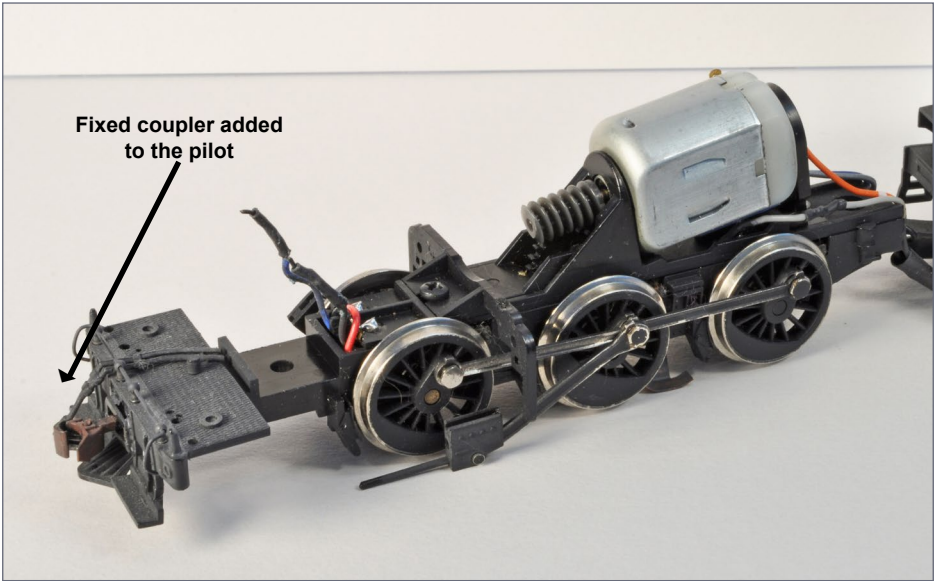

6. I installed a Kadee coupler on the front pilot.

RE-REWORK A STEAM LOCO | 10

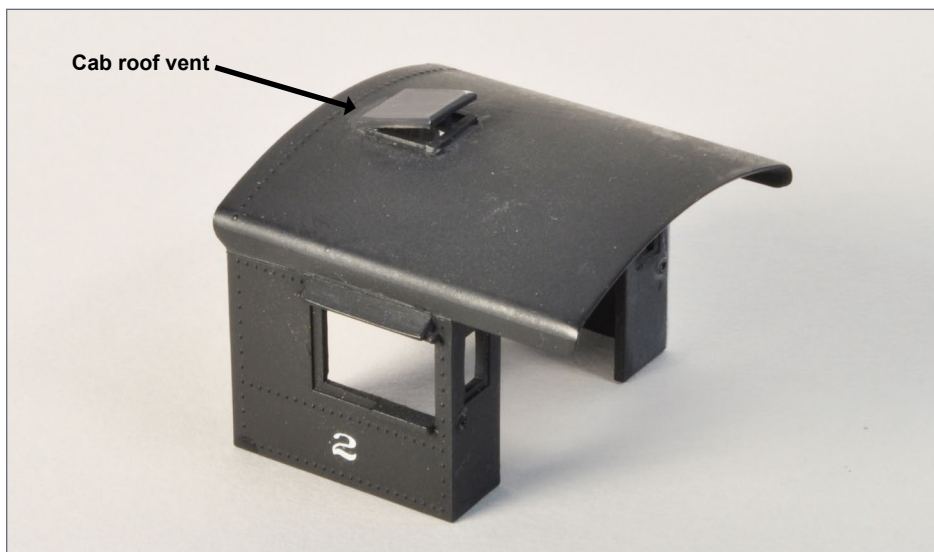

7. I added a vent to the cab roof.

With the top of the tube cemented flush with the center of the roof, I then added a 0.010" styrene square for the vent cap and a prop made from strip styrene.

Finally, I formed the deck plate between the cab and the tender from another piece of 0.010" styrene cut to the width of the rear cab opening and long enough to span the gap. I used CA to glue a piece of thin piano wire along one edge, slightly longer than the width of the plate on both ends to help keep that edge captured inside the cab. The opposite edge I trimmed to a semi-circular shape to allow the tender and engine to pivot around curves without the deck plate hanging up.

The trickiest part of this project was adding new electrical pickups and routing the various wires. On the locomotive itself [8], I relied on the existing wheel wiper contacts, and attached

RE-REWORK A STEAM LOCO | 11

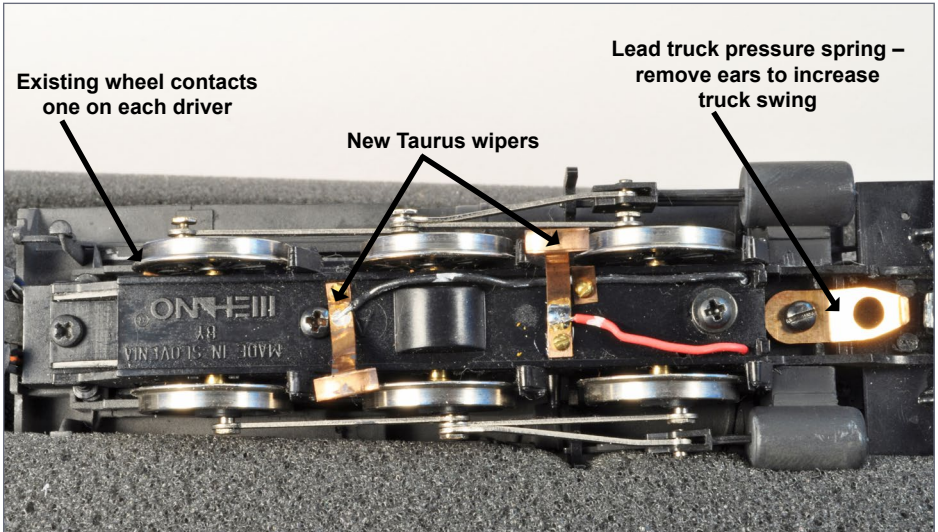

8. I also improved electrical pickup and lead truck swing.

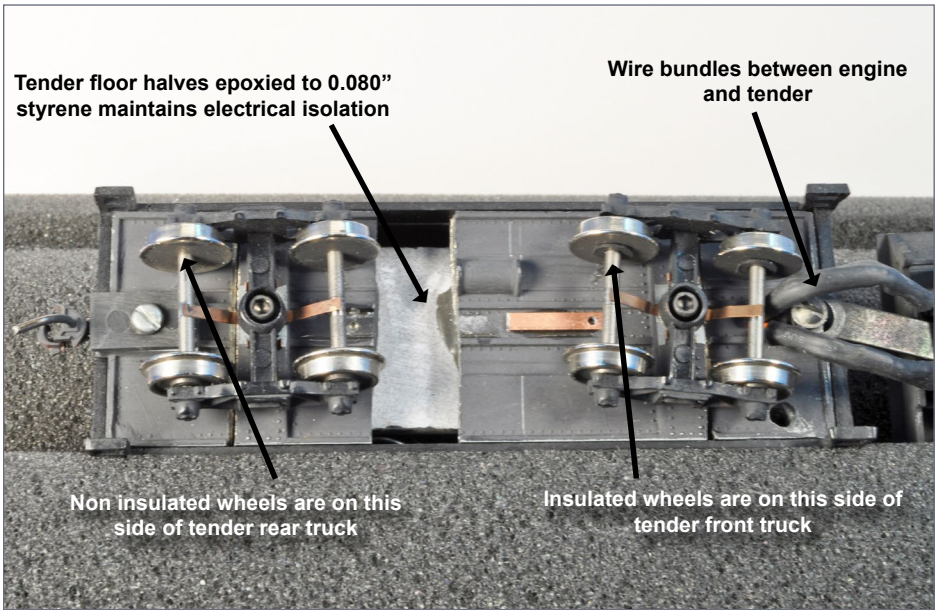

9. Modified underside of tender.

RE-REWORK A STEAM LOCO | 12

two Taurus Products pickup shoes (part number 100) to the axle retainer plate using the provided 0-80 screws and fine flexible wire. I found room to route all these and the headlight wires back through the frame to the rear.

To pass these wires back to the tender [9], I drilled a ¼” hole in the tender floor behind the drawbar mount. I bundled the wires into two groups, one on each side of the drawbar, and slid lengths of shrink tubing over each. Passing the wire ends up through the hole in the tender floor and holding them in place, I carefully heated each shrink tube into a curved shape. These wire bundles now suggest the presence of water and oil hoses between the engine and tender.

ADVERTISEMENT

Checked us out lately?

- ✓ HO/N and now O scale products too!
- ✓ Laser-cut Structures & Bridges.
- ✓ Advertising & Storefront Signs.
- ✓ Highway Signs, vintage & modern.
- ✓ New Detail Items.
- ✓ Laser-cut Grade Crossings.
- ✓ Billboards, roadside & rooftop.
- ✓ Laser-cut Graffiti Decals
- ✓ 1000's of satisfied customers.

WHAT'S
NEW?



Established 1993...

Blair Line

ADVERTISEMENT

Select MODEL RAILROADS

**Design & Build Services
For Discriminating Modelers**



WE WILL:

**Complete Unfinished Railroads
Fix or Rebuild Bad Railroads**

OR

**Design & Build A Custom
Railroad Of Your Dreams**

CLICK HERE FOR OUR WEBSITE
www.SelectModelRailroads.com

(844) 872-4670

• INDEX



SUBSCRIBE
(free)

• TABLE OF CONTENTS

RE-REWORK A STEAM LOCO | 13

For simplicity, I chose not to use any sort of electrical plug connections here. This left the engine and tender permanently connected, and any further repairs or modifications would be made with both at the same time.

I used the trucks and wipers that came with the MDC tender kit to collect power from both rails. Because the two ends of the metal tender floor did not touch, I could orient one of the trucks 180 degrees to the other, so that each had electrical contact with a different rail when placed on the track. By mounting each truck to its bolster with a long 2-56 brass screw, the extended screws then became terminal points for all the left- and right-rail wires.

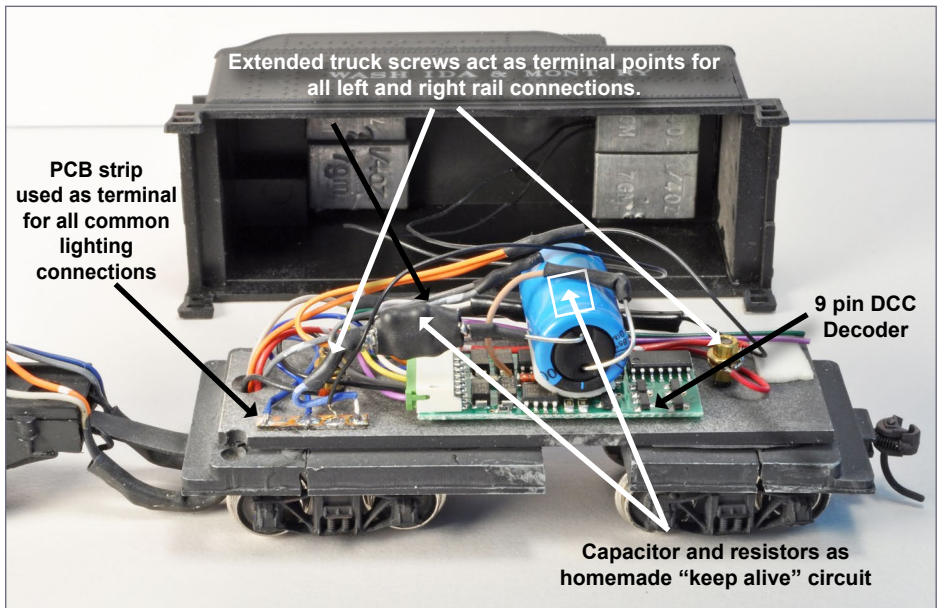

10. Changes I made to the inside of the tender. Note: A sound decoder, speaker and commercial "keep alive" module are planned for a future upgrade to this engine's tender.

RE-REWORK A STEAM LOCO | 14

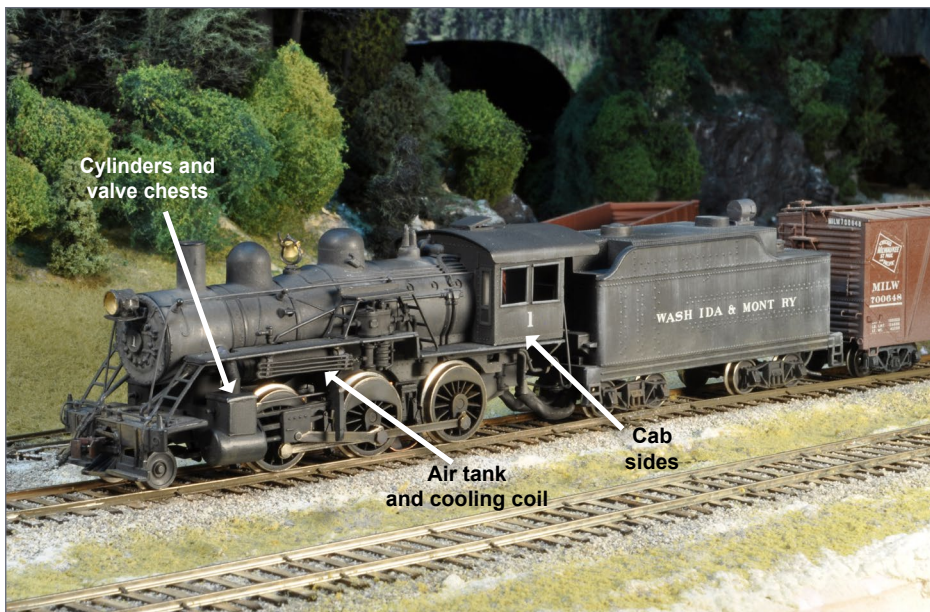

11. After finishing my upgrade, I soon found areas I wanted to change so that my model would more closely resemble its prototype. This called for another re-work!

Inside the tender [10] I glued a strip of PCB tie stock to the floor as a soldering terminal for the common lighting wire. Installing a 9-pin DCC decoder to the floor with double-sided foam tape, I attached a 1000 μF capacitor to it as a homemade keep-alive device. By then connecting the appropriate wires from the pickups, headlight, reverse light and the motor, the locomotive was ready to re-assemble and test run. With multiple pickup points on both locomotive and tender, along with the keep alive capacitor, the engine ran like a champ!

Once I knew this was all going to work I painted all the visible components using a spray can of Krylon Dark Gray Primer or by brush painting with PollyScale Grimy Black, which was a close

RE-REWORK A STEAM LOCO | 15

enough match to the Krylon color. I lettered the locomotive with Microscale white “Railroad Roman” decals.

The WI&M originally had two 4-6-0s. Number 1 was frequently photographed and had more modern appliances added through its active life. Number 2 did not get modernized and was seldom photographed before its scrapping. Because my model was a 2-6-0 instead of a 4-6-0, I opted to number mine as the 2, thinking that with fewer photographs available I might have an easier time slipping my less than accurate model past any possible “rivet counters.”

The engine ran on my layout for several years, and I was pleased with the outcome of this exercise in compromise. After all, the engine certainly looked like something the WI&M would have owned.



12. I pulled some references photos of my prototype, looking especially at the cab.

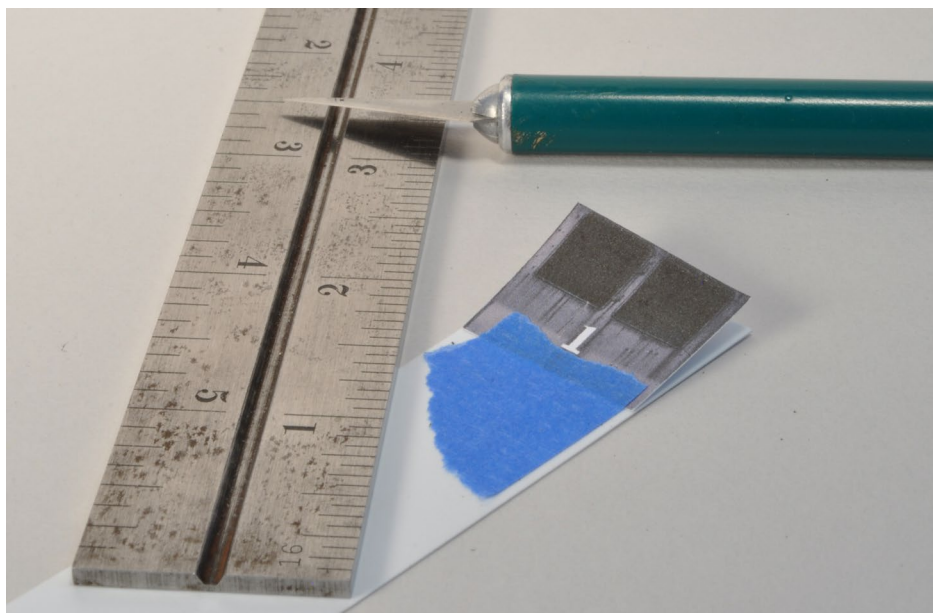

13. I resized my reference photo to HO scale and taped it to some 0.010" styrene as a pattern for cutting a new cab side.

Re-working the re-work

And then one day, I realized I could improve the engine's appearance considerably with just a few more modifications. I identified three significant changes that would help my model more closely resemble its prototype [11]: the cab sides, cylinders and valves, and the air tanks and walkways along the length of the boiler. Mechanically, the engine ran fine, so I hoped to avoid any changes other than these cosmetic improvements.

The only significant difference between the cab sides on the model and the prototype were two square windows for the WI&M engines, versus a single rectangular window on the SP prototype. For this, I resized a broadside photo I had taken of

RE-REWORK A STEAM LOCO | 17

Number 1's cab [12] so that it had the same proportions as the model cab, and printed several copies. Then I taped two of these paper templates to 0.010" styrene sheet and used them to cut out two new cab sides [13]. I also edged the window openings with 0.020" round rod to simulate the rolled edges on the prototype [14].

I tried two different methods to attach these new cab sides. In both instances I began by scoring a groove along the top edge of the existing cab side where it meets the rounded roof edge. The first time, I attempted removing 0.010" from the entire cab side with files and sanding sticks. I also used my nibbler tool to widen the window opening. However, it proved difficult to maintain an even thickness and the new cab side bowed slightly in the middle when I glued it over the old side.

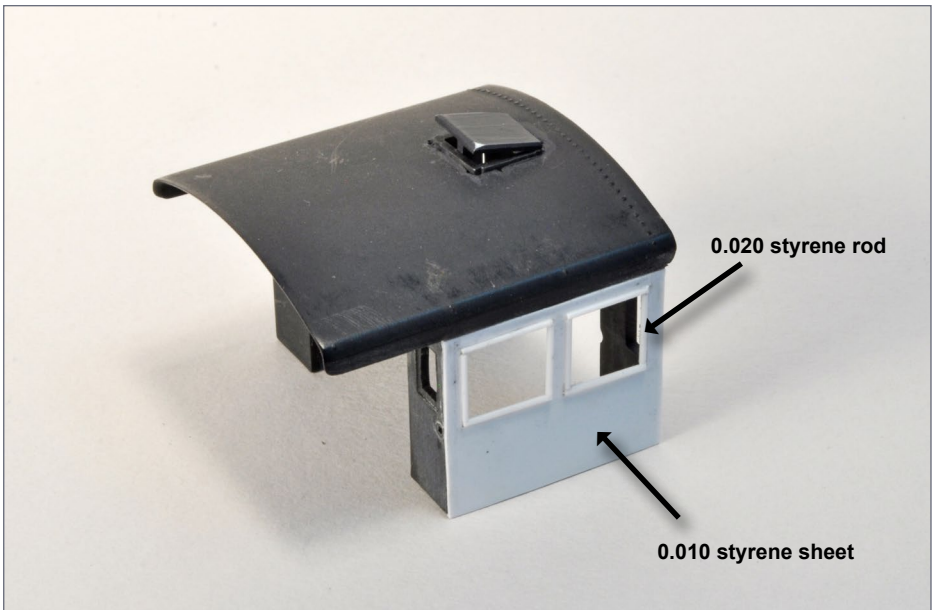

14. After cutting a new cab side from 0.010" styrene sheet, I edged the windows with 0.020" styrene rod.

RE-REWORK A STEAM LOCO | 18

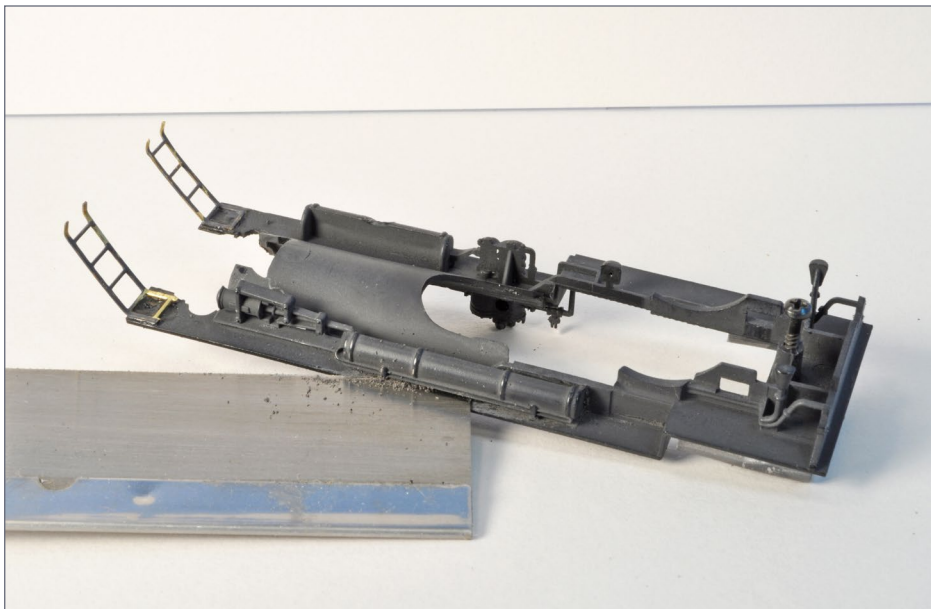

15. I cut off the cast air tanks and power reverse under the walkway on the fireman's side with a razor saw.

On my second attempt, I used the nibbler and files to remove the entire old cab side. Then, I narrowed the remaining edges of the front and rear cab walls by about 0.010", using the molded rivet lines as guides, and cemented the new cab side to the trimmed edges.

I washed and dried the cab prior to applying Micro-Mark rivet decal strips to match prototype photos, and then I gave the cab a new coat of Krylon dark gray primer.

As an afterthought, I cut two lengths of ¼" square styrene tube to fit between the front and rear cab walls, capped one end, and filled them with lead fishing weights. Gluing these "seat boxes" for the engineer and fireman into the cab gives the model a little extra heft and helps stiffen the new cab sides.

RE-REWORK A STEAM LOCO | 19

I knew the most challenging part of this project would be building new cylinders and valve chests . . . so I put that off until last! While figuring out the best way to clear that hurdle, I worked on the walkways. They are included as part of the lower boiler casting on this model, which made it easy to rework them. First, I removed the cast air tanks and power reverse detail from underneath both walkways [15].

On the fireman's side, the air pump casting is too far forward to match the WI&M 4-6-0s, and I opted to accept this compromise. But, I did take two short lengths of brass ladder stock to fabricate the step-over platform the WI&M engine had [16]. The walkway across the top of the air pump came from my scrap box.

On the engineer's side, I cut out a portion of the walkway ahead of the cab, and lowered it to the level of the cab floor [17]. With

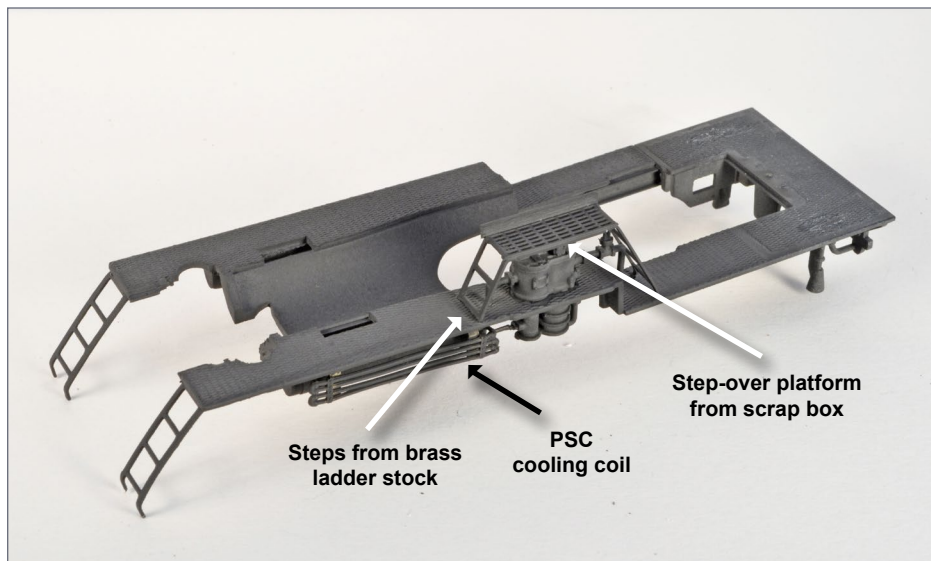

16. I fabricated a new walkway over the air pump and I added a new cooling coil casting on the fireman's side.

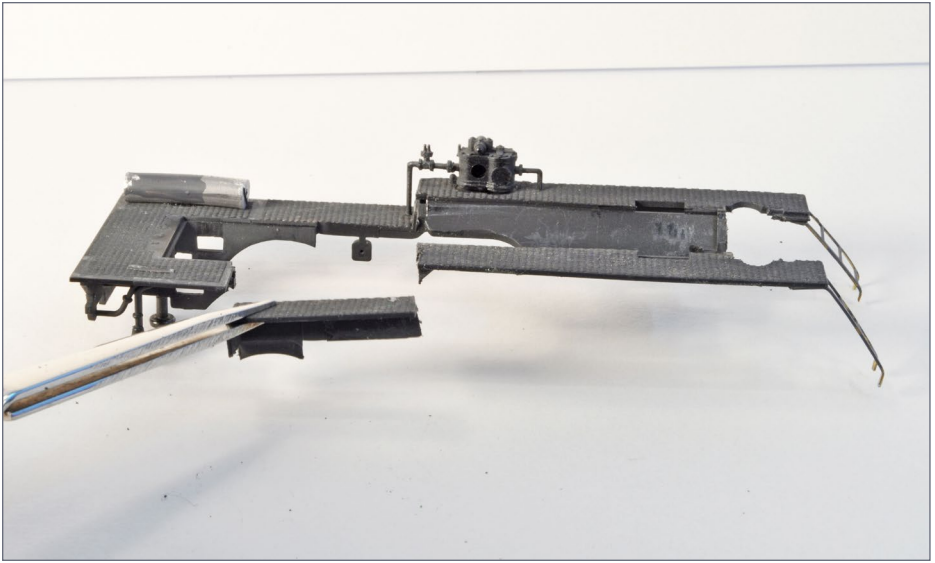

17. On the engineer's side, I lowered the back half of the walkway to the cab level.

no boiler casting behind it, I now had to devise an alternate way to mount the lowered piece of walkway. A 0.010" splice plate worked just fine at the cab end, but for the rest of the walkway, I glued a length of styrene "C" channel underneath with a trapezoidal 0.030" gusset plate suspending the channel beneath the walkway ahead of it [18]. This didn't match the prototype at all, so I camouflaged it with two lengths of styrene rod simulating air or steam lines to some unknown locomotive appliance.

Then, I fabricated two new tanks from styrene, gauging the lengths of the $\frac{1}{4}$ " dia. tubes by eye, with 0.015" caps and 0.010" x 0.030" strip for the mounting bands. Before capping the tanks, I filled them with lead weights to provide a little extra weight over the drivers. Once these were done, I glued them under the walkways. I shifted the tank on the fireman's side closer to the boiler so there would be room to mount a Precision Scale cooling coil (PSC 31164) underneath the edge of the walkway.

RE-REWORK A STEAM LOCO | 21

Finally, I used styrene strips with some rivet detail to plug the unsightly gap between the lowered walkway and the upper boiler casting to make it appear like the side of the firebox extends up to the boiler.

New cylinders and slide chests

At this point, I could no longer procrastinate building new cylinders and slide valve chests, as this was the one difference between the model and the prototype that bothered me most. The SP prototype for the IHC model had piston valves, which are visible as a second cylinder above the drive cylinder. In contrast, Alco built WI&M Number 1 with slide valves, which appear as a vertical box seated over the drive cylinder.

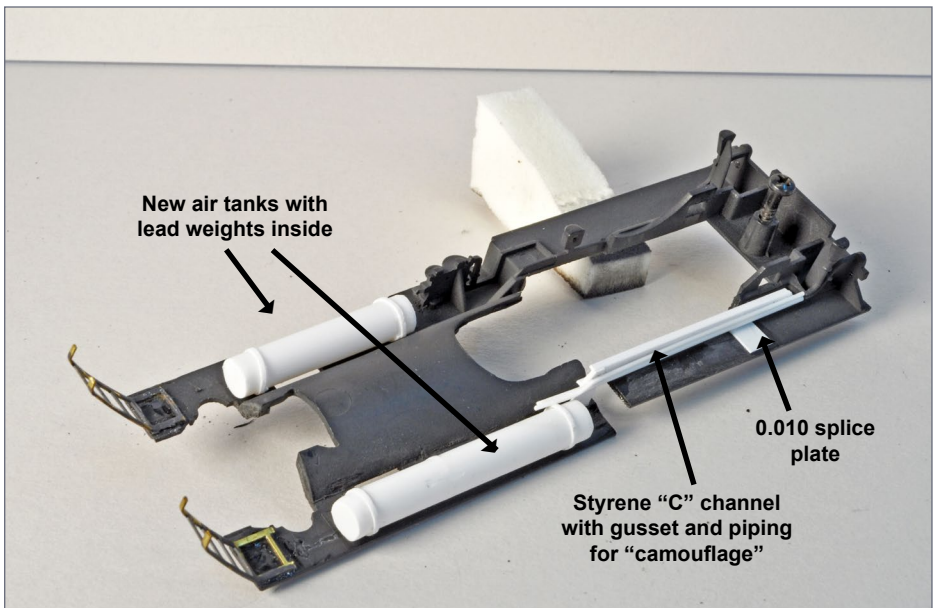

18. I added new air tanks, along with a gusset and splice plate to support the lowered walkway on the engineer's side.



19. My prototype had an upgraded valve gear by Franklin Valve Co. I set about fabricating a new cylinder assembly to match this.

Comparing as-built photos with later images, I realized something had changed on Number 1. Further investigation led me to learn that Number 1 had been rebuilt with a piston valve “retrofit kit”; the bolt-on Universal Valve Chest manufactured by Franklin Ry. Supply Co [19]. This probably happened when WI&M shop crews outfitted Number 1 with a superheater in 1925, as slide valves did not work well with superheated steam. Armed with this knowledge, I tackled fabricating a new cylinder assembly.

I first cut the cylinders from two 5/16” dia. styrene tubes 7/16” long. Next, I set up my drill press with a small Dremel sanding drum (which measures slightly larger than the 5/16” dia. cylinders) and a styrene jig to help me sand a concave notch centered across the full width of two 5/16” square styrene tubes [20]. Then,

RE-REWORK A STEAM LOCO | 23

I cut each square tube $\frac{1}{4}$ " up from the apex of the notch to form my valve chests.

After generating a template by photocopying the rear face of the original cylinder casting [21], I placed the cylinders and valve chests on the template along with a vertical length of $\frac{5}{16}$ " square tube for the smokebox saddle [22]. I then relied on trial and error to cut horizontal pieces of square tube until they fit between the saddle and the cylinders. I also added strips of 0.060" styrene to each side of the smokebox support [23]. I carefully cemented the seven pieces of square tube to each other, and placed a weighted steel rule on top to maintain alignment while they dried.

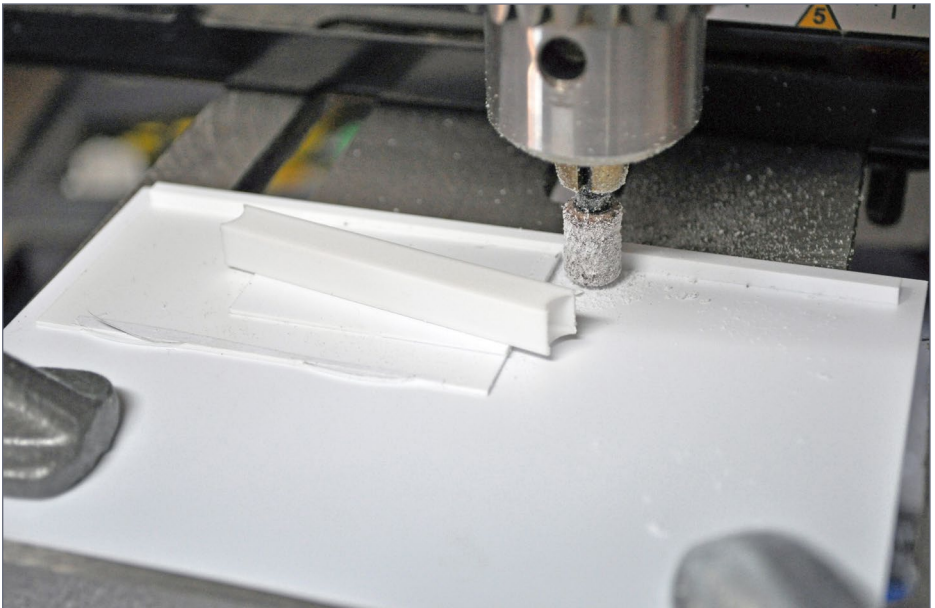

20. I built my new cylinders from styrene. I used a small Dremel sanding drum to form the proper concave curves in the square styrene tubes that would form the valve chests.

RE-REWORK A STEAM LOCO | 24

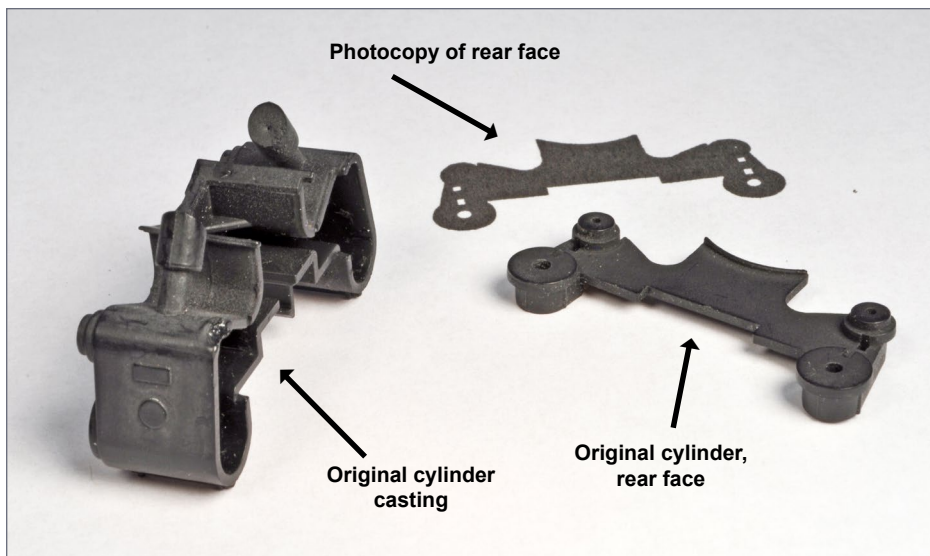

21. I disassembled and photocopied the original cylinder rear face to use as a template for making new cylinders.

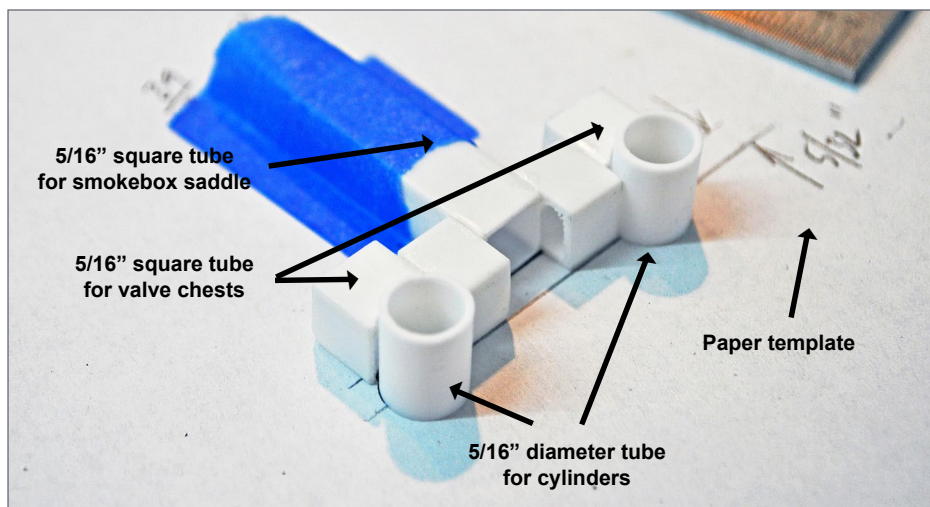

22. On top of my template, I placed various styrene shapes together to make the cylinder assembly and smokebox saddle.

RE-REWORK A STEAM LOCO | 25

After reinforcing these joints with CA and letting it all dry again, I sanded the front and rear faces smooth. Then I set up my drill press with a larger sanding drum to create a concave curve in the smokebox saddle [24], following my template. I also widened the notch where the cylinder assembly would fit over the locomotive frame.

I glued both cylinders into their respective notches in the valve chests and added a few bits of styrene to strengthen the joint. I also glued a piece of pre-curved 0.010" styrene into the smokebox saddle to form a mounting flange.

Having used a 1/16" spacer while gluing, to make sure the cylinders were centered front to back under the valve chests, I realized

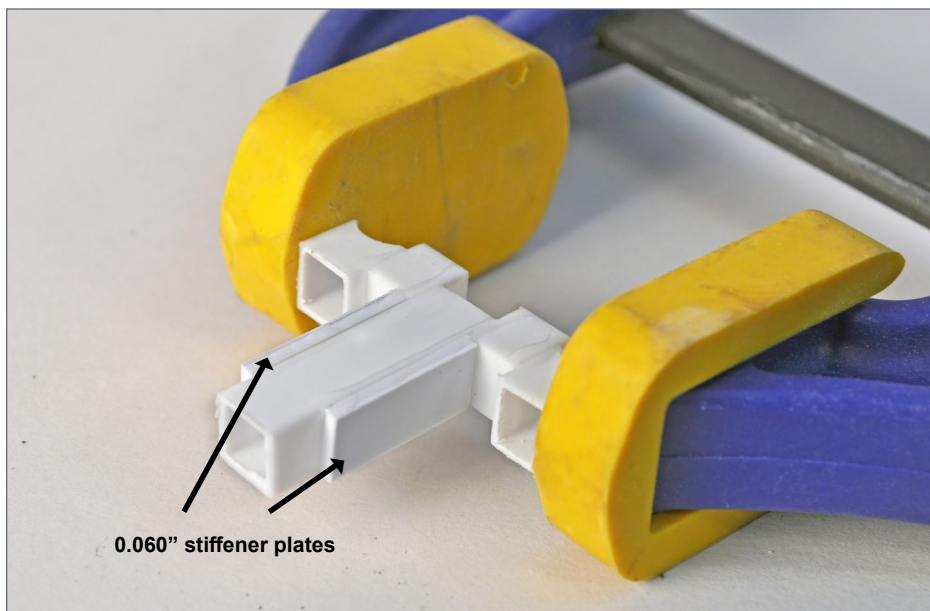

23. With the new styrene cylinder assembly constructed, I added 0.060" styrene stiffeners to each side of the smokebox support.

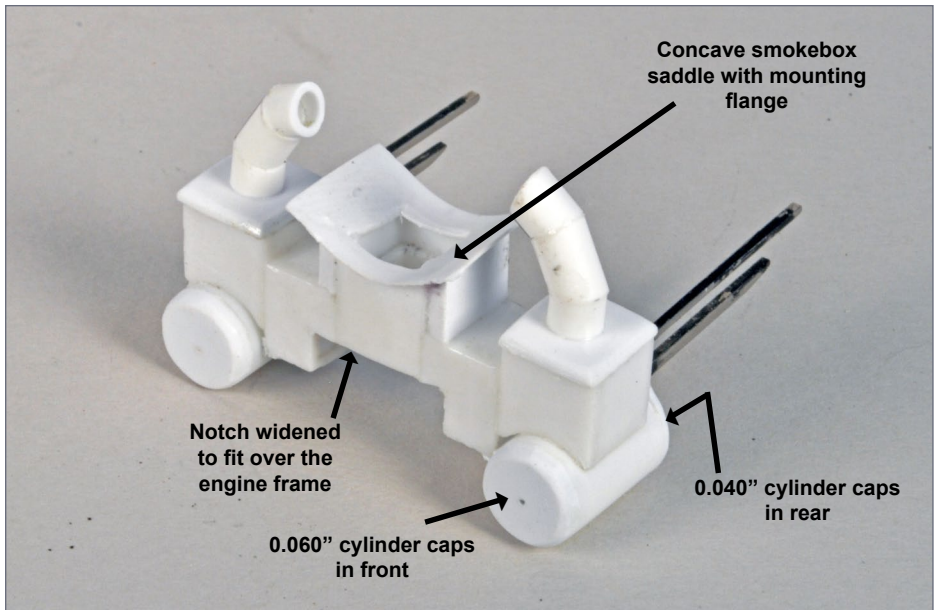

24. After further sanding and test fitting, the new cylinder assembly is starting to take shape.

after gluing that my cylinders had been cut slightly less than $7/16$ " and were, in fact, not centered. I rectified this blunder by fabricating the front cylinder ends from 0.060" styrene and the rear ones from 0.040". The end result appeared much more balanced.

Now I faced a challenge I'd expected all along. In addition to having piston-valve cylinders, the SP prototype for the model had an underslung style of crosshead that did not match WI&M practice. If I really wanted to get carried away, I would have built completely new crossheads, guides and yoke. But, for simplicity I chose to fit the original parts onto the new cylinders I was fabricating.

To use the stamped crosshead guides that came with the model, I again used my template to mark where the lower guide would

RE-REWORK A STEAM LOCO | 27

extend through the rear cylinder caps. Before cutting the rear cylinder caps out of 0.040" sheet, I opened up these slots with a small twist drill and the tip of a hobby knife.

However, the top guide would need to extend un-prototypically from the valve chests rather than the rear cylinder caps. To allow this, I marked and cut a small slot along the top edge of each cylinder and up into the valve chest [25]. By carefully widening these slots with a hobby knife, I obtained a close fit with the stamped crosshead guides. I then slid the valve covers over the bottom guides until they met the rear of the cylinders and glued the styrene parts together.

After that joint hardened, I used a file and sanding sticks to bring the oversize cylinder caps down to the diameter of the cylinder

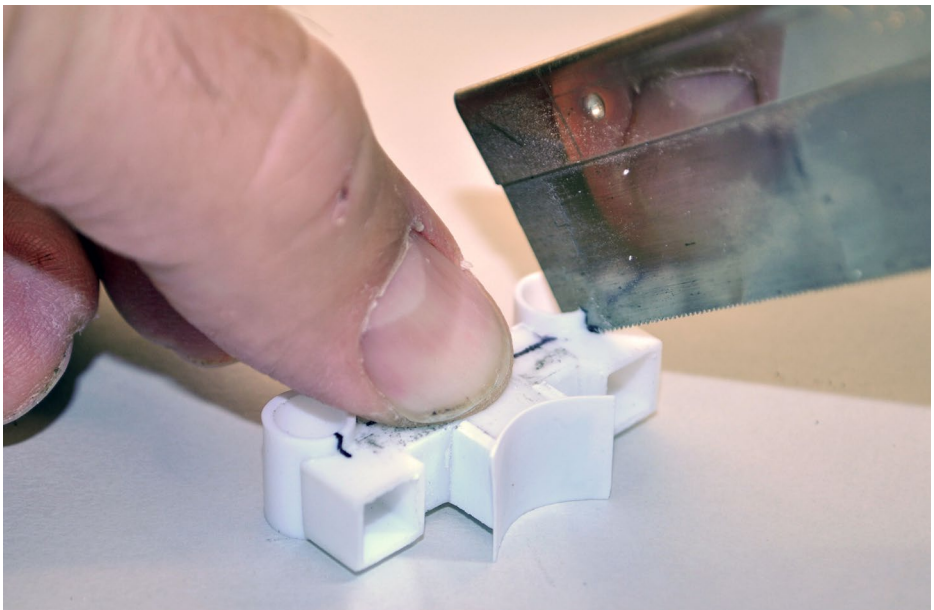

25. I cut slots in the new cylinder assembly for the crosshead guides.

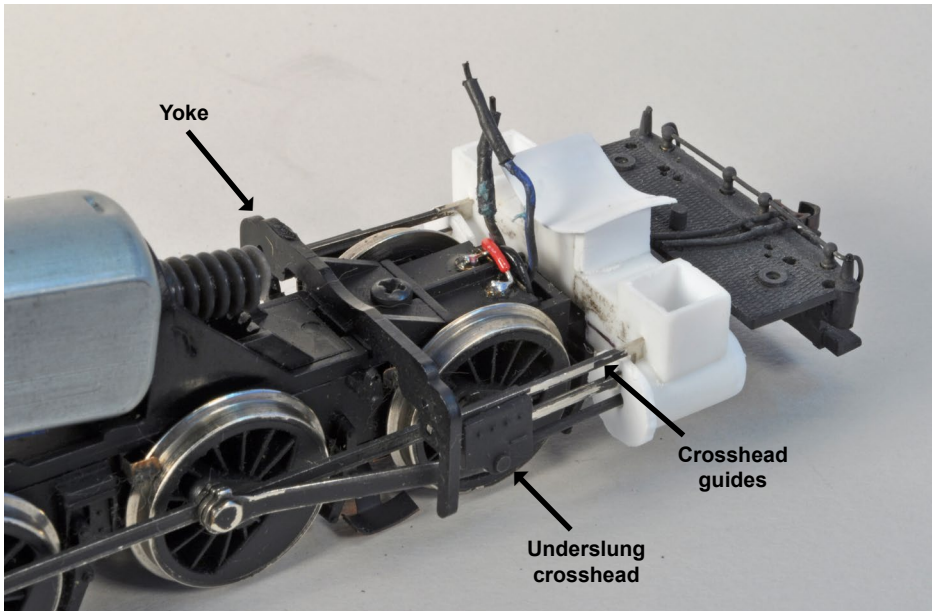

26. I test fit the new cylinder assembly on the loco frame and ran the loco to look for issues.

tubes, and to add a curved bevel to the edges. Finally, I test-fit the cylinder assembly in place on the engine frame [26] with the crossheads installed and the ends of the guides pressed into the yoke on both sides. I test ran the engine for a few minutes and was relieved to find no binding!

Another major addition to the cylinder assembly was the steam inlet piping from the smokebox to the valve chests (these were also part of Number 1's superheater/piston valve conversion). For these I used 3/16" round styrene tube, cut into three angled segments, "guesstimating" and trimming the length of each segment until they fit [27].

Even after gluing the ends together, the pipe assemblies seemed a little fragile, so I strengthened them by sliding a short length of

RE-REWORK A STEAM LOCO | 29

stripped 14 gauge braided wire (I had it handy and it was flexible and about the right diameter). After locating where the pipes would exit the steam chests, I drilled a 1/8" hole and glued in the copper wire bundles with CA. Then, with the styrene tubes slid down to contact the steam chest lids, I used styrene cement to seal this joint. Where the other end would meet the smokebox, I trimmed the pipes slightly long to allow for adjustment when the engine was assembled.

Using my paper template once more, I located and drilled where the valve rods on each side would exit the valve chests [28]. I added two small discs and a short length of styrene rod to each valve chest to simulate details from the slide-to-piston valve conversion kit.

At this point, with the major subassemblies largely complete, I re-painted everything using the Krylon gray again, and added

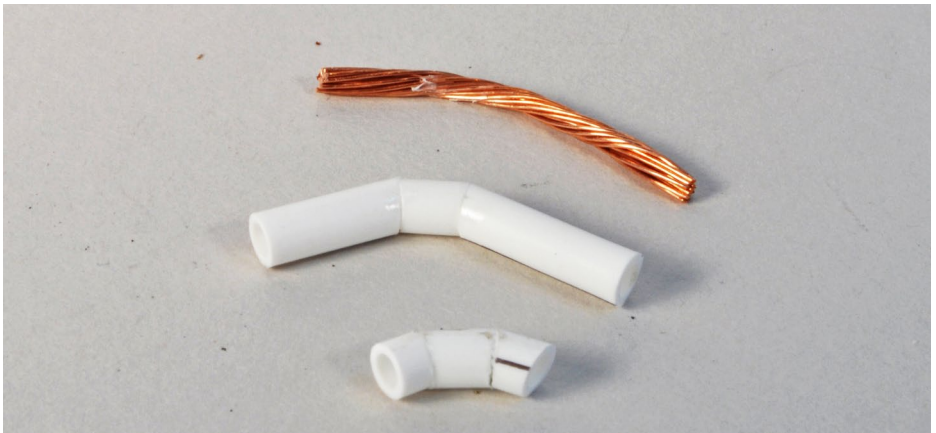

27. I also modeled new steam inlet pipes between the smokebox and the valve chests from styrene tube. I added some 14 gauge braided wire inside to add strength to the fragile assembly.

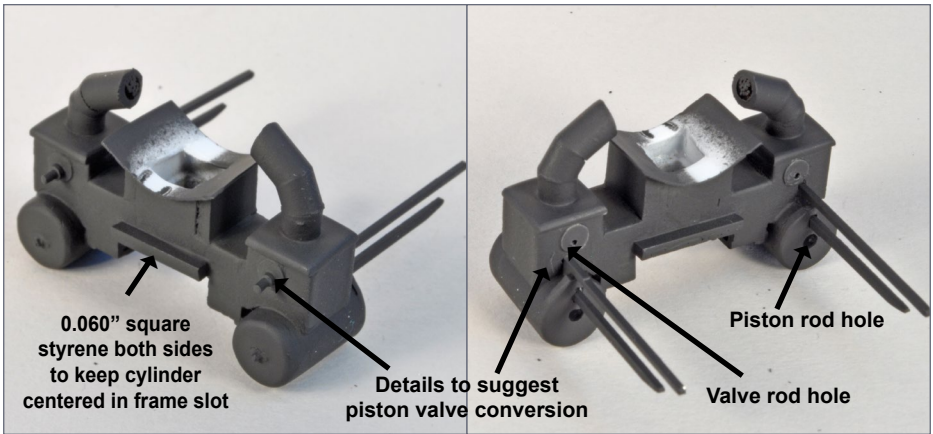

28. Here is the finished and painted cylinder assembly.

decals to identify my model as WI&M Number 1. Now that it more closely resembles that locomotive in the Potlatch park, I could reasonably number it accordingly. I pre-weathered both halves of the boiler [29], the cab, cylinders and running gear before final assembly using my set of PanPastels. I also used a lighter shade of PanPastel gray to give the smokebox and firebox the appearance of graphite.

I won't pretend reassembly was a simple matter, especially with the tender attached, but it only took small doses of caution, patience and head-scratching to complete the task.

As the final touch, I glued etched Alco builder's plates from American Scale Models (part number 2450-38) to each side of the smokebox, and dusted them with the "graphite" PanPastel.

Overall, I'm very pleased with the outcome of this project [30]. An engine that was "good enough" after the first conversion project is now even better. Alongside the model itself, the most valuable thing I gained from this project was a greater understanding

RE-REWORK A STEAM LOCO | 31

of and appreciation for steam locomotives. In fact, I'm already examining other inexpensive steam locomotive models, looking for hidden gems that might be brought forth through similar conversion projects.

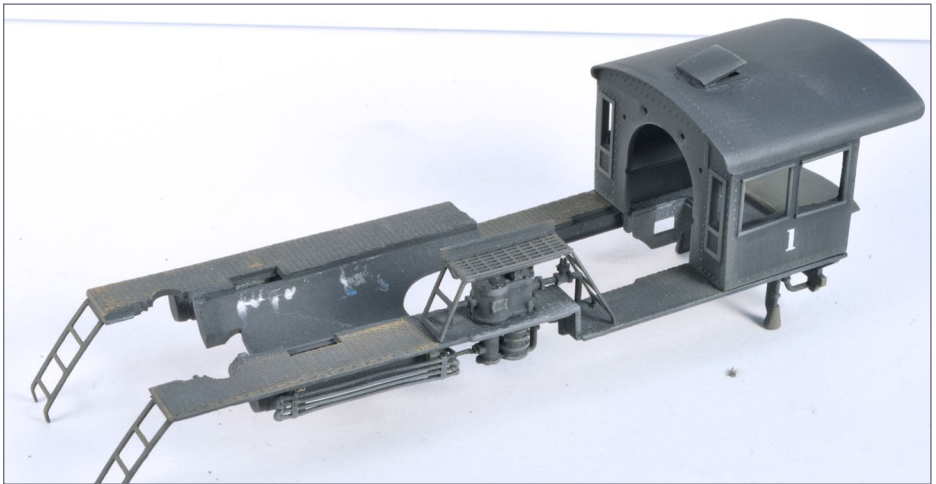
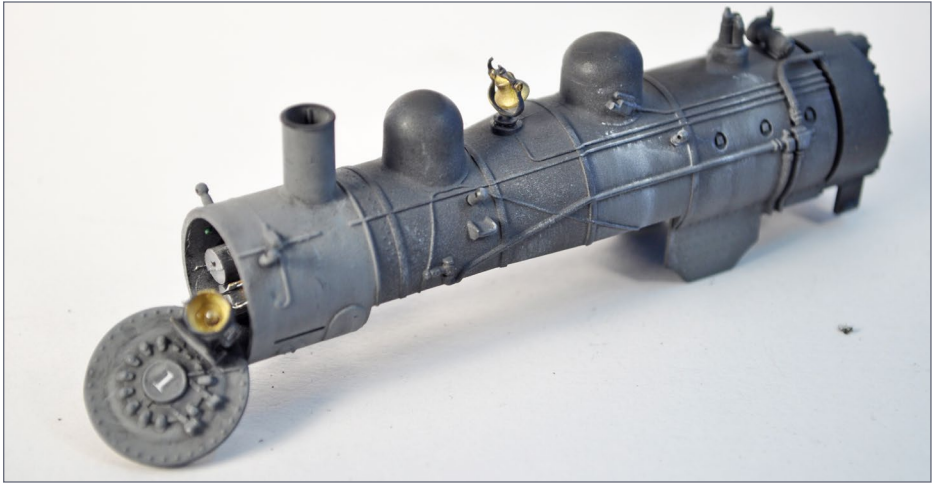

29. I repainted and re-weathered the locomotive subassemblies before final assembly, then touched up the weathering to tie all my upgrades into a cohesive whole.

A message from
Joe Fugate
MRH Media Founder



What topics does TrainMasters TV have?

TMTV has 400-some videos in nine categories, & we're adding 1-2 new videos per week ...



LAYOUTS



PLANNING



BUILDING



ELECTRICAL



MODELING



OPERATING



TOOLS/TIPS



PROTOTYPE



VENDORS/EVENTS

LOOKS GOOD, SIGN ME UP >>



• [INDEX](#)



SUBSCRIBE
(free)

• [TABLE OF CONTENTS](#)



30. Now that my new and improved WI&M Number 1 has returned to service, it can be found hard at work, like here



as it pulls a freight train into the siding at Harvard, Idaho in the summer of 1954.



.....
THE PROTOTYPE



31. This is the condition in which I first encountered WI&M 4-6-0 Number 1, in February 1984. Her first display location, behind the Potlatch, ID depot (in background) and under a stand of trees, was less than ideal. Before the rust could set in too deeply, community activists helped move her to a more suitable location, in the nearby Scenic 6 Park. *Thomas Hillebrant photo*



32. At work in March 1950, WI&M 1 appears to be in solid and serviceable condition. She was one of the true workhorses on the Washington, Idaho & Montana Ry., owing to her superheater and other upgrades. She remained on the roster until her donation to the City of Potlatch in 1961. Details visible on the fireman's side include the modified valve chests, air tank, compressors and cooling coil under the walkway. Also, notice the canvas water bag hanging from the side of her tender.

Tom Kreutz photo, WI&M Ry. HPG collection

.....
THE PROTOTYPE *CONTINUED...*
.....



33. WI&M 2, also a 4-6-0, poses on the Potlatch turntable circa 1946. She had recently been overhauled, and decorated with white trim on the walkways and tires in hopes of attracting a buyer. Never outfitted with a superheater like her sister Number 1, she illustrates the as-built appearance of both engines with her original slide valves. *Tom Kreutz photo, WI&M Ry. HPG collection*



34. A 1965 view of Number 1 in her original display location. Her paint has not yet begun to rust through, and she appears nearly ready for a return to service. *John Henderson photo, WI&M Ry. HPG collection*



35. In temporary storage behind the Potlatch depot, we get a good view of Number 1's tender. Originally built with a coal bunker, it was converted to an oil bunker in 1912. During WWI, the engine was switched back to burn coal, and then re-converted to oil at the end of the conflict. *Ivan Ergish photo, WI&M Ry. HPG collection*

.....



THE PROTOTYPE *CONTINUED...*
.....



36. Although it is not clear from this snapshot which engine is assisting which, it illustrates that Number 1 did operate at the same time as the WI&M's first diesel, S-3 Number 30. This shot must be from the early 1950s, as the paint on the diesel is still clean. This shot was taken just east of the Potlatch yard. *Bill Lemke photo, WI&M Ry. HPG collection*



37. In this view from 2003, Number 1 has now been moved to the Scenic 6 Park in Potlatch, her current location. Some fencing has been set up to guard against vandals (Potlatch is only 15 miles north of the University of Idaho, so there are lots of “Vandals” nearby¹). Since this photo was taken, a shelter roof has been erected over the engine to provide basic protection against the elements. *Thomas Hillebrant photo* ■

¹ It might help to know the University of Idaho’s sports team is known as the “Vandals.” The author is writing this with a wink and a grin! See: govandals.com.





38. The finished model. Use your mouse or finger (touch screen) to spin. ■

RE-REWORK A STEAM LOCO | 41



• [INDEX](#)



SUBSCRIBE
(free)

• [TABLE OF CONTENTS](#)

.....

BILL OF MATERIALS

International Hobby Corp (IHC):

Premier Series 2-6-0 Mogul (model number M524 for Undecorated, any M5XX will do)

Model Die Casting (MDC):

“Oil (Santa Fe Type)” tender (model number 401)

Taurus Products:

Pickup shoe kit (part number 100)

Cal-Scale:

Bell (190-281)

Number plate (190-245)

Headlight (190-202)

Platform (190-246)

Rear light (190-207)

American Scale Models:

Alco builder’s plates (2450-38)

Evergreen Styrene:

5/16” dia. tube

¼” dia. tube

3/16” dia. tube

¼” sq. tube

5/16” sq. tube

0.010” sheet

0.010” x 0.030” strip

0.020” dia. rod

3/16” “C” channel

Assorted sizes rod sheet and tube ■

.....

THOMAS HILLEBRANT



Introduced to model trains by his maternal grandfather, Thomas Hillebrant is a life-long railroad enthusiast with a strong interest in studying and modeling railroads serving the Inland Northwest. Employed as a mechanical engineer, Thomas and his wife, Nici, live in Richland, WA with two of their four children, and several cats.

His current layout focuses on the prototype Washington, Idaho & Montana Railway, a segment of which still serves a North Idaho lumber mill. In addition to modeling this shortline railroad, Thomas edits the quarterly newsletter for the WI&M Ry. History Preservation Group (wimryhpg.com).

Thomas' other interests include photography, history, and travel. ■



**Click here to rate or
comment on this article**



NEW!

TMTV Season 2 DVDs and downloads

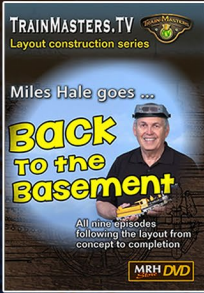

DVD
~~\$36.99~~
\$29.99



DVD
~~\$36.99~~
\$29.99



Download DOWNLOAD
~~\$19.99~~
\$14.99 9 files



Download DOWNLOAD
~~\$21.99~~
\$16.49 12 files



DVD
~~\$44.99~~
\$31.99



DVD
~~\$49.99~~
\$33.99



Download DOWNLOAD
~~\$24.99~~
\$19.99 14 files



Download DOWNLOAD
~~\$29.99~~
\$22.99 16 files



ALSO: The Complete TMTV Season 2 DVD set, volume 1 and 2 are now shipping!

SHOP NOW >>

**Model Railroad
Hobbyist Store**

store.mrhmag.com

• [INDEX](#)

• [TABLE OF CONTENTS](#)



YES, IT'S A MODEL

compiled by
DON HANLEY
.....



**Click here to rate or
comment on this article**



1. ATSF 11077 waits in the sun as its paint fades a little more. The model is an Athearn blue box kit. These brown 50-foot boxcar kits were very popular in their day and many unbuilt examples can still be found for bargain prices. This built up example has been weathered with acrylic paints, with Kadee #158 couplers and Kato wheels and trucks added. Terence Boardman took this photo outside on a diorama.

▶ **MRH'S MONTHLY PHOTO ALBUM**





2. East Tennessee & Western North Carolina locomotive number 11 has just arrived at the depot at Buladeen, Tennessee with the afternoon commuter train for the rayon mills in Elizabethton. The conductor and station master are discussing a freight meet half-way to the ET&WNC main line interchange at Hunter, TN after the 11 gets turned. The sailor waits until the last moment to board, savoring his final remaining moments of shore leave before he begins his return journey to his ship, the USS Indianapolis. The Stoney Creek Branch of the ET&WNC is experiencing what will be



its high water mark during WW2, and this scene in the summer of 1943 shows how busy the narrow gauge line could be at the time.

Lee Bishop built this 4-6-0 from a slightly modified Bachmann On30 locomotive and the coach is from AMS. The track is code 83 by Micro Engineering. All structures in this photo were scratch-built. This action takes place on a 11X10 foot point-to-point On30 layout with a concept of a fictional branch line bought out by the ET&WNC in the 1930s and now going through the war years.



3. Neil Schofield did this Tangent MILW Appliance Car which he originally did not intend to have on his layout. “Do not underestimate the importance of advertising,” says Neil. When Tangent first announced their 40-foot appliance box cars, Neil says he didn’t really pay much attention since they didn’t show up regularly on the CP Rail in Vermont, or at least so he thought.

Then some photos showed up on Tangent’s website of one of the MILW cars departing East Deerfield, MA on train EDCP headed up the Connecticut River Line. Neil was wrong, and he couldn’t resist getting one of these great looking cars. Within a few days of picking up one of these cars, Neil sat down with some artist oil paints, graphite pencils, and a few miscellaneous decals to replicate 4601 headed up the Connecticut River Line at Orleans, VT on the CP Rail/B&M run through train.



4. Neil Schofield also modeled this car following behind the MILW appliance car. This is an Atlas 11,000-gallon tank car of anhydrous ammonia headed to a local fertilizer distribution plant. The car represents an early version tank car with full-length walkways. It's an Atlas factory-painted car with some airbrush weathering, chinks, and artist oils to replicate 30-plus years of service.



[Click here to rate or comment on this article](#)



\$ GET PAID FOR YOUR PHOTO

We pay \$40 per photo we publish. If you'd like to get your modeling in our photo feature, just start posting your photos on the MRH website, especially in the Weekly Photo Fun thread created each week.

See mrhmag.com/help for more on how to post an image. You need to be an MRH subscriber to post photos to our website, and becoming a subscriber is free, [just fill out this form here](#). ■

ADVERTISEMENT

END OF TRAIN DEVICE

NEW SAFETY GREEN



Bright Red Flashing Light!

**Installs in minutes!
No freight car modification required!**

Patented Technology - US Patent 7,549,609

Does not affect Load!

↓ Car without Load ↓



↓ Car with Load ↓



Click Here to Learn More

**RE RING™
ENGINEERING**

Announcing a New Limited Run PWRS / River Point™ Vehicle!!!

Ford F-350 Series XL SRW Super Duty
Ford F-450 XLT Regular Cab Utility



PWRS 

Modern Era Hi-Rail & Highway Trucks

Canadian National (CN)
Canadian Pacific (CP)



HO
SCALE



PACIFIC WESTERN RAIL SYSTEMS
SPECIAL RUN CAR



Pacific Western Rail Systems

NORTH AMERICAN RAILCAR CORPORATION



**"Celebrate
Canada's 150th Birthday"**

2 Sets available:

CPWX • CNWX

CLICK HERE FOR
HO-Canada 150

CLICK HERE FOR
N-Canada 150

Each 2-pack set includes one car with 1867 and one car with 2017 reporting marks.
Each car will have the official Canada 150 Logo. Expected Delivery is April - May 2017

**NARC Cars are sold
exclusively through**

Pacific Western Rail Systems

• **INDEX**



SUBSCRIBE
(free)

• **TABLE OF CONTENTS**

Nickerson switching puzzle:

Leaving them for later: working a turn

BY GREG BAKER

Can you solve it ...?

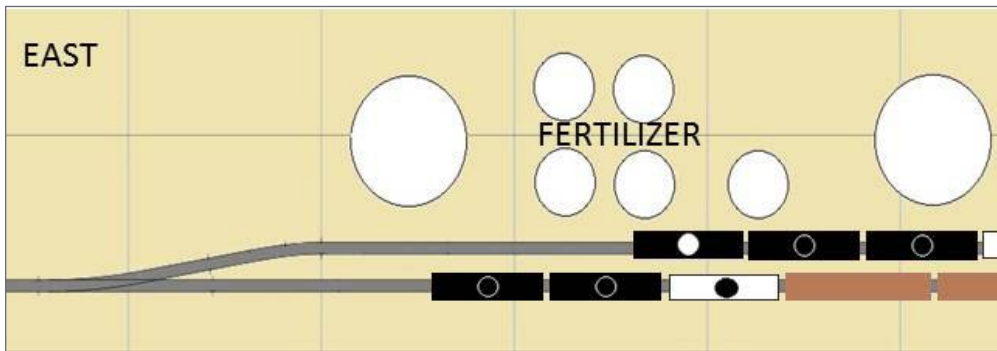

1. **Scenario 1 setup:** Here's the starting setup for scenario 1.

SOMETIMES WHEN WORKING A TURN, A JOB

that works out and back to the same location during the shift, it makes more sense to leave the cars at a customer's facility than it does to take them with you just to bring them back by later in the same shift. This was the case with a facility in Nickerson, Kansas that receives both acid and fertilizer for a Co-op. The cars would be spotted and once all the other work was completed the cars would be picked up on the return trip to the yard later that day.

In order to get the facility switched, all empties need to be placed on the East end of the facility. Also the cars already on spot need to be moved East of the cars arriving on the train. The loaded fertilizer cars need to be East of the loaded acid cars. One other thing to keep in mind is to try and clear up the crossing to allow motorists through occasionally.



[Click here to rate or comment on this article](#)

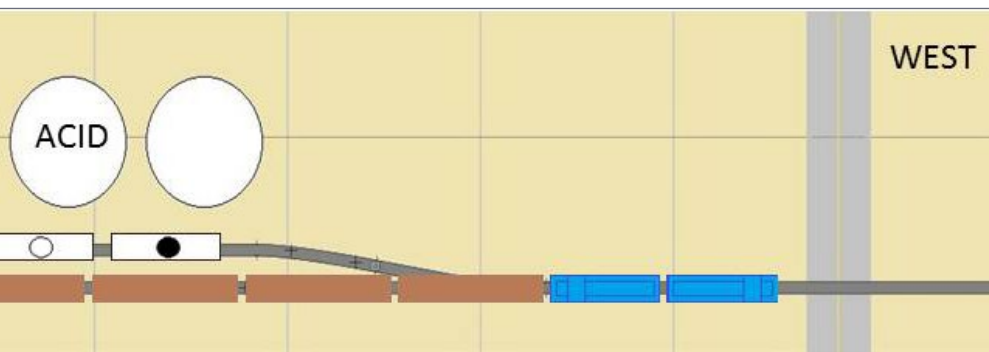

CAR KEY



Loaded Fertilizer Car



Empty Fertilizer Car



Loaded Acid Car



Empty Acid Car



Boxcar



Locomotive



NICKERSON SWITCHING PUZZLE | 3

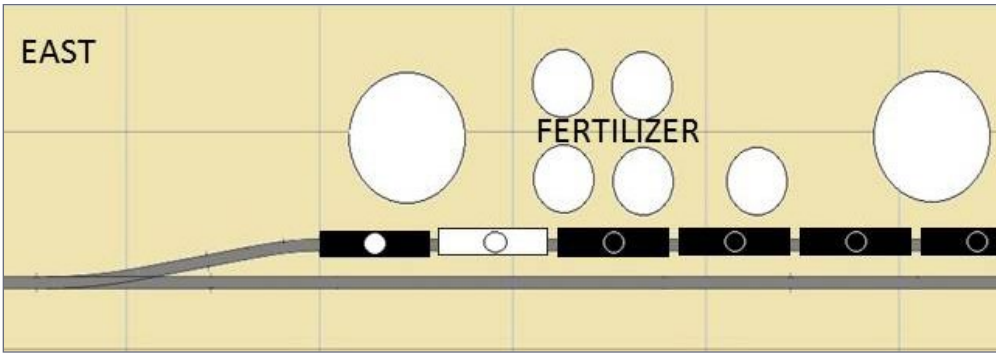

2. **Ending position, scenario 1:** Here's how things should look once you're done.

This time, we have two scenarios for you to consider.

Scenario 1: Normally the customer would unload the cars to the East first, making the switching relatively straight forward. Gather the empties to the East and spot the old and new loads on the West end.

I was able to get completed in 15 moves, how did you do?

Scenario 2: Sometimes the customers did not unload the cars in order, which always made things a little more interesting. Again the empties need to be moved to the East, then the loaded fertilizer and then the loaded acid cars on the West end.

I was able to get completed in 19 moves, how did you do?

What is a move? A change of direction or moving cars in the same direction after coupling constitutes a move.

You can get the answer to this switching puzzle in the free subscriber bonus extras.



Click here to rate or comment on this article

NICKERSON SWITCHING PUZZLE | 4

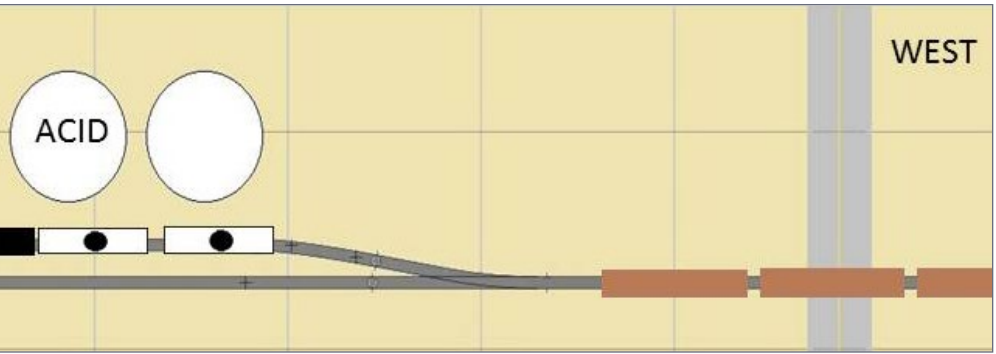

There's more! Scenario 2 is on the next page >>>



GREG BAKER

Greg Baker has been serious about model railroading since 2000, but as long as he can remember he has been fascinated by trains.

Greg's main interests are the railroads of Central Oregon in 1968, with the focus on the Spokane Portland & Seattle, Great Northern, and the Union Pacific along the Oregon Trunk. He is also interested in the City of Prineville Railway and its connection to the Oregon Trunk.

He currently resides in Lewiston, Idaho, with his wife Tiffany, 4-year-old daughter and 8 year-old son as he continues his career in railroading. He is actively involved in promoting Free-mo and has created an Idaho Free-mo group. ■



NICKERSON SWITCHING PUZZLE | 5

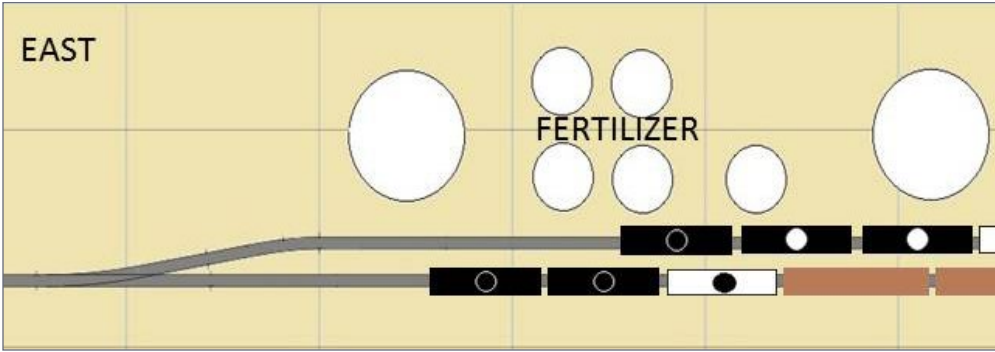

3. **Starting position, scenario 2:** Here's the starting setup for scenario 2.

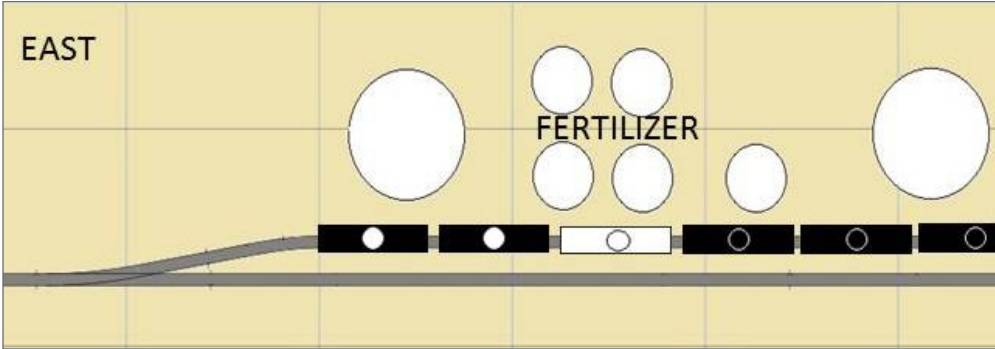

4. **Ending position, scenario 2:** Here's how things should look once you're done.



[Click here to rate or comment on this article](#)

NICKERSON SWITCHING PUZZLE | 6

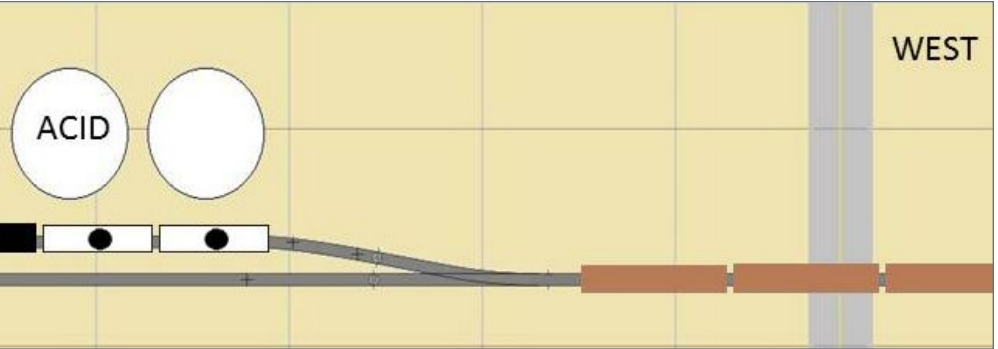
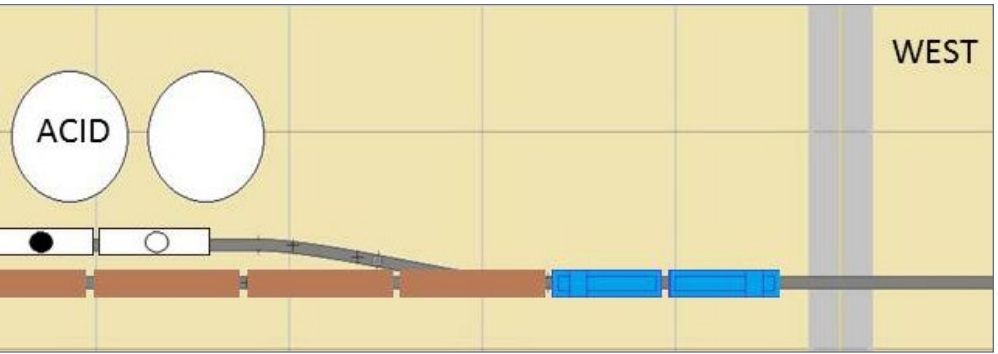

Want to help keep
MRH free?

Then **click on ads!**



Modeling the B-27 baggage car



BY GREGORY LARocca

Building "flat" passenger car kits, using the Model Railroad Warehouse B-27 baggage car ...

DESPITE THE PROLIFERATION OF READY-TO-RUN passenger cars in the last 15 years or so, the prototype-minded modeler still needs to assemble kits for the more obscure cars they may desire for their layout. My own prototype, the Baltimore and Ohio Railroad, has been blessed by Walthers' Capitol Limited train set. They wisely chose a circa 1960 version, which provides cars suitable not only for the Cap, but also the Columbian and a host of other less-known trains. Despite this, a myriad of B&O head-end, heavyweight sleeper, diner, and lounge cars have not been available commercially.

• [INDEX](#)

• [TABLE OF CONTENTS](#)



[Click here to rate or comment on this article](#)

Opening photo. *The Washingtonian* exits Sand Patch Tunnel on its daily trek to Cleveland. B-27 735 is in today's consist, perhaps hauling fresh seafood from Baltimore to "The Metropolis of The Western Reserve." These cars are unusual for baggage cars in that they have large water tanks, used for watering horses when they were the primary cargo carried by the B-27.

Many of these cars can be made from the large and seemingly growing group of prototype-specific passenger car kits that haven't been offered in ready-to-run form. Companies that make these kits include Bethlehem Car Works, NKP Car Co., Brass Car Sides, Union Station Products, Laser Horizons, and, in particular for B&O head end cars, Model Railroad Warehouse. In some cases, the company only makes the specific car sides, to be used on a generic "core" kit from Train Station Products or others.

The B-27/C-10 Horse-Baggage Car

Pullman built the Baltimore and Ohio Class C-9 (#730-739) and Class C-10 (#740-749) in 1919 and AC&F in 1926 respectively. These were 73'6" three-door cars built with end doors to handle horses, automobiles, or other large, bulky items that needed to be moved at express speeds. The C-9 cars were built with 12 side windows. These were removed in 1945 when they were rebuilt into B-26 baggage cars. The C-10 cars were built without windows, but with floor drains, clerestory windows, and an air pressure water system with which to water the horses. It is unclear if the C-9 cars ever had this feature.

Originally, this water tank was about the size of an air tank and resembled one as well, but was replaced at some point with a



B-27 BAGGAGE CAR | 3

full-sized Pullman-style tank. The C-10 cars were never reclassified, but were later used as baggage cars and were painted the same as the B-27 cars. In the 1960s, some of these cars found their way into MOW service. For more information, see: “Horse Cars and Raspberries,” *Mainline Modeler*, November, 1985, pp. 50-52 and “An Elusive B&O Passenger Car: The President’s Limos Also Traveled by Rail,” *The Sentinel*, B&O Historical Society, Fourth Quarter, 2006, pp21-29. It should be noted that although I numbered my car in the B-27 series, I detailed it as a C-10 because the air pressure water system is just too good of an unusual model detail to pass up.

Before starting

Most of the assembly is done with super glues (CA, or cyanoacrylate). I put a drop on a microscope slide, and then use an 0.020” steel wire bent to an angle to apply it, including running a bead

SOME GENERAL CONSTRUCTION NOTES

Whole feet and inches are scale measurements, such as “4 x 8”. Decimal measures, such as “0.123,” are actual measurements. The decimal measurements are done with a dial caliper, which is one of the handiest tools a modeler can own, in my opinion. Speaking of measurement, I urge you to double check all decimal measures I give —I’m not perfect and may have mixed up digits when transcribing them from my notes. Also, due to temperature and humidity changes, parts may shrink or expand slightly. Remember the adage, “Measure twice, cut once.”

B-27 BAGGAGE CAR | 4

when necessary. For large areas, I carefully apply the CA directly from the tube to the part. I usually manage to glue myself to the model at least once doing this. For styrene to styrene, or styrene to the resin used in the kit, I use MEK, but any thin styrene cement should work. Finally, five-minute epoxy is useful for reinforcing joints or joining plastic to wood.

Assembling the model

Model Railroad Warehouse mrrwarehouse.com makes etched brass sides and end for the B-27 Horse-Baggage car. Working with Merle Rice of MRW, I put together a “kit” to build the B-27. In addition to the car sides, the kit included an ex-Branchline underframe, trucks, diaphragms, and underbody details;



1. The B-27 “kit” in all its glory. Merle Rice was instrumental in helping me pick out appropriate parts for building this model. Initially, he offered only the sides for sale, but is now offering some of the parts as an accessory kit for the model.

B-27 BAGGAGE CAR | 5

and KitBits screen vents, regular end, roof, and floor, all from Bethlehem Car Works. See the parts list at the end of the story.

Begin by removing the sides, the end, and the doors from the fret to which they are attached. One can use Xuron fret cutters, but I laid the fret on a self-healing mat, aligned the back edge of an X-Acto #17 blade against the part, and pushed down, cutting the attachment. This is a neat, fast way to separate metal parts from a fret, and leaves a very small nub to be cleaned with a file. I left the separate rivet strips on the fret at this time so I wouldn't lose or bend them.

Place each door in its opening on the side, and run a bead of CA along the long edge of the door. The door is aligned with the top of the door flush with the top of the side, and the door centered in the opening. Make sure that the etched window frame faces outward. I also glued the end door into the brass end at this time.

After the CA has set, position a scale rule along the bottom edge of each door and scribe a line on the inside of the side the length of the car, making sure that the line is even with the bottom of

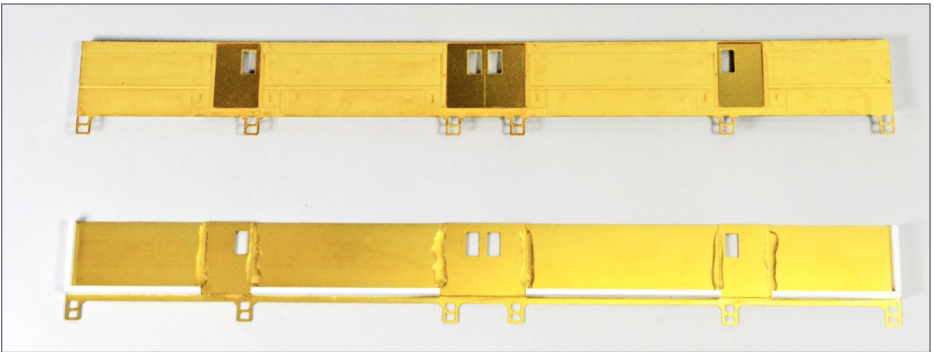

2. The sides with doors and 6 x12 framing in place. Note the position of the framing with respect to the bottom of the doors, and how the doors are reinforced with beads of epoxy cement.

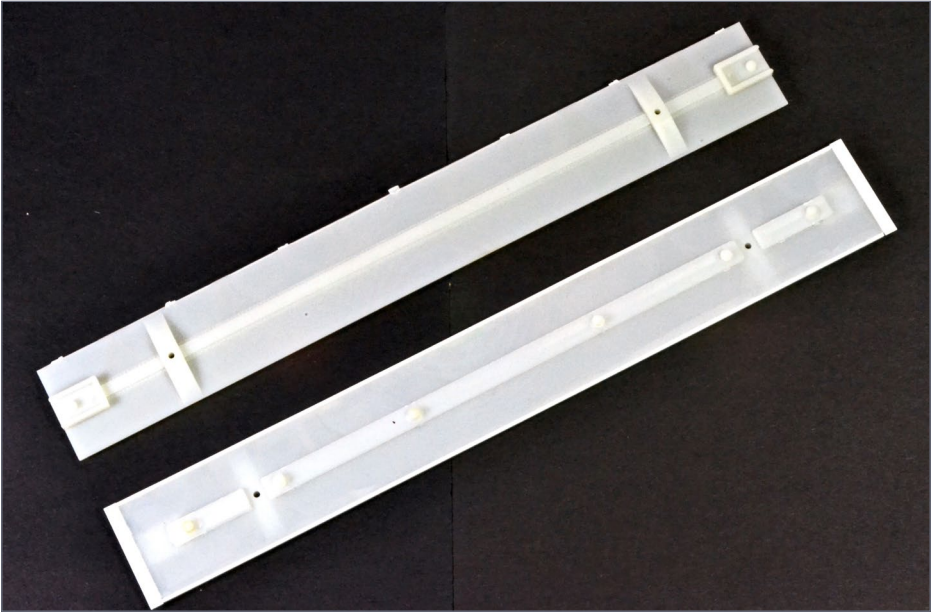

3. The floor is modified by converting the coupler boxes into mounting pads, and extending the floor's width and length.

the doors. Then glue HO scale 6" x 12" styrene strips along the line between each of the doors, with the 6" dimension against the side, and the bottom of the strip flush with the top of the line. I also place 6" x 12" styrene strip along each end, approximately 0.020" shorter than the end to allow clearance for the roof. Once the glue has set up, run a bead of five-minute epoxy along the edge of each door to reinforce it [2]. I did not reinforce the end door with epoxy, so that it would not interfere with placement of the car end later.

Remove the sides from the coupler pockets on the floor piece, converting them to coupler pads. Glue HO scale 4" x 4" strips along each edge of the floor, and then extend each end of the floor with 0.040" x 0.156" Evergreen strip cut to the width of the floor (including the 4 x 4). Although the floor is resin, you can

B-27 BAGGAGE CAR | 7

bond the styrene to the resin using MEK (methyl ethyl ketone), a solvent available at hardware stores [3].

Drill out the grab iron holes in the sides with a #79 drill bit if they fill in with epoxy when the doors are reinforced.

Attach the sides to the floor by running a bead of CA along the bottom of the 6" x 12" strips of one side. Attach the floor to the strips, and center the floor with the side, making sure that the floor is at a 90° angle to the side.

Once the first side sets up, attach the second side like the first, and run a cross piece across the top of each side. This an HO scale 6 x 12 cut to an actual length of 1.016". Note that the cross

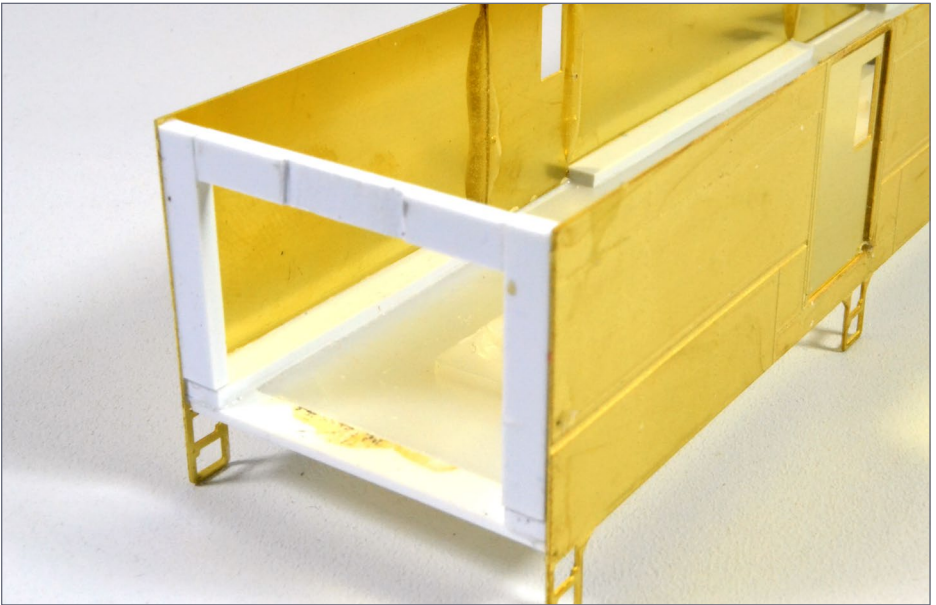

4. The sides and floor are joined using the 6 x 12 framing as a "skeleton" to build around. The end that will be the flat, brass end has had a notch cut into the upper frame span piece to clear the end door.

B-27 BAGGAGE CAR | 8

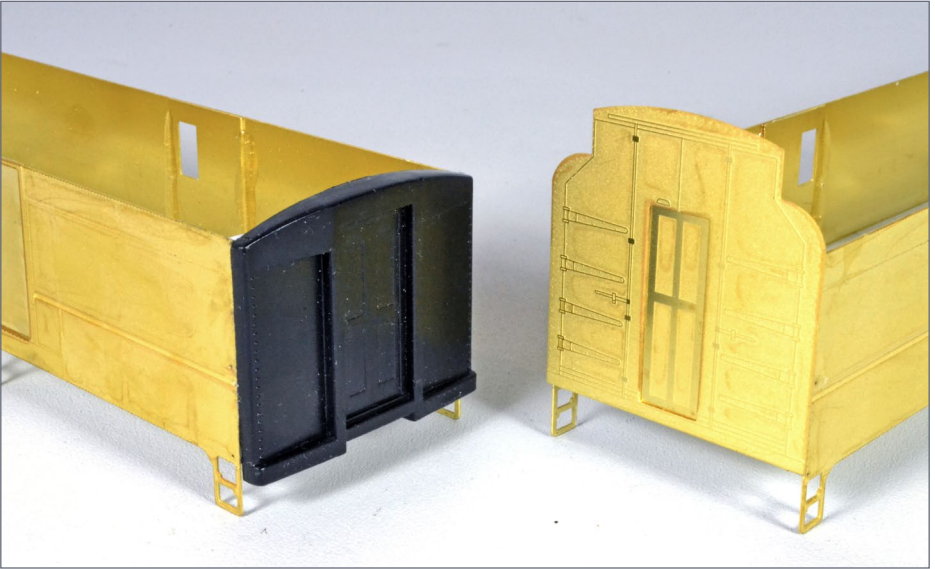

5. The two ends are joined to the basic box to finish the car body. Note that the plastic end is attached to the shorter side of the car as measured from the small baggage doors.

brace for the end of the car that gets the flat brass end is notched to clear the door.

At this stage, it is important to notice that the distance from the end of the car to the small door is not the same on each side of the car. The flat brass door is attached to the longer end.

On one brass side piece, there is a scale 11' 3" from the edge of the left small side door to the side's left edge. At the right side of this same piece, there is 12' 3" from the edge of the right-hand small door to the side's right edge.

The opposite is true of the other side – the shorter distance from small door to side edge will be to the right. The flat brass end is glued to the end of the car with the 12' 3" distances from the small door edge to the end of the sides.

B-27 BAGGAGE CAR | 9

Glue the ends to the car using CA for the brass end and MEK for the plastic end. To align the brass end, hold the wood roof in place while placing the end. In my experience, CA tends not to grab at once, giving a couple of seconds to align parts. Align the plastic end by placing the plastic clerestory end piece on the top of the car and push the end piece against it, while centering it side to side. Be careful to not glue the plastic roof end to the end at this time [5].

Make the end sill for the brass end from a strip of 6" x 12" cut to 10 scale feet long. Put this against the end of the car and mark the edges of the coupler pads on the end sill. My measurement put the marks 0.409" apart, centered on the end sill. This is the outside edge of the sill. Draw a line from each mark to each end, 6" from the outside edge. Using rail nippers, remove this wedge of

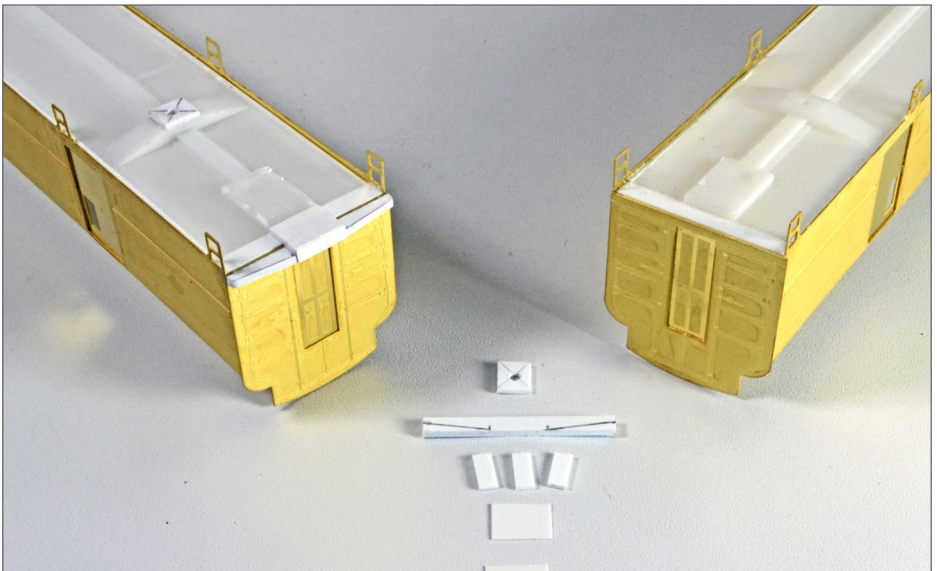

6. The coupler mounting pads are extended to the end of the end sill using styrene strip, The sill for the flat, brass end is fabricated with styrene strip.



7. The fabricated end sill is capped with a piece of strip styrene cut to fit the width of the coupler mounting pad.

material from the sill, then round the ends of the sill with a file, and CA it to the end door of the car with its bottom flush with the bottom of the end [6, 7].

Coupler pads

The coupler pad is extended for each end as follows. The illustrations show only the end door: Cut three pieces of scale 4" x 12" to 0.308" long for the brass end, and three to 0.163" long for the plastic end. Lay these side by side between the coupler pad and end. These extension pieces are then capped with a piece of 0.010" styrene cut 0.409" x 0.308" for the brass end and 0.409" x 0.163" for the plastic end [6].

Cap the end sill on the end door with a piece of 1" x 10", 0.409" centered on the endsill matching the coupler pad extensions [7].

B-27 BAGGAGE CAR | 11

Also shown in [6] are the truck bearing plates, made from 0.040" styrene sheet, cut to 0.250" x 0.300". I found the center by drawing lines from corner to corner, and then drilled for a 2-56 clearance hole. These were bonded to the bolsters with MEK.

Assemble the Branchline trucks next, leaving off the brake beam on the end that will be closest to the center sill of the car. I used Kadee red washers to space the side frames away from the bolster plate so they will not bind on the Kadee 36" wheelsets [8].

Next I turn my attention to the car's underbody and modify the Branchline center sill pieces. These were shortened by removing a scale 1'-9" from each end. Then cut a notch into each end going back two scale feet. Also remove the angle that runs along the top of each center sill piece (the edge that goes against the car's bottom). This angle goes into a slot in the bottom of Branchline model cars and is not needed in this application [9].

Finish up the center sill by gluing the two sides together using the cross braces. Add the Branchline brake cylinder and air lines



8. The Branchline trucks are assembled with minor modifications – Kadee red washers space the side frames out from the central span piece to keep the Kadee wheelsets from binding, and the rear brake beam is left off to avoid interference with the center sill.

B-27 BAGGAGE CAR | 12



9. The center sill is modified by shortening and notching each end. In addition, the mounting tab is removed from each center sill's top.

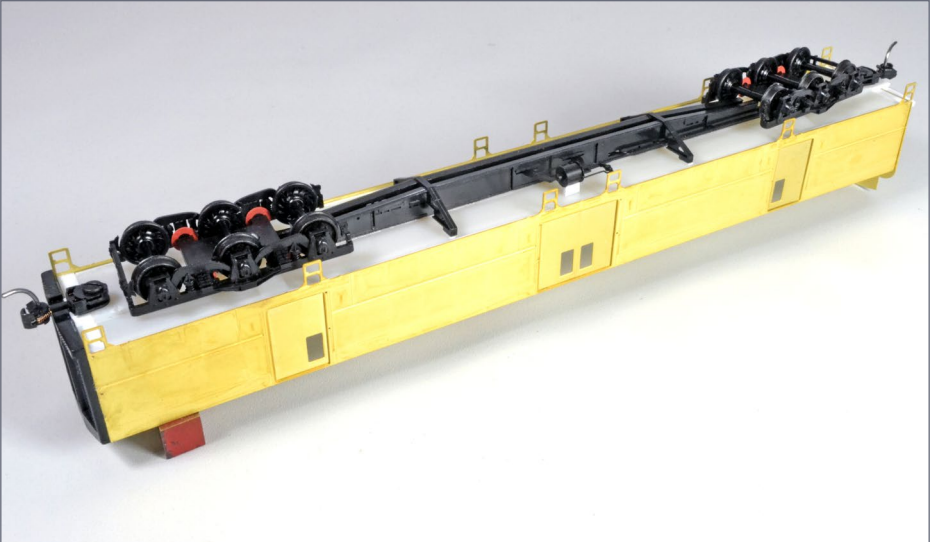

10. The center sill, air brake cylinder, trucks and couplers mount onto the carbody. Note that the brake cylinder points to the brass end.

B-27 BAGGAGE CAR | 13

that are included with the center sill parts. This assembly is then glued to the car's underbody with MEK [10]. Note that the brake cylinder points to the flat, brass end of the car, and is supported by a 0.182" long piece of scale 6" x 10" styrene strip, mounted on edge. The Kadee #36 couplers are mounted using the #30 series coupler box. Mount the coupler with the spring underneath the coupler, using the thicker of the lid options, and put a Kadee gray washer between the coupler and the pad to get the correct height. Because these are extended length couplers, the mounting hole was drilled and tapped for a 2-56 screw 0.370" back from the edge of the end sill. This puts the coupler head in the same position a #5 coupler would be, but gives additional swing for curves.



11. Underbody details are mounted to the underbody. After assembly, I discovered that the twin air tanks in the foreground should have been mounted closer to the brake cylinder, and a second battery box installed next to the cross brace, mirroring the battery box on the other side. C'est la vie!



12. A closeup showing the brace beams, generator, and truck mounting plate.

As shown in [11 and 12], mount the underbody details from the Branchline Pullman underbody detail set, including the brake lines that come with the center sill. Unfortunately, the triple valve included with the center sill is a poor representation, so I substituted one from my scrap box, from a Bachmann P-70 coach. An appropriate substitute from Bethlehem Car Works KitBits is called out in the parts list.

Build the roof

Moving from bottom to top, the roof is next. You probably won't want to do what I did, for reasons that I will explain in a moment. I offer an alternate way to do the roof that will look better. Sometimes I get too clever for my own good, and this was one of them. The KitBits roof I selected is a wood core with two

B-27 BAGGAGE CAR | 15

correctly shaped plastic end caps. One is needed for this particular car. I glued the end cap onto the top of the car's plastic end, and then cut the roof to fit tightly between the plastic end cap and the flat, brass end at the other end of the car.

My thought on this was that the two ends would hold the center section in place, but leave it removable. And, in fact, that is how it worked out. It also left an unsightly gap between the wood section and the plastic end cap, which is evident in several of the photos. A better way would be to cut the wood roof to length, roughen up the end of the plastic cap with sandpaper or a file, and then epoxy it onto the end of the roof. Any seam can then be blended with putty and sanding. In any event, I had to cut the wood roof to a length of 69' and then sand it to a final length by



13. Eleven screen vents are super-glued to each side of the clerestory, using a styrene spacer.



14. The plastic end has a plethora of grab irons, along with a brake wheel and drip strip.

test fitting. Seal the wood with three coats of Scalecoat sanding sealer, sanding with #000 steel wool between each coat.

Before attaching the 11 screen vents to the clerestory, make a spacer from scale 6" x 12" styrene strip cut to 0.388". The spacer is then laid onto the clerestory against the plastic end cap, and a screen is butted up against it. Attach each screen to the roof with CA. When the glue is set, move the spacer to the next position, abutting the attached screen, and fix the next screen to the roof [13].

Detail the plastic end with drop grabs, L grabs, vertical grabs, a drip strip, and a brake wheel, housing, and chain. [14]. The drop grabs can be Detail Associates #2202 or Tichy #3015. Drill the holes but wait until after painting to attach the grabs, to ease masking of the end before painting the underbody. The L

B-27 BAGGAGE CAR | 17

grabs are DA #6504 Caboose End Grabs, modified by bending the bottom leg 90 degrees to form an L. The length of this bend corresponds to the width of my fine, smooth jaw pliers, and is about 6" to 9" in length.

The vertical grabs are DA #6602 Roof Grabs. The drip strip is scale 1" x 3" styrene strip cut to a scale 4' long, and shaped into an arc using tweezers. Finally, I used a brake wheel and housing from my scrap box (from a Proto 2000 gondola I believe) but you can use parts from Tichy #3013 Westinghouse AB Brake set on your model. The chain is Builders in Scale #251 40 links per inch, and was cut to length before super-gluing in place.

The brass end of the car gets only drop grabs and L grabs [15]. Note the Archer decal rivets along the end sill. Add these after



15. The brass end has fewer grabs, but Archer rivets, which shouldn't be added until immediately before painting.



16. Drip strips are formed from styrene strip, and glued to the roof above each baggage door.

the car has been washed and is ready for painting. Don't forget to reopen the drop grab holes after applying the rivets! I didn't, and had a heck of a time finding the holes when attaching the grabs. There should really be a "Caution: Genius Model Railroader at Work" sign atop my workbench.

Drip strips are added above each baggage door. These are the same 1" x 3" styrene strip used on the end, cut to 4' long for the small doors and 7' long for the large doors. Bend them to a shallow "V" using tweezers, and attach with ACC. [16]

The rivet strips left on the fret back at the beginning of construction can now be removed and CA'd into the indentation along each section of belt rail. I ran a bead of glue into the indentation and then placed the strip, pressing it into place with a wooden

B-27 BAGGAGE CAR | 19



17. Overall view of the finished car after addition of the belt rail rivet strips before painting.



18. Same as Fig 17, but other side of car.

B-27 BAGGAGE CAR | 20

skewer. Remember, the distance between each door is not the same, so test fit each rivet strip prior to attaching it. See [17] and [18] for the finished car prior to painting.

To ensure good paint adhesion, remove the wood roof, trucks, and couplers, and dunk the car body in warm water with a little dishwashing detergent. After several minutes, use a soft brush to go over the car and wash it, and then rinse it thoroughly with tap water. Etch the brass parts by soaking the car in white vinegar for 30 minutes. After again rinsing with tap water, wear latex gloves when handling the car to avoid leaving any finger oils.

After all of this cleaning and drying, apply two other details before painting. The Archer rivet decals can go on now. Glue 28 pennies (2.5 ounces) into the car for weight, using clear latex caulk. I arranged the pennies two deep in a zig-zag pattern.

Painting

I painted my model using craft paints. See “Using Craft Paint as a Replacement for Polly Scale Acrylics,” *Railroad Model Craftsman*, June 2015, pp38-41. I used Folk Art #467 Italian Sage for the gray, Americana #DA167 Payne’s Gray for the blue (no, that is not a typo), and Americana #DA607 Lamp (Ebony) Black for the black. After the paint cured for a day or so, I over-sprayed the model with Liquitex Gloss Medium and Varnish, thinned the same as the craft paint to provide a glossy surface for the decals.

Lettering comes from Microscale decals. The DA #6605 36” Passenger Grabs were glued into the pre-drilled holes at the baggage doors using CA, and left in natural stainless steel. Attach the end drop grabs into their pre-drilled holes with CA, and touch them up with Payne’s Gray. Install the roof, trucks, and couplers and over-spray the model with a 1:1 mixture of gloss medium as used above and Liquitex Ultra Matte Medium, thinned the same as the craft paints. This gave the car a nice, semi-gloss finish.



B-27 BAGGAGE CAR | 21

Attach a Branchline diaphragm to the plastic end of the car. Assemble the diaphragm according to the instructions, remove the mounting pins, and add scale 2" x 6" styrene strip to the back of the diaphragm to space it out from the roof overhang. Paint it with Folk Art #925 Wrought Iron before attachment [19]. To finish up, glue #1 microscope cover glass to the windows for the look of real glass, and lightly weather the car by airbrushing thinned gray and grimy black colors. I typically use 80 drops of color in one ounce of rubbing alcohol for this type of weathering. The finished car is shown in [20 and 21]. This was a fun project and I plan to build the other B&O head end cars offered by Model Railroad Warehouse to fill out my passenger trains with realistic mail and express traffic. ✓



[Click here to rate or comment on this article](#)



19. The diaphragm for the plastic end is modified with styrene strip spacers so as to not interfere with the roof overhang.

B-27 BAGGAGE CAR | 22



20. Left side of the finished car.



21. Right side of the finished car.

B-27 BAGGAGE CAR | 23



22. These cars were very useful to the MOW department and several lasted well into the CSX era. 911516 is shown at Grafton, WV in late 1990. D. Scott Seders photo



23. C-10 749 is shown at "National Station" on the Buckeye Central short line railroad. John Teichmoeller took this photo at the B&ORRHS Annual Convention in Columbus, OH in October of 2001. 749 was apparently subsequently destroyed. John Teichmoeller photo



24. A close-up of 749's end doors. It is unknown if the large pipe on the roof was installed later, or existed when the car was in service.

Please tell your buddies about MRH!

WE RELY ON WORD-OF-MOUTH TO GROW AND A BIGGER CIRCULATION MEANS MRH IS MORE LIKELY TO STICK AROUND FOR A LONG TIME TO COME!



PARTS LIST

Model Railroad Warehouse

772.2-74: B&O Class B-27 Express/Baggage Car

Bethlehem Car Works ex-Branchline

*#51115 Pullman Underbody detail set

*#51003 80' Coach centersill w/brake

*#51105 Diaphragms

#50001 Pullman 2411 trucks, bottom equalized

Bethlehem Car Works KitBits

*#108 Screen Vent for Passenger Cars

*#20 70'3" floor

*#22D Baggage Car Ends

*#130 Clerestory Roof Kit

#45 Triple Valve (Optional for better triple valve casting.)

Kadee

#36 couplers

#521 36" Code 110 wheels

#208 Red Washers

#209 Gray Washers

Detail Associates

#6504 Caboose End

#6602 Roof Grabs

#2202 Drop Grabs (or Tichy #3015)

#6605 36" Passenger Hand Rails

(Note: Tichy makes many grabs in the same size as DA, or you can bend your own using a Mission Models "Grabhandler" or similar tool.)

Evergreen Styrene

- #8612, HO Scale 6 x 12
- #8610, HO Scale 6 x 10
- #8412, HO Scale 4 x 12
- #8404, HO Scale 4 x 4
- #8206, HO Scale 2 x 6
- #8110, HO Scale 1 x 10
- #8103, HO Scale 1 x 3
- #147, 0.040" x 0.156"
- #9040, 0.040" thick sheet
- #9010, 0.010" thick sheet

Tichy

- #3013 Westinghouse AB Brake Set

Archer Rivets

- #AR88014 Resin Fastener Heads

Builders in Scale

- #251 40 Links per inch Chain

Microscale Decals

- #87-797 B&O Passenger Car
- #87-798 B&O Stripes

Plus paint of your choice.

**These parts are included in Model Railroad Warehouse #772.2-74P B&O B27 KitBits & Branchline Carbody Parts Set for use with #772.2-74 Sides*



GREGORY M. LARocca



When Greg was four, Santa left two Tyco train sets under the Christmas tree. After he begged and pleaded for 10 years, his parents finally gave him permission to build a permanent layout in the basement. That layout lasted only a couple of years. Its successor lasted more than a dozen. By the time it was started, he had discovered the Baltimore and Ohio Railroad and has been modeling it ever since.

His current layout fills one room of his basement and depicts the B&O's line from Cumberland to Connellsville over Sand Patch Grade. He models the railroad as it was from 1956 to 1964. Those dates allow him to run the equipment that he likes the best.

He is married, has two children, and is a senior research technician in the Neurobiology Department, School of Medicine at the University of Pittsburgh.

(Here he is with his oldest daughter Rachel, installing the cardboard webbing for Haystack Mountain on his B&O Sand Patch Division layout.)



[Click here to rate or comment on this article](#)

Model Railroad Hobbyist *Store*

We have more Allagash!

VIDEOS

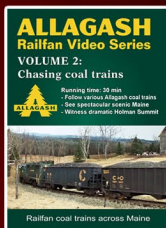
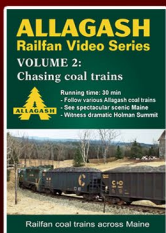
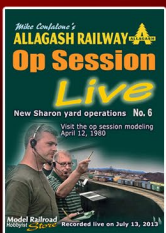
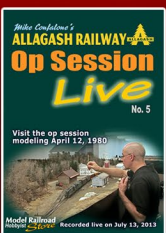
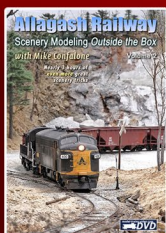
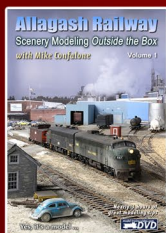

BOOKS

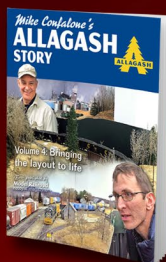
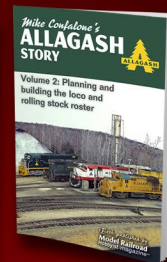

Shop the MRH Store >>



• INDEX



SUBSCRIBE
(free)

• TABLE OF CONTENTS

DCC projects using the **Arduino**

BY DR. GEOFF BUNZA

Photos by the author

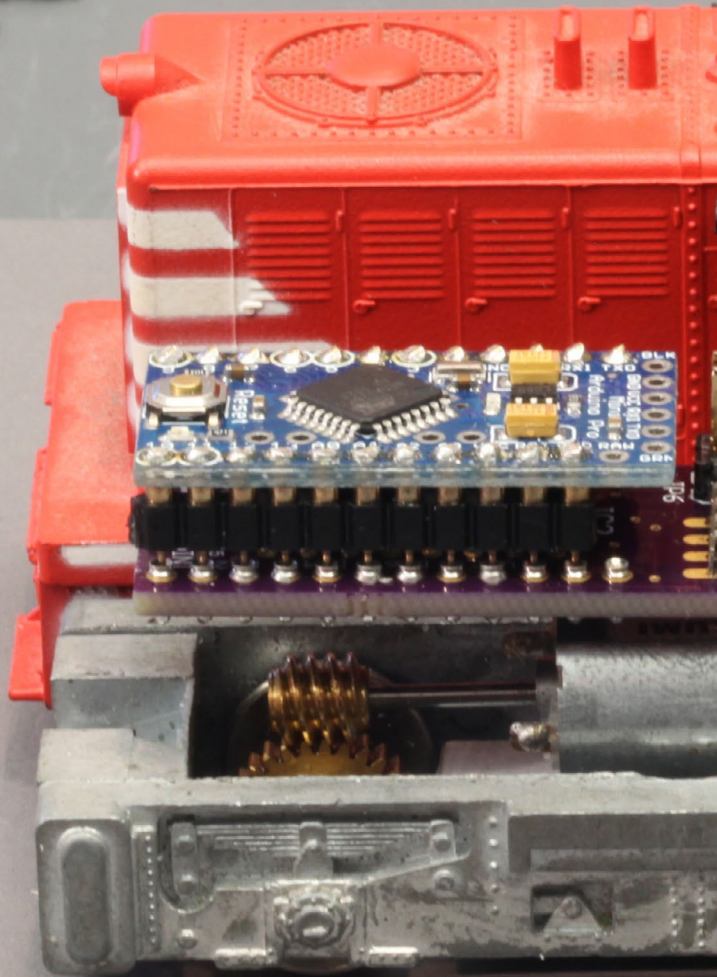

1. This is an Arduino-based mobile decoder in a loco. This isn't a project for the faint-hearted, but it illustrates just how incredibly versatile and powerful the Arduino is for model railroaing use.

• [INDEX](#)

• [TABLE OF CONTENTS](#)

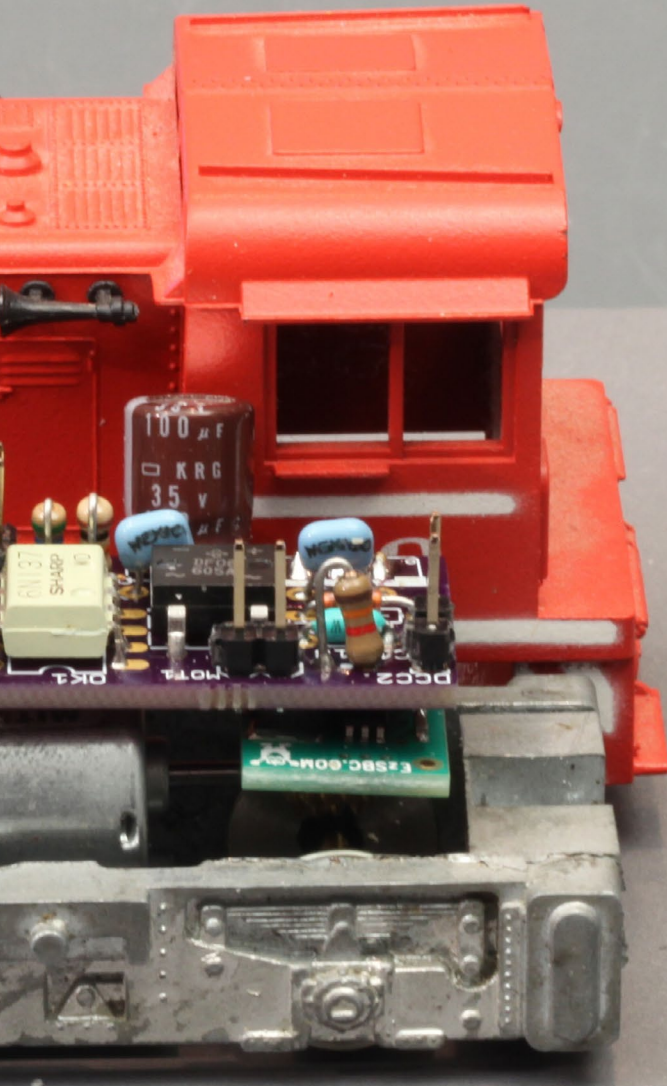

Advanced Arduino projects for DCC ...

• [INDEX](#)



SUBSCRIBE
(free)

• [TABLE OF CONTENTS](#)



Click here to rate or
comment on this article

IN THE DECEMBER 2016 *MODEL RAILROAD HOBBYIST*, I wrote an article entitled “A modeler’s introduction to the Arduino.” This article offered a collection of simple model rail-roading applications using Arduino controllers. In this article, I’m going into far more advanced DCC applications of the Arduino to show the incredible versatility Arduinos offer.

While this article offers much more complicated projects, it also assumes only a basic knowledge of soldering. I recommend reading my December article first as a good lead-in to the topics here if you’d like to explore more advanced DCC-specific projects with the Arduino. I build on the fundamentals presented in the previous article as I explore these more adventurous DCC projects.

Now, let’s see what we can build!

DCC++ base station with a low cost JMRI interface

When I first came across references to the DCC++ project, I was so impressed that I thought more modelers should be aware of its capabilities. Simply put, if you take the two boards pictured opposite [2] (the Uno’s motor driver shield and the Arduino Uno), then download and add the efforts of Gregg E. Berman (creator of DCC++, see: sites.google.com/site/dccppsite) and finally add two wire jumpers: ***you get a DCC base station!***

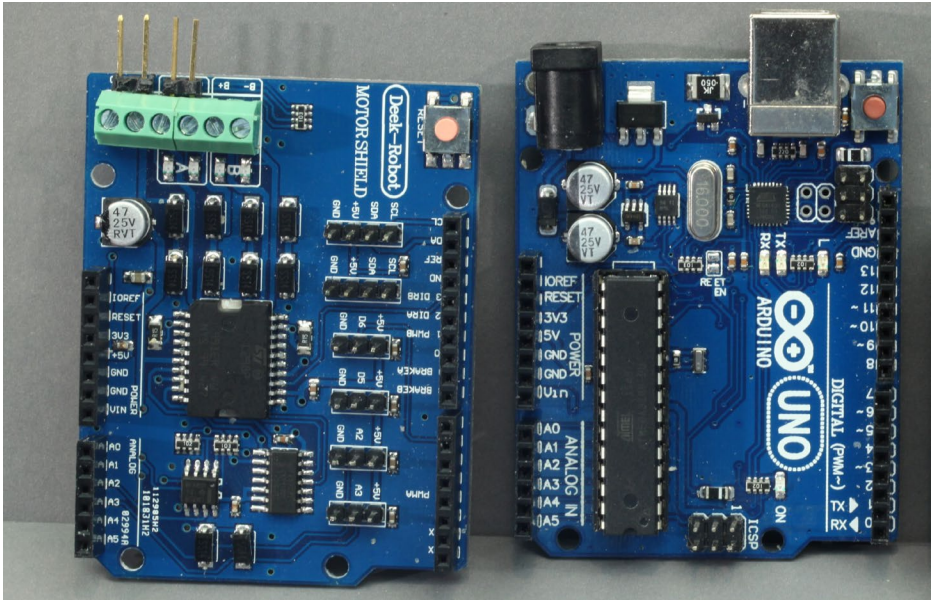

2. Motor driver shield (left) and Arduino Uno (right).

What's in this article?

The first part of this article outlines how a modeler can build a DCC base station with the Arduino, which is just a bit more involved than the lighting projects in the December article.

Following that, we look into a series of very low cost, multi-function DCC decoders that can cope with LEDs, servo motors, DC motors, stepper motors, and play audio. While these are not beginners' projects, they do demonstrate the powerful capabilities of Arduinos.

Do note that the DCC multifunction decoder is a project that modelers from around the world have contributed to from its inception in the summer of 2014. ■

ARDUINO DCC PROJECTS | 5

Read the material on each of Gregg’s pages and have a look at his YouTube videos. His documentation is quite good.

Are you a fan of JMRI, the free, open source Java Model Railroad Interface (see sidebar)? The Arduino-based DCC++ boards can be controlled with multiple JMRI throttles – yes really!

DCC++ first caught my attention when Dave Merrill pointed out its ability to work with JMRI in this MRH forum thread: *DCC++ on Arduino supported by JMRI* (mrhmag.com/node/24757).

Here’s how to make a DCC++ base station.

Step 1: Let’s build the basic unit. In addition to the Uno control board, you will need an “Arduino Motor Shield R3.”

Sources for the UNO include: adafruit.com, sparkfun.com, pololu.com, allelectronics.com, digkey.com, surplusgizmos.com, frys.com, eBay.com, and amazon.com.

Sources for the R3 include: amazon.com (amazon.com/dp/B006UTE70E), dfrobot.com, and eBay.com (ebay.com/itm/262336202340).

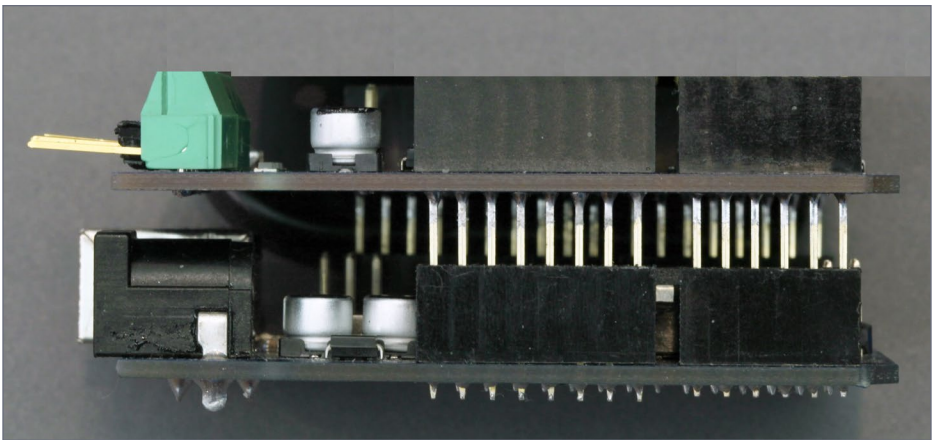

3. Motor driver shield inserted into the Arduino Uno.

The Java Model Railroading Interface (JMRI)

For those who may not know, JMRI is a collection of free software tools that allows connecting a PC, Mac, or Linux computer to many DCC base stations, including the Arduino-based DCC++ system I discuss in this article.

JMRI also includes decoder programming tools, signaling tools, WiFi connected throttles, operations tools, and more such goodies, all free!

I do not cover the details of JMRI DCC installation and operation here. This article does discuss building an Arduino interface to JMRI, however.

Although using the JMRI toolset is beyond the scope of this article, the JMRI website (jmri.org) has a wealth of information including instructions on downloading and setting up the JMRI toolset.

Recent JMRI releases can directly control the Arduino board combo without any other software on your PC. Other modelers, such as the inventive Dave Bodnar, have added even more capabilities.

You can follow the DCC++ exploits of Dave Bodnar in this MRH thread: *My Experiments with DCC++* (mrhmag.com/node/25429).

Dave discusses many interesting add-ons, such as adding a booster or doing a remote handheld throttle. Talk about some great stuff! ■



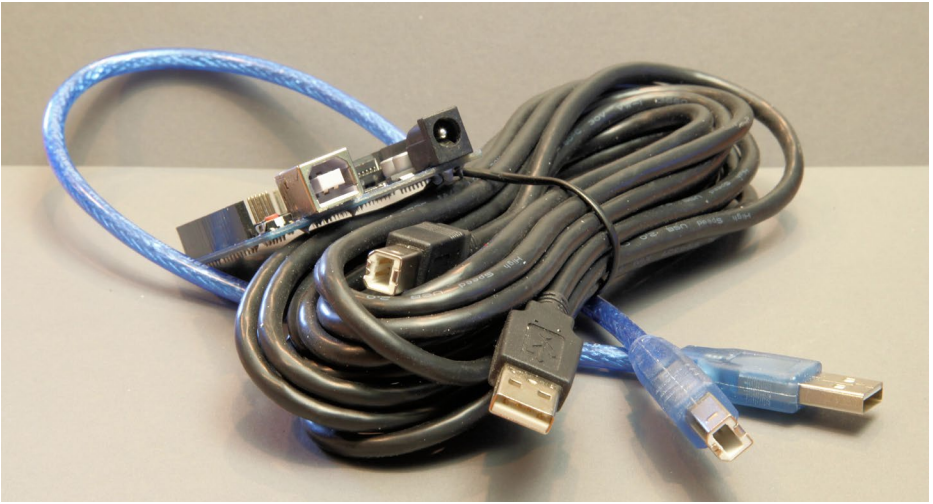

5. USB AB cables for the Uno.

Source for suitable power supply: Amazon.com (a.co/iRcqZtn).

This power supply includes screw terminals to ease your power wiring job. This supply will also power the Uno at the high end of its safe input power range.

If you want to run the DCC bus at a higher voltage, follow the advisory here:

github.com/DccPlusPlus/Documentation/blob/master/Motor%20Shield%20Pin%20Mappings.pdf

You will have to cut a jumper wire on the motor shield before applying power.

Step 4: Load the Uno exactly the same way that was covered in my article in the December 2016 issue of MRH. I've also included these instructions [in the bonus materials for the March issue](#).

Also from the bonus materials, load the entire **DCCpp_Uno** folder into your ...**Documents**\Arduino\ folder where your



ARDUINO DCC PROJECTS | 9

sketches are stored. Then open the sketch **DCCpp_Uno.ino** and load it into your Uno.

The latest version of the DCC++ base station software can be found here: github.com/DccPlusPlus/BaseStation.

Once you successfully load your Uno you should close down the Arduino editor (IDE).

Step 5: Download and install (if not already using it) the latest production release of JMRI from jmri.org/download/index.shtml.

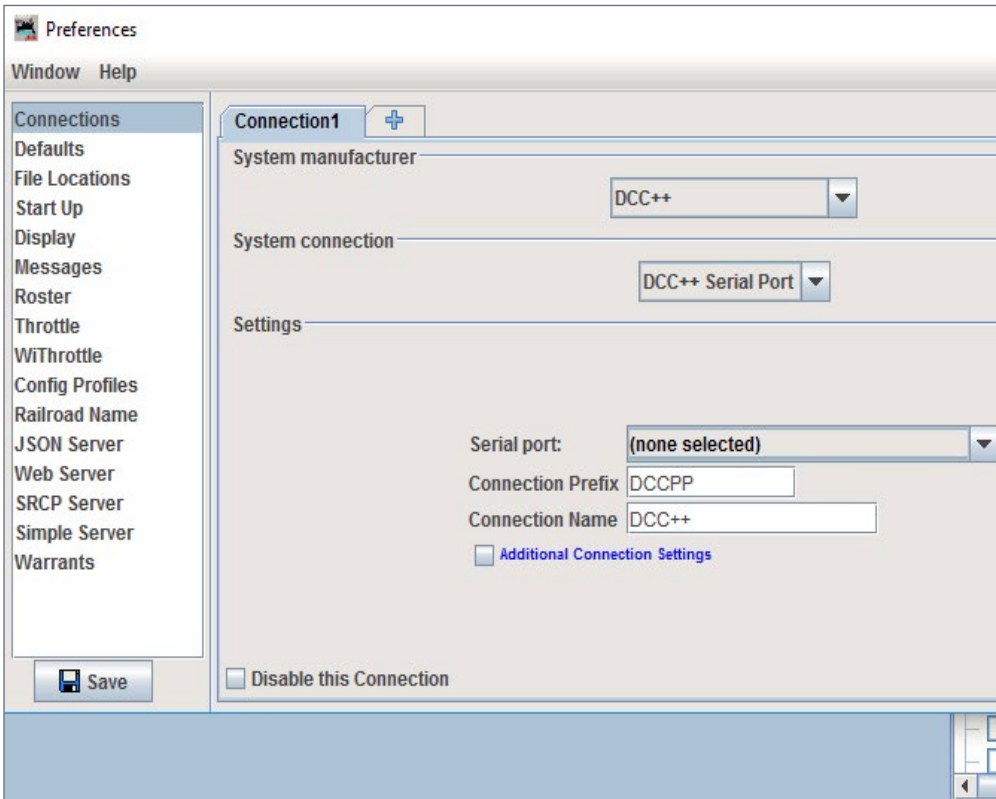

6. JMRI preferences set up screen for DCC++.

ARDUINO DCC PROJECTS | 10

You will need to configure the connection to your Arduino/DCC++ controller by setting up the connection in JMRI preferences: Choose System Manufacturer: DCC++, and choose System Connection: DCC++ Serial Port [6]. This is the same connection you used to download your Uno sketch, and it's the same Serial Port – COMxx from your Uno connection.

Once you have completed this set-up, you can open up a JMRI throttle and run some trains!

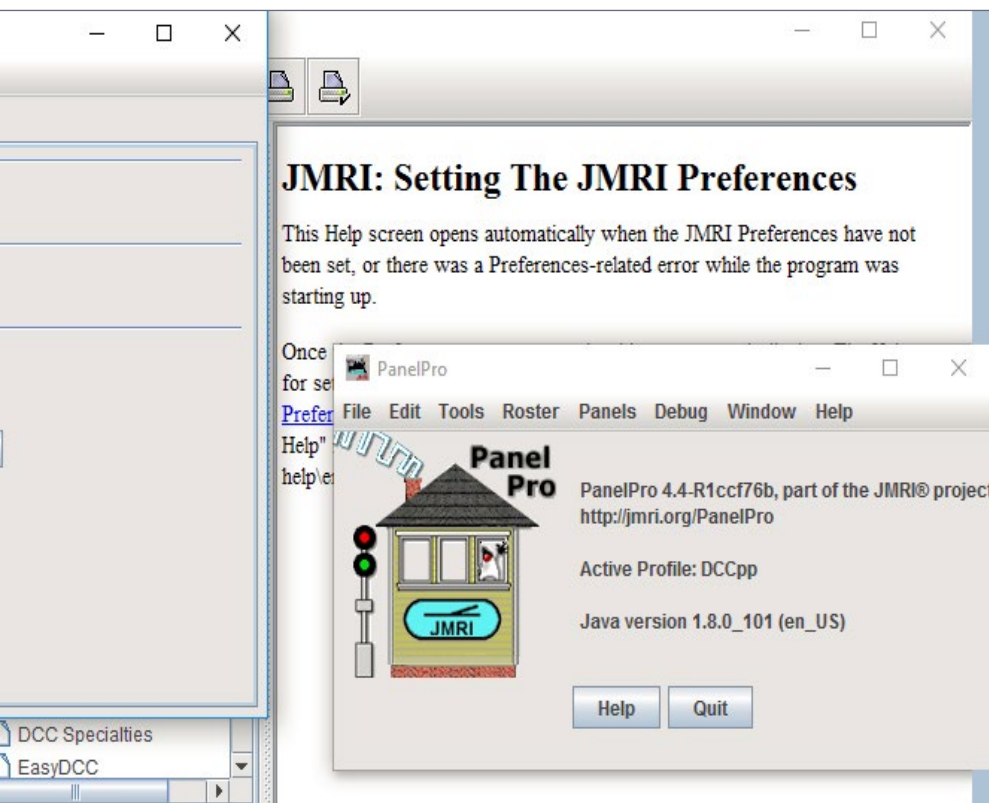

ARDUINO DCC PROJECTS | 11

This is a simple, low cost, and effective interface to JMRI and it supports multiple throttles and decoders. It also enables a modeler to easily set up and operate a secondary DCC bus which might be used to control a trolley, a mining line, lighting and animations operated via DCC decoders, or even a separate signaling system.

Some modelers are even looking to DCC++ as a low cost entry point to a DCC based layout. There is much more to DCC++ and to JMRI, so I encourage you to explore!

Low Cost DCC Mobile/Function & Accessory Decoders

If you are interested in decoders with 17 independent pin functions, where each pin can be set up to perform one of six different operations, all for a cost of \$5-\$8, then read on!

In this section, I describe a family of DCC decoders that you can build yourself by loading one of 18 pre-configured Arduino sketches. Those who have followed my work before should take note of two new decoders – one for generating audio, and the other for stepper motor control.

Like most decoders, you will be able to customize these further by changing CV values in the decoders. Beyond controlling LEDs and two motors, you can use these to control up to 17 servo motors, a stepper motor, pairs and groups of LEDs, and generate a multitude of sounds.

First, I'll cover the range of decoders that you can build, then I will move to focusing on the basic construction of the decoder hardware. Last, I cover the technical details of the decoder operation.

How it all started: Back in August of 2014 I proposed a nice, simple idea in a blog post to control animations. Commercial DCC decoders and Arduinos had already been used to create animated scenes like this [8, opposite]:

ARDUINO DCC PROJECTS | 12

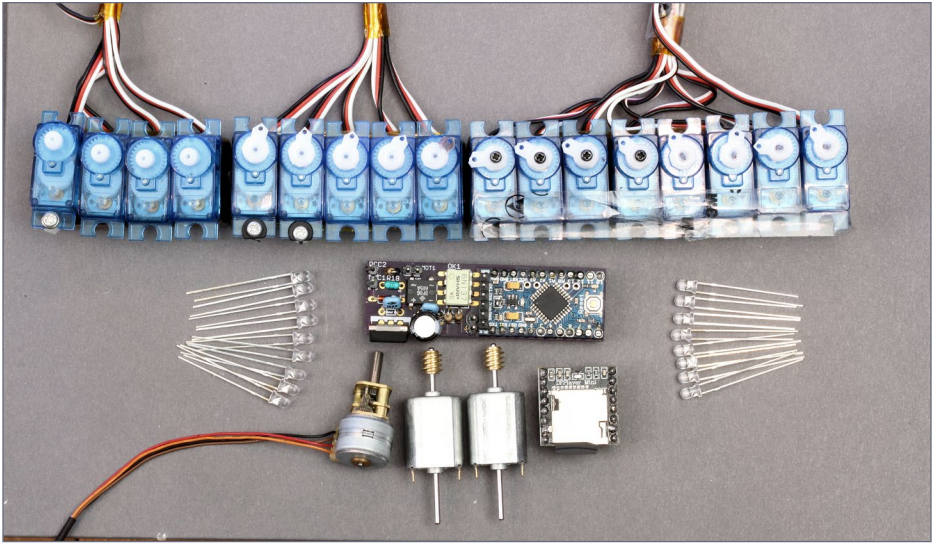

7. An example of devices these Arduino-based decoders can drive.



Playback problems? [Click here ...](#)

8. A DCC decoder-based animation.

But with a need for more customized control of LEDs and motors for animation, I looked for more alternatives. With the encouragement, suggestions, and interest from many modelers, the features and functions naturally evolved, or should I say, got completely out of control!

What can you do with a DCC decoder?

After reading my December 2016 MRH article, “A modeler’s introduction to the Arduino,” and the DCC++ project description in this article, you may be realizing it’s the sketch we load into the Arduino that determines the behavior we see at its pins.

The Arduino-based decoders I’m about to describe are based on essentially the same hardware (although we can consider variations here too). With what’s available, you can configure a decoder to have a variety of characteristics and either be a mobile/function decoder or a stationary accessory decoder.

See the sidebars “Arduino mobile DCC decoder sketches” and “Arduino accessory DCC decoder sketches” for an overview of the sketches currently available. The description lists the name of the sketch on the upper left which needs to be loaded into your Arduino. All these sketches and libraries listed are [included in the subscriber bonus materials for the March issue.](#)

Decoder construction

These DCC decoders were originally designed for animation applications, so cost and size were very important criteria. The availability of very low cost (\$2-\$6) small Arduino boards (Pro Mini [11]) is an obvious benefit. Alex Shepherd’s excellent **NmraDcc** library for the Arduino sealed the decision for me.

Arduino mobile DCC decoder sketches

The following is a list of Arduino mobile decoder sketches that can be used with a DCC system.

SERVO / LED CONTROL

Dec_7Serv_10LED_6Ftn	7 Servo 10 LED 6 Function
Dec_10Serv_7LED_6Ftn	10 Servo 7 LED 6 Function
Dec_13Serv_4LED_6Ftn	13 Servo 4 LED 6 Function
Dec_15Serv_2LED_6Ftn	15 Servo 2 LED 6 Function

These are all configured as Mobile/Function Decoders controlling a group of servos and LEDs – the number of each is in the sketch name. Each pin can be set to perform one of six functions: LED on/off, LED blink, Servo motor control, dual LED blink, Pulsed output, and LED fade on. Blink rates can be changed, servo start, stop, and rate of travel can be changed, and pulse duration can be changed all with DCC CV settings per pin. All preset configurations can be reconfigured with ops-mode DCC programming. To be clear, one of these decoders can control 17 servo motors, or 17 LEDs, or any combination thereof.

Dec_17LED_1Ftn	17 LED ON/OFF Control
-----------------------	------------------------------

This is the simplest decoder (internally). Each DCC Function only turns an LED on and off. This is included for those who might want to learn about the internal operation of the decoder.

Dec_17LED_6Ftn	17 LED 6 Function
-----------------------	--------------------------

Each DCC Function turns an LED on and off, but each pin can be reconfigured to one of six functions.



Dec_Dir_and_Fade

17 LED with Dual Direction Control & FADE

Each DCC Function turns an LED on and off based on direction of travel, with fade on and fade off. This is a mobile decoder with a configurable list defining how each of the 17 function pins operate:

- “0” allows for normal on/off control with fade on and fade off
- “1” allows for normal control when the decoder sees a forward speed setting. Reverse turns the LED off.
- “2” allows for normal control when the decoder sees a reverse speed setting. Forward turns the LED off.

```
byte LED direction [] = {0,1,2,0,1,1,1,1,2,2,2,2,0,0,0,0,0};  
//0=On/Off, 1=On Forward, 2=On Reverse
```

Dec_SMA12_LED_Groups

LED group control for euro signaling

Each DCC Function turns an LED on and off. This is a mobile decoder with five pin sets of arbitrary lighting functions, set in 4-function groups with fade on and fade off. Requested to control German signals with perhaps other uses as well:

- F0-F3 controls preset light group pins D3-D7
- F4-F7 controls preset light group pins D8-D12
- F8-F11 controls preset light group pins D13-D17.



[Click here to rate or comment on this article](#)

MOTOR CONTROL

Dec_2MotDrive_12LED_1Srv_6Ftn **Dual motor drive, 12 LED 6 Function**

This is a “mobile/function” decoder that supports simple speed control via throttle speed setting for two motors. Motor selection is through motor select Function 13 (Motor1) and Function 14 (Motor2). Motor speed for each can only be changed if the corresponding Function is on (F13 and/or F14).

Motor speed is maintained if the corresponding Motor select function is off. Thus, each motor can be controlled independently and run at different speeds. The other 12 functions are configurable but are preset for LED on/off control.

Please note, time dependent functions like servo control and motor speed control interact. Function10 is pre-configured to operate a single servo. I have tested servo operation simultaneous with motor speed control and it worked, but motor timing was affected.

I am using this with small motors (50ma drive) in situations where such timing is not at all critical. Developing better timing control is left as an exercise for the reader.

Dec_2Mot_10LED_Audio_6Ftn **Dual motor drive, Audio Output, 10 LED 8 Function**

This is a “mobile/function” decoder that adds audio play to dual motor control and LED functions. Audio tracks or clips are stored on a micro SD card for playing, in a folder labeled mp3, with tracks named 0001.mp3, 0002.mp3, etc.

F0 is configured as an on/off LED function, F1-F5 play audio tracks 1-5 respectively. F6 plays a random selection in random order of tracks 1-6. F7-F9 control LEDs on Pro Mini Digital Pins 11-13.



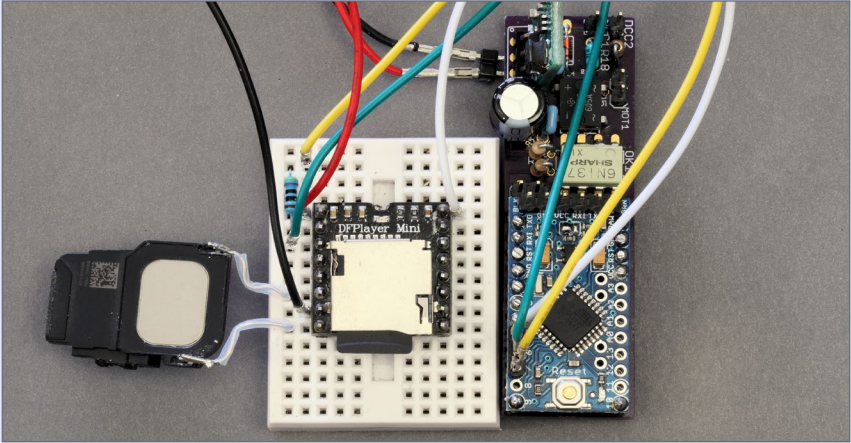

9. Audio setup with an Arduino DCC mobile decoder.

Simple speed control is made via throttle speed setting for two motors. Motor selection is via motor select Function 13 (Motor1) and Function 14 (Motor2). Motor speed for each can only be changed if the corresponding Function is on (F13 and/or F14).

Motor speed is maintained if the corresponding motor select function is off. Thus, each motor can be controlled independently and run at different speeds. The other functions are configurable but are preset for LED on/off control.

DFPlayer Audio Module Wiring to Decoder (Dec_2Mot_10LED_Audio_6Ftn)

DFPlayer

Pin	Other	Pro Mini Pin
1		+5 volts / VCC
2	470 Ohm 1/4 Watt Resistor	D7
3		D6
6	8 Ohm Speaker	
7		GND (Ground)
8	8 Ohm Speaker	
16		D5

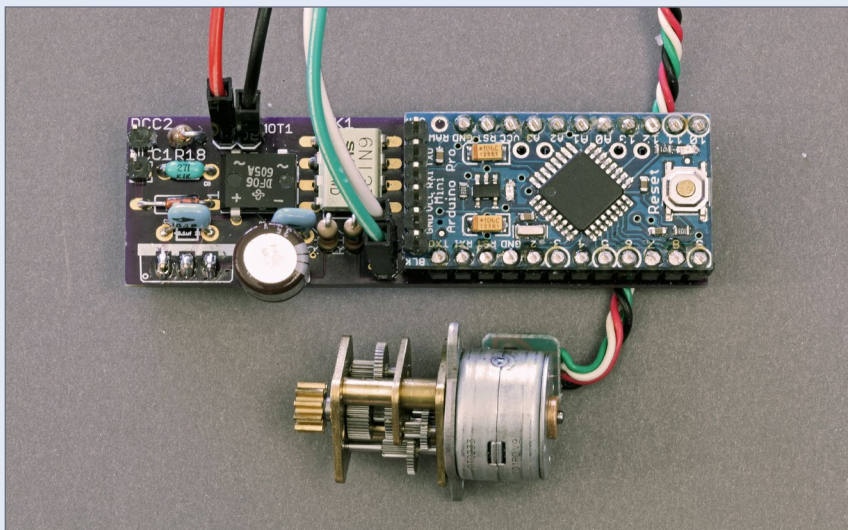

10. Stepper motor connections to an Arduino DCC mobile decoder.

Dec_Stepper_8Ftn

Single Stepper Motor Control

This is a “mobile/function” decoder that controls a single four wire stepper motor (5 or 12 volt) via throttle speed setting and a multiplier which can be set in CV121. Stepper speed is pre-set in the sketch but can be changed.

The library also supports setting acceleration/deceleration for the stepper. The other functions are configurable but are preset for LED on/off control. No servo motor control is available. Steppers whose coils need less than 500 ma can be accommodated. Each coil of the stepper attaches to MOT1 and MOT2. You may have to reverse the connections of one or the other until you get the connections right.

The number of steps moved is set by the speed setting multiplied by the contents of CV 121. Every Off to On activation of F2 will move the stepper the specified number of steps, in the direction set by the DCC speed direction. ■

.....

ARDUINO DCC PROJECTS | 19

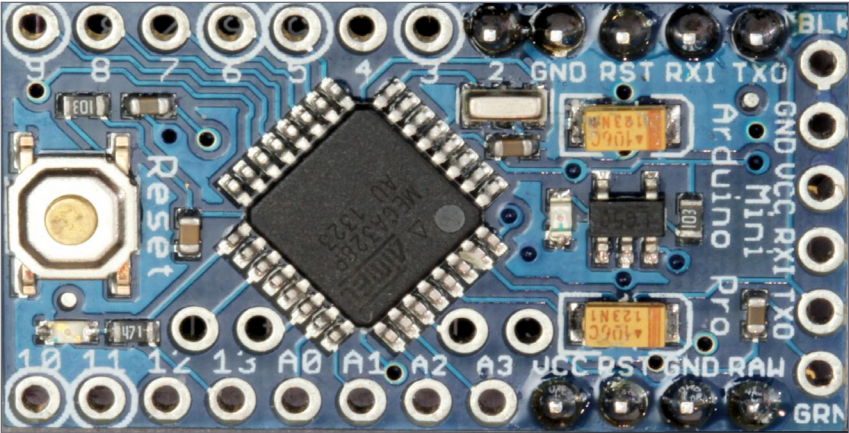

11. Arduino Pro Mini board.

My early decoders were all hand wired on small “perf” boards, since there really were not many components [12]. The entire decoder could be built for less than \$5.00! Later, I designed a small printed circuit board to go with the Pro Mini, which added \$3.20 to the cost, but made it easier to build – and a lot smaller.

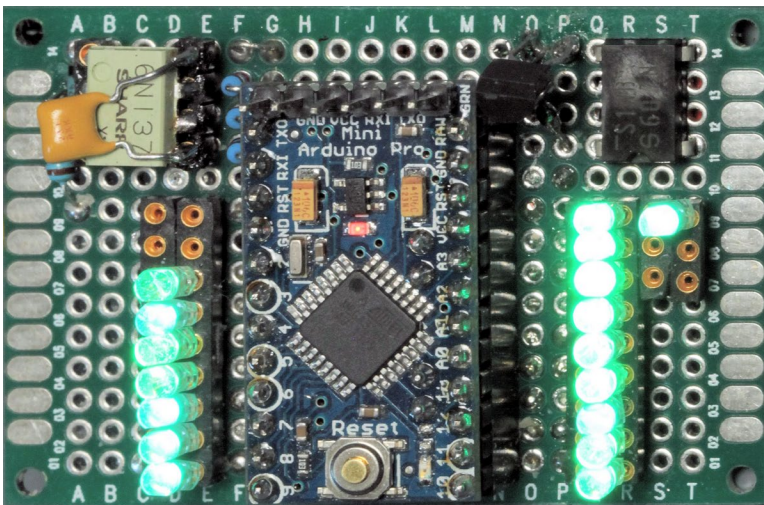

12. Original \$5 decoder hand-wired on a “perf” prototyping board.

Arduino accessory DCC decoder sketches

The following is a list of Arduino stationary accessory decoder sketches that can be used with a DCC system.

SERVO / LED CONTROL

AccDec_7Servos_10LED_6Ftn **7 Servo 10 LED 6 Function**

AccDec_10Servos_7LED_6Ftn **10 Servo 7 LED 6 Function**

AccDec_13Servos_4LED_6Ftn **13 Servo 4 LED 6 Function**

AccDec_15Servos_2LED_6Ftn **15 Servo 2 LED 6 Function**

These are all configured as Accessory Decoders controlling a group of servos and LEDs – the number of each is in the sketch name.

Each pin can be set to perform one of six operations: LED on/off, LED blink, Servo motor control, dual LED blink, pulsed output, and LED fade on. Blink rates can be changed, servo start, stop, and rate of travel can be changed, and pulse duration can be changed all with DCC CV settings per pin.

All preset configurations can be reconfigured with ops-mode DCC programming. Accessory decoders only respond to DCC switch commands. To be clear, one of these decoders can control 17 servo motors, or 17 LEDs, or any combination thereof with DCC switch commands.

AccDec_17LED_1Ftn **17 LED ON/OFF Control**

This is the simplest Accessory decoder (internally). Each DCC switch command only turns an LED on and off. This is included for those who might want to learn about the internal operation of the decoder.



AccDec_17LED_6Ftn

17 LED 6 Function

Each DCC Switch command turns an LED on and off, but each pin can be reconfigured to one of six functions.

AccDec_7ServoBackandForth6Ftn

7 Servo 10 LED 6 Function

The appropriate servo will travel end to end once, and stop, when the corresponding switch command is set.

.....

The decoder's bill of materials is listed at the end of this article with sources. Order what you need for the decoder versions you want to build, as well as the printed circuit boards (PCBs). There is no special sequence when soldering components. Clear pictures of decoder component placement are provided [13, 14].

Pay attention to the orientation of the 6N137 and SN754410 integrated circuits, and the DF06 bridge rectifier. Make sure the band/stripe of the 1N4148 diode is placed correctly. Lastly, if you use a polarized capacitor (one that has a "+" and "-") for C1, the positive "+" side is mounted toward the adjacent IC1 voltage regulator.

All the resistors are ¼ watt and are mounted vertically to save space. I add the pins and/or sockets, last. I use a low temperature soldering iron / low wattage soldering iron.

An included printed circuit board makes the construction a bit easier. A dual H-Bridge can be added which allows for decoder control of two motors or a stepper motor. Optionally, the H-Bridge circuit can be omitted.

ARDUINO DCC PROJECTS | 22

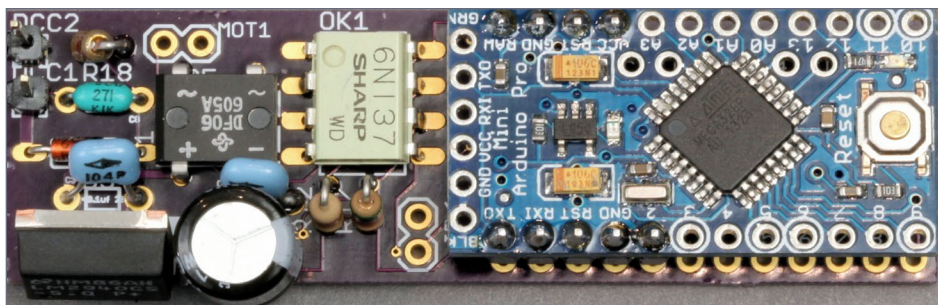

13. Top mounted decoder components.

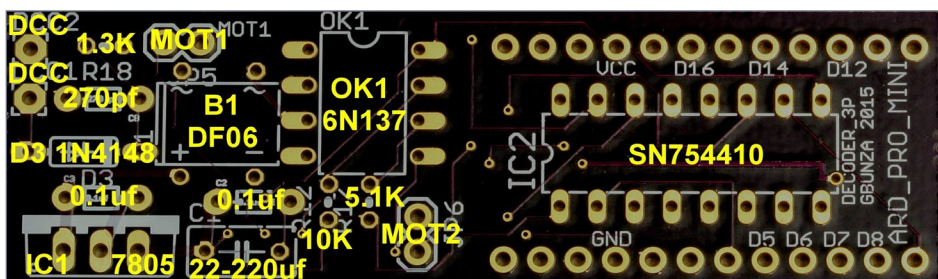

14. Top component placement.

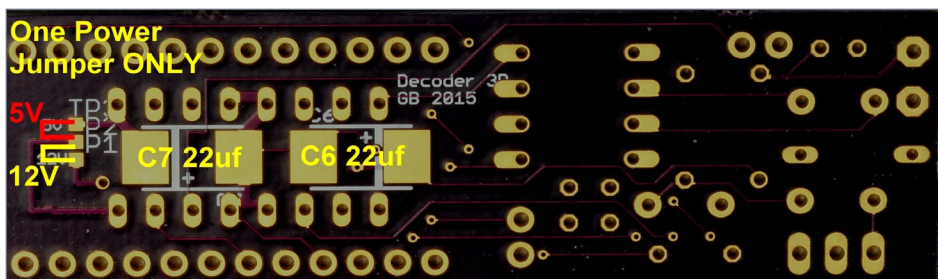

15. Bottom component placement.

The on-board power supply, which powers the board from the DCC bus directly, can also be dropped. This allows for a higher power, local five volt power source from batteries, power adapt-ers, and other power supplies. This board attaches to the Arduino Pro Mini board directly, via header connectors, pins and sockets, or plain wire.

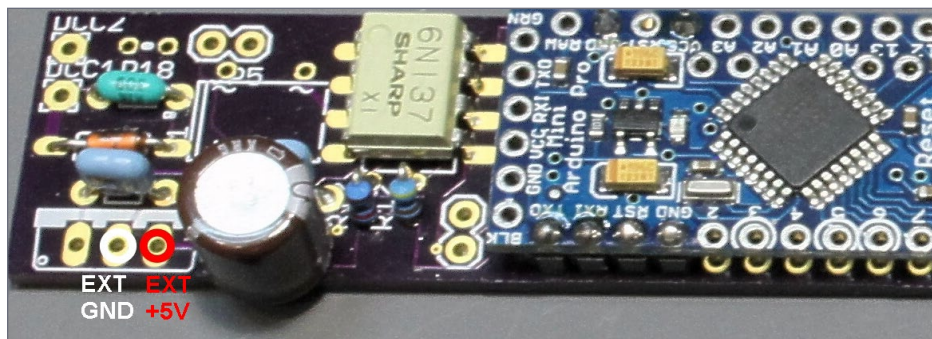

16. Alternate external power connection.

The LEDs and servos are connected directly to the Pro Mini board. The motor connections are located on the add-on board. There is a small set of pads on the underside of the board [15] to select either 5 volt or 12 volt power to the H-Bridge for DC motor and stepper motor power. The middle pad is solder bridged with a small solder blob to the appropriate outer pad.

The Decoder3P is configured to accept a voltage regulator like a L7805 (1.5 amp) regulator. These voltage regulators can get quite warm, so I prefer to use the PSU3-5, a 5 Volt 1 amp cool-running switch-mode voltage regulator, from EzSBC.com. Resistors are 1/4 watt. The value of C1 is listed at 22uf, but I use the largest capacitor I have on hand that can fit in the space with a 25-35 volt rating.

Some of the pictures show a round 100uf 25 volt capacitor that barely fits in the space. The 1N4148 diode can be almost any small signal diode with a 30 volt or more reverse voltage specification.

The SN754410 Dual H-Bridge chip is optional. This is a bi-directional DC driver for two motors or for the stepper motor drive! Before I get the next 500 change requests, the “Dec_2MotDrive_

ARDUINO DCC PROJECTS | 24

12LED_1Srv_6Ftn” sketch implements what one might call a mobile function decoder, with the usual throttle/speed control. However, there are no speed tables, jump starts, momentum effects, back emf, doodads, whizzies, or anything else.

There is only a direct mapping from the 0-127 speed setting to the motor Pulse-Width-Modulation plus direction control of the selected motor. If you do not intend to power any motor(s) you can omit the SN754410, as well as C6 and C7. (C6 and C7 are the surface mounted capacitors on the underside of the driver board.) Don't worry, these are rather large surface mounted capacitors and are easy to solder.

If you power the little board(s) with an external 5 volt supply or batteries, omit B1, C3, and IC1. If you control more than a few servos, you should use a separate 5 volt DC supply due to the high peak power demands of servo motors. See the power attachment points in the Alternate External Power Connection picture [16].

Printed Circuit Boards

The Eagle PCB layout board file (.brd) is included in the additional materials with this article. You can send the board file to any of a multitude of businesses for fabrication. In fact, now I am aware of several people providing this as a service to modelers by manufacturing these and selling them. If I remember correctly there is one shop in Germany, one in the UK and recently Model Railroad Control Systems in California, among them.

I have no financial or business interest with any of them, and I make all my designs to-date available free to everyone. There are likely several hundred modelers that are using these, with over 2000 of these built, by my best estimates.



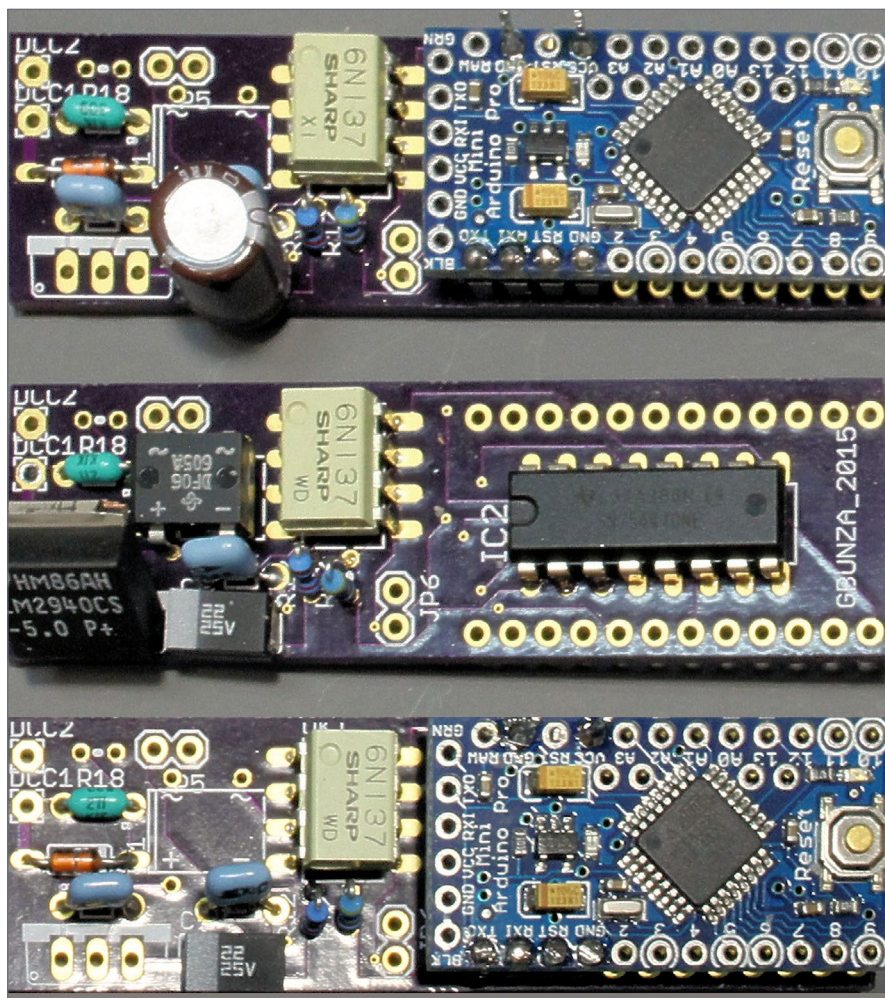

17. Decoder construction variations.

The boards pictured here were ordered from the board fabricator, OSHPark.com. It is a 2.51x0.77 inch (63.75x19.51 mm) two layer board. OSHPark offers a public service fabricating very high quality, low cost PC boards in low quantities.

Set up an account at OSHPark (really easy) and upload the board file you want to fabricate and specify the quantity (always in

ARDUINO DCC PROJECTS | 26

multiples of 3—their rules), either of these cost \$9.60 for three (3.20 per board). They accept PayPal and ship internationally.

I have no vested interest in OSHPark – I’m just a satisfied customer. Please feel free to use whatever fabricator you know. The bare boards are shipped “panel-ized” so break or cut them apart. Use the labeled decoder pictures [14,15] and/or the component diagram [21] and solder the components to the board. Remember, you do not have to add IC2, the SN754410 motor driver component, if you do not need it.

The Arduino Pro Mini can either be attached by soldering header pins to the driver board as shown in the pictures (the header pins are sometimes included with the Pro Mini), or it may be socketed with peel-away-socket-strips from Allelectronics.com – also shown below [18].

Note: In all cases DCC bus/rail connections are to the DCC1 and DCC2 terminals.

If you intend to use a servo motor attached to Pro Mini Digital Pin 13 – the same pin used to drive the built-in LED – please unsolder the LED, or the LED dropping resistor on board, or cut the trace to the LED to disable it [20]. The LED connection often interferes with the servo control on that pin!

Build the decoder hardware variant of choice, and then look here for information on setting up and loading the decoder sketch (program) of your choosing. With that said, a step by step cookbook for loading the decoder, oriented to the modeler, can be found here: “Starting from Scratch with an Arduino Pro Mini” (mrhpub.com/2014-11-nov/land/#99). It is also provided in the additional materials with this article.

In the decoder examples, servos are preconfigured on the lower numbered pins, contiguously, followed by the “LED” drivers. The



ARDUINO DCC PROJECTS | 27

file names say it all, so pay attention. Remember, you can configure each pin to do what function you would like, including a 17-servo driver. Load them into your Pro Mini and you are good to go!

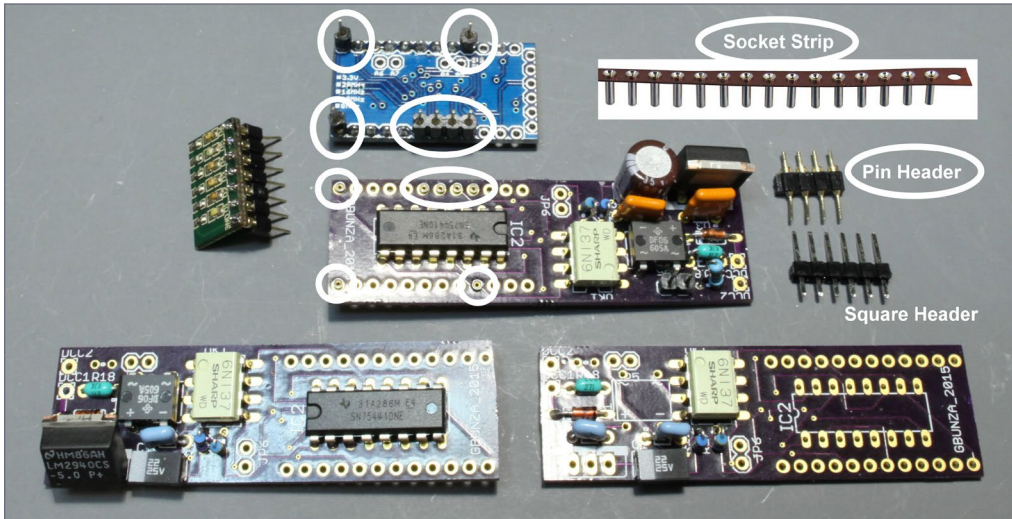

18. Socketed decoders.

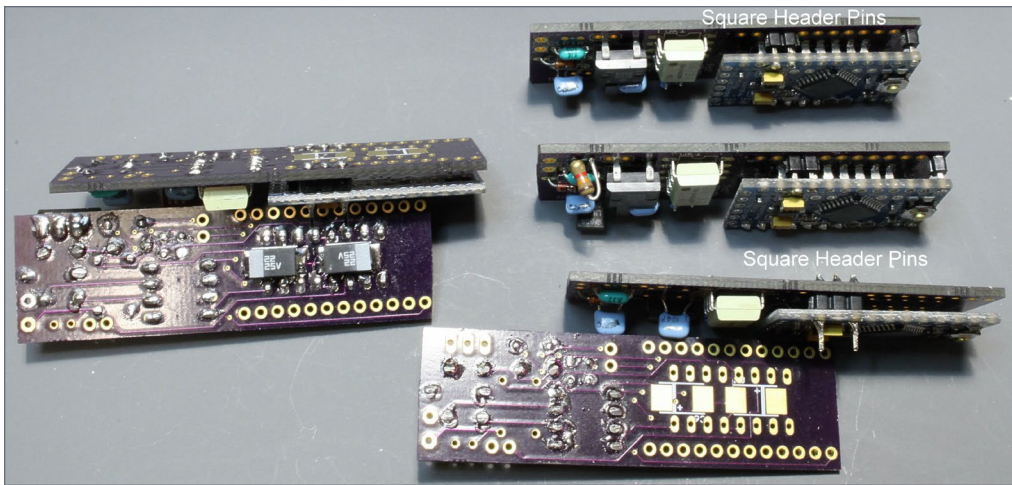

19. Pin-soldered decoders.

ARDUINO DCC PROJECTS | 28

The libraries and examples are included in the additional materials with this article. Updates can infrequently be found on my MRH blog: mrhmag.com/blog/geoff-bunza or on mrrwa.org in the NmraDcc Library depository.

The **NmraDcc** library, provided in this article's additional materials, in its folder (NmraDcc) should be placed as is in your ...

`\Documents\Arduino\libraries\` folder on your computer.

Do not modify it.

Final notes

These decoders have been used with a wide variety of commercial DCC base stations and DCC++. A reported common use for these decoders is to run multiple servos to control track switches.

Many of these variations have been specifically requested by modelers from around the world. The two wire DCC bus with power allows for remote control, and coordinated control of lighting and animation. This is why the audio and stepper motor additions were created.

Close inspection of the decoder configurations will show there are hundreds, if not thousands of variations available to the modeler. I rarely use Ops Mode DCC programming to set these up. Rather I configure them in the Arduino editor and simply download the new sketch, and save it for later reference.

Many modelers have taken these sketches as the starting point for their own efforts. I encourage this in every way. It's another way to have more fun with modeling!

There has never been any intention with these projects to create a competitive commercial decoder – and there still is none. I only want a simple reconfigurable decoder that I can customize for my own model work. I hope those modelers reading this can



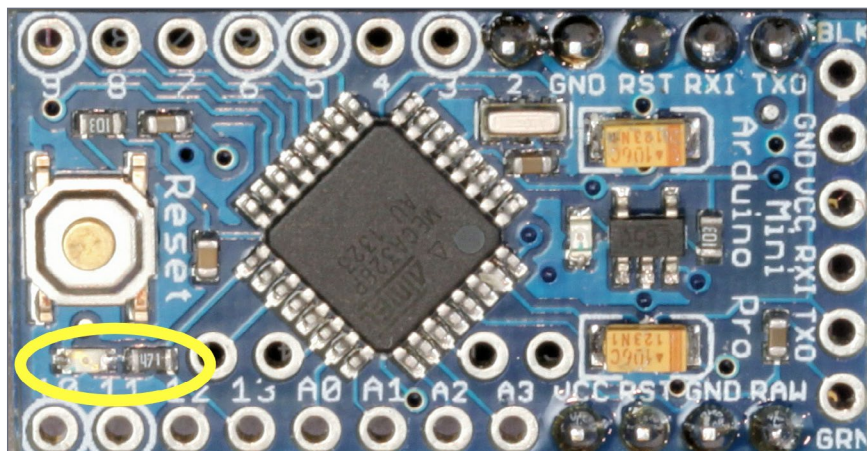

20. Pro Mini LED and/or resistor to be removed.

take advantage of these efforts, and will also share your variations with others.

Many of these have been built, perhaps many more than I am aware of. I doubt very much that I would have pursued all these variations, especially the accessory decoder variants, without the interest and enthusiasm shown by scores of modelers, literally, from around the world. To all of you – many sincere thanks!

Many thanks again to Alex Shepherd of New Zealand for his work on the **NmraDcc** library, and a special note to Franz-Peter Müller for his suggestions on code improvements. ☑

More how-to materials for this article are included in the [March issue subscriber bonus downloads](#).



Click here to rate or comment on this article

ARDUINO DCC PROJECTS | 30

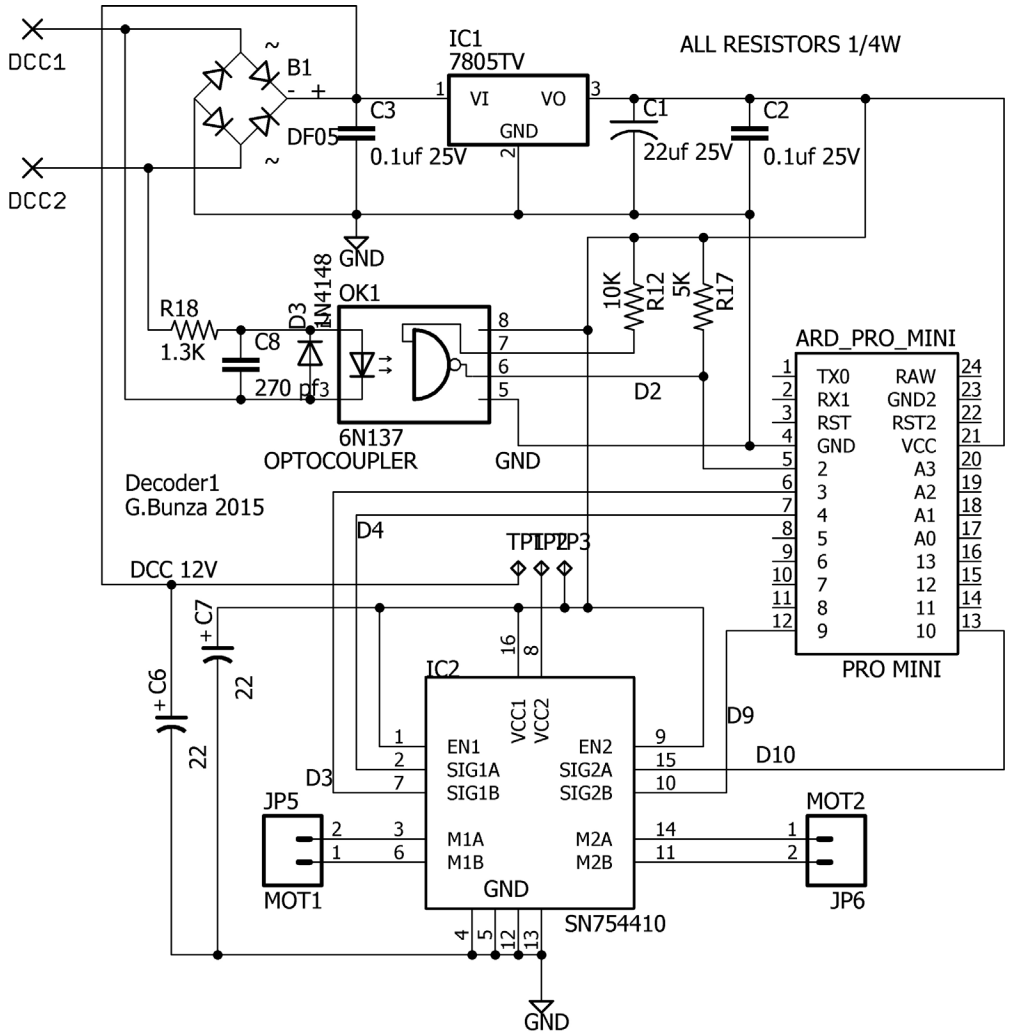

21. DCC_Decoder3P schematic.

See the next page for a video demonstration of what can be done with the DCC_Decoder3P ...



Playback problems? [Click here ...](#)

.....

GEOFF BUNZA



Geoff Bunza started as a model railroader when he received a Mantua train set for Christmas, at age 6. He fed his interests through college, becoming a member of the Tech Model Railroad Club (TMRC) at MIT while getting his doctorate and three other degrees in electrical engineering. He has collected Lionel HO trains for many years,

which spawned his interest in realistic model animation and lighting. Primarily, he models the New York Central Railroad.

Geoff is a member of the New York Central System Historical Society, a life member of the NMRA, and holds an Extra Class amateur radio license. ■

.....

ARDUINO DCC PROJECTS | 32

Bill of Materials: Decoder3P, Quantity One

Digikey parts (digikey.com):

OK1	160-1791-ND	6N137 OPTOCOUPLER HS 8-DIP	0.81
B1	DF06M-ND	DIODE BRIDGE 600V 1.5A 4-DIP	0.41
R12	CF14JT10K0CT-ND	RES 10K OHM 1/4W 5% CARBON FILM	0.10
R17	CF14JT5K10CT-ND	RES 5.1K OHM 1/4W 5% CARBON FILM	0.10
R18	CF14JT1K30CT-ND	RES 1.3K OHM 1/4W 5% CARBON FILM	0.10
C2,C3	445-8421-ND	CAP CER 0.1UF 25V 10% RADIAL	0.29
C8	BC1018CT-ND	CAP CER 270PF 50V 5% RADIAL	0.35
C6,C7	478-8312-1-ND	CAP TANT 22UF 25V 10% 2312 SMD	1.22
C1	P13476-ND	CAP ALUM 100UF 20% 25V RADIAL	0.32
OR			
C1	478-8312-1-ND	CAP TANT 22UF 25V 10% 2312 SMD	1.22
OR			
C1	493-5914-1-ND	CAP ALUM 220UF 25V 20% RADIAL	0.38
IC2	296-9911-5-ND	SN754410 IC HALF-H DRVR QUAD 16-DIP	2.43
IC1	497-15682-5-ND	L7805 IC REG LDO 5V 1.5A TO220	0.58

OR

IC1 PSU3-5 5V 1A Cool-running switch-mode voltage regulator. from EzSBC.com:

www.ezsbc.com/index.php/products/psu3-5.html#.VpGVvV55yMQ

PSIP-80 PEEL-A-WAY(R) MACHINE PIN SOCKET STRIP 2.50/50 socket pins

allelectronics.com/make-a-store/item/psip-80/peel-a-way-r-machine-pin-socket-strip/1.html

These socket strips accept Integrated Circuit DIP packages, or 0.020 wire – like the Tichy phosphor bronze wire.

SHS-40 1 X 40 HEADER, 0.1" SPACING 0.85 per strip of 40

allelectronics.com/item/shs-40/1-x-40-header-0.1-spacing/1.html



**Click here to rate or
comment on this article**





S T A T I O N

NCE
The Power of DCC

DiGiTrax
Complete Train Control

Tsunami 2

LOKSOUND
SELECT

TRAIN CONTROL SYSTEMS

Model Railroad Technologies Accutrack Speedometer 2



- Click here to visit our website -

www.LitchfieldStation.com
623-298-7355

• INDEX

• TABLE OF CONTENTS



LOOK

column



[Click here to rate or comment on this article](#)

JOE FUGATE

LOGICRAIL FUSEE PRO/M

LOGICRAIL RELEASED their Fusee PRO product a while back that you install in a fixed track location on your layout. The LED fits into the end of a small flare-like tube that lays on the track and looks very realistic [1]. While this product looks quite realistic, it needs a fixed location – you can't move it around.

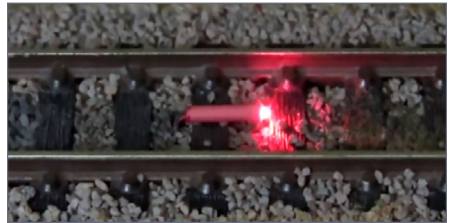

1. The LogicRail Fusee PRO (unlike the PRO/M) product uses a very nice flare-like casing to house the red LED but it's not mobile. LogicRail's Fusee PRO/M reviewed here solves the mobility problem.

Enter LogicRail's new Fusee PRO/M. It's a mobile Fusee board that has metal pads on the back and you power it by just placing it on the rails. Once the fusee burns out, you just remove it. Very clever!

A fusee is a type of flare that burns for 10 minutes, and includes a spike at one end so it can easily be embedded upright in a railroad tie if desired [2].

The railroad uses a fusee to keep trains apart, primarily in dark

► **NEW PRODUCT FIRST LOOK**



FIRST LOOK | 2

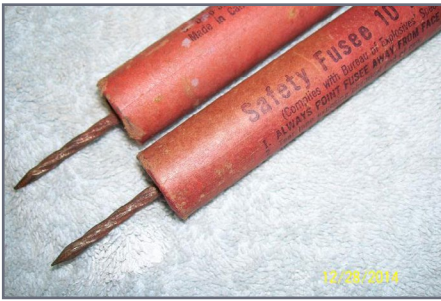

2. A railroad fusee typically has a spike in one end, so it's easy to embed upright in a railroad tie if desired.



3. This gives you an idea of the Fusee PRO/M's size. It can sit across the rails from S through Z scale, and is powered directly from the rails. It will also work in O scale if you place it diagonally across the rails.

When using the Fusee PRO/M on my Siskiyou Line, the brightly burning red LED creates enough glare that it looks like a flare fusee between the rails and the board isn't that visible (see the demo video).

You can find the Fusee PRO/M on the LogicRail Tech website at: logicrailtech.com. The retail price is \$14.95. ✓

territory. A railroad fusee is timed to burn for ten minutes and they are dropped behind a train to ensure a safe spacing. If a following train encounters a burning fusee it is not to pass until the fusee burns out.

The LogicRail Fusee PRO/M has a 10 minute burn time at 1:1. But it also includes a tiny pot on the board that you can use to set the fast time ratio from 1:2 to 1:16. Then the fusee will burn out in 10 *fast minutes* according to your fast clock time ratio!

This makes the Fusee PRO/M very convenient to use in a prototype-based op session to space out the trains using fusee rules, just as on the prototype.

While the Fusee PRO/M board does not look as realistic as the flare-shaped Fusee PRO product, the very useful mobile capability somewhat makes up for this.

FIRST LOOK | 3

4. The Fusee PRO/M comes with the board, complete instructions, and an small piece of 0.020" styrene (optional) to help align the board and keep from shorting the rails when you place it on the track.

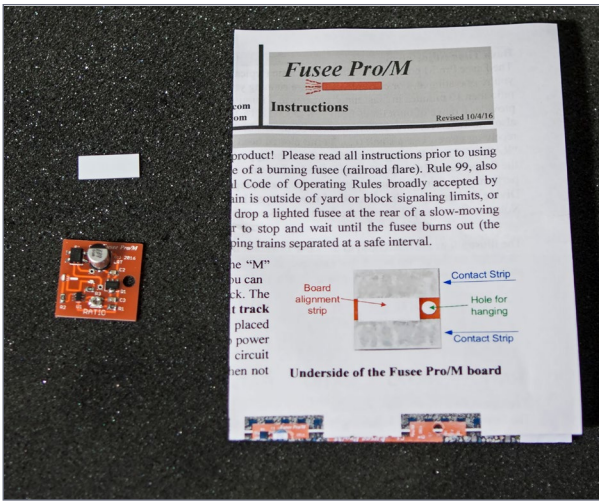

Playback problems? [Click here ...](#)

5. In this one-minute video, I demonstrate using the Fusee PRO/M on my HO Siskiyou Line.



[Click here to rate or comment on this article](#)



Bowser

HO GMD SD40-2 Locomotives

Arriving late February

See Dealer



Road Names: Algoma Central, BC Rail, CN, CP Rail, CP, HLCX, ON Rail, QNS&L, St L&H



MSRP Analog \$199.95 With Sound \$299.95



Ready to Run:

Crisp details and sharp painting and printing, metal wheels and knuckle couplers.

HO X32 Box Cars

Delivery October 2017

MSRP \$24.95

Road Names:

D&H,
D&M,
DT&I,
MRS,
N&W,
NP,
OP&E,
TAG,
Virginian,
Wabash,
& PRR

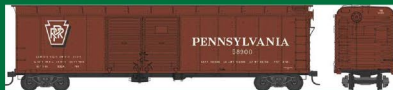
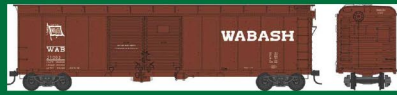

Click here to check out the details for these and other great Bowser Products

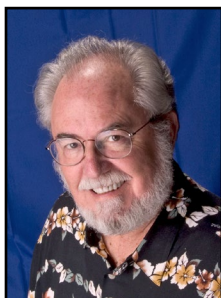

MARCH NEWS

column

RICHARD BALE *and* JEFF SHULTZ



[Click here to rate or comment on this article](#)

Fast Tracks Acquires Mt. Albert

Fast Tracks Hobbyworks has agreed to acquire Mt. Albert Scale Lumber, a well-known supplier of structure kits and precision wood products. Fast Tracks owner Tim Warris said he is looking forward to working with Gerry Cornwell of Mt. Albert to ensure the company continues to offer the best scale lumber money can buy. Fast Tracks currently serves its worldwide customer base from its manufacturing facility in Stoney Creek, Ontario, Canada. Warris, who founded Fast Tracks in 2003, said he is moving the company to larger quarters in Port Dover, Ontario, where he will continue to develop innovative fixtures that allow hobbyists to build precision trackwork ...

▶ THE LATEST MODEL RAILROAD PRODUCTS, NEWS & EVENTS

• [INDEX](#)



SUBSCRIBE
(free)

• [TABLE OF CONTENTS](#)

NEW CLUB CARS



The South Shore Model Railway Club of Hingham, MA, is selling an HO scale kit for a 40-foot single-sheathed box car decorated for East Coast

Line. The special club car is based on an Accurail kit. For additional information visit ssmrc.org/clubcars.aspx.

NEW PRODUCTS FOR ALL SCALES

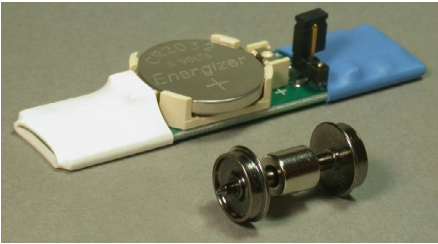

Boulder Creek Engineering has introduced the RollBy OnBoard Speedometer and RollBy Speedometer App for Android devices. The two-part system consists of the battery-powered speedometer board with a rotation wheelset (above) and a free Android app (Android 4.3 or above and Bluetooth Low Energy required) that will display the scale speed and either scale or real distance traveled.



MARCH NEWS | 3

Both metric and imperial (American) standards are supported. The Android app comes with a virtual demo speedometer that can confirm that your device will support the software. For more information go to bouldercreekengineering.com.



Digitrax has introduced two new DCC boosters that have been designed to supply more power to operate trains. The new boosters offer 3, 5, or 8 amps of output power to match most popular command stations. The model DB210 single booster in regular or opto-isolated mode provides up to 8 amps of power. For additional power the model DB220 dual booster provides up to 16 amps of power. A custom voltage trim feature assures consistent track voltage throughout a layout. For additional information contact a dealer or visit digitrax.com/ne.../2017/.../07/new-advanced-boosters.



In celebration of its 25th anniversary, **Downtown Deco** has released The Atomic Café, a small rundown restaurant that can also be signed as a taco shop. The kit for the cast plaster structure includes full color signs, rooftop details, a bit of deteriorated concrete sidewalk and complete assembly and suggested painting instructions. N,



HO, and O scale kits are available now. For additional information visit downtowndeco.com.

.....



Logic Rail Technologies has released the Fusee Pro/M, a track powered warning device intended to enhance model railroad operations by replicating prototype practice. The device realistically emulates a railroad fuse, or flare, as used by real railroads to protect the rear end of a stopped or slow moving train. The Fusee

Pro/M has an adjustable burn cycle of up to 10 minutes. The fuse begins to “burn” shortly after the board is placed across the rails. Constant rail power such as DCC is required. The board includes a yellow LED which flashes after the fusee is extinguished to remind the crew to remove the board from the rails. For additional information visit logicrailtech.com/fusee%20proM.htm.

.....

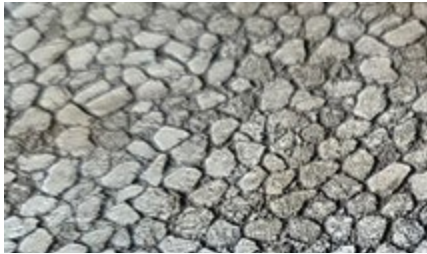

Monster Model Works has introduced cobblestone sheets in N, HO, S & O scales. The laser-etched .025-inch thick material is patterned from photographs of a real cobblestone street. The 7.5 x 3.5-inch sheets are tiled which

allows sheets to be positioned adjacent to one another with virtually no visible joint. For additional information visit monstermodelworks.com.

.....

MARCH NEWS | 5

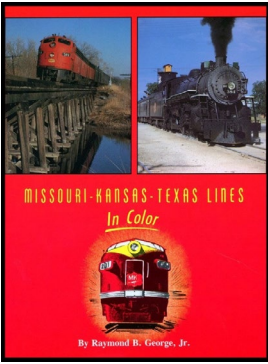

Morning Sun Publications has released several digital reprints including *Missouri-Kansas-Texas Lines in Color*, by Raymond B. George, Jr. Additional new eBooks are *Ann Arbor*, *the Best of Emery Gulash*; and *Columbus Crossroads of Change*, which documents the rail photography of Paul Geiger at Columbus, Ohio from 1964 to 1979. New hardcover books from Morning

Sun include *Conrail Northern Region*, by Douglas N. Leffler; *Milwaukee Road Facilities in Color, Volume 1*; and *Erie-DL&W-EL Trackside*, by Bob Krone. For additional information visit morningsunbooks.com.

.....

NCE has released several new decoder and layout wiring products. Included are N scale decoders for Atlas and Kato and 6-pin NEM plug products, the D16MTC, a six-function decoder with a 21 “MTC” plug, and a new, smaller D13 decoder, hardwired, equipped with the 9-pin JST socket and with an 8-pin NMRA plug.

NCE is also producing the Light-It Universal Lighting and Signal Decoder and a Scenic Lighting Decoder which is compatible with the Woodland Scenics Just Plug system.

For layout wiring, NCE now has Anderson power poles and European style terminal strips. For more information on NCE products, visit the website at ncedcc.com.

.....

Speedwitch Media has released Prototype Railroad Profile No. 4, which covers the Missouri Pacific Line’s large group of 2,400 panel-side gondolas and how to model them correctly using a Funaro & Camerlengo HO scale kit. Author Ted Culotta reports that in



In addition to the download version, the publication is also available in a printed format.

Speedwitch Media is also releasing Volume Nine in its *Focus on Freight Cars* series, *Single-Sheathed Box and Automobile Cars 2*. Featuring images from medium format negatives, the 94 page book covers cars from 17 railroads. For additional information visit speedwitchmedia.com.

O SCALE PRODUCT NEWS



Atlas O's third quarter schedule includes the release of 40-foot 2600 cu. ft. GATX Airslide covered hopper cars in new paint schemes. In

addition to the Santa Fe version shown, road names will be BNSF (Swoosh scheme), Burlington Northern, CSX (How Tomorrow Moves slogan), Kansas City Southern, Norfolk Southern, and Southern Pacific. Features of the O scale model include see-through brake wheel platform and roof walks, separately applied grab irons and brake line details, operating hatches, and sprung 70-ton roller-bearing or solid-bearing trucks (depending on the road name).



Also scheduled for release during the third quarter is a group of 40-foot steel refrigerator cars with swing doors. The O scale model is

based on the 4,700 Pacific Fruit Express R-40-10 class reefers built during 1936/1937. Decorating schemes include NRC-Illinois

Central, MERX-National Packing Co. URTX-Needham Packing, URTX-Spencer Packing Co., and Soo Line. All Atlas O models are available with trucks suitable for 2-rail or 3-rail operation. For additional information contact a dealer or visit atlaso.com.

HO SCALE PRODUCT NEWS

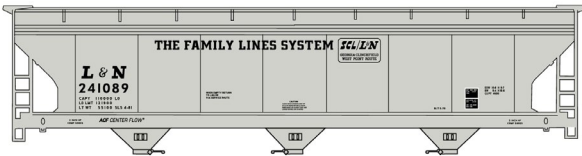

New HO scale car kits available from **Accurail** include this ACF triple-bay covered hopper decorated for

L&N/ Family Lines. The model represents a prototype built in 1970 and rebuilt in 1981.



This Wisconsin Central 50-foot double plug-door steel boxcar is based on a full-size car that was rebuilt in 1983.



Santa Fe's SFRD refrigerator car division rebuilt the prototype of this 40-foot ice reefer with plug doors in 1947.



Accurail's newest body style is a group of 36-foot double-sheathed wood boxcars with various ends, doors and underframes. This New York

Central car has Murphy steel ends, National wood doors and a fish belly steel underframe. All variations of the car are available painted in oxide red or mineral red and decorated with data only.



MARCH NEWS | 8

This allows hobbyists to decal the model with any road name they choose.

Additional new HO kits available from Accurail include a Nashville, Chattanooga & St. Louis 50-ton twin-bay hopper car with offset sides; and a Union Pacific 40-foot PS-1 steel boxcar as rebuilt in 1972. All Accurail kits include appropriate trucks and Accumate couplers which are compatible with popular knuckle couplers. For additional information on all Accurail products contact a dealer or visit accurail.com.

.....

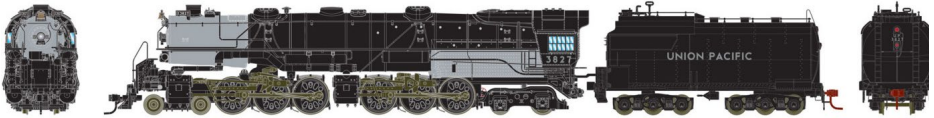

Athearn has announced plans to deliver several HO scale versions of an Alco 4-6-6-4 steam locomotive this December. The Genesis project includes Union Pacific class CSA-1 (oil, shown) and CSA-2 (coal) Challengers, and two class Z-8 versions decorated for Spokane, Portland & Seattle; and Northern Pacific. Features of the articulated locomotive model include a detailed boiler backhead with printed manual controls, individually applied piping, valves and other appliances; illuminated LED directional headlight, and backup tender light. An 8-pin connector is provided between the locomotive and tender.



The Z-8 versions will have several road specific details including a cast pilot with a drop coupler, air compressors mounted on the smokebox front, two sizes of wheels in the trailing truck, and an

MARCH NEWS | 9

enclosed cab with side entry doors. Sound models will be equipped with an ESU LokSound DCC decoder. The model will negotiate an 18-inch radius but for both appearance and operational reliability a minimum of 22 inches is recommended.

Athearn has added locomotives decorated for Santa Fe (Kodachrome scheme), Great Northern, and Burlington Northern (ex GN) to the production run of Genesis HO scale F45 diesels scheduled for release late this year. As shown here, the BN units will be decorated in Athearn's Primed for Grime look with patches and the base color faded.



Santa Fe sponsored the creation of the FP45, an SDP45 designed with a lightweight “cowl” body to cover the locomotive, though it did not, as in earlier cab units, provide any structural strength. Santa Fe liked the sleeker look which also allowed crewmen to safely enter the engine compartment while underway, and requested that EMD do the same for the SD45. Great Northern also bought some F45 diesels, not for the aesthetics but as a way to protect crews from the hazards of winter operation. The model will be available without sound as well as factory-equipped with a Tsunami2 Sound system.



A new production run of Genesis FGE 57-foot smooth side mechanical reefers is scheduled for release in December. Notable

MARCH NEWS | 10

features of the HO scale model include a detailed Detroit Diesel 2-17 Genset visible through protective screens, see-through end platforms, full underbody detail, 100-ton trucks with rotating bearing caps, and optional onboard SoundTraxx sound.

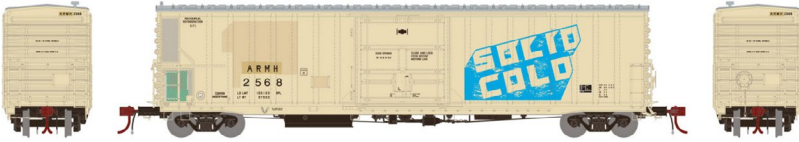

Road names will be Union Pacific/ARMN/Chilled Express (previous page), UP/ARMH/Solid Cold (above), Burlington Northern (box car red), FGE/FGMR/The Chiller, and FGE/FGMR/Solid Cold (below).

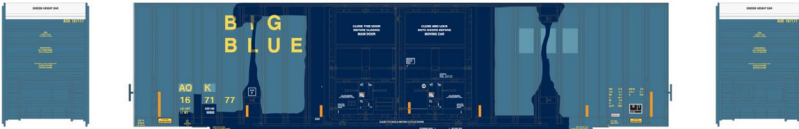

Another release of Athearn's popular 60-foot Gunderson boxcar with double plug doors is included in the December schedule. In addition to the Arkansas Oklahoma faded scheme shown above, road names will be CSX, TTX Railbox, Kansas City Southern, Union Pacific, and General American. The Ready-to-Roll model has separately applied wire grab irons and etched end platforms.



This triple-bay coal hopper with ribbed sides will be available in December in singles and in 4-packs with multiple road numbers.

MARCH NEWS | 11

Athearn's HO scale Ready-to-Roll model comes with a removable coal load. Additional features include factory applied wire grab irons, stirrup steps, end braces and brake platform. Road names will be Chesapeake & Ohio, Baltimore & Ohio, Chicago & Eastern Illinois, Pennsylvania Railroad, Virginian, and Denver & Rio Grande Western. The B&O and C&O cars have round ends, all others are flat.



Athearn plans to release a big seven-axle centipede style steam locomotive tender this December. The HO scale model will be designated for maintenance of way service and fitted with a knuckle coupler at each end. Tenders with grey (above), black, and silver bodies will be available lettered for MOW. Tenders decorated for Northern Pacific and NYC will have black bodies. A D&RGW tender with a grey body and a BN version on a Tuscan red body complete the release. Features include wire grab irons and ladders, and machined metal wheelsets.



Athearn Roundhouse brand models scheduled for release this December include a 50-foot high-cube boxcar with a plug door, decorated for the stillborn Southern Pacific & Santa Fe Railway Company. Additional road names will be BNSF, Coe Rail Inc., Cotton Belt (ex-Golden West), Union Pacific (ex-Western Pacific), and Western Pacific. The HO scale model will have machined metal wheelsets and knuckle couplers.



MARCH NEWS | 12



Athearn's December production schedule concludes with a 30-foot steel flat car under the Roundhouse brand. The model will have appropriate trucks with machined metal wheelsets. In addition to the Canadian National versions shown here, road names will be Santa Fe, Baltimore & Ohio, Milwaukee Road, Union Pacific, and Pennsylvania Railroad. All Athearn and Roundhouse brand HO scale models come with knuckle couplers. For additional information contact a dealer or visit athearn.com.

.....



Atlas is planning a third quarter release for new AMT paint schemes for its ALP-45DP locomotives, multi-level trailers and cab

cars (below). The HO scale ALP-45DP is based on a dual-mode prototype capable of drawing power from either overhead electrical wires or its own pair of 12-cylinder Caterpillar diesel engines. The model has directional LED headlight/ditchlights and red marker lights, a positionable non-functioning pantograph, and factory applied railings, air horn, antenna details, and Kadee couplers.



For hobbyists wanting to install additional details, a package of grab irons is supplied along with a drilling template. Atlas'

Gold series model of the ALP-45DP comes with an ESU

MARCH NEWS | 13

LokSound decoder. Atlas' Silver series DCC-ready model includes an 8-pin socket and 21-pin plug for a DCC decoder (not supplied).



Atlas is planning a third quarter

release of a Trainman series 85-foot trash flat car. New road names include CWMX, HESX, and Envirosolutions. Previously released road names with new road numbers include General American, and East Carbon - DSEX (above). The trash flats are compatible with Atlas's 20-foot MSW (municipal solid waste) trash containers which are sold separately.

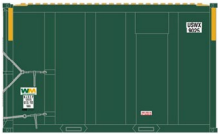

In conjunction with the release of the 85-foot trash flat cars, Atlas has also scheduled the release of a group of 20-foot MSW containers. Decorating schemes will be AWIU, AWIU-Sajo

Transport, OVAU, USWX, USWX (orange stripes), and DSEU. The 20-foot MSW containers differ from the common intermodal containers in that they are taller (12-foot versus 8-foot 6-inches) and have a top lid. For additional information contact a dealer or visit atlasrr.com.

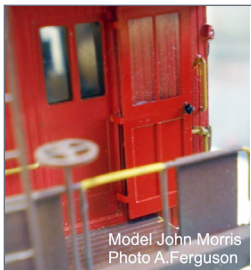

Model John Morris
Photo A. Ferguson

Black Cat Publishing has etched brass storm doors for both Canadian National and Canadian Pacific wood sheathed cabooses. CPR prototype doors had two window panes which were replaced in the summer with screens. CNR's wood storm doors have four



MARCH NEWS | 14

.....

panes. Black Cat's doors sets include clear plastic inserts for the windows. For additional information visit blackcatdecals.com.

.....



Bluford Shops is booking reservations through March 17 for a new production run of bay window transfer cabooses. Delivery is planned for early autumn. The HO scale ready-to-run models feature injection molded plastic bodies, wire grab irons and cut levers, metal wheelsets, and Kadee couplers.

Bay window transfer cabooses with a short body will be available decorated for CSX (two schemes). Toledo, Peoria & Western; and Union Railroad. Bay window transfer cabooses with a short roof will be available for Conrail (two schemes), Southern Pacific, Indiana Harbor Belt, Kansas City Southern, Missouri Pacific, MP-Texas & Pacific Dodger Service, New York Central, and Central Indiana Railway. For additional information contact a dealer or visit bluford-shops.com.

.....

Bowser is taking reservations through the 10th of March for a series of F-unit diesels with delivery expected in October. New features on this production run include improved diaphragms and a cab interior with engineer and fireman figures. Additional details include air hoses, windshield wipers, grab irons, coupler lift bars, operating headlight, window glass, and Kadee couplers. Road-specific details include, where appropriate, cut away fuel tank skirts, roof-mounted oil cooler and piping, large branch line snow plow, nose grab irons, lift rings, and a hostler light.

MARCH NEWS | 15



F7 units will be available decorated for Spokane, Portland & Seattle and two different Milwaukee Road schemes.



F9 diesels will be available for Rock Island (ex UP), Santa Fe (yellowbonnet), and Union Pacific.

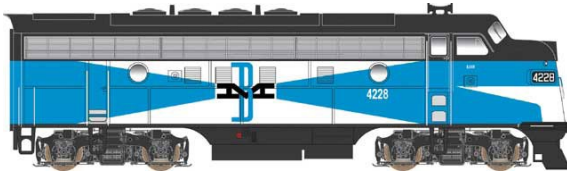

F3 units will be available decorated for NYO&W, Southern Railway, Bangor & Aroostook, Boston & Maine (two schemes), and Jersey Central. Standard DC models will have an NMRA 21-pin plug for an aftermarket DCC decoder (not supplied). DCC/Sound versions feature LokSound Select Dual-Mode decoder which allows locomotive to be used on DC as well as on DCC layouts.



Bowser is now taking pre-orders for a Ready to Run PRR N-5 caboose. The

HO scale caboose has separate hand grabs, brake system parts, free rolling trucks with metal wheels, and knuckle couplers. Many paint schemes are planned, with each scheme having



MARCH NEWS | 16

.....

at least four road numbers and the PRR Trainphone-equipped schemes having six numbers each. Paint schemes include Boston & Maine, Conrail, Detroit & Mackinac, Long Island, New Haven, two Penn Central, and ten Pennsylvania RR schemes. For additional information contact a dealer or visit bowser-trains.com.

.....



Broadway Limited Imports is selling a selection of HO scale USRA 4-6-2 Pacific steam locomotives.

Road names are

Atchison Topeka & Santa Fe, Baltimore & Ohio, Chicago & North Western, Erie, Fort Worth & Denver, Great Northern, Atlantic Coast Line (shown), Canadian Pacific, Louisville & Nashville, Gulf Mobile & Ohio, Northern Pacific, Southern Pacific, and New York Central. A painted but unlettered version is also available. The models come equipped with Paragon3 Sound and operating system.



BLI plans to make an HO scale cryogenic tank car available this summer. The HO scale model will have a molded plastic body and a die cast metal chassis.

Decorating schemes will be

Airco, Air Products (shown), Big Three Industries, Canadian Liquid Air Co, Linde, Liquid Air Corp., and NCG. Contact a dealer for information on all Broadway Limited products or visit broadway-limited.com.

.....

MARCH NEWS | 17



ExactRail is selling its Evans-USRE Plate C 5277cu. ft. boxcar decorated for four different railroads: Lake Erie, Franklin &

Clarion Railroad; Burlington Northern, Rock Island, and Louisiana Midland. Features of the HO scale Evolution series model include Barber 70-ton S-2 trucks, 33-inch machined metal wheelsets, wire grab irons, and Kadee #5 couplers. For additional information visit exactrail.com.



Fos Scale Models has introduced an HO scale craftsman kit named Rohlen Welding, a small structure with a footprint of 5 x 6-inches. Much of the character of the structure comes from the varieties of siding which include scribed, shake shingles, and clapboard. The kit

includes numerous metal details, color signage, instructions, and finishing suggestions. Figures shown are not included. For additional information visit fosscalemodels.com.



InterMountain Railway has scheduled the second production run of its SD40-2 locomotives for

release in September-October. Reservations to guarantee availability will close at the end of this month. The HO scale model features railroad specific details such as different headlights, noses,



MARCH NEWS | 18

radiator grilles, and optional dynamic brake housing. Non-sound versions of the ready-to-run model will have a factory installed ESU LokPilot DCC decoder. Sound models come with an ESU LokSound Select Sound decoder. An optional DC-only plug is available upon request. All versions are fitted with Kadee couplers.

In addition to the Santa Fe version shown, road names will be Iowa, Chicago & Eastern; Southern Railway, Burlington Northern (green with white front), CSX, GATX, Union Pacific, and Norfolk Southern. InterMountain's SD40-2 will also be available as an undecorated kit with separate American and Canadian versions each featuring different styles of skirts, steps and headlights in the long hood.

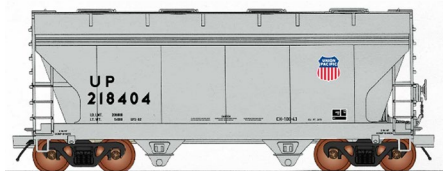

Also due from InterMountain this fall is a group of ACF twin-bay covered hopper cars. Decorating schemes will be Union Pacific, Southern Pacific, Winchester & Western, Western Maryland, ACFX (gray), Burlington Northern and Montana Rail Link.



Cars decorated for Chicago & North Western, and Norfolk Southern will also be available. A gray car with data only will be included in this release. For additional information on all InterMountain Railway products contact a dealer or visit intermountain-railway.com.

.....

Kadee plans to release this 50-foot Detroit, Toledo & Ironton PS-1 steel boxcar later this month. The ready-to-run HO scale model features a 9-foot Pullman-Standard door with a low tack board, full side sills, a cushion underframe, and sides fabricated from 12

MARCH NEWS | 19



welded panels. The model represents a prototype with a factory fresh paint job from 1962.



This 40-foot PS-1 boxcar decorated for Baltimore & Ohio is scheduled for release by Kadee in April. The model represents a car built in 1956

and shipped in 1965. Note the six-foot Youngstown doors on a Pullman-Standard car.



Kadee is planning a May release date for this ACF 11,000 gallon ICC-105A tank car decorated for SHPX-Warren of Tulsa, Oklahoma. The HO scale model features a full loading

platform. The ready-to-run model replicates a prototype built in 1948. For additional information on all Kadee products contact a dealer or visit kadee.com.



KatoUSA has released its popular General Electric C44-9W diesel locomotive with two new road numbers for Southern Pacific and Union Pacific. Notable features include working

ditch lights and Hi-Adhesion trucks. The model is available with ESU LokSound DCC Sound decoder. A standard DC version comes with an 8-pin DCC plug. For additional information contact a dealer or visit katousa.com.





KC's Workshop is now selling a new limited edition craftsman kit, K&W Butter Company. The kit features two buildings, a three story main structure with factory and warehouse and a two

story secondary office/living quarters building. The kit features Northeastern Scale Lumber, Tichy Windows, laser-cut doors, and both BEST and Scale Model Masterpiece castings. More information on this and other products can be found at kcworkshop.com.



Rapido Trains showed this preproduction sample of a Marine Industries 3800 cu. ft. cylindrical hopper at the recent Springfield Show. Dan Darnell decorated

the car in the iconic CP Rail scheme. Additional road names on the initial release will be Toronto, Hamilton & Buffalo; Canadian National (four variations), Canadian Pacific (three schemes), and Procor (two schemes). The HO scale model will be available with three brake equipment variations and two body variations: six or 11 side panels. Rapido has extended the deadline for reservations to March 17. Delivery is planned for this fall. For additional information on all Rapido Trains products contact a dealer or visit rapidotrains.com.

MARCH NEWS | 21



Tichy Train Group has introduced a series of HO scale roadside billboards based on actual signs from the 1940s through the 1960s. The billboards are injection molded in black styrene with the image of the sign printed in full color directly on the plastic billboard structure. The poles, platform, and base are included. More than 30 authentic billboard images are available. For additional information visit tichy-traingroup.com/Shop/tabid/91/c/ho-billboards/Default.aspx.

.....



Walthers plans to release another run of EMD GP35 Phase 2 diesels in June. This is in addition to the previously announced run

due to be released this month. Road names include Burlington Northern, Chesapeake & Ohio, Erie Lackawanna, and Milwaukee Road. Also Santa Fe, Chessie System, Conrail, Rock Island, Southern Pacific, and Gulf, Mobile and Ohio.

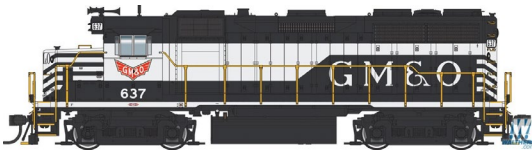

Southern Pacific and Santa Fe locomotives are included in both runs with different road numbers.



Walther's Proto series EMD E8A locomotives

are scheduled for release late this month. Decorating schemes include a Santa Fe red and silver warbonnet and Pennsylvania



MARCH NEWS | 22

Railroad's Broadway Limited. The 1959 PRR scheme consists of a single bold gold stripe and 17-inch non-extended serif lettering. The HO scale ready-to-run locomotives will be available individually and as matched E8A-E8A sets.

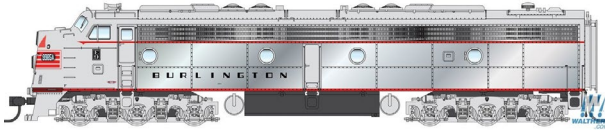

An EMD E9A decorated for the Chicago, Burlington &

Quincy is also scheduled for release this month.



Walthers plans to release Proto series F7 A-units in late March. Road names will be Union Pacific, Santa Fe (300 class

red and silver warbonnet and yellowbonnet), Canadian Pacific, Southern Pacific (black widow scheme), CB&Q, and Southern Railway. Walthers Proto series locomotives are available for standard DC operation or equipped with SoundTraxx Tsunami Sound and DCC decoder.

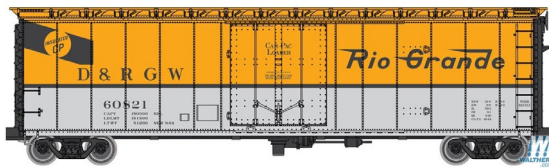

A 50-foot PC&F insulated boxcar is scheduled to be released by Walthers in June. Road names

include Denver & Rio Grande Western, CB&Q, Chicago & North Western, Santa Fe, and Baltimore & Ohio.



Completing the run is a Pennsylvania car with a shadow Keystone herald.

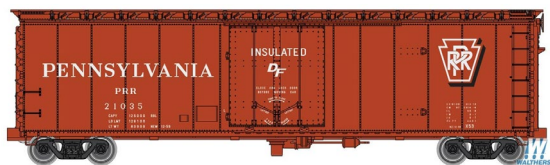

N SCALE PRODUCT NEWS



Athearn plans to deliver several N scale versions of an Alco 4-6-6-4 articulated steam locomotive this December. The project includes class Z-8 versions decorated for Spokane, Portland & Seattle; and Northern Pacific. Features include a detailed boiler backhead with printed manual controls, individually applied piping, valves and other appliances, illuminated LED directional headlight, and a backup tender light. An 8-pin connector is provided between the locomotive and tender.



The models will have several road specific details including a cast pilot with a drop coupler, air compressors mounted on the smokebox front, two sizes of wheels in the trailing truck, and an enclosed cab with side entry doors. Sound models will be equipped with ESU LokSound and DCC decoder. The model will negotiate an 11-inch radius, however a minimum of 15 inches is recommended.

Athearn has added locomotives decorated for Santa Fe (Kodachrome scheme), Great Northern, and Burlington Northern (ex-GN) to the production run of N scale F45 diesels scheduled for



MARCH NEWS | 24

release late this year. The BN units will be available in Athearn's Primed for Grime look with patches and the base color faded. (See the HO scale report for more details on the prototype F45).



The model will be available without sound as well as factory-equipped with Tsunami2 Sound system.

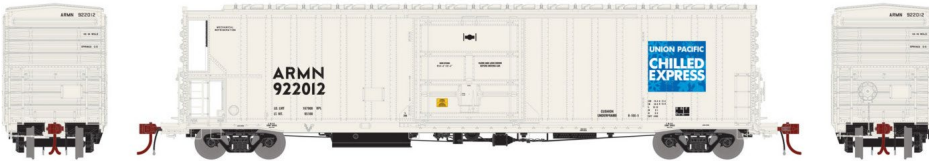

A new production run of N scale FGE 57-foot smooth-side mechanical reefers is scheduled for release in December. Notable features of the model include a nicely detailed Detroit Diesel 2-17 Genset visible through protective screens, see-through end platforms, full underbody detail, 100-ton trucks with rotating bearing caps, and optional onboard SoundTraxx sound.



Road names will be Union Pacific/ARMN/Chilled Express (top), UP/ARMH/Solid Cold, Burlington Northern (box car red), FGE/FGMR/Solid Cold, and FGE/FGMR/The Chiller (above).



Here's an early look at Athearn's new UPS

MARCH NEWS | 25

40-foot drop sill trailer scheduled for introduction in September. As we mentioned in our December report, the N scale model will be available in five different UPS decorating schemes. Special features include rubber tires and individually painted wheels.



Another release of Athearn's popular 60-foot Gunderson boxcar with double plug doors is included in their December schedule. In addition to Kansas City Southern shown above, road names will be CSX, TTX Railbox, Union Pacific, General American, and Arkansas Oklahoma in a faded scheme. The Ready-to-Roll model will have separately applied wire grab irons and etched end platforms.



This triple-bay coal hopper with ribbed sides will be available in December in singles and in four-packs with multiple road numbers. Athearn's N scale model comes with a removable coal load. Additional features include factory applied wire grab irons, stirrup steps, end braces, and brake platform. Road names will be Chesapeake & Ohio, Baltimore & Ohio, Pennsylvania Railroad, Virginian, Denver & Rio Grande Western, and Chicago & Eastern Illinois as shown here. The B&O and C&O cars have round ends, all others are flat.

Additional N scale models due from Athearn this December include a 50-foot high-cube boxcar with a plug doors decorated for Western Pacific, BNSF, Coe Rail Inc., Cotton Belt (ex-Golden



MARCH NEWS | 26



West), Union Pacific (ex-Western Pacific), and Western Pacific. Of special interest is a car decorated for the stillborn Southern Pacific & Santa Fe Railway Company. The N scale models will have machined metal wheelsets and knuckle couplers. For additional information contact a dealer or visit athearn.com.

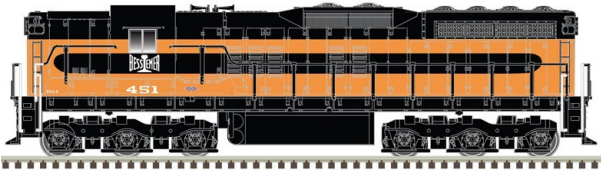

Atlas Model Railroad Company has set a third quarter release date for a group of N

scale SD7 and SD9 diesel locomotives in new paint schemes and road numbers. New schemes for the SD7 include Bessemer & Lake Erie (above), Milwaukee Road, and Minneapolis & St. Louis.



Atlas' SD9 will be available decorated for Elgin, Joliet & Eastern; Denver & Rio Grande Western,

and Winchester & Western (above).



An SD9 decorated in Southern Pacific's popular black widow scheme will be reissued in four

new road numbers. The models will be factory equipped with an NCE decoder..

MARCH NEWS | 27



Also due for release in the third quarter is another run of 85-foot trash flat cars. New road names for the N scale models will be CWMX, HESX, and Envirosolutions. Previously released road names with new numbers include General American, and East Carbon - DSEX (above). The trash flats are compatible with Atlas' 20-foot municipal solid waste (MSW) trash containers which will be available separately.

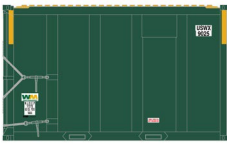

In conjunction with availability of the 85-foot trash flat cars, Atlas has also scheduled the release of a group of 20-foot MSW containers. Decorating schemes for the N scale

models will be AWIU, AWIU-Sajo Transport, OVAU, USWX, USWX (orange stripes), and DSEU. The 20-foot MSW containers differ from the common intermodal containers in that they are taller (12-foot versus 8-foot 6-inches) and have a top lid.

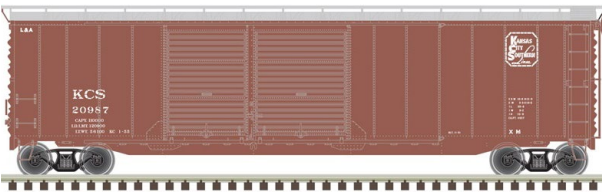

The final N scale item in Atlas' third quarter release is a Trainman series 50-foot steel boxcar with offset double

Youngstown doors. New paint schemes and road numbers will be available for Canadian National, Kansas City Southern, Michigan Northern, Pennsylvania, Denver & Rio Grande Western (The Action Road slogan), and Wabash. For additional information on all Atlas products contact a dealer or visit atlasrr.com.



MARCH NEWS | 28



Bluford Shops is booking reservations through March 17 for a new production run of

bay window transfer cabooses. Delivery is planned for early autumn. The N scale ready-to-run model features injection molded plastic body, etched brass and wire details, knuckle couplers, and metal wheelsets by Fox Valley Models. Bay window transfer cabooses with a short body will be available decorated for CSX (two schemes), Toledo, Peoria & Western; and Union Railroad. Transfer cabooses with a bay window and a short roof will be available for Conrail (two schemes), Southern Pacific, Indiana Harbor Belt, Kansas City Southern, Missouri Pacific, MP-Texas & Pacific Dodger Service, New York Central, and Central Indiana Railway. For additional information contact a dealer or visit bluford-shops.com.

.....



Bowser is now taking pre-orders for a ready to run PRR N-5 caboose. The N scale caboose will be equipped

with body-mounted knuckle couplers and Fox Valley Model metal wheels in caboose trucks. Many paint schemes are planned, with each scheme having at least two road numbers and the PRR Trainphone-equipped schemes having three numbers each. Paint schemes include Boston & Maine, Conrail, Detroit & Mackinac, Long Island, New Haven, two Penn Central, and ten Pennsylvania RR schemes. For additional information contact a dealer or visit bowser-trains.com.

.....

MARCH NEWS | 29



ExactRail is selling its Evans-USRE Plate C 5277 cu. ft. boxcar decorated for four different railroads: Lake Erie, Franklin & Clarion; Burlington

Northern, Rock Island, and Louisiana Midland. Features of the N scale model include Barber 70-ton S-2 trucks, 33-inch machined metal wheelsets, and wire grab irons. For additional information visit exactrail.com.

.....



InterMountain Railway has scheduled the second production run of its N scale SD40-2 locomotives for release

in September or October. Reservations will close at the end of this month. Railroad-specific details on the model locomotives include different headlights, noses, radiator grilles, and dynamic brakes. DC models have a DC only circuit board and are DCC-ready. Non-sound versions are equipped with a factory installed ESU LokPilot DCC decoder. Sound models come with an ESU LokSound Select Sound decoder. An optional DC-only plug is available upon request.

In addition to the Norfolk Southern version shown above, road names will be Iowa, Chicago & Eastern; Southern Railway, Burlington Northern (green with white front), CSX, GATX, Union Pacific, and Santa Fe (yellowbonnet scheme). InterMountain's SD40-2 will also be available as an undecorated kit with separate American and Canadian versions each featuring different styles of skirts, steps and headlights in the long hood.



MARCH NEWS | 30



Also coming from InterMountain this fall is a group of N scale ACF twin-bay covered hopper cars. Decorating schemes will be Chicago & North Western,

Norfolk Southern, Union Pacific, Southern Pacific, Winchester & Western, Western Maryland, ACFX (gray), Burlington Northern and Montana Rail Link. A gray car with data only will be included in this production release. For additional information on all Intermountain Railway products contact a dealer or visit intermountain-railway.com.



Micro-Trains Line has expanded its Presidential Series of N scale collectible models to include a boxcar decorated with the Presidential Seal, President

Trump's portrait, and the American flag.



Also available now from Micro-Trains is this DTTX

70-foot Husky-Stack well car designed to handle containers in the bottom position up to 48 feet in length.



This N scale CSXT twin-bay covered hopper car follows a class HC-41 cylindrical hopper introduced in 1970.

Completing Micro-Trains recent list of new releases is an NLAX (NASA) 50-foot rib side boxcar with double Youngstown doors.

MARCH NEWS | 31



NASA used this special car in its various Florida operations. The car is equipped with a Hennessy Slidewell door opening system.

For additional information on all Micro-Trains Line products contact a dealer or visit micro-trains.com.



Walthers is selling an N scale version of a Thrall 5-unit articulated 48-foot well car decorated for Santa Fe, Canadian Pacific, and TTX. Like the prototype, the model can handle 20-, 40-,

and 48-foot containers in the well and containers up to 53-foot in length stacked on top. The model has a diecast metal body and comes with Accumate couplers. For additional information on all Walthers products contact a dealer or visit walthers.com.

NEW DECALS, SIGNS AND FINISHING PRODUCTS

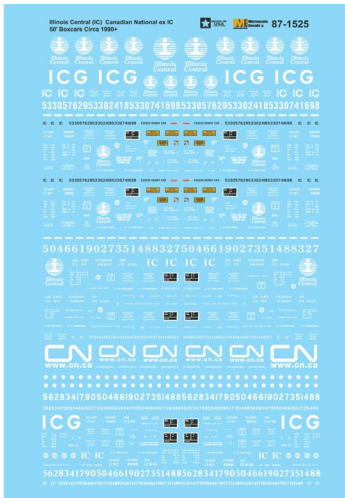

Photo courtesy of Trevor Marshall

Black Cat Decals is selling a lettering set for a Canadian National wood sheathed caboose with a large white leaf. Both HO and O scale sets are available. The prototype decorating scheme

circa 1954 included an orange body with the roof and under-body painted brown. For additional information visit blackcat-decals.com.

MARCH NEWS | 32



Microscale Industries has released HO and N scale decals for Illinois Central and Canadian National (ex IC) 50-foot boxcars circa 1990. The lettering sets include the IC rail logo. Sufficient material is provided to decorate two cars in each road name. For additional information on all Microscale products contact a dealer or visit microscale.com.

Resin Car Works is selling an upgraded HO scale decal lettering set for Union Tank Line. The set offers extra data for UTLX 10,000 gallon class X-3 tank cars. Sufficient material is included in the set to correctly letter two cars. For additional information visit resincar-works.com/decals_parts.htm.

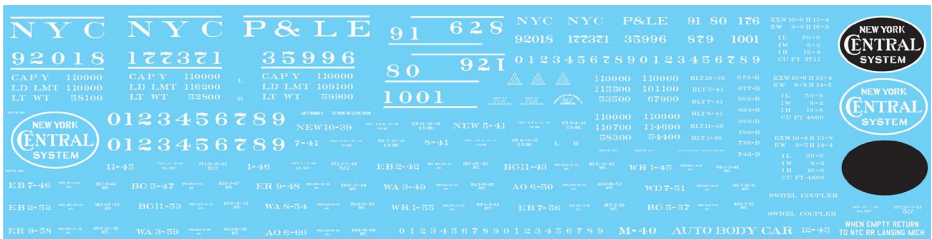

Speedwitch Media has announced several new decal sets, including Pennsylvania FM flat car and DD1-A containers; Baltimore & Ohio P-11 flat cars, New York Central System (NY, PL&E) 50-foot Box cars built 1939-1946 (above), Pennsylvania X29B rebuilt box car, Pennsylvania X26C rebuilt box car, Pennsylvania G22 gondolas and HB1/HB1A containers; Wabash panel-side hopper, Pacific Fruit Express R-40-14 refrigerator cars, Richfield AC&F 10,000 gallon

Type 25 insulated tank car, West India Fruit (ex-Erie) rebuilt box car, and Rohm & Haas pressed steel tank car. More information on all Speedwitch products can be found at speedwitchmedia.com.

.....



SEND US YOUR PRODUCT ANNOUNCEMENTS

If you are a hobby manufacturer with a product announcement, just [click here](#) and submit your announcement to us. Our web site and free magazine reach continues to grow, so get on board this new media train! ■

.....



Click here to rate or comment on this article

DISCLAIMER

The opinions expressed in this column are those of the writer and do not necessarily reflect the opinion of *Model Railroad Hobbyist* or its sponsors. Every effort is made to provide our readers with accurate and responsible news and information, however, neither *Model Railroad Hobbyist* or the writer of this column can be held responsible for any inaccuracies or typographical errors that may inadvertently appear in this column.





BRIEFLY NOTED AT PRESS TIME ...

Fos Scale Models has introduced a line of smaller, low-cost kits in HO scale named "Fos Foundations." Intended for first-time modelers, the kits consist of laser cut wood and plastic parts. The first kits in the Foundations line include the Oakwood Station, Huxley & Powell Milling; Crawley Auto & Tire Repair; Shelton Depot, and a set of two crossing sheds. Kits are priced between \$9.95 and \$34.95. More information is at fosscalemodels.com/t/for-beginners.

Motrak Models has released its first HO scale structure kit in two years, an HO scale tool shed. Featuring laser cut clap-board wood walls, tarpaper material, and acetate, the kit also contains plastic windows and doors by Tichy Train Group and resin detail parts. The structure measures two inches by two inches. See motrakmodelsusa.com for more information.

Train Control Systems is selling a new eight-function DCC decoder equipped with a socket for the MTC 21-pin DCC adapter. A non-sound decoder, the EU821 is designed for HO scale locomotives and includes TCS's next generation BEMF, quiet drive, and auto-adjusting motor control. For more information see tcsdcc.com.

KatoUSA's N scale 4-8-4 GS-4 in Southern Pacific Daylight and BNSF fantasy paint schemes will arrive at the end of this month. Unfortunately, they are already sold out, which serves as a reminder to modelers to make reservations for any item they may want. A second production run of these locomotives is due in early May. To ensure delivery make a reservation with your preferred hobby dealer now.

Monster Model Works has released an HO scale kit for the historic Whitley & Whitley Building in Placerville, CO. Built in 1920, the prototype structure served the narrow gauge Rio Grande Southern Railroad and the numerous mines of the San Juan Mountains. For additional information visit monstermodelworks.com/HO-Scale/HO-Kits/ho-scale-placerville-store-ki.

.....



Click here to rate or comment on this article

Get the latest Model Railroading News, Tips, Reviews & Opinions



Our iTunes feed has changed search for "Mike And Scotty Live" to receive the latest episodes!

www.themodelrailroadpodcast.com

Hosts:

Scott Mason: www.scottymason.com

Mike Rose: www.mrhobby.com

Don't Miss our Monthly Interviews & Product Announcements





SELECTED EVENTS

March 2016

(Please note that many events charge a fee. Check individual info website for details.)

AUSTRALIA, CANBERRA, KALEEN ACT, March 25-26, 29th Annual Model Railway Expo, hosted by the Canberra Model Railway Club, at University of Canberra High School. Info at cmrci.info.

CANADA, ONTARIO, BOWMANVILLE, March 11, 8th Annual Bowmanville Model Railroad Flea Market, hosted by Soper Valley Model Railroad Association. New location at Clarinton Central Secondary, 200 Clarington Blvd. Send information request to sopervalley@gmail.com.

CANADA, ONTARIO, CAMBRIDGE, March 25, 34th Annual Self-Guided Tour, sponsored by Doubleheaders Model Railroad Club. Info at doubleheaders.org.

CANADA, ONTARIO, TORONTO, March 18, Annual Toronto Railway Prototype Modellers Meet, at Humber College, 205 Humber College Blvd, North Campus, Building B, rooms B201& B202. For more info visit qgryinhoscale.wordpress.com/2016/04/10/toronto-railway-prototype-modelers-meet.

ALABAMA, MOBILE, March 11-13, SWARM Model Trainfest, sponsored by South West Alabama Railroad Modelers, at Via Health Fitness & Enrichment Center, 1717 Dauphin Street. Request info from Glenn Samuel at gasamuel@aol.com.

SELECTED EVENTS | 2

COLORADO, DENVER, March 4-5, Rocky Mountain Train Show, sponsored by Rocky Mountain TCA, at Denver Mart, 451 East 58th Avenue. Info at rockymountaintrainshow.com.

ILLINOIS, SPRINGFIELD, March 19, Train Fair, at Orr Building, State Fairgrounds, sponsored by Springfield Railroad Society, Inc. Info at springfieldtrainfair.com.

INDIANA, NAPPANEE, March 18, 13th Annual Train Show at Dutch Village Market. Info at trainweb.org/ew.

MISSOURI, JOPLIN, March 25, Model Train Show, sponsored by Tristate Model Railroaders at Joplin Museum Complex, 504 S. Schifferdecker Avenue. Info at tristatemodelrailroaders.com.

NEW JERSEY, CLARK, March 5, Train Show sponsored by Jersey Central Railroad Historical Society, at Mother Seton High School, Valley Road at Clark Circle. Info at jcrhs.org.

NEW YORK, ALBANY, March 11, Albany Train Show, at Polish Community Center, 225 Washington Avenue Extension. Info at albanytrainshow.com.

NEW YORK, WESTBURY, March 4, Model Train Show sponsored by Boy Scout Troop 233 at United Methodist Church, 265 Asbury Avenue.

OHIO, KIRTLAND, March 18-19, Railfest 2017, at Lakeland Community College, sponsored by NMRA Western Reserve Division 5. Info at railfest.org.

OHIO, GREENVILLE, March 5, Swap Meet, sponsored by Darke County Model Railroad Club, at Youth Building, Darke County Fairgrounds, 800 Sweitzer Street. Request info from Joe Worz at josephbw@embarqmail.com.

OREGON, CORVALLIS, March 18, Winterail Railroad Photography Exposition & Railroadiana Show, at 1400 Northwest Buchanan Avenue. Info at winterail.com.



SELECTED EVENTS | 3

OREGON, PORTLAND, March 25, Model Railroad Swap Meet. Sponsored by Willamette Model Railroad Club, at W.D. Jackson Armory, 6255 N.E. Cornfoot Rd. Info: Brigg Franklin (360) 241-5908. wmrswapmeet@yahoo.com.

PENNSYLVANIA, GREENSBURG, March 24-25, RPM-East Prototype Modelers Meet, at Ramada Greensburg Hotel & Conference Center, 100 Ramada Inn Drive. Info at hansmanns.org/rpm_east/index.htm.

VERMONT, St. ALBANS, March 11, Vermont Rails Train Show, sponsored by North West Vermont Model Railroad Association, at Collins Perley Sports & Fitness Center, Exit 19 Interstate 89. Info at nwwrailroad.org.

April 2017, by location

AUSTRALIA, VICTORIA, GEELONG, April 14-16, 13th Annual Australian Narrow Gauge Convention. Info at austnarrowgaugeconvention.com.

CANADA, ONTARIO, April 8-9, Lindsay & District 43rd Annual Model Train Show at the Victoria Park Armory. For more information send inquiry to waynelamb@sympatico.ca.

CALIFORNIA, OCEANSIDE, April 22, Model Train Swap Meet, sponsored by North County Model Railroad Society, at Oceanside Heritage Park, 220 Peyri Drive. Request info from Rich Blankinship at 760-518-0014 or visit info@ncmrs.org.

COLORADO, COLORADO SPRINGS, April 29-30, TECO - Train Expo Colorado, at Mortgage Solutions Financial Expo Center, 3660 N. Nevada Avenue. For more info call 719-640-2076.

INDIANA, ELWOOD, April 29, 10th Annual Hoosier On30 Meet (All NG and fine scale modelers invited), at Wesleyan Church, 2535 E. Main Street. Request info from Kevin Jones at krjone01@aye.net.

SELECTED EVENTS | 4

MICHIGAN, WYOMING, (Grand Rapids area), April 8, Spring Train Show sponsored by Grand River Valley Railroad Club, at HSB Home School Building, 2625 Burlingame Avenue SW. Info at grandrivervalleyrrc.org.

MISSOURI, ST. LOUIS, April 6-8, 32nd Annual Sn3 Symposium, at St. Louis Airport Marriott, 10700 Pear Tree Lane. Info 2017sn3symposium.com.

NORTH CAROLINA, WILMINGTON, April 1-2, 2nd Annual Coastal Carolina Trainfest, at Coastal Conference Center, 501 Nutt Street. Info at coastalcarolinatrainfest.org.

WASHINGTON, BURIEN (Seattle area), April 1, 18th Annual Mini-Meet Santa Fe Railway fans and modelers, at Pacific Northwest Railroad Archive, 425 SW 153rd Street. Request info from John Thompson at jthomp1945@aol.com.

WASHINGTON, CHEHALIS, April 1-2, Spring Model Railroad Show & Swap Meet at Southwest Washington Fairgrounds, 2555 N. National Avenue, sponsored by Lewis County Model Railroad Club. Request info from Ted at 360-985-7788.

Future 2017 and beyond (by location)

CANADA, ONTARIO, KITCHENER, May 5-7, NMRA Niagara Frontier Region Convention, at Conestoga College, Doon Campus, 299 Doon Valley Drive. Info at GrandRiverExpress.ca.

CALIFORNIA, SANTA CLARA, May 25-28, 27th Annual O Scale West, at Hyatt Regency Santa Clara, 5101 Great America Parkway. Info at oscalewest.com.

COLORADO, DENVER, August 30-September 2, National Narrow Gauge Convention, at Marriott Denver Tech Center Hotel. Info at 37nngc.com.



SELECTED EVENTS | 5

FLORIDA, ORLANDO, July 30-Aug 5, NMRA National Convention. Info at nmra2017.org.

FLORIDA, ORLANDO, August 4-6, National Train Show, at Orange County Convention Center. Info at nationaltrainshow.org.

ILLINOIS, COLLINSVILLE (St. Louis area), June 23-24, St. Louis Prototype Modelers Meet, hosted by Lonnie Bathurst and John Golden, at Gateway Convention Center. Details at icg.home.mindspring.com/rpm/stlrpm.htm.

OKLAHOMA, TULSA, June 21-25, Annual Convention of the Santa Fe Railway Historical & Modeling Society. Info at atsfr.com/convention/index.htm.

PENNSYLVANIA, ALLENTOWN, May 19-10, 23rd National Model Trolley Meet, sponsored by East Penn Traction Club, at Allentown Fairground Agri-Plex Charles Hall, 17th and Chew Street. Info at eastpenn.org. ■



**Click here to rate or
comment on this article**

ADVERTISEMENT

ACCURATE 3800 HOPPERS



RESERVE YOURS BY ST. PATRICK'S DAY

CLICK HERE!

• INDEX



SUBSCRIBE
(free)

• TABLE OF CONTENTS

Clickable advertiser index – 1

[Accu-Lites](#)

[American Ltd \(San Juan\)](#)

[ANE Models](#)

[Archer Fine Transfers](#)

[Athearn](#)

[Atlas Model Railroad Co.](#)

[Bachmann](#)

[Backdrop Junction](#)

[Banta Modelworks](#)

[Berrett Hill Trains](#)

[Black Cat Publishing](#)

[Blair Line](#)

[Bowser](#)

[Canyon Creek Scenics](#)

[Clever Models](#)

[Coastmans Scenic Products](#)

[Coffman Graphics](#)

[Crow River Products](#)

[Digitrax \(2 page spread\)](#)

[ESU LokSound](#)

[Fast Tracks](#)

[Fox Valley Models](#)

[Good Deals DCC](#)

[Great Decals](#)

[HO Diesel Supply](#)

[Iowa Scaled Engineering](#)

[ITLA Scale Models](#)

[Ken Patterson.com](#)

[Lights 4 Models](#)

[Litchfield Station](#)

[Logic Rail Technologies](#)

[Main Street Heritage Models](#)

[Model Railroad Benchwork \(1\)](#)

[Model Railroad Benchwork \(2\)](#)

[Monster Modelworks](#)

[Motrak Models](#)

[Model Railroad Control Systems](#)

[Mountain Subdivision Hobbies](#)

[MRH Store \(1\)](#)

[MRH Store \(2\)](#)

[MRH Store \(3\)](#)

[MRH Store \(4\)](#)

[Mt. Albert Scale Lumber](#)

[National Train Show](#)

[NCE \(2 page spread\)](#)

[Nick & Nora Design](#)

[Norfolk & Western Hist. Society](#)

[North American Railcar Co.](#)

[Oak Hill MRR Track Supply](#)

[Pre-Size Model Specialities](#)

[Precision Design Co.](#)

[Rapido \(1\)](#)

[Rapido \(2\)](#)

[Ring Engineering \(1\)](#)

[Ring Engineering \(2\)](#)

[Rulers-of-the-World](#)

[Rusty Stumps](#)

[Scale Trains](#)

[Scotty Mason Show](#)

[Sea Port Model Works](#)

[Select Model Railroads](#)

[Streamlined Backshop Services](#)

[Soundtraxx \(Blackstone\)](#)

[Southern Digital](#)

Clickable advertiser index – 2

[TAM Industries](#)

[TAM Valley Depot](#)

[Tony's Train Exchange](#)

[Train Control Systems](#)

[TrainMasters TV \(1\)](#)

[TrainMasters TV \(2\)](#)

[TrainMasters TV \(3\)](#)

[TrainMasters TV \(4\)](#)

[Traintek](#)

[TSG Multimedia](#)

[Westerfield Models](#)

[Yankee Dabbler](#)

[Yarmouth Model Works](#)

Clickable “other” index

[Other – Cover](#)

[Other – Derailments](#)

[Other – Hobby Marketplace](#)

[Other – MRH Sponsors](#)

[Other – Contents](#)

DOWNLOAD ISSUE



DOWNLOAD PORTRAIT



DOWNLOAD LANDSCAPE

• INDEX



SUBSCRIBE
(free)

• TABLE OF CONTENTS



REVERSE RUNNING

commentary

DAVID EVANS
.....



[Click here for
reader comments](#)

TRULY HAVING *FUN* WITH TRAINS

I READ LAST MONTH'S REVERSE RUNNING

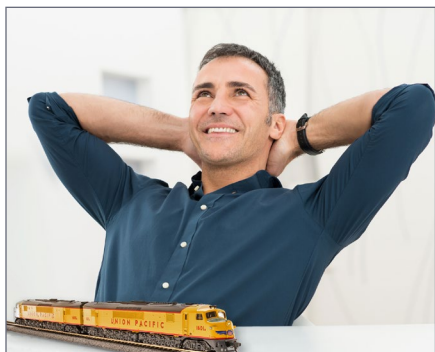

column with interest.

It makes some good points about being overwhelmed with a huge layout, but I have another way to deal with the problem of “too much to do.”

It's simple really: I just build what I want to build for fun and I don't fret about what's not done. I'm

hearkening back to the TOMA sectional idea – but using the best of this approach for *any* layout, TOMA or otherwise.

I'm on my third large layout now and I'm still working on the house above it, so progress isn't always consistent, especially when the weather is good. My layout is double-decked with about 400 feet of mainline, 200 feet of which is down and operating now.

I can't honestly say the full layout as planned will *ever* be built. I'm feeling the itch to do some scenery right now and that will certainly

▶ STEPPING OUTSIDE THE BOX WITH A CONTRARY VIEW

delay the construction of any further benchwork, trackwork and wiring. The TOMA approach says finish what you've built first before building more, right? Works for me.

I'm doing scenery right now because I want to have fun with it, not because I feel the need to impress, awe, inspire, or otherwise get "fancy-dancey" about making progress. I'm indulging in self-expression, sharpening my skills, or just plain "beating on things" as the spirit moves me. I'm having fun!

Sometimes the only progress I've made recently is adding detail to a locomotive or weathering a car. What others think of my progress or my lack of progress isn't what matters to me.

I'm having fun, I'm fulfilling my goals for what a hobby does to enrich my free time. Life is good. So what if my goals are too small? Why should anyone else care? What matters is that I'm good with it!

Not long ago, I read an editorial suggesting that I needed to "take a long, hard look at how I spend my hobby time." Sorry, but no.

I have spent my work career taking long hard looks at pretty much everything, so stick me with a fork: I'm done. When I think of my hobby time, whatever makes me smile is what I'm going to do next.

With my hobby, I have no schedule and no "do or die" goals other than does it look good to me and is it done enough to operate? If only one area ever gets done to the nines, that's just fine with me.

If visitors doubt that I can do the hobby to the nines, then permit me to direct your attention to my locomotive terminal area. I typically finish that area first because I'm a locomotive junkie at heart.

But on the other hand, maybe I won't finish the loco area first this time. I've got a great little branch line area that has my fascination right now, and I just might get done first *instead*.

Whatever makes my heart smile is what I'll do next. At the end of the day, that's what works best for me when I'm talking about a hobby I love with a passion.

Having fun with trains *first* just might work for you too.





DERAILMENTS



Jerry King

“The railroad wishes all its customers a happy 2017 and apologizes for the late arrival of this message ...”

► BIZARRE FACTS AND HUMOR (SUPPOSEDLY)

SPINNING LOCO WHEELS MELTED THE RAIL



The lead engine stopped with brakes engaged and the remaining engine had to overcome not only the braked loco but trying to pull the entire load on its own. Once a slight railhead groove got established, the engine just spun in place and melted

through the rail. The time to repair? Two hours tops: MOW employees cut out the rail with a chop saw and welded in some new rail. ■

💰 GET PAID ...

If you're the first to submit a bit of good humor or bizarre facts and we use it, it's worth \$25! Just send to derailments@mrhmag.com ■

Coming next issue ...

- Mike Tylick builds some narrow gauge Ocean Spray box cars based on prototype research
- Grand prize winning design of the one Module Challenge Contest
- SMD LED's in dwarf signals
- City scenes in tight spaces
- And lots, *lots* more!



Click here to rate or comment on this article

• INDEX



SUBSCRIBE
(free)

• TABLE OF CONTENTS