

# MRH

MODEL RAILROAD HOBBYIST

## ALSO:

- Modeling a small cement plant
- Illuminated lanterns with LEDs
- Engine servicing details
- Weathering a covered hopper
- Using capacitors in DCC

... and lots more inside!

Jeremiah Shoemaker  
& Blake Freudenberg

## Design a TOMA copper mining layout

»» **READ NOW**

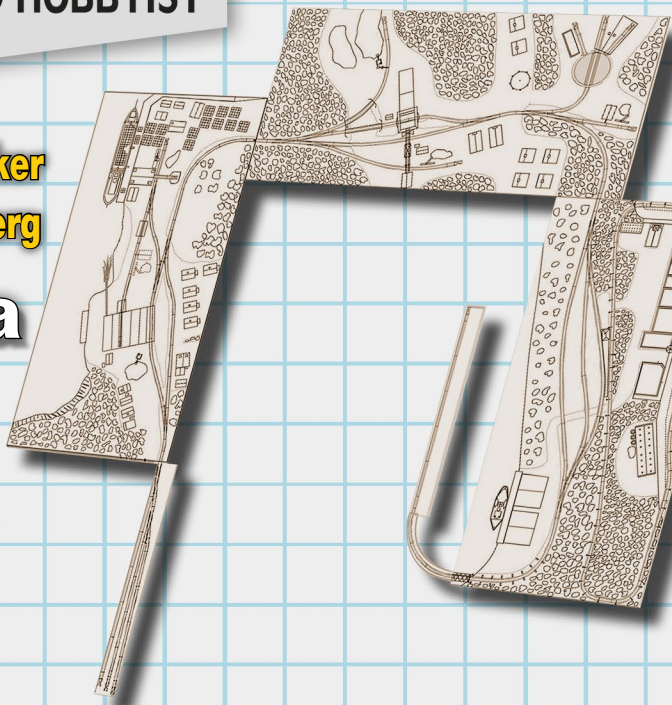

Third Place "One Module" Challenge Winners



AVAILABLE FOR PRE-ORDER IN AUGUST 2017 FROM



# ATLAS MASTER® N 40' REBUILT WELL CARS AND CONTAINERS



\*Containers and Well Cars sold separately. Technical artwork shown.



TTX - FORWARD THINKING VER. 1



EARLY TTX



NOKL



TTX - FORWARD THINKING VER. 2



EVERGREEN EISU



EVERGREEN EMCU



WAN HAI



UNIGLORY



GENSTAR

**CLICK HERE!**

FOR MORE INFORMATION OR TO LOCATE A DEALER, PLEASE VISIT [WWW.ATLASRR.COM](http://WWW.ATLASRR.COM).  
ATLAS MODEL RAILROAD CO., INC. • 378 Florence Ave., Hillside, NJ 07205





# STAFF CREDITS

(Updated 7/28/2017)

**Front cover:** These two fine young gentlemen won third place in our “One Module” Challenge layout design contest. Check out their clever design, in this issue!

ISSN 2152-7423

## Editorial Staff

Joe D. Fugate, Publisher and Editor

Don Hanley, Assistant Editor

## Production

Patty Fugate, Pasteup and Layout

Joe Brugger, Copy Editing

Mike Dodd, Copy Editing

## Technical Assistant

Jeff Shultz

## Advertising

Les Halmos, Account Manager

Daniel Nava, Advertising Assistant

Jean-François Delisle, Marketing Assistant

## News and Events

Richard Bale, News and events

Jeff Shultz, News and events

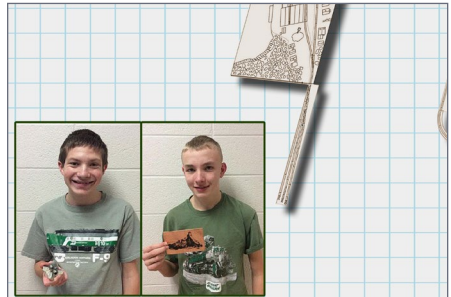

## Columnists

Les Halmos, Modular railroading

Larry Smith, Narrow Gauge/Shortlines

Bruce Petrarca, DCC

Ken Patterson, Reporter at large

## Rotating Columnists

Jack Burgess, Getting Real column

Nick Muff, Getting Real column

Mike Rose, Getting Real column

Tony Thompson, Getting Real column

Rob Clark, Imagineering

Dave Meek, Imagineering

Ray Dunakin, Imagineering

Issue password: Aug2017

Published for the glory of God. [What's this?](#)





# MRH SPONSORS

## A - E



[acculites.com](http://acculites.com)



[americanlimitedmodels.com](http://americanlimitedmodels.com)



[railroadhobbyshow.com](http://railroadhobbyshow.com)



[anemodel.com](http://anemodel.com)



[archertransfers.com](http://archertransfers.com)



[athearn.com](http://athearn.com)



[www.atlasrr.com](http://www.atlasrr.com)



[bachmanntrains.com](http://bachmanntrains.com)



[bachrus.com](http://bachrus.com)



[backdropjunction.com](http://backdropjunction.com)

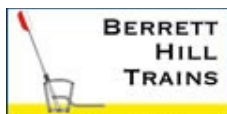

[berrethill.com/trains](http://berrethill.com/trains)



[blairline.com](http://blairline.com)



[bowser-trains.com](http://bowser-trains.com)



[mycaboose.com](http://mycaboose.com)



[coffmaneng.com](http://coffmaneng.com)



[con-cor.com](http://con-cor.com)



[www.digitrax.com](http://www.digitrax.com)



[esu.eu/en](http://esu.eu/en)

[Vendors: Get your clickable logo here ...](#)

# MRH SPONSORS | 2

## F - R



[handlaidtrack.com](http://handlaidtrack.com)



[modelrailroadexpo.com](http://modelrailroadexpo.com)



[foxvalleymodels.com](http://foxvalleymodels.com)



[iascaled.com](http://iascaled.com)



[lights4models.com](http://lights4models.com)



[litchfieldstation.com](http://litchfieldstation.com)



[micro-trains.com](http://micro-trains.com)



[store.mrhmag.com](http://store.mrhmag.com)



[stores.ebay.com/Motrak-Models](http://stores.ebay.com/Motrak-Models)



[mtalbert.com](http://mtalbert.com)



[37nngc.com](http://37nngc.com)



[ncedcc.com](http://ncedcc.com)



[nickandnora.com](http://nickandnora.com)



[nwhs.org](http://nwhs.org)



[www.pwrs.ca/main.php](http://www.pwrs.ca/main.php)



[rapidotrains.com](http://rapidotrains.com)



[ringengineering.com](http://ringengineering.com)

[Vendors: Get your clickable logo here ...](#)

• [INDEX](#)



[SUBSCRIBE](#)  
(free)

• [TABLE OF CONTENTS](#)



# MRH SPONSORS | 3

## S - Z



[sanjuancarco.com](http://sanjuancarco.com)



[scaletrains.com](http://scaletrains.com)



[selectmodelrailroads.com](http://selectmodelrailroads.com)



[soundtraxx.com](http://soundtraxx.com)



[sodigi.com](http://sodigi.com)



[sbs4dcc.com](http://sbs4dcc.com)

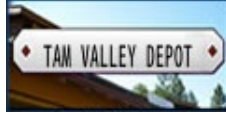

[tamvalleydepot.com](http://tamvalleydepot.com)



[tcsdcc.com](http://tcsdcc.com)



[trainfest.com](http://trainfest.com)



[tonystrains.com](http://tonystrains.com)



[traintekllc.com](http://traintekllc.com)



[tsgmultimedia.com](http://tsgmultimedia.com)



[walters.com](http://walters.com)



[yankeedabbler.com](http://yankeedabbler.com)

[Vendors: Get your clickable logo here ...](#)

Looking for something? Check the MRH Marketplace!

The screenshot shows the MRH Marketplace website interface. At the top, it says "MRH MARKETPLACE | 2" and "Your ad could be in this space for as low as \$50 a month. Click to learn more...". Below this are several vendor listings with images and text:

- GOODDEALS.DCC**: WWW.GOODDEALS.DCC.COM
- WESTERFIELD**: WWW.WESTERFIELDMODELS.COM
- THE DCC SHOP**: WWW.DCCSHOP.COM
- CRASHMAN PITS & BUILT-UPS**: WWW.CRASHMANPITS.COM
- YANMOUTH MODEL WORKS**: WWW.YANMOUTHMODELWORKS.COM
- YANKEE DABBLER.COM**: WWW.YANKEEDABBLER.COM
- TRINTEK**: WWW.TRINTEKLLC.COM
- SCALE TRAINS**: WWW.SCALETRAINS.COM
- SONDRAXX**: WWW.SONDRAXX.COM
- SELECT MODEL RAILROADS**: WWW.SELECTMODELRAILROADS.COM
- SOUTHERN DIGITAL**: WWW.SODIGI.COM
- SBS4DCC**: WWW.SBS4DCC.COM
- TAM VALLEY DEPOT**: WWW.TAMVALLEYDEPOT.COM
- TCS**: WWW.TCS.DCC.COM
- TSG MULTIMEDIA**: WWW.TSGMULTIMEDIA.COM
- WALTERS**: WWW.WALTERS.COM

A large green button with the text "Take me there!" is positioned to the right of the marketplace screenshot.

**HO**  
SCALE

# BE PREPARED FOR FUN!

## THE SCOUT SPECIAL

### with E-Z APP® TRAIN CONTROL



SHIPPING NOW! MSRP \$349.00  
Item No. 01503 • Scout Special with  
E-Z App® Train Control

**NEW**

Click to  
learn more.



Bachmann salutes the Boy Scouts of America® with the E-Z App®-equipped Scout Special. Enjoy wireless touch-screen control of this ready-to-run set through your smart device and the FREE E-Z App® download. The Scout Special includes an E-Z App®-equipped F7-A diesel with operating headlight, box car with Norman Rockwell and Joseph Csatari illustrations, quad hopper with BSA® Railroad Merit Badge design, off-center caboose, 56" x 38" oval of snap-fit nickel silver E-Z Track®, wall power pack, and illustrated instructions. Be prepared for touch-screen train control fun with the Boy Scouts of America® and Bachmann Trains!

Features of E-Z App® Touch-Screen Train Control include:

- wireless control with any Android™ device (running Android™ 4.3 or newer) or Bluetooth® 4-supported iPhone®, iPad®, or iOS device (includes iPhone® 4s, 5, 5c, 5s, 6, and 6 Plus; iPad Air® and iPad mini™, 3rd and 4th generations; and iPod touch® 5 or newer)
- operates from up to 100 feet away with Bluetooth® Smart technology
- realistic, dynamic engine sound broadcast through your smart device
- ready to launch and use instantly after downloading the FREE Bachmann E-Z App® from the Apple App Store™ or Google Play™ store.
- no configuration or additional equipment required



Bachmann Trains commemorates the 2017 Jamboree® with a limited edition BSA Jamboree® 50' Plug-Door Box Car. It's a great collectible that's ready to run with your HO scale trains. Only 400 made! Get yours today.

Click to  
learn more.



SHIPPING NOW! MSRP \$29.00

Item No. 18004 • 50' Plug-Door Box Car – Jamboree®

**NEW**

Boy Scouts of America®, the Corporate Emblem, Jamboree®, Merit Badge Designs and Prepared. For Life.® are either registered trademarks or trademarks of the Boy Scouts of America in the United States and/or other countries. Manufactured under license from the Boy Scouts of America. All rights reserved.

OFFICIALLY LICENSED



Bachmann Industries, Inc. • 1400 East Erie Avenue • Philadelphia, PA 19124 USA • [www.bachmanntrains.com](http://www.bachmanntrains.com)

Click for more information.

• INDEX



SUBSCRIBE  
(free)

• TABLE OF CONTENTS



# TABLE OF CONTENTS

## FEATURES

### Layout design: the Calumet Central

*JEREMIAH SHOEMAKER and BLAKE FREUDENBERG*

Our third place “One Module” Contest winner

---



### Illuminated kerosene lanterns

*BERNHARD SCHROETER*

Modeling railroad lanterns with micro LEDs

---



### Enhancing Jensen Concrete

*CLARK PROPST*

Modeling what-could-have-been realistically

---



### Weathering a covered hopper

*NICK CAMPBELL*

A patched-out car for the TrainMastersTV

---

TOMA project

---



### OPSIG Compendium of model railroad ops

*JOE FUGATE*

Finally, a current all-things-ops mega-book

---



**ALSO:** MRH Marketplace | Subscriber extras



# TABLE OF CONTENTS | 2

## COLUMNS

**MRH Q-A-T: Planning for signals, and more**

*compiled by JOE BRUGGER*

**DCC Impulses: Capacitors in DCC**

*BRUCE PETRARCA*

**Getting Real: Engine servicing details**

*TONY THOMPSON*

**What's Neat: Talking to Caboose and lots more**

*KEN PATTERSON*

**Photo feature: Yes, it's a model**

*compiled by DON HANLEY*

**Derailments: Bizarre facts & humor**

*compiled by the MRH STAFF*

## NEWS and EDITORIAL

**Assistant Editor's Thoughts: Creativity**

*DON HANLEY*

**News & Events: August 2017**

*RICHARD BALE & JEFF SHULTZ*

**Reverse Running: Should I host an open op session?**

*CHRIS ADAMS*



ADVERTISEMENT



# DUE AUGUST

HO Scale Tier 4 GEvo  
(Actual Model Shown)



Scene and photography by Ken J Johnson  
Preproduction model shown

Also available in N Scale

See All 7 Railroads and Preorder Now

This product is made under trademark license from General Electric (GE).  
© 2017 ScaleTrains.com, Inc. ScaleTrains.com, Rivet Counter and  
respective logos are trademarks of ScaleTrains.com, Inc.  
ScaleTrains.com, Inc. 7598 Highway 411 Benton, TN 37307  
844-9TRAINS 844-987-2467 International 423-299-3689



• INDEX

• TABLE OF CONTENTS



Model Railroad Hobbyist | August 2017 | #90

# ASSISTANT EDITOR

editorial

DON HANLEY  
.....



Click here to rate or  
comment on this article

## CREATIVITY

**IN THE JUNE REVERSE RUNNING, *MODEL Railroading R.I.P.***, I wrote a light-hearted poke at those who believe the hobby is dying. The comments this column generated were “all over the map” as to perspective.

In the comments, TMTV Executive Producer Barry Silverthorn illustrated the cost of the hobby by showing two photos: one with a large amount of rolling stock (estimated at \$3,000) and another of a structure that cost \$250 [See [mrhmag.com/magazine/mrh2017-06/reverse-running?page=2#comment-288552](http://mrhmag.com/magazine/mrh2017-06/reverse-running?page=2#comment-288552)].

Getting Real columnist Jack Burgess posted a video about his Yosemite Valley Railroad produced by TSG Multimedia [[mrhmag.com/node/30296](http://mrhmag.com/node/30296)]. In the video, Jack noted it has taken him 30 years to build his layout. His track is handlaid because he was on a budget. Even though he knew it would take longer to handlay the track compared to using flex track, this allowed him to spend more time on the hobby yet still keep within his budget.

• INDEX  
.....



SUBSCRIBE  
(free)

• TABLE OF CONTENTS  
.....



## ASSISTANT EDITOR'S THOUGHTS | 2

I see a common theme in these two posts. The hobby is not about how fast you can get something accomplished, or about how much money you need to spend. Rather, it's about the time you *invest*. The more time you invest in the hobby, the more creative you become at solving problems in your modeling.

Creativity, in my opinion, is a key metric regarding the strength of the hobby. What do I mean by creativity? How well do you bring unique solutions to building a model? Can you look at a product (especially non-hobby items) and see a potential hobby use for it? In other words, creativity involves adapting an item into a clever modeling solution on your layout / diorama.

What would happen if the products you normally use to build your models suddenly vanished? Could you adapt and continue

ADVERTISEMENT

### New N & Z HEINZ® 12-Car Reefer Series



Series Begins September 2017



The Heinz trademarks are owned by H.J. Heinz US Brands LLC and Kraft Heinz Canada ULC and are used under license.

ADVERTISEMENT

## CABOOSE™

Sharing Our Passion for Trains Since 1938

### Click Here for the Serious Modeler's Resource!

More than 170,000 items,  
over 490 manufacturers,  
most at a discount from  
full retail – all at a fair price.  
**As always, in-stock orders of  
\$100.00 or more ship free  
within the Continental U.S.!**\*

\*surcharges may apply for oversize items.

10800 West Alameda Ave.  
Lakewood, CO 80226  
(303) 777-6766

MAKING RAILROAD HISTORY  
**WALTHERS MAINLINE**

# EMD SD60

## HO SCALE



**UPDATED MODEL AVAILABLE NOW!**

- Early version with EMD Spartan cab
- Updated shell with molded drill starter points for grab irons (sold separately)
- All-new drive including newly tooled power trucks & sideframes
- Same powerful drive as WalthersProto<sup>®</sup> locos
- Available with factory-installed SoundTraxx<sup>®</sup> sound for DCC & DC layouts
- 9-pin plug for easy DCC conversion

### Canadian National



### Chicago & North Western†



### CSX\*



### Norfolk Southern



### Soo Line



### Union Pacific†



**CLICK HERE TO LEARN MORE!**

**WALTHERS**

Support your local hobby shop • visit [walters.com](http://walters.com) • call 1-800-4-TRAINS

Delivery date and prices shown were accurate at press time, for updates visit [walters.com](http://walters.com).  
 \*CSX proprietary marks used by permission of CSX Transportation Inc. †Union Pacific licensed product. ©2017 Wm. K. Walthers, Inc.

• INDEX



SUBSCRIBE  
 (free)

• TABLE OF CONTENTS



## Announcing Motrak Models New Structure Kit HO Scale "The Tool Shed"

**CHECK  
IT OUT!**



**CHECK  
IT OUT!**

Website: [motrakmodelsusa.com](http://motrakmodelsusa.com)  
Email: [info@motrakmodelsusa.com](mailto:info@motrakmodelsusa.com)

### ASSISTANT EDITOR'S THOUGHTS | 3

the hobby or would you just give up on it? Testors eliminating the Floquil line of paints is a recent example of this. For me, it required finding a different paint and starting over learning the ins-and-outs of using it.

I have often wondered, if styrene were to suddenly disappear, could I build a model from cardstock? How long would it take me to figure out how to make a detailed yet durable structure?

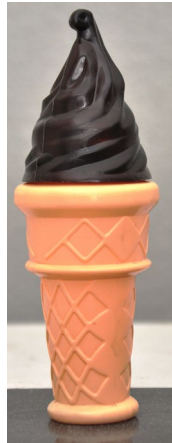

1. My future ice cream stand, the "Whippy Dip." It's named after the ice cream stand in the small town where I grew up.





H0 models shown

# N-SCALE ROLLING PIPELINE

## ANNOUNCEMENT

Loading and unloading individual tank cars is a time consuming process, so GATX developed a unique solution—the TankTrain. The TankTrain is literally a pipeline on wheels. Sets of up to 13 cars are interconnected with a transfer hose so they can be loaded and unloaded from one end at a rate of 3,000 gallons per minute. Based upon GATX diagrams, as well as photos and field measurements, these new N-scale models faithfully replicate the differences between the 282-number series and 486-number series. For the first time ever, these models make their debut in N-scale exclusively by Athearn®

### \$84.98 N TANKTRAIN 3-PACK

- ATH14999 A/B Ends & Intermediate Car GATX/B-S-T (3)
- ATH15000 Intermediate, GATX/B-S-T #1 (3)
- ATH15001 Intermediate, GATX/B-S-T #2 (3)
- ATH15002 Intermediate, GATX/B-S-T #3 (3)
- ATH15003 A/B Ends & Intermediate Car GATX/P-TT-L (3)
- ATH15004 Intermediate, GATX/P-TT-L #1 (3)
- ATH15005 Intermediate, GATX/P-TT-L #2 (3)
- ATH15006 Intermediate, GATX/P-TT-L #3 (3)
- ATH15007 A/B Set, GATX/White #48701 #48735
- ATH15008 Intermediate, GATX/White #1 (3)
- ATH15009 Intermediate, GATX/White #2 (3)



**Down to the Last Detail**  
Accurately represented flexible soft vinyl transfer hose with characteristic sag that easily bends as the cars negotiate curves.



**Accuracy Counts**  
Details specific to both the 486xx and 282xx series including different tank saddles, uncoupling lever and bracket, top walkway and supports, and transfer piping and gas purge lines.



**HORIZON**  
H O B B Y

**VISIT**  
Your Local Retailer

**CLICK**  
Athemn.com

**CALL**  
1.800.338.4639

**SERIOUS FUN™**

©2016 Horizon Hobby, LLC. Athearn, Genesis, Ready To Roll, Train in Miniature, Serious Fun and the Horizon Hobby logo are trademarks or registered trademarks of Horizon Hobby, LLC. All other trademarks, service marks and logos are property of their respective owners. Union Pacific Licensed Product. Final models may vary slightly from photos shown. Model photos by Tom Bacarella, 55933

• INDEX



**SUBSCRIBE**  
(free)

• TABLE OF CONTENTS

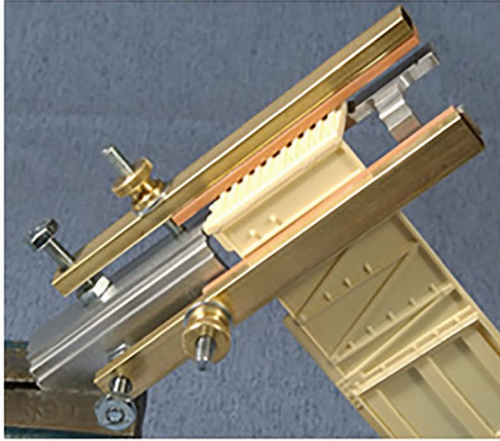
**Combo Right Clamp™**

**Combo Right Clamp™**  
with cast resin boxcar

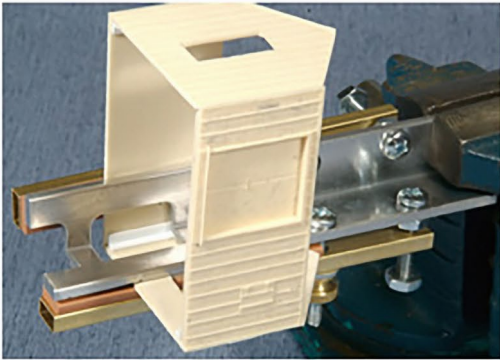

**Combo Right Clamp™**  
with Wolf Design Pump House

**Click here for  
all our products ...**

**Tools for Modelers**

**Coffman Graphic Solutions Co.**  
1500 River Circle, Richmond,  
KY 40475-7907

**ASSIST EDITOR'S THOUGHTS | 4**

On the other hand, there is the ability to look at an object and see new possibilities. I have one such item waiting to be built.

My wife bought some bubble bottles for the grand kids to play with, shaped like little ice cream cones. I kept one, and in the near future it will become an ice cream stand on my layout [1].

The more creative I can be as a modeler, the more I can enjoy the time I invest in the hobby. I can find new ways to solve problems and then share them with others. Other hobbyists who do the same can share their discoveries with me (and others), helping to build a strong hobby ripe with great solutions.

There is another benefit of learning how to be creative in modeling: time. The more creative I become, the more time it may take me to build a model. The expense of purchasing locomotives, rolling stock, tools and all the things that it takes to build a layout out can add up to a significant sum of money.

But as Barry noted in his post about the structure, by the time



# YOU DON'T HAVE TO BUILD IT...

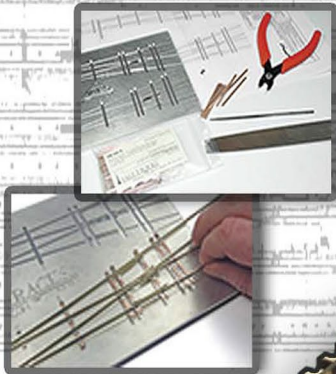

# YOU GET TO BUILD IT!

With track building tools  
and supplies from...

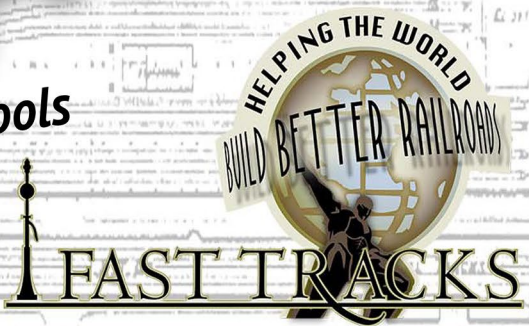

Visit [HANDLAIDTRACK.COM](http://HANDLAIDTRACK.COM) and start today!

• INDEX



SUBSCRIBE  
(free)

• TABLE OF CONTENTS

# Bowser

## HO 40' Boxcars

Ready to Run. Features:  
Crisp details and sharp painting and printing, metal wheels and knuckle couplers.

## HO Freight Car Kits

## HO ALCo Century C-628, C-630, & C-630M Locomotives

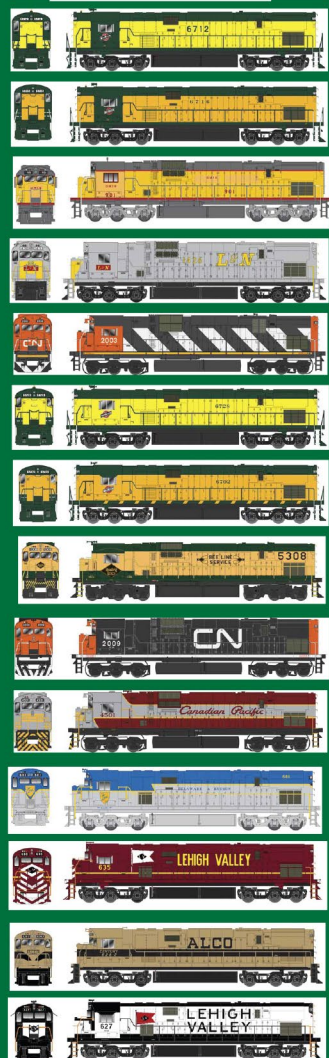

Click here to check out the details for these and other great Bowser Products



## ASSISTANT EDITOR'S THOUGHTS | 5

you divided the cost of the tools and materials by the time spent building, it works out to about \$1 hour. That's an extremely affordable investment in today's economy!

Certainly, there are trade-offs to be made. I can become "so creative" that I build very few models because I scratchbuild everything. Or I can spend a significant sum of money buying almost all of the models to be placed on the layout.

The extremes at either end of the scale fit very few people perfectly. Most of us tend to fit somewhere between the extremes. For me, it's a little more on the side of creativity – which means I'm good with investing a bit more time and spending a little less money.



[Click here to rate or comment on this article](#)

**Did you know  
there is an  
MRH index  
available?**

[CLICK TO FIND OUT MORE](#)

• [INDEX](#)



[SUBSCRIBE](#)  
(free)

• [TABLE OF CONTENTS](#)

# MRH “TOMA WITH A TWIST” CONTEST

**ENTRY DEADLINE: January 31, 2018**

**Goal: Design the “starting position” for a sectional home layout design using TOMA.\***

**GRAND PRIZE: \$1000, plus get published as an MRH cover story**

First Prize: \$750; Second Prize: \$500; Third Prize: \$350;  
First, Second, and Third prize also get published.

Honorable mentions: \$100 each, publishing at editors’ discretion.

Hypothetical room is 14’ x 20’. Space under the stairs not available, and a 4’ clearance must be maintained along the utility wall.

Note: This is a sectional home layout design, no modular standard required.

**Room 14’ x 20’**

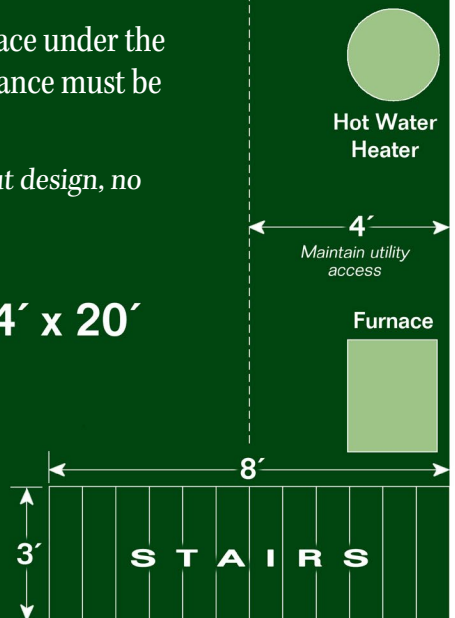

\*For reference, see the July 2017 MRH Editorial, “TOMA with a twist”.

## CONTEST RULES

- Modules can be any size or shape but must fit up the stairs and through the door at the top of the stairs (80" tall and 30" wide) without damage or pinching your fingers.
- Scale: From Z to O, using any track gauge.
- Design the "starting position" for layout construction phase 1 – we want to see one or two TOMA module sections that can be completely finished and configured for an operating session. Show and tell how staging would work. Tell a brief backstory of the line and how it operates.
- Your TOMA modules need to have some form of temporary staging, either singled-ended staging off one/both ends, or double ended staging connected to both ends of the modules, which would also allow continuous running if desired.
- Don't waste your time drawing and describing a detailed room-filling layout. Rough in outlines of the other modules, that is, the "ending position." Just sketch simple boxes and lines to show how the modules will fit in the room. Bonus points awarded for explaining – in words, sketches or both – a phased module construction progress plan.
- Modules can follow a standard or not. Custom sections okay.
- Module support method / height up to you, but please describe.
- Innovative or creative approaches get extra points: please describe and illustrate if possible.
- Include a cost estimate for the starting position. There is no need to actually build anything, this is a design contest only.
- This contest is *all about getting started*. People who can get that far will be able to fill in the rest with their own imagination.
- All submissions must be publishable. If the submission is not formatted to be ready for publication, it will be disqualified. Take the time to be complete, provide captions, and to describe things completely in your text. See the [MRH submission guidelines for more information](#).

**SUBMIT ENTRY (Choose "Contest Entry")**



### TOMA INDEX (TOMA = **T**he **O**ne **M**odule **A**pproach)

We have been asked to provide an index to what has been produced so far on the topic of doing a layout using TOMA.

Part of our mission in recent years has been to get the armchair guys up and doing some modeling – and that started with Joe Fugate's One Module Challenge editorial back in the May 2013 MRH.

That has morphed into the TOMA method for doing a layout – rather than building an entire room-filling monster, you start by building a single small module section to completion and drop some temporary flattop staging on each end. You can grow the layout from there by adding more module sections.

TOMA is low risk and small scope, the perfect opportunity to start doing the entire scope of the hobby quickly, with minimal investment.

Here is a chronological index to what's available so far on TOMA:

### TOMA MRH Forum threads by the MRH Staff

- TOMA home layout (TOMA) ... [mrhmag.com/node/27542](http://mrhmag.com/node/27542)
- Down at the Station ... [mrhmag.com/node/27658](http://mrhmag.com/node/27658)
- TOMA Project layout sneak peek ... [mrhmag.com/node/28302](http://mrhmag.com/node/28302)
- End of Siskiyou Line 1 details ... [mrhmag.com/node/28870](http://mrhmag.com/node/28870)
- Siskiyou Line 1 grand finale ... [mrhmag.com/node/29242](http://mrhmag.com/node/29242)
- Lighting - SL2 - TOMA Sections ... [mrhmag.com/node/29536](http://mrhmag.com/node/29536)
- TOMA part 6 track plan ... [mrhmag.com/node/30411](http://mrhmag.com/node/30411)

### TOMA MRH Forum threads by others

- Building one module at a time ... [mrhmag.com/node/14472](http://mrhmag.com/node/14472)
- Module challenge ... [mrhmag.com/node/22109](http://mrhmag.com/node/22109)
- Module guidelines ... [mrhmag.com/node/23735](http://mrhmag.com/node/23735)
- Using TOMA and Free-mo ... [mrhmag.com/node/26503](http://mrhmag.com/node/26503)
- Module rotisserie ... [mrhmag.com/node/27491](http://mrhmag.com/node/27491)



# ASSISTANT EDITOR'S THOUGHTS | 7

- My first model railroad project ... [mrhmag.com/node/27586](http://mrhmag.com/node/27586)
- Twisting main DCC bus wires ... [mrhmag.com/node/27815](http://mrhmag.com/node/27815)
- Feeling overwhelmed? ... [mrhmag.com/node/27913](http://mrhmag.com/node/27913)
- TOMA Module DCC wiring ... [mrhmag.com/node/28193](http://mrhmag.com/node/28193)
- TOMA Hill Street crossing ... [mrhmag.com/node/28420](http://mrhmag.com/node/28420)
- TOMA construction methods... [mrhmag.com/node/28790](http://mrhmag.com/node/28790)
- TT Scale "TOMA" ... [mrhmag.com/node/29045](http://mrhmag.com/node/29045)
- Should I have entered ... [mrhmag.com/node/29727](http://mrhmag.com/node/29727)
- Mascoutin Valley - TOMA TOMA TOMA ... [mrhmag.com/node/29748](http://mrhmag.com/node/29748)
- In need of some good ideas ... [mrhmag.com/node/29822](http://mrhmag.com/node/29822)
- Corrimal Colliery and its incline ... [mrhmag.com/node/30200](http://mrhmag.com/node/30200)
- TOMA ideas in practice ... [mrhmag.com/node/30353](http://mrhmag.com/node/30353)

## TOMA MRH Magazine articles

- The "one-module" challenge ...  
[mrhmag.com/magazine/mrh-2013-05-may/rr\\_one-module-challenge](http://mrhmag.com/magazine/mrh-2013-05-may/rr_one-module-challenge)
- "One module" challenge contest ...  
[mrhmag.com/magazine/mrh-2015-09-sep/staff-notes](http://mrhmag.com/magazine/mrh-2015-09-sep/staff-notes)
- Doing layouts - time for TOMA ...  
[mrhmag.com/magazine/mrh-2015-10-oct/publishers-musings](http://mrhmag.com/magazine/mrh-2015-10-oct/publishers-musings)
- Chama-Division layout ...  
[mrhmag.com/magazine/mrh2016-04-apr/omc\\_chama-division](http://mrhmag.com/magazine/mrh2016-04-apr/omc_chama-division)
- Pembroke ...  
[mrhmag.com/magazine/mrh2016-06-jun/omc\\_pembroke](http://mrhmag.com/magazine/mrh2016-06-jun/omc_pembroke)
- Ferryville & Eastern ...  
[mrhmag.com/magazine/mrh2016-08-aug/omc\\_third-place](http://mrhmag.com/magazine/mrh2016-08-aug/omc_third-place)
- Dismantling the Siskiyou Line ...  
[mrhmag.com/magazine/mrh2017-01/publishers-musings](http://mrhmag.com/magazine/mrh2017-01/publishers-musings)
- Eyes bigger than your stomach ...  
[mrhmag.com/magazine/mrh2017-02/reverse-running](http://mrhmag.com/magazine/mrh2017-02/reverse-running)
- Central Oregon and Pacific ...  
[mrhmag.com/magazine/mrh2017-04/contest-grand-prize](http://mrhmag.com/magazine/mrh2017-04/contest-grand-prize)



- Easton Lumber Company ...  
[mrhmag.com/magazine/mrh2017-06/omc-first-place](http://mrhmag.com/magazine/mrh2017-06/omc-first-place)
- “TOMA with a twist” contest ...  
[mrhmag.com/magazine/mrh2017-07/publishers-musings](http://mrhmag.com/magazine/mrh2017-07/publishers-musings)
- Port of Tacoma ...  
[mrhmag.com/magazine/mrh2017-07/omc-second-place](http://mrhmag.com/magazine/mrh2017-07/omc-second-place)
- Calumet Central ... [in this issue](#)

### TOMA on TrainMasters TV

- Start small. Think BIG. TOMA project layout series ...  
[trainmasters.tv/video-type/start-small-think-big](http://trainmasters.tv/video-type/start-small-think-big)
- Siskiyou Line lessons learned episode ...  
[trainmasters.tv/videos/2017-03-1](http://trainmasters.tv/videos/2017-03-1)

### TOMA on the MRH Store

- Siskiyou Line lessons learned video ...  
[store.mrhmag.com/store/p152/dwnld/siskiyou-line-lessons](http://store.mrhmag.com/store/p152/dwnld/siskiyou-line-lessons)

As if this is not enough, we have the TMTV TOMA video series coming to DVD and downloadable video on the MRH Store once it's complete on TMTV this winter.

Finally MRH Publisher Joe Fugate is embarking on a TOMA of his Siskiyou Line (replacing his prior layout), and will be documenting the progress of that in MRH, on TMTV, and through MRH Store books and videos. ●



**Click here to rate or  
comment on this article**

ADVERTISEMENT

# THE SW1200RS

Canada's Most Versatile Engine!



**CN or CP**  
**WE'VE GOT THE OPTIONS**



**CLICK HERE!**

• INDEX



SUBSCRIBE  
(free)

• TABLE OF CONTENTS



## LAST ISSUE'S RATINGS

The five top-rated articles in the [July 2017 issue](#) of *Model Railroad Hobbyist* are:

- 4.8 Getting Real: It's all in the details
- 4.8 One module challenge: Second place winner
- 4.7 Deploying potash cars
- 4.6 What's Neat: Weathering a coal train, ...
- 4.6 Yes, it's a model

Issue overall: **4.5**

**Please rate the articles!** Click the reader comments button on each article and select the star rating you think each article deserves. Thanks! ■

*TrainMasters TV is part of  
the MRH product family.*

*TMTV members not only get great network TV level  
videos, they help pay for MRH and keep it free ...*



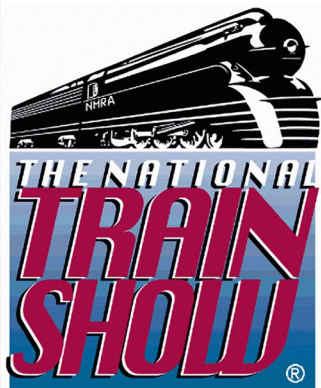

# 2017 National Train Show

August 4 - August 6, 2017

in **ORLANDO, FLORIDA**

Get the details >>

*(click me)*

## Fun for the Whole Family

From your littlest engineer ...

To the most experienced Model Railroader



- The World's Best Known Manufacturers
- Over 180,000 square feet of exhibit space
- Hands-On Demonstrations
- 44,000 Sq. Feet of Modular Layouts
- Ask The Collectibles Appraiser
- The Incredible Lego® MiniLand

• INDEX



SUBSCRIBE  
*(free)*

• TABLE OF CONTENTS

**FINAL  
KIT!**



# FINE SCALE MINIATURES

FSM is closing its doors after 50 years of business!



I.M. Dunn Co. \$280 + S&H



*Destined to become an  
instant collector's item*

**BUY NOW >>**

Brought to you by the MRH Store: [store.mrhmag.com](http://store.mrhmag.com)



Model Railroad Hobbyist | August 2017 | #90

# MRH Q-A-T

column

compiled by  
**JOE BRUGGER**



[Click here to rate or comment on this article](#)

## QUESTIONS AND ANSWERS

### Planning for signals

**Q.** I have started a small 36" x 80" N scale door layout for now to learn the new ways of model railroading ... I have a 16' x 16' area for a later layout. Like most modelers, I have plans within plans, so to speak. When planning a layout, do you also try to plan for signals and wiring, or do you build a track plan and then worry about signals later on? I am looking to model the Arkansas Oklahoma Railroad. There is some major interchange action on the east end at or near Heavener, OK with the Union Pacific and Kansas City Southern. They also interchange with the BNSF in Shawnee and Oklahoma City as well. This would be a modern day layout, 1995 and later.

—Kriegwulfe

**A. Dave Husman:** Depends on what you mean by "signals." Most of the planning is in the track construction and wiring. Make sure

► MRH QUESTIONS, ANSWERS, AND TIPS

• INDEX



SUBSCRIBE  
(free)

• TABLE OF CONTENTS

## MRH Q-A-T | 2

you have contacts on switch mechanisms and insulated blocks. Build in the connections and feeders first and then you can add the signal apparatus later.

Then comes the “signals” part. *Railroad Model Craftsman* published an exhaustive series on all things signal over the course of the last year. How prototypical are you wanting to be? Do you just want lights that change color when the train goes by or do you want a full-fledged CTC or interlocking system?

Regular block signals tend to have either a three- or four-block system. That is, between green signals in the same direction there



1. Appropriate signals add atmosphere and emphasize a scene's connection to the larger system. This is the Baltimore & Ohio Railroad in southeastern Ohio in 1968.  
– *Josef Brugger photo*



## MRH Q-A-T | 3

are either three or four train lengths of room. A 30x80” door has room for a 13- or 14-foot long loop. If you want to have one train on the loop, you need three or four blocks, so your max train length would be three to four feet. If you wanted to run trains in opposite directions with two sidings, that would be six blocks, about a two-foot train length.

Heavener is the KCS yard south of Fort Smith, AR. Back in the early 1980s, when I lived in Fort Smith, the KCS had a B&O wagon-top boxcar off its trucks as a storage shed at Heavener.

The actual interchanges are with the KCS at Howe, OK on the east end and with the UP at McAlester, OK on the west end. The UP doesn't operate through Howe or Heavener.

As far as I can see, the only signals would be at the interchanges or diamonds on either end, which should be pretty straightforward. The diamond on the east/Heavener end appears to have been removed, so there really aren't any working signals there. On the McAlester side it's a manual interlocking with the UP. At most you would need four masts, one for each quadrant of the diamond, which is a manual interlocking controlled by the Choctaw Sub dispatcher in Omaha, NE. Pretty much any way you go it shouldn't be hard at all to put in just four heads and a timer that gives you a light when you step on the approach circuit at Mac.

The UP is CTC and KCS appears to be ABS.

**Paul Schmidt:** Signals need to be planned, like everything else, or you run the risk of things looking contrived and overly compressed. Don't expect to put a 25- or 30-car CTC or ABS siding on a hollow-core-door N scale layout. Anything shorter doesn't look the part. Heck, in reality, even a siding under 50 car lengths would probably have just an electric lock rather than a lighted signal.



I have a fixed distant signal on my HCD layout in approach to a swing gate across the Southern's track. It adds some interest.

**Rob in Texas:** The era you model would have an impact on signals, as well as the location you want to model. Even if you are not counting rivets, the signals used by the Pennsy or the SP or the B&O are all different and can be a great deal different from the red/yellow/green traffic light types that show up on lots of model railroads.

In addition to wiring for your signals, you need to plan for what aspects you wish to show. I can't begin to cover the topic in a few paragraphs but a good book is *Railroad Signaling* by Brian Solomon.

There is a great deal to discover on the idea of concept of signaling. I have been looking at it for a while and it is like peeling an onion; the more you find out the more there is to find out.

**Mitch Schuess:** Short blocks are a real pain. I installed signals and detection on my 4x4-foot N scale layout. I had to take each block and shorten the detection section such that the signal wasn't still red because the rear of the train was still in the block. I certainly learned a lot from that signal installation, including how much they can cost. From those mistakes, I'm using the TOMA approach and am now making HO modules of the interlockings. I'd like to use an Arduino or Raspberry Pi to drive my signals.

Read the ongoing thread at [mrhmag.com/node/30385](http://mrhmag.com/node/30385).

## All-metal cars and DCC

**Q.** I am getting back into the hobby after 40 years away. I am currently running DC because I have no DCC motive power, but plan on converting as soon as the budget will allow. I am working to get my old rolling stock back in operating



- New Signs Available -  
OK Cars, Chessie System, B&O



find us on [facebook](#)

**Shop Now**

# Checked us out lately?

- ✓ HO/N and now O scale products too!
- ✓ Laser-cut Structures & Bridges.
- ✓ Advertising & Storefront Signs.
- ✓ Highway Signs, vintage & modern.
- ✓ New Detail Items.
- ✓ Laser-cut Grade Crossings.
- ✓ Billboards, roadside & rooftop.
- ✓ Laser-cut Graffiti Decals
- ✓ 1000's of satisfied customers.

WHAT'S NEW?



Established 1993...

**Blair Line**

• INDEX



SUBSCRIBE  
(free)

• TABLE OF CONTENTS

Want it on Blu-ray?

Selected titles are now available on Blu-ray disc in spectacular HD!

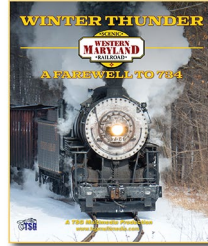
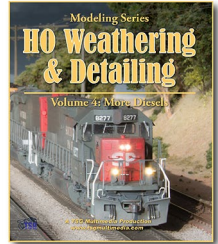
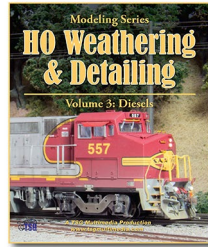

CLICK FOR  
BLU-RAY



**TSG Multimedia**

# Select MODEL RAILROADS

**Design & Build Services For Discriminating Modelers**



**WE WILL:**  
Complete Unfinished Railroads  
Fix or Rebuild Bad Railroads  
OR  
Design & Build A Custom Railroad Of Your Dreams

CLICK HERE FOR OUR WEBSITE  
[www.SelectModelRailroads.com](http://www.SelectModelRailroads.com)

**(844) 872-4670**



2. All-metal cars like this Ulrich GS gondola can lead to electrical gremlins if insulation breaks down or there is too much wear in side frames. In a derailment, the side frame can drop onto the track and cause a short circuit.  
– *32nd Avenue Shops photo*

condition, and among the survivors from that era are an all-metal Ulrich gondola, a flat, and a hopper. When any of these three cars derail they cause a short. Are all-metal cars really compatible with DCC? Are there some general guidelines about all-metal trucks or all-metal cars that I should follow?

—Hamster09

**A. Ed.:** The derailment short happens when a side frame strikes the rail and bypasses the wheels' insulation. The conductive all-metal car allows a current path between the two rails.

**Don Mitchell:** If the trucks on those Ulrich cars have the original cast metal side frames, replace the trucks with some having plastic





# Archer

**FINE TRANSFERS**  
PROUDLY SERVING MODEL BUILDERS SINCE 1989

**THE ORIGINAL  
SURFACE DETAILS™**

**WE NOW HAVE MORE  
THAN 130 SHEETS OF  
RIVETS, LOUVERS,  
TREADPLATE, WELD  
SEAMS AND MORE  
CAST ONTO  
MICROSCALE CLEAR  
DECAL FILM**

**LOW SHIPPING:**

**DOMESTIC USA ORDERS  
\$2.80**

**INTERNATIONAL ORDERS  
\$9.95**

**CLICK HERE TO  
VISIT OUR WEBSITE!**

*"Archer Fine Transfers 3D decals have revolutionized kitbashing and scratchbuilding. Putting rivets or other low-relief details like louvers or weld seams on your models is now as easy as applying decals."*

Joe Fugate,  
Publisher/Editor  
Model Railroad  
Hobbyist



Archer Fine Transfers • PO Box 1277 • Youngsville, NC 27596 • USA  
(919) 570-1026 • info@archertransfers.com • archertransfers.com

ADVERTISEMENT

**HO GP60M, GP60B AND GP60 Locos**



**NOW AVAILABLE !**



**DC OR DCC WITH SOUND!**



www.foxvalleymodels.com

• **INDEX**



**SUBSCRIBE**  
(free)

• **TABLE OF CONTENTS**

**TRINITY 3281  
IN STORES NOW**



Norfolk Southern -- 12 #s

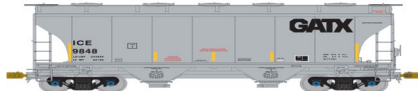

ICE-GATX -- 8 #s



Winchester & Western -- 12 #s



NRLX Ciment Quebec -- 12 #s

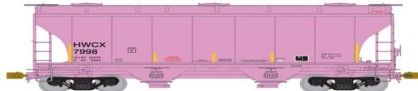

HWCX -- 7 #s

**American Limited**

www.americanlimitedmodels.com

ADVERTISEMENT



**NICK & NORA DESIGNS**

Uniquely inspired craftsman kits  
**Craftsman Structure Kits in HO & N**

**Detail Parts,  
laser cut shingles,  
HO Vehicles, Tru-Color Paints,  
glues, tools & more!**

www.nickandnoradesigns.com

side frames. From decades of experience, I expect most of those derailment shorts will go away.

**Bob Reck:** I agree, replace the trucks with plastic ones. I have some old Roundhouse and Ulrich cars that I replaced the metal trucks on, and have had no problems on DCC.

**Dave B.:** You can keep the trucks but make sure the insulated wheels are all on the same side of the car. Insulating the couplers with plastic coupler boxes is also a good idea to keep stray shorts from running between two coupled metal cars. Derailments should not be a problem, as they are rare on well-built trackwork.

**Graham L.:** When adding a car or engine to a layout, check its wheel gauge, coupler height and swing, and rolling capabilities. Maintaining cars up to NMRA or tighter standards goes a long way to preventing any derailments. Use a meter to check across the axle for failed insulation.

The same goes for track. Correct any uneven spots or bad joints, and make sure the points and frogs in switches have the right amount of clearance. Fix the bad spots instead of putting up with them.

See more at [mrhmag.com/node/29966](http://mrhmag.com/node/29966).



## TIPS

### Cheap weights for modelers

Do you have a shelf full of old running, softball, or bowling trophies? Disassemble them and use the acrylic bases as weights to keep parts flat while glue or paint is drying, or to assist with keeping walls vertical during construction.

—Jack Dziadul

## Workbench car chock

One of my primary interests in the hobby is weathering freight cars. One or two times I nearly – or did – lose a car by having it roll off the cardboard or lazy susan while I was putting on a coat of Dullcote.

Over the last few years I have purchased a few Walthers molten sulfur tank cars. Walthers packages their tank cars with clip bases under the trucks. These make a perfect tool for setting freight cars on and keeping them from rolling around. They work on Walthers trucks and most other brands. Athearn Genesis cars



3. Black plastic truck clips saved from Walthers molten sulfur tank cars will stop most freight car weathering projects from rolling off of the workbench.

–David D. Lederhouse

## MRH Q-A-T | 8

are the only brand I have in my fleet that do not accept the clips. The next time you buy a Walthers sulfur car ... don't throw away that truck clip!

Even if you don't buy these cars, you can use leftover styrene scraps to make a similar flat platform that will hold the trucks and wheels in place.

—David D. Lederhouse

### GET PAID FOR YOUR TIP

We pay \$25 per tip we publish, or \$40 each if the tip also includes a photo or finished drawing. [Click here and select article type TIP.](#) ■



[Click here to rate or comment on this article](#)

70,000 have seen this MRH video - *have you?*



[Watch the video now](#)





# HUGE SAVINGS!

5-volume Siskiyou Line video series

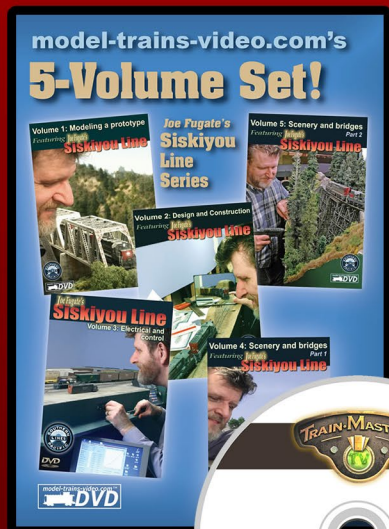

Sold seperately  
~~\$149.95~~

Now just  
**\$29.99**  
 Save 84%!

PLUS BONUS DVD:  
 Siskiyou Line Lessons  
 Learned



Lessons from layout 1 and sneak peek at Siskiyou Line 2!

Yes, send me my disks >>

[store.mrhmag.com](http://store.mrhmag.com)

• INDEX



SUBSCRIBE  
 (free)

• TABLE OF CONTENTS



# Introducing

Complete Train Control

## *The next Evolution in* Complete Train Control®

- Premium Advanced 5/8 Amp Starter Sets.
- Starter sets are available as standard tethered or duplex radio.
- The system features a DCS210 Advanced Command Station, DT500 series throttle, and includes a power supply to make getting started easier than ever.
- The DT500 series throttles can be purchased separately from the new Starter Set.

Find out more @ [www.digitrax.com](http://www.digitrax.com)



E  
St  
DT  
PS  
  
E  
D  
DT  
PS

# the **EVOLUTION**™



## Evolution (shown) | **\$450 MSRP**

Standard Set Includes: DCS210 Advanced Command Station, T500 Advanced Super Throttle, UP5 Universal Panel, 6615 power supply, and a LT1 LocoNet Tester.

## Evolution Duplex | **\$660 MSRP**

Duplex Set Includes: DCS210 Advanced Command Station, T500D Advanced Duplex Throttle, UR92 Universal Panel, 6615 power supply, and a LT1 LocoNet Tester.



# Southern Digital

[WWW.SODIGI.COM](http://WWW.SODIGI.COM)

Celebrating 25 Years of serving you !



**Soundtraxx Tsunami  
Motor/Sound Decoder**  
**50% Off while they last**



**Super Sale**



Complete Train Control

Simplex Radio  
Throttle clearance  
while they last



**Close Out**

**DT402R**  
**\$165**

**UT4R**  
**\$99**

**DCC Conversions, Service & Support**

E-mail: [sales@sodigi.com](mailto:sales@sodigi.com) (770) 929-1888







# DCC IMPULSES

column

BRUCE PETRARCA MMR  
.....



[Click here for  
reader comments](#)

## THE TRUTH ABOUT CAPACITORS IN DCC

**I WROTE ABOUT BASIC ELECTRONICS IN MY** December 2012 column ([mrmag.com/magazine/mrh-2012-12-dec/di-basic-electronics-for-dcc](http://mrmag.com/magazine/mrh-2012-12-dec/di-basic-electronics-for-dcc)). There I discussed capacitors briefly. Recent traffic on the web shows that it may be time for more in-depth information about these pesky little devices.

### What is a capacitor?

A capacitor [1] is basically a pair of conductive plates separated by an insulator. As such, it can couple varying voltages (AC) from one lead to the other while blocking constant (DC) voltages. It can also store energy in the form of an electrical field.

The insulator may be one of many things, such as air, ceramic, polypropylene, mica, or an electrolytic solution in a semi-liquid form. Capacitors are most frequently classified by their insulating medium.

Capacitors are rated with two important numbers: capacitance and working voltage. Capacitance is measured in farads (F) or

▶ DCC TIPS, TRICKS, AND TECHNIQUES

• INDEX  
.....



SUBSCRIBE  
(free)

• TABLE OF CONTENTS  
.....

## DCC IMPULSES | 2

fractions of a farad, frequently microfarads (a millionth of a farad, abbreviated  $\mu\text{F}$  or  $\text{uF}$  or  $\text{MFD}$ ).

Most capacitors are not polarized, meaning that it doesn't matter which way you hook them up. That said, electrolytic and super-caps are polarity sensitive and if you hook them up incorrectly they may leak nasty fluid or explode.

For safety, it is best that the capacitor be rated for 150% or more of the maximum expected voltage, including spikes or transients. A capacitor with a higher voltage rating than specified or calculated will work just fine; it just will take up more room and possibly cost a bit more.

Do not remove the wrapping found on polarized capacitors, such as electrolytic or super-caps. The case is frequently the negative

ADVERTISEMENT

### Great control in a tiny package



- Touch Toggle™ plug in controls
- Bright clear indication
- Easy setup
- Flexible system

Stall Motors, Twin-coils,  
Power, and Servos

Now for Tam Valley Depot  
and MRservo too!

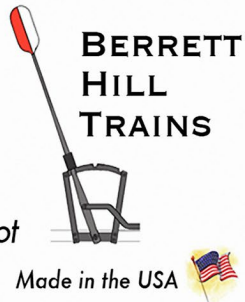

What will they think of next?

[www.berrethillshop.com](http://www.berrethillshop.com)

# TONY'S TRAIN XCHANGE

*Committed to your DCC support!*

## Intermountain HO EMD SD40-2



Those awesome porches!

Smooth Operation with ESU Dual Mode DCC/DC & Sound, LED Lighting, 33+ Road Names with Road Specific Details

Starting at \$149.95

**Order Yours**

## Intermountain HO Paducah GP10



Nothing else like it on the market!

ESU Dual Mode DCC/DC on Board, Impressive Details, Multiple Lighting Effects, 12 Different Road Names



Starting at \$139.95

**Order Yours**



## Intermountain HO Tier 4 GEVO



Available Now!

ESU DCC w/Authentic Tier 4 Sounds, Ultra-Modern, All-New Tooling and Motor Drive, LED Lighting, Road Specific Details

Starting at \$149.95

**Order Yours**

**Do you need a Sound or DCC Installation done?**

**Get a quote!**



Providing unmatched person to person DCC support for more than 28 years, the kind of service that has made us #1 in DCC.

**DCC questions? CALL US! 1-800-978-3472**

*We'll get you on the right track!*

Aug. 2017



• INDEX



SUBSCRIBE  
*(free)*

• TABLE OF CONTENTS

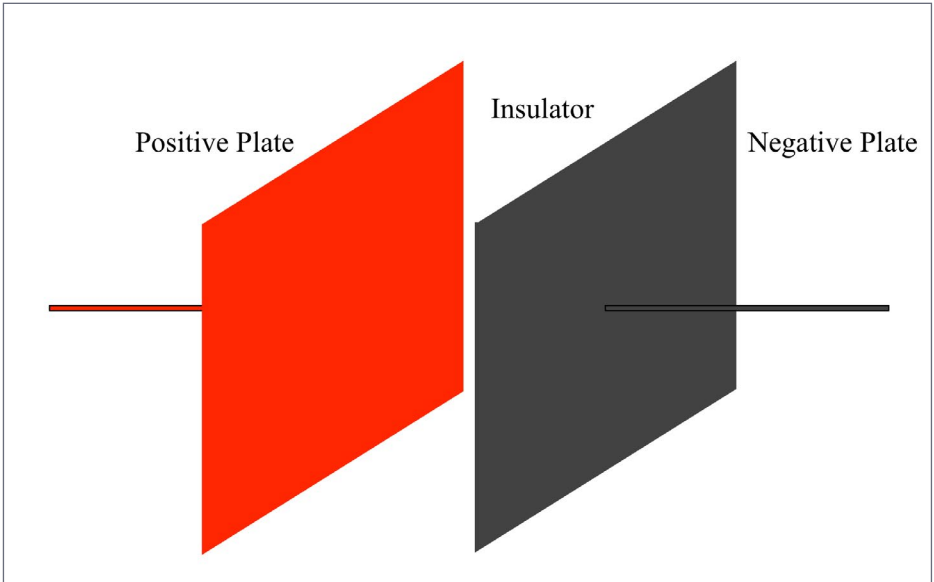

1. A capacitor is basically two plates separated by an insulator. *Bruce Petrarca diagram*

plate of the capacitor and is actively connected to the circuit. Removing the wrapping may lead to a short within your loco.

## What do I get if I connect two or more capacitors together?

If you connect them in parallel [2], the capacitance will be the sum of all of the capacitors and the voltage rating of the group will be that of the lowest capacitor connected.

If you connect them in series [3], the voltage rating will be the sum of the voltage ratings and the capacitance will be reduced. There is a complicated formula to calculate the resulting capacitance. However, if all connected capacitors have the same value, the result is simplified: with two connected,  $\frac{1}{2}$  the capacitance; three are  $\frac{1}{3}$ , etc.



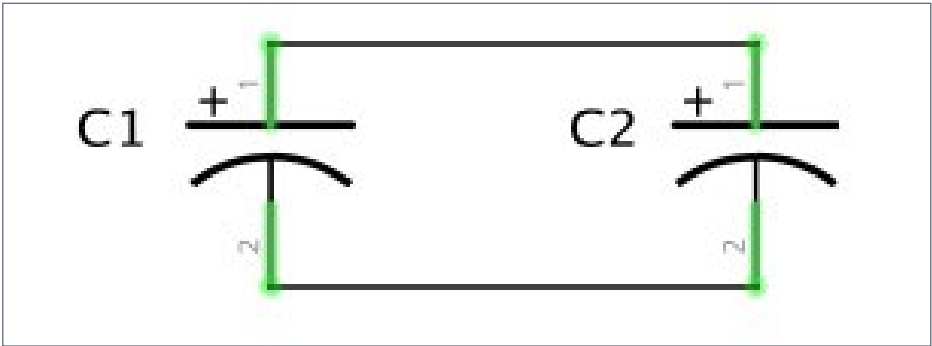

2. Parallel connected capacitors. *Bruce Petrarca diagram*

Okay. Let's look at some model railroading applications for capacitors and how they affect folks who are working with DCC.

ADVERTISEMENT



**Version 4 of WOWDiesel  
NOW SHIPPING!**

WOWDiesel Version 4 Introducing the  
**645 Non-Turbo Prime Mover**

All with Unmatched CD Quality Sound at  
TRUE 16 bit Resolution that nobody else can  
come close to!

[click here](#)

Learn why loco sound fans *prefer* WOWSound ...

Remember you "Rivet Counters", Sound has rivets too and TCS counts them better than anyone!

[www.TCSDCC.com](http://www.TCSDCC.com)



## Energy storage

Energy storage capacitors allow your loco to run, or the micro-processor in the decoder to keep thinking when the power drops out, such as due to dead rails, dead frogs, or dirt or discontinuities.

They frequently have been polarized electrolytic units [4]; 100 to 10,000  $\mu\text{F}$ ; frequently rated 25 (indoor) or 35 volts (garden) for DCC applications.

In smaller scales, some folks are willing to work with surface mount capacitors [5] in order to make things fit in the available space or spaces. I recommend 20 volt capacitors as the minimum

to use with DCC. While this technically violates the NMRA standards for DCC (track voltage as high as 22 volts), most folks in the smaller scales limit their track voltage to 16 volts or less. Thus, there is still a slim safety margin but less than the 150% I mentioned earlier.

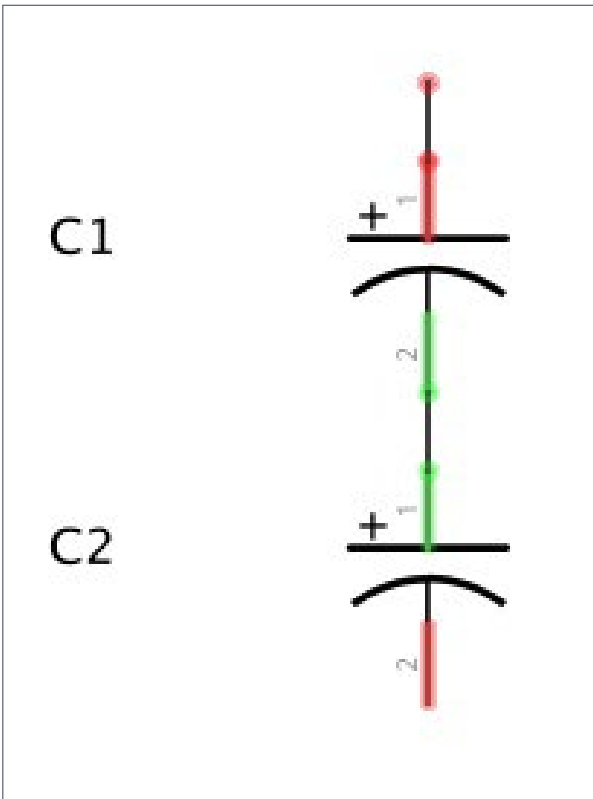

**3. Series connected capacitors.**  
*Bruce Petrarca diagram*



S T A T I O N



\$49.95 - \$119.96



N & HO SELECT SERIES

\$85.95



\$70.00



\$87.96 - \$143.96



- Click here to visit our website -

[www.LitchfieldStation.com](http://www.LitchfieldStation.com)  
623-298-7355

• INDEX



SUBSCRIBE  
(free)

• TABLE OF CONTENTS



4. Electrolytic capacitors are polarized, requiring attention to detail when connecting them. This radial design designates the negative lead by the stripe. [digikey.com](https://www.digikey.com) photo of their part number 1189-1733-ND, used by permission



5. Surface Mount Device (SMD) 100  $\mu\text{F}$  20 volt electrolytic capacitor. The negative lead is indicated by the band on the upper left side in this photo. *Bruce Petrarca photo*



ADVERTISEMENT

Make LocoNet wiring extremely simple!



Suitcases belong in your baggage cars, not under you layout!

Introducing the DCC Vampire II ... this guy does the job of two suitcase connectors! And really holds the connection good too!



CLICK NOW TO DISCOVER THE AMAZING VALUE!

Dealer Inquiries Accepted

ADVERTISEMENT

# END OF TRAIN DEVICE

**NEW SAFETY GREEN**



**Bright Red Flashing Light!**

Installs in minutes!  
No freight car modification required!

Patented Technology - US Patent 7,549,609

**Does not affect Load!**

↓ Car without Load ↓

↓ Car with Load ↓



**Click Here to Learn More**

**RE RING ENGINEERING™**

• INDEX



SUBSCRIBE (free)

• TABLE OF CONTENTS

## DCC IMPULSES | 7

Be sure to insulate the contacts to avoid shorting out the power supply of your decoder. Heat-shrink tubing, Kapton tape or even the liquid electrical tape products will do.

Decoder manufacturers (and some hobbyists) build modules out of super capacitors to store more charge than is possible using electrolytic units. Three 1-farad 5.5 volt capacitors in series will be about 330,000  $\mu\text{F}$  ( $1,000,000 \mu\text{F} / 3$ ). Remember, the voltage ratings add, so the resultant stack will have a voltage rating of 16.5 ( $5.5 \times 3$ ) volts. This is a bit low to connect directly to a DCC decoder, which is why I recommend additional protection.

There are two versions of a super-cap.



6. Super capacitors have very large storage capabilities but are very limited in the voltage that they can withstand. The negative lead is indicated by the stripe. Most model railroading uses will need a low IR unit; see text. The unit on the left is a low IR model. The "coin" versions as shown on the right tend to be high IR units and, therefore, not usable for model railroading purposes. [digikey.com](https://www.digikey.com) photos combined by Bruce Petrarca, used with permission

# DCC IMPULSES | 8

One is designed to keep memory chips functional during power outages. They have what is called a high Internal Resistance (IR), as in tens of ohms. This is similar to the Equivalent Series Resistance (ESR). But IR is measured at DC and ESR is measured with AC, frequently 1 kHz. This means that they are not able to deliver more than a few mA of current, barely enough to keep a microprocessor functioning and certainly not enough to run a motor. High IR units are frequently “coin” units, such as shown on the right in figure [6]. They are usually less expensive than low IR units.

To make an energy storage module for model railroading, one will need super-caps that have an IR less than  $\frac{1}{2} \Omega$  (500 millionohms); the lower the better. These caps may not be available through eBay, surplus stores or other low-cost retailers.

## ADVERTISEMENT

**IOWA SCALED  
ENGINEERING**

Master clock



Remote clock



Easiest-to-use, most advanced  
fast clock on the market

[LEARN MORE >](#)

## ADVERTISEMENT

**TamValleyDepot.com**

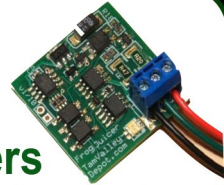

### Frog Juicers

Automatic DCC polarity reversers for frogs on turnouts and crossings.

### Servo Switch Machines

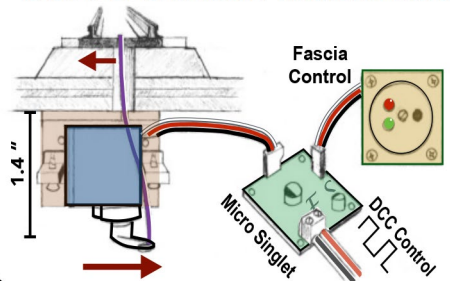

[INDEX](#)



[SUBSCRIBE](#)  
(free)

[TABLE OF CONTENTS](#)

# DCC IMPULSES | 9

I recommend Mouser ([mouser.com](http://mouser.com)) or Digi-Key ([digikey.com](http://digikey.com)), at least as a starting point.

Absent a specification for IR, the ESR number will give you an idea of the capabilities of the capacitor. For example a unit with an ESR of 70  $\Omega$  is unlikely to have an IR under  $\frac{1}{2} \Omega$ .

Since the lowest cost versions usually do not have the low IR needed to keep a motor running, I recommend you inquire or test before you purchase large quantities of a super-cap to roll your own energy storage modules. Also, don't blindly accept a different part number than the one you selected. I recommend negotiating a return clause before you purchase large quantities.

If you are building your own module, find a safe circuit to follow. I've drawn up a circuit [7] that I believe includes all these elements. Use this as a starting point for your own design.

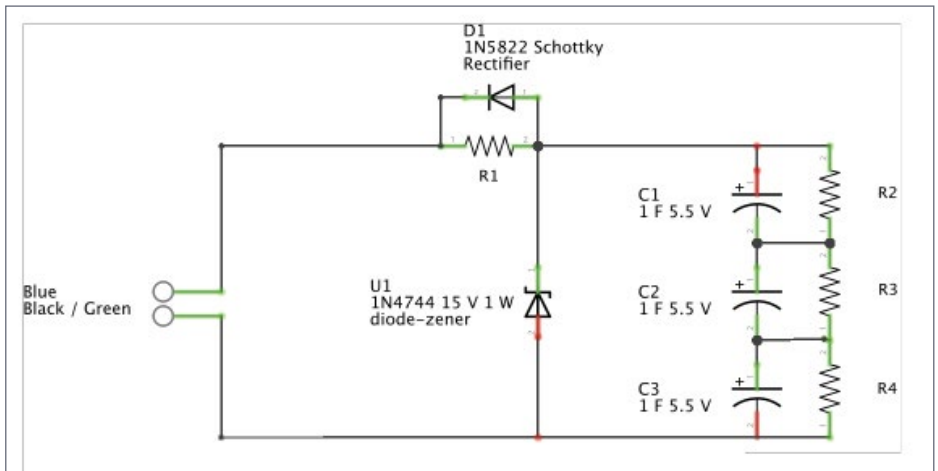

7. A generic circuit diagram of what I consider a safe design for a homemade energy storage module. I haven't calculated values for the components nor tested such a circuit. That's why it is incomplete. *Bruce Petrarca diagram*



# ANE MODEL

Navigator of Turnout & Digital control



**LD101**  
Coming Soon



[www.anemodel.com](http://www.anemodel.com)

[www.SBS4DCC.com](http://www.SBS4DCC.com)



## SOUNDTRAXX®



**DCC Specialties**  
INNOVATION FOR DCC



**ACCUTRACK II**  
SPEEDOMETER

**SPROG DCC**  
the DCC Programmer and Control Family

**Digital plus**  
by Lenz

**TAM VALLEY DEPOT**  
Great Electronics for Great Model Railroads



**TEAM DIGITAL, LLC**  
Improving the world of DCC

**N - HO - HO<sub>N3</sub> Scale Trains**

# RailPro™

**NEW TECHNOLOGY**



# RE RING™

ENGINEERING

**NEW Starter Kit**  
**\$399.99 MSRP**

- Includes Wireless Color Touch Screen Handheld Controller and 56 Watt Power Supply
- Expandable to Virtually any Size Layout

**NEW Locomotive Module**  
LM-3 & LM-3S



- Direct Radio RF
- Sound and Non-Sound
- New Tiny Size
- 6 Light Outputs

**Click Here to Learn More**

For more information visit our Internet site: [www.RingEngineering.com](http://www.RingEngineering.com)

• INDEX



**SUBSCRIBE**  
(free)

• TABLE OF CONTENTS

# DCC IMPULSES | 10

Safety to me includes a small resistor (called R1 in [7]) series connected with the stack of capacitors and a 15-volt zener diode across the entire stack. This keeps the applied voltage from exceeding the rating of the capacitors. Also, I recommend a large value resistor (R2 to R4 in [7]) in parallel with each capacitor, distributing the applied voltage evenly across all capacitors. A discharge diode (regular or Schottky) in series with the small resistor (R1) will bypass the resistor when the module is supplying power to the decoder.

While my circuit is based on 5.5 volt capacitors, there are lower voltage super-caps available, down to 2.5 volts. I recommend enough in series to get the total voltage rating at or above 16.5 volts. Remember, the more you put in series, the more the IR will add up.

I haven't built or tested any of these circuits, so I cannot thoroughly recommend them. Unless someone is needing lots of these modules, I find that purchasing them is a better route than purchasing the components to build them. Also, if the circuit diagram or any of the terms in the last few paragraphs aren't easily understood by you, I recommend you leave the fabrication of these modules to the professionals.

DCC manufacturers label these devices with their own monikers: Keep-Alive, CurrentKeeper, Power Xtender, or No Halt, for example.

## Noise suppression

There are two cases where ceramic capacitors [8] enter into the realm of DCC installations. In both case they are suppressing noise.

The boards [9] in early Bachmann DCC-ready locos (mostly HO) are designed to keep the motor noise away from the track when

# Got Steam?

**Full Throttle Steam  
Available Now!!!**

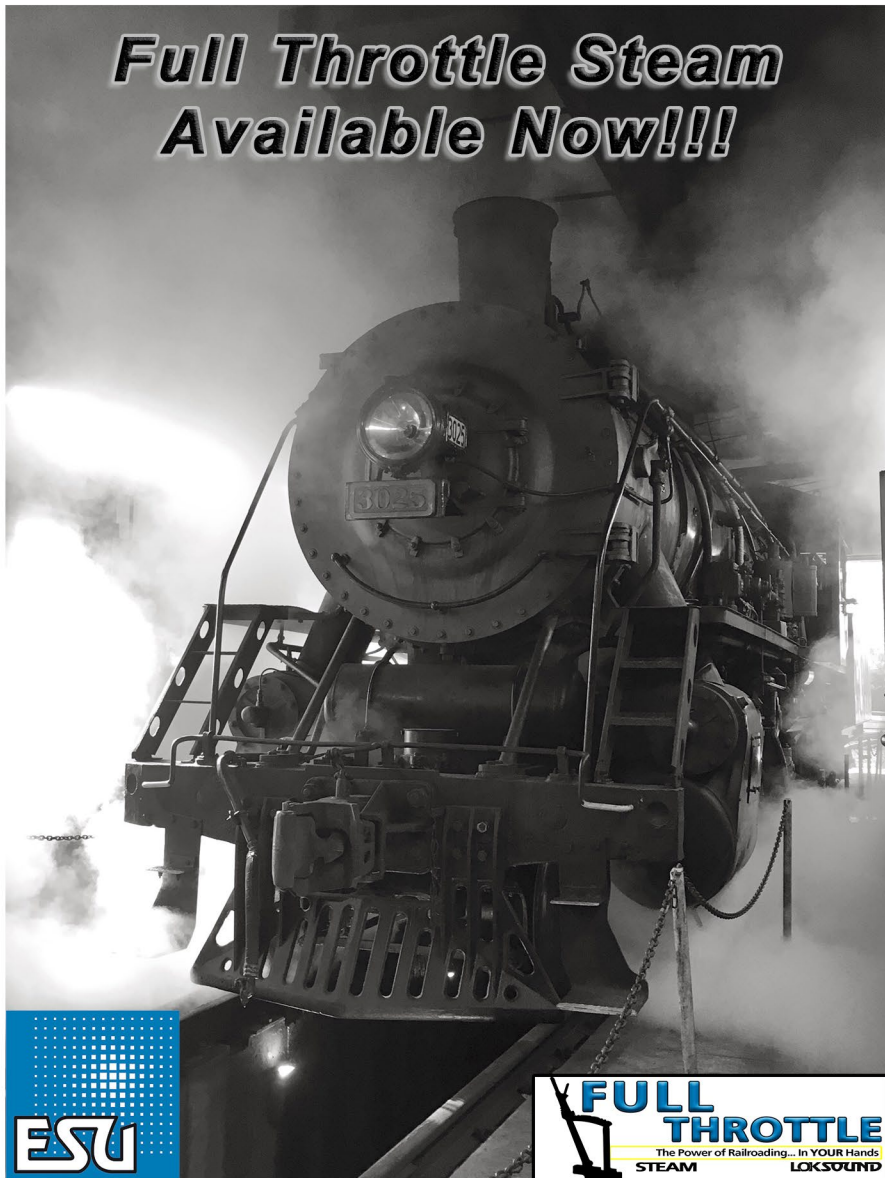

**[www.LokSound.com](http://www.LokSound.com)**

• **INDEX**



**SUBSCRIBE**  
(free)

• **TABLE OF CONTENTS**



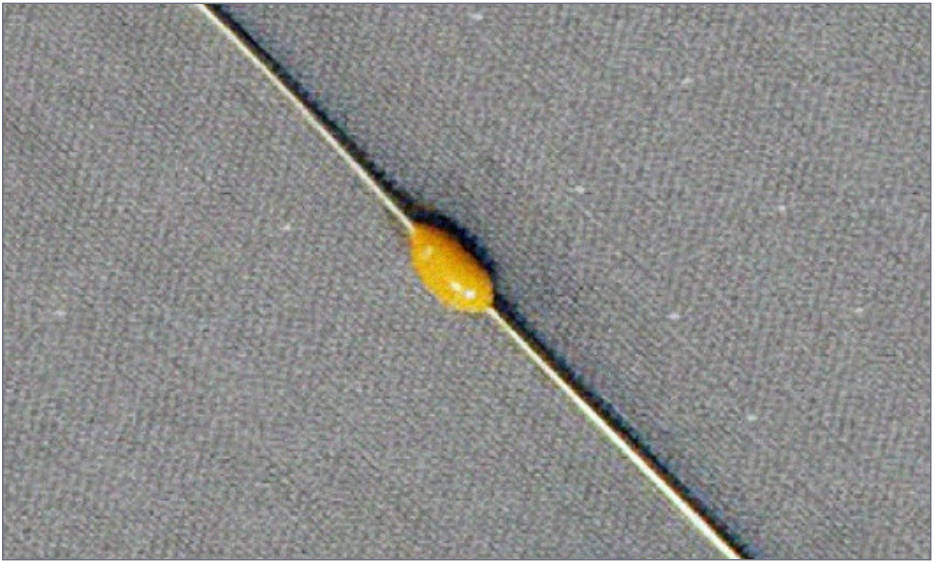

8. Ceramic capacitors have capacities up to about 1  $\mu\text{F}$  (1 micro-Farad). They are frequently used in model railroad-ing to remove noise or RF interference (RFI). This unit is rated 0.1  $\mu\text{F}$  at 50 volts. *Bruce Petrarca photo*

the loco is run without a decoder. Two coils of wire wrapped on small ferrite rods (inductors) plus a ceramic capacitor or two help these locos meet the requirements for minimal Radio Frequency Interference (RFI) when a decoder is not installed.

For the most reliable DCC operation, the capacitors should be removed from the circuit when a DCC decoder is installed. This can be accomplished by removing the Bachmann board entirely or by cutting the capacitors off the board when plugging a decoder in.

SoundTraxx LC series decoders (out of production for about a decade now) were designed for light bulbs, but not LEDs. If you use LEDs and resistors for head and rear lights instead



ADVERTISEMENT

YD



Yankee Dabbling

Visit OUR NEW WEBSITE!  
SAME GREAT SERVICES & PRICES!

www.yankeedabbling.com



Search

Call us at 977-727-451-9227

My Account

SEARCH  
button



HOME SCALES BRANDS SHIP/RETURNS CONTACT SHOW SCHEDULE NJ STORE HOURS



Brands

YD Products

View all brands

Categories

DCC PRODUCTS

View All Categories

The YD Conductor greets  
Visitors to the NJ store



Specializing in DCC! ~ The Best for Less! ~ Sales-Services-Installation!

Free Technical Coordination (727) 457-9227 9AM to 9PM EST

CLICK AND SAVE TODAY!



Visit YD Team  
Booths 717 719 816  
08/4-08/6  
NMRA  
Orlando, FL

New RingEngineering RailPro Announcements  
DCC Demonstrations  
New DCC Products and SOUNDS in Stock

Use coupon code "MRH" for FREE SHIPPING

YD installs DCC or RailPro in your engines

ADVERTISEMENT

Get the latest Model Railroading News, Tips, Reviews & Opinions



Our iTunes feed has changed search for  
"Mike And Scotty Live" to receive the latest episodes!

www.themodelrailroadpodcast.com

Hosts:

Scott Mason: www.scottymason.com

Mike Rose: www.mrhobby.com

Don't Miss our Monthly Interviews  
& Product Announcements

• INDEX



SUBSCRIBE  
(free)

• TABLE OF CONTENTS

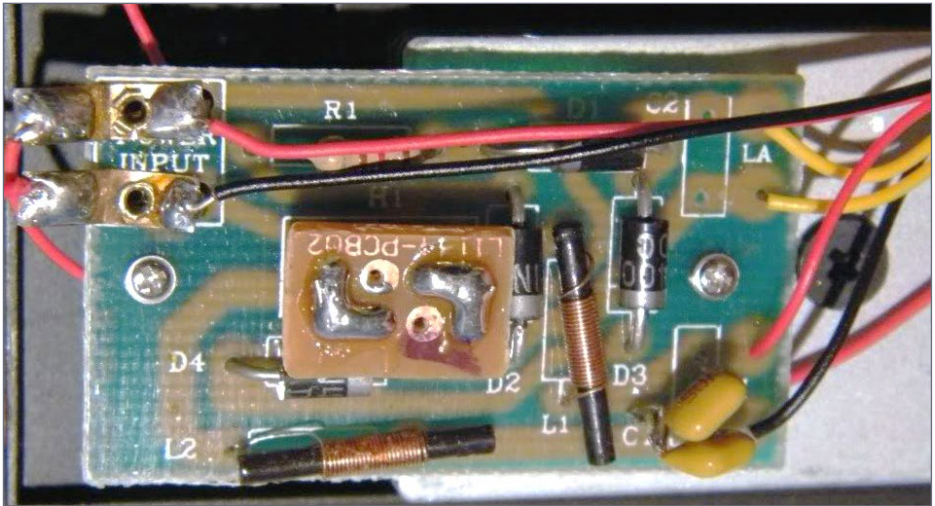

9. Early Bachmann board showing the (yellow) capacitors for RFI reduction in the lower right. These capacitors can confuse decoders which use Back EMF (BEMF) to control the motion of the locos. When a decoder is installed, using the 8-pin plug in the middle of the board, the ceramic capacitors can be safely cut off the board. Or, the entire circuit board can be removed and the decoder wired directly to the rails, motor and lights.

of bulbs, the LEDs will flicker some when they should be off. Adding a capacitor and a second resistor to the LED & resistor combination, as shown in [10], will tame this wild LED setup. More details are on my website at [mrdccu.com/curriculum/soundtraxx/dsd-lc.html](http://mrdccu.com/curriculum/soundtraxx/dsd-lc.html).

## Speaker isolation

In some decoder designs, a capacitor is used to couple the sound to the speaker from an amplifier. Many early sound decoders (SoundTraxx DSD and DSX series, for example) had this component external to the decoder for flexibility of installation.

# DCC IMPULSES | 13

SoundTraxx supplied non-polarized electrolytic capacitors rated at 33  $\mu\text{F}$  and 16 volts with their decoders. This special style of electrolytic capacitor doesn't care which way it is connected. They are larger and more expensive than a polarized electrolytic capacitor with the same ratings. This type of capacitor looks [11] just like an electrolytic, except there is no band indicating the negative lead.

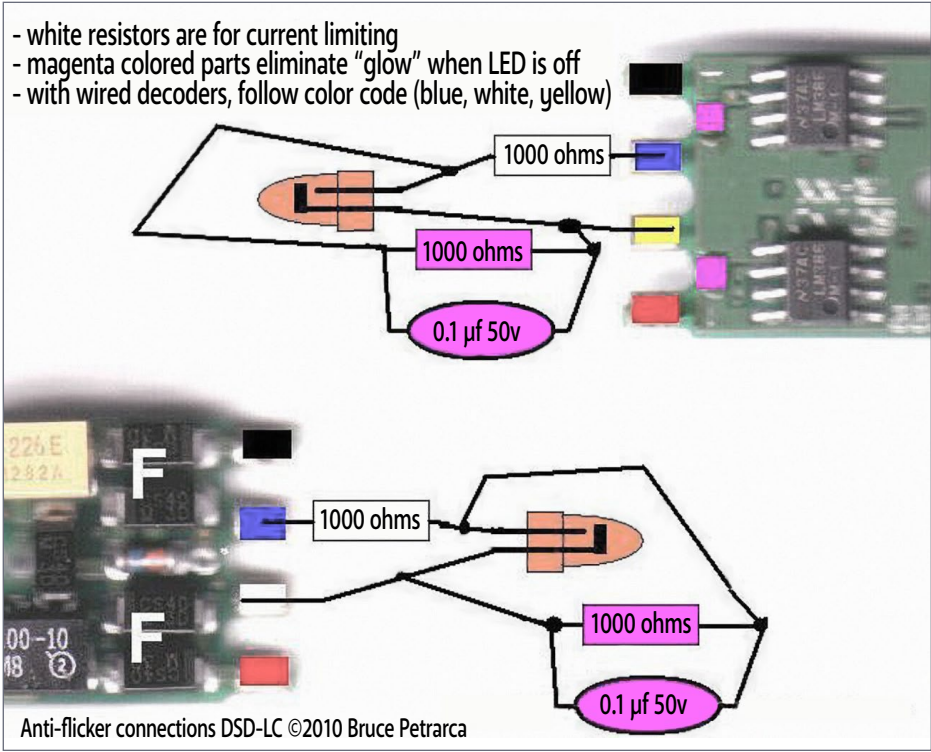

10. Adding a ceramic capacitor and resistor to the SoundTraxx DSD-LC series decoders will eliminate LED flicking when the function is turned off.

The Atlas light board version of the DSD-LC decoder is shown. *Bruce Petrarca diagram*

## DCC IMPULSES | 14

This capacitor is connected between the decoder and the speaker. It protects the circuitry and the speaker by keeping the DC voltage that exists on the speaker output from connecting through to the speaker. The design of the amplifier in these decoders limits the DC voltage on the speaker terminals to half of the power supply (track) voltage. Thus the 16-volt rating will maintain the 150% safety margin with track settings up to about 22 volts.

Newer amplifier designs either don't need this capacitor or it is built into the board. I included this short explanation of this older technology for legacy sake.



11. A non-polarized version of an electrolytic capacitor will be needed to decouple the amplifier in the decoder from the speaker in early SoundTraxx decoders. Note: there are no polarity-defining markings. [digikey.com](https://www.digikey.com) photo, used with permission



## DCC IMPULSES | 15

Hopefully these tips and comments will give you some more insight into these multi-faceted electronic components. Please share your ideas with us all. Just click on the Reader Feedback icon at the beginning or the end of the column. While you are there, I encourage you to rate the column. “Awesome” is always appreciated. Thanks.

Until next month, I wish you green boards in all your endeavors.



[Click here for reader comments](#)

ADVERTISEMENT

## SoundCar Summer Special

At SoundTraxx it doesn't have to be a locomotive to get a decoder. Transform your railroad with the only full-featured Digital Sound Decoder loaded with prototypical sounds for rolling stock. Limited Edition, Tsunami SoundCar Bonus Packs include a **free speaker and baffle** while supplies last!



**SOUNDTRAXX**<sup>TM</sup>  
www.soundtraxx.com

[Watch the Install Now ▶](#)

• [INDEX](#)



**SUBSCRIBE**  
(free)

• [TABLE OF CONTENTS](#)

# From first train set to railroad empire...

*Our complete line of DCC products  
grows with you. Discover the fun!*

- Designed and manufactured in the U.S.A.
- Preferred for ease of use and ergonomic design
- Unlimited scalability for any size model railroad
- Plug-and-play means more time running trains
- Great customer service and excellent support



## See your dealer



## Visit our new and improved web site for all your DCC needs!

- Get the latest new product announcements
- Watch our detailed how-to videos
- Browse the all-new Information Station
- Enjoy secure online sales, day or night!

Visit **ncedcc.com**



• [INDEX](#)



[SUBSCRIBE](#)  
(free)

• [TABLE OF CONTENTS](#)





TRAINMASTERS.TV

**HOT**  
*Summer*  
**SALE** 2017

**SAVE BIG!**



|                     |                     |             |
|---------------------|---------------------|-------------|
| 3-month membership: | <del>\$19.00</del>  | <b>\$16</b> |
| 6-month membership: | <del>\$37.00</del>  | <b>\$29</b> |
| 1-year membership:  | <del>\$59.00</del>  | <b>\$49</b> |
| 2-year membership:  | <del>\$118.00</del> | <b>\$99</b> |

**Become a TMTV member >>**



Brought to you by

**MRH**

MODEL RAILROAD HOBBYIST





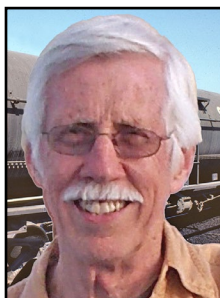

# GETTING REAL

column

ANTHONY THOMPSON  
.....



[Click here to rate or comment on this article](#)

## ENGINE SERVICING DETAILS | USING REAL-LIFE EXAMPLES FROM THE PROTOTYPE ADDS CREDIBILITY TO FREELANCED SCENES

**IT IS A RARE MODEL RAILROAD THAT INCLUDES** no facilities for locomotive servicing or any kind of engine terminal. The broad concept and prototype design of such facilities is a complex subject, not only because individual railroads differed in how they designed them, but also because even on a single railroad, few terminals were the same as any other such terminal on that railroad.

There have been many magazine articles on the modeling of engine terminals, and at least one quite good book, the Kalmbach softbound volume about *Locomotive Servicing Terminals*, by Marty McGuirk (see Bibliography). The book is a rich source of photos of prototype engine terminals. Just because that book is so good, I won't try to cover the full breadth of the subject in this column.

Instead, I want to talk about the details. My own layout, which represents a mythical Southern Pacific branch line, has only

▶ **MODELING REAL RAILROADS AND WHAT THEY DO**



## GETTING REAL | 2

modest engine facilities. Most SP branch lines had a small engine facility, either at the junction with the main line or, more commonly, at the end of the branch. Some of the branches were operated by “turns” out of larger yards nearby. I chose to locate my engine facility at a junction.

I should also emphasize that my engine facility is proto-free-lanced. It is based on SP practice but not on any specific SP engine terminal. This is a strength, in that I am not bound to particular features, but also a weakness in that I don't get to research and duplicate a set of actual arrangements, which would not only be fun but can make for a striking model. My



1. The Banta Modelworks roundhouse as installed on my layout. For a description of building this kit, see the Bibliography. Offices, lockers and boiler room are along the left side of the structure. A gondola of new wheels is spotted at the machine shop behind the main roundhouse. The water tank is a standard SP 65,000-gallon design, produced in brass by Overland.

goal, then, is simpler in some ways: to try and replicate typical features that are found at SP terminals.

### The basics

I want to show very briefly the scope of my own engine facility, not because it's important in itself, but simply to provide a canvas on which to show details. And by the way, I model in HO scale.

### Roundhouse

I was still considering whether to build a rectangular engine house or a small roundhouse when the Banta Modelworks kit for the SP roundhouse at Port Costa, CA was released. This is not only an accurate kit for the prototype structure, but is typical of many smaller wood-frame SP roundhouses. I enjoyed building that kit and am happy with how it looks on the layout [1].

A roundhouse usually had the ability to generate steam, for moving dead locomotives, steam cleaning, and other tasks. Most importantly for oil-fueled steam locomotives, steam was used to keep the viscous oil warm enough to flow. That was true for the facility's storage tank, and even for the steam coils in the tank cars that delivered the fuel. And generating steam, of course, means a boiler. Boilers were installed in almost all SP roundhouses.

There would also be an office for the roundhouse foreman, and likely a storage area for materials and spare parts. And in many cases, a locker room would be included. If engine crews used the facility, they would ordinarily have a separate locker room from the machinists and boilermakers who worked in the roundhouse. There was space for all these functions in the Port Costa roundhouse, duplicated in the kit, so my branchline roundhouse has them too.

Even a small roundhouse normally was used for light repairs, and might either contain a machine-shop area inside the roundhouse itself, or have a connected building for that purpose. I decided



# GETTING REAL | 4

to add a small machine shop to the roundhouse, at the back, to reflect this practice [2].

In the 1950s era I model, many SP company facilities that needed portable fuel burned coal. This included section houses, depots, and cabooses, as well as stationary boilers, and sand houses. Accordingly, a coal pile outside the roundhouse should be included. I simply made a styrene bin and added coal to it. This one may look a little small, but is similar to what I have seen in photos of SP roundhouses and shops. The Port Costa roundhouse also had a coal storage area inside the building, next to the boiler.

At least some of the parts to be handled in a machine shop would be too heavy for manual movement or lifting, so a crane of some kind is likely outside the shop. There would likely be a crane inside

## ADVERTISEMENT



**ROLLING ROADS**

**SPEEDOMETER** For Speed In Real Time!

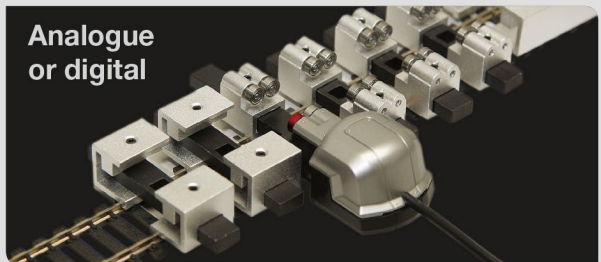

Analogue  
or digital

**CLICK HERE**

**Bachrus** inc  
RUNNING ON QUALITY

[www.bachrus.com](http://www.bachrus.com)  
Hannon, ON Canada

• [INDEX](#)

• [TABLE OF CONTENTS](#)





2. A side view of the Banta Modelworks roundhouse prior to adding some of the details described in this article. Its length accommodates small steam power such as Consolidations. The coal bin is in the middle of the side wall. The machine shop addition to the roundhouse is at the back, as is a loading dock for that shop. That's a pile of wheels by the shop track.

the shop also. I added the Tichy jib crane (see Parts list) to serve this purpose, and it is shown in a later photo in this article.

I hinted in my caption to [2] that wheels and wheelsets are handled at this facility. I described my modeling of wheel and wheelset operation in my column in the *Model Railroad Hobbyist* issue for September 2016 (see Bibliography).

## Servicing

The classic servicing of steam locomotives involves fuel and water supply, along with sand and lubrication. It was common on

## GETTING REAL | 6

the SP to use water and fuel cranes, with the storage tanks moved outside the immediate servicing area. This saves space in the busiest part of the terminal. To illustrate these services at a small-scale SP terminal, I include [3] to show the overall appearance.

The large water storage tank visible in [1] is of course the source of water for the water crane on my layout, and [4] shows the fuel



3. A view of the Wendel, CA engine terminal in the summer of 1951. Baldwin AS-616 no. 5233 is at left, not yet a year old. Behind it is the two-stall engine house. At right is Class AC-9 articulated no. 3811, last of the 12 engines in the class. Originally a coal burner, it has been converted to oil and is running out its final miles on the Modoc line. Just visible at right is the sand house, and that rickety-looking piping over the track is for sand delivery. There is a water crane, and a fuel crane which is in use. Note the duck-boards on both sides of the tracks and between the rails, and note also the six visible barrels. *Richard Steinheimer photo, DeGolyer Library*

## GETTING REAL | 7

and water servicing pad with minimal other details in place. The water crane is a Sheffield design, widely used across the SP system, and was imported in brass by Lambert.

My fuel supply is a Precision Scale brass oil column. Many SP facilities used the Rose oil column, available as a kit from Tichy Trains. But SP purchased its fuel and water columns from a variety of manufacturers, so modeling a specific terminal will require research.

Photos of SP engine terminals show a wide variety of ground treatments at servicing pads, in some cases paved (usually with concrete, sometimes asphalt), dirt or gravel, and sometimes duckboards, about which more in a moment. For my small terminal [4], I chose concrete for the basic support of the fuel and water cranes.



## Available Now! Standard Station Kit HO Scale



Over a decade out of print!  
This Laser-cut kit is a  
detailed model and fits any  
era from 1895 on  
New limited run now in stock!  
Item 134.32  
Retail \$84.95

[Click Here!](#)





## GETTING REAL | 8

I should mention that modeling a fleet of oil-burning steam locomotives does free one from coaling towers, ash pits, and other complications of coal fuel. Those “complications,” of course, can also be modeling opportunities, as is well illustrated in the McGuirk book.

### Duckboards

One noteworthy aspect of the terminal in [3] is the presence of extensive working surface in the service area in the form of duckboards. These were used in many SP facilities. The purpose is to provide a walking surface above any puddles of spilled oil or water, and keep workmen’s feet a little cleaner. For a more dramatic view of such duckboards in service, the wash rack area



4. The minimum in fuel and water cranes, on my layout. The immediate pad area is shown as concrete paving. A caboose service building is at lower left. In this view, a water hose is at one end of the paved area. But there should be more details.



Make it run like a

# Dream

*By Joe Fugate*

EBOOK SERIES:

First time these methods all collected in one place

\$12.99

\$12.99

\$12.99

**PREORDER  
SPECIAL**

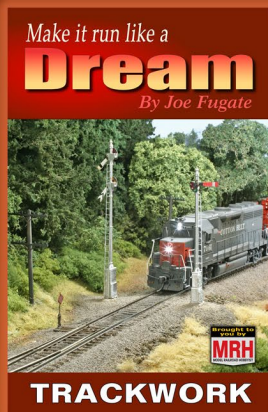

Available NOW!



Est release: Sep 2017

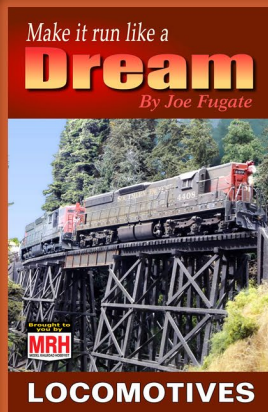

Est release: Apr 2018

Pre-order customers get regular sneak peeks at chapters as they're finished, and get exclusive access to video shorts ...

~~\$38.97~~

**\$29.99**

Price for eBooks ... also available in paperback

**PRE-ORDER EBOOKS TODAY >>**



[store.mrhmag.com](http://store.mrhmag.com)

• INDEX



SUBSCRIBE  
(free)

• TABLE OF CONTENTS



5. This photo of the wash rack north of the roundhouse at SP's Taylor Yard in Los Angeles, taken in the summer of 1950, shows the duckboards provided so workmen's feet could mostly stay out of the accumulated oil and water in the area. *Richard Steinheimer photo, DeGolyer Library*



6. This is the SP fuel track at San Luis Obispo, CA in the late 1950s. Hoses are connected to the tank cars for gravity unloading. The duckboards for workmen alongside the track are evident. *Southern Pacific photo*

at Taylor Yard in Los Angeles is shown in [5]. Here the oily water from steam cleaning would be ubiquitous.

Another use of protective treatments such as duckboards is the surface where light repairs are made. This may or may not be near the fuel and water servicing pad. Most SP photos showing areas of repair work seem to be paved, with either asphalt or concrete.

The examples in [3] and [5] do show engine terminal areas, but of course duckboards might be used anywhere there might be spillage. Another example was the area for unloading locomotive fuel at San Luis Obispo, CA [6]. In all these photos, the duckboards



look fairly similar. They are wooden slats, not tightly fitted but with spaces to allow drainage, and they are not perfectly lined up in length, though pretty consistent in spacing. Modeling these would obviously require accomplishing a similar appearance.

These would not be difficult to model from scratch, using strip-wood or strip styrene, though it would be a tedious process and likely not easy to get the boards consistently parallel. I've adopted a much easier way. I make the duckboards from HO scale pallets. There is a convenient Preiser set of pallets, their number 17104, which contains 60 pallets.

I will observe in passing that actually these are “Euro-pool” or, as they are termed, EUR-pallets. They are narrower than standard American pallets, so are not really suitable to stack on loading docks of your layout industries, but they are fine for duckboards. (The EUR-pallet is 800 x 1200 mm; standard U.S. pallets are 40 x 48 inches, or 1020 x 1220 mm. Today there are several additional standard EUR pallet sizes. If this topic is of interest, Google “EUR-pallet” for more information.)

The Preiser pallets are molded in what is definitely a new-wood color, but of course duckboards in service would be quite different from that. I begin by lightly priming them, usually with gray or light brown, sanding the bottoms, and attaching a strip of thin styrene sheet or sometimes a scale 1×10-inch styrene strip, to hold them in alignment. A photo of this arrangement [7] shows one set of duckboards upside down to show the 1x10 strip I used in this case. They are not particularly well aligned; the irregularity is deliberate. One could certainly align them very precisely if desired.

Once I have an assembly of pallets, I paint them a medium to dark brown if that wasn't done on the sprue [7], varying along the length of the assembly. I then weather and dirty them heavily. An example is included here [8].



## GETTING REAL | 12

For my layout's engine terminal, because the fuel and water pad is represented as concrete, I didn't need duckboards for the service area. But I also model an unloading area for locomotive fuel just as in [6], so I have built duckboards for that area. I also added a storage tank for the fuel oil and a pump house next to it. Note in [6], incidentally, that the hoses are not very long, only long enough to just reach from the tank car to the pipe connection.

I model hoses several ways, usually with hook-up wire as a starting point. Stripping wire ends and painting the exposed end bronze color can represent connectors. An example using no. 18 wire is included in [8]. I have also used small brass tubing, glued over the stripped wire end, to represent hose couplings or connectors.



# Did you know ...

**MRH subscribers**  
**SAVE 10%**

**... on the MRH Store &  
on TrainMasters TV?**

***Click to get 10% off coupon code***

***(Must be a subscriber to access)***



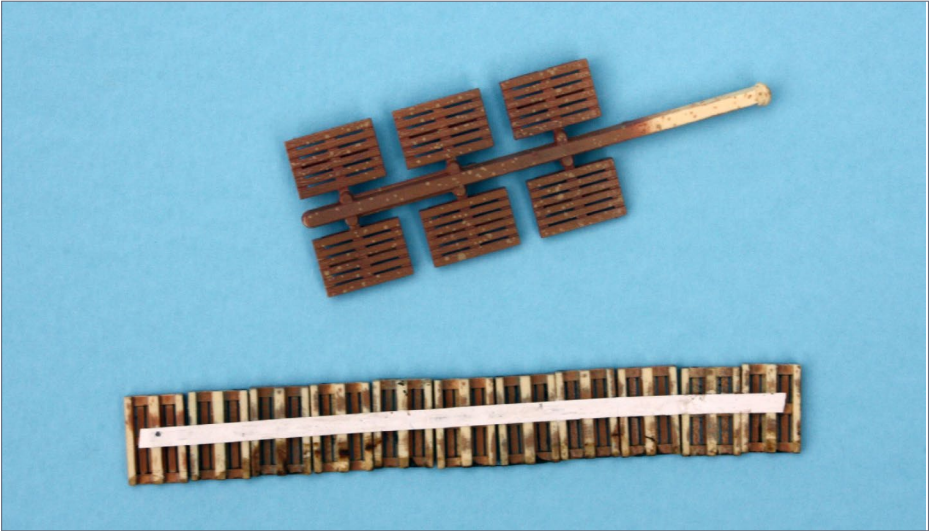

7. The Preiser pallets come six to a sprue. The sprue here has been painted an aged-wood brown. At bottom are 11 pallets, tied together underneath with a strip of scale 1 x 10-inch styrene strip.

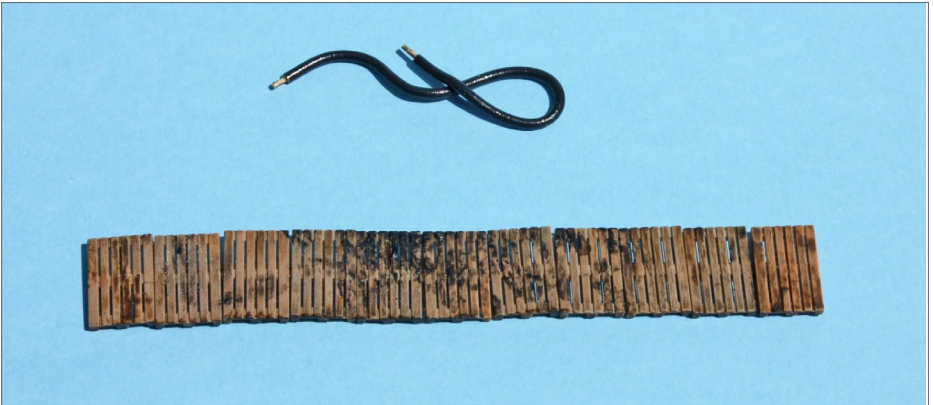

8. This photo shows a completed section of duckboards, suitably weathered and stained to represent fuel handling. Also shown is one kind of hose I make, reflecting the kind of hose lengths visible in [6].

Smaller hoses, perhaps similar in size to a garden hose, are visible in some prototype photos. I have modeled such a hose at my engine service area, using no. 24 hook-up wire. This can be seen in [4]. I made the hose bib by bending a length of stripped wire at the end of the hose, and painting it black. With most hoses, the appearance is improved if some time and effort is taken to achieve a realistic looking shape, either neatly coiled or simply left lying as it was last used. A hose reel is another modeling opportunity, though I have not been happy with how my attempts have turned out so far.

### Additional details

A wide variety of smaller components that make up engine terminals are worth observing and modeling. It has long been “common modeling” to strew various kinds of locomotive parts and other “junk” around engine houses, but examination of prototype photos quickly reveals two vital points. First, any stored parts are neatly arranged or stacked, often on skids or other supports to keep them out of rainwater, etc. Second, “junk” simply is not present. It would be in the way. Even photos of railroad facilities on the verge of abandonment do not show random junk piles.

The Wendel, CA photo [3] is one example. For two more examples, which also show additional features I want to discuss, I show a pair of service-area photos from SP facilities in Los Angeles [9,10]. Both of these latter photos show that there is not “junk” lying around, though each working area does indeed contain a myriad of details. The areas are paved, and the number of carts, probably containing tools, materials, or parts, is striking. So is the frequency of ladders, stands, and other means of conveniently accessing work areas well off the ground. To be sure, there are a few minor items visible, such as an oil can in one photo, and a pipe and a box in another. But they are neatly placed out of the way.



## Carts

In a range of SP engine terminal and shop photos I have seen, there are hardly any two carts alike; compare [9] and [10]. No doubt these are home-made in the shop for each specific purpose. Color images show them to be mostly dark colors, though orange and yellow can be found. Because they are so variable



9. This superb image shows open-air repair work on the garden tracks at the Taylor Yard roundhouse in Los Angeles, in the summer of 1950. In addition to cab-forward 4192 at right, 0-6-0 switcher 1244 is being serviced here. Note the several carts, the ladders and stands, and the general cleanliness of the area. *Richard Steinheimer photo, DeGolyer Library*



## GETTING REAL | 16

in shape, almost any small box shape will work for these. They almost always have wheels on one end. There have been commercial models of things like this, but they are easy to scratch-build also.

I have built several small carts, and described fairly thoroughly how I made some very simple styrene ones, in my blog (see Bibliography), so I won't go into the production process here. There are also some commercial kits for carts, such as the nice cast pewter metal one from B.E.S.T. (Bollinger Edgerly, see Bibliography). Examples are shown in the photo here [11].



10. Southern Pacific steam passenger power was usually serviced in Los Angeles at the Alhambra Street roundhouse, adjoining the Los Angeles General Shops. This 1948 view shows outdoor servicing with the usual numerous small carts, ladders, barrels, and generally orderly appearance. *Malcolm Gaddis photo*

## Barrels

One thing often visible in photos of engine servicing areas and shops is barrels (often oil drums). Most are evidently in use as trash receptacles, though some may contain lubricants. If you examine the photo of the Wendel terminal [3] carefully, there are at least six barrels around the area. These are easily modeled with any of several commercial barrels, but I like the Grandt Line ones best because they are hollow, thus easily used for the kind of containers visible in many photos.

These barrels might be plain black or gray in color, or they might well have a color code stripe like many oil company barrels [12]. Several photos of SP facilities clearly show solid-color barrels, and color images have shown both orange and red ones. Some might contain sand for fire fighting or to scatter on oil spills. I have included a photo [13] of orange barrels.

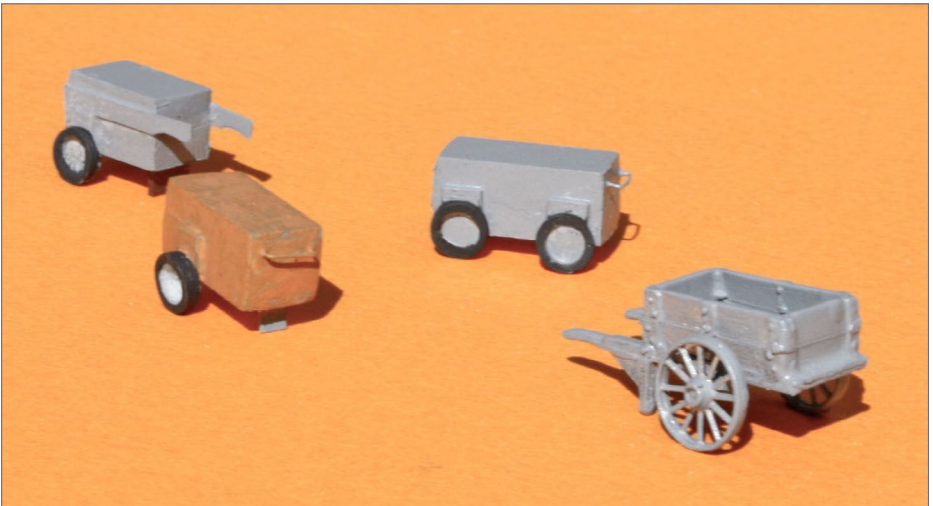

11. Several work carts for engine terminal use. The three at left are built from scratch out of styrene, while the one at right is a pewter kit from BEST (see text).

## GETTING REAL | 18



12. The wheeled work cart near the center of this view has a gable top, though flat tops are far more common in SP photographs. The striped barrel is also noteworthy. The scene is at Tucson, AZ where power was changed on many trains, and minor repairs often made. *Al Phelps photo, August 1952, Signature Press collection*



13. Color images show a mix of barrel colors. In this October 1955 view at West Oakland, CA there appears to be an orange barrel at the end of each garden track, and a group of both black and orange barrels at left. *Detail of a Dallas Gilbertson photo, courtesy Tom Dill*

## Ladders

Another highly visible component in almost any photo like this is the ladders and stands, of all shapes and sizes, many doubtless home-made in the shop for specific needs. These sometimes are made of steel tubing, but most commonly are wood. Examples of all these can be found among the photographs here, such as [9, 10, and 14].

Modeling these can readily use commercial ladder material, such as the nice Central Valley set (see Parts list), which contains several styles of ladders. I like their 10-foot stepladder as typical of engine terminal ladders. I also used more of the ladder material in their set to make a 5-foot stepladder. Both are shown in [15]. Other ladders have been commercially available over the years. I have a couple of HO scale stepladders for which I no longer remember the origin.

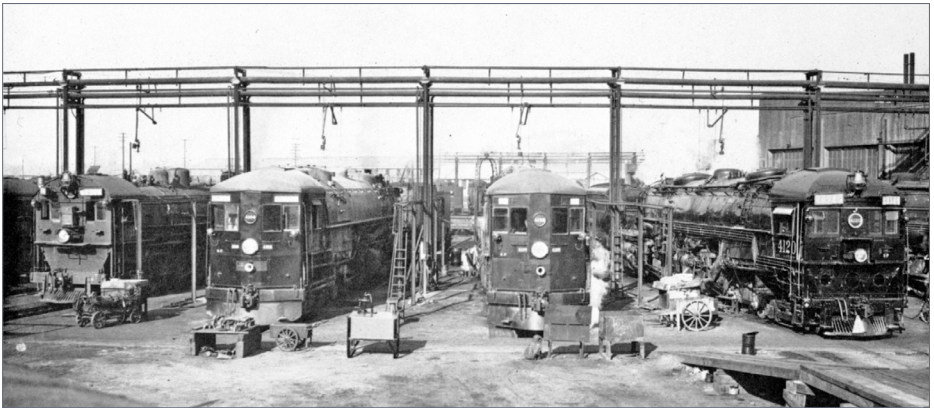

14. Another photo of the garden tracks at Taylor roundhouse in Los Angeles, this one in 1939. There are four carts visible; at left is an unusual four-wheeled cart, and a couple of skids, and some ladders and stands. *Allan Youell photo, Arnold Menke collection*





15. The taller ladder is the stock Central Valley 10-foot step ladder from their set 1602. The shorter one is made from material in the same set. Both are quite similar to ladders seen in prototype photos of engine servicing.

### Skids

These are less frequently evident in engine service areas for fuel and water, but are commonplace in shops and repair areas. They are all different shapes and sizes, and sometimes are labeled with what is supposed to be put in them. An example is in [16]. I have no suitable shop area to include a model skid, but they would be pretty easy to make from styrene.

### Blue flags

Most modelers already know about blue flags, which are a system to prevent movement of equipment when such movement might be dangerous to someone working on the equipment or damaging to the equipment. The key point is, that only the person who placed the blue flag is entitled to remove it. The idea, of course, is that only that person can be sure that the work has been done, and that workers are out of danger. This is enshrined in most railroad rule books as Rule 26. I found it interesting that at one time, blue flags really were fabric flags [17]. More recently, they are metal rectangles.

## GETTING REAL | 21

In a shop, blue flags are not as important, because equipment is often worked on for an extended time. But in a fuel and water servicing area, the opposite is true, and blue flags are routinely used. Most blue flags are metal rectangles on a steel rod post, and can be inserted between ties, or, if equipped with a channel base or clamp, can be set atop a rail [18]. Blue flags are used to warn about a wide variety of safety issues, as is evident from the range available [19].

There is also a style of blue flag with a hook at the top end, and the hook can be engaged onto a small loop on the side of a locomotive cab. The blue flag in that case is visible from inside the cab, reminding the engine crew of its presence [20]. I happen to



16. This 1955 view inside the Erecting Hall at Sacramento General Shops shows cab-forwards undergoing class repairs. In the foreground is a skid for brake shoes, labeled "SP CO STORES DEPARTMENT," as well as indicating the desired contents. *Ken Yeo photo, Bob Church collection*



17. Originally the “blue flag” was just that, a fabric flag. In this photo from a snowy day in March 1943, John Paulinski, a Santa Fe car inspector, is blue-flagging a train for inspection at Corwith Yard, Chicago. *Jack Delano photo, Library of Congress, image LC-USW 361-609*



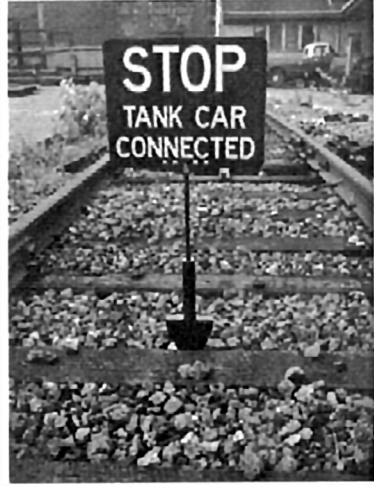

18. There are several types of commercial blue flags for the prototype, including these two. At left is a flag which clamps to the rail; at right is one which has a pointed staff for insertion into ballast. There are also motorized flags that can be raised and lowered by remote control. *Photos from the Western-Cullen-Hayes catalog*



19. Here is the array of available blue flags from Western-Cullen-Hayes, including a blank blue sign to which the buyer can affix any chosen wording. They also produce custom signs.



## GETTING REAL | 24

have such a blue flag, given to me by an SP carman years ago. The flag part is an aluminum rectangle, about 12 x 13 inches, a more or less typical size, and this particular flag does have the hook at top for locomotive cabs.



20. In this photo at San Luis Obispo, 2-10-2 helper no. 3711 is about to help the westward Daylight, no. 99, over Cuesta. The engines are coupled up and all servicing has been completed, so the worker on the ground is about to remove the metal blue flag from its place on the cab side (just to the right of the engineer). The flag reads "MEN AT WORK," and Rule 26 provided that it be placed on engineer's cab side. *Richard Steinheimer photo, De Golyer Library*



## GETTING REAL | 25

There have been model blue flags available from a variety of sources over the years. I have mostly made my own from brass sheet, soldered to a brass wire staff. Construction of these flags, and some additional background on the prototype, has been presented in my blog (see Bibliography). Some of my model blue flags are shown in [21].

The simplest way to use model flags on the layout is by drilling a hole to accept small tubing between the rails, so that the flagstaff can be inserted or removed easily. I have found this to work well. An example of a model flag in use is [22], showing one of the many applications of blue flags in railroad operations. Because it is merely inserted into tubing, it is easily removed when appropriate.

### Firefighting equipment

One thing that can be found in many photos of locomotive service areas is a cabinet or box containing fire hoses or extinguishers. See [12], just to the right of the barrel. These are often painted red for identification.. There may also be fire barrels of sand, as can be seen in some photos.



21. Examples of blue flags I use on my layout. Construction of them was described in a post to my blog (see Bibliography). They may be compared to the prototype range shown in [19].



**22. A blue flag warning of a connected tank car, in use at the Richfield bulk oil dealership on my layout.**

Southern Pacific seems to have had two kinds of firefighting boxes. One was mounted on a post and contained a hose. Sometimes this type was simply labeled “FIRE” but examples exist of such a box labeled “FIRE HOSE.” The larger boxes, standing on the ground, ranged from slender cabinets to small sheds, usually labeled “FIRE” though sometimes simply painted red. An example is presented here as [23].

A cabinet like this is easily made from sheet or strip styrene to suitable size and shape. Few SP photos show consistent designs. I formed the sides of one cabinet with Evergreen styrene strip, 0.125×0.188 inch. I used 0.20-inch styrene sheet for the faces and roof, with scale 4x4 inch styrene legs. I made it in halves, as you seen in [24]. The cabinet was assembled, then primed, painted red, and lettered with a decal alphabet set. A completed one is shown on the side wall of my roundhouse [25].

I mentioned hose reels earlier in this article. A hose reel near a fire equipment cabinet would make sense, and would be an additional feature to model.



23. The south end of the SP sand house at Dunsmuir had a fire equipment cabinet, indicated by the arrow, and it was painted bright red. Notice it is supported off the ground. This is the type of cabinet I decided to model. *SP photo, Shasta Division Archives, courtesy Bob Church*

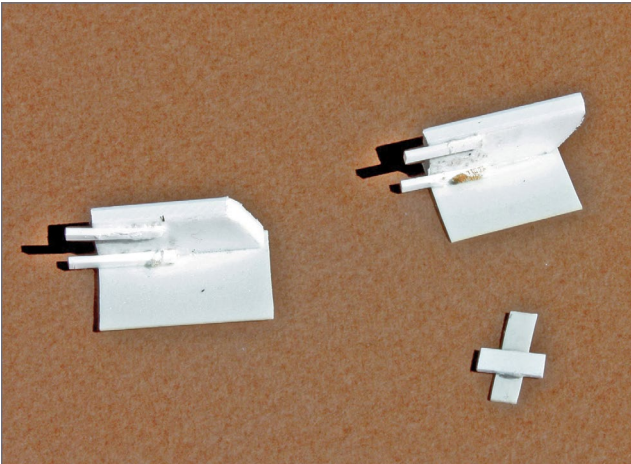

24. Two styrene halves of a fire cabinet (materials in text). Height of the body of the cabinet is 6 scale feet. At bottom right is the small fixture I made to ensure that all legs extended the same distance (1 scale

foot, the lower end of the fixture) below the cabinet.



## Putting it together

I have added many of the details mentioned above to my model engine service area, shown in its original form as [4]. Including work carts, barrels, and ladders definitely makes this a more realistic and interesting scene [26]. There is also a blue flag capability here, as would be needed whenever locomotive servicing involves workers around or under a locomotive. One suitable flag is presented in [27]. I have already learned that these model flags are not as visible to visiting operators as one might like, so warnings are very much in order. Don't ask how I learned this.

## Concluding remarks

Both railroad engine terminals and repair areas contain details typical of each railroad. Modeling these requires study of relevant



25. A completed fire equipment cabinet beside my roundhouse. The jib crane mentioned in the text is at left. A pile of car wheels is in the left foreground. The machine shop addition to the roundhouse, and its loading dock, are behind the crane. The doors onto that loading dock were also additions to the roundhouse kit. The coal bin is at photo center.

## GETTING REAL | 29

period photographs, and awareness of commercial products that may match those details. Many simple components are easily made from styrene or other materials. However they are made, such details can add considerable interest to a model engine service area. Modelers are usually very interested in locomotives, making an engine terminal one of the most-viewed parts of any layout. It deserves realistic details. ✓



[Click here to rate or comment on this article](#)



26. The same engine terminal seen in [4] with added ladders and work carts, along with a typical oil drum used as a barrel. A workmen's tool house is also planned for the far (left) end of this area. Note the coiled unloading hose at the tank car spot in the right background.



27. A “MEN WORKING” blue flag in place at the engine servicing terminal. This is placed in brass tubing between the ties, as in [22]. The roundhouse and other facilities are in the distance.

# Please tell your buddies about MRH!

WE RELY ON WORD-OF-MOUTH TO GROW AND A BIGGER CIRCULATION MEANS MRH IS MORE LIKELY TO STICK AROUND FOR A LONG TIME TO COME!



## BIBLIOGRAPHY AND SOURCES

**McGuirk, Marty**, *The Model Railroader's Guide to Locomotive Servicing Terminals*, Kalmbach Books, Waukesha, WI, 2002.  
[still available as of this writing: visit [kalmbachhobbystore.com/product/book/12228](http://kalmbachhobbystore.com/product/book/12228)]

**Thompson, Tony**, "Accurate Modeling of Individual Trucks Requires Knowing the Prototype," *Model Railroad Hobbyist*, September 2016 (available at: [mrhmag.com/magazine/mrh-2016-09-apr](http://mrhmag.com/magazine/mrh-2016-09-apr))

**Thompson, Tony**, building the Banta Modelworks roundhouse kit, series of posts concluding with: [modelingthesp.blogspot.com/2014/02/a-roundhouse-for-shumala-part-5.html](http://modelingthesp.blogspot.com/2014/02/a-roundhouse-for-shumala-part-5.html)

**Thompson, Tony**, building work carts, blog post at: [modelingthesp.blogspot.com/2017/04/building-work-carts.html](http://modelingthesp.blogspot.com/2017/04/building-work-carts.html)

**Thompson, Tony**, modeling blue flags, blog post at: [modelingthesp.blogspot.com/2017/04/blue-flags-part-2-modeling.html](http://modelingthesp.blogspot.com/2017/04/blue-flags-part-2-modeling.html)

.....



**Click here to rate or  
comment on this article**



## PARTS

**Banta Modelworks**, “Southern Pacific’s Port Costa Roundhouse,” kit no. 2097.

**Bollinger Edgerly Scale Trains (B.E.S.T.)**, extensive line of detail parts: see [besttrains.com/products\\_4-0000.html](http://besttrains.com/products_4-0000.html).

**Central Valley**, “Steps and Ladders,” set no. 1602.

**Century Foundry** (now part of **Showcase Miniatures**), oil column, white metal, kit no. 2120.

**Evergreen** styrene strip, scale 4 x 4-inch, no. 8404; scale 1 x 10-inch, no. 8110; 0.125 x 0.188 inches, no. 389; styrene sheet, 0.015-inch thick, no. 9015

**Grandt Line**, 55-gallon drums, no. 5041.

**Overland Models**, brass, 65,000-gallon Harriman water tank.

**Preiser pallets**, set no. 17104.

**Tichy Trains**, jib crane, kit no. 8007; Rose oil column, kit no. 8169.

---



Click here to rate or  
comment on this article



# WHAT'S NEW on TMTV!

Non-members: Watch episodes for \$1.49: become a member for unlimited access

Brought to you by  
**MRH**  
MODEL RAILROAD HOBBYIST



HO weathering & detailing: Diesels



Loksound decoder sound loading



A look back at vintage kits



Layout tour: Our home & miniature land



# TRAINMASTERS.TV



• [INDEX](#)

• [TABLE OF CONTENTS](#)



Model Railroad Hobbyist | August 2016 | #90

# WHAT'S NEAT WITH KEN PATTERSON

KEN PATTERSON

column



[Click here to rate or  
comment on this article](#)

**TALKING TO CABOOSE IN DENVER, MORE SAW-  
MILL WORK, ATHEARN'S NEW SDP40F, AND WHAT  
DOES 'DCC READY' REALLY MEAN? ...**

**THIS MONTH WE INTERVIEW KEVIN RUBLE FROM** Caboose – that famous hobby shop in Denver, CO – as he shares with us his passion for the hobby. For layout construction, we build further towards the completion of the BTS Sawmill project by building two lift-out sections to span the gap from the 5x12 foot Blackstone layout to the trestle diorama that leads to the sawmill. There are many great tips in this construction segment.

Later, we look at the new Athearn SDP40F locomotive as I share my photo shoot creating promotional material for the product. We also discuss the term “DCC ready” as we show a few quick plug-and-play decoder installations.

▶ **PHOTOS AND VIDEO OF SUPERB MODELS**

• [INDEX](#)



**SUBSCRIBE**  
(free)

• [TABLE OF CONTENTS](#)



# WHAT'S NEAT | 2

## Kevin Ruble interview





## WHAT'S NEAT | 3

1. (Left) Kevin Ruble, the new owner of Caboose, the famous hobby shop in Denver is really excited about the future of our model railroading hobby. He acquired Caboose Hobbies seven months ago, a hobby shop with a 78-year history of promoting and serving the hobby. He wants to build on that legacy by providing quality service and hands-on guidance to the modeler just starting out and the customer who has a dedicated building full of trains.

He mentioned that half of his business is internet sales and that segment keeps getting stronger. There are three layouts in the store at present and he is planning six more to show what is achievable in various scales, and how easy it is without being overwhelmed by the process of construction and model building.

"We focus on being welcoming to all modelers, those with a passing interest and the serious hobbyist building a large layout." He discussed the fact that the name "Caboose" has value along with the reputation of the company, and this name and reputation were part of the assets considered during the purchase of the company.

"We stock 500 manufacturers' products with over 170,000 items in inventory. It's a big task to keep track of it all," he said. "In five years we want to be the go-to source for the hobbyist as we support the railfan community, and are making a great effort to bring more kids in to the hobby." It was a great 10-minute interview and you can hear it all in this month's video.



[Click here to rate or comment on this article](#)



## 'DCC Ready' explained



2. In this month's video, Daniel Coombs helps me with an explanation of what "DCC Ready" means when you see it in ads or on the packaging of new locomotives. When you go to the hobby shop or a swap meet, you may see locomotives for sale with the words "DCC Ready" on the box. You might think it's ready to run on your DCC layout or train set.

Imagine the new to the hobby train set enthusiast who wants to add his second locomotive to a DCC powered train set and is confused as to why the model will not run.

Let's understand the term to avoid the confusion. "DCC Ready" usually means the model is equipped with an 8 or 9 pin quick-connect plug so you can plug in your aftermarket DCC decoder to run the model on a DCC powered layout. In its current state it will run just fine on a regular DC layout or run on your DCC system with the throttle set to 00, but the motor's brushes will "sing" from the DCC signal and that's not really good for the motor.

## WHAT'S NEAT | 5

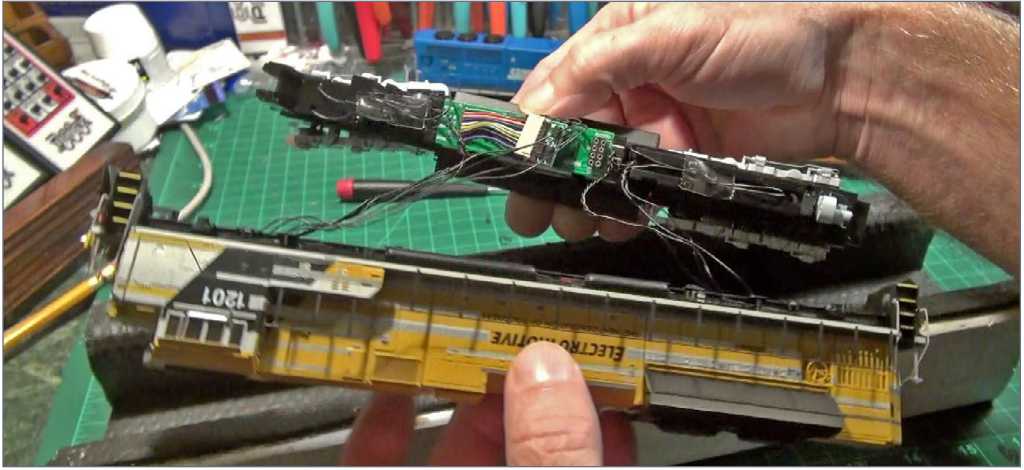

3. As a quick example of to how to convert a “DCC Ready” model to actual DCC operating condition, let’s install a decoder in this Athearn locomotive. Simply remove the two screws that hold coupler boxes in place and the two screws holding the shell in place and you will see the locomotive’s circuit board on top of the motor.



Playback problems? [Click here ...](#)

• [INDEX](#)



SUBSCRIBE  
(free)

• [TABLE OF CONTENTS](#)



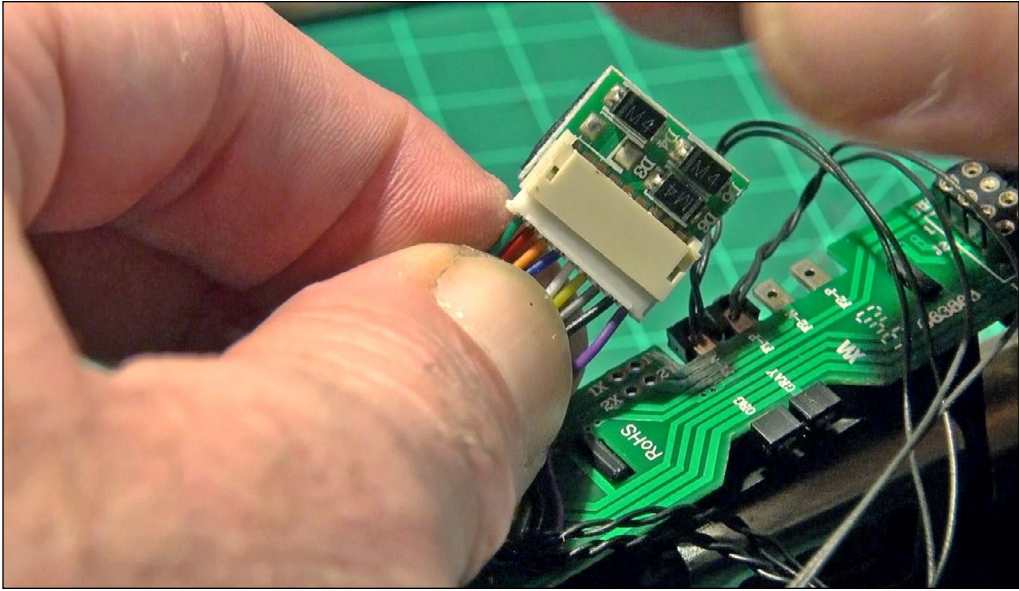

4. Simply pull out the DC plug in the 9-pin connector. Use a screwdriver or your fingers to gently wiggle it out like a loose tooth, as you see me doing in this photo.

**Want to help keep  
MRH free?**

**Then *click* on ads!**



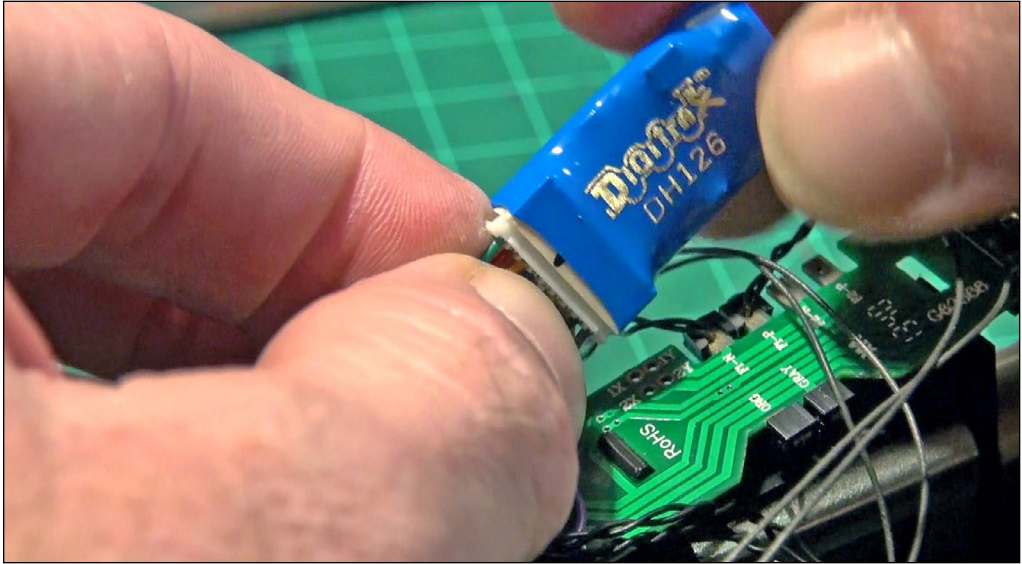

5. Then plug in you new decoder. We are using a two-function Digitrax decoder that matches the Athearn nine-pin harness plug. That's it! Replace the shell and the coupler boxes. Now is a good time to install Kadee #5 or #148 couplers for reliable operation when pulling cars on uneven track.



[Click here to rate or comment on this article](#)



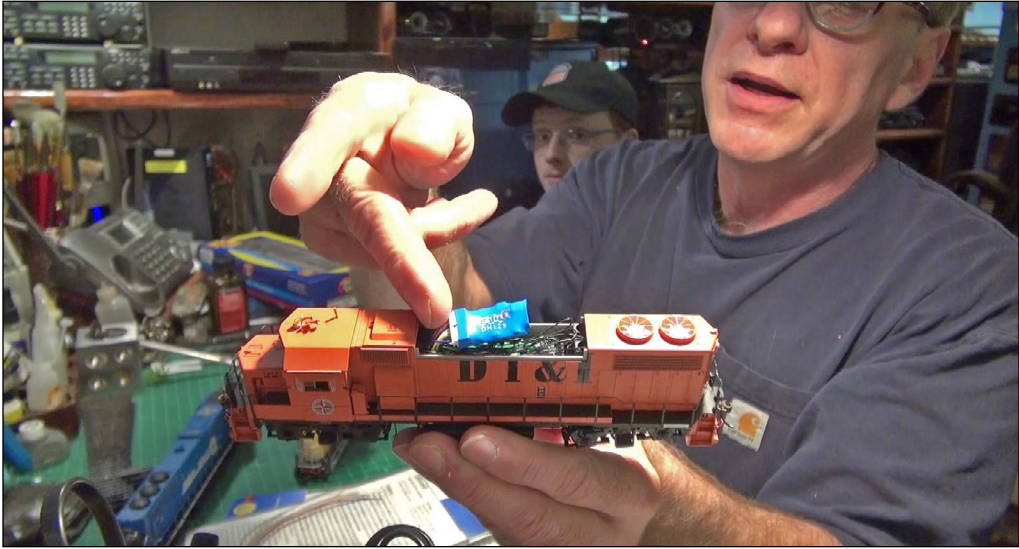

6. Installing the same decoder in this Athearn DT&I GP38 was even easier. All that all I have to do is remove the long hood cover to gain access to the decoder's circuit plug, without removing the shell. It took fewer than three minutes to install the Digitrax decoder in that model.



[Click here to rate or comment on this article](#)

*Have you seen this?*

**CHECK IT  
OUT!**



**kenpatterson.com**

*click here to ...*

**Visit Ken's website**

**Ken Patterson  
reveals his modeling  
secrets on video!**





## Athearn SDP40F HO locomotive photo shoot

7. I spent two days in July shooting this new SDP40F locomotive with Tsunami2 sound for Athearn. I shot video runbys on two scenes on the first day. You can see either a desert scene or a city industrial scene in this month's video. The second day I wanted to do a really special still photo of the locomotive rounding a super





elevated curve pulling a string of cars through farm country. I set up various small sections of cornfield models, a pickup truck and the old 2002 Walthers Catalog cover track scene with black ballast. After about two hours of moving things around to catch the changing sun angle I was lucky and got the perfect shot.



## Layout lift-out construction



8. I am holding the old lift-out wood section you saw me build in the June 2016 “What’s Neat” video. I am placing it over the walkway between the Blackstone 5x12 layout and the Lightner trestle diorama – this is the gap we need to span to get track to the sawmill. I want to use 16 or 18 bigger magnets this time, but avoid wired to connect or rail joiners to move when lifting each of the two sections out of place.



[Click here to rate or comment on this article](#)

## WHAT'S NEAT | 12



9. After studying the existing trackwork, I decided to come off the Blackstone layout with a #6 turnout on the curve running left across the walkway and onto the trestle diorama. Here you see me holding a  $\frac{3}{4}$ -inch plywood curve of 26 inches radius. I'm fitting it to the span to ensure correct placement and flow before notching out the foam to accept this flush with the existing rail height. I cut the foam with a small saw to fit the shape of the plywood lift-out piece.





## WHAT'S NEAT | 13



10. I then test-fit this into place. You can see a  $\frac{3}{4}$ -inch block of wood under the lift-out. This will be the base in the foam to which we will mount magnets. I checked that the track on the lift-out matched the level of the track on the layout. This is the most important measurement to keep constant through the entire project.



[Click here to rate or comment on this article](#)





11. I also notched the plywood and foam on the trestle diorama to fit the  $\frac{3}{4}$ -inch base and lift-out section, keeping the rail height as the guide for this test fitting. To check for perfect alignment, I rolled a passenger car over the connection, and things lined up just right.

***TrainMasters TV is part of  
the MRH product family.***

*TMTV members not only get great network TV level videos, they help pay for MRH and keep it free ...*



## WHAT'S NEAT | 15

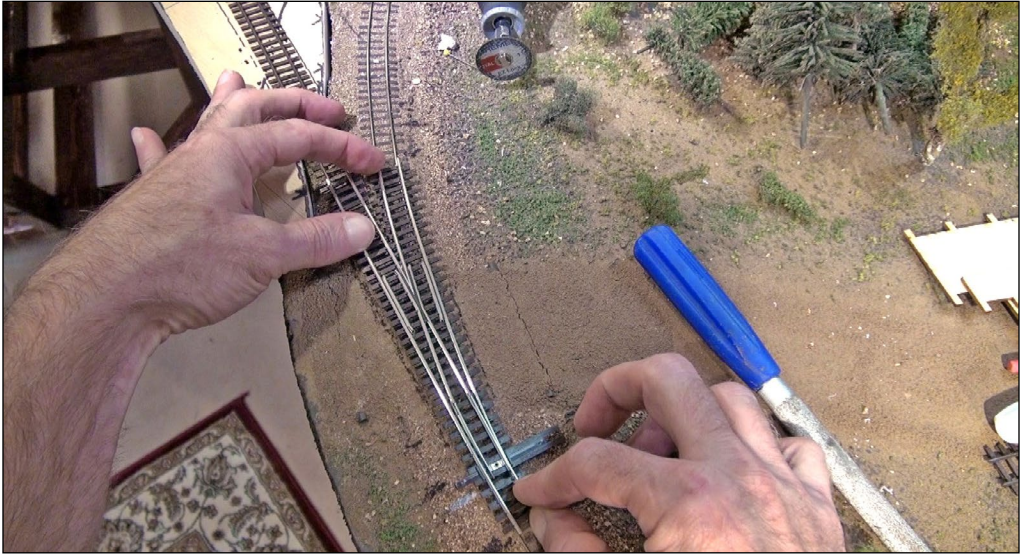

12. I curved one leg of the turnout to match my 26-inch radius curve. I did this by cutting six of the long switch ties between tracks with a cut-off wheel and then cut each tie separate on the track I wanted to bend. This allows the switch to flex and match the 26-inch curve, as you can see.



[Click here to rate or comment on this article](#)

## WHAT'S NEAT | 16



13. Using the same cut-off wheel, I sectioned out the space where the turnout will fit. I removed the rail and ties and then sanded the area smooth to accept the turnout and ground throw. I then sealed the spot with brown latex paint to protect the foam from the liquid nail adhesive that I will use to glue down the turnout. The long sanding board helps me get a dead-flat surface.





## WHAT'S NEAT | 17

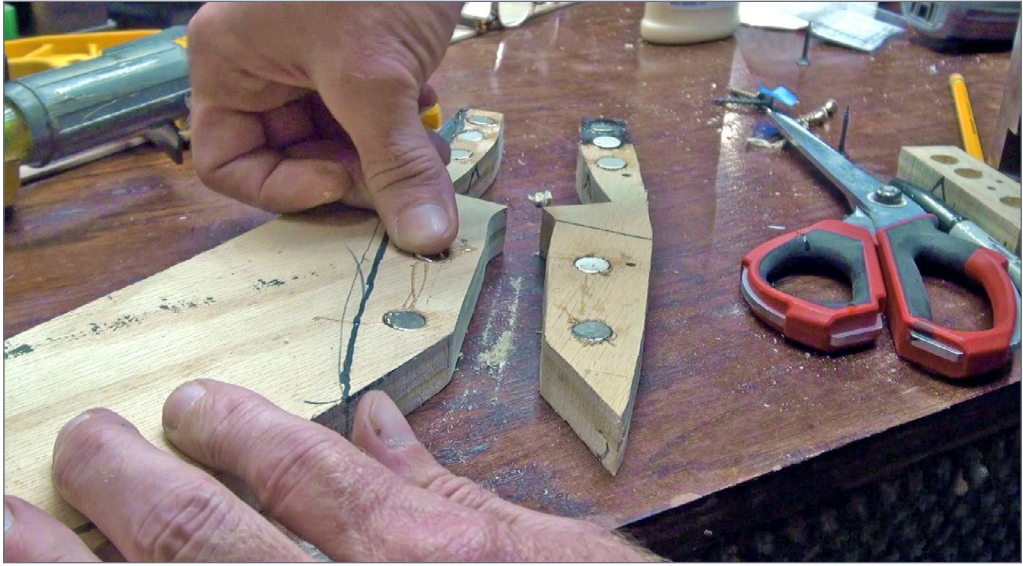

14. Now I started placing the magnets in the wood, drilling 16 holes in the two bases and in the lift-out section on both ends. The holes will accept the magnets flush and lined up vertically. After filling the holes with five-minute epoxy, I placed each magnet in position, being careful to get the polarity correct so the parts will attract rather than being pushed away.



[Click here to rate or comment on this article](#)





15. (Above) To make a flat surface to which we will glue our track, I masked the end of the plywood with blue masking tape to create a barrier as I proceeded to wet the area and apply a thin layer of Gorilla Glue. I let this work its way between the taped plywood and the foam layout.

16. (Next page, top) After the foaming glue expanded and cured, I cut it off flush to form a flat surface for our track. The foam also fills any gap between the wood and foam. The tape, in fact, pulled off the wood when I removed the lift-out, sticking instead to the foam glue. When I removed the tape from the foam, it revealed a smooth surface that conformed to the wood's shape perfectly.

17. (Next page, bottom) I painted the Gorilla Glue foam with latex paint to seal it. Here you can see how the foam cured into the shape of the plywood, making a seamless joint. I also stained the wood section and applied a clear coat. I added wood sides of 3/16-inch oak plywood and attached these to the curved lift-out with 1/4-inch black sheet metal screws, working my way around the curve on both sides.

# WHAT'S NEAT | 19

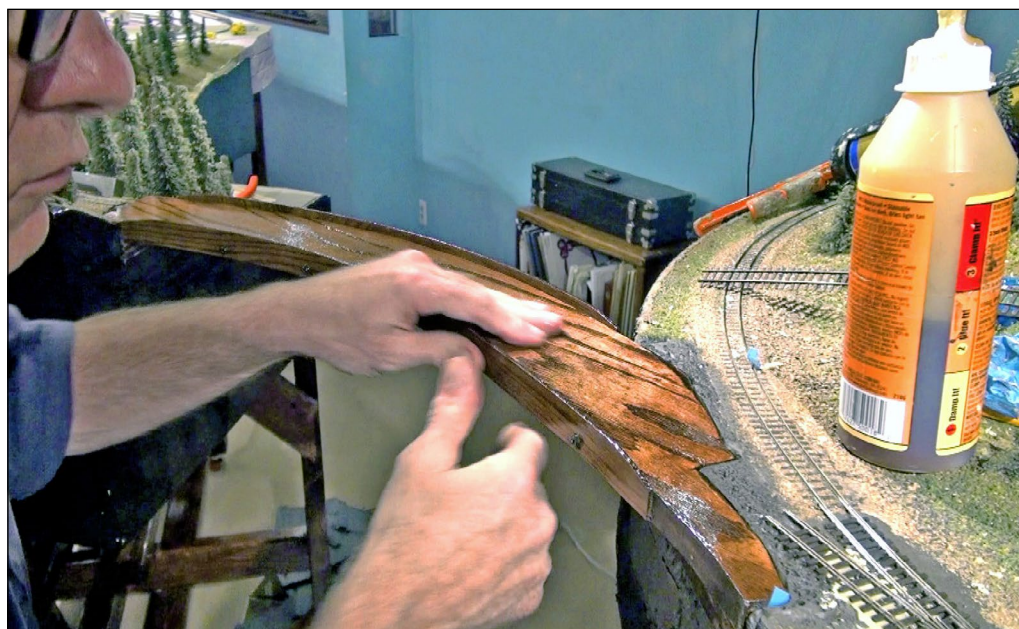
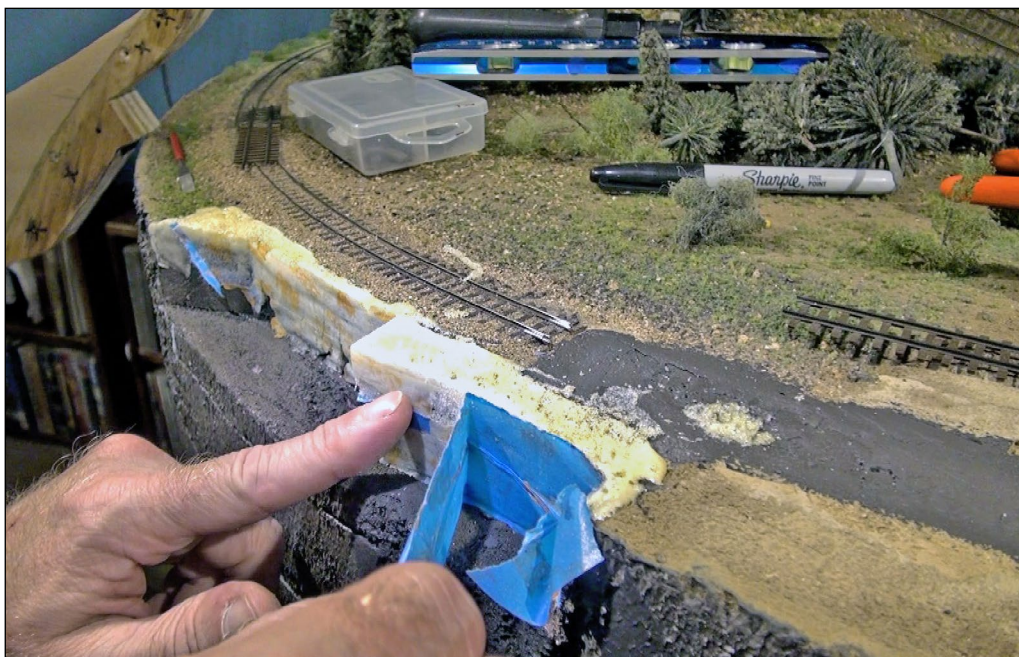



## WHAT'S NEAT | 20



18. After finishing the base pieces with stain and a clear coat, I used Gorilla Glue to attach the finished base with magnets to the cut-out foam area where it fit snugly.



19. I followed the same steps on the other end of the lift-out section, gluing the base in place where it joins my trestle diorama with a more straight section of wood measuring only three inches across.

## WHAT'S NEAT | 21



20. After gluing down the turnout with Liquid Nails adhesive, I laid a piece of track on the wood lift-out section, gluing this down with silicone caulk. This is the time to make sure the track lines up on both ends, with a smooth flow through the curve.



[Click here to rate or comment on this article](#)



## WHAT'S NEAT | 22



21. After the track glue cured, I cut the rail on the ends with a cut-off wheel, leaving a 1/16-inch overhang to the foam section, ensuring rail clearance when removing or setting the section into place.



22. I cut another  $\frac{3}{4}$ -inch piece of oak plywood to fit into our lift-out space. This time, the 26-inch radius curved roadbed was just wide enough to hold the track. This will become our scenicked lift-out section.



## WHAT'S NEAT | 23

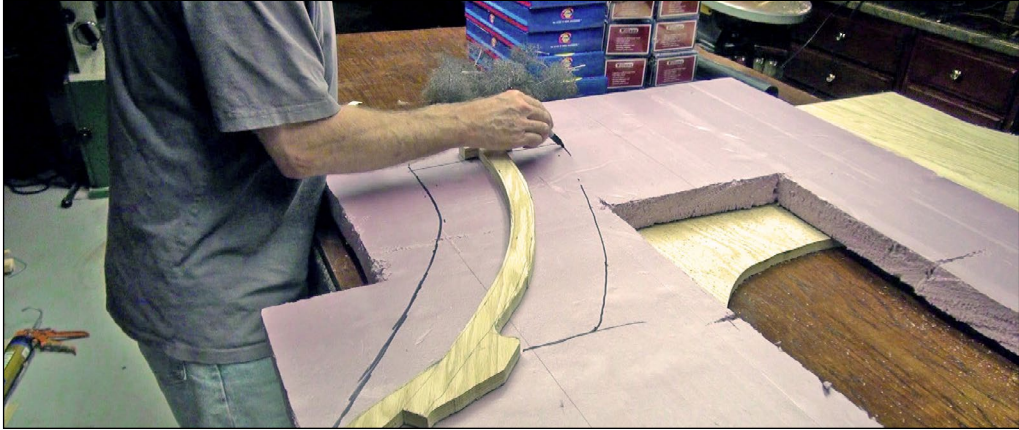

23. I placed our curve on a sheet of foam and drew lines to create the dimensions for our scenery base. I left about five inches of space for scenery on each side of the track.



24. I cut this section out with a jig saw. I embedded the plywood in the foam flush, by setting my router to the depth of the plywood and channeling out the foam to accept the wood. I glued this into place with Foam Pro adhesive and weighed it down while it cured so the foam would not expand the wood up out of the foam.



## WHAT'S NEAT | 24



25. After the foam cured, I carved the topography in our scene with a pruning saw and my Stanley SurForm planer to match the scenery where the lift-out and the other modules will blend.



26. After sealing this section with latex house paint. I test fit it into the space between the layout sections. It fit very well, although I did notice  $\frac{1}{4}$ -inch gaps where the new section met the surrounding diorama's scenery. This needs to be filled with more foam.



27. Now it was time to figure a way to match the magnet placement on the scenicked lift-out section to the existing bases on each end in the foam. The best way I found to do this was to shorten a roofing nail as you see here. I painted black ink on the tip of the nail that is centered on the base magnet and pressed the lift-out section onto this.



[Click here to rate or comment on this article](#)





28. I did this on each of the nine magnet locations, transferring the ink from the nail's point onto the wood, marking the exact location to drill holes to hold each magnet in place flush and centered to its mate in the base. This trick worked with precision!



29. Turning my attention to the electrical pickups to get power to each lift-out section, I placed strips of brass stock into the base and ran wires from this brass to each rail on the turnout.



30. The curved plywood also had two brass stock pieces attached to the bottom of it to match the contacts in the base. The rails in the lift-out section were connected to this brass stock with 20 gauge wire running through the plywood. I repeated this process on the lift-out section with scenery to provide power to the track.



31. I added  $\frac{1}{4}$  of an inch more scenery to fill the gaps between the sections. I did this by adding a small layer of Great Stuff foam to the end and shaping it with a saw.



## WHAT'S NEAT | 28



32. I added dirt, rocks, ballast and ground foam to the lift-out section to give some color and texture to the scene. I glued this into place with Woodland Scenics Scenic Cement.



33. Here you see the two lift-out sections with the scenery glue drying under a hot photoflood to speed things up. Notice that I did add ballast to the plain plywood lift-out section using the same glue dripped slowly on the rocks to avoid messing up the clear coat.



34. I added 30 pine trees from Grand Central Gems. They are pre-made and vary in size. They look very believable when grouped. I simply stuck these into the foam with no glue as they have a wire base measuring an inch long.



35. With that, we now have two finished lift-out sections that fit in to the same space. This brings us seven feet closer to the sawmill trackwork, and now a train can run across Lightner trestle. Here you see me test-fitting the finished scene and running my first train across. The 1/4-inch gaps are gone. The track and scenery flow well as the train ran perfectly across the new section. ☑



# Debug trackwork *like an expert.*

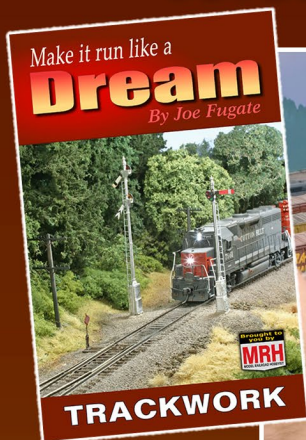

**\$12.99**

**\$11.99**

eBook

Also in  
paperback

Click me to  
**LEARN MORE ...**

Make it run like a  
**Dream**

**TRACKWORK:** *By Joe Fugate*

From the MRH Store: [store.mrhmag.com](http://store.mrhmag.com)

Other books in this series: *ROLLING STOCK* (Sep 2017) and *LOCOS* (Apr 2018)

• INDEX



SUBSCRIBE  
(free)

• TABLE OF CONTENTS



# MRH MARKETPLACE

LOOK at what's new at Black Cat this month

Click here for our website

## CPR 50 ft Box car large newsprint service shield



Black Cat Publishing  
(204)489-5005  
ajfergus@mymts.net  
blackcatdecals.com



## CROW RIVER PRODUCTS

**NEW O SCALE KIT 335 A – LATHE**  
FIRST IN A SERIES OF VINTAGE MACHINE TOOLS

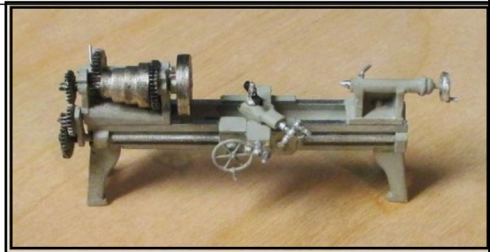

HO & O Scale Machinery, Derricks, Engines, Hardware & Waterfront Models  
Pawtucket, RI 02861 Tel 401-723-0065  
www.crowriverproducts.com

We Accept Visa, Master Card, Discover or PayPal  
**For the Layout or the Display Shelf**

## THE DCC SHOP

YOUR COMMAND CONTROL SPECIALISTS  
www.DCCSHOP.com



Quantity Pricing for the Layout Builder



Complete Train Control



HO Brass



Start your model railroad empire on the right track with **THE DCC SHOP**

The Little Train Store that is **BIG** on Customer Service!

www.DCCSHOP.com

ph. 208-889-9111



## Yarmouth Model Works

HO scale resin kits and detail parts

..... U.S.A. MAILING ADDRESS  
2014 Holland Ave Unit 617  
Port Huron, MI 48060  
Tel. 519-633-7574  
pierre.oliver@elgincarsshops.com  
www.yarmouthmodelworks.com  
..... CANADIAN MAILING ADDRESS  
263 Sunset Dr.  
St. Thomas, ON N5R 3C4



# MRH MARKETPLACE | 2

Your ad could be in  
this space for as low  
as \$58 a month.

Click to learn more ...

## GOODDEALSDCC

WWW.GOODDEALSDCC.COM



HOME OF THE

**PROGRAMMER TEST TRACK SYSTEMS**

GARY COHN

GARY@GOODDEALSDCC.COM

# W

GOLDEN AGE LINE  
**WESTERFIELD**  
MODELS, LLC

New One Piece Body Kits:  
USRA STEEL AUTO BOX  
#3000 Series: MC, NYC



westerfieldmodels.com

*Imagine That!*  
Tastes Art Products

## ITLA Scale Models



Olympia Tool & Die  
HO Scale Laser Cut Wood Kit

CLICK HERE FOR MORE INFORMATION  
[www.itlascalemodels.com](http://www.itlascalemodels.com)

Where the Rail Meets the Sea...



CRAFTSMAN KITS & BUILT-UPS  
HO - O - N Scale



H141-HO 77' Converted Menhaden Steamer Kit  
[www.seaportmodelworks.com](http://www.seaportmodelworks.com)

Click here for our website:

MODEL TRAINS  
**BenchWork**.com

To build your dreams, You need a plan!  
**Affordable track planning**  
Starting at only \$250

CLICK ME to get started!

GREAT LOOKING TREES  
MAKE ALL THE DIFFERENCE

CANYON CREEK  
SCENICS

• INDEX



SUBSCRIBE  
(free)

• TABLE OF CONTENTS



## TAM Industries

*"Preserving the Romance"*

The highest quality in Display Cases for sharing your excitement of Model Railroading. We manufacture Display Cases for all gauges of Model Railroading, from "G" to "N". Custom Sizes are available for some styles.



Visit us today at: [www.TAM-IndustriesOnline.com](http://www.TAM-IndustriesOnline.com)



Your #1 source for **TOMA** Benchwork  
**250+ shapes & sizes!**

Built to order benchwork also available! (224)201-9868



## clever models LLC

Cardstock models & materials

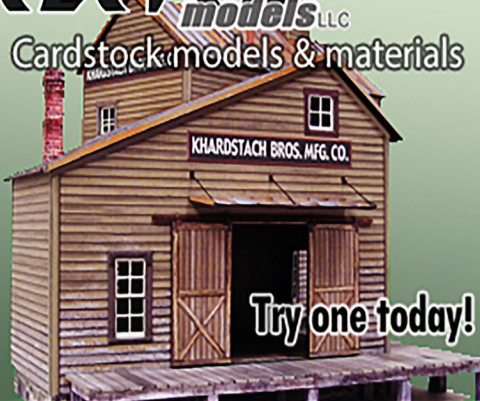

Try one today!

[www.clevermodels.net](http://www.clevermodels.net)

## PRE-SIZE MODEL SPECIALTIES

P.O. Box 6 Paonia, CO 81428

Ph. 970 527 4586

Made in The USA

Cast resin items for All Scales.  
Tunnel portals, bridge piers, abutments, culverts, and retaining walls.  
Trackside details and sage brush tree armatures.

"FREE SHIPPING see website for details"

We're not in Florida for the National Train Show so we're offering a discount in our online store Aug 1-7.

See website for details!



**LOGIC RAIL™**  
TECHNOLOGIES

"Sophisticated  
Model Railroad  
Electronics™"



21175 Tomball Pkwy  
Suite 287  
Houston, TX 77070

Phone: (281)251-5813  
<http://www.logicrailtech.com>  
info@logicrailtech.com

## MAIN STREET AMERICA HISTORIC ARCHITECTURE



**MAIN STREET  
HERITAGE**

[www.mainstreet-heritage.com](http://www.mainstreet-heritage.com)

CLICK  
HERE  
for all  
our HO  
& O kits



Your ad could be in  
this space for as low  
as \$88 a month.

*Click to learn more ...*

**MOUNTAIN SUBDIVISION HOBBIES**

[www.modelrrsupply.com](http://www.modelrrsupply.com)

FREE USA SHIPPING OVER \$29.00

NCE - SOUNDTRAXX - DIGITRAX - PECO - CIRCUITRON  
DCC SPECIALTIES - INTERMOUNTAIN - CMX - ATLAS  
BAR MILLS - BOWSER - KATO - MRC - TOMAR - RIX -  
PIKESTUFF - LOGICRAIL - CENTRAL VALLEY AND MORE!

**RULERS-of-the-WORLD**

Scale Rulers \$4 each

Over 200+ scales!

Metric or Imperial

[www.rulers-of-the-world.com](http://www.rulers-of-the-world.com)

**PRECISION DESIGN CO.**

**LASERCUT KITS - CUSTOM DECALS**

**PDC.CA**

Authorized *RailPro* Dealer

FREE SHIPPING in the US and CANADA

**Great Decals!**<sup>TM</sup>

FEC, Interstate, Virginian  
Railway, & L&N Titles  
After Hours Graphics Line  
Coupler Gages and More  
In O, S, HO, and N Scales



**HO DIESEL SUPPLY**

CUSTOM SOUND LOCO'S-REPAIRS-UPGRADES  
Weathered New and Rebuilt Locomotives  
Powered Chassis-Trucks-Motors-Handrails-Electronics  
Parts Inventory Always Changing  
[www.hodieselsupply.com](http://www.hodieselsupply.com)  
email:gerry@hodieselsupply.com

**Model Railroad Control Systems**

Geoff Bunza Project Boards  
DCC Occupancy Detectors  
CMRInet Compatible Nodes  
Layout Telephone Systems  
RFID Switchlist Generator  
Switch Machines and Drivers



**HOBBY  
MARKETPLACE**  
ads are  
economical and  
effective.

Click HERE to learn more.



# One Module Challenge

Third place winner

BY JEREMIAH SHOEMAKER  
AND BLAKE FREUDENBERG

*Copper mining in the Keweenaw – MRH's  
third place winner in the One Module  
Challenge contest ...*

1. My copper postcard of the Quincy Mine.

• [INDEX](#)

• [TABLE OF CONTENTS](#)

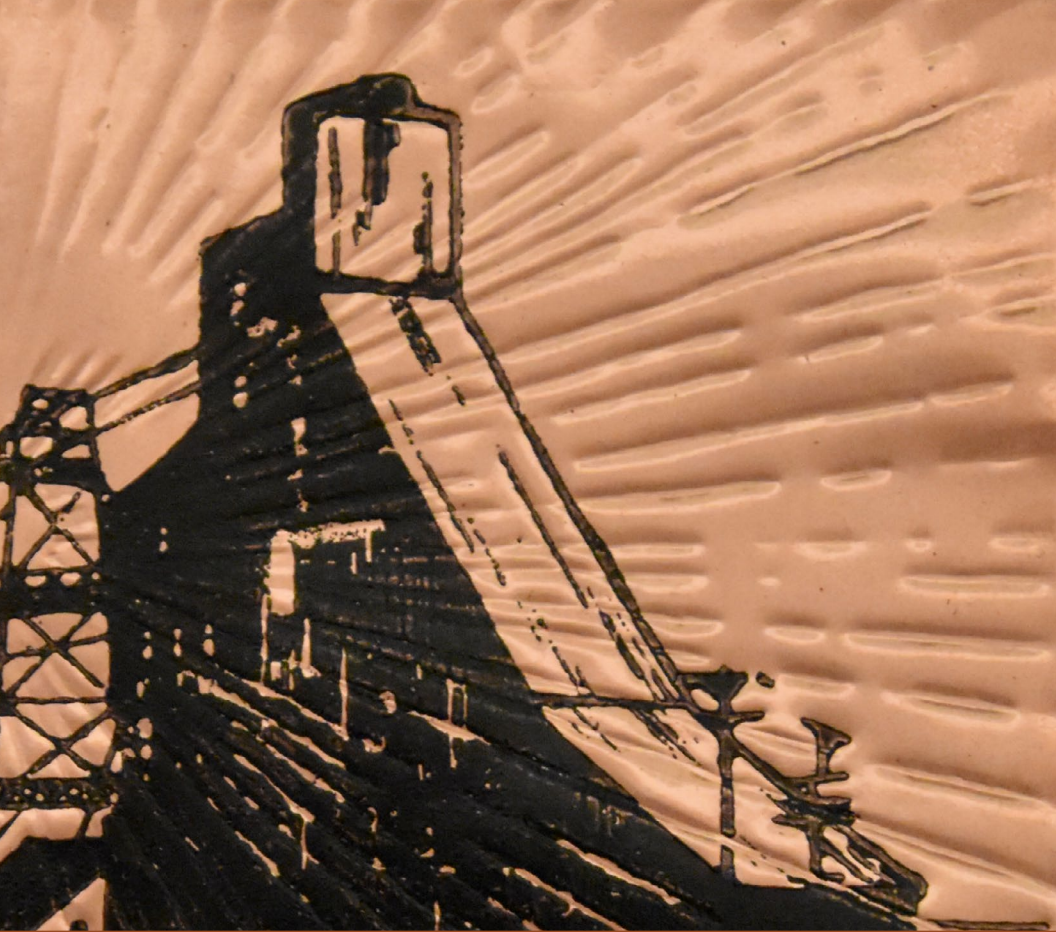

**THE CALUMET CENTRAL REPLICATES THE RICH** copper mining heritage of the Keweenaw peninsula in Michigan (Look up Houghton, Michigan on a map). It is a proto-freelanced layout of three copper mining railroads: The Calumet & Hecla Railroad (C&H), the Copper Range Railroad (COPR), and the Quincy and Torch Lake Railroad (Q&TL). When I discovered the *MRH* design contest, I remembered a prototype that seemed to fit all the criteria..

Like so many plans, this one just grew and grew until there were three modules. Only one of them plus the two staging yards fit in the room. Using my hand-drawn sketch of Houghton [2], I started

• [INDEX](#)



[SUBSCRIBE](#)  
(free)

• [TABLE OF CONTENTS](#)





[Click here to rate or comment on this article](#)

lining up scenery using buildings with some selective compressing. I prefer N scale, so I searched to see what I could find in N scale. Nothing. Nada. So I made the decision to explore another scale.

Earlier in the year at school, I found another model railroader, Blake Freudenberg, who favors HO scale, and we became friends. I immediately enlisted his help, as HO is not my forte.

I sketched up the track plan on a 4' x 8' module. A perfect fit. I know you may be asking "how will it get through the door if it's 48+ inches wide and the door is only 30 inches?" Well, keep reading!

## Benchwork

The goal of this contest was to design a completed module that will operate in the room of the specified size. To get the depth

**Use our custom  
Google search on the  
MRH website to find  
topics of interest**

[CLICK TO FIND OUT MORE](#)

## ONE MODULE CHALLENGE | 4

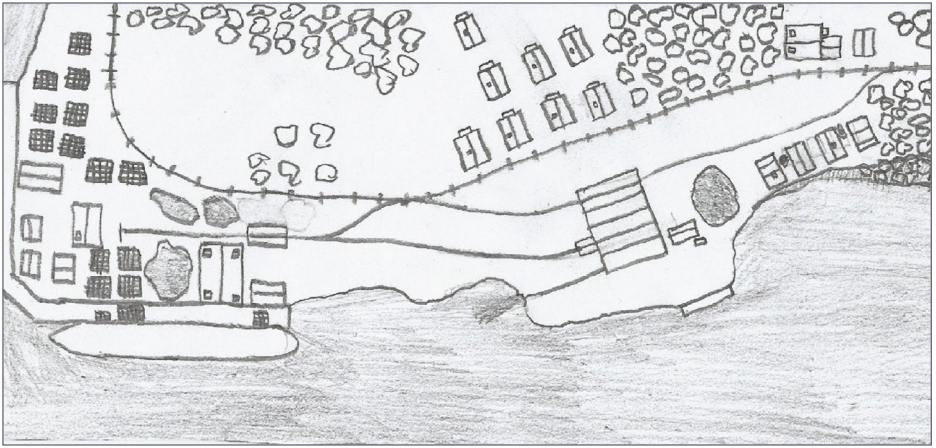

### 2. My original hand-drawn sketch of Houghton that inspired it all.

required to showcase the layout, I needed something wider than 30 inches. So I went with a standard 4' x 8' as a custom module.

To make it extra-light, I chose an unconventional benchwork material: aluminum. While most people are used to working with wood, I find aluminum is just as easy, if not easier to work with. I know this from experience being on my school's robotics team (Shoutout to FRC Team 5999).

To fasten it, you need aluminum brackets which I included in the materials list (see Benchwork Materials), and your basic nuts and bolts. To drill it, you just need a steel drill bit. It's that easy!

I used no plywood in the layout frame – only extruded polystyrene insulation (EPI) and aluminum. Using the two 8-foot sections of square aluminum tubing, make the frame as shown [3]. You can repeat this process for all modules you choose to build, then add the EPI to form your scenery base.

Fasten the Masonite onto the frame and pink styrofoam [4] as edging. If you want extra protection, sandwich a piece of plexi-glass between the frame and the masonite.



# ONE MODULE CHALLENGE | 5

To get the module to fit through a 30-inch door, I designed a tilting mechanism to rotate the layout on its side. The tilting mechanism is cheap and easy to build.

## Benchwork Materials

| Name                                     | Price per unit | Quantity  | Purpose           |
|--|----------------|---|-------------------|
| 8 foot aluminum bar stock (square tube)  | \$15.07        | 2 per module  | Benchwork frame   |
| 4 foot aluminum bar stock (square tube)  | \$8.61         | 4 per module  | Benchwork frame   |
| 90 degree aluminum brackets              | \$9.00         | 2 per module  | Benchwork frame   |
| Masonite board 4x8 feet                  | \$11.00        | 1 per module<br>(enough to do 1.5 modules so plan accordingly!) | Benchwork plating |
| Extruded Polystyrene Insulation 4x8 feet | \$11.00        | 2 per module  | Scenery Base      |
| 2x4 construction lumber 8 feet           | \$4.00         | 3   | Tilting Mechanism |
| 2x6 construction lumber 8 feet           | \$5.00         | 3   | Tilting Mechanism |
| Steel L brackets                         | \$4.00         | 10  | Tilting Mechanism |
| Steel T brackets                         | \$4.00         | 6   | Tilting Mechanism |
| Locking Caster wheels                    | \$56.66        | 1 (package of 4)  | Module Mobility   |
| Screws box of 50                         | \$9.98         | 1   | Tilting Mechanism |
| 3/8 inch bolt                            | \$3.45         | 4   | Tilting Mechanism |
| Flat washers                             | \$3.97         | 6 (package Of 100)  | Tilting Mechanism |

*\*Note all prices are approximated as of January 2017*

**For still more on the Calumet Central layout, see this issue's [Subscriber Bonus downloads!](#)**



**Click here to rate or comment on this article**



## ONE MODULE CHALLENGE | 6

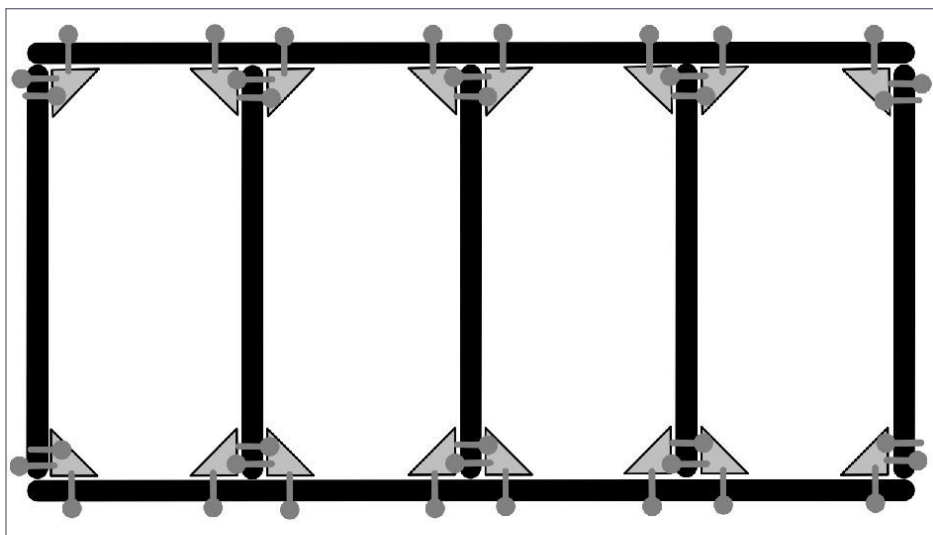

3. Diagram shows how the aluminum benchwork is constructed. Black bars represent the aluminum bar stock, light gray triangles are the mounting brackets, and dark gray are the nuts and bolts. Final dimensions should be 4x8 feet. Not to scale.



4. Layer pink styrofoam over the aluminum benchwork and edge it with Masonite. Sandwich plexiglass if desired.

## ONE MODULE CHALLENGE | 7

Since the entire layout can tilt, it is *imperative* that all scenery be glued down or removed before transport. To tilt, simply release the two locking bolts and carefully rotate the layout, then wheel it through the door. The size can be easily adjusted by making the structure longer or shorter.

In this design, I made the vertical 2x4s 25 inches high, for a layout height of 36 inches. The horizontal 2x4s are 28 inches to allow it to fit through the 30" door. In [5], red represents 2x4s, blue represents 2x6s, green represents metal L-brackets, and black is pre-fabricated components.

The steel L-brackets make a square side frame and to attach the 2x4s together. The 2x6s form the sides of the table, and are 96 inches long. One side is different to allow clearance for the entire layout top to tilt to vertical.

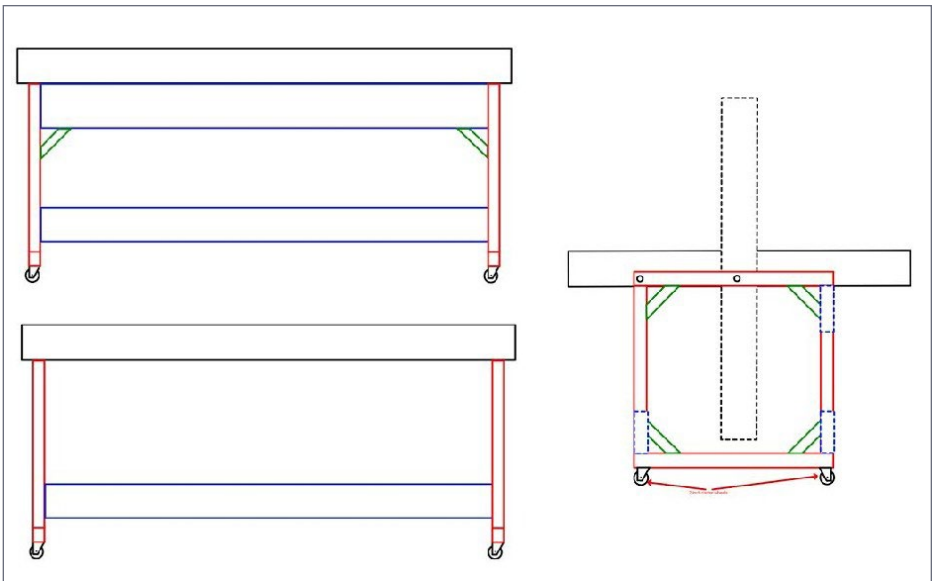

5. Drawing of the layout benchwork with the built-in tilting mechanism.

## ONE MODULE CHALLENGE | 8

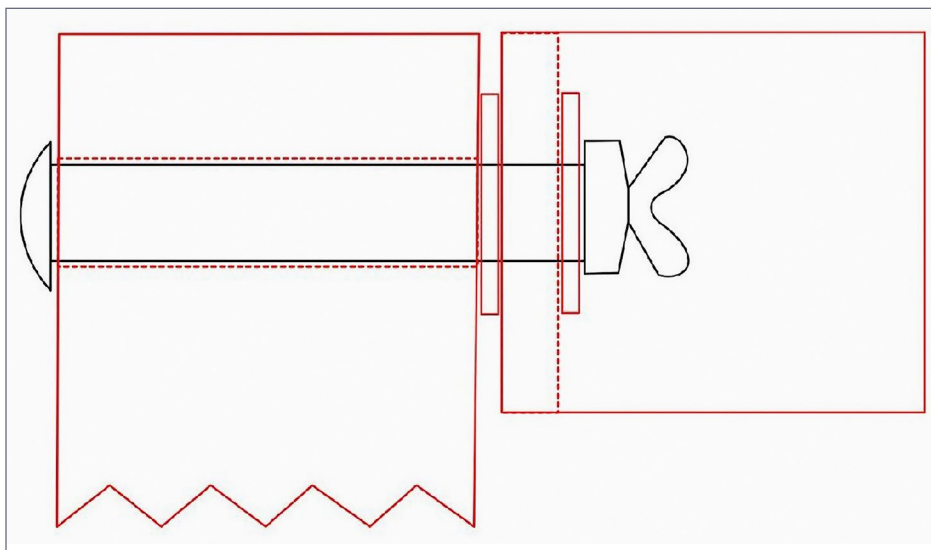

6. Bolt inserted through center hole, with a wingnut on the end. Insert a washer between the table and frame, and between frame and nut.

On one side, the 2x6 makes a square edge for the layout top to be level. To get the top to tilt, the hole for the bolt should be drilled 1/2 inch off-center toward the side. A second hole for the locking bolt should also be drilled on this side and has to go through the layout frame.

When the layout top is deployed for use, secure it in place and level using a bolt with a wing nut inserted through the locking hole. The layout rotates on a simple bolt and washer fulcrum. See [6] for how to construct it. In addition to allowing the layout to go through the door, this also makes layout storage very easy.

Every module can be condensed into 28x96 inches when tilted for storage. A scale diagram [7], shows all three modules and staging yards in storage so the room can be used for other purposes.



## ONE MODULE CHALLENGE | 9

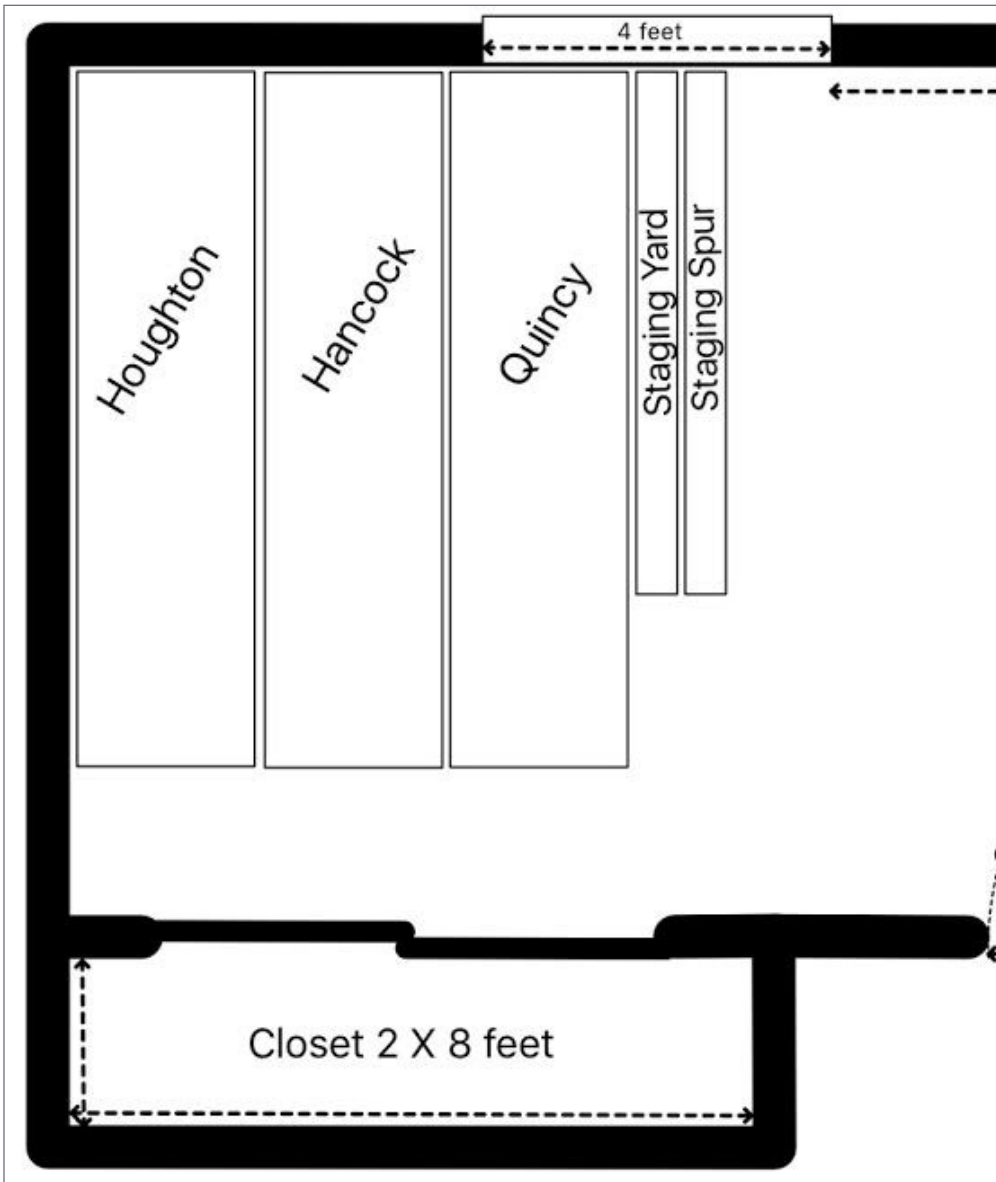

7. The entire layout in storage mode (module sections tilted and stored). The layout can condense into a very small area, allowing the room to be used for other purposes. One module can be set up, and the other two stored simultaneously.

## Scenery

General scenery tips on the Calumet Central are as follows:

1. Keep in mind water tables when building scenery, which is especially important on Quincy.
2. The layout grades are pretty steep, so design the scenery and choose rolling stock accordingly. (Ed: Curves are also quite sharp, further limiting rolling stock choices.)
3. The land is mostly flat near the canal, with small rolling hills elsewhere, and a few bluffs here and there.
4. TREES! In 1911, the Keweenaw peninsula was booming, but there were still many dense forests where the town wasn't.

The Calumet Central has a lot of water, especially in Houghton. Water comprises nearly 40% of the module. We recommend poured resin water for Houghton and Hancock. Place ships and all waterfront scenery before pouring the water. Model wakes and waves as the resin sets.

Use plaster molds or even real rocks to model the bluffs, and extra styrofoam for hills. Use static grass for ultimate realism and ease of installation. Other parts of the Calumet Central require some skill as the subjects are rarely modeled.

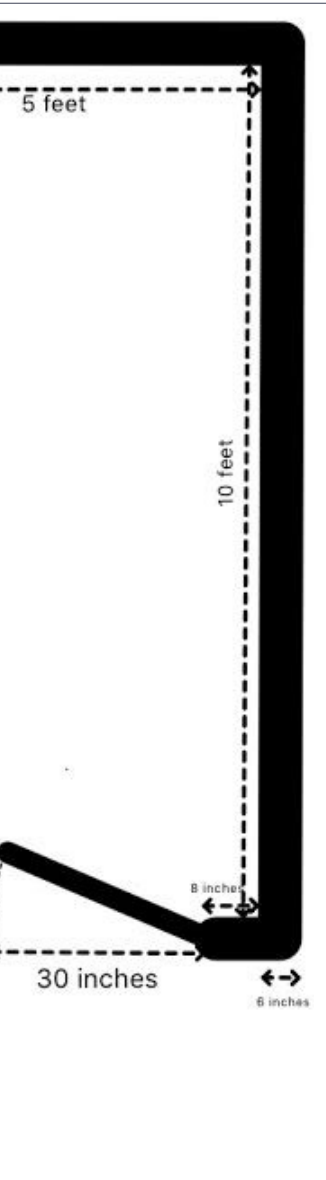

## ONE MODULE CHALLENGE | 11

Slag, for instance, can be modeled with coarse black ballast, with a gloss finish. I have two actual pieces of slag from smelter No. 5, seen in [8] for modeling reference. Ballast on the Calumet Central is made of mining tailings and local rock. To model tailings, use ultra-fine gray ballast.

### Track

For the Calumet Central's track, I chose Atlas Code 100. Using a program on my computer, I planned what Houghton's track plan would look like on a layout.

I started with Houghton, then Quincy, then Hancock, and finally the staging yards. Included below is a list and cost estimate of Atlas Code 100 track required to make Houghton and Quincy:

- 12: 9" Straight track
  - 10: 36" Super-Flex Track
  - 8: Bumpers
  - 7: Customline #4 Switch, left
  - 5: 6" Straight track
  - 4: 22 inch radius 22.5 degrees
  - 3: 3" Straight track
  - 3: Full section 18 inch radius, 30 degrees
  - 2: Customline #4 Switch, left
  - 1: 1/2 section 15 inch radius
  - 1: 5" Straight track
- Final cost: \$94.34

The Calumet Central can be equipped with either motorized or manual switches. To save on costs, and for more realistic operations, I chose to use manual ground throws on the turnouts.

# ONE MODULE CHALLENGE | 12

This way the train must stop, the fireman has to climb out, throw the switch, and then continue. Per the prototype, all switches were thrown manually and I chose to replicate this on the Calumet Central.

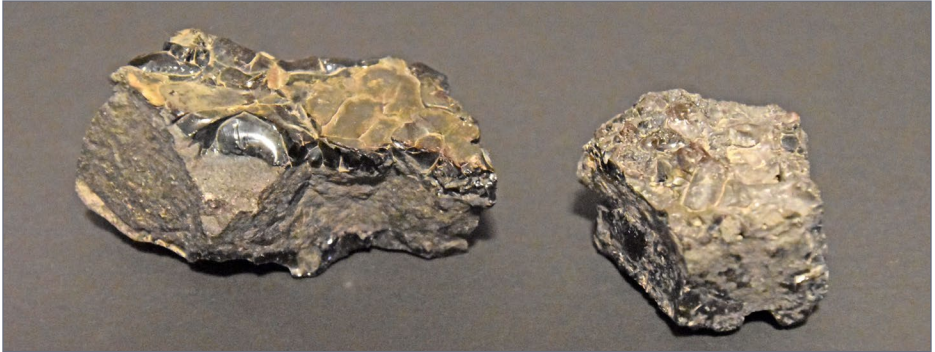

8. Actual slag from Quincy smelter No. 5.

ADVERTISEMENT

**FAST TRACKS**  
**Mt. ALBERT**  
**SCALE LUMBER CO.**

**NOW AVAILABLE ONLINE  
FROM FAST TRACKS**

visit: <http://www.handlaidtrack.com/mtalbertscalelumber>

Specializing in manufacturing fine scale lumber for model makers.  
**Free Shipping on orders over \$100**  
Easy ordering • Live online support  
Earn Waypoints with every purchase

shop online 24/7 [handlaidtrack.com](http://handlaidtrack.com)  
1-888-252-3895 [service@fast-tracks.net](mailto:service@fast-tracks.net)

HELPING THE WORLD  
WILD BETTER RAILROADS

ADVERTISEMENT

**Backdrop Junction**  
Your Stop for Railroad Backdrops

**Click Here** →

**For the Finest in Custom  
Designed backdrop**

[www.backdropjunction.com](http://www.backdropjunction.com)

• [INDEX](#)



**SUBSCRIBE**  
(free)

• [TABLE OF CONTENTS](#)



# ONE MODULE CHALLENGE | 13

## Structures and vehicles

The Calumet Central has many structures. Most are kits that that can be found online or in your local hobby shop. The structures for Houghton are as follows:

### Houghton Structures and Vehicles

| Name  | Price per unit | Quantity  | Purpose and number                            |
|---|----------------|-----------|---|
| Sylvan Scale Models Langell Boys Kit                  | ~\$150         | 1         | Copper ingot ship, number 1                   |
| Jordan Highway Models Erie B-2 Steam Shovel           | ~\$60          | 1         | Tailings shovel, number 2                     |
| Micron Models Model T Utility Truck                   | \$35           | 1-2       | Company Utility truck, number N/A             |
| Micron Models Model T Civilian                        | \$45           | 1-2       | Foreman transportation, number N/A            |
| City Classics The Company House                       | \$50           | 2         | C&H company housing, number 3                 |
| Ragg's to Riches Ingots or Scratchbuilt               | \$4            | 17        | Copper ingots on dockside, number 4           |
| Ratio/Wills Pump/boiler house kit                     | \$26           | 2         | Smelter and stamp mill boiler house, number 5 |
| McCabe Engine House                                   | \$65           | 1         | Dockside engine house, number 6               |
| Frenchman River Model Works Pier or Scratchbuilt      | \$30           | 2         | Waterfront pier, number 7                     |
| Laser Kit Dill's Market                               | \$20           | 2         | Foreman housing, number 8                     |
| American Model Builders 2-story Farm House            | \$45           | 2         | Foreman housing, number 9                     |
| Guts Gravel and Glory Bob's Liquor                    | \$150          | 1         | C&H machine shop, number 10                   |
| Slag Cart   | \$N/A          | As needed | Smelter slag cart, number N/A                 |
| Campbell Scale Models Ten Stamp Mill or Scratchbuilt  | \$80           | 2         | Stamp mill, number 11                         |
| Sluice Pipe Scratchbuilt                              | \$N/A          | 1         | Stamp mill sluice pipe, number 12             |
| JL Innovative Design Industrial Pillar Crane and Dock | \$25           | 1         | Dockside crane, number 13                     |
| Smelter Trestle Scratchbuilt                          | \$N/A          | 1         | Smelter slag dump, number 14                  |
| P&D Marsh Mine Cars                                   | \$5            | 1         | Slag dump cars, number N/A                    |
| Walters Cornerstone Clayton County Lumber             | \$45           | 1         | Dockside Warehouse, number 15                 |
| Busch Wood Shed                                       | \$35           | 2         | Dockside Warehouse, number 16                 |
| Walters Cornerstone Co-op Shed                        | \$25           | 1         | Dockside warehouse, number 17                 |
| Walters Cornerstone Union Crane & Shovel              | \$35           | 1         | Smelter No. 5, number 18                      |
| Walters Cornerstone 2 piece brick smokestack          | \$15           | 2         | Smelter No. 5, number 19                      |
| #Durango Press Q&TL Water Tank                        | \$20           | 1         | Engine servicing facilities, number 20        |
| #Durango Press Coal loader                            | \$20           | 1         | Engine Servicing Facilities, number 21        |

*# Use on Houghton only if Quincy is not built. All prices and items approximated as of January 2017. Some items may be out of production*

The vehicles should reflect the era of the layout. In this case I chose the year 1911, before the famous 1913 strike. Most C&H company structures were built out of local materials. The buildings were made of stone and mortar.

## ONE MODULE CHALLENGE | 14

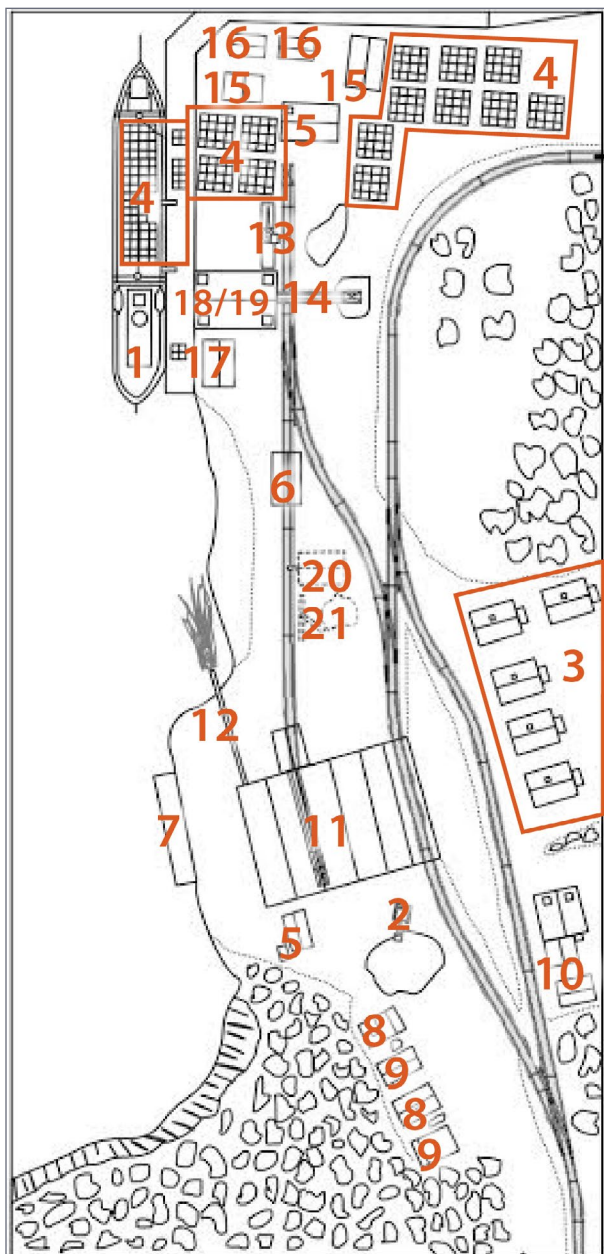

Also, most C&H structures were uniform, meaning one type of engine shed, one type of warehouse, etc. Other buildings were occasionally made of other materials such as concrete and brick; wood was also used, most often for less-permanent structures.

To make the buildings look like they are made of stone, use sheet styrene and cover it with stonework (either embossed sheet or photo-textured). To make them look more realistic, paint the stones different colors, per prototype (Google Calumet and Hecla Main Office). Most structures were built this

9. Houghton with structures labeled and numbers corresponding to the structure table.



## ONE MODULE CHALLENGE | 15

way and were virtually unchanged until the 1980s when towns modernized and most of the buildings were demolished.

I used selective compression extensively. However, to yield a more-accurate prototype, scratchbuilding will be your best option.



10. The Quincy Smelter in Hancock, Michigan.



11. The Quincy Smelter as viewed from the Portage Canal lift bridge.

# ONE MODULE CHALLENGE | 16

Using photos is a major help when kitbashing and scratchbuilding the structures. For reference, I recommend [coppercountry-explorer.com](http://coppercountry-explorer.com). I have also included some photos from my own travels to get you started.

## Operations

Operations on the Calumet Central originate at the mine shaft and go to the stamp mill, where the copper ore is unloaded and crushed. The stamp sand is then sent to the smelter where it is processed into copper ingots and loaded into ships.

A train of one steam locomotive, either a 2-6-0 or a 2-8-0, and a caboose start at the Quincy roundhouse facilities and go to Hancock yard, where it picks up a strand of eight to 10 ore cars and proceeds back to the mine where copper ore is loaded.

### ADVERTISEMENT

**"HO" mP-54's Shipping Mid August 2017!**  
Reserve Yours Now Some Paint Schemes Close to Being Sold Out  
Coach and Combine Cars Available In All Road Names!



Pennsylvania with "PRR Futura" Lettering



Norfolk & Western



"Pennsylvania Roman" Lettering



Long Island "Tichy" Grey-White Paint Scheme



Pennsylvania "Keystone" Logo each end of the car



Long Island Goodfellow Gray cars with Dashing Dan Logo For Diesel Territory



Long Island Goodfellow Gray cars with Dashing Dan Logo For Electrified Territory



Long Island with "Futura" Lettering Tuscan Red Body

**\*We have added "N" Rivarossi Heavyweight Passenger Cars, "HO" 85ft Passenger Cars, and a New Scratch and Dent Section to our website, check it out today !**



Click Here for  
Con-Cor Website  
[www.con-cor.com](http://www.con-cor.com)

• INDEX



SUBSCRIBE  
(free)

• TABLE OF CONTENTS



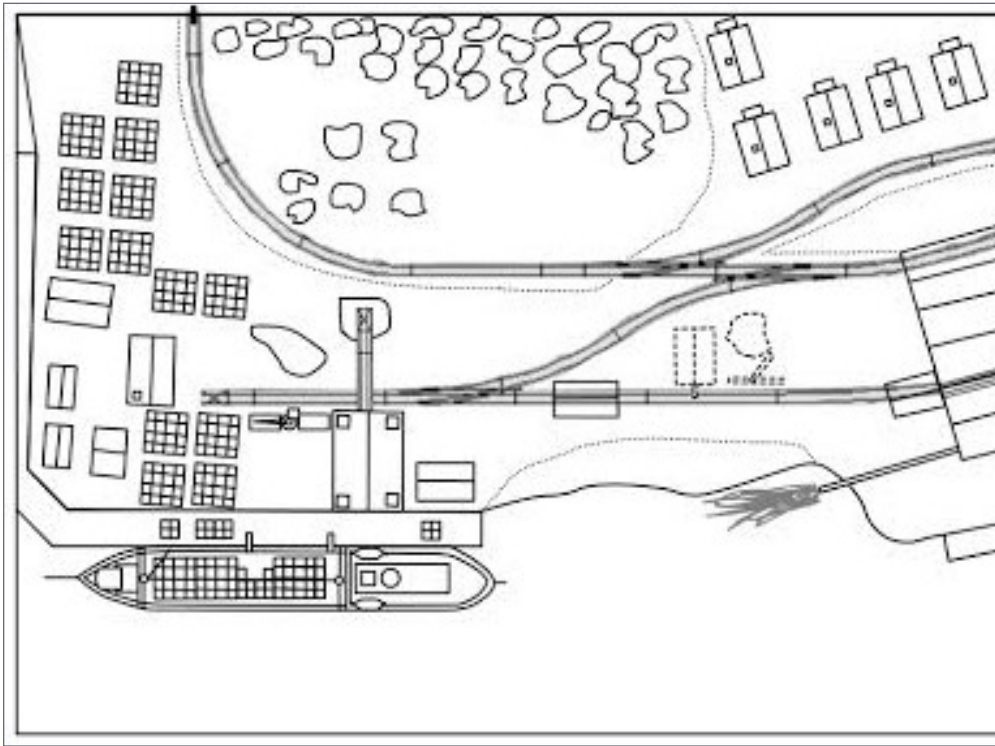

## 12. Houghton Plan.

After the train has finished loading, it continues to the stamp mill via the upper track, where the ore is unloaded by a gravity dump to be processed by the stamp mill. The train is then finished and would go to a wye (off layout, use staging) reverse for the trip back to the mine, and repeat the process, stopping for water and coal along the way at the Quincy facilities.

Originating with one locomotive at the Houghton engine shed, a separate train, a switching job, picks up one or two ore cars from the stamp mill loaded with copper ore and brings them to the smelter. Then the train is busy shuffling flatcars and box cars full of copper ingots to the dockside to be loaded onto the ship.

## ONE MODULE CHALLENGE | 18



When done, it is replaced by a new locomotive from the Quincy facilities. Occasionally there is a through freight of general goods, or a passenger train. A through freight will drop off any box cars or flatcars near the smelter, where they will be picked up by the Houghton switcher.

A third train works in the Hancock yard shuffling ore cars into eight- or 10-car cuts, and sorting box cars and flatcars into general goods trains by destination. A fourth and final train origi-

nates at the Quincy facilities, and picks up a cut of three or four ore cars, and goes to the tailings pile where the cars are loaded by steam shovel one at a time.

After the train is loaded, it dumps its load at the stamp mill. Here the tailings are further processed into refined copper. This train will repeat the cycle. The final unit is resting at the roundhouse on call to replace another unit in the case of a breakdown, derailment, or the like.

Paperwork for operations will be the basic waybills and train orders of normal operations. However, there will also be ore car tags. Pictured in [14] are some genuine ore car tags from the C&H railroad.

# ONE MODULE CHALLENGE | 19

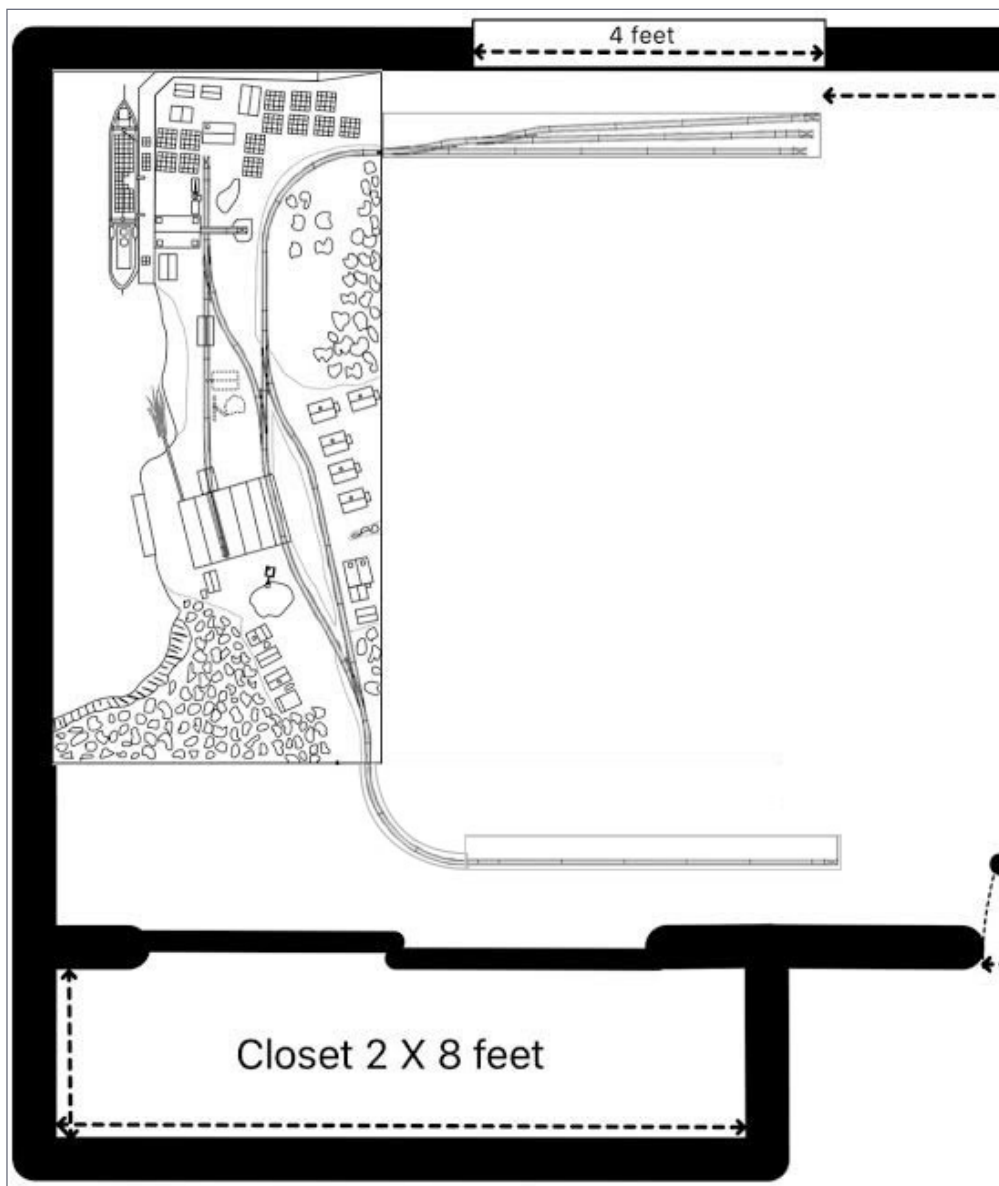

13. Houghton module in room with staging yards.

## Rolling stock

Rolling stock on the Calumet Central is centered on copper mining. The primary type of rolling stock is ore/rock cars. To model these, you can choose to scratchbuild a fleet of about 20 cars, or Tichy ore cars are close enough stand-ins.

The original Calumet Central also calls for flatcars. The flatcars were used to transport copper ingots and mining equipment.

A JV Models 36' truss-rod flatcar or a JV Models 40' truss-rod flatcar is an almost perfect match. No more than three are needed for operations. The Calumet Central utilizes box cars for general goods and copper ingots. They can be modeled by using JV Models 36' box cars, 36' Reefers, and 36' S.S. box cars. Only three or four are needed for operations.

Cabooses on the Calumet Central are bobber cabooses of almost any type or size as most were home built to suit the railroad's needs. Plan on building five cabooses, one for each locomotive. Locomotives consist of 2-6-0s and 2-8-0s. The Q&TL had three 2-6-0s and two 2-8-0s.

Maintenance-of-way (MOW) on the layout consists of a Russell plow, and a couple of handcars. To model the plow, use an Ambroid or Northeastern Scale Models kit if you can find one; otherwise, modern steel plows should be used as temporary stand-ins.

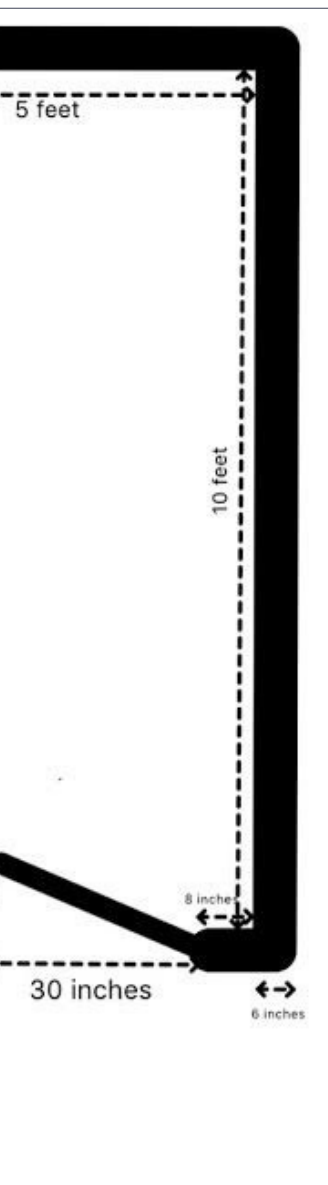



## ONE MODULE CHALLENGE | 21

The Ambroid/Northeastern Scale Models Kit is a nearly perfect match to the prototype. Handcars are just basic MOW equipment, standard in every railroad.

All rolling stock will have to be custom-painted and decorated with custom decals. You can substitute, add, or subtract from my list, but this is what I believe to be the closest to the prototype without the need to scratchbuild everything.

### Hancock

On the map, Hancock is just across the portage canal from Houghton. Hancock has many similar characteristics to Houghton. On the module, there is a large harbor. The majority of passenger boat traffic, mostly ferries, passed through here.

There are large warehouses near the dock for incoming and outgoing cargo. They are not directly served by the railroad, but the railroad drops off a majority of the freight in the yard. A trolley line runs through the streets of Hancock per prototype, and was included to add visual interest to the layout.

Structures for Hancock consist of a main street, station, powerhouse, a church, and tenement housing. Main Street can



14. Genuine ore car tags from the C&H railroad.

## ONE MODULE CHALLENGE | 22

be modeled in a variety of ways. I used Walthers Cornerstone Merchant's Row kits for planning purposes.

The powerhouse is two Cornerstone Northern Light and Power kits placed end-to-end. The church is a stone church made



15. Quincy & Torch Lake 2-6-0 number 5.



16. Quincy & Torch Lake rock car ruins.



17. Calumet and Hecla Russell plow side and rear view.



18. Calumet and Hecla Russell plow front.



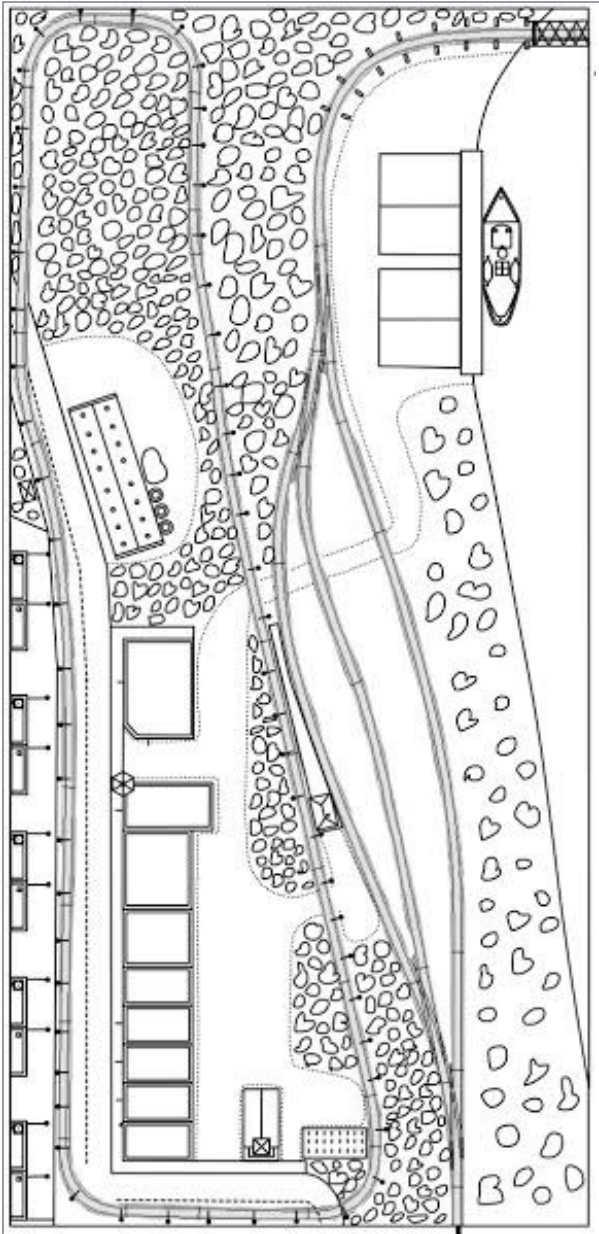

19. Hancock plan.

of local materials per prototype in Calumet (look up “Calumet Main Street” for ideas). The buildings are arranged with an alleyway toward the railroad on purpose, although for aesthetics this could be modified.

The Hancock yard is just a small three-track yard for a passing siding and arranging train cars. The station serves both the traction line and the railroad, and the platform should be made accordingly. Whatever land of Hancock that isn’t city is forested.

## Quincy

Quincy is the focus of the entire Calumet Central. Quincy represents



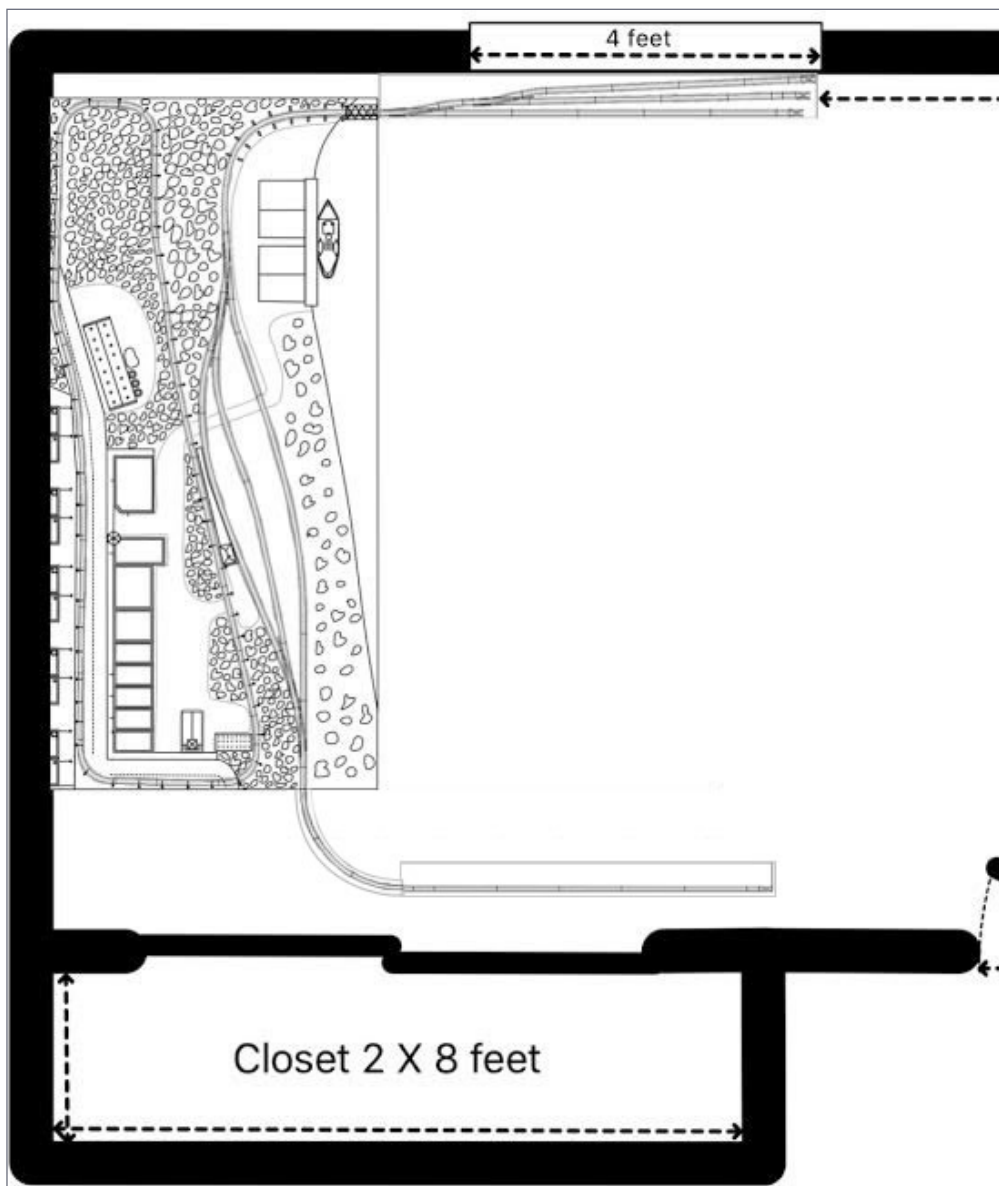

20. Hancock in room with staging yards.

## ONE MODULE CHALLENGE | 26

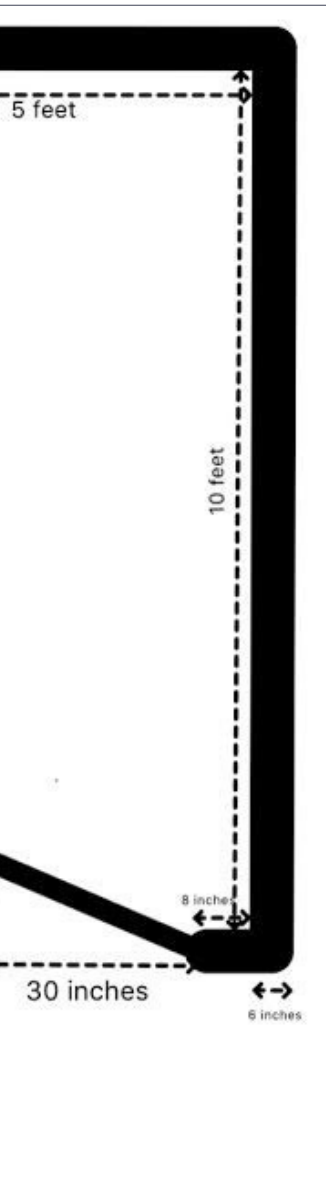

the heart of copper mining – the headhouse. Here copper-rich rock is brought to the surface from underground mine shafts going almost two miles deep!

The headhouse contains the buckets used to bring up the rock from that extreme depth. The rock is dumped into a hopper above the railroad tracks, where the trains are loaded. The cables for the headhouse go across some trestles to the boiler where there is a steam-powered drum. The Quincy mine has the largest in the world!

The boiler house is another structure that is on-site to support the mining operation. A head office must also be built for the workers to process ore car tags and way-bills, inspect the cars, and perform other office tasks.

A water tower is on-site to store extra water for the neighboring towns and industries. The tailings from mining operations pile up in back of the mine, where a spur (should you choose to build it) ends at the tailings pile. A steam shovel and conveyor will load the tailings into awaiting ore cars.

As stated in operations, these cars go to the stamp mill where the process continues.

A small trestle leads up to the headhouse leaving an access to the tailings pile under the trestle, creating a small depression under the trestle large enough for two cars to pass.



21. Quincy mine No. 2 shaft head house.



22. Quincy mine fuel dump.



23. Quincy Mine hoist house.





## ONE MODULE CHALLENGE | 29

This extra height allows humans to walk under without having to duck. Utility trucks deliver much-needed supplies to the site. To model the headhouse and winch house, they should be scratchbuilt. However, if you can find a suitable model, by all means use it.

The cable towers can be easily scratchbuilt from brass wire or styrene shapes. The office is placed within a short walk of the headhouse entrance with a gravel path and space for at least two cars. There are also some company warehouses on this module. They should be placed near the headhouse with sufficient clearance for the railroad.

The water tower is on the far side of the layout, and was added for effect, not to be prototypically accurate. There is not sufficient clearance at the headhouse for a locomotive, so the locomotive will push the first few cars through, then run around the headhouse to the other side and pull the train through the rest of the way.

There are numerous photos on the internet to get you started on the Quincy mine. Also, I have included some of the less-photographed subjects of Quincy mine in this article.

**For still more on the Calumet Central layout, see this issue's [Subscriber Bonus downloads!](#)**



**Click here to rate or comment on this article**

## Conclusion

We feel the Calumet Central makes an excellent modular railroad. I did not make the layout 100% prototypical; I made it to remember a mostly forgotten piece of history, and to capture the feel of the prototype.

At one time, the Keweenaw region was the top copper producer in the world, yet you may never have heard of it until now. The Calumet Central is a perfect small railroad layout that can easily be expanded into an empire.

And to think it all started with a vacation, a sketch, and a 10x14-foot room.

[See pictures on following pages ...](#)

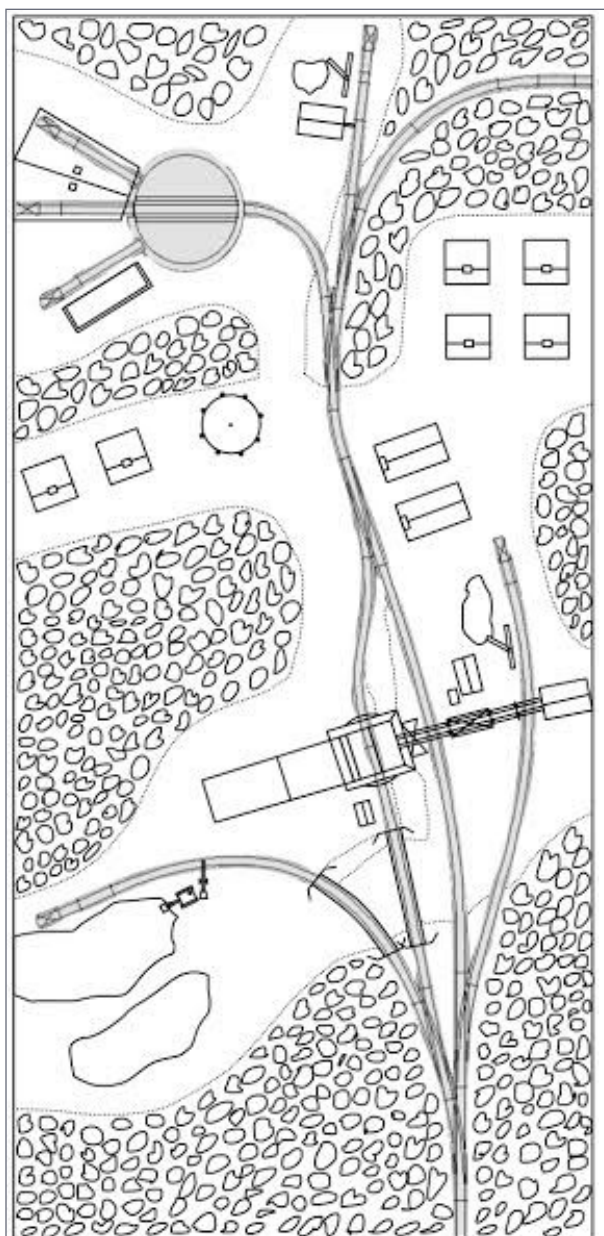

24. Quincy plan.

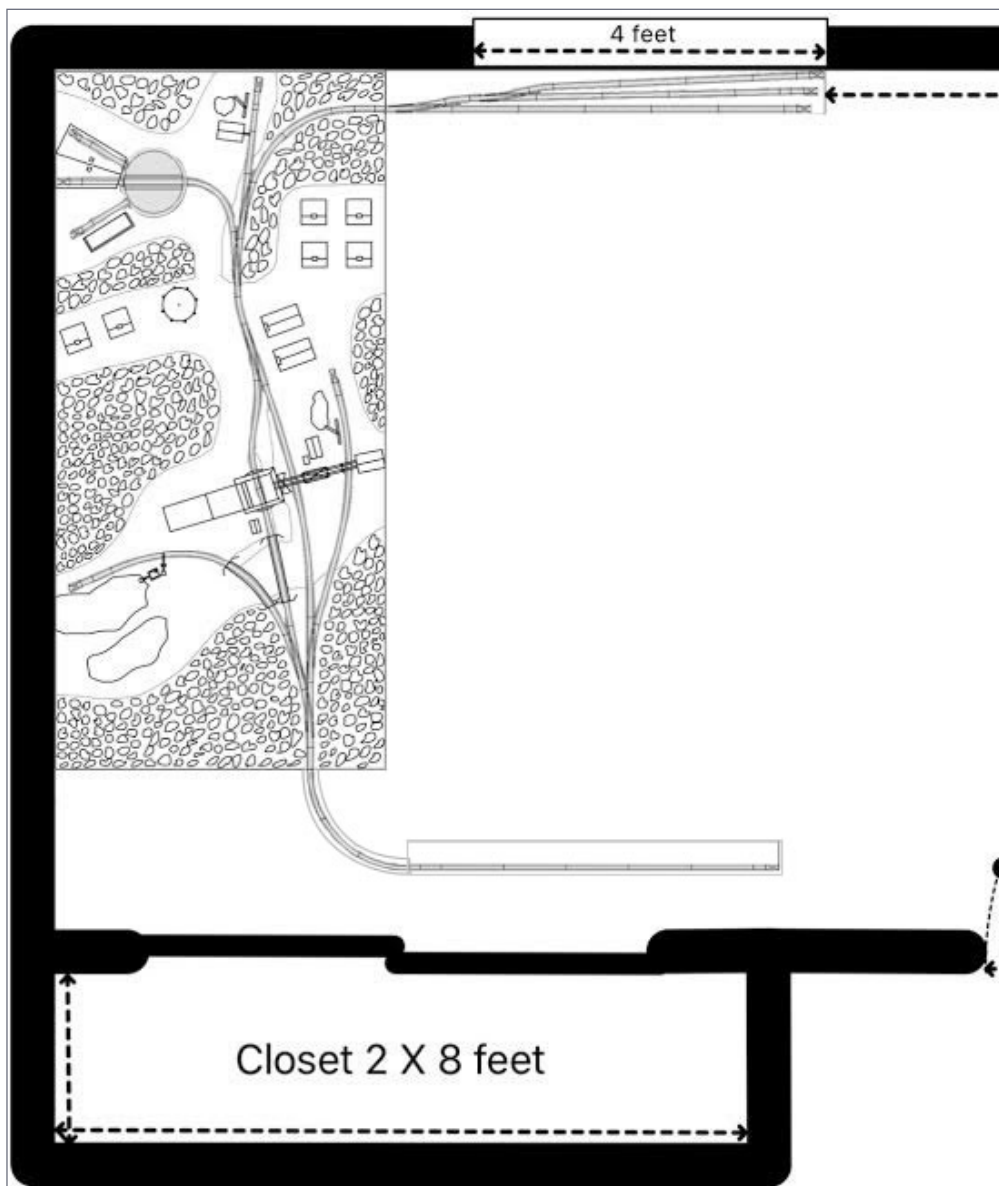

25. Quincy in room with staging yards.

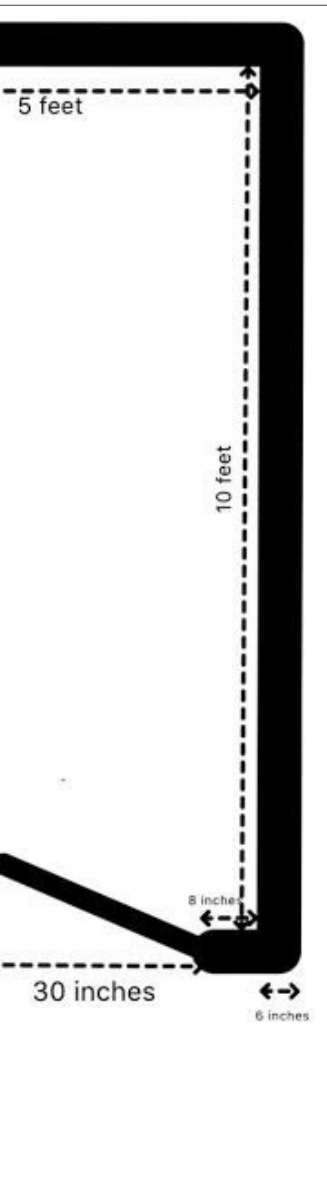

[Click here to rate or comment on this article](#)

For still more on the Calumet Central layout, see this issue's [Subscriber Bonus downloads!](#)





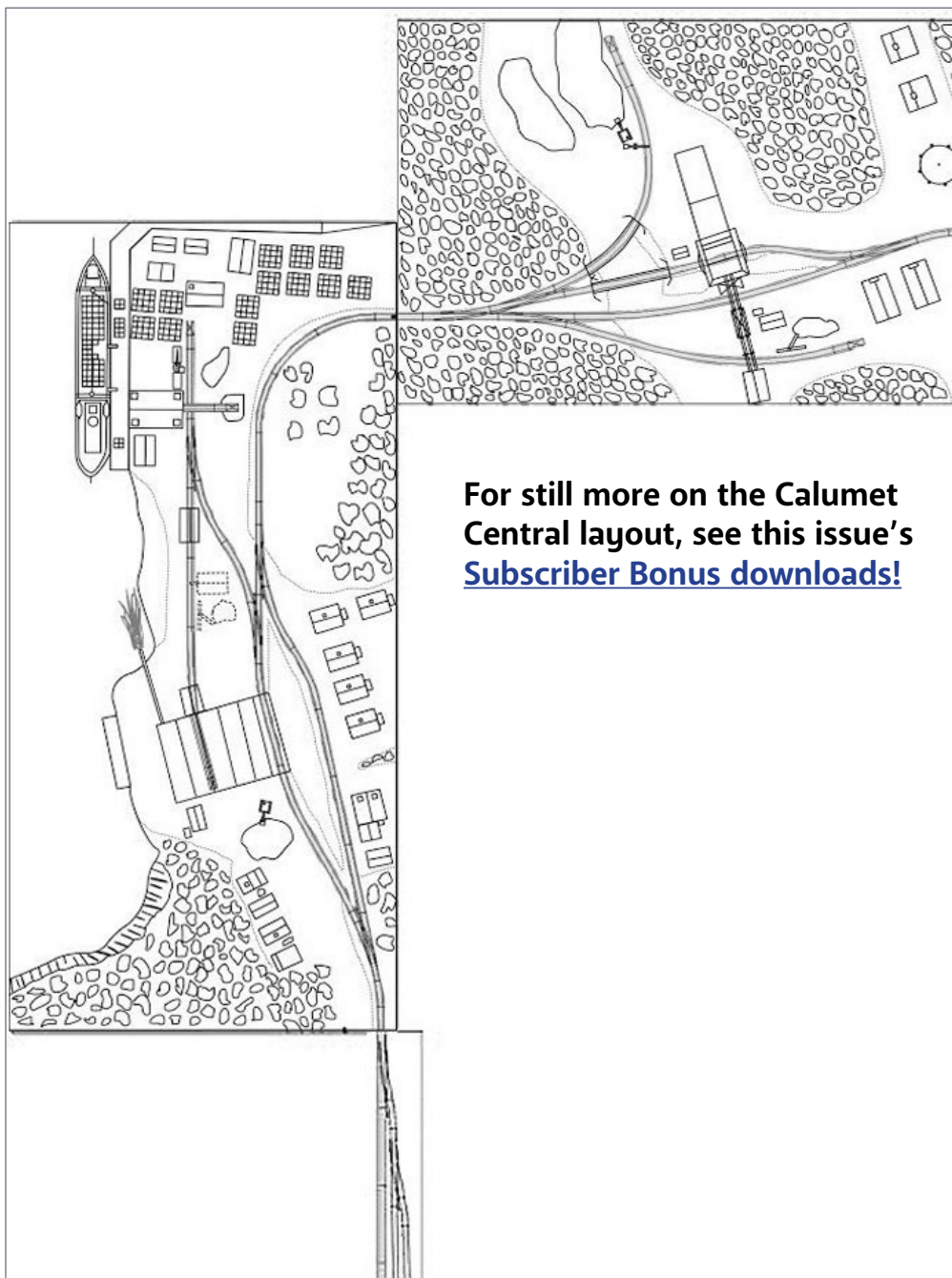

For still more on the Calumet Central layout, see this issue's [Subscriber Bonus downloads!](#)

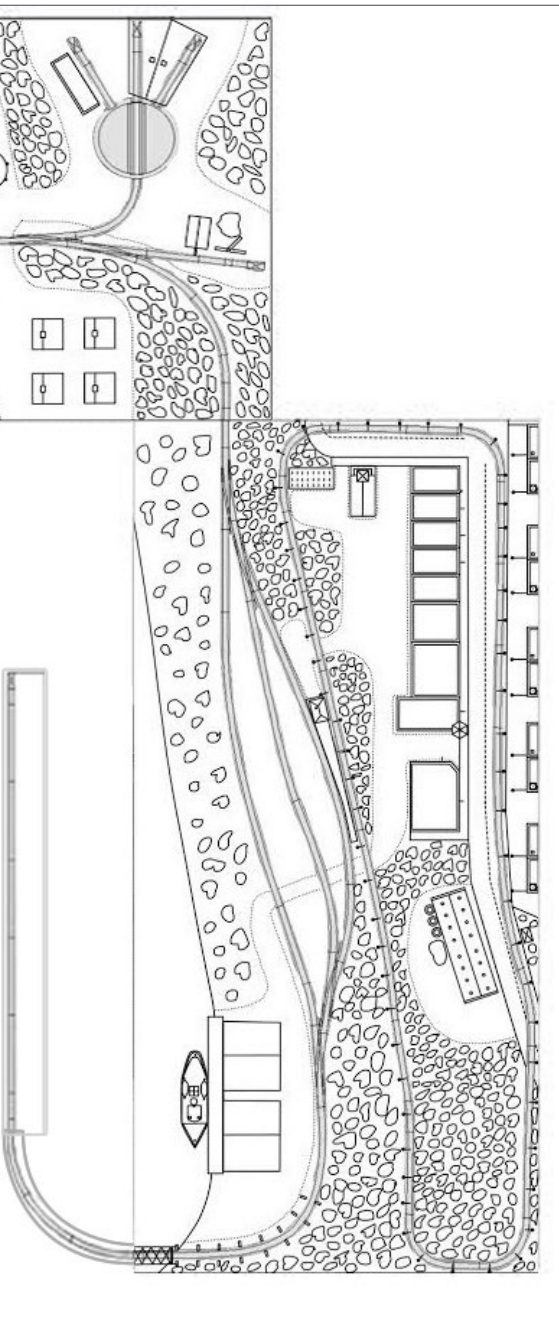

26. This is how I envision the Calumet Central in all its glory. Here it exists in a perfect world where room dimensions don't matter.



## JEREMIAH SHOEMAKER



Jeremiah is a junior at Milaca High School in Milaca, MN, and has a 6x4-foot N scale layout in his basement that very loosely depicts the Burlington Northern in Everett, Washington, 1970. He got into model railroading when he received an N scale train set for his seventh birthday. In addition to model railroading, he enjoys railfanning, robotics, choir, and band. During this project, he designed, sketched, photographed,

researched, and wrote the article that depicts the design and construction of the Calumet Central. ■

## BLAKE FREUDENBERG

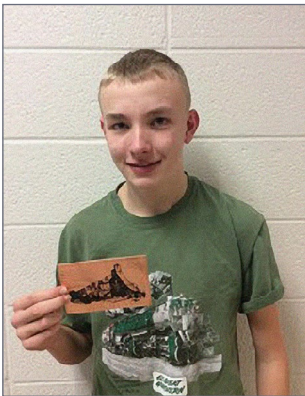

Blake is a freshman at Milaca High School in Milaca, MN, and has a 4x8-foot HO train layout in his basement that is a work in progress. He first got into model railroading by buying an HO scale train set at a flea market. He loves the Great Northern, and in addition to model railroading, he enjoys snowmobiling, racing, and baseball. During this project he was the HO scale consultant for the design and development of the Calumet Central. ■

**The Fine Scale  
Model Railroader  
2017**



**NOVEMBER 2-4\***

**THE EXPO GOES TO  
ALTOONA, PA**

**HOME OF HORSESHOE CURVE!**

**LEARN. BUILD. CREATE.  
ENJOY MODELING AT ITS BEST.**

**MODELRAILROADEXPO.COM**

• [INDEX](#)



[SUBSCRIBE](#)  
(free)

• [TABLE OF CONTENTS](#)



# Announcing our next Limited Run PWRS / Micro-Trains® Car!!!



**PWRS** 

**Burlington Northern (BN) 4 pack**  
3 Bay ACF Center Flow® Covered Hopper,  
w/ Round Hatches



CLICK HERE FOR  
**BN Hopper** 

- Green, White Lettering - Large BN logo - Heavy Weathering and Rust

# Canadian Pacific Railway (CP) 4 pack

## 50' Gondola, Fishbelly Side, Drop Ends, and w/Tie Loads



**COMING**  
February 2018

- Black - White Block Lettering - Weathered - with Tie Loads

CLICK HERE FOR  
**CPR Gondola** 



**Pacific Western Rail Systems**

• INDEX

• TABLE OF CONTENTS



# YES, IT'S A MODEL

*compiled by*  
**DON HANLEY**  
.....



[Click here to rate or comment on this article](#)



1. Rick Sutton's layout, the Visalia Electric, runs along the edge of the Sierra Nevada mountains on the east side of the San Joaquin Valley, based on the real San Joaquin Valley Railroad. The bridge is a pair of Exactrail units with brass details added for piping along the bottom. Scenery is plaster and the vegetation relies heavily on locally gathered materials from dirt and gravel to tufts made from paint brush bristles. Rick painted the backdrop with latex house paint.

▶ **MRH'S MONTHLY PHOTO ALBUM**





2-3 [opposite]. Don Wirth built Frisco 1050 from scratch. Don started with running gear from a Toby/PFM Frisco 1520 class 4-8-2, then removed the 4th driver to shorten the frame. He built the boiler, cab, stack, domes and tender from scratch and used commercial castings for the rest. Tru-Color paint and ALPS printed decals finished off the loco. Frisco 1050 is equipped with a can motor and Sountraxx Tsunami sound.





.....

## GET PAID FOR YOUR PHOTO

We pay \$40 per photo we publish. If you'd like to get your modeling in our photo feature, just start posting your photos on the MRH website, especially in the Weekly Photo Fun thread created each week.

See [mrhmag.com/help](http://mrhmag.com/help) for more on how to post an image. You need to be an MRH subscriber to post photos to our website, and becoming a subscriber is free, [just fill out this form here.](#) ■

.....



**Click here to rate or comment on this article**



# ILLUMINATED KEROSENE LANTERNS



BY BERNHARD SCHROETER

## *How I build them in HO scale ...*

**SOMETIME AGO I PURCHASED A NORFOLK AND Western Ry caboose model.** After I made some repairs and corrections, I decided to add working marker lights, and light the inside. Illuminating the end markers is not a big problem if you use very small LEDs. But were there some kind of lamps used inside of a 1930 caboose that did not have battery boxes, or gas tanks mounted on the underside of the caboose? Blueprints from the archives of N&W Historical Society showed something that looked like a lamp holder,



**Click here to rate or comment on this article**

and maybe a hook. Unfortunately there were not enough details to be sure.

I decided I would build kerosene lamps for the interior lighting. Maybe that was not the correct solution, but one I could live with.

From the beginning it was clear that I could not model the lantern's lattice top or bottom because the parts had to be strong enough to be handled, yet they still ought be as close to scale size as possible.

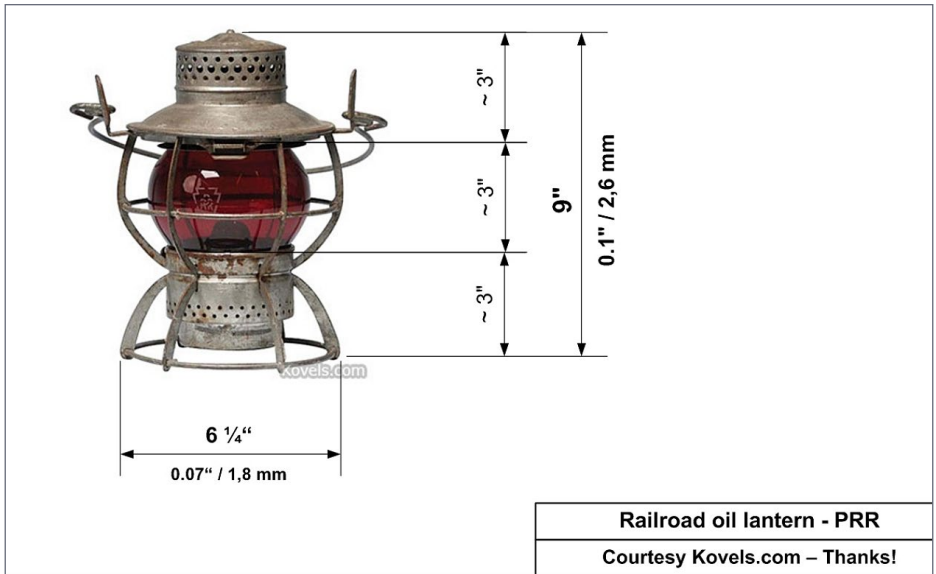

1. The search for a prototype led to this photo of an old PRR lantern, where I also found the height of the lantern – 9 inches. Thanks to [Kovels.com](http://Kovels.com) for permission to use this picture here in *MRH* magazine.



## ILLUMINATED LANTERNS | 3

I was not sure I could find the right size kerosene lamps, because I am modeling in HO scale, so the only way was to build them myself on my work table.

My first idea was to use ordinary modeling materials like clear acrylic rod and styrene strips I found in my material boxes. My thought was to build lanterns in different scales, but could I build them small enough for HO? If so, those lanterns would only be a bit over 0.1" tall, or around 2.7 mm.

The tools needed are very common – a scalpel with a sharp tip, a pin vise with two different drill bits, and an old broken, but fine, saw blade, a fine single-cut file, different grit fingernail sanding and polishing sticks for smoothing and polishing, a caliper and cyanoacrylate (CA) glue. The small electric drill shown also was especially useful [2].



### 2. Tools to use for making the lamps!



### 3. Clear acrylic, and styrene material.

Yes, and don't forget the LEDs! I used 0402 SMDs, the smallest size that is readily available. I prefer LEDs pre-wired with fine enameled wire. They are available in many different colors, but for ordinary lighting you should use sunny-white or golden-white LEDs, or you can use red LEDs if you would like to build a red lantern.

The materials are very simple. Some of the preliminary steps can be skipped, depending on what you have on hand. The clear acrylic I had was big enough for turning the globe and lantern base on a lathe. However I needed thicker styrene for turning the top of the lamp. To make the top, I drilled a hole in a heavy strip and glued-in a piece of white styrene rod [3].

After the glue cured, I sawed off the strip, and with my scalpel I roughly cut an oversized lantern hood that I would finish by turning with an electric drill. Unfortunately the drill chuck was not large enough to hold the thicker material [4].



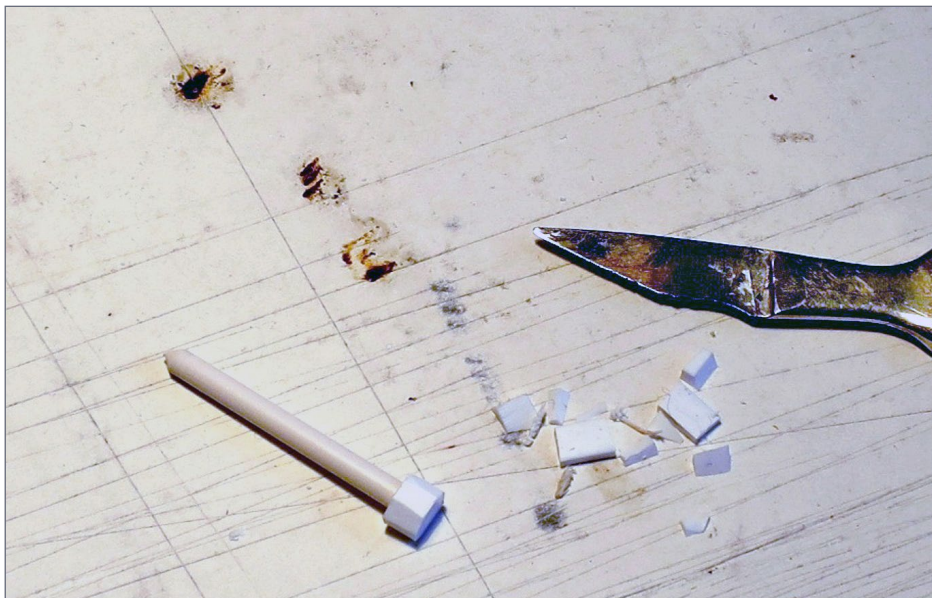

### 4. Cutting the material for the lantern hood.

The glass globe was turned using the electric hand drill and a scalpel. To work safely you should make sure that the tip of the scalpel contacts only the spinning rod along its horizontal axis, or a little below that. I used a wooden block as support for the sharp blade. That way I could securely hold the scalpel in position without letting the blade fly away or twist.

In every case you should work as shown. The top of the rod should turn toward the scalpel, a right-handed rotation if you are looking from the chuck toward the rod. That way, if the tip of the scalpel grabs the rod, the blade will be pulled down toward the wooden block, not up toward your face. However, if you are a left-hand modeler then please face the drill chuck to your left, and work with a left-handed rotation of your drill. And one more important safety tip: Wear safety glasses or goggles during this step.

## ILLUMINATED LANTERNS | 6

If you are a new modeler or if you do not have experience using sharp scalpels, you can also work with an old and broken saw blade from a jeweler's saw like I used in the later steps of my project. The results are absolutely identical and the risk of injury is greatly reduced!

I found that the turning should be done at a relatively slow speed. At high speed the acrylic overheats and loses its shape very quickly. So I turned the globe in small steps until it reached the desired diameter and height [5].

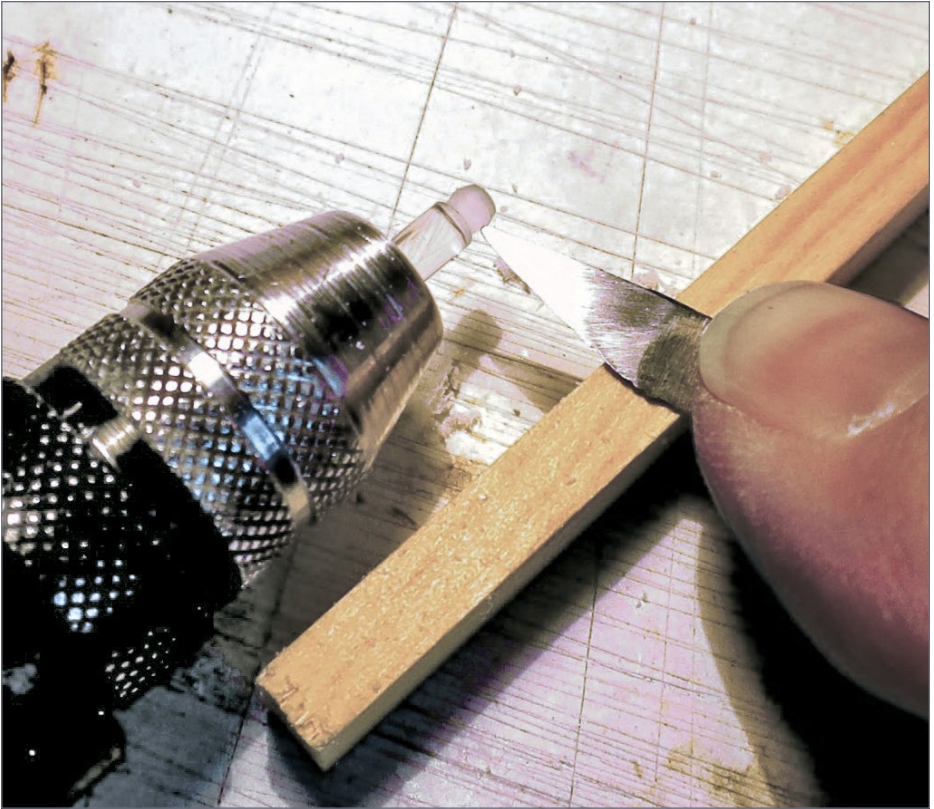

5. Turning the globe.

## ILLUMINATED LANTERNS | 7

Next I drilled the hole for the LED. Here I also worked at a very low speed to avoid overheating the plastic from the friction of the drill bits. After some initial failures, I drilled the hole in two steps, using a small drill bit first and then a second one with the final diameter. Do not drill deeper than the height of the globe! Check the depth with the LED and repeat this step if the diameter is too small or the hole is not deep enough [6]. The acrylic rod rotates with the drill chuck on the drill, while the drill bit is held with the pin vise in my hand.

Use a no. 68 or 69 for the second drill bit; this will be large enough for a 0402 pre-wired LED. I used a 1/32 drill bit, but later I noticed that I did not need such a “large” hole.

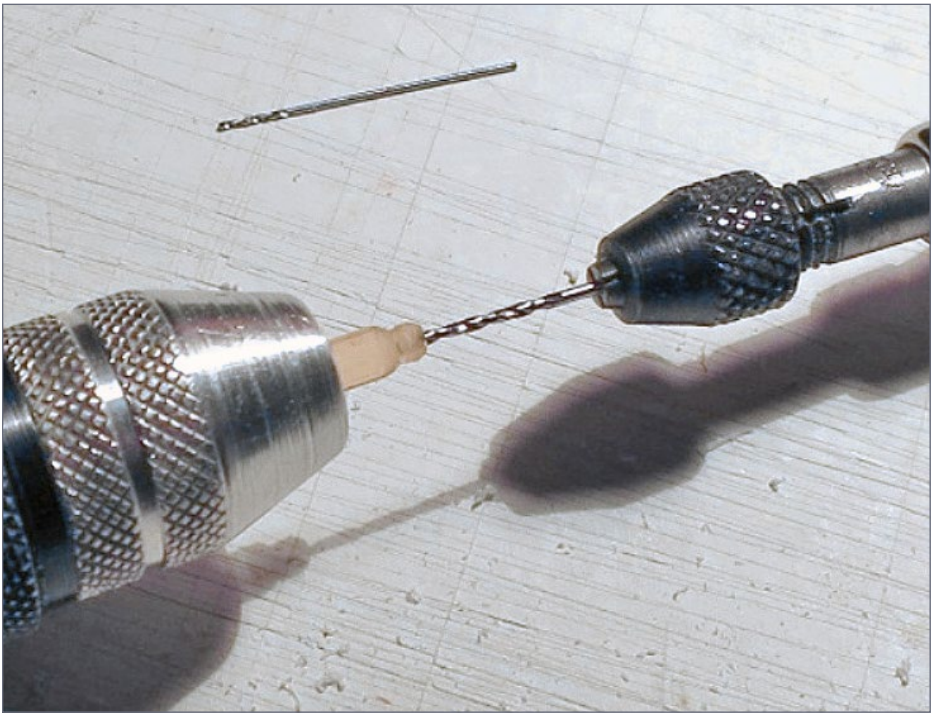

6. Drilling a hole for the LED.





## 7. Polish the globe before cutting off the base.

Finally, before you cut off the bottom of the base from the rod, you should polish the globe portion of the lantern above the base. Here I used a very fine file followed by progressively finer fingernail sanding and polishing sticks until the surface was smooth. Do not polish the globe to a high-gloss finish. Especially, you must not polish the hole inside of globe; the LED will produce an even light in all directions through the “frosted” or slightly diffuse surface [7].

This is the first part of the lamp. The globe has a small hole drilled in its top, and the foot of the piece is already shaped as the base of lantern. The globe has a diameter of 0.08” and a height of 0.07” (2.0mm by 1.7mm), and the overall height, including the base, is around 1/8” (3.2 mm). This appears a bit too big for an HO scale lantern and I was not sure that this method would work. However I continued in order to see what I could accomplish by making all the scratchbuilt parts for this small lantern [8].





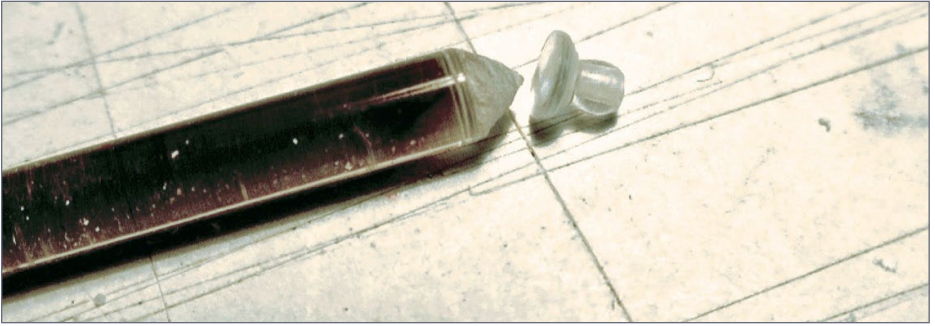

8. The first part of the lamp with a hole drilled in the middle.

Next I sawed a fine groove across the top of the globe so the wires for the LED could run out of each side and the lantern top could be glued directly on top of the globe. It may be simpler to cut this groove before globe and base are separated from the rest of the acrylic rod [9].

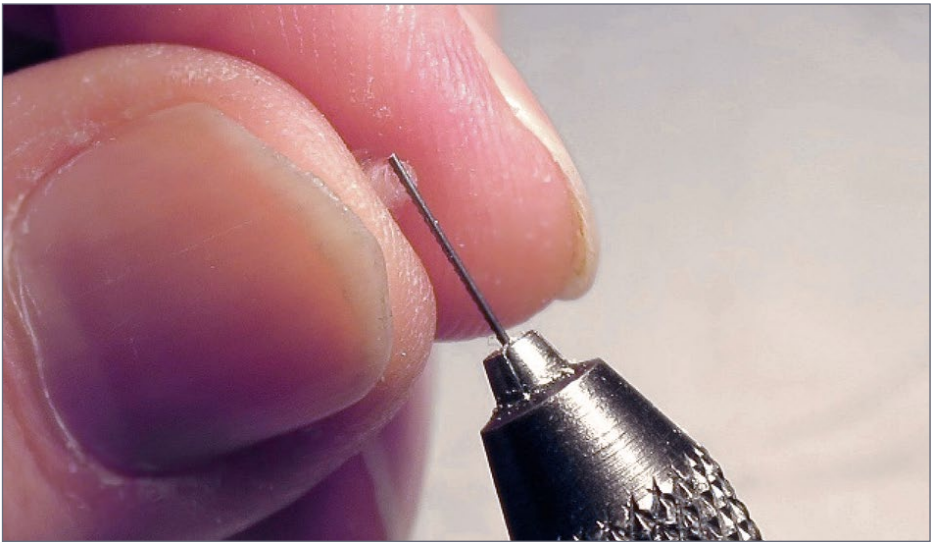

9. Putting a fine groove across the top of the globe.



10. Turn the styrene the same way the globe was turned.

I finished the previously prepared rough-cut styrene piece for the lantern top by using the same turning techniques as before. I used my scalpel as the first step again [10].

I finished working with an old broken saw blade from a jeweler's saw held in a pin vise. With this you can make the very fine cutouts, and shape the thin edges that you will need under the cover of the lantern head. In all cases where you work with a rotating plastic rod for shaping your parts, please hold the saw blade in your handle or pin vise like this so the side of the rod being worked on, mostly the top side, rotates against the teeth of your saw blade as shown in the photo. This is an absolutely safe

## ILLUMINATED LANTERNS | 11

working method and I never had any injuries. In the worst case a saw blade was broken, that's all [11].

I also used the saw blade for the final shaping of the underside of the lamp head, and I could make the very fine contours as well as cut an absolutely flat bottom [12].

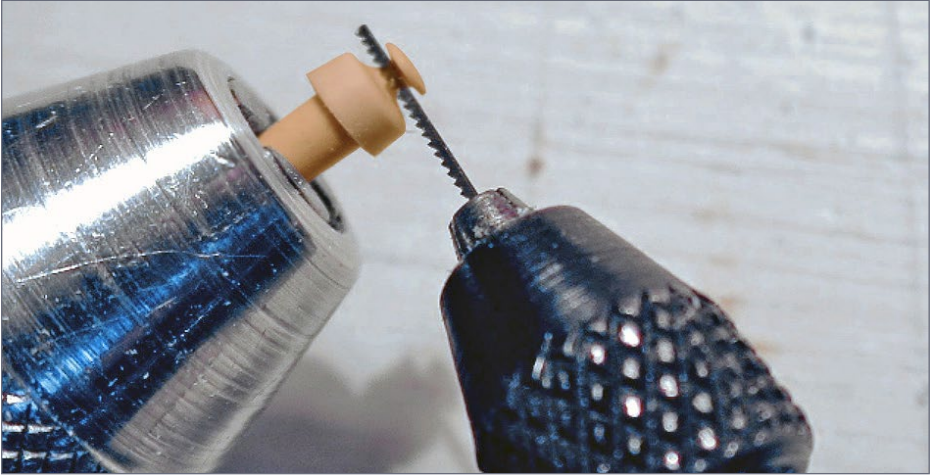

11. Use a fine saw blade for this next step.

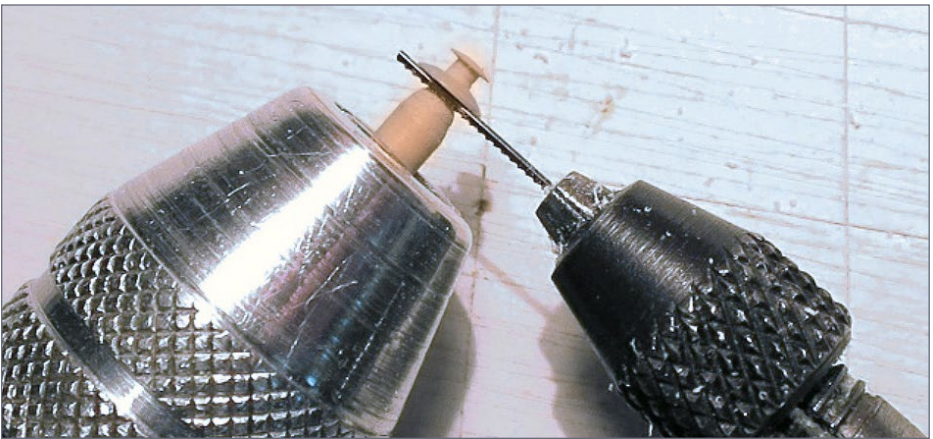

12. Shaping the underside of the lamp head.



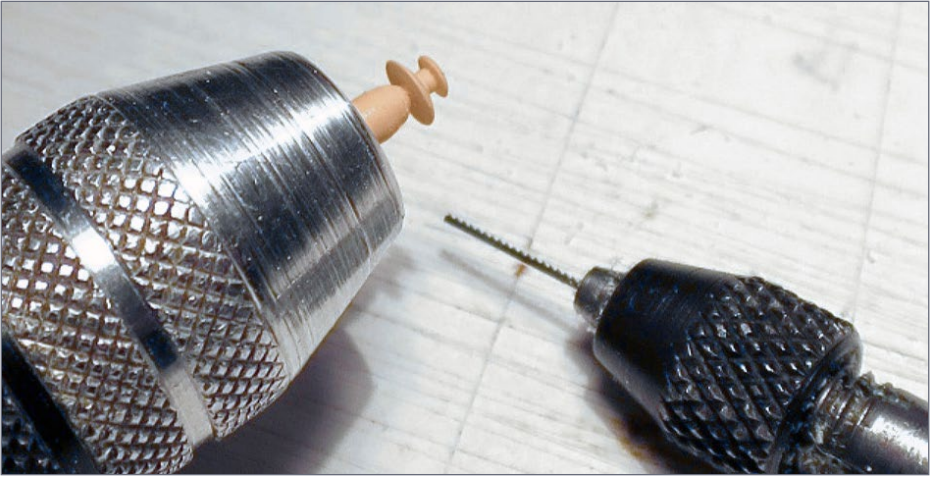

### 13. All parts are complete after the head is detached from the rod.

Here is where I used the saw blade on the lantern head again, shortly before I detached it from the rod. With this step, all the parts for my first lantern were completed [13]. I think this project also can be done by a beginning modeler. Maybe you will need a second attempt, but success will come. I'm absolutely sure of it! Now the assembly can begin.

Before assembly please first check that the LED will light. You cannot replace a faulty LED after it has been glued into the acrylic globe. This is also a good time to determine the right resistor. I used a 2.7K 1/8-watt resistor for use with 16 Volts DC. A 1K resistor will work, but you will have a very bright light that will not look very realistic for a kerosene lantern [14].

Dip the LED into a drop of CA and set it into the hole in the globe. This should be done in one quick step in order to avoid having the CA set with the LED only halfway inserted [15]. Alternatively, you could put the LED into the hole in the globe first and then fix it in place with CA. However, if you use this



## ILLUMINATED LANTERNS | 13



14. Check that the LED lights up.

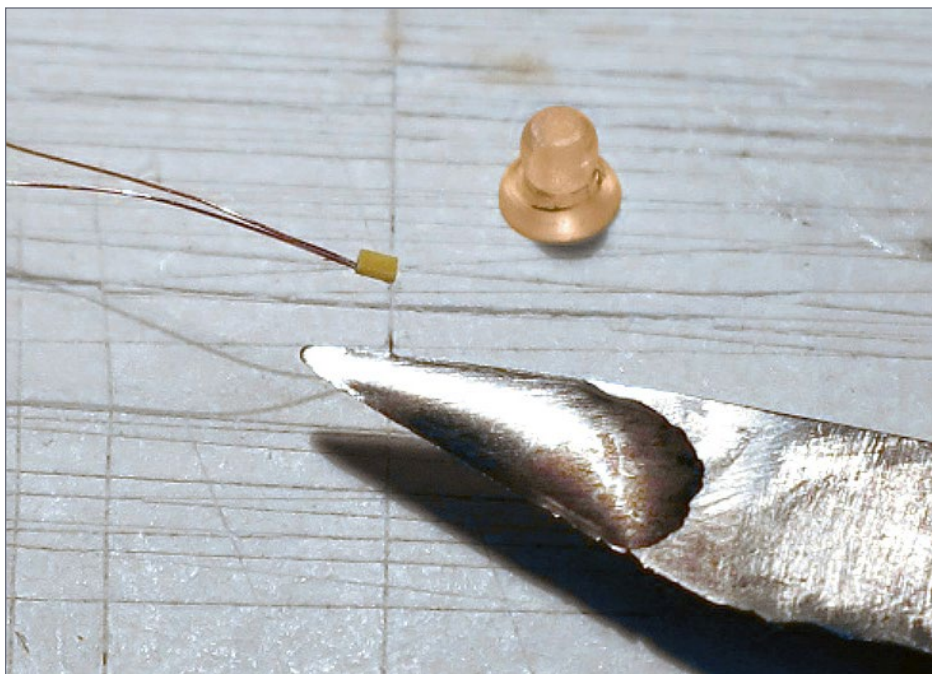

15. Quickly glue the LED into the globe with CA.

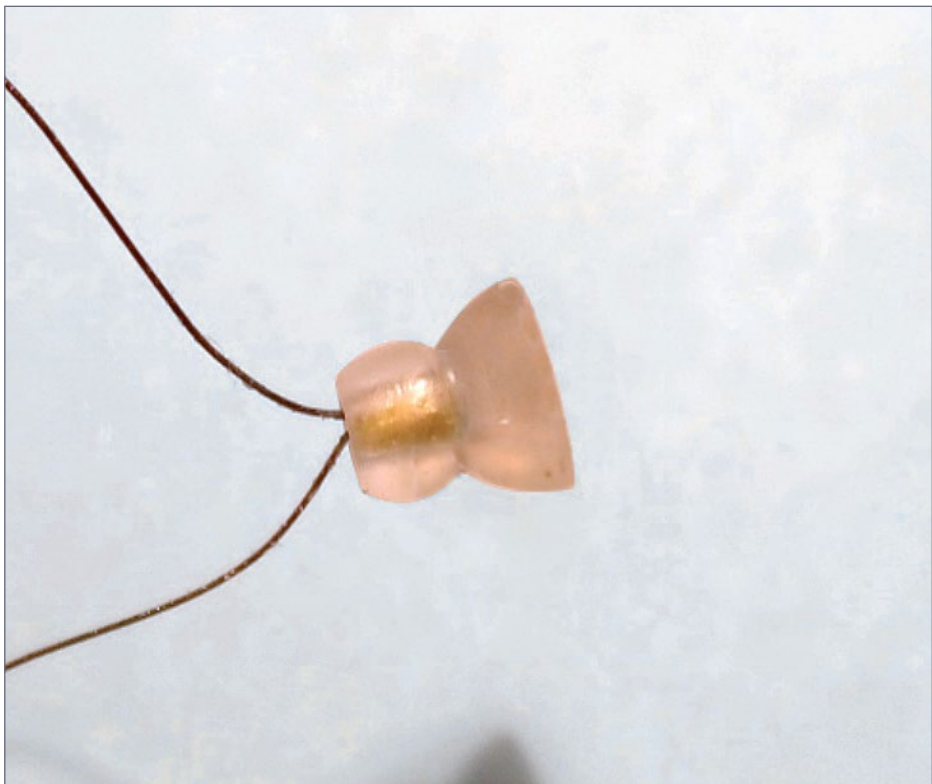

### 16. The LED is inside the globe.

method, don't let the glue run outside of the globe. The other thing to watch when inserting the LED into the globe is that the two wires are spread sideways a bit and that they are aligned with the small groove in the head of globe.

Here is the result. The LED and globe are glued together [16]. Next I spread the wires and pressed them down into the groove. If the CA sets before this step is completed, you can use a very small hammer to press in the wires. However do not tap too heavily because you could break the wires, rendering all your work to this point futile.

## ILLUMINATED LANTERNS | 15

Nearly done. The wires have been spread and the head of lantern has been glued on top of the globe with a tiny drop of CA-glove. I placed this small drop of glue on the center of the hood because this was the larger surface and the glue would not run sideways onto the wires, which would thicken, and harden the wires next to the head [17].

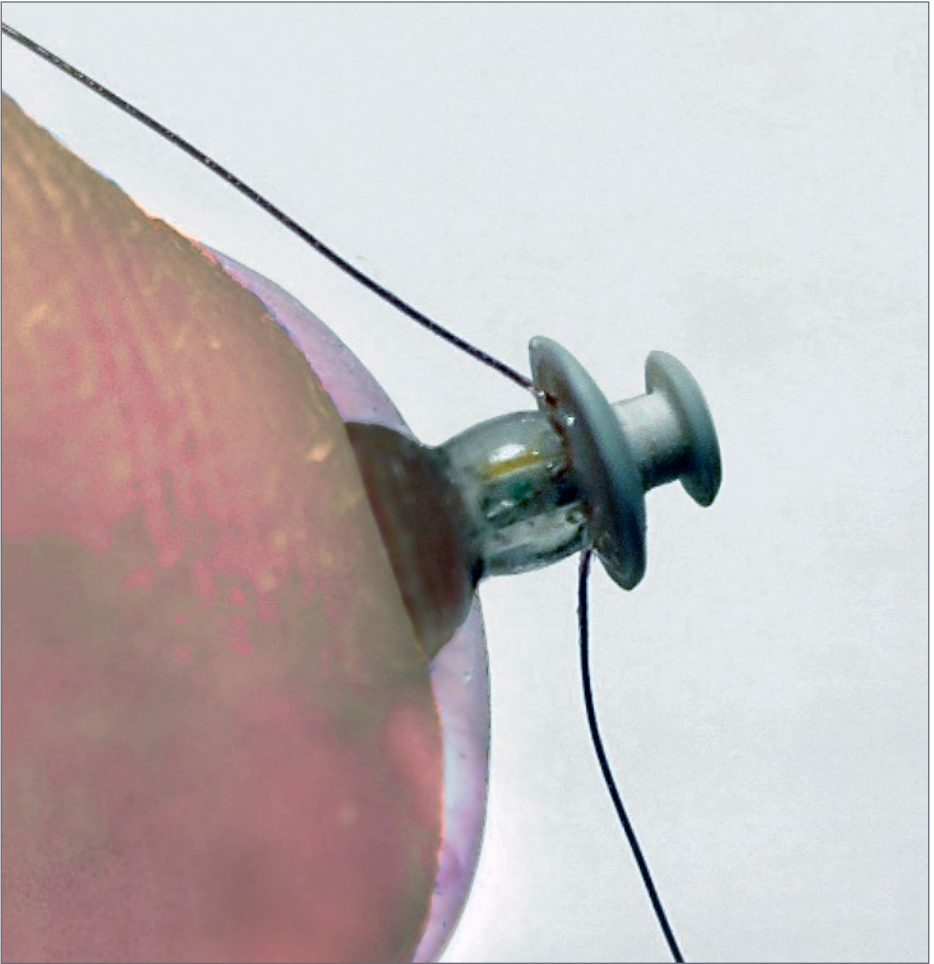

17. Nearly assembled lantern.



18. The wires are twisted together into a handle.

That's all! Here the wires are twisted together a little over the head of the lantern and shaped into a handle. I secured the twisted part of the wires with a drop of CA again. There will not be any problems with electrical shorts if you have not accidentally removed the enamel insulation from the wires [18].



## ILLUMINATED LANTERNS | 17

Here is the first test of the finished lantern. The head and foot (base) of the lantern and also the handle are painted black, and my first lantern is finished and glowing! [19]



19. The first one is ready!

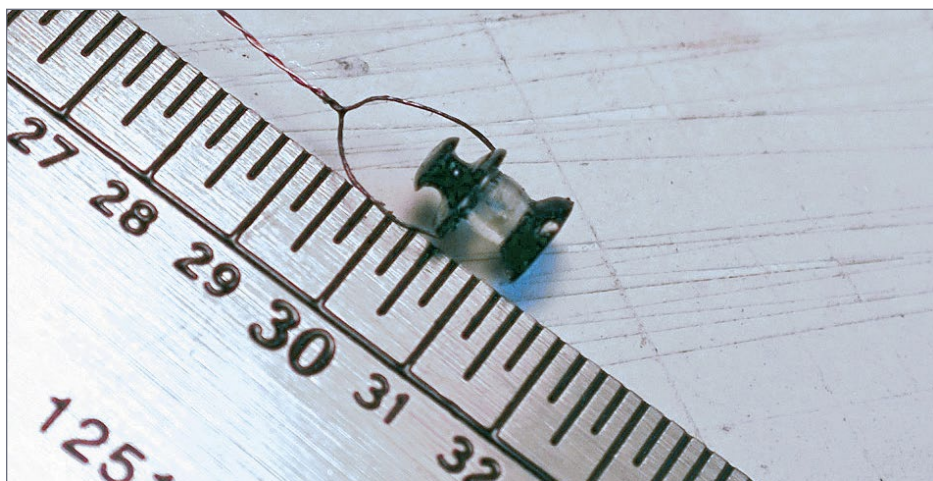

## 20. Whoops! Too big.

However, next I measured the height of the lantern with a ruler, and it indicated a height of a bit more than  $1\frac{1}{4}$  feet, [20] or around 40 centimeters! Yes I must admit that I have built a usable lantern in O scale, and therefore I decided to try to find a different technique for building a smaller lantern, one closer to what is shown in the drawing in the first picture. I should note here that I did not use a caliper when turning most of the parts for this prototype kerosene lantern. In most cases my eyes told me where I should remove material or when I should stop the shaping. This was definitely my error, but I have proven that I can build kerosene lanterns in very different sizes – however you, and especially beginning modelers, should use a caliper to check the sizes at each step and on each part.

So I searched for a new idea how I could make the parts smaller, maybe by using different materials? And I found what I searched for: new materials and a simpler technique that brought a faster way to success.

The new materials: first, small beads children use for necklaces or for fine bead-works, and second, leftover black plastic sprues from kits that every modeler has. I was surprised by the large variety of small clear glass beads for sale on the web, also called “seedbeads” or “rocailles,” and I selected those with a diameter of 1.5 mm which are near to 0.07” in diameter and only 0.04” high in reality. My first concern was that I could not find beads with holes large enough for inserting a LED, but this was groundless. All these beads have holes between 0.035” and 0.04”, which is large enough for 0402 LEDs [21]. Yes, I also was surprised that I must buy a small box with some 1,000 beads, but they were a reasonable price. Look at all of them in the picture! And I also found a simple method to work with them. Take a short wire almost the same diameter as the hole in the beads and glue it into the hole with a small drop of CA. That way you will have a handy handle for these beads which will roll away and jump off your work table. It’s important to use wire for this handle and not a plastic rod or a wood strip, because there is a simple way to remove it. You can pull out the wire from the bead if you will warm the wire using a small soldering iron at a medium temperature, but then clean the hole with a small drill bit at a high speed you can use like a fine milling cutter.

I’m sure you know that acetone is a solvent for CA and for cleaning surfaces. However I think that you ought not to use it here. All joints in this lamp are glued with CA and I’m not sure you can dissolve only one joint or remove this handle without damaging the other joints beside it.

The first step of this new technique to create a lantern in HO scale was to make one single starting piece for the two parts, the foot and the head, which then will be turned simultaneously on the electric drill. I turned a shaft from the black sprue with a 0.09” diameter (around 2.2mm) as the base for the foot and head.





21. New materials for the smaller lantern.



22. Using the sprue as a starter piece, I turned the parts.

I mainly used a flat double-cut file. This way, neither of the parts would have a diameter larger than the base rod [22].

Shaping the head was done exclusively with the broken saw blade because of the fine contours on the head. And I worked at



## ILLUMINATED LANTERNS | 21

slow speed again. An important step was to check the height of the head which ought to be no larger than 0.04", or just a little bit more than 1.0mm [23].

But how was I going to hold these small parts and work with them? This solution was simple – I drilled a small, short hole into the top of the head. This hole should be exactly centered. And then I glued a short thin wire into it. And afterwards I cut off the head together with its “handle” from the rod. See the next pictures [24, 26, 27].

I used the same method to shape the base of the lamp, however this time I worked from the bottom so that I could also add a wire there for better handling [25].

Marking a little point at the center of the bottom where I will drill a small, short hole - while the plastic rod turns! You can find the center only while the rod turns at a slow speed [26].

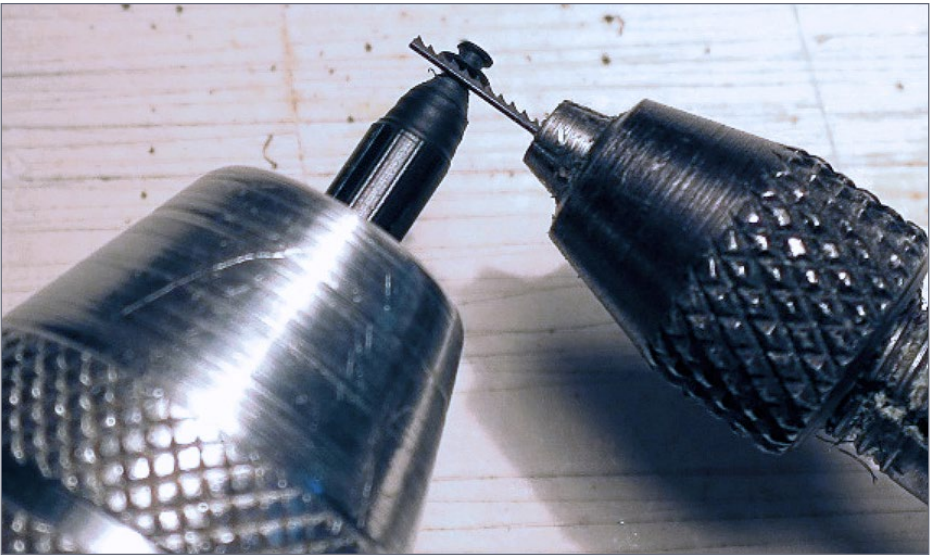

23. Shaping the head.

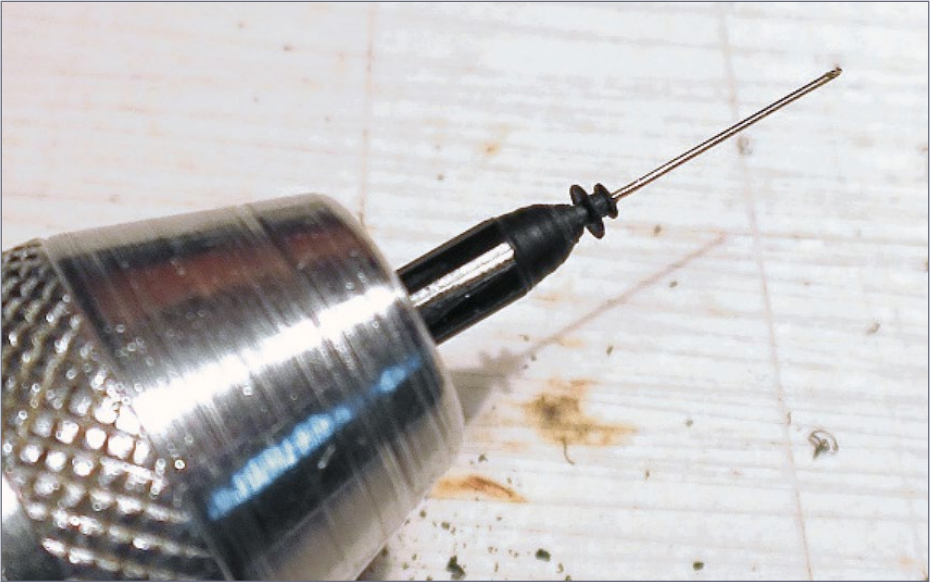

24. I drilled a hole in top of the head, and put a wire in it.

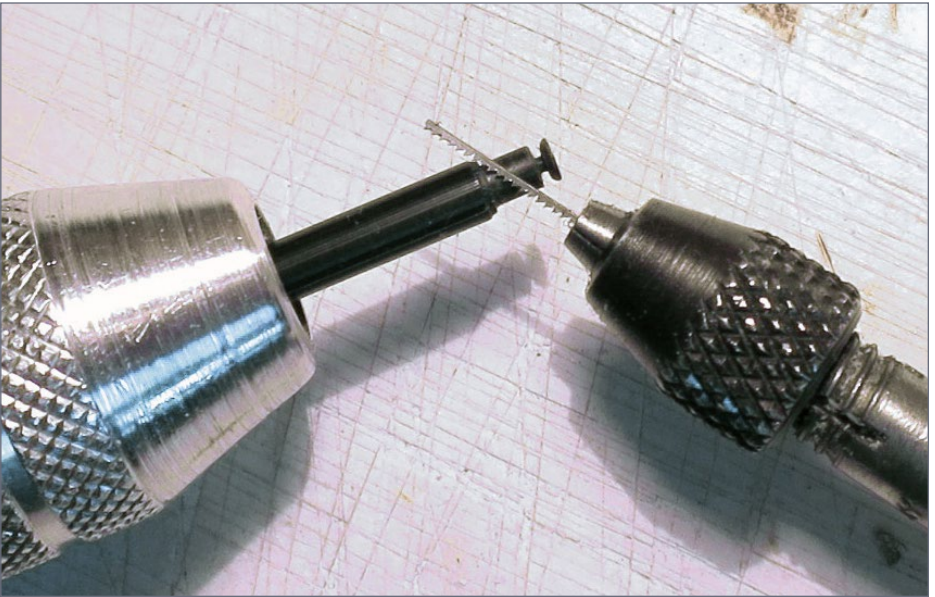

25. Working on the base.

## ILLUMINATED LANTERNS | 23

Before cutting the lamp base from the rod, this part also must get a thin wire glued into a small hole drilled into the part. The best way for gluing the wire is to dip it into a drop of CA glue and set it into the hole where the glue will set quickly. Please note, this wire has a diameter of no more than 0.12" or 0.3mm and ought not to be any thicker [27]. You should also make sure here that the height or greatest thickness of the base is not more than 0.04", 1mm again, maybe a bit smaller.

A new step in construction! I ground a small indentation, like a round seat, into both the lamp base and the head where the glass bead will sit. I used a cheap diamond ballpoint cutter and

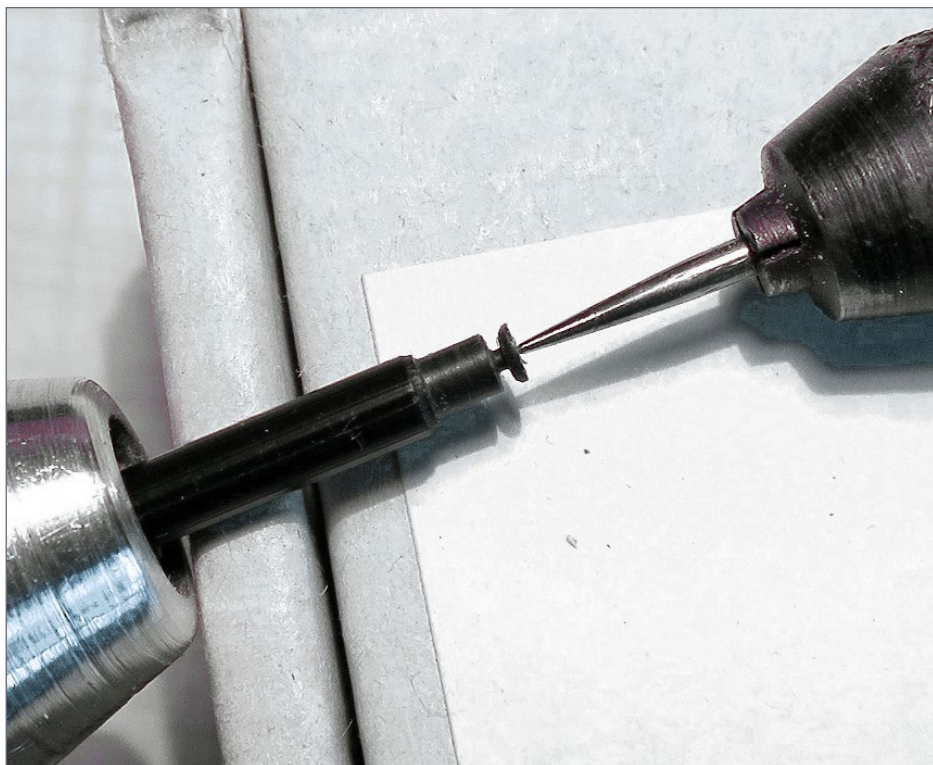

26. Mark the center of the bottom and drill a hole.



### 27. Glue a wire into the hole of the lamp base.

worked at a slow speed. You can use also a steel cutter, however it ought to have very fine cutting edges so that the parts will be cut gently. These indentations will give the round bead a better-shaped seat – and they will reduce the overall height a little bit. Also remember that the wires on the LED will add a little to the overall height of the lantern, so I tried everything I could to reduce that [28].

The picture [29] shows my first attempt connecting and gluing the lantern parts together, but it was not very successful. The LED was glued into the bead and then I glued the parts together. It was



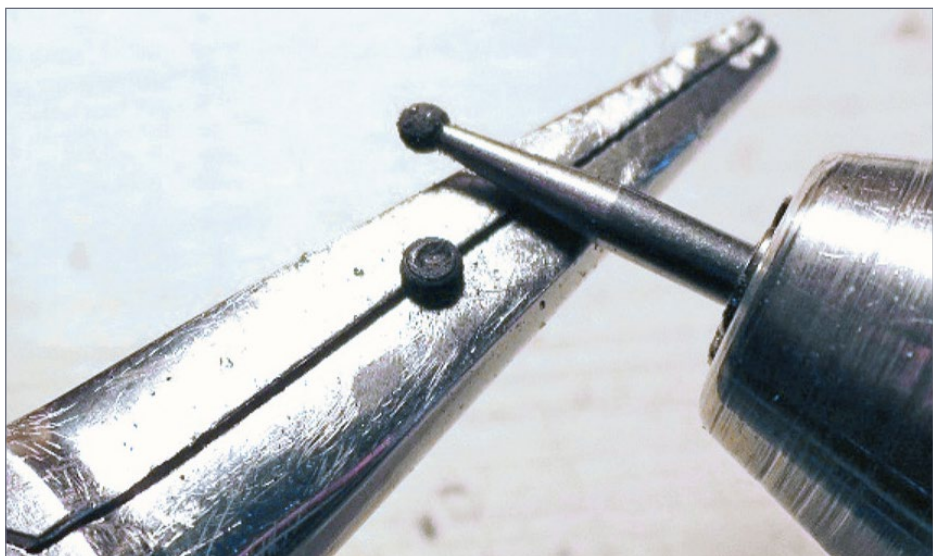

28. Grinding a small indentation to seat the glass bead.

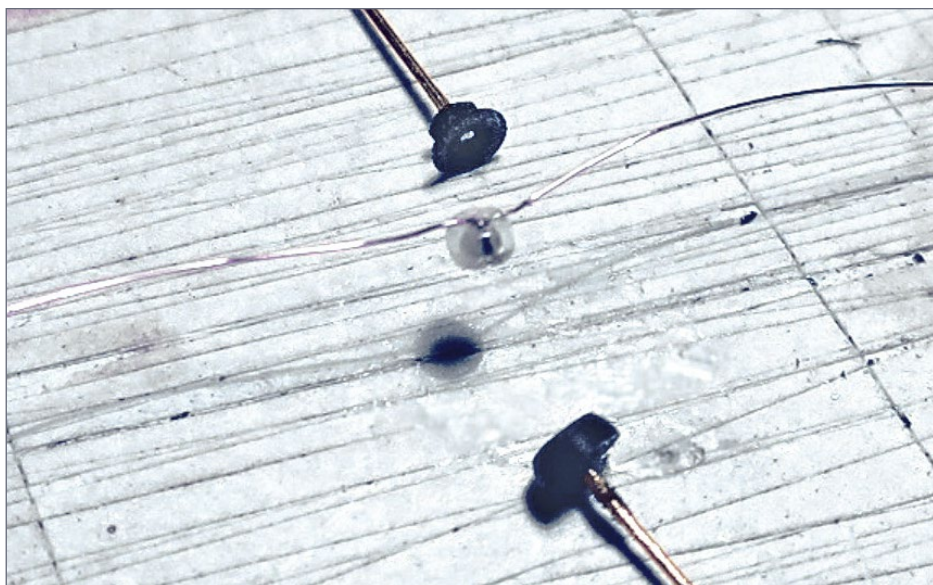

29. Assembling is very difficult if the LED was inserted into the bead previously.

difficult setting the bead in the correct axial orientation because I could hold the bead only by the two very thin LED wires. [29].

I had to repeat the assembly of the lantern using the bead without the LED. Next I glued a snug-fitting wire into the hole of the bead. That made a good way to handle the bead so I could correctly align the parts before the glue set. I made the first successful assembly of lantern base and glass bead. I suggest that you can use a small bench vise to hold one of the parts. You can also use a third-hand device to hold one part and then hold the second part with your hands without any undesirable wobbling while the glue sets [30]. After the glue has set, you must remove the wire from the bead. For this I clamped the “handle” on the base part of the lamp into my bench vise, warmed the wire in the bead with a small, medium-hot soldering iron until the glue was softened so that I could pull the wire out [see 32]. Warm the wire very briefly with a hot iron so the bead will not fall off the lamp base again. Next I used a small drill bit at a higher speed to clean any remaining glue from the hole. Then Check that the whole length of the LED can be inserted into the hole of bead. If not, use your drill bit again and drill the hole to the required depth. This should not be a big problem, except that you also must remove any remains of hardened CA that crept into the hole.

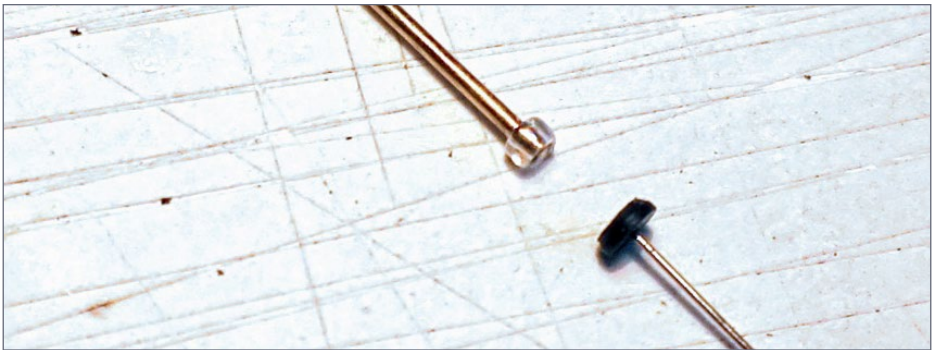

30. Assembling the base and bead is now simple!

## ILLUMINATED LANTERNS | 27

Now you can glue the LED into the hole the same way as the first lantern. Dip the LED into a drop of CA, insert it into the glass bead, wait for the CA to set, and bend the wires sideways in opposite directions. Also, like the first lantern, flatten the wires over the edges of hole with a very small hammer. Firstly this will reduce the overall height of lantern a little bit and secondly, it is necessary

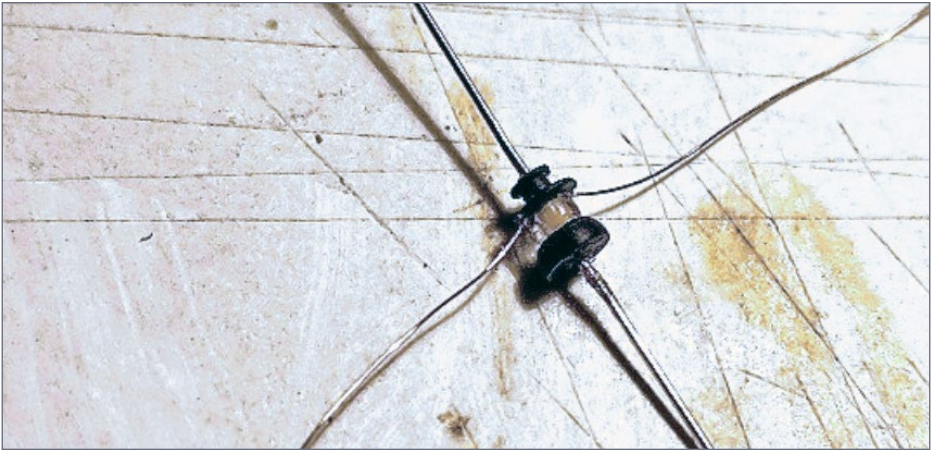

31. Parts of lantern are glued together.



32. Wire handles have to be removed.

because there are no grooves in the bead for the wires to sit in. For this step I used a very small watchmaker's hammer with a weight of only 2 oz. I repeat: do not tap too heavily because you could break the wires, rendering all your work futile.

This is the result after the head has been glued on top of the glass bead and the wires of the LED are attached to the roof so they will not break after the glue has hardened. [31]

Nearly the last step, the wire “handles” must be removed again. The free wire must be warmed with a small soldering iron so you can pull out the wire using pliers or tweezers. Turn the lamp over and repeat it on the other end where you can grasp the lamp with tweezers that you can hold in the bench vise or a third-hand [32].

Really the last steps: smooth the holes on the bottom and head of the lantern, fill them with tiny drops of glue, and paint them black. If you don't do this, you will see small points of light leaking through the top and bottom. This will be blocked by the paint[33]. For the last step, shape the wires into a handle, twist and secure them with glue as before, and then give the handle a bit of black paint. Finished now, really!



33. Paint bottom and head of lantern black.



## ILLUMINATED LANTERNS | 29

Now to check the measurements – this looks really good. Around 10” high, this is 30cm, so the model is only 10% over the planned height. I think that this is a good result, and is very close to HO scale. I emphasize that I achieved this result only by using a very small bead and by working with a caliper to frequently check the height of the head and base [34].

Here is a direct comparison of the first and the second lamp. This smaller lantern could find a place on a lot of locations on an HO scale layout. I think the other would work in O scale or S scale [35].

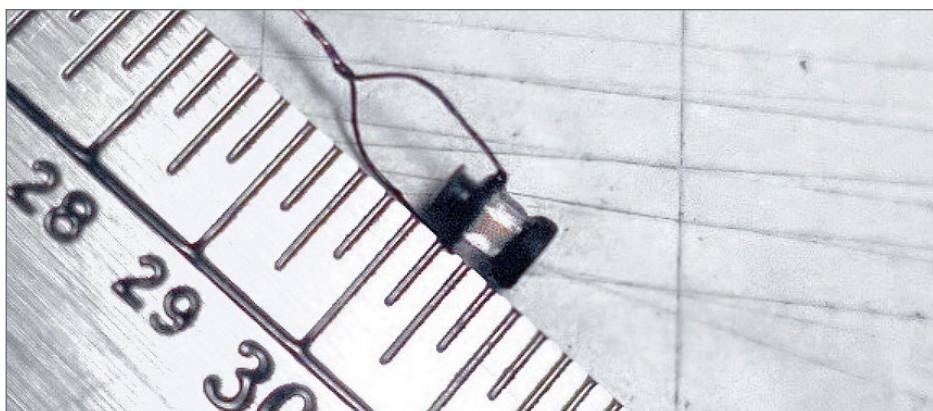

34. The result? Looks pretty good for HO-scale.



35. Lanterns in comparison: O scale and HO scale.

## ILLUMINATED LANTERNS | 30

I put this lantern into the hand of my silent railroad worker who perpetually watches over my modeling jobs. Of course, the wires were removed by a bit of photo editing. I found a YouTube video [youtube.com/watch?v=TIqgQy\\_47GI](https://www.youtube.com/watch?v=TIqgQy_47GI) of an Australian modeler who threaded the wires of the LED through the body of a conductor figure. So model figures certainly can be adapted like that and should be an eye-catcher – with an illuminated lantern in his hand [36].

As the last of this “how-do” description, here is a picture with my railroad worker beside my latest load project, the “Variable Density Tunnel – VDT” a heavy and extraordinary large load on a modified flatcar model that I built using pictures and lots of documents from NASA archives [37].

This brought back to me an idea from my friend Bill Gill, that I ought to add a brakeman with a lantern in his hand who is standing on the platform steps of a caboose. And for that I would like to offer a simple solution where I added a switch to the caboose so the lantern can be turned on or off. Please see my short video



36. One of my model figures – now with an illuminated lantern!

## ILLUMINATED LANTERNS | 31

[youtube.com/watch?v=yjGeHArurcw](https://youtube.com/watch?v=yjGeHArurcw) where I have installed a flashing train-end light powered by a battery in an N scale car. Of course you can use also a cheap function decoder on a DCC layout,

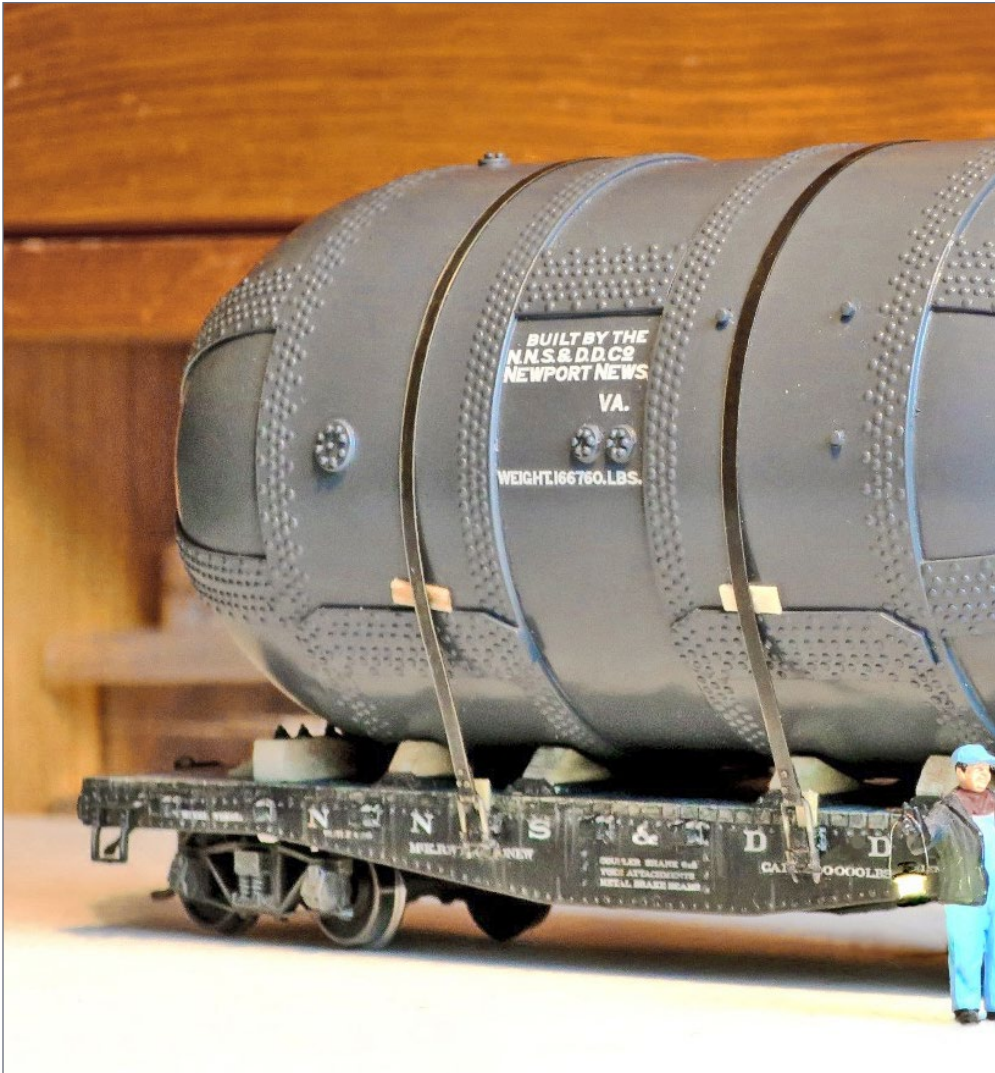

37. One of my most recent modeling projects. See my MRH blog "An extra-ordinary load!" – [mrhmag.com/node/20932](http://mrhmag.com/node/20932).

## ILLUMINATED LANTERNS | 32

but this was a simple and fast solution for a friend who owns a DC-powered layout. Maybe next time I will make this brakeman on a caboose with an illuminated lantern.

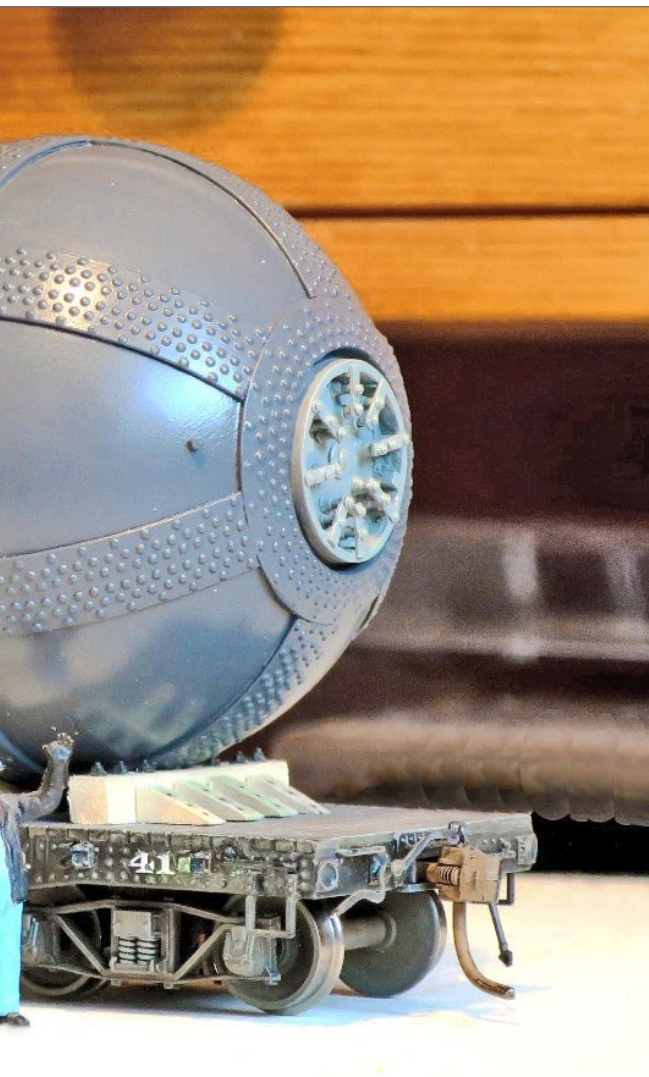



## BERNHARD SCHROETER



Bernhard lives in Dresden, Germany and retired 10 years ago. In 1950 at age 7, he received his first train set at Christmas with a two-coupled and streamlined steam engine. In his younger years, Bernhard got an education in steam engine back shop services and he worked many years as a foreman there.

For 14 years he was member of a model train club, and there he met an excellent model builder who built high-quality American steam engines in brass. That is when his American railroad modeling in steam was born.

In 1989 the Iron Curtain became history, and starting in 1990 East Germany's model railroaders could purchase models they wanted from around the world. Bernhard sold his whole railroad collection and completely changed to U.S. model railroading. At that time, he began scratchbuilding cars, especially rarely seen prototypes.

You can find most of his model projects on his well-documented website [us-modelsof1900.de](http://us-modelsof1900.de) which is written in German but includes many, many pictures. You will also find a lot of links where Bernhard has written in US forums or magazines about his projects, there. See also his blog here – [mrhmag.com/blog/20899](http://mrhmag.com/blog/20899).



**Click here to rate or comment on this article**



# The Amherst Railway Society Railroad Hobby Show

Our 2018 Show will be

## January 27 & 28, 2018

Save the dates!

**Click  
to learn  
more ...**



## About The Show

Every year late in January or early in February, the Amherst Railway Society holds its Railroad Hobby Show at the Eastern States Exposition Fairgrounds (The home of The Big E) in West Springfield, Massachusetts. More than 25,000 railfans and public attended the Show each of the past three years.

The event features real life railroads and scale model railroads, historical societies, travel agencies, art shows, flea market dealers, importers, manufacturers and photographers. You have to see it to believe it!

• [INDEX](#)



[SUBSCRIBE](#)  
(free)

• [TABLE OF CONTENTS](#)



# ***Enhancing*** **JENSEN CONCRETE**

BY CLARK PROPST

## ***Enhancements and a little “imagineering” turn research into a viable rail-served industry ...***

**IT'S NORMAL TO THINK SOMEONE'S STORIES OF** their fishing trip are just fish tales (lies), especially the stories about the one that got away. I base my fishing stories on fact with maybe a bit of enhancement for entertainment value. I base my modeling on fact as much as possible, but felt Martin Jensen Concrete Products in Story City, IA needed a bit of dressing up to increase the entertainment value.

A move to a smaller home gave me the opportunity to build a branchline layout I'd been mulling over in my head for a few years. After considerable cogitating, I chose to model the Minneapolis & St. Louis Railroad's Story City branch in central Iowa.





[Click here to rate or comment on this article](#)



2, 3. Martin Jensen is in his “toy” excavator while his two employees he laughingly refers to as Mutt and Jeff (from the cartoon strip of the time) keep busy cleaning up the messes Martin makes.







4. My best shot at copying the actual structure from the only available photo. I'm willing to exchange total accuracy for speed and ease of assembly by using commercially available doors and windows.

I wanted to build this layout as accurately as possible. I've had information on this branch line for years, so I didn't want to spend a great deal of time now researching the area. But some additional facts sort of fell in my lap, along with some contradictions – Martin Jensen's Concrete being the biggest contradiction.

## A little history

A scanned book photo from the Story City Historical Society, dated 1937, shows track in front of the building and concrete blocks stacked as if for loading into a box car. The M&StL Directory of Industries from 1936 does not list Jensen's as a customer. At first glance, there does not appear to be a track in front of Jensen's on the Story City station map from the M&StL AFE files, courtesy of Gene Green, a railroad historian, air brake and M&StL expert.



5. M&StL 149, a GE 44 tonner is spotting a load of cement over the discharge hopper between the rails. The cement will be transported by screw and elevator to the storage tank atop the batch mixer tower.

Close inspection of the map shows that track has been removed from in front of the building. So, armed with the photo of the place with tracks – and a station map without – it was easy to enhance my operations by placing Jensen’s on the spur that appeared to extend there at one time. An Authority For Expenditure (AFE), at least on the M&StL, is correspondence covering management decision-making and actual cost for projects.

Building Jensen’s was straightforward. I laminated embossed block styrene to sheet styrene for strength, and used commercially available windows and doors plus some styrene strips. The small size of the building in the photo suggests they would have most likely hand-mixed their concrete and hand-packed their block molds. If that was indeed the case, the most business the railroad would have gotten would be an outbound box car of blocks every now and then.

# JENSEN CONCRETE | 5

As a small concern, Jensen's sales territory would be very limited. Maybe they would get a car of cement in bags once in a while, but they probably combined their order with a local lumber yard because the building does not appear to have much storage space.

## A few additions

I decided to expand and modernize their operation for them by adding a batch mixer they could use to feed an automated block machine.



6. Overview of Jensen's Concrete Products. Everything in the fenced in area to the right of the main building is a figment of my imagination, based on similar actual facilities. Thus, they are believable. Believability is the ultimate goal of a layout builder.



## JENSEN CONCRETE | 6

Like batch mixers at concrete bulk plants, ingredients would need to be introduced into the batch mixer from above. This would require a stockpile of aggregate and some type of waterproof container to hold cement. Transporting these materials would be done by belt conveyor or elevator.

Because of the modeler's curse, limited space, I decided to position my cement silo on top of the structure containing the batch mixer. The silo was made from a PVC pipe coupling, with



[Click here to rate or comment on this article](#)

• [INDEX](#)



[SUBSCRIBE](#)  
(free)

• [TABLE OF CONTENTS](#)



## JENSEN CONCRETE | 7

a styrene roof and railings added. Aggregate would enter the batch mixer by conveyor. I heavily modified a Walthers Modern Conveyor for this job. I haven't narrowed down my modeling date yet, but it will be in the fall of 1950 to '52.

Roads were poor quality in rural areas in those days so these heavy materials would need to be brought in by rail. Now I can expand my rolling stock variety as well as increasing spotting frequency. I shortened a Walthers grain leg to transport bulk cement unloaded from a covered hopper to the storage silo. I added another Walthers conveyor to transport aggregate unloaded from open hoppers.

At first I was going to use a tractor with a bucket attachment to move various materials to their appropriate storage piles. I wanted my storage piles to represent about a carload of material. I made a core by whittling cones from foam and covering the forms with various screened aggregates.



7. On this day 149 is picking up an empty hopper that brought aggregate or sand used in the making of concrete blocks.



8. Since Jensen is the farthest east customer in the end of the line town of Story City, Iowa, the crew switches it last on their way back home. Here they are spotting an empty box car to be loaded with the block staged next to the spur. The date is Oct. 2, 1951. The only load out of Story City this day is a car of canned corn from the cannery at the west end of the line. This lack of traffic may help explain why in another year the line was abandoned between Story City and Roland (next town east).

The resulting storage piles were too tall for a tractor with bucket to have made so I bought a Woodland Scenics backhoe. Not the best choice for this application, but my choices were very limited. I'll have them use the tractor with bucket to clean up after the messy excavator. Remembering my youth, I decided to enclose the perimeter of the stone yard with Central Valley fencing in an effort to keep the local children from playing on the piles and equipment. This fence serves a dual purpose by distinguishing the actual representation of Jensen's from my enhancements. Now, besides box cars, Jensen's will be able to accept open and covered hoppers.

One of the biggest concerns people have when planning a layout is whether the thing will hold their interest over time.



By enhancing facts with a little logical “what if” here and there, one can ensure a more interesting operating layout. My enhancement of Jensen’s Concrete Products has tripled the entertainment value. ✓

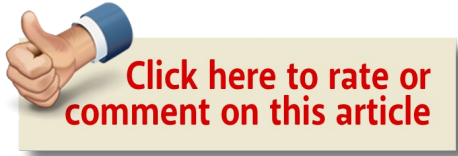

---

## CLARK PROPST



Like many baby boomers, Clark grew up playing with model trains. His father worked for the M&StL/CNW, and he has fond memories of cab rides and solo passenger train trips to visit his grandparents.

First time Clark saw two steel strips in the mud, he was hooked! After 60 plus years of modeling, Clark prefers to duplicate those little used spurs on his new layout. Retired after almost 40 years working as an electrician, Clark has made modeling his job since retiring. Life is good! ■

## AUTHORITY FOR EXPENDITURE

My experience with the Authority For Expenditure is extremely limited. I would assume that all railroads keep the same type of records.

The AFEs, at least the M&StL ones, contain lots of correspondence of management decision making and actual cost for projects. To me they are a better history of a railroad than any scholarly rendition. Most scholarly writings on the histories of railroads are nice information for the modeler to know, but offer little practical information of a railroad's day to day existence. The AFEs give the modeler insight as to what was added, deleted or changed and on what date.

The AFEs, on the other hand, list expenditures – from a new

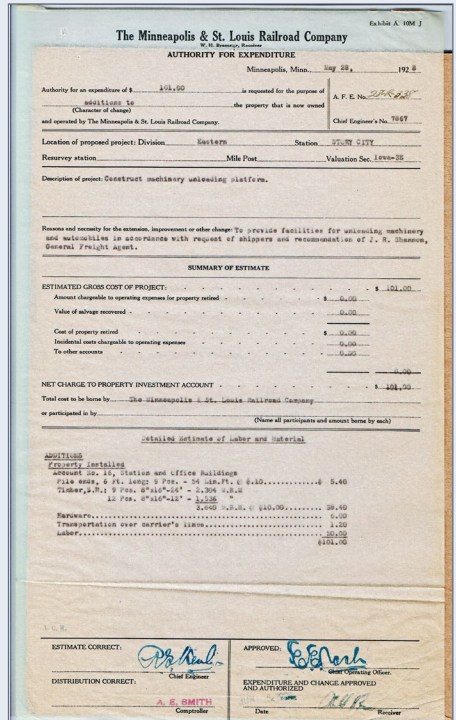
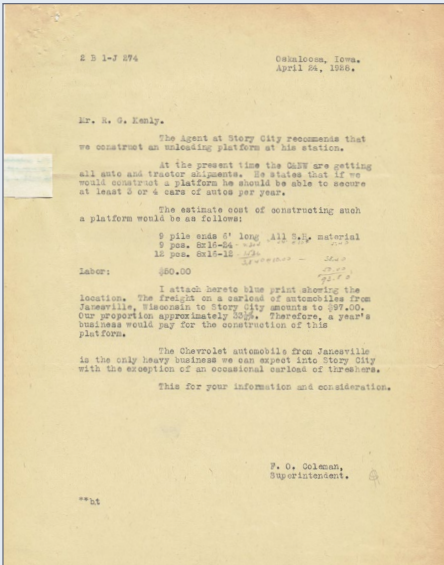

9, 10. Examples of Authorities for Expenditures.



## AUTHORITY FOR EXPENDITURE CONTINUED ...

typewriter for an agent to the purchase of new locomotives. This is the kind of stuff a modeler can sink his teeth into, especially when trying to model a specific place in a specific time period.

I model the Minneapolis & St. Louis Railway, known as the “MandSaintL,” one word, four syllables. While their AFEs are the property of the Chicago & North Western Historical Society, most of the documents reside with passionate historian and noted author Gene Green. I’m very fortunate to be able to ask Gene about a particular item, and Gene will supply photo copies of the file.

The file contains all the accounting paperwork, listing costs down to nuts and bolts used. They sometimes include updated station maps showing changes, both proposed and as built. But, the most interesting contents of the file are the correspondence between the participating parties, from stating their case for why monies should spent, to the authorization for the project.

To find out if AFEs exist for your favorite road, try contacting the relevant historical society. Nowadays the internet may provide some guidance to finding these treasures of railroad history. ■



**Click here to rate or  
comment on this article**

# NEW HAVEN 8600-SERIES COACHES



BY RAPIDO TRAINS INC.



**NH GREEN**



**NH ORANGE**



**PC**

**CLICK  
HERE**



**MBTA**



# Weathering a covered hopper



For the TrainMasters TV  
TOMA project layout

*click to learn more ...*

*Bob Fallowfield photo*

**BY NICK CAMPBELL**

*PHOTOS BY THE AUTHOR UNLESS OTHERWISE CREDITED*

***Nick Campbell of The Weathering Shop transforms an SP car into a patched Vermont Railroad hauler for the TMTV TOMA layout ...***

**BACK IN OCTOBER OF 2016, MRH EDITOR JOE FUGATE** contacted Jeremy St. Peter of “The Weathering Shop.” Joe was interested in having some cars weathered by TWS artists. Being fortunate to be a member of the TWS crew, would I be able to weather a car for the TMTV TOMA project layout if I so chose?

• **INDEX**

• **TABLE OF CONTENTS**



[Click here to rate or comment on this article](#)

I was all in! I thought it would be fun – and neat – to see one of my pieces rolling on their layout on Trainmasters TV or at a train show. I received a list of cars to pick from and was asked to choose three. I looked up some of the cars and found great prototype pictures to work from for two out of the three I was interested in picking.

I figured I could find pictures of the third choice with deeper searching, but it was my third choice so I didn't think I'd get it. Lo and behold, what do I receive but my third choice, an SP covered hopper! No worries, I thought, and started searching. I searched all of my known databases for prototype trains on the ol' interwebby but to no avail.

Then I asked someone who I know is an SP aficionado and TWS member, Gary Christensen, for help finding a hidden gem of a prototype picture for this car. No dice. Therefore, from what I could find (or not find, as it were), I would need to do a “fantasy” weathering scheme.

I have always weathered my trains from prototype photos of at least one side of the actual car or engine. If I didn't have photos for the other side/ends/roof, I used proto photos of the same types of cars to make do.

For this project I would need to use prototype photos from similar types of cars, as the Southern Pacific never had four-bay ACF hoppers. They only had three-bay cars and those weren't in the “Speed Lettering” scheme like this hopper – they were done with block lettering.





## WEATHERING A COVERED HOPPER | 3

I ended up selecting several photos as reference. The two main pictures I selected were side photos of three-bay ACF Cotton Belt hoppers on [rrpicturearchives.net](http://rrpicturearchives.net). I chose end and roof photos of similar hoppers from my personal collection.

To tie it all together, I felt a backstory was needed for the hopper to fit it into the TOMA layout setting, which is the modern-day Vermont Railroad. My story: the Vermont Railroad just bought this hopper from Southern Pacific. The hopper had issues and damage, so it was shopped before going into service.

The shops patched over the SP numbers and stenciled on VTR numbers. They also patched over the graffiti, added safety stripes, put on that new wheelset, replaced a roof hatch, replaced all the bottom bin hatches with new ones, put on a new brake wheel, added new buffer plates in the coupler pockets and new air hoses.

How's that for a fantasy LO hopper? Hopefully it passes muster.

### Weathering this car

Here is the weathering journey for this car.



1. Breaking down and washing the Atlas model thoroughly came first.

## WEATHERING A COVERED HOPPER | 4

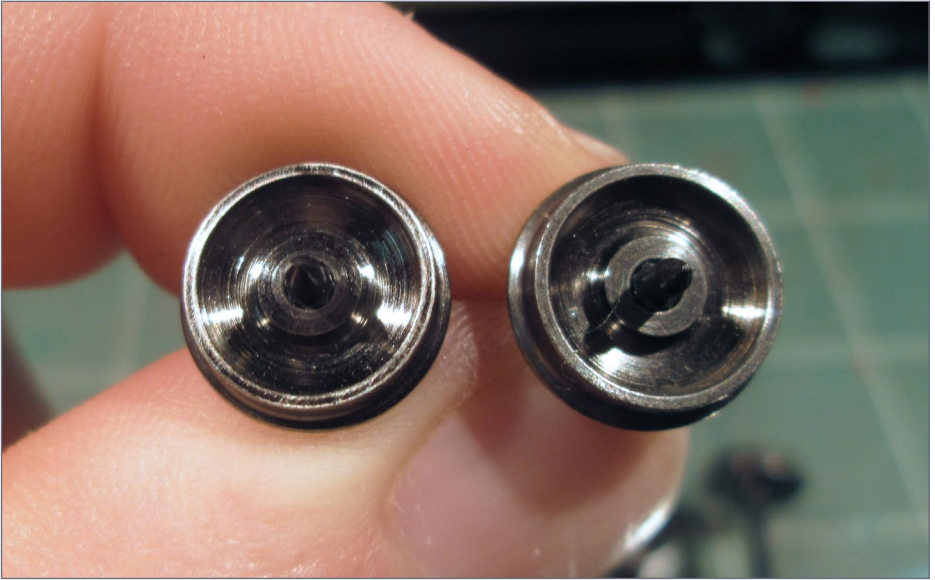

2, 3. I used 800 grit sandpaper to sand the wheel edges and backs to give the primer grip. You can see the sanded surfaces on the left in the photos.



## WEATHERING A COVERED HOPPER | 5

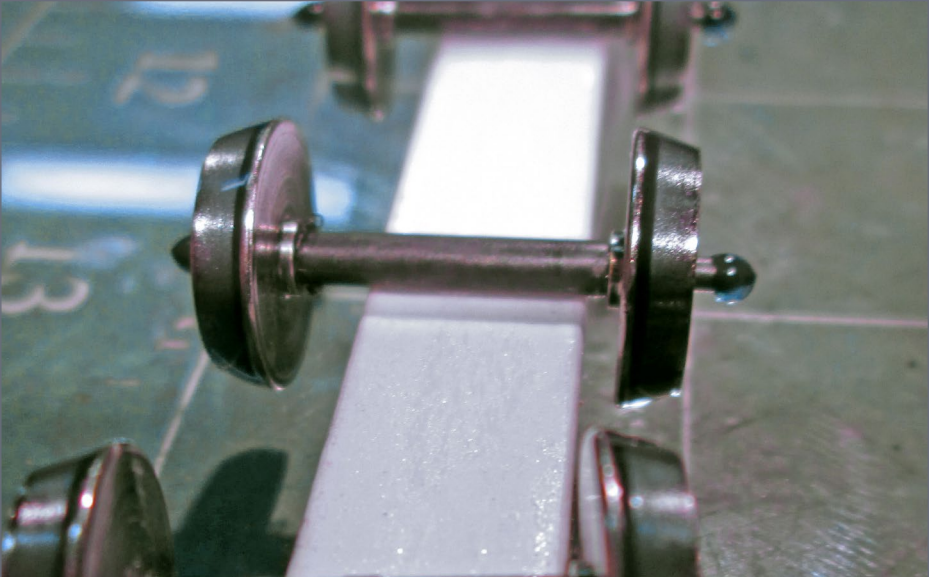

4, 5. I masked the wheel treads and needle bearings so as not to foul them with any paint.



## WEATHERING A COVERED HOPPER | 6

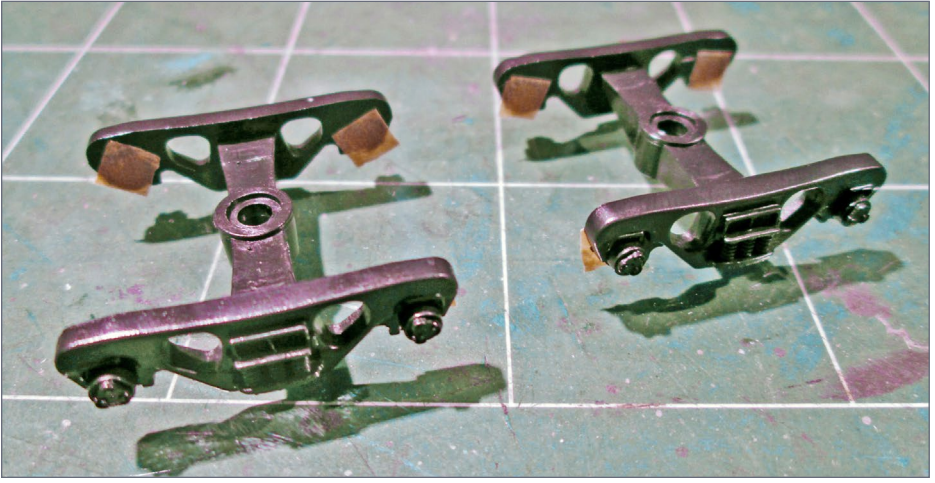

6, 7. I also masked the needle bearing receptacles and sprayed the truck with primer.





## WEATHERING A COVERED HOPPER | 7



8. After the primer dried I painted the rust and such details before a final sealing spray of Dullcote.



9. I went back later and painted the bearing caps on the “new” wheelset to better match a prototype picture I was using.

## WEATHERING A COVERED HOPPER | 8



10, 11. For the next step, I sprayed Dullcote on the car in order to apply the fade. Here you can see the first couple washes applied and some damp toothpick removal. I made the wash from inexpensive acrylic craft paint like you find at Walmart, Hobby Lobby, and such places. I mixed white and black until I had the hue of gray desired and then thinned it with water to a skim milk consistency.

I dipped the brush in the thinned paint and then blotted it onto a paper towel to leave me with a brush just damp with paint. I applied it and repeated the process as needed.



12. Here's the fade final state and built-up grime on the lower sill and panel seams. The grime build-up was done in the same fashion as the fade – several applications with thinned paint to build up opacity.

13-15. (Right top to bottom) After the fade was applied and a little grime added, I took a left turn in Albuquerque and instead of applying more weathering or a matte finish, I applied a clear gloss coat as a base for the remaining weathering. The gloss coat is one of only two steps where I used my airbrush. The gloss medium used was Future acrylic floor wax applied full strength. Most model train artists weather over a matte coat and I do too. Usually. However, to create some of the effects I thought it would be better in this instance to weather over a gloss coat. This also sealed the fade to protect it from damage later on.

Then I started painting on mother nature's vomit. The floors of the ends were started with thinned burnt umber/raw sienna acrylics and washed over with thinned glycol acrylic.



# WEATHERING A COVERED HOPPER | 10

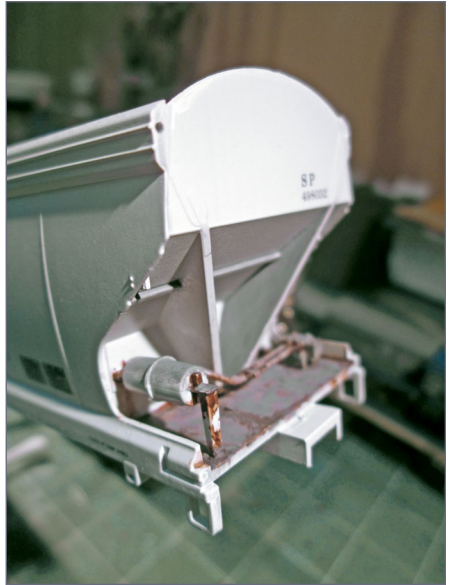
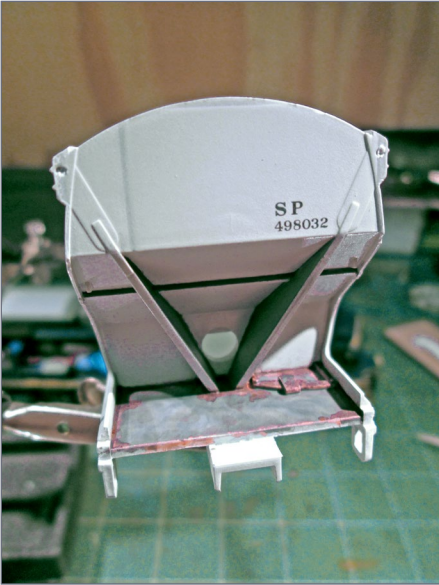



## WEATHERING A COVERED HOPPER | 11

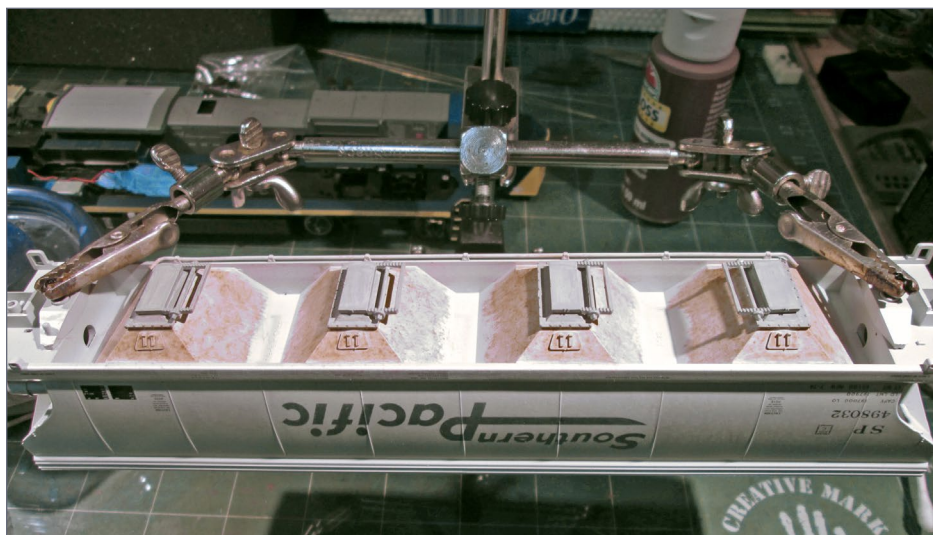

16, 17. A little underside love. I started with the thinned burnt umber and burnt sienna again to represent rust and dirt. Then washed over it with a thinned light gray. I believe you're seeing a pattern by now of thinning all of the paints a lot and doing multiple passes to build opacity. This keeps the layers from looking like thick, out-of-scale layers.

## WEATHERING A COVERED HOPPER | 12



18, 19. More applications of “weather,” and painting the bay doors to “like new” condition. I added grime and wheel splatter on the bays but unfortunately forgot to take more photos.

# WEATHERING A COVERED HOPPER | 13

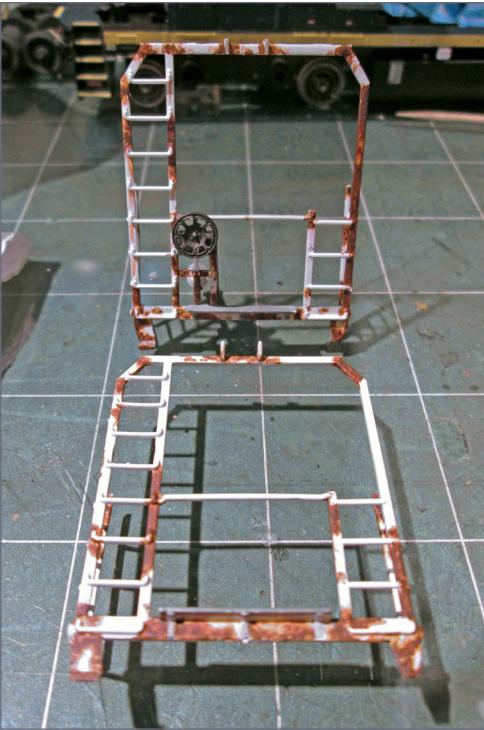
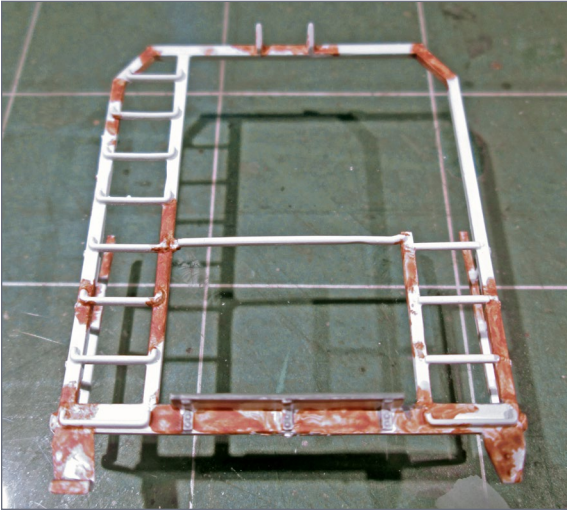

20, 21. First layer on the end cages, and then more.



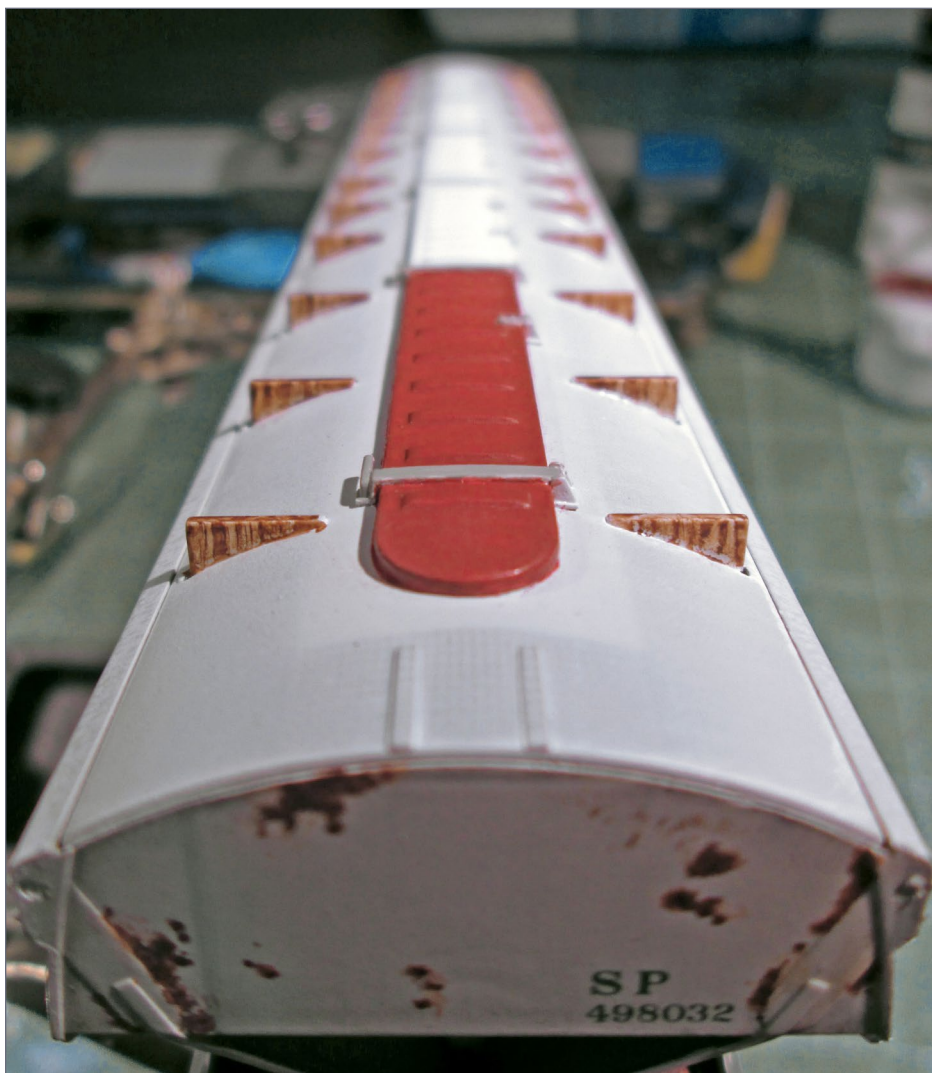

22. At this point I painted the “replacement” roof hatch and the rust streaks coming down the solid roofwalk supports. Of course, those solid roofwalk supports do not exist in the real world ... pfft.



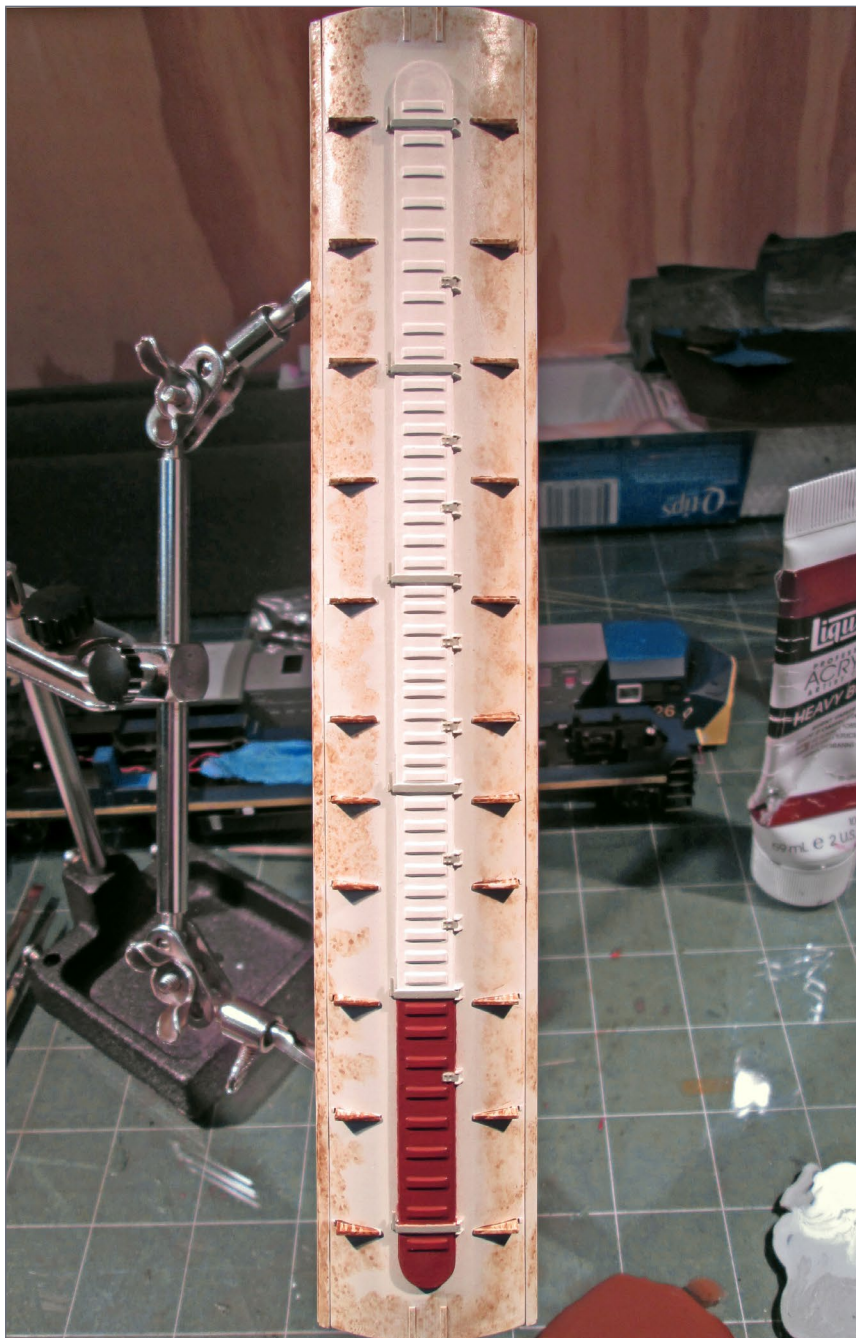

## WEATHERING A COVERED HOPPER | 16

23. (Left) On to the roof. I used thinned acrylics again and applied each color one at a time. They blend in appearance on the roof giving it depth, but they were separate layers. I determine the colors – sometimes blended while wet – and apply layers after studying the proto photo A LOT and thinking, often for hours and over the course of days, about what color/effect I think should go first. I had never seen anyone do a roof with this type of rust pattern on a model. I had never seen any technique articles that showed how to approach it. I stared at that prototype picture a lot, thinking.

I could see that along with and over the streaks were the more “normal” feathered edge rust “pools.” I theorized that I needed to put the stripes down first using the toothpick erasing technique. If not, trying to use the toothpick to create the streaks over the large rust patches would definitely damage them. I then thought that I wouldn’t need to do more than a couple washes to create the bed for the streaks, because applying the larger patches would deepen the color of the streaks.

If you look closely at the first pic showing the first wash of rust you will see the very obvious, hard edged, round brush paint dabs. You can almost count them. In the next pic the hard edges aren’t quite as hard, and later pictures show them becoming even more smoothed/faded around the edges.

After I applied each new layer, I used a damp Q-tip – yes, I use TONS of Q-tips! – and dabbed/lightly scrubbed away the paint to feather the edges. I used one color for several coats, and a lighter color for a few more coats, followed by the final two or three gray washes. Here the first wash of rust is applied.



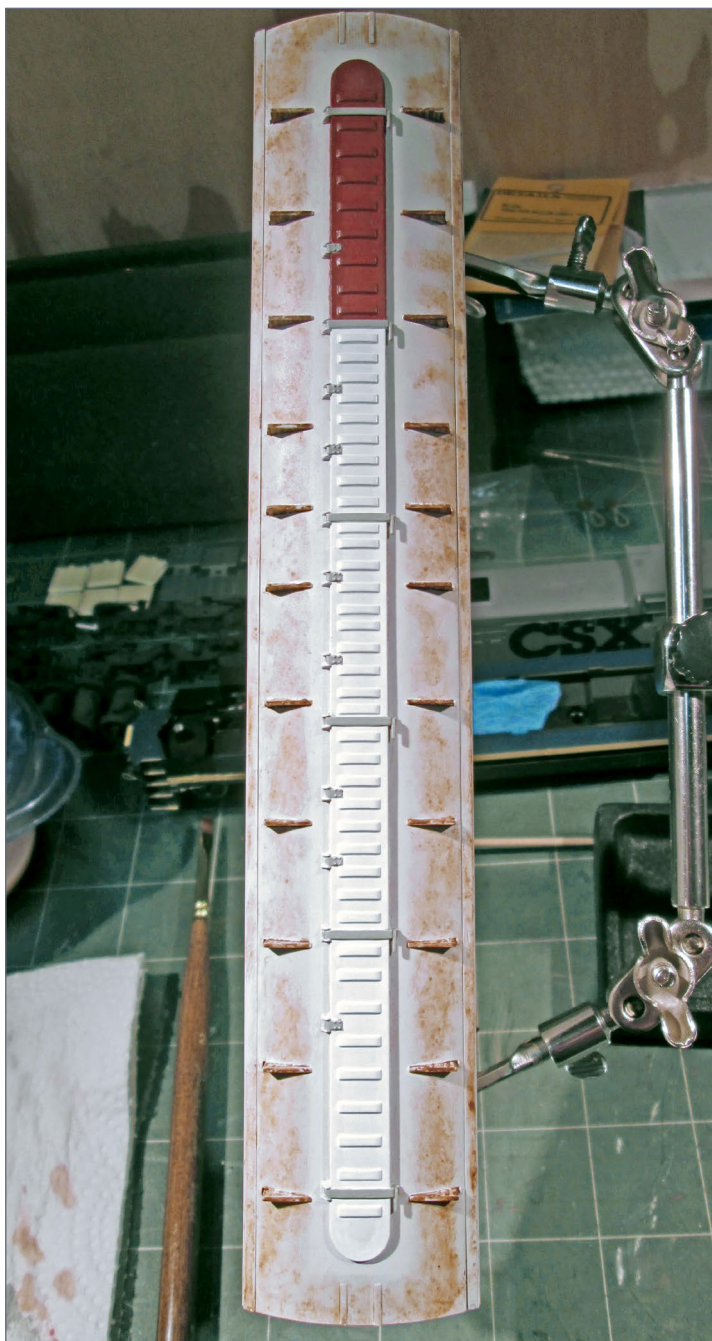

24. Second layer.



## WEATHERING A COVERED HOPPER | 18



25, 26. After a couple more layers, streaking was begun. The best part of this streaking technique is that it is extremely tedious! Also, notice the model is turned vertically for this. I find it much easier to scrape side to side in a straight line than up and down.





27-29. After the streaking was completed, more layers were applied on top. The new layer is on the right side, to compare the difference with the previous layers on the left side.

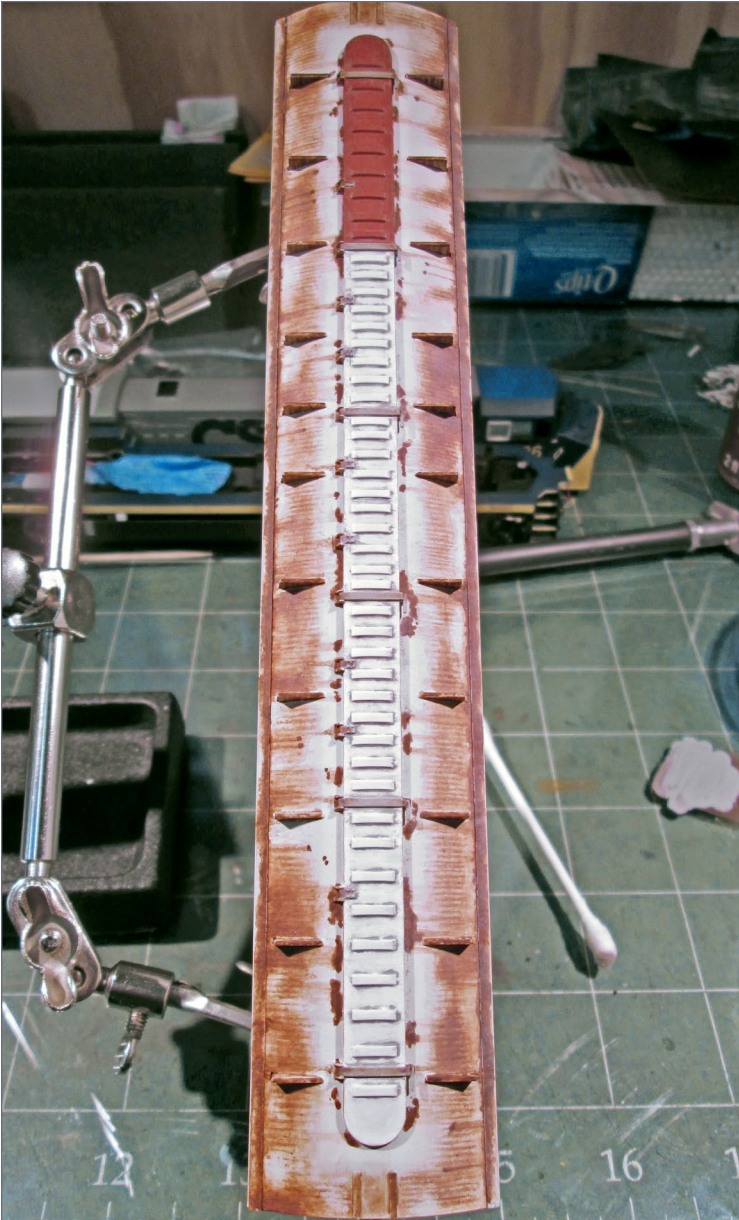

30. Finally, a gray wash was applied over the rust, followed by a little gouache to create grime on the roof hatches. Dullcoted, and a completed roof!







31. This photo shows adding the light vertical bands on the sides, with very thin gray acrylics applied with a brush just damp with paint. After several passes to attain opacity I went back with a moist Q-tip and scrubbed them to blend them in better.



32. Roof and ends on!

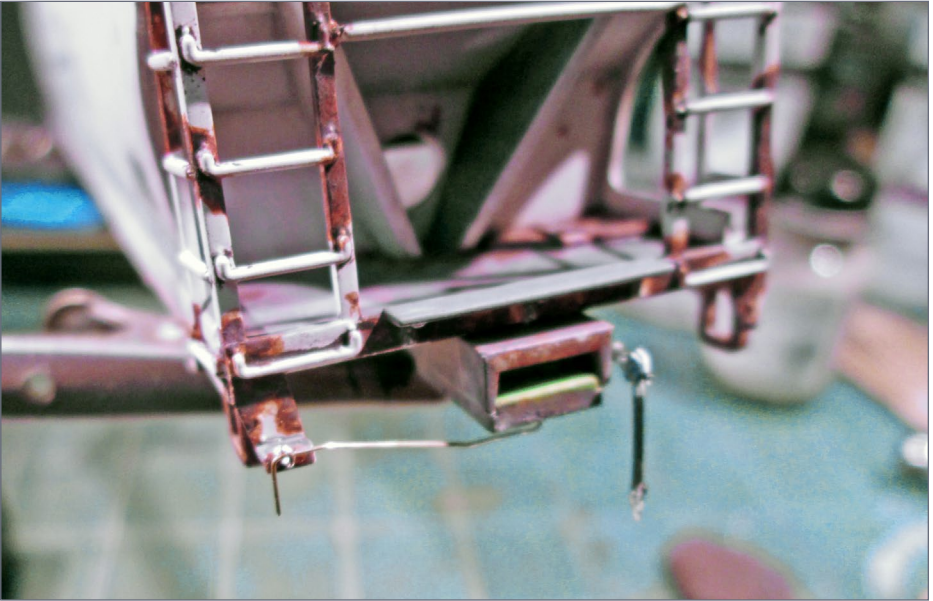

33. I added air hoses and scratchbuilt cut levers plus a detail I've seen in person – new skid plates in the coupler pockets painted fluorescent green.



This car was done as part of the rolling stock for the TrainMasters TV TOMA project layout.

*[click to learn more ...](#)*



**Click here to rate or  
comment on this article**







34, 35. The completed weathering was then Dullcoted. After that dried, I masked off for the patches. I use Tamiya masking tape for the initial mask edges but to save the good tape, I use painters tape for the bulk of the mask.



36. After masking I sprayed a gray, which happened to be the only solvent based paint I used on the model, and the second use of the ol' airbrush. This paint was chosen because I just liked the color, an old bottle of TruColor Concrete. I followed that by decaling the new road info, and applying Future acrylic floorwax (for shine) to represent fresh paint and seal in the decals.



[Click here to rate or comment on this article](#)



## WEATHERING A COVERED HOPPER | 25



37, 38. For the last step, I applied the safety stripes and stuck a fork in it – it only took 41.5 hours!

As a footnote, I use a hair dryer between every coat of paint to speed the drying process.



[Click here to rate or comment on this article](#)



## NICK CAMPBELL



As a young boy, there were many times that Nick would accompany his grandfather on various errands. On occasion, he would see a train coming and his Grandpa would pull his truck over to the side of the road. When the train roared by, shaking the truck, it always left an impression on Nick... as did the tuxedo scheme of the Southern Railroad.

Other seeds that were planted were the train sets he received as Christmas gifts from his father. From

around 5 until 11 years old this was the gift of all gifts!

After an absence from the hobby during his early adult life, he happened to randomly stop in a hobby shop near where he was living, and the train bug bit again! He was hooked and a trickle of new models (rolling stock/engines) began to find their way to his home, and a layout was started.

During the layout building phase, and a very regular internet search on model railroading questions, he stumbled upon the “Model Trains Weathered” website. Being a visual artist (oils) already, seeing these models being transformed into miniature replicas of reality was fascinating to him. Shortly after “Model Trains Weathered” went away, he found “The Weathering Shop” and its forum “The Rustbucket.” Just about every technique he has employed was found on “The Rustbucket.” The tutorials and answers to questions about how to accomplish weathering goals have been invaluable.

---









39. Nick's hopper running on the TrainMasters TV TOMA project layout. *Bob Fallowfield* photo.





# TRAINMASTERS.TV SERIES: Building a TOMA layout



Brought to  
you by



## Watch it now!



**Summer  
special:  
Join now  
and  
SAVE!**

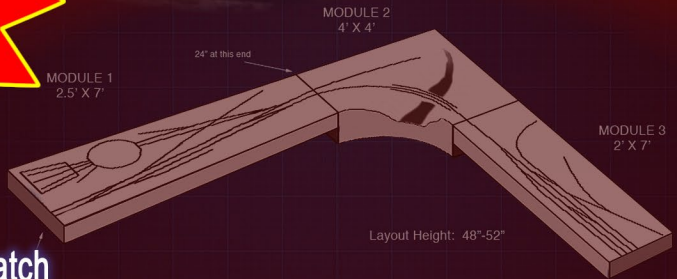

Non-members can watch  
for only \$1.49 per episode

**Visit the TrainMasters TV website**



# LOOK

column



[Click here to rate or comment on this article](#)

JOE FUGATE

## OPSIG COMPENDIUM OF MODEL RAILROAD OPERATIONS

Model railroad operation has needed a modern book on the subject for quite some time. The last such “comprehensive” treatise on all-things operation for a model railroad was Bruce Chubb’s book,

last published by Kalmbach in 1977.

This OpSIG book is hardbound and weighs in at 300 pages. The book sports many impressive full color photos of ops-oriented

1. The Operations Special Interest Group (OpSIG) just released this 300-page hardbound book on model railroad operations.

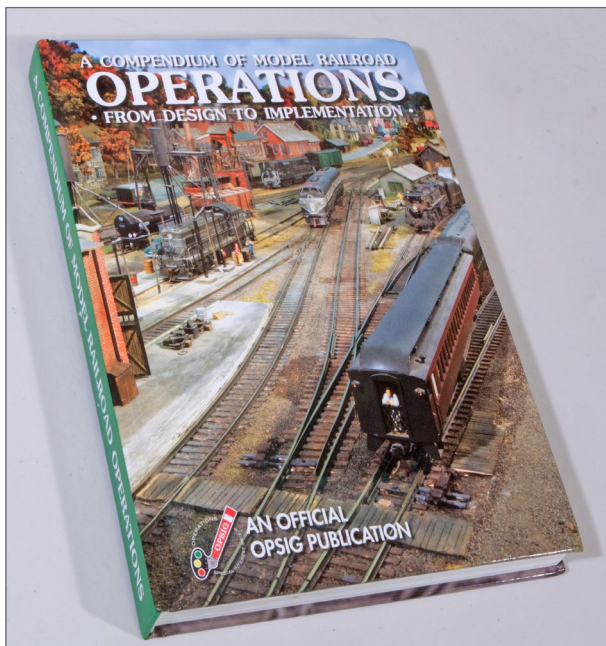

▶ NEW PRODUCT FIRST LOOK

• INDEX



SUBSCRIBE  
(free)

• TABLE OF CONTENTS



# FIRST LOOK | 2

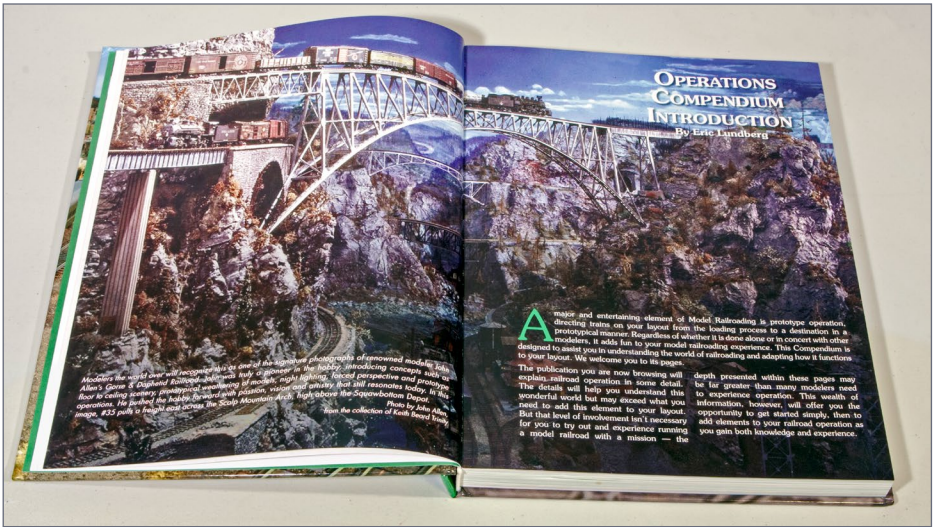

2. The OpSIG's new Operations Compendium includes many impressive full color photographs of ops-oriented layouts both past and present. This photo is of John Allen's last Gorre & Daphetid layout – John was a pioneer in many areas of the hobby and a strong proponent of realistic operations.

layouts both past and present [2]. The book also lists some of the most experienced modelers today on the subject of model railroad operation as authors [3]. The table of contents includes:

- Introduction
- What to Model and Why Operate It?
- Layout Design for Operations
- 'The Crew': Your Operating Positions
- Fundamentals of Freight Operations
- Passenger Operations
- Yard Operations
- Centralized Traffic Control & Railroad Signal Systems
- Authorizing Train Movement
- Model Railroad Communications
- Hosting An Operating Session

3. The Ops Compendium includes many contributing authors who have become “names” in model railroad-ing operation over the last 20 years. Also in this list are a few who have written on operation since the 60s and 70s. In short, a great cross-section of the most experienced modelers in the hobby on the subject of ops.

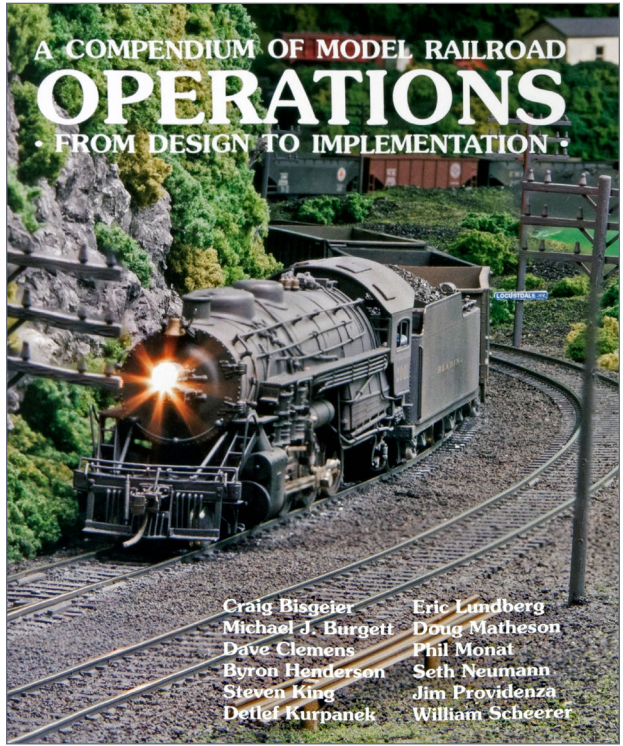

Because this book is *so comprehensive*, it may be somewhat overwhelming for an ops newcomer. For a good newbie intro to model railroad ops, I recommend Tony Koester’s book *Realistic Model Railroad Operation* - Second Edition. [Amazon: [a.co/hEM2vVe](https://www.amazon.com/dp/B000APR004)]. Then *definitely* add the **Operation Compendium** to your ops library and round out your knowledge with the most comprehensive and up-to-date book on the subject available today.

The Compendium sells for \$49.95 plus shipping, or if you’re an OpSIG member, you can save \$10 off that price. For more, see: [opsig.org/OPSigBook2.pdf](https://opsig.org/OPSigBook2.pdf)

Since a digital OpSIG membership is just \$10, maybe it’s time to join up: [opsig.org](https://opsig.org)



**Click here to rate or comment on this article**





## AMERICA'S LARGEST OPERATING MODEL RAILROAD SHOW

4 FOOTBALL FIELDS OF SERIOUS TRAIN ENTHUSIAST FUN

## TRAIN FUN FOR EVERY GAUGE OF RAILFAN

- 70 Detailed Operating Railroads
- 56 "How to" Clinics
- 75 Demos
- 60 Manufacturers – All the Majors & Cottage Industries too
- 50 Hobby Dealers
- 12 Train Historical Societies
- **NEW** "All Rail" Photo Contest

## MODELER'S DELIGHT

EXPERT MODELERS HOST 56 **FREE** CLINICS

A wide range of clinic topics will challenge every modeler skill level. Clinics are free with admission and held daily during Trainfest. Space is limited; register today at [trainfest.com](http://trainfest.com).

## NEW PRODUCTS UNVEILED

If a manufacturer is making a new product, they announce it at Trainfest – the nation's premiere train show. Make sure to visit all the manufacturers to see this year's new and exciting products and skills.

*New!*  
**1/2-PRICE  
 TICKETS**  
 NOW THROUGH 7/30/17  
 AT [TRAINFEST.COM](http://TRAINFEST.COM)  
 USE PROMO CODE  
**mrh2017**



# Trainfest

SATURDAY &amp; SUNDAY · NOV. 11 - 12, 2017

9AM - 5PM · MILWAUKEE · WI STATE FAIR PARK

**RUN THE  
 TRAINS  
 ON MOST  
 LAYOUTS!**

**Trainfest**<sup>®</sup>  
 America's Largest Operating Model Railroad Show

## GREAT FAMILY EVENT OF HUGE OPERATING RAILROADS, PLUS...

- Kid-Friendly Activities
- Kids-Only Make 'n Take
- Clinics & Demos to Get Started in Modeling
- Become a Jr. Engineer
- Ride the MLES Train on 600 ft. of track

## CELEBRATE THE SOO LINE

Trainfest is partnering with the Soo Line Historical Assn. to celebrate the Soo Line. We've created a spectacular 32-panel display on the railroad. Manufacturers will have Soo Line merchandise and layouts will be running the Soo. A limited-edition Soo Rolling Stock Freight Car is offered through [trainfest.com](http://trainfest.com). Reserve yours today to pick up at Trainfest.



Sponsored by the  
 WISE Div of the  
 National Model  
 Railroad Association

SHOW DETAILS, DISCOUNT TICKETS & LODGING DEALS AT [TRAINFEST.COM](http://TRAINFEST.COM)

• INDEX

• TABLE OF CONTENTS

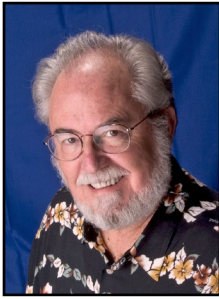

# AUGUST NEWS

column

RICHARD BALE *and* JEFF SHULTZ



[Click here to rate or comment on this article](#)

## Model Retailer Ends Publication

Kalmbach Publishing has announced that *Model Retailer*, a trade magazine targeted at hobby store operators, will cease publication at the end of this month. The magazine has been published monthly since its introduction in 1975. The change reflects the evolutionary change in communications as well as in how consumers purchase hobby products ...

## NEW CLUB CARS

The **Amarillo Railroad Museum** and the **Missouri Pacific Historical Society** are selling two American Refrigerator Transit ice refrigerator cars decorated in the iconic 1936-1948 paint schemes that were applied to the 24300 series cars. Although the application of the single herald (above) ended in

▶ THE LATEST MODEL RAILROAD PRODUCTS, NEWS & EVENTS





# AUGUST NEWS | 2



1948, the cars were repainted slowly, and it was not uncommon to spot this scheme on cars operating in the late 1950s.



ART cars with three full-color heralds numbered in the 32000 series are also available. Multiple road

numbers are available for both reefers. The ready-to-run HO scale models were produced for this project by InterMountain Railway. For complete details go to [amarillorailmuseum.com](http://amarillorailmuseum.com).



**The Providence Northern Model Railroad Club** is selling a kit for a Rhode Island & Massachusetts

class X31 wagon top boxcar. The HO scale custom decorated model was produced for PNMRC by Bowser. The kit comes with metal wheelsets and Kadee compatible couplers. This is a fantasy design loosely based on a railroad that existed around 1900. For additional information visit [providencenorthern.com/pn-store](http://providencenorthern.com/pn-store).

# NEW PRODUCTS FOR ALL SCALES

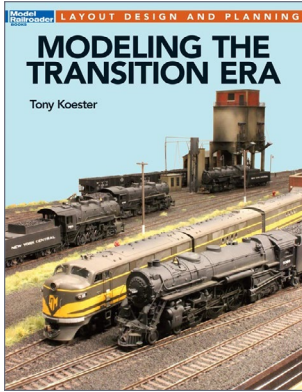

Tony Koester's latest effort is titled *Modeling the Transition Era*, in which he offers an in-depth look at the 1940s and 1950s time period when railroads were replacing their steam locomotives with diesels. Various surveys have confirmed that this is also the most popular modeling era. Key points covered by the author include: an overview of the period, why diesels replaced steam, types of railroad

equipment in use at the time, and a look at the operation of a typical transition-era railroad. The 112-page softbound book is illustrated with a balance of model and prototype photographs. **Kalmbach Publishing** has scheduled the release of the book for November 1, 2017.

.....

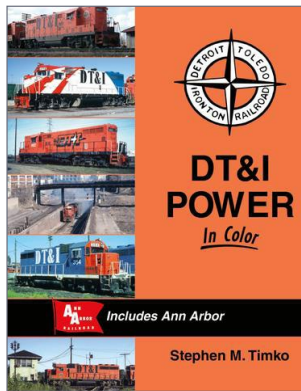
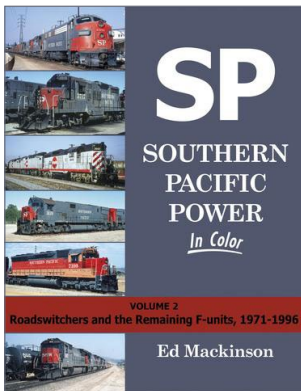

New hardback publications scheduled for release this month from **Morning Sun Books** include *Southern Pacific Power, Volume 2, Road Switchers and F-Units 1971-1996*, by Ed Mackinson,

and *Detroit, Toledo & Ironton Power*, by Stephen M. Timko. For more information contact a dealer or visit [morningsunbooks.com](http://morningsunbooks.com).

.....



## AUGUST NEWS | 4

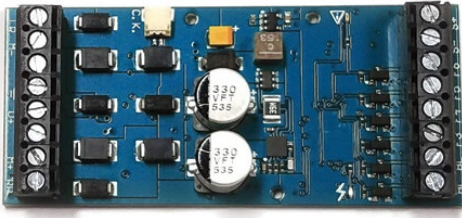

**SoundTraxx** has introduced the Tsunami2 TSU-4400, a universal-type 4 amp digital sound decoder with six function outputs. The decoder measures 69x30.5x14 mm. It

is available for steam, diesel or electric applications. The TSU-4400 is designed for models with high stall currents such as some S, O, and smaller large-scale locomotives. Features include terminal blocks for solder-free wiring, a high-power audio amplifier for enhanced volume, Hyperdrive2 advanced motor control, and simplified function mapping using SoundTraxx Flex-Map technology. An expanded library of sounds is available including new prime movers and exhaust chuffs. The TSU-4400 also features Dynamic Digital Exhaust in all versions - steam, diesel or electric. Steam versions contain over 60 whistles, while diesel versions have upwards of 40 horns and as many as nine prime movers available in each version.

SoundTraxx has also updated the Tsunami SoundCar product with new sounds, including BeastBanter livestock sound effects of cattle and sheep. For additional information contact a dealer or visit [soundtraxx.com](http://soundtraxx.com).

## O SCALE PRODUCT NEWS

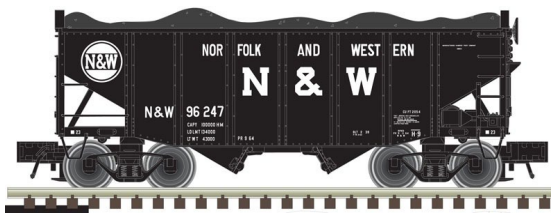

represents a 1930s-era car that saw service into the diesel age.

**Atlas O** plans to release its 55-ton twin-bay coal hopper car with new paint schemes during the first quarter of next year. The O scale model

## AUGUST NEWS | 5

Features of the ready-to-run model include a removable coal load and Bettendorf sprung trucks. Cars with peaked ends will be available decorated for Akron, Canton & Youngstown; and Norfolk & Western. Models decorated for Delaware & Hudson, Reading, and Chessie System (WM) will have flat ends. Undecorated models are included in the release.

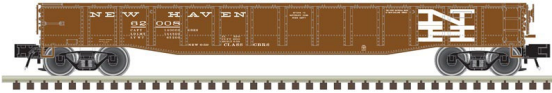

Also coming from Atlas O in the first quarter of 2018 is an ACF 52-foot 6-inch mill gondola. The Trainman series model will have metal couplers, sprung diecast trucks, and separately applied brake wheel, brake lines, and ladders. Road names will be New Haven, Canadian National, CSX, Illinois Central Gulf, and Missouri Pacific. All Atlas O rolling stock is available with trucks and couplers appropriate for 2-rail or 3-rail operation. For additional information contact a dealer or visit [atlaso.com](http://atlaso.com).

.....



**B.T.S.** has released O scale kits for the Hyde Park Mill. The complete industrial complex is composed of seven craftsman kits which allows hobbyists to build the model as time and budget allow. Each of the kits can also be built as stand-alone projects or in combination with other industries. Modelers who plan to build the entire complex are advised to start with the Dock (#14095.6) and Shipping/Storage Building (#14095.3) as these structures are





# AUGUST NEWS | 6

critical for setting the track positions for all of the buildings. For complete details visit [btsrr.com/bts4095.htm](https://btsrr.com/bts4095.htm).



**Rusty Rails** has introduced an O scale Bulk Fuel Tank that is produced on a 3D printer. The tank is available with or without the stand for hobbyists who want to build their own scene. The castings are sold unpainted. The figure is not included.

For additional information visit [rustyrail.com](https://rustyrail.com).

## S SCALE PRODUCT NEWS



**Monster Modelworks** has released a Railway Express Agency background flat kit in S scale. Measuring 14- long x

3.25- wide x 4.5-inches high, the kit includes 3D laser engraved aged American brick and aged brick corners, a laser-cut freight door, peel & stick windows with glazing, pre-cut bracing, and 3D printed detail parts. For more information visit [monstermodelworks.com](https://monstermodelworks.com).

## HO SCALE PRODUCT NEWS



**Accurail** has released three new kits for HO scale boxcars including this Union Pacific 40-foot steel

# AUGUST NEWS | 7

car with both a plug door and a sliding Youngstown door. The model follows a prototype built in 1959 and includes the *Be Specific - Ship Union Pacific* slogan.



This DL&W Lackawanna 50-foot insulated steel boxcar with a plug door is available now as an HO scale kit from Accurail.

The prototype was built in 1959 with riveted sides and included full height ladders and a running board.



This 50-foot Southern Railway insulated steel boxcar features welded sides and a plug door. Accurail's HO scale kit

is based on a 1968 prototype that was shopped in 1978. All Accurail kits come with Accumate knuckle-compatible couplers and appropriate trucks. For more information contact a dealer or visit [accurail.com](http://accurail.com).

.....

**American Model Builders** sells a wide selection of laser-cut acrylic windows for locomotives and rolling stock. Accurate, computer-designed window sets are available for most popular brands of locomotives, cabooses, and passenger equipment including Athearn, Atlas, Bowser, Branchline, Rivarossi, Kato, Model Die Casting, and Walthers. For more information visit [laserkit.com](http://laserkit.com).

.....

**Artitec** produces a variety of HO scale models of both American and European commercial and military vehicles. Many of their products are ideal for use on model railroad



## AUGUST NEWS | 8



layouts. The Fordson tractor and forklift truck shown left are available as resin kits with etched metal details.



The American Bulldozer and Bucyrus shovel-excavator are available assembled and professionally

hand-painted. Artitec models are available in North America from Reynaud's Euro Import, Elburn, IL. For additional information visit [reynaulds.com](http://reynaulds.com).



**Athearn** has added Vermont Railway (above) and Providence & Worcester decorating schemes to the list of SD70M-2 diesel locomotives scheduled for release next May. The HO scale models are based on ex-FEC units with a high mounted headlight, front and rear illuminated ditch lights, early handrail configuration, and early non-isolated cabs. Two road numbers are available for each road. The models are available in primed-for-grime paint with faded base colors and patches to match the prototypes.

# AUGUST NEWS | 9



Athearn plans to release another production run of its EMD GP38-2 locomotive next June. The Genesis series model will be available decorated for Penn Central, Rock Island (powder blue scheme with ECAFB cabinet), Frisco (St. Louis–San Francisco), Burlington Northern (patch on Frisco scheme, above), Southern Pacific (sunshades and housing for extended range dynamic brakes), and Illinois Central (black scheme with Operation Life Saver slogan, below).

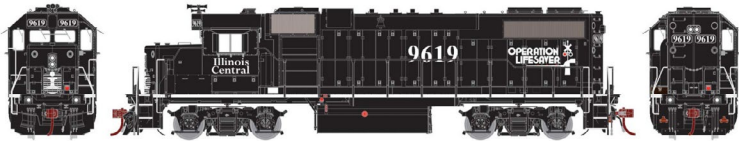

A high-hood version will be available decorated for Norfolk Southern which operated the prototype with the long hood forward.



All Athearn Genesis sound-equipped locomotives feature an onboard DCC decoder with SoundTraxx Tsunami2 sound. The sound unit will operate on both DC and DCC layouts. DC-only models are DCC-ready with both 8- and 9- pin connectors to simplify installation of an after-market decoder.

Also coming from Athearn next June is another round of GATX TankTrain cars. The production run will include GATX 23,000-gallon tank cars with new Barber-Scheffel 100-ton trucks, an experimental self steering design that was intended





# AUGUST NEWS | 10



to help alleviate rail wear. These will be the first Barber-Scheffel trucks available in HO scale. Patched GATX cars will be available as well as a pair of white GATX cars.



The models come in 3-packs with one intermediate and two end cars. The white version will be available in a 2-pack. An unnumbered intermediate car will be included in the release.

Athearn's June 2018 production schedule includes HO scale Ready-to-Roll EMD SD50 diesel locomotives.



In addition to the Chicago & North Western scheme shown here, road names will include Union Pacific, CSX, Chessie System (B&O), and Norfolk Southern.



Although Erie-Lackawanna and Northern Pacific never owned or operated SD50s, those two road names will be available under Athearn's "What-if" fantasy schemes. All Athearn Ready-to-Roll locomotives are available for DCC operation with Onboard Econami Sound by SoundTraxx. Models for standard DC operation with DCC-ready capability are also available.

# AUGUST NEWS | 11

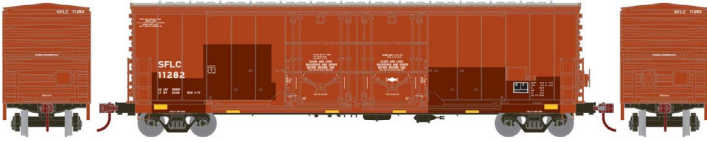

HO scale versions of Evans 50-foot double plug door boxcar are also scheduled for release next June. The Ready-to-Roll models feature separately applied end ladders and brake wheel, machined metal wheelsets, and knuckle couplers. Road names will be Santa Fe Leasing (above), Hartford & Slocomb, Multnomah Plywood, Wickes Agriculture, Southern Pacific, and Evans Railcar Leasing.



Additional road names include two versions of Wisconsin & Southern - Sargento Cheese, and four patriotic themes for Wisconsin & Southern.

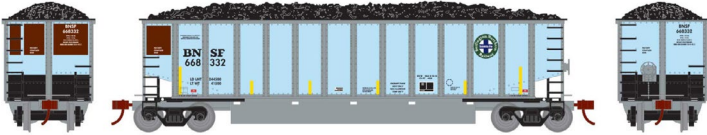

Athearn's June 2018 production schedule concludes with a run of Bethgon Coalporters. The HO scale models feature a removable coal load, separately applied formed wire grab irons, etched metal coupler platforms, machined metal wheelsets, and knuckle couplers.

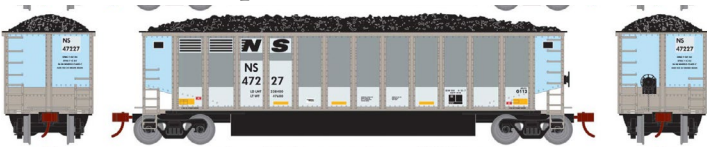

The cars will be decorated in Athearn's primed-for-grime scheme with faded base colors. Road names will be



# AUGUST NEWS | 12

Conrail, CSX, First Union Rail, Union Pacific, Norfolk Southern, and two BNSF schemes. For additional information on all Athearn products contact a dealer or visit [athearn.com](http://athearn.com).

.....



**Atlas** has scheduled the release of HO scale Thrall 53-foot articulated well cars for the first quarter of 2018. The triple-unit model is based on a prototype introduced in 2000. Spotting features include angular wheel cut-outs, and three flared-bottom wide and eight narrow side posts. In addition to the TTX scheme shown, road names will include TTX ex-BRAN (blue, white and red), BNSF-SFLC (blue, white and red), and WRWK-Providence & Worcester (blue, white and red).



A 2018 first quarter release has also been scheduled for a new production run of 53-foot CIMC and Jindo corrugated steel containers.

The side corrugations are arranged in an 8-55-8 configuration. Decorating schemes will include HUB Group (Norfolk Southern), CSX, North American Container System, EMP, UMAX (UP-CSX), and Florida East Coast. For additional information on all Atlas products contact a dealer or visit [atlasrr.com](http://atlasrr.com).

.....

**Bowser Trains** is booking advance orders for a new HO scale 70-ton 14-panel triple-bay coal hopper. Delivery is planned for next March. Six road numbers will be available for cars

# AUGUST NEWS | 13

.....



decorated for Burlington Northern (ex-GN), C&O Chessie, Clinchfield, Delaware & Hudson, Erie Lackawanna, and Santa Fe.



Four road numbers each will be available for Detroit, Toledo & Ironton; CSXT-Chessie, Pittsburgh & Lake Erie, and Caso-Canada Southern. All Bowser ready-to-run models come with metal wheelsets and knuckle couplers. For additional information on all Bowser products contact a dealer or visit [bowser-trains.com](http://bowser-trains.com).

.....



New models coming from **Broadway Limited Imports** this month include an Alco RSD-15 diesel locomotive. The HO scale model replicates a 2,400-hp prototype built in the late

1950s. In addition to the Southern Pacific bloody-nose scheme shown, the ready-to-run model will be available decorated for Quebec Cartier Mining, Squaw Creek, Utah Railway, and two Santa Fe versions: zebra stripes and yellow bonnet. A high-nose RSD-15 decorated in PRR Brunswick green with a train-phone antenna will also be available. All versions of the model feature the BLI Paragon2 Sound/DC/DCC Control System.

Pennsylvania Railroad class M1a and M1b 4-8-2 Mountain steam locomotives are also scheduled for release from BLI this month.







The M1 group was considered to be among the best of the Pennsy's steam locomotives. They were designed as

dual service locomotives and during their long career hauled passenger trains, general freight trains, and in the end, even heavy ore trains. Four road numbers each will be available for pre-war and 1946 post-war versions of the iconic PRR locomotive. BLI's feature-laden HO scale version comes with Paragon3 Sound/DC/DCC Control System. For additional information on all BLI products contact a dealer or visit [broadway-limited.com](http://broadway-limited.com).

.....



**Central Valley Model Works** has introduced a new kit for an HO scale 200-foot single track steel truss bridge.



The model is composed of injection molded high-impact styrene plastic parts. For additional information contact a dealer or visit [cvmw.com](http://cvmw.com).

.....

**Chooch Enterprises** continues to expand its selection of flexible pre-weathered scenic wall material. The latest offering is for blasted rock walls pre-weathered in three natural shades. The flexible material is approximately 3.5x11.5 inches. A video

# AUGUST NEWS | 15

demonstrating the use of the material can be viewed at [chooch-enterprises.com/blastedrockwall.html](http://chooch-enterprises.com/blastedrockwall.html).



**Fos Scale Models** has introduced a new HO scale craftsman kit called Murdock Fasteners. The kit builds into a shallow background structure with a footprint of just 2.25 inches square. Components in the kit include laser-cut clapboard walls, plastic windows, a laser-cut door, metal detail parts, appropriate signage, and assembly instructions. For additional information go to [fosscalemodels.com](http://fosscalemodels.com).



**InterMountain Railway** has released its new HO scale version of General Electric's

Tier 4 GEVO ET44AC locomotive. Available road names include BNSF, Canadian National, CSX, Norfolk Southern, and Union Pacific. Six road numbers are available for each road except NS which is limited to four numbers.

A few of the features of the ready-to-run model include correctly sized ditch lights, rotating bearing caps on trucks, see-through etched metal grilles and walkway steps, accurate brake and truck



# AUGUST NEWS | 16



chains, and road specific roof antennas.



InterMountain plans to release a new production run of A-line 40-foot corrugated containers

next spring. Reservations are due August 31. The containers will be available in 2-packs. New road names include Beacon/Horizon Lines-BMOU, Container Association Rotterdam-CARU, Hyundai-HDMU, Mitsui OSK Lines-MOFU, NYK Logistics-NKYU, and Safmarine-MKRU.



Popular road names being reissued with new numbers include Evergreen-EMCU, Hamburg

SUD-SUDU, K-line-KKFU, Orient Overseas, P&O Nedloyd-PONU, and Uniglory-UGMU. For additional information on all InterMountain Railway products contact a dealer or visit [intermountain-railway.com](http://intermountain-railway.com).

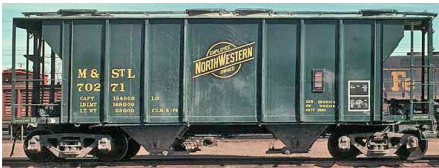

**Kadee** is working on two new HO scale freight cars for release in December. They include a PS-2 twin-bay covered hopper decorated for M&STL

-Minneapolis & St. Louis. The prototype was built in 1955 and received the green paint job shown here in April of 1974.

The second model, scheduled for release just in time for Christmas, is a Boston & Maine PS-1 50-foot steel boxcar with a 9-foot

# AUGUST NEWS | 17



Youngstown sliding door. The ready-to-run HO scale model is based on a prototype built by Pullman-Standard in 1956 and shipped in 1977. Both models will come with Kadee two-piece self-centering trucks, and Kadee #2100 scale knuckle couplers. For additional information contact a dealer or visit [kadee.com](http://kadee.com).



**KatoUSA** has added a baggage car to its lineup of Phase IVb Amtrak cars. HO scale Superliner cars available from Kato now include a coach, lounge, diner, Phase III and IVb sleepers, coach-baggage combination, material handling car, and the newly announced baggage car. The head end car is available in two road numbers and includes Kato's Kinematic coupling unit that permits prototypically close coupling while still navigating tight radii curves. For additional information on all KatoUSA products contact a dealer or visit [katousa.com](http://katousa.com).



**Mt. Albert Scale Lumber Co.** has released a limited edition lumber yard kit. The kit includes three structures, a 3D printed cut-off saw, a Sylvan 2-ton Chevy flatbed truck kit, and Faller, Grandt Line & Tichy Train Group detail parts. Wood parts





# AUGUST NEWS | 18

are laser cut, and construction jigs for pallets and fencing are included. The footprint as pictured above is 10x10 inches. Only 120 kits will be produced. Mt. Albert Lumber Co. products are produced by FastTracks. More information is available at [handlaid-track.com](http://handlaid-track.com).



sizeable fleets of the SW1200RS, and while the locomotives were internally identical, units from each road had numerous differences in details and arrangement of external appliances. Rapido says it is committed to replicate all of them. Each road name will also be offered with details reflecting differences in eras.



The undecorated CN model will be supplied with three different cabs. The ready-to-run models will be available for standard DC operation and with DCC sound featuring an ESU LokSound decoder with authentic SW1200RS recordings. The order deadline is September 15 with delivery planned for early in 2018.



**Rapido Trains** has announced plans to produce the Canadian-built GMDD SW1200RS diesel locomotive in HO scale. The Canadian National and Canadian Pacific Railway both owned

The SW1200RS will be available in six different Canadian Pacific paint schemes and four Canadian National schemes. Unnumbered and undecorated models will come with a range of details. The

Rapido has also announced plans to move forward with their HO scale version of a Budd stainless steel mid-train dome car. The

# AUGUST NEWS | 19

project was originally announced three years ago but has been on hold for an extended period of time. The ready-to-run model will feature Rapido's realistic stainless steel finish. Road names on the first release will be Canadian Pacific, Delaware & Hudson, Missouri Pacific, and unlettered.



Additional features include individual grab irons, full underbody detail with air, steam and electrical lines, fully decorated interiors, window blinds at different heights, interior lighting, operating

diaphragms with etched-metal end gates, and metal knuckle couplers. A 22-inch minimum radius is recommended for reliable operation. A release date has been tentatively set for the first half of 2018. For additional information on all Rapido products contact a dealer or visit [rapidotrains.com](http://rapidotrains.com).



**Tangent Scale Models** has released an HO scale General American 8,000 gallon insulated radial-course tank car. The ready-to-run model replicates a 1917 GATC design that continued in

service to the early 1970s. Spotting features of the cars include recessed ends and circumferential rivets that surround the tank body with a noticeable height differences between the courses. The prototype carried a wide range of lading including gasoline, wine, and corn products.



Features of the Tangent model include KC or AB brake variations, Cardwell draft sill springs, different hand brakes, see-through bolster



## AUGUST NEWS | 20

section, CNC metal wheelsets, and Kadee knuckle couplers. Decorating schemes available now include Roma Wine-GATX (circa 1940), Virginian Gasoline -VGOX (circa 1933), and Warren, Tulsa, Okla (circa 1950).



For additional details including extensive prototype information and ordering instructions visit [tangentscalemodels.com](http://tangentscalemodels.com).

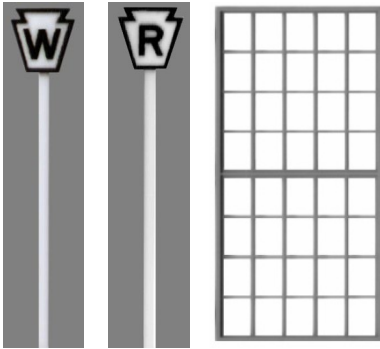

**Tichy Train Group** has released three new HO scale products. They include a PRR Keystone whistle post and a PRR Keystone ring sign. In municipalities where the use of a whistle at grade crossings was prohibited, a ring sign was used to instruct trainmen to warn of their approach by ringing the locomotive's bell. Also

new is a 40 pane window for masonry buildings. For additional information visit [tichytraingroup.com](http://tichytraingroup.com).

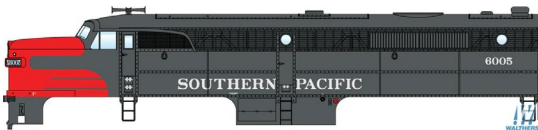

**Walthers** is scheduled to release an impressive assortment of HO scale diesel locomotives in the

coming months. Heading the list are Alco PA and PA-PB sets. In addition to the SP scheme shown, the HO scale ready-to-run model will be available decorated for Santa Fe (red and silver warbonnet scheme), Pennsylvania Railroad (Tuscan red with five stripes), and Union Pacific. Features of the economy-priced Mainline series model includes a working Mars light on A units

## AUGUST NEWS | 21

and molded drill starter points for installation of individual metal grab irons (sold separately). The model will be available for standard DC operation and with factory-installed DCC SoundTraxx Sound. Availability is expected late this month.



Walthers Proto series EMD F7A and F7A-B sets

are scheduled for release in September. The HO scale models will be available decorated for Burlington Northern (Cascade green), Canadian National, C&O, Union Pacific, and Santa Fe. As shown, the ATSF warbonnet scheme follows prototype practice of the 1956 Super Chief and the 1954 edition of the El Capitan. All models in this release will have factory-installed DCC SoundTraxx Sound.

Walthers has scheduled an October release for its Mainline series GE ES44AC locomotives. The HO scale ready-to-run model features several road specific details to match the practice of the prototype road being modeled. Worth noting are the high or low headlight positions, and three different truck styles: standard high-adhesion, steerable, and C4 A1A center idler axle. This Mainline model has molded drill starter points for installation of metal grab irons which are available separately. Road names will be BNSF, Canadian National, Canadian Pacific, CSX (blue scheme with boxcar logo), Norfolk Southern (horse head scheme), Union Pacific, and undecorated.

Also scheduled for release in October is a run of EMD F7A and A-B sets. The Mainline series models will be available decorated for Chicago, Burlington & Quincy; Santa Fe (blue and yellow with cigar band logo on nose), Canadian Pacific (maroon, yellow and





## AUGUST NEWS | 22

gray scheme), Pennsylvania Railroad (Brunswick green with single stripe), Southern Pacific (black widow scheme), and Southern Railway (green and aluminum). All Walthers Mainline series locomotives are available for standard DC operation or with factory-installed DCC SoundTraxx Sound.



Walthers has set a December release date for a limited run of EMD E8A and E8A-A locomotives decorated in the Broadway Limited scheme. The Proto series model will be released with both standard DC and factory installed DCC SoundTraxx Sound. Selected road numbers are already sold out. Check your dealer for availability.



New HO scale ready-to-run freight cars coming from Walthers this month include this Mainline series 50-foot

Evans boxcar. The smooth side prototype has a 10-foot sliding door and is rated at 70 tons. Walthers has upgraded the tooling on this model with the addition of door gussets and thinner stirrup steps. In addition to Illinois Central, road names will include U.S. Army, Boston & Maine, Burlington Northern, Conrail, and Rock Island.



Walthers plans to release a Proto series 53-foot 6-inch AAR flat car this month. Introduced just prior to WWII, the AAR prototype was based on Union Pacific's class F-50-11 cars. Some cars

# AUGUST NEWS | 23

remained in service into the 1980s. Road names will be Elgin, Joliet & Eastern; Chessie System C&O, Chicago & North Western, Denver & Rio Grande Western, Union Pacific, and Western Maryland. For additional information on all Walthers products contact a dealer or visit [walthers.com](http://walthers.com).

.....

## N SCALE PRODUCT NEWS



**Athearn** is developing N scale versions of the GATX TankTrain cars. Delivery is planned for June 2018. The production run will include GATX 23,000 gallon tank cars with new Barber-Scheffel 100-ton trucks, an experimental self steering design that was intended to help alleviate rail wear. Patched GATX cars will be available as well as a pair of white GATX cars.



The models come in 3-packs with one intermediate and two end cars. The white version will be available in a 2-pack. The release will include an unnumbered intermediate car. Features include photo-etched metal walkways and end platforms, wire safety rails and end handrails, printed placards, screw mounted trucks, and body-mounted knuckle couplers.



Athearn's June 2018 production schedule includes a run of Bethgon Coalporters. The N scale models feature a removable coal load,



# AUGUST NEWS | 24

separately applied formed wire grab irons, 36-inch wheelsets, and knuckle couplers.



The cars will be decorated in Athearn's primed-for-grime paint with faded base colors. Road names will be Conrail, CSX, First Union Rail, Union Pacific, Norfolk Southern, and two BNSF schemes. For additional information on all Athearn products contact a dealer or visit [athearn.com](http://athearn.com).

.....



**Atlas** plans to release its 55-ton twin-bay hopper with new road numbers and paint schemes during the first quarter of next year. The N scale model represents a 1930s-era car that continued in revenue service well into the diesel age. The ready-to-run model comes with a removable coal load, solid-bearing trucks, and Accumate knuckle couplers. Cars with peaked ends will be available for Akron, Canton & Youngstown; Norfolk & Western, and Atlantic Coast Line. Models decorated for Delaware & Hudson, Reading, and Western Maryland will have flat ends. Undecorated versions and cars decorated with data only will also be available.



New N scale models coming from Atlas during the first quarter of 2018 include this 70-ton ore car. Road names for the Trainman series ready-to-run

# AUGUST NEWS | 25

model will be Birmingham Southern, Canadian National, Missabe “Mini Quad,” Canadian Pacific, Long Island, and Duluth, Missabe & Northern. For additional information on all Atlas products contact a dealer or visit [atlasrr.com](http://atlasrr.com).

.....

**Centralia Car Shops** is planning a new production run of its N scale lightweight baggage cars. Delivery is expected next February or March. Road names will include Chicago, Burlington & Quincy; Amtrak, Burlington Northern, Canadian National, Chicago Great Western, Chicago North Western, Delaware & Hudson, and Illinois Central. Features of the ready-to-run model include wire grab irons, interior lighting, and truck mounted knuckle couplers. InterMountain Railway is responsible for marketing Centralia Car Shops products. For additional information contact a dealer or visit [intermountain-railway.com](http://intermountain-railway.com).

.....



New N scale items being released this month by **KatoUSA** include a pair of baggage cars decorated in Amtrak’s Phase I scheme.



Amfleet I cars released this month include a coach and café car. Both cars are decorated in Amtrak Phase VI scheme. For additional information on all KatoUSA products contact a dealer or visit [katousa.com](http://katousa.com).

.....





# AUGUST NEWS | 26

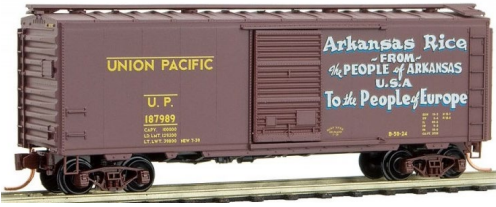

**Micro-Trains Line** has released four new N scale boxcars including a 40-foot Union Pacific car decorated for the 1947 Friendship Train. The unique paint

scheme called attention to the national program during which Americans donated food to the people of France and Italy who desperately needed help following the end of World War II. Ultimately, over 250 railcars of food and clothing were donated.



This 50-foot Gulf, Mobile & Ohio boxcar with a 10-foot Youngstown sliding door represents a Pullman-Standard car built in 1968

with a Hydroframe draft gear cushioning system and Evans DF-2 interior belt rails.



This Santa Fe model is based on a 50-foot car built by Pullman-Standard in the 1950s. In a 1979 rebuild it lost its running board but

received plug doors and roller bearing trucks.



The fourth new N scale boxcar from Micro-Trains Line is a 50-foot Denver & Rio Grande Western car with double Youngstown sliding

doors. The model is based on a prototype Pullman-Standard built in the late 1960s. For additional information on all Micro-Trains Line products contact a dealer or visit [micro-trains.com](http://micro-trains.com).

## AUGUST NEWS | 27

.....



**The N Scale Architect** is producing Picker's Paradise, the 10th kit in their Tracksides Series. The kit features two re-purposed TOFC trailers, five inches of photo-etched fence, a laser-cut office, and two concrete trailer platforms and stairways, as

well as many other details and signs. The completed kit measures approximately 4x2.75x1 inches. More information can be found at [thenarch.com](http://thenarch.com).

.....



**Rapido Trains** has announced plans to produce an N scale version of the famous United Aircraft TurboTrain.

The TurboTrain was a high-speed intercity passenger

train that operated in Canada and the United States from the 1960s to the 1980s. It was powered by gas turbine engines and holds the record for the fastest production train in North American history. It regularly achieved speeds from 140 to 160 MPH. The cars featured a unique pendular suspension above articulated single-axle trucks, which allowed the train to tilt in curves. That feature, combined with the short car length, meant that the Turbo could travel much faster than regular trains on conventional track. It was a high-speed train without the need to invest in high-speed train infrastructure.





Rapido's N scale version will have full interior details. Decorating schemes will include United Aircraft, Penn

Central/DOT, Amtrak (early and late schemes), Canadian National, and VIA Rail Canada. Reservations are required by September 15, 2017 with delivery planned for late next year.



Rapido is adding 8600-series stainless steel coaches to its growing assortment

of N scale models based on New Haven prototypes. Features will include accurately profiled Pullman-Standard stainless steel fluting, Rapido's stainless steel finish, full underbody detail, separate grab irons, and interior details.



Additional features include battery-powered interior lighting, and new 41-BNO-11 high-speed passenger trucks with outside

swing hangers. The cars will have partial skirting or no skirting as appropriate to the prototype being modeled. Decorating schemes available on the initial release will be New Haven (three variations), Penn Central, MBTA-Boston, and stainless steel but unlettered. The order deadline is September 15 with delivery planned for late this year. For more information on all Rapido products contact a dealer or visit [rapidotrains.com](http://rapidotrains.com).

# AUGUST NEWS | 29



**ScaleTrains.com** has announced plans to produce an N scale version of General Electric's Tier 4 GEVO ET44C4 locomotive. Reservations are being

booked now with delivery planned for this coming winter. Road names will be BNSF, Union Pacific, CSX, Canadian National, General Electric Demo scheme, and Norfolk Southern.



Features of the new Rivet Counter series model include directional LED headlights, lighted number

boards, operating alternating ditch lights, battery charging receptacle details on front and rear pilots, cab roof antenna dome, wire grab irons, GE Hi-Ad trucks with separately applied details, window in nose door, interior cab details, tinted cab windows, 5,300 gallon fuel tank with external waste retention tank, and body-mounted semi-scale E Type knuckle couplers. DCC and sound equipped models come with ESU-LokSound Next18 Select Micro DCC and a sugar cube-type speaker. For additional details visit [scaletrains.com](http://scaletrains.com).

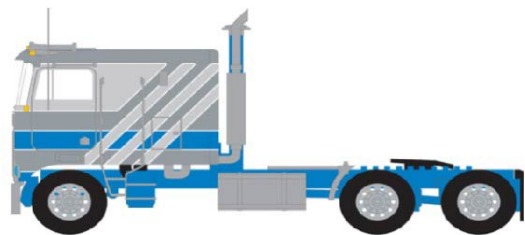

**Trainworx** plans to release N scale Kenworth W900 and K100 sleeper trucks during the first quarter of 2018. The release includes a variety

of sleepers and colors. Dealer reservations are being handled





# AUGUST NEWS | 30

through InterMountain Railway. For additional information contact a dealer or visit [intermountain-railway.com](http://intermountain-railway.com).



**Wheels of Time** has announced a Pacific Car & Foundry 70-ton 50-foot exterior post insulated boxcar in N scale.

Produced in a variety of capacities from 4400 to 5033 cu. ft., they featured cushioned underframes and load restraining devices from Car Pac or DF Evans. Models will be equipped with Youngstown or Landis plug doors as appropriate. Road names in the first release include Santa Fe, D&RGW, Frisco, Missouri Pacific, Penn Central, Nestle (TNCX), and Helm-Pacific Leasing. Pre-orders are due for these models by August 9, 2017 with delivery expected in the fourth quarter of 2017. For more information see your dealer or [wheelsotime.com](http://wheelsotime.com).

## NEW DECALS, SIGNS AND FINISHING PRODUCTS



**Black Cat Publishing** is selling HO scale waterslide decals to correctly model this Napierville Junction 50-foot plug door boxcar. (Item NJ #806).

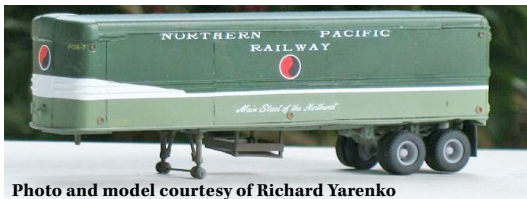

Photo and model courtesy of Richard Yarenko

For those who model in N scale, Black Cat has a lettering set for an early Northern Pacific



# AUGUST NEWS | 32

They include UP G-50-11 GS gondolas circa 1943 (above left), and 1956 UP G-50-11 GS gondola with 20-inch road name.

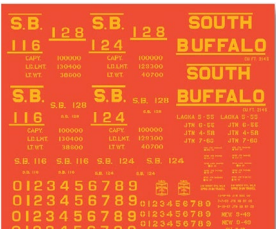

Also new is an O scale lettering set for a South Buffalo 70-ton twin-bay hopper car with offset sides. For additional information go to [protocraft.com](http://protocraft.com).

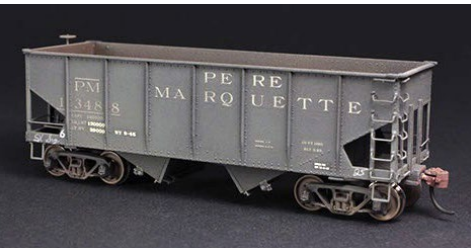

**Smoke Box Graphics** offers a limited selection of thin film HO scale railroad decals. This Pere Marquette USRA hopper car was decorated using letters from set DF0187 which includes enough material to

decorate up to five PM freight cars dating from the mid-1930s through the mid-1960s. These are high quality silk screened water slide decals produced in Italy by Cartograf. For more information including ordering instructions visit [smokeboxgraphics.com/decals.html](http://smokeboxgraphics.com/decals.html).



**Click here to rate or comment on this article**



## SEND US YOUR PRODUCT ANNOUNCEMENTS

If you are a hobby manufacturer with a product announcement, just [click here](#) and submit your announcement to us. Our web site and free magazine reach continues to grow, so get on board this new media train! ■

DISCLAIMER .....

The opinions expressed in this column are those of the writer and do not necessarily reflect the opinion of *Model Railroad Hobbyist* or its sponsors. Every effort is made to provide our readers with accurate and responsible news and information, however, neither *Model Railroad Hobbyist* or the writer of this column can be held responsible for any inaccuracies or typographical errors that may inadvertently appear in this column.

**Want to help keep  
MRH free?**

**Then *click* on ads!**







**Come join us for a  
Colorado Narrow  
Gauge Adventure!**

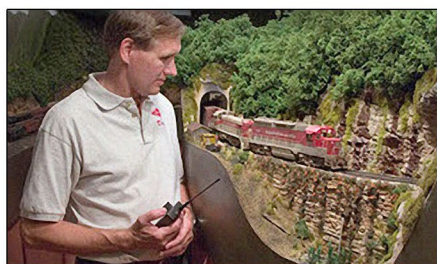
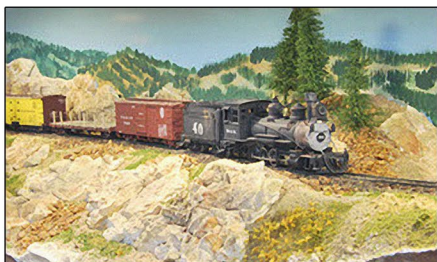

**37th National  
Narrow Gauge Convention  
Aug. 30th - Sept. 2nd, 2017  
Denver, Colorado**

**LEARN MORE >>**





## BRIEFLY NOTED AT PRESS TIME ...

**Mask Island Decals Inc.** has released HO scale decals for ABC Coke Drummond Co. locomotives. The lettering set includes material for decorating one Alco and two types of EMD diesels. For additional information visit [maskislanddecals.com](http://maskislanddecals.com).

**Rapido Trains Inc.** has announced plans to produce a highly-detailed model of a 1950s-era Birmingham New-Look bus. The model is based on a 3D scan of a prototype housed at the Transport Museum, Wythall, UK. Features of the double-deck bus will include full interior details, separate metal wire handrails and rear platform grab pole, flush-fitting windows, and steerable front wheels with rubber tires. A deluxe version will have working lights and illuminated destination signs. The model will be produced in OO-scale (1:76), the most popular model railroad scale in the UK. For more details including pricing and reservation information visit [rapidouk.com/bct-guy-arab-iv](http://rapidouk.com/bct-guy-arab-iv).

**Team Track Models** is a new company that offers downloadable paper models of buildings, vehicles, semi-trailers, and detail parts in a variety of scales including HO, OO, N, UK N, and Z. The company presently has more than 150 printed textures available for download. For additional information visit [teamtrackmodels.com](http://teamtrackmodels.com).



**Click here to rate or comment on this article**





# SELECTED EVENTS

## August 2017

*(Please note that many events charge a fee. Check individual info website for details.)*

**COLORADO, GREENWOOD VILLAGE**, August 27-30, Rio Grande Modeling & Historical Society Convention, at La Quinta Inn , 7077 South Clinton Street. Info at [rgmhs.org](http://rgmhs.org).

**FLORIDA, ORLANDO**, August 4-6, National Train Show, at Orange County Convention Center, 9800 International Drive, 276 West Center Street. Info at [nationaltrainshow.org](http://nationaltrainshow.org).

**INDIANA, SELLERSBURG**, August 25-26, Model Train Show & Swap Meet hosted by Southern Indiana Railroad, at Sellersburg Moose Lodge Family Center, 1040 S. Indiana Avenue. Request info from Jeff McMahan at [trainnutt56@yahoo.com](mailto:trainnutt56@yahoo.com) .

**OHIO, MARION**, August 12, Summerail 2017, at Marion Palace Theater. Info at [summerail.com](http://summerail.com).

**PENNSYLVANIA, ALTOONA**, August 19-20, 13th Annual N-Scale Weekend, at Jaffa Shrine Center, Broad Avenue & 22nd Street. Info at [n-scaleweekend.com](http://n-scaleweekend.com).

## September 2017

**AUSTRALIA, QUEENSLAND, TOOWOOMBA**, September 24, Carnival of Trains, sponsored by Toowoomba Model Railway Club, at Model railway Museum & Display Centre, Towoomba Showgrounds, Glenvale Road. Request info at [info-ddmrc@ddmrc.com.au](mailto:info-ddmrc@ddmrc.com.au).

## SELECTED EVENTS | 2

**AUSTRALIA, SOUTH ADELAIDE, OLD REYNELLA**, September 7-10, 15th National N Scale Convention, at St. Francis Winery Function Centre, 14 Bridge Street. Info at [convention2017.nscale.org.au](http://convention2017.nscale.org.au).

**CANADA, ONTARIO, BRAMPTON**, September 30 –October 1, Brampton Model Railway Show, at Brampton Fairgrounds, 12942 Heart Lake Road. Info at [bramptonmodelrailwayshow.com](http://bramptonmodelrailwayshow.com).

**CALIFORNIA, ONTARIO**, September 13-16, NMRA Pacific Southwest Region Convention, at Ontario Convention & Airport Hotel, 2200 East Holt Boulevard. Info at [psrconvention.org/ontariomanifest](http://psrconvention.org/ontariomanifest).

**COLORADO, DENVER**, August 30-September 2, National Narrow Gauge Convention, at Marriott Denver Tech Center Hotel. Info at [37nngc.com](http://37nngc.com).

**INDIANA, INDIANAPOLIS**, September 8-9, Hoosier Traction Meet and Midwest Interurban & Streetcar Society, at Clarion Waterfront Plaza Hotel, 2930 Waterfront Parkway West. Info at [hoosiertractionmeet.com](http://hoosiertractionmeet.com).

**INDIANA, SOUTH BEND**, September 22-23, NMRA, Michiana Division Education & Training Conference – Modeling Like the Prototype, at McKenna Hall Conference Center. Info at [michiana-nmra-org](http://michiana-nmra-org).

**MARYLAND, SHARPSBURG**, September 9, Model Train Sale, sponsored by Hagerstown Model Railroad Museum, at Washington County Agricultural Education Center, 7313 Sharpsburg Pike. Info at [antietamstation.com](http://antietamstation.com).

**MICHIGAN, GRAND RAPIDS**, September 14-17, NMRA North Central Region Convention, at Delta by Marriott, 28th and East Beltline. Info at [psrconvention.org/ontariomanifest](http://psrconvention.org/ontariomanifest).





## SELECTED EVENTS | 3

**NEW HAMPSHIRE, CONCORD**, August 20, CMRC Annual Train Show, at Everett Arena, Louden Rd. Info at [trainweb.org/cmrc](http://trainweb.org/cmrc).

**PENNSYLVANIA, ALTOONA**, August 19-20, 13th Annual N-scale Weekend, at Jaffa Shrine Center, Broad Avenue & 22nd Street. Info at [n-scaleweekend.com](http://n-scaleweekend.com).

**TEXAS, TEMPLE**, September 16-17, Temple Model Train Show, at Frank Mayborn Convention Center, 3303 North Third Street.

**VIRGINIA, VIRGINIA BEACH**, September 30-October 1, 28th Annual Train Show & Sale, sponsored by Tidewater Division Model Railroaders, at Virginia Beach Convention Center, 1000 19th Street. Info at [nmra-mer-tidewater.org](http://nmra-mer-tidewater.org).

### Future 2017, by location

**CALIFORNIA, SIMI VALLEY**, November 4, Swap Meet, sponsored by Santa Susana Railroad Historical Society, at 6503 Katherine Road. Info at [santasusannadepot.org/Clubhome.html](http://santasusannadepot.org/Clubhome.html).

**ILLINOIS, LISLE**, October 26-28, Chicagoland RPM (formerly known as Naperville RPM), at Sheraton Hotel and Conference Center. Event hosted by Mike Skibbe and co-sponsored by NMRA. Info at [rpmconference.com](http://rpmconference.com).

**MICHIGAN, EAST LANSING**, November 5, Lansing Model Railroad Club Show & Sale, at Michigan State University Pavilion, 4301 Farm Lane. Info at [lmre.org](http://lmre.org).

**MICHIGAN, WYOMING**, October 14, Grand River Valley Railroad Club Fall Train Show, at Home School Building, 5625 Burlingame Ave. Info at [grandrivervalleyrrc.org/shows.html](http://grandrivervalleyrrc.org/shows.html).

## SELECTED EVENTS | 4

**SOUTH CAROLINA, COLUMBIA**, October 14, Model Train Show, at Jamil Shrine Temple, 206 Jamil Road. Info at [southcarolinatradeshows.com](http://southcarolinatradeshows.com).

**UTAH, SANDY**, November 11-12, Intermountain Train Expo, at South Towne Expo Center, 9575 South State Street. Info at [intermountaintrainexpo.com](http://intermountaintrainexpo.com).

**WASHINGTON, CHEHALIS**, October 14-15, Fall Swap Meet & Train Show, sponsored by Lewis County Model Railroad Club, at Southwest Washington Fair Grounds, Blue Pavilion Building, 2555 North National Avenue. Request info from [tedstrains@lewiscounty.com](mailto:tedstrains@lewiscounty.com).

**WISCONSIN, MILWAUKEE**, November 11-12, Trainfest, sponsored by NMRA WISE Division, at Wisconsin State Fair Park, Info at [Trainfest.com](http://Trainfest.com).

### 2018 and beyond, by location

**MISSOURI, KANSAS CITY**, August 5-12, 2018, NMRA National Convention. Info at [kc2018.org](http://kc2018.org).

**UTAH, SALT LAKE CITY**, July 7-13, 2019, NMRA National Convention. Info at [nmra2019slc.org](http://nmra2019slc.org). ■



**Click here to rate or  
comment on this article**



# Clickable advertiser index – 1

[Accu-Lites](#)

[American Ltd \(San Juan\)](#)

[Amherst Railway Society](#)

[ANE Models](#)

[Archer Fine Transfers](#)

[Athearn](#)

[Atlas Model Railroad Co.](#)

[Bachmann](#)

[Bachrus](#)

[Backdrop Junction](#)

[Berrett Hill Trains](#)

[Black Cat Publishing](#)

[Blair Line](#)

[Bowser](#)

[Caboose Limited](#)

[Canyon Creek Scenics](#)

[Clever Models](#)

[Coastmans Scenic Products](#)

[Coffman Graphics](#)

[Con-Cor](#)

[Crow River Products](#)

[Digitrax \(2 page spread\)](#)

[ESU LokSound](#)

[Fast Tracks](#)

[Fine Scale Miniatures](#)

[Fine Scale MRR Expo](#)

[Fox Valley Models](#)

[Good Deals DCC](#)

[Great Decals](#)

[HO Diesel Supply](#)

[Iowa Scaled Engineering](#)

[ITLA Scale Models](#)

[Ken Patterson.com](#)

[Lights 4 Models](#)

[Litchfield Station](#)

[Logic Rail Technologies](#)

[Main Street Heritage Models](#)

[Micro-Trains Line](#)

[Model Railroad Benchwork \(1\)](#)

[Model Railroad Benchwork \(2\)](#)

[Motrak Models Co.](#)

[Model Railroad Control Systems](#)

[Mountain Subdivision Hobbies](#)

[MRH Store \(1\)](#)

[MRH Store \(2\)](#)

[MRH Store \(3\)](#)

[Mt Albert Scale Lumber](#)

[National NG Convention](#)

[NCE \(2 page spread\)](#)

[Nick & Nora Design](#)

[Norfolk & Western Hist. Society](#)

[North American Railcar Co.](#)

[Pre-Size Model Specialities](#)

[Precision Design Co.](#)

[Rapido \(1\)](#)

[Rapido \(2\)](#)

[Ring Engineering \(1\)](#)

[Ring Engineering \(2\)](#)

[Rulers-of-the-World](#)

[Scale Trains](#)

[Scotty Mason Show](#)

[Sea Port Model Works](#)

[Select Model Railroads](#)

[Streamlined Backshop Services](#)

# Clickable advertiser index – 2

[Soundtraxx \(Blackstone\)](#)

[Southern Digital](#)

[TAM Industries](#)

[TAM Valley Depot](#)

[The DCC Shop](#)

[The National Train Show](#)

[Tony's Train Exchange](#)

[Train Control Systems](#)

[Trainfest](#)

[TrainMasters TV \(1\)](#)

[TrainMasters TV \(2\)](#)

[TrainMasters TV \(3\)](#)

[TSG Multimedia](#)

[Walthers](#)

[Westerfield Models](#)

[Yankee Dabbler](#)

[Yarmouth Model Works](#)

# Clickable “other” index

---

[Other – Contents](#)

[Other – Cover](#)

[Other – Derailments](#)

[Other – Hobby Marketplace](#)

[Other – MRH Sponsors](#)

[Other – Yes it's a model](#)

## DOWNLOAD ISSUE



DOWNLOAD PORTRAIT



DOWNLOAD LANDSCAPE

• INDEX



SUBSCRIBE  
(free)

• TABLE OF CONTENTS





# REVERSE RUNNING

commentary

CHRIS ADAMS  
.....



[Click here for  
reader comments](#)

## SHOULD I HOST AN OPEN OP SESSION?

### WITH THE POUNDING OF THE “GOLDEN SPIKE,”

I reached one of my major goals – having a layout I can share with my friends by hosting operating sessions.

As the op session host I am essentially inviting folks over to use my railroad, handle my locos & rolling stock, operate the electronics, etc. When you have a crew of trusted friends over, you probably never even considered that you're placing a lot of valuable models into their hands.



But what of opening the layout to a group on an open operating weekend, a so called “op til you drop” event? I have a not-insignificant amount of time and money in this layout and I am leery of handing the layout ops over to just anybody who walks through the door.

▶ STEPPING OUTSIDE THE BOX WITH A CONTRARY VIEW

But I've decided to give it a try, so I hope the following thoughts help raise your comfort level as they do mine.

## Start within the “family”

Your first operators will likely be the folks who helped build your layout. Show your gratitude by giving your regulars the first chance to operate and to choose their preferred jobs.

Over time, they'll become the “old heads” who can pilot anybody new who comes to operate.

## Get them qualified

Real railroads rely on qualified operators to train newbies, and so should you. Hopefully, you planned your layout space to accommodate two-man crews. If not, then keep a couple experienced crew members nearby to answer questions, lend a hand, or offer a helpful tip.

This helps raise the comfort level of your guests – and increases your comfort level as well. Since you won't have to go into great detail about each job, it will limit the pre-session crew briefing to just safety exits, bathrooms, and snack locations.

## Be open to “Friends you haven't met yet”

You were new to operating once. Give a little back by extending a warm welcome. Don't forget “newbie” may just mean “new to your railroad.”

It's likely they'll bring along a wealth of hobby experience and will offer feedback on things you didn't even know you didn't know.

Whether to host an open ops session is up to you. It's your home and your railroad. Follow your instincts, but don't get overly concerned and then miss the chance to make some new friends and learn something new in the process.





# DERAILMENTS



Jerry King

## QUICK QUIPS ...

**Q:** Why did the lady track worker prefer to work only on crossings?

**A:** Because diamonds are a girl's best friend!

► BIZARRE FACTS AND HUMOR (SUPPOSEDLY)



# STEAM LOCO IN A FLOOD

Let's see a diesel  
(or an electric)  
*do this!*

## GET PAID ...

If you're the first to submit a bit of good humor or bizarre facts and we use it, it's worth \$25! Just send to [derailments@mrhmag.com](mailto:derailments@mrhmag.com) ■

## Coming next issue ...

- Bob Rivard models two SOO LINE diesels – the 2500 & 700
- Modeling Thompson Canyon on the CP/CN
- Intro to Timetable & Train Order ops
- Minimalist weathering insights from Joe Fugate
- And lots, *lots* more!



**Click here to rate or  
comment on this article**

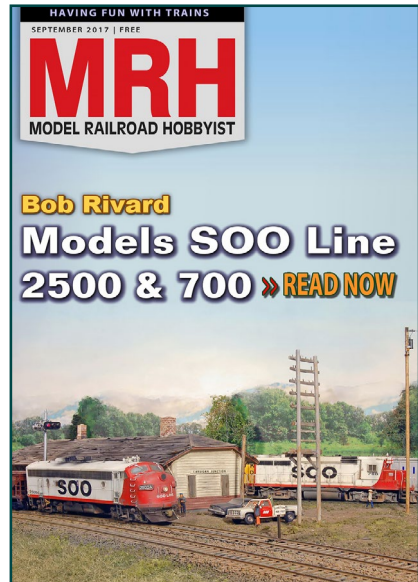

• [INDEX](#)



**SUBSCRIBE**  
(free)

• [TABLE OF CONTENTS](#)