

HAVING FUN WITH TRAINS

JANUARY 2018 | FREE

# MRH

MODEL RAILROAD HOBBYIST

## ALSO:

- MRH layout signaling roundup
  - Build a working scale track
  - Fun layout vignette example
  - Multi-tool use for layout construction
  - More prototypical waybills for ops
- ... and more inside!*

**Erik Kalinski**

**Builds a new home layout using TOMA** ▶ **READ NOW**



STANDARD EDITION | PORTRAIT



DOWNLOAD



SUBSCRIBE  
*(free)*

AVAILABLE FOR PRE-ORDER IN JANUARY 2018 FROM



## ATLAS MASTER® N 40' PS-1 BOX CARS



SOO LINE



RUTLAND



CHESAPEAKE & OHIO\*



COTTON BELT



SEABOARD\*



UNION PACIFIC



NORFOLK & WESTERN



JERSEY CENTRAL



\*CSX LICENSED PRODUCT

FOR MORE INFORMATION OR TO LOCATE A DEALER, PLEASE VISIT [WWW.ATLASRR.COM](http://WWW.ATLASRR.COM).  
ATLAS MODEL RAILROAD CO., INC. • 378 Florence Ave., Hillside, NJ 07205



# STAFF CREDITS

HAVING FUN WITH TRAINS

**MRH**  
MODEL RAILROAD HOBBYIST

Model Railroad Hobbyist | January 2018 | #95

(Updated 01/06/18)



**RATE THIS ISSUE**

**ISSN 2152-7423**

## Editorial Staff



Joe D. Fugate, Publisher and Editor



Don Hanley, Assistant Editor



Patty Fugate, Pasteup and Layout



Richard Bale, News and events



Jeff Shultz, News and events, Tech Assistant



Joe Brugger, Copy Editing



Mike Dodd, Copy Editing

## Advertising

Les Halmos, Account Manager

Daniel Nava, Advertising Assistant

Jean-François Delisle, Marketing Assistant

## Columnists

Larry Smith, Narrow Gauge/Shortlines

Bruce Petrarca, DCC

Ken Patterson, Reporter at large

## Rotating Columnists

Jack Burgess, Getting Real column

Nick Muff, Getting Real column

Mike Rose, Getting Real column

Tony Thompson, Getting Real column

Rob Clark, Imagineering

Dave Meek, Imagineering

Ray Dunakin, Imagineering

Issue password: Jan2018

Published for the glory of God. [What's this?](#)

• [INDEX](#)



**SUBSCRIBE**  
(free)

• [TABLE OF CONTENTS](#)

# MRH SPONSORS



Model Railroad Hobbyist | January 2018 | #95

## A - D



[acculites.com](http://acculites.com)



[americanlimitedmodels.com](http://americanlimitedmodels.com)



[railroadhobbyshow.com](http://railroadhobbyshow.com)



[archertransfers.com](http://archertransfers.com)



[athearn.com](http://athearn.com)

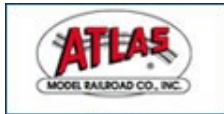

[www.atlasrr.com](http://www.atlasrr.com)



[bachmanntrains.com](http://bachmanntrains.com)



[bachrus.com](http://bachrus.com)



[backdropjunction.com](http://backdropjunction.com)

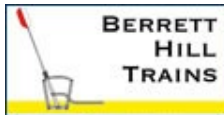

[berretthill.com/trains](http://berretthill.com/trains)



[blairline.com](http://blairline.com)



[bowser-trains.com](http://bowser-trains.com)



[mycaboose.com](http://mycaboose.com)



[coffmaneng.com](http://coffmaneng.com)



[con-cor.com](http://con-cor.com)



[www.digitrax.com](http://www.digitrax.com)

[Vendors: Get your clickable logo here ...](#)



# MRH SPONSORS | 2

## E - R



[trackplanning.com](http://trackplanning.com)



[esu.eu/en](http://esu.eu/en)



[handlaidtrack.com](http://handlaidtrack.com)



[handlaidtrack.com/mt-albert-scale-lumber](http://handlaidtrack.com/mt-albert-scale-lumber)



[iascaled.com](http://iascaled.com)



[kadee.com](http://kadee.com)



[lights4models.com](http://lights4models.com)



[litchfieldstation.com](http://litchfieldstation.com)



[micro-trains.com](http://micro-trains.com)



[store.mrhmag.com](http://store.mrhmag.com)



[modeltechstudios.com](http://modeltechstudios.com)



[ncedcc.com](http://ncedcc.com)



[www.pwrs.ca/main.php](http://www.pwrs.ca/main.php)



[rapidotrains.com](http://rapidotrains.com)



[ringengineering.com](http://ringengineering.com)



[rustystumps.com](http://rustystumps.com)

[Vendors: Get your clickable logo here ...](#)

• [INDEX](#)



[SUBSCRIBE](#)  
(free)

• [TABLE OF CONTENTS](#)

# MRH SPONSORS | 3

## S - Z



[sanjuancarco.com](http://sanjuancarco.com)



[scaletrains.com](http://scaletrains.com)



[soundtraxx.com](http://soundtraxx.com)



[sodigi.com](http://sodigi.com)



[sbs4dcc.com](http://sbs4dcc.com)

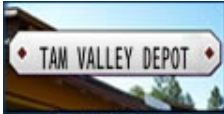

[tamvalleydepot.com](http://tamvalleydepot.com)



[tcsdcc.com](http://tcsdcc.com)



[trainfest.com](http://trainfest.com)



[tonystrains.com](http://tonystrains.com)



[traintekllc.com](http://traintekllc.com)



[tsgmultimedia.com](http://tsgmultimedia.com)



[walters.com](http://walters.com)



[yankeedabbler.com](http://yankeedabbler.com)

[Vendors: Get your clickable logo here ...](#)

Looking for something? Check the MRH Marketplace!

The screenshot shows the MRH Marketplace website interface. At the top, it says "MRH MARKETPLACE | 2". Below this, there are several product listings and vendor advertisements. On the left, there's a "MODERN MODELS" section with a "CLICK ME" button. In the center, there's a "Scale Models" section featuring a detailed building model. On the right, there's a "Yankee Model Works" advertisement. At the bottom, there are more product listings, including "MAIN STREET AMERICA HISTORIC ARCHITECTURE" and "Grand Trunk Railway". The website footer includes "MRH MAG.COM", a "SUBSCRIBE" button, and navigation links for "INDEX" and "TABLE OF CONTENTS".

Take me there!



MAKING RAILROAD HISTORY  
**WALTHERS PROTO**

# EMD F7A & F7B

HO SCALE

SoundTraxx® Tsunami® Sound & DCC A-B Sets \$549.98 Each • Matching A or B Units \$279.98 Each



**SECOND SERIES - AVAILABLE NOW**

- Limited quantities available - see your participating dealer!
- Limited edition - one-time run of these engine numbers
- Available with SoundTraxx® Tsunami® Sound for DCC and DC layouts
- Road-specific details

## Burlington Northern\*



## Chesapeake & Ohio\*\*



## Canadian National



## Union Pacific†



**CLICK HERE TO LEARN MORE!**

**WALTHERS**

Support your local hobby shop • visit [waltthers.com](http://waltthers.com) • call 1-800-4-TRAINS

©2017 Wm. K. Walther's, Inc. Delivery dates, prices and specifications were accurate at press time, for updates visit [waltthers.com](http://waltthers.com). Photos show early pre-production models, colors and details may vary. \*The ATSF and BN marks are licensed marks owned by BNSF Railway Company. \*\*CSX proprietary marks used by permission of CSX Transportation Inc. †Union Pacific licensed product.

• [INDEX](#)



**SUBSCRIBE**  
(free)

• [TABLE OF CONTENTS](#)

# TABLE OF CONTENTS



Model Railroad Hobbyist | January 2018 | #95

## FEATURES



HO

### The *NEW* Pacific & Northwestern

*ERIK KALINSKI and BOGDAN KRMEJ*



ALL SCALES

### MRH Signaling roundup

*DENNIS DRURY and LARRY SEBELLEY*



ALL SCALES

### Multi-tool for model railroaders

*BRIAN LARSEN*



N

### Quiet noon at Glen Green

*KARL-HANS KOCH*



HO

### Make a working scale track

*MICHAEL ANTEAU*



# TABLE OF CONTENTS | 2

## COLUMNS

### MRH Q-A-T

Compiled by *JOE BRUGGER*

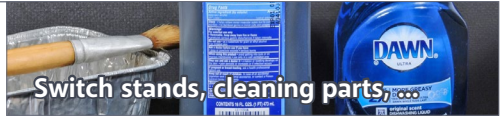

Switch stands, cleaning parts, ...

### Getting Real

*TONY THOMPSON*



Operating with prototypical waybills

### What's Neat

*KEN PATTERSON*



Digitrax Xtender, Joe & Patty Fugate, ...

### Yes, it's a model

Compiled by *DON HANLEY*



MRH's realistic model photo gallery

### Derailments

Compiled by the *MRH Staff*



Can you say oops?

## NEWS and EDITORIAL

### Publisher's Musings

*JOE FUGATE*

### News & Events

*RICHARD BALE and JEFF SHULTZ*

### Reverse Running

*DON HANLEY*

**ALSO:**

**MRH Marketplace**

**Subscriber extras**

• [INDEX](#)



**SUBSCRIBE**  
*(free)*

• [TABLE OF CONTENTS](#)

# ALL-NEW FREIGHT CAR

## Pullman-Standard PS-2GD 4785cf Covered Hopper

(Actual Models Shown)



1960s to Today • Numerous Variations  
Six Roadnames

**Preorder Now**

ARRIVING  
SPRING  
2018



ALSO AVAILABLE IN...  
**OPERATOR**  
SCALETRAINS.COM

© 2018 ScaleTrains.com, Inc. ScaleTrains.com, Operator, Rivet Counter, and respective logos are trademarks of ScaleTrains.com, Inc. ScaleTrains.com, Inc. 7598 Highway 411 Benton, TN 37307 844-9TRAINS 844-987-2467 International 423-299-3689

**HO**  
F87 SCALE

WWW.SCALETRAINS.COM

Scene and photography  
by Ken J Johnson  
First test model shown

• [INDEX](#)

• [TABLE OF CONTENTS](#)



# PUBLISHER'S MUSINGS

editorial

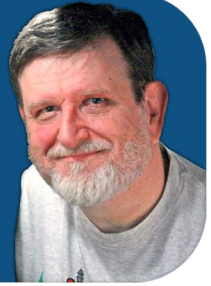

Model Railroad Hobbyist | January 2018 | #95

**JOE FUGATE** TALKS ABOUT  
WHAT'S NEW WITH THIS ISSUE



RATE THIS ARTICLE

**WE'RE STARTING OUR NINTH YEAR OF PUBLISHING** *Model Railroad Hobbyist* and with this issue we've instituted a fresh new "easy-to-read" look.

We're also making a big change as of this issue with what I'm calling our "cutting room floor" policy.

For many articles, we do not publish everything we get from the contributor, but we edit the article down to fit the magazine. Yes, it's true we don't have paper and ink or shipping costs with a digital magazine – but every page we add to the magazine takes editorial time.

If we add too many pages to the magazine, the editorial time can get so large that it won't fit into 30 days. So we trim back articles and "tighten them up" for the magazine. That makes the magazine articles more concise and to the point.

What happens to the parts of article submissions that don't make it into the magazine, but [end up on the cutting room floor](#), so to speak?

As of this issue, we're adding these to the subscriber bonus extras. We won't be spending a lot of time editing or formatting these bonus extras, just making them available "raw," more or less as they were submitted. [Click here to access the free bonus downloads](#) ...

• [INDEX](#)



SUBSCRIBE  
(free)

• [TABLE OF CONTENTS](#)

That means you can expect a lot of bonus extras if you're a subscriber to MRH. You can only access these bonus extras if you are a subscriber, so that's one very good reason to subscribe. Since subscribing is free, we don't see this as a big deal.

We use the subscriber number a lot when talking with potential advertisers, so a bigger subscriber number helps us get more advertisers. The more advertisers we have, the more income we get.

As we grow, we prefer to plow any extra income back into making the magazine better: more visits to layouts, more special projects to explore areas of the hobby you would like to see, and so on.

So if you're not a subscriber, [now is the time to subscribe](#). You'll get access to extra pages of model railroading info each month. Plus we can keep growing and help you better achieve your hobby dreams!

ADVERTISEMENT

# CABOOSE™

Sharing Our Passion for Trains Since 1938

## Click Here for the Serious Modeler's Resource!

More than 170,000 items,  
over 490 manufacturers,  
most at a discount from  
full retail – all at a fair price.  
**As always, in-stock orders of  
\$100.00 or more ship free  
within the Continental U.S.!**\*

\*surcharges may apply for oversized items.

10800 West Alameda Ave.  
Lakewood, CO 80226  
(303) 777-6766

ADVERTISEMENT

## PACIFIC FRUIT EXPRESS® 16-CAR REEFER SET

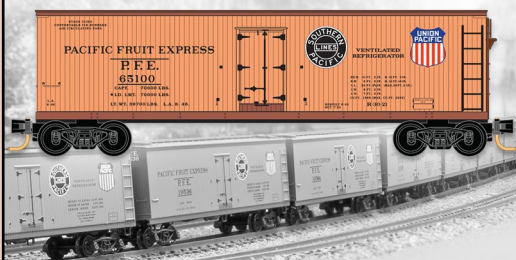

**PRE-ORDER THRU JANUARY 31<sup>ST</sup>  
COMING MAY 2018**



**MICRO-  
TRAINS®  
LINE**

VISIT [www.micro-trains.com](http://www.micro-trains.com)  
FOR MORE INFORMATION

**N**  
SCALE 1:160

• [INDEX](#)

• [TABLE OF CONTENTS](#)



*Diesels*  
**EMD SD50**  
 REFRESHED TO RUN



## GREAT SOUND, SUPERIOR VALUE

### THE NEW RTR EMD SD50 DIESELS FEATURE ECONAMI SOUND

In an effort to keep up with a changing marketplace, the fuel crisis of the late 1970s, and competition of that era, EMD responded with the SD50. Generating 3600 horsepower from a 16 cylinder 645F3 prime mover. The principle of fewer cylinders equating to fuel economy was a lesson learned with the GP39-2. EMD scaled this approach to the larger six-axle SD50. As several railroads jumped on board with the SD50, these workhorses can still be found rebuilt and running today. The Athearn Ready to Roll SD50 has been refreshed with factory installed sound, enhanced detail, while maintaining superior RTR value.

- Separately applied wire grab irons
- New rubber MU hoses
- Separately applied coupler cut levers
- Fine scale handrails molded in engineering plastic
- Etched metal windshield wipers
- Detailed fuel tank
- New tooling HTC trucks Hyatt or Timken roller bearings (per prototype)
- With Sound version features Econami Sound by Soundtraxx



VISIT [ATHEARN.COM](http://ATHEARN.COM) FOR COMPLETE LISTING  
 OF ROADNAMES AND PRICING

**HORIZON**  
 H O B B Y

VISIT

Your Local Retailer

CLICK

Athearn.com

CALL

1.800.338.4639

SERIOUS FUN™

©2017 Horizon Hobby, LLC. Athearn, Genesis and McHenry are registered trademarks of Horizon Hobby, LLC. All other trademarks, service marks and logos are property of their respective owners. Final models may vary slightly from photos shown. 5792

• [INDEX](#)



SUBSCRIBE  
 (free)

• [TABLE OF CONTENTS](#)



YD



Yankee Dabblers

www.yankeedabblers.com (856) 312-8084

101 West King, Bellmawr, NJ 08031

In Philly? YD store is 1 mile from NJ end of Walt Whitman Bridge

Visit OUR NEW WEBSITE! SAME GREAT SERVICES &amp; PRICES!

CHECK IT OUT!

SEARCH  
BUTTON

Search

Call us on (856) 312-8084

My Account

Gift Certificates

Sign In or Create an Account



Brands

YD Products

View all brands

Categories

DCC PRODUCTS

View All Categories

HOME SCALES BRANDS SHIP/RETURNS CONTACT SHOW SCHEDULE NJ STORE HOURS

Featuring New ESU Cab Control Wifi Digital System &amp; Wifi Mobile Control

FEATURED PRODUCTS

Sale \$385

Plus New ESU  
"N" Scaled  
Sound DecodersAdd 2nd CAB  
to order  
Sale \$240

"CLICK" ON SPECIALS

Specializing in DCC! ~ The Best for Less! ~ Sales-Services-Installation!

Free Technical Coordination (727) 457-9227 9AM to 9PM EST

Stop by and meet us at the following hobby shows:

CLICK AND SAVE TODAY!

01/27 - 01/28/18  
Westspring Field, MAClick on  
Show Schedule  
for info links2/3 - 2/4 2018  
Timonium, MDUse coupon code "MRH" for FREE SHIPPING  
YD installs DCC or RailPro in your engines

## PUBLISHER'S MUSINGS | 3

## We're ad supported, remember

As a subscriber, you will get our weekly email pointing out some of the more interesting posts that week to the MRH website. And of course when a new issue of MRH magazine is available, we'll let you know that as well.

When I attend shows, I have many subscribers come up to me and thank me for these weekly emails. Many of these modelers tell me they don't have time to hang out on the MRH website all week long, but they appreciate the weekly email highlighting some of the best threads that week. More than a few modelers have told me they've picked up a lot of great new hobby insights from these weekly emails.

Because we're ad-supported, becoming a subscriber also means we'll email you some special advertising emails a few times per year. You'll get an average of maybe two extra advertising emails per month

• [INDEX](#)• [TABLE OF CONTENTS](#)

*Build*



# RDC

by Rapido Trains Inc.

RDC  
**1**  
RDC  
**2**  
RDC  
**3**

**HO**  
SCALE

**Order By  
February 9!**



# Click Here!!

• [INDEX](#)



• [SUBSCRIBE](#)  
(free)

• [TABLE OF CONTENTS](#)



LED's, Signs, and Sounds for  
All Scales

Visit Us At The  
Amherst  
Railroad Hobby Show

Miller Signs | Evan Designs

Iron Penguin | Ring Engineering

EZ Line | Tomar | ITT Sound Boards

find us on [facebook](#)

[www.lights4models.com](http://www.lights4models.com)

614-296-8691

ADVERTISEMENT

**Lasercut structures. Highway,  
storefront and billboard signs.**

Neat ag customer for your railroad:  
**Farmers Fertilizer Supply**



WHAT'S  
NEW?



Established 1993...

**Blair Line**

besides the regular weekly subscriber emails.

These special emails typically have an "opt out" button at the bottom if you really don't want to see any more of that particular sale campaign.

Your other option is to do an ad-free paid subscription. Since ads are how we pay to produce MRH, doing an ad-free subscription is not free – it's \$25 per year. That more-or-less makes up for the loss of income we figure we have if you're not taking email ads.

But if you can stand a couple extra emails per month from us with ads for model railroading products, then a free subscription is certainly a good way to go.

## It's reader survey time again

Every two years, we like to do a reader survey – and it's that time again! This time, we're doing a drawing to give away ten (count them, ten) Amazon Kindle 7" 8GB tablets.

This year's survey is a little different. We're especially interested



# BACHMANN

## BACHMANN E-Z TRACK SYSTEM

**ASSEMBLES IN MINUTES!**

 Snap together,  
stays together on floors,  
tables, and carpets.  
No nails, screws,  
or special tools needed.

*Ken Atherton*

# CELEBRATING 25 YEARS OF E-Z TRACK®!

Bachmann's exclusive *E-Z Track*® has long been one of the most popular track systems in HO and N scale because it makes set-up quick, easy and fun! Just snap it together and it stays together on floors, tables, and carpets. Modeled from AAR track engineering dimensions, our HO and N scale products feature finescale tie detailing accuracy plus:

- Code 100
- low-profile spike heads
- available in HO scale (nickel silver track with gray roadbed or steel alloy track with black roadbed) and N scale (nickel silver track with gray roadbed)
- use with DC and DCC layouts



*The World's Greatest Hobby® Track Packs include all the track needed to build this layout.*

The *E-Z Track*® system is included in every HO, N scale and On30 train set we sell. Bachmann is proud that *E-Z Track*® is the choice of other companies for their sets as well. We also offer decoder-equipped turnouts, making this the first DCC-equipped track system. There are over 100 styles of HO and N scale track offered. In HO scale alone, there are straight sections, .75"–36" long; curved sections, 15"–35.5" radius; turnouts, #4–#6; and crossovers, 30°–90°. With all these options available, plus a wide variety of accessories, it's no wonder that snap-together *E-Z Track*® has been the modeler's choice for 25 years and counting!

Start your railroad with these *E-Z Track*® products.



WORLD'S GREATEST HOBBY® FIRST RAILROAD TRACK PACK  
with HO STEEL ALLOY E-Z TRACK®  
Item No. 44497 • MSRP \$195.00

Click to  
learn more.



WORLD'S GREATEST HOBBY® FIRST RAILROAD TRACK PACK  
with HO NICKEL SILVER E-Z TRACK®  
Item No. 44596 • MSRP \$279.00

Click to  
learn more.



WORLD'S GREATEST HOBBY® FIRST RAILROAD TRACK PACK  
with N SCALE NICKEL SILVER E-Z TRACK®  
Item No. 44896 • MSRP \$250.00

Click to  
learn more.

Bachmann Industries, Inc. • 1400 East Erie Ave. • Philadelphia, PA 19124 • [www.bachmanntrains.com](http://www.bachmanntrains.com)

Click for more information.

• [INDEX](#)



SUBSCRIBE  
(free)

• [TABLE OF CONTENTS](#)

in determining what parts of the hobby can be the most frustrating. Once we know the answer, we will look at doing articles to give you good solutions to these frustrations.

We could guess at what we think your greatest hobby frustrations might be, but it's better if you tell us. That way we're addressing real frustrations you have!

We're also interested in your thoughts on some pricing of the products we sell, so the survey has some questions about that as well.

And finally, we have some questions about how you read MRH.

You can [find the 2018 survey here](#).

### Win big in the "One Module" Challenge contest!

This year, we're offering some cash prizes for the winners in our One Module Challenge layout design contest.

Grand prize is \$1000, plus get your layout design published as a cover story. First Prize: \$750; Second Prize: \$500; Third Prize: \$350; First, Second, and Third prize also get published.

Honorable mentions: \$100 each, publishing at editors' discretion.

You can [find the contest entry rules here](#).

### Big plans for 2018

We have a lot of fun things planned for 2018!

As you can see with this issue, we're doing more layout tour stories this year. And don't worry, they won't all be modular layouts.

Our one guideline for a layout tour: would doing a layout tour article on this layout be in some way beneficial to our readers?

Generally, a nice layout is a nice layout regardless of how it was made, modular or otherwise.



**2003** Celebrating 15 Years! **2018**  
**OF TRACK BUILDING INNOVATION**

# FAST TRACKS

Build your own trackwork easily, quickly, and affordably.

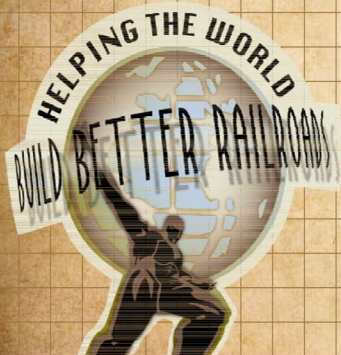
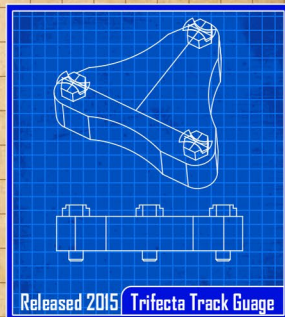
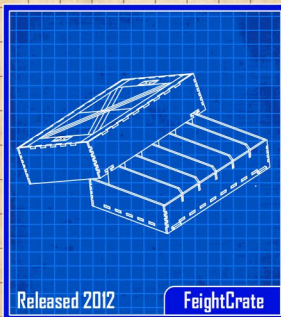
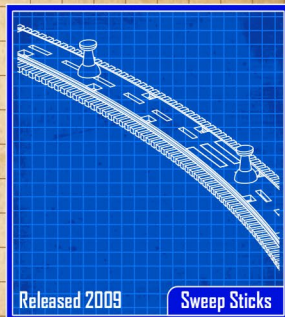
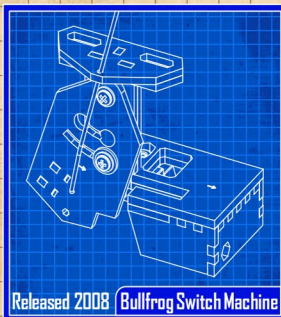
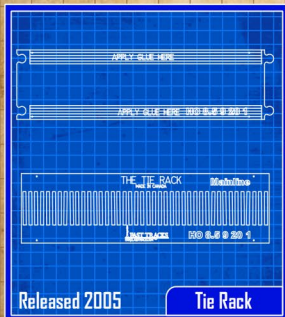
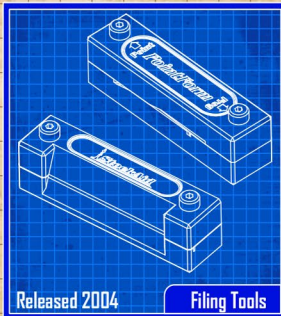
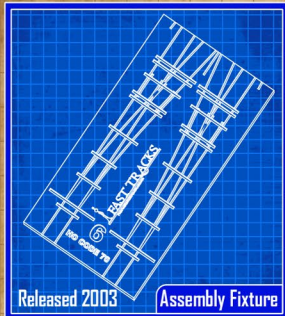

Easy ordering • Live online support • Earn Waypoints with every purchase

shop online 24/7 [handlaidtrack.com](http://handlaidtrack.com)

1-888-252-3895 [service@fast-tracks.net](mailto:service@fast-tracks.net)

• [INDEX](#)



**SUBSCRIBE**  
(free)

• [TABLE OF CONTENTS](#)



# Bowser

## HO MLW M630 Locomotives

Ready to Run and Detailed. Features: air hoses, windshield wipers, grab irons, coupler lift bars, operating headlight, window glass, can motor, flywheels, nickel silver wheels with RP25 flanges and knuckle couplers.

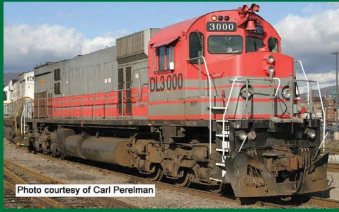

Photo courtesy of Carl Poreiman

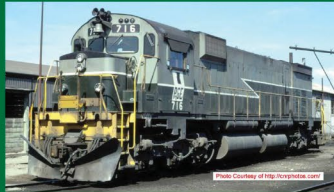

Photo Courtesy of http://vaproto.com



Photo courtesy of Conner Frasier



Photo courtesy Scott Davis

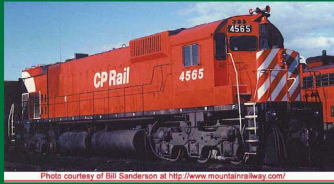

Photo courtesy of Bill Sanderson at http://www.mountainrailway.com/



Photo Courtesy of http://vaproto.com

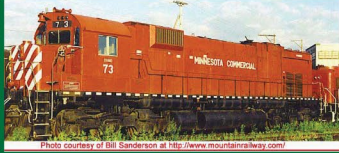

Photo courtesy of Bill Sanderson at http://www.mountainrailway.com



Photo Courtesy of http://vaproto.com

Road Names: CP Rail, PGE,  
BCR, BC Rail, DL, WNY&P,  
& Minnesota Commercial

**KIT INCLUDES:** One piece plastic molded body, under frame, brake wheel, air tank, brake cylinder, triple valve, free rolling trucks with metal wheels, knuckle spring couplers, smooth painting, sharp lettering & car weights.

## HO Freight Car Kits

In Stock!!  
\$17.95 each



55 Ton  
Fishbelly,  
Wood Chip,  
70 Ton 12  
& 14 Panel  
Hopper Cars



Click here to check out the details for these and other great Bowser Products

The other big thing we have planned for 2018 is our 100th issue, which comes this June 2018. We're planning a very special issue this June, so you won't want to miss that one.

And finally, the first steps toward Siskiyou Line 2 ought to appear later this year. I've factored a lot of what I learned from Siskiyou Line 1 into version 2, so if you would like to build on my own 26+ years of learning and insight, this will be your chance. Stay tuned!



**VIEW READER  
COMMENTS**

*click here*

## ADVERTISEMENT

**Making changes should be easy!**

**SoftTrak<sup>©</sup>**

Flexible track with optimized geometry between track ends, with or without easements or S-curves. Ignore the details - design faster, design better!

See how Denny designed  
a steel mill in a month!

*Click here!*

**3rd Plant 3D CAD**  
The ultimate track planning software



**El Dorado  
SOFTWARE**

• [INDEX](#)



**SUBSCRIBE**  
(free)

• [TABLE OF CONTENTS](#)

# MRH “TOMA WITH A TWIST” CONTEST

**ENTRY DEADLINE: January 31, 2018**

**Goal: Design the “starting position” for a sectional home layout design using TOMA.\***

**GRAND PRIZE: \$1000, plus get published as an MRH cover story**

First Prize: \$750; Second Prize: \$500; Third Prize: \$350;  
First, Second, and Third prize also get published.

Honorable mentions: \$100 each, publishing at editors’ discretion.

Hypothetical room is 14’ x 20’. Space under the stairs not available, and a 4’ clearance must be maintained along the utility wall.

*Note: This is a sectional home layout design, no modular standard required.*

**Room 14’ x 20’**

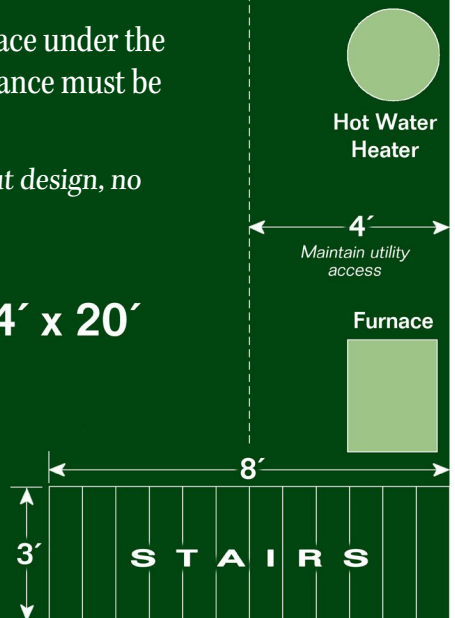

\*For reference, see the July 2017 MRH Editorial, “TOMA with a twist”.



## CONTEST RULES

- Modules can be any size or shape but must fit up the stairs and through the door at the top of the stairs (80" tall and 30" wide) without damage or pinching your fingers.
- Scale: From Z to O, using any track gauge.
- Design the "starting position" for layout construction phase 1 – we want to see one or two TOMA module sections that can be completely finished and configured for an operating session. Show and tell how staging would work. Tell a brief backstory of the line and how it operates.
- Your TOMA modules need to have some form of temporary staging, either singled-ended staging off one/both ends, or double ended staging connected to both ends of the modules, which would also allow continuous running if desired.
- Don't waste your time drawing and describing a detailed room-filling layout. Rough in outlines of the other modules, that is, the "ending position." Just sketch simple boxes and lines to show how the modules will fit in the room. Bonus points awarded for explaining – in words, sketches or both – a phased module construction progress plan.
- Modules can follow a standard or not. Custom sections okay.
- Module support method / height up to you, but please describe.
- Innovative or creative approaches get extra points: please describe and illustrate if possible.
- Include a cost estimate for the starting position. There is no need to actually build anything, this is a design contest only.
- This contest is *all about getting started*. People who can get that far will be able to fill in the rest with their own imagination.
- All submissions must be publishable. If the submission is not formatted to be ready for publication, it will be disqualified. Take the time to be complete, provide captions, and to describe things completely in your text. See the [MRH submission guidelines for more information](#).

**SUBMIT ENTRY (Choose "Contest Entry")**





## LAST ISSUE'S RATINGS

The five top-rated articles in the [December 2017 issue](#) of *Model Railroad Hobbyist* are:

- 4.8 What's new on the Franklin & South Manchester
- 4.7 Craft paints as weathering colors
- 4.7 Getting Real: Modeling Skinner's Eddy: 2
- 4.5 What's Neat: Digitrax WiFi, UP Turbines, ...
- 4.5 Yes, it's a model (MRH Christmas card)

Issue overall: **3.8**

**Please rate the articles!** Click the reader comments button on each article and select the star rating you think each article deserves. Thanks! ■

*TrainMasters TV is part of  
the MRH product family.*

*TMTV members not only get great network TV level  
videos, they help pay for MRH and keep it free ...*

# DELETED ARTICLE CONTENT

*The MRH cutting room floor is now available!*



**Access the deleted content >>**  
*(you must be a subscriber -- but hey, it's free!)*



• [INDEX](#)



**SUBSCRIBE**  
*(free)*

• [TABLE OF CONTENTS](#)



Discover the wonders of  
TrainMasters TV ...

FREE peek >>



[www.trainmasters.tv](http://www.trainmasters.tv)



**TRAINMASTERS.TV**

# MRH ... QUESTIONS, ANSWERS, TIPS



Model Railroad Hobbyist | January 2018 | #95

compiled by **JOE BRUGGER**



## Switch stand spacing

**Q.** I do not know how far switch throws should be from the turnout. Can someone help me? I model a mid-1950s Canadian National branch line.

—Deemiorgos

**A. Dave Husman:** UP standard is 8'-6" from track centerline. Others should be similar.

**Marc Simpson:** The CNR historic association ([cnrha.ca](http://cnrha.ca)) published a selection of drawings from the CN archives many years ago that showed most of the standards that CN used during your era. If you ask around someone might have a drawing of the switch stand standards.

**Ed:** Canadian National has its current specifications for industrial trackage online at [cn.ca/-/.../Track.../Engineering-Specifications-for-Industrial-Tracks-en.pdf](http://cn.ca/-/.../Track.../Engineering-Specifications-for-Industrial-Tracks-en.pdf). It calls for placing objects along the tracks no closer than 8'-6" from the track centerline.

► MRH QUESTIONS, ANSWERS, AND TIPS

• [INDEX](#)



SUBSCRIBE  
(free)

• [TABLE OF CONTENTS](#)

# MRH Q-A-T | 2

Find more and read about railroad clearance cars at [model-railroad-hobbyist.com/node/30976](http://model-railroad-hobbyist.com/node/30976).

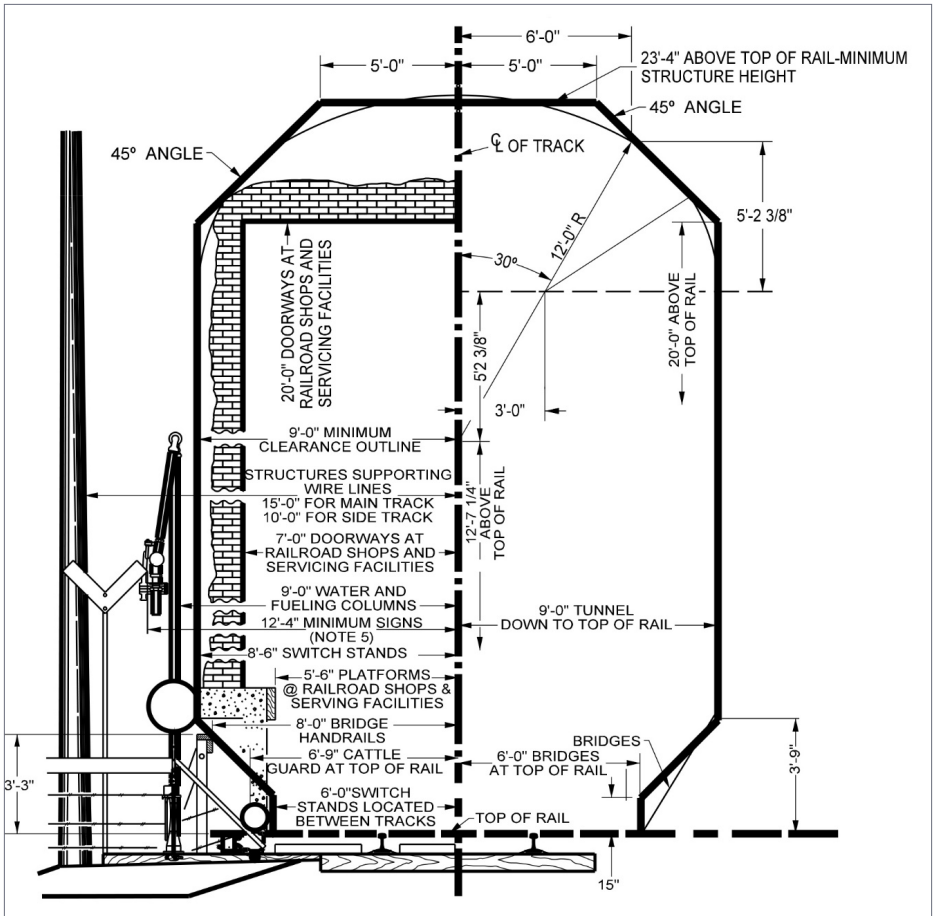

1. A 1977 Union Pacific clearance diagram calls out the proper spacing for various lineside construction and appliances.



## Cleaning parts before painting

**Q.** In reading the monthly magazines on preparing models for painting, many authors seem to default to washing items with soap and water and letting them dry overnight. That seems too time-consuming, and I've had very good



2. Painters who want a clean canvas can choose between alcohol and a mild, unscented, lotion-free dish soap for washing a project. The tradeoffs include sensitivity to alcohol, obnoxious odors, speed of action, and drying time. Isopropyl alcohol is available in several strengths, and can be filtered and reused. *32nd Ave. Shops photo*

success with lightly washing the items with 70% rubbing alcohol and a clean paper towel prior to painting. A few plastics don't do well with an alcohol bath, so I always test the backside of the part first.

You don't have to wait long for the alcohol to dry – certainly not overnight! I'm curious to hear how other people handle this.

—Dave Casey

**A. Warflight:** I use the 50% rubbing alcohol from the dollar store. It's a bit cheaper, and useful for anything from cleaning to wet water. I live in a desert so drying overnight means fine layer of dust to paint on.

**Deemiorgos:** I use a little water and alcohol with a drop of dish-washing detergent, scrub gently with a super-soft bushy makeup brush, then rinse it off with bottled water.

**Michael Watson:** I do both. I wash with Dawn for any serious oil removal, rinse with water, then finish with a light wash of alcohol from my wash bottle. The alcohol will remove moisture in the nooks and crannies, and allow you to proceed right away to the next step. In stubborn cases, I break out the hair dryer to accelerate the process.

**Dave B.:** Unless it's a resin kit with mold release I rarely wash anything before painting, I just dust it with a paintbrush and wipe off the flat surfaces with a clean, lint-free rag. If I do see something on there that needs some water, I dry the car with my heat gun which only takes a few minutes. Be careful: Plastic cars will melt if you rush them. I don't sweat the prep too much, since weathering will hide any problems that show up. I find the less time I can spend on these kind of details, the more I enjoy the big picture.

**PTRRN56:** I've built hordes of plastic (styrene) airplane model kits, scratchbuild in styrene plastic, and have always used



# Archer

**FINE TRANSFERS**  
PROUDLY SERVING MODEL BUILDERS SINCE 1989

**THE ORIGINAL  
SURFACE DETAILS™**

**WE NOW HAVE MORE  
THAN 130 SHEETS OF  
RIVETS, LOUVERS,  
TREADPLATE, WELD  
SEAMS AND MORE  
CAST ONTO  
MICROSCALE CLEAR  
DECAL FILM**

**LOW SHIPPING:**

**DOMESTIC USA ORDERS  
\$2.80**

**INTERNATIONAL ORDERS  
\$9.95**

CLICK HERE TO  
VISIT OUR WEBSITE!

Archer Fine Transfers • PO Box 1277 • Youngsville, NC 27596 • USA  
(919) 570-1026 • info@archertransfers.com • archertransfers.com

"Archer Fine Transfers 3D decals have revolutionized kitbashing and scratchbuilding. Putting rivets or other low-relief details like louvers or weld seams on your models is now as easy as applying decals."

Joe Fugate,  
Publisher/Editor  
Model Railroad  
Hobbyist



## SANTA FE TK-N & TK-O LATE 2018

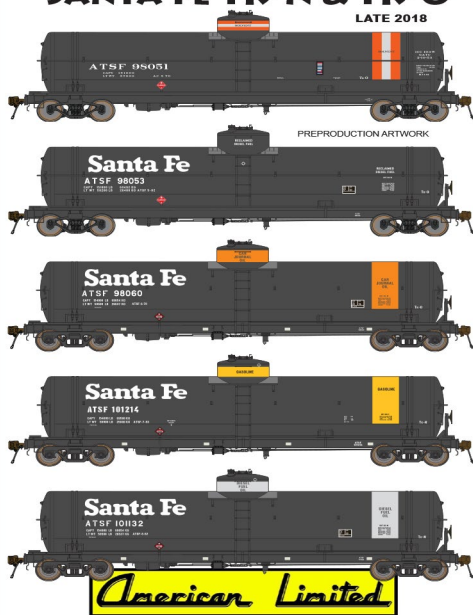

**American Limited**

6 numbers per version! Please contact your dealer!  
www.americanlimitedmodels.com

## www.SBS4DCC.com

**N - HO - HO<sub>N3</sub> Scale Trains**

Also Checkout our **DETAIL 3D Parts** in HO, S and O Scales.  
**CHECK IT ALL OUT AT**  
**WWW.RUSTYSTUMPS.COM**  
THE QUALITY IS INSIDE BECAUSE OUR NAME IS OUTSIDE

• [INDEX](#)

**SUBSCRIBE**  
(free)

• [TABLE OF CONTENTS](#)



isopropyl alcohol to wipe down parts, mostly to get rid of finger oils and contaminants. Alcohol cuts oil and residues, and does not leave any residual coatings behind. Cast resin parts and certain handmade/small production parts may have mold release agents on them, and should be washed in warm soapy water and followed up by an alcohol wipe. There's nothing worse than going to paint and having adhesion problems, "fisheye," and silicone infection on the parts.

**Al Carter:** I thought I'd add my method of cleaning resin parts, learned from a local car modeler who paints a lot of 1/25 scale resin model cars. He scrubs the parts with a toothbrush and Westby's Tire and Whitewall Cleaner, rinses thoroughly, and air-dries the parts. Once dry, primer on resin is essential. I've used this product on several HO resin structures, and a lot of 1/87 resin vehicle kits.

*Join the discussion at [mrhmag.com/node/30784](http://mrhmag.com/node/30784).*

## Dating rolling stock

**Q.** I'm planning an HO layout that will feature the Harlan & Hollingsworth rail car shops at Wilmington, DE circa 1925. It will include passenger and freight operations. When I look at freight rolling stock in stores or online, I really have no idea what is or is not close to prototype for the time. I want to know that any stock I run is close to the right period – not put into production 30, 40, or 50 years later. Most manufacturers don't include this detail on the packaging. Any suggestions for finding period-specific stock? Especially freight?

—A. Hansen

**A. Ed:** The first step is to become familiar with the rolling stock of the era – there is not a lot of material published on railroading in

# Great control in a tiny package



**Original  
Touch Toggles**

- Touch Toggle™ plug in controls
- Bright clear indication
- Easy setup
- Flexible system

Stall Motors, Twin-coils,  
Power, and Servos

Now for Tam Valley Depot  
and MRservo too!

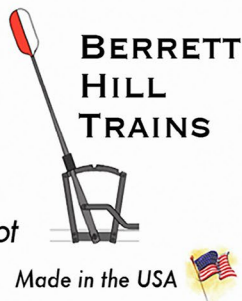

What will they think of next?

[www.berretthillshop.com](http://www.berretthillshop.com)

ELECTRONICS MADE EASY!



**IOWA SCALED  
ENGINEERING**

**LEARN  
MORE**

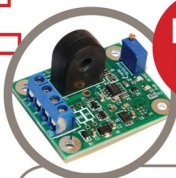

**DCC BLOCK DETECTORS**

- Fully isolated
- High reliability
- Easy installation

**LEARN  
MORE**



**MODULAR SIGNAL SYSTEM**

- Easily implement ABS signaling on any layout
- Fully integrated detectors, logic & signal drivers
- Plug and play simplicity!

[WWW.IASCALED.COM](http://WWW.IASCALED.COM)

## TamValleyDepot.com

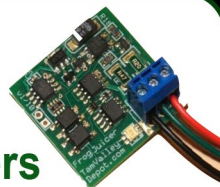

### Frog Juicers

Automatic DCC polarity reversers for frogs on turnouts and crossings.

### Servo Switch Machines

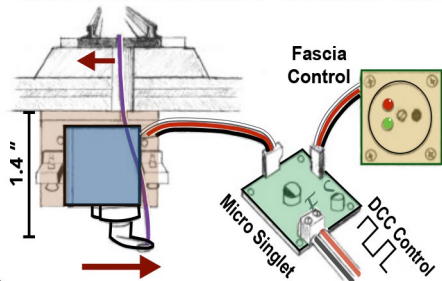

• [INDEX](#)



**SUBSCRIBE**  
(free)

• [TABLE OF CONTENTS](#)

the first quarter of the 20th century, but it's out there. Look at old postcards, books, and magazines – anything that has a reliable date on it. Take mental notes, or keep a notebook on the size and construction of cars and engines.

**Irish Rover:** Accurail's website includes the build date of each car. Some will have a couple of build dates, but if you telephone to order, instead of ordering online, the folks there are wonderful, and will get you cars with the right date. Very helpful people. Good to see Made in USA! [accurail.com](http://accurail.com).

**Eric Hansmann:** I enjoy sharing rail info from the 1920s, so modelers can understand the railroads and industries of that decade.

As far as tips for dating rolling stock, start keeping notes. That is how the '20s guide at [designbuildop.hansmanns.org/a-guide-to-1920s-era-ho-scale-plastic-freight-cars](http://designbuildop.hansmanns.org/a-guide-to-1920s-era-ho-scale-plastic-freight-cars) started. As more modelers inquired about the info, it became important to post it as



3. Accurail's new Fowler boxcar kit is a good example of a 1920s freight car, with wood sides and ends, stem-winder brake wheel, and a relatively low interior height. *Accurail photo*



a resource. Invest in a mid-1920s Official Railway Equipment Register (ORER) so you gain an understanding of the in-service freight cars on several railroads. I summarized the 1926 Wheeling & Lake Erie fleet when that was my focus. See [designbuildop.hansmanns.org/wle-freight-car-fleet-of-1926](https://designbuildop.hansmanns.org/wle-freight-car-fleet-of-1926). I'm halfway done with a B&O version and hope to post that soon. The larger the railroad, the more detailed the summary.

Your interest in Harlan & Hollingsworth is interesting. By the 1920s, the company seems to have been a subsidiary of Bethlehem Steel, and mainly a shipbuilder. Check out the car builder history at [midcontinent.org/rollingstock/builders/harlan-hollingsworth3.htm](https://midcontinent.org/rollingstock/builders/harlan-hollingsworth3.htm) for more. There would be lots of interesting inbound loads to a shipyard but few outbound shipments.

Become a sponge for information and take notes. I find research into the freight cars of the 1900-1930 years to be fascinating. Feel free to contact me directly through the ID on my MRH Forum posts or via a comment on my blog. The 1920s are a fascinating era for rail and industry that have had little coverage in the hobby press. My railroad modeling blog is at [designbuildop.hansmanns.org](https://designbuildop.hansmanns.org).

**Dave Husman:** If it's not a USRA design, or has an internal height (IH) of more than 10 feet, it's probably too new. Look at the Westerfield Models website at [westerfieldmodels.com](https://westerfieldmodels.com). He specializes in your era and gives build dates and a service time span for the models. Even if you don't want to build resin kits, they will show you what the cars look like. If a model has Andrews trucks, it's probably in your era. The biggest and newest hopper cars you would have are the Athearn offset quads. The offset and rib-side twin hoppers would be appropriate. Ironically, the composite wood-side hoppers like the Athearn one are too new for your era



– they are 1940s wartime cars. Except for hoppers, all steel cars would be brand new. Gons would be mostly in the 40- and 46-foot length. There would be a few 52'-6" and very few 60- to 65-foot cars. Steel cars would be riveted and not welded.

**Highway70:** The Westerfield site and Hansmann's site are excellent but also check the dates printed on the sides of the cars. Even if the car is correct for your era, it may have a paint scheme that is too new. If the date is too new, further research is necessary. A car with an out of period date would be acceptable if the paint scheme is otherwise correct and the date doesn't bother you. Or you can change the date. Some model manufactures may use fictional dates, but this is less prevalent than it used to be.

Look at prototype photos in books and online. While many are not dated, it may be possible to read the dates on the cars with some magnification.

**Gary:** I enjoy reading Eric's blog, and anyone interested in modeling the 1920s or 1930s should check it out. I also look at [steamer-afreightcars.com](http://steamer-afreightcars.com), but it doesn't seem to be active anymore. Still tons of interesting data.

**Ironrooster:** *The Model Railroader's Guide to Freight Cars* by Jeff Wilson (out of print) could help. It covers WWI to the present.

*Keep up with the 1920s discussion and add your own experiences at [mrhmag.com/node/30709](http://mrhmag.com/node/30709).*



## TIPS

## Rolling stock test plank



4. A test plank gathers all the tools and tests needed to check a car or locomotive before it is handed off to operating crews on the layout, and is useful in any scale and gauge. Tethering the NMRA gauge keeps it from walking away. *Franck Combe photo*

first one. The plank is long enough to easily accommodate cars and locomotive sets.

The MDF plank is equipped with a Kadee coupler height gauge to test the couplers, a Kadee uncoupling magnet under the track to test the couplers in real situations, and the NMRA standards gauge to accomplish the various tests.

I have been a model railroader for 10 years working with narrow gauge and in various scales: OO9, G<sub>n</sub>15, and 7/8th. I like to scratchbuild locomotives, rolling stock, and buildings. I have already built six layouts. At my railroad club, RMB of Gennevilliers near Paris in France, we are starting to expand an American HO layout based on contemporary Chicago.

I decided to build a test plank for locomotives and rolling stock. It's my second plank and more sophisticated than the





On the side of the plank, there is the checklist for all the tests to be performed, and a copy of the NMRA test gauge diagram for reference.

I added, on the side of the plank, a converter rule to read directly the length of the rolling stock, and the NMRA's weight in grams (not in ounces because we don't use ounces in France). The scale is kept close by the test plank. Some small scales will read out in either grams or ounces, at the press of a button. Two alligator clamps (not shown) are soldered in the rails to test the locomotives.

## Take the MRH 2018 Reader Survey ...



... and get a chance  
to win a 7" Kindle  
Fire tablet!

(10 tablets will be awarded)

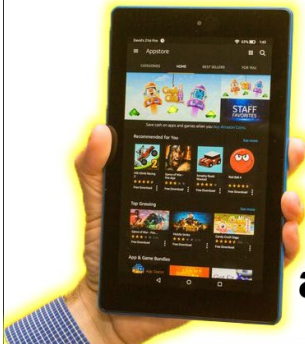

amazon

**TAKE THE SURVEY >>**

*Please take this survey, it really helps us know much better what kind of articles and videos to make for you!*



## GET PAID FOR YOUR TIP

We pay **\$25 per tip** we publish, or \$40 each if the tip also includes a photo or finished drawing.

[Click here and select article type TIP.](#) ■

**VIEW READER  
COMMENTS**

*click here*

### ADVERTISEMENT

## Better Features

FOR THE SERIOUS MODELER

# Tsunami2

Get the best GE sounds on the market for the models you love. Recently updated Tsunami2 Digital Sound Decoders faithfully reproduce GE's most iconic sounds and locomotive specific features, including:

- GEVO G12 Tier 4
- Prime Mover Pitch Shift
- Updated GE Dynamic Braking Effects
- Electronic Air Dryer

**SOUNDTRAXX™**  
www.soundtraxx.com



Hear the difference for yourself!

Buy your models without sound or easily replace the factory installed decoder with a TSU-21PNEM for the best results. Don't settle for less, get the most full featured sound effects for your models!

Listen Now ▶

• [INDEX](#)



**SUBSCRIBE**  
*(free)*

• [TABLE OF CONTENTS](#)

# NORTH AMERICAN RAILCAR CORPORATION



CLICK HERE FOR  
**HO-5077 Boxcar**

CLICK HERE FOR  
**N-5077 Boxcar**

Accuracy and  
Detail... in Scale

Look for  
these  
Railways in  
our first  
production  
of 16 Roads



NARC Cars are sold  
exclusively through

**Pacific Western Rail Systems**

• [INDEX](#)

• [TABLE OF CONTENTS](#)



# GETTING REAL

column

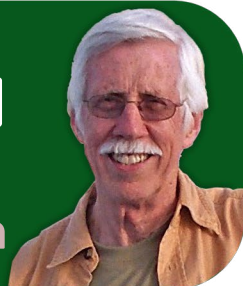

Model Railroad Hobbyist | January 2018 | #95

**TONY THOMPSON** OPERATES



**RATE THIS ARTICLE**

WITH PROTOTYPICAL WAYBILLS  
TO ACHIEVE A BALANCE BETWEEN  
REALISM AND SIMPLICITY ...

**OVER THE YEARS, THERE HAS BEEN A STEADY INCREASE** among model railroaders in increased fidelity to prototype, everything from more accurate models of locomotives and cars, to more realistic structures and scenery, and – the subject here – more prototypical operation.

Of these, operation is in some ways the most challenging. We have extensive photographic evidence and considerable engineering documentation of most of the other aspects I mentioned, but often operational information is lacking. Especially for the more distant periods, few if any people are still with us who actually performed those operations. They are the only ones who could tell us from experience the “how and why” of those days.

But even if we can't talk to such individuals, there still exist many interviews and articles about actual prototype operation, and these are vital documents for those desiring to emulate the

▶ **MODELING REAL RAILROADS AND WHAT THEY DO**

• [INDEX](#)



**SUBSCRIBE**  
(free)

• [TABLE OF CONTENTS](#)

## GETTING REAL | 2

prototype. Narrowing this down to a single point, this column is concerned with the paperwork used to move freight cars, whether loaded or empty, and what we know about how it was done.

I should hasten to say that practically no one among modelers wants to reproduce the full panoply of railroad paperwork and accounting, especially that of the pre-computer age when vast amounts of data were managed by employing armies of clerks. But many of us do wish to be as prototypical as is practical, compacting the documentation to achieve a balance between realism and simplicity [1].



1. Paul Weiss, background, and Jim Providenza, foreground, operate with prototype waybills at my layout town of Ballard. In this 2015 operating session, Paul was the conductor on the Santa Rosalia Branch local and is about to uncouple a car. Jim was the engineer and is holding a throttle. These are the circumstances in which prototypical operating paperwork can add value to layout operation.

## Background

The topic of realistic operation has a long history in model railroading. As early as 1939, some authors, such as Al Kalmbach (writing under the pseudonym “Boomer Pete”), were describing ways to accomplish more realistic freight car movement (see Bibliography for citations). The first system using car cards and waybills was described by Frank Ellison in 1944.

By 1961, when Doug Smith wrote his extensive review of previous work, along with recommendations for ways forward, the hobby literature (thoroughly cited by Smith) was already extensive on this topic. I attempted to bring some of this up to date, in an overview fashion, in my 2009 article in *Railroad Model Craftsman (RMC)*.

Since the Boomer Pete days, numerous books on model railroad operation have been published, usually with extensive information on methods of freight car movement. These range from Paul Mallery’s work to the currently available Kalmbach book by Tony Koester. Probably the most detailed and complete coverage of freight car forwarding is Bruce Chubb’s book (all cited in the Bibliography).

Some methods used by modelers reflect the prototype, as Doug Smith eloquently urged us to do. There have been a number of most informative books on prototype practices, from John Armstrong to Larry Sagle to E.W. Coughlin. These contain considerable insight into not only the how, but the why, of waybill procedures. To my knowledge, the first modeler to really start with the prototype waybill, and reduce it to a convenient size for modelers’ use, was Dan Holbrook. But at least in the early versions, the reduced size was hard to read.

Inspired by Bill Neale’s 2009 magazine article describing the use of clear plastic sleeves for waybill documents, I made an attempt at a prototypical design, as I showed in my RMC article of 2009.



## GETTING REAL | 4

The core of this idea is to put waybills into these sleeves [2]. That in turn causes the waybill shown here to be about 2.5×3.5 inches.

My own 2009 design of the waybill itself began with the AAR standard form [3]. It and several companion prototype forms are covered extensively in the AAR book, *Railway Accounting Rules*. But one needs more than a blank form to move freight cars. After research into the prototype publications just mentioned, and others, I summarized what comprises the content of a filled-out waybill, in an article for the NMRA OpSIG magazine, *The Dispatcher's Office*, in 2010. That was followed by another article in the same magazine in 2011, describing the entire sequence of events in prototype movement of freight cars. Corrected, digital versions of both articles are now available (see Bibliography).

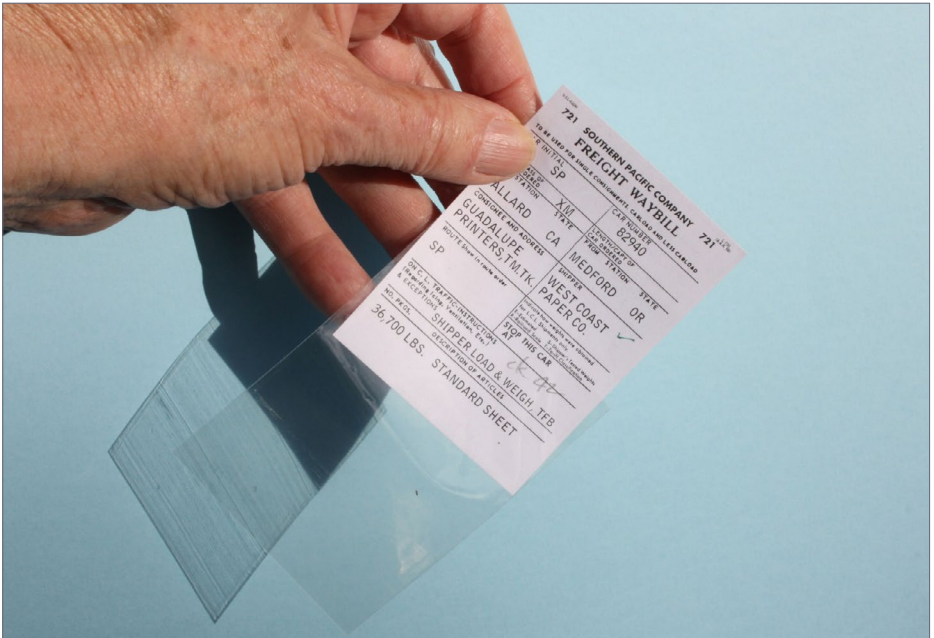

2. Here is one of my completed waybills being inserted into the clear plastic sleeve, a protective sleeve sold for baseball cards.



PLACE SPECIAL SERVICE PASTERS HERE

544—NEW YORK, ONTARIO AND WESTERN RAILWAY—544

LEWIS D. FREEMAN, Trustee

FORM ST-200-REV. 2  
AAR Std. Form No. AD 98

**FREIGHT WAYBILL**

TO BE USED FOR SINGLE CONSIGNMENTS, CARLOAD AND LESS CARLOAD

<b>STOP THIS CAR AT</b>		WEIGHT IN TONS		LENGTH OF CAR		MARKED CAPACITY OF CAR		
		Gross	Tare	Ordered	Furnished	Ordered	Furnished	
FOR CAR INITIALS AND NUMBER		KIND		DATE		WAYBILL No.		
TO STATION		STATE		FROM No.		STATION STATE		
ROUTE (Show each Junction and Carrier in route order to destination of waybill)				FULL NAME OF SHIPPER, AND, FOR C. O. D. SHIPMENTS, THE STREET AND POST OFFICE ADDRESS, AND INVOICE NUMBER IF AVAILABLE.				
RECONSIGN TO STATION STATE				ORIGIN AND DATE ORIGINAL CAR, TRANSFER FREIGHT BILL AND PREVIOUS WAYBILL REFERENCE AND ROUTING WHEN REBILLED.				
AUTHORITY CONSIGNEE AND ADDRESS				C. AMOUNT		WEIGHED		
FINAL DESTINATION AND ADDITIONAL ROUTING				D. FEE		AT		
				D. TOTAL		GROSS		
				PICKUP SERVICE		TARE		
				DELIVERY SERVICE REQUESTED		ALLOWANCE		
WHEN SHIPPER IN THE UNITED STATES EXECUTES THE NO-RECOURSE CLAUSE OF SECTION 7 OF THE BILL OF LADING, INSERT "YES".				YES NO		NET.		
Indicate by symbol in Column provided *Show weights were obtained for L.C.L. Shipments only. R—Railroad Scale, S—Shipper's Treated Weights, E—Estimated—Weigh and Correct, T—Tariff Classification or Minimum.				YES NO		IF CHARGES ARE TO BE PREPAID, WRITE OR STAMP HERE, "TO BE PREPAID"		
ON C. L. TRAFFIC—INSTRUCTIONS (Regarding Icing, Ventilation, Heating, Milling, Weighing, Etc. If lost, Specify to Whom Icing Should be Charged.)				ON L. C. L. TRAFFIC TRANSFER STAMPS TO BE SHOWN IN THESE SPACES				
No. Pkgs.	DESCRIPTION OF ARTICLES, SPECIAL MARKS AND EXCEPTIONS *			WEIGHT	RATE	FREIGHT	ADVANCES	PREPAID
DESTINATION AGENT'S FREIGHT BILL No.								
Outbound Junction Agent Will Show Junction Stamps in Space and Order Provided. Additional Junction Stamps and all Yard Stamps to be placed on back hereof.								
FIRST JUNCTION	SECOND JUNCTION	THIRD JUNCTION	FOURTH JUNCTION	DESTINATION AGENT WILL STAMP BEGIN STATION NAME AND DATE REPORTED				
544—NEW YORK, ONTARIO AND WESTERN RAILWAY—544 LEWIS D. FREEMAN, Trustee								

3. An example of an original railroad waybill form, from the New York, Ontario and Western. Nearly every detail of the form matches AAR Form AD-98 (as noted at upper right), as was the case for all major railroads. An original Form AD-98 can be found in *Railway Accounting Rules* (see Bibliography). It was the basis for my own waybill design.



Others have continued with development of the same kind, aiming at more prototypical waybills while keeping them practical for model railroad use. Important among these have been Ted Pamperin and Tony Koester, some of whose articles are cited in the Bibliography.

I tried to summarize some of those ideas, along with extensions of my own, in a previous column in *Model Railroad Hobbyist*, in the issue for May 2012. That article also showed in detail my method of creating the waybills.

Because that 2012 MRH article described the creation process, I won't repeat it here; but it may be helpful to examine the final product, in the form of a particular waybill. This is shown with explanatory notes as [4], and the corresponding load is shown as [5]. Comparing this diagram [4] to the prototype in [3], you can see that typefaces which are part of the form itself are identical in both because the model form was scanned from the prototype, and that the vertical division between consignee information on the left, and shipper information on the right, has been maintained.

Choosing cargo descriptions in filling out waybills can be done in several ways. The *Uniform Freight Classification* book (or UFC) allows use of prototype designations for various kinds of freight, though sometimes in a rather bureaucratic form. Or, simple everyday language can be used. This was somewhat true in the prototype, where the key information was the product code (also found in the UFC), and those who might wish to use those codes can readily do so.

Finally, I wrote a “progress” article for *The Dispatcher's Office* that was published in 2016, conveying a number of improvements in the making and use of prototype waybills for model railroad use. In sum, all the foregoing (along with the various citations in the Bibliography) provide ample background in how the prototype managed waybills, and how prototypical ones can be designed,

**RAILROAD INITIALS** → 728

**AAR CAR TYPE** → UP

**RAILROAD HEADER** → 728—SPOKANE, PORTLAND AND SEATTLE RAILWAY COMPANY—728

**CAR NUMBER** → 57255

**CONSIGNEE INFORMATION** → PAC GAS & ELEC, TM TK

**SHIPPER INFORMATION** → DESCHUTES TIMBER CO

**ROUTE WITH ALL JUNCTIONS SHOWN** → SP&S-BEND-GN-K FALLS-SP

**CARGO (C/L MEANS FULL CARLOAD)** → C/L POLES, CREOSOTED

**STOP THIS CAR AT** → AT

**OK** (handwritten)

**42** (handwritten)

4. A model waybill with contents identified. The railroad name in the header is taken from an actual document of the prototype railroad (SP&S), along with its AAR code number, 728. Examples of these code numbers are in my 2012 MRH column. Routing is included, with junctions identified. There were no standard abbreviations for these, so different clerks might abbreviate place names differently. Note that this load is destined to a team track, not an industry siding. Some hand-written notations of various kinds are also present, as was common on prototype bills.

**VIEW READER COMMENTS**  
[click here](#)



produced and put into use for model railroading. But the latter part, about use of these waybills in the model environment, has not been described in much detail.

## Model operations: Produce

The purpose of the present column is to turn away from issues of waybill design and construction, and address some of the ways these waybills are used in operation.

The clear plastic sleeves are an important part of the design. In addition to protecting the waybills in use, they also allow multiple documents in each sleeve. An Empty Car Bill can readily be added to complement each loaded-car waybill with the paperwork for its empty move [6].



5. The Union Pacific flat car, and the load for which the waybill in [4] was written, are spotted at the team track in my layout town of Shumala. Pismo Dunes Road is in the foreground. The model, including load, was built by Richard Hendrickson.



**NEW!**

# Airbrushing how-to videos!

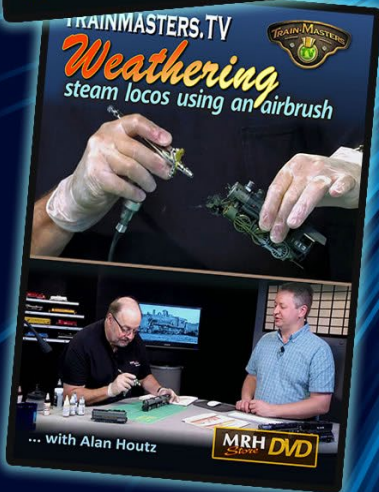
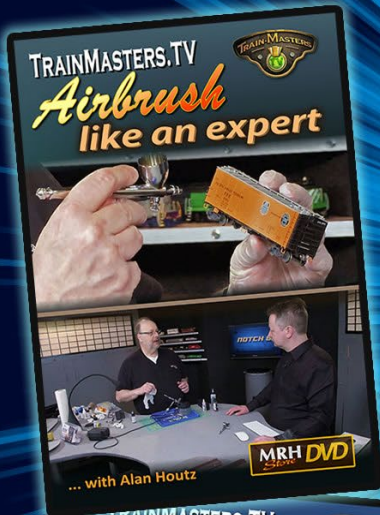
**Order Videos!**

## Airbrush like an expert

Airbrushing 101 - All about airbrushes  
 Airbrushing 102 - Outfitting and strip-down  
 Airbrushing 103 - Painting technique  
 Airbrushing 104 - Simple weathering  
 Bonus: Easy airbrush cleaning

Video download: \$16.49

DVD (2 disks): \$24.99

## Weathering steam locos with an airbrush

Into & weathering working passenger steam  
 Weathering working freight steam  
 Weathering steam near end-of-service

Video download: \$12.49

DVD (1 disk): \$19.99

**SPECIAL VIDEO PRICING!**

from the  
**Model Railroad  
 Hobbyist Store**

• [INDEX](#)• [SUBSCRIBE](#)  
(free)• [TABLE OF CONTENTS](#)

An even more important function of the sleeve is to facilitate the use of “short” or “overlay” bills. The idea here is to provide only the information below the uppermost part of a regular waybill, where car initials and number are shown. Then, when placed atop a regular waybill, an entirely different destination and even a different load can be implemented.

An example of an inbound overlay bill is shown as [7]. Any of the covered hopper cars (AAR class LO) in my fleet that are of the

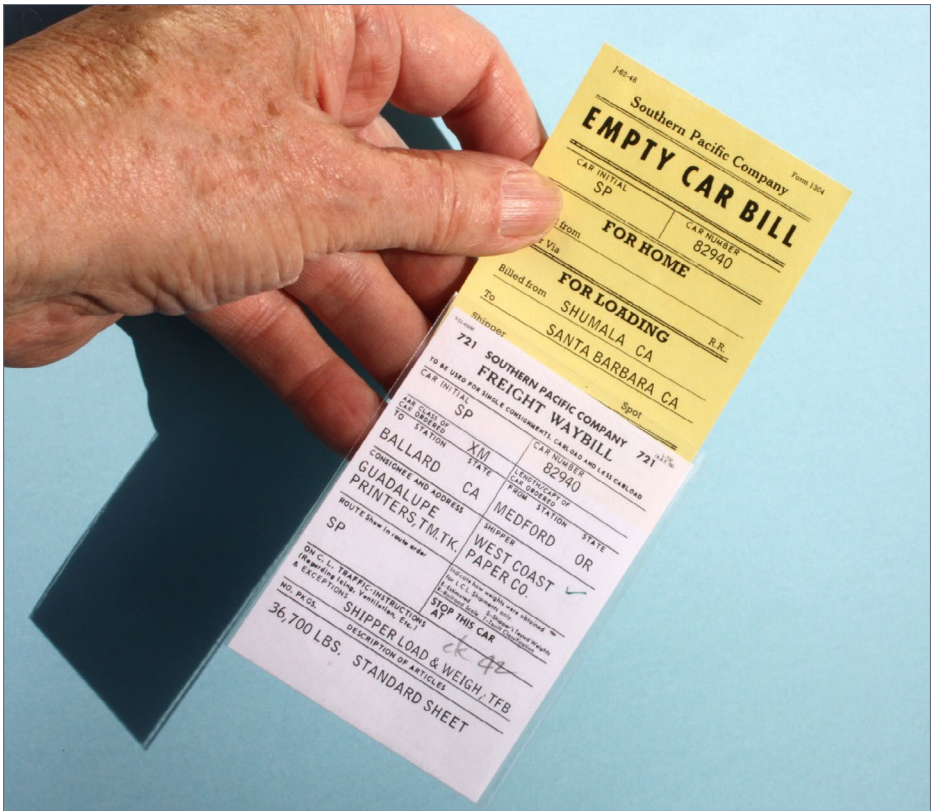

6. The Empty Car Bill for the reverse movement of a particular loaded waybill can readily be inserted into the plastic sleeve behind the waybill. Empty Car Bills were discussed at some length in my 2012 MRH article.

AAR CLASS OF CAR ORDERED <b>LO</b>	LENGTH/COPY OF CAR ORDERED
TO STATION STATE <b>BALLARD CA</b>	FROM STATION STATE <b>MONOLITH CA</b>
CONSIGNEE AND ADDRESS <b>CALIF. DIV. OF HIGHWAYS</b>	SHIPPER <b>MONOLITH PORTLAND CEMENT</b>
ROUTE Show in route order <b>SP</b>	Indicate how weights were obtained for L.C.L. Shipments only. E—Estimated S—Shipper's Tested Weights R—Railroad Scale T—Tariff Classification <b>STOP THIS CAR AT</b>
ON C. L. TRAFFIC-INSTRUCTIONS (Regarding Icing, Ventilation, Etc.) & EXCEPTIONS	
NO. PKGS.	DESCRIPTION OF ARTICLES
<b>C/L</b>	<b>CEMENT</b>

7. An example of a “short” or “overlay” bill, in this case describing a carload of cement, sent from an on-line SP industry to a consignee on my layout. It can be paired with the full SP waybill for any covered hopper in cement service, from any railroad in the far west. Note in comparison to [4] that it would cover everything below the reporting marks.



cement type, and already have an SP waybill for any cargo, can receive this overlay to create a shipment of cement. You can see how this would fit atop a full waybill by comparing to the waybill in [4].

These overlay bills can extend the flexibility of loads for any particular car, as well as creating flexibility of cargoes from any particular industry. The example of [7] is for a somewhat specialized car, a covered hopper. For free-running cars, such as box cars, gondolas, and flat cars without any special equipment, this is even more appropriate and realistic.

But an important use of “overlay” bills in my layout operation is for perishables. These are an ideal shipping category for use of these bills. All my outgoing loads will have Southern Pacific waybills [8] because any refrigerator car that will be used for produce shipment (that is, cars other than meat cars) can accept such bills. Of course, outgoing loads on any railroad will have home-road waybills.

I use this flexibility in my operating sessions, because any particular operating day is regarded on the layout as that same date in my modeling year, 1953. So a recent October session would be treated as October 15, 1953, and all outbound produce from packing houses should conform to that season.

So how do “overlay” bills support this idea? Let me offer an example. The waybill here [8] is for a PFE car, no. 98478, and its load is shown as celery, one of the categories of produce grown in the locale of my layout. But quite a few other vegetable types are also grown.

Presented in [9] is an extract from a Pacific Fruit Express chart of harvesting seasons in the Santa Maria plain, near where I model. You will note that there is a year-round harvest among all the various kinds of vegetables. A table like this could be made up for any growing area in the country, using state or federal crop data.



L-710-B

## 721—Southern Pacific Company—721 PERISHABLE FREIGHT WAYBILL

TO BE USED FOR SINGLE CONSIGNMENTS, CARLOAD AND LESS CARLOAD

CAR INITIAL <b>PFE</b>		CAR NUMBER <b>98478</b>	
AAR CLASS OF CAR ORDERED <b>RS</b>		LENGTH/COPY OF CAR ORDERED	
TO STATION	STATE	FROM STATION	STATE
<b>SCRANTON</b>	<b>PA</b>	<b>BALLARD</b>	<b>CA</b>
CONSIGNEE AND ADDRESS <b>GREAT A&amp;P TEA CO. WAREHOUSE</b>		SHIPPER <b>WESTERN PACKING CO.</b>	
ROUTE <i>Show in route order</i> <b>SP-OG-UP-CO BL- C&amp;NW-CHI-PRR</b>		Indicate how weights were obtained for L.C.L. Shipments only. E—Estimated      S—Shipper's Tested Weights R—Railroad Scale    T—Tariff Classification <b>STOP THIS CAR AT</b>	
RECONSIGNEED TO			
PRE-ICE	INITIAL ICE	YES	CPS SEC. 2
NO. PKGS.	DESCRIPTION OF ARTICLES		
<b>410 BOXES</b>	<b>CELERY</b>		

8. A full waybill for a shipment of celery from one of my on-line packing houses, in this case using the AAR-recommended pink stock for a perishable waybill.



Depending on the season, the table [9] shows that harvested crops may include broccoli, cabbage, carrots, cauliflower, lettuce and tomatoes. Do I need to make a new waybill for each of these vegetables for car 98478 (or for any particular PFE car)? No, I only need to make one perishable waybill for this car, such as shown in [8]. Then I make sets of “overlay” bills for other crops, examples of which you see in [10].

So a particular packing house, such as the Phelan & Taylor house in my layout town of Shumala [11], ships seasonally correct produce with the aid of overlay bills. Just to emphasize the final result, the waybill shown in [12] is the same waybill as in [8] but with the overlay for cauliflower, shown in the overlay assortment [10], added as the top sheet in the sleeve.

The same approach to seasonal produce harvests can apply for fruit shipment. In [13] is a table, made the same way as [9], showing the corresponding harvesting seasons for various fruits. With

Normal Growing and Shipping Season

Commodity	Producing District	Producing State
<b>Broccoli</b>	Guadalupe-Santa Maria	CA
<b>Cabbage</b>	Guadalupe-Santa Maria	CA
<b>Cauliflower</b>	Santa Maria-Guadalupe District	CA
<b>Celery</b>	Santa Maria-Guadalupe District	CA
<b>Lettuce</b>	Guadalupe-Santa Maria	CA
<b>Peas-Green</b>	Guadalupe-Santa Maria District	CA
<b>Potatoes-Irish (White)</b>	Guadalupe-Santa Maria District	CA
<b>Tomatoes</b>	Santa Maria-Guadalupe	CA





ARR CLASS OF CAR ORDERED	RS TO STATION STATE	LENGTH/CAPY OF CAR ORDERED	FROM STATION STATE
ST. PAUL MN	BALLARD CA		
CONSIGNEE AND ADDRESS UNION FRUIT & PRODUCE CO.		SHIPPER WESTERN PACKING CO	
ROUTE Show in route order SP-0G-UP-CO BL-MILW		Indicate how weights were obtained for L.C.L. Shipments only. 1-Netweight 2-Shipper's Tareted Weights 3-Revised Scale 4-Tareted Classification STOP THIS CAR AT	
RECONIGNED TO			
PRE-ICE	INITIAL ICE	YES	CPS SEC. 2
NO. PKGS. DESCRIPTION OF ARTICLES			
290 CARTONS CABBAGE			

ARR CLASS OF CAR ORDERED	RS TO STATION STATE	LENGTH/CAPY OF CAR ORDERED	FROM STATION STATE
CINCINNATI OH	BALLARD CA		
CONSIGNEE AND ADDRESS QUEEN CITY PRODUCE		SHIPPER WESTERN PACKING CO.	
ROUTE Show in route order SP-ELP-T&N-COR-SSW-STL-B&O		Indicate how weights were obtained for L.C.L. Shipments only. 1-Netweight 2-Shipper's Tareted Weights 3-Revised Scale 4-Tareted Classification STOP THIS CAR AT	
RECONIGNED TO			
PRE-ICE	INITIAL ICE	YES	CPS SEC. 2
NO. PKGS. DESCRIPTION OF ARTICLES			
410 BOXES CARROTS COARSE ICE, 24 HRS. MAX.			

ARR CLASS OF CAR ORDERED	RS TO STATION STATE	LENGTH/CAPY OF CAR ORDERED	FROM STATION STATE
BOISE IDA	BALLARD CA		
CONSIGNEE AND ADDRESS JENKINS FRUIT & VEG.		SHIPPER WESTERN PACKING CO.	
ROUTE Show in route order SP-PORT-UP		Indicate how weights were obtained for L.C.L. Shipments only. 1-Netweight 2-Shipper's Tareted Weights 3-Revised Scale 4-Tareted Classification STOP THIS CAR AT	
RECONIGNED TO			
PRE-ICE	INITIAL ICE	YES	CPS SEC. 2
NO. PKGL. DESCRIPTION OF ARTICLES			
440 CARTONS CAULIFLOWER			

ARR CLASS OF CAR ORDERED	RS TO STATION STATE	LENGTH/CAPY OF CAR ORDERED	FROM STATION STATE
TACOMA WA	SHUMALA CA		
CONSIGNEE AND ADDRESS STANDARD GROCERY CO.		SHIPPER PHELAN & TAYLOR PRODUCE CO.	
ROUTE Show in route order SP-PORT-UP		Indicate how weights were obtained for L.C.L. Shipments only. 1-Netweight 2-Shipper's Tareted Weights 3-Revised Scale 4-Tareted Classification STOP THIS CAR AT	
RECONIGNED TO			
PRE-ICE	INITIAL ICE	YES	CPS SEC. 2
NO. PKGS. DESCRIPTION OF ARTICLES			
380 CARTONS LETTUCE			

ARR CLASS OF CAR ORDERED	RS TO STATION STATE	LENGTH/CAPY OF CAR ORDERED	FROM STATION STATE
SPOKANE WA	SHUMALA CA		
CONSIGNEE AND ADDRESS WESTERN STATES GROC.		SHIPPER PHELAN & TAYLOR	
ROUTE Show in route order SP-PORT-SP&S		Indicate how weights were obtained for L.C.L. Shipments only. 1-Netweight 2-Shipper's Tareted Weights 3-Revised Scale 4-Tareted Classification STOP THIS CAR AT	
RECONIGNED TO			
PRE-ICE	NO	INITIAL ICE	YES CPS SEC. 2
NO. PKGS. DESCRIPTION OF ARTICLES			
482 CARTONS BROCCOLI			

ARR CLASS OF CAR ORDERED	RS TO STATION STATE	LENGTH/CAPY OF CAR ORDERED	FROM STATION STATE
NEW YORK NY	BALLARD CA		
CONSIGNEE AND ADDRESS DUANE ST. WHLSL. MKT., PIER 21		SHIPPER WESTERN PACKING CO.	
ROUTE Show in route order SP-0G-UP-CO BL-RI-CHIERIE		Indicate how weights were obtained for L.C.L. Shipments only. 1-Netweight 2-Shipper's Tareted Weights 3-Revised Scale 4-Tareted Classification STOP THIS CAR AT	
RECONIGNED TO			
PRE-ICE	INITIAL ICE	YES	CPS SEC. 2
NO. PKGS. DESCRIPTION OF ARTICLES			
380 LUGS TOMATOES			

10. Six different vegetable crops, harvested in the seasons shown in [9], can be moved in reefers with these overlay bills. Two packing houses, in two layout towns, are shown here.



11. Switcher SP 1423 is spotting an empty reefer, PFE 2095, for loading at the Phelan & Taylor packing house in my layout town of Shumala. Just to the right of the locomotive can be seen a stack of shipping boxes, ready to go into the car for today's load of vegetables. The structure was built from a Showcase Miniatures kit.



## PERISHABLE FREIGHT WAYBILL

TO BE USED FOR SINGLE CONSIGNMENTS, CARLOAD AND LESS CARLOAD

CAR INITIAL <b>PFE</b>		CAR NUMBER <b>98478</b>	
AAR CLASS OF CAR ORDERED <b>RS</b>		LENGTH/COPY OF CAR ORDERED	
TO STATION <b>BOISE</b>	STATE <b>IDA</b>	FROM STATION <b>BALLARD</b>	STATE <b>CA</b>
CONSIGNEE AND ADDRESS <b>JENKINS FRUIT &amp; VEG.</b>		SHIPPER <b>WESTERN PACK- ING CO.</b>	
ROUTE Show in route order <b>SP-PORT-UP</b>		Indicate how weights were obtained for L.C.L. Shipments only. E—Estimated      S—Shipper's Tested Weights R—Railroad Scale    T—Tariff Classification <b>STOP THIS CAR AT</b>	
RECONSIGNEED TO			
PRE-ICE	INITIAL ICE	<b>YES</b>	CPS <b>SEC. 2</b>
NO. PKGS.	DESCRIPTION OF ARTICLES		
<b>440 CARTONS</b>	<b>CAULIFLOWER</b>		

12. The original waybill for PFE 98478, shown in [8], overlaid with a short bill for cauliflower, part of the assortment shown in [10], to make up a different waybill. This overlay bill for cauliflower, of course, could be overlaid on a waybill for any PFE car.



summer operating date. I show some of the overlay bills for Guadalupe Fruit in [14]. These also could readily be used with a full bill like [8].

Note, in addition, that in [14] is one overlay bill for an express reefer, AAR type BR, for late winter strawberries, a California product always bringing a premium price in eastern markets and thus justifying use of an express reefer. These do ship in March and April.

But not all the fruits in [13] have such short seasons. I also have a lemon packing house on the layout, and the table shows that lemons are shipped pretty much year-round. Accordingly, the lemon packer on my layout is about as busy year-round as the vegetable packers, with shipments departing most any day of the year [15].

## Normal Growing and Shipping Season

Commodity	Jan	Feb	Mar	Apr
<b>Apricots</b>				
<b>Cherries</b>				
<b>Grapes</b>				
<b>Plums</b>				
<b>Lemons</b>	■	■	■	■
<b>Oranges</b>	■	■	■	■

## Agent instructions

Note in the caption to [15] the mention of agent instructions. Prototype switch crews would be informed by the local agent which cars needed to be picked up and which industries would receive empty cars, maybe with spotting specified. When an agent was on duty, this would be verbal, but if the agency was closed,

13. Growing and shipping seasons for fruit in one part of Southern Pacific territory, with the table constructed the same way as for the accompanying vegetable table [9], from a six-page table, pp. 442–447, in *Pacific Fruit Express* (see Bibliography). The darker parts of each bar represent peak seasons. A table like this could be constructed for any growing area in the country.

Seasons in Southern Pacific Territory

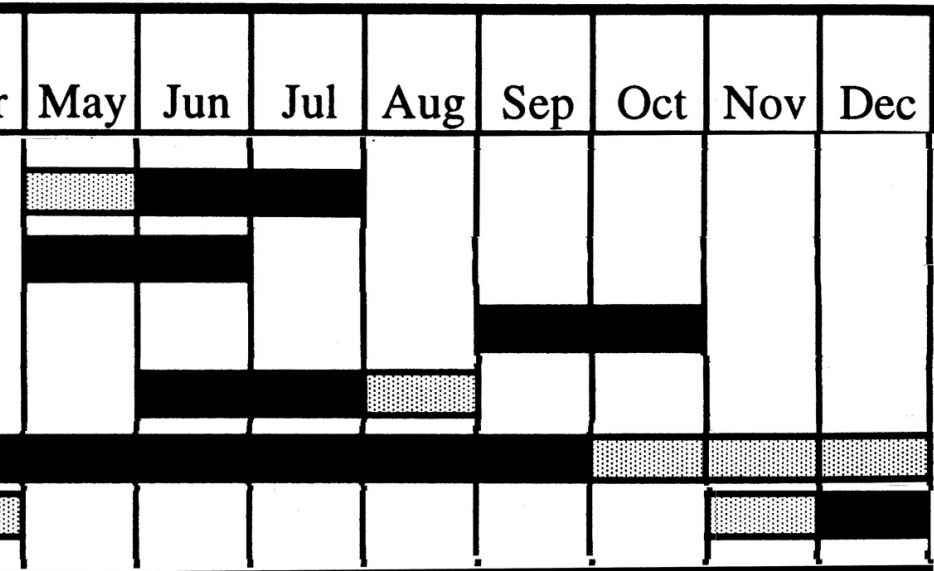

a message could be left by the agent in the bill box outside the depot. I've discussed this at some length in a series of blog posts (see Bibliography).

<table border="1"> <thead> <tr> <th>AIR CLASS OF CAR ORDERED</th> <th>RS</th> <th>LEADERSHIP OF CAR ORDERED</th> <th>TO STATION</th> <th>STATE</th> <th>FROM STATION</th> <th>STATE</th> </tr> </thead> <tbody> <tr> <td>ST. PAUL</td> <td>MIN</td> <td>BALLARD</td> <td>CA</td> <td></td> <td></td> <td></td> </tr> <tr> <td colspan="7">CONSIGNEE AND ADDRESS</td> </tr> <tr> <td colspan="2">STACEY DISTRIBUTING COMPANY</td> <td colspan="5">SHIPPER GUADALUPE FRUIT COMPANY</td> </tr> <tr> <td colspan="7">ROUTE shown in route order</td> </tr> <tr> <td colspan="7">SP-OG-UP-CO BL-R1</td> </tr> <tr> <td colspan="7">RECONIGNED TO</td> </tr> <tr> <td>PRE-ICE</td> <td>YES</td> <td>INITIAL ICE</td> <td>YES</td> <td>CPS</td> <td>SEC. 2</td> <td></td> </tr> <tr> <td colspan="7">NO. PKGS. DESCRIPTION OF ARTICLES</td> </tr> <tr> <td colspan="7">C/L CHERRIES</td> </tr> </tbody> </table>	AIR CLASS OF CAR ORDERED	RS	LEADERSHIP OF CAR ORDERED	TO STATION	STATE	FROM STATION	STATE	ST. PAUL	MIN	BALLARD	CA				CONSIGNEE AND ADDRESS							STACEY DISTRIBUTING COMPANY		SHIPPER GUADALUPE FRUIT COMPANY					ROUTE shown in route order							SP-OG-UP-CO BL-R1							RECONIGNED TO							PRE-ICE	YES	INITIAL ICE	YES	CPS	SEC. 2		NO. PKGS. DESCRIPTION OF ARTICLES							C/L CHERRIES							<table border="1"> <thead> <tr> <th>AIR CLASS OF CAR ORDERED</th> <th>RS</th> <th>LEADERSHIP OF CAR ORDERED</th> <th>TO STATION</th> <th>STATE</th> <th>FROM STATION</th> <th>STATE</th> </tr> </thead> <tbody> <tr> <td>SALT LAKE CITY</td> <td>UT</td> <td>BALLARD</td> <td>CA</td> <td></td> <td></td> <td></td> </tr> <tr> <td colspan="7">CONSIGNEE AND ADDRESS</td> </tr> <tr> <td colspan="2">HEWLETT BROS. COMPANY</td> <td colspan="5">SHIPPER GUADALUPE FRUIT COMPANY</td> </tr> <tr> <td colspan="7">ROUTE shown in route order</td> </tr> <tr> <td colspan="7">SP-OGDEN-D&amp;RGW</td> </tr> <tr> <td colspan="7">RECONIGNED TO</td> </tr> <tr> <td>PRE-ICE</td> <td>YES</td> <td>INITIAL ICE</td> <td>YES</td> <td>CPS</td> <td>SEC. 2</td> <td></td> </tr> <tr> <td colspan="7">NO. PKGS. DESCRIPTION OF ARTICLES</td> </tr> <tr> <td colspan="7">480 LUGS APRICOTS</td> </tr> </tbody> </table>	AIR CLASS OF CAR ORDERED	RS	LEADERSHIP OF CAR ORDERED	TO STATION	STATE	FROM STATION	STATE	SALT LAKE CITY	UT	BALLARD	CA				CONSIGNEE AND ADDRESS							HEWLETT BROS. COMPANY		SHIPPER GUADALUPE FRUIT COMPANY					ROUTE shown in route order							SP-OGDEN-D&RGW							RECONIGNED TO							PRE-ICE	YES	INITIAL ICE	YES	CPS	SEC. 2		NO. PKGS. DESCRIPTION OF ARTICLES							480 LUGS APRICOTS							<table border="1"> <thead> <tr> <th>AIR CLASS OF CAR ORDERED</th> <th>RS</th> <th>LEADERSHIP OF CAR ORDERED</th> <th>TO STATION</th> <th>STATE</th> <th>FROM STATION</th> <th>STATE</th> </tr> </thead> <tbody> <tr> <td>CINCINNATI</td> <td>OH</td> <td>BALLARD</td> <td>CA</td> <td></td> <td></td> <td></td> </tr> <tr> <td colspan="7">CONSIGNEE AND ADDRESS</td> </tr> <tr> <td colspan="2">GERMANTOWN FRUIT &amp; VEG.</td> <td colspan="5">SHIPPER GUADALUPE FRUIT CO.</td> </tr> <tr> <td colspan="7">ROUTE shown in route order</td> </tr> <tr> <td colspan="7">SP-ELP-T&amp;N-COR-SSW-STL-B&amp;O</td> </tr> <tr> <td colspan="7">RECONIGNED TO</td> </tr> <tr> <td>PRE-ICE</td> <td></td> <td>INITIAL ICE</td> <td>YES</td> <td>CPS</td> <td>SEC. 2</td> <td></td> </tr> <tr> <td colspan="7">NO. PKGS. DESCRIPTION OF ARTICLES</td> </tr> <tr> <td colspan="7">484 LUGS PLUMS COARSE ICE, 24 HRS. MAX.</td> </tr> </tbody> </table>	AIR CLASS OF CAR ORDERED	RS	LEADERSHIP OF CAR ORDERED	TO STATION	STATE	FROM STATION	STATE	CINCINNATI	OH	BALLARD	CA				CONSIGNEE AND ADDRESS							GERMANTOWN FRUIT & VEG.		SHIPPER GUADALUPE FRUIT CO.					ROUTE shown in route order							SP-ELP-T&N-COR-SSW-STL-B&O							RECONIGNED TO							PRE-ICE		INITIAL ICE	YES	CPS	SEC. 2		NO. PKGS. DESCRIPTION OF ARTICLES							484 LUGS PLUMS COARSE ICE, 24 HRS. MAX.							<table border="1"> <thead> <tr> <th>AIR CLASS OF CAR ORDERED</th> <th>BR</th> <th>LEADERSHIP OF CAR ORDERED</th> <th>TO STATION</th> <th>STATE</th> <th>FROM STATION</th> <th>STATE</th> </tr> </thead> <tbody> <tr> <td>PITTSBURGH</td> <td>PA</td> <td>BALLARD</td> <td>CA</td> <td></td> <td></td> <td></td> </tr> <tr> <td colspan="7">CONSIGNEE AND ADDRESS</td> </tr> <tr> <td colspan="2">ALLEGHENY PRODUCE BROKERS</td> <td colspan="5">SHIPPER GUADALUPE FRUIT COMPANY</td> </tr> <tr> <td colspan="7">ROUTE shown in route order</td> </tr> <tr> <td colspan="7">SP-OG-UP-COBL-RI-CHIERIE-CLE-PRR</td> </tr> <tr> <td colspan="7">RECONIGNED TO</td> </tr> <tr> <td>PRE-ICE</td> <td>YES</td> <td>INITIAL ICE</td> <td>YES</td> <td>CPS</td> <td>SEC. 2</td> <td></td> </tr> <tr> <td colspan="7">NO. PKGS. DESCRIPTION OF ARTICLES</td> </tr> <tr> <td colspan="7">C/L STRAWBERRIES</td> </tr> </tbody> </table>	AIR CLASS OF CAR ORDERED	BR	LEADERSHIP OF CAR ORDERED	TO STATION	STATE	FROM STATION	STATE	PITTSBURGH	PA	BALLARD	CA				CONSIGNEE AND ADDRESS							ALLEGHENY PRODUCE BROKERS		SHIPPER GUADALUPE FRUIT COMPANY					ROUTE shown in route order							SP-OG-UP-COBL-RI-CHIERIE-CLE-PRR							RECONIGNED TO							PRE-ICE	YES	INITIAL ICE	YES	CPS	SEC. 2		NO. PKGS. DESCRIPTION OF ARTICLES							C/L STRAWBERRIES						
AIR CLASS OF CAR ORDERED	RS	LEADERSHIP OF CAR ORDERED	TO STATION	STATE	FROM STATION	STATE																																																																																																																																																																																																																																																																																					
ST. PAUL	MIN	BALLARD	CA																																																																																																																																																																																																																																																																																								
CONSIGNEE AND ADDRESS																																																																																																																																																																																																																																																																																											
STACEY DISTRIBUTING COMPANY		SHIPPER GUADALUPE FRUIT COMPANY																																																																																																																																																																																																																																																																																									
ROUTE shown in route order																																																																																																																																																																																																																																																																																											
SP-OG-UP-CO BL-R1																																																																																																																																																																																																																																																																																											
RECONIGNED TO																																																																																																																																																																																																																																																																																											
PRE-ICE	YES	INITIAL ICE	YES	CPS	SEC. 2																																																																																																																																																																																																																																																																																						
NO. PKGS. DESCRIPTION OF ARTICLES																																																																																																																																																																																																																																																																																											
C/L CHERRIES																																																																																																																																																																																																																																																																																											
AIR CLASS OF CAR ORDERED	RS	LEADERSHIP OF CAR ORDERED	TO STATION	STATE	FROM STATION	STATE																																																																																																																																																																																																																																																																																					
SALT LAKE CITY	UT	BALLARD	CA																																																																																																																																																																																																																																																																																								
CONSIGNEE AND ADDRESS																																																																																																																																																																																																																																																																																											
HEWLETT BROS. COMPANY		SHIPPER GUADALUPE FRUIT COMPANY																																																																																																																																																																																																																																																																																									
ROUTE shown in route order																																																																																																																																																																																																																																																																																											
SP-OGDEN-D&RGW																																																																																																																																																																																																																																																																																											
RECONIGNED TO																																																																																																																																																																																																																																																																																											
PRE-ICE	YES	INITIAL ICE	YES	CPS	SEC. 2																																																																																																																																																																																																																																																																																						
NO. PKGS. DESCRIPTION OF ARTICLES																																																																																																																																																																																																																																																																																											
480 LUGS APRICOTS																																																																																																																																																																																																																																																																																											
AIR CLASS OF CAR ORDERED	RS	LEADERSHIP OF CAR ORDERED	TO STATION	STATE	FROM STATION	STATE																																																																																																																																																																																																																																																																																					
CINCINNATI	OH	BALLARD	CA																																																																																																																																																																																																																																																																																								
CONSIGNEE AND ADDRESS																																																																																																																																																																																																																																																																																											
GERMANTOWN FRUIT & VEG.		SHIPPER GUADALUPE FRUIT CO.																																																																																																																																																																																																																																																																																									
ROUTE shown in route order																																																																																																																																																																																																																																																																																											
SP-ELP-T&N-COR-SSW-STL-B&O																																																																																																																																																																																																																																																																																											
RECONIGNED TO																																																																																																																																																																																																																																																																																											
PRE-ICE		INITIAL ICE	YES	CPS	SEC. 2																																																																																																																																																																																																																																																																																						
NO. PKGS. DESCRIPTION OF ARTICLES																																																																																																																																																																																																																																																																																											
484 LUGS PLUMS COARSE ICE, 24 HRS. MAX.																																																																																																																																																																																																																																																																																											
AIR CLASS OF CAR ORDERED	BR	LEADERSHIP OF CAR ORDERED	TO STATION	STATE	FROM STATION	STATE																																																																																																																																																																																																																																																																																					
PITTSBURGH	PA	BALLARD	CA																																																																																																																																																																																																																																																																																								
CONSIGNEE AND ADDRESS																																																																																																																																																																																																																																																																																											
ALLEGHENY PRODUCE BROKERS		SHIPPER GUADALUPE FRUIT COMPANY																																																																																																																																																																																																																																																																																									
ROUTE shown in route order																																																																																																																																																																																																																																																																																											
SP-OG-UP-COBL-RI-CHIERIE-CLE-PRR																																																																																																																																																																																																																																																																																											
RECONIGNED TO																																																																																																																																																																																																																																																																																											
PRE-ICE	YES	INITIAL ICE	YES	CPS	SEC. 2																																																																																																																																																																																																																																																																																						
NO. PKGS. DESCRIPTION OF ARTICLES																																																																																																																																																																																																																																																																																											
C/L STRAWBERRIES																																																																																																																																																																																																																																																																																											

14. These four overlay bills show the fruit that is shipped when seasonally appropriate from my layout's fruit packing house in the town of Ballard. Note the bill at far right is for an express refrigerator, AAR class BR.



15. The shipping building of the citrus packing house on my layout at Santa Rosalia. Field boxes of lemons can be seen in the open doorway and PFE reefer 64739 is spotted for loading at Door 3 per the instructions from the agent.



Because the Central Coast area that I model is also an area in which wine grapes are grown, and in which wine is produced, my layout has a couple of wineries, or at least their shipping operations. The wine business has its complex aspects, including those touching on rail shipments. I have discussed “wine as an industrial commodity” in moderate detail in a blog post (see Bibliography).

One of my layout wineries, Zaca Mesa Wines, ships bulk wine, both in tank-containing box cars (AAR type XT) and in insulated tank cars. A local freight picking up such a car is shown in [16]. Tank cars like this were often destined to the eastern U.S., where local companies would bottle the wine under their own label. The car shown in [16], like many cars converted by General American from one to three compartments, has unequal dome sizes. Construction of this tank car was described in a blog post (see Bibliography).



16. Consolidation SP 2829, the power for today's branch local, is picking up a three-compartment tank car of bulk wine at the loading rack of the Zaca Mesa winery in Ballard. The car is likely destined to wine brokers or packagers in other parts of the country.

# GETTING REAL | 21

A shipment like this might be waybilled as shown in [17]. As was common for privately owned tank cars, the empty movement was on a regular freight waybill, because a railroad's own Empty Car Bill would only be valid to the boundary of that railroad. By contrast, a freight waybill could move the car all the way back to its originating location on a single document. Owners of leased cars such as General American also believed that empty cars moved more promptly on waybills. Lastly, a waybill also has the feature that the prior load can be shown for safety reasons, though of course that is not an issue for wine cargoes.

721—Southern Pacific Company—721 FREIGHT WAYBILL			
TO BE USED FOR SINGLE CONSIGNMENTS, CARLOAD AND LESS CARLOAD			
CAR INITIAL GATX		CAR NUMBER 1392	
CAR CLASS OF CAR ORDERED TLI		LENGTH/COPY OF CAR ORDERED	
TO STATION	STATE	FROM STATION	STATE
BALLARD	CA	FRESNO	CA
CONSIGNEE AND ADDRESS ZACA MESA WINES		SHIPPER SP AGENT	
ROUTE Show in route order SP		Indicate how weights were obtained for L.C.L. Shipments only. E—Estimated S—Shipper's Tested Weights R—Railroad Scale T—Tariff Classification <b>STOP THIS CAR AT</b>	
ON C. L. TRAFFIC-INSTRUCTIONS (Regarding Icing, Ventilation, Etc.) & EXCEPTIONS			
RECORD RIGHTS, REVERSE ROUTE			
NO. PKGS.	DESCRIPTION OF ARTICLES		
L/C	WINES, VARIOUS		

721—Southern Pacific Company—721 FREIGHT WAYBILL			
TO BE USED FOR SINGLE CONSIGNMENTS, CARLOAD AND LESS CARLOAD			
CAR INITIAL GATX		CAR NUMBER 1392	
CAR CLASS OF CAR ORDERED TLI		LENGTH/COPY OF CAR ORDERED	
TO STATION	STATE	FROM STATION	STATE
WELLESLEY MA	BALLARD	CA	
CONSIGNEE AND ADDRESS WELLESLEY WINE CO.		SHIPPER ZACA MESA WINES	
ROUTE Show in route order SP-OG-UP-COB- C&NW-CHI-NYC- ALB-B&A		Indicate how weights were obtained for L.C.L. Shipments only. E—Estimated S—Shipper's Tested Weights R—Railroad Scale T—Tariff Classification <b>STOP THIS CAR AT</b>	
ON C. L. TRAFFIC-INSTRUCTIONS (Regarding Icing, Ventilation, Etc.) & EXCEPTIONS			
NO. PKGS.	DESCRIPTION OF ARTICLES		
A	2105 GALS. PORT		
B	2101 GALS. PREMIUM PORT		
C	3102 GALS. RED TABLE WINE		

17. The pair of waybills for moving the tank car shown in [16]. The car had been moved empty from Fresno (where it was probably unloaded from a previous move) by order of the owner, General American, for loading at Ballard with a cargo going to Massachusetts. The bill at right could be overlaid with a "short bill" to another destination if desired.

Overlay bills are practical for tank cars like this also, such as shown in [18]. But this overlay can only be used with the bill shown in [17], unless another model in the fleet has the same capacities of its individual compartments.

<b>AAR CLASS OF CAR ORDERED</b> TLI		<b>LENGTH/CAPY OF CAR ORDERED</b>	
<b>TO STATION</b>	<b>STATE</b>	<b>FROM STATION</b>	<b>STATE</b>
HARBERT	MI	BALLARD	CA
<b>CONSIGNEE AND ADDRESS</b> MOLLY PITCHER WINERY		<b>SHIPPER</b> ZACA MESA WINES	
<b>ROUTE Show in route order</b> SP-OG-UP-CO BL- C&NW-PROVISO-PM		Indicate how weights were obtained for L.C.L. Shipments only. E-Estimated      S-Shipper's Tested Weights R-Railroad Scale      T-Tariff Classification	
		<b>STOP THIS CAR AT</b>	
<b>ON C. L. TRAFFIC-INSTRUCTIONS (Regarding Icing, Ventilation, Etc.) &amp; EXCEPTIONS</b>			
<b>NO. PKGS.</b>		<b>DESCRIPTION OF ARTICLES</b>	
A 2105 GALS.		PREMIUM PORT	
B 2101 GALS.		RED WINE	
C 3102 GALS.		RED TABLE WINE	

18. An example of a tank car overlay bill, in this case for the three-compartment car shown in [16], and to be used with the loaded bill in [17].



Note also that each compartment of the car has its contents separately listed.

In the 1950s, which I model, most wine consumed in the United States was fortified wine (such as port and sherry). For more on that topic, interested readers can consult my blog post about “wine as an industrial commodity.”

That post also includes some information about wine grapes as a commodity. These too are shipped from place to place, as different vineyards and wineries buy and sell grapes to balance the product they intend to produce from a particular harvest. Accordingly, wine grapes are also shipped in the fall [13] from my layout wine

AAR CLASS OF CAR ORDERED		RS		LENGTH/COPY OF CAR ORDERED	
TO STATION	STATE	FROM STATION	STATE	FROM STATION	STATE
SEATTLE	WA	BALLARD	CA	HEALDSBURG	CA
CONSIGNEE AND ADDRESS		SHIPPER		CONSIGNEE AND ADDRESS	
POMMERELLE WINE CO.		WINE-GROWERS COOPERATIVE		NORTH COAST GRAPE BROKERS	
ROUTE Show in route order		Indicate how weights were obtained for L.C.L. Shipments only. E-Estimated S-Shipper's Tested Weights R-Railroad Scale T-Tariff Classification		ROUTE Show in route order	
SP-PORT-NP		STOP THIS CAR AT		SP-SCHEL-NWP	
RECONSIGNEED TO					
PRE-ICE	NO	INITIAL ICE	NO	CPS	SEC. 3
NO. PKGS.		DESCRIPTION OF ARTICLES			
C/L		BLENDING WINE, BARRELS NOT ICED			

AAR CLASS OF CAR ORDERED		RS		LENGTH/COPY OF CAR ORDERED	
TO STATION	STATE	FROM STATION	STATE	FROM STATION	STATE
HEALDSBURG	CA	BALLARD	CA	HEALDSBURG	CA
CONSIGNEE AND ADDRESS		SHIPPER		CONSIGNEE AND ADDRESS	
NORTH COAST GRAPE BROKERS		WINE-GROWERS COOPERATIVE		NORTH COAST GRAPE BROKERS	
ROUTE Show in route order		Indicate how weights were obtained for L.C.L. Shipments only. E-Estimated S-Shipper's Tested Weights R-Railroad Scale T-Tariff Classification		ROUTE Show in route order	
SP-SCHEL-NWP		STOP THIS CAR AT		SP-SCHEL-NWP	
RECONSIGNEED TO					
PRE-ICE	YES	INITIAL ICE	YES	CPS	SEC. 2
NO. PKGS.		DESCRIPTION OF ARTICLES			
480 LUGS		GRAPES, WINE, WHITE			

19. Additional overlay perishable bills. One is for blending wine in barrels, still shipped in a refrigerator car, that could be used with [8]. Note that the car will not be iced, and is under CPS (Carrier Protective Services) Section 3, which covers ventilation service. Such a car might or might not have ice hatches open upon departure from the packing house. At right is an example of an overlay bill for wine grapes being shipped.



industries, often to brokers in other districts, and like other produce categories, can use full and overlay bills as a way to accomplish flexible destinations [19]. Included in [19] is an example of blending wine being shipped in barrels [20], as was commonplace as late as the 1950s.

## Model operations other than produce

Flexibility of produce shipments is conveniently realized with overlay bills, and the same is true for any layout industry which is a shipper. For a clear example of my own, I have an industry named Jupiter Pump & Compressor [21], envisioned as a large manufacturer of water pumps and air compressors, and which ships product all over the country. Again, all originating or outbound waybills will be Southern Pacific, and so box cars, gondolas and flat cars departing with loads from Jupiter can share an array of overlay bills.



20. Preparing wine barrels for loading at the Wine-Growers Cooperative in Ballard. This load will move in ventilator service under CPS Sec. 3 (see left bill in [19]), and PFE 95740 accordingly has its ice hatches latched open.

As an example, I show a trio of such overlay bills [22], suitable for box cars and gondolas. This same approach can work for any shipper on the layout, because they are all located on Southern Pacific tracks and thus will have Southern Pacific outbound waybills.

But any “foreign” freight car, meaning one not owned by the Southern Pacific, may have arrived inbound with a load from a shipper located on some other railroad, and of course with a waybill from that railroad. So any suitable foreign cars must already also have outbound SP waybills if they are to accept the overlay bills in [22]. Such a waybill is shown as [23], and it is one which could accept the boxcar overlay bills in [22].



21. Jupiter Pump & Compressor in my layout town of Ballard receives a lot of materials for manufacturing, such as pump parts, castings, and steel sheet. The B&O gondola at right has been switched out from the plant by the plant switcher (background) and the next SP local can pick up the empty car on the plant lead. This is only the edge of the Jupiter plant.

With all the options described above, it is evident that setting up an operating session involves a certain amount of structure (for example, with produce seasons), and also a considerable amount of choice. But as I carry out that process there is more structure than might appear, in the way I make choices. These arise from my method of planning of car flow, as described in the following section.

## Managing car flow

The question naturally arises, how car flow is managed in this (or any) waybill system? Waybills direct movement of loaded (and some empty) cars, and most empty cars are moved on Empty Car Bills. But how are these selected for use? What determines which industries receive or load cars in a particular operating session?

Similarly to the history of car card and waybill systems, described in the Background section of this column, the issues associated with management of car flow also have a long history. Rather than

AAR CLASS OF CAR ORDERED		XM		LENGTH/COPY OF CAR ORDERED		AAR CLASS OF CAR ORDERED		GB		LENGTH/COPY OF CAR ORDERED		AAR CLASS OF CAR ORDERED		XM		LENGTH/COPY OF CAR ORDERED			
TO STATION	STATE	FROM STATION	STATE	TO STATION	STATE	FROM STATION	STATE	TO STATION	STATE	FROM STATION	STATE	TO STATION	STATE	FROM STATION	STATE	TO STATION	STATE		
CLIFTON	AZ	BALLARD	CA	WALSENBURG CO	BALLARD	CA	BERNALILLO	NM	BALLARD	CA	CONSIGNEE AND ADDRESS	SHIPPER	CONSIGNEE AND ADDRESS	SHIPPER	CONSIGNEE AND ADDRESS	SHIPPER	CONSIGNEE AND ADDRESS	SHIPPER	
ARIZONA COPPER COMPANY		JUPITER PUMP & COMPRESSOR		MORNING GLORY MINE, TEAM TK.		JUPITER PUMP & COMPRESSOR		SANDOVAL DISTRIBUTING CO.		JUPITER PUMP & COMPRESSOR		SANDOVAL DISTRIBUTING CO.		JUPITER PUMP & COMPRESSOR		SANDOVAL DISTRIBUTING CO.		JUPITER PUMP & COMPRESSOR	
ROUTE Show in route order				ROUTE Show in route order				ROUTE Show in route order				ROUTE Show in route order				ROUTE Show in route order			
SP				SP-OG-D&RGW				SP-DEMING-ATSF				SP-DEMING-ATSF				SP-DEMING-ATSF			
ON C. L. TRAFFIC-INSTRUCTIONS (Regarding icing, Ventilation, Etc.) & EXCEPTIONS				ON C. L. TRAFFIC-INSTRUCTIONS (Regarding icing, Ventilation, Etc.) & EXCEPTIONS				ON C. L. TRAFFIC-INSTRUCTIONS (Regarding icing, Ventilation, Etc.) & EXCEPTIONS				ON C. L. TRAFFIC-INSTRUCTIONS (Regarding icing, Ventilation, Etc.) & EXCEPTIONS				ON C. L. TRAFFIC-INSTRUCTIONS (Regarding icing, Ventilation, Etc.) & EXCEPTIONS			
SHIPPER LOAD & COUNT, WWIB				SL&C -- WWIB				SL&C -- WWIB				SL&C -- WWIB				SL&C -- WWIB			
NO. PKGS.		DESCRIPTION OF ARTICLES		NO. PKGS.		DESCRIPTION OF ARTICLES		NO. PKGS.		DESCRIPTION OF ARTICLES		NO. PKGS.		DESCRIPTION OF ARTICLES		NO. PKGS.		DESCRIPTION OF ARTICLES	
26		DEEP SUBMERSIBLE PUMPS		6		FULL FLOW AIR COMPRESSORS, CRATED		68		NO. 8		IRRIGATION PUMPS							

22. Three overlay bills for shipments from Jupiter Pump & Compressor, two in box cars and one for crated loads in a gondola. The boxcar loads could move in any free-running boxcar, from any railroad in the U.S., and the same would be true for AAR class GB gondolas. The only requirement would be the existence of a full SP waybill for that car.



1-51-400M

L-706-N

## 721—Southern Pacific Company—721 FREIGHT WAYBILL

TO BE USED FOR SINGLE CONSIGNMENTS, CARLOAD AND LESS CARLOAD

CAR INITIAL <b>NYC</b>	CAR NUMBER <b>154679</b>
AAR CLASS OF CAR ORDERED <b>XM</b>	LENGTH/COPY OF CAR ORDERED
TO    STATION                  STATE <b>PUEBLO                  CO</b>	FROM    STATION                  STATE <b>BALLARD                  CA</b>
CONSIGNEE AND ADDRESS <b>AIRFLOW ENG- INEERING CO.</b>	SHIPPER <b>JUPITER PUMP &amp; COMPRESSOR</b>
ROUTE <i>Show in route order</i>  <b>SP-OG-D&amp;RGW</b>	Indicate how weights were obtained for L.C.L. Shipments only. E—Estimated                  S—Shipper's Tested Weights R—Railroad Scale    T—Tariff Classification  <b>STOP THIS CAR AT</b>
ON C. L. TRAFFIC-INSTRUCTIONS (Regarding Icing, Ventilation, Etc.) & EXCEPTIONS  <p style="text-align: right;"><b>SL&amp;C -- WWIB</b></p>	
NO. PKGS.	DESCRIPTION OF ARTICLES
<b>27</b>	<b>DEEP FLOW AIR COMPRESSORS</b>

23. An example of a foreign-road box car, NYC 154679, which already has an outbound waybill from Jupiter Pump & Compressor. It could readily accept an overlay bill from this shipper.



review the extensive literature on the topic, I will simply show the system I use. Much of the history can be found in the references cited in the Bibliography.

I begin, as many authors have advocated, by analyzing the industries on the layout. Determining what kind of cars they will receive and dispatch, and with what frequency, allows construction of a pattern of operation. One way to do this is simply to start making a table, something like the one shown in [24]. Represented here is a single industry, a produce shed or packing house.

In this example [24], open or hollow letters indicate an empty car to be delivered, chosen here to be every odd-numbered day. Of course during the even-numbered days, loaded cars will be picked up at this industry; but there is no need to indicate that here, as this schedule is only for deliveries. The waybill cycle will then naturally lead to pickup of the load.

The same process is then followed for as many industries as you wish to schedule. Obviously the details of such plans could be quite different from layout to layout. With information about each particular type of industry, these plans can be made quite realistic.

		Day									
		1	2	3	4	5	6	7	8	9	10
Industry											
Produce shed	RS		RS		RS		RS		RS		

24. Starting a distribution schedule for a single industry, a packing house. The open letters indicate empty cars (refrigerator cars, AAR class RS) to be spotted for loading.



When a number of industries are added, as I show in an extended example in [25], a good variety of car movements are indicated. You may note that no two days are alike. Again, these are only deliveries. Spotting inbound loads, the solid or filled letters, would naturally be followed by the unloaded empty car or the loaded car, being picked up on a following day.

This process has been described in much more detail in a three-part blog post from 2011, cited in the Bibliography, so I won't go into more detail here.

In my original version of this table, I began by making 31 columns instead of the ten you see in [25], with the idea of having the day of the month of each operating session be chosen as the column

		Distribution Schedule									
		Day									
Industry	1	2	3	4	5	6	7	8	9	10	
<b>Shumala</b>											
Produce shed	RS		RS		RS		RS		RS		
Team track			XM							FM	
Oil dealer		TM					TM				
<b>Ballard</b>											
Peerless Foods		RS			XM		RS			RS	
Zaca Winery			TMI				RS	TMI			
Team track		XM				FM					
Guadalupe	RS		RS		RS		RS		RS		
<b>"Random"</b>	2B	1S	1SR	2B	1SR	2S	1B	2SR	1S	2B	

25. An extended version of the table in [24], with seven industries chosen in two towns, Shumala and Ballard. The cars are indicated by AAR car class symbols. The "random" row at bottom is explained in the text.

number of the table. But this destroys the sequencing that had been planned in preparing the table. I soon changed the system to one of regarding the column numbers as simply sequence numbers of operating sessions.

One additional feature of this table [25] is the row across the bottom of the table, for what are called “random” additional movements. They are shown for different towns each day, such as 2B in the first column. This means two “random” waybills chosen for Ballard. The other two towns are Shumala (S) and Santa Rosalia (SR).

But in fact the pool of waybills to be chosen here is limited, so that the choices are not really “random,” and thus this may be a poor name. The actual intent is to include rare or even one-time cargoes. They are simply not part of a repeating pattern as the other industries would have.

The idea was to go to the waybill file for the town identified and draw from a separate set of waybills for rare loads. That’s the original reason for calling them “random.” This process kind of worked when I first used it, but I now try to use the “random” waybills simply as less frequent events. For that approach, returning to a 30-column or even 50-column table might be the best way to implement the idea.

At one time I maintained a paper copy of such a table, so that it could be used in the layout room. Each successive operating session was marked by moving a paper clip along the top of the table, to indicate what “day” was next. That process makes a perfectly workable system, especially if operation is frequent. At the time I used the paper system, the layout was formally operated once a week.

But with less frequent and more complex operating sessions, as is now true for my layout, that doesn’t work as well. I have added a number of industries, compared to the previous situation, and



have become more specialized in the application of “sure spots,” that is, particular tracks, or loading doors, or unloading equipment, at which particular cars must be spotted. Accordingly, a different system is now in use.

## Layout survey

I still begin with my “industries” Distribution Schedule, but there is no need to mark sessions with a paper clip. For any upcoming session, I first survey the layout, making note of the status at each industry, whether and which cars are spotted. This makes a starting point, and that survey is then compared to the industries schedule. Cars can be quickly identified as ready to pick up, whether loads or empties. For demurrage reasons, it is unlikely that a car would remain on any industry siding for very long, and most cars are picked up in the following session.

In the same way, needs for incoming cars also emerge from the Distribution Schedule. Then, one needs to select two things: the specific car, and, for outbound cars, the load. To do so means in turn that one has to have a filing system for waybills and overlay bills, and a system for retrieving waybills from the system in order to re-use them.

I now file all unused waybills by industry. When a waybill has been used in an operating session, it goes to the back of the stack for that industry, ensuring that it won't be repeated anytime soon. Of course, filing by industry means that a specific car's waybills are not directly findable, because they are sequenced primarily by date of use. Instead, I maintain a separate electronic “pairs list,” of all the pairs of shippers and consignees, inbound and outbound, for which I have waybills, and of course the list includes the car reporting marks on each waybill (or no marks, for overlay bills).

It is quick and easy on the computer to use the pairs list to find what is wanted. Let's say I want to get a particular freight car back into use, that hasn't operated for a while, let's say T&NO 60928, a



box car that would be a free-runner. I simply use those marks as the search terms in the computer file, and go right to the industry where that waybill is filed.

Looked at this way, it might seem easier to file the waybills by car number, making it easy to find a particular car's waybill. But since my Distribution Schedule for car flow is by industry, it would then be a task to find where the waybills for that industry were located in the file, as they would be scattered through the car sequences.

But in that method too, the pairs list would still be the tool of choice. I would of course enter the industry name as the search term, and would again immediately find the waybills for desired cars. But this is no simpler than filing by industry, so I have retained that system.

## ADVERTISEMENT

# END OF TRAIN DEVICE

**NEW SAFETY GREEN**



**Bright Red  
Flashing Light!**

**Installs in minutes!  
No freight car  
modification required!**

**Patented Technology - US Patent 7,549,609**

**Does not affect Load!**

↓ Car without Load ↓

↓ Car with Load ↓



**Click Here to  
Learn More**

**RE RING<sup>TM</sup>  
ENGINEERING**

• [INDEX](#)



**SUBSCRIBE  
(free)**

• [TABLE OF CONTENTS](#)

Note that the Distribution Schedule only sets a framework for operating sessions. It isn't a rigid specification, just an overall pattern. And it doesn't call for specific freight cars for any particular slots in the schedule, only the car type. I still choose the individual cars.

Pulled all together, this system of using the waybills for operation performs smoothly and generates all the variety I could want in car movements, while retaining some pattern in determining which cars go to which industries, and how often. I have been modifying and perfecting it for some years now, testing it against dozens of different layout visitors and operators, and it continues to do what I want.



## Concluding remarks

The idea of waybills for model railroad operation which move cars as desired, and have the general appearance of the prototype waybills, is now in use on a number of layouts around North America. A number of refinements can be pursued in such systems, and I have only tried to indicate one such set of refinements, as I use them on my own layout. The waybills are put into action with the help of the Distribution Schedule, which structures the frequency and kind of cars that are directed to each industry.

**VIEW READER  
COMMENTS**

*click here*



26. This view shows the Santa Rosalia Branch local, with Consolidation 2763 as today's power, switching at Ballard. The cabooses has been spotted where it won't be part of any switching moves, as most conductors prefer. All the cars in this photo are moving or will move in accord with prototype waybills or messages from the Ballard agent.



## Bibliography

Armstrong, John H., *The Railroad – What It Is, What It Does* (Chapter 8, Railroad Operations), Simmons-Boardman Publishing, Omaha, 1982. [there are several subsequent editions with updates; the original is closest in time to the era I model]

Chubb, Bruce, *How to Operate Your Model Railroad*, Kalmbach, Milwaukee, 1977.

Coughlin, E.W., *Freight Car Distribution and Handling in the United States*, Car Service Division, Association of American Railroads, Washington, 1956.

Ellison, Frank, “The Art of Model Railroading, Part 6,” *Model Railroader*, August 1944, pp. 342–347; reprinted as “All in the cards” in *Model Railroader*, January 1965, pp. 52–55.

Kalmbach, A.C. (writing as “Boomer Pete”), “Realistic Operation,” *Model Railroader*, March 1939, pp. 127–130.

Kalmbach, A.C. (writing as “Boomer Pete”), *How to Run a Model Railroad*, Kalmbach, Milwaukee, 1944 (revision of earlier book, *Operating a Model Railroad*, 1942).

Koester, Tony, *Realistic Model Railroad Operation*, Kalmbach, Waukesha, WI, 2003 (2nd edition, 2013).

Koester, Tony, “In search of the perfect waybill,” *Model Railroader*, February 2012, p. 82.

Mallery, Paul, “Waybills,” Chapter 7 in *The Complete Handbook of Model Railroad Operations*, TAB Books, Blue Ridge Summit, PA, 1979, pp. 133–174.

Neale, Bill, “Plastic pockets improve waybill operation,” *Model Railroader*, February 2009, pp. 62–65.



Pamperin, Ted, “Upgrade your car routing with realistic waybills,” *Model Railroader*, February 2012, pp. 45–49.

*Railway Accounting Rules*, Accounting Division, Association of American Railroads, Washington, 1950. [numerous editions exist; this one suits my era]

Sagle, Lawrence W., *Freight Cars Rolling*, Simmons-Boardman, New York, 1960.

Smith, Doug, “The latest word on card operations,” *Model Railroader*, December 1961, pp. 52–62.

Thompson, Anthony W., Church, Robert J., and Jones, Bruce H., *Pacific Fruit Express* (2nd edition), Signature Press, Berkeley and Wilton, CA, 2000.

Thompson, Anthony, “Prototypical waybills for car card operation,” *Railroad Model Craftsman*, December 2009, pp. 71–77.

Thompson, Anthony, “Contents of a Waybill,” *The Dispatcher’s Office*, Vol. 16, No. 2, pp. 17–24, April 2010.

[corrected version available at: [modelingthesp.blogspot.com/2011/01/waybills-2.html](http://modelingthesp.blogspot.com/2011/01/waybills-2.html)]

Thompson, Anthony, “Freight Car Handling and Distribution,” *The Dispatcher’s Office*, Vol. 17, No. 4, pp. 28–31, October 2011.

[corrected version available at: [modelingthesp.blogspot.com/2011/09/my-article-in-dispatchers-office.html](http://modelingthesp.blogspot.com/2011/09/my-article-in-dispatchers-office.html)]

Thompson, Anthony, “Progress with Prototypical Waybills for Modelers,” *The Dispatcher’s Office*, Vol. 22, No. 4, pp. 26–33, October 2016.

[corrected version available at: [modelingthesp.blogspot.com/2017/11/yet-another-correction-of-dispatchers.html](http://modelingthesp.blogspot.com/2017/11/yet-another-correction-of-dispatchers.html)]



Thompson, Tony, “Operations: Demand-based car flow,” blog post, 7 November 2011, three-part series; see for example: [modelingthesp.blogspot.com/2011/11/operations-demand-based-car-flow-2.html](http://modelingthesp.blogspot.com/2011/11/operations-demand-based-car-flow-2.html).

Thompson, Tony, “Getting Real: A More Prototypical Waybill for Model Railroads,” *Model Railroad Hobbyist*, pp. 31–46, May 2012 [mrhmag.com/magazine/mrh-2012-05-may/getting\\_real](http://mrhmag.com/magazine/mrh-2012-05-may/getting_real).

Thompson, Tony, “Wine as an industrial commodity,” blog post, 15 February 2012, available at: [modelingthesp.blogspot.com/2012/02/wine-as-industrial-commodity.html](http://modelingthesp.blogspot.com/2012/02/wine-as-industrial-commodity.html).

Thompson, Tony, “Agent messages,” 2015 blog post series culminating with: [modelingthesp.blogspot.com/2015/06/operating-with-agent-messages.html](http://modelingthesp.blogspot.com/2015/06/operating-with-agent-messages.html).

Thompson, Tony, “Creating a wine tank car,” blog post, 31 May 2017, three-part series; available at: [modelingthesp.blogspot.com/2017/05/creating-wine-tank-car-part-3.html](http://modelingthesp.blogspot.com/2017/05/creating-wine-tank-car-part-3.html).

*Uniform Freight Classification*, Uniform Classification Committee, Chicago, numerous editions.

**VIEW READER  
COMMENTS**

*click here*

# Litchfield



S T A T I O N

"Where  
we make  
DCC fun!"

***We Carry  
A Full Line of  
Digitrax Products  
at GREAT Prices!***

***Lenz is back  
& we have stock  
available!***



**Click here to visit our website:**

**[www.LitchfieldStation.com](http://www.LitchfieldStation.com)**  
**623-298-7355**





# WHAT'S NEW on TMTV!

*Start Small. THINK BIG.*

**Layout operation!**

**TOMA**  
THE ONE-MODULE APPROACH

**NOTCH 8**

Weathering steam with an airbrush

**THE BACKSHOP CLINIC**

Photo manipulation & structures

**DCC DECODED**

New ESU WiFi DCC system

*Railway Life*

Railway Life documentary

**Become a member** >>

Holiday special pricing in effect

[www.trainmasters.tv](http://www.trainmasters.tv)

Brought to you by

**MRH**  
MODEL RAILROAD HOBBYIST

MRH Subscriber? Get your 10% off coupon code here:

Get Subscriber  
10% off code



# WHAT'S NEAT

column



Model Railroad Hobbyist | January 2018 | #95



RATE THIS ARTICLE

**KEN PATTERSON** INTERVIEWS JOE AND PATTY FUGATE, SHOWS YOU HOW TO SOLVE STALLS WITH DIGITRAX'S HELP, CHECKS OUT THE WALTHERS GP35, BUILDS A MORE COMPACT YARD LADDER, AND ENJOYS MORE DRONE VIDEOS ...

**THIS MONTH, WE INTERVIEW JOE AND PATTY** Fugate, the owners (and founders) of Model Railroad Hobbyist magazine. They tell us about working together to produce the magazine, as well as future plans for the publication.

We look at the Digitrax Px112-2 Power Xtender, to solve the problems of my narrow-gauge Galloping Goose stalling on dirty switch points. Micro Engineering has recently produced a new Track Ladder System to save space and make yard tracks longer. I build a yard ladder using the new #5s and compare it to the length regular #6 turnouts require to form a seven-track yard.

▶ PHOTOS AND VIDEO OF SUPERB MODELING

• [INDEX](#)



SUBSCRIBE  
(free)

• [TABLE OF CONTENTS](#)



1. (Above) Also this month, Steven M. Conroy shares beautiful drone footage of an Amtrak train in the mountains, pulling a full consist with Burlington Zephyr dome cars on the rear.

Walthers shares their new GP35 in HO scale, which I photographed outdoors for a clear view of its sharp details. Add to that a few model runbys, and we have a good video presentation this month.

2, 3. (Top and bottom right) This month, Walthers sent us their new GP35 phase II locomotive, Burlington Northern #2580. This particular locomotive was built for the Frisco in 1964-65; it was renumbered to 2580 when Frisco merged into the Burlington Northern in 1980. Walthers does a good job in representing the prototype. The paint is smooth, the model features Tsunami sound, there are crew figures in the cab, and working number board lights operate separately from the headlights. The model runs perfectly out of the box and has Proto MAX metal knuckle couplers installed. I photographed the model in real sunlight to highlight the details.

## Walthers GP35



## Digitrax Power Xtender

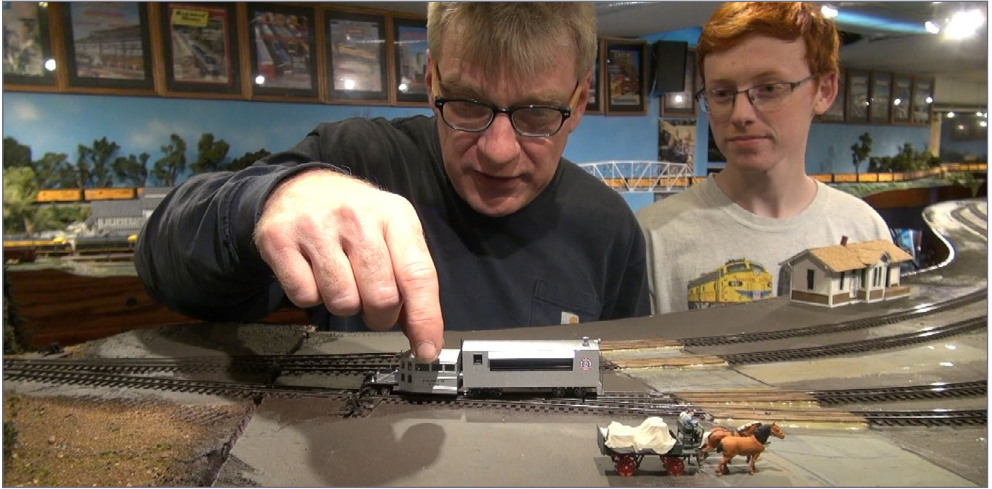

4. I was trying to run my HO<sub>N</sub>3 Galloping Goose rail bus on my newly laid track near the log mill and it kept stalling on switch points – which I just cleaned last week. Due to the light weight of the model it stalls easily on dirty track. Daniel Coombs pointed out that Digitrax makes a Power Xtender that allows the model to run many feet without track power. That sounded like just the project I wanted to jump into.

**VIEW READER  
COMMENTS**

*click here*



Also see the new “What’s neat  
this week” weekly video podcast!

**WATCH  
NOW >>**



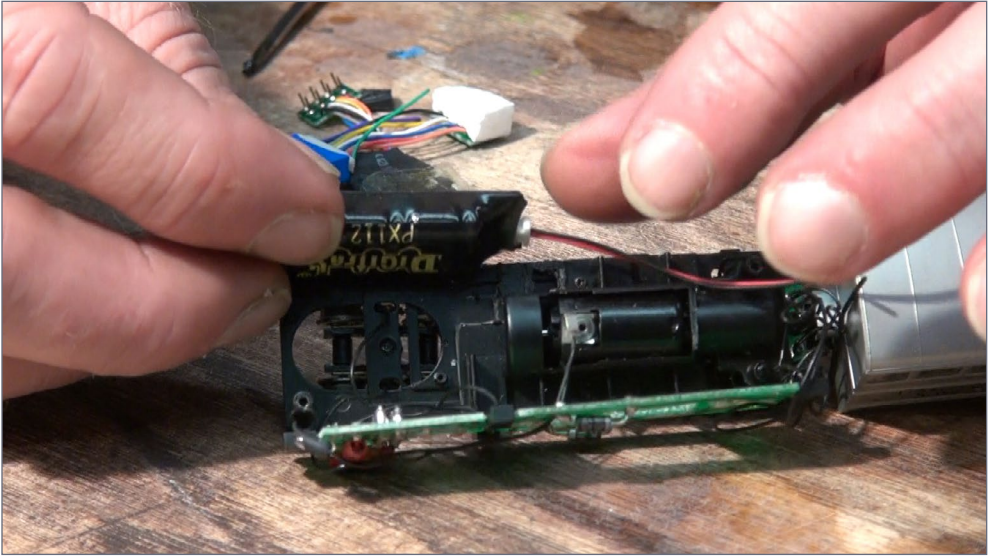

5. We pulled the model apart to see the space we had to work with. After cutting out five seats in the model, there was enough space to fit the Power Xtender under the circuit board.

HAVING FUN WITH TRAINS  
**MRH**  
MODEL RAILROAD HOBBYIST

▶ January 2018 --  
What's neat ...

Playback problems? [Click here ...](#)

• [INDEX](#)



SUBSCRIBE  
(free)

• [TABLE OF CONTENTS](#)

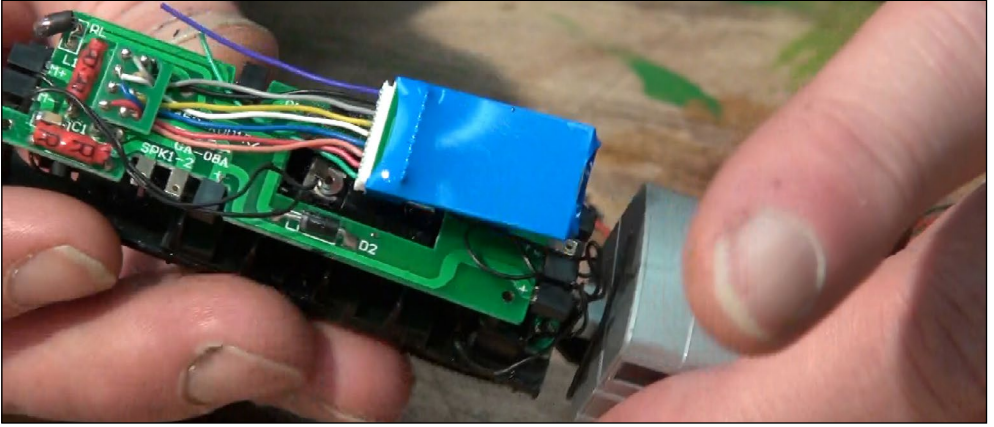

6. I plugged a new Digitrax DH126PS decoder into the model's main board, using the eight-pin harness plug.

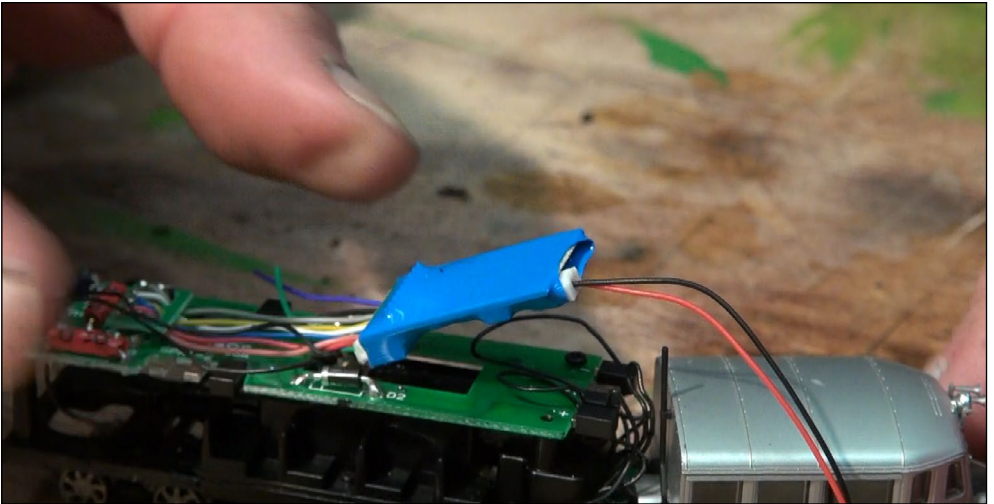

7. The Power Xtender plugged into the two-prong jack on the end of the decoder. That was it. I snapped the shell back onto the model and it was ready to test on the layout. It ran smoothly and did not stall on any of the newly laid turnouts and straight sections of the trackage. When taken off the track while under power, it ran about two feet on the plywood before the power stopped.

*Have you seen this?*

**CHECK IT  
OUT!**



**kenpatterson.com**

*click here to ...*

**Visit Ken's website**

**Ken Patterson  
reveals his modeling  
secrets on video!**





## Joe and Patty Fugate interview



8. I interviewed MRH Editor Joe Fugate and his able assistant Patty Fugate this time. I haven't interviewed Joe on the show for over two and a half years, so we catch up on the latest happenings around MRH. Joe shared his plans for the 100th issue of MRH, which is coming this June. It sounds like Joe has some great things planned, so that's an issue you don't want to miss!

Patty assembles the magazine along with Joe, so they have their hands full of mice and keyboards all month long as they crank out about 300 pages per issue!

**VIEW READER  
COMMENTS**

*click here*



Also see the new "What's neat this week" weekly video podcast!

**WATCH  
NOW >>**





9. I asked Patty what's it like to work on 300 pages of magazine each and every month? Patty replied, "Yes it's a lot of work and I wear a lot of hats. But my mom always told me to get in there and join in with your husband, so I'm always asking Joe, 'what are we doing this month?' ... I just want to enjoy being with him."

Joe went on to tell about their courting days, "While we were still courting in our teens and corresponding long distance, I sent her some photos of my model trains to see what she would think. It was a 'test' to see if she would think I was crazy or not."

What did Patty think? "He didn't tell me they were models. I thought they were the real thing – it was only in the next letter I learned they were models!"



Also see the new "What's neat this week" weekly video podcast!

**WATCH  
NOW >>**





10. Patty thinking Joe's model photos were the real thing was a testament to his photographic and modeling skills, even in his teenage years.

Joe continues, "Patty joins me a lot in the hobby. She comes to op sessions and has even been a guest operator on layouts at op session meets right along with me. Also over the years, she's worked on scenery a lot. She's very picky and she's very good at it. She 'has the eye,' I guess you could say."

"I'd also like to get better at structures," Patty responded. "Boy, do we need structures!"

I recommended to Patty she look more at the latest crop of structure kits out there, and watch some of the builds I've done on "What's Neat." Like the BTS structures – once you build a few of them, they get much easier!



Also see the new "What's neat this week" weekly video podcast!

**WATCH  
NOW >>**



11. We reflected back on how far “What’s Neat” has come since I first approached MRH. We started out thinking I (Ken) would do a “What’s Neat” column kind of like Tony Koester’s “Trains of Thought” in Model Railroader – one photo and a bit of text. Look at how far we’ve come! We’ve done 70-some “What’s Neat” shows now, and we have accumulated more than two million views on all those shows!

“The ‘What’s Neat’ show is one of the major ways modelers discover MRH,” Joe responded, “as we found out at TrainFest. I walked up to a table with three young fellows eating their lunch, pointed at my shirt with the MRH logo and asked if they had heard of MRH. They replied, ‘Oh yes, Ken Patterson’s What’s Neat show!’ YouTube is a major way people discover the whole array of what Model Railroad Hobbyist is doing.”

From there we wrapped up with an update on Joe’s Siskiyou Line layout. Joe started dismantling Siskiyou Line 1 (SL1) last spring but that got put on hold pending repairing and selling his 89-year-old mother’s house. It looks like the house will be sold as of January 2018, so Joe plans to get back to dismantling SL1 and starting on his new TOMA (modular) Siskiyou Line 2 soon. Watch for more from Joe about that in MRH this year.





# Southern Digital

[WWW.SODIGI.COM](http://WWW.SODIGI.COM)

Celebrating 25 Years of serving you !



**Soundtraxx Tsunami  
Motor/Sound Decoder**  
**50% Off while they last**



**Super Sale**



Complete Train Control

Simplex Radio  
Throttle clearance  
while they last



**Close Out**

**DT402R**  
**\$165**

**UT4R**  
**\$99**

**DCC Conversions, Service & Support**

E-mail: [sales@sodigi.com](mailto:sales@sodigi.com) (770) 929-1888





## Micro Engineering #5 Yard Ladder Track system

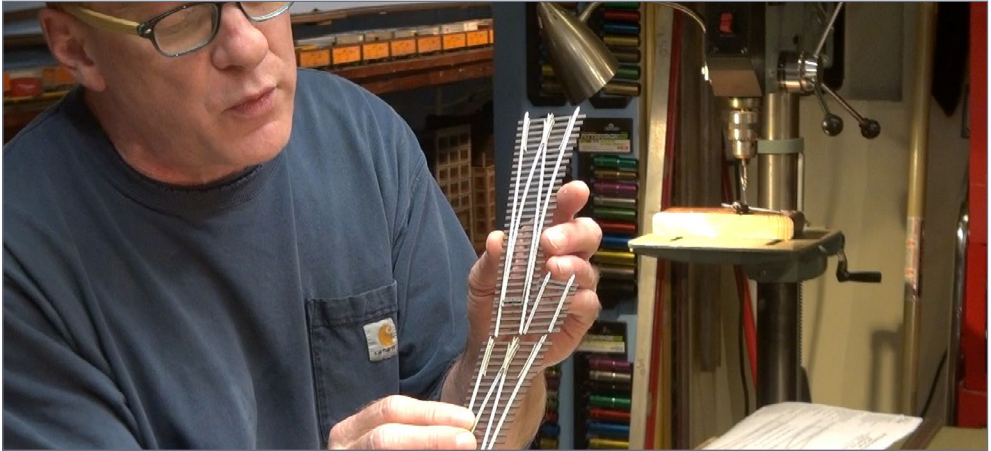

12. This past year, Micro Engineering introduced a new ladder track building system using very specialized #5 turnouts where the points for the next turnout start directly after the frog.

Four different types of turnouts form the ladder. Starting with the #5d Curved Diverging track off the main, it provides an 11.4 degree frog angle with the addition of a 16 degree curve as you leave the frog. This provides a "faster" departure angle than regular #5 turnouts. The next switch is the #5c Lead Ladder which seems short, as it ends right after the frog. The next turnout, a #5b Intermediate Ladder Turnout, connects right at the frog, as seen in this photograph, where I am holding the turnouts together.

You will also see additional track molded into the turnout right next to the points. This helps save space in the length of the ladder, similar to how we hand lay track and place the frogs right next to the points to save space, maintain ladder track spacing, and compact the turnouts together. Repeat the #5d Intermediate Ladder Turnout for as many tracks as you will need in your yard. The last turnout, to complete the ladder, is the #5e Last Ladder turnout which allows the last track, and a runaround track completing this end of your yard ladder.



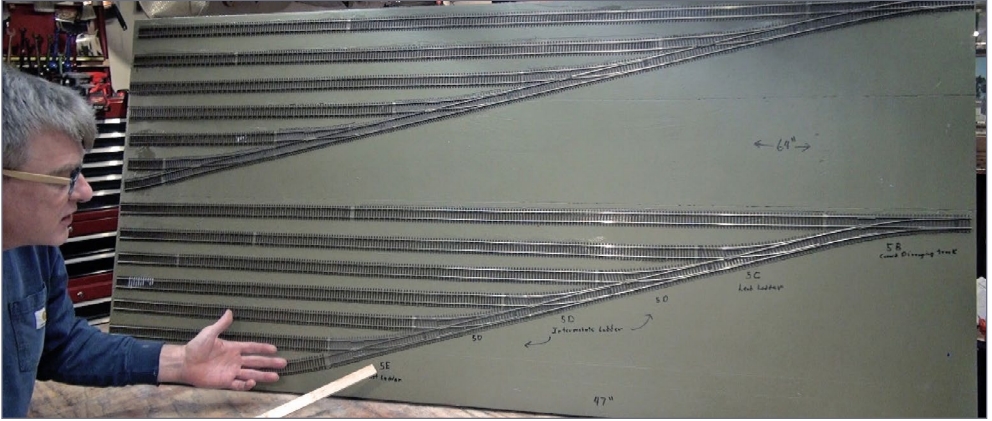

13. I built this foam board diorama, placing the new ME ladder system on one side and regular Micro Engineering Number 6 turnouts on the other, each forming a seven-track ladder. The #5 ladder system saved 17 inches – it was 47 inches long compared to 64-inch long ladder using number 6 turnouts.



14. An 89-foot freight car had no problems running through the #5 turnouts. If you want to save space on a yard ladder, this #5 turnout ladder system will do just that.

Remember to rate this column “outstanding” if you like what I’m doing and want more every month! ☑

★ ★ ★ ★ ★  
**RATE THIS ARTICLE**



ADVERTISEMENT

FROM MT. ALBERT SCALE LUMBER

**NEW!** **PAINT GRADE**

**STRIPWOOD**

Standard Grade  
Suitable for  
staining

Paint Grade  
Less suitable for  
staining. Ideal  
for painting

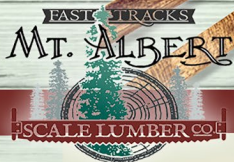

Not all wood used in your projects will need to be stained, so why pay for stain quality wood?

SAVE 20% over the price of our regular high quality stainable stripwood with our new *Paint Grade Stripwood!*

Same great quality, 20% less.

**Order online today!**

Easy Ordering Live online support Earn WayPoints with every purchase

shop online 24/7 [handlaidtrack.com/scalelumber](http://handlaidtrack.com/scalelumber) 1-888-252-3895

ADVERTISEMENT

**RailPro™**

**NEW TECHNOLOGY**



**RE RING™**  
ENGINEERING

**NEW Starter Kit \$399.99 MSRP**

- Includes Wireless Color Touch Screen Handheld Controller and 56 Watt Power Supply
- Expandable to Virtually any Size Layout

**NEW Locomotive Module**

LM-3 & LM-3S



- Direct Radio RF
- Sound and Non-Sound
- New Tiny Size
- 6 Light Outputs

**Click Here to Learn More**

For more information visit our Internet site: [www.RingEngineering.com](http://www.RingEngineering.com)

• [INDEX](#)



**SUBSCRIBE**  
(free)

• [TABLE OF CONTENTS](#)

# MRH MARKETPLACE



## HO-MODERN MODELS

[www.ho-modernmodels.com](http://www.ho-modernmodels.com)



Discover  
Built and Ready Models

**CLICK ME**

*Imagine that!*  
Laser Art Products

### ITLA Scale Models

York Industries  
HO Scale Laser  
Cut Wood Kit

CLICK HERE FOR MORE INFORMATION  
[www.itlascalemodels.com](http://www.itlascalemodels.com)

## Kadee

What Coupler  
Do I use?

Coupler  
Conversions

CLICK  
HERE



## MAIN STREET AMERICA HISTORIC ARCHITECTURE



### MAINSTREET HERITAGE

[www.mainstreet-heritage.com](http://www.mainstreet-heritage.com)

CLICK  
HERE  
for all  
our HO  
& O kits

• [INDEX](#)

• [TABLE OF CONTENTS](#)



Where the Rail Meets the Sea...



**CRAFTSMAN KITS & BUILT-UPS**  
HO – O – N Scale



NEW! H148-HO Police Boat "Lannan"

[www.seaportmodelworks.com](http://www.seaportmodelworks.com)

Click here for our website:



**Yarmouth Model Works**  
HO scale resin kits and detail parts

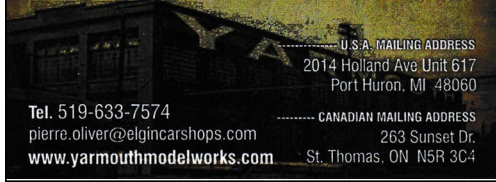

U.S.A. MAILING ADDRESS  
2014 Holland Ave Unit 617  
Port Huron, MI 48060

Tel. 519-633-7574

[pierre.oliver@elgincars.com](mailto:pierre.oliver@elgincars.com)

[www.yarmouthmodelworks.com](http://www.yarmouthmodelworks.com)

CANADIAN MAILING ADDRESS  
263 Sunset Dr.  
St. Thomas, ON N5R 3C4



Your #1 source for **TOMA** Benchwork  
**250+ shapes & sizes!**  
Built to order benchwork also available! (224)201-9868

**CROW RIVER PRODUCTS**

New "O" Kit 335 B  
FLOOR MODEL DRILL PRESS  
SECOND IN A SERIES OF  
VINTAGE MACHINE TOOLS

17 Pewter Castings.  
For Overhead Belt  
Available, No. O-53  
or Motor Conversion  
(Available Dec. 2017)

Price \$28.00  
Made in USA



HO & O Scale Machinery, Derricks,  
Engines, Hardware & Waterfront Models  
Pawtucket, RI 02861 Tel 401-723-0065  
[www.crowriverproducts.com](http://www.crowriverproducts.com)

**LOOK**  
at what's new at  
Black Cat this month

Click here for  
our website

**Grand Trunk Railway**  
**1900's ventilated box car**



**Black Cat Publishing**  
(204)489-5005  
[ajfergus@mymts.net](mailto:ajfergus@mymts.net)  
[blackcatdecals.com](http://blackcatdecals.com)



## THE DCC SHOP

YOUR COMMAND CONTROL SPECIALISTS

[www.DCCSHOP.com](http://www.DCCSHOP.com)



Quantity Pricing for  
the Layout Builder



HO Brass



WOWSound™

Start your model railroad  
empire on the right track  
with **THE DCC SHOP**

The Little Train Store that is BIG on Customer Service!

[www.DCCSHOP.com](http://www.DCCSHOP.com)

ph. 208-889-9111

## HO DIESEL SUPPLY

CUSTOM SOUND LOCO'S-REPAIRS-UPGRADES

Weathered New and Rebuilt Locomotives

Powered Chassis-Trucks-Motors-Handrails-Electronics

Parts Inventory Always Changing

[www.hodieselsupply.com](http://www.hodieselsupply.com)

email:gerry@hodieselsupply.com



## TAM Industries

"Preserving the Romance"

The highest quality in Display Cases for sharing your excitement of Model Railroading. We manufacture Display Cases for all gauges of Model Railroading, from "G" to "N". Custom Sizes are available for some styles. Visit us today at:



[www.TAM-IndustriesOnline.com](http://www.TAM-IndustriesOnline.com)

Nature + Design =

THE  
NEW  
'GOLD  
STANDARD'  
FOR  
GLUE  
APPLICATION



THE GLUE  
LOOPER®  
MICRO-GLUE  
APPLICATOR

$$\frac{a+b}{a} = \frac{a}{b} = \phi = 1.61803$$

U.S. PAT. NOS. 0754,796; 9,314,894; 9,889,853 AND OTHER PAT. PENDING

## ULTIMATE CONTROL

THE GLUE LOOPER® family of products is worlds only patented self-regulating micro fluid applicators made for applying a VERY small amount of glue where you want it to go with very little or no trace of the glue.

It's available for thin or thick glues. (v2, v3 or v4)



MADE  
IN  
U.S.A.

Think different,  
glue different.

(PATENTED)  
Designed and made  
By a  
Professional Artist for Artists

[CREATIVEDYNAMICLLC.COM](http://CREATIVEDYNAMICLLC.COM)



MODELS, LLC

USRA DS Express Box  
NWP Redwood Empire



[westerfieldmodels.com](http://westerfieldmodels.com)





**BenchWork.com**

To build your dreams, You need a plan!  
**Affordable track planning**  
 Starting at only \$250

**CLICK ME to get started!**

**PRE-SIZE MODEL SPECIALTIES**

P.O. Box 6 Paonia, CO 81428  
 Ph. 970 527 4586  
 Made in The USA

Cast resin items for All Scales.  
 Tunnel portals, bridge piers, abutments, culverts, and retaining walls.  
 Trackside details and sage brush tree armatures.  
 "FREE SHIPPING see website for details"

**GOODDEALSDCC**

[WWW.GOODDEALSDCC.COM](http://WWW.GOODDEALSDCC.COM)

HOME OF THE  
**PROGRAMMER TEST TRACK SYSTEMS**  
 GARY COHN      GARY@GOODDEALSDCC.COM

Come visit our booth at Trainfest in Milwaukee, Nov 11&12.  
 We'll have a show special discount!

**LOGIC RAIL™ TECHNOLOGIES** "Sophisticated Model Railroad Electronics"

21175 Tomball Pkwy Suite 287 Houston, TX 77070      Phone: (281)251-5813  
<http://www.logicrailtech.com>      info@logicrailtech.com

**MOUNTAIN SUBDIVISION HOBBIES**

[www.modelrrsupply.com](http://www.modelrrsupply.com)

FREE USA SHIPPING OVER \$39.00

NCE - SOUNDTRAXX - DIGITRAX - ESU LOKSOUND  
 SPROG - DCC SPECIALTIES - INTERMOUNTAIN - CMX  
 BAR MILLS - BOWSER - ATLAS - CIRCUITRON - PECO  
 RIX - PIKESTUFF - CENTRAL VALLEY AND MORE!!!

**Great Decals!™**

FEC, Interstate, Virginian Railway, & L&N Titles  
 After Hours Graphics Line  
 Coupler Gages and More  
 In O, S, HO, and N Scales

**RULERS-of-the-WORLD**

Scale Rulers \$4 each  
 Over 200+ scales!  
 Metric or Imperial

[www.rulers-of-the-world.com](http://www.rulers-of-the-world.com)

**Model Railroad Control Systems**

Geoff Bunza Project Boards  
 DCC Occupancy Detectors  
 CMRInet Compatible Nodes  
 Layout Telephone Systems  
 RFID Switchlist Generator  
 Switch Machines and Drivers

**Click Here**

**PRECISION DESIGN CO.**

**LASERCUT KITS - CUSTOM DECALS**

**PDC.CA**

Authorized **RailPro** Dealer

FREE SHIPPING in the US and CANADA





***ERIK KALINSKI redoes his home layout,  
this time going with TOMA ...***

• [INDEX](#)

• [TABLE OF CONTENTS](#)





# The New Pacific & Northwestern

• [INDEX](#)



SUBSCRIBE  
(free)

• [TABLE OF CONTENTS](#)



**RATE THIS ARTICLE**



*click here*

**THERE'S MORE!**

Check out the Subscriber  
bonus extras

**SOME OF YOU MAY REMEMBER MY FIRST ARTICLE** about my Pacific & Northwestern layout, featured some years ago in the February 2011 *MRH*.

**Web:** [mrhmag.com/magazine/mrh-2011-02-Feb](http://mrhmag.com/magazine/mrh-2011-02-Feb)

It was a nice 14'x11' HO scale layout which gave me many years of joy. But it wasn't without its flaws, and one day I decided it was time to move on. It was not exactly the easiest decision I ever made – I wrestled with it for a good half a year. Plus, friends telling me I was “out of my mind for contemplating destruction of a working layout” weren't very helpful either.

But my thinking went like this:



### WHAT IS THIS “TOMA” THING?

If the term TOMA (The “**O**ne **M**odule” **A**p-**p**roach) is new to you, we have a full bibliography on past TOMA discussions in the August issue of MRH.

**WEB:** [mrhpub.com/2017-08-aug/online/?page=22](http://mrhpub.com/2017-08-aug/online/?page=22)

**VIEW READER  
COMMENTS**

*click here*



1 (Lead), 2. These scenes on the author's TOMA layout sections rival the scenery on any traditionally built layout. These scenes include removable scenery; the removable portion of the scenery starts right behind the tracks. Thanks to some strategic blending, you would never guess this scenery is removable.

- I could not handle layout visitors very well –more than two or three people in the room made it crowded and uncomfortable. I really wanted extra space to sit and talk with visitors
- I had a chance to move the layout to a better room in the house, but the current layout would not be easy to move
- I really liked the idea of making a proper workshop in my current layout room.

## Dealing with my doubts

I had been playing around with the idea of a modular layout for a while, but it was all just in theory. I was not really sure I wanted to take that path.





At about that same time, I read some articles in *MRH* about “the one module approach” (TOMA) for doing a sectional home layout. There was even a competition for planning a modular layout for a specific room, which I thought I might enter as a useful exercise.

One thing led to another, and instead of doing a plan for a contest layout, I found myself making drawings for a modular layout in my new layout room.

## TOMA starts to grow on me

I missed all the deadlines for the *MRH* contest – but all of a sudden I was completely sucked into the sectional home layout concept. With every passing day, I became more certain this was the way to make my new layout.

***I started to recognize some benefits of the TOMA concept compared to my previous permanent layouts which I’ve built over the years.***

If one day I have to move the layout, I don’t need to tear it down, but simply move it and keep it.

In case I would like to sell it, I could actually do that. All this was clearly a no-go with my old layout – I couldn’t move it, I couldn’t sell it: so all I could really do is tear it down and scrap it.

## Benefits or looking for trouble?

Day after day I saw more and more benefits to TOMA – or, as my wife would put it, I kept finding *more excuses*.

For example, I could temporarily remove a module and take photographs outdoors in sunlight, instead of building special photo dioramas, which I regularly did for taking the best photos of my





3. This river goes through three modules, so Erik used pieces of clear Plexiglass to make the barriers between modules. This kept the epoxy used for the water from flowing where it shouldn't. Once finished, those plexi joints are barely visible (not shown here, however). For modeling the rivers and streams, Erik used Microscale's Kristal Klear.

models. But then I had no idea what to do with one of those photo modules afterward, or where to store them!

Also, if I wanted to make scenery changes to the layout, it would be *so much easier* to just replace one module section. In fact, I could deliberately make new modules to fit, each with different scenery, and keep the layout changing over time. How tempting!

But modular is for club or exhibition layouts, not home layouts, right?



All this thinking was rather theoretical. In the last 25 -30 years, I've built four or five permanent layouts, but going modular at home required a radical change in my mindset.

Adding to my indecision was how most of the modular layouts I saw at train shows were rather flat. I wanted the same theme as my previous layout: mountainous scenery, a lot of forested areas, and at least two levels of track – all with a superb finish and nice detailing. Making all that on a sectional, transportable layout was asking for trouble, I had been told.

### Let's do this!

At this point a friend of mine, Bogdan Krmelj, entered the story. He has an absolutely extraordinary collection of US model trains (we are talking hundreds). At that same time he was trying to decide how to approach building his first home layout.

We would meet often for a cup of coffee and discuss ideas.

At one of those coffee meets, I told him I was weighing the idea of making my new layout modular or sectional. I also told him about the TOMA concept I was reading about in *MRH*.

Bogdan was ecstatic and jumped on the wagon immediately. “Yes,” he said, “this is so cool! We can even make it so your sections and my sections could connect, and we could have a large exhibition layout. Let's do this!”

To make a long story short – that nailed it! Each of us would make his own layout following the TOMA guidelines, and we would make it so we could connect both of them at a train show.

It all sounded great; after all, how hard can it be?



4. Looks like the railfans are out in force today as they catch a train passing by.

## How hard can it be?

There are quite a few modular layout approaches and standards out there for show layouts.

The one thing I love most about the TOMA concept is the freedom of not needing to follow any particular standard.

It doesn't matter exactly where the tracks are laid at the joints, or the size of the modules. I took a lot of liberties when I built my previous layouts, so TOMA suits me very well in that regard!

We defined all the important aspects of the layout(s) in a short time, and from then on, I had no more excuses not to start tearing down the good old Pacific & Northwestern.

Bogdan started working on his layout, consisting of five modules for his train yard. These could then be inserted into my eight

## BUILDING THE LAYOUT BASE

One of the cool things about TOMA is that there's no limitations or strict rules on how to build the layout or what size the modules should be. That suits my way of planning a layout and track plan perfectly.

Actually, I just draw a simple drawing on a piece of paper to get the basic shape, and that's about it (video 1).

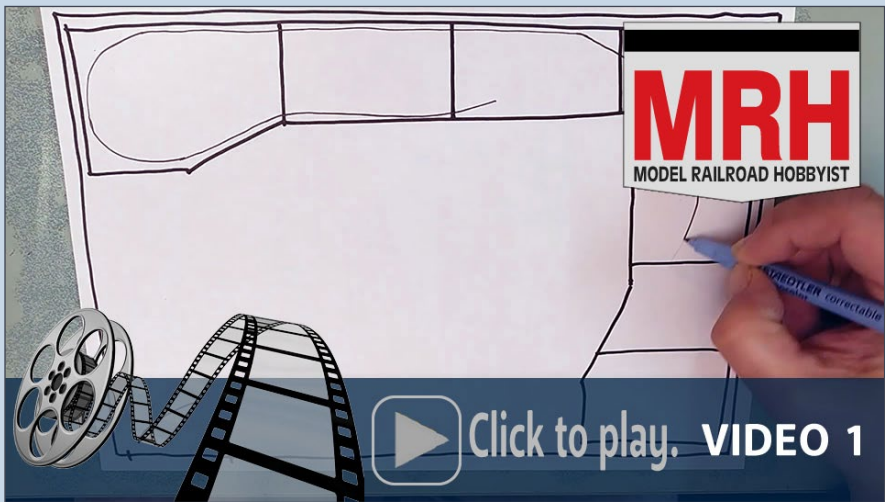

Playback problems? [Click here ...](#)

When I lay the tracks now, I start with that basic drawing in mind, then go along following my intuition. With my first layouts back in the day, I made very detailed track plans (common sense), only to find out I was changing things so much as I went along that it came out quite different from what I had drawn up originally.

I really love model train photography, so I always check with my camera while laying tracks. Sometimes I need to move tracks only an inch or so to get an much better view or angle for photos later.



Bogdan and I decided to have most of the modules slightly over 3' long and 31-1/2" deep. This size allows enough space for decent scenery while the length allows a module to be transported in the trunk of a moderate sized car.

While the three-foot size worked fine with Bogdan's yard, I had to adjust these dimensions some to fit my room. Only three out of eight modules are that exact size; the rest of them are all different. Of course the first and last modules are larger to accommodate the return loop.

We had to think about the portability and weight in advance, of course. We decided to make simple frames with spruce boards (video 2), 4" high and 5/8" thick. We used a poplar plywood base board, which is extremely light and easy to work with. In hindsight, it wasn't the brightest idea.



Playback problems? [Click here ...](#)

## BUILDING THE LAYOUT BASE *CONTINUED*

Namely, once I had the frames in my room and had screwed the poplar board on top, all of a sudden I realized I would have a hard time moving and handling those modules alone. And that was before there were even any tracks or scenery installed.

It was very difficult to grab and move a module by myself alone. “Nope, not happening,” I said. Since I wasn’t prepared to compromise the size of the modules (I wanted plenty of space for scenery and towns), I had to rethink the whole idea.

As for the support legs, I wanted legs with no need to screw/unscrew every single leg into the module frame every time – and I wanted a way to attach legs I could do alone, without any help. I built a pair of legs as a unit with an U-shaped aluminum channel screwed on top.

The width of the channel should be just double the thickness of the frame side, meaning that one pair of legs is sufficient to support two frames, instead of having four legs for every module.

Instead of having 28 legs for eight modules, I have only 16 of them assembled in pairs, with no screwing required.

This proved to be quite simple to make and very effective solution (video 3 - opposite, top of page). ■



Playback problems? [Click here ...](#)

ADVERTISEMENT

# INSTANT ANSWERS

SHOP FOR ANSWERS



Put your hobby into overdrive

Downloadable books and videos from ... **The Model Railroad Hobbyist Store**

ADVERTISEMENT



Installing DCC sound just **NOT** your thing?  
Trust Traintek for sales and installation of sound decoders from these fine vendors!



"Taking model railroad control to the next level ..."



[traintekllc.com](http://traintekllc.com)

Click here for more details...

"Traintek was the way to go!"



• [INDEX](#)



SUBSCRIBE (free)

• [TABLE OF CONTENTS](#)

modules. As far as the details of each module section, we had not worked out those yet.

At about this same time, we learned about the US Model Train Convention in Germany, a large exhibition of strictly US-themed layouts. We signed up and got approved even before we started building!

Now all of a sudden, there was a deadline in front of us – which meant that we also had to finish what we started.

## THE MODULES

Ultimately, we came up with two-part modules. One part would be the frame itself, with its only purpose being to carry the module base. The module base would not be permanently screwed to the frame, but would rather would just lie on top of it.

This idea wasn't working well with the poplar boards – they were great when they were screwed to the frames, but just resting on top of the frame was impossible – they bent easily, rendering them practically useless.

We ended up with a compromise: fix the poplar boards to the frame (some 6-10" deep) to carry the tracks at the back edge of the modules. For the rest of the module, use removable MDF boards (video 4). The MDF is heavy, but still manageable by one person, and the panels stay straight (most of the time).

This solution offered a huge advantage – if I wanted to work on a module, all I had to do was take the module MDF base board out, without needing to dismantle half the layout to



## Does TOMA work in real life?

Basically, building the layout went quite well, and as expected. Saying that, I don't mean flawless by any stretch. There were things I had to do more than once, but after all, that is nothing unusual when building any layout.

The worst problem was the wood material itself – if not screwed together properly it has a tendency to bend, stretch, or shrink. My only regret is that we didn't make the frames with plywood, which

reach it. For repairs or additions, I could just lift the MDF base, work on it, then push it back down in place.

It's as simple as that! ■



Playback problems? [Click here ...](#)



## THE MODULES *CONTINUED*



1. Erik decided to make the module sections in two parts: a base frame and a topside baseboard. The topside baseboard module has some advantages. First, it makes a module light enough that setting up the layout can be done by one person.

Also once the frames are in position (and screwed together), Erik found he could do any kind of electrical repair or addition without needing to move or break up anything.

All he had to do is remove the movable scenery on top, slide the rail joiners to the "open" position and simply lift the module board. Erik added a pair of handles in the middle of every module board so handling and moving became no trouble at all.



2. All grades on the layout are 2% and made with Woodland Scenics Subterrain foam products. That proved to be a most elegant solution, especially for a sectional layout where there is a need to cut the grade in several places due to the length of the modules.

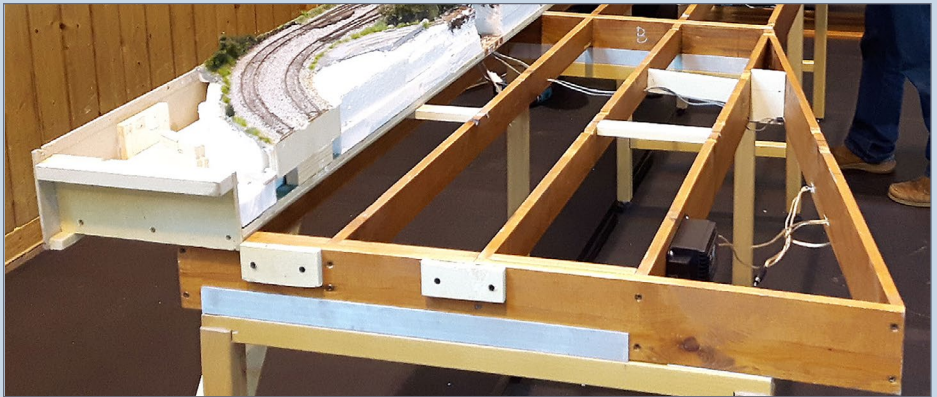

3. The image shows what the sub-base frames look like before adding the module board. At the back side there is a 10" poplar board fixed to the frame, carrying the tracks and some backdrop scenery. This way Erik could handle and carry the frames with ease.



seems more stable. But in my ignorance, I started the sectional layout the same way I would do a permanent layout. Lesson learned!

For the next 10 months we were up to our ears in work, meeting frequently to make sure the joints between our modules aligned and were 100% tight. Working on one module at a time made things a lot easier.

Inevitably the day came when we had to put down our tools and say “that’s it, what’s done is done.” Then it was off on a 500-mile trip to the convention.

After that, the two layouts each went back in their respective rooms, doing what they supposed to do – be a home layout. I can’t say the project is finished for good; after all, does one ever “finish” a layout?

It is indeed a joy watching the trains running on this new layout without any hint of a problem. It’s just the same as it would be on a permanent layout. I can put the trains on the layout running and then go out for half an hour – certain they will still be running fine when I come back!

I don’t know when we’ll exhibit the layout again, if ever, but that doesn’t really matter. We’ve taken the layout to a show and we have the possibility of doing it again if we want to.

## **TOMA or not TOMA?**

Looking back, I had doubts about going modular. In fact, I was second-guessing myself even while I was already building it. At times, things didn’t go as smoothly as I would have wanted. But that had less to do with the TOMA concept and more with my way of working and the mistakes that resulted.

Regardless of everything, I don’t regret the decision to go with TOMA for a moment!



## COPPER TAPE WIRING

Since we opted for modules with a frame sub-base and base-board of MDF, we had to rethink the electrical connections.

We decided the electrical feeds should all be on the underside of the removable top board, which is easier said than done. A layout can take a lot of wire for track feeders, the main bus, layout accessories, track switches, building lighting, and you name it.

On my past layouts, I generally have a gazillion wires going in every direction, which is workable on a permanent layout, but such a birds nest of wires becomes almost unmanageable with modules. I have no idea how others solve this issue on their modular layouts – but I prefer the KISS concept (Keep It Simple Stupid) if at all possible.

On my previous layout, I used copper foil tape for connecting some street lighting. My pal Bogdan really liked that approach, so he suggested we use the same idea for the rest of the wiring on our modules.

The copper tape is self-adhesive, paper thin, easy to use, and inexpensive with no mess underneath the board. Using copper tape has turned out to be flawless.

Although the copper tape has allowed us to make electric connections between the modules by simply keeping them close to each other, I wanted some extra security in the wiring.

We connect all the modules to each other with RCA cinch connectors (as we know them from audio products). I like RCA connectors because you can't connect them wrong.



## COPPER TAPE WIRING *CONTINUED*

The dummy-proof connecting for wiring becomes important when you work in poor light or you're in a hurry, or otherwise distracted. You just push it in and that's it, it just works.

I made my own RCA cables using RCA connectors attached to my wire because I can control the wire size needed to get the least amount of resistance over the length of the layout. Ordinary audio cables are typically "one size fits all" and this doesn't work as well for our purpose.

### **Rail joiners or not?**

At the module joints we used copper head ties, which we made of PC boards (video 5).

#### **MRH Staff notes: COPPER TAPE WIRE**

1" wide tape = 22 gauge wire

2" wide tape = 20 gauge wire

3" wide tape = 18 gauge wire

Since most copper foil tape adhesive is conductive, you can stack layers of copper foil tape to get less voltage drop.



### **WHAT ABOUT COPPER TAPE?**

Copper foil tape wiring is a clever idea, so we did some research. We found 1" wide copper tape 0.0035" (0.08mm) thick has a voltage drop over its length roughly equivalent to 22 gauge wire.

Note: The most affordable copper foil tape can be found on eBay.

**WEB:** [ebay.com/  
bhp/copper-tape](http://ebay.com/bhp/copper-tape)



Playback problems? [Click here ...](#)

**This video shows the diversity our take on TOMA allows. Since we used copper foil tape for all electrical connectivity, changes are easy. If I want to add more structure lighting, for instance, I just make a hole in the module and solder the wires to the copper tape running on the underside of the MDF module base. If I need to make repairs, they are easy and fast to make, without needing to remove the whole module.**

The PC ties keep the tracks firmly fixed on the base and properly aligned. But beside that, we made one more decision. It's perhaps a little counter-intuitive, but we wanted to have rail joiners at the module joints as well. We felt this helped keep the tracks aligned under **any** circumstances. This decision proved to be a good one when we first exhibited the layout.

That means we do not solder the copper head ties to the track right on the edge but a bit inside. This allows just enough space for the rail joiner on each edge.

Once we have the modules set up, we simply push the rail joiners to the next rail with a flat screwdriver.



## COPPER TAPE WIRING CONTINUED

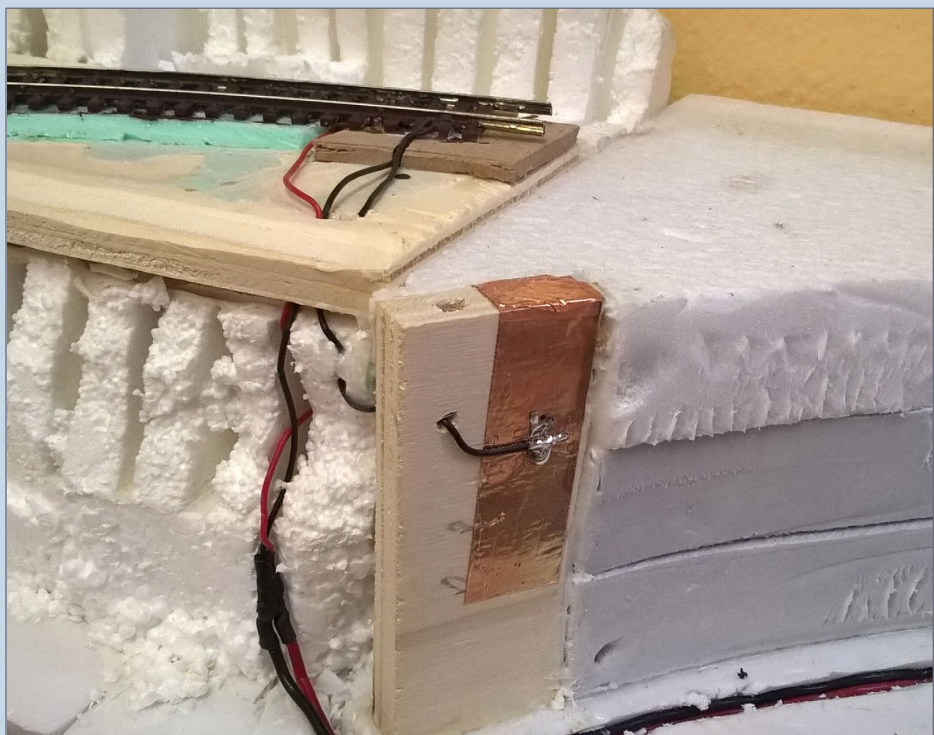

1. We made the “MDF bridge” supports from poplar board, a super light and sturdy wooden material. Since most parts of the layout including the bridges are removable, we made the electric connection to the tracks with copper tape. The MDF bridge has copper tape on the underside with feeders soldered to the tracks. When the bridge is laid into position, the copper tape of the bridge lays firmly on a piece of copper tape on the base frame support as shown here, which then connects to the main bus. As soon as the bridge is in place on the support, electric contact is established. This proved to be an elegant and secure solution.





2. For the track joints between the modules, besides copper head ties near the edge, we used rail joiners. The joiners help keep the tracks aligned in just about any circumstances. It makes the module alignment less susceptible to temperature changes or accidental misalignment from transport.



3. We needed to be especially careful with track joints at curved sections of track. Those can be rather fragile – those good old fashioned rail joiners did their job perfectly. ■

While building the TOMA layout, I would discuss it with fellow modelers. More than once I was told there are “just too many compromises” with modular for it to be practical for a home layout.

For example, I was told you shouldn't make multiple track levels, and doing grades could be troublesome. I was also told you couldn't (or shouldn't) make it with high detail because of damage is more likely during transport. I also heard modular is not for really large layouts with a lot of tracks and action, hidden trackage is a problem, and so on....

Oddly enough, most of this “advice” came from people who had never attempted to build a modular/sectional layout.

In reality, I found none of it to be true. You can make anything you want either modular or permanent – it is more about your determination to properly connect the sections with some strategic thinking.

Sure, things differ somewhat with modular, but we kept that in mind while working, being sure to plan ahead as needed. Yes, it could get complicated to do spaghetti-bowl trackage on a sectional layout, but that's not something I would like on a permanent layout either.

## **Make it modular or permanent**

We call our combined layout the K&K Railroad, by the first letters of our surnames. It's not really a small layout. It is an L-shaped 29'x15' piece of model railroad real estate, featuring a large yard, grades and, yes, a hidden yard as well.

What I like most about the TOMA concept is the freedom to do things my way but still be within the concept's guidelines. I don't see any serious downsides; actually it's just the opposite.

The ability to take part of the layout (or all of it) to a convention is just a bonus. For me, a major benefit is the ability to take part of the layout outdoors for photo shooting, or to make changes over



5, 6. All the hills and trees creating this canyon are easily removable.





## MAKE EVERYTHING REMOVABLE

The first thing I had learned in the TOMA building process was to alter my mindset a bit. Building a modular/sectional layout is not exactly the same as building a permanent one. Although the building techniques themselves may be no different, there are generally some compromises to be made, and more things need to be thought out in advance.

At first, I was bothered by needing to really pay attention to where one module starts and where another ends when planning and building the scenery.

Sometimes, I would need to take one specific module out without removing any others. I felt everything had to fit perfectly, otherwise I simply could not take it out without “damage.”

That bothered me until one day I said, “wait a minute... why do I have to make the scenery exactly the length of the module?” One of the main points of a modular layout is that it is movable – so, why not make the scenery movable too?

This way I can make my mountains larger than one module. This also means it should be much easier to take the layout apart without breaking anything. Finally, if my mountains are removable, I don’t have to worry about the weight of the modules as much!

This leaves me the option of using real rocks for my scenery, which is my favorite scenery material. Finally, to ensure the finished layout is just as immersive as any permanent one, this allows me to cover most of the joint lines between modules with the scenery, so they can’t be seen as easily.

That was the way to go! I cut some thin MDF boards (roughly 1/4”) to fit the space available, and built my scenery, mountains, and town upon it.



In the end, only the tracks and surrounding scenery are permanently fixed onto the modules. Everything else is removable, including the long bridge carrying the main line tracks. It spans over three modules, so instead of cutting it into three parts, the most elegant solution was to have it as one, removable piece.

The removable scenery idea worked quite well (video 6).



Playback problems? [Click here ...](#)

Yes, it does mean more cartons and boxes for packing the layout when transported if needed. But then again, that means less of a chance for the modules to be damaged.

Last but not least, if one day I want some new scenery on the existing track plan, I don't even need to make new modules, but only new scenery inserts!

Bogdan took the same approach with his TOMA module sections as well – all objects and buildings are removable and can be exchanged for something else if desired.

## MAKE EVERYTHING REMOVABLE *CONTINUED*

Since all buildings and structures have interior and exterior lighting, we make the electrical connections simply by using copper tape on the building bottom and on the layout base-board. As soon as you put an object in place, there is electrical contact and everything is lights up! ■

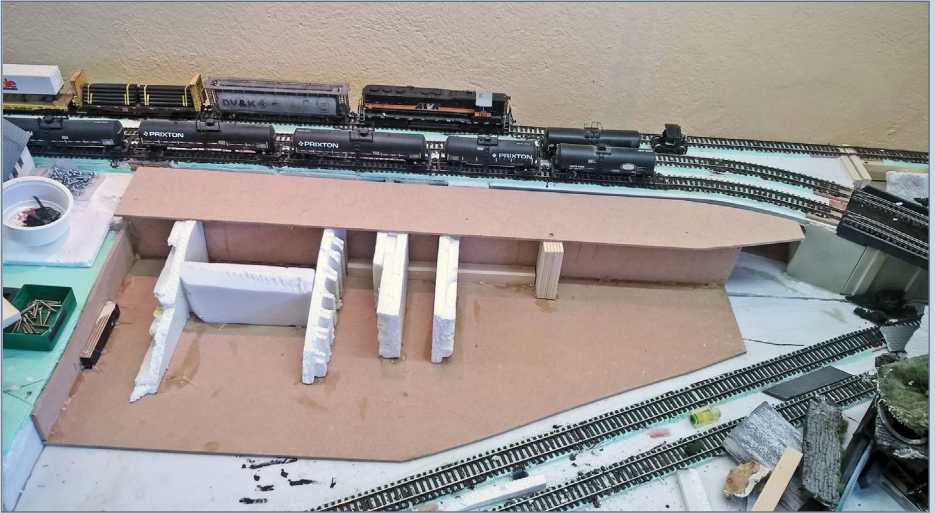

1. Our “everything-removable” approach means that besides the tracks and some immediate scenery, virtually everything else is removable. First, I made the base for the large scenery part I wanted to install on the layout, as you can see here.



2. I took the scenery base [1] to my workbench and created the scenery working from the back forward.



3. Here is the finished scenery part on the layout. I later blended this scene with the rest of the layout scenery.



MAKE EVERYTHING REMOVABLE *CONTINUED*

4. Here is this part of the layout finished and blended. You can't tell that this scenery section is actually movable – it looks like an integral part of the scene.



5. I made the long bridge that spans over three modules removable as well. With it spanning three module sections you would at first think it also should be three pieces, but that is not something I would recommend. I made the bridge deck as a single piece from two thin MDF boards (with laser cut openings) and laminated them together for additional strength.





5A. The bridge is placed on and off the layout as a whole. For transport purposes, it goes into its own carton box – no chance for damage!

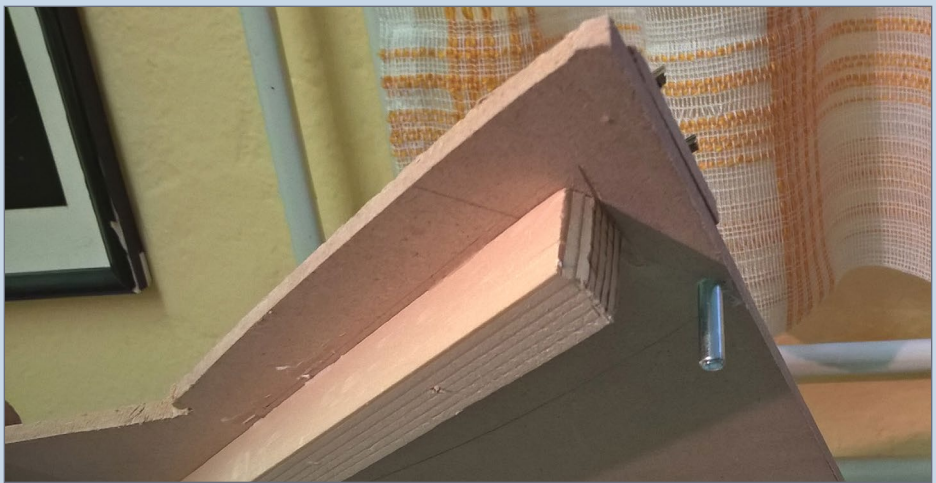

6. I fixed most of the removable parts in place with some metal pins, glued into the MDF base as you see here. I also used the metal pin method with bridge as I did this piece of scenery, which includes a spur track!

## MAKE EVERYTHING REMOVABLE *CONTINUED*



6A. There is a hole in the module base to accept the metal pin in the scenery section.

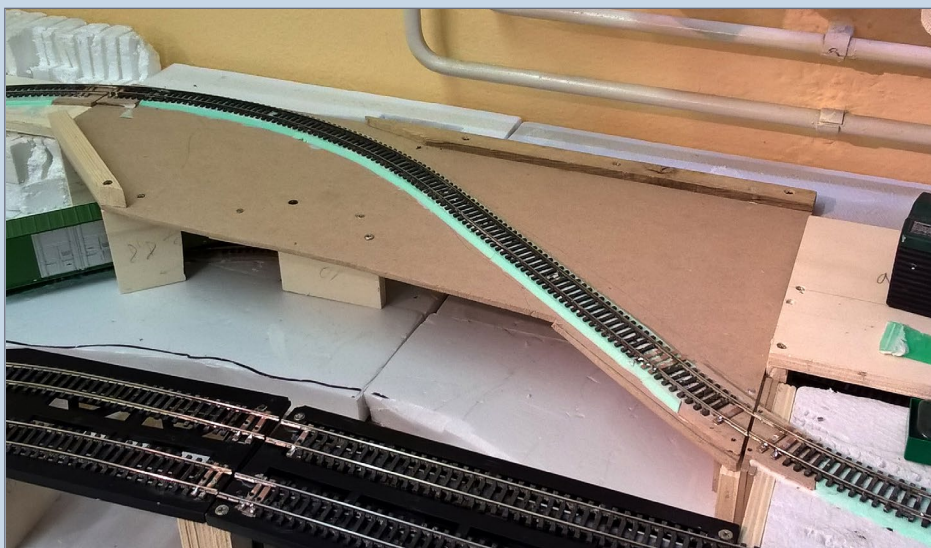

6B. Here is this scenery base in its place. I just pull it up to remove it. ■

time without major dismantling. Also if a part is in need of repair, the ability to take it out and work on it one module at a time in the workshop is priceless.

I can't think of anything I could not do with the TOMA concept.

I was on the fence for some time whether to go TOMA or not with the new layout, but I can say now it was the right choice. I don't want to go back to permanently built layouts. I have ideas for future additions and extensions of the layout, and for sure I'll build the extensions the same way again.

Using TOMA makes some things easier, but with the same result.

By no means can I say that my way is the only way – every modeler adopts the techniques which suit him best. But the experiences we got while building our TOMA project showed that using TOMA makes some things a lot easier, but with the same satisfying result. At the end of the day, what counts is the final result and the quality of the modeling, not the way it was built.

For those who would like to see the final result more closely, here is a 10-minute Youtube video about my New Pacific & Northwestern.





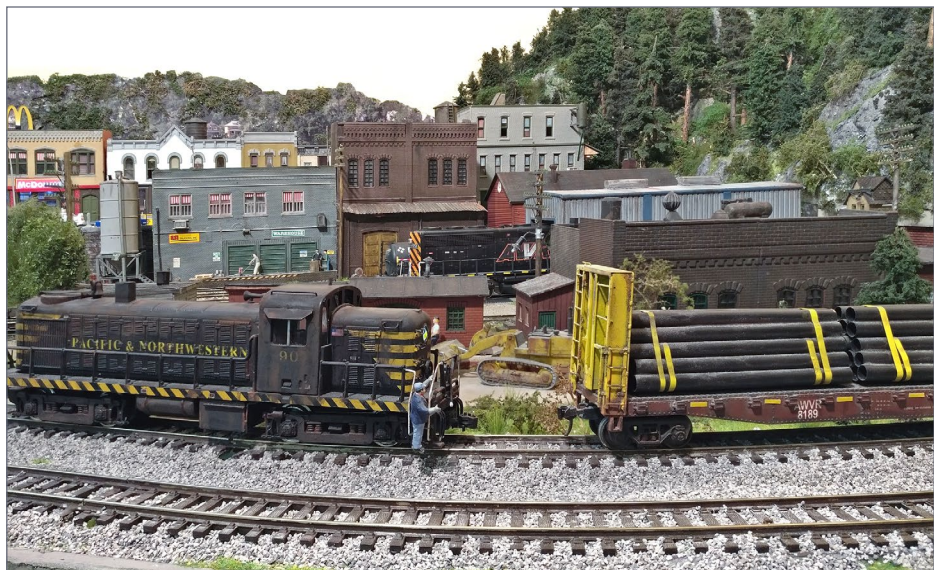

7, 8. The city of Cicely, AK, known from the TV series Northern Exposure, was a focal point of Erik's previous layout, and still is. He reworked the city to fit his modules and it can be removed entirely.





9. Here is a spot where two modules come together. The removable scenery behind the train is also joined at the same spot. With a little careful scenery work, the joint line is barely visible.

## LAYOUT SUMMARY

**Name:** The New Pacific & Northwestern

**Layout style:** L-shaped sectional layout, 8 modules, continuous run

**Layout size:** Approx. 15'x12'

**Scale:** HO standard gauge

**Era:** Present time

**Maximum grade:** 2%

**Minimum curves radius:** 20"

**Loco control:** Digitrax DCC

**Turnouts:** Electrofrog, controlled with PECO motors ■



## Would I do it again?

There is now a third layout coming into this story. A fellow modeler heard what Bogdan and I were doing, so he asked if he could drop by periodically and watch our progress.

He also wants to make a smaller layout at home, but didn't really know how. As he saw how the TOMA concept works, he became very excited and elected to do TOMA as well.

With a little help from his friends, the result was a really nice 11'x7' layout, consisting of three sections. And he is one very happy guy!

This would be my answer to anyone asking me whether I would recommend the TOMA concept for a home layout: *Yup, I used TOMA for my home layout and I would do so again, any day of the week and twice on Sunday!* ☑



10. Erik heavily kitbashed the Chevron gas station to fit the available space. It is one of the rare details that he permanently installed on the module and did not make removable.



11, 12. The joint line between two modules is right at the center of these two photos.





# TRACKPLAN

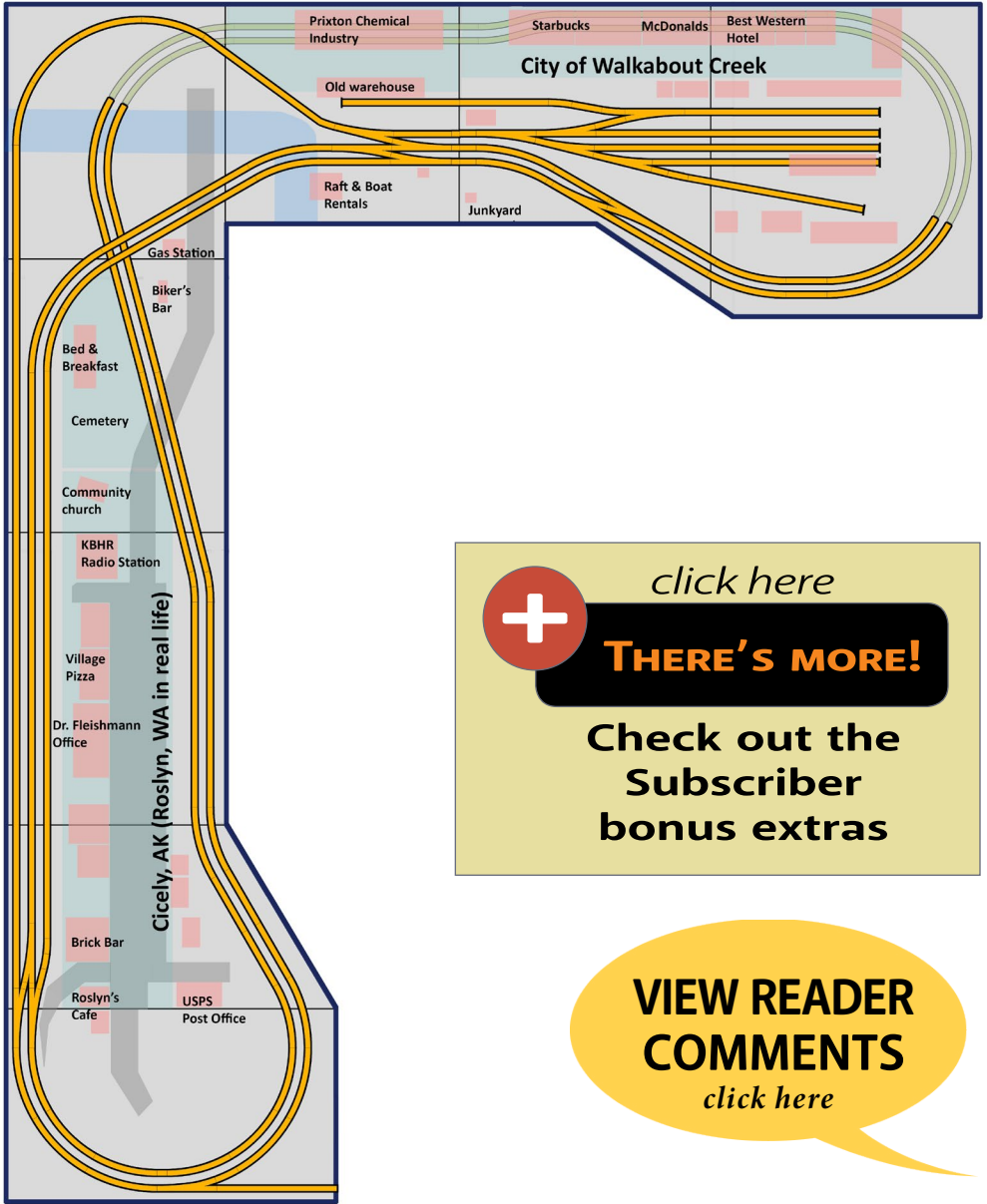

*click here*

**THERE'S MORE!**

**Check out the  
Subscriber  
bonus extras**

**VIEW READER  
COMMENTS**

*click here*





## Expanding (or shrinking) a TOMA layout

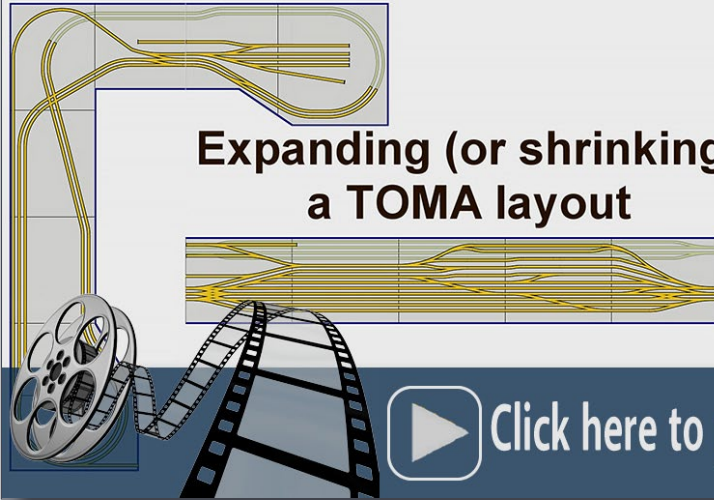

Playback problems? [Click here ...](#)



13. My friend Bogdan Krmelj (left) and me at the US Model Train Convention in Germany. Our combined TOMA home layouts stood the exhibition test with flying colors.



## ERIK KALINSKI

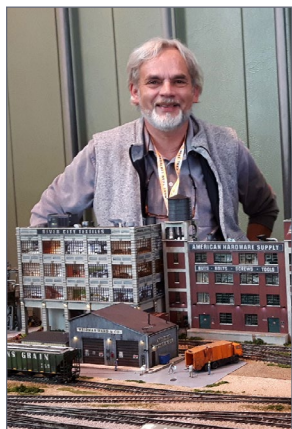

Erik lives in Slovenia, a country of spectacular scenery in Central Europe.

Erik was bitten by the train bug as a child. Years later as an adult, his first two layouts were of local themes, but once he saw American trains, he has been modeling American prototypes ever since.

Erik says his whole attitude towards trains and modeling might be described through a few quotes:

- “If something is worth doing, then it is worth doing well.”
- “Don’t overdo it!”
- “How hard can it be?”
- “If you don’t know, ask someone who does.”

Erik has worked in the hi-fi audio business most of his career. He has been a distributor for audio products and for a time was chief editor of the only hi-fi magazine in the country. Later in his career, he became a product manager, designer, and manufacturer of audio products.

Most recently, Erik has been working on custom modeling and painting jobs, both for commercial and for private clients.

Erik says the sign on the door of his train room betrays his fun-loving hobby attitude: “The Temple Of Doom.” ■



**RATE THIS ARTICLE**

# Kadee

## July Pre-Order

### Two Road Numbers



Mathieson Chemicals

#9014 SHPX 2569 .....\$44.95

#9015 SHPX 2570 .....\$44.95



**For More  
Pre-Order Cars  
Click Here**

## Backdrop Junction

Your Stop for Railroad Backdrops

**Click Here** →

**For the Finest in Custom  
Designed backdrop**



[www.backdropjunction.com](http://www.backdropjunction.com)

ADVERTISEMENT

# TCS *WOWSound*

**Version 4 of WOWDiesel  
NOW SHIPPING!**

WOWDiesel Version 4 Introducing the  
**645 Non-Turbo Prime Mover**

All with Unmatched CD Quality Sound at  
TRUE 16 bit Resolution that nobody else can  
come close to!

*click here*

**Learn why loco sound fans prefer WOWSound ...**

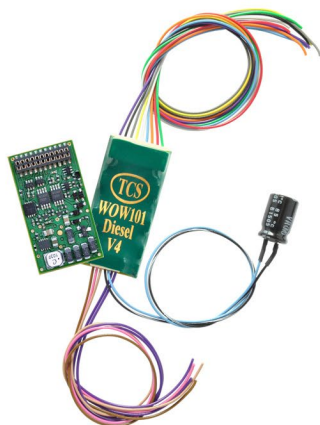

Remember you "Rivet Counters", Sound has rivets too and TCS counts them better than anyone!

[www.TCSDCC.com](http://www.TCSDCC.com)

• [INDEX](#)



**SUBSCRIBE**  
(free)

• [TABLE OF CONTENTS](#)



Start the layout of your dreams now! No space? No problem!

# Building a modular home layout with

# TOMA



**THE ONE MODULE APPROACH**

**TRAINMASTERS.TV** 

Building a modular home layout with **TOMA**  
THE ONE MODULE APPROACH



**NEW!**



TOMA lets you start the layout of your dreams now. No space? No problem!

**MRH DVD**

**Episodes in this video:**

- 01. TOMA series introduction
- 02. TOMA design
- 03. TOMA benchwork
- 04. TOMA trackwork
- 05. TOMA wiring
- 06. TOMA structures
- 07. TOMA scenery, part 1
- 08. TOMA scenery, part 2
- 09. TOMA adding details
- 10. TOMA operation

**Bonus: TOMA make grass tufts**

<b>DVD</b> (4 disks)	<b>Download</b> Avail. Now!	
<b>\$29.99</b>	<b>\$19.99</b>	
<del><b>\$44.99</b></del>	<del><b>\$29.99</b></del>	11 files

**SPECIAL INTRODUCTORY PRICING!**



**How to build toward that eventual dream pike now in the space you do have!**



**Get the video!** 



# YES ... IT'S A MODEL



Model Railroad Hobbyist | January 2018 | #95

compiled by **DON HANLEY**



1. A lone Seaboard Central SD40-2 works the west end of South Yard in Griffin, GA switching out cars for local area industries. The Seaboard Central is a Class II regional carrier that operates between Birmingham, AL and Savannah, GA over former Seaboard Coast Line and Central of Georgia trackage.

Tim Garland focuses on operations in and around Griffin, GA. It is powered with an NCE wireless DCC system and most locomotives are equipped with LokSound decoders with the Full Throttle feature.

► **MRH'S MONTHLY PHOTO ALBUM**

• [INDEX](#)



**SUBSCRIBE**  
(free)

• [TABLE OF CONTENTS](#)



2. Another boring brown boxcar rolls on by in the blazing sun. These old SFLC cars just blend in and barely attract attention on any mixed freight train. SFLC 10772 is a Atlas HO scale 53-foot double door Evans Boxcar, and looked quite good out of the box with separately applied details and so much potential from a weathering artists point of view. For this car, Terence Boardman did an initial fade on his model with oil paints, sealed that with a clear lacquer, airbrushed the patches, then finished up with more fades, streaks and grime done with acrylic paints.

3. [opposite]. New wheels get rusty quick. When these eventually get used they will be slipped under the needy trucks rust and all, no pretty painting or cleaning. Terence Boardman's model uses Exactrail trucks and 33" code 88 wheels to keep SFLC 10772 on the rails. Terence added Plano platforms and coupler cut levers, Moloco draft gear boxes, and Kadee #158 couplers to complete the upgraded details. For the rusty spare Terence used Exactrail "Worlds Finest" 36" code 88 wheels with Tichy Train bearing caps fitted.



**VIEW READER  
COMMENTS**

*click here*



## GET PAID FOR YOUR PHOTO

**We pay \$40 per photo** we publish. If you'd like to get your modeling in our photo feature, just start posting your photos on the MRH website, especially in the Weekly Photo Fun thread created each week.

See [mrhmag.com/help](http://mrhmag.com/help) for more on how to post an image. You need to be an MRH subscriber to post photos to our website, and becoming a subscriber is free, [just fill out this form here](#). ■

• [INDEX](#)



**SUBSCRIBE**  
*(free)*

• [TABLE OF CONTENTS](#)





Complete Train Control

# Introducing Wifi Interf

- **Wi-Fi interface to a Digitrax LocoNet for up to four compatible mobile Wi-Fi devices and Apps.**
- **Compatible with most Android and Apple devices running supported throttle apps**
- **Easy Setup and Configuration. A single LNWI works 'out of the box', with no additional configuration required.**



**LNWI Loconet**  
The LNWI allows  
to LocoNet and r

**Find out how eas**



# g the LNWI face



et Wifi Interface | **\$79 MSRP**  
you to connect compatible WiFi devices  
run trains using compatible throttle apps

by it is @ [www.digitrax.com/throttleapps/](http://www.digitrax.com/throttleapps/)

• [INDEX](#)



SUBSCRIBE  
(free)

• [TABLE OF CONTENTS](#)

# MRH'S SIGNALING Roundup



Model Railroad Hobbyist | January 2018 | #95



RATE THIS ARTICLE

**TWO ARTICLES YOU CAN USE TO GET A COMPLETE SIGNALING SYSTEM UP AND RUNNING ON YOUR LAYOUT...**

**SOMETIMES WE HIT PAYDIRT WHEN IT COMES TO** reader article submissions.

We knew we had a gold mine when we saw these two articles by Dennis Drury and Larry Sebelley, both on different but complementary aspects of using realistic signals on your layout.

We start with the article by Dennis Drury that talks about a simple one-board solution to getting a prototype-based Absolute

• [INDEX](#)

• [TABLE OF CONTENTS](#)



**MRH's SIGNALING ROUNDUP | 2**

Block Signaling (ABS) system on your layout – without needing computers or complex programming.

Once you have the wiring you need installed using Dennis' article, you'll need some nice signals for your layout to go with it. Larry Sebelley tells how to take BLMA/Atlas signals and make them easily installed on your layout using a simple DIP socket.

Taken together, these two articles give you all you need to create an easy-to-implement but fully functional ABS signal system.

If you decide these articles describe a system you would like to install on your layout, check out the subscriber extras. They have all the details you'll need to build this system and install it on your layout.

On to ABS signaling for the "average Joe" article by Dennis Drury.

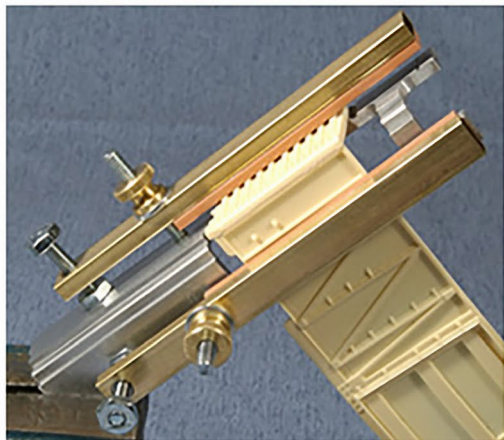
**Combo Right Clamp™**

**Combo Right Clamp™**  
with cast resin boxcar

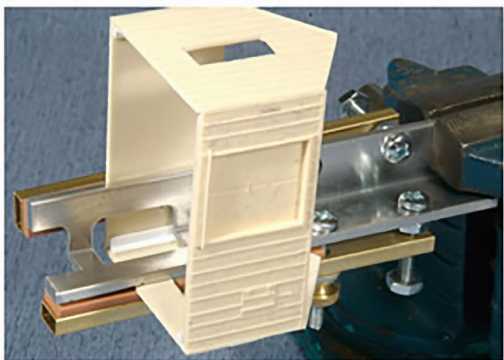

**Combo Right Clamp™**  
with Wolf Design Pump House

**Click here for  
all our products ...**

**Tools for Modelers**

**Coffman Graphic Solutions Co.**  
1500 River Circle, Richmond,  
KY 40475-7907





# **AUTOMATIC BLOCK SIGNALS** *FOR THE "AVERAGE JOE"*

**DENNIS DRURY DISCUSSES ADDING A SIMPLE BUT EFFECTIVE BLOCK SIGNALING SYSTEM TO YOUR LAYOUT...**

**I HAVE SEEN AN INCREASED INTEREST LATELY IN** adding signaling to a model railroad. Many modelers seem to be under the impression that realistic working signals get complicated.

If you go with a full-featured signal system involving computers, microcontrollers and plenty of programming to get it all to operate correctly, then yes, adding signals becomes a major undertaking. Some of these full-featured signal systems use the DCC bus, which can put a lot of additional load onto the DCC system bandwidth.

But it doesn't need to be that complicated. Here is an easy-to-install and use signal system that allows achieving a prototypically correct system without a lot of difficulty or expense.



The Dual Automatic Block Signal system (DABS) I describe here is just such a system.

## Block diagram and theory of operation

The DABS controller board (Signal Control Board or SCB) is the heart of the system. It receives inputs from current-sensing block detectors and uses internal logic to drive a pair of three-color signals to provide the correct aspect.

This can be used to implement either single-track or double-track ABS systems.

Each block is fed from the two-wire DCC bus marked DCC A and DCC B. It doesn't matter which side of the DCC signal is fed through the detectors as long as it's consistent throughout the layout.

Tracing the wire path [1], DCC A feeds the track directly while the DCC B signal goes through a current detector before it is connected to the track.

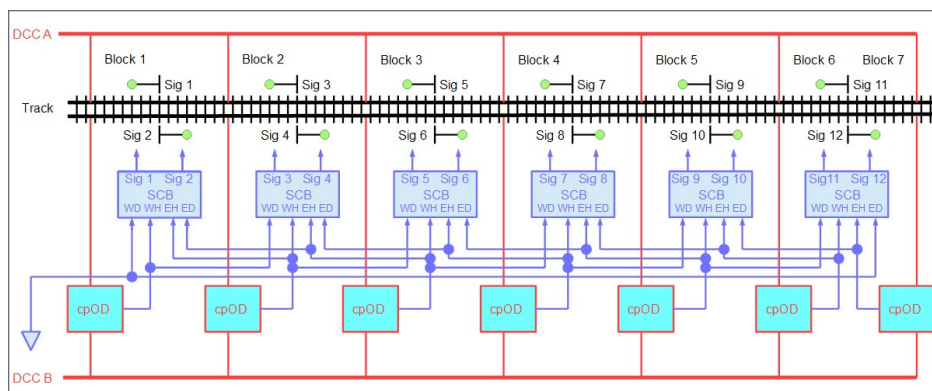

1. Block diagram for a single-track railroad. All signals are green because there is no train on the track. This is the default state for an automatic block system.

# ABS SIGNALS FOR THE "AVERAGE JOE" | 5

The current detectors shown [1] are the cpOD detectors available from Model Railroad Control Systems ([modelrailroadcontrol-systems.com](http://modelrailroadcontrol-systems.com)) but any current detector can be used as long as it provides a TTL logic low output when occupancy is detected.

The output from the detector is fed to the Signal Control Board, or SCB. Each detector board [1] feeds into the inputs on the SCB called WD, WH, EH and ED. These stand for the West Distant, West Home, East Home and East Distant inputs.

The outputs of the SCB boards connect to the signals themselves.

In operation, the SCB provides the signal aspects are as follows:

- If the West Home input is logic low, the west signal will be red.
- If the West Home input is logic high, and the West Distant input is low the west signal will be yellow.

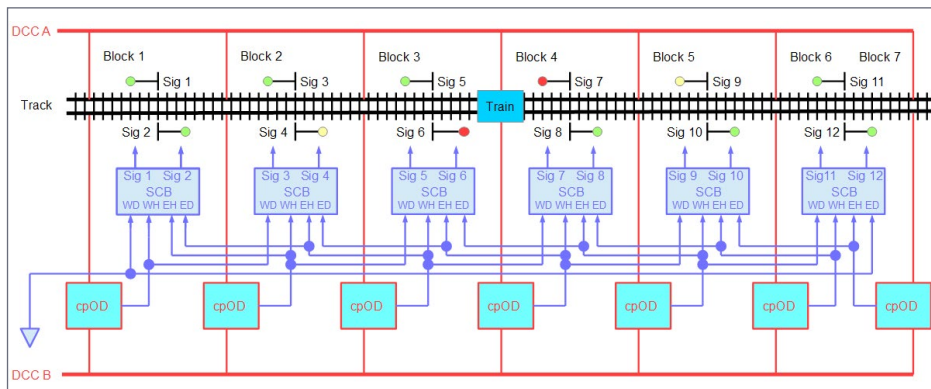

2. What the signals look like if there is a train in the block. In this example there is a train in Block 4. Signals 6 and 7 are red, signals 4 and 9 are yellow, and the rest are green. As the train moves across the layout, the signals will automatically change aspect based on the position of the train. The basic rule is this: signals leading immediately into a detected block will be red, signals one removed from a detected block will be yellow, and all other signals will be green.

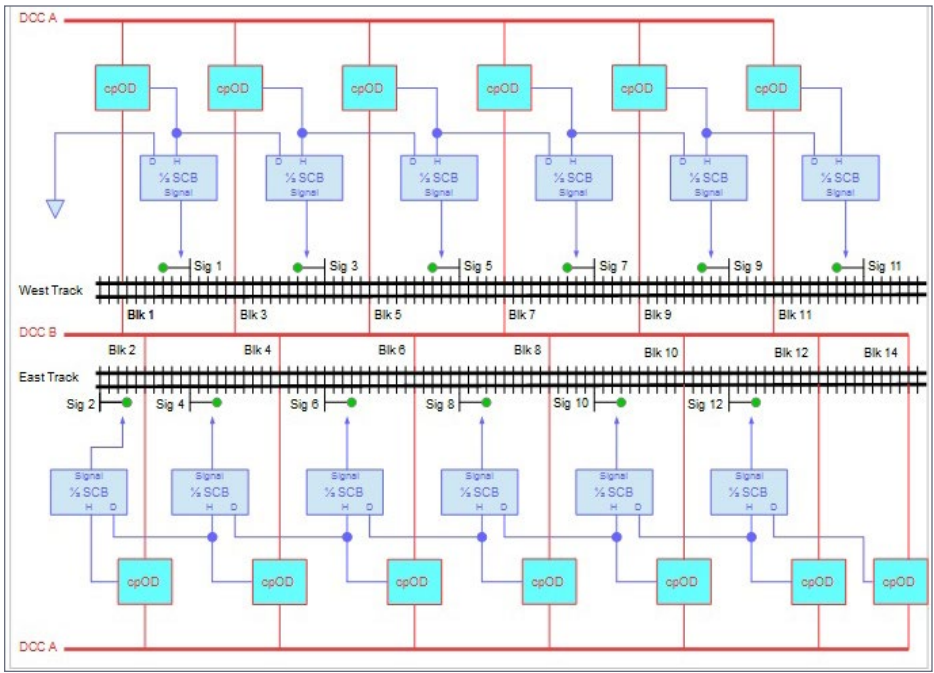

3. Here is the setup for ABS signals on double track. Note it is typical for double track to be signaled for movement in one direction on each track. Going the opposite direction means crossing over to the other track. In this case here, the signals all display green because there is no train on either track.

- Finally, if both the West Home and West Distant inputs are high, the signal will display a green aspect.
- The same logic holds true for the east signals using the East Home and East Distant inputs.

Note that even though there is only one arrow going from the SCB to the signals, that arrow represents four wires, one for each color and the common supply voltage. This makes it very easy to use a length of CAT-5 Ethernet cable to feed two signals. You also can use a length of CAT-5 for the cabling between SCB boards.



Four wires make up the East and West Home and Distant connections, and the other four are ground connections to reduce noise. Use one of each color for the connections and the mating colors in the twisted pair for the grounds.

The major difference between single and double track is you're only using half of the SCB for each signal. This doesn't mean you need to use twice as many SCBs – not at all! Instead, each half of the SCB is now independent of the other, so you get *added flexibility* in how to work your signal system. The other change is you now

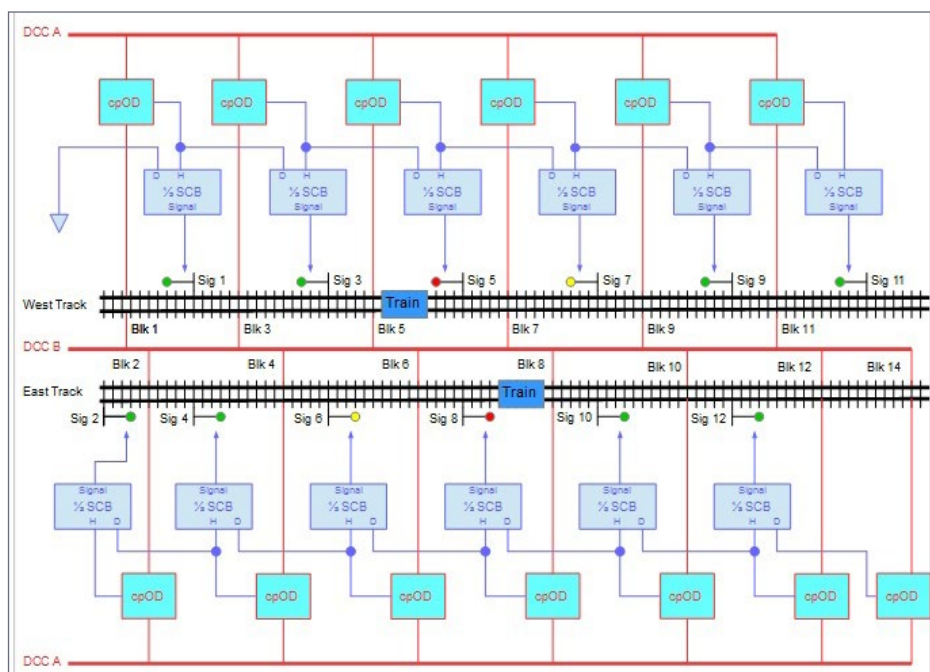

4. Here is how the signals look for double-track ABS with a train in both the east and westbound tracks. The westbound train is in block 7 while an eastbound train is in block 8. In both cases the signals behind each train provide protection for following moves, while the signals in advance of the trains show clear indications.



need only two wires between SCBs instead of the four required in the single-track version.

 [click here](#)  
**THERE'S MORE!**  
Check out the  
**Subscriber  
bonus extras**

**VIEW READER  
COMMENTS**  
[click here](#)

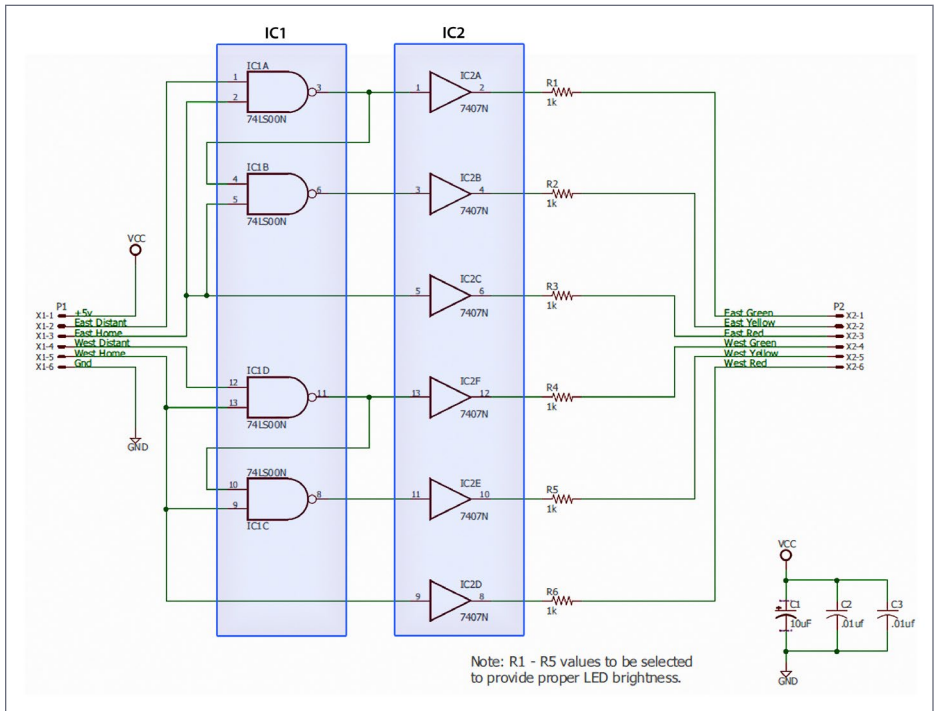

6. Here is a schematic of the Dual ABS (DABS) controller. It is described in detail in the text.



## HANDLING TURNOUTS

You may notice there are no turnout signals shown in the block diagrams. How then are turnouts handled?

On the prototype, if a turnout is thrown against the main line, the block signals in ABS territory go to red (stop) over that section of track. On the model, it's extremely easy to implement this feature when using current detection.

All that's needed is one set of contacts from whatever turnout controller you are using, along with a resistor. The controller can be a Tortoise, Blue Point, micro-switch or a toggle switch.

Here is how to wire up a resistor to detect when a turnout is thrown against the main line. When the turnout is lined for the main, the resistor is out of the circuit. If you throw the turnout for the diverging route as shown in the diagram, the turnout contacts place the resistor across the rails, acting just like a resistor on your rolling stock wheels.

This draws a small amount of current through the detector, which will trigger it to show the track as occupied. The detector will then cause the SCB to put the home signals to stop and the distant signals to approach. In practice it's just that easy.

It should be noted that if you use a manual method of throwing your turnouts such as Caboose Industries ground throws, you will need to devise some way of throwing a microswitch or otherwise detecting turnout position when the points are thrown.

A resistor value in the 10K ohms range ought to work, but you should determine the final value by testing.

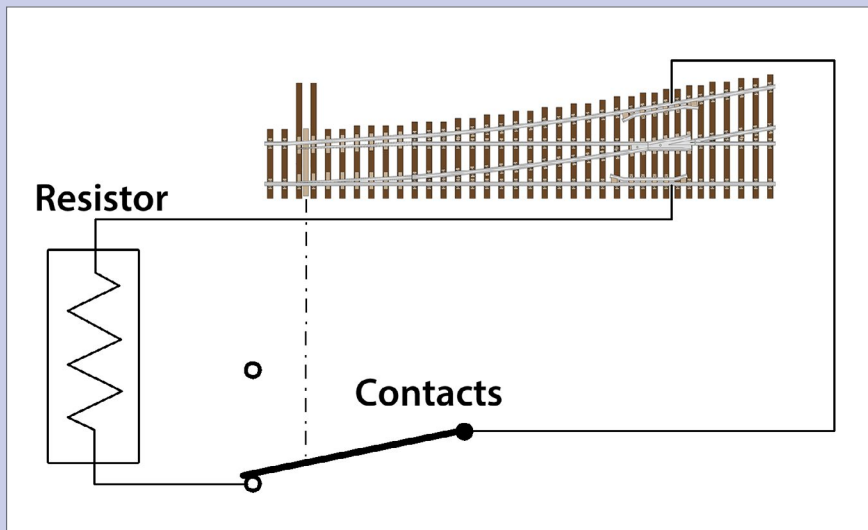

**5. To have a turnout thrown against the main line route trigger occupancy, use contacts to connect a resistor across the rails when the turnout is thrown.**



## NEAT WAY TO HANDLE TURNOUTS

This is a pretty neat way to handle turnouts with a current-sensing signaling system! Just add a resistor to make it "pseudo-rolling stock" when thrown!



## DABS schematic and theory of operations

Now that we've covered the overall theory, let's delve deeper into the operation of the DABS board itself.

Looking at the schematic diagram [6] you can see that connector P1 on the left holds the input connections, and P2 on the right has the output connections to the signals. On P1, pins 1 and 6 provide the +5V and ground (GND) connections (supplied by the layout owner) for the board.

Pins 2 thru 5 are the home and distant inputs from the occupancy detectors (discussed later below). When something is detected in the block by the occupancy detector, its output goes low. When nothing is detected, the occupancy detector output goes high. Keep that in mind as we discuss how the DABS circuit works.

Looking at the diagram [6], you'll note there are two integrated circuits (ICs) on the board. These are IC1 with four sections and IC2 with six sections.

IC1 is a quad NAND gate and IC2 is a hex buffer/driver. IC1 requires both inputs (pins 1 and 2 as examples) to be a logic high for the output (pin 3) to go low. If either of the input pins of each section of IC1 goes low, the output will be driven high. IC2's output pins mirror the inputs but the device provides a higher current output capability for driving the signal LEDs. An output going logic low will cause that LED to light.

Looking at the board inputs, if both the home and distant inputs are high (nothing detected in the blocks), then pin 3 of IC1 will go low, which will make IC2, pin 2 go low, which will illuminate the green LED.

Further, with pin 3 being low (nothing in the two blocks as described above) will force pin 6 high, which will turn off the



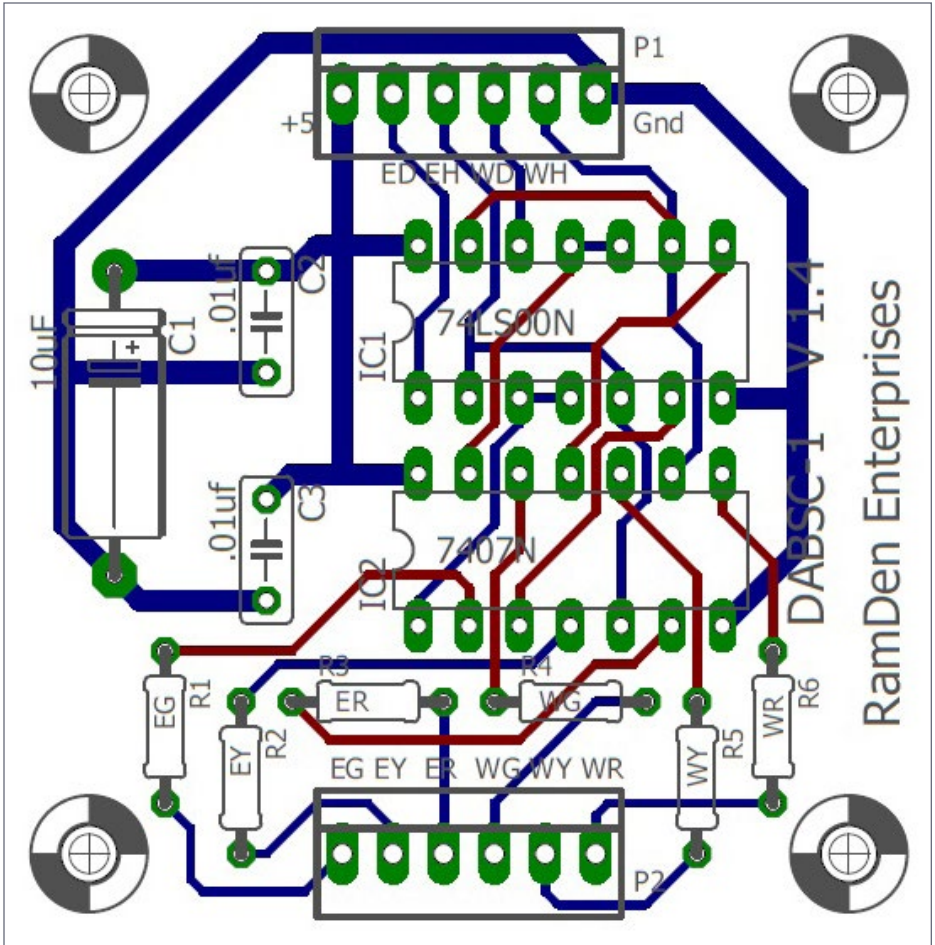

7. Here is the layout of the printed circuit board. P1 (inputs) is at the top and P2 (outputs) is at the bottom. Traces shown in blue are on the bottom of the board while the traces in red are on the top side of the board. The circles with crosses in the four corners of the board are mounting holes pre-drilled in the board. If you decide to build the boards yourself, make sure you follow the orientation of IC1, IC2 and C1. You'll also want to have the holes for the wires on P1 and P2 face out from the board. Note that the pins for the inputs and outputs are labeled directly on the board.



yellow LED. The home input being high (same situation as above) will turn off the red LED.

This is the base state when there is nothing detected in either the home or distant block.

Now if the distant input goes low (something detected in the distant block), it will force IC1, pin 3 high, which will turn off the green LED. Since pin 3 is high, pin 4 will also be high and that, along with pin 5 being high, which will *turn on* the yellow LED.

Finally, if the home input is low (something detected in the home block) it will force both the green and yellow LED's to off and will illuminate the red LED.

The resistor values are listed as 1K ohms, but you may need to adjust these values based on what LEDs are used in your signals. Note that the east and west sections of the board are completely independent of each other.

You can order assembled and tested boards directly from *Model Railroad Control Systems* [[modelrailroadcontrolsystems.com/dual-abs-signal-controller](http://modelrailroadcontrolsystems.com/dual-abs-signal-controller)]. You'll also need to specify if you want the standard 1k resistors or a different value. The bare boards come direct from MRCS in the US, while the assembled boards come from China and generally take longer to get.

## Build it yourself

You can also build this circuit yourself on a breadboard, or you can take my PC board files and order the bare board directly from any PC board fabrication house [7]. Refer to PC board for Model Railroaders article in the December 2017 *MRH*.

All you need to order the bare boards are a set of Gerber files which can be downloaded as an *MRH* subscriber extra.

You can find a large number of PCB providers by searching online for “prototype PCB fabrication.” Some of the fabrication houses include Sseed Studios, OSH Park, ExpressPCB, Advanced Circuits, PCBWAY, or FX Circuits.

To order the boards, go to the website of the respective company and upload the Gerber files. You’ll then be given a quote based on the number of boards you need.

Note that most of these companies are in China, so shipping times can be several weeks unless you’re willing to pay extra for expedited shipping. You’ll also need to order the components that are mounted on the boards. A detailed parts list and step-by-step instructions for building the board is included in this month’s subscriber extras.

## Other components needed

There are several components you must provide besides the DABS boards.

The first is a power supply for the system. It’s recommended you purchase one 5V regulated supply for your system, and you dedicate it to only providing power to the signal system.

Each board only draws about 2-3 milliamps of current, but when you add the current drawn by the LEDs and block detectors, it’s best to figure 50 milliamps per board. This is the worst-case load, but by allowing for that much current draw you will not overload the power supply.

This means is that for every 20 signal boards, you need one amp of current from your supply. You can buy 5V regulated supplies from several vendors, but make sure you purchase a good quality regulated supply and that you use good bus wiring practices when hooking up the boards. In particular, make sure the +5V and ground are connected to the correct pins on P1.



Next you'll need to provide is the wiring to connect the boards to each other. In actual installations, a CAT-5 Ethernet cable has worked quite well for connecting the boards to each other as well as connecting the boards to the signals.

Use a heavier set of wires (12-14 gauge) for the power and ground connections. Note that you don't need to run the heavy wires directly to the boards.

It's best to run the bus wires to a terminal block, then use smaller wire between the terminal block and the board [8].

## Train detection

Next let's talk about how a train is detected. Whichever current detector you choose, there will need to be track current passing through the detector to tell the signal system a train is present.

Locomotives are detected automatically because the motor and decoder always pass some current when on the rails, but in order to have cars detected takes some extra work.

If you have lighted cabooses or passenger cars, these also will be automatically detected. But what about freight cars or unlit cars?

These cars need resistors added to the wheels. Doing a Google search or looking on YouTube will show you many techniques for installing these resistors.

Alternatively, you can buy resistor wheelsets from several vendors (Google “resistor wheelsets HO” for example). With resistor wheelsets (two per car is generally enough) on your cars, even a single car in a block will trigger the signals, just like the prototype.

For more on making your own resistor wheel sets, see the MRH subscriber bonus downloads.



## And then the signals

Finally you'll need the signals themselves.

Note: Purchase only signals wired as common-anode devices.

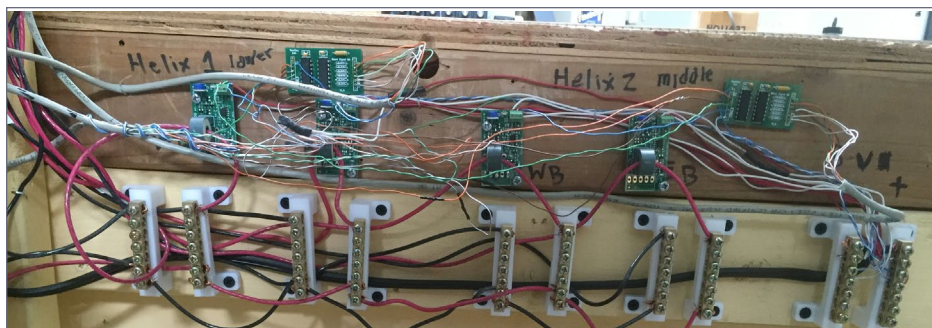

8. Here is one method showing how the SCBs, detector boards and bus connections can be made. At the top of the image you'll see two SCB boards (these are an earlier version without the screw connectors and are mounted to the benchwork with double-sided tape). Since the signals selected by this layout owner came pre-wired with resistors, there are wire jumpers instead of resistors on these SCBs.

Below the SCBs are four cp0D detector boards. You'll see the red wire from each DCC block feeding through the donut on the detector boards. Below the detector boards are the bus bars this particular layout owner uses to wire up his DCC bus, but if you look closely at the bus bars on the right side of the photo, you'll notice the +5V and ground connections for the signal system.

The detector boards also get power from the same power supply as the signal boards. A dedicated power supply is being used for the signal system. You can also see the gray CAT-5 cable used to connect SCBs to each other as well as connecting the SCBs to the signals. *Photo by Lenny Wyatt, used with permission*

Almost all signals sold today are wired this way, but if you're in doubt ask the signal provider before ordering. Also note this signal system does not support interlocking, CTC, APB, or diverging aspects – it is just a straight Automatic Block Signal (ABS) system.

For an example of commercial signals you can install and use with this system, see the next article on BLMA/Atlas signals. For this system, the easiest is to use their single-head search-light signals.

I hope this article has shown you just how simple it can be to install a fully functional signal system on your layout without using any computers or requiring you to do any programming.

## DENNIS DRURY



Dennis recently retired from GE as an electrical engineer – he and his wife have since enjoyed traveling the country in their RV.

They have purchased a new home where Dennis once again has a train room. He is building his version of the SP and BN railroads as they ran from Klamath Falls to Chemult in Oregon.

In early adulthood, Dennis spent seven years working for the Southern Pacific in the signaling and engineering departments. After that, Dennis spent 11 months working for Morrison Knudsen in Colombia, South America, building a railroad.

Dennis has installed signal systems on the large model railroads of three friends and plans to install a signal system on his own railroad. ■

The resulting signals implement prototype-based ABS signaling used by real railroads.

To see this system in operation, check out the video below.

I look forward to hearing from any of you who decide to take the plunge, or if you have any questions. Just use the yellow feedback button to post on the MRH forum any comments or questions you have. See you online!

**VIEW READER  
COMMENTS**

*click here*



**REMEMBER  
THE BONUS  
EXTRAS!**

Remember to check the [bonus extras](#) for the MRH signaling roundup. Dennis shows you how to build a DABS circuit for yourself!

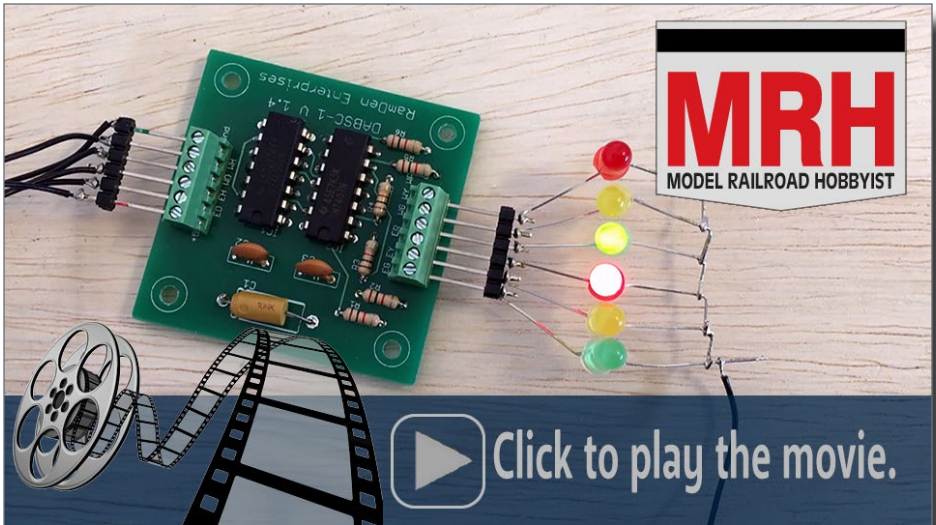

Playback problems? [Click here ...](#)





# MODIFYING BLMA SIGNAL MASTS TO BE REMOVABLE

STEP  
by  
STEP  
1-2-3

**Lead: BLMA signals modified to just plug in using a DIP plug.**

**FOLLOW ALONG AS LARRY SEBELLEY MAKES EASILY  
REMOVABLE SIGNALS STEP-BY-STEP ...**

**THE CLOSEST THING I HAVE FOUND TO HO SCALE**

Canadian-style target signals from a commercial manufacturer are those by BLMA Models.

BLMA recently sold its signal division to Atlas Model Railroad Company. However, I confirmed with Atlas that they intend to keep making and distributing the BLMA signal masts for the foreseeable future.

Although the BLMA signals are very detailed, they also are quite fragile. The joint between the electrical cabinet and the vertical mast is particularly subject to breakage from the slightest bump.

On a Free-mo module, the signal masts often get placed near the end of the module. During layout setup and knockdown, it is extremely easy to damage them.



# MODIFY A BLMA SIGNAL MAST | 20

To avoid damage, I developed a method of making the signal masts easily detachable. This creates the dual benefit of avoiding damage, and also allows for easy change-out should damage occur to the signal mast.

The conversion entails installing an 8-pin socket on the module deck where a signal mast is to stand, plus converting the signal mast bottom to hold a matching 8-pin plug.

These instructions cover the conversion of a two-head mast. A single-head mast can be converted in the same manner by following the instructions for the upper head only.

Let's get started!

## ADVERTISEMENT

Make LocoNet wiring extremely simple!

**ACCU-LITES, inc**

Your DCC Center!

Dealer Inquiries Accepted



**PM42**  
breakout  
board



**BDL168**  
Multi-zone  
breakout board

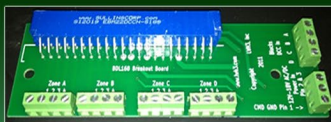

**SE8C**  
breakout  
board



**BDL168**  
Single-zone  
breakout board



Now Offering SNAPS! in packs of 6 or 12 pieces! [CLICK TO LEARN MORE ...](#)

• [INDEX](#)



**SUBSCRIBE**  
(free)

• [TABLE OF CONTENTS](#)

## STEP 1: PREPARE A MODULE SOCKET

Here are the steps needed to prepare a module socket for a single two-head signal mast.

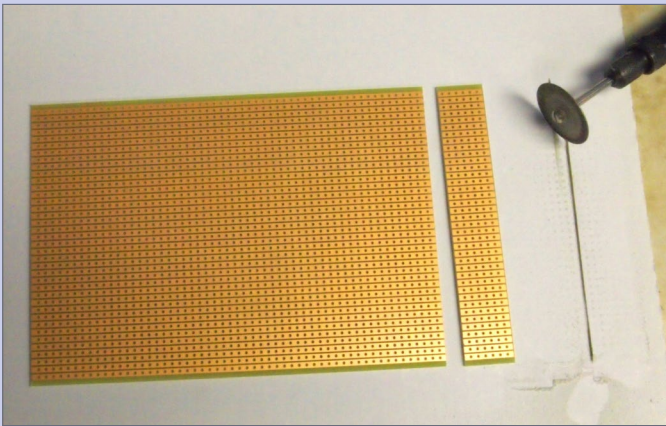

**1. Cut a strip of perf board six holes wide. Use of a Dremel cutting wheel is recommended.**

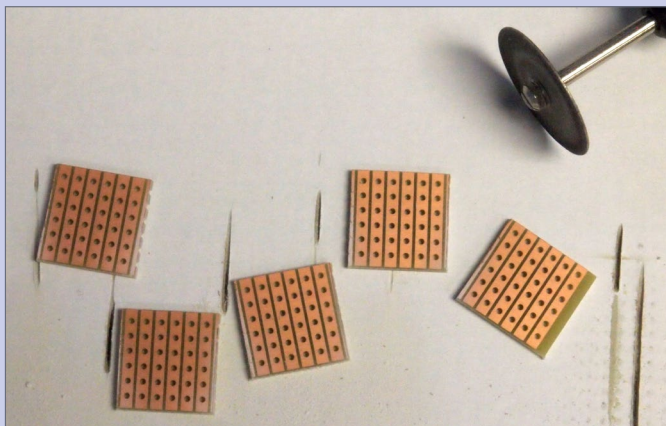

**2. Cut the perf board strips into squares of six holes long.**

## CONTINUED ... STEP 1: PREPARE A MODULE SOCKET

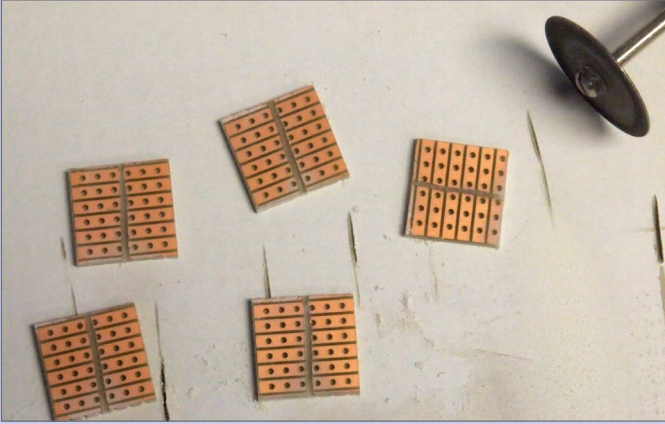

**3. Slice a groove in the center only through the metal to insulate the holes across the perf board squares.**

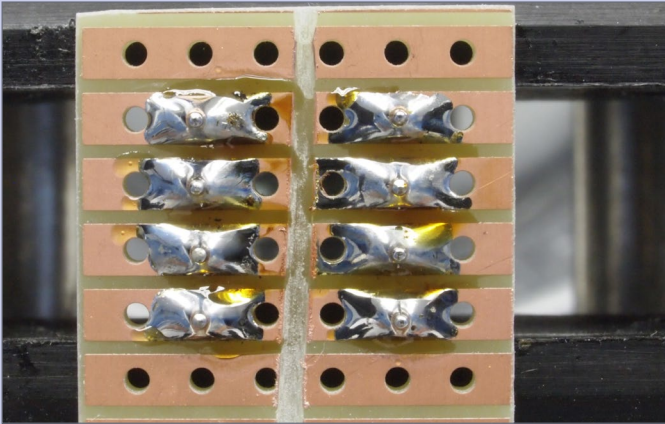

**4. Insert a DIP socket in the center of the perf board square from the fiberglass side, straddling the insulating groove, so the socket legs appear on the metal side of the perf board square. Solder all eight socket legs to the perf board square.**

**CONTINUED ... STEP 1: PREPARE A MODULE SOCKET**

***DIP SOCKET***  
***(from above)***

Upper  
Aspect

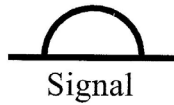

Lower  
Aspect

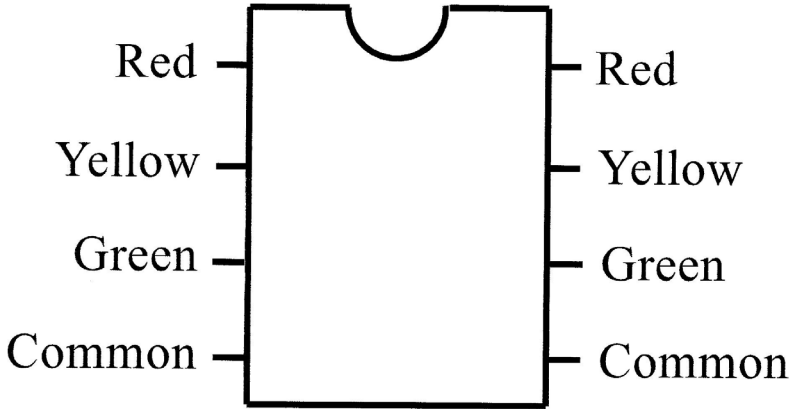

**5. Strip the red, yellow, green, and orange wires from the middle of the 10-conductor ribbon cable that comes with the signals. You will not need the other colors for this project – save them for use elsewhere. Refer to the drawing for the wire locations.**



## CONTINUED ... STEP 1: PREPARE A MODULE SOCKET

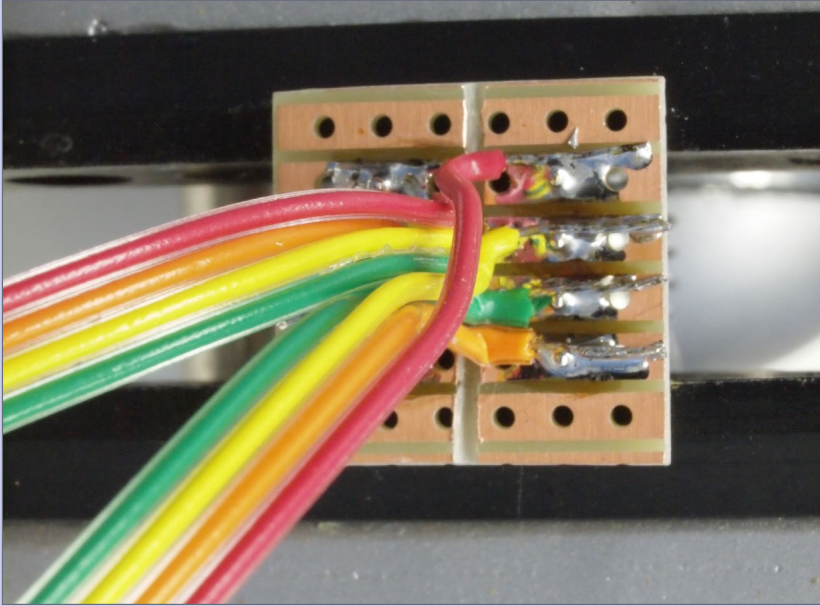

### 6. Wires soldered to the perf board as indicated in the text.

Solder the four wires to the underside of the perf board for the Upper connections [6]. The orange wire will be the Common+. Likewise, solder the four wires to the underside of the perf board for the Lower connections. The orange wire is likewise the Common+ here.

Test the conductivity of the eight wire connections with a multimeter set to measure resistance to ensure there are no short circuits. Drill a ¼" hole through the layout deck where the signal mast is to be installed.

## **CONTINUED ... STEP 1: PREPARE A MODULE SOCKET**



### **7. Perf board placed on the layout as indicated in the text.**

Glue the underside of the perf board square to the layout deck with epoxy [7].

Cut the wires to a suitable length to reach the signal driver board. Strip and attach the eight wires to the signal driver board according to its instructions.

## STEP 2: MODIFY THE SIGNAL MAST

Now that you have done the module socket, let's modify the two-head signal mast itself.



**8. Carefully remove the BLMA signal mast from its packaging.**

## CONTINUED ... STEP 2: MODIFY THE SIGNAL MAST

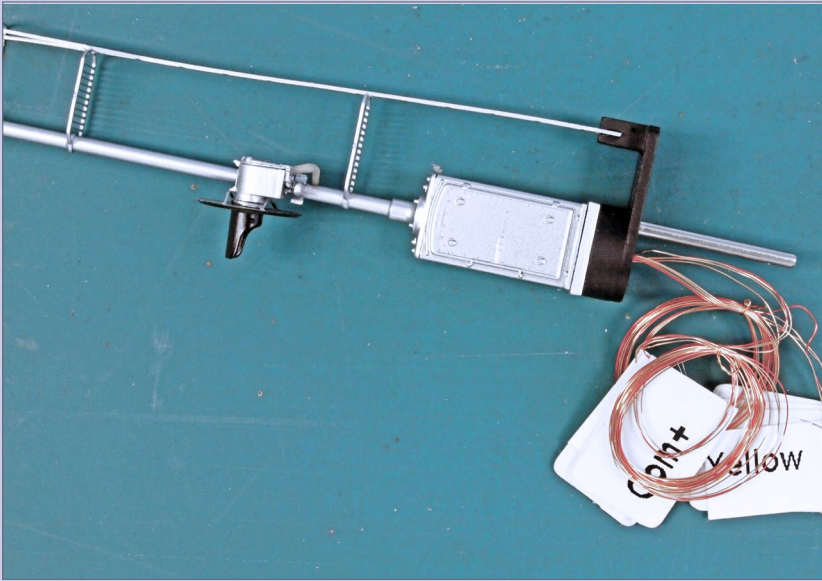

### 9. Here is the signal mast, removed from the packaging.

With pliers, pull out the metal mounting pin from the bottom of the signal mast, and dispose of it – it is not required for this project.

Untwist the tie-up wire from the longer loop of wires. Some may need to be untwisted right-handed, others left-handed. This longer set of wires is the set of four wires for the lower signal head. Unbraid the wires to separate all four wires from each other all the way up to the mast's base.

I use “Craftsmart” paint pens from Michaels to color the wires according to the tags affixed to the ends of the wires (red, yellow, green). I leave the Common+ (red) wire unpainted. Once you have the wires colored, dispose of the printed tags.



## **CONTINUED ... STEP 2: MODIFY THE SIGNAL MAST**

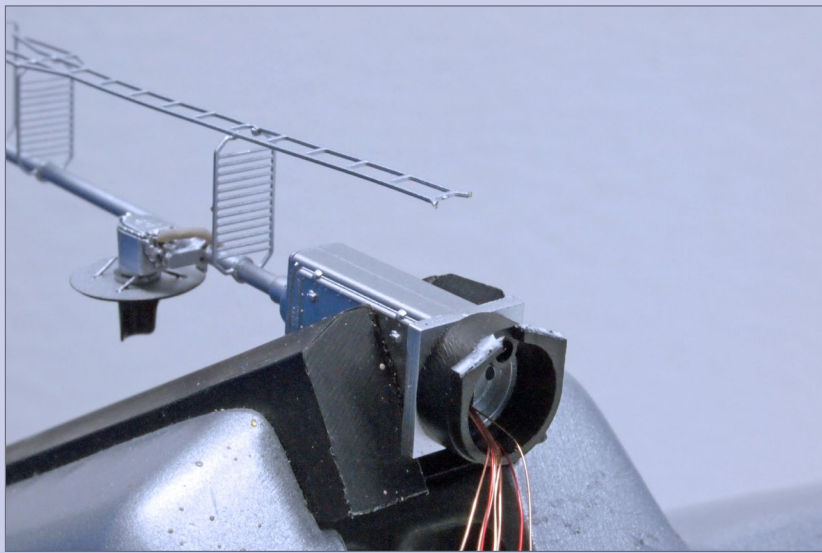

**10. Here is the signal mast, with the black plastic ladder support removed. Next we want to cut off the black plastic ring without damaging the wires.**

Group the wires near the ends to a piece of Scotch tape and mark the tape with an “L” for lower signal head.

Repeat the process for the shorter loop of wires – these are for the upper signal head. Mark the tape on this set of wires with a “U” for upper signal head.

With a fine diagonal cutter, snip the two black plastic ladder legs on each side of the ladder base support and remove it [10].

## CONTINUED ... STEP 2: MODIFY THE SIGNAL MAST

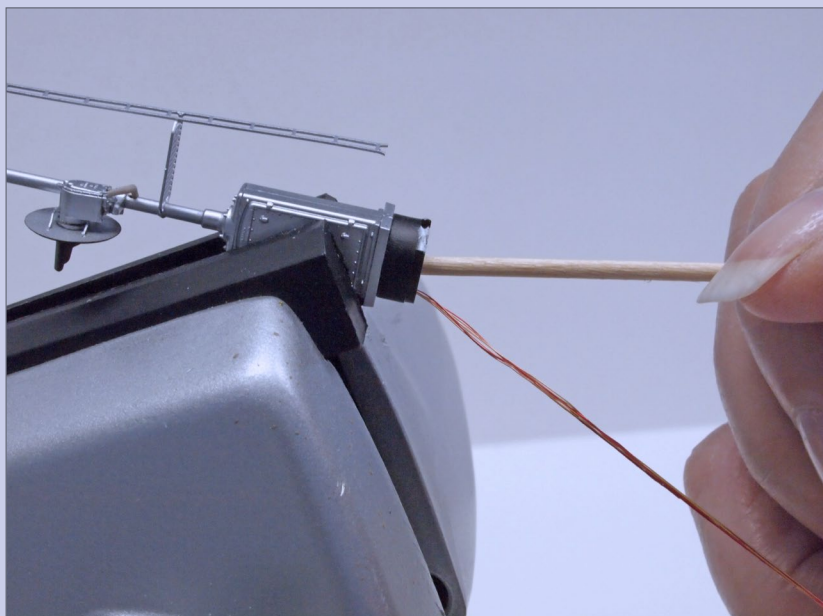

**11. Here is the signal electrical cabinet, clamped in a Panavise. My wife is inserting a toothpick into the center to protect the wires from harm while I cut through the black base ring.**

This is the most critical step - *use extreme caution* or you can destroy your signal mast!

Clamp the signal's electrical cabinet into a Panavise or other stable holder. Having an assistant to hold the wires and watch for straying saw teeth is very helpful. Also, using a round toothpick between the saw and wires provides an extra measure of safety to avoid cutting off any wires [11].

## CONTINUED ... STEP 2: MODIFY THE SIGNAL MAST

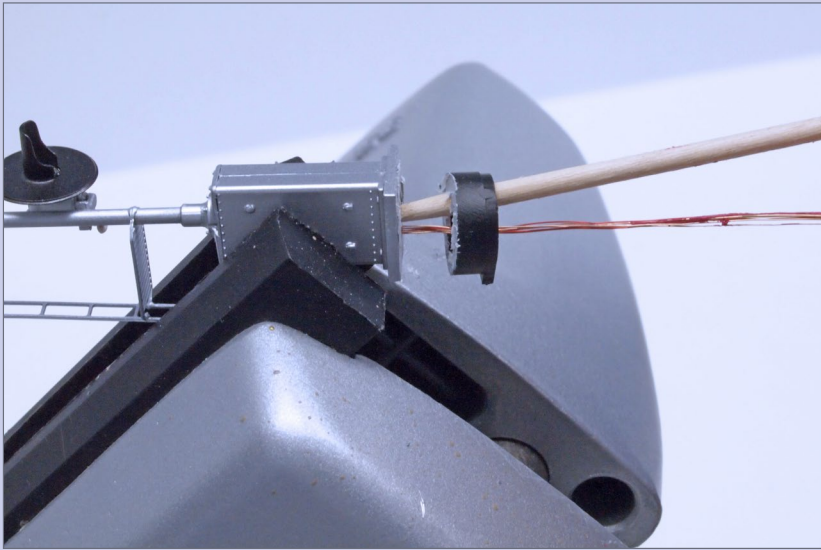

**12. Once I'm about halfway around the black base ring, I flip the signal over in the Panavise and finish cutting through until the black base ring comes completely off. Take care to not nick or cut off any wires!**

Use a fine-tooth saw to slowly and carefully to cut halfway around the black plastic base perimeter at the bottom of the silver base. You want to just cut through the perimeter black plastic around the outside, and avoid touching any of the wires in the middle.

Rotate the electrical cabinet in the Panavise and carefully finish sawing all the way around the black plastic base perimeter until it falls off the silver base [12].



## CONTINUED ... STEP 2: MODIFY THE SIGNAL MAST

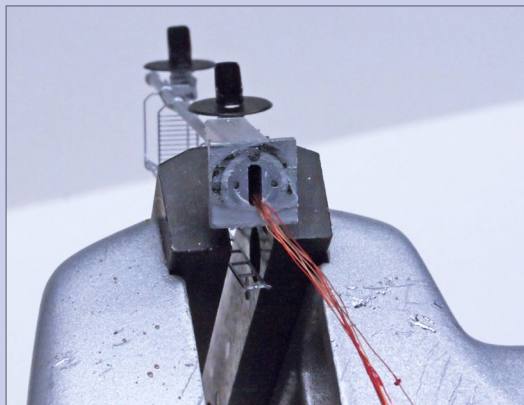

**13. Here is the bottom of the signal with all traces of the black bottom ring removed.**

Clean away any leftover bumps from the black ring on the bottom of the electrical cabinet, and smooth it out using a scalpel or X-Acto knife [13].

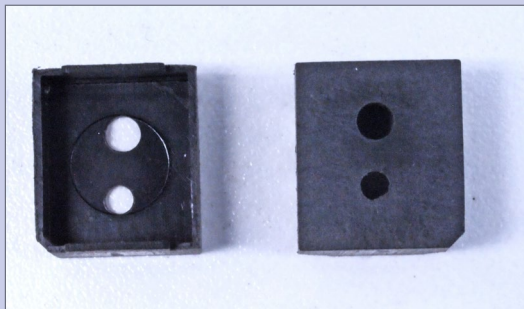

**14. Here is the header cover with the two holes drilled in it and sanded smooth.**

Next, prepare a header cover. Drill two #43 holes in the cover from the inside, to be located at the front and rear of the molded-in circle.

Sand the top of the cover completely smooth. Finally, lightly sand all the four sides of the cover to improve paint adhesion [14].



## CONTINUED ... STEP 2: MODIFY THE SIGNAL MAST

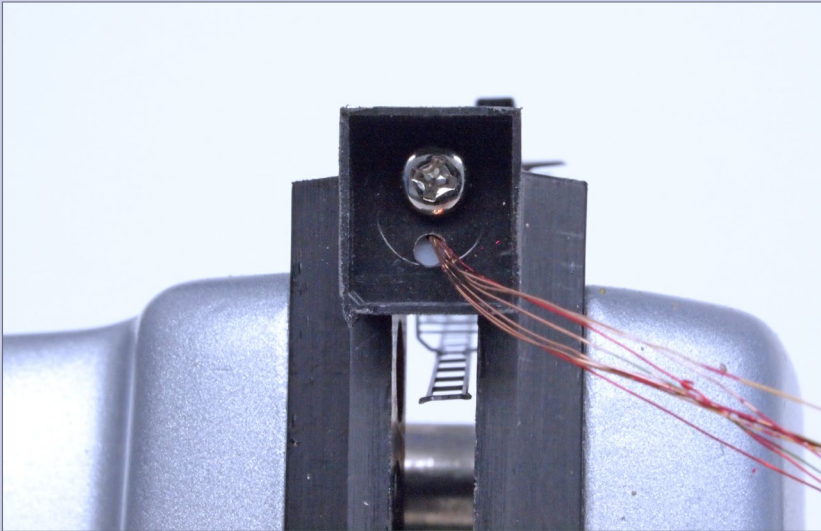

**15. Header cover with the eight wires fed through the bottom hole and the signal mast screwed to the top hole with a 2-56 screw.**

Remove the Scotch tape from the upper (U) signal wires and feed the four upper signal wires through the bottom hole in the cover. attach more Scotch tape and relabel it “U.”

Do the same thing with the four lower signal wires, feeding them through the same hole and attaching more Scotch tape and relabeling it “L”.

Carefully insert a #2-56 x ¼” machine screw up through the top empty hole in the cover into the tapped hole in the bottom of the signal mast. Ensure the eight signal wires do not get pinched between the cover and the bottom of the signal mast [15].

**CONTINUED ... STEP 2: MODIFY THE SIGNAL MAST**

***DIP HEADER  
(from above)***

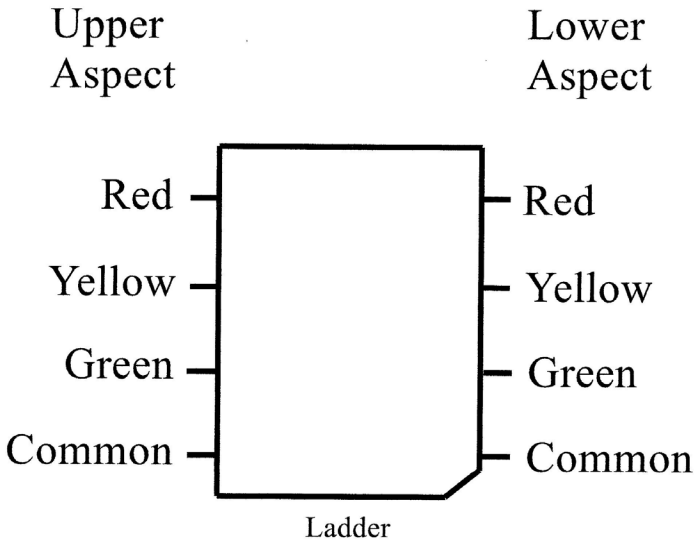

**16. Orient the DIP header so the commons are on the ladder side of the signal.**

Next, attach the eight signal wires to the DIP Header. See the DIP header drawing [16] for the wire locations. One at a time, solder the red, yellow, green, and common upper signal wires to the left-hand row of pins on the DIP header [17] using this process:

1. Make the distance as short as possible between the signal mast and the header – about 1” long.

## CONTINUED ... STEP 2: MODIFY THE SIGNAL MAST

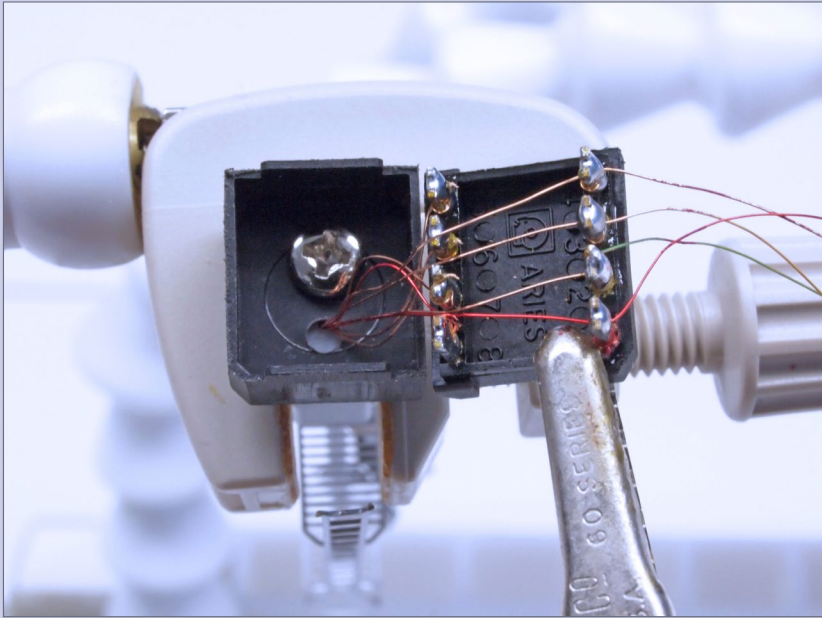

### 17. The wires all soldered to the DIP header.

2. One at a time, wrap each wire around its header pin per the diagram and leave the wires long for now.
3. Use rosin-core electronic solder. No separate flux is necessary. Ensure the solder melts through the wire's insulating varnish to make contact with the header pin.
4. Then test the connectivity of the four wires.
5. Once everything tests good, trim the excess wire. For the four lower signal head wires, follow the same steps, but solder them to the righthand row of pins on the DIP header [17].

## CONTINUED ... STEP 2: MODIFY THE SIGNAL MAST



**18. Finished DIP plug base on the signal, snapped together and ready for final testing.**

Once you're done, tuck the eight wires into the header cover, then snap the cover and header together.



## CONTINUED ... STEP 2: MODIFY THE SIGNAL MAST

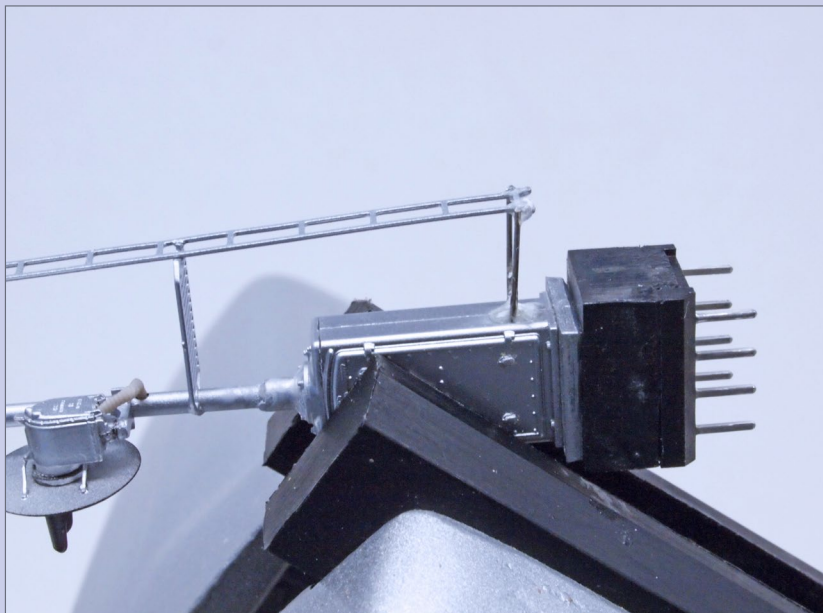

### 19. Adding an extra ladder support per the text.

Test both signal heads to ensure that the LEDs light red, yellow, and green as expected. Apply thin CA to the joint between the signal mast base and the cover. Also apply thin CA to the joint between the cover and the DIP header.

Next, make an extra ladder support. Bend a squared U-shape from 0.015" wire (stainless steel or brass). Cut the legs to 7mm (0.28") long and glue the support to the ladder and cabinet rear with CA. Finish by painting the support flat aluminum [19].

## CONTINUED ... STEP 2: MODIFY THE SIGNAL MAST

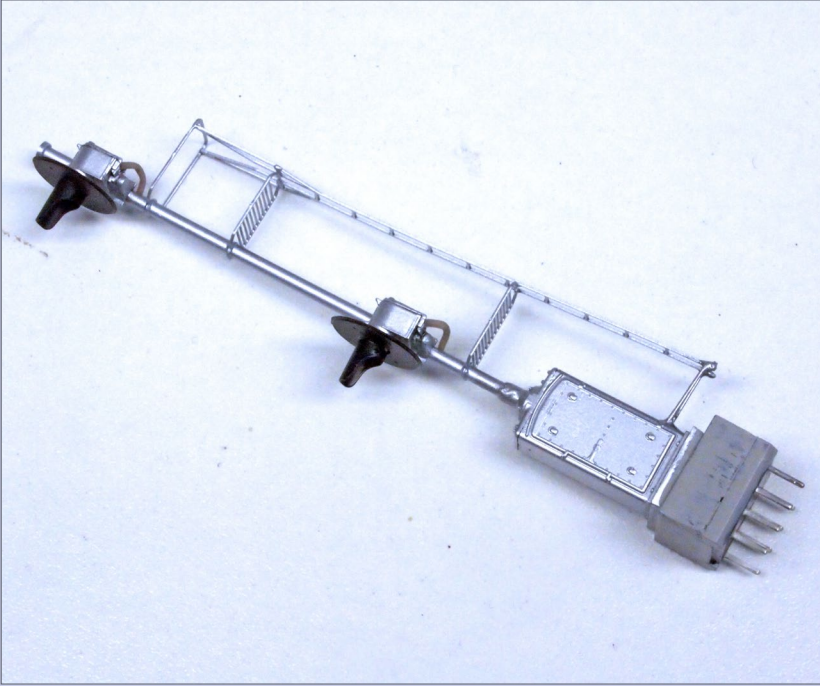

**20. The finished signal, with the DIP plug base painted concrete.**

Finally, paint the cover and header with a concrete-color paint [20].

## CONTINUED ... STEP 2: MODIFY THE SIGNAL MAST



**21. Plugging the finished signal mast into the DIP layout socket.**



**22. And here it is, all plugged-in and ready for use.**

That's it! Insert the newly constructed signal mast into its layout socket and enjoy the fruits of your labors [21, 22].

Now your engineers will know how to proceed when they see a working signal ahead!





**23. The finished signal, ready to tell your engineers how to proceed.**





## BILL OF MATERIALS

BLMA	#4050 Dual Head Signal
PC Stripboard	BPS Part #ST3U or equivalent
10-conductor Ribbon Cable	3M 3302/40 300 SF or equivalent
8 Position DIP Socket	Aries 08-3518-10
8 Pin DIP Header	Aries 08-600-10
8 Pin Cover	Aries 08-650-10
Paint Pens	Craftsmart: red, yellow, and green



### REMEMBER THE BONUS EXTRAS!

Remember to check the bonus extras for the MRH signaling roundup. There are some nice goodies that we could not fit into this issue!

### VIEW READER COMMENTS

*click here*



*click here*

**THERE'S MORE!**

**Check out the  
Subscriber  
bonus extras**

## LARRY SEBELLEY



Larry lives in Chilliwack, BC with his wife, Lori. They are both retired, but very active in the Coldslop Free-mo group, building, displaying, and operating Free-mo modules.

They had a fledgling interest in model railroading in their 20s, but then along came the usual family and work constraints. Sometime in the late 1990s, they attended an event in Salmon Arm and their

interest was rekindled.

They joined the Chilliwack Model Railway Club and constructed two N scale modules, developing their modeling skills. After a while, they learned about the Free-mo concept and were sold on it.

They have participated with the Coldslop Free-mo group to build the core group modules and also have built seven of their own modules.

Both the group and the Sebelleys have participated in many Free-mo events locally and at three NMRA National Train Shows (Anaheim, Sacramento, and Portland).

They hope to expand to even more Free-mo events on the continent, and join in the fun with other like-minded individuals. ■



**RATE THIS ARTICLE**



# From first train set to railroad empire...

*Our complete line of DCC products  
grows with you. Discover the fun!*

- Designed and manufactured in the U.S.A.
- Preferred for ease of use and ergonomic design
- Unlimited scalability for any size model railroad
- Plug-and-play means more time running trains
- Great customer service and excellent support



## See your dealer





## Visit our new and improved web site for all your DCC needs!

- Get the latest new product announcements
- Watch our detailed how-to videos
- Browse the all-new Information Station
- Enjoy secure online sales, day or night!

Visit **ncedcc.com**



• [INDEX](#)



SUBSCRIBE  
(free)

• [TABLE OF CONTENTS](#)

# TOOL SHED



## THE OSCILLATING MULTI-TOOL FOR LAYOUT CONSTRUCTION

Model Railroad Hobbyist | January 2018 | #95



RATE THIS ARTICLE

**BRIAN LARSEN** demonstrates a versatile tool that fills the gap between a motor tool for fine work and heavier-duty power tools ...

I WAS READING A MODELING ARTICLE ABOUT REMOVING some finished scenery and replacing it with an industry. The photo showed the author cutting out the old scenery out with a coarse keyhole saw.

I suddenly had a lightbulb moment – this task would be *so much easier* with a Dremel Multi-Max! This style of oscillating multi-tool

• [INDEX](#)

• [TABLE OF CONTENTS](#)

is available in other brands beside Dremel. Search for “oscillating multi-tool” on Google and find versions of this tool from Rockwell, Fein, Craftsman, Black & Decker, Makita, Dewalt, Bosch, Milwaukee, WEN, and Rigid, to name most of the vendors.

As a journeyman carpenter by trade, I have collected my fair share of tools. One of my latest purchases is the Dremel Multi-Max [1]. It is one of those tools that, the longer you have it, the more applications you find for it. This tool can make clean, square, and precise cuts in multiple materials.

What exactly is a Dremel Multi-Max? It is a handheld oscillating power tool that can saw, sand, rasp, grind, and scrape. The oscillating multi-tool appeared on the market around 2010, and fills the gap between the motor tool we're familiar with, for fine shaping work, and heavier power tools used for ordinary construction projects. The multi-tool comes in corded and cordless models.

The first oscillating power tool was built by Fein in 1967 as a plaster cast saw. Then they built the first power tool for the public in 1986 (these facts can be found by googling Fein history). It took quite a few years before this tool became popular.

It works simply by oscillating the head back-and-forth. Because the oscillation is so slight, you have a lot of control with the tool. But that slight movement doesn't make this tool a wimp! It is surprisingly powerful – it's just quite *different* from the way conventional cutting tools or saws work.

I first purchased the Dremel Multi-Max to undercut all the door-frames in my house so that I could install engineered hardwood flooring. It did a great job but I did go through a few blades.

The Dremel comes with two offset saw blades that are great for getting into tight places [2]. One is for wood and the other is for



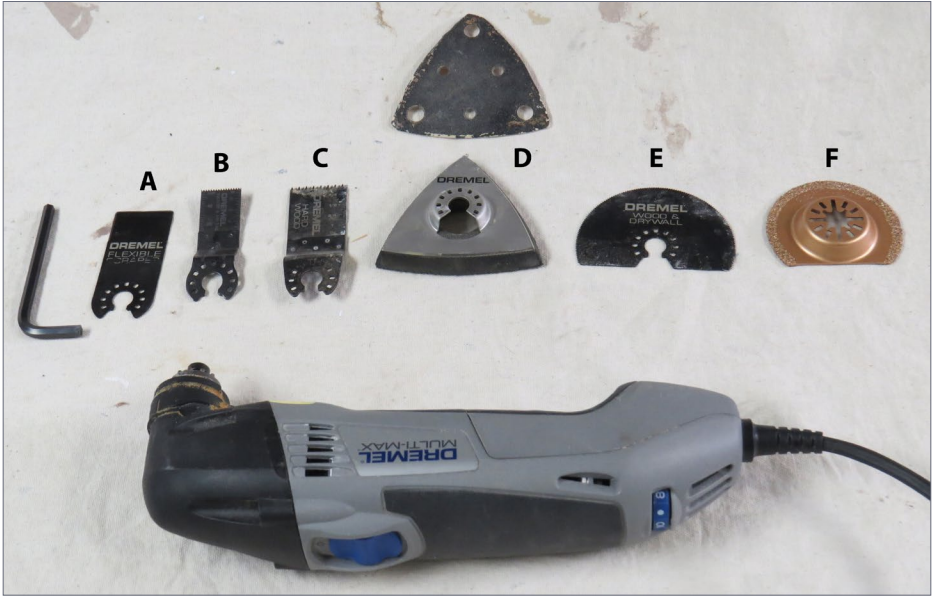

1. Here is the author's Dremel Multi-Max tool with attachments. From left to right: A) Flexible scraper; B) Wood & metal cutting blade; C) Wood cutting blade; D) Sanding attachment and sandpaper; E) Half-moon drywall and wood blade; F) Grinding attachment, purchased separately.

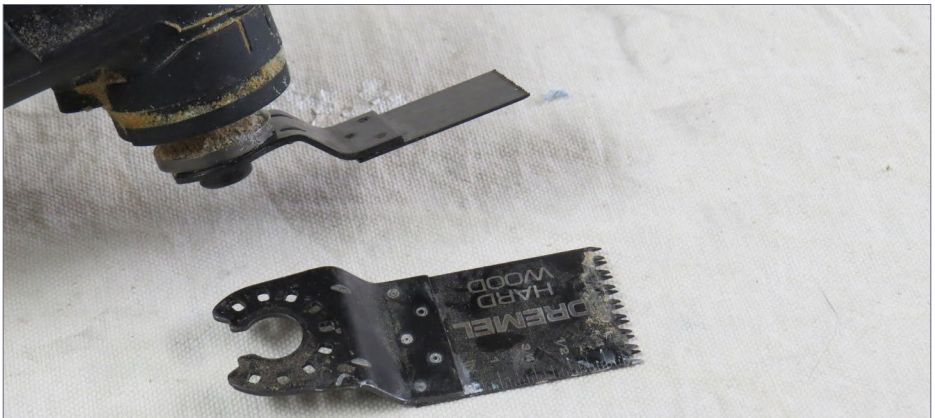

2. Both the wood blade on the tool and the wood & metal offset blade shown below the tool lets you cut flush to a surface.





**3. Meet Atticus, terrorizer of train layouts. He has met his match, however, thanks to my handy multi-tool!**

wood and metal cutting. There is also a half-moon blade, flexible scraper and hook-loop sanding pad with six Velcro sandpaper sheets [1].

My 18”x 60” N scale switching layout didn’t need any modification, so I put together a sample diorama to showcase things you can do with the Multi-Max.

I used cardboard strips and plaster-soaked paper towel for the diorama scenery. I was going to have tracks running down the middle of the scene but my cat [3] did his Godzilla imitation and crushed part of the upper half (sigh). This is why part of the diorama is still unfinished – blame the cat!

The photos and video show using the Multi-Max to cut out a section of scenery.



4. Starting with just a corner of the blade to make a plunge cut into the scenery.



5. The finished hole, with remarkably clean and straight edges.

First, I took a ruler and marked a square area with a Sharpie to show how easy the tool is to control. I start the tool and apply a corner of the blade first to start the plunge cut [4]. As you can see, the tool is very easy to control. The blade cuts so cleanly that the piece that was removed has square smooth edges [5].



6. Here is a great example of the flush-cutting capabilities of the tool.



7. The tool's unique blade attachment system allows almost unlimited angles for attaching blades. This is fantastic for tight spaces.



The tool is great for flush cutting, as seen in the photo of the riser being cut [6]. The blade can be attached to the tool at

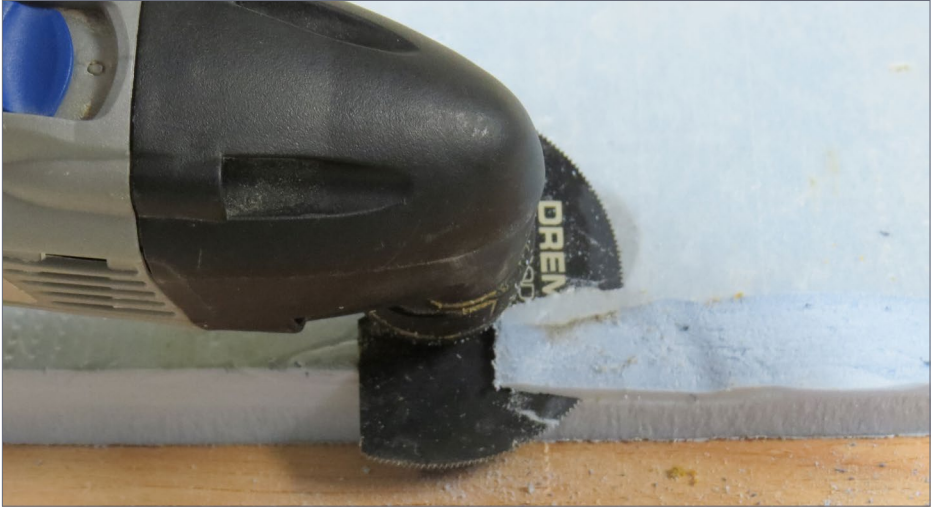

8. The half-moon blade can be used for shaping foam board.

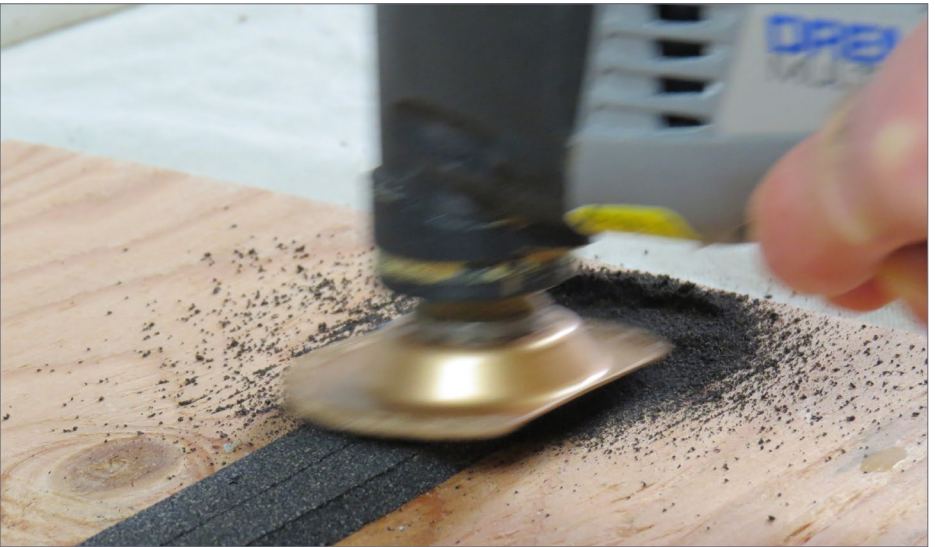

9. The grinding attachment makes short work of tapering cork road bed.



various angles for working in tight positions [7]. The half-moon blade, along with the straight blade, can be used to rough-shape foam board [8].

The grinding attachment, which was purchased separately, works well for shaping foam board and also for tapering cork roadbed [9, 10].



10. The grinding attachment is touted as being for tile grout removal, so you will get a lot of roadbed tapered before it wears out!



11. Run out of sandpaper for your multi-tool? No problem – just cut pieces from your orbital sander pads.

With the sanding pad, you can smooth imperfections on track underlayment, roadways, and parking lots. The hook-loop back makes changing between sanding grits quick and easy.



12. The flexible scraper works great for lifting cork roadbed.



13. Here is the coping blade attachment.

If you run out of sandpaper, you can always just cut pieces out of orbital sanding pads [11]. This trick has saved me a trip to the hardware store.

The flexible scraper blade really surprised me as to how well it worked [12]. Not only did it remove the glued cork roadbed easily, a second pass with the scraper lifted 90% of the glue residue!

Lastly, the multi flex attachment [13] made by Dremel is basically a coping saw. The spiral blades let you cut from any angle or direction. The spiral blades are just a super-fine blade that has been twisted into a spiral [14]. This works well for shaping foam scenery, for example.

If you haven't added a multi-tool as part of your layout construction tool arsenal, you should get one. Once you do, you'll wonder how you ever did without it!



Playback problems? [Click here ...](#)

15. Here is a video showing the Dremel Multi-Max in use for various layout construction tasks.

## BRIAN LARSEN



As a child, Brian's parents took him to their homeland of Denmark, where the train stations had model railways under glass that could be activated with a coin. He emptied his father's pockets watching those trains!

Later, at age 12 back in Canada, Brian discovered magazines about model trains. Inspired by what he was reading, Brian built a 4X8 lay-

out that was mostly track and cheap street lights – scenery never really happened.

After time passing with school, work, marriage, and starting a family, Brian found his interest rekindled when he began borrowing model train magazines from his library. His youngest son, then age 10, asked his dad why he didn't build a railroad instead of just reading about them!

So together they built an 18" X 60" N scale switching layout. Brian's ultimate plan when he retires is to have a dedicated train room in the basement.

Brian's family now consists of his wife, two sons, and a cat. He is a journeyman carpenter by trade. His other hobbies are fishing, camping, and building custom furniture. ■



**RATE THIS ARTICLE**



# TONY'S TRAIN XCHANGE

*Committed to your DCC support!*

## CMX Cleaner Car



Superior, All-Brass  
Build Quality, Super  
Easy To Use & Cleans  
Exceptionally Well!

N, HO, S, O, & G Scales

Starting at \$149.95

[Order Yours](#)

## NCE DCC Systems Super Sale!



Get a great  
price on all  
NCE DCC  
Starter Systems

[Order Yours](#)

**Find Us At The Amherst  
Train Show, Jan. 27th - 28th**

Call to place your orders now  
for pick up at the Big-E show!

## Rapido HO Scale Budd RDC 2nd Run!



Pre-Order  
Deadline Feb 9, 2018

RDC-1, RDC-2 & RDC-3 Units  
Available in 19 Road Names  
DC or ESU LokSound Equipped

Starting at \$186.95

[Order Yours](#)

**Do you need a Sound or  
DCC Installation done?**

[Get a quote!](#)



Providing unmatched person to person  
DCC support for more than 25 years, the  
kind of service that has made us #1 in DCC.  
**DCC questions? CALL US! 1-800-978-3472**

*We'll get you on the right track!*

Jan 2018



• [INDEX](#)



[SUBSCRIBE](#)  
(free)

• [TABLE OF CONTENTS](#)



# NOON AT GLEN GREEN

Model Railroad Hobbyist | January 2018 | #95



RATE THIS ARTICLE

**KARL-HANS KOCH** ADD LIFE AND INTEREST TO A  
LAYOUT WITH VIGNETTES ...

**THIS IS A SHORT STORY OF A WARM SUMMER NOONTIME**  
at Glen Green, a fairly unknown station on the Norfolk &  
Virginia Eastern.

Let's get out our hypothetical drone and camera, then time travel  
back into the 1970s. We'll send up our time travelling drone to fly  
around and see what's going on near the N&VE railroad on this  
summer day in the past ...

• [INDEX](#)

• [TABLE OF CONTENTS](#)



1. After launching the drone and looking around, we see a local freight has just arrived with an almost-new GE U30CG, a test unit leased from the Santa Fe. After the merger of Norfolk & Western and Virginian to the Norfolk & Virginia Eastern, there is a lack of modern motive power.



### WHY WE LOVE THIS ARTICLE

Scenes on your layout are so much more fun when they tell a story. Karl-Hans has done a great job making his scenes do just that!

**VIEW READER  
COMMENTS**

*click here*







2. In this overhead drone view, we see number 405 is carefully switching the short local through the station tracks. Apparently the station agent has given clear orders on where to put the cars?





3. While the 405 is switching, we see travelers awaiting their local passenger train in the sunshine. Near the roof overhang, there is an officer standing discussing something with another person hidden behind him.



4. Flying the drone around to the front of the station, it looks like the officer may be discussing a burglary which occurred in the night. If you look closely, you can see the broken glass of the station window.



5. We turn the drone to see what else is going on around the freight house. Looks like one of the workers rolled his hand-cart over the edge of the loading ramp and the flour sack burst open onto the road! He doesn't look too happy ...



6. We fly the drone farther up to get an overview of the broken flour sack scene. The freight house needs a new roof and the house workers have put up a scaffolding to make working safe. In front of the building, we see a dump truck standing with an open door ...





7. Zooming in on the dump truck, it looks empty. We surmise the driver needs to get back into the truck from the passenger side because he parked too close to the scaffolding!



8. Flying the drone on past the freight house gives us another view of the whole freight house scene. From this angle we can clearly see the dump truck load next to the freight house.



9. We fly back past the freight house the other direction with the drone and see 405 has moved a gondola to the truck loading area, but will this be the last place? Is the station master still looking for his paperwork? On the right we see some track workers leaving their VW bus. We'll catch up with them in [14].



10. Flying the drone on around to the other side of the freight house, we can now see the location of the freight house as compared to the station. An empty 50-foot boxcar and a 40-foot reefer stand in the sun, waiting to be moved. But where has 405 gone?



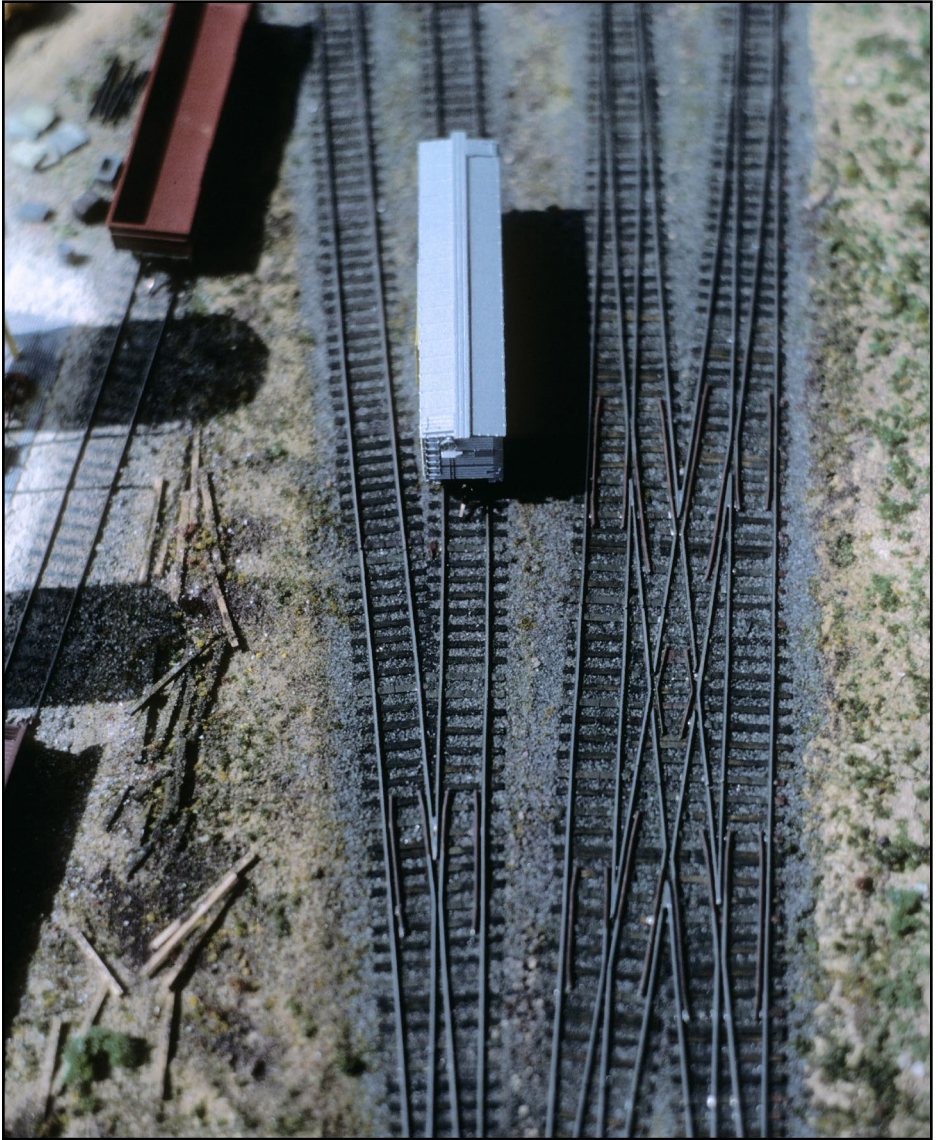

11. We turn the drone camera to the left of [10]. No engine there either. We can see the double crossover and a 40-foot car on the tracks to the left, but we can't see what that car is from this angle. It looks like the gon has been moved from where it was in [9], so 405 can't be too far away.





12. We finally found 405 sitting way down under the over-pass. It can't stay there too long because a local passenger train will soon arrive!



13. Flying the drone above the road bridge 405 is standing under, we spin around have a look to the other side of the station and see a farmer collecting his empty milk cans. We know this farmer – his '42 International pickup must be in the repair shop again, so it seems he is trying to load his milk cans into his two-door coupe. Will they fit?



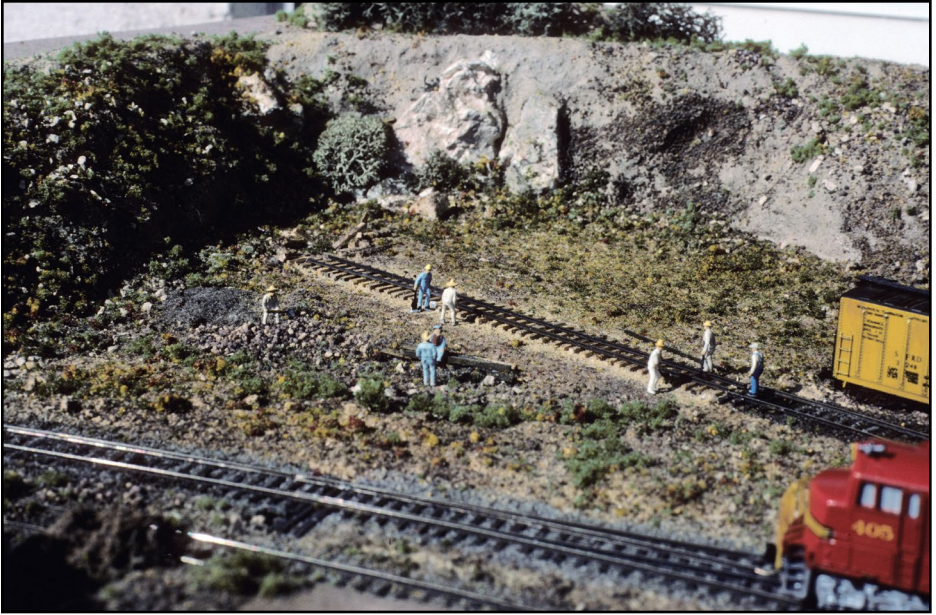

14. Spinning the drone around another direction from the bridge, we see the track gang from [9] have begun their work. Once there was a turntable here, but with the decline of the station, it has been removed. The turntable pit has been filled up, and the track gang is now laying rails to provide additional storage space for cars. At the right you can see an old box car placed beside the rails used as a tool shed for the track gang. And here on the lower right is 405 back again moving cars.

**VIEW READER  
COMMENTS**

*click here*



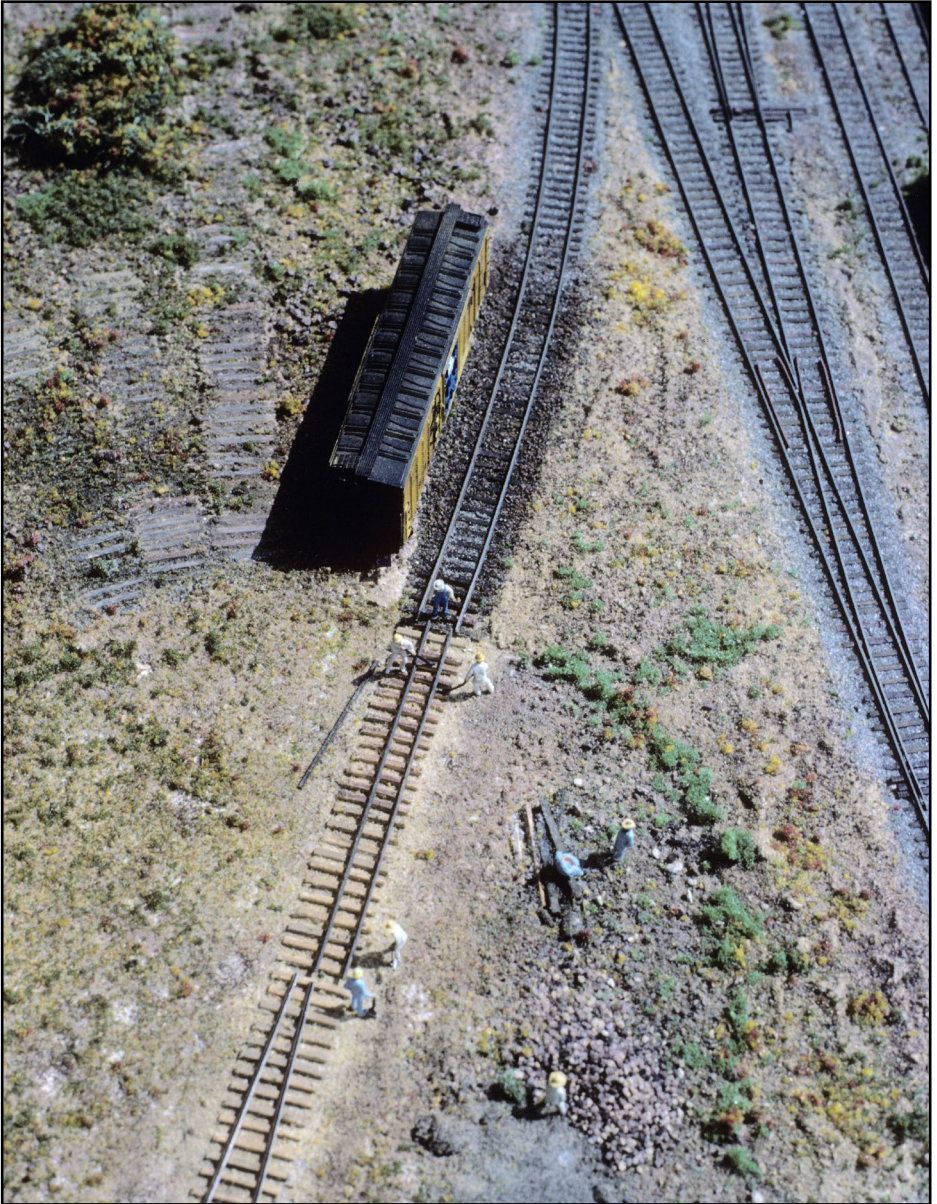

15. Flying the drone up higher and looking down on [14], we can see remnants of the old turntable and garden tracks through the ground cover.



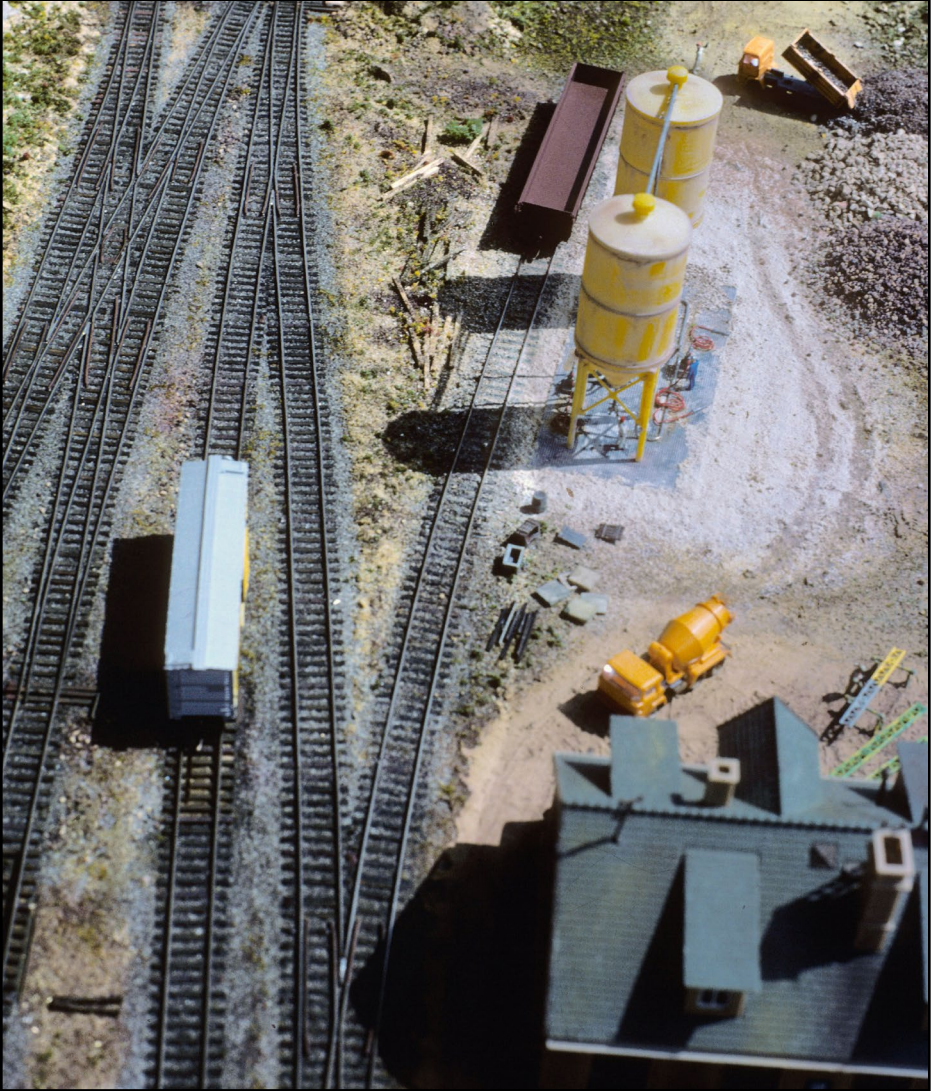

16. Flying over to look at the other end of the station toward the double crossover again, in this view on the lower right there is a company building. In the middle right stand two plaster silos, and in the far upper right there is an excavator doing his job. It looks like the gon may have been placed in its final spot.

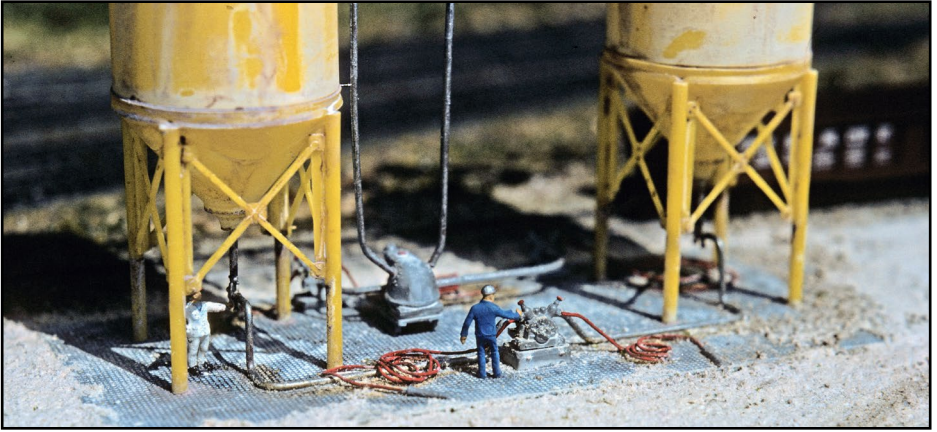

17. Flying around and zooming the camera in to look closer at the plaster silos, we see two workers managing the pumps, and preparing hoses for the arrival of covered hoppers coming with the next local.



18. Spinning around and zooming back to look off to the left of [17], we see a worker painting gray-primed girders with a bright yellow color. In front of him there is more work: old faded girders needing new primer and paint. On the right, we see a yellow cement truck leaving the yard. The pile on the left looks like a load for the gondola: wooden beams, barrels and an old sign of the "Sanford & Son" company.



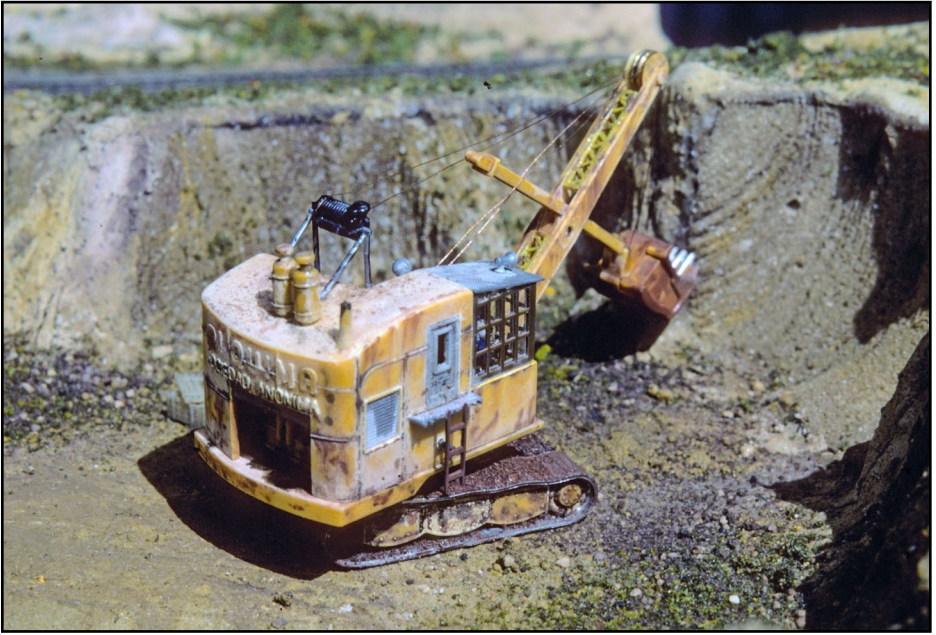

19. Flying the drone over to the edge of the large pit the excavator has dug out, we get a closer view of that great old piece of machinery. It's really huge! Unfortunately, we don't want to get any closer with the drone, so this photo will have to do.

We hope this gives you a good taste of how much fun you can have adding interesting vignettes like this to your layout. Look at the many fun stories we've managed to add to this one small N scale module!

**VIEW READER  
COMMENTS**

*click here*



## KARL-HANS KOCH



Karl-Hans received his first Märklin train when he was 3 years old – he suspects his father was looking for an excuse to play with trains! His suspicions were borne out because in following years, his father secretly built a Christmas layout.

When Märklin introduced their first F7 and F9 engines, Karl-Hans realized there was another rail-

way world behind the great pond and became interested in American railroads. He met another American model railroader in the early '80s and became permanently infected.

Starting with an American-style module, he built two layouts, but due to changes in career and associated moves, these layouts were dismantled before reaching completion. Being in 5-inch modeling (1/8 scale) for some years, he has returned to N scale. After renovating his house and preparing a train room, he started his proto-freelanced Norfolk & Virginia Eastern in 2013 after retiring.

Karl-Hans was a master mechanic for automobiles and worked as a Group Leader for General Motors in Russelsheim, Germany.

He and his Korean wife, Choon-Nyo, live in Friesenheim, a tiny village near Mainz, Germany. The couple have two children in their 20s, Jennifer and Christian. ■



**RATE THIS ARTICLE**





# The Future of Model Railroading

ESULLC 23 Howard Street Montoursville, PA (570) 980-1980

## CabControl WIRELESS CONTROL SYSTEM

- ✓ Completely wireless model railroad operation
- ✓ Ergonomic, Android based remote control unit with TFT Display
- ✓ Internal database capable of holding more than 16,000 locomotives with specific names and symbols and up to 28 functions per locomotive.
- ✓ Easy to create multiple unit consists. Capable of configuring and controlling more than 1,000 switches and other accessories
- ✓ Conveniently updatable with internet connection
- ✓ Runs all DCC decoder equipped locomotives
- ✓ Automatic train detection using RailCom-Plus®
- ✓ Integrated 7A Booster

### ESU Mobile Control II

- + Android operating system
- + 3.2" TFT Display, 800x400 resolution
- + Large Dial for easy speed control and direction change capabilities.
- + 4 user-personalized buttons
- + Micro USB port for Software Updates and battery charging
- + 5-8 hours of battery life.
- + 3.5 mm stereo headset port (microphone & headphone)

### ESU Integrated Control Unit

- + CabControl creates a wireless network for over 32 wireless controllers
- + Connects through your LAN to provide internet connection
- + USB Port for Software Updates and throttle charging
- + DC 5.5 mm / 2.1 mm socket for external regulated DC power supply



### Locomotives

Data for over 16000 locos can be held in the system  
Loco Icons show the engine you are running  
28 colorized graphical Icons for easy function identification



### Accessories

More than 1000 accessories can be controlled and can have status visually displayed



### Consisting

Easily created virtual consists so no CV changes are needed  
Ability for all functions to be controlled while in consists



### Conveniently Updatable

Updated easily for free as new features become available



Ethernet

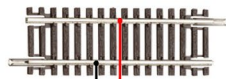

YouTube

[Click here for a short introductory video!](#)

• [INDEX](#)



SUBSCRIBE  
(free)

• [TABLE OF CONTENTS](#)

# BUILD A SCALE TRACK



Model Railroad Hobbyist | January 2018 | #95



RATE THIS ARTICLE

STEP  
by  
STEP  
1-2-3

**MICHAEL ANTEAU** uses CadRail and Fast Tracks tools to create a functional track to “weigh” freight cars ...

**IN THE SEPTEMBER 2002 ISSUE OF *MODEL RAILROADER***, Bill Darnaby wrote about building a working scale track for his HO-scale Maumee Route. Bill constructed his track using traditional handlaying methods that were beyond my skill level, and his results were great. I filed this idea away in my head as a “someday” project.

• [INDEX](#)

• [TABLE OF CONTENTS](#)

## BUILD A SCALE TRACK | 2

Fast forward a decade and a half and I'm now building my seventh layout. It's the Nicholas & Ashley Creek Railway, a coal-hauling branch line set in West Virginia in the early 1950s.

So the time had come to try my hand at creating a working scale track.

I handbuild all of my switches using Fast Tracks tools and templates from [handlaidtrack.com](http://handlaidtrack.com) . Fast Tracks manufactures excellent products to help you build your own switches, crossovers, and other complex trackwork. They are easy to use and produce the smoothest switches I've ever used. But I digress ...

A scale track is much less complex than a switch since it has no frog, and it seemed to me that my Fast Tracks tools would be perfect to make a functional scale track, with one track diverging to



1. This video demos what a scale track does and how an operational scale track works. Watch this two minute video first to give context for the rest of the article.

• [INDEX](#)



SUBSCRIBE  
(free)

• [TABLE OF CONTENTS](#)



carry cars over the scales, and a parallel bypass track for the heavy locomotive. The primary tool I used was the Fast Tracks #6 Point Form tool, but I also used most of the skills and techniques I had learned from building their switches.

To create my scale track, I needed an accurate track diagram. I do all of my layout design work in CadRail ([cadrail.com](http://cadrail.com)) and this turned out to be perfect for designing a scale track.

Armed with the tools and materials I'd need, I jumped in with both feet. You can view the finished scale track in action in this video.

Note: There is a list of tools and materials with this article. Many of these items can be obtained from other sources; some you may already have, but for convenience I included links to the items on the Fast Tracks website that I used. I purchased all of my materials from Fast Tracks for convenience, and everything is top quality. For rail, I use code 83 rail cut from two strips of flex track.

Follow along as I construct my scale track.



### DID YOU WATCH THE VIDEO?

I found watching the video on how Michael uses the scale track really helped me appreciate this article more. If you skipped the video on the previous page, go back and watch it now.

**VIEW READER  
COMMENTS**

*click here*



## STEP 1: MAKE A PRINTED PLAN

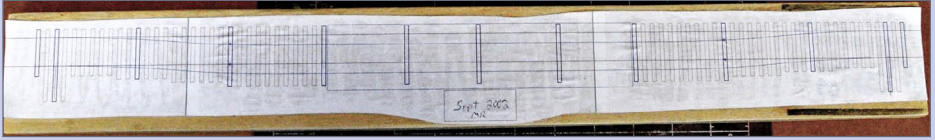

**1. Design the scale track layout:** I started by designing my scale track in CadRail. I considered wheel clearances in positioning the rails, and sized the scale tracks to weigh a 40-foot car, standard for my era. The purple ties on the plan indicate copper-clad fiberglass ties to which the rails are soldered. The other ties are wood. A copy of the CadRail file is available in the Subscriber bonus extras. If you don't have CadRail, the bonus extras include three PDF pages you can print at 100% and use to build a scale, or use to scan into your own CAD program.

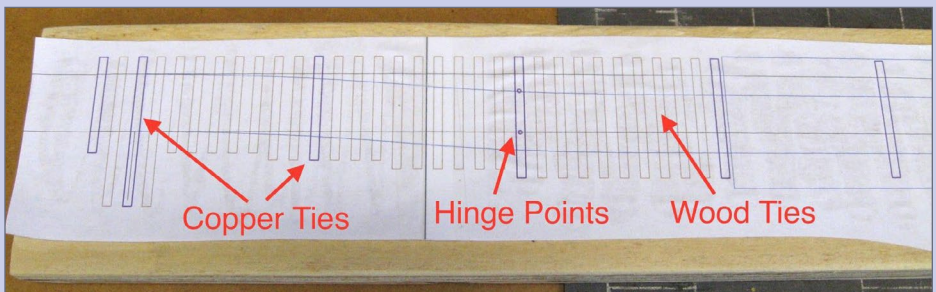

**2. Looking closer at the scale track layout:** Here is a close up view of my plan. I attached the plan to a piece of plywood using spray glue giving me a strong base to support my work. You can see I included a concrete pad on the far right where the actual scale would be. The fourth tie from the left shows the "solder location" for the point rails (that is, the hinge points).

## STEP 2: MAKING MY OWN TRACK GAUGE

**3. Determine the proper track gauge spread:** To assist in laying the rail accurately I needed a track gauge. Fast Tracks now sells several track gauges such as the Trifecta 3-Point Track Gauge ([handlaidtrack.com/tri-ho-s-me83](http://handlaidtrack.com/tri-ho-s-me83)). I would buy one if I did this again. Since I wasn't aware of this product when I built my scale, I made my own track gauge from styrene.

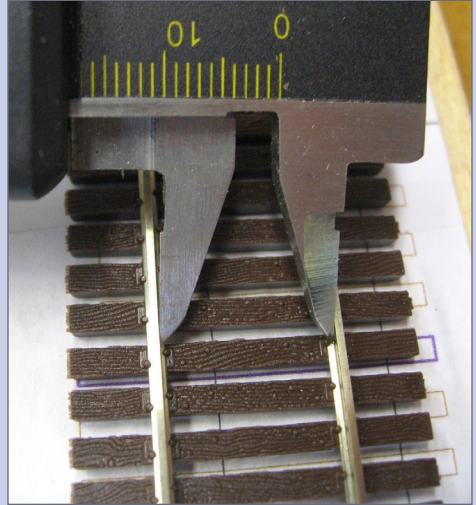

**4. Transfer calipers measurement to styrene:** To begin, I used calipers to measure the distance between the rails of a section of MicroEngineering bridge flex track [3]. Next, I transferred this measurement to a piece of sheet styrene and carefully cut it out. I sanded it as necessary for a good fit.

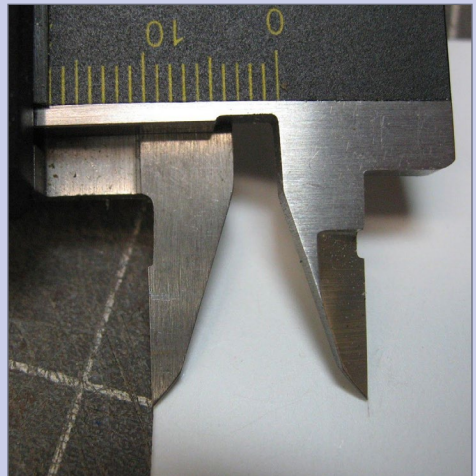



**5. Check the finished styrene track gauge:** When I was happy with my work, I labeled the gauge for future reference. You can see the edges of the gauge aren't perfect, but this method proved workable. I recommend purchasing a commercial gauge for the best results.

## STEP 3: LAYING THE RAILS

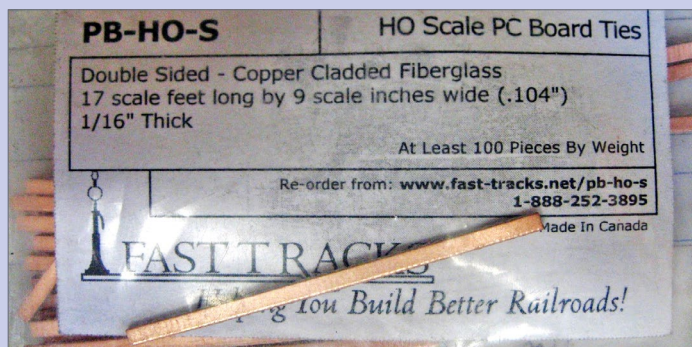

**6. Get some appropriate PC ties:** The ties that hold the track together are copper PC board. If you get these from Fast Tracks, use the number in my materials list as the part numbers have changed since this photo was taken.



## CONTINUED ... STEP 3: LAYING THE RAILS

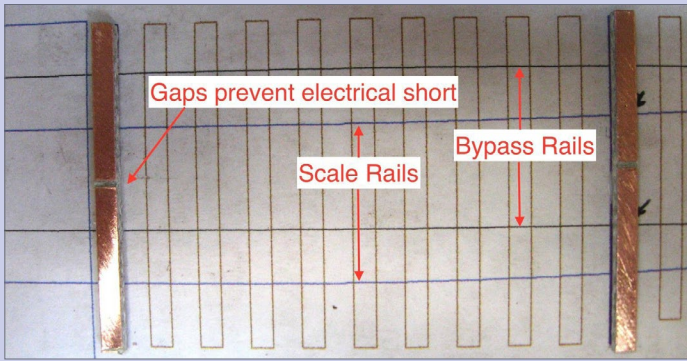

**7. Prepare the PC ties:** To get the PC board ties ready to use:

- Cut the tie to length using rail nippers
- Lightly file the top with a 10" mill file to remove oxidation
- File a center gap using a needle file to prevent electrical shorts
- Glue the tie to the plan using a couple of drops of white glue

**Note:** If I did this again, I would use two copper ties next to the concrete scale area so I could cut the rail more easily to isolate the scale itself. I plan to do this on my scale so I can easily activate the scale electronics with track detection.



**MAKE SURE  
YOU GAP  
THE FOIL**

Remember to gap the foil in the middle of the ties. I'm particular enough that I also gap the foil on the bottom of the ties too. I hate mystery shorts!

**VIEW READER  
COMMENTS**

*[click here](#)*



## CONTINUED ... STEP 3: LAYING THE RAILS

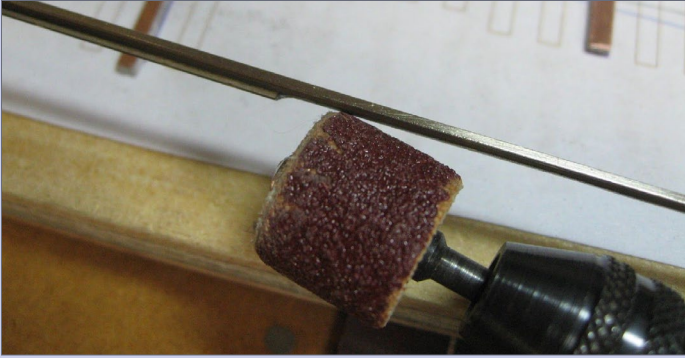

**8. Notch the stock rails:** The two outside rails are the stock rails and need notches filed in them to admit the point rails leading to the scale. Fast Tracks sells a tool called the Stock Aide for doing this ([handlaidtrack.com/sa-m](http://handlaidtrack.com/sa-m)) but I did not have one, so I used a sanding drum in a Dremel rotary tool to notch my stock rails. To do this:

- Lay the rail on the plan and mark the location that needs to be notched with a fine point Sharpie marker. You will need to gently curve one stock rail with your fingers to match the plan (be careful not to cut yourself doing this)
- Run the 10" mill file lightly across the rail base bottom a couple of times to remove tarnish. This will help later when soldering the rail to the PC ties.
- Mount a sanding drum in your rotary tool and carefully grind away the base of the rail, being careful not to damage the railhead. I find this easier if I use a flexible attachment or use a Dremel work stand to hold the Dremel tool.



## CONTINUED ... STEP 3: LAYING THE RAILS

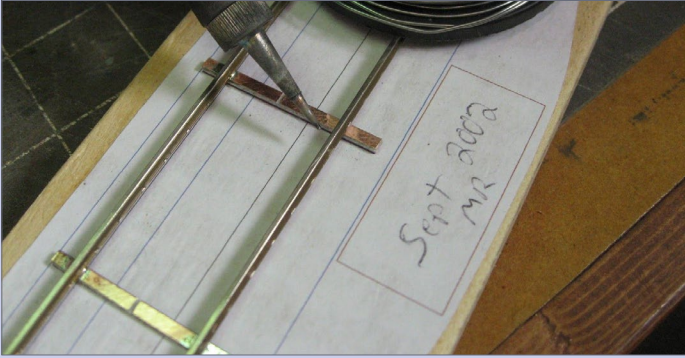

**9. Proper rail and tie prep:** A few light passes of the mill file on the tops of the ties and the bottoms of the rails will remove any tarnish. This way the solder joint will heat quickly and the solder will flow smoothly. Do this file prep now to make the soldering go easier later.

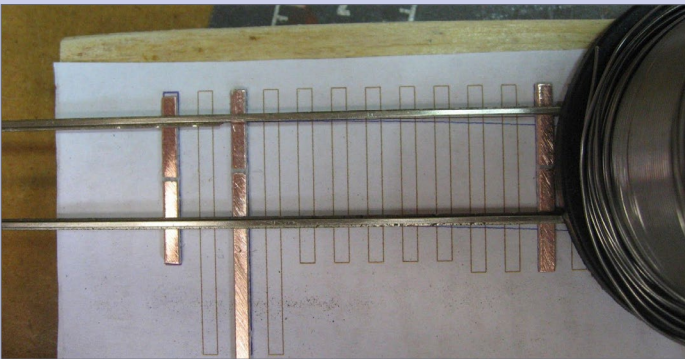

**10. Position the stock rails:** When the two stock rails are ready, carefully align them on the PC Board ties and weight them down so they don't move. I use spools of solder as weights since they are very heavy, flat on the bottom, and just about the right size.

## CONTINUED ... STEP 3: LAYING THE RAILS

### 11. Solder the straight stock rail to the PC ties:

I began by carefully soldering the straight stock rail. First I added a little flux to the joint, then I placed the sol-

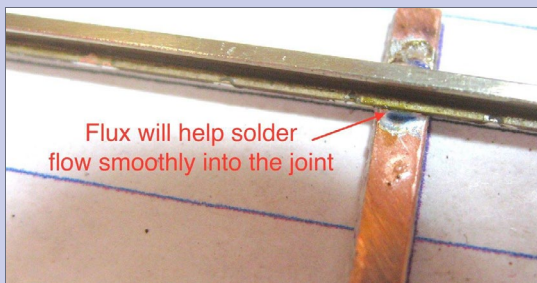

dering iron against the web of the rail. I placed the solder against the PC Board tie at the base of the rail, and kept the hot iron on the joint until the solder flowed. The solder should flow *under* the rail making a solid joint. Excess solder outside the joint is not necessary. The Fast Tracks site has some excellent videos on proper soldering techniques: [[handlaidtrack.com/FTV-Turnouts-5](http://handlaidtrack.com/FTV-Turnouts-5)].

### 12. Solder the curved stock rail to the PC ties:

After soldering the straight stock rail to each of the PC board ties, I proceeded with the curved stock rail. I used my track gauge and NMRA

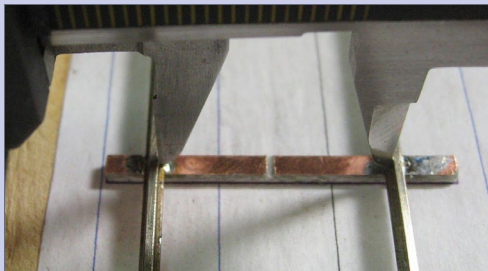

gauge to double check track spacing before and after soldering. Note that the track gauges are only useful until the stock rails begin to diverge. After that, you will need to rely on your printed plan for placing the curved stock rail. This is okay, because we will use the track gauge later to make sure everything is correct when soldering the point rails [16].

## CONTINUED ... STEP 3: LAYING THE RAILS

**13. Track gauge limitation:** The track gauge can be used until the stock rails diverge.

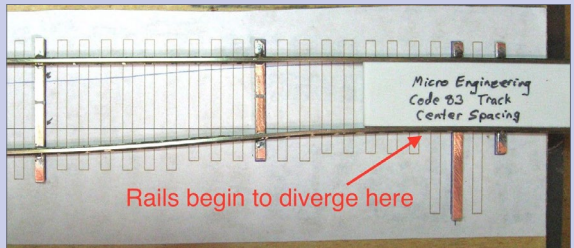

**14. Stock rails in place:** When the stock rails are complete, the scale track is half done and will look like this. Note that the stock rails are not soldered to the two long throwbars, they're just sitting in place unfastened to determine placement for now. The throwbars must be able to move to allow switching the points between the scale and bypass tracks.



### ANOTHER SOLDERING METHOD

Recently, I have moved to [no clean soldering paste](#) for soldering rails to PC ties. I can control the solder application very precisely with the paste and I *love* the no-clean part!

**VIEW READER  
COMMENTS**

*[click here](#)*



## CONTINUED ... STEP 3: LAYING THE RAILS

### 15. File the points:

I created the points using a Fast Tracks #6 point form tool. This tool is very easy to use.



- Cut the rail to length and lightly file the bottom of the rail to remove tarnish. Since this is not a switch, the rail will run the entire length of the scale track, and a point must be filed on each end. Like the curved stock rail, you will need to gently curve one point rail with your fingers to match the rail route on the printed plan.
- Clamp the rail in the point form tool.
- Use a 10" mill file to file the point smooth.

Again, there is an excellent video on the Fast Tracks site that cover this step in detail [[handlaidtrack.com/FTV-Turnouts-6](http://handlaidtrack.com/FTV-Turnouts-6)].

### 16. Solder the point rails in place:

Gauge the point rails with their adjoining stock rails when they are soldered in place.

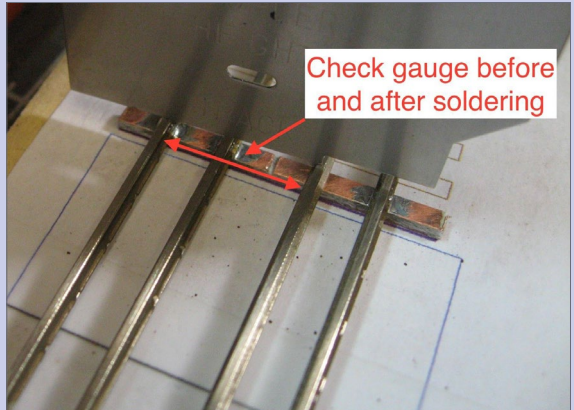

## CONTINUED ... STEP 3: LAYING THE RAILS

### 17. Soldering the straight point rail:

I placed the straight point rail in place on the plan and weighted it down. I then carefully soldered it to the center ties and to the throwbar. I skipped one tie past the throwbar to allow the points to move. Be careful not to solder the point rail to the stock rail when soldering to the throwbar. If this happens (experience talking) you can generally loosen it later with your soldering iron and then file away any excess solder. I checked my work with my track gauge at each solder joint. The straight point rail should be in perfect gauge with the straight stock rail.

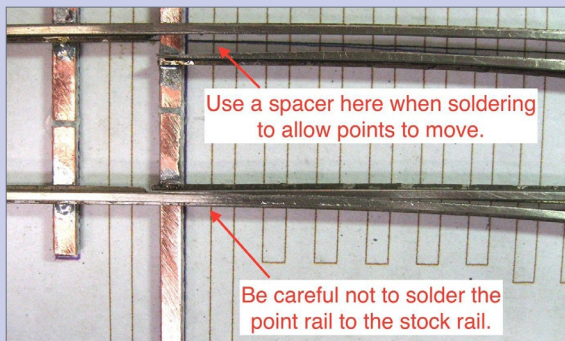

### 18. Soldering the curved point rail:

After soldering the straight point rail, I proceeded with the curved point rail. I followed the same procedure, weighting the rail and checking gauge as I went, except

when I reached the throwbar. The points must be able to move, so to accomplish this, I placed a PC board tie as a shim temporarily between the straight stock rail and the curved point rail. I soldered the point rail to the throwbar and then removed the temporary PC tie shim. This left a gap that allows the points to move. I then removed the completely soldered scale track from the template.

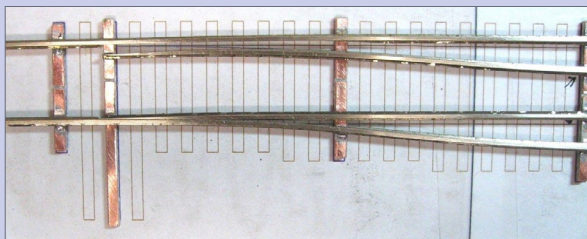

## STEP 4: ATTACHING THE SCALE TRACK TIES

**19. Position the wood ties on the plan:** Next, I cut wooden ties to length and glued them directly to the plan with a drop of white glue, leaving gaps where all the PC board ties would go. If your printed plan was damaged removing the soldered track, you can simply print a second one to use for the remaining steps.

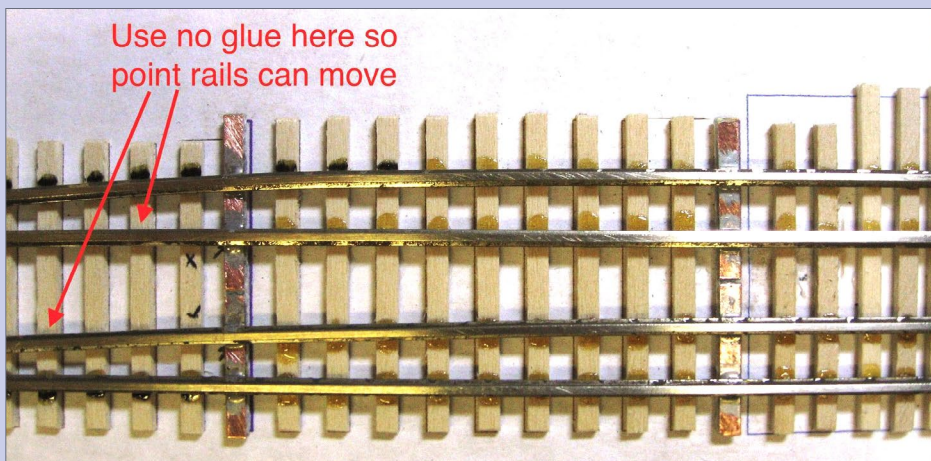
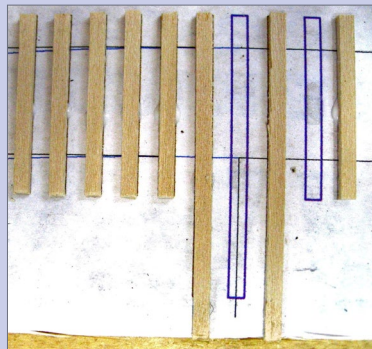

### **20. Glue the rail assembly to the wood ties:**

When all the wooden ties were in place, I used Pliobond contact cement to glue down the soldered scale track. I ran a bead of glue on the wooden ties, then one on the rail, then another bead on the ties again. The ties tend to absorb the first glue application, and the second bead on the wood ties helped to create a stronger bond.

## CONTINUED ... STEP 4: ATTACHING THE TIES

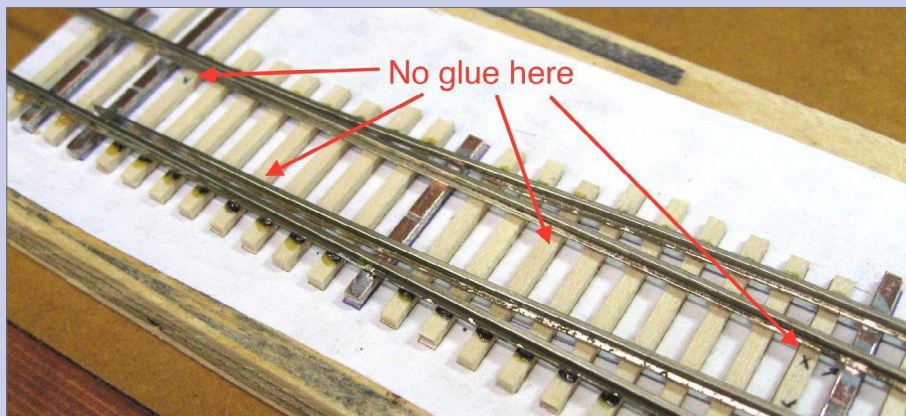

**21. Avoid gluing the movable points area:** *Do not glue the point rails beyond their last solder joint.* The point rails must be able to move! After the Pliobond glue had dried for a few minutes, I carefully set the scale track on a flat surface and weighted it down, then let the glue cure overnight.



### SUPERDETAILING YOUR SCALE TRACK

To take this scale track to an extra level of detail, you could add [Proto:87 Stores](#) tie plates and turnout details. You might also use their tiny etched spikes to add spike-head detail.

**VIEW READER  
COMMENTS**

*click here*



## STEP 5: FINISH THE SCALE TRACK DETAILING

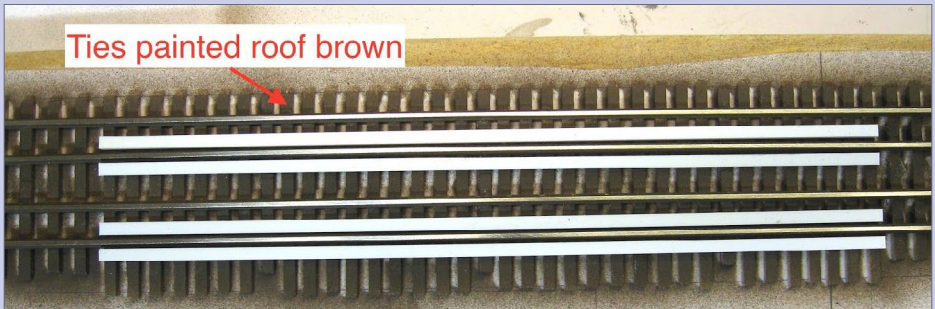

**22. Paint the rail and tie assembly:** When the Pliobond cement dried, I spray painted the ties and rails Roof Brown, then cleaned off the rail tops with lacquer thinner. Prototype scales have track guards that help prevent debris from getting into the scale mechanism. I simulated these with strips of styrene glued to the tops of the ties around only the rails over the scales.

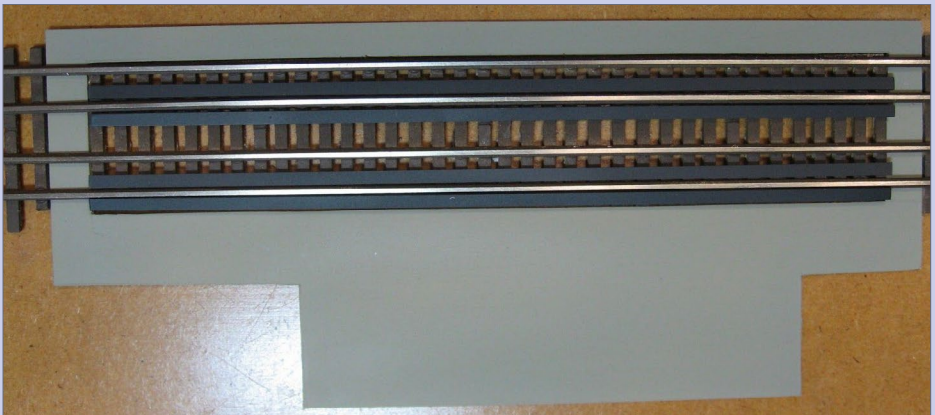

**23. Finish the scale area:** I painted the rail guards grimy black. I then created a concrete pad from thin sheet styrene, and extended it to allow for a scale house. I had to remove a couple of ties to accommodate the pad. I did not glue this pad to the scale track.

## CONTINUED ... STEP 5: FINISHING THE TRACK

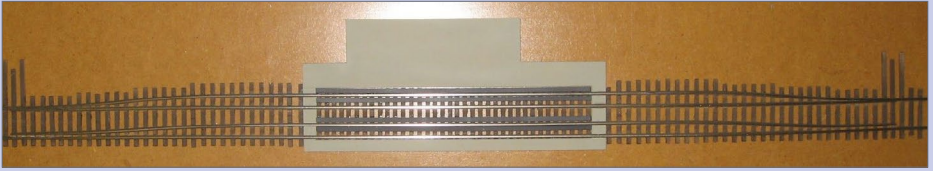

**24. Done and ready to install:** Completed scale track with concrete pad, ready for installation. Note how difficult it is to tell which ties are wood and which are copper clad fiberglass after they have been painted.

## STEP 6: INSTALL ON THE LAYOUT

**25. Place on the layout:** I fitted the concrete pad and my scale track to the layout and glued them in place with white glue and spikes. I added a few more styrene strips to cover ties in the scale area, and painted these to match the concrete pad. I made sure the flangeways were clear and did not interfere with any wheel flanges.



## CONTINUED ... STEP 6: INSTALL ON LAYOUT



**26. Install Tortoises and test:** When the glue was dry, I installed Tortoise switch machines and checked the points operation. With everything operating satisfactorily, I ballasted the track, being careful around the throw rod. The yellow dot on the throw rod helps operators see when the wheels of a car have passed the switch points and it's safe to throw the switch. ☑





## TOOLS AND MATERIALS

### TOOLS

- 10" mill file - <https://www.handlaidtrack.com/tl-0007>
- #6 point form tool - <https://www.handlaidtrack.com/pf-6-m>
- Soldering iron - <https://www.handlaidtrack.com/wp35>
- Conical soldering iron tip - <https://www.handlaidtrack.com/st7>
- HO NMRA standards gauge - <http://www.handlaidtrack.com/tl-0005>
- Track gauge - <https://www.handlaidtrack.com/tri-ho-s-me83> (I built my own)
- Needle files - <http://www.micromark.com/12-piece-Swiss-Pattern-Needle-File-Set>
- Track cutters - <https://www.handlaidtrack.com/769-2175b>
- Fine point Sharpie marker
- Dremel rotary tool w/sanding drum <https://www.handlaidtrack.com/sa-m>
- Calipers

### MATERIALS

- MicroEngineering code 83 rail - <http://www.handlaidtrack.com/17-083-c>
- Uncoupling magnets - <https://www.apexmagnets.com/1-8-x-1-4-cylinders>
- PC board ties - <https://www.handlaidtrack.com/ch-ho-s>
- Wooden ties - <https://www.handlaidtrack.com/wt-ho-t>
- Pliobond contact cement - <https://www.handlaidtrack.com/sp-0001>
- Small diameter solder - <https://www.handlaidtrack.com/SP-0003>
- Soldering flux - <https://www.handlaidtrack.com/sp-0063>
- White glue
- Rail Brown paint
- (Optional) Blair Line scale house - <http://www.blairline.com/scalehouse>



## MICHAEL ANTEAU



Michael Anteau comes from a rail-roading family: his grandfather was an engineer for the C&O, and his father was an engineer for CSX.

Michael was bitten by the model railroad bug while watching his dad's Lionel trains. He built his first 4x8 layout at the age of 10, on a sheet of plywood on the dining room floor!

These days, Michael works on his "dream" layout, a prototype freelanced coal hauling railroad set in transition-era West Virginia. His wife, Angie, leased him the largest room in the basement, and she actively encourages his hobby.

Michael lives in Northwest Ohio and works in Information Technology. He and his wife have two grown children. When he is not working on the Nicholas & Ashley Creek Railway, he enjoys playing piano, biking, hiking, traveling, and winemaking. ■



*click here*

**THERE'S MORE!**

**Check out the  
Subscriber  
bonus extras**

**VIEW READER  
COMMENTS**

*click here*



LIMITED  
SUPPLY!

**FINAL  
KIT!**



# FINE SCALE MINIATURES

FSM is closing its doors after 50 years of business!



Fine Scale Miniatures founder  
George Sellios with his final kit

**ONCE  
GONE,  
THAT'S  
IT!**

I.M. Dunn Co. \$280 + S&H



*Destined to become an  
instant collector's item*

**BUY NOW >>**

Brought to you by the MRH Store: [store.mrhmag.com](http://store.mrhmag.com)

# JANUARY NEWS

column



Model Railroad Hobbyist | January 2018 | #95



RATE THIS ARTICLE

**RICHARD BALE** and

**JEFF SHULTZ** report the latest hobby industry news

## NEW PRODUCTS FOR ALL SCALES

**Deepwoods Software** has released version 2.1.42 of its Model Railroad System. This software package, frequently updated, includes programs for working with the NMRA standard Layout Command Control (LCC) system, a Freight Car Forwarding program, a program for setting up a Time Table, and several other useful programs and references. The latest version includes a new program for enabling LCC to communicate with elements of the CMRI signaling system, improved printing support for the Freight Car Forwarding program, and minor bug fixes. More information can be found at [deepsoft.com/ModelRailroadSystem](http://deepsoft.com/ModelRailroadSystem).

.....

**Morning Sun Books** has released a digital reprint of *Western Maryland Tracksides with George M. Leilich*. Edited by Jeremy F. Plant, the publication provides a color history of the final three

▶ THE LATEST MODEL RAILROAD PRODUCTS, NEWS & EVENTS

• [INDEX](#)



SUBSCRIBE  
(free)

• [TABLE OF CONTENTS](#)

# JANUARY NEWS | 2

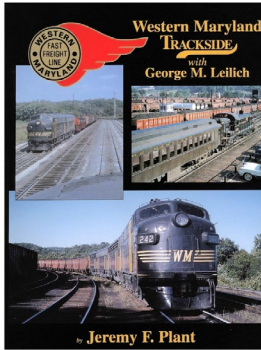

decades of the WM. Hardcover books available now include *Union Pacific Power 1965-2015, Volume 3*, by Stephen M. Timko; *Missouri Pacific Through Passenger Service*, by Greg Stout; *Trackside Around Peoria 1963-1980*, by Ed Johnson; and *Western States Trolleys in Color*, by Edward Rudolph. For additional information contact a dealer or visit [morningsunbooks.com](http://morningsunbooks.com).

.....



**Woodland Scenics** has a new Built & Ready structure for a rural post office. Called Letters, Parcels & Post, the fully assembled model features a printed interior and Woodland Scenics JustPlug lighting. The structure is

available in N, HO, and O scale. For additional information contact a dealer or visit [woodlandscenics.com](http://woodlandscenics.com).

.....



**Kalpso Media** is releasing a tycoon rail video game this month titled *Railway Empire*. The program will be available for PlayStation 4 and Xbox One. In the game, players will lead their railway empire to success

against heavy competition by establishing a comprehensive rail network and optimizing transportation of passengers and freight.





Over 40 historic locomotives and more than 30 different cars can be acquired over the course of the game. For additional information visit [kalypso-media.com](http://kalypso-media.com).



**Soundtraxx** has updated its Tsunami2 Diesel Digital Sound Decoder for GEVO Tier 4 locomotives. Identified as version 1.2, changes include improved replication of GE dynamic braking effects and the electronic air dryer system with a distinctive change in the release

rate sound of the poppet valve. For complete details contact an authorized dealer or visit [soundtraxx.com](http://soundtraxx.com).

## O SCALE PRODUCT NEWS



**Atlas O** has announced the second quarter release of two O scale hopper cars. Both 2-rail and 3-rail versions of a Trinity 5161 cu. ft. covered hopper are in the

release. Road names will be CP-Soo, GSC-Demo, and Kyle. Six additional BNSF cars will display heritage schemes for Frisco, Great Northern, Burlington Northern, Santa Fe, SP&S, and CB&Q.

Also in the second quarter release is a PRR class H21A quad-bay hopper. The O scale model represents one of the most numerous





coal hoppers, with more than 39,000 having been built. In addition to the Virginian scheme shown, road names will include Norfolk & Western, Penn

Central, Pennsylvania, and Pennsylvania keystone scheme with Coal Goes to War slogan. For additional information on all Atlas O products, contact a dealer or visit [atlaso.com](http://atlaso.com).

.....

## HO SCALE PRODUCT NEWS



**Accurail's** new 36-foot Fowler boxcar kit is a welcome addition to the selection of prototypically accurate models available to HO scale hobbyists. Details

on the first release are pending. Some of the initial release's road names are expected to include New York, Susquehanna & Western; Soo Line, and CI&L (Monon) as shown here in this pre-production sample. The Fowler patent boxcar was developed in the early 1900s by the Canadian Pacific Railway in cooperation with Dominion Car and Foundry. Prior to WW I, cars of this design were constructed by multiple builders for both U.S. and Canadian railroads. Fowler cars were a simple, robust design with many continuing in service past WW II.



New HO scale kits just released by Accurail include this Missouri Pacific 4750 cu. ft.

triple-bay covered hopper. The model is based on a prototype car built by Pullman-Standard in 1977.

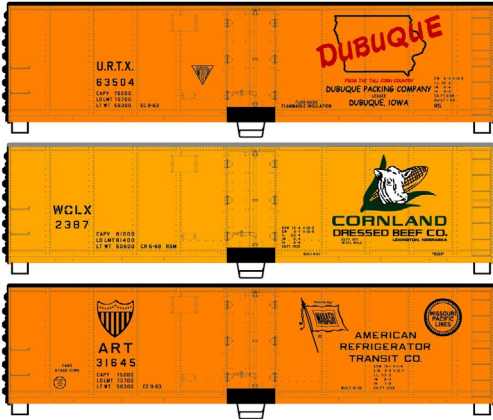

Accurail is selling three-car sets of kits for 40-foot steel refrigerator cars with 4-foot hinged doors. The HO scale models are decorated for URTX-Dubuque Packing, WCLX-Wilson Car Line (Cornland slogan), and ART-American Refrigerator Transit.

Additional new HO scale car kits recently issued by Accurail include Erie and MKT 36-foot double-sheathed boxcars, a Soo Line 41-foot AAR steel gondola, and a 50-foot insulated plug-door boxcar decorated for Chessie/B&O. All Accurail kits include appropriate plastic trucks and Accumate couplers that are compatible with popular knuckle couplers. For more information on all Accurail products visit [accurail.com](http://accurail.com).

.....

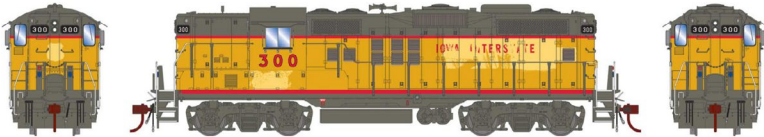

**Athearn** plans to release a new run of EMD GP7/9 diesels in November. New features on this run include LED lights and rubber MU hoses. Decorating schemes will be Iowa Interstate (ex-UP GP9 Phase II, Primed-for-Grime, above), Baltimore & Ohio (Phase II GP9 configured for long hood forward), and Union Pacific.





A Conrail GP9 will be offered (No. 7105) as well as a cableless GP9B unit (No. 3803). Both are ex-PRR diesels decorated in Athearn's faded Primed-for-Grime paint scheme.



Completing Athearn's November GP7/9 release are three Southern Pacific paint schemes (Black Widow, Halloween, and T&NO). See MRH July 2017 for details on a previously announced run of Genesis GP7/9 diesels scheduled for release in May. All Genesis sound-equipped locomotives feature an onboard DCC decoder with SoundTraxx Tsunami2 sound. The sound unit will operate on both DC and DCC layouts. DC-only models are DCC-ready with both 8- and 9-pin connectors to simplify installation of an after-market decoder.



Athearn plans to release several HO scale versions of EMD's SD40T-2 Tunnel-Motor diesels in October. To avoid hot exhaust fumes lingering along the roof of tunnels, EMD modified standard



SD40-2s with large low-level air intakes along the rear of the deck. Between the summer of 1974 and July 1980 EMD built 310 of the 3,000 horsepower, six-axle SD40T-2s.

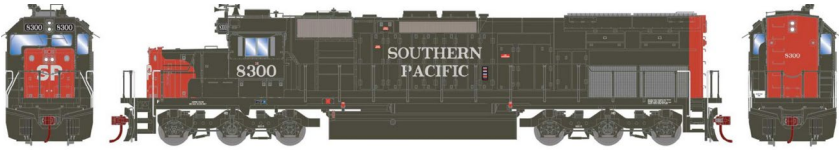

Since the last release of its SD40T-2 in early 2016, Athearn has added LED lights and rubber MU hoses to the HO scale locomotive. Models with an 88-inch nose and 3,600 gallon fuel tanks will be available decorated for Denver & Rio Grande Western, and Southern Pacific (speed writing version). An SP locomotive with a 116-inch nose and a 4,000 gallon fuel tank will be available decorated with serif lettering (above).



Models with 123-inch noses and 4,000 gallon fuel tanks will be SSW-Cotton Belt, and Union Pacific. Athearn's SD40T-2 will be available for standard DC operation as well as with factory-installed DCC decoder and SoundTraxx Econami Sound system.



Athearn HO scale rolling stock due in November includes a 100-ton Gunderson 60-foot high-cube boxcar with 8-foot double plug doors. The white band across the top of the ends indicates this is a Plate F car that is between 15 feet, 9 inches and 17 feet in height. In addition to this Railbox/TBOX version, road names will be BNSF,



Canadian National, Canadian Pacific, Penn Central (fantasy), and Northwestern Oklahoma in Primed-for-Grime faded paint.

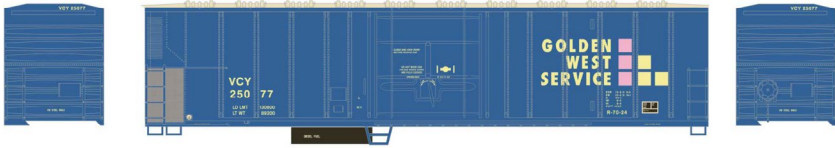

A Pacific Car & Foundry 57-foot mechanical refrigerator car is set for release by Athearn in November 2018. Road names for the HO scale Ready-to-Roll model will be Golden West Service, Alaska Railroad, Fruit Growers Express, Bangor & Aroostook, Green Bay & Western, and Union Pacific Fruit Express.



An HO scale model of a modern 30,000-gallon ethanol tank car will also be released in November. The Ready-to-Roll model features numerous separately applied details including wire handrails, photo-etched metal walkways and end platforms, printed placards, and 100-ton roller bearing trucks with 36-inch metal wheelsets. Decorating schemes will be ADM Archer Daniels Midland, TEIX Transport Equipment, UTLX Union Tank (white), UTLX Union Tank (black), TILX Trinity Industries (green), TILX Trinity Industries (black), and GATX Rail Canada.

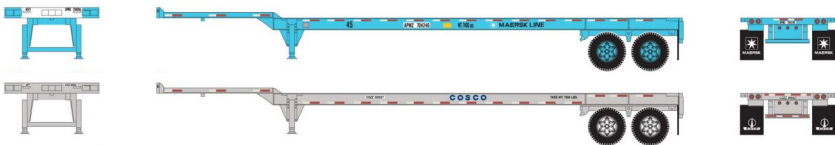

New intermodal equipment coming from Athearn next November will include a 45-foot container chassis specifically designed to handle domestic containers. Carrier names will be Maersk Line

(top), COSCO (bottom), Yang Ming, NYK, and Crowley. They will be sold in 2-packs with each chassis individually numbered.



Athearn has included its nicely detailed version of a Ford Model A pickup configured as a tow truck. Features of the assembled HO scale model include molded cab interior, separate steering wheel, clear window glazing, and rubber tires. Decorating schemes will be six private business names including the Automobile Club version illustrated.

.....



**Roundhouse Brand** products scheduled for release next November include this HO scale Eastern-style steel caboose with a centered cupola. Road names listed in the production schedule are Maine Central, Central Railroad of New Jersey, Chessie System, Reading, Shawmut Line (red), and Shawmut bicentennial scheme.



Hobbyists who model the Western Maryland Railway will have a choice of a red (above) or orange scheme. For additional information on all Athearn and Roundhouse brand products contact a dealer or visit [athearn.com](http://athearn.com).

.....





**Atlas Model Railroad Company** has released an HO scale Pullman 10-1-1 heavyweight sleeper. The ready-to-run model features full interior detailing, operating diaphragms, well-executed window glazing, full underbody detail, and AccuMate couplers. The Master series model is produced from tooling acquired from Branchline in 2011.

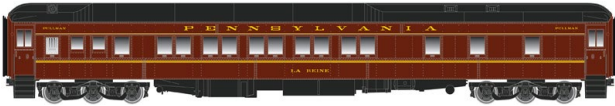

Road names and individual car names include Norfolk & Western (Island Regal), Burlington (Carter Lake), Chicago & North Western (Floyd River), Northern Pacific (Chief Black Bear), Pennsylvania (La Reine), Southern Pacific (Prior Lake), Union Pacific (Crown Point), and a Pullman-owned car (Chief Red Tomahawk).



New HO scale locomotives coming from Atlas during the second quarter of this year include new paint schemes and road numbers for the

MP15DC diesel switcher. The Master series model will be available with three different hood styles: standard hood, hood with a square air filter box, and hood with an angled air filter box just ahead of the cab. Additional road specific details include exhaust stacks with or without a muffler, and a standard or snow plow pilot. Road names will be GMTX, Union Pacific, Morristown & Erie, CITX, Reading & Northern, Kansas City Southern, and Conrail.





Also scheduled for release during the second quarter is a group of class NE-6 steel cabooses. Atlas' HO scale version is based on a standard prototype built by the

International Car Co. in the 1940s. In addition to the Conrail scheme shown here, other road names on the ready-to-run Master series model include Chicago, West Pullman & Southern; Seaboard/Family Lines, Norfolk & Western, Monongahela, Penn Central, and New Haven.



A Master series 40-foot post-war boxcar is included in the Atlas second quarter releases. The prototype cars were built with different combinations of roof, ends, and doors.

Variations in the Atlas HO scale version include early and late Improved Dreadnaught ends, straight and diagonal panel roofs, seven or eight rung ladders, and Youngstown or Superior steel sliding doors. Road names will be Gulf, Mobile & Ohio; Norfolk Southern, Montana Rail Link, Indiana Harbor Belt, Pittsburgh & Lake Erie, and Santa Fe. For additional information on all Atlas products contact a dealer or visit [atlas.com](http://atlas.com).

.....



**Bachmann Trains** is selling an HO scale Bay-Window Caboose that features a see-through running board, road specific bay window styles,

and metal wheelsets. Road names are Erie, New York Central, Nickel Plate Road, Baltimore & Ohio, and Union Pacific. For



additional information contact a dealer or visit [bachmann-trains.com](http://bachmann-trains.com).

.....



**Broadway Limited** is selling an HO scale version of an EMD SW1500 diesel switch engine. The model replicates the more than 800 prototypes built between 1966 and 1974.



Road names include BNSF (Heritage I scheme), Conrail, Great Northern, US Pipe & Foundry, US Steel Corporation, Southern Pacific (Kodachrome scheme), SP (bloody nose),

Southern Railway, Union Pacific, Western Pacific, and Penn Central. The ready-to-run model features Paragon2 Sound & Control System with integrated DCC Decoder.



Also new from Broadway Limited are several versions of the famous Pennsylvania Railroad P5a Boxcab Electric Locomotive. Passenger versions with a brown roof and gold leaf Roman lettering are available as well as several freight versions of the locomotive with a body-color roof and buff-yellow lettering. All versions feature Paragon3 Sound and control system for DC and DCC. For more information on all BLI products contact a dealer or visit [broadway-limited.com](http://broadway-limited.com).

.....



separate door tracks and door bars, etched stainless steel cross-over walks, Kadee #58 couplers, and 100-ton ASF Ride Control trucks with 36-inch machined metal wheelsets.

**ExactRail** has released an all new HO scale model of a Gunderson 6269 cu. ft. boxcar. The ready-to-run Evolution series model has wire grab irons,



as delivered), BNSF, International Bridge & Terminal, Illinois Central (1996 as-delivered gray), and Burlington Northern (1994 as delivered). For additional information visit [exactrail.com](http://exactrail.com).

The model is available in five road names with accurately reproduced font design and lettering placement. Road names are Wisconsin Central (1995



detailed HO scale ready-to-run model features several etched metal parts, machined metal wheelsets, and Kadee couplers. Four road numbers each will be available for cabooses decorated as delivered with an orange bay (above), as repainted with a brown bay, with SP end mounted markers, and as rebuilt in 1973/75 with a brown bay (below).

Reservations are being booked for another release of **Centralia Car Shops** Southern Pacific bay window cabooses. The nicely



An undecorated economy kit with plastic wheelsets and no couplers will also be available. InterMountain Railway is responsible for marketing



Centralia Car Shops products. For additional information contact a dealer or visit [intermountain-railway.com](http://intermountain-railway.com).

.....

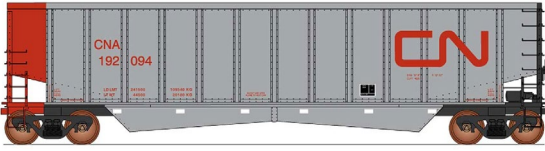

**InterMountain Railway** is selling a Trinity Aluminator coal gondola in its Value Line of HO scale

models. Road names for the economy priced ready-to-run cars are Canadian National, TIMX-Trinity Demonstrator, Burlington Northern, CITX-CIT Group Capital Finance, DEEX-Detroit Edison, and GEAX-Transcisco Leasing.

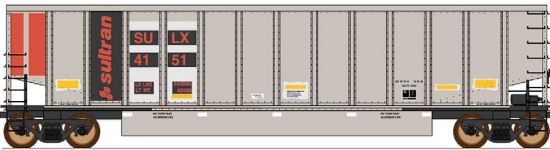

InterMountain Railway has set a May release date for the next production run of Value Line 14-panel

Coalporters. In addition to the SULX-Sultran car shown here, road names for the HO scale ready-to-run model will be BNSF, FPPX-Fayette Power, Canadian National, HIPX-Houston Lighting & Power, TGNX-NRG Energy, WFAX-Western Fuels, Conrail, GSNX-Gulf States Utilities, JECX- Jeffrey Energy Center, MBKX-Mitsui Rail Capital, and WEPX-Wisconsin Electric Power.



Bi-level auto racks are set for release by InterMountain Railway in March. The HO scale ready-to-

run cars will be available for Burlington Northern, BNSF on a TTX flatcar, BNSF (circle logo), Southern Pacific, Denver & Rio Grande Western, Soo Line, Chicago & North Western, Union Pacific/Missouri Pacific, Louisville & Nashville, Ferromex, and Norfolk Southern.





Features include metal wire grab irons, Kadee couplers and appropriate trucks with machined metal wheelsets. For additional information on all InterMountain products contact a dealer or visit [intermountain-railway.com](http://intermountain-railway.com).

.....



HANDPAINTED PREPRODUCTION SAMPLES

**Rapido Trains** is booking reservations for a Northern Pacific double-sheathed 10000-series boxcar. The all-new HO scale model replicates the steel underframe, wood sides, steel ends, and radial roof of the 1920s-era prototype. Additional details include lumber doors, lever handbrakes, AB or K brakes as appropriate to the period of the individual car being modeled, and new U-section Bettendorf-type trucks with in-line brake shoes and blackened turned metal wheelsets. Twelve numbers each will be available for cars decorated as NP (1923-1938), NP 36-inch Monad (red ends 1940-1944), NP 36-inch Monad (black ends 1945-1950), NP (Main Street slogan 1951-1956), and NP (company service 1956-1982). An undecorated model will also be available. Delivery is planned for this fall with reservations due by April 30. For more information contact a dealer or visit [rapidotrains.com](http://rapidotrains.com).

.....



**Kadee Quality Products** has announced a March release date for two new HO scale ready-to-run models. First up is a Tidewater Southern 50-foot



PS-1 boxcar built by Pullman Standard with an 8-foot 6-panel Superior sliding door. The HO scale model is based on a prototype built in 1955 and painted in factory-new boxcar red.



The second new model coming in March is a Rock Island PS-2 twin-bay covered hopper with channel rib sides. Kadee's decorating scheme follows a

prototype built by Pullman-Standard in 1956. For additional information on all Kadee products contact a dealer or visit [kadee.com](http://kadee.com).

.....

**Resin Car Works** has cancelled plans to produce an HO scale kit for a UTLX class X tank car. Meanwhile, work continues on developing an SFRD Rr 35/36/39/40 reefer, and a Santa Fe 50-foot "whalebelly" auto car. Both models are tentatively planned for release in July. For more information visit [resincarworks.com](http://resincarworks.com).

.....



**River Point Station** has HO scale Ford F-450 series XL cab trucks equipped with Hi-Rail wheels and a cherry-picker bucket. These are well-detailed non-operating plastic models based on prototype vehicles. Tinted clear

window inserts and pre-colored interiors are included. Decorating schemes are BNSF, NS, CSX, Canadian Pacific, Canadian National, and Union Pacific. The models are held together by friction-fit and are also available as undecorated kits. For additional information contact a dealer or visit [riverpointstation.com](http://riverpointstation.com).

.....



**Sylvan Scale Models** has introduced a resin kit for an HO scale 22-foot Fruehauf type F trailer. The kit includes Microscale decals for Yellow Transit Co. An undecorated kit is also available. Additional new kits are a 1962-65 Mack

C single and tandem axle semi-trucks, and 1946-47 Canadian Mercury pickup trucks. For additional information visit [sylvanscalemodels.com](http://sylvanscalemodels.com).

.....

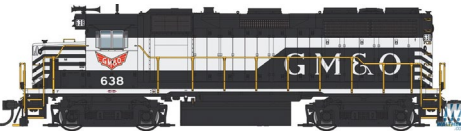

**Walthers** plans to release its latest version of an EMD GP35 road switcher later this month. The Proto series HO

scale model is based on Phase 2 units in service from the mid-1960s to the present. Road names on this release will be Gulf, Mobile & Ohio; Santa Fe (yellow bonnet), Chessie System, Conrail, Rock Island, and Southern Pacific. The ready-to-run model will be available for DC and for DCC with SoundTraxx Tsunami sound system.



Walthers plans to release newly-tooled F7 diesel units in March. The new Mainline series F7 A units and matching A-B sets are based on an EMD class 200 dual-service prototype. Road names will be available

for Chicago, Burlington & Quincy (above); Santa Fe (blue and yellow cigar band), Canadian Pacific (maroon, gray, yellow), Pennsylvania Railroad (Brunswick green, single stripe), Southern



Railway, Canadian Pacific, and Southern Pacific (Black Widow scheme, below).



Several road specific details to match the prototype being modeled include single or dual headlights, Mars lights, and steam generator details. The ready-to-run model will be available for DC with a 9-pin plug, and for DCC with 16-bit digital sound.



An upgraded version of WalthersProto EMD SW1200 diesel switcher is scheduled for release in June. Modifications include improved body tooling, new sill-mounted handrails, and Flexicoil

trucks. Decorating schemes with some road-specific details will be Great Northern, Canadian National, Denver & Rio Grande Western, Illinois Terminal, and New Haven. The ready-to-run locomotive will be available with DC and with ESU LokSound Select Sound with integrated DCC decoder.



A new production run of 55-foot Trinity 30,145-gallon tank cars is coming from Walthers next August. The Proto series model is based on a prototype modified with reinforced ends, revised end



platforms, and multi-valve housing to comply with FRA mandates. Features include see-through photo-etched metal end shields, walkways, and end platforms; factory-installed grab irons, and a nicely detailed underbody with separate brake cylinder, brake pipe and rigging. Road names will be CBTX-CIT Group, PPRX-Conoco Phillips, DPRX-Holdin Inc, SCMX-Shell Oil, and TILX-Trinity Industries Leasing. For additional information on all Walthers products contact a dealer or visit [walthers.com](http://walthers.com).

.....



**Westerfield Models** is selling HO scale craftsman kits for a Northwestern Pacific USRA double-sheathed express boxcar. The one-piece cast urethane kits represent USRA cars rebuilt for express service

in 1939 (above). Some were again rebuilt in 1949 for passenger train service with steam, air, and signal lines (below). They were painted SP dark olive green with the famous “Redwood Empire Route Overnight” slogan. The roof, underframe, and trucks were painted black.



Westerfield is offering both the 1939 and 1949 versions with authentic decals. The kits are available with or without appropriate Tahoe trucks. A video showing assembled kits may be viewed at [youtube.com/watch?v=STwb5OzeA8o](https://www.youtube.com/watch?v=STwb5OzeA8o).

For additional details including ordering instructions visit [westerfieldmodels.com](http://westerfieldmodels.com).

.....



## N SCALE PRODUCT NEWS

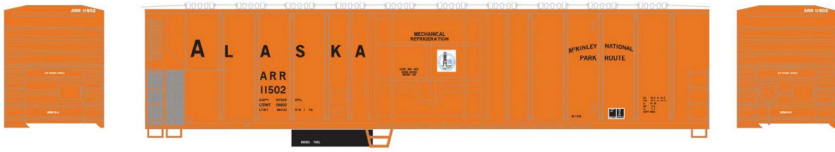

A Pacific Car & Foundry 57-foot mechanical refrigerator car is set for release from **Athearn** in November. Road names for the N scale Ready-to-Roll model will be Alaska Railroad, Golden West Service, Fruit Growers Express, Bangor & Aroostook, Green Bay & Western, and Union Pacific Fruit Express.

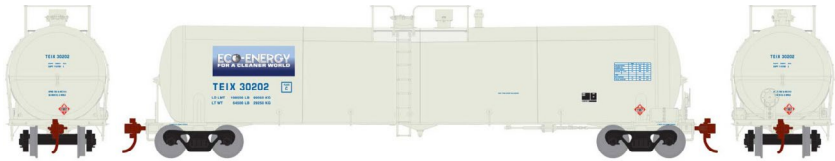

An Athearn N scale model of a modern 30,000-gallon Ethanol tank car is also due in November. The Ready-to-Roll model features numerous separately applied details such as wire handrails, photo etched metal walkways and end platforms, and 100-ton roller bearing trucks with 36-inch metal wheelsets. Decorating schemes will be TEIX Transport Equipment (above), ADM Archer Daniels Midland, UTLX Union Tank (white), UTLX Union tank (black), TILX Trinity Industries (green), TILX Trinity Industries (black), and GATX Rail Canada.

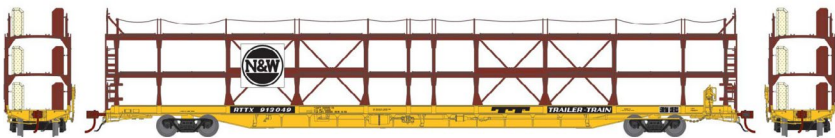

Completing Athearn's November production run of N scale models is this 89-foot class F89 Tri-Level Autorack. The Ready-to-Roll

model features end bridge plates, 70-ton roller bearing trucks with 33-inch machined metal wheelsets, and a Whitehead & Kales auto rack. Scheduled road names include Missouri Pacific, Northern Pacific, Norfolk & Western, Seaboard Coast Line, Frisco, and Southern Pacific. For additional information on all Athearn products contact a dealer or visit [athearn.com](http://athearn.com).

.....



New N scale locomotives coming from **Atlas Model Railroad Co.** during the second quarter of this year include new paint

schemes and road numbers for the MP15DC diesel switcher. The Master series model will be available with different hood styles: standard hood, hood with a square air filter box, and hood with an angled air filter box just ahead of the cab. Road names will be GMTX, Morristown & Erie, CITX, Reading & Northern, Kansas City Southern, Conrail, and Union Pacific.



Also scheduled for release during the second quarter is a group of class NE-6 steel cabooses. Atlas' N scale version is based on a standard prototype built by the

International Car Co. in the 1940s. In addition to the Penn Central scheme shown, other road names on the ready-to-run Master series model will be Chicago, West Pullman & Southern; Seaboard/Family Lines, Norfolk & Western, Monongahela, Conrail, and New Haven.

Completing Atlas' second quarter release of N scale models is this 40-foot wood refrigerator car. The model is based on a prototype Pullman built in 1930 for the Northern Refrigerator Car Co.





Of note are the working roof hatches and the accurate painting of the door hinges, ladders, and end straps. Road names will be DAMX-

Dewey & Almy Chemical Co. Multibestos; American Refrigerator Transit, Northern Refrigerator Car Co. Jelke Good Luck; Northern Refrigerator Car Co. Yes! Bananas; URTX-Soo Line, North Western Refrigerator Line, and New Haven Ice Service. An undecorated version will also be available. For additional information on all Atlas products contact a dealer or visit [atlas.com](http://atlas.com).

.....



**Broadway Limited** is selling an N scale General Electric ES44AC diesel locomotive. The ready-to-run model replicates the Evolution series 4,400 horse-

power units GE built to meet EPA Tier 2 emissions standards. BLI's model features Paragon3 Sound and Operation System with integrated DCC decoder.



Road names are Norfolk Southern, NS-Conrail Heritage, NS-Southern Railway Heritage, NS-Nickel Plate Road Heritage, NS-Central of

Georgia Heritage, NS-Pennsylvania Railroad Heritage, NS-Norfolk & Western Heritage, NS-Lehigh Valley Railroad Heritage,



NS-Interstate Railroad Heritage, NS-Norfolk Southern Heritage, and Union Pacific-Building America scheme. For complete details on all Broadway Limited models contact a dealer or visit [broadway-limited.com](http://broadway-limited.com).

.....



**Eastern Seaboard Models** is preparing to release N scale versions of a 50-foot X65 exterior post

boxcar. The N scale injection molded model is based on a series of prototype cars built by Despatch Shops in the late 1960s. Simulated cushioned-underframe coupler pockets are integrated into the underframe. The ready-to-run model will have ASF 70-ton Ride Control roller-bearing trucks with metal wheelsets, and knuckle couplers compatible with Micro-Trains couplers.



Road names will be New York Central, Lehigh Valley, and two Pittsburgh & Lake Erie schemes. A Shiny Baubles holiday version

with ghost graphics is also planned. Additional projects under-way at ESM include a New Haven NE-5 caboose based on an Atlas model, a Hooker ACF Type-27 class 103B 8,000 gallon acid tank car, and a Fruit Growers Express (ex-Pennsylvania R7) outside braced reefer. For additional information visit [esmc.com](http://esmc.com).

.....



**InterMountain Railway** has released another production run of EMD SD40-2



diesel locomotives. The N scale model will be available decorated for Genesee & Wyoming-GEXR (above), Genesee & Wyoming-RCPE, Nebraska Central, Indiana Railroad, CEFX, Saint Lawrence & Hudson, CSX, Union Pacific, Seaboard System, Montana Rail Link, and in BC Rail's red, white, and blue scheme.



The ready-to-run diesels have several road-specific details, some of which may be included

for installation by the modeler. Non-sound units are equipped with an ESU LokPilot DCC decoder. Sound units are equipped with an ESU LokSound Select DCC decoder. DC versions are equipped with a DC-only circuit board and are DCC-Ready. For information on all InterMountain Railway products contact a dealer or visit [intermountain-railway.com](http://intermountain-railway.com).

.....

## Z SCALE PRODUCT NEWS

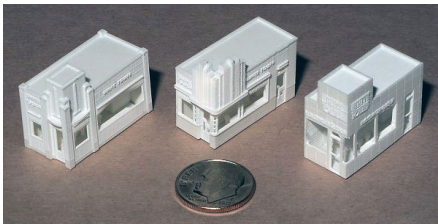

**Eastern Seaboard Models** has created three versions of White Tower Restaurants. The one-piece Art-Deco structures are made to order by Shapeways. For additional information visit [esmc.com](http://esmc.com).

.....

## NEW DECALS, SIGNS AND FINISHING PRODUCTS

**Dan Kohlberg** has released a new HO scale decal set for a Gulf, Mobile & Ohio 40-foot boxcar repainted red in 1966 at GM&O's Frascatti Shops in Alabama. According to Dan the



roof was painted black but the paint quickly peeled showing the silver galvanized panels. The screened set includes a prototype lettering diagram. For additional information visit

[home.mindspring.com/~paducah](http://home.mindspring.com/~paducah).



New HO scale lettering sets from **Mask Island Decals** include The Rock paint scheme for GE

U-Boat locomotives (above), Reading boxcars, and EJ&E 40-foot green boxcars (below).

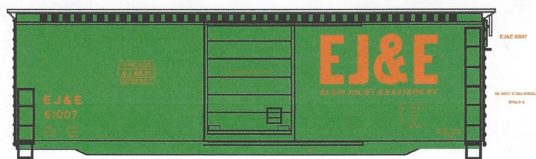

Also new from Mask Island are HO scale decal sets for 2-door and 8-door versions of a Norfolk & Western 86-

foot auto parts cars. For additional information visit [maskisland-decals.com](http://maskisland-decals.com).

**The New Haven Railroad Historical & Technical Association** sells a variety of HO scale decals for New Haven equipment. Recent additions include NH-008 wooden work service and tool cars, NH-009 Difco dump cars and wood ice reefers, and NH-010 Troop Sleeper. For additional information visit [nhrhta.org/htdocs/decals.htm](http://nhrhta.org/htdocs/decals.htm).

**The Northern Pacific Railroad Historical Association** has released HO scale decals for a variety of NP gondolas. The gondola pack includes four sheets of decals that can be used to



accurately decorate virtually every gondola NP ever rostered. There is sufficient material to letter up to 30 models. These are high quality water-slide decals produced by Cartograf in Bologna, Italy. For additional information visit [store.nprha.org](http://store.nprha.org).

.....



**Precision Design Company** is selling DOT Placard and Holder decals for HO scale trains and highway trucks. The water-slide decals cover a wide range of

HAZMAT requirements. For additional information visit [pdc.ca/rr/catalog/products/decal-sets/11](http://pdc.ca/rr/catalog/products/decal-sets/11).

.....



## SEND US YOUR PRODUCT ANNOUNCEMENTS

If you are a hobby manufacturer with a product announcement, just [click here](#) and submit your announcement to us. Our web site and free magazine reach continues to grow, so get on board this new media train! ■

.....

**VIEW READER  
COMMENTS**

*click here*



**N  
SCALE**

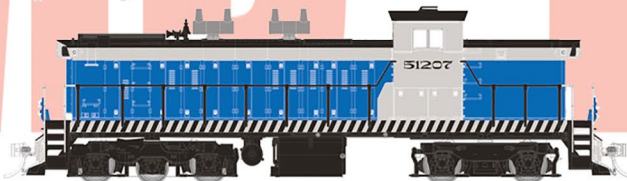
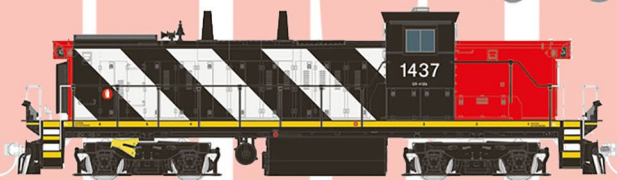
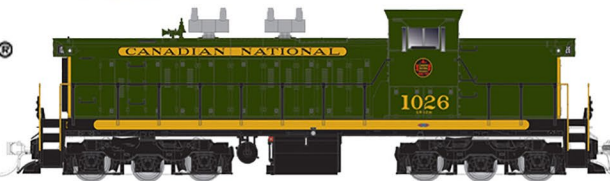

**Order By  
February 9!**

**Click Here!!**

• [INDEX](#)



**SUBSCRIBE**  
*(free)*

• [TABLE OF CONTENTS](#)



## BRIEFLY NOTED AT PRESS TIME ...

**GATR Works** has introduced a kit for a new N scale end of train device called NanoFRED G3. The battery-powered unit uses an LED that flashes at a rate of 80 blinks per minute. The battery life is reported at 80 hours. For additional information visit [gatrworks.com](http://gatrworks.com) ...

**ExactRail** is selling its Johnstown America Autoflood II open hopper cars in two UCEX paint schemes: American Military Veterans (red, white and blue), and On Track For the Cure (pink). More information is available at [exactrail.com](http://exactrail.com) ...

**Mask Island Decals** has released HO scale decals for Central of Georgia, and Louisville & Nashville 5750 wood chip hoppers. The CG set includes "The Right Way" slogan. Each decal set will letter one car. For additional information visit [maskislanddecals.com](http://maskislanddecals.com) ...

**TrainLife** is selling laser-cut kits for HO scale flat car lumber loads. Based on an original design by Blaine Hadfield, the kits are available in 8-, 10-, 12-, and 16-foot long bunks. For details visit [trainlife.com](http://trainlife.com) ...

**VIEW READER  
COMMENTS**

*click here*

# Take the MRH 2018 Reader Survey ...



... and get a chance  
to win a 7" Kindle  
Fire tablet!

(10 tablets will be awarded)



amazon

**TAKE THE SURVEY >>**

Please take this survey, it really helps us know much better what kind of articles and videos to make for you!

Get the latest Model Railroading News, Tips, Reviews & Opinions



Our iTunes feed has changed search for  
"Mike And Scotty Live" to receive the latest episodes!

[www.themodelrailroadpodcast.com](http://www.themodelrailroadpodcast.com)

Hosts:

Scott Mason: [www.scottymason.com](http://www.scottymason.com)

Mike Rose: [www.mrhobby.com](http://www.mrhobby.com)

Don't Miss our Monthly Interviews  
& Product Announcements

• [INDEX](#)



SUBSCRIBE  
(free)

• [TABLE OF CONTENTS](#)

# SELECTED EVENTS



Model Railroad Hobbyist | January 2018 | #95



**RATE THIS ARTICLE**

## JANUARY 2018

*(Many events charge a fee. Check individual info website for details.)*

**CALIFORNIA, ALAMEDA**, January 26-28, 2018 San Francisco Bay Area PCR/Layout Design/Operations SIG Meet, at the Elks Lodge, 2255 Santa Clara Avenue. Information and pre-registration at [pcrnma.org/sigs](http://pcrnma.org/sigs).

**COLORADO, COLORADO SPRINGS**, January 20-21, TECO 31 Model Train Show, hosted by Train Expo Colorado, Chapel Hills Mall Event Center, 1710 Briargate Blvd. Info at [tecoshow.org](http://tecoshow.org).

**FLORIDA, COCOA BEACH**, January 4-6, Prototype Rails RPM Meet, hosted by Mike Brock at Cocoa Beach Hilton Oceanfront Hotel. Info at [prototyperrails.com](http://prototyperrails.com).

**FLORIDA, STUART**, January 20-21, Annual Train Show, sponsored by Martin County Model Railroaders, at Martin County Fairgrounds, 2616 SE Dixie Highway. Info at [martincountymodel-railroaders.org](http://martincountymodel-railroaders.org).

**GEORGIA, ROSWELL (Metro Atlanta)**, January 13, 2018, O Scale South 2018, at Cross of Life Lutheran Church, 1000 Hembree Road. Sponsored by the Southern O Scalers and the Model Railroad Club of Atlanta. Info at [oscalesouth.com](http://oscalesouth.com).

**ILLINOIS, WHEATON**, January 14, Great Midwest Train Show, at DuPage County Fairgrounds, 2015 Manchester Road. Info at [greatmidwesttrainshow.com](http://greatmidwesttrainshow.com).



**MARYLAND, BALTIMORE**, January 7, 14, 21, and 28; Open House at the Baltimore Society of Model Engineers (BSME), 225 West Saratoga Street. Info at [modelengineers.com](http://modelengineers.com).

**MASSACHUSETTS, WEST SPRINGFIELD**, January 27-28, Amherst Railroad Hobby Show, sponsored by the Amherst Railway Society, at Eastern States Exposition Fairgrounds, 1305 Memorial Avenue (enter at Gate 9). Info at [railroadhobbyshow.com](http://railroadhobbyshow.com).

**MINNESOTA, WOODBURY**, January 20, Model Railroad Flea Market & Train Show, sponsored by Newport Model Railroad Club, at Woodbury High School, 2665 Woodlane Drive. Request info from Ed Petry at [sierraed@usfamily.net](mailto:sierraed@usfamily.net).

**ONTARIO, PARIS**, January 21, 2018 Paris Junction Model Train Show, 139 Silver Street. Info at [facebook.com/paristrainshow](https://facebook.com/paristrainshow).

### February 2018, by location

**KANSAS, LAWRENCE**, February 10-11, Train Show & Swap Meet, sponsored by Lawrence Kansas Model Railroad Club, at Crown Toyota Kingdom, 3400 South Iowa Street. Info at [lawrencemodelrailroadclub.org](http://lawrencemodelrailroadclub.org).

**KANSAS, WICHITA**, February 3-4, Train Show & Swap Meet, at Cessna Activity Center, 2744 George Washington Blvd. Info at from Phil at 316-259-5190.

**MASSACHUSETTS, AUBURN**, February 25, Greater Worcester Model Train Show & Sale, sponsored by Worcester Model Railroaders, Inc., at Auburn Elks Club, 754 Southbridge Street. Info at [wmrr.org](http://wmrr.org).

**NEW YORK, FISHKILL**, February 11, Model Train Show & Sale, Fishkill Recreation Center, 793 Route 52. Info at [kingston-trainshow.com/fishkill-model-train-and-railroad-hobby-show](http://kingston-trainshow.com/fishkill-model-train-and-railroad-hobby-show).



**OREGON, PORTLAND**, February 10, Bridgetown Railroad Prototype Modelers Meet. Info at [facebook.com/groups/2001136043323501/about](https://www.facebook.com/groups/2001136043323501/about).

**SOUTH CAROLINA, EASLEY**, February 9, Model Train Expo, sponsored by CRMHA, at Rock Spring Church, 207 Rock Springs Road. Info [trainshow@crmha.org](mailto:trainshow@crmha.org).

**WASHINGTON, VANCOUVER**, February 17, Railroad Swap Meet, sponsored by Spokane, Portland & Seattle Railway Historical Society, at Warehouse 23, 100 Columbia Street. Request info from Jerry Pickell at [pickell5141@msn.com](mailto:pickell5141@msn.com).

## Future 2018, by location

**CANADA, BRITISH COLUMBIA, BURNABY**, May 4-6, 2018, 3rd Annual 7th Division PNR Modellers Meet, at Simon Fraser University (Burnaby Campus), West Mall Centre. Info [facebook.com/RailwayModellersBritishColumbia](https://www.facebook.com/RailwayModellersBritishColumbia).

**CANADA, ONTARIO, COPETOWN**, March 4, Prototype Modellers Show. Info at [facebook.com/CopetownShow](https://www.facebook.com/CopetownShow).

**CALIFORNIA, SAN BERNARDINO**, April 28, Western Prototype Modelers Meet, Santa Fe/Amtrak Station, 1720 West 3rd Street. Info at [railroadprototypemodelers.com](http://railroadprototypemodelers.com).

**COLORADO, DENVER**, March 3-4, Rocky Mountain Train Show, at Denver Merchandise Mart, 451 East 58th Avenue. Info at [rockymountaintrainshow.com](http://rockymountaintrainshow.com).

**ILLINOIS, SPRINGFIELD**, March 25, Annual Train Fair, sponsored by Springfield Railroad Society, at Illinois State Fairgrounds, Orr Building. Info at [springfieldtrainfair.com](http://springfieldtrainfair.com).

## SELECTED EVENTS | 4

**MARYLAND, ROCKVILLE**, August 22-26, 2018, 50th O scale National Convention, Co-sponsored by NMRA MER, Standard Gauge, Narrow Gauge, P48 and Traction modelers, at Rockville Hilton Hotel, 1750 Rockville Pike. Info at [2018oscalenational.com/newsletters/september-2017-newsletter](http://2018oscalenational.com/newsletters/september-2017-newsletter).

**MISSOURI, KANSAS CITY**, August 5-12, 2018, NMRA National Convention and National Train Show. Host hotel is Westin Kansas City at Crown Center. Info at [kc2018.org](http://kc2018.org).

**OHIO, GREENVILLE**, March 4, Model Railroad Swap Meet, at Darke County Fairgrounds, Youth Building, 800 Sweitzer Street. Info from Joe Worz at [josephbw@hughes.net](mailto:josephbw@hughes.net).

**OHIO, MARION**, April 26-28, Central Ohio RPM, at Marion Union Station. Info at [facebook.com/groups/438383252883060/about](https://facebook.com/groups/438383252883060/about).

**OREGON, PORTLAND**, March 10, Willamette Model Railroad Club 33rd Annual Swap Meet. 9:30 a.m.-3 p.m. at W.D. Jackson Armory, 6255 NE Cornfoot Road. Email [wmrswapmeet@yahoo.com](mailto:wmrswapmeet@yahoo.com).

**PENNSYLVANIA, VALLEY FORGE**, March 23-25, RPM Meet, at Desmond Great Valley Hotel & Conference Center. Info at [rpm-valleyforge.com](http://rpm-valleyforge.com).

**SOUTH CAROLINA, NORTH CHARLESTON**, March 17-18, 2018, Spring Train Show, sponsored by Charleston Area Model Railroad Club, at Danny Jones Armory Park, 5000 Lackawanna Blvd. Info at [chamrc.com](http://chamrc.com).

**VIRGINIA, ROANOKE**, April 21-22, Coalfield Railroads RPM & Scale Train Show, at Valley View Holiday Inn. Info at [facebook.com/TheCoalfieldRailroadsRPMMeetAndScaleTrainShow](https://facebook.com/TheCoalfieldRailroadsRPMMeetAndScaleTrainShow).

**WISCONSIN, CEDARBURG**, March 11, 23rd Annual Model Railroad Show & Swap Meet, sponsored by Metro Model Railroad Club, at Circle B Recreation Center, 6261 Highway 60. Info at [metrorrclub.org](http://metrorrclub.org).



## Beyond 2018

**UTAH, SALT LAKE CITY**, July 7-13, 2019, NMRA National Convention and National Train Show. HQ hotel is Little America Hotel. Info at [nmra2019slc.org](http://nmra2019slc.org).

**MISSOURI, ST. LOUIS**, July 12-18, 2020, NMRA National Convention and National Train Show. HQ hotel is Hilton St. Louis at the Ballpark. Info at [gateway2020.org](http://gateway2020.org).

**CALIFORNIA, SANTA CLARA**, 2021, NMRA National Convention. ■

### Take the MRH 2018 Reader Survey ...



... and get a chance  
to win a 7" Kindle  
Fire tablet!

(10 tablets will be awarded)



amazon

**TAKE THE SURVEY >>**

Please take this survey, it really helps us know much better what kind of articles and videos to make for you!

**VIEW READER  
COMMENTS**

*click here*





# The Amherst Railway Society Railroad Hobby Show

Our 2018 Show will be

## January 27 & 28, 2018

Save the dates!

**Click  
to learn  
more ...**



## About The Show

Every year late in January or early in February, the Amherst Railway Society holds its Railroad Hobby Show at the Eastern States Exposition Fairgrounds (The home of The Big E) in West Springfield, Massachusetts. More than 25,000 railfans and public attended the Show each of the past three years.

The event features real life railroads and scale model railroads, historical societies, travel agencies, art shows, flea market dealers, importers, manufacturers and photographers. You have to see it to believe it!

• [INDEX](#)



**SUBSCRIBE**  
*(free)*

• [TABLE OF CONTENTS](#)

<a href="#"><u>Accu-Lites</u></a>	<a href="#"><u>Lights 4 Models</u></a>
<a href="#"><u>American Ltd (San Juan)</u></a>	<a href="#"><u>Litchfield Station</u></a>
<a href="#"><u>Amherst Railway Society</u></a>	<a href="#"><u>Logic Rail Technologies</u></a>
<a href="#"><u>Archer Fine Transfers</u></a>	<a href="#"><u>Main Street Heritage Models</u></a>
<a href="#"><u>Athearn</u></a>	<a href="#"><u>Micro-Trains Line</u></a>
<a href="#"><u>Atlas Model Railroad Co.</u></a>	<a href="#"><u>Model Railroad Benchwork (1)</u></a>
<a href="#"><u>Bachmann</u></a>	<a href="#"><u>Model Railroad Benchwork (2)</u></a>
<a href="#"><u>Backdrop Junction</u></a>	<a href="#"><u>Model Railroad Control Systems</u></a>
<a href="#"><u>Berrett Hill Trains</u></a>	<a href="#"><u>Mountain Subdivision Hobbies</u></a>
<a href="#"><u>Black Cat Publishing</u></a>	<a href="#"><u>MRH Store (1)</u></a>
<a href="#"><u>Blair Line</u></a>	<a href="#"><u>MRH Store (2)</u></a>
<a href="#"><u>Bowser</u></a>	<a href="#"><u>MRH Store (3)</u></a>
<a href="#"><u>Caboose</u></a>	<a href="#"><u>MRH Store (4)</u></a>
<a href="#"><u>Canyon Creek Scenics</u></a>	<a href="#"><u>MRH Survey (1)</u></a>
<a href="#"><u>Coffman Graphics</u></a>	<a href="#"><u>MRH Survey (2)</u></a>
<a href="#"><u>Creative Dynamic</u></a>	<a href="#"><u>NCE (2 page spread)</u></a>
<a href="#"><u>Crow River Products</u></a>	<a href="#"><u>North American Railcar Co.</u></a>
<a href="#"><u>Digitrax (2 page spread)</u></a>	<a href="#"><u>Pre-Size Model Specialities</u></a>
<a href="#"><u>El Dorado 3rd PlanIt</u></a>	<a href="#"><u>Precision Design Co.</u></a>
<a href="#"><u>ESU LokSound</u></a>	<a href="#"><u>Rapido (1)</u></a>
<a href="#"><u>Fast Tracks</u></a>	<a href="#"><u>Rapido (2)</u></a>
<a href="#"><u>Fast Tracks (Scale Lumber)</u></a>	<a href="#"><u>Ring Engineering (1)</u></a>
<a href="#"><u>Fine Scale Miniatures</u></a>	<a href="#"><u>Ring Engineering (2)</u></a>
<a href="#"><u>Good Deals DCC</u></a>	<a href="#"><u>Rulers-of-the-World</u></a>
<a href="#"><u>Great Decals</u></a>	<a href="#"><u>Rusty Stumps</u></a>
<a href="#"><u>HO Diesel Supply</u></a>	<a href="#"><u>Scale Trains</u></a>
<a href="#"><u>HO-Modern Models</u></a>	<a href="#"><u>Scotty Mason Show</u></a>
<a href="#"><u>Iowa Scaled Engineering (ISE)</u></a>	<a href="#"><u>Sea Port Model Works</u></a>
<a href="#"><u>ITLA Scale Models</u></a>	<a href="#"><u>Soundtraxx (Blackstone)</u></a>
<a href="#"><u>Kadee (1)</u></a>	<a href="#"><u>Southern Digital</u></a>
<a href="#"><u>Kadee (2)</u></a>	<a href="#"><u>Streamlined Backshop Services</u></a>
<a href="#"><u>Ken Patterson.com</u></a>	<a href="#"><u>TAM Industries</u></a>

[TAM Valley Depot](#)

[The DCC Shop](#)

[Tony's Train Exchange](#)

[Train Control Systems](#)

[Traintek](#)

[TrainMasters TV \(1\)](#)

[TrainMasters TV \(2\)](#)

[Walthers](#)

[Westerfield Models](#)

[Yankee Dabbler](#)

[Yarmouth Model Works](#)

## Clickable "other" index

---

[Other - Contents](#)

[Other - Cover](#)

[Other - Derailments](#)

[Other - Hobby Marketplace](#)

[Other - MRH Sponsors](#)

## DOWNLOAD ISSUE

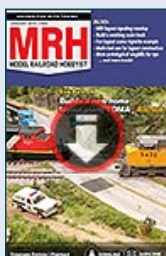

DOWNLOAD PORTRAIT



DOWNLOAD LANDSCAPE



# REVERSE RUNNING

commentary



Model Railroad Hobbyist | January 2018 | #95

**DON HANLEY** GETS A DREAM  
COME TRUE GIFT FOR CHRISTMAS ...



RATE THIS ARTICLE



**WELL,  
CHRISTMAS IS  
OVER. I TRUST  
THAT SANTA**

brought you just  
what you wanted.

Since Santa sprinkled his Christmas elf dust all over me, there are all sorts of things that I can do now. I have all the time I need to

work on the layout. And everything I work on, I only have to do once.

My track plan fits with no problems, and track laying is perfect the first time around. Ah, no more frustrations!

▶ **STEPPING OUTSIDE THE BOX WITH A CONTRARY VIEW**



Hobby money is not an issue, I have all the discretionary funds I need for the hobby, as well as a large finished layout room in which to build my dream layout.

I have a separate work room where I can take sections of the layout in and work on them. The section being worked on can be rotated so there is no crawling under the benchwork.

When I am done working on that piece, I just roll it back into its place and plug it back in. I have all of the tools and supplies I need at my fingertips.

My backdrops are works of art that appear to go on forever. The seam between the backdrop and the layout is, well, seamless – you can't see it. My trees seem to sway in the wind. I even have leaves that fall off the trees during an autumn operating session and then return to the trees after it's over.

What, you didn't get all of this for Christmas?

Oh wait, I just woke up ... yeah, I was having a dream!

Yes, I have to work through my track laying problems and my model building kinks just like the rest of you. Nothing just comes naturally, it seems.

Like you, my time and money limitations are real. And yes, I too struggle to help family and friends understand my model train hobby.

Well, Don – welcome back to the real world.

Sigh... it was nice while it lasted!

*P.S. Happy New Year and may all of you have a blessed 2018.*



# DERAILMENTS



RATE THIS ARTICLE

Model Railroad Hobbyist | January 2018 | #95

**VIEW READER  
COMMENTS**

*click here*

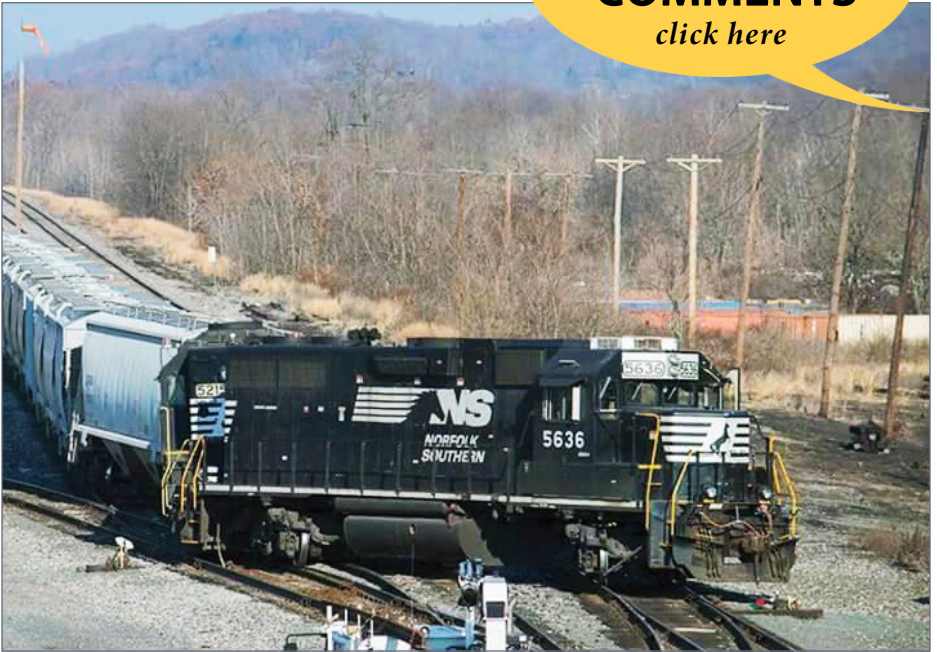

## Can you say oops?

For this engine to split the switch this badly, it likely had some speed. Once the engineer realized what was happening, he would have thrown it into emergency, but the train mass just kept dragging it. ■

► **BIZARRE FACTS AND HUMOR (SUPPOSEDLY)**

• [INDEX](#)

• [TABLE OF CONTENTS](#)

COMING NEXT ISSUE ...



Union Pacific modules of Peter Bakhtar and Mel Johnson



Tale of two hoppers ...

HAVING FUN WITH TRAINS  
FEBRUARY 2018 | FREE

# MRH

MODEL RAILROAD HOBBYIST

Peter Bakhtar and Mel Johnson's  
Union Pacific layout modules  
▶ **READ NOW**



Building an Accurail 36' boxcar ...

... and lots more coming  
in February MRH!

• [INDEX](#)



SUBSCRIBE  
(free)

• [TABLE OF CONTENTS](#)