

HAVING FUN WITH TRAINS

FEBRUARY 2018 | FREE

MRH

MODEL RAILROAD HOBBYIST

ALSO:

- Upgrading Accurail 36' boxcars
- Modeling El Portal
- Rusting a metal boxcar roof
- Easy wireless walkaround DC
- CSX covered hopper kitbash

... and more inside!

Peter Bakhtar and Mel Johnson's

Union Pacific layout modules

▶ **READ NOW**



STANDARD EDITION | PORTRAIT



DOWNLOAD



SUBSCRIBE
(free)

AVAILABLE FOR PRE-ORDER IN FEBRUARY 2018 FROM



BERWIND "C" REPAINT

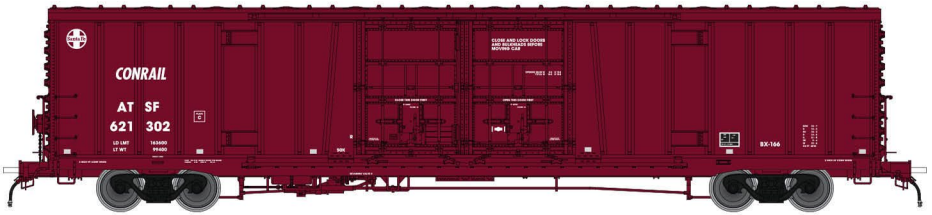

Custom-built by the ATSF in 1974, a total of 300 Bx-166 boxcars were built at the Santa Fe's car shops in Topeka, KS. Measuring 61'-6" in length (66'-1/2" over strikers), this icon of beer transportation has proven invaluable to the Santa Fe and, later, BNSF. Boasting two 8' insulated doors on each side, the Bx-166 provides a total of 16' door opening width for crews to load and unload pallets and kegs of beer. With over 40 years in service and still going strong, many Bx-166 boxcars have now been relegated to non-beer service, such as the hauling of bundled corrugated and paper recyclables. Some cars have also been retired altogether, but a large number of these boxcars are still living up to their original mission of delivering beer.

ATLAS MASTER® HO & N BX-166 BOX CARS



BERWIND "C" REPAINT



ATSF MINERAL BROWN 24" LOGO-VAR#3



ATSF MINERAL BROWN - LATE "Q" LOGO VAR#2



BERWIND "J" REPAINT



ATSF MINERAL BROWN 24" LOGO-VAR#4



ATSF MINERAL BROWN - PLAIN (NO LOGO)



ATSF MINERAL BROWN 24" LOGO-VAR#1



ATSF MINERAL BROWN - EARLY "Q" LOGO



ATSF MINERAL BROWN 24" LOGO-VAR#2



ATSF MINERAL BROWN - LATE "Q" LOGO VAR#1

**GUARANTEE YOUR
PRE-ORDER TODAY!**

CLICK HERE!

FOR MORE INFORMATION OR TO LOCATE A DEALER, PLEASE VISIT WWW.ATLASRR.COM.
ATLAS MODEL RAILROAD CO., INC. • 378 Florence Ave., Hillside, NJ 07205

STAFF CREDITS

HAVING FUN WITH TRAINS

MRH
MODEL RAILROAD HOBBYIST

Model Railroad Hobbyist | February 2018 | #96

(Updated 02/28/18)



RATE THIS ISSUE

ISSN 2152-7423

Editorial Staff



Joe D. Fugate, Publisher and Editor



Don Hanley, Assistant Editor



Patty Fugate, Pasteup and Layout



Richard Bale, News and events



Jeff Shultz, News and events, Tech Assistant

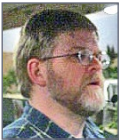

Joe Brugger, Copy Editing



Mike Dodd, Copy Editing

Advertising

Les Halmos, Account Manager

Daniel Nava, Advertising Assistant

Jean-François Delisle, Marketing Assistant

Columnists

Larry Smith, Narrow Gauge/Shortlines

Bruce Petrarca, DCC

Ken Patterson, Reporter at large

Rotating Columnists

Jack Burgess, Getting Real column

Nick Muff, Getting Real column

Mike Rose, Getting Real column

Tony Thompson, Getting Real column

Rob Clark, Imagineering

Dave Meek, Imagineering

Ray Dunakin, Imagineering

Issue password: Feb2018

Published for the glory of God. [What's this?](#)

• [INDEX](#)



SUBSCRIBE
(free)

• [TABLE OF CONTENTS](#)

MRH SPONSORS



Model Railroad Hobbyist | February 2018 | #96

A - D



acculites.com



americanlimitedmodels.com



railroadhobbyshow.com



archertransfers.com



athearn.com

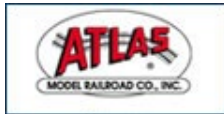

www.atlasrr.com



bachmanntrains.com



backdropjunction.com

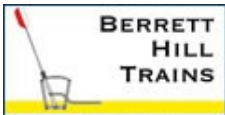

berretthill.com/trains



blairline.com



bowser-trains.com



mycaboose.com



coffmaneng.com



con-cor.com



www.digitrax.com

[Vendors: Get your clickable logo here ...](#)

E - R



trackplanning.com



esu.eu/en



handlaidtrack.com



handlaidtrack.com/mt-albert-scale-lumber



iascaled.com



kadee.com



lights4models.com



litchfieldstation.com



micro-trains.com



store.mrhmag.com



modeltechstudios.com



ncedcc.com



www.pwrs.ca/main.php



rapidotrains.com



ringengineering.com



rustystumps.com

When talking to hobby vendors, please remember to mention MRH.

[Vendors: Get your clickable logo here ...](#)



S - Z



sanjuancarco.com



scaletrains.com



soundtraxx.com



sodigi.com



sbs4dcc.com



tamvalleydepot.com



tsdcc.com



tonystrains.com



traintekllc.com



walthers.com

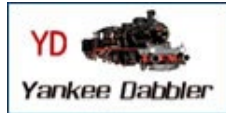

yankeedabbler.com

[Vendors: Get your clickable logo here ...](#)

Looking for something? Check the MRH Marketplace!

The screenshot shows the MRH Marketplace website with several vendor advertisements. Advertisements include: 'MRH Marketplace' banner, '771.5 Scale Models' by Main Street America, 'Main Street Heritage' for model buildings, 'Yarmouth Model Works' for model houses, 'The DCC Shop' for DCC products, 'Crow River Products' for model cars, 'Coupler Conversions' for model couplers, and 'Kadlec' for model trains. The website also features a search bar, navigation links, and a footer with 'MRH MAG.COM', 'SUBSCRIBE', 'INDEX', and 'TABLE OF CONTENTS'.

Take me there!

LED
LIGHTING
INSTALLED



R&D sample model shown

TUNNEL VISION

ANNOUNCING THE REFRESHED ATHEARN® READY-TO-ROLL® SD40T-2

The Athearn® RTR SD40T-2 matches a high level of detail, Econami sound by SoundTraxx, and innovative new features, to an affordable price. Additionally, the new run features for the first time LEDs, Rubber MU hoses, and photoetch windshield wipers. Never has there been a more flexible and unique solution for modelers who not only enjoy operation, but customizing their locomotives as well.

Recreating the essence of the tunnel motor, with its see-through low set radiator grilles, challenged previous underframe designs. Many common Athearn driveline parts were utilized to make maintenance and upgradability

simple. Plus, the new underframe is compatible with the optional ATHG63839 Genesis® motor retrofit kit.



NEW SOUND & LED LIGHTING
DCC-READY: \$139.98
DCC+ECONAMI SOUND: \$199.98



Gear tower moved, providing more visibly see-through grilles



New DRWG late delivery nose with protruding gyralight

VISIT ATHEARN.COM FOR COMPLETE LIST OF FEATURES.
ORDER TODAY!

HORIZON
H C B B Y

VISIT
Your Local Retailer

CLICK
Athearn.com

CALL
1.800.338.4639

SERIOUS FUN®

©2007 Horizon Hobby, LLC. Athearn, Genesis and McHenry are registered trademarks of Horizon Hobby, LLC. All other trademarks, service marks and logos are property of their respective owners. Final models may vary slightly from photos shown. 56638

• [INDEX](#)



SUBSCRIBE
(free)

• [TABLE OF CONTENTS](#)

TABLE OF CONTENTS



Model Railroad Hobbyist | February 2018 | #96

FEATURES



Union Pacific Railroad modules

ROBERT SCHLEICHER



Tale of two hoppers

ANDREW CASTLE



Easy wireless DC walkaround

MARK GILGER



Accurail 36' boxcar assembly

ERIC HANSMANN

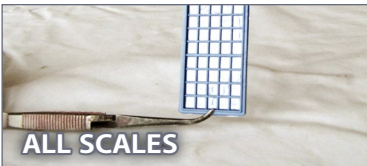

Easy inexpensive window glass

EDWARD WERICK

TABLE OF CONTENTS | 2

COLUMNS

MRH Q-A-T

Compiled by *JOE BRUGGER*

X2f couplers, Bachmann steamer, ...

DCC Impulses

BRUCE PRETRARCA

Adjust your decoder's personality ...

Getting Real

JACK BURGESS

Modeling El Portal ...

What's Neat

KEN PATTERSON

Weathering roofs, On30 layout, ...

Yes, it's a model

Compiled by *JOE FUGATE*

MRH's realistic model photo gallery

Derailments

Compiled by the MRH Staff

Surprising train twist

NEWS and EDITORIAL

Assist. Editor's Thoughts

DON HANLEY

News & Events

RICHARD BALE and JEFF SHULTZ

Reverse Running

JOE FUGATE

ALSO:

MRH Marketplace

Subscriber extras

• [INDEX](#)



SUBSCRIBE
(free)

• [TABLE OF CONTENTS](#)



AVAILABLE FEBRUARY

HO Gunderson 5188cf Covered Hopper

(ACTUAL MODEL SHOWN)

AOK  **CMO**



BNSF

Heritage:   



HO
E87 SCALE

Preorder Now

PREORDER N SCALE TOO



ALSO AVAILABLE IN...



© 2018 ScaleTrains.com, Inc. ScaleTrains.com, Operator, Rivet Counter, and respective logos are trademarks of ScaleTrains.com, Inc. ScaleTrains.com, Inc. 7598 Highway 411 Benton, TN 37307 844-9TRAINS 844-987-2467 International 423-299-3689

Scene and photography by Ken J Johnson
First test model shown

• [INDEX](#)

• [TABLE OF CONTENTS](#)

ASSISTANT EDITOR editorial



Model Railroad Hobbyist | February 2018 | #96



RATE THIS ARTICLE

DON HANLEY ASKS IF THE
HOBBY IS GETTING TOO EXPENSIVE ...

A COMMON HOBBY COMPLAINT IS HOW EXPENSIVE it is and at the rate it's going, soon no one will be able to afford it. But has it really gotten that expensive?

We all dream of having a huge basement or garage-filling layout empire. I have gone so far as to draw up plans for such a layout. However, let's have a reality check: for 95% of us, it ain't going to happen.

One major pitfall working against us (myself included) is that we purchase what we want, not what we need. We go to a train show and see all of the eye candy and losing all self-control, we purchase a bit of everything. At home later, you wonder: why did I buy that?

In this phase we are just consumers. It's important to get out of this phase as soon as possible for sake of sanity, the budget, and maintaining a happy home! But let's be honest: this is where we all start.

Somewhere along the way, I got smart and scaled down my hobby aspirations to focus on a specific road, time period, and yes, all the way down to a single town.

• [INDEX](#)



SUBSCRIBE
(free)

• [TABLE OF CONTENTS](#)

A key to enjoying the hobby more, I believe, is to determine what you like. I mean more than just "I like the steam to diesel transition era." It needs to be as specific as possible.



THE ONE TOWN LAYOUT

Check out the "One Town Layout" blog by Jim Six on the MRH website for some good ideas on how to do a one-town layout well.

WEB: mrhmag.com/blog/jamessix

I began focusing on a specific railroad, then down to a specific time period, and finally a down to a *specific town*. I now have an "L" shaped layout that is 24' x 5' along two walls of the garage.

It's a one town layout, Bluffton IN. I am proto-lancing a line that existed in that

ADVERTISEMENT

CABOOSE™

Sharing Our Passion for Trains Since 1938

Click Here for the Serious Modeler's Resource!

More than 170,000 items, over 490 manufacturers, most at a discount from full retail – all at a fair price.

As always, in-stock orders of \$100.00 or more ship free within the Continental U.S.!*

*surcharges may apply for oversize items.

10800 West Alameda Ave.
Lakewood, CO 80226
(303) 777-6766

ADVERTISEMENT

Lasercut structures. Highway, storefront and billboard signs.

**Neat ag customer for your railroad:
Farmers Fertilizer Supply**



WHAT'S NEW?



Established 1993...

Blair Line

MAKING RAILROAD HISTORY
WALTHERS MAINLINE

General Electric Evolution Series Diesels

HO SCALE



ALL-NEW MODELS AVAILABLE NOW!

- Standard high-adhesion, steerable or C4 A1A sideframes to match prototypes
- LED directional headlights & working front ditchlights
- NEW - Add grab irons and more with the GE ES44 Evolution Series Diesel Detail Kit (910-250, sold separately)
- Same powerful drive as WalthersProto® locos
- Available with SoundTraxx® sound for DCC or DC layouts
- Limited edition - one time run of these unit numbers!

BNSF Railway™ GE ES44C4



CSX® GE ES44AH



Canadian National GE ES44AC



Norfolk Southern GE ES44AC



Canadian Pacific GE ES44AC



Union Pacific® GE ES44AH



CLICK HERE TO LEARN MORE!

WALTHERS

Support your local hobby shop • visit walthers.com • call 1-800-4-TRAINS

Availability information is accurate at press time, for updates visit walthers.com. Photos show early preproduction models, some colors and details may vary. **The BNSF marks are licensed marks owned by the BNSF Railway Company. *CSX proprietary marks used by permission of CSX Transportation, Inc. †Union Pacific licensed product. ©2017 Wm. K. Walthers, Inc.

• [INDEX](#)



SUBSCRIBE
(free)

• [TABLE OF CONTENTS](#)

**MICRO-
TRAINS®
LINE**

NEW N & Z LOCOMOTIVES NOW AVAILABLE!

986 00 513 - SW1500 Southern Pacific®

986 00 080 - SW1500 NASA

993 01 550 - Weyerhaeuser Logging Train Set w/ SW1500 Locomotive

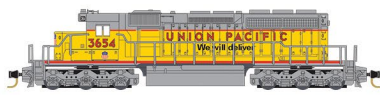
**970 01 211 - Z SD40-2 Norfolk Southern
COMING SOON**

**970 01 221 - Z SD40-2 Union Pacific®
COMING SOON**

<<< VISIT MICRO-TRAINS.COM TODAY! >>>

ASSISTANT EDITOR'S THOUGHTS | 3

town between 1902 and 1917, before it was sold to scrappers for liquidation. While the line did not exist during the time period I model, 1952-55, for my purposes I assume it survived with the Erie leasing it sometime around 1916.

What has this planning and focus done for me? I limit my purchases now to what supports my modeling goals, not whatever catches my eye at the moment. By reducing the size of my layout, I have reduced its cost.

I need to purchase fewer turnouts and less track. The number of locomotives and rolling stock required for the layout is smaller. My existing fleet that I have acquired over 35 years is more than adequate to service the layout.

I also discovered that by building a small layout, tasks that I don't enjoy such as wiring and installing switch machines, get

N
SCALE

DCC[®]
SOUND VALUE
ON BOARD



C&O KANAWHA #2724 • Item No. 50953

THE SOUND VALUE BERK IS BACK!

The 2-8-4 Berkshire is back in stock in Bachmann's line of N scale DCC sound-equipped locomotives. It features our Sound Value *SoundTraxx*[®] steam package including authentic prototypical chuff, short and long whistles, bell, air pump, steam release, and blower—all in 16-bit polyphonic sound. The Berkshire also features a die-cast chassis, precision motor, and finescale detailing per prototype. Visit your favorite hobby dealer to enjoy this popular N scale sound-equipped steam engine from Bachmann!

Features include:

- DCC sound-equipped
- precision motor
- die-cast chassis
- details and tender style per prototype
- brass-machined flywheel
- metal handrails and standchions
- LED headlight and tender backup light
- die-cast marker lights
- see-through underframe
- metal wheels
- magnetically operated *E-Z Mate*[®] Mark II couplers



NICKEL PLATE #765 - RAILFAN VERSION
Item No. 50951

Click for
more info



NICKEL PLATE #759 - RAILFAN VERSION
(with Mars Light)
Item No. 50952



C&O KANAWHA #2760
Item No. 50954



PERE MARQUETTE #1225
Item No. 50955



SHIPPING NOW! • MSRP \$349.00 each



Bachmann Industries, Inc. • 1400 East Erie Avenue • Philadelphia, PA 19124 USA • www.bachmanntrains.com
Click to learn more.

• [INDEX](#)



SUBSCRIBE
(free)

• [TABLE OF CONTENTS](#)



LED's, Signs, and Sounds for All Scales

FIND US ON FACEBOOK



Miller Signs | Evan Designs

Iron Penguin | Ring Engineering

EZ Line | Tomar | ITT Sound Boards

www.lights4models.com

614-296-8691

ADVERTISEMENT



CRAFTSMAN KITS



Also Checkout our **DETAIL 3D Parts** in HO, S and O Scales.

CHECK IT ALL OUT AT

WWW.RUSTYSTUMPS.COM

THE QUALITY IS INSIDE BECAUSE OUR NAME IS OUTSIDE

ASS'T EDITOR'S THOUGHTS | 4

reduced too. I can spend more time on the tasks I enjoy!

I can detail structures and scenes. Since I am a bit of a detail hound, this suits me well. I am also able to get my layout operational much sooner. By downsizing my aspirations, I have moved from the consumer phase of the hobby to more advanced phases of actively doing the hobby.

Was my journey to this point fast? No, it took me many years to get to this mindset. It does not need to take this long, though!

I am one of the few who stayed active in the hobby since I first entered it around the 8th grade. I made a lot of mistakes and my learning has come as much from what doesn't work as what does work. But one of my bigger mistakes has been being in the hobby consumer phase for way too long.

As I move away from the consumer phase to going deeper into the hobby, my degree of satisfaction and enjoyment of

NEW FROM RAPIDO ELECTRIC POWER

**HO
SCALE**



**CLICK
HERE**

NEW HAVEN'S ICONIC EP-5 ELECTRIC LOCOMOTIVE



SIX



PAINT



SCHEMES

• [INDEX](#)



SUBSCRIBE
(free)

• [TABLE OF CONTENTS](#)

the hobby has increased. And my commitment to the hobby now is stronger than ever.

As for costs, I did a little research and found a 1966 ad for an Athearn SD45. The price listed was \$17.95. I can hear it now: “see, I told you so. Model railroading was a lot cheaper” ...

Not so fast!

Allowing for inflation, that equates to \$134.90 in 2016 dollars. Athearn lists their current SD45-2 with DCC at \$189.98. That's only \$55.08 more and it's also DC vs DCC now, which is a big step forward in locomotive control. Some online discount sites sell it for under \$140, which is close to the inflation-adjusted price.

So is the hobby more expensive today? For at least a couple of reasons, I don't think so, especially if you move from being a conspicuous consumer to a more focused modeler.

Sad news: end of the line

As everyone knows, there are times we find ourselves at a crossroads in life. A decision must be made involving choices that are not always pleasant.

We recently closed one of our three businesses, and God blessed our other two business with explosive growth. My wife has had to focus on one business while I take the lead on the other, requiring each of us to spend more time in each respective business. That's the good news, bringing me to one of those crossroads.

Now the sad news. Because of our business growth, I no longer have the time required to be the Assistant Editor of MRH. With a heavy heart I tendered my resignation, effective the end of January.

While I will no longer be a member of the immediate MRH family, I will remain an active member of the MRH extended family. I still plan

Bowser

HO MLW M630 Locomotives

Ready to Run and Detailed. Features: air hoses, windshield wipers, grab irons, coupler lift bars, operating headlight, window glass, can motor, flywheels, nickel silver wheels with RP25 flanges and knuckle couplers.

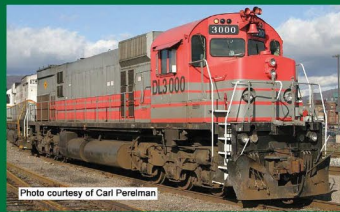

Photo courtesy of Carl Peralman

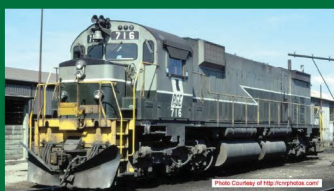

Photo Courtesy of http://mtrains.com



Photo courtesy of Conner Frasier



Photo courtesy Scott Davis

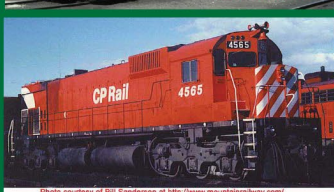

Photo courtesy of Bill Sanderson at <http://www.mountainrailway.com/>

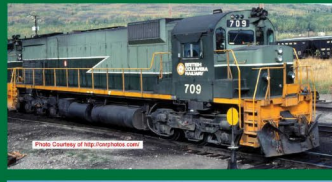

Photo Courtesy of <http://bowser.com>

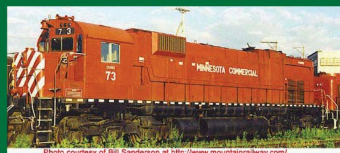

Photo courtesy of Bill Sanderson at <http://www.mountainrailway.com/>



Photo Courtesy of <http://mtrains.com>

Road Names: CP Rail, PGE, BCR, BC Rail, DL, WNY&P, & Minnesota Commercial

KIT INCLUDES: One piece plastic molded body, under frame, brake wheel, air tank, brake cylinder, triple valve, free rolling trucks with metal wheels, knuckle spring couplers, smooth painting, sharp lettering & car weights.

HO Freight Car Kits



In Stock!!
\$17.95 each

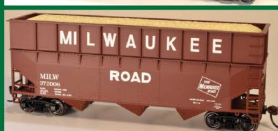

55 Ton
Fishbelly,
Wood Chip,
70 Ton 12
& 14 Panel
Hopper Cars

Click here to check out the details for these and other great Bowser Products

• [INDEX](#)



SUBSCRIBE
(free)

• [TABLE OF CONTENTS](#)

2003

Celebrating 15 Years!

2018

OF TRACK BUILDING INNOVATION

FAST TRACKS

Build your own trackwork easily, quickly, and affordably.

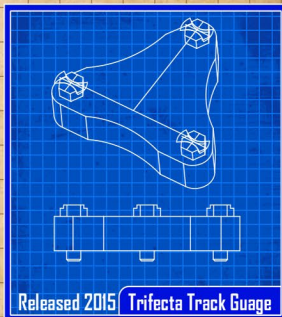
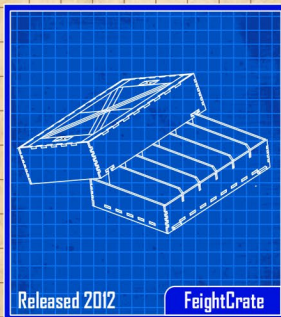
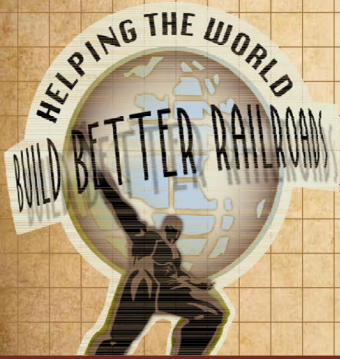
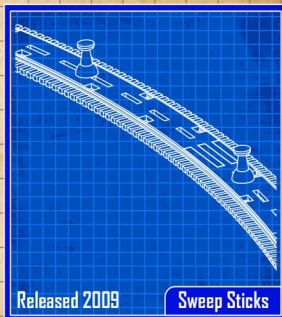
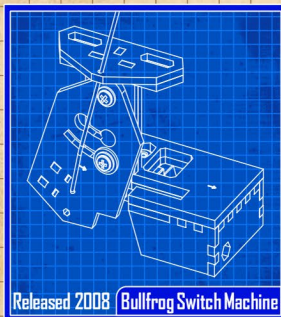
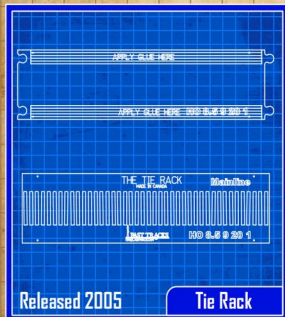
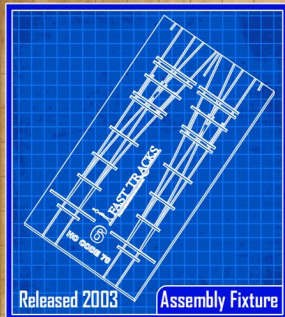

Easy ordering • Live online support • Earn Waypoints with every purchase

shop online 24/7 handlaidtrack.com

1-888-252-3895 service@fast-tracks.net

• [INDEX](#)

• [TABLE OF CONTENTS](#)

on writing articles from time to time. Maybe I can still write an editorial or two, or stir the pot with an occasional Reverse Running, which I have done on more than one occasion!

I want to take a moment to thank Joe, Patty, and the rest of the MRH staff for the friendship and camaraderie during my time with MRH.



**VIEW READER
COMMENTS**

click here

ADVERTISEMENT

“The Original Splice Clamp”™

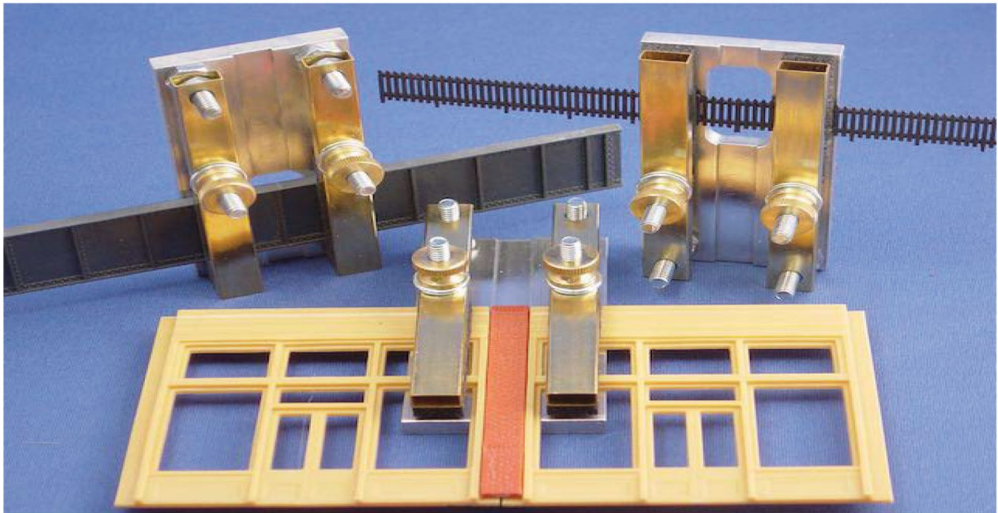

Coffman Graphic Solutions Co.
www.coffmaneng.com

• [INDEX](#)



SUBSCRIBE
(free)

• [TABLE OF CONTENTS](#)



LAST ISSUE'S RATINGS

The five top-rated articles in the [January 2018 issue](#) of *Model Railroad Hobbyist* are:

- 4.8 The NEW Pacific & Northwestern
- 4.8 MRH signaling roundup
- 4.7 What's Neat: Digitrax Xtender, Joe&Patty Fugate, ...
- 4.7 January 2018 news
- 4.6 Tool Shed: Multi-tool use for layout construction

Issue overall: **4.9**

Please rate the articles! Click the reader comments button on each article and select the star rating you think each article deserves. Thanks! ■

**Do ALL your model
railroading friends know
about MRH?**

**WE CONTINUE TO BE SURPRISED BY HOW MANY
MODELERS STILL HAVE NEVER HEARD OF US -
SO SPREAD THE GOOD WORD ABOUT MRH!**

DELETED ARTICLE CONTENT

The MRH cutting room floor is now available!



Access the deleted content >>
(you must be a subscriber -- but hey, it's free!)



• [INDEX](#)



SUBSCRIBE
(free)

• [TABLE OF CONTENTS](#)

DISCOVER TRAINMASTERS.TV

Helping you
achieve your
hobby dreams



Brought to
you by



[CLICK HERE](#)

Explore our
video treasure >>



MRH Subscriber? Get your 10% off coupon code here:

Get Subscriber
10% off code

• [INDEX](#)

• [TABLE OF CONTENTS](#)

MRH ... QUESTIONS, ANSWERS, TIPS



Model Railroad Hobbyist | February 2018 | #96

compiled by **JOE BRUGGER**



X2f coupler replacement

Q. My son and I have collected dozens old Life-Like freight cars and they all have the old-style plastic couplers that are not compatible with anything out today. I have looked at converting them to knuckle-type couplers, but the pivot point/hole on the old couplers is tiny compared to the couplers on our new rolling stock. Is there a way, short of cutting off the old coupler box (most are truck-mounted) and attaching a new body-mounted coupler box? We really like a number of the cars and I don't want to buy new cars, just to try to retrofit a few of them to the old couplers.

—Stephen W.

A. Tim Cunningham: I had similar cars from my youth when I recently took up the hobby again – mostly Tyco, and a couple Life-Like.

The one-piece molded plastic couplers themselves are called X2f, and the way they are mounted on the truck is called Talgo-style.

▶ **MRH QUESTIONS, ANSWERS, AND TIPS**

• [INDEX](#)



SUBSCRIBE
(free)

• [TABLE OF CONTENTS](#)

You want Kadee “whisker” couplers, most likely the standard 148 model, which can be bought in bulk.

You also need the Kadee 212 Talgo truck adapters, also sold in bulk, which look like a little “I.” You don’t necessarily need the special installation tool, but if you are doing a lot it may be handy. They can be just twisted in with needle nose pliers. Getting the old couplers out is actually harder than getting the new ones in! Remove the truck from the car by just yanking it off, and the installation is done from the top. The Talgo adapter fits over the little nub, with the shank of the coupler going around it, making for a perfect fit.

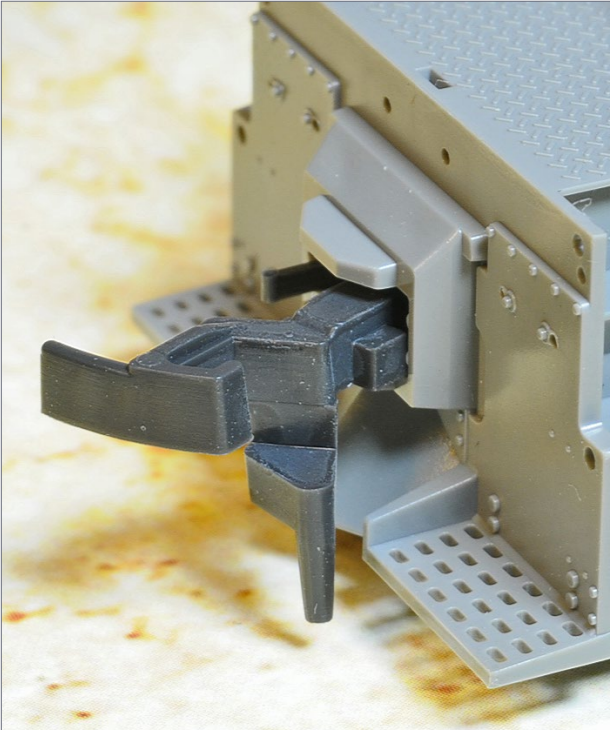

1. The X2f, or horn-hook coupler, was ubiquitous for decades in model railroading and a lot of older engines and cars still have them. But most modelers now prefer a knuckle coupler. What to do?



2. Kadee 212 Talgo truck adapter. *Kadee photo*

Ed: Truck-mounted couplers can work OK if you are always pulling a train, but if you try to back up, the pressure on the couplers and trucks will encourage them to skew sideways and derail. Body-mounting the coupler changes the forces.

Dave Branum: If you like the old cars it's possible to cut off the truck-mounted couplers, and then body-mount Kadees. It takes some experience to develop the skills needed to make this easy but it is interesting work. The other option is make a few transition



EARLY HO COUPLER CHAOS

An NMRA committee developed the X2f to resolve HO coupler chaos in the 1950s. Mantua, Varney, and others produced their own couplers. Some were knuckles; some like the Baker were a hook-and-loop design. Few of the plastic X2f couplers made met the NMRA specs for the design, so one form of chaos was replaced with another. Manufacturers liked a cheap, one-piece coupler that didn't have to be licensed. When Kadee's knuckle coupler patents expired, several companies developed their own versions.



cars with Kadees on one end and the old couplers on the other. Then run the old cars in cuts with a transition car on each end of the cut. Some cars like reefers and hoppers would often be run in cuts of the same type so they would look realistic running this way. One last thing to consider is that body-mounted Kadees work much better when backing up trains so there is a mechanical advantage to the effort.

Shoofly: My best suggestion is to take each car case-by-case. There will be no single technique that will work for every car on your roster. You may discover some neat shortcuts that will make coupler installation easier.

Choose three of your least-favorite cars to practice on, and develop the skills of using a pin vise and a 2-56 tap, and you will learn what works best for coupler location and mounting. Couplers have to be centered on the end of the car and at a consistent height.

Ken Rickman: Look at the Kadee website at kadee.com. A chart lists the right conversion for most of the cars you have. Some come with the plastic insert to fit over the tiny pin on the cars, so that you won't have to modify anything.

BeerLineModeler: Body-mounting Kadee couplers to cars like this is not out of reach for anyone. Get a Kadee coupler height gauge so you get everything at the right height. Buy some thin styrene strip about the width of the coupler boxes in case body-mounting flush against the floor of the car puts the coupler too high. If so, you can shim it down. I did this back in my youth (before middle school). You can do this, so go for it.

Before investing in a bulk pack, use the Kadee gauge (kadee.com/htmbord/height.htm) to make sure the standard coupler will give you the right height. All of my Tycos were spot-on but you may need overset or underset couplers on some of them; none needed

Kadee

August Pre-Order



#4321 RF&P 2878..... \$39.95



#6379 DHCY 50058... \$43.95



**For More
Pre-Order Cars
Click Here**

SANTA FE TK-N & TK-O

LATE 2018

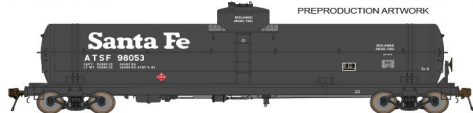

American Limited

6 numbers per version! Please contact your dealer!
www.americanlimitedmodels.com

Backdrop Junction

Your Stop for Railroad Backdrops

Click Here →

**For the Finest in Custom
Designed backdrop**



www.backdropjunction.com



Archer

FINE TRANSFERS
PROUDLY SERVING MODEL BUILDERS SINCE 1989

**THE ORIGINAL
SURFACE DETAILS™**

**WE NOW HAVE MORE
THAN 130 SHEETS OF
RIVETS, LOUVERS,
TREADPLATE, WELD
SEAMS AND MORE
CAST ONTO
MICROSCALE CLEAR
DECAL FILM**

LOW SHIPPING:

**DOMESTIC USA ORDERS
\$2.80**

**INTERNATIONAL ORDERS
\$9.95**

**CLICK HERE TO
VISIT OUR WEBSITE!**



MADE IN THE USA

Archer Fine Transfers • PO Box 1277 • Youngsville, NC 27596 • USA
(919) 570-1026 • info@archertransfers.com • archertransfers.com



anything but the standard length though. While you are at it, replace the plastic wheelsets with metal ones; the Intermountain 33-inchers work great (and are also sold in bulk). For an investment of a few minutes and dollars per car you will have a fleet that rolls almost as well as new rolling stock, with lots of great memories too!

Kadee conversion test kit: kadee.com/htmbord/page13.htm.

Kadee Talgo truck adapter: kadee.com/htmbord/page212.htm.

See the whole thread at mrhmag.com/node/14514.

Bachmann 4-8-4 problem

Q. I have a Bachmann 4-8-4 Northern. It is new production with the updated drive and can motor. It was purchased in 2011, and ever since I bought it it has had problems with the wheels slipping even when unloaded. I tried adding a traction tire with Bullfrog Snot, but it didn't do anything to ease the problems. This thing can barely pull itself, much less a train. All of my other 4-8-4s by Bachmann work flawlessly. What could possibly cause this and what can I do to fix it?

—Gopernoper

A. Ah-ha! As soon as I (Gopernoper) got home from a trip, I immediately got to work on it. When I removed the pilot truck, it turned out that there was NO SPRING underneath it! So I did as recommended, and ran it without it. The problem persisted. I removed the trailing truck, and the engine ran strongly with no wheel slip. The issue was the connection between the trailing truck and the unit. I simply adjusted it so that it wouldn't bind up against the frame and lift the drive wheels off the tracks. The problem is fixed and it now pulls fantastically. Thanks for all the help.



Announcing our next Limited Run PWRS / Micro-Trains® Car!!!

PWRS 

Canadian Pacific (CP) 3-pack

89' Tri-Level Closed Autorack



- black, gray
- white lettering
- CP Rail placard
- horizontal yellow reflectors
- moderate weathering

CLICK HERE FOR
CP Autorack

COMING
August 2018

Toronto Hamilton & Buffalo (TH&B) 4-pack

40' Single Door Standard Box Car

- brown
- white lettering
- light to moderate weathering



CLICK HERE FOR
TH&B Boxcar

COMING
September 2018

PACIFIC WESTERN RAIL SYSTEMS
SPECIAL RUN CAR



Pacific Western Rail Systems

• [INDEX](#)



SUBSCRIBE
(free)

• [TABLE OF CONTENTS](#)

While the questioner was away on business, the forum got together and offered several helpful steam troubleshooting hints:

Nelson Beaudry: Points to check on misbehaving steam: Can you actually see the wheels slipping? Or are you just assuming they are slipping when the engine is acting up? If in fact the wheels are really slipping, try to observe what is happening at the track. Are the wheels lifting off the track or are they just spinning with no tractive effort? Get yourself a good magnifying glass (cheapo from the dollar store is fine) and watch what happens to the driver wheels.

Is it possible that the leading and trailing truck are causing issues? Try removing them and run the engine that way. If the traction improves then you're on to something. On straight and level track (set up a 6-foot section on a table or the floor) and see how much force is exerted. Does it feel like it's pulling? Simple diagnostics will help you figure this out and ask more pointed questions.

It appears that this model does NOT have sprung drivers, whereas the Spectrum model does. Make sure that all the drive wheels are making good contact with the rail head.

Prof Klyzlr: Any time a loco simply “won’t put traction to the rail,” I place the loco on a sheet of glass. On a dead-flat sheet of



3. Bachmann’s Northern’s provide a modern mechanism and detailed body at a moderate price. *Bachmann photo*

glass, any wheels or axles which are cockeyed, not seated properly, or causing teeter-totter misloading of the loco weight balance instantly become obvious.

Ed: While the locomotive is on the piece of glass, try to slip a strip of notebook paper under each wheel. If the wheel is resting on the glass, the paper will bind up, or not go under the wheel at all. If the paper slides right under the wheel with little to no resistance, it's not making proper contact. In that case, adjustments need to be made to the axle mount or springs, so it will sit flat.

Read the whole story at mrhmag.com/node/32030.

Dripping salt etc.

Q. I would like to add spillage from cars, like a trail of salt leaking out of a covered hopper. What's the best way?

A. Dave Husman: My suggestion is to use diatomaceous earth, baking soda, plaster, or products made to represent snow. Real salt is too corrosive and a conductive to risk on a layout. Dribble a line of material, then mist it with a mix of alcohol and water (mostly water), followed by a mix of 1/3 white glue, 1/3 alcohol, 1/3 water using a squeeze bottle fitted with a fine nozzle. Much easier to control than a sprayer and you can put the glue exactly where you want it.

Selector: If the material you use to represent salt is fake and insoluble, sticking it down with thinned white glue might be the best way to get it to stick in place and to look realistic. Try Woodland Scenics "snow" in the smallest size and make a suitable scene with that. It can be vacuumed or scooped up, washed, dried, and relaid to restore your scene.

Peter F.: Marble dust (sold at art supply stores) is fine enough to look right and will have a little sparkle. Use a power saw, sander, file or rasp on a scrap of stone to make your own.



Ed: The same techniques will work to represent any fine, powdery material, like potash or blended fertilizers. Sanded grout comes in many colors.

Go to the thread at mrhmag.com/node/32079.

VIEW READER COMMENTS
click here

Take the MRH 2018 Reader Survey ...



... and get a chance to win a 7" Kindle Fire tablet!

(10 tablets will be awarded)

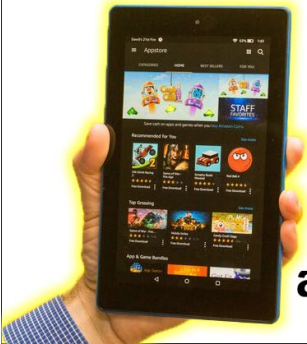

amazon

TAKE THE SURVEY >>

Please take this survey, it really helps us know much better what kind of articles and videos to make for you!



TIPS

Paint palettes; good for glue



4. Six by six. Six trays, six compartments.

much any dollar store, WalMart, Target, and anywhere else that has arts and crafts or artist's supplies. Each tray has six small plastic cups for mixing paint – they are perfect for applying CA glue.

Squeeze some glue into the cup, and the glue will stay fresh for several hours while you work. Should the glue dry up (usually after about 12 hours or so... at least, that's when I finally noticed it dry) the dried glue will pop right out of the cup so the cup can be used again!

I use one tray for my "Crazy Glue," and the rest for mixing paint colors. It handles all three varieties of CA I've been using, from the thick gel

I ran across something by accident that I'd love to share as a quick tip! Use CA glue? Now, generally, we squeeze a couple of drops into a bit of plastic, like an old WalMart bag or plastic grocery bag, but that can get messy and the CA can be hard to see on the plastic.

I found a solution: Dollar Store plastic Paint Palettes. They come six to a package for a buck at pretty



to the “original formula” to extra-strength thin liquid, as well as white glue and water-mix, for smaller projects. All of these glues just pop out of the trays when dried. They are also handy for blending weathering pigments or chinks.

Note: The palette is made of styrene and will not work well with solvent glues for styrene. Try a glass shot glass for that.

—Richard Lantz

**VIEW READER
COMMENTS**

click here



GET PAID FOR YOUR TIP

We pay \$25 per tip we publish, or \$40 each if the tip also includes a photo or finished drawing.

[Click here and select article type TIP.](#) ■

When talking to hobby vendors, please remember to mention MRH.

Litchfield



S T A T I O N

"Where we make DCC fun!"

**We Carry
A Full Line of
Digitrax Products
at GREAT Prices!**

**Lenz is back
& we have stock
available!**



Click here to visit our website:

**www.LitchfieldStation.com
623-298-7355**





Complete Train Control

Introducing Wifi Interf

- **Wi-Fi interface to a Digitrax LocoNet for up to four compatible mobile Wi-Fi devices and Apps.**
- **Compatible with most Android and Apple devices running supported throttle apps**
- **Easy Setup and Configuration. A single LNWI works 'out of the box', with no additional configuration required.**



LNWI Loconet
The LNWI allows
to LocoNet and r

Find out how eas

g the LNWI face



et Wifi Interface | **\$79 MSRP**
you to connect compatible WiFi devices
run trains using compatible throttle apps

by it is @ www.digitrax.com/throttleapps/

• [INDEX](#)



SUBSCRIBE
(free)

• [TABLE OF CONTENTS](#)

TONY'S TRAIN XCHANGE

Committed to your DCC support!

SoundTraxx Tsunami2



Premium Sound Decoders with Accurate, Prototypical Sounds and Superior Motor Control. For N Scale Through G Scale.

Starting at \$87.96

[Order Yours](#)

TDS SuperSonic Speakers & Enclosures

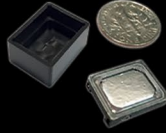

Incredibly Big, High Quality Sound, From Incredibly Small, High Quality Speakers. Don't Forget Enclosures!

Starting at \$5.95

[Order Yours](#)

SoundTraxx Current Keeper



Experience hiccup-free sound and operation with any DCC decoder using this quality capacitor!

\$21.60

[Order Yours](#)

**Do you need a Sound or
DCC Installation done?**

Get a quote!



Providing unmatched person to person DCC support for more than 25 years, the kind of service that has made us #1 in DCC. **DCC questions? CALL US! 1-800-978-3472**

We'll get you on the right track!

Feb 2018



• [INDEX](#)

• [TABLE OF CONTENTS](#)

DCC IMPULSES

column



Model Railroad Hobbyist | February 2018 | #96

BRUCE PETRARCA MMR

SHOWS HOW TO ADJUST YOUR DCC
DECODER'S PERSONALITY EASILY ...



“PROGRAMMING A DECODER” HAS MANY model railroaders thinking of geeks in white lab coats in a room full of flashing lights. That’s why I avoid the term “programming” in favor of “setting” or “adjusting personality.” Heck, “training” is better, in my mind.

Let’s see what we can do to blow away the fog.

For starters, there are two versions of programming: setting personality and loading sounds. I covered sound loading in a prior column, mrhmag.com/magazine/mrh2016-08-aug/dcc-impulses. Here we’ll just talk about training the decoders, not loading sounds.

Okay, there are a few initial steps to get you to where you can fine tune your decoder to your own desires. You need to be communicating with your decoder.

One step builds upon another. First, we need to get your DCC system set up so that you can adjust a decoder. It is all about

▶ **MODELING REAL RAILROADS AND WHAT THEY DO**

• [INDEX](#)



SUBSCRIBE
(free)

• [TABLE OF CONTENTS](#)

communication. Later, I'll get into some of the basics of programming.

The initial step is to assure that you can talk to your DCC system command station. This communication can originate from a cab connected to the command station, or from a computer. Let's walk first, by working initially with a cab. Then we can run with the computer.

Using a cab to communicate

To assure that you are talking with your DCC command station [1], put a loco with a decoder installed on a running, not programming track and make sure you can control it. Running it forward and backward will suffice.

Types of programming

Most DCC systems allow two places to program your decoders: on the isolated programming track and on the main track where you run your locomotives.



Most of what we'll discuss here relates to the programming track, also called service-mode programming. Beforehand, I'd like to share a few thoughts about Programming On the Main track (POM).

1. Using a DT400 cab to communicate with the decoder.
Bruce Petrarca photo



Southern Digital

WWW.SODIGI.COM

Celebrating 25 Years of serving you !



**Soundtraxx Tsunami
Motor/Sound Decoder**
50% Off while they last

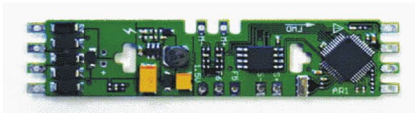

Super Sale



Complete Train Control

Simplex Radio
Throttle clearance
while they last



Close Out

DT402R
\$165

UT4R
\$99

DCC Conversions, Service & Support

E-mail: sales@sodigi.com (770) 929-1888



• [INDEX](#)



SUBSCRIBE
(free)

• [TABLE OF CONTENTS](#)

There is a 99% chance that, if you are programming using the main track, you will not be able to read what is stored in the locomotive's decoder. That remaining 1% will involve sophisticated DCC systems with either RailCom or Digitrax Transponding bidirectional communication.

POM utilizes the decoder's address to tell one specific decoder to make a unique change. Blast-mode is a special case of POM and is activated by selecting address zero. On supported systems, this blasts the change to every locomotive on the layout.

So, verifying that you have selected the specific decoder you want to program is very important. If you enter an incorrect address and there is not a corresponding locomotive on the layout, nothing will happen. A message will be sent but nothing will respond. You will have no notification that the message just fell on the floor. If the address is set to zero, you may set every locomotive on the layout to the characteristic in the command issued.

How do I use the programming track?

Set a locomotive with a decoder on the programming track. The programming track should be the only one connected to the programming track outputs (PROG A and PROG B in [2]). To verify that you are programming the locomotive on your programming track, select page-mode programming and read CV 1 (the short address). You are very likely to get an answer of "3". You should get an answer between 0 and 127. In most cases, the locomotive will jerk slightly when the CV is read.

If you don't get a correct value readback, troubleshoot your setup until you do. For example: check your cab connection and your track connections. Make sure you have the locomotive on the programming track. Check for clean track and wheels. Try another locomotive, preferably one without a sound decoder or without a keep-alive module. If you are successful in reading this alternate



The Future of Model Railroading

ESULLC 23 Howard Street Montoursville, PA (570) 980-1980

CabControl WIRELESS CONTROL SYSTEM

- ✓ Completely wireless model railroad operation
- ✓ Ergonomic, Android based remote control unit with TFT Display
- ✓ Internal database capable of holding more than 16,000 locomotives with specific names and symbols and up to 28 functions per locomotive.
- ✓ Easy to create multiple unit consists. Capable of configuring and controlling more than 1,000 switches and other accessories
- ✓ Conveniently updatable with internet connection
- ✓ Runs all DCC decoder equipped locomotives
- ✓ Automatic train detection using RailCom-Plus®
- ✓ Integrated 7A Booster

ESU Mobile Control II

- + Android operating system
- + 3.2" TFT Display, 800x400 resolution
- + Large Dial for easy speed control and direction change capabilities.
- + 4 user-personalized buttons
- + Micro USB port for Software Updates and battery charging
- + 5-8 hours of battery life.
- + 3.5 mm stereo headset port (microphone & headphone)

ESU Integrated Control Unit

- + CabControl creates a wireless network for over 32 wireless controllers
- + Connects through your LAN to provide internet connection
- + USB Port for Software Updates and throttle charging
- + DC 5.5 mm / 2.1 mm socket for external regulated DC power supply



Locomotives

Data for over 16000 locos can be held in the system
Loco Icons show the engine you are running
28 colorized graphical Icons for easy function identification



Accessories

More than 1000 accessories can be controlled and can have status visually displayed



Consisting

Easily created virtual consists so no CV changes are needed
Ability for all functions to be controlled while in consists



Conveniently Updatable

Updated easily for free as new features become available



Ethernet

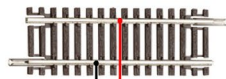

YouTube

[Click here for a short introductory video!](#)

• [INDEX](#)



SUBSCRIBE
(free)

• [TABLE OF CONTENTS](#)

locomotive, you may need a Programming Track Booster to read the original decoder.

Programming Track Boosters (PTBs)

PTBs are circuits that connect between the DCC command station and the programming track. They don't really boost anything, but interpret the signals between the original NMRA specification and a later variation designed to accommodate reading from newer decoders. Decoders with a lot of energy storage, such as many



2. Track connections on Digitrax DCS100. The “main” track connects to RAIL A and RAIL B (right side of the grey connector). The “programming” track connects to PROG A and PROG B (in the center of the same connector). *Bruce Petrarca photo*

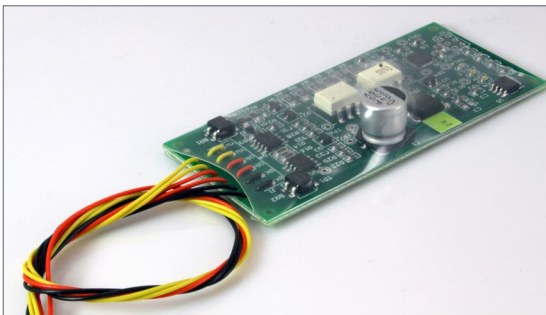

3. Soundtraxx PTB-100 Programming Track Booster. *Bruce Petrarca photo*

sound decoders and those with large keep alive modules or capacitors, may need a PTB. Newer command stations may not need a PTB with many, or all, decoders.

A PTB won't damage a decoder connected to it, whether the decoder needs a PTB or not.

Some PTBs may cause issues with some command stations that don't need them. Check with other users or the manufacturer of your system to see if you need one. For more information, see my July 2012 column at mrhmag.com/magazine/mrh-2012-07-jul/dcc_impulses.

Now, if you have all this together, you can use your cab to set up your locomotives and keep a notebook with all the changes you made to your roster. There are online tutorials as to how to work with those complicated indexed CVs, such as 2.503. Of course, you will still have to deal with the various programming track modes, such as page, direct-bit, and direct-byte. Do you know which mode your decoder prefers?

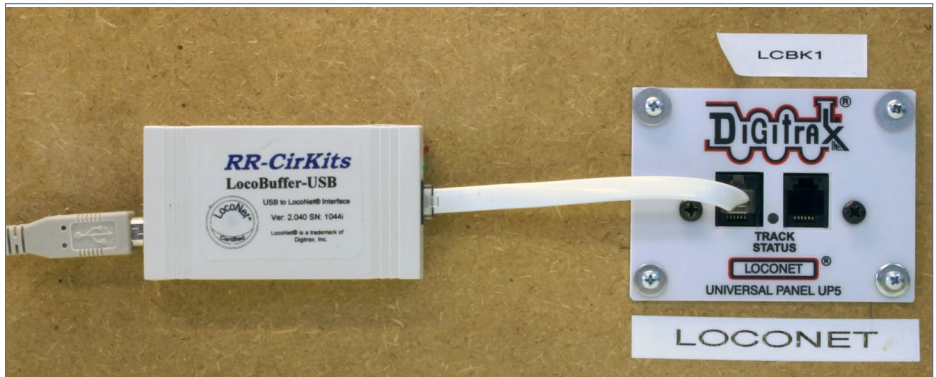

4. Computer Interface LocoBuffer-USB for Digitrax command stations. This was a prior installation at our club (pcmrc.org). The LocoBuffer-USB has since been moved behind the fascia panel and connected to one of the rear jacks on the UP5 panel. *Bruce Petrarca photo*



Didn't you promise an easy way?

Yes, I did. But first we needed to get everything in your system working together. If you jumped to this section looking for a simple solution, I need to send you back to the beginning to work your way up to this point. The early part of this column is essential to getting communication established.

The easy solution is to let a computer do repetitive things and remember what it has done for you. That's what they are good at doing.

In order to get a computer working for you, we need to get it

Roster Group	ID	DCC Address	Icon	Decoder Model	Road Name
All Entries	1:20.3 Goose #1		1	TSU-1000 Galloping Goose	RMP
All Entries	1:20.3 K-27 #34		34	QSI Magnum Steam	Silverton North
	1:24 C-16 #268		268	Titan Steam	Denver & Rio
Mine	Fn3 K-27 #34		34	QSI Magnum Steam	Silverton North
Mr. DCC	G C-16 #268 Titan		268	Titan Steam	Denver & Rio
	HO 0-4-0 #4410		4410	T1	SP Daylight
	HO 2-8-0 #2518		2518	TSU-1000 Medium Steam	AT & SF
	HO 70 Ton #40		40	2 function decoder (36-5...	SMVRR
	HO 70 Ton #50		50	Silver Mini	SMVRR
	HO F3A #6119		6119	DH163A0	SP
	HO F7A #6156		6156	DH163A0	SP
	HO F7A #6245		6245	DH083	SP
	HO GP-7 #2841		2841	LE1835	Santa Fe
	HO Lt Mk #21		3709	DH163D	Santa Maria V
	HO n3 Goose #5		5	TSU-750 EMD 567	Rio Grande S
	HO NW2 #1313 DSX		1313	DSX Diesel	Southern Paci
	HO NW2 #1313 LE521		1313	LE0521W	Southern Paci
	HO NW2 #1315		1315	TSU-GN1000 EMD 567	Southern Paci
	HO NW2 #2405 DSX		2405	DSX Diesel	Santa Fe
	HO NW2 #2405 LE521		2405	LE0521W	Santa Fe
	HO RS1 #2397		2397	TSU-AT1000 Alco 251 (V...	Santa Fe
	HO RSD5 #5294		5294	LE1024	Southern Paci
	HO RSD5 #5307		5307	LE1024	SP
	N 2-8-0 #722		722	Gold Mini	Southern (Chr
	B... B... B...		13	DSX Diesel	

5. DecoderPro roster page. Bruce Petrarca screen capture

talking to your DCC system. There are interface modules [4] to do this. They are generally specific to a specific manufacturer and, sometimes, a specific system within their product line. Detailed instructions for every system exceed what can be covered in one column. But I get ahead of myself.

Here's why you'd want to have your computer talking to your DCC system. In addition to simplifying decoder personalization, you would be able to:

- Use smartphones and tablets to run locomotives and throw turnouts,

The screenshot shows a software window titled 'Pro: Mine' with a 'Programming Mode' dropdown set to 'Paged'. Below is a table of locomotive data:

Road Number	Manufacturer	Model	Owner	Date Modified
1	Bachmann	Rail Truck	Bruce Petrarca	Mar 16, 2016 9:34:51 PM
hern 34	Bachmann	Consolidati...	Bruce Petrarca	Mar 17, 2016 9:08:35 PM
G... 268	Aristocraft	C-16	Bruce Petrarca	Mar 10, 2016 7:19:05 PM
hern 34	Bachmann	Consolidati...	Bruce Petrarca	Feb 11, 2014 5:37:09 PM
G... 268	Aristocraft	C-16	Bruce Petrarca	Feb 26, 2014 4:27:15 PM
4410	AHM	0-4-0	Bruce Petrarca	Sep 28, 2012 9:15:31 AM
2518	Bachmann	Consolidati...	Bruce Petrarca	Sep 28, 2012 9:42:26 AM
40	Bachmann	70 Ton	Bruce Petrarca	Nov 14, 2012 4:23:09 PM
50	Bachmann	70 Ton	Bruce Petrarca	Sep 28, 2012 9:49:30 AM
6119	Stewart	F3A	Bruce Petrarca	Sep 28, 2012 9:12:51 AM
6156	Stewart	F7A	Bruce Petrarca	Sep 28, 2012 9:16:11 AM
6245	Stewart	F7A	Bruce Petrarca	Sep 28, 2012 9:14:41 AM
2841	Life-Like P...	GP-7	Bruce Petrarca	Oct 22, 2012 12:05:22 PM
al... 21	Athearn G...	Light Mikado	Bruce Petrarca	Sep 28, 2012 9:12:57 AM
ou... 5	Con-Cor	Goose	Bruce Petrarca	Sep 28, 2012 9:25:10 AM
fic 1313	Kato	NW-2	Bruce Petrarca	Nov 20, 2012 4:11:47 PM
fic 1313	Kato	NW-2	Bruce Petrarca	Nov 20, 2012 4:11:51 PM
fic 1315	Kato	NW-2	Bruce Petrarca	Dec 17, 2012 1:05:49 PM
2405	Kato	NW-2	Bruce Petrarca	Nov 20, 2012 4:11:54 PM
2405	Kato	NW2	Bruce Petrarca	Nov 14, 2012 4:30:05 PM
2397	Atlas	RS1	Bruce Petrarca	Sep 28, 2012 9:13:46 AM
fic 5294	Atlas	RSD5	Bruce Petrarca	Oct 10, 2012 5:03:42 PM
5307	Atlas	RSD5	Bruce Petrarca	Oct 10, 2012 5:03:45 PM
ist... 722	Bachmann	Consolidation	Bruce Petrarca	Sep 28, 2012 9:29:22 AM
	Kato	NW2	Bruce Petrarca	Jan 22, 2015 5:22:51 PM



- Build layout control panels that can control turnouts and signals,
- Fully signal your layout, and
- Share your loco roster between computers anywhere in the world.

One package will let you do all of this: JMRI, from JMRI.org. It will run on any desktop or notebook computer that:

- has a USB port and
- can run Java (the full version, not the run-time version used for browsers)

It matters not whether you are using Windows, Mac OS X or Linux.

I am unaware of tablets or smartphones that meet all of these requirements. I'm told that Microsoft Surface units will, but I consider them a small notebook, not a tablet. If you have a setup that works, please share it with all of us in the blog associated with this column, by clicking the Reader Comments box at the beginning or end of this column.

As you can see from the list here, which is a partial list of what it does, JMRI is very complex and powerful. I'm not going to try to discuss all the features here. I'm just focusing on a sub part called DecoderPro. From the JMRI.org website, there are a lot of pages with information about computer interfaces, DCC system compatibility, help for different features, etc. Check them out.

How expensive is such a powerful program? It is shareware. That means that it is free to download and install.

Once you have DecoderPro running on a computer connected to your DCC system, you will be able to ignore CV numbers, even those pesky indexed ones. You simply go to the tab (Sound Level, for example) and adjust volume using a slider and write

END OF TRAIN DEVICE

NEW SAFETY GREEN

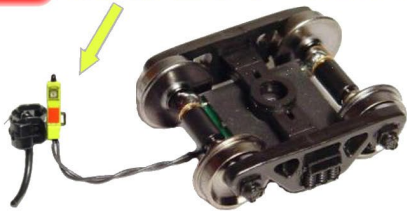

Bright Red Flashing Light!

**Installs in minutes!
No freight car modification required!**

Patented Technology - US Patent 7,549,609

Does not affect Load!

↓ Car without Load ↓

↓ Car with Load ↓



Click Here to Learn More

RE RING ENGINEERING™

ADVERTISEMENT

ELECTRONICS MADE EASY!



IOWA SCALED ENGINEERING

LEARN MORE



INFRARED SENSORS

- Simple, discrete under-track installation
- Variable release time up to 20 seconds
 - Small size (0.25" x 2.25")
 - No adjustment needed!

LEARN MORE

DCC SHIELD FOR ARDUINO

- Build your own stationary decoder
- Power and control accessories
- Easy to use Arduino environment

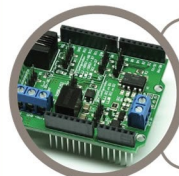

WWW.IASCALED.COM

ADVERTISEMENT

TamValleyDepot.com

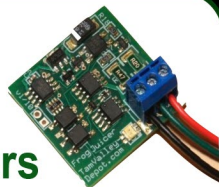

Frog Juicers

Automatic DCC polarity reversers for frogs on turnouts and crossings.

Servo Switch Machines

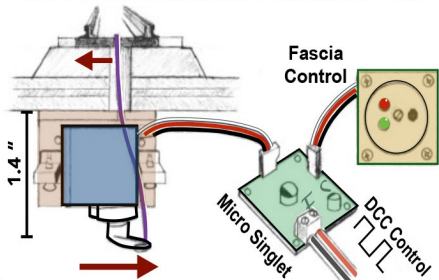

the changes to the decoder. If you are doing this on the main (POM), you hear the results immediately and can tweak to the Nth degree. Great for speed adjusting.

Besides, DecoderPro knows what mode (language) your decoder hears the best (paged, direct-bit, etc.).

DecoderPro automatically saves the configuration for your locomotive in a file. These files are indexed in what is called a roster [5] (a list of all your locomotives). Copying the roster files to another computer or a backup disk will help protect against data loss. If the decoder loses its mind or is replaced with the same model, resurrecting your locomotive settings is as simple as opening DecoderPro and clicking on the WRITE ALL SHEETS button.

This feature can be used as a starting place for making multiple decoders identical, perhaps later changing the addresses for different locomotives. Imagine if you could weather a single iced reefer and have the computer make all the rest of yours look the same, allowing you to only need to add a few tweaks to make the fleet look similar, but different.

Enough sales pitch. Let's get into the details.

How do I set up DecoderPro?

You need your DCC system talking to your loco and your computer talking to your DCC system, as I discussed in the beginning of this column. If you don't have that, go no further. Go back to the beginning and read the details, perhaps even clicking on the links to other columns of mine.

An internet connection is not needed for the computer you will use, but it is helpful during the setup phase. If needed, the desired files can be copied to a memory stick or disc and run from there. However, here I'm going to assume an internet connection.

First, go to java.com/en/download/installed8.jsp on the computer you'll be using and test for the latest Java release.

Note to Windows XP users. Java version 8 will run on XP even though the web site will tell you it is not supported. Just tell it to install it anyway. The only Windows computer I have is XP and I just loaded Java onto it yesterday.

Once you have the latest Java installed and verified, download the JMRI package for your operating system and install it on your computer. I recommend the production releases, not the test releases. Directions are on the jmri.sourceforge.net/download/index.shtml website.

Understand, I've done all this for many versions of both Windows and Mac OS X. Linux may or may not be the same. I've never played in that court. However, Windows and Mac OS X are the vast majority of installations.

The JMRI web site at jmri.org/help/en/html/setup/index.shtml

answers lots of setup questions.

Note for Mac users:

When you are selecting the serial interface in the basic setup, look for names like “/dev/cu.KeyUSA19181.1”.

There may be similar names “/dev/tty.KeyUSA19181.1”. Be sure to use the “cu” version.

Fire up DecoderPro by clicking on the icon that was installed on your



6. DecoderPro Icon. *Bruce Petrarca screen capture*



computer with JMRI. The PanelPro and SoundPro icons will open the same program, but put you in a different place. Think of three doors into the same house: one puts you in the living room and one puts you in the kitchen and one puts you into the garage. Same house, different rooms.

When the DecoderPro home page opens, you should get green text at the bottom of the page verifying that the computer is talking with the computer interface and the DCC system. You may see something like:

Service Mode Programmer NCE PowerCab is Online
Operations Mode Programmer NCE PowerCab is Online

To verify that you have DecoderPro communicating with your DCC system you can open the function that shows you what commands are passing along the DCC system you have connected and see if it reports commands moving.

For example, with a Digitrax system [7], use the LocoNet tab at the top of the home page to bring down the menu, then click on the MONITOR LOCONET tab. Other DCC system manufacturers will have a similar tab located in the same place on the menu bar as the LOCONET, but named differently.

You should see a pane like [8]. Select a locomotive with a cab on the system and try to run it. You won't actually need a locomotive on the main track, because your system will send commands whether there is a locomotive or even some track connected. You should see commands like [9]. If so, you can move on. If not, troubleshoot your connections until you do.

How do I set up my first locomotive?

With DecoderPro open, put a locomotive with a decoder installed in it on the programming track, not the main track.

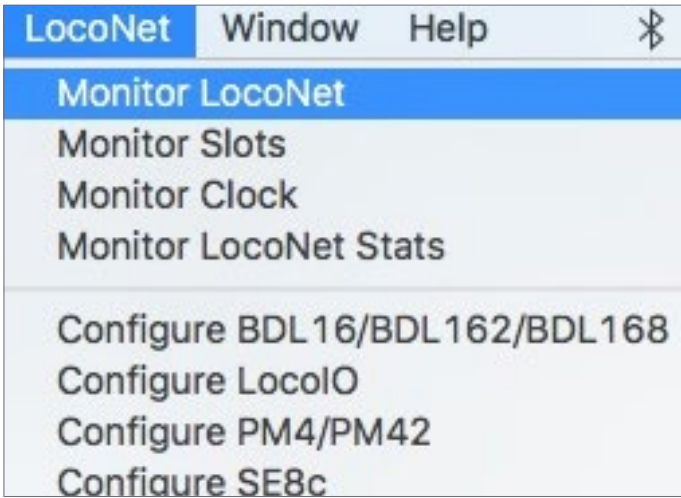

7. Monitor LocoNet selection to verify Digitrax system.
Bruce Petrarca screen capture

ADVERTISEMENT

Better Features

FOR THE SERIOUS MODELER

Tsunami2™

Get the best GE sounds on the market for the models you love. Recently updated Tsunami2 Digital Sound Decoders faithfully reproduce GE's most iconic sounds and locomotive specific features, including:

- GEVO G12 Tier 4
- Prime Mover Pitch Shift
- Updated GE Dynamic Braking Effects
- Electronic Air Dryer

SOUNDTRAXX™
www.soundtraxx.com



Hear the difference for yourself!

Buy your models without sound or easily replace the factory installed decoder with a TSU-21PNEM for the best results. Don't settle for less, get the most full featured sound effects for your models!

Listen Now ▶

• [INDEX](#)



SUBSCRIBE
(free)

• [TABLE OF CONTENTS](#)

Use the ACTIONS tab at the top of the home page to bring down the menu, then click on the SINGLE CV PROGRAMMER tab [10].

For the maximum compatibility at this phase, leave the programming mode selected as PAGED [11].

Enter CV = 1 and press READ CV [11]. The answer will likely be 3. If it is any number from 1 to 127, all is probably well and JMRI is hearing the decoder. This is the short address as stored in the locomotive, even if you are using the long address.

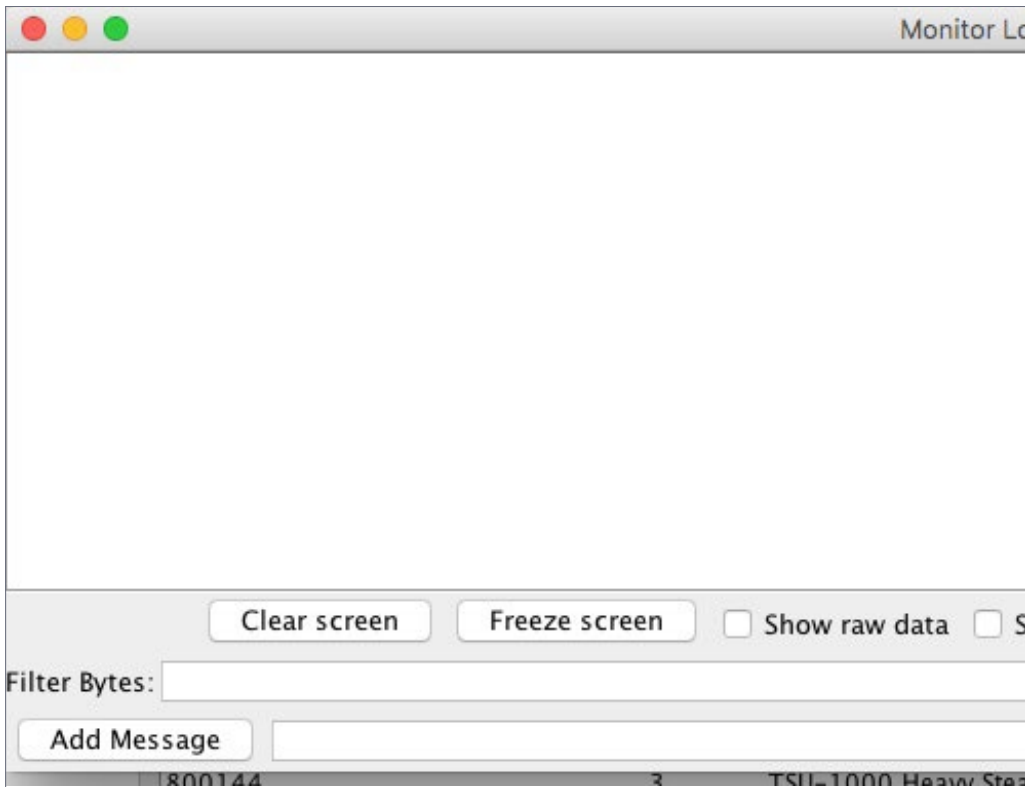

8. Monitor LocoNet window when first opened.
Bruce Petrarca screen capture

DCC IMPULSES | 14

Now prove that the decoder is hearing JMRI. Enter a different short address (1 to 127) into the single CV programmer (I suggest the last two digits of the locomotive cab number - using 45 as an example) and press WRITE CV [12].

Now, press the READ CV button. You should read back the CV you entered (the screen will not change). If so, all is well and you can proceed to set up the locomotive.

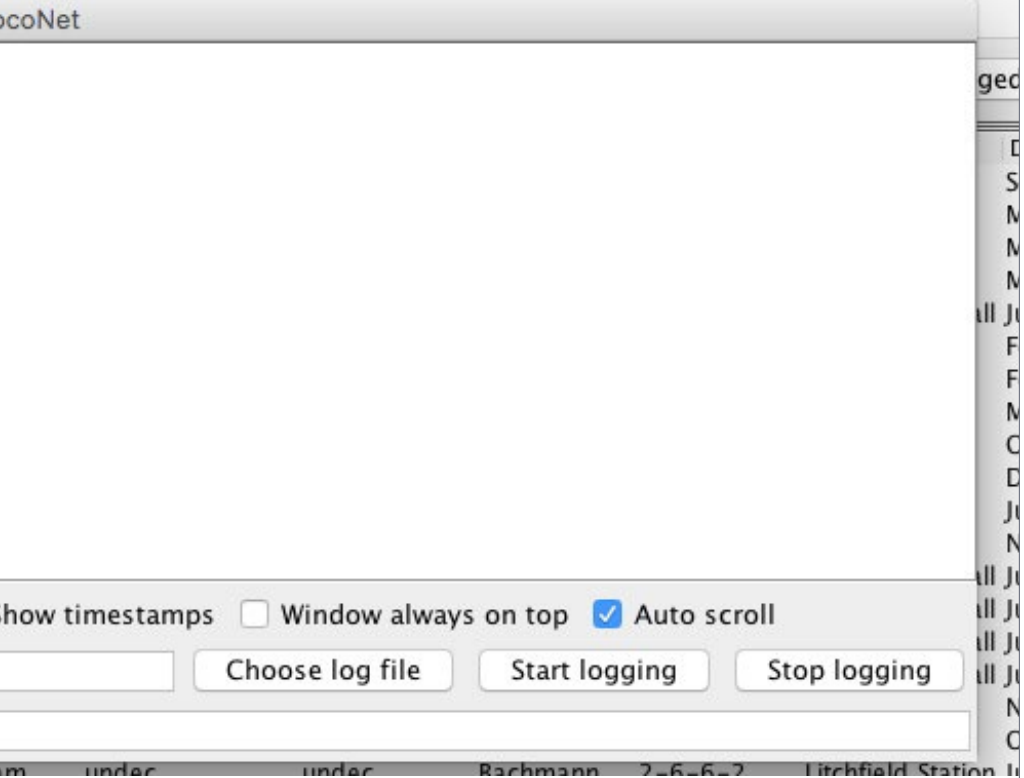

If you have successfully changed the short address in the decoder from something that you want to use, now is a good time to change it back.

Initial setup of a locomotive

From the roster page, press + NEW LOCO [13], which will bring up a decoder selection page. Press READ TYPE FROM DECODER [14].

DecoderPro should read several CVs and return a list of decoders that correspond to the manufacturer's ID and version ID that were stored in the decoder as it was built.

Monitor

Request slot for loco address 4413.
 Response slot 10 information:
 Loco 4413 is Not Consisted, In-Use, operating in 128 SS mode
 F0=On, F1=Off, F2=Off, F3=Off, F4=Off, Sound1/F5=Off, So
 Master: LocoNet 1.1; Track: On; Programming Track: Available

Request slot 10 information:
 Loco 4413 is Not Consisted, In-Use, operating in 128 SS mode
 F0=On, F1=Off, F2=Off, F3=Off, F4=Off, Sound1/F5=Off, So
 Master: LocoNet 1.1; Track: On; Programming Track: Available

LONG_ACK: Function not implemented, no reply will follow.
 Query Tetherless Receivers.
 UR91 Responding with LocoNet ID 0.
 UR92 Responding with LocoNet ID 0, duplex enabled.
 Set speed of loco in slot 10 to 0.
 Request Command Station Ops Switches.

Clear screen Freeze screen Show raw data

Filter Bytes:

Add Message

9. Monitor LocoNet window with some commands issued and reported. *Bruce Petrarca screen capture*

Manufacturer ID numbers (stored in CV 8) are assigned by the NMRA. The manufacturers decide on their own version ID, stored in CV 7. Thus, JMRI may be able to identify down to a specific decoder in one case and, in another situation, only be able to tell the manufacturer and offer a smorgasbord of choices.

The second situation results from the manufacturer using the same version number in many different decoders. Some manufacturers use the same version number for all decoders of the same size, perhaps regardless of what sound set is loaded in the decoder. Others may use it to identify a certain version of

LocoNet

```
e, and is going in Reverse at speed 0,  
und2/F6=Off, Sound3/F7=Off, Sound4/F8=Off  
; SS2=0x0, ThrottleID=0x75 0x66 (15078)  
e, and is going in Reverse at speed 0,  
und2/F6=Off, Sound3/F7=Off, Sound4/F8=Off  
; SS2=0x0, ThrottleID=0x75 0x66 (15078)
```

Show timestamps Window always on top Auto scroll



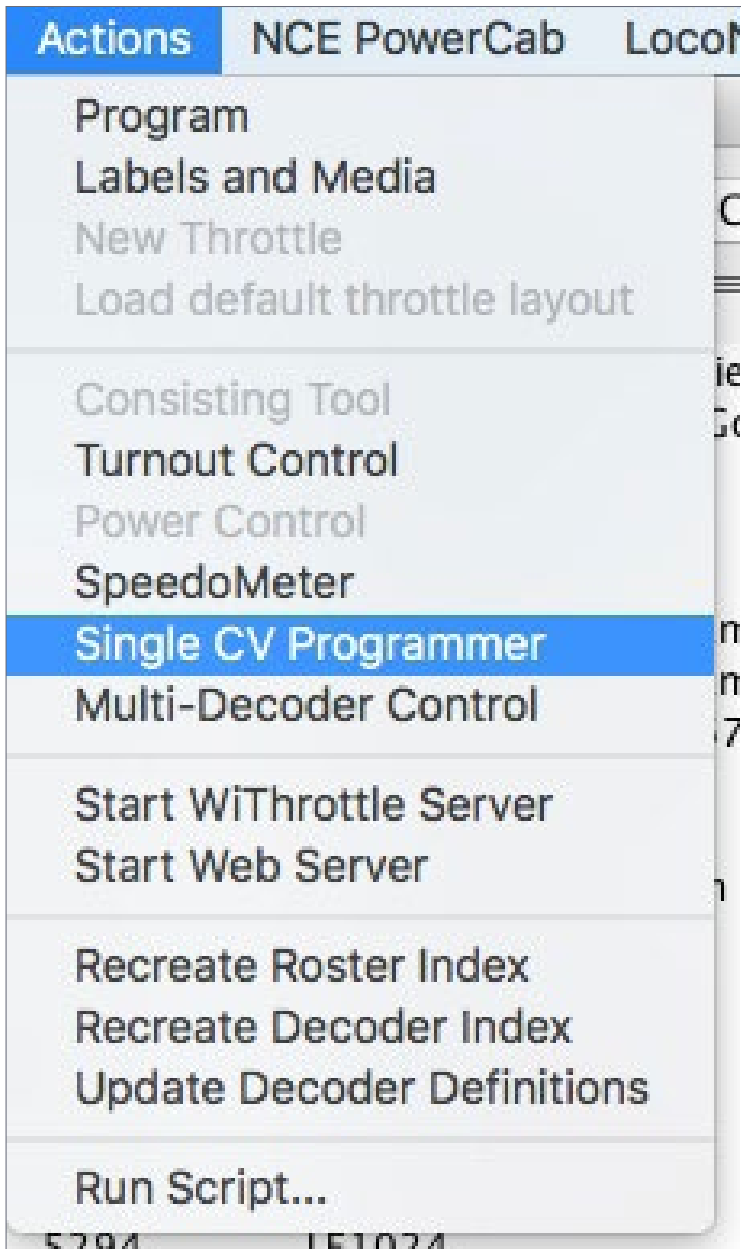

10. Single CV Programmer selection menu. *Bruce Petrarca screen capture*

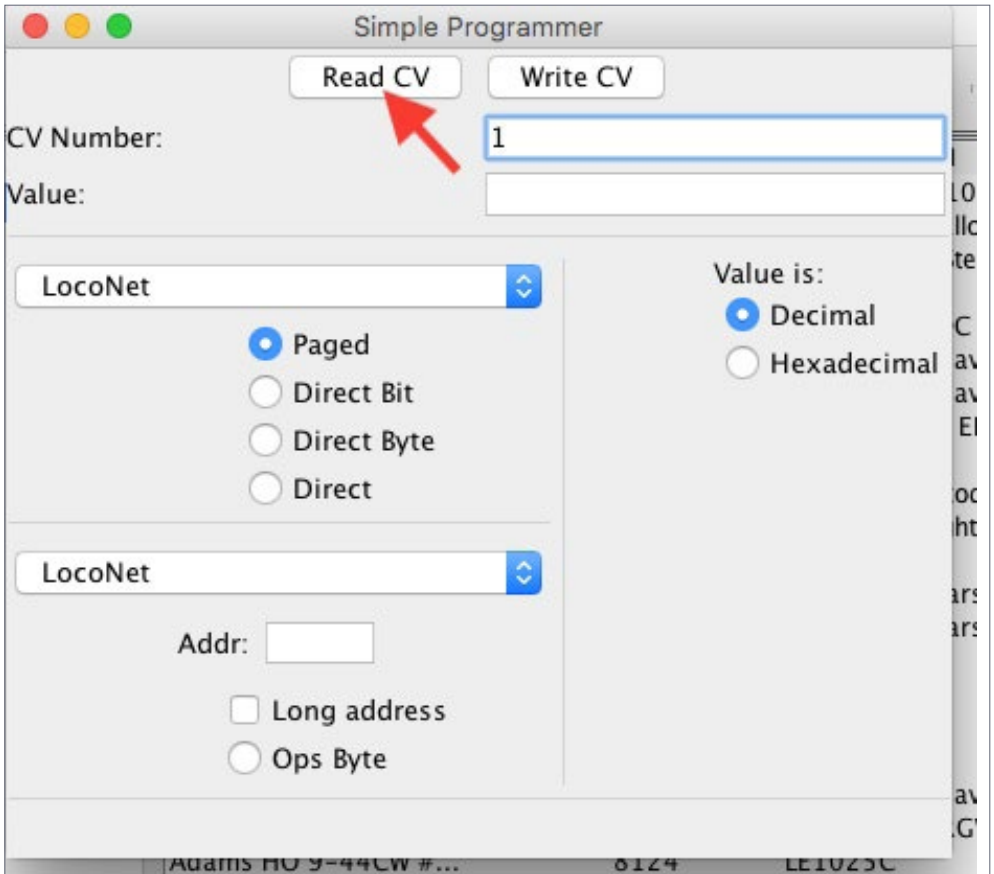

11. Simple Programmer window CV 1 selected, ready to press the READ CV button. *Bruce Petrarca screen capture*

**VIEW READER
COMMENTS**

click here



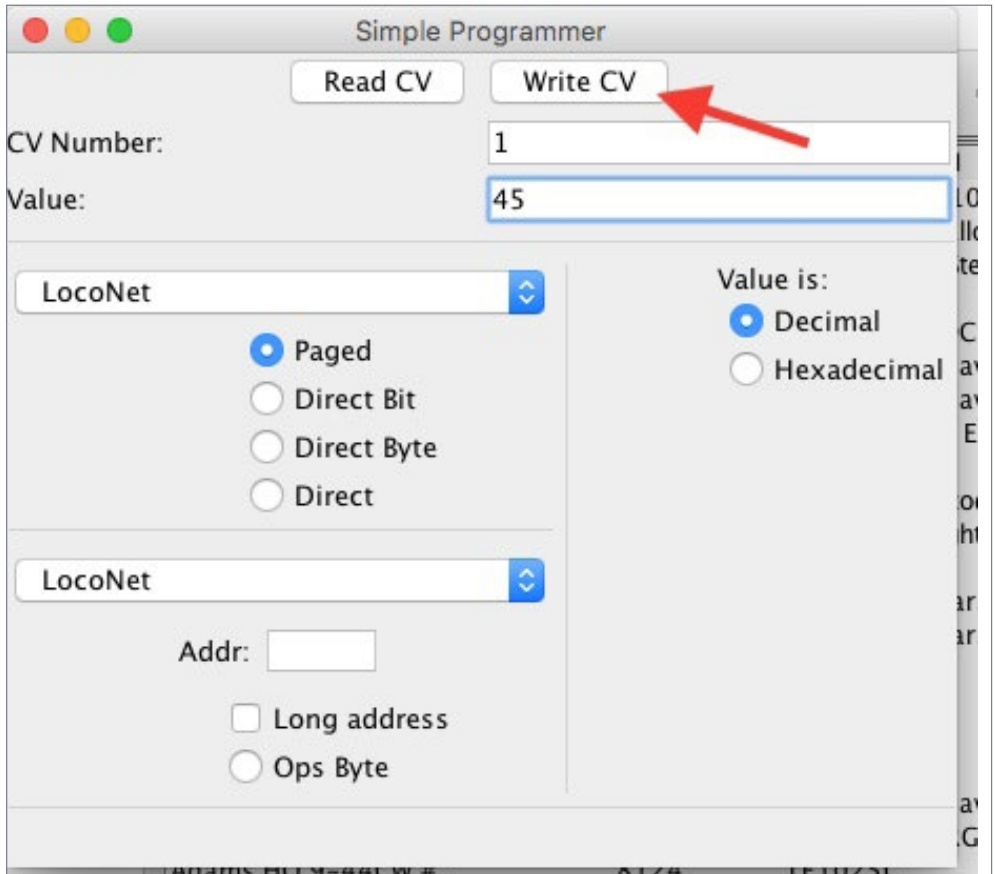

12. Simple Programmer window CV 1 ready to program 45 by pressing the WRITE CV button. *Bruce Petrarca screen capture*



13. Initial setup of a locomotive - selecting a NEW LOCO. *Bruce Petrarca screen capture*

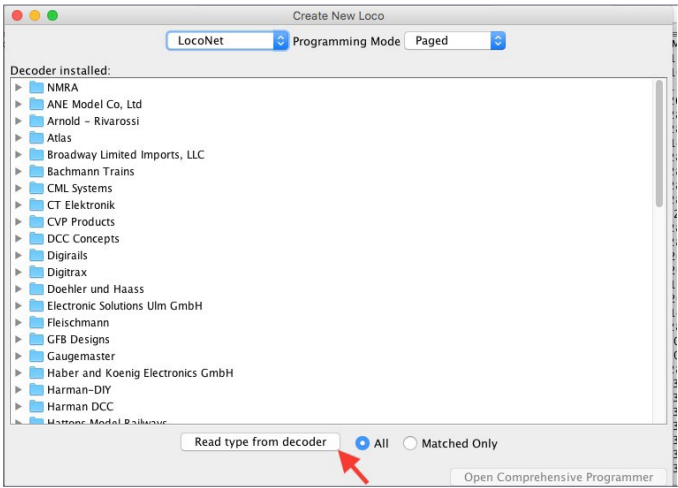

14. Asking DecoderPro to read the decoder type.
Bruce Petrarca screen capture

ADVERTISEMENT

Great control in a tiny package



**Original
Touch Toggles**

- Touch Toggle™ plug in controls
- Bright clear indication
- Easy setup
- Flexible system

Stall Motors, Twin-coils,
Power, and Servos

Now for Tam Valley Depot
and MRservo too!



Made in the USA 

What will they think of next?

www.berrethillshop.com

• [INDEX](#)



SUBSCRIBE
(free)

• [TABLE OF CONTENTS](#)

decoder, regardless of size. I know of no manufacturer who gives every variation of decoder a different version number. Thus, the user is left to choose the closest match from the list [15].

If only one decoder is highlighted, you are in tall cotton. If multiple versions are selected, as shown in [15], you will need to decide which decoder you have. In this case, the loco was an Atlas HO scale model and not a H15-44 or H16-44, so I selected “Four Function Dual Mode” by clicking on it.

Once the decoder is selected, a second pane is added to the window [15], as shown in [16]. I chose a roster name (“Soo Line 4413), answered the questions (shown in yellow), and hit SAVE.

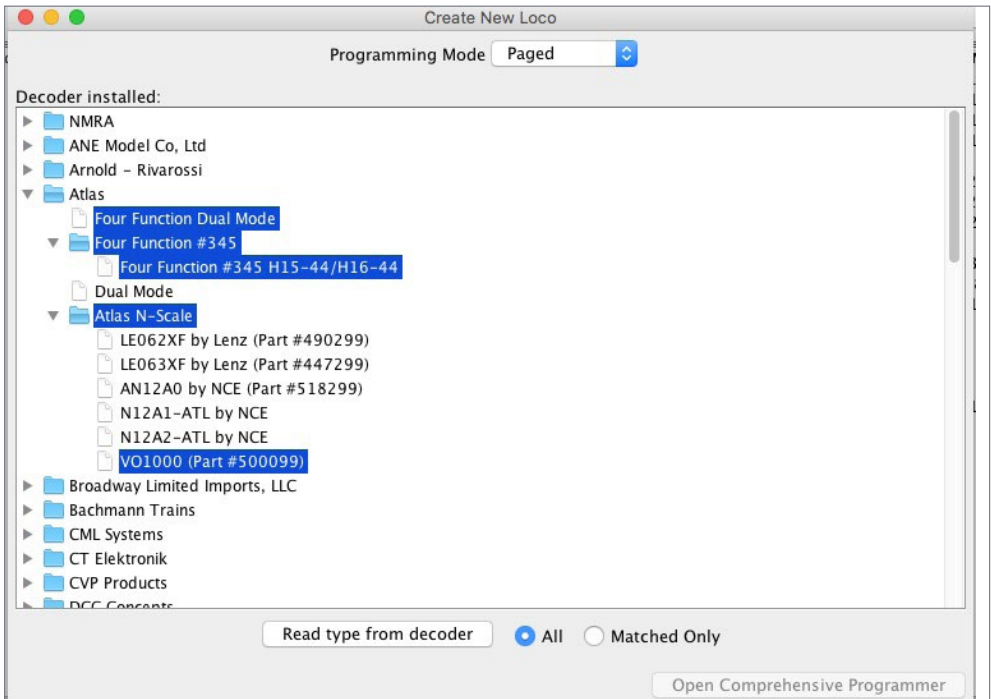

15. DecoderPro offering a smorgasbord of decoder choices.
Bruce Petrarca screen capture

I recommend NMRA DIGITAL ONLY or whatever no-analog choice there is for the DC Operation window. If you are going to run the locomotive on DC, you can change this back. Having it set this way is safer. When a DCC system starts up, sometimes the sequence has some transitions on the track power that don't conform to the DCC standards. In such a case, a decoder that is set to respond to analog (DC) may decide that it is connected to a pulsed power pack that is set for full speed (track voltage is at maximum) and respond accordingly. This is one of the most frequent causes of runaway locomotives on DCC startup. So, I change it as soon as I can. Safety first.

ADVERTISEMENT

TCS **WOWSound**

**Version 4 of WOWDiesel
NOW SHIPPING!**

WOWDiesel Version 4 Introducing the
645 Non-Turbo Prime Mover

All with Unmatched CD Quality Sound at
TRUE 16 bit Resolution that nobody else can
come close to!

click here

Learn why loco sound fans *prefer* WOWSound ...

Remember you "Rivet Counters", Sound has rivets too and TCS counts them better than anyone!

www.TCSDCC.com

• [INDEX](#)



SUBSCRIBE
(free)

• [TABLE OF CONTENTS](#)

Then I click on OPEN COMPREHENSIVE PROGRAMMER to get to work customizing the loco [16].

The locomotive pages open to the ROSTER ENTRY tab [17]. The tabs are across the top of the window and end with the ATLAS tab.

I entered the data shown and hit SAVE TO ROSTER.

The BASIC tab [18] is where you teach the locomotive its name (address) and some basics of its operation. I recommend “28/128 speed steps” and “NMRA Digital only” as settings for all decoders.

The locomotive direction is designed to reverse operation, such as when a loco is permanently used facing against the direction

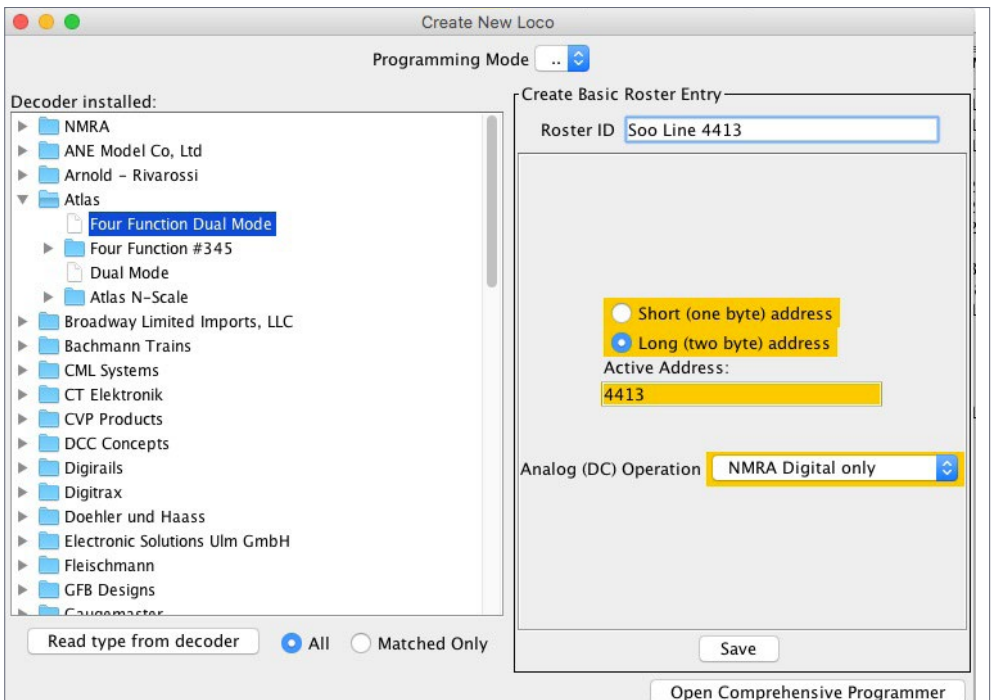

16. Decoder selected and ready to save the basic information to the roster. *Bruce Petrarca screen capture*

Program Soo Line 4413 in Service Mode (Programming Track)

Roster Entry Basic Motor Basic Speed Control Speed Table Function Map Lights Analog Controls Consist CVs Atlas

ID:

Road Name:

Road Number:

Manufacturer:

Owner:

Model:

DCC Address:

Throttle Speed Limit (%):

Comment:

Decoder Family:

Decoder Model:

Decoder Comment:

Date Modified:

17. ROSTER ENTRY tab filled out. *Bruce Petrarca* screen capture

ADVERTISEMENT

Make LocoNet wiring extremely simple!



**Suitcases belong in your baggage cars,
not under you layout!**

**Introducing the DCC Vampire II ...
this guy does the job of two suitcase
connectors!
And really holds the connection good
too!**

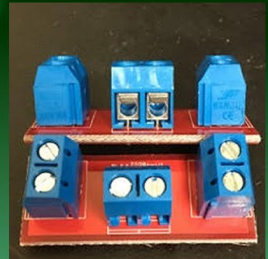

CLICK NOW TO DISCOVER THE AMAZING VALUE!

Dealer Inquiries Accepted

• [INDEX](#)



SUBSCRIBE
(free)

• [TABLE OF CONTENTS](#)

Soo Line 4413

Roster Entry Basic Motor Basic Speed Control Speed Table Function Map Lights Analog Controls Consist CVs Atlas

Short (one byte) address
 Long (two byte) address
 Active Address: 4413

Primary Address: 13
 Extended Address: 4413
 Address Format: Long (two byte) address

Locomotive Direction: normal
 Speed Steps: 28/128 speed step format(recommended)
 Power Source Conversion: NMRA Digital only

User ID #1 (0-255): 0
 User ID #2 (0-255): 0
 Manufacturer ID: 0
 Version ID: 0

Programming Mode: Direct

18. Filling out the BASIC tab. Bruce Petrarca screen capture

of travel, such as the trailing unit in an ABA consist. It is not useful in fixing wiring errors, such as the motor gray and orange wires reversed. If you do that, man up and go back in and change them. Flipping the direction here will reverse the motor, but now the lights will be backwards.

When you have it all the way you want, click on WRITE FULL SHEET, which will move the settings into your decoder.

A quick mention of the colors shown on DecoderPro panes:

White is data that has been proven to be the same both on the computer and in the decoder. This means that it has been written from the computer (but not verified by a reading it back) or has been read from the decoder.

Orange (either outline or background) means that the data has been changed on the computer but not yet written to the decoder.

Yellow means that the data was retrieved from the computer but has not been written to the decoder or read from it. In other words, it is not a guarantee that the decoder has that value stored.

After the settings are stored in the decoder, the sheet will look like [19]. The next step is to press the READ ALL SHEETS button.

This will cycle through the entire decoder and read all values into the computer file. This may take a minute or several. If you are reading a modern complex sound decoder, go get a cup of coffee or a light lunch.

Once DecoderPro has finished reading all the sheets, save the file on the computer. One of the easiest ways to do this is to

ADVERTISEMENT

ADVERTISEMENT

www.SBS4DCC.com

ESU TCS WOW Sound OSI Solutions ZIMO SOUNDTRAXX NCE The Power of DCC DIGITRAX DCC Specialties INNOVATION FOR DCC MRC Model Rectifier Corporation ACCUTRACK II SPEEDOMETER SPROG DCC the DCC Programmer and Control Family Digital plus by Lenz TAM VALLEY DEPOT Great Electronics for Great Model Railroads TEAM DIGITAL, LLC Improving the world of DCC

N - HO - HO_{N3} Scale Trains



Installing DCC sound just **NOT** your thing?
Trust Traintek for sales and installation of sound decoders from these fine vendors!



"Taking model railroad control to the next level..."



traintekllc.com

Click here for more details...



"Traintek was the way to go!"



• [INDEX](#)



SUBSCRIBE
(free)

• [TABLE OF CONTENTS](#)

close the locomotive window. You should be prompted [20] to determine your desires. Select SAVE AND CLOSE. That should bring you back to the DecoderPro Roster window [5].

How to tweak a loco saved in DecoderPro

From the roster screen [5] highlight the desired loco. Then, in the lower right corner of the screen [21] select the desired programming method and press the PROGRAM button.

You can now tweak and adjust to your heart's content, confident that all your work will be saved on your computer.

What CV do I need to adjust to change the sound volume?

I hear questions like this all the time. My response is usually, "I don't know."

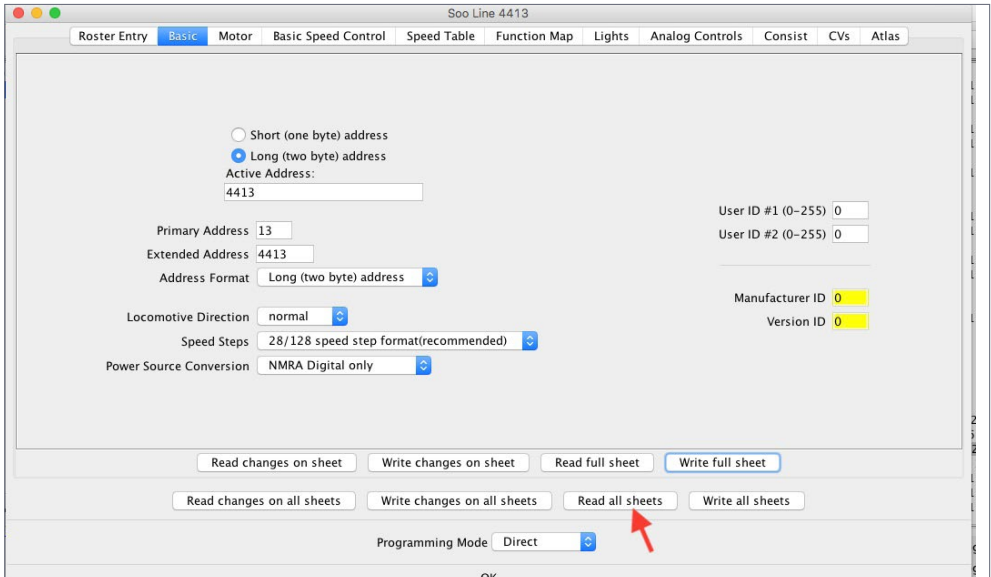

19. READ ALL SHEETS to load the decoder settings into the computer. *Bruce Petrarca screen capture*

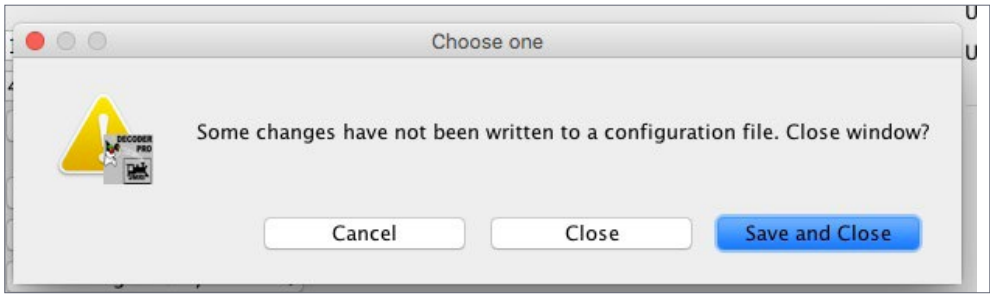

20. Closing a locomotive file will bring up this prompt to exit. Choose **SAVE AND CLOSE** to make sure the data is saved on your computer. *Bruce Petrarca screen capture*

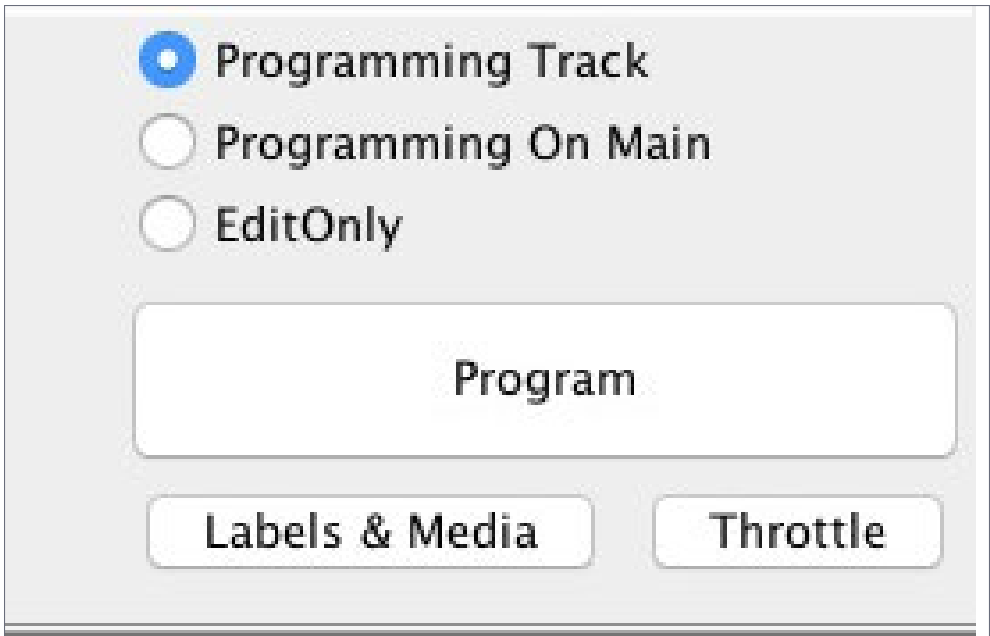

21. Selecting programming mode from the roster screen in DecoderPro. *Bruce Petrarca screen capture*



Why?

Because I use DecoderPro. I don't have to remember CVs. I let the computer do it for me.

I just open the SOUND LEVEL tab and adjust all the different sounds using the sound level sliders and POM [22]. As soon as I hit the WRITE ALL CHANGES button, the sound level changes. A few tweaks and I have it where I want it.

The same is true for lights, speed matching, etc. All are a snap to adjust in Programming On the Main (POM) with DecoderPro.

Remember that chance of programming the wrong locomotive when using Programming On the Main (POM)? Well, that is virtually impossible with DecoderPro. You tell DecoderPro what locomotive you are interested in talking to by which file you open.

How do I keep all of this straight?

Once I put a bunch of time into a locomotive, I don't want to lose those settings. Before DecoderPro, I was using spreadsheets and notebooks to keep track of how I personalized decoders. Ugh.

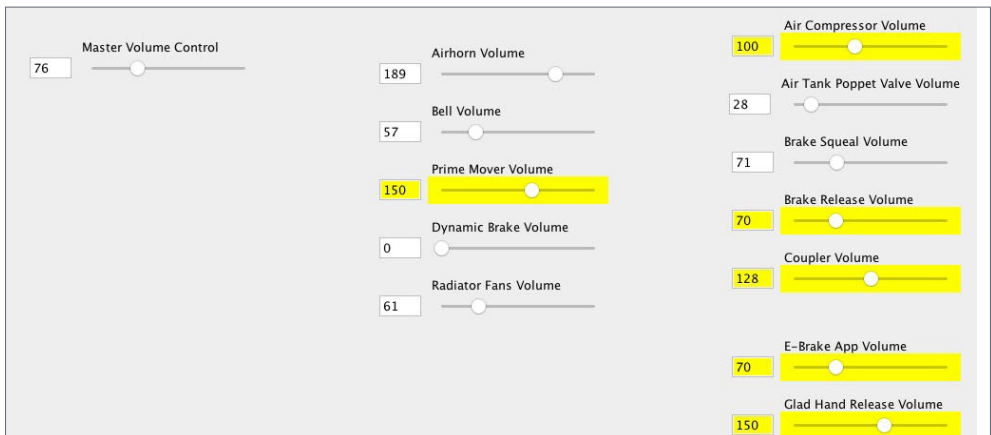

22. Adjusting sound volume on a Soundtraxx Econami decoder. *Bruce Petrarca screen capture*

When DecoderPro is ready to close a file, it asks if you wish to save the changes. By saying YES, you assure that the latest version of a decoder setup is saved on your computer.

When you want to work on a locomotive again, you have two choices. You can select the locomotive manually from the roster and then select – in the lower right – which programming method you want to use. You can also select EDITONLY, if you want to make clerical changes to your file without changing the setup.

Or you can allow DecoderPro to find your file by pressing the IDENTIFY button in the upper right of the DecoderPro home page [23], when you have your locomotive on the programming track.

How do I handle two or more computers?

Backing up your data is beneficial. One of the best ways is to store it on several computers in several locations. The more synchronized sets of data you have, the better the odds that you won't lose it. Separate but different sets of data are a nightmare.

Here is what I do. You may choose to do a similar thing or something different. Again, share your experiences in the MRH

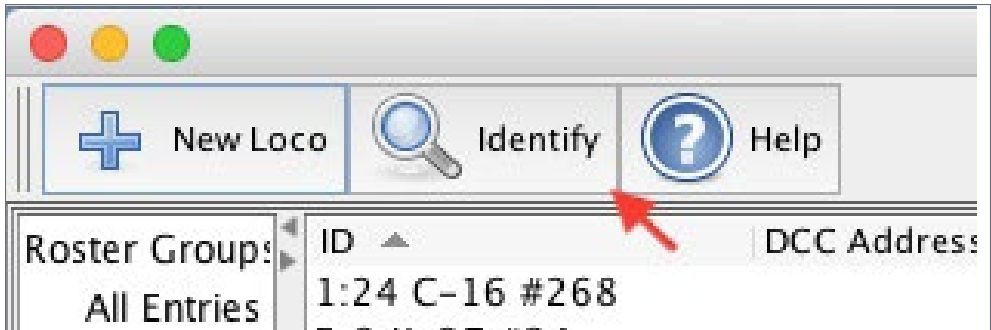

23. DecoderPro will find the roster entry for your locomotive, if you ask it to IDENTIFY your locomotive.

Bruce Petrarca screen capture

subscribers' forum by clicking on the Reader Feedback buttons at the beginning or end of this column.

I use Dropbox (dropbox.com).

When I installed DecoderPro, I installed all of my decoder programming data (DecoderPro roster plus all of the sound loading files) in folders contained within a single main folder in the Dropbox folder that I share amongst all my desktop and notebook computers. That way, my files are available on multiple computers and are automatically backed up in several locations. Yes, they are very likely to be in the same house all the time, but, if we have a major fire, I think missing the DecoderPro roster will be the least of my challenges.

Our club (pcmrc.org) has an internet-connected computer that is interfaced with the Digitrax system [4]. We installed Dropbox so that board members have access to our club documents from home.

When I program a locomotive from the club, I check the club's folder and mine for the latest version of the DecoderPro data file (in .XML format). I copy that into my folder, if necessary. When I'm done with the club locomotive, I try very hard to copy the new file into the club's folder, so that it will be available at the club layout the next time I'm there.

There is a help page for Dropbox interaction on the jmri.org/help/en/html/setup/Dropbox.shtml site.

How do I get help with DecoderPro?

That brings us to the question of how to get more JMRI help, including DecoderPro issues.

I've mentioned that there are many helpful pages on the jmri.org/help/en/webtoc.shtml site. But sometimes a bit of handholding is needed. The users and developers frequent a Yahoo group and can help iron out many issues. To join the group, send an email to

jmriusers-subscribe@yahoogroups.com. Once you have joined, you can send questions to jmriusers@yahoogroups.com.

Also, many of the users and developers attend conventions and give hands-on clinics in various aspects of the package. A query on jmriusers@yahoogroups.com will probably get a schedule of future plans for clinics.

Who builds and benefits from JMRI?

One comment before I answer that question. These screen captures were made with DecoderPro version 4.4. Other versions may or may not have the same attributes or look the same.

The JMRI organization is all volunteers. There is no paid staff; no customer service department. The folks who answer questions on the Yahoo group are just volunteers, too. Most of them have

ADVERTISEMENT

**NEW TECHNOLOGY**
**NEW Starter Kit \$399.99 MSRP**

- Includes Wireless Color Touch Screen Handheld Controller and 56 Watt Power Supply
- Expandable to Virtually any Size Layout

NEW Locomotive Module
LM-3 & LM-3S

- Direct Radio RF
- Sound and Non-Sound
- New Tiny Size
- 6 Light Outputs

Click Here to Learn More

For more information visit our Internet site: www.RingEngineering.com



invested their own money in hardware to be able to do what they do for the organization.

While nobody makes a penny by doing what they do for JMRI, the beneficiaries are model railroaders the world over.

Donations to jmri.sourceforge.net/donations.shtml are appreciated. I recommend that everyone who uses DecoderPro, or any part of JMRI, donate \$10 every year. If all users did, things would be peachy-keen.

The money from contributions helps defray past, present, and future expenses. You will keep up your part, won't you?

It's your choice

You can keep doing things the hard way: learning CVs, manually tracking changes and backing up files. Or, you can sit back and let your computer do something more than just surf the web and read email.

I cannot imagine living without DecoderPro. When I was first introduced to it, more than a dozen years ago, I put off dealing with it for Litchfield Station until after the Christmas rush. When I realized that I had it up and running in a few minutes and thought of all the time I could have saved over those months that I procrastinated, I wanted to cry. If you are at all computer savvy, DecoderPro can keep you from needing to become exceptionally DCC savvy, too.

Please share your ideas with us all. I'd love to hear what you think. Just click on the Reader Feedback icon at the beginning or the end of the column. While you are there, I encourage you to rate the column. "Awesome" is always appreciated. Thanks.

Until next month, I wish you green boards in all your endeavors.



MR. DCC'S WORKBENCH

HOW TO SAVE MONEY ON UNDER-LAYOUT BUS CONNECTIONS.

Several years ago, a friend, Chuck (AKA “Rick”) Ricketts, moved from the Phoenix area to the Seattle area. Even with failing eyesight, he has pressed on and become a Master Model Railroader.



24. Chuck Rickett's On30 layout.
Bruce Petrarca photo

In conjunction with the NMRA national convention in Portland, I got a chance to visit Chuck and see his amazing On30 layout [24]. It is truly fitting for a MMR.

I'd like to share a trick I learned from him. He has made his DCC bus connections quickly, easily and at low cost.

He drilled [25] and countersank holes in a piece of Masonite. He then used flat-head #6-32 screws for the terminal posts. Nuts and washers complete

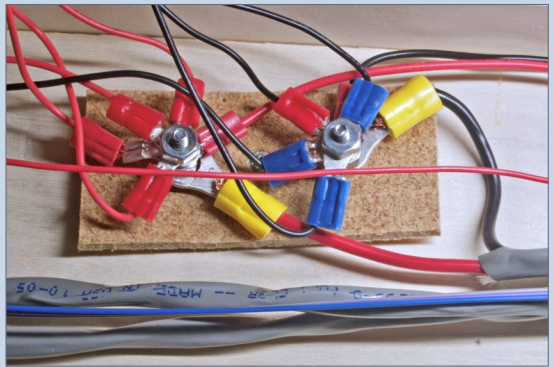

25. Simple bus connections under Chuck Rickett's layout.
Bruce Petrarca photo

MR. DCC'S WORKBENCH *CONTINUED...*

HOW TO SAVE MONEY ON UNDER-LAYOUT BUS CONNECTIONS.

the connection. He uses ring terminals and different sizes of wire for his bus and his district wiring. The piece of Masonite is held to the layout with either nut-bolt-washer combinations or #6 sheet metal screws (½ inch or so long).

Notice the red and black color coding.

While this may not be the answer for every layout, it is a tool to keep in your arsenal, in case you need it. ■

**VIEW READER
COMMENTS**

click here

Get the latest Model Railroading News, Tips, Reviews & Opinions

**CHECK
IT OUT!**



**Our iTunes feed has changed search for
"Mike And Scotty Live" to receive the latest episodes!**

www.themodelrailroadpodcast.com

Hosts:

Scott Mason: www.scottymason.com

Mike Rose: www.mrhobby.com

**Don't Miss our Monthly Interviews
& Product Announcements**



Did you know ...

MRH subscribers **SAVE 10%**

... on the MRH Store & on TrainMasters TV?

*Click to get 10% off coupon code
(Must be a subscriber to access)*

ADVERTISEMENT



www.yankeedabbling.com (856) 312-8084

101 West King, Bellmawr, NJ 08031

In Philly? YD store is 1 mile from NJ end of Walt Whitman Bridge

Visit OUR NEW WEBSITE! SAME GREAT SERVICES & PRICES!

SEARCH BUTTON

YD Yankee Dabbling

HOME SCALES BRANDS SHIP/RETURNS CONTACT SHOW SCHEDULE NJ STORE HOURS

Featuring New ESU Cab Control Wifi Digital System & Wifi Mobile Control

FEATURED PRODUCTS

Sale \$385

Plus New ESU "N" Scaled Sound Decoders

Add 2nd CAB to order Sale \$240

“CLICK” ON SPECIALS

Specializing in DCC! ~ The Best for Less! ~ Sales-Services-Installation!
Free Technical Coordination (727) 457-9227 9AM to 9PM EST

CLICK AND SAVE TODAY!

Use coupon code “MRH” for FREE SHIPPING
YD installs DCC or RailPro in your engines

Stop by and meet us at the following hobby shows:
2/3- 2/4 2018
Timonium, MD

Click on Show Schedule for info links

• [INDEX](#)



SUBSCRIBE
(free)

• [TABLE OF CONTENTS](#)

From first train set to railroad empire...

*Our complete line of DCC products
grows with you. Discover the fun!*

- Designed and manufactured in the U.S.A.
- Preferred for ease of use and ergonomic design
- Unlimited scalability for any size model railroad
- Plug-and-play means more time running trains
- Great customer service and excellent support



See your dealer



Visit our new and improved web site for all your DCC needs!

- Get the latest new product announcements
- Watch our detailed how-to videos
- Browse the all-new Information Station
- Enjoy secure online sales, day or night!

Visit **ncedcc.com**



• [INDEX](#)



SUBSCRIBE
(free)

• [TABLE OF CONTENTS](#)

DISCOVER TRAINMASTERS.TV

Helping you
achieve your
hobby dreams



Brought to
you by



CLICK HERE

Navigate the
video archive



MRH Subscriber?
Get your 10% off
coupon code here:

Get Subscriber
10% off code

• [INDEX](#)

• [TABLE OF CONTENTS](#)

GETTING REAL column



Model Railroad Hobbyist | February 2018 | #96



RATE THIS ARTICLE

JACK BURGESS MODELS EL PORTAL AND ITS FACILITIES ...

MY ARTICLE IN THE SEPTEMBER *MRH* DESCRIBED THE structures in the Merced yards of the Yosemite Valley Railroad. This time I want to talk about the structures at the other end of the line – El Portal at the western boundary of Yosemite National Park. At the time of construction of the YV in 1906-07, railroads were not permitted to actually lay tracks within national parks. Fortunately, after following the Merced River upstream 50 miles through the V-shaped canyon carved by the river, there was a wide-enough location just a mile from the park boundary for the construction of a small yard [1]. It was named “El Portal” which is Spanish for “The Gateway.”

Even though El Portal was the “end of the line” from an operations standpoint, no water, fuel, or sand was available there. So a water tank was constructed at Moss Canyon, 2.7 miles downstream from El Portal where the railroad crossed over Moss Creek. In 1912, a wye was built here to turn both passenger trains and log trains headed to El Portal where a logging incline was built the same year across the river from El Portal. The passenger trains thus backed into the El Portal yard, which put the Pullman cars under the train

▶ **MODELING REAL RAILROADS AND WHAT THEY DO**

• [INDEX](#)



SUBSCRIBE
(free)

• [TABLE OF CONTENTS](#)

shed and out of the hot summer sun. That also put the passengers just steps from buses waiting to transport them to the Park.

When I designed my YV layout in 1980, I didn't have room for a workshop in my home so I included a 7'x11' workshop in the layout room (typically called a "two-car garage" in California). That resulted in just a 2-foot wide shelf only about 5 feet long to replicate El Portal, which really limited the amount of trackage and which buildings I could include in the space.

Fortunately, once the last of our adult children moved out of our home, my wife suggested I move my workshop into the largest extra bedroom, which I did within the next few days. That



1. Looking east toward the El Portal station and train shed. The backdrop was painted on a bare backdrop over a projected color slide taken from the same location. The distant mountains and granite cliffs were outlined in pencil and painted using acrylics. The sky was washed-out in this and the other model photos and was replaced with a photo using Photoshop.

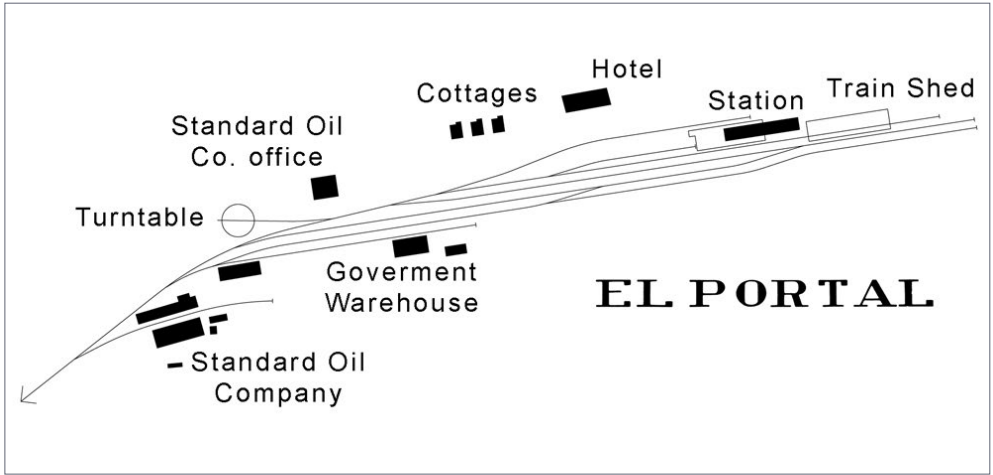

2. This track plan circa 1939 shows the main buildings in El Portal which are also included on my layout. On the layout, the Standard Oil Co. bulk plant is on the other side of the tracks.

suddenly opened up a 7" x 16' area in the layout room for a new, expanded version of El Portal.

The prototype El Portal yards were about 2,000 feet long [2] from the first turnout to the Standard Oil bulk plant on the west end to the most-easterly track bumper. Moving the west turnout closer to the yard meant that I needed to shrink the prototype plan only by about 30% to fit it into my available space.

To do that, I printed a copy of the prototype plan to the same scale as my drawing of the layout. I cut the prototype plan into sections centered on the tangent (straight) segments. I then trimmed those tangent sections to reduce the space between turnouts and then taped them back together when everything fit.

The buildings

While the buildings in El Portal may not be as informative as the yard buildings in Merced, maybe they will provide some

inspiration toward modeling other typical buildings. One of the advantages of modeling a prototype is that the buildings you spend time constructing, which are based on prototype photos, will more accurately reflect the building practices of the location you are modeling. For example, due to mild winter temperatures and earthquakes, there aren't many old brick buildings in the part of California that I model. Thus, on my layout there are only two brick buildings (an oil house in the Merced yards and a ice plant near the SP interchange) out of a total of about 100 buildings.

The most-westerly set of structures was the Standard Oil (SO) bulk plant. The plant shipped gasoline to the SO service stations



3. Looking west toward a passenger train backing into El Portal. To the left of the train are three buildings which were part of the Standard Oil bulk plant. Behind the first building is the top of the horizontal main storage tank, while the second building has "EL PORTAL" painted on the roof as well as a company name sign on the ridge. *California State Railroad Museum collection*

in the Park. There are only two known photos of the installation. One of them provides a view of some of the buildings to the south of the tracks. [3]

Note the “Standard Oil Company of California” sign on top of the second building from the right. Also note the “air markers” sign painted on the roof of this building. In the early days of aviation, pilots typically navigated by comparing landmarks and topographic features to a map resting on their lap, a less-than-accurate method. In 1926, the federal government proposed a formal program of painting town names on barns, buildings, water towers, gas storage tanks, and hangers. The black letters were to be 10-to-30 feet high on a chrome-yellow background. An arrow pointing to the nearest landing field was also to be included. The sign on the roof of the Standard Oil building did not have the suggested yellow background or the arrow. Since it was on the top of a small building at the bottom of a 2,500-foot-deep V-shaped canyon which was miles from the nearest airport, its value as an “air marker” would be limited, and it was most likely the result of a corporate policy.

Lacking any more details than shown in the two available photos, I had to build the truck loading platform based on prototype photos of similar installations. This prototype complex should be located on the south side of the tracks. Unfortunately there just wasn't room available on my layout on that side of the tracks to fit the spur into the plant, nor for all the buildings. [4]

East of the bulk oil plant was a 60-foot-diameter Armstrong turntable. [5 and 6] The turntable was originally the Southern Pacific RR turntable in Merced, Calif. and moved to El Portal in 1907. Although it was rarely used after construction of the wye at nearby Moss Canyon, it was completely rebuilt in 1929/1930.





4. My model of three of the structures associated with the Standard Oil bulk plant. The spur to the main storage tank is hidden behind the structures. The truck is a White Super Power tanker which introduced in 1935. It is kit V-014 from Sylvan Scale Models.

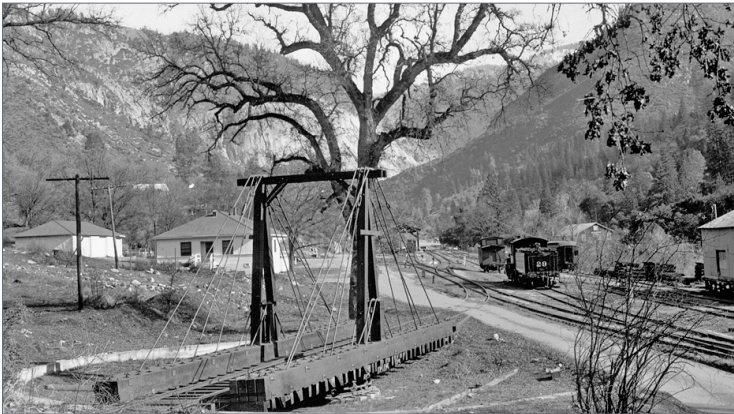

5. This view looking east shows some of the buildings alongside the El Portal yard. The Standard Oil office building is left of center

beyond the turntable. To the right is a portion of the Government Warehouse. You can see the train shed in the center of the photo in the distance. *Guy Dunscomb photo*

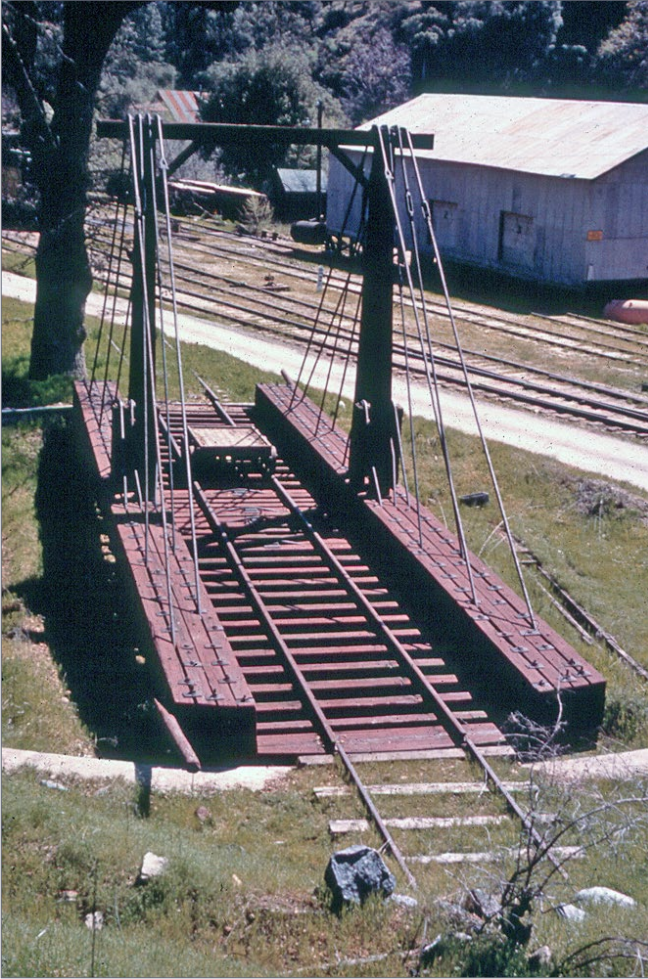

6. Looking down on the turntable with its short extension track. This turntable was used only to turn locomotives and passenger cars (such as the observation car). The approach track is overgrown with grass, and the road crossing covers the rails, confirming that the turntable wasn't being used by the time of the photo. The Government Warehouse is on the other side of the tracks. Note the pair of rails half-buried in the turntable pit.
Al Rose photo



As part of this rebuild, the original design of four stringers (two per side) was replaced with one with eight stringers. I have a print of the original YV drawings for this turntable, and in drawing up the rebuilt design, I naively kept the tie length the same as the original design and inserted the extra stringers on the “inside” of the frame. Unfortunately, the *Narrow Gauge and Shortline Gazette* accepted my turntable plans for publication. Regrettably, a friend who models the YV (together with several California short lines plus the WP) used those plans to build his model of the turntable. He discovered the error in my plans when his YV caboose wouldn't fit on his nearly completed model. My turntable was also built from the same incorrect plans but, since I don't use it, I hadn't noticed my error. [7]

Fortunately my friend told me about the error, because a year later, I suggested that the National Park Service (which owns all



7. Again looking east but this time from the other end of the El Portal yards. To the left is the turntable with those half-buried rails, while just beyond the turntable is the Standard Oil office.

Make it run like a

Dream ROLLING STOCK

PRE-ORDER

By Joe Fugate

Sneak peek #5 now available to all pre-order customers!

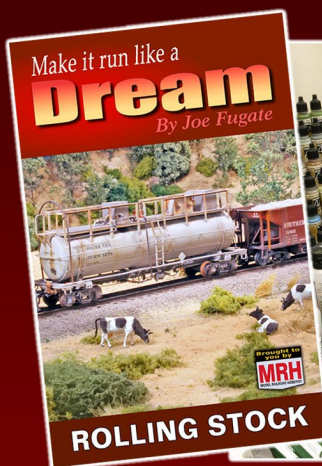

TOPICS INCLUDE: Setting standards • Building a test track • Wheelset/truck issues • Coupler issues • Carbody issues • Car weight considerations • Better maintenance procedures • Performance diagnosis & debugging • Special considerations

Click me to
PRE-ORDER eBook >>
~~\$12.99~~ \$11.49

Click me to
PRE-ORDER PAPERBACK >>
~~\$29.99~~ \$27.49 + S&H

Expected release: Spring 2018 - see the MRH Store: store.mrhmag.com

Other books in this series: **TRACKWORK** (available now) and **LOCOS** (Q1 2019)

• [INDEX](#)



SUBSCRIBE
(free)

• [TABLE OF CONTENTS](#)

of the land in El Portal) consider applying for a grant to build a new turntable in the still-remaining concrete-rimmed pit. The grant was approved, and I corrected and refined my drawings which the NPS then used to construct the new turntable which was completed in 2013. [8]

Opposite the turntable was the Government Warehouse. [9] An opportunity to supply the United States Cavalry (which patrolled the high country of Yosemite National Park until 1913) with hay and grain led the YV to construct a warehouse in El Portal in 1910. This corrugated, 36'x70' building was always referred to by the railroad as the "Government Warehouse" even though it was owned by the railroad.



8. A 2013 photo of the newly constructed replica of the original turntable at El Portal. The grant for this project was from the non-profit Yosemite Fund whose director had some interest in railroads and who visited my layout a few years earlier. The YV fans in the photo show the scale of this turntable.

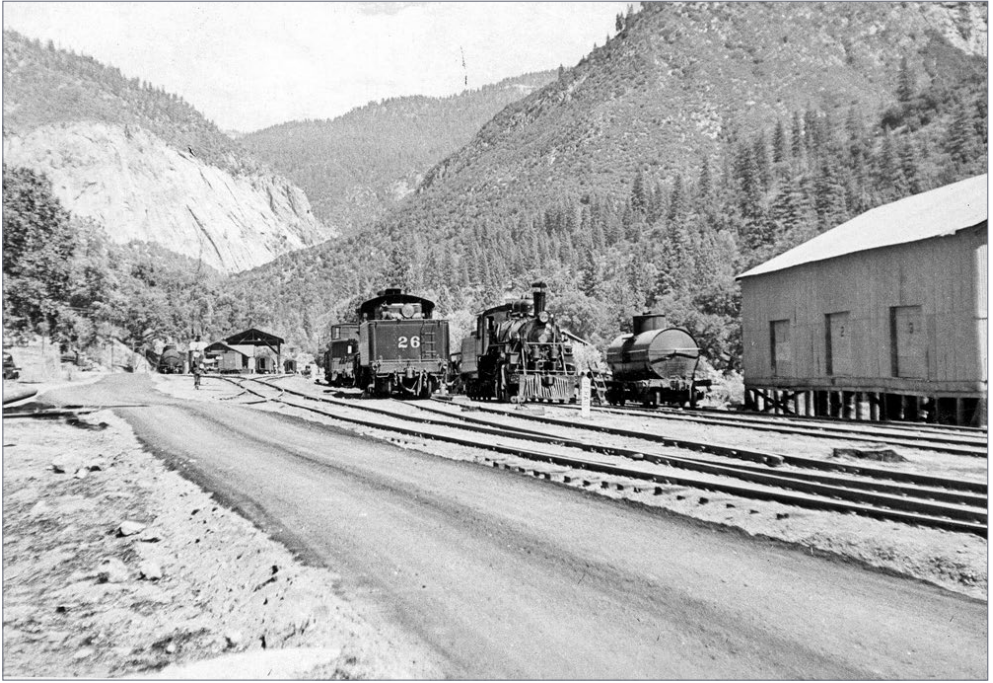

9. Again looking east with the Government Warehouse on the right. Note the door numbers on the building, which were included on the model. *Author's collection*

It was built on an elevated set of stringers, 4 feet high on the north/track side and, because the ground sloped away from the track, 10 feet high on the south side. This configuration allowed hay to be transferred directly from box cars into the building and then simply lowered to waiting wagons. There are photos of three of the sides of the building but not the down-slope side.

My model of the Government Warehouse, like those in the bulk oil plant, was built from 0.040" Evergreen sheet styrene. It was covered with pre-cut strips of Campbell Scale Models Corrugated Aluminum. The corrugated siding was bonded to the styrene subsurface with an industrial-strength 3/4"-wide double-sided



tape from Bron Tapes called Killer Red. It is available on eBay by searching for “Bron Killer Red tape.” I cut and bonded strips of Killer Red to cover all sides of the building and the roof. The corrugated strips were then “laid up” on the building without the use of any glue.

Rather than following the Campbell Scale Models instructions to paint the corrugated metal with SP Lettering gray, I finished the material on these buildings by first airbrushing on several coats of Dullcote. I continued to over-spray the model until all the gloss of the aluminum was gone. Once dry, I lightly over-sprayed the siding with some grays, and then highlighted the building with a dusting of Bragdon Enterprises weathering powders in grays, blacks, and rust colors. [10]



10. The Government Warehouse looking east. A YV engineer who lived in El Portal told me, “Unless you had worked there before the highway went in [1926], you’d have no idea what a business they had. They had four, five, six men working in the warehouse up there in the summertime unloading boxes at El Portal.”



11. Looking south across the Merced River toward the first logging incline which operated from 1912 to 1923. The storage shed is on the right. While it might have been an outhouse, it would seem that the door would have been in the center if it was an outhouse. *Al Rose collection*



Just to the east of the Government Warehouse is a small building that appears in a couple of photos. [11] My guess is that it was a storage shed which was a simple one-evening project. The core is again 0.040" Evergreen sheet styrene, this time covered with 1x12 stripwood pre-stained with varied shades of light brown. It was easier to cut the pieces of stripwood longer than needed, glue them to the sides of the building, then trim them to length.



12. My model of that storage shed. The debris on the hillside includes scraps of brass blackened with ME Rail Weathering Solution and other odds and ends. The "broken colored glass bottles" are broken up pieces of casting resin leftover from pouring bodies of water on the layout.

Battens of 1x2 stripwood were likewise cut longer than needed, stained, and glued to the building, then trimmed to length. With construction complete, I brush-painted the sides of the building with Floquil Boxcar Red. To replicate the weathered look of the building, I used my air eraser (a light-duty sand blaster normally used to prep brass models for painting, etc.) to remove as much paint as needed to model a building which hadn't been repainted for some time. It was easy to replicate the paint that remained under eaves, against battens, and other "hidden" locations. [12]

On the opposite side of the tracks was the Standard Oil office which still exists today. It is my understanding that the manager of the Standard Oil bulk plant lived and worked in this house. This idea was somewhat confirmed when, while measuring the building in the mid-1990s, I was invited to tour it by one of the renters. The west end of the building had a door that opened onto a hallway with several small "offices" on each side. The other end of the building had a living room, kitchen, bedroom, and bathroom. This might have been an early form of telecommuting! [5]

Like the prototype, my styrene model features a hip roof that slopes down on all four sides of the building. This building also has enclosed soffits where the eaves of the roof were covered by T&G siding. I had previously built structures with this roof style, only to later discover that the eaves had warped over time, making the building look more like a Japanese pagoda. I suspect this was due to using scribed styrene for the eaves. My solution for this building was to construct the entire roof and ceiling as a single substructure. The ceiling was constructed with an opening in the center which let me fill the entire "attic" with wet plaster. Once set, that plaster prevented the eaves from ever warping. [13]

To the east of this building were three cottages. [14] These houses were built in 1909 for railroad employees. Although highly



modified with second-floor additions, etc., they still exist today. My models were built from styrene with cast-resin porch railings. [15]

The El Portal Inn to the east of the cottages was built to replace an earlier hotel that burned in 1917. I have only four photos of this building, but no dimensions. [16] I started by drawing it in CAD (computer-aided drafting) using the height of the individual porch steps to scale the entire building. As I worked on the plans, I switched to using 30 inches as the distance between the surface of the porch and the bottom of the windows. That seemed to fit, so I built the structure from those plans using styrene with Grandt Line windows and doors.

Since I had only B/W photos, the color of the hotel was somewhat of a mystery. Based on a few color photos of other buildings along the YV and other information, nearly all of the buildings on my layout are white, boxcar red, or gray. For example, the YV



13. Looking west toward the Standard Oil Company offices. This end of the building was the private residence of the oil bulk plant manager.

station at Merced and the railroad cottages at El Portal were painted gray with white trim, while the other stations were white with gray trim.

I really wanted the hotel to be something different, such as green with yellow trim. But before I got to that point in the project, I

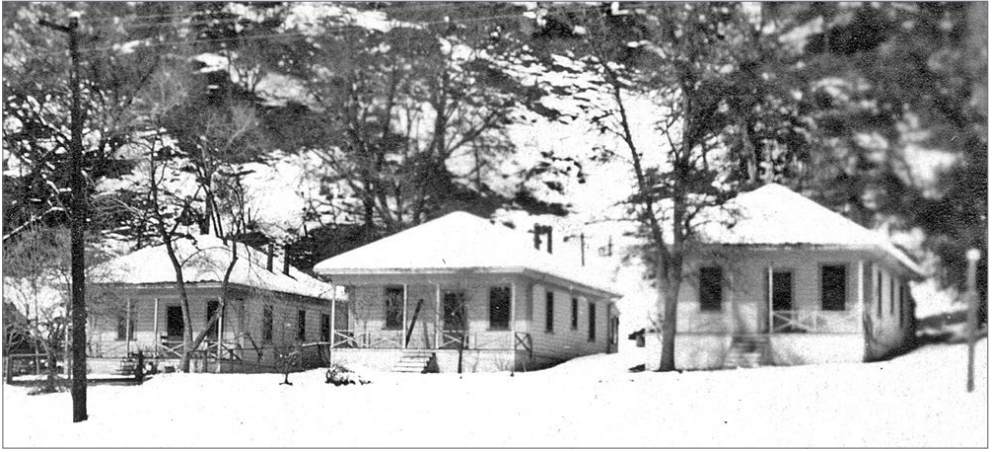

14. This family photo was given to me by a YV engineer who lived in the cottage on the left in 1939. It most likely was taken to document a rare snow storm. *Melvin Williams photo*



15. My three cottages. The mother of a small child watches her daughter kick a ball down the road.

visited a long-time friend named Jim Law who had arrived in El Portal with his family in 1907 and spent his entire life in and around El Portal. I obviously was trying to convince him that my color choices were correct when I asked him, “Jim, do you remember the El Portal Inn?” He answered in the affirmative so I continued, “I think that the building was painted green with yellow trim...is that correct?” I thought I got the answer I wanted when he answered again in the affirmative. But then his 70-year-old daughter interjected and said “No, Dad, I think it was painted red with white trim.” Drat! So I painted it red with white trim. [17]

Station and train shed

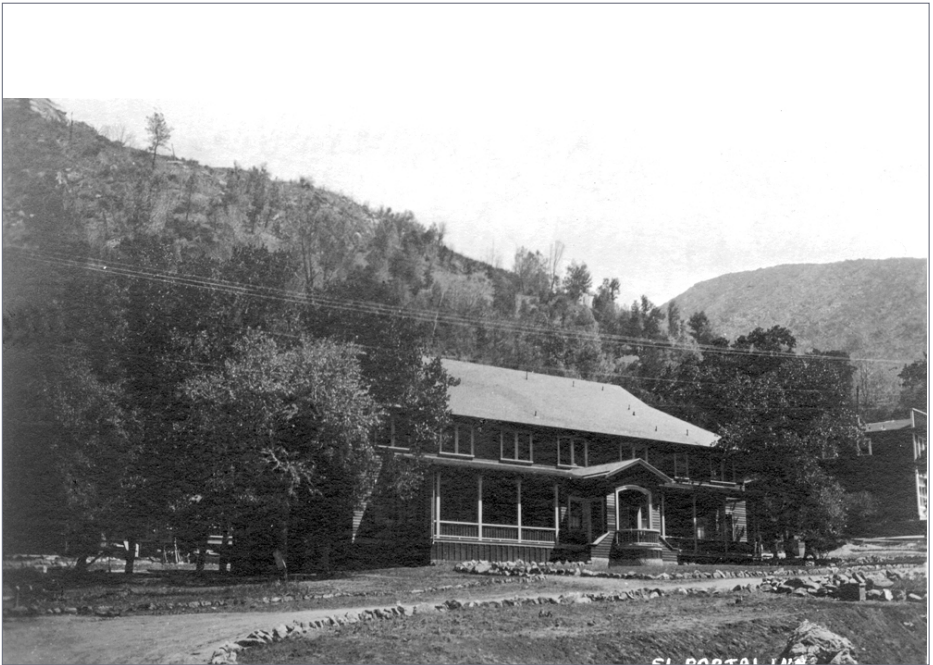

16. A postcard view of the El Portal Inn. The front stairs featured a circular porch with a curved railing.



17. My model of the El Portal Inn was built long before I discovered 3D printing. Without a way to curve a styrene railing, I left the porch off but I did include the light-colored rocks lining the road.

The railroad station at El Portal was built in 1908 and featured peeled log posts and beams with the exterior covered with patterns of natural Incense Cedar bark and pine branches. [18 and 19] Elements of this early architecture design would later become part of the style known as National Park Service Rustic which was formalized by the National Park Service in 1918.

Fortunately, I have a print of the original “ink-on-linen” drawing of the front elevation of this unique building, and also knew the overall width from an official YV map of El Portal. While I considered using basswood for this structure, I ultimately decided to use styrene. The exterior is covered with individual strips of styrene that were textured after rounding the edges. Styrene rod was used for the log posts and beams. The interior is fully



detailed, but after I installed the building on my layout, I realized it was too far from the front of the layout for visitors to view the details. The large roof opening also was very obvious in model photos, so I finally glued the roof in place. [20 and 21]

While the station sign on the front and rear of the building used a lettering style to match the building architecture, station signs on the ends of the structure conformed to the standard used on the other stations. YV railfan Al Rose didn't know how much he would help me decades later when he took a good photo of the station sign on the east end of the building. [22] I used Photoshop to straighten the image, remove the key-stone effect, eliminate the background, and then fix the "flaws" to create an accurate reproduction of the prototype sign for my El Portal station. [23]



18. The El Portal station in July 1940. The waiting room was on the right and the baggage room on the left. Baggage delivered to the station included everything from groceries and beer, to furniture and blasting caps. *Wilbur C. Whittaker photo*



19. It is early March 1945 and a young passenger steps into the station ticket office. If I'd had this photo when I was building my model of the station, I would have darkened the weathering on my building. Note the blackout hood visor around the rear marker lantern. Visors were installed on YV locomotives, cabooses, rear-end passenger cars, and even switch-standard lanterns after the start of WWII.

Al Rose photo



20. My model of the El Portal station is about 22 (real) inches long. It has complete interior details which are no longer viewable.





21. The station agent had his office in the front part of the building. The blinds in the windows were to block the bright sunlight in the mornings. The unique station sign was made the same way as the station signs on the ends of the building.

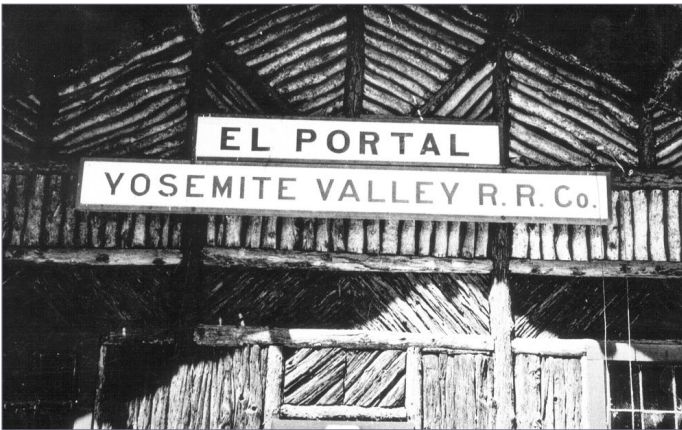

22. A photo of the station signs on the east end of the building. Even though the corporate name of the railroad changed from Yosemite Valley Railroad to Yosemite Valley Railway in 1937, these signs were never changed. *Al Rose photo*

The train shed at El Portal was 125 feet long. [24] Photos provided enough information to understand the design of the trusses supporting the roof but I was not sure about the actual size of the structural members. An architect friend helped ensure



23. The west end of the station had the same signs.



24. By March 1944, when Al Rose took this photo, the YV had discontinued all passenger trains and was operating mixed trains using coach 302 on this day. *Al Rose photo*

that my design was adequate for the prototype loads and spans. My model is a scale 100 feet long. [25]

At the end of the mainline track was a construction equipment loading ramp constructed over a track bumper. [26] I was told it was used by the California Division of Highways to move maintenance equipment to and from El Portal. Once I saw this photo, I had to add it to the end of that track.

Derails

An early map of the El Portal trackage shows derails on both sidings which directly connected to the mainline. Derails are somewhat like a turnout with a single point which, when open, will derail any equipment running through it. They were installed to protect a train on the mainline from a wreck with a runaway freight car from a siding. This was especially important in the El Portal yard, since the passenger trains were turned at Moss Canyon and backed into the train shed.



25. My model of the train shed. Note the equipment loading ramp on the adjacent track.

I constructed working derails on the two tracks connected to the west end of the mainline. [27] Both are functional with working switch stands. Initially, I used two under-the-layout slow-action switch motors, one “throwing” the switch and the other rotating the switch stand target. However, it was difficult to have them both work in sync with each other. I finally drew up a device in 3D and had it printed by Shapeways which solved that problem. It uses one motor with two crank arms with a series of holes running the length of the arms. That let me match the length of the throw for the points and the switch target. The “Mole II,” now sold by Proto 87 stores (proto87.com), will perform the same

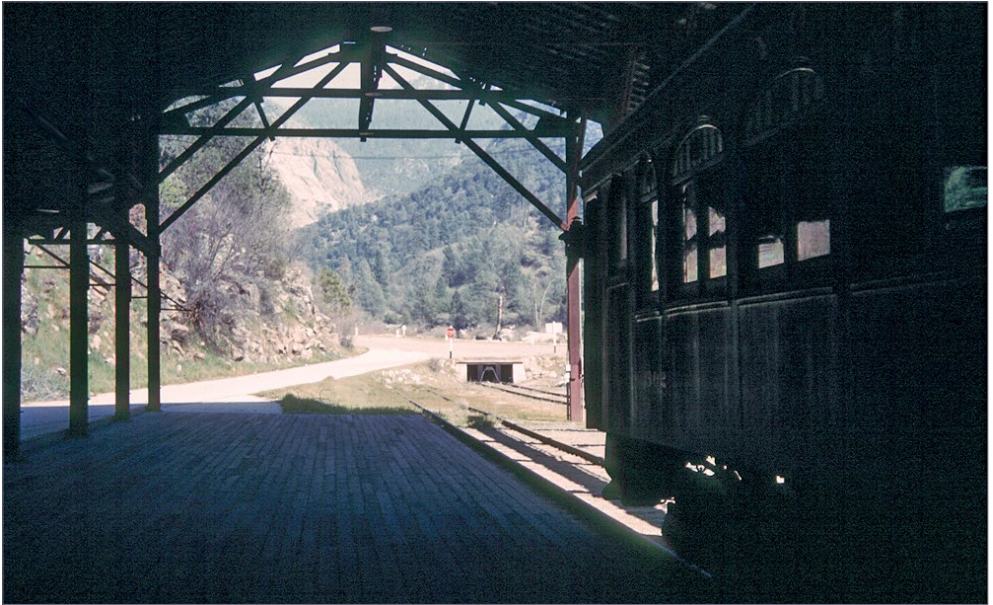

26. This was the view from the passenger loading platform under the train shed looking toward Yosemite Valley which was nine miles further east. De-training passengers enjoyed this view for 38 years. The equipment loading ramp is visible near the highway. *Al Rose photo*



way, moving the points and rotating the switch target at the same time.

With new operators, I always point out the derails but, inevitably, half of them forget. Since I don't allow operators to rerail my equipment, they have to tell me of their mistake. But I have never had someone make that mistake twice!

Modeling August 1939

During the time period I model, August 1939, activity in El Portal had slowed down somewhat from years before the Great Depression. Until 1935, four daily passenger trains operated on the YV during the summer months, two eastbound and two



27. One of the two working derails with working switch stands protects the mainline from a runaway freight car.

westbound. Passenger traffic actually had started declining as early as 1931 but management didn't act to reduce the losses until four years later. By August 1939, summer passenger trains typically consisted of the YV RPO, a leased SP diner, one or two heavyweight Pullmans, and the YV observation car. Double-headers were required a few times that month when there were four or more heavyweight Pullmans.

But traffic on the line was much more impressive earlier, as demonstrated by a special operated by the Federal Telegraphy Delivery National Association (FTD) in 1930. Three sections were planned including a Red Section from Philadelphia, a Green Section from New York, and a Blue Section from Chicago. Sections ran under a regular timetable with the first section following the departure times listed on the timetable but operating with green flags. These flags let other opposing trains know that another train, not on the timetable, would be following the first train. With three sections, the second train also displayed green flags. The third or final section did not display green flags.

For this 1930 special, the sections operated on the YV with 30-minute headways which were needed to accommodate switching movements at the Merced station. The number of cars in each section continued to increase during the planning process to eventually be limited on the YV to 16 cars. That train length required a double-header for each of the three sections, which required leasing three SP super-heated 2-6-0s. Each section was thus handled by one YV super-heated 2-6-0 together with an SP 2-6-0. Even with that lineup, the YV added a 4-4-0 helper on each section to assist in the last seven miles of the run over the 1.5% grade leading to El Portal.

These three sections resulted in 43 Pullmans and associated passenger cars that had to be stored in the El Portal yards while the



passengers visited Yosemite National Park. After passengers had gotten off, each train also needed to run back to Moss Canyon to turn on the wye before returning to El Portal where the cars were stored in the yard until the passengers returned from the Valley to continue their trip around the west coast.

Can you imagine being a rail fan on that day just west of El Portal? A double-headed passenger train with 16 cars with a helper on the end passing every 30 minutes! The sound of those engines working up grade reverberating off the canyon walls must have been amazing!

★★★★★
RATE THIS ARTICLE



28. Even though this is a relatively sharp No. 5 turnout, the extra distance between the frog and the points makes it appear broader.

MODELING EL PORTAL

When I designed my layout in 1980, I took the advice of track planning expert John Armstrong in his book *Track Planning for Realistic Operation* regarding setting a minimum track radius based on expected motive power.

Armstrong also lists design guidelines for matching the minimum curve radius to turnout frog numbers. The idea was that if you have an 18” minimum curve radius, you don’t need #6 turnouts.

Keep in mind that turnouts with larger frog numbers take more space – the shallow angle between the straight leg and the diverging leg pushes the “clean point” farther from the frog.

Based on my minimum curve radius of 22” I decided that, since I would be hand-laying all of my track, I would build No. 5 turnouts. On the rest of the layout, the No. 5 turnouts were built based on NMRA standards which set the frog just over 5” from the points.

However, on a suggestion from Tony Koester, the No. 5 turnouts in El Portal have the points set at 9” from the frog. The result is a relatively sharp turnout which looks more like a No. 6 or No. 8. [28]. ■

**VIEW READER
COMMENTS**

click here





WHAT'S NEW on TMTV!



Bill Scobie's Rio Grande Southern

Bill Scobie has been re-creating the RGS railroad in Sn3 on a massive scale in his basement for more than 30 years. Two part video.



Fixing Warped Resin Kits

Pierre Oliver shows us examples of warped resin rolling stock kits and techniques for getting things straightened out.



HO weathering & detailing, vol 4: Diesels

Dan Cortopassi takes you through four diesel projects, painstakingly aging and detailing each loco to match a specific prototype. (TSG Multimedia)



Modeling background trees

Fran Hale demonstrates a fast and cheap way to create a backdrop forest for your model railroad.

[CLICK HERE](#)

**Become a
TMTV member** >>

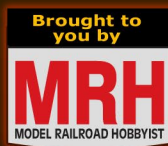

MRH Subscriber? Get your 10% off coupon code here:

**Get Subscriber
10% off code**

WHAT'S NEAT

column



Model Railroad Hobbyist | February 2018 | #96



RATE THIS ARTICLE

KEN PATTERSON SHOWS US BIG PLANS IN ON30, MAGNETIC N SCALE MODULES, WEATHERING ROOFS, A BIG MONON LAYOUT, AND MORE MODELING IDEAS ...

THIS MONTH, WE BUILD AN N SCALE MODULAR layout connected with magnets. We look at Gerald Styles' beautiful On30 layout. Jason Quinn shows how to weather boxcar roofs with oil and acrylic paints. Kevin Ruble shows the starting phase of his huge Monon home layout in a custom-made building, and Steven M. Conroy shares more of his California railroad drone footage – all in the pages of this magazine and in this month's "What's Neat" video.

**VIEW READER
COMMENTS**

click here

▶ PHOTOS AND VIDEO OF SUPERB MODELING

• [INDEX](#)



SUBSCRIBE
(free)

• [TABLE OF CONTENTS](#)

Rusting box car roofs



1. (Above) Jason Quinn, Daniel Coombs (left) and Mike Budde (center) his secret steps secret steps in weathering box car roofs to look rusty and very believable. He started by painting this Tangent car's silver roof a light gray color to represent an oxidized galvanized metal roof. He then dry-brushed black Pan Pastels to highlight the details.

2. (Top right) Acrylic burnt umber represents heavy rust around the various panels. Jason uses prototype photos to paint rust patterns on roof panels. The key here is to be random along the edges.

3. (Bottom right) After the "rust" paint dried for a day, Jason used burnt sienna oil paints to create the lighter rust bleed that appears along the darker rust edges. He suggests blotting this color on very lightly, as a little oil paint goes a very long way.



Also see the new "What's neat this week" weekly video podcast!

**WATCH
NOW** >>

• [INDEX](#)



SUBSCRIBE
(free)

• [TABLE OF CONTENTS](#)



4. Before the oils dry completely, Jason uses a brush dampened with thinner or turpenoid (in this case) to wash the light rust-colored paint into a bleed over the galvanized areas between the heavy rust and the cleaner galvanized panel surface.

**VIEW READER
COMMENTS**

[click here](#)



Also see the new "What's neat
this week" weekly video podcast!

**WATCH
NOW >>**



5. After this dried for a week – seven days – Jason then sprayed Testors Dullcote over the entire roof. After you “rust” all the roof panels, the finished results look very realistic.

A video thumbnail for MRH Model Railroad Hobbyist. It features a man in a blue shirt standing in a workshop, gesturing towards a model train layout. The background is filled with various tools and equipment. A film strip graphic is overlaid on the bottom right. The text "HAVING FUN WITH TRAINS" is at the top, "MRH" is in large red letters, and "MODEL RAILROAD HOBBYIST" is below it. A play button icon is on the bottom left. The text "February 2018 -- What's neat ..." is overlaid on the bottom left.

HAVING FUN WITH TRAINS

MRH

MODEL RAILROAD HOBBYIST

February 2018 --
What's neat ...

Playback problems? [Click here ...](#)



Build an N scale layout with magnets

In this two-part series, I am going to experiment with magnets to connect layout modules. In this first part, we will build a small N scale modular layout that can be expanded to any size, and secure the modules with magnets. In Part 2, we will apply larger magnets to a wood-framed HO scale modular layout, the type you might see set up at a train show. Will magnets be up to the task without it coming apart?



7. To start the N scale layout, I drew the layout's dimensions on a sheet of two-inch pink foam. The track radius is about 14 inches and the layout's overall size is 3'x4'4". It could be expanded by adding more modules, as you will see.

To ensure perfectly vertical sides on the layout, I cut to size and applied 80 grit self-stick sandpaper to a steel square block. Rubbing this new tool around the sides of the layout carved the foam sides square and made the curve flow perfectly around the layout.

Have you seen this?

**CHECK IT
OUT!**



kenpatterson.com

click here to ...

Visit Ken's website

**Ken Patterson
reveals his modeling
secrets on video!**



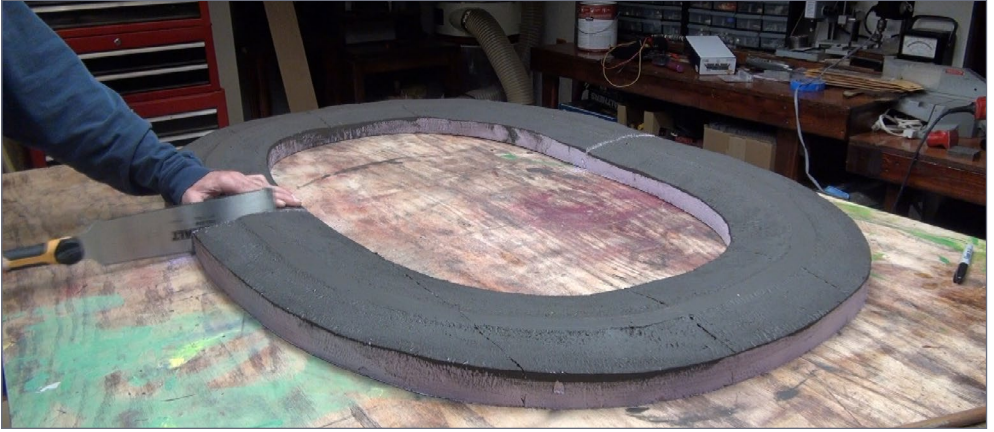

8. I used blue painters masking tape to represent the N-scale track in the middle of the layout, following the flow of the oval-shaped circuit, then carved the track profile and topography with a horse rasp and Stanley Surform planer. I sealed the top of the layout with brown latex house paint and cut the layout into two pieces at the center of the oval, as you see here.



9. To create a solid surface to mount the magnets, I set my router to a depth of $\frac{3}{4}$ " and used a $\frac{3}{4}$ " straight router bit. I then guided the ends of the layout along the router fence to cut a straight groove into the ends of the foam sections.



10. In the same way, I secured $\frac{3}{4}$ " blocks to the outside curved ends of the layout. We'll use these when we attach plywood sides with half-inch staples. I soaked an 8' by 2" strip of $\frac{1}{4}$ " oak plywood with the garden hose. I also sprayed the outside edges of the layout foam with water, applied a few lines of Gorilla Glue to the plywood, and wrapped the plywood strip around the outside curve, stapling the wood into place where the wood blocks are secured in the foam. I did this to each half, wrapping wood inside and outside the edges framing the layout.

**VIEW READER
COMMENTS**

click here



Also see the new "What's neat this week" weekly video podcast!

**WATCH
NOW >>**

• [INDEX](#)



SUBSCRIBE
(free)

• [TABLE OF CONTENTS](#)



11. Within 5 minutes of attaching the wood sides, I used bar clamps to draw the layout back into the correct shape as the plywood wants to spread the U shape open. The bar clamps prevent this and hold everything to shape as the glue cures over 20 to 30 minutes. Once the glue sets up, you can remove the clamps and the layout will hold its shape.

**VIEW READER
COMMENTS**

click here



Also see the new "What's neat
this week" weekly video podcast!

**WATCH
NOW >>**



12. I contoured the top of the plywood to match the topography with a cabinet bead flush trimmer before I sanded, stained, and finished the wood surface with three coats of polyurethane for a glass-like furniture finish to match my studio. Using a circle template, I drew an $11/16$ " circle center on the $3/4$ " board on the end of the module, centered $1\frac{1}{2}$ " from the outside edge of the layout section. This circle matched the diameter of the magnets perfectly. I routed this circle with a Dremel router attachment to the depth of the magnets' thickness, and just a little wider around the edge to give the magnet some wiggle room to line up with its mate as the glue sets.



Also see the new "What's neat this week" weekly video podcast!





13. I used 5-minute 2-part epoxy to glue the magnets into their routed circles. I placed a piece of paper between the modules as they were connected, ensuring precise alignment as the magnets find each other, "snap," and mate up. The paper prevents the modules and or the magnets from permanently attaching to each other while the glue cures and sets up. I did this same process with all eight magnets holding the layout together. Watch and follow this process in the video portion of this column

**VIEW READER
COMMENTS**

click here



Also see the new "What's neat
this week" weekly video podcast!

**WATCH
NOW >>**

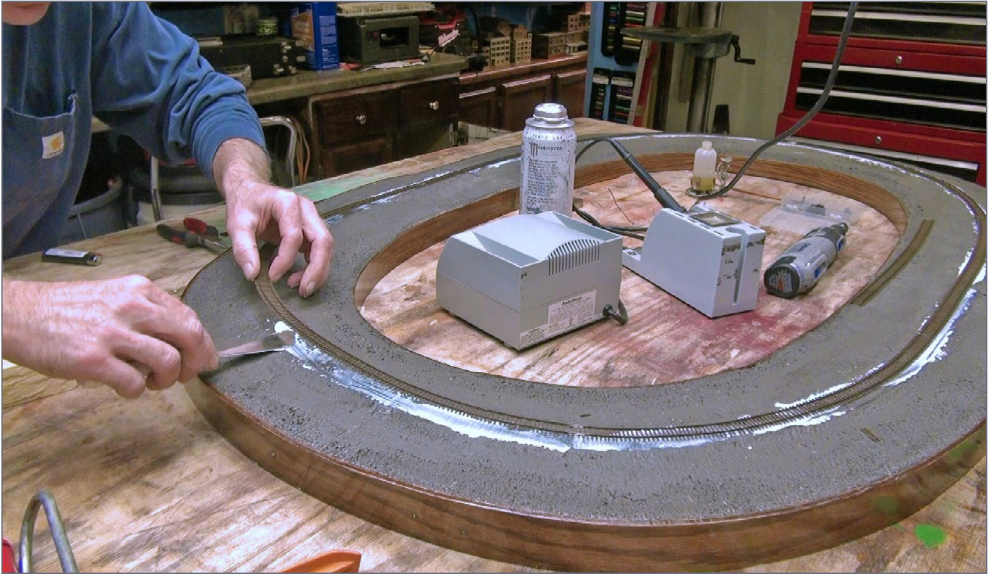

14. I put down Micro Engineering code 55 N scale flex track, carefully bending it to match the flat 1" wide roadbed area following the 14" radius curve around the layout. I cut and soldered the track using rosin core solder, lining it up with Atlas N scale track joiners. I glued the track into place with DAP Kwik Seal Plus adhesive using a painter's knife. This glue dries fast and clear. It is paintable, so the ballast will stick to it. It also remains flexible, allowing the track to "breathe" during seasonal temperature and humidity changes.



Also see the new "What's neat this week" weekly video podcast!

**WATCH
NOW >>**

• [INDEX](#)



SUBSCRIBE
(free)

• [TABLE OF CONTENTS](#)

ADVERTISEMENT

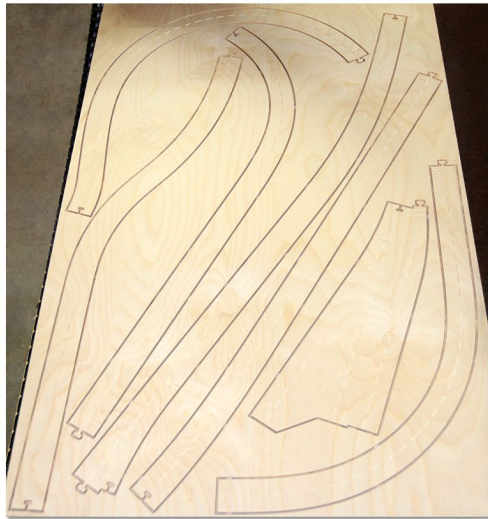

Splines make smooth curves.

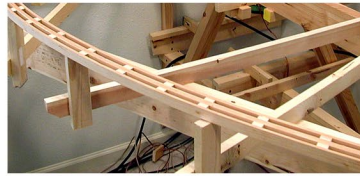

Making splines takes a long time!

Custom CNC roadbed is precise, costs less, and builds more quickly.

Laser-cut splines - accurate enough for hand-laid track. *Plan for the future!*

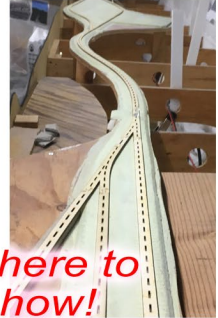

How will you build your layout?

3rd Plant 3D CAD
The ultimate track planning software

El Dorado
SOFTWARE

Click here to learn how!

ADVERTISEMENT

FROM MT. ALBERT SCALE LUMBER

NEW!
PAINT GRADE

STRIPWOOD

Standard Grade
Suitable for staining

Paint Grade
Less suitable for staining. Ideal for painting

Not all wood used in your projects will need to be stained, so why pay for stain quality wood?

SAVE 20% over the price of our regular high quality stainable stripwood with our new Paint Grade Stripwood!

Same great quality, 20% less.

Order online today!

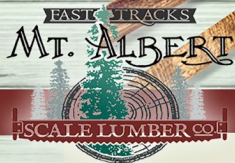

Easy Ordering Live online support Earn WayPoints with every purchase
shop online 24/7 handlaidtrack.com/scalelumber 1-888-252-3895



15. When the track was firmly in place, I cut the rails apart at the module connection points on each side of the layout. I then pulled the layout apart, placed an N scale box car on the track and snapped the layout back together. The magnets made a solid connection and the rails lined up perfectly as I rolled the box car across the connection.

Tell your friends about MRH!

**We depend on word-of-mouth to grow
... if you don't share us, we don't grow**



Also see the new "What's neat this week" weekly video podcast!

**WATCH
NOW >>**

• [INDEX](#)



SUBSCRIBE
(free)

• [TABLE OF CONTENTS](#)



16. I applied dirt, ballast, and ground foam to the layout with Woodland Scenic scenery cement. I sifted on some static grass while things were still wet, to give color and texture to the layout, and let this dry for 12 hours. I powered the layout temporarily by soldering wires to an Atlas N scale track joiner, and slid this on to the rail at the connection point. I then ran a locomotive around the layout a few times.

**VIEW READER
COMMENTS**

click here



Also see the new "What's neat
this week" weekly video podcast!

**WATCH
NOW >>**



17. To further test the magnets' strength, I held the layout up in the air, swinging it around. Check out this month's video. The layout held together, proving the value of this magnet/layout connecting idea.

Gerald Styles' On30 railroad



18. This month we visit with Gerald Styles and look at his wonderful On30 layout, the Termite and Tarantula RR.





19. Gerald designed the T&T with the shadow box concept in mind, to control the lighting and the viewer's eyepoint, just like a theatrical stage set. It is a double deck layout with most of the scenery on the lower deck complete. The upper deck holds staging, and future scenery. The track is a combination of handlaid and commercial track. It occupies about 500 square feet. Gerald started the layout in 2001 and it has been featured in the *On30 Annual* and in the National Narrow Gauge Convention in Denver.

**VIEW READER
COMMENTS**

click here



Also see the new "What's neat this week" weekly video podcast!

**WATCH
NOW >>**



20. Most of the buildings are scratchbuilt, with lighting and full interior details. The buildings include storefronts, mines, snowsheds, brick warehouses, homes, and cabins along with a full roundhouse scene.



21. The roundhouse was a kit Gerald designed and offered commercially under the name Firebox Models. Gerald added animation to the layout like the gophers that pop up and down in their burrows (see them in the video) or.....



22. ... the flying birds which were gaming figures. They are suspended on wire linked to a chain that is guided through cogs and servos to make the birds fly around the cliff tops. You can see the mechanics in this photo. Gerald is simply an amazing model railroad artist.

**VIEW READER
COMMENTS**

click here



Also see the new "What's neat
this week" weekly video podcast!

**WATCH
NOW >>**

Kevin Ruble's HO layout, a first look



23. Kevin Ruble is the owner of the Caboose model railroad store in Lakewood CO. He invited me to tour the store and see his new home layout. In this month's video, we look at the layout from top to bottom as Kevin describes his layout design philosophy.

The layout was originally designed to represent the Monon line switch for switch from State Line to Lowe, in Indiana, in the summer of 1967. After purchasing the former Caboose Hobbies in Denver, Kevin was concerned with the time it would take to install 160 Tortoise switch machines and build over 411 buildings to model the Monon railroad with full operation.

So, he decided to scale it down, to model the Monon starting just south of Bedford IN to Orleans, IN and then include the branch line to French Lick.



Also see the new "What's neat this week" weekly video podcast!

**WATCH
NOW** >>





24. The layout occupies the 35x53' second story of a custom-built horse barn. It is fully heated and air-conditioned with a dark vaulted ceiling with can lights positioned throughout. The layout has 60" or wider aisles, with 40-foot peninsulas and track running around the outside perimeter of the room.

**VIEW READER
COMMENTS**

click here



Also see the new "What's neat this week" weekly video podcast!

**WATCH
NOW >>**



25. The mainline will be 260', modeled as single track with passing sidings designed for multiple operators running with six trains per day – two passenger trains and four locals. Kevin figures 40-car trains will run during operating sessions. The scenery will primarily be rural small towns.

**Want to help
keep MRH free?
Then click on
Ads!**



Also see the new "What's neat
this week" weekly video podcast!

**WATCH
NOW >>**





26. The benchwork is built from 2x6 and 2x4 board with a rail height around 54". With backdrops painted blue, and valance lighting all the way around the layout, it is time to start laying track. Look forward to updates on "What's Neat," as progress continues on this magnificent home layout project.

**VIEW READER
COMMENTS**

click here



Also see the new "What's neat
this week" weekly video podcast!

**WATCH
NOW >>**

Drone footage by Steven M Conroy



27. This month, Steven Conroy flies his drone above the passenger trains running through California. Plenty of modeling ideas, road colors, tree structures and height, and mainline track profiles can be seen in this high-quality aerial videography, which I call "Modeling Ideas from Above."



Also see the new "What's neat this week" weekly video podcast!



MRH MARKETPLACE



LOOK
at what's new at
Black Cat this month

Click here for
our website

**CN ore cars now in
block or post 61 noodle**



Photo: Bill Grayson

Black Cat Publishing
(204)489-5005
ajfergus@mymts.net
blackcatdecals.com



Yarmouth Model Works

HO scale resin kits and detail parts

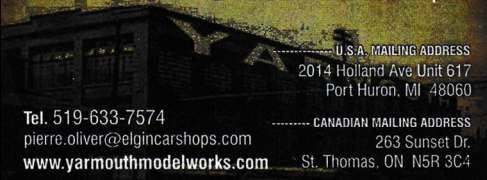

U.S.A. MAILING ADDRESS
2014 Holland Ave Unit 617
Port Huron, MI 48060

Tel. 519-633-7574
pierre.oliver@elginarcshops.com
www.yarmouthmodelworks.com

CANADIAN MAILING ADDRESS
263 Sunset Dr.
St. Thomas, ON N5R 3C4

CROW RIVER PRODUCTS

**New "O" Kit 335 B
FLOOR MODEL DRILL PRESS
SECOND IN A SERIES OF
VINTAGE MACHINE TOOLS**

17 Pewter Castings.
For Overhead Belt
Available, No. O-53
or Motor Conversion
(Available Dec. 2017)

Price \$28.00
Made in USA



**HO & O Scale Machinery, Derricks,
Engines, Hardware & Waterfront Models**
Pawtucket, RI 02861 Tel 401-723-0065
www.crowriverproducts.com

THE DCC SHOP

YOUR COMMAND CONTROL SPECIALISTS
www.DCCSHOP.com



Quantity Pricing for
the Layout Builder



HO Brass



Start your model railroad
empire on the right track
with **THE DCC SHOP**

The Little Train Store that is **BIG** on Customer Service!

www.DCCSHOP.com
ph. 208-889-9111

Imagine that!
Laser Art Products

ITLA Scale Models

*York Industries
HO Scale Laser
Cut Wood Kit*

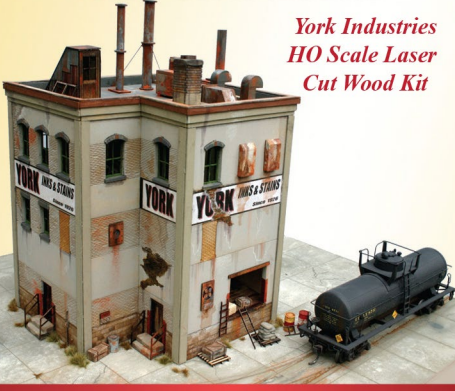

CLICK HERE FOR MORE INFORMATION
www.itlascalmodels.com

MAIN STREET AMERICA HISTORIC ARCHITECTURE



MAIN STREET HERITAGE

www.mainstreet-heritage.com

CLICK
HERE
for all
our HO
& O kits

Where the Rail Meets the Sea...



CRAFTSMAN KITS & BUILT-UPS
HO - O - N Scale



B114-HO Lobster Shack/Dock kit \$74.95

www.seaportmodelworks.com

Click here for our website:

BenchWork.com

To build your dreams, You need a plan!
Affordable track planning
Starting at only \$250

CLICK ME to get started!

Kadee

What Coupler
Do I use?

**Coupler
Conversions**





Your #1 source for **TOMA** Benchwork
250+ shapes & sizes!
 Built to order benchwork also available! (224)201-9868



LOGIC RAIL™ "Sophisticated Model Railroad Electronics"
 TECHNOLOGIES

Please visit our website and online store!

21175 Tomball Pkwy Phone: (281)251-5813
 Suite 287 <http://www.logicrailtech.com>
 Houston, TX 77070 info@logicrailtech.com

PRE-SIZE MODEL SPECIALTIES
 P.O. Box 6 Paonia, CO 81428
 Ph. 970 527 4586
 Made in The USA

Cast resin items for All Scales.
 Tunnel portals, bridge piers, abutments,
 culverts, and retaining walls.
 Trackside details and sage brush tree
 armatures.
 "FREE SHIPPING see website for details"

GOODDEALS DCC
WWW.GOODDEALSDCC.COM

HOME OF THE
PROGRAMMER TEST TRACK SYSTEMS
 GARY COHN GARY@GOODDEALSDCC.COM

Altoona Model Works
 Railroad Track Side Structures in O & HO scale
 Museum Quality Workmanship

WWW.ALTOONAMODELWORKS.US
 814-793-7016

W GOLDEN AGE LINE
WESTERFIELD
 MODELS, LLC

USRA DS Express Box
 NWP Redwood Empire

westerfieldmodels.com

Your ad could be in
 this space for as low
 as \$58 a month.
 Click to learn more ...

HO DIESEL SUPPLY

CUSTOM SOUND LOCO'S-REPAIRS-UPGRADES

Weathered New and Rebuilt Locomotives

Powered Chassis-Trucks-Motors-Handrails-Electronics

Parts Inventory Always Changing

www.hodieselsupply.com

email:gerry@hodieselsupply.com

Great Decals!™

FEC, Interstate, Virginian

Railway, & L&N Titles

After Hours Graphics Line

Coupler Gages and More

In O, S, HO, and N Scales



Model Railroad Control Systems

Geoff Bunza Project Boards

DCC Occupancy Detectors

CMRinet Compatible Nodes

Layout Telephone Systems

RFID Switchlist Generator

Switch Machines and Drivers



Click Here

MOUNTAIN SUBDIVISION HOBBIES

www.modelrrsupply.com

FREE USA SHIPPING OVER \$39.00

NCE - SOUNDTRAXX - DIGITRAX - ESU LOKSOUND
SPROG - DCC SPECIALTIES - INTERMOUNTAIN - CMX
BAR MILLS - BOWSER - ATLAS - CIRCUITRON - PECO
RIX - PIKESTUFF - CENTRAL VALLEY AND MORE!!!

PRECISION DESIGN CO.

LASERCUT KITS - CUSTOM DECALS

PDC.CA

Authorized *RailPro* Dealer

FREE SHIPPING in the US and CANADA

Have you seen these popular blogs on the MRH website?



Tom Johnson's L&N

353,000 reads

[CLICK TO READ IT NOW](#)

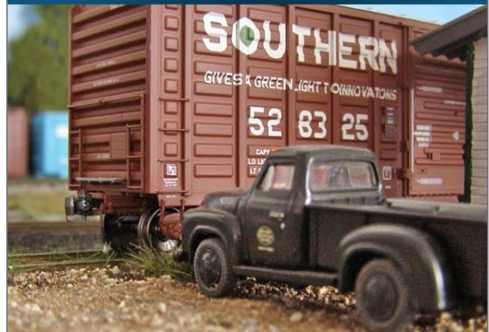

Ken Glover's Shelf Layout

127,000 reads

[CLICK TO READ IT NOW](#)



The Union Pacific Railroad modules of Peter Bakhtar and Mel Johnson



• [INDEX](#)

• [TABLE OF CONTENTS](#)

ROBERT SCHLEICHER *looks at two realistic UP segments of a Southern California modular group ...*



(Lead) Peter Bakhtar's "signature" coaling tower scene on the Union Pacific in Cheyenne. *Bill Grunklee photo*

• [INDEX](#)



SUBSCRIBE
(free)

• [TABLE OF CONTENTS](#)



RATE THIS ARTICLE

*click here***THERE'S MORE!**Check out the Subscriber
bonus extras

PETER BAKHTAR HAS RECREATED A PORTION OF the Union Pacific in Cheyenne, WY, and Mel Johnson has recreated a portion of the UP in Marysville, KS.

Both men built these sections as portable shelf layouts to the standard specifications of the '20s and '30s Model Railroad Club in Southern California. The group gets together an average of once a month when the members' modules are joined to create a layout capable of operating 30-car freights and 12-car passenger trains.

The club does not specify a prototype railroad and, in fact, several of the modules recreate the Pacific Electric interurban's city and industrial trackage in Los Angeles.

The club's standards state that "Scenery and rolling stock must depict North American or similar fictitious railroads from 1920 through December 7, 1941."

The majority of the group's modules depict real-world scenes like Peter's Cheyenne and Mel's Marysville.

Standards for your modular model railroad?

The club's standard for module construction are downloadable from their website at trainweb.org/20s30s.

Several other modular groups have adopted their standards and you can use them yourself as well (non-commercial use only). The basic modules are open-grid framed with 1 x 4s. The standard



2. Mel Johnson's Union Pacific's M-10000 idles on Peter Bakhtar's re-creation of the Union Pacific in Cheyenne, including its ornate stone station (in the background). Peter's modules occupy a 3x16' space.



module length is 6 feet long, with a 2½-foot standard width at the interchange end. The module itself can be up to three feet wide.

The standards include detailed assembly drawings, interface specifications, and wiring diagrams so all of the 17 members' 35 modules will interface with one another.

The club originally opted for conventional analog control with tethered walk-around throttles. More recently, however, enough motive power has been fitted with DCC receivers that the layout can be operated with DCC radio control handheld throttles.

Peter Bakhtar's 3 x 12-foot Cheyenne, Wyoming modules

Peter Bakhtar knew he faced a daunting task in recreating the Cheyenne, WY depot on the Union Pacific. There was no kit available but he did possess scratchbuilding skills.

Peter selected the closest match he could find for windows and doors from the Grandt Line series and scaled the dimensions of the depot's walls to match them. He shortened the depot by modeling only the center three structures, leaving off the baggage room and the dining hall. He added a covered waiting platform in the area the baggage room would normally occupy.

The majority of the walls are Plastruct styrene sheets with molded-in stone detail. He carved the window sills and lintels and the tower corners in balsa and prepared RTV rubber molds so he could cast replicas in Hydrocal plaster. The interior is fully detailed with operating ceiling fans and lighting. The four clocks on the tower are small watch faces so they do portray accurate time.

Peter's module is actually two modules that interface with other club modules only at their extreme ends. His 3 x 12-foot

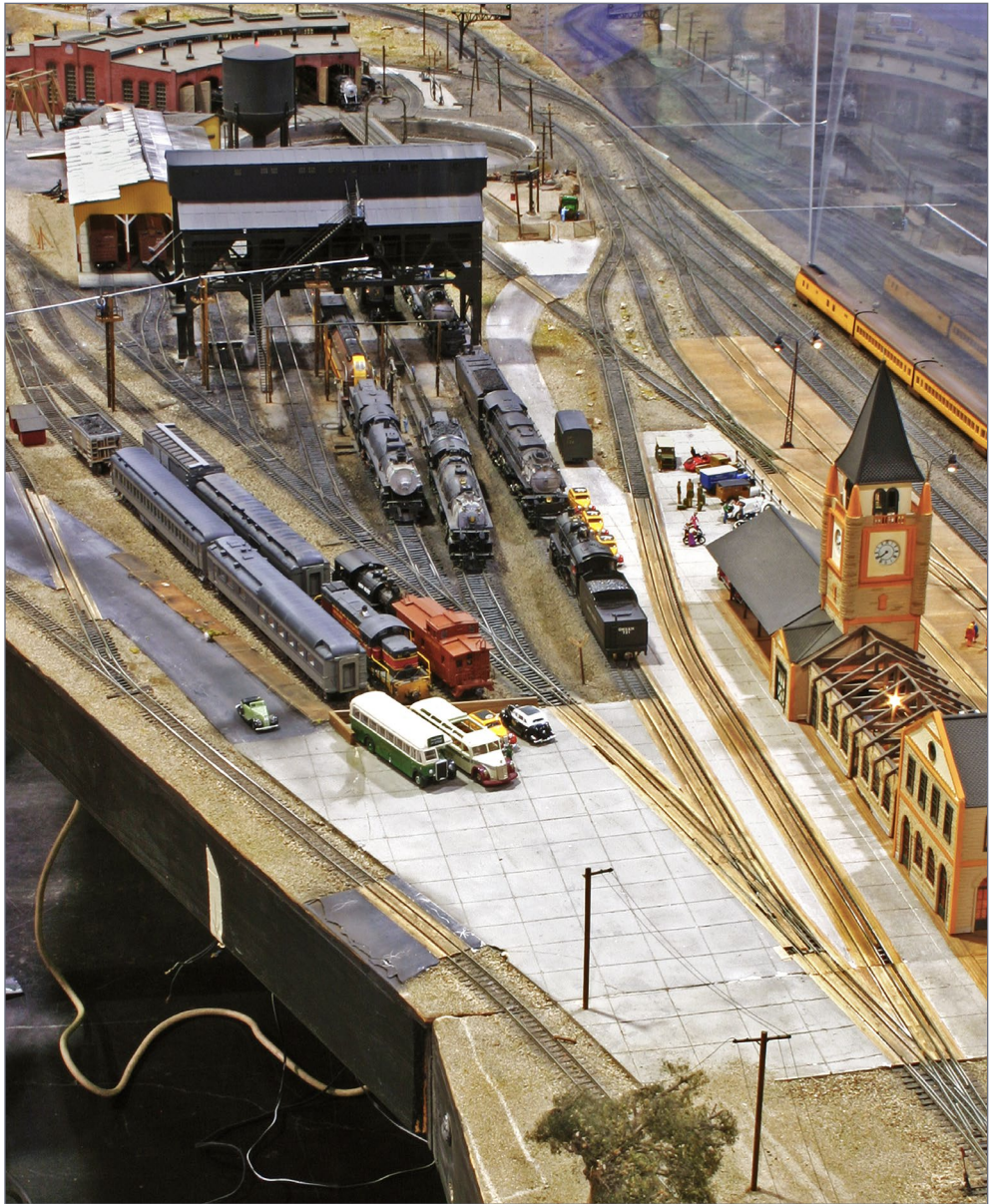

3. Peter Bakhtar's re-creation of the depot and coaling tower portion of the massive Union Pacific yard at Cheyenne only occupies an area of 2½x12 feet on a pair of portable modules.



multi-module set provides more freedom in track design than just what the usual 6-foot module would allow.

He had completed the trackwork on the module when Mel Johnson offered to help him kitbash an IHC coaling tower to more closely match the structure at Cheyenne, so, to fit the improved coaling tower onto the layout, Peter replaced several sidings to align the tracks with the coaling bays.

The combination of the stone depot and that massive steel coaling tower make it instantly clear that this has to be Cheyenne.

THE MODULES

1. Why select this particular railroad?

Peter prefers the older yellow and brown Union Pacific Streamliners to more modern yellow and grey trains.

2. How to determine which portion of the real railroad to model?

Cheyenne, WY was the passenger hub of the railroad (much like O'Hare airport is a hub for airlines today), with trains from all four corners of America converging on Cheyenne. And that station is instantly recognizable to UP fans.

3. How to decide on which era or eras to recreate?

Peter is fan of art deco automobile styling and the passenger trains of the thirties, particularly the Union Pacific's M-10000. After reading some books about the Union Pacific, he realized that the 1920s and 1930s were the eras that appealed to him the most.

4. What type of freight and passenger operations to recreate?

When the module is in operation, Peter runs a much-reduced flow of the passenger trains that operated through Cheyenne, and replicates the locomotive servicing moves at Cheyenne in the '30s.

5. What were the most important factors considered when designing the layout to fit the space?

Peter had space at home for a small shelf layout, so he built one. His layout, however, has the capability of being combined with others because it is built to match the modular standards of the local '20s and '30s Modular Model Railroad Club.

6. What are the defining (signature) structures?

The Cheyenne station is distinctive and the coaling tower is a standard Union Pacific design that was used, in various forms, at most of their major locomotive coaling centers across Wyoming and Utah.

7. What are the defining (signature) scenes?

The combination of the Cheyenne stone depot and the massive steel coaling tower within sight of the depot defines the scene as being possible only at Cheyenne.

8. How to decide on the locomotive roster?

Because the layout is usually operated with other trains from the modular model railroad club, there are only three or four locomotives, including the self-powered articulated M-10000 streamlined train. There's an 0-6-0 for yard switching and there will be power to head at least one train of heavyweight baggage cars and coaches.

9. How to decide on the mix of cars in the freight car fleet?

The freight cars are a random mixture of his preferences of Westerfield cast-resin kits that are based on '30s-era prototypes.

10. What research sources were most useful?

- Union Pacific Historical Society, uphs.org
- The book *History Of The Union Pacific In Cheyenne*, by Robert Darwin
- Knowledgeable friends like Mel Johnson ■



Mel Johnson's 2½x6-foot Marysville, Kansas

Mel Johnson's passion is the history of the Union Pacific Railroad, specifically how the road looked and how it operated in the 1930s. He is a volunteer in the Union Pacific Historical Society and spends a week or more every year helping to catalog the Union Pacific's vast collection in Council Bluffs, IA, and working with the historical society.

That passion was kindled when Mel discovered *Union Pacific Central Division Hub* by Ronald T. Schlichter and Wayne W. Link. The book's photographs showed scenes he wanted to recreate in HO scale.

Mel's interest in HO scale modeling began when he visited one of the pioneer layouts in Southern California at Karl Wald's in the late '30s when Mel was just 8 years old. By 1961 he had shifted from freelance model railroading to modeling specific prototypes.

Mel has built several 2½x6-foot modules including the Marysville module, a small town module scene with an ice platform, and a '30s-era engine terminal with roundhouse and elevated coaling trestle, as well as a 6x6-foot diamond-shaped corner module with a replica of his wife's parents farm.

Mel assembled all his modules according to the '20s and '30s Modular Club drawings and specifications. The track is Walthers/Shinohara code 70 and code 83.

Mel screens his own ballast to match the color of ballast rock used by the UP in Kansas. Mel collects gravel from nearby southern California mountains water runoff since the sand and soil is already segregated into fine particles of white and tan granite.



4. The “signature” depot and steel cooling tower at Cheyenne dominate Peter Bakhtar’s module.

That matches the color of the ballast he believes was common in Kansas in the 1930s.

Most of Mel Johnson’s structures are scratchbuilt using Evergreen styrene with roofs covered with laser-cut paper shingles. If plans are not available, he uses the doors and windows as a gauge to obtain the proper proportions of the prototype buildings.



TEN SIGNIFICANT FACTORS THAT MAXIMIZE SATISFACTION

1. Why this particular railroad?

Mel was inspired to recreate portions of the Union Pacific in the '30s because of a personal interest in history. He wanted to place boundaries on his purchases of HO scale locomotives and rolling stock to avoid a willy-nilly mixture of New York Central and Union Pacific.

2. How to determine which portion of the real railroad to model?

Mel found a book at a Union Pacific Railroad Historical Society meeting that contained photographs of precisely the scenes he had dreamed of recreating.

3. How to decide on which era or eras to recreate?

Mel picked the '30s because he wanted to model a period before he was born. In the '60s he bought Pacific Fast Mail imported brass steam locomotives because they were all that was available and they were models with the details that were common on the real locomotives in the '30s.

As a college student, he wrote a term paper on railroads and focused on the building of the transcontinental railroads which, of course, meant the Union Pacific and the Central Pacific (which became the Southern Pacific in later years). His discovery of books with photographs of Marysville, KS made it a doable choice.

4. What type of freight and passenger operations to recreate?

The operations are primarily through freights and passenger trains during the club's get-together at train shows.

5. What were the most important factors to consider when designing the layout to fit the space?

Having the courage to limit the number of structures to provide as much “open space” as possible to best portray the atmosphere of Marysville in the 1930s.

6. What are the defining (signature) structures?

The signature structure is the Marysville station with its pyramid-shaped tower.

7. What are the defining (signature) scenes?

The signature scenes along much of the Union Pacific in Kansas and Nebraska at the time are typical of this arrangement of station, freight station, and water tower.

8. How to decide on the locomotive roster?

The locomotive roster has been based primarily on what brass steam locomotives were available and were detailed to match 1930s prototypes on the Union Pacific. Con-Cor’s plastic model of the Union Pacific M-10000 Streamliner was helpful but Mel repainted the brown to match the information he collected from museum documents.

9. How to decide on the mix of cars in the freight car fleet?

Mel’s selection of freight cars was influenced by matching cars in published photos of scenes on the Union Pacific in the ’30s. Most of the models are from Westerfield resin kits.

10. What research sources were most useful?

- Union Pacific Historical Society, uphs.org
- Union Pacific Railroad Museum at Council Bluffs, IA, uprr.com/aboutup/history/museum/index.shtml
- Otto Perry Collection at the Denver Public Library, photoswest.org/perrycat.htm



TEN SIGNIFICANT FACTORS THAT MAXIMIZE SATISFACTION *CONTINUED ...*

- Smithsonian Institution's Pullman collection, pullman-museum.org/misc/bibliography.html
- California State Railroad Museum in Sacramento, cstrmf.org

See the Library of Congress for out of print books you can photocopy in person. ■

YOUR RESOURCE GUIDE TO AN ACCURATE UNION PACIFIC MODEL RAILROAD

Books on the Union Pacific Railroad:

- *Union Pacific Railroad Color History*, by Brian Solomon
- MBI Publishing, motorbooks.com
- Four Ways West Publications, fourwayswest.com
- Morning Sun Books, morningsunbooks.com
- Withers Publications, witherspublishing.com

Videos on the Union Pacific Railroad:

- A & R Productions, classicrailroadvideos.com
- Green Frog Productions, greenfrog.com
- Pentrex, pentrex.com
- Charles Smiley Presents (see MBI Publishing, motorbooks.com)
- WB Video, railfanvideo.com

Union Pacific websites:

- Union Pacific Historical Society, uphs.org
- Passenger cars, uphs.org/libpass.htm



5. Peter Bakhtar used Plastruct styrene sheets with stone textures for the walls of his Cheyenne depot. He carved the sills, lintels, and towers in plaster and cast replicas in resin.

- The NERAIL North American Railroad Photo Archive, naphotos.nerail.org
- Don Strack's utahrails.net ■



UP RAILROAD MODULES | 15





6. (Top left) This is an eye-level view of Peter's model of the Union Pacific Cheyenne depot on his '20s & '30s Modular Model Railroad HO module.

7. (Bottom left) The roof on the Cheyenne depot can be removed to display the details in the passenger waiting room. The room is illuminated and the ceiling fans rotate via a pulley and belt mechanism attached to a hidden electric motor.

8. (Above) The street side of the Cheyenne depot in 1972, and a post-card view of the railroad side of the depot from 1928.



THESE ARE MODULES?

These modules show you can do some pretty impressive modeling without needing a huge space. Focusing your modeling down like this can actually lead to more hobby satisfaction, not less.

WEB: trainweb.org/20s30s



UP RAILROAD MODULES | 17

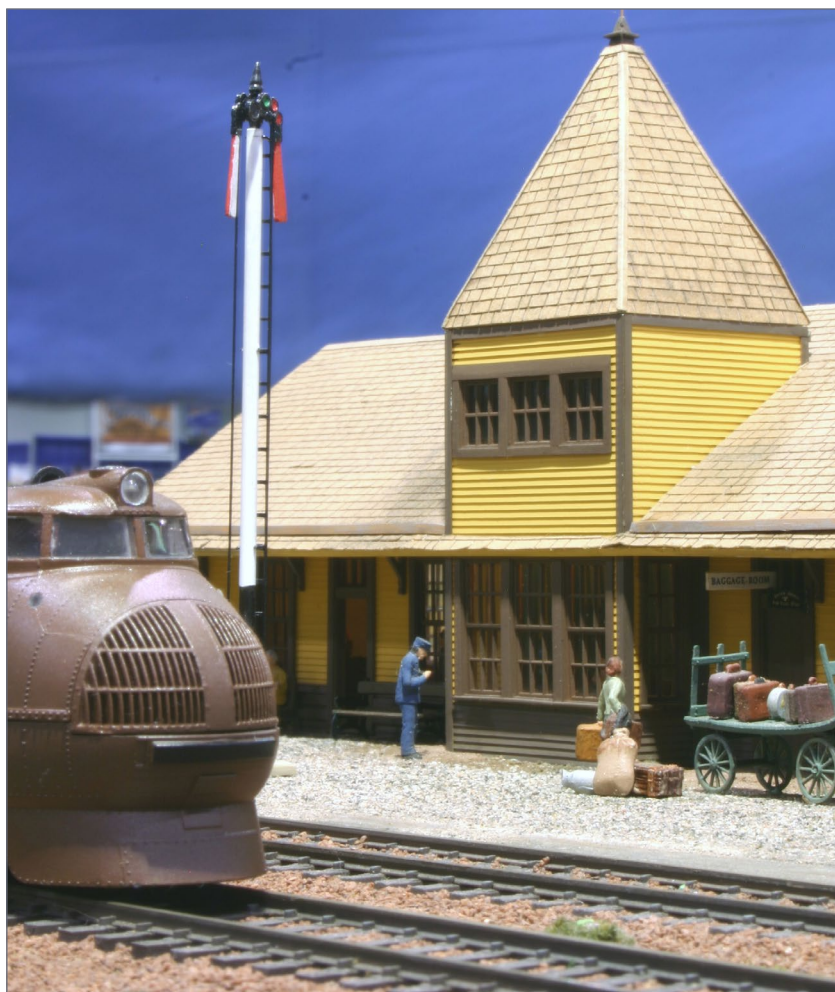
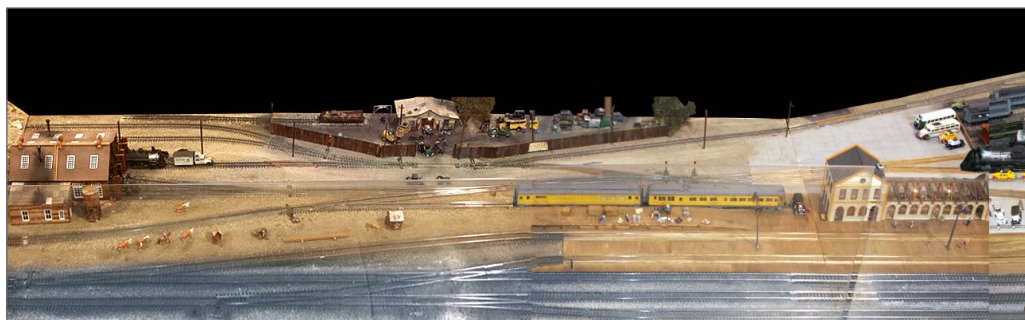

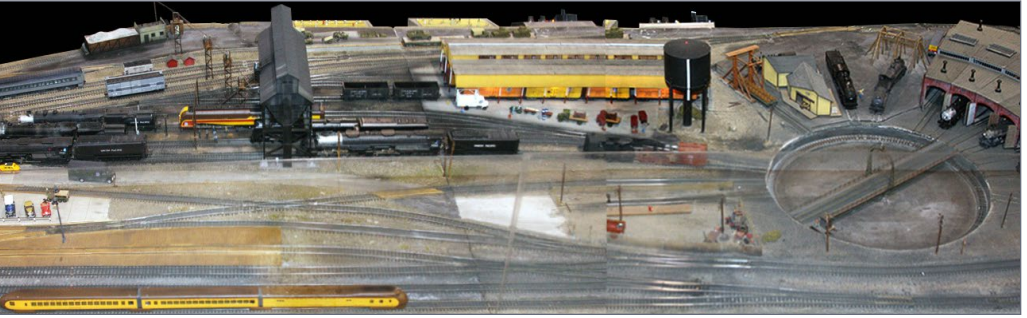

9. (Top left) Stitched-together panoramic bird's eye view of Peter Bakhtar's two modules of the Cheyenne depot and engine facility. One module is 2½x6' and the other is 3x8'. *Steve Crise photos*

10. (Bottom left) The Union Pacific's M-10000 was built in 1934 and scrapped by 1942 so it dates Mel Johnson's Marysville scene to that relatively short period in history.

11. (Above) The Con-Cor model of the Union Pacific M-10000 on this wider view of Mel's Marysville module.



12. (Top) Mel Johnson scratchbuilt the freight house based on a Union Pacific drawing of the structure at Morgan, UT. A load of Ford Model T truck cabs-and-chassis are braced and tied



down on the flat car to match the details in a photograph of a similar car from the '30s.

13. (Bottom left) Mel Johnson's 2½x6-foot module provided enough space for a very credible replica of a small Midwestern town like Marysville. The station, a freight house, water tower, and water plug are all scratchbuilt to match Union Pacific Common Standard drawings. In the background are a barn and grain elevator from the adjacent corner module, also built by Mel.

14. (Above) Mel Johnson also built a corner module to go with his Marysville module. On this module, Mel scratchbuilt this house to recreate the rural birthplace of his wife in Ridgefarm, IL based on a family photo taken circa 1917. The barn and grain elevator are by American Model Builders.

UP RAILROAD MODULES | 21



15. (Left, top) On a more industrial “small town” module, Mel added some industries such as this icing platform. He modified the Walthers Cornerstone number 3049 “Ice House and Icing Platform” kit to create this replica of a typical Pacific Fruit Express ice deck.

16. (Left, bottom) Bird’s-eye view of Mel Johnson’s 2½x6’ Marysville, KS module. *Charles Hepperle photo*

[click here](#)

 **THERE'S MORE!**

Check out the Subscriber bonus extras

VIEW READER COMMENTS

[click here](#)







17. Mel's '30s-era engine terminal module sports this impressive elevated coaling trestle. *Steve Crise photo*



LAYOUT SUMMARY

Module Specifications for the '20s & '30s Model Railroad Club in Southern California

The club's design standards and the module construction specifications are all in downloadable form on their web-site at trainweb.org/20s30s. The standard module is 30x72 inches with three tracks, set back 4, 6 and 8 inches. The club specifies that the permanent tracks end 3 inches from the end of each module so a 6-inch piece of track can be fitted to join one module to the next. The curves on the corner module are spaced 2½ inches apart to leave room for larger locomotives and longer cars so the trains cannot sideswipe one another. ■



RATE THIS ARTICLE

ROBERT SCHLEICHER



Robert was editor of *Railmodel Journal* for 19 years and, prior to that, editor of *Model Railroading* magazine. He has also authored over a dozen model railroad books including the *Tyco Model Railroad Big Book of Model Railroad Track Plans* and three books for Lionel. Bob has been a consultant to several manufacturers and helped to kick-start the Railroad Prototype Modelers concept. He is modeling the standard gauge Colorado & Southern in northern Colorado circa 1959 in HO scale. ■

TRAINMASTERS.TV



Layout tours

volume 3



12 layout video segments in all!

VOLUME 3



NEW: VOLUME 3

Our best layout video yet!

LAYOUT TOUR VIDEOS!

DVD
Now shipping!
\$27.99
~~\$39.99~~



3 disks

Download
Avail. Now!

\$14.99
~~\$21.99~~



12 files

SPECIAL INTRODUCTORY PRICING!

VOLUME 1

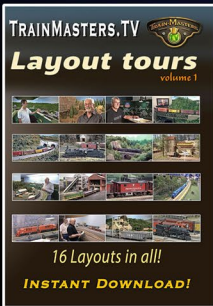

DVD
\$29.99
~~\$36.99~~



2 disks

VOLUME 2



DVD
\$29.99
~~\$36.99~~



2 disks

Download
\$16.49



~~\$21.99~~ 16 files

Download
\$16.49



~~\$21.99~~ 12 files

Brought to you by



Get the videos



• [INDEX](#)



SUBSCRIBE
(free)

• [TABLE OF CONTENTS](#)

Start the layout of your dreams now! No space? No problem!

Building a modular home layout with

TOMA



THE ONE MODULE APPROACH

TRAINMASTERS.TV 

Building a modular home layout with **TOMA**
THE ONE MODULE APPROACH



NEW!

TOMA lets you start the layout of your dreams now. No space? No problem!

MRH DVD

Episodes in this video:

- 01. TOMA series introduction
 - 02. TOMA design
 - 03. TOMA benchwork
 - 04. TOMA trackwork
 - 05. TOMA wiring
 - 06. TOMA structures
 - 07. TOMA scenery, part 1
 - 08. TOMA scenery, part 2
 - 09. TOMA adding details
 - 10. TOMA operation
- Bonus: TOMA make grass tufts**

<p>DVD (4 disks)</p> <p>\$29.99 \$44.99</p>  <p>DVD 4 disks</p>	<p>Download Avail. Now!</p> <p>\$19.99 \$29.99</p> <p>11 files</p> <p>SPECIAL INTRODUCTORY PRICING!</p>	<p>DOWNLOAD</p> 
---	---	---

How to build toward that eventual dream pike now in the space you do have!



Get the video!



YES ... IT'S A MODEL



Model Railroad Hobbyist | February 2018 | #96

compiled by **JOE FUGATE**



1. After working Hancock Elevator, Joe Atkinson's eastbound Iowa Interstate local XCBSW approaches the 460th St. crossing. LLPX SD38-2 2805 and IAIS C420 850 lead today's train through the gently rolling farm country of southwest Iowa.

Backdrops are photos from the prototype location, processed through Photoshop Elements, while the static grass is from Silflor and the trees are Scenic Express SuperTrees. The SD38-2 is a heavily reworked, detailed, and custom-painted Kato model, while the C420 is a factory Atlas model with additional details and weathering.

Photo by Murray Bouschlicher, done handheld with a Nikon D810 and an AF-S Nikkor 24-70mm f/2.8G ED lens at 32mm zoom, f10, 1/250, ISO 2000.

► **MRH'S MONTHLY PHOTO ALBUM**

• [INDEX](#)



SUBSCRIBE
(free)

• [TABLE OF CONTENTS](#)

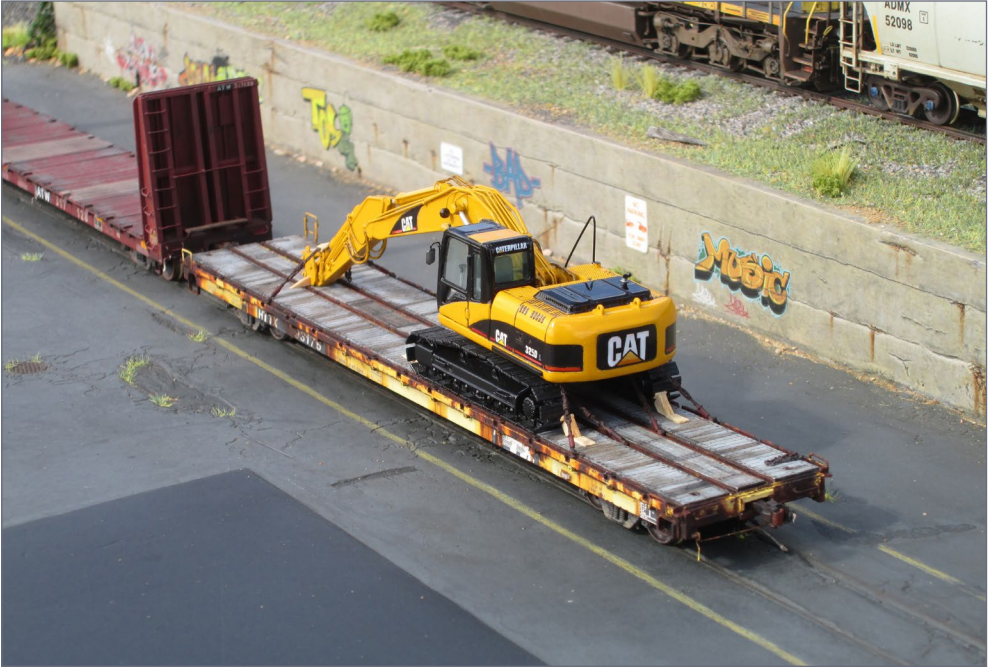

2, 3. (Right) The excavator is a Norscott diecast model that Nick Campbell disassembled completely and stripped to the bare metal in order to do the mods necessary to mirror the prototype. For the flatcar, Nick started with an Intermountain model of an older Illinois Central flatcar and modified it into a more modern-looking flat. Nick said he found the project quite interesting because he had never tried to prototypically model a piece of construction equipment before. Nick based this model on a prototype photo found on rpicturearchives.net.

**VIEW READER
COMMENTS**

click here



★ ★ ★ ★ ★
RATE THIS ARTICLE



GET PAID FOR YOUR PHOTO

We pay \$40 per photo we publish. If you'd like to get your modeling in our photo feature, just start posting your photos on the MRH website, especially in the Weekly Photo Fun thread created each week.

See mrhmag.com/help for more on how to post an image. You need to be an MRH subscriber to post photos to our website, and becoming a subscriber is free, [just fill out this form here](#). ■

• [INDEX](#)



SUBSCRIBE
(free)

• [TABLE OF CONTENTS](#)

A TALE OF TWO HOPPERS



Two CSX covered hoppers roll by in a Canadian National freight train on the author's layout.



ANDREW CASTLE BUILDS A PAIR OF CSX COVERED HOPPERS ...

WHEN I FIRST BECAME INTERESTED IN MODEL railroading during the 1990s, the closest rail-served industry to my home was a small plant in Milford, Nova Scotia, Canada, that made cat litter.

The plant only received a few carloads a month and many of the cars they received were two and three-bay covered hoppers. CSX owned some of the most interesting cars, which often carried the paint schemes of the Chessie System and CSX predecessor railroads with CSXT reporting marks.

One day I discovered an undecorated Athearn PS-2 2893 cu.ft. covered hopper in HO scale at my local hobby shop. I already had CSX tan paint and decals at home. I vaguely remembered having

photographs of similar cars in my collection, taken at the kitty litter plant. Obviously, I needed to buy the car and paint it!

Sure enough, I had several photographs of CSX PS-2 covered hoppers that my father took at the cat litter plant. As I studied the pictures I discovered some differences between the Athearn model and the cars in my photographs. The side ribs, hatch spacing, and trucks were different, plus one car was a bit taller.

Some online research revealed the CSX cars were not 2893 cu.ft. cars but 2929 and 3500 cu.ft. cars. They rode on 100-ton roller bearing trucks versus the 70-ton trucks on the Athearn model.

The cars also had different outlet doors and ladders. The later PS-2 covered hoppers are about six inches wider than the Athearn 2893 car. I decided I wanted to build one of each style of car as close as possible, except for correcting the width of the car. Adding 6" to the width of the car seemed too complicated for a difference very few people would notice.

I could not find a second undecorated model to build the second style car, so I started with a model decorated for Conrail.

I built these models in HO scale, but similar steps could be used to build cars. In N scale start with the Athearn PS2893; in O scale start with the Atlas O PS-2.

I chose to model CSXT 223144 and CSXT 240292. I was unable to find much information on these cars, so I contacted freight car historian Eric Neubauer to see if he was able to help me out. Eric was kind enough to provide me with the information that both cars were built in 1967 by Pullman Standard at its Bessemer, AL plant. CSXT 223144 was built for the Atlantic Coast Line and CSXT 240292 was built for the Louisville & Nashville.

Both cars received SBD reporting marks when the Seaboard system was created and eventually received CSXT paint and reporting marks.



The website rrpicturearchives.net was a great resource of photos to help me build these cars. David R. Olsen posted lot of pictures posted on the site, including detail shots of CSXT 222674 which were particularly helpful.

Like most of my projects, this one ended up becoming far more involved than I intended. If you choose to only replace the side ribs and relocate the roof hatches, you will still have a credible model of a 2929 cu.ft. PS-2. Follow along as I build the pair of CSX covered hoppers.

CSXT 223144, the 2929 cu.ft. car

I used the undecorated Athearn car to build the 2929 cu.ft. The undecorated car came in kit form, and this made the initial steps easier than if I had used a decorated car. I used a small Phillips



1. CSXT 223144 in Milford NS Canada, May 2006. *Bruce Castle photo*



2. The undecorated Athearn car ready for construction.

screwdriver to remove the couplers, trucks, and center sill. I planned to replace the trucks with 100-ton roller bearing trucks, so I set the 70-ton trucks aside for future projects.

The center sill does not need to be removed if you do not plan to modify the coupler boxes., You may want to remove it until the major modifications are done so you don't accidentally damage it.

When I studied photos, it appeared all the existing side ribs on the car were in the right place but the ribs closest to the ends were the wrong style. The taper on the top of the ribs was too steep, and there should not have been a taper on the bottom.

The car needed two additional ribs on each side, giving 13 ribs in total. The spacing between the fifth and six posts from each end is a bit narrower than all the other posts. The easiest way to correct these issues was to remove all the ribs and side detail and build new ribs from styrene.

Preparing the sides

I debated the best method to remove the molded-on ribs: in the end I cut off as much of the ribs as I could with a pair of Xuron

nippers. I shaved more off with a hobby knife and #11 blade, and filed and sanded the sides until they were smooth.

I tried to save the ridges along the top and bottom edges of the hopper sides but decided it was easier to sand the sides completely smooth and make new ridges from styrene.

Putty repaired places where I had gouged the side of the car. Once it was dry I sanded the areas smooth with 400- and 600-grit sandpaper [3]. This is also a good time to remove the six shaker brackets from the bottom of each side of the hopper bays. The photos show that I did not remove them at this point, as I had not yet realized I needed to replace them.

One advantage to working with Athearn cars is they are molded in styrene, so modifications can be done with Evergreen styrene and normal solvent cement. I prefer Testors.

Each rib has a flange on each side of it and there are raised strips along the top and bottom edge of the side panel. I cut a strip of .005" styrene .060" wide and glued it horizontally along the bottom, then glued a piece .040" wide along the top.



3. Athearn car with side ribs and other detail removed.

Next, I cut 13 strips of .005" styrene .080" wide to go under the vertical ribs on each side. These strips were cut to length to fit between the top and bottom horizontal strips.

First, I glued one vertical strip on each end, about .020" from the end of the hopper body, then glued one in the middle of the car. Working from the ends of the car, I glued four more vertical strips spaced 7/16" center to center. I glued one strip on each side of the center strip, also using 7/16" spacing [4].

This gives you two panels on the car side which are slightly narrower than the rest. Sand all the added pieces of .005" styrene to remove any raised edges and sand any panels which have glue marks on them.

The ribs themselves are made from pieces of .040" square styrene. I cut the ribs slightly longer than needed and glued them in place on the side of the car [5]. Center the ribs on the vertical strips of .005" x .080" styrene previously glued to the car side, and the bottom of the post should be about .020" above the bottom of the car side.



4. .005" styrene strips added to sides of car.

Once all the posts were in place and the glue was dry, I trimmed and filed the tops of the ribs, so they were flush with the top of the car sides.

For these CSX cars, eight of the 10 roof hatches on the Athearn car are in the wrong location. I debated building a new roof from styrene, but I liked the strength of the Athearn roof and the fact the roofwalk supports are molded on.

I decided it would be easiest to reposition the hatches on the Athearn roof. I first removed the eight hatch bases closest to the ends using a razor saw. Leave the center bases in place. Once most of a base was cut off, I used a file and 400-grit sandpaper to get the area smooth.

I also sanded off all the panel lines on the roof. These were in the wrong place for the reworked model [7], plus I had sanded half of them off when removing the hatch bases. New panel lines could be added using raised panel line decals from Archer Fine Transfers.

I cut eight pieces of 11/32" styrene tube .060" long to make bases for the new roof hatches.

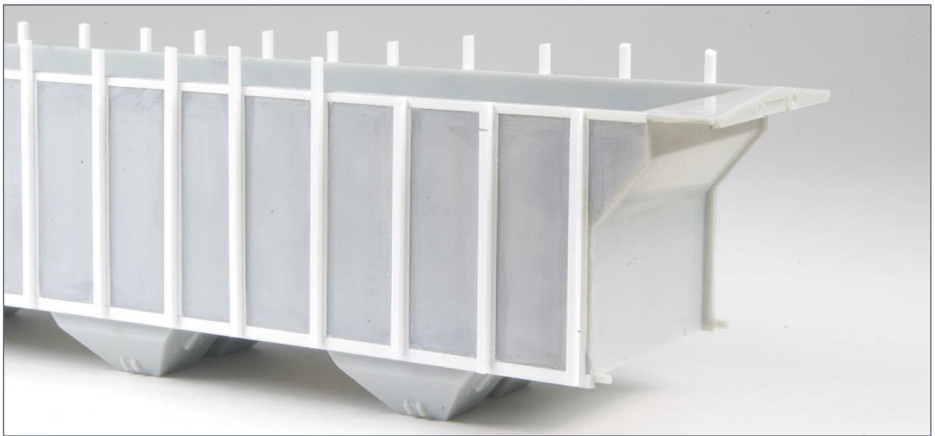

5. Styrene .040"x.040" posts added to sides of car.

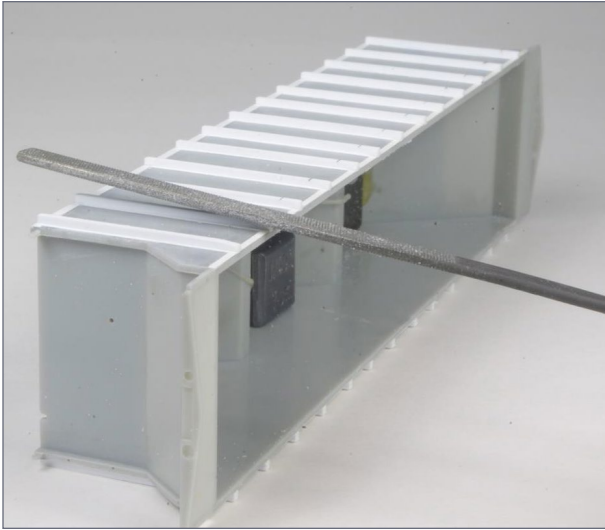

6. Filing a taper at the top of the side posts.

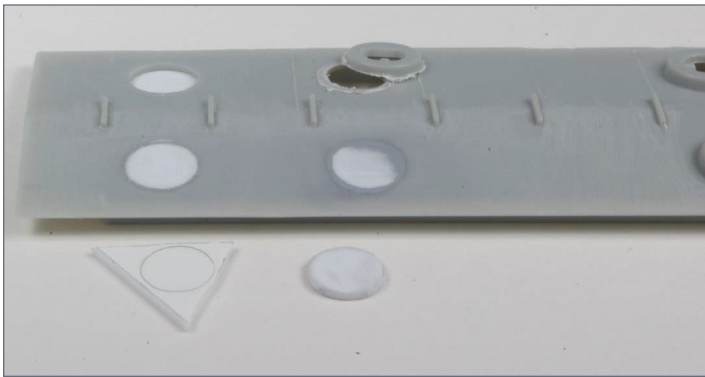

7. Four stages of removing and filling the roof hatches, which are in the wrong place for our project.

Using the remaining original hatch bases as a reference, I glued in place the four bases closest to the ends of the car. I did not have a measurement of the hatch spacing on the prototype cars, so I used a spacing of five scale feet between the edge of the hatch base and the end of the roof. This looked right when compared to prototype pictures. I glued the other four hatch bases in place halfway between the end hatches and center hatches [8].

I modified the hatch covers before gluing them to the roof. On these cars, all the hatches have their latch on the same side and all the hatches on one side of the roof walk face the same way. If you are standing on the roof walk looking at a hatch cover, the latch is on the left and the hinge is on the right.

Some of the Athearn hatch covers have the latch on the correct side but some don't. As the Athearn latches are the wrong style for these cars I decided to cut them all off and modify the hatch cover. The latches end and hinge ends of the cover are trimmed to the same width as the rest of the rib running over the top of the cover.

On the latch end, a #80 hole was drilled horizontally and a short length of .010" brass wire bent to an L-shape and glued in the hole. A piece of .010"x.030" styrene strip was cut to a length of .060" and glued on as well. For the hinge end I cut a piece of .020" styrene rod approximately .100" long and glued it in place under the end of the rib.

Glue all 10 hatches in place on the roof. The original Athearn hatch base castings have locating pins to orient the hatches in the correct manner for a 2893 cu.ft. car. I had to trim away a couple of them to orient the new hatch covers properly.



8. New roof hatch bases glued in place.

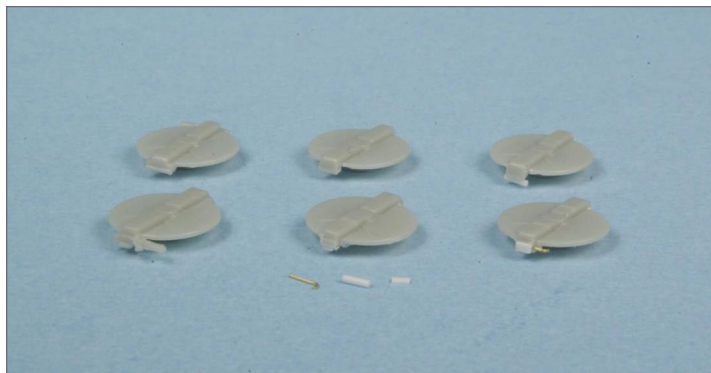

9. Steps for modifying roof hatches. On the left are unmodified hatches, on the right are completed ones.



10. Roof glued to the hopper body with the hatches in the correct location.

Before gluing the roof to the car body, I added two ¼ ounce peel and stick weights inside the middle bay. This makes the car slightly over the NMRA recommended weight but that is how I prefer my cars. Next, I glued the roof to the car body.

I glued a strip of Plastruct .010” square styrene along the bottom of each side of the roof to give it a bit of a lip over the tops of the ribs.

My next step was to glue the end platforms onto the car. One end platform has a small hole which matches a pin on one end of the Athearn car to help you get the correct platform on each end of the car.

Center sill and underframe

After the sides and roof, I started to work on the center sill and underframe. I removed the brake rigging from the middle part of the center sill. I like the look of scale coupler boxes on freight cars, but they can be tricky to install on cars like covered hoppers with open end platforms.

If you want to use the original Athearn coupler boxes I suggest using a long shank coupler such as the Kadee #26, #146, or #156 for reasons that will become apparent as you read on.

I tried to use part of the Kadee scale coupler box that comes with their #178 couplers. I kept the original mounting post on the Athearn underframe and narrowed the remaining part of the Athearn coupler box to match the Kadee scale coupler box.

After I had this all worked out and had the couplers installed I discovered the coupler box was set too far back for both the 2929 and the 3500 cu.ft. car [12], and the coupler did not clear the Plano cross-over platform which would be installed later.

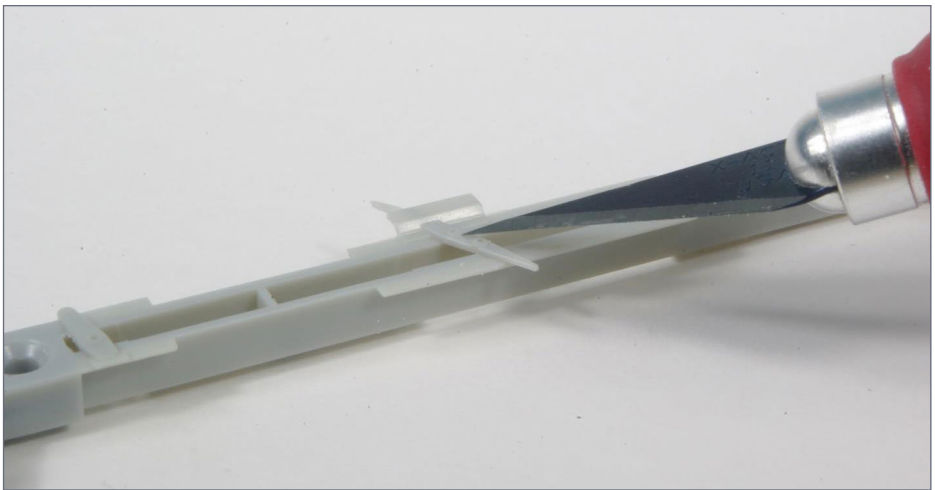

11. Remove this brake rigging from the center sill.

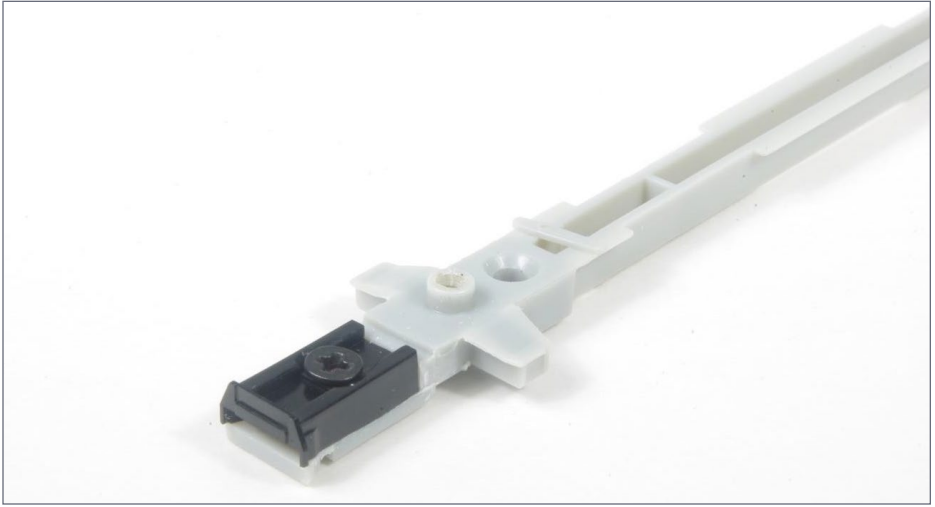

12. My first coupler box design did not work out but may be useful for other projects.

Next, I glued the center sill in place as well as attaching it with the provided screws. If you follow the Athearn parts diagram that comes with the car, note the center sill is shown backwards to the way it should be.

Once the center sill was attached, I started the end cage detail by cutting the ladders off the end frame. I continued to remove all the vertical pieces except the outside corner posts. I left these in place to keep everything lined up when I glued the ends to the car body [13].

I also removed the stirrup supports and coupler cut lever brackets. I glued the remaining pieces onto the car ends and let the glue dry. Once the glue was dry, I cut off the corner posts and sanded everything smooth.

This is also a good time to fill the holes for the roof walk end supports.

It was on to plan B for the coupler boxes. In the end, I used Kadee #178 couplers in the scale coupler box that comes with them. When using the #178 couplers, I often cut off the tab with the smaller screw hole and rely on just the larger screw to hold the coupler and box in place.

But on these cars, I want to use both screws for maximum strength. I had to cut about .020" off the end of the tab with the small screw hole to get the coupler box to sit in the right place.

I cut the ends of the center sill even with the end cage. Then I shaved about .020" off the area where the coupler box would mount [14], so the couplers would not be too low once the car was assembled. I mounted the coupler boxes so they would extend .200" past the end cage.

I drilled and tapped the car for a 2-56 screw in the large hole in the coupler box. Then, I drilled the smaller hole with a #55 bit



13. End cage frame glued in place with vertical posts removed.

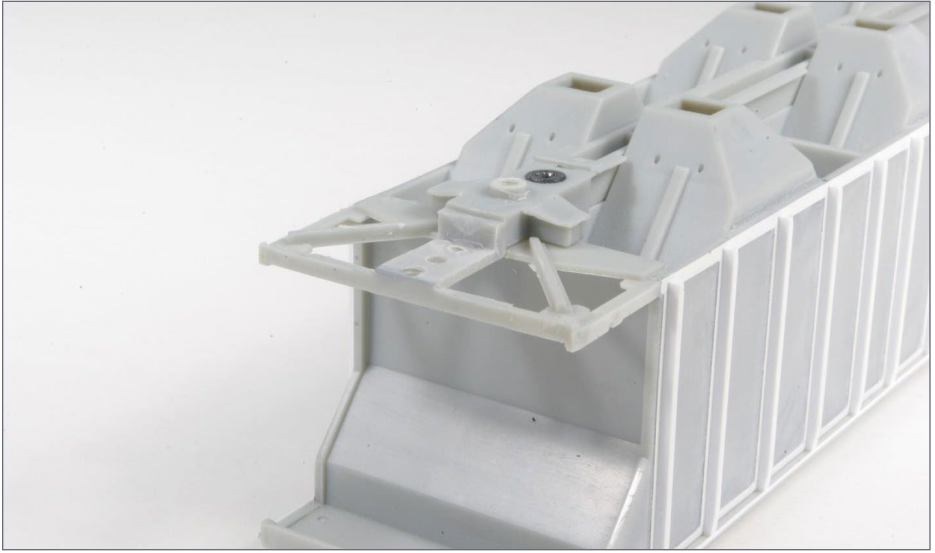

14. Center sill ready for new coupler box.

and threaded the smaller screw from the Kadee #178s into the hole. Both screws were cut to length, so they extended through the center sill but did not stick up above it. The other coupler box was mounted the same way.

I filled the gaps between the coupler boxes and the main part of the center sill with two short lengths of 0.040" x 0.100" styrene strip on each end [15].

I temporarily installed the trucks at this point. I chose Athearn Genesis 100-ton trucks with semi-scale wheels. It was necessary to shave a bit off the bolster pins on the bottom of the car so the truck screws would tighten enough to eliminate excess play in the trucks. I also double-checked the coupler height.

Before starting the new end cages, I made a new train air line and added a few details to the brake system. I removed the trucks and set them aside. Next, I drilled holes in the side of each

coupler box and attached three Detail Associates 2206 eye bolts. Two are to hold the brake hoses in place and one holds the end of the train line. The two which hold the brake hose may have to be opened slightly so the hose fits in place. Glue a Detail Associates brake hose in place on each end of the car.

I bent the train line from a single piece of .015" brass wire following prototype photos. This is a tedious process, but I don't know of a better way to do it.

Plano makes beautiful etched train line hanger brackets for a PS4427 covered hopper. They are slightly different than the hanger brackets on these cars but they look good and are close enough for me. I drilled six #75 holes for the brackets, following prototype photos for their placement, and bent six of the Plano brackets to shape following the included directions and photos on the Plano website at planomodelproducts.com.

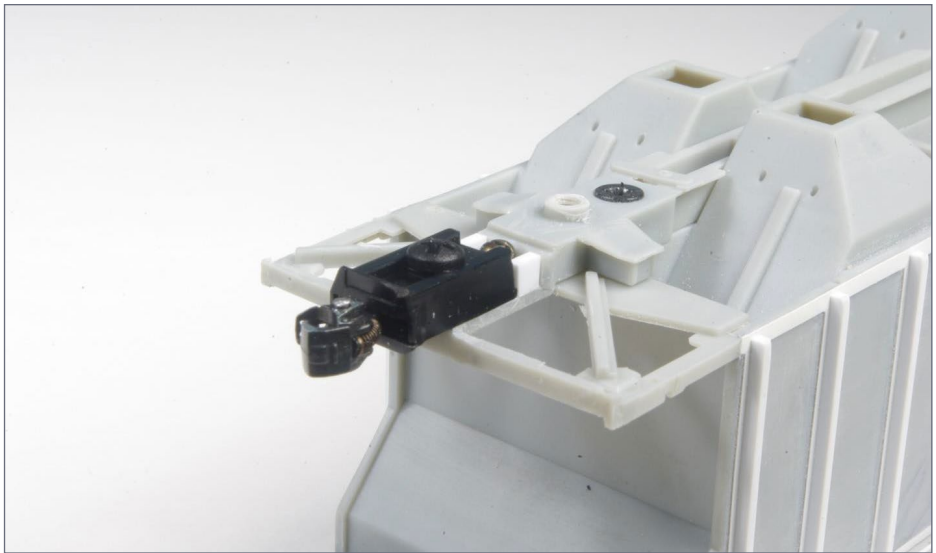

15. Kadee #178 coupler and box installed on the car.



16. New train line made from .015" brass wire follows the outside of the car.

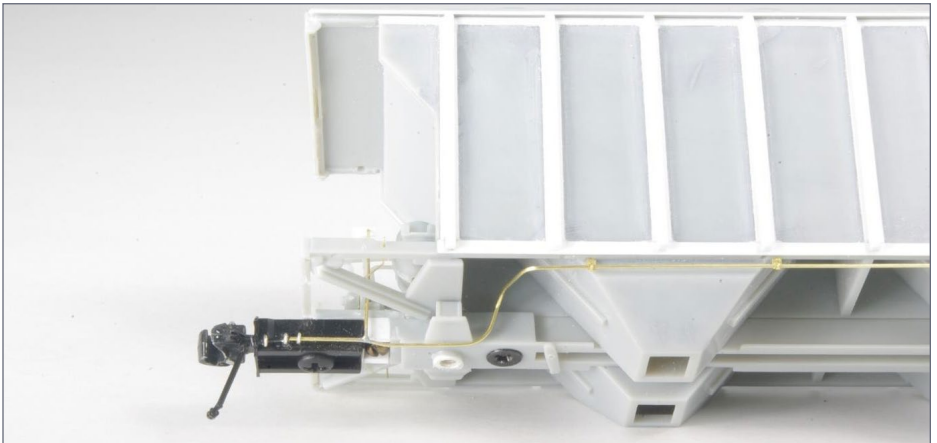

17. Train line detail on B end of car.

I threaded the brackets onto the wire train line and glued them in place [16]. Once they were in place, I used



WHAT IS THE DIFFERENCE BETWEEN A AND B ENDS ANYWAY?

The B end of the car has the brake wheel; the other end is the A end.





18. Train line on the A end of car.

tweezer nose pliers to tighten the brackets onto the air line. The ends of the air line fit into the eyebolts on the coupler boxes to line up with the previously installed air hoses. Do not glue them, so the coupler boxes can still be removed.

End ladders and brake parts

I drilled a #77 hole and a #79 hole in the brake valve, and bent a piece of .015" wire to form the connection from the train line to the valve. I glued the line into the #77 hole in the brake valve and soldered it to the previously installed train air line.

Next I made the retaining valve by making a small L-shaped bracket from two pieces of .010" x .040" styrene strip and bent a piece of .010" wire into a L-shape. I drilled a #78 hole in each side of the car and bent the brake bleed rods from two pieces of .008" brass wire following prototype photos.

19. Completed brake system detail. Note the piping to the brake valve on the center sill, and the retainer rods out to the side.



Plano Model Products makes a beautiful etched metal set for rebuilding the end cages of PS 4427 cubic foot covered hoppers. Some of the pieces in the set are not useable for these cars but the ladder posts, stirrups, cut lever brackets, rope pull loops, and crossover platforms work great.

Plano set 10875 is a set for one car and includes a brass drilling template that is very useful. I used set 10876 which includes parts for two cars but has a paper drilling template instead of a brass template. The set also includes nut-bolt-washer castings and .010" brass wire. I did not have enough wire and NBWs for two cars, so I also used some Detail Associates .010" brass wire and Grandt Line 5100 nut-bolt-washer castings.

When working with the Plano etched parts and bending new grab irons I use Xuron 450 tweezer nose pliers, which are invaluable for making precise bends.

I replaced the corner posts with four pieces of Plastruct 3/64" styrene angle cut 1.180" long. You can either glue the corner posts in place on the car and then drill the holes for grab irons, or drill the holes first and then glue the posts in place. I drilled the holes first. Use either the Plano drilling template or the etched ladder post as a template to get the holes in the right place. Follow prototype pictures for grab iron placement.

The Plano ladder posts [20] need to be modified to work on these cars. Before bending the two ladder posts to shape, I cut 0.195" or 17 scale inches off the bottom and cut off the top mounting pin. There is an unneeded hole in the ladder for mounting a long grab iron which extends across the middle of the car. I filled this hole with a small piece of .010" styrene rod and drilled a new hole above the next grab iron higher up the ladder. I glued a short piece of .030"x.040" styrene strip inside the angle at the bottom of the ladder post so I had a larger area to glue it to the car.



20. New corner posts and ladder post glued in place.

I bent a couple of grab irons from .010" brass wire, using the bending jig included with the Plano detail set. Rather than use the Plano template to position the ladder posts, I temporarily installed a grab iron near the top of the ladder and one near the bottom.

I adjusted the post until the grabs were straight, then glued the bottom of the ladder post and drilled the top for a nut-bolt-washer casting. I glued the first NBW casting in place, then drilled and installed the second.

Next, I made the other vertical supports. I couldn't find any styrene angle that was small enough (I could have also looked for some brass angle), but instead I decided to make my own angle by gluing together strips of .010"x.030" and .010"x.040" styrene cut 1.180" long.

The A end of the car only needs two of the smaller vertical supports. I made the righthand post first and drilled four #80 holes in it for grab irons. I glued it to the car end .340" from the corner post. I glued the second smaller post in place .460" from the left corner post. Two posts were glued to the B end of the car in the same position as on the A end. A third post was glued in place halfway between the second post and the ladder post [21].

Check pictures to make sure you get the angles facing the right way.

My next step was to add nut-bolt-washer castings to the vertical posts. I used Grandt Line 5045 NBW castings for this as they are a bit smaller than the ones included with the Plano kit.

Each vertical post gets two on the top. The corner posts get two more on the top on the other angle. The smaller posts on the ends each get one NBW casting on the bottom. For each NBW I made a #80 hole, then glued the casting in place.



I cut a piece of .030"x.060" styrene .190" long and drilled a #70 hole in the middle of it. I glued this in place on the B end of the car behind the closest-together vertical supports to support the end of the fulcrum for the brake rod.

I cut two pieces of .010"x.040" strip that were .125" long and glued them to the sides of the vertical supports, then cut a piece of .010"x.125" strip .210" long and glued it to the front of the supports to build a mount for the brake wheel.

The Plano detail kit comes with etched stirrups and coupler cut lever brackets. They are not the same as the stirrups on the CSX cars but are very close and are very sturdy, so I used them. I bent them following photos and the included instructions, then drilled holes in the appropriate places on the car and glued the stirrups in place.



21. All vertical end posts glued in place on the B end, with gray nut-bolt-washer castings attached.

I drilled holes for the end crossover platform brackets. Plano 10882 are the correct style but by the time I realized this, I already had the ones from the 10876 detail kit. I bent three brackets to shape for each end and glued them in place.

The crossover platforms themselves will not be installed until after painting, but I drilled and installed the Plano rope pull tabs using the provided etched template and following prototype photos for exact placement.

I drilled three #80 holes on each corner of the hopper body for the side horizontal grab irons. These need to be in line horizontally with the corresponding holes in the corner posts. I drilled the required holes for the bottom corner grab irons.

Finally, it was time to bend all the grab irons from .010" brass wire and glue them all in place [22]. The ladder grabs were shaped using the Plano etched bending jig. The remaining grabs were bent to the required length using tweezer nose pliers. I glued an NBW casting in place above the outside end of each ladder grab and wherever they showed on the prototype photos.

I used Grandt Line 5100 NBW castings for this, as I had used the NBW castings from the Plano kit on the 3500 cu.ft. car. Rather than drill holes for the castings this time, I cut off the heads of the NBW castings and glued them on the surface of the model.

Hopper outlets

Finally, it was time to move to the bottom of the car. I installed the stiffeners to the hopper outlet bays. Six are just stiffeners, and six have braces for the bottom outlets; I cut off the braces so all twelve stiffeners look the same.

There are no commercially available hopper outlets which match these cars. I have an Athearn PS2600 two-bay covered hopper



which has almost identical outlets. As I did not want to buy two of those hoppers just to cut off the outlets, I decided to scratch-build what I needed. My outlets are not perfect, but they are as close as I could get without investing too much time and energy in the project.

First, I glued two pieces of .010" x .040" styrene across each hopper bay flush with the bottom of the bays [23]. I cut the pieces longer than required. Once the glue dried, I trimmed them flush with the sides of the hopper bays.

Next, I cut twelve pieces of Evergreen .060" channel to .420" long. I beveled the ends at about a 30-degree angle. I glued two of these to the bottom of each hopper bay with the channel on the outside pieces facing out and the channel on the inner ones facing the center sill.

I cut six pieces of .010" x .060" styrene to a length of .440". One end was beveled at an angle to match the slope of the hopper bays



22. B end of car with grab irons, stirrups, and other details in place.

and the other end was left square. These pieces were glued on the outside of the hopper bay and overlap the top of the channel previously installed.

For the matching pieces on the inside of the hopper bays I needed strips of .010"x.050". Since these are not available, I made them from .010" styrene sheet. I cut six pieces of the .010"x.050" strip .440" long, beveled the end, and glued them in place on the inside of the hopper bays overlapping the channel as before.

Next, I cut six strips of .020"x.060" styrene .210" long to go across the ends of the outlets and glued them in place at an angle to match the end of the channel previously installed.

I cut six pieces of .010" styrene sheet .210"x.240" and glued them in place over the outlet hole, then cut six pieces of .020"x .030" strip to .210" long to go across the other end of the outlets.

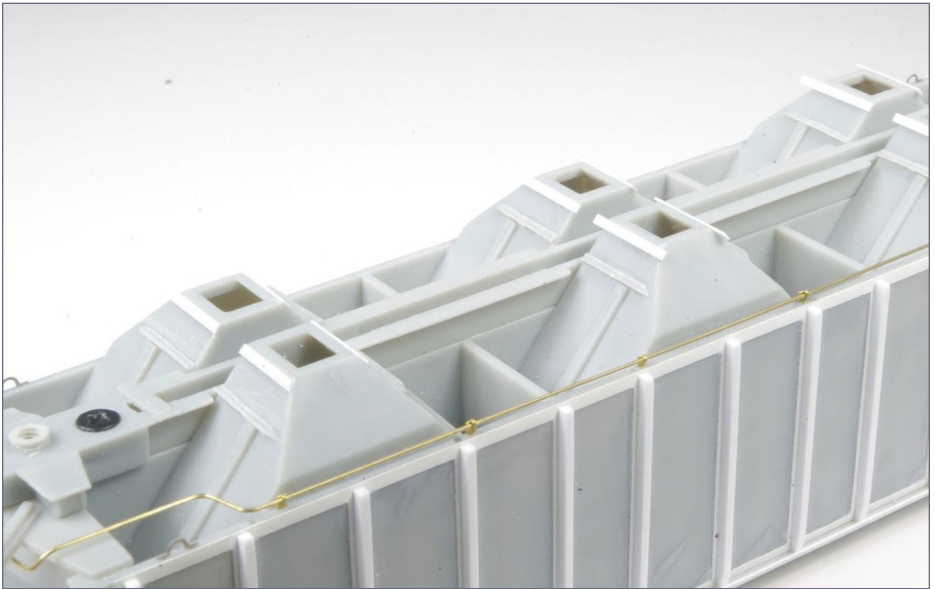

23. First strips of styrene added to hopper bays.

Finally, I drilled holes and glued in place a piece of .015" brass wire and a piece of .010" brass wire across the hopper outlets, following prototype photos as close as possible.

Lastly, I took the shaker brackets from the Tangent PS4750 parts kit, cut the mounting pin off the back, and glued them in place on the sides of the hopper bays .040" above the outlet [24,25].

Brake rigging

I glued a slack adjuster from the Tangent PS4750 set in place on the car's center sill and made the connecting linkage from .012" brass wire.

To finish the brake rigging I moved to the B end of the car and glued a short piece of .020"x.040" styrene between the vertical supports and under the brake wheel mount.

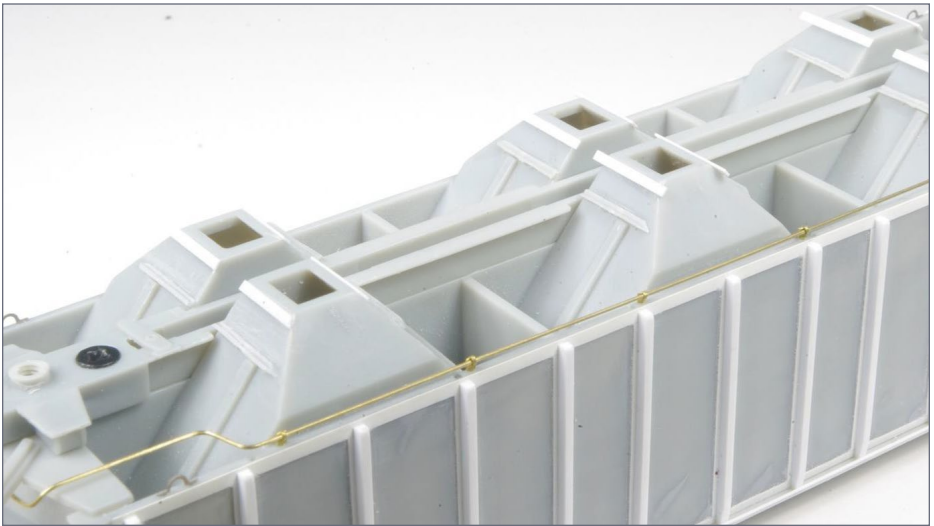

24. Stages of building hopper outlets, going counter-clockwise from top left.

I enlarged the hole in a Tangent brake wheel housing so a Kadee 2025 brake wheel would fit, then glued the housing in place and bent the chain slightly so it lined up with the connecting linkage. I glued the brake wheel in place on the housing [26].



25. Completed hopper outlets and slack adjuster glued in place on center sill.



26. Completed end of car with roof walk supports and brake wheel.

The last step in construction was to install the roof walk. The Athearn car comes with an etched metal roof walk. It is slightly short compared to the prototype 2929 cubic foot cars but using it is much easier than building a new exact-length roof walk.

I glued the roof walk in place with Microbond and bent grab irons for the ends from 0.010" brass wire. I cut a piece of .020"x.020" styrene to go across the bottom of each end of the roof walk and glued it in place. I bent the angled supports from Detail Associates 2522 .010"x.018" brass bar and glued them in place.

You may notice the car now has different brake hoses on it. I broke one while working on the model; the new parts I had were a different color and slightly different style than the first ones I had installed.

Next step is the paint job!



27. Completed car CSXT 223144 ready for paint.



28. CSXT 240292 in Milford, Nova Scotia in May 2006.
Bruce Castle photo

CSXT 240292, the 3500 cu.ft. car

I used the Conrail car to build the 3500 cu.ft. car. I used the Conrail car rather than the undecorated car because I broke one of its end ladders when stripping the paint, and broke one of the end roof overhangs when I was removing the roof.

As the 3500 cu.ft. car would require new end ladders and a rebuilt roof overhang anyway, I threw the broken ladder in the garbage and chopped off the remaining ladders and roof overhang with nippers.

I removed the trucks, couplers, and center sill from the car in the same manner as the 2929 cu.ft. car, and removed the roof walk with a bit of light prying with a flat screwdriver.



I stripped the paint from the car before doing any further disassembly. If I was doing it again, I would remove the roof and end ladders before stripping the paint. I soaked the car in 99% isopropyl alcohol to remove the paint, soaking it for a couple of hours before the paint began to bubble and come off.

Scrubbing with a toothbrush removed most of the paint. A few spots needed a touch up with 600-grit sandpaper. I dried the car, then used a Badger 260 Abrasive Gun with baking soda to remove some hard to reach paint in the ends and bottom of the car.

If I had removed the roof, roof overhang area, and end ladders before stripping the car, I probably could have removed all the paint off with just the toothbrush. I used 400-grit sandpaper to remove the paint from the roofwalk.

As I mentioned, it was at this point that I chopped off the end ladders and roof overhang. I removed the roof by prying with



29. Athearn car disassembled and paint stripped using 99% isopropyl alcohol.

a small flat screwdriver. I also removed the outlet doors on the bottom of the hoppers, the corner stirrups, the coupler cut lever brackets, and any remaining ladder pieces.

I was careful to leave the brake system components on the B end of the car. Next, the ribs were removed from the sides of the car using the same method as on the 2929 cu.ft. car. The shaker brackets from the hopper bottoms should be removed as well. I learned that later.

The top of the hopper needs to be extended by 17 scale inches, or approximately .196". The top of the sides of the hopper are .040" thick so the extension can be built with strips of .040" styrene.

I had planned to attach pieces of styrene to the inside of the hopper to keep the extension vertical, but I discovered the inside of the car is molded at a slight angle and the sides get thicker as they go lower. Gluing a large brace inside would force the extension to slope outwards.

Instead, I glued strips of .010"x.188" styrene to the inside of the car sides so they extended .020" to .030" above the top. This gives a lip [30] to glue the extension to, but is not high enough for the angle to be an issue.

30. Thin styrene lip added to top of hopper body.



I cut two pieces of 0.040" x 0.156" styrene strip to the same length as the hopper and glued one in place along the top of each side. I cut two more pieces of 0.040" x 0.156" strip to fit across the ends and glued a short length of 0.040" x 0.040" strip inside each corner to add strength.

I filed anywhere the extension and original car side were not flush, then puttied and sanded the joint. I waited to add the remaining 0.040" to the height of the car. You will see why shortly

Body side ribs

I started building up the new side detail by gluing a piece of .005" styrene cut .060" wide horizontally across the bottom edge of the car side, the same as on the 2929 cubic foot car [32]. I did not add the .040" wide strip across the top, for reasons you will see in a moment.

I added vertical pieces of .005" styrene cut .080" wide the same as the other car, but cut them longer than needed so they extended past the top of the car.

Once the glue dried, I cut them all flush with the top of the side extension.



31. Extension added to hopper body.

Next, I cut two pieces of .040”x.040” styrene strip slightly longer than the hopper body. One was glued on the top of each side, so it overhung the top extension by .005” and was flush with the .005”x.080” strips glued to the sides of the hopper.

A small piece of .005” styrene was glued inside the .040”x.040” strip on each end to match the small ridge on the corners of the hopper ends [33]. Once the glue dried, I trimmed the piece to match the profiles of the surrounding pieces. I cut two pieces of .040”x.100” strip to fit across the ends of the hopper between the recently added .040”x.040” strips. I filed and sanded the joints.

Using the underside of the roof as a reference I cut and filed the top of the new end pieces so they had the same profile and fit under the roof piece with no gaps. At this time, I also cut around .060” off each end of the large ribs on the underside of the roof casting so it fit properly on the extended hopper body.

I added the .040”x.040” ribs using the same method as the 2929 cu.ft. car.

**VIEW READER
COMMENTS**

[click here](#)

32. Strips of .005” styrene added to hopper sides.





33. Pieces of .005" styrene added to hopper ends. They still need to be trimmed.



34. Hopper body extensions complete, including ends.

Roof hatches

On the 3500 cu.ft. cars only four of the 10 roof hatches need to be relocated. The outer and middle hatches can stay, but the second set of hatches from each end needs to be relocated using the same methods as on the smaller car.

This car started out assembled with the hatch covers glued in place. I used the razor saw to remove the four hatches with their covers still in place. Once the whole part was cut off the roof, I carefully cut the remaining base off the hatch lid so the lid could be reused.

If you are not able to remove the hatch covers from their bases I suggest buying new PS4000 hatch covers from Tangent Scale Models at tangentscalemodels.com/parts.

To make the new hatch bases, I cut four pieces of 11/32" styrene tube .060" long and glued them in place halfway between the other roof hatches. I glued a hatch cover in place on each base. Next, I glued the roof to the car body and glued a strip of Plastruct .010"x.010" styrene along the bottom of each side of the roof to give it a bit of a lip over the tops of the ribs [35].



35. Roof glued in place with hatches relocated.

Build the end cages

The end platforms and end brake detail were already on this car as it was a factory assembled model.

My next step was to build new end cages and ladders. I started by cutting two pieces of .020" styrene that measured .175"x1.315" to make the top of the new end piece. The top of each piece was cut to match the angle of the end of the roof. I cut four strips of .020"x.030" styrene that were .640" long with the ends slightly angled.

Two of these pieces were glued to the back of each new end piece approximately .010" from the top to create a lip, and one new end piece was glued to each end of the car. I cut four pieces of .020"x.040" strip to fit between the new top end pieces and the ends of the hopper body [36].



36. New top piece for end cages.

I assembled the rest of the end detail almost the same way as the 2929 cu.ft. car. The difference with this car is the Plano P-S ladder posts do not have to be cut shorter, and the bottom mounting pin on the ladder posts can be used. Also, the vertical supports on the ends of the car all need to be longer. I found a length of 1.250" worked well.

On this car, I used the Athearn housing that came with the car and drilled it out to mount a Kadee 2025 modern brake wheel.

Complete the hopper outlets and underframe brake detail using the same steps as the 2929 cu.ft. car. The stiffeners near the outlets were in place because this was a factory-assembled car, but I had to cut off the braces which go from the stiffeners to the bottom outlets.

The last step in construction was to install the etched roof walk. The 3500 cu.ft. cars have a slightly different support for the ends of the roof walk.

To model these, I cut two pieces of .010"x.010" styrene strip and four pieces of .010"x.020" strip to a length of .220", the same measurement as the width of the roofwalk.

I glued the two smaller pieces to two of the bigger pieces to form an angle, then glued one of these pieces under each end of the walk. The two other pieces are glued to the cross pieces on the ends of the car [37].

Next I cut two pieces of .010" styrene that measured .180"x.220" and glued them at an angle between the other pieces to finish the roof walk support [38].

With construction of the second car complete [39], it is time for paint and decals!



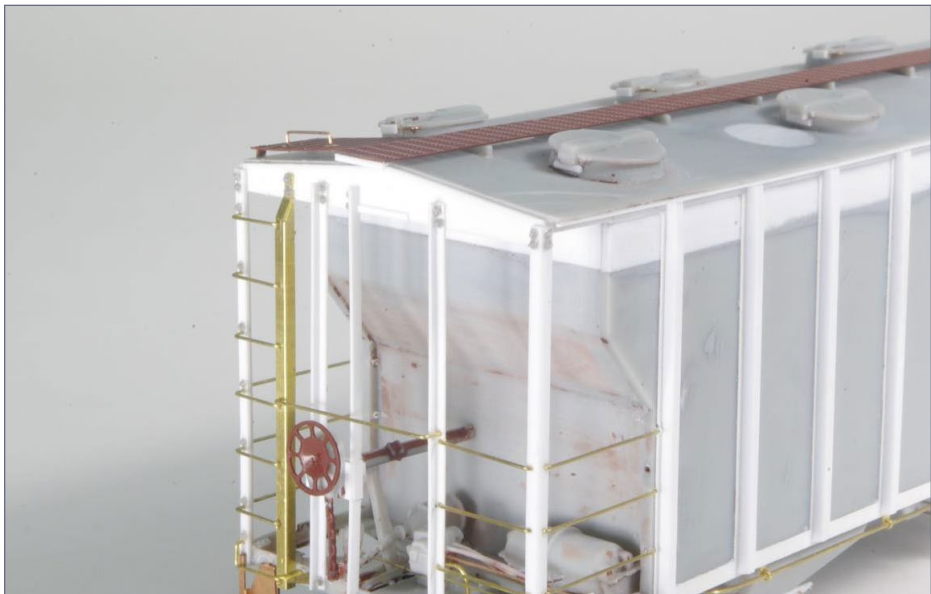

37. First pieces glued in place for roof walk support.



38. Roofwalk support complete.



39. Completed car CSXT 240292 ready for paint.

Paint, decals, and weathering

I removed the trucks, then very gently washed both cars using warm water and Dawn dish soap. I blew most of the water off with an airbrush blowing just air, then let both models air dry.

After they were dry, I placed both cars on their roofs and gave the underside a coat of Tamiya Fine Surface Primer. Once the primer was dry I installed a pair of old trucks on each car, flipped the cars right side up, and gave the tops and sides a coat of primer.

Next, I airbrushed both cars with PollyScale CSX Tan. With PollyScale colors discontinued, you may want to use either Model Master Desert Sand FS33722 or Tru-Color ACL Hopper Beige. After the tan paint had cured, I gave both cars a coat of Testors Glosscote using an airbrush.

I decaled the cars using Microscale set 87-1311. Be sure to use pictures of the car you are modeling as there are variations in lettering placement. I used the larger CSX lettering on the smaller capacity car and the smaller lettering on the larger car.

I pieced together the size and capacity data to match the prototype cars. Many of the 2929 cu.ft. cars have repairs and paint patches. Car 223144 had some grey paint patches on the sides [40].

To recreate these, I painted some Microscale clear trim film with a light grey I mixed from Model Master's Gloss White and Flat Gull Gray. I cut the trim film to size and applied it the same as a normal decal. I had no pictures of the other side of the car, so I did not put any patches on that side. Once the decals had set up, I gave both cars a coat of Pledge Floor Finish using an airbrush. If you add a few drops of Windex to the Pledge, it will be easier to get a nice even coat.

I disassembled the trucks and wheels, washed them, and gave the trucks a coat of primer. The wheels are brush-painted with a base coat of PollyScale Roof Brown. Next, I brush painted the trucks with a coat of Vallejo USA Olive Drab which I find to be a good grimy color for freight car trucks.



40. Patches added to side of CSXT 223144.

I brush-painted a couple of the wheelsets with Vallejo Burnt Umber, then mixed Vallejo Burnt Umber and USA Olive Drab for a couple wheelsets, and made up a mixture of Burnt Umber and Flat Earth for the remaining wheelsets.



BRUSHES?

The green Micro-brush is a great tool for painting wheelsets. Find them on the web or at hobby, craft, and art stores.

WEB: [amazon.com](https://www.amazon.com) or [micromark.com](https://www.micromark.com)

This gives some variation in the color of the wheelsets, to represent wheels which have been changed at different times. I gave the air hoses a coat of Vallejo Black Grey.

I cut the trip pin off the Kadee 178 couplers and installed them on the cars. I glued the Plano crossover platforms in place on the ends, then drilled a #79 hole in the bottom of each coupler box and installed a Tangent coupler cut lever on each end of the cars.

I brush-painted the cut bar with CSX Tan. I added an A-Line AEI tag to each side of each car and brush-painted each one with dark gray paint. I added two Plano 311 placard frames to each car, following prototype photos for their placement.

I left the placard frames on 240292 in their stainless-steel color, but painted the ones on 223144 with CSX Tan. In retrospect, I could have added them before painting the car.

I used a Q-tip dipped in lacquer thinner to clean the wheels and my cars were complete! ✓



RATE THIS ARTICLE





41. Roof weathering on CSXT 223144 with heavier weathering on roof panels, and less weathering around hatches.



42. Completed CSXT 223144.



43. Completed CSXT 240292.

ANDREW CASTLE



Andrew bought his first model train at age 13 and has been hooked ever since. His favorite part of the hobby is building and kitbashing models of locomotives, freight cars, and structures that are not commercially available.

Andrew is currently building a mid-size multi-deck HO scale layout based on the Canadian National around Truro, Nova Scotia, Canada in the late 1990s.

Andrew is a commercial pilot and lives in Enfield, Nova Scotia with his wife and son. ■



BILL OF MATERIALS

A-Line 29460 AEI tags

Athearn PS-2 93700 PS 2893 cubic foot covered hopper, undecorated
(or decorated equivalent) Athearn G4599 Genesis 100-ton trucks

Detail Associates –

- 2206 eye bolts
- 2502 .008" brass wire (or Tichy 1100)
- 2503 .010" brass wire (or Tichy 1101)
- 2504 .012" brass wire (or Tichy 1106)
- 2505 .015" brass wire (or Tichy 1102)
- 2522 .010"x.018" brass bar
- 6206 brake hoses

Evergreen –

- 9009 .005" styrene sheet
- 9020 .020" styrene sheet
- 101 .010"x.030" styrene strip
- 102 .010"x.040" styrene strip
- 103 .010"x.060" styrene strip
- 108 .010"x.188" styrene strip
- 121 .020"x.030" styrene strip
- 122 .020"x.040" styrene strip
- 123 .020"x.060" styrene strip
- 142 .040"x.040" styrene strip
- 147 .040"x.156" styrene strip
- 211 .040" styrene rod
- 231 11/32" styrene tube
- 261 .060" styrene channel

Grandt Line -

5045 nut-bolt-washer castings

5100 nut-bolt-washer castings

Kadee -

178 couplers

2025 modern brake wheel

Microscale -

87-1311 CSX covered hopper decals

TF-0 clear trim film

Plano Model Products -

10875 or 10876 PS 4427 covered hopper detail set

10882 coupler platforms

10886 trainline hanger brackets

Plastruct -

90709 .010" square styrene rod

90501 3/64" styrene angle

Pledge Floor Finish

PollyScale -

CSX tan (substitute Model Master Desert Sand

or Tru-Color TCP-277 ACL Hopper Beige)

Roof Brown (substitute your favorite rusty brown color)

Railroad Tie Brown Tamiya -

Fine Surface Primer

Putty

Tangent Scale Models -

95005-05 PS4750 parts, brake details

95005-07 PS4750 parts, shaker brackets and slack adjuster

TSM-203 coupler lift bars



BILL OF MATERIALS *CONTINUED ...*

Testors -

Model Master 4696 Gloss White

Model Master 4763 Flat Gull Gray

Model Master 4769 Flat White

Dullcote

Vallejo -

70862 Black Gray

70889 USA Olive Drab

70941 Burnt Umber

70983 Flat Earth ■

**VIEW READER
COMMENTS**

click here



click here

THERE'S MORE!

**Check out the
Subscriber
bonus extras**

NEW!

Airbrushing how-to videos!

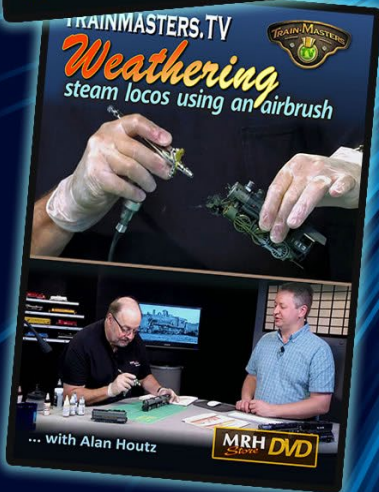
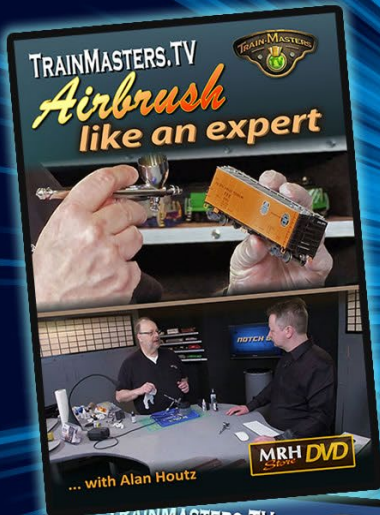
**Order Videos!**

Airbrush like an expert

Airbrushing 101 - All about airbrushes
 Airbrushing 102 - Outfitting and strip-down
 Airbrushing 103 - Painting technique
 Airbrushing 104 - Simple weathering
 Bonus: Easy airbrush cleaning

Video download: \$16.49

DVD (2 disks): \$24.99

Weathering steam locos with an airbrush

Into & weathering working passenger steam
 Weathering working freight steam
 Weathering steam near end-of-service

Video download: \$12.49

DVD (1 disk): \$19.99

SPECIAL VIDEO PRICING!

from the
**Model Railroad
 Hobbyist Store**

• [INDEX](#)

SUBSCRIBE
 (free)

• [TABLE OF CONTENTS](#)

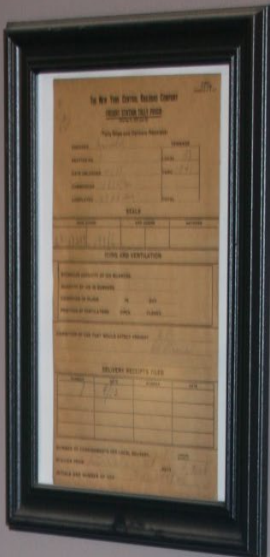

EASY **WIRELESS DC** **WALK-AROUND CONTROL**

★★★★★
RATE THIS ARTICLE

• [INDEX](#)

• [TABLE OF CONTENTS](#)

MARK GILGER USES A GARDEN RAILWAY WIRELESS SYSTEM TO CONTROL HIS DC-POWERED N SCALE LAYOUT ...

DO YOU STILL PREFER DC CONTROL FOR YOUR TRAINS, but are you envious of those DCC guys who have wireless control and sound?

Then I just may have the answer for you. That's right, wireless DC control, with sound if you want – all done without a lot of fuss.

For the last couple of years, I've been building my 12' x 2' N scale railroad along one wall of a spare bedroom. One of the decisions that I needed to make early on was which control system to use. Should I use a DCC or a DC control system?

Since this is a small layout and I planned to run only one set of engines at a time, I felt it was not necessary to go with DCC. Yet, I did not want to be tied to a system that wouldn't allow me to follow my trains.

I needed a DC-based walk-around system.

Inspiration: My outdoor G scale layout

I've been into G scale with a large outdoor layout for over 12 years, and I have standardized on the Crest Train Engineer DC system [2], now known as The Revolution system by Revolution Electronics. For more information on my garden railroad, visit mmg-garden-rr.webs.com.

I realized this system might work well on my indoor N scale layout, too. For more on Revolution Electronics products, visit revoelec-tronics.com.

1. Wireless DC control (with sound) can not only run your trains, but also control your accessories wirelessly too, if you like.



Some testing and exploration of options would be required, however.

The Revolution system

The Revolution system uses a wireless handheld throttle as the transmitter, while the receiver (typically in the locomotive for G scale) picks up the signals and powers the locomotive. It was designed for garden-railway-sized trains, but it can power any scale train that requires 12-24 volts DC.

The handheld throttle control unit is about the same size as a cell phone, although about twice as thick. The receiver is about 2 x 3 inches in size.



The Revolution is a wireless radio system operating in the 2.4 GHz frequency range between the handheld unit and its receiver(s). The only wires are what's needed to connect the receiver to its power (can be batteries in G scale), any control relays, and a speaker for sound.

The Revolution satisfies my need for a walk-around type system using DC on an indoor layout.

2. Crest Train Engineer DC system (now Revolution) throttle/transmitter and receiver board by Revolution Electronics.



Revolution features

The feature set of the Train Engineer includes a lot for a DC wireless train control system:

- Built-in sound.
- The 2.4 gigahertz radio system that is bidirectional. The transmitter not only sends commands to the locomotive, but it also gets feedback from the receiver in the locomotive.
- Spread-spectrum radio transmission provides immunity from interference caused by radio sources that are in the same frequency range.
- Locomotives can easily be identified by name and road number such as PACIFIC 5305 or MIKADO 3185.
- Information about the locomotive being operated is clearly displayed on a modern back-lit LCD display.
- Each transmitter can hold information on as many as 50 different locomotives.
- Multiple transmitters can independently operate additional groups of 50 locomotives without interfering with one another.
- The receiver can supply 5 amps of current while accommodating peak loads that can go to 8 amps. If more power is needed, there is a larger base unit that is rated at 15 amps continuous output. This is more than enough for the smaller scales.
- Most transmitter control operations can be performed with one hand.
- Textual information is keyed into the transmitter using a keypad similar to that used on cell phones.
- Six auxiliary outputs on the receiver can be used to operate switch machine, lighting, and other accessories.
- Each locomotive can have individualized settings that include start speed, maximum speed, delay, and momentum, and so on.



To power the receiver and accessories, just about any 12-24 volt DC supply can be used. I use a 19-volt, 5-amp laptop computer power supply I purchased new on eBay [3].

System block diagram

In its simplest form, you need a power supply and one receiver per train block [4]. If you are like me and need only one power block and run only a single train at a time, then you need only a single receiver. In this diagram, I show how a second receiver can be added to allow controlling another train in another block (think traditional cab control).

Up to 50 receivers can be controlled via a single handheld transmitter, providing a lot of room for expansion. In the real world, I doubt anyone would ever need 50 receivers!

Receiver board wiring



3. Laptop power supply (19V 5A) I use to power the Revolution receiver.

Wiring the receiver board to the layout is a breeze. The receiver board plugs directly into the supplied termination board, making for easy wiring of DC power and track power [5].

I plugged the Revolution-provided wires directly into the receiver. These plugs and wires go to a pushbutton used to link the receiver and transmitter, an optional speaker, and any optional output devices.

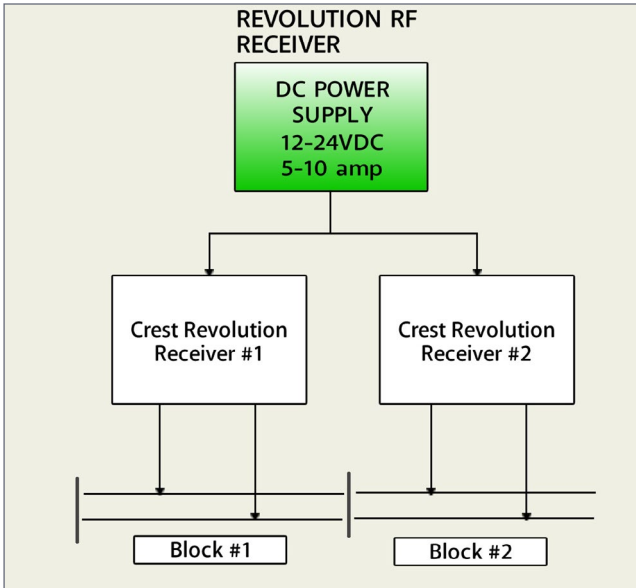

4. The basic Revolution setup with only train control and no sound or accessories.

Did you see this MRH video?



A full-sized F7
cab in the
layout room?

Watch the video now 



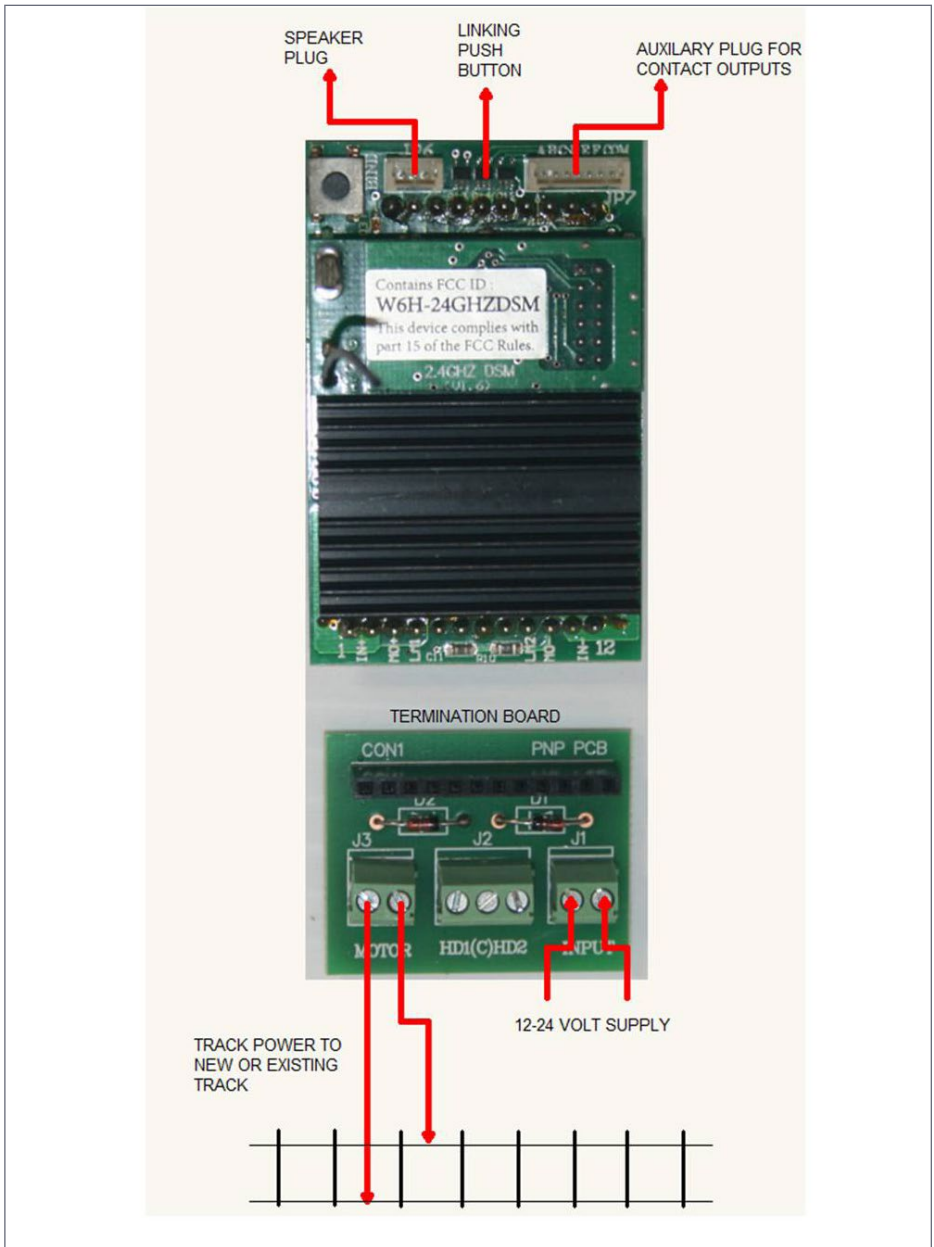

5. Receiver showing electrical hookup points to both the receiver and termination board.

Adding sound

The receiver has built-in sound that can power a speaker directly. Any 4- to 8-ohm speaker will work. When ordering the receiver board, specify either the Diesel or Steam sound unit.

The Revolution receiver has three built-in audio levels. If you press the #7 key, it selects the loudest level. The #8 key sets the middle level with #9 being the lowest sound level. I've found the lowest level might be a little too loud for a quiet room.

By wiring in a small 1K-ohm potentiometer to one of the two speaker wires, you can adjust it for a comfortable listening level [6].

I installed the speaker under my small N scale layout so it adds some loco sound to the operation experience.

Adding accessories

In my case, I wanted to add wireless accessory control to my receiver.

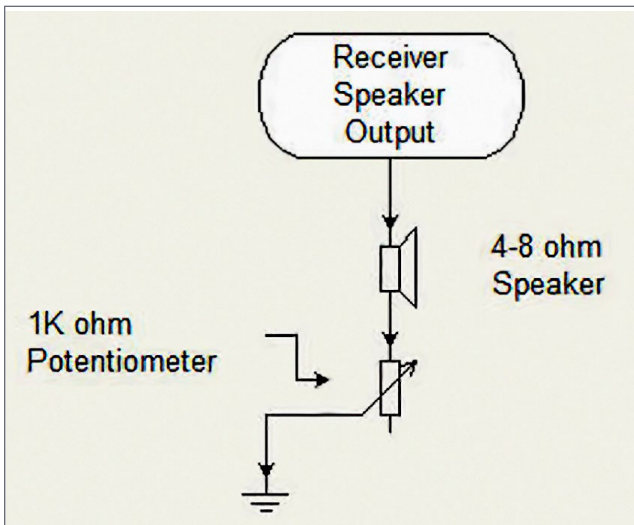

Since the Revolution system provides up to six outputs for each receiver, I thought it would be fun to have several on my system. These

6. Wiring diagram for adding sound to a receiver.

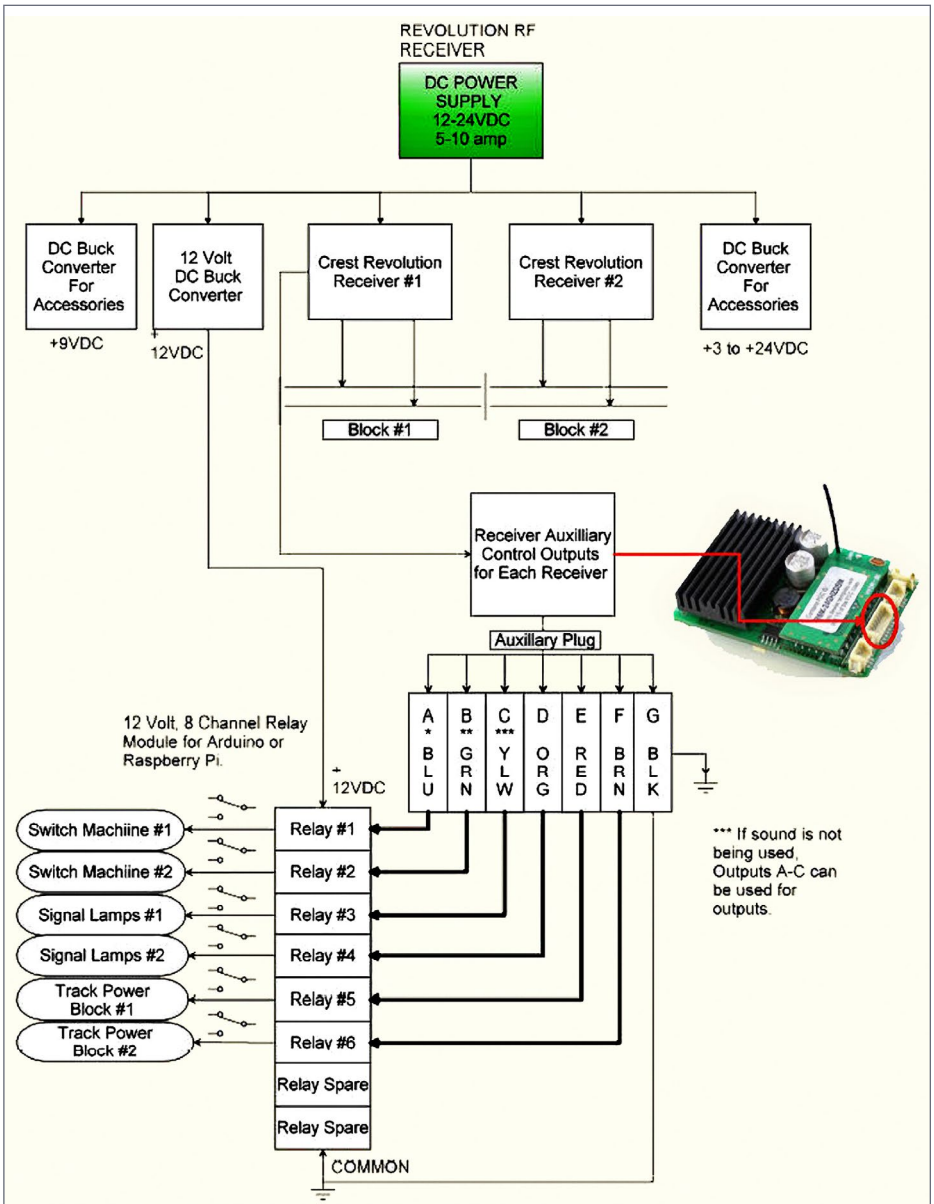

7. Adding accessories to the receiver involves not only extra wiring, but providing a power supply for the accessories you are powering.

accessory outputs provide a method of turning external devices on and off via the handheld control unit.

Examples of things you can turn on and off are track signals, strings of LED lights, switch machines, and so on. Basically, anything that can be switched on and off via a single-pole, double-throw switch can be automated. See the diagram with accessories added [7].

More accessory fun: relays

This starts to get more involved, and you may not want the extra complication. But if you are adventurous and willing to explore wireless accessory control, it can be a lot of fun.

The six outputs are typically connected to a buffer circuit to drive higher-powered devices such as what we typically use on a layout.

In my case, I used a relay board [8] designed to work with a Raspberry PI or Arduino microcontroller . The relays can switch up to 250 volts AC or 30 volts DC.

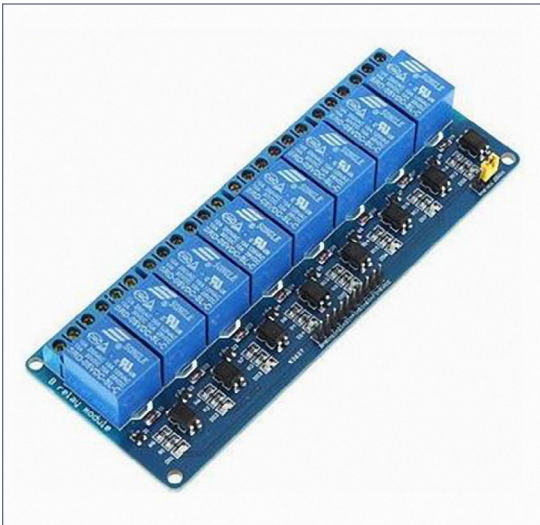

WHO SAYS
YOU CAN'T
DO DC

WIRELESS WITH SOUND?

This article shows a very practical way to do DC wireless walkaround control, with sound, no less!

8. Relay accessory board with 8 relays; cost, about \$10.



These relay boards are inexpensive, reliable, and small in size. I paid less than \$10 for my 8-relay board. The 2- or 4-relay board varieties are even cheaper.

Relay board voltage regulator

The relay board requires a 12-volt DC supply, which I provided by using a small DC-to-DC step-down adjustable power supply “buck module” [9].

The buck module can change any DC input voltage from 4-30 DC volts to 3-35 DC volts. When tied into my 19-volt DC receiver power supply, I get a regulated 12 volts DC.

I also added a second step-down board for other non-12-volt devices I’m using. The unit I picked has a built-in digital display that can show both the input voltage and the output voltage.

These voltage regulators can be found on eBay or Amazon for less than \$5. The board can be purchased without the voltage display for a few dollars less.

Auxiliary control wiring

[10] shows how I connected the receiver’s auxiliary control outputs to the relay board and the bucking voltage regulator.

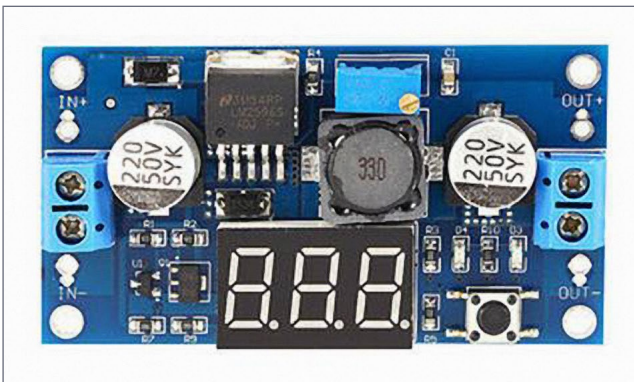

To wire the Revolution receiver to the relay board, I used jumper wires

9. Adjustable power supply “buck module.”

typically used on Arduino or Raspberry PI projects [11]. The wires have the sockets needed for the relay board inputs. A set of 40 wires was less than \$2, again from eBay or Amazon.

WARNING! It's important to adjust the regulator output before hooking up the relay board! The relay board I used requires 12 volts DC for power. I hooked the voltage regulator to my 19V power supply and adjusted the regulator output voltage to the relay board accordingly.

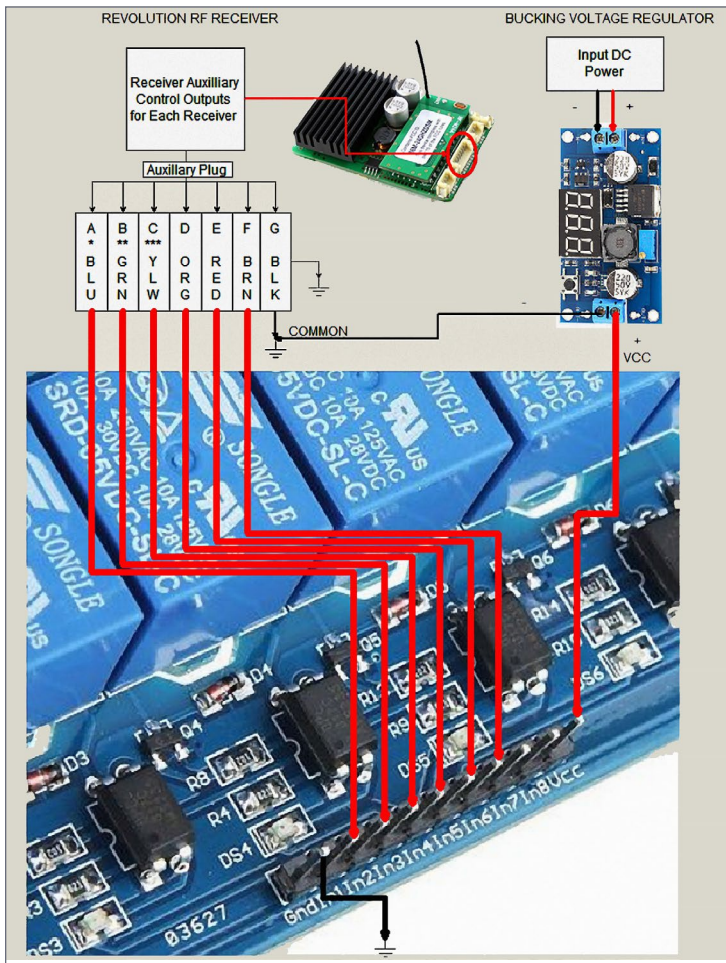

10. Output board signal input wiring.





11. Jumper wires with pins on one end (left) and sockets on the other end (right).

Finished setup

[12] shows the complete setup on my layout.

I used corrugated plastic yard sign material from Hobby Lobby, as a mounting platform. I chose the corrugated material because it is light and easily cut to size. Since I was planning to attach this to the wall directly under my layout, I wanted it to be lightweight.

I attached each item with Scotch double-sided tape, and also attached the entire corrugated board to my layout with the same tape.

Plexiglas or a sheet of plywood could work just as well if the extra weight is not a problem.

Final thoughts

If you have an existing DC power-pack control system, you can replace it with a Revolution wireless throttle and receiver. This gives you the versatility of wireless walk-around control and sound, plus optionally automating some of your lighting, switch machines, block switches, and so on.

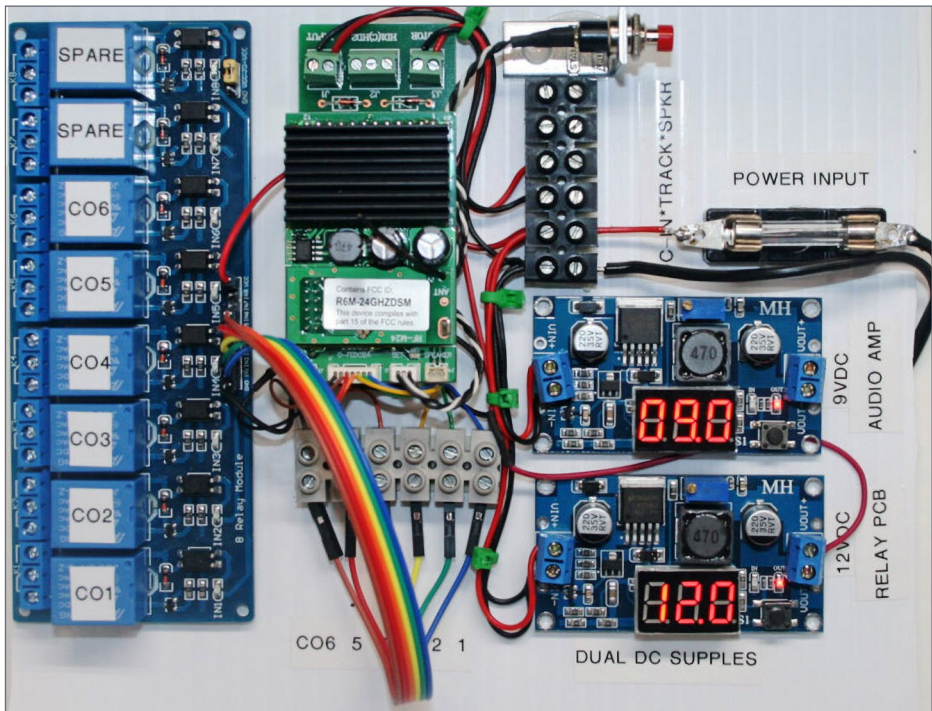

12. My complete unit showing the receiver, the relay board and two auxiliary power supply boards.

Just move the existing DC output wires from your power pack over to the new receiver output, and you now have a walk-around system up and running!

If you need more than the six outputs in a single receiver, additional receivers and relay boards can be wired in to provide them. If you don't want or need wireless accessory control, the relay board and its regulator boards are not needed.

I especially like having momentum and delay features built-in and programmable. No more jack-rabbit starts or stops with this! The built-in sound is nice, and being able to turn it off with one button is great when I don't want it.

I find it very convenient to walk around with my wireless control unit and not only run my train, but control switch machines, lights and other devices.

I'm very satisfied with how this project turned out. The system has been reliable, and I expect many hours of trouble-free use with it. ✓



LIST OF MATERIALS

Revolution On-board TX/RX set with sound \$279.00 (Precision RC)	
12V 8-channel relay module for Arduino or \$ 7.88 Raspberry Pi (eBay)	
DC-DC step-down CC-CV adjustable power supply \$ 2.08 buck module (eBay)	
DC 12V – 19VDC 5-amp laptop PC power supply \$ 7.59 (eBay or Amazon)	
Foxnova breadboard jumper wires male-to-female \$ 4.99 (Amazon)	
Uxcell screw terminals (Amazon) \$ 13.49	
12" x 12" Plexiglas or foam board to mount module \$ 6.00	
Scotch 4011 double-sided tape (Amazon) \$ 9.06	

Most of these parts can be found on Amazon or eBay. Search on the item's title to find it. When searching on eBay, you will find multiple sellers selling the same thing. I normally just go for the cheapest. Expect a two-to-three-week delivery time if the seller is in China. I've ordered a lot of stuff from China and I've never had a problem.

MARK GILGER



Mark is retired from the process control industry and lives with his wife and two dogs in Doylestown, Ohio. His primary interest is outdoor G scale operations. His MM&G railroad has 1,800 feet of track with over 45 turnouts.

Mark holds several operating sessions per year for the local BSGR (Buckeye State Garden Railroad) group. Learn more about his layout at: mmg-garden-rr.webs.com.

He also has a 16x2-foot indoor N scale layout that he uses primarily in cooler and inclement weather. ■



click here

THERE'S MORE!

**Check out the
Subscriber
bonus extras**

**VIEW READER
COMMENTS**

click here



ACCURAIL 36-FOOT BOXCAR

ASSEMBLY TUTORIAL



**STEP
by
STEP
1-2-3**

1. Here is one of these 36' Accurail cars finished and ready for the layout.

ERIC HANSMANN SHARES HIS TRICKS TO ASSEMBLING THESE NICELY DETAILED CARS ...

I'VE SEEN AND HEARD MANY GOOD COMMENTS ON the new Accurail HO scale, 36-foot double-sheathed boxcar kits. The prototype cars first appeared during the 1910s, and many ran into the 1950s in revenue service. A few survived into the 1970s in maintenance-of-way duty.

The car shell has good detail. Bolster ends, brake staff stirrup, doors, and grab irons are cast into the one piece body. The running board, running board latitudinals, and brake step platform are separate castings that are snapped into place on the body casting. A touch of styrene cement on the mounting pins inside of the car secures these parts in place.

• [INDEX](#)

• [TABLE OF CONTENTS](#)

But many people seem puzzled when building the more detailed underframe on these kits. Modelers have come to expect an Accurail kit to assemble easily. This kit is no exception; there are just a few additional parts to carefully assemble in this new kit.

The extra underframes parts are engineered for an easy fit. Follow this tutorial to help you assemble this nicely detailed underframe.



RATE THIS ARTICLE

THESE CARS AND MY MODELING

For my own 1926 modeling focus, these 36-foot boxcars reflect a huge number of in-service box cars.

The New York Central Lines may have rostered the most in 1926, but nearly half of the B&O boxcar fleet of that year had interior lengths less than 40 feet as well.

The B&O had 9988 M-8 class, 36-foot boxcars in late 1926. The B&O had 19,038 boxcars with interior lengths less than 40 feet in late 1926, representing 47.5% of the boxcar fleet. The Twenties were the last hurrah for these shorter box cars, as railroads began adding 40-foot, steel-sheathed boxcars by the thousands through the 1920s.

I've displayed some of my Accurail 36' boxcars at Railroad Prototype Modelers (RPM) meets, and most people ask me for the Westerfield stock number so they can get one. They are very surprised when I tell them it's an Accurail kit with the stock underframe and a few upgraded end details! ■



STEP 1: GATHER PARTS AND TOOLS

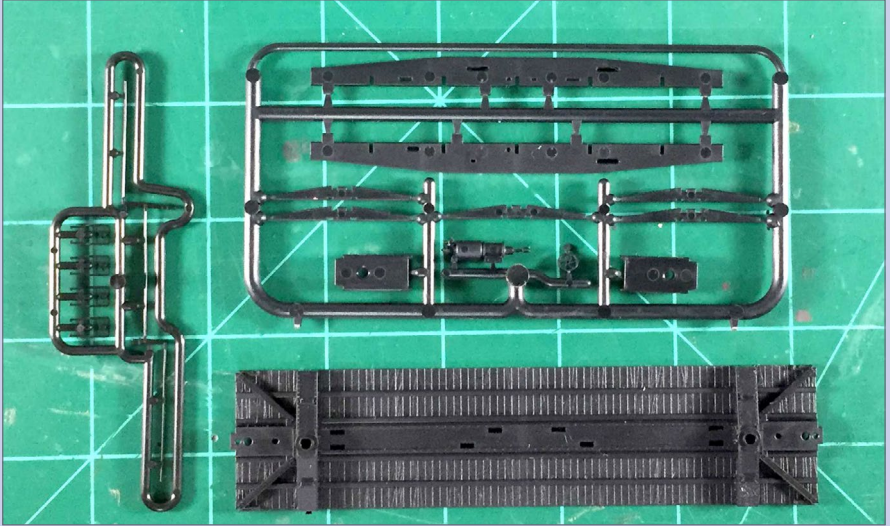

2. Gather the underframe parts. The sprue on the left has the brake levers and rods cast in a flexible material. Above the main underframe part is the sprue with the center sills, K brake component, cross bearers, coupler box covers, and the brake wheel.



SHAKE-THE- BOX KIT EVOLUTION

It's encouraging to see that Accurail is evolving their newer "shake-the-box" kits to have more detail fidelity. Nice!

WEB: accurail.com

**VIEW READER
COMMENTS**

click here

CONTINUED ... STEP 1: GATHER PARTS AND TOOLS



3. Gather the tools needed for assembly. Styrene cement is used in a few spot applications. A sharp blade like a fresh single-edged razor blade or an X-Acto knife with a fresh blade is a must for removing larger parts from the sprue. The orange-handled flush side cutter also works to remove the parts from the sprue [4]. Keep a roll of masking or painter's tape handy for the later steps.

STEP 2: PREP PARTS FOR ASSEMBLY

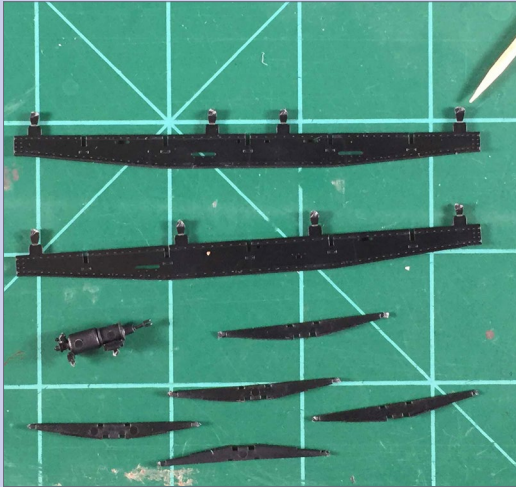

4. Roughly trim parts from the sprue. Use the flush nippers to remove the parts from the sprue by cutting through the sprue back a bit from where the part joins the sprue. I am pointing with the toothpick at the excess sprue nub to be removed with the sharp blade.

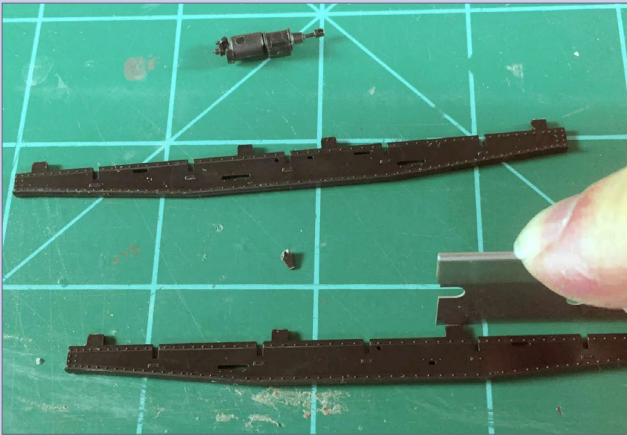

5. Cut off sprue nubs with sharp blade. My favorite cutting tool is a fresh single-edge razor blade although an X-Acto knife with a fresh blade will work as well. I start each project with a new blade for clean cuts.

CONTINUED ... STEP 2: PREP PARTS FOR ASSEMBLY



6. Cut "close-clearance" sprues with the sharp blade. The brake levers and rods are a one-piece casting with tight sprue clearances. I use the sharp razor blade to cut the sprue here on these parts.



7. Cut off sprue nubs. Use the sharp blade to remove those leftover nubs. Take your time to do a nice job here. We still have more parts to prep before assembling.



CONTINUED ... STEP 2: PREP PARTS FOR ASSEMBLY



8. Closeup of the brake casting. Here's the K brake casting with the sprue nubs cleanly trimmed off.



SEPARATE UNDERBODY BRAKE DETAIL

Simple plastic kits never used to have separate underbody brake detail like this. Accurail hit a home run with this model kit!

WEB: accurail.com

VIEW READER COMMENTS

click here

STEP 3: ASSEMBLE THE BRAKE GEAR ONTO THE CENTER SILL

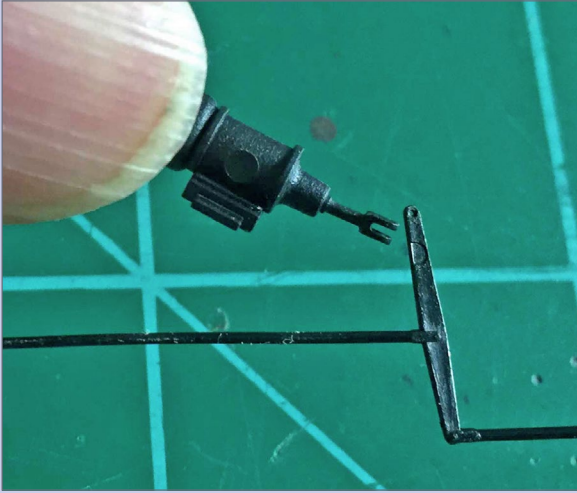

9. Fit clevis over long brake lever. There is a small half-round dimple on the brake lever where the clevis fits. You can see it in this image as the light reflects off of the area.

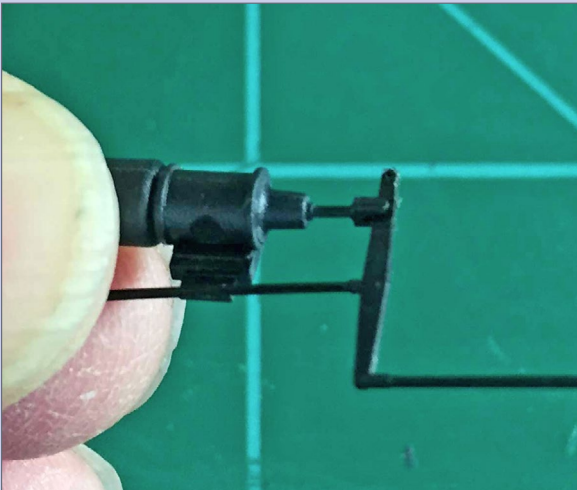

10. Check brake cylinder fit. Align the brake cylinder so the lever slides right into place with the clevis. Do not glue these at this time. Just check the fit.

**CONTINUED ... STEP 3: ASSEMBLE THE BRAKE GEAR
ONTO THE CENTER SILL**

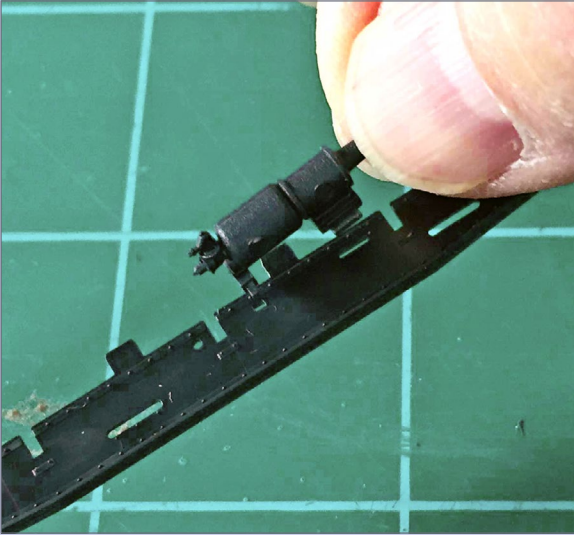

11. Install brake cylinder onto center sill. At this point, we can install the brake cylinder to the proper center sill part. It fits only one way.

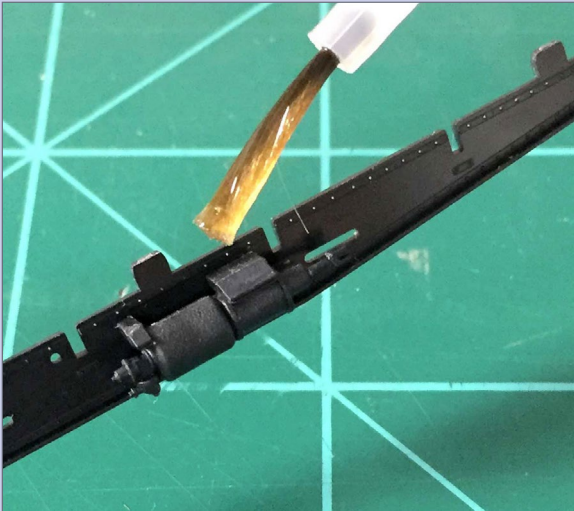

12. Apply cement to brake cylinder. A touch of styrene cement holds the cylinder in place. Cement also can be applied to the back side of the center sill casting.

CONTINUED ... STEP 3: ASSEMBLE THE BRAKE GEAR ONTO THE CENTER SILL

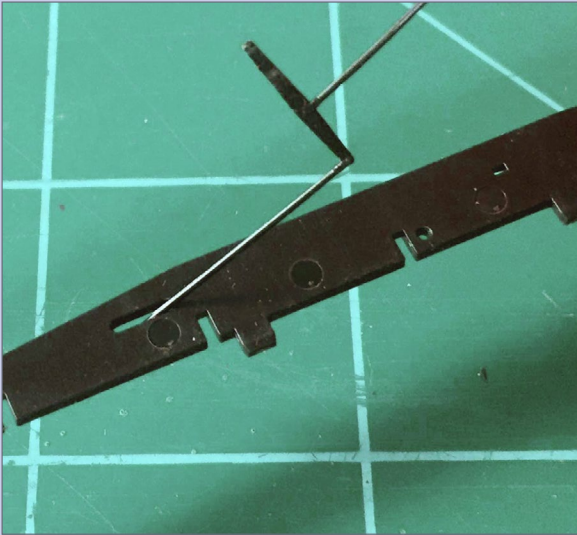

13. Thread brake rod through center sill. The next step is atypical for a model railroad freight car kit. The brake rod is threaded through the other center sill first. The rod attached to the long brake lever needs to go through the wide slot.

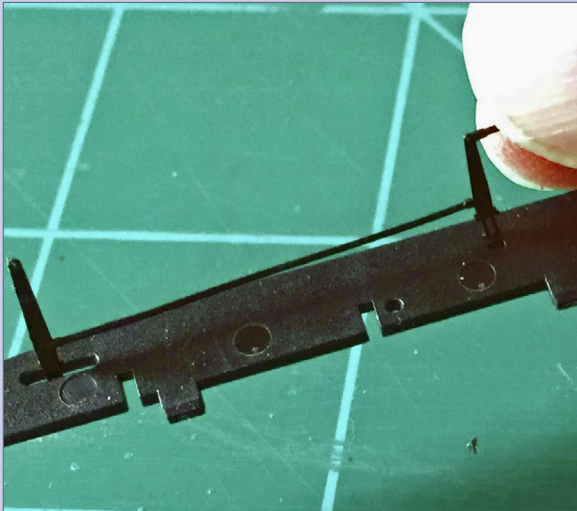

14. Insert shorter brake lever into sill. The small forked end of the shorter brake lever is inserted into the small hole on the back of the center sill casting. A touch of styrene cement on the hole keeps the part in place.

CONTINUED ... STEP 3: ASSEMBLE THE BRAKE GEAR ONTO THE CENTER SILL

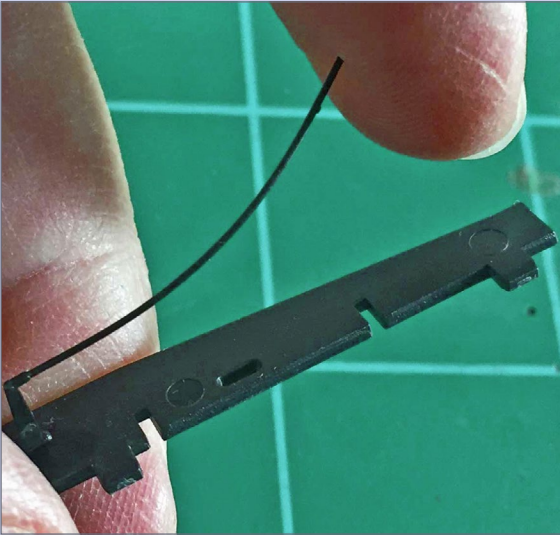

15. Careful to not snap off the brake rod. As I said before, the brake rod casting is made from a flexible material; just don't bend it too far!



16. Thread brake rod through other sill. Now thread the other brake rod end through the center sill that has the brake cylinder on it. The long brake lever goes through the other wide slot and inserted into the clevis on the brake cylinder. Remember we started out by test-fitting it [9, 10].

CONTINUED ... STEP 3: ASSEMBLE THE BRAKE GEAR ONTO THE CENTER SILL

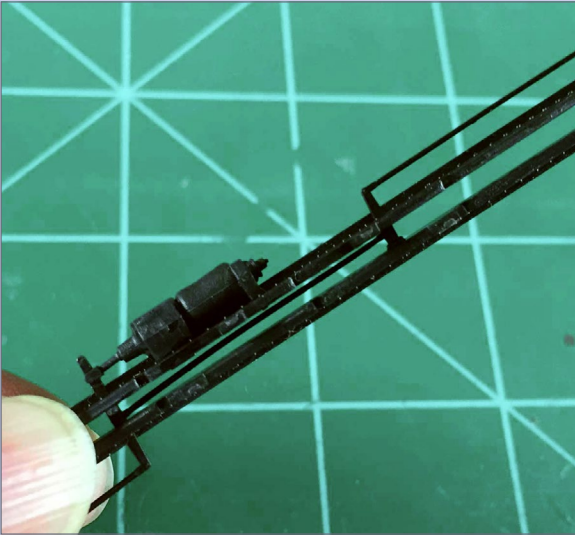

17. Brake/center sill assembly so far. Here is how the assembly looks at this point with the clevis and brake lever fit together, and the center sill parts held in place. My fingers are holding it all together for this photo.



18. Use tape to hold the sill sides together. I use some blue painter's masking tape applied to the bottom of the center sill to hold the parts in place for the next step. Don't worry about the tape holding the two center sill parts at an odd angle.

STEP 4: COMPLETE THE UNDERFRAME ASSEMBLY



19. Get the five cross bearer castings. Don't worry, we will correct the odd center sill parts spacing shortly. The tape keeps the center sill sides standing up and not falling over – which is mainly what we need to make final assembly easier.



IT'S WORTH IT

This kit might be a little more "fiddly" than your typical Accurail boxcar kit to assemble, but the detail is worth it. It just doesn't look like your typical plastic kit!

WEB: accurail.com

**VIEW READER
COMMENTS**

click here



CONTINUED ... STEP 4: COMPLETE THE UNDERFRAME ASSEMBLY

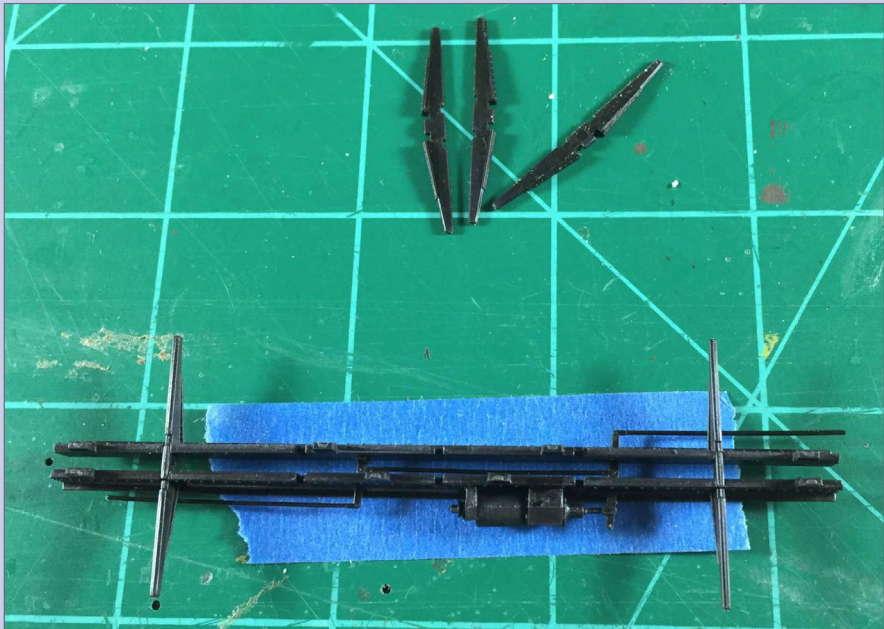

20. Install two end cross bearers. Carefully install the two cross bearer castings at the ends of the center sill. Adjust the center sill spacing on the tape so the cross bearers fit into place. The angled part of the cross bearer castings is facing down toward the tape for this installation. The top is flat as it goes against the car floor.

CONTINUED ... STEP 4: COMPLETE THE UNDERFRAME ASSEMBLY



21. Cement two cross bearers in place. A touch of styrene cement fixes the two cross bearers in place.



FLEXIBLE PLASTIC DETAILS

Accurail uses flexible plastic for the brake line detail, which I think is a stroke of genius. Bravo to Accurail for going the extra mile on these parts.

WEB: accurail.com

**VIEW READER
COMMENTS**

click here

CONTINUED ... STEP 4: COMPLETE THE UNDERFRAME ASSEMBLY

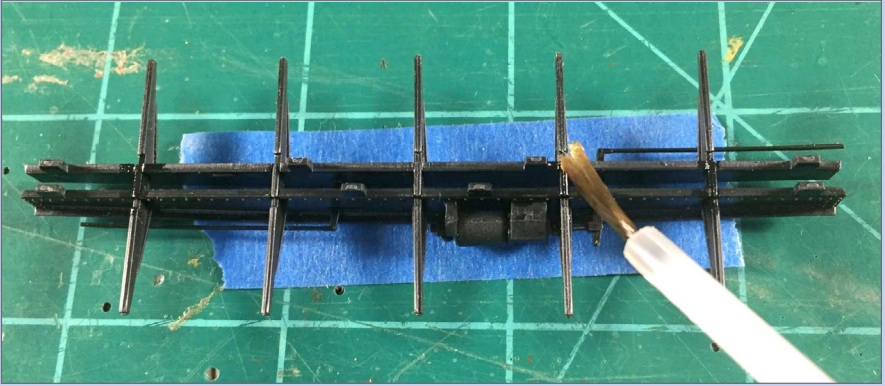

22. Install the remaining cross bearers. Let the cement dry for a moment. Then install the remaining cross bearers. Touch them with the cement to finish this part of the assembly.

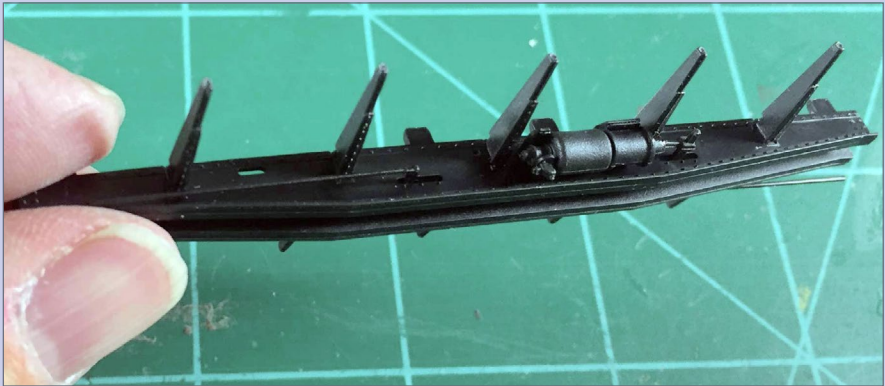

23. The finished underframe assembly. When the cement is dry, this is how your underframe assembly should look.

CONTINUED ... STEP 4: COMPLETE THE UNDERFRAME ASSEMBLY



24. Check underframe assembly fit. Now we can check the installation on the car bottom casting. The center sill casting tabs are keyed to slots on the car bottom casting.



25. Snap the assembly into place. The underframe assembly will only fit one way onto the car bottom casting.

CONTINUED ... STEP 4: COMPLETE THE UNDERFRAME ASSEMBLY



26. Apply cement from above. Touch the tabs with some cement from the top side of the car body casting. Allow this to completely dry before installing the car weight.

**VIEW READER
COMMENTS**

click here

STEP 6: INSTALL COUPLERS

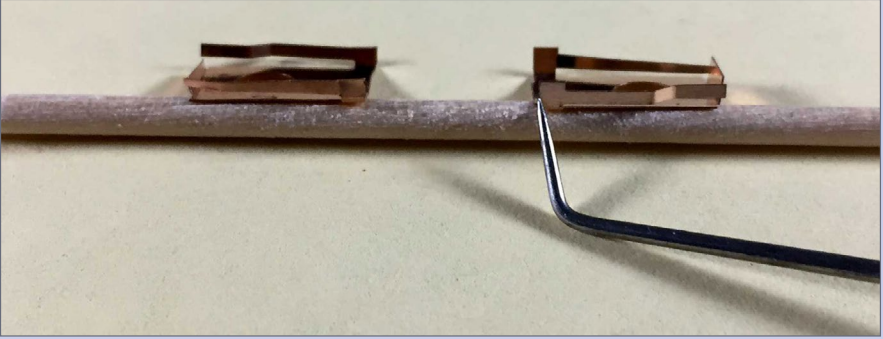

28. Coupler spring modifications. I've heard of modelers having difficulty installing #58 Kadee couplers on these models. They say the #58 flat coupler spring does not fit. I trim parts of the spring: here is a comparison of a trimmed spring on the left and a spring straight from a new package of Kadee #58 couplers on the right. Note the difference in height front and back. Use flush-cutting nippers and carefully file any rough remains away. Once the spring is modified, it fits fine.

CONTINUED ... STEP 6: INSTALL COUPLERS



29. Install the coupler spring in the box. I install the spring in the lid first and then add the coupler.



WHAT ABOUT THE SPRING?

Oops! The #58 spring here is installed upside down – the spring tabs on the two sides of the spring and the coupler shank shape on each side are different, so spring orientation does matter. The spring goes against the car body above the coupler shank, not underneath it. See Kadee's installation photo for proper installation of the spring (shown on next page).



CONTINUED ... STEP 6: INSTALL COUPLERS



KADEE COUPLER SHANKS



* Whisker® Shank
(symmetrical)



Standard Shank
(asymmetrical)

The simplest solution is probably to just use the new Kadee #158 whisker couplers and avoid spring orientation problems completely.

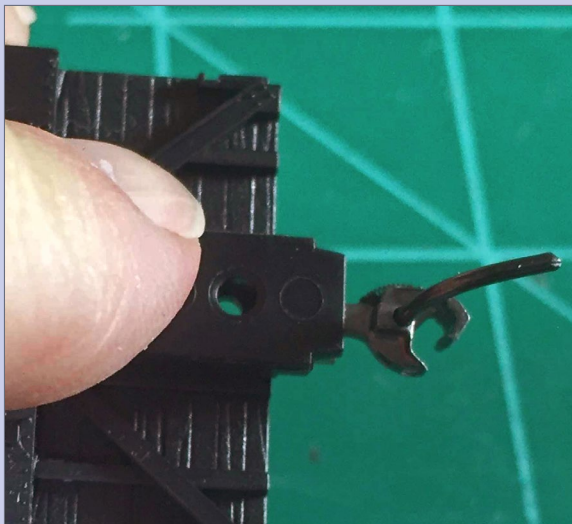

30. Attach the coupler box to the car bottom. The assembly slides into place on the car body bottom. Install the screw provided in the kit to finish it up.

CONTINUED ... STEP 6: INSTALL COUPLERS

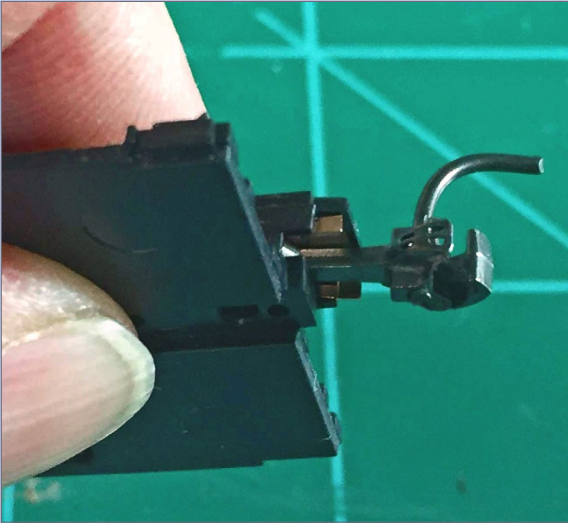

31. Coupler view from above. At this point, you probably think the coupler area looks funky in this view from above. But the body casting has a detail casting that covers this [32].

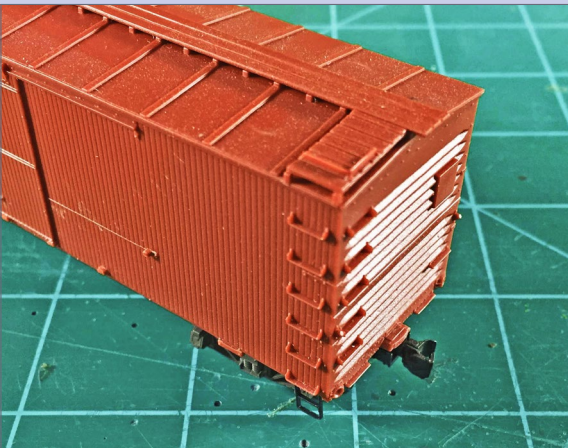

32. Car body with coupler box top in place. You can see how the car body coupler top casting hides the funky coupler box top of the bare car floor from the above [31].



CONTINUED ... STEP 6: INSTALL COUPLERS



33. Proto:HO couplers fit great, too. If you use the Accurail Proto:HO scale couplers (that is my preference), they have a cover that reflects the prototype draft gear. The lid is not needed when installing these on the 36-foot box car kits. These couplers also have less play between coupled faces and reflect the prototype with a closer coupling than other couplers. The Accurail Proto:HO couplers have worked well on my freight cars.



AVOID MIXING COUPLER BRANDS

In my *Run like a Dream: Rolling Stock* book, I recommend you do not mix coupler brands on your layout if you want the best performance.

WEB: store.mrhmag.com

**VIEW READER
COMMENTS**

click here

STEP 7: FINISH UP THE CAR



34. Snap on car shell, add steps and trucks. With the car shell in place, the double-rung sill steps fit into their locations. The sill steps are cast in engineering plastic and are designed for a press fit. Then screw the trucks onto the car bottom, and the model is ready for painting and decaling! I substituted AC&F arch bar trucks by Tahoe Model Works [resincarworks.com/tahoe.htm] for the Accurail kit trucks.



RATE THIS ARTICLE



CONTINUED ... STEP 7: FINISH UP THE CAR



35. Add extra detail to the car ends (optional). For the car on the left, I added supports for the brake platform and the running board ends by fitting 1×3 styrene strip to the support area then cutting each piece to half its width lengthwise to present a finer detail. I added a retainer valve and retainer line next to the ladder using a Tichy Train Group casting (found on the K brake parts sprue) along with 0.008" brass wire. I formed some uncoupling levers from 0.0125" brass wire and installed some eyebolts at the pivot points.

Now you are ready to assemble one or a dozen of the new Accurail 36-foot boxcar kits. Take your time with your first assembly and you will do a great job. Once you assemble several of these underframes, you can do this blindfolded!

Concluding thoughts

There are many possibilities for these models. Replacing the grabs with ladders to reflect a specific prototype would be an update to make these even more distinctive. Sanding the Murphy roof castings and installing scribed styrene for a wood roof is another possible update. Adding a half-door and door track to the left of the main door would push these closer to Michigan Central prototypes.

I know a few modelers who are already modifying their kits to reflect cars that were moved to maintenance service in the post-WWII years.

I look forward to adding several of these 36' cars to my 1926 fleet. Looks like I need to fire up the paint booth again!

ERIC HANSMANN



Eric started model railroading in 1972 and has been a prototype modeler since 1999.

He lives in Murfreesboro, TN, with his wife, Dr. Cheryl Torsney. He built a 9'x16' HO scale switching layout based upon the Baltimore & Ohio's Wheeling, WV, freight terminal and set in late 1926. Crews move nearly 100 freight cars during the monthly

operating sessions.

Eric authored a narrow gauge column sidebar in the debut issue of *Model Railroad Hobbyist* and has contributed articles to *Railroad Model Craftsman* and *Model Railroad Planning*. He has been involved with several prototype modeler events as a presenter, coordinator, promoter, and web guy. ■



SOME BACKGROUND ON THIS MODEL

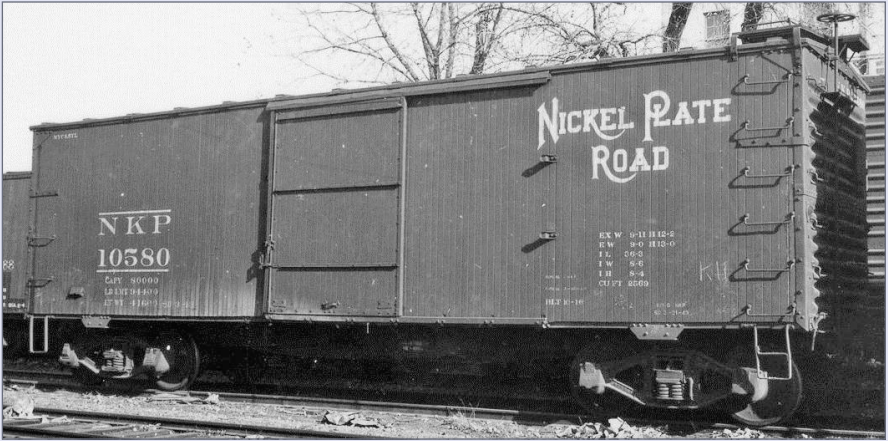

In late 2016, Accurail released a brand new boxcar model that is welcome news to anyone modeling North American railroads in the 1900-1950 period, as the model is of an extremely common prototype.

As a simple but finely detailed kit molded in styrene, this is the first time ever that a “modern” short boxcar has ever been offered in anything but resin. LaBelle wood kits and the old Roundhouse short boxcars are all of older, all-wood prototypes not really suitable for the post-1928 wood underframe ban period and generally reflect pre-1905 built prototypes.

Since this is a model of an older prototype, some modelers are wondering if the car is suitable to run on their layouts. Other modelers question the era-appropriateness of Accurail’s initially-announced road names and paint schemes.

Accurail has four variations of this new model:

- 1300-series: steel roof, steel ends, fishbelly center sill underframe
- 1400-series: steel roof, steel ends, straight center sill underframe
- 1700-series: steel roof, wood ends, fishbelly center sill underframe
- 1800-series: steel roof, wood ends, straight center sill underframe.

Since this is an affordable, mass-produced plastic model utilizing as many common parts as possible, there are naturally some compromises in the detailing. Straight out of the box, none of these four versions is 100% right; all modeling requires some forms of compromise.

However, none of them is 100% wrong either, and each of the four variants are quite appropriate for several prototype cars that were built and used in large numbers before and after World War I.

In the bonus downloads for February, I focus on the 1300-series kits, with the historical background on the other models coming in future issues of MRH.

–Ray Breyer



click here

THERE'S MORE!

**Check out the
Subscriber
bonus extras**

**VIEW READER
COMMENTS**

click here



EASY INEXPENSIVE WINDOW GLASS



EDWARD WERICK SHARES A QUICK TRICK FOR GLAZING STRUCTURE WINDOWS ...

**I RECENTLY BEGAN CONSTRUCTION OF A ROUND-
HOUSE** using seven Walthers Cornerstone kits. That's 21 stalls and a *lot* of windows. I was reluctant to use the clear styrene "glazing" which comes with the kit for several reasons, so I decided to experiment.

I had read numerous examples of using cheap hair spray as an adhesive, usually for sticking ground foam to tree armatures or to furnace filter material to model foliage. This gave me an idea.

I went to my local dollar store and bought a can of cheap hair spray. I already had a roll of clear plastic Glad Cling Wrap in my kitchen. I taped a length of cling wrap to a scrap of cardboard (an old cereal box) while keeping it as smooth as possible.

Next, I sprayed the inside surface of the window frames with a good wet coat of hair spray, dropped them one at a time on the plastic wrap, and let them dry for about an hour.

I cut around the outside of the frames with a new #11 X-Acto blade and my windows were ready to install.

Using this method allowed me to glaze several windows at a time at a cost of just pennies, and with a minimum of effort. As a bonus, the very thin (about 0.001”) plastic wrap is close to the scale thickness of window glass!



1. I used this method to quickly glaze the many windows on my large kitbashed roundhouse project.



2. Here are the materials I used: Glad ClingWrap, cheap extra hold hairspray, transparent tape, tweezers, a large scrap of cardboard (old cereal box unfolded), and an X-Acto knife with a new blade. And of course, the window castings! Paint the frames before applying ClingWrap.



3. I tape the plastic to the cardboard. I took my time: the smoother I can get it, the better my windows will look!

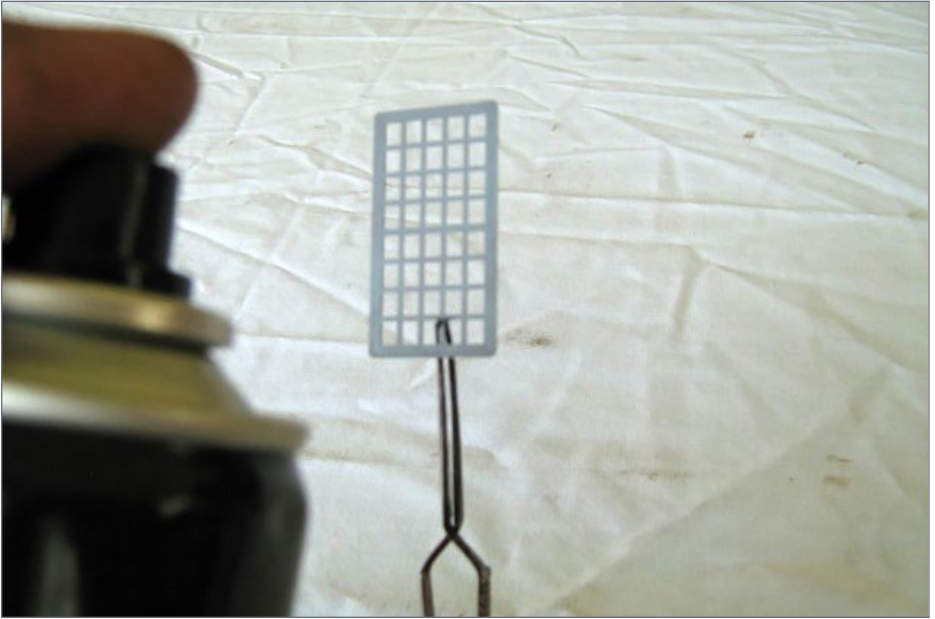

4. I apply a good, wet coat of hair spray to the inside of the window frames ...

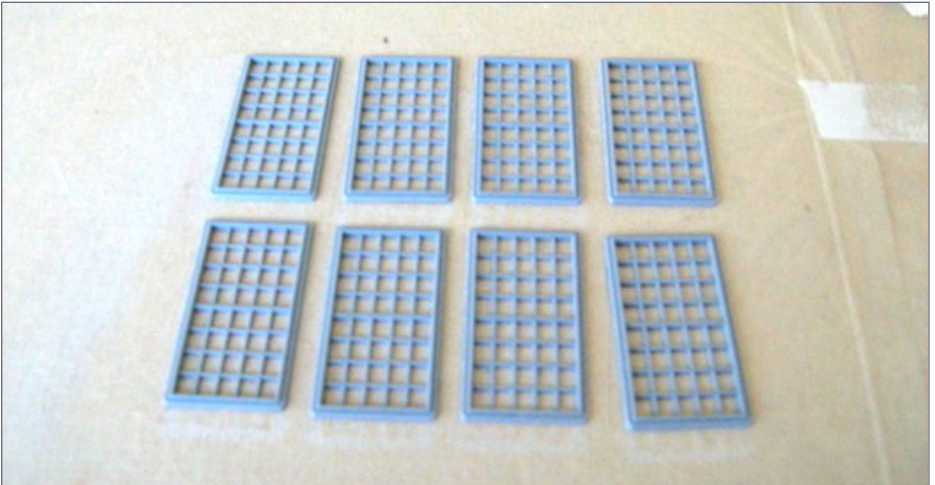

5. Then I drop the window frames (wet side down) onto the plastic wrap and let them dry for about an hour.



6. I put a fresh blade in my X-Acto knife and cut around the outside of each frame.

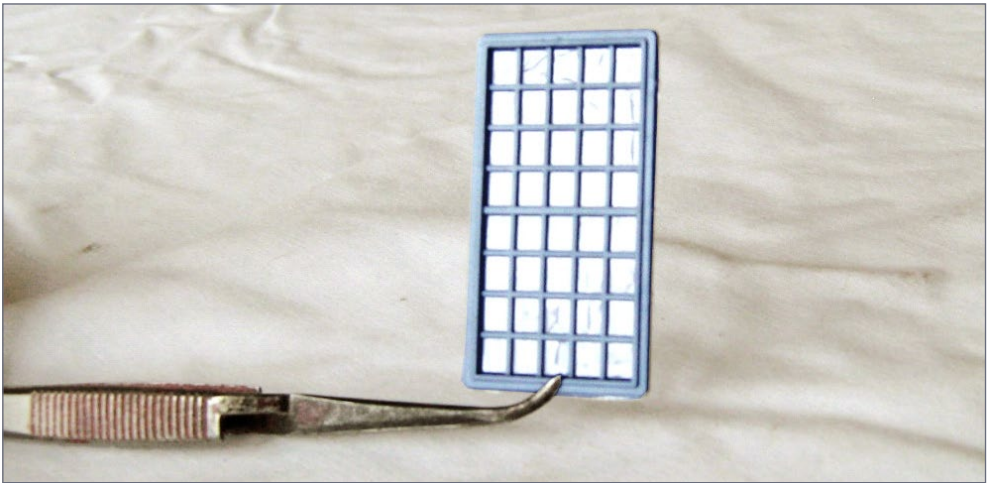

7. That's it, my windows are ready to install!



LIMITED SUPPLY!

FINAL KIT!



FINE SCALE MINIATURES

FSM is closing its doors after 50 years of business!

Fine Scale Miniatures founder George Sellios with his final kit



ONCE GONE, THAT'S IT!

I.M. Dunn Co. \$280 + S&H



Destined to become an instant collector's item

BUY NOW >>

Brought to you by the MRH Store: store.mrhmag.com

• [INDEX](#)



SUBSCRIBE
(free)

• [TABLE OF CONTENTS](#)

Turbo

CLICK
HERE

Hand-painted 3D-printed

It's a train
It's a plane
It's THE TURBO!

United Aircraft/US DOT (3-Cars)

Penn Central/US DOT (3-Cars)

Early Amtrak (5-Cars)

Late Amtrak (5-Cars)

Canadian National (5-Cars)

VIA Rail Canada (5-Cars)



TurboTrain

BRINGING HISTORY TO LIFE IN N SCALE

• [INDEX](#)

• [TABLE OF CONTENTS](#)

FEBRUARY NEWS column



Model Railroad Hobbyist | February 2018 | #96



RATE THIS ARTICLE

RICHARD BALE and
JEFF SHULTZ report the latest hobby industry news

INDUSTRY NEWS

Deignan Acquires FSM Castings

Jimmy Deignan, owner of Railroad Kits, has acquired the rights to manufacture and sell cast metal detail parts from Fine Scale Miniatures. The acquisition includes the original masters, molds, casting supplies, and equipment including centrifugal spin caster, furnace, and vulcanizer required to produce high-quality castings. Deignan noted that having the original FSM equipment will permit him to continue producing FSM's blemish-free, polished, and jewel-like castings which he plans to sell under his own brand name.

The agreement also allows Deignan to include the castings in his Railroad Kits structure line. Deignan, who is the organizer of the Fine Scale Model Railroaders Expo held annually in the Northeast, emphasized that he has only acquired the FSM metal castings and

▶ **THE LATEST MODEL RAILROAD PRODUCTS, NEWS & EVENTS**

• [INDEX](#)



SUBSCRIBE
(free)

• [TABLE OF CONTENTS](#)

tools and that George Sellios still owns Fine Scale Miniatures. Since establishing Railroad Kits in 2006, Deignan has purchased several small kit manufacturers including White River Structures, Southcoast Scale Models, Sheepscott Scale Products, and Pine Valley Scale Models. For additional information go to railroadkits.com.

Iowa Scaled Engineering taking ProtoThrottle reservations



Iowa Scaled Engineering has announced they are now taking advance registrations for the ProtoThrottle – a full-function DCC-compatible diesel throttle.

Their website at proto-throttle.com contains a form to register, which includes a discount on pre-orders. The

ProtoThrottle manual is available in addition to a bonus publication by professional railroad engineer, Tim Garland, who provides an extensive outline on how to operate the ProtoThrottle.

The ProtoThrottle is a wireless controller that works in tandem with your DCC system. It features an aluminum anodized faceplate, fully detented throttle handle with eight notches plus idle, fully detented three-position reverser handle, smooth resistive brake handle, dimmable horn handle, and many other features.

An additional receiver will need to be purchased to communicate with specific DCC systems.

design, which was published in his MRH blog, is a significantly updated version of the Twin-T circuit developed by Linn Westcott in 1958. For additional information visit modelrailroadcontrolsystems.com/geoff-bunzas-improved-twin-t-dc-detector-bare-board.

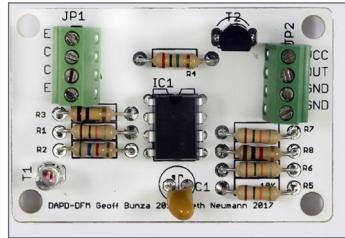
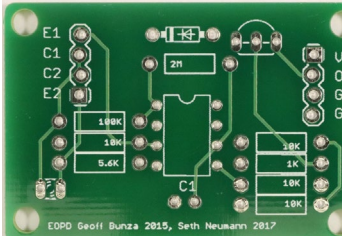

Also new from MRCS is an Enhanced Optical Position Detector

(EOPD). The device is useful when precise position detection is needed such at a staging throat or a blind-end depot track. The EOPD provides a 1.4 second turn-on and turn-off delay and high power output stage similar to Bruce Chubb’s DCC-OD. The EOPD is electrically compatible with a cpOD or DCC-OD. The EOPD is shown above as a bare board and with components mounted including screw terminals. For additional information visit modelrailroadcontrolsystems.com/enhanced-optical-position-detector.

.....

Ngongo B has upgraded their free online TRAX layout design software to Version 2.0. Supporting over 100 track libraries from Rokuhan Z to USA Trains G, Trax works inside the designer’s web browser, and supports all modern web browsers on Windows, Mac, and Linux computers and iOS and Android mobile devices. The new TRAX2 software now includes module support, independent tables that can be moved together with the track and objects on top of them, and printing scalable PDFs. Video tutorials are available for the TRAX features on the website. TRAX can be found at traxeditor.com.

.....

TCS – Train Control Systems has announced a new DCC Command Station. Expected to be available later in 2018, the Command Station will feature an integrated Wi-Fi base station, NMRA standard LCC connectivity, an NCE network connector, and a 4 amp booster. Additionally, TCS will be introducing a new Wi-Fi throttle that includes a 2.3 inch diagonal LCD screen, a full keypad including several mappable softkeys, a thumbwheel, 28 function support, and a built-in LED flashlight. The throttle will be powered by AA batteries. A separate 8 amp booster is also expected to be available. Video of the introduction and a demonstration of a prototype of the throttle can be seen at [facebook.com/tcsdcc/videos/1535736959845737](https://www.facebook.com/tcsdcc/videos/1535736959845737). Information on other TCS products can be found at your local dealer or tcsdcc.com.

.....

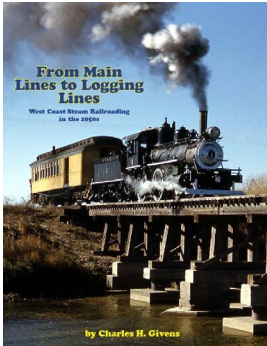

The Southern Pacific Historical & Technical Society is selling a new book by Charles H. Givens titled *From Main Lines to Logging Lines: West Coast Steam Railroading in the 1950s*. Givens shares his mid-century pilgrimage to the great SP and Santa Fe, and to the lesser but no less fascinating Western Pacific, Georgia Pacific, Arcata & Mad River, and other lines

during the period when both steam and diesel were abundant, and shortline gems soldiered on everywhere. Hardback 8.5 x 11, 128 pages with 223 color and black & white photos. For ordering information visit sphs.myshopify.com/collections/books/products/from-main-lines-to-logging-lines-west-coast-steam-railroading-in-the-1950s.

.....



Denver & Rio Grande The Early Years



Mallory Hope Ferrell

Mallory Hope Ferrell's *Denver & Rio Grande, The Early Years*, explores the glory period of the narrow gauge D&RG from 1871 through 1910. It is difficult to comprehend the amount of energy, manpower, and money that went into constructing the railroad as it pushed into and

across the Rockies. Ferrell's text is supported by more than 650 rare black & white photos, art and maps. For more info visit mcmillan-publications.com/products/denver-rio-grande-the-early-years.

.....

O SCALE PRODUCT NEWS

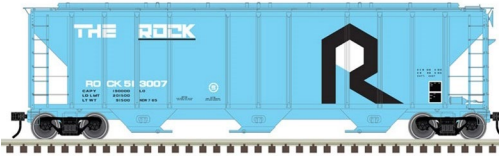

Atlas O is working on releasing a Pullman Standard 4427 cu. ft. covered hopper with low sides. The ready-to-run O scale model

will have full brake line details, operating hatches with working latch assembly, separately-applied wire grab irons, see-through roof walks, and sprung 100-ton roller-bearing trucks with rotating bearing caps. Road names will be Rock, BNSF, Conrail, CSX, Missouri Pacific, and Santa Fe.



Also in the works at Atlas O is a new run of 50-foot PS-1 plug door boxcars. The typical insulated RBL car was designed to carry canned

goods that required protection from extremes of temperature, but

not refrigeration. These cars had neither ice bunkers nor cooling units. The tight-fitting plug doors ensured minimum temperature fluctuation. Atlas' Master series model will have separately-applied grab irons, ladders and brake line details; etched-metal running boards, and either 50-ton Bettendorf or 70-ton roller-bearing trucks with rotating bearing caps. Road names will be Canadian National, Erie Lackawanna, New York Central, Bangor & Aroostook, American Colloid, Santa Fe, and Great Northern. All Atlas O rolling stock is available with trucks for either 2-rail or 3-rail operation. For additional information on all Atlas O products contact a dealer or visit atlaso.com.

.....

HO SCALE PRODUCT NEWS



Accurail has released HO scale kits for its new 36-foot Fowler boxcar painted in a choice of mineral red or oxide red. The cars are

decorated with data only, making them ideal for hobbyists wanting to letter the models for their favorite railroad. Extensive notes on prototype Fowler cars, plus a summary of the variations Accurail plans to release and an assembly tutorial by Eric Hansmann, can be accessed at designbuildop.hansmanns.org/accurail-prototype-data.

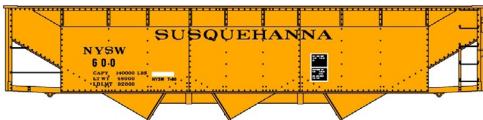

HO scale kits are also available for New York, Susquehanna & Western 70-ton steel open hopper

car with offset sides. The triple-bay hopper is based on a prototype built in 1967 and rebuilt in 1980.





New boxcar kits from Accurail include this 50-foot Southern Railway steel riveted car.

The HO scale model represents a car built in April 1957 with 8-foot Superior doors.

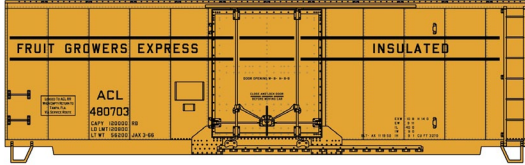

The HO scale model represents a car built in April 1957 with 8-foot Superior doors.

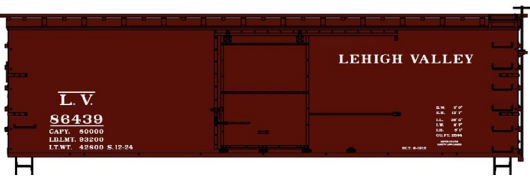

World War I. Features include a straight steel underframe, wood ends and a steel roof. The data lettering indicates the car was upgraded in 1924. All Accurail kits include appropriate trucks and Accumate knuckle couplers. For additional information on all Accurail products contact a dealer or visit accurail.com.



Here's an early look at Athearn's HO scale version of an SD60E locomotive decorated in Norfolk Southern's distinctive 9-1-1 scheme. One of the final tweaks Athearn is working on is

ascertaining the correct color of the fans and antenna arrangement. Announcement of a release date on this model, and three additional NS units in standard livery, is expected soon.

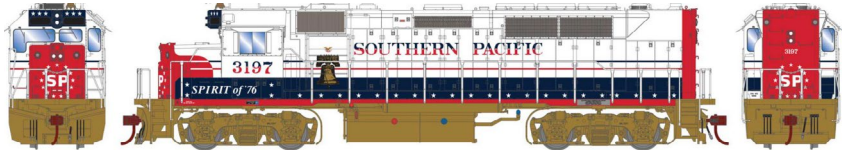

At the top of Athearn's production schedule for next December is this EMD GP40P-2, four-axle, 3,000 horsepower diesel road switcher. In addition to the Southern Pacific Bicentennial scheme shown here, the HO scale Genesis model will be available decorated for SP Bloody Nose, and SP Bloody Nose in faded Primed-for-Grime paint.



Athearn is including a Union Pacific version of the GP40P-2 in the December release. All Genesis sound-equipped locomotives feature a DCC decoder with SoundTraxx Tsunami2 sound. The sound unit will operate in both DC and DCC environments.



Athearn has included this 8,000 gallon tank car in its December production schedule. North American Car Corporation designed these small tank cars for customers who couldn't handle, or didn't need, large shipments. In an era of big tank cars, this little car earned the nickname Beer Can. The HO scale Ready-to-Roll model



will be available in three road numbers each for NATX/Amaizo, AESX/Staley, UTLX (Black), UTLX (Brown), UTLX/National Starch, and VMCX/Vulcan Chemicals

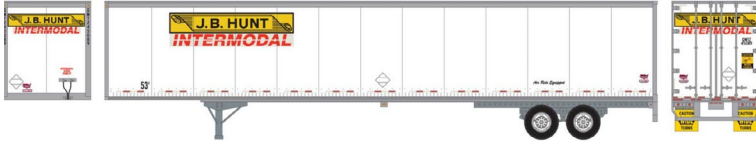

Fifty-three foot Duraplate trailers featuring a sliding tandem, eight rubber tires, and etched-metal mud flaps are due from Athearn in December. Undercarriage Echo Wings and separate etched-metal hazmat placards will be included where appropriate to the prototype carrier being modeled. Decorating schemes on the HO scale model will include JB Hunt, Vermont Railway, XTRA, Estes, Averitt Express, and Schneider.



A three-pack of 20-foot refrigerated containers is also coming from Athearn next December. Carrier names on the HO scale models will be Mitsui O.S.K. Lines, Australia-New Zealand Direct, Cosco, Cronos/CCL, PM&O, and Swire Shipping.



Athearn will offer this Ford C-series cab-over-engine Fire-Rescue Truck in eight paint schemes including the red and white County Rescue 6 version shown here. Additional schemes for the rescue vehicles include white, yellow, orange, red, and chartreuse. The fully-assembled models are expected in December.



Roundhouse branded models scheduled for release next December include an HO scale version of General Electric's Dash 9-44CW. Features of the ready-to-run model of the 4,400-horsepower road switcher include separately applied wire grab irons, a 5,000-gallon fuel tank, and either Hi-Ad or steerable trucks as appropriate to the prototype being modeled. Road names will be Chicago & North Western, BNSF (red and silver War Bonnet scheme), Union Pacific (ex-CNW), Norfolk Southern, and Canadian National. The Dash 9-44CW will also be available in three fantasy schemes including Chicago, Burlington & Quincy; Spokane, Portland & Seattle; and Great Northern. This is a DC-only model. It comes with a DCC-ready Quick Plug to simplify installations of an aftermarket decoder. For additional information on all Athearn and Roundhouse products contact a dealer or visit athearn.com.

.....



Atlas Model Railroad Company has upgraded its Master series GP7 with a retooled die cast frame and sill. Details on the HO scale diesel locomotive include

painted hand rails and stanchions, separately applied wire grab irons, MU hoses and coupler cut bars; and golden-white LEDs. Two crewmen are installed in the cab. Road names will be Erie Lackawanna, Algoma Central, Central California Traction, Great Northern, Amtrak, MKT, Bangor & Aroostook, Belt Railway of Chicago, and Toronto, Hamilton & Buffalo. Road name options include either 800- or 1,600-gallon fuel tanks.



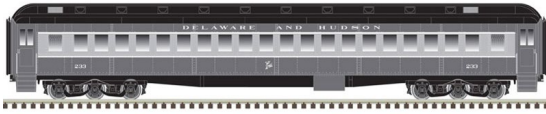

Atlas has announced two groups of Master series heavyweight coaches. Single-window coaches are based on cars owned by the New York Central. The prototype for Atlas's paired-window coaches was built for the Chesapeake & Ohio Railroad. Similar versions of both designs were assigned to commuter and through-service on many other railroads. Features of the ready-to-run Master series cars include interior detailing, scale operating diaphragms, full underbody detail, and three-axle trucks with metal wheelsets. A minimum 24-inch radius is recommended.

Single window coaches will be decorated for Delaware & Hudson, Virginian, Rutland, Canadian Pacific, Pere Marquette, Great Northern, Louisville & Nashville, Burlington, and Spokane, Portland & Seattle.



Road names for coaches with paired windows will be Gulf, Mobile & Ohio; Baltimore & Ohio, Florida East Coast, Union Pacific, Wabash, and Rock Island.



Atlas has announced a new production run of ACF 3560 cu.ft. triple-bay covered hopper cars. The HO scale ready-to-run Trainman series model comes with Accumate knuckle couplers and trucks with metal wheelsets. Road names will be DOWX-Dow Chemical, SHQX-Agrium, Delaware & Hudson, Illinois Central, Norfolk Southern, Southern Railway, Canpotex, CSX, DJJX, POTX-Potash, and CCLX-Corn Products.



This HO scale Detroit, Toledo & Ironton 50-foot postwar boxcar is one of six decorating schemes available from Atlas. Spotting features on the Master series model include diagonal panel roof, fishbelly side sills, and double Youngstown sliding doors. Depending on the practice of the prototype road, the model will have either Dreadnaught, Despatch, or “dartnot” steel ends.

This HO scale Detroit, Toledo & Ironton 50-foot postwar boxcar is one of six decorating schemes available from Atlas. Spotting features on the Master series model include diagonal panel roof, fishbelly side sills, and double Youngstown sliding doors. Depending on the practice of the prototype road, the model will have either Dreadnaught, Despatch, or “dartnot” steel ends.



Additional road names include Union Pacific, Erie, Grand Trunk Western, Kansas City Southern, Southern Pacific, and Wabash. For more information on all Atlas products contact a dealer or visit atlasrr.com.

Additional road names include Union Pacific, Erie, Grand Trunk Western, Kansas City Southern, Southern Pacific, and Wabash. For more information on all Atlas products contact a dealer or visit atlasrr.com.



Bachmann Trains showed two early production samples of its new Siemens ACS 64 electric locomotive at a recent trade show.



The HO scale models should be available from authorized dealers within the next few weeks. For information on all Bachmann products contact a dealer or visit bachmanntrains.com.

The HO scale models should be available from authorized dealers within the next few weeks. For information on all Bachmann products contact a dealer or visit bachmanntrains.com.





In addition to Delrin wheels with brass axles, **Bowser** now offers freight car trucks with blackened metal wheelsets. Bowser's current lineup of HO scale freight trucks include 70-ton AAR Bettendorf (above), 70-ton roller bearing, 100-ton roller bearing, 70-ton Roadrailer, PRR Crown, PRR coil/semi elliptical, PRR caboose, and archbar trucks. For additional information on all Bowser products contact a dealer or visit bowser-trains.com.

.....



Broadway Limited Imports is offering this ATSF 4-8-4 Northern-type steam locomotive in seven

road numbers. Shown here is No. 3751, which replicates the locomotive Baldwin built for Santa Fe in 1928. The prototype is the oldest surviving 4-8-4 steam locomotive in America. She has been fully restored and frequently operates on special excursions in Southern California.



BLI plans to release its latest run of Southern Pacific class AC-4 4-8-2 cab forward steam locomotives late next month. The HO scale ready-to-run model

has an ABS plastic body with a heavy die-cast metal chassis. It requires a minimum radius of 22-inches. In addition to No. 4109 shown above, locomotives No. 4102, 4112, and 4117 will all be available with a black boiler and Southern Pacific on the tender. Cab Forwards No. 4100 and 4125 will be available with a

gray boiler, black cab, oxide red cab roof, and Southern Pacific Lines on the tender.

Both the ATSF 4-8-4 and the SP Cab Forward are equipped with BLI's Paragon3 Sound and DC/DCC control system. For additional information on all BLI products, contact a dealer or visit broadway-limited.com.

.....

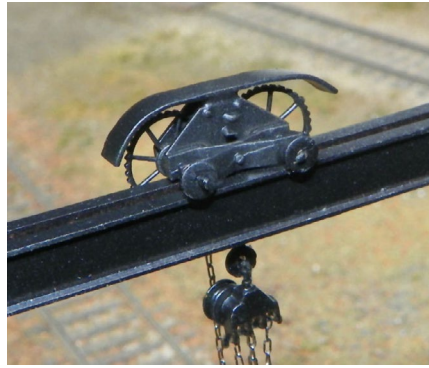

BTS is selling this HO scale Bridge Crane that includes a positionable hoist trolley. The model is a nominal 28-foot wide (measured outside the footings) with a 21-foot clearance from ground level to the bottom of the bridge. For additional information visit btsrr.com.

.....

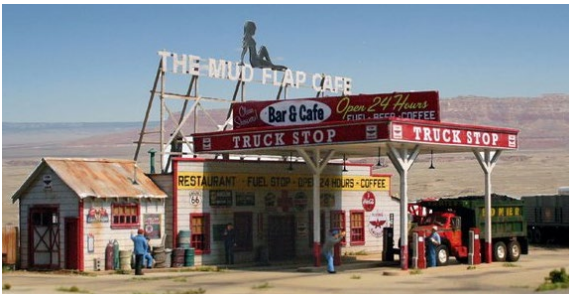

Fos Scale Models has introduced a kit for an HO scale structure named The Mud Flap Café. The walls, canopy roof, gas pumps and islands in the craftsman-type kit

are all laser-cut. Additional components include plastic doors and windows, metal detail parts, color signage, and detailed



assembly instructions. The finished model has a footprint of approximately 7 x 10 inches. Figures and vehicles in the illustration are not included. For additional information visit fosscalemodels.com.

.....



Funaro & Camerlengo has retooled its resin kit for an HO scale 36-foot Northern Pacific boxcar. The revised kit offers a one-piece cast resin body for

the double sheathed wood car. Notable features include a radial roof and fishbelly side sills. The kit includes appropriate NP decals for correctly lettering the period car.



Also new from F&C is a one-piece resin body kit for a Wabash 70-ton covered hopper. The car has eight loading hatches and four discharge bays. Trucks and couplers are

not included. For additional information visit fandckits.com.

.....



InterMountain Railway has scheduled the release of A-Line 20-foot corrugated containers for late March. The HO scale models will be available in two-packs with

different numbers decorated for MRKU-Maersk, TEMU-Textainer Equipment, CMAU-CMA CGM, CXDU-Cronos Group, TCKU-Triton, PCIU-Pacific International, APLU-American Presidents Line, MOAU-Mitsui OSK Lines, TRLU-Transamerica Leasing, and MSKU-Safmarine.

Additional A-Line HO scale intermodal containers due for release in the next 30 days include 40-foot corrugated containers, 45-foot exterior post containers, 53-foot smooth side containers, 53-foot Duraplate containers, 48-foot Jindo corrugated containers, and 53-foot Hyundai hi-cube containers.

A new production run of HO scale ACF 2927 cu.ft. covered hopper cars is set for release in May. The HO scale ready-to-run models feature etched-metal roof walks, machined metal wheelsets, and Kadee couplers. Road names will be Santa Fe, Illinois Central, Denver & Rio Grande, Reynolds Metals, Louisville & Nashville, Missouri Illinois, Wabash, and three versions of Rock Island.

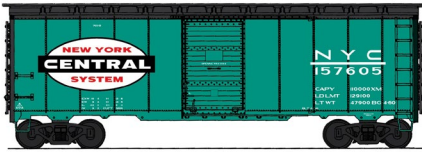

A new group of 1937 AAR 40-foot steel boxcars is scheduled for release in May. The HO scale ready-to-run models equipped with dreadnaught ends will be decorated for New York Central, Chicago & Eastern Illinois, Louisiana & North West, Atlantic & East Carolina, Copper Range, and Delaware, Lackawanna & Western. Cars with Deco ends will be available for Chesapeake & Ohio, and Baltimore & Ohio. Completing the list of road names is a Canadian National car with NSC-2 steel ends.



Seven variations of HO scale PFE wood refrigerator cars are scheduled for release to dealers in May. In addition to the R-30-18 car shown here with double SP and UP heralds, the run will include the same car with black & white heralds and with a single SP herald. Also coming are class R-30-21 and R-40-19 reefers with a variety of herald combinations.





InterMountain plans to release a rerun of HO scale 1958 cu. ft. twin-bay covered hopper cars in August. New road names with closed body-style will be

Colorado & Southern Burlington, Chicago & North Western, Northern Pacific, and Chicago, Burlington & Quincy. A Santa Fe car with a closed body will be rerun.



New road names for 1958 cu. ft. hopper cars with open sides will be Missouri-Kansas-Texas, Missouri Pacific, and Great Northern. Two popular road

names, Denver & Rio Grande Western, and Frisco, will be rerun with open sides. Each road name will be available in six numbers. Both body styles will have Type-3 inward hinged roof hatches with longitudinal locking bars, etched-metal running boards, wire grab irons, appropriate trucks with 33-inch machined metal wheelsets, and Kadee couplers. Undecorated economy kits with plastic wheels and no couplers will be included in the production run.



InterMountain is booking dealer orders for a new production run of

R-70 refrigerator cars. Road names for the HO scale ready-to-run models will be SPFE (Perishable slogan), SPFE (white with blue medallion). SPFE (restenciled), PFE (early roof, Keystone underframe), PFE (late roof, Hydra-Cushion underframe), UPFE (R-70-25), Union Pacific-ARMN (Carrier A/C panel), and ARMN (R-70-24 with Carrier A/C panel).



R-70-20 cars decorated for Santa Fe and Milwaukee Road will also be

available. For additional details on all InterMountain Railway products contact a dealer or visit intermountain-railway.com.

.....



New HO scale ready-to-run models coming from **Kadee Quality Products** include

this Illinois Central 50-foot PS-1 boxcar with Youngstown sliding doors. The prototype was built in 1968 without running boards. Kadee has scheduled a May release date.



A release date of June is planned for an HO scale version of this 40-foot Minneapolis Northfield & Southern boxcar. Spotting features of the PS-1 car, built by Pullman-Standard

in 1952, include 10-panel welded sides and wide bolster tabs. The ready-to-run model is based on a prototype rebuilt in 1967 with five-panel 6-foot Superior doors. During the rebuild the running board was removed and the ladders were shortened.

Both models are equipped with Kadee #2100 series scale couplers and two-piece self-centering trucks. For additional information on all Kadee products contact a dealer or visit kadee.com.

.....





KatoUSA will soon release both Southern Pacific and Union Pacific (ex-SP) versions of an HO scale General Electric 4400 horsepower C44-9W diesel locomotive. Two numbers

will be available for each road. Special features include hi-adhesion trucks and working ditch lights mounted in the high position. The release will include ready-to-run models for DC operation and with ESU Loksound DCC/Sound.



Kato has added two new road numbers to its lineup of General Electric P42 Genesis Phase Vb locomotives. The HO scale ready-to-run model uses a pair of Kato's coreless truck-mounted motors

which concentrate all the mechanical weight on the powered wheels. An additional feature is a three-way switch disguised as a GPS dome which permits manual selection of three different lighting patterns: all lights on, front lights only, and all lights off. This is useful when running a consist of multiple units. For information on all KatoUSA products contact a dealer or visit katousa.com.



MRC-Model Power has an HO scale Missile Force train set that includes an F2A diesel locomotive and six ready-to-run cars all decorated in a U.S. Army scheme. The cars include big gun, operating launcher with three SAM Missiles, Q-car (hidden tank buster car), flat

car with a tank, an exploding boxcar, and a bay window caboose. The set includes a 36 x 45-inch oval of Bachmann track and an MRC Railpower 1300 Power Pack. For additional information visit modelrectifier.com.

.....



New HO scale diecast vehicles currently under development by **Oxford Diecast USA** include, clockwise from the top left: 1959 Pontiac Bonneville in Sunrise Coral, 1957 Chevrolet Nomad in India Ivory over Surf Green, 1955 Buick Century in California Highway Patrol scheme, and a 1965 Chevrolet Stepside pickup in white over Maroon Metallic. For additional information visit oxforddiecast.co.uk.

.....



Rapido Trains is developing an HO scale version of Canadian-built FP7 and F7B diesel units. According to company president Jason Shron, Rapido's model will incorporate all of the unique features that set the Canadian version of the iconic locomotive apart from those built and operated in the United States.



HAND-PAINTED PRE-PRODUCTION SAMPLE

Built originally for Canadian Pacific and Ontario Northland in GMD's London, Ontario plant,

the FP7s subsequently saw service in a variety of Canadian liveries including VIA and Montreal Commuter Agency. A total of eight decorating schemes plus an undecorated version will be produced.



Rapido's HO scale ready-to-run locomotives will be available for standard DC operation and with a DC/DCC ESU Loksound

decoder that will reproduce authentic sounds recorded from a Canadian locomotive. The deadline for ordering is April 30 with delivery planned for this fall.



Rapido Trains showed this first painted sample of their forthcoming GNR Sterling Single

at the recent Warley National Model Railway Exhibition in the UK. Rapido is producing the OO gauge (1:76.2) model in association with Locomotion and the UK National Railway Museum. The historical model will become part of the National Collection in Miniature series. The model is in production now and is expected

to be released in the UK next month. For information on all Rapido Trains products contact a dealer or visit rapidotrains.com.

.....



Here is a work-in-progress look at the cast components of a new kit being developed by **Resin Car Works**. The HO scale one-piece body kit will allow hobbyists to accurately model

SFRD class RR-35/36/39/40 refrigerator cars that were rebuilt with reinforced eaves and unique doors. The kit is an upgrade of a resin model issued several years ago by Sunshine Models. This new version will include several photo-etched details including metal running boards, and accurate decals. As with all RCW kits, production will be very limited with no assurance of reruns. For additional information visit resincarworks.com.

.....

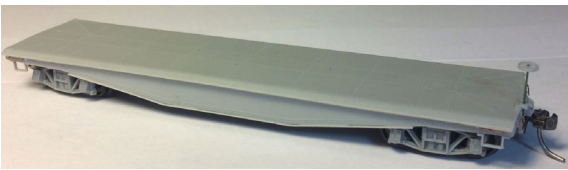

The Schuylkill Iron Works is selling craftsman style kits for three versions of an HO scale flat car based on a

prototype built by Pacific Car & Foundry. One-piece cast resin body kits are available for cars with a steel riveted deck (above), a rail deck, and an I-beam deck (below).

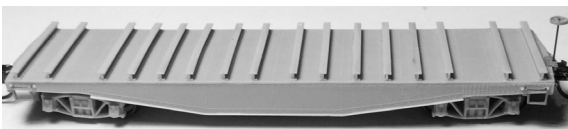

The kits include all detail parts, less wheels and couplers. Assembly instructions



and prototype information are included. For additional information contact Eric Craig at eacraig1947@gmail.com or call 717-421-1561.

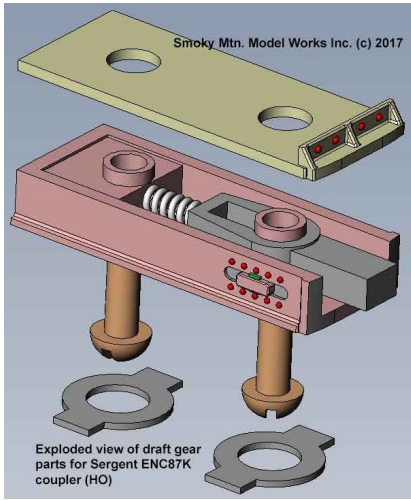

Smoky Mountain Model Works is selling an HO scale cast resin coupler box to accommodate Sergent narrow-shank #ENC87K couplers. The box incorporates a coupler self-centering option. Visual features include rivet details on the box, and rivets/gussets on the lid. The coupler boxes are available in brown, black or natural grey urethane. For additional information visit [smokymountainmodelworks.com/HO & S draft gear+cplrs.html](http://smokymountainmodelworks.com/HO%20%26%20S%20draft%20gear%20cplrs.html).

[com/HO & S draft gear+cplrs.html](http://smokymountainmodelworks.com/HO%20%26%20S%20draft%20gear%20cplrs.html).



Tangent Scale Models is selling an undecorated version of a General American Transportation Corporation 3500 cu.

ft. Dry-Flow covered hopper car. Although GATC production ended in 1962, many of the prototypes continued in service well into the 1990s. Features of the HO scale model include rectangular shaker brackets, see-thru etched-metal running boards, wire grab irons and coupler lift bars; Ajax handbrake and wheel; separate air hoses, Barber S-2-A 70-ton trucks with 33-inch machined metal wheelsets, and Kadee couplers. The ready-to-run car is painted primer gray. Fully decorated models

in a variety of road names are also available. For more information visit tangentscalemodels.com.

.....



New HO scale boxcars coming from **Walthers** include this Mainline 40' AAR Modified 1937 boxcar decorated for Delaware, Lackawanna & Western; Maine

Central, Detroit & Mackinac, Florida East Coast, Southern Pacific, and Pittsburgh & Lake Erie with a NYC System herald.



Walthers is working toward a late June release of a new Mainline series General Electric ES44AC

Evolution locomotive. Variable features, depending on the road being modeled, include two- or four-unit dynamic brake vents and either high adhesion or steerable trucks. Road names with hi-ad trucks will be Canadian Pacific (ex-Vancouver scheme), Citrail CREX, BNSF, and Kansas City Southern.

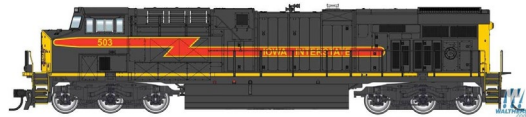

An ES44AC decorated for Iowa Interstate will have steerable trucks. All versions will be available with

ESU Sound for DCC and DC operation. A diesel detail kit (item 910-250) with metal grab irons is sold separately.



Walthers has International series 4300 trucks with a crew cab and a choice of dump (above left), stake or fire truck body. Standard



cabs are available in two-axle dump body (above right), and utility body with a lift bucket. Standard cabs are also available on three-axle trucks with a flat bed, and heavy duty dump body.

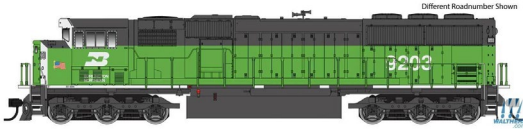

A Walthers Mainline series EMD SD60M with a three-piece windshield is scheduled for release in

late April. Road names will be Burlington Northern (shown), BNSF, Canadian Pacific, Norfolk Southern (Horsehead scheme), Soo Line, and Union Pacific. Both DC and DCC with ESU LokSound will be available.



Walthers is developing a 50-foot FGE insulated boxcar decorated with a fantasy United Parcel

Service scheme. It should be ready for release in July. For additional information on all Walthers products contact a dealer or visit walthers.com.

N SCALE PRODUCT NEWS



Athearn has set a December release date for an N scale bay window caboose. Road names will include Conrail, Southern Pacific (two schemes plus Cotton Belt), Western Pacific, Santa Fe, Great Northern, Norfolk & Western, Nickel Plate Road, and Kansas City Southern. The model will be fitted with appropriate trucks with machined metal wheelsets.



Also coming from Athearn next December is a Ford C-series cab-over-engine Fire-Rescue Truck in eight paint schemes including Rescue Squad No. 2 shown here. Additional paint schemes for the N scale model include white, yellow, orange, red, chartreuse, and County Rescue No. 6 in red and white. For additional information on all Athearn products contact a dealer or visit athearn.com.



Atlas Model Railroad

Company plans to release an N scale version of an EMD SD50 locomotive. Introduced

in the early 1980s, the six-axle SD50 offered 3,500 horsepower on an extended chassis that allowed the dynamic brake resistors to be placed in a cooler area between the cab and the central air intake. Atlas's Master series model will have directional lighting, golden-white LEDs, blackened wheels, and Accumate magnetic knuckle couplers. A separate plow and winterization hatch will be included for modelers wishing to install those fixtures. The DCC version will be equipped with NCE decoders. Road names will be Conrail, Chessie System, Reading & Northern, and Lehigh Gorge.



In the mid-1980s EMD launched the SD60, which introduced the use of microprocessor controls

and the 3,800 horsepower 710G3A prime mover. Externally, it is indistinguishable from the SD50. In addition to the Electro Motive



demo shown here, Atlas will offer the SD60 decorated for Canadian Pacific, Union Pacific, and CSX in the YN3B scheme.



Atlas has announced a large number of road names for a new N scale 40-foot PS-1 boxcar. The ready-to-run Master series model will have body-mounted Accumate couplers, etched-metal running boards, separately applied ladders, either Ajax or Miner brake wheels, and Barber S-2A 50-ton trucks with metal wheelsets.

At the top of the list of road names is the Pullman-Standard version decorated as the 50,000th PS-1 boxcar produced. Other decorating schemes will be Vermont Railway, Lehigh Valley, Union Pacific, Rock Island, Delaware & Hudson, Grand Trunk Western, U.S. Army, Chicago & North Western, Atlanta & West Point, Central of Georgia, and New York Central.



Additional road names announced are Chicago & Illinois Midland, Great Northern, Louisville & Nashville, Chesapeake &

Ohio, Cotton Belt, Jersey Central, Norfolk & Western, Seaboard Air Line, Soo Line, Rutland, Union Pacific, Copper Range, Duluth, South Shore & Atlantic; and Nashville, Chattanooga & St. Louis.



Atlas has scheduled a new production run of ACF 3560 cu.ft. triple-bay covered hopper cars. The N scale ready-to-run Trainman series model comes with Accumate knuckle

couplers and trucks with metal wheelsets. Road names will be



SHQX-Agrium, DOWX-Dow Chemical, Delaware & Hudson, Illinois Central, Norfolk Southern, Southern Railway, Canpotex, CSX, DJJX, POTX-Potash, and CCLX-Corn Products. For additional information on all Atlas products contact a dealer or visit atlasrr.com.

.....



Broadway Limited Imports plans to release an N scale version of the PRR T1 Duplex steam locomotive in April. The 4-4-4-4 non-articulated

ready-to-run models will feature Paragon3 Sound and DC/DCC operating system. Six road numbers will be available plus one unlettered version. The decorating scheme represents the way the Pennsy prototype appeared in the 1950s.



BLI is selling N scale ready-to-run models of a New York Central all-steel boxcar. The successful prototype design was introduced in 1922. BLI's N scale model represents subsequent versions as they appeared in the late 1940s and 50s with rectangular paneled roofs, steel running boards, corrugated doors, AB brakes, and ARA Bettendorf-type trucks. The boxcars will be available with a choice of Dreadnaught or Murphy 8/8 corrugated ends. For additional information on all Broadway Limited Imports products contact a dealer or visit broadway-limited.com.

.....

.....

Eastern Seaboard Models is in the design stage of producing an N scale kit for an ACF type-27 103B 8,000 gallon acid tank



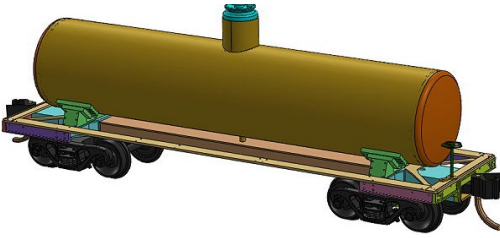

car. The initial road name is expected to be Hooker Electrochemical. The model will ride on custom-produced Micro-Trains National B-1 non-coupler truck frames with a centered bol-

ster hole. ESM is planning on a late spring release. For additional information visit esmc.com.

.....



Centralia Car Shops has released a series of N scale ready-

to-run coaches with corrugated sides. In addition to Chicago & North Western (above), the generic lightweight coaches will be available decorated for Chesapeake & Ohio, Denver & Rio Grande Western, and Chicago & North Western.



Additional road names will include Atlantic Coast Line,

Delaware & Hudson, Seaboard, Southern Pacific (Sunset scheme), Amtrak (Phase I), Norfolk & Western (Tuscan scheme), and Nickel Plate Road. InterMountain Railway is responsible for marketing Centralia Car Shops. For additional information contact a Centralia dealer or visit intermountain-railway.com.

.....

InterMountain Railway plans to deliver a new production run of quadruple-bay cylindrical covered hoppers in April. The release includes two versions of the N scale model. Cars with trough



hatches will be available for Saskatchewan Grain, Canada (red), Canadian Wheat Board, Canadian

Pacific (black), Scouler, Chicago & North Western, Procor, Ferrocarril Del Pacifico, Santa Fe (ex-Koppel), and four variations of Alberta Heritage. Cylindrical covered hoppers with round loading hatches will be available for Canadian National, Canadian Pacific (two schemes), Potash, Andersons, Procor, and Inland Cement.



New N scale rolling stock coming from InterMountain in April includes a group of 40-foot Santa Fe Bx-37 boxcars with an interior height of

10-foot-6-inches. Name-train slogans will be available for Chief, Texas Chief, San Francisco Chief, Scout, Grand Canyon, El Capitan, and Super Chief.



InterMountain is booking dealer orders for a new production run of R-70 refrigerator cars.

Road names for the N scale ready-to-run models will be UPFE (R-70-25, above), SPFE (Perishable slogan), SPFE (white with blue medallion). SPFE (restenciled), PFE (early roof, Keystone underframe), PFE (late roof, Hydra-Cushion underframe), Santa Fe, Milwaukee Road, ARMN (R-70-24 with Carrier A/C panel), and Union Pacific-ARMN (Carrier A/C panel, below).



N scale locomotives scheduled for release from InterMountain



during the first half of this year include SD38-2s in April, SD40-2 and SD40T-2s in May, and two-unit EMD FTs in June. For additional information on all InterMountain Railway products contact a dealer or visit intermountain-railway.com.

.....



KatoUSA has re-run its N scale version of Union Pacific's 4-8-4 FEF-3 steam locomotive. The ready-to-run model is available decorated

for freight service (matte finish) or as the UP excursion version as shown above in gloss black with white trim. Choices for operating system include standard DC, TCS DCC, and ESU Loksound.



KatoUSA has released its N scale Siemens ACS-64 electric locomotive in three new numbers including the David L. Gunn No. 600. Appropriate Amfleet I Phase VI cars are also available. For more information on all Kato products

contact a dealer or visit katousa.com.

.....



Micro-Trains Line is booking reservation for June delivery of a five-car set of Cotton Belt heavy-weight passenger cars. The N scale ready-to-run models include a baggage car, mail/baggage combine, 10-1-2 sleeper, and open-end observation. All are decorated in the Daylight colors of parent Southern Pacific. The

fifth car is a diner in traditional Pullman green with an aluminum roof. All of the cars ride on six-wheel passenger trucks.

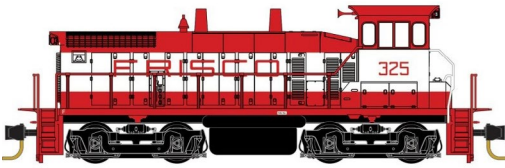

Micro-Trains plans to release an N scale SW1500 diesel switcher in a variety of schemes over the next several months. Two

road numbers each will be available for Canadian Pacific, Cotton Belt, CSX, Southern, Norfolk Southern, Western Pacific, and Frisco. Models decorated for Genesee & Wyoming, and Southern Pacific will be available in a single road number. The ready-to-run locomotive will be DCC-ready and will accept TCS MT1500 and Digitrax DN-12M2 decoders. For additional information on all Micro-Trains Line products contact a dealer or visit micro-trains.com.

.....



MRC-Model Power has scheduled another production run of N scale EMD FP-7 diesel locomotives with DCC and sound. Features will include an LED headlight, Mars light, lighted number board, eight-wheel drive and body-mounted knuckle couplers. The application of dynamic brake fans and fuel tanks will be road specific. Road names will be Chesapeake & Ohio, Santa Fe, Pennsylvania Railroad, Canadian Pacific, Canadian National, Southern Railway, Union Pacific, Western Pacific, Amtrak, Northern Pacific, Soo Line, and U.S. Army. For additional information contact a dealer or visit modelrectifier.com.

.....



NEW DECALS, SIGNS AND FINISHING PRODUCTS

Dan Kohlberg has released three new HO scale silk screen decal lettering sets for 50-foot Fruit Growers Express RBL box-cars. Item SE-22 covers 1963-65+ for ACL, B&O, C&EI, RBNX, RF&P, and SAL. Item SE-23 is for 1963-65+ for B&O, CG, L&N, N&W, PC, and Southern. Item SE-24 covers 1970s+ for C&NW, CRR, MILW, NS, Southern, SCL, and WP. Sets SE-22 and SE-23 will decorate three cars. Set SE-24 will handle six cars. For additional information including ordering details visit home.mind-spring.com/~paducah.

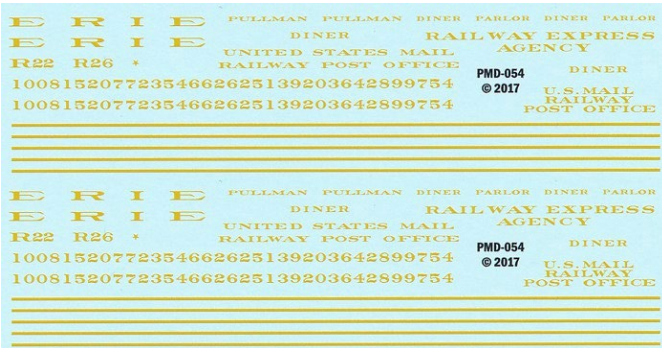

Prime Mover Decals has released a new decal set for Erie passenger equipment. The new set provides authentic lettering for

Erie passenger equipment in the original solid green and later two-tone green paint schemes. The set is available in HO, N and O scales.



An earlier HO scale decal set for Morrystown & Erie Railroad has been upgraded with

additional details and now covers all M&E EMD switchers. For additional information visit primemoverdecals.com.

DISCLAIMER

The opinions expressed in this column are those of the writer and do not necessarily reflect the opinion of *Model Railroad Hobbyist* or its sponsors. Every effort is made to provide our readers with accurate and responsible news and information, however, neither *Model Railroad Hobbyist* or the writer of this column can be held responsible for any inaccuracies or typographical errors that may inadvertently appear in this column.

**VIEW READER
COMMENTS**

click here



If you are a hobby manufacturer with a product announcement, just [click here](#) and submit your announcement to us. Our web site and free magazine reach continues to grow, so get on board this new media train! ■





BRIEFLY NOTED AT PRESS TIME ...

KatoUSA has announced several new N scale track items including a single track grade crossing with working crossing gate and two types of bumper tracks. More information is available at katousa.com .

Fos Scale Models has scheduled its 2018 craftsman workshops for April 14th and 15th. Participation in the hands-on event is limited to eight individuals. The workshops will be personally conducted by Joe Foss at his new studio in Preston, CT. For details visit fosscalemodels.com .

Great Decals has HO scale decals for Louisville & Nashville 180000 series triple-bay hopper cars. Set #143 includes appropriate heralds, road numbers, repack stencils, and dimensional data for one car. Although developed for a Bowser model the decals are well-suited for other manufacturer's HO scale hopper. A choice of white or yellow lettering is available. For information visit greatdecals.com .

Iowa Scaled Engineering has re-released its MRServo line of economical low-profile switch motors. A basic slow-motion unit is available without contacts. Turnout drives with two accessory contacts or with a single SPDT contact and frog powering contacts are also available. For complete details visit iascaled.com/mrservo.



Take the MRH 2018 Reader Survey ...



... and get a chance
to win a 7" Kindle
Fire tablet!

(10 tablets will be awarded)

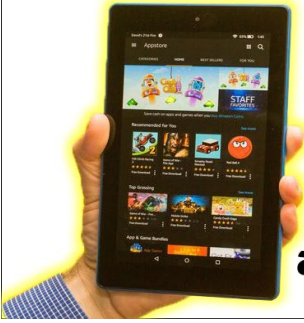

amazon

TAKE THE SURVEY >>

Please take this survey, it really helps us know much better what kind of articles and videos to make for you!



Did you know ...

MRH subscribers
SAVE 10%

... on the MRH Store &
on TrainMasters TV?

Click to get 10% off coupon code

(Must be a subscriber to access)



SELECTED EVENTS



Model Railroad Hobbyist | February 2018 | #96

FEBRUARY 2018



RATE THIS ARTICLE

(Many events charge a fee. Check individual info website for details.)

KANSAS, LAWRENCE, February 10-11, Train Show & Swap Meet, sponsored by Lawrence Kansas Model Railroad Club, at Crown Toyota Kingdom, 3400 South Iowa Street. Info at lawrencemodelrailroadclub.org.

KANSAS, WICHITA, February 3-4, Train Show & Swap Meet, at Cessna Activity Center, 2744 George Washington Blvd. Info from Phil at 316-259-5190.

MARYLAND, TIMONIUM, February 3-4, the Great Scale Model Train & Railroad Collectors Show, at 2200 York Road. Info at gsmts.com.

MASSACHUSETTS, AUBURN, February 25, Greater Worcester Model Train Show & Sale, sponsored by Worcester Model Railroaders, Inc., at Auburn Elks Club, 754 Southbridge Street. Info at wmrr.org.

NEW YORK, FISHKILL, February 11, Model Train Show & Sale, Fishkill Recreation Center, 793 Route 52. Info at kingston-trainshow.com/fishkill-model-train-and-railroad-hobby-show.

OREGON, PORTLAND, February 10, Bridgetown Railroad Prototype Modelers Meet. Info at facebook.com/groups/2001136043323501/about.

SELECTED EVENTS | 2

SOUTH CAROLINA, EASLEY, February 9, Model Train Expo, sponsored by CRMHA, at Rock Spring Church, 207 Rock Springs Road. Info trainshow@crmha.org.

WASHINGTON, VANCOUVER, February 17, Railroad Swap Meet, sponsored by Spokane, Portland & Seattle Railway Historical Society, at Warehouse 23, 100 Columbia Street. Request info from Jerry Pickell at pickell5141@msn.com.

WISCONSIN, MADISON, February 17-18, Mad City Model Railroad Show and Sale, sponsored by NMRA South Central Wisconsin Division, at 1919 Alliant Energy Center Way. Info at travelwisconsin.com/events/fairs-festivals/mad-city-model-railroad-show-and-sale-40169.

March 2018, by location

CANADA, ONTARIO, COPETOWN, March 4, Prototype Modellers Show. Info at facebook.com/CopetownShow.

CANADA, ONTARIO, TORONTO, March 17, Toronto Railway Prototype Modellers Meet, at Humber College, North Campus, Building B, Rooms B201-B220, 205 Humber College Boulevard. Info at torontoprototypemodellers.wordpress.com.

COLORADO, DENVER, March 3-4, Rocky Mountain Train Show, at Denver Merchandise Mart, 451 East 58th Avenue. Info at rockymountaintrainshow.com.

FLORIDA, PALMETTO, March 10-11, Model Train Show, at Bradenton Area Convention Center, 1 Haben Boulevard. Sponsored by Real RailRailroad Education and Learning Center of Florida.

ILLINOIS, SPRINGFIELD, March 25, Annual Train Fair, sponsored by Springfield Railroad Society, at Illinois State Fairgrounds, Orr Building. Info a springfieldtrainfair.com.



SELECTED EVENTS | 3

NEW YORK, BATAVIA, March 25, The Great Batavia Spring Train Show, at Richard Call Arena, Genesee Community college, 1 College Road. Info from David Napper at dncnapper@gmail.com.

OHIO, GREENVILLE, March 4, Model Railroad Swap Meet, at Darke County Fairgrounds, Youth Building, 800 Sweitzer Street. Info from Joe Worz at josephbw@hughes.net.

OHIO, SALEM, March 22-24, 26th Annual Midwest Narrow Gauge Show, at Timberlanes Complex at Stables Inn, 544 East Pershing Street. Info at portlandlocomotiveworks.com/events/26th-annual-midwest-narrow-gauge-show.

OREGON, PORTLAND, March 10, Model Railroad Swap Meet, at Jackson Armory, 6255 NE Cornfoot Road, 9:30am-3pm. Information from capt.brigg@pacificcascaderailway.com.

PENNSYLVANIA, VALLEY FORGE, March 23-25, RPM Meet, at Desmond Great Valley Hotel & Conference Center. Info at rpm-valleyforge.com.

SOUTH CAROLINA, NORTH CHARLESTON, March 17-18, 2018, Spring Train Show, sponsored by Charleston Area Model Railroad Club, at Danny Jones Armory Park, 5000 Lackawanna Blvd. Info at chamrc.com.

WISCONSIN, CEDARBURG, March 11, 23rd Annual Model Railroad Show & Swap Meet, sponsored by Metro Model Railroad Club, at Circle B Recreation Center, 6261 Highway 60. Info at metrorrclub.org.

Future 2018, by location

CANADA, BRITISH COLUMBIA, BURNABY, May 4-6, 2018, 3rd Annual 7th Division PNR Modellers Meet, at Simon Fraser University (Burnaby Campus), West Mall Centre. Info [facebook.com/RailwayModellersBritishColumbia](https://www.facebook.com/RailwayModellersBritishColumbia).

SELECTED EVENTS | 4

NEW ZEALAND, MOSGIEL, May 12-13, Dunedin Model Train Show, at Taieri Bowling Club, 12 Wickliffe Street. For info send email to dunedinmodeltrainshow@gmail.com.

CALIFORNIA, SAN BERNARDINO, April 28, Western Prototype Modelers Meet, Santa Fe/Amtrak Station, 1720 West 3rd Street. Info at railroadprototypemodelers.com.

MARYLAND, ROCKVILLE, August 22-26, 2018, 50th O scale National Convention, Co-sponsored by NMRA MER, Standard Gauge, Narrow Gauge, P48 and Traction modelers, at Rockville Hilton Hotel, 1750 Rockville Pike. Info at 2018oscalenational.com/newsletters/september-2017-newsletter.

MISSOURI, KANSAS CITY, August 5-12, 2018, NMRA National Convention and National Train Show. Host hotel is Westin Kansas City at Crown Center. Info at kc2018.org.

OHIO, MARION, April 26-28, Central Ohio RPM, at Marion Union Station. Info at facebook.com/groups/438383252883060/about.

PENNSYLVANIA, MONACA, April 15, Beaver County Spring Model Train Sale, sponsored by Beaver County Model Railroad & Historical Society, at 1700 Old Brodhead Road. Info bcmrr.railfan.net.

VIRGINIA, ROANOKE, April 21-22, Coalfield Railroads RPM & Scale Train Show, at Valley View Holiday Inn. Info at facebook.com/TheCoalfieldRailroadsRPMMeetAndScaleTrainShow.

Beyond 2018

UTAH, SALT LAKE CITY, July 7-13, 2019, NMRA National Convention and National Train Show. HQ hotel is Little America Hotel. Info at nmra2019slc.org.



MISSOURI, ST. LOUIS, July 12-18, 2020, NMRA National Convention and National Train Show. HQ hotel is Hilton St. Louis at the Ballpark. Info at gateway2020.org.

CALIFORNIA, SANTA CLARA, 2021, NMRA National Convention. ■

**VIEW READER
COMMENTS**
click here

Take the MRH 2018 Reader Survey ...

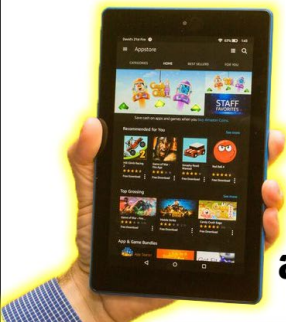

... and get a chance
to win a 7" Kindle
Fire tablet!

(10 tablets will be awarded)

amazon

TAKE THE SURVEY >>

Please take this survey, it really helps us know much better what kind of articles and videos to make for you!

Get the first 50 issues of
**Model Railroad
Hobbyist magazine™**

Save
yourself
endless
hours of
downloading

On a data DVD for \$10!

Send me one!

(Sold by Model Trains Video)

*Includes a coupon
good for \$20 off on
TrainMasters TV*

*Over 5000
pages of
how-to
information
on model
railroading*



• [INDEX](#)



SUBSCRIBE
(free)

• [TABLE OF CONTENTS](#)

[Accu-Lites](#)

[American Ltd \(San Juan\)](#)

[Archer Fine Transfers](#)

[Athearn](#)

[Atlas Model Railroad Co.](#)

[Altoona Model Works](#)

[Bachmann](#)

[Backdrop Junction](#)

[Berrett Hill Trains](#)

[Black Cat Publishing](#)

[Blair Line](#)

[Bowser](#)

[Caboose](#)

[Canyon Creek Scenics](#)

[Coastmans Scenic Products](#)

[Coffman Graphics](#)

[Crow River Products](#)

[Digitrax \(2 page spread\)](#)

[El Dorado 3rd PlanIt](#)

[ESU LokSound](#)

[Fast Tracks](#)

[Fast Tracks \(Scale Lumber\)](#)

[Fine Scale Miniatures](#)

[Good Deals DCC](#)

[Great Decals](#)

[HO Diesel Supply](#)

[Iowa Scaled Engineering \(ISE\)](#)

[ITLA Scale Models](#)

[Kadee \(1\)](#)

[Kadee \(2\)](#)

[Ken Patterson.com](#)

[Lights 4 Models](#)

[Litchfield Station](#)

[Logic Rail Technologies](#)

[Main Street Heritage Models](#)

[Micro-Trains Line](#)

[Model Railroad Benchwork \(1\)](#)

[Model Railroad Benchwork \(2\)](#)

[Model Railroad Control Systems](#)

[Mountain Subdivision Hobbies](#)

[MRH Store \(1\)](#)

[MRH Store \(2\)](#)

[MRH Store \(3\)](#)

[MRH Store \(4\)](#)

[MRH Store \(5\)](#)

[MRH Survey \(1\)](#)

[MRH Survey \(2\)](#)

[NCE \(2 page spread\)](#)

[North American Railcar Co.](#)

[Pre-Size Model Specialities](#)

[Precision Design Co.](#)

[Rapido \(1\)](#)

[Rapido \(2\)](#)

[Ring Engineering \(1\)](#)

[Ring Engineering \(2\)](#)

[Rusty Stumps](#)

[Scale Trains](#)

[Scotty Mason Show](#)

[Sea Port Model Works](#)

[Soundtraxx \(Blackstone\)](#)

[Southern Digital](#)

[Streamlined Backshop Services](#)

[TAM Valley Depot](#)

[The DCC Shop](#)

[Tony's Train Exchange](#)

[Train Control Systems](#)

[Traintek](#)

[TrainMasters TV \(1\)](#)

[TrainMasters TV \(2\)](#)

[TrainMasters TV \(3\)](#)

[Walthers](#)

[Westerfield Models](#)

[Yankee Dabbler](#)

[Yarmouth Model Works](#)

Clickable "other" index

[Other - Contents](#)

[Other - Cover](#)

[Other - Derailments](#)

[Other - Hobby Marketplace](#)

[Other - MRH Sponsors](#)

DOWNLOAD ISSUE



DOWNLOAD PORTRAIT



DOWNLOAD LANDSCAPE

• [INDEX](#)



SUBSCRIBE
(free)

• [TABLE OF CONTENTS](#)

REVERSE RUNNING

commentary



Model Railroad Hobbyist | February 2018 | #96

JOE FUGATE WONDERS ABOUT
OPS FOR THE REST OF US ...

★★★★★
RATE THIS ARTICLE



**RECENTLY, AN
MRH READER POSTED
THIS ON THE MRH
FORUM:**

“I am building a very small layout, so I don’t need or want anything too complicated. I bought the OPSig’s book and that was way over my head, so I sold it.”

This is a concern: it suggests there is a huge disconnect between fans of ops (such as the OPSig) and the general modeler. By ops, I mean having a specific process for moving cars and trains from place to place.

We’re currently conducting our 2018 Reader Survey, and early responses to our “how do you prefer to run trains?” question shed further light on how people like to run their trains:

▶ **STEPPING OUTSIDE THE BOX WITH A CONTRARY VIEW**

• [INDEX](#)

• [TABLE OF CONTENTS](#)

Roundy-roundy or just running trains to railfan is fine	19.3%
Simple but realistic ops with no paperwork (Mother-may-I)	55.0%
Track warrants, radios, and a dispatcher	8.0%
CTC system with signals and a dispatcher	8.3%
Timetable and train order with a dispatcher	9.4%

Notice the whopping percentage who likes realistic ops but want to keep it simple? The survey has many comments like the following:

“Mostly roundy round at the moment, but trying to slowly incorporate simple but realistic ops. Some good articles would help; simple ops for one or two engineers.”

I love the new Op SIG Operations Compendium book [opsig.org/OPSigBook2.pdf] but I fear it mostly preaches to the choir. A newbie’s tutorial it is *not*.

As I discuss operations with modelers-at-large, ops gets a big thumbs down from more than a few modelers, and it’s something of a hobby industry “dirty little secret” that ops stuff *doesn’t sell*.

Whenever we run a serious ops article, it generally gets poor ratings and negative comments.

I’m a prototype ops guy myself. As I look at how we realistic ops fans have spread the word, it looks like a total fail, frankly.

Anecdotes abound about folks being thrown in the deep end of complex operations and stressing out. They get buried in ops minutiae and are just turned off.

It’s time for us ops fanboys to do some soul-searching and work out a way to truly help modelers wanting to take a first step into realistic operation by keeping things ultra simple. The all-or-nothing approach to introducing modelers to realistic ops is a bust.

Once they get used to simple ops and want more, then we can show them more. How about it, realistic ops fans?



DERAILMENTS



RATE THIS ARTICLE

Model Railroad Hobbyist | February 2018 | #96

**VIEW READER
COMMENTS**

click here



I LIKE TRAINS

Fakeposters.com surprise

Watch this clever animated poster on fakeposters.com. Prepare to be surprised as this train traverses a most unlikely route! It's amazing what they can do with video editing tricks these days ... ■

► BIZARRE FACTS AND HUMOR (SUPPOSEDLY)

• [INDEX](#)

• [TABLE OF CONTENTS](#)

COMING NEXT ISSUE ...



HAVING FUN WITH TRAINS
MARCH 2018 | FREE

MRH

MODEL RAILROAD HOBBYIST

Don Ball's
Stockton & Copperopolis RR

▶ **READ NOW**

NMRA NATIONAL CONVENTION
KANSAS CITY
2018



... and lots more coming
in the March MRH!

• [INDEX](#)



SUBSCRIBE
(free)

• [TABLE OF CONTENTS](#)