

HAVING FUN WITH TRAINS

NOVEMBER 2018 | FREE

MRH

MODEL RAILROAD HOBBYIST

ALSO:

- More on signaling your layout
- LED lighting in Blue Box locos
- Tips on dating rolling stock
- Double-track Central Valley bridge

... and more inside!

Jim Lincoln

Models in Proto:48

▶ **READ NOW**



PORTRAIT EDITION



DOWNLOAD



REGISTER
(free)

Available for Pre-Order in November 2018



NEW MODEL!

CHESSIE SYSTEM C&O*

ATLAS MASTER® N RUSSELL SNOW PLOW

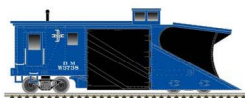

BOSTON & MAINE



PENNSYLVANIA

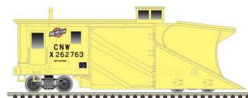

CHICAGO & NORTHWESTERN



CONRAIL



RIO GRANDE

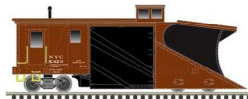

NEW YORK CENTRAL*

FEATURES

- WEIGHTED, DETAILED UNDERFRAME
- CRISPLY MOLDED BODY DETAIL
- KNUCKLE COUPLERS
- WINDOW GLAZING



CANADIAN NATIONAL



*CSX Licensed Product

FOR MORE INFORMATION OR TO LOCATE A DEALER, PLEASE VISIT WWW.ATLASRR.COM.
ATLAS MODEL RAILROAD CO., INC. • 378 Florence Ave., Hillside, NJ 07205

STAFF

HAVING FUN WITH TRAINS

MRH
MODEL RAILROAD HOBBYIST

Model Railroad Hobbyist | November 2018 | #105

(Updated 11/05/18)



RATE THIS ISSUE

ISSN 2152-7423

Editorial Staff



Joe D. Fugate, Publisher and Editor



Patty Fugate, Pasteup and Layout



Richard Bale, News and events



Jeff Shultz, News and events, Tech Assistant

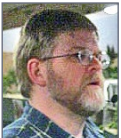

Joe Brugger, Copy Editing



Mike Dodd, Copy Editing

Advertising

Les Halmos, Account Manager

Jean-François Delisle, Marketing Assistant

Columnists

Larry Smith, Narrow Gauge/Shortlines

Ken Patterson, Reporter at large

Rotating Columnists

Jack Burgess, Getting Real column

Nick Muff, Getting Real column

Mike Rose, Getting Real column

Tony Thompson, Getting Real column

Rob Clark, Imagineering

Dave Meek, Imagineering

Ray Dunakin, Imagineering

Issue password: Nov2018

Published for the glory of God. [What's this?](#)

MRH SPONSORS



Model Railroad Hobbyist | November 2018 | #105

A - E



acculites.com



railroadhobbyshow.com



archertransfers.com



athearn.com

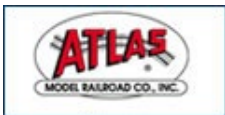

www.atlasrr.com



bachmanntrains.com



backdropjunction.com

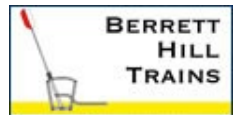

berrethill.com/trains



blairline.com



bowser-trains.com



mycaboose.com



coffmaneng.com



[youtube channel](http://youtube.com)



www.digitrax.com



decalprof.com



trackplanning.com



esu.eu/en

[Vendors: Get your clickable logo here ...](#)

MRH SPONSORS | 2

F - Z



modelrailroadexpo.com



handlaidtrack.com



handlaidtrack.com/mt-albert-scale-lumber



iascaled.com



lights4models.com



litchfieldstation.com



micro-trains.com



store.mrhmag.com



ncedcc.com



www.pwrs.ca/main.php



rapidotrains.com



ringengineering.com



scaletrains.com



soundtraxx.com



sodiqi.com



sbs4dcc.com



tamvalleydepot.com



traintekllc.com



walters.com



yankeedabbler.com

Looking for something? Check the MRH Marketplace!

The screenshot shows the MRH Marketplace website with several product listings:

- CROW RIVER PRODUCTS**: A listing for a model train set.
- 1/87 Scale Models**: A listing for a model train set.
- Yarmouth Model Works**: A listing for a model train set.
- NEW KIT: E-50-15**: A listing for a model train set.
- MAIN STREET AMERICA HISTORIC ARCHITECTURE**: A listing for a model train set.
- ALUMINUM MODEL WORKS**: A listing for a model train set.
- Local Rail**: A listing for a model train set.
- PAK-TRAXX**: A listing for a model train set.

At the bottom of the screenshot, there are navigation links: MRHMAG.COM, SUBSCRIBE, INDEX, and TABLE OF CONTENTS.

Take me there!



Publisher's Musings: Puff ball trees that aren't ugly

JOE FUGATE



MRH QAT: Dating rolling stock, ...

Compiled by JOE BRUGGER



Electrical Impulses: Signaling my layout, part 2

JASON MILLER



What's Neat: Central Valley bridge build, ...

KEN PATTERSON

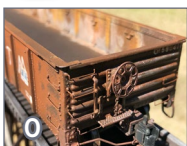

Adventures in Proto:48

JIM LINCOLN



Yes, it's a model

compiled by JOE FUGATE



Adding LEDs to Blue Box locos

LES GREEN



November 2018 news

RICHARD BALE and JEFF SHULTZ



Derailed

Compiled by the MRH STAFF

More content beyond what ads will pay for ...



RUNNING
EXTRA

Publisher's Welcome: Running Extra Inaugural issue

JOE FUGATE



Limited Modeler: Satisfied downsizing

JIM SIX



Getting Real: Art deco station build

NICK MUFF

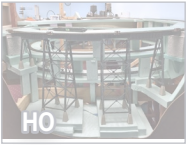

Building a herniated helix

MICHAEL ANTEAU



TOMA contest 3rd place: Logging & rail barge layout

SCOTT WILLIAMSON and MICHAEL WOLF



Santa Fe industrial park switching puzzle

GREG BAKER



Ah-Hah Moment: Tungsten powder for car weighting

JOE FUGATE

[CLICK HERE](#)

\$1.99 gets access to these *Running Extra* articles

FIRST TIME [CSX]

(Actual Models Shown)

H0 CSX SD40-3™



Additional SD40-2 Roadnames: BN, Milwaukee, and NS "Admiral Cab"

Preorder Now

© 2018 ScaleTrains.com, Inc. ScaleTrains.com, Rivet Counter, and respective logos are trademarks of ScaleTrains.com, Inc.
 ScaleTrains.com, Inc. 7598 Highway 411 Benton, TN 37307
 844-9TRAINS 844-987-2467 International 423-299-3689



Scene and photography
 by Ken J Johnson
 First test model shown



PUBLISHER'S MUSINGS

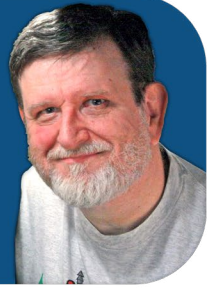

Model Railroad Hobbyist | November 2018 | #105

JOE FUGATE: PUFF BALL TREES DON'T HAVE TO BE UGLY ... AND PUBLISHING MORE ARTICLES THAN EVER



I HAVE VISITED A LOT OF LAYOUTS OVER MY YEARS

in the hobby and more often-than-not, when somebody goes the puffball tree route for populating their hills with trees, they look pretty much like what they are: balls of polyfiber rolled in ground foam. Unfortunately, they don't look much like trees.

Don't get me wrong – any scenery is better than no scenery, certainly! However, all too many modelers model scenery from their minds eye rather than using a reference. Those same modelers would never model a locomotive, railcar, or a prototype structure without a reference!

You should also never model scenery without a photo reference! If you want more realistic scenery, *always* work from reference photos. Don't just model what's in your mind's eye.

Thanks to the internet, it's extremely easy these days to get a reference photo. For example, if I'm planning to model Appalachian hills, I can just Google *appalachian hills* and get thousands of great reference photos.

Once you have some reference photos, study them carefully. Look at the details and particularly notice form, color, and texture. If you do this you will start to understand how to get more realistic scenery.

Let's take an example. On the next page is a photo I found with Google:



1. Here is a sample photo of some Appalachian hills I found using Google. Notice the profile of an arbitrarily defined "foreground" line of trees marked in yellow.

ADVERTISEMENT



Introducing THE LUMBER STORE

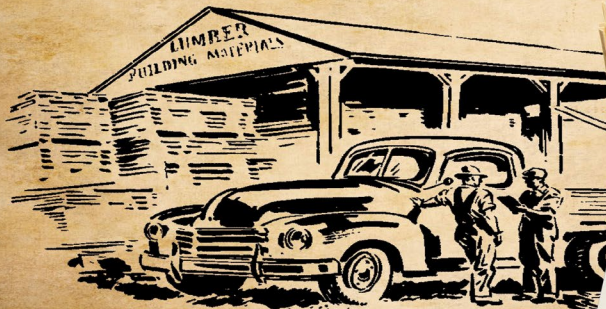

ROTATING STORAGE RACK

On its own, or fully loaded with Mt. Albert Scale Lumber!

handlaidtrack.com

1-888-252-3895

N
SCALE

DCC
SOUND VALUE
ON BOARD



Item No. 62354 • RIO GRANDE™ #5307

NEW

The “CADILLAC OF ENGINES” NOW WITH SOUND! EMD SD9 with *ECONAMI™* DCC SOUND VALUE

The SD9 was nicknamed the “Cadillac of Engines” because of its smooth ride. Now you can enjoy its smooth performance in Bachmann’s N scale model that features a flywheel and precision motor. Equipped with an *Econami™* DCC sound decoder factory set for EMD SD9 realism, it offers a choice of 5 prime movers, 16 airhorns, multiple variations of 7 bell types, 2 air compressors, and 3 couplers plus a function-activated grade-crossing signal—all in 16-bit polyphonic sound. *Econami™* from SoundTraxx® also includes adjustable auto-notching sensitivity for prototypical operation, adjustable master volume and individual sound effect volume levels, advanced consist-ing, and more. Visit your favorite hobby dealer today to enjoy all the sounds of the smooth-riding SD9!

Features include:

- DCC sound-equipped with *Econami™* decoder
- dual-mode NMRA-compliant decoder
- directional headlights with Rule 17 dimming
- precision motor
- flywheel
- die-cast frame
- fine-scale handrails
- *E-Z Mate®* Mark II couplers, front and rear

Econami™



NEW

SOUTHERN PACIFIC™ #5472
(Black Widow)
Item No. 62351



NEW

PENNSYLVANIA RAILROAD #7607
Item No. 62352



NEW

NORFOLK AND WESTERN #2346
Item No. 62353



NEW

DM&R #116
Item No. 62354

Click to
learn more

SHIPPING NOW! MSRP \$249.00 each



Bachmann Industries, Inc. • 1400 East Erie Avenue • Philadelphia, PA 19124 USA • www.bachmanntrains.com

Click for more information.

MRHMAG.COM

[INDEX](#)

[TABLE OF CONTENTS](#)



Join Chance Ryder on his journeys back in time to visit historical railroad events which changed history and the future in this all-new product line!

CLICK HERE FOR MORE INFO

A DIVISION OF
**MICRO-
TRAINS-
LINE**

PUBLISHER'S MUSINGS | 3

Most puffball forests on a model railroad are too uniform. You want *variety* – big balls, little balls, and even a variation in puff ball spacing (leaving some deliberate small low spots) or even throwing in the occasional dead tree. Here, we're talking about *form*.



Most puffball tree forest profiles are too uniform

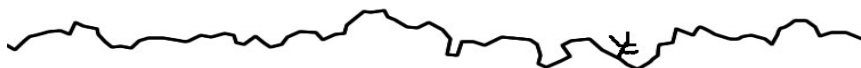

Real tree forest profiles have more variety

2. Take the yellow foreground tree line from the actual forest photo (bottom) and compare that to most layout puff ball tree forest profiles. Notice the puff ball profile is too uniform.



Actual Athearn Genesis HO scale model depicted



HELP TO PRESERVE RAILROAD HISTORY

To help support the effort by the Youngstown Steel Heritage Foundation (YSH) to move and preserve the Erie Lackawanna #3639 EMD SDP45 (SD45M), Athearn will assist in driving a donation per unit reserved to the effort by offering models as Erie Lackawanna #3639 and Conrail #6670. Both DCC-Ready and DCC+Sound configurations are available. The real EL #3639/CR #6670 is the basis for our engineering and measurements for the Athearn Genesis EL/CR models.

Through exhaustive research, including measuring one of the last known real-world survivors, Conrail #6670, to studying thousands of images and drawings, we've captured every unique detail for the Southern Pacific, Great Northern, and Erie Lackawanna/Conrail. Visit www.extra3639north.com to help preserve the 1:1 EL #3639.

From SP's road specific features to trucks with high-low brake cylinder mounts to different long hood ends, and beyond, it's all here.



Now equipped with new LED lighting and a full Tsunami2 sound decoder featuring brand new recording: prototypical EMD 20-cylinder 645E3 sound profile.



SP and GN long hood end is flat to allow room for steam generator equipment while the EL includes a pointed end. Note the steam generators are road specific.

VISIT WWW.ATHEARN.COM FOR MODEL DETAILS.

HORIZON
H O B B Y

VISIT
Your Local Retailer

CLICK
Athearn.com

CALL
1.800.338.4639

SERIOUS FUN[®]

©2018 Horizon Hobby, LLC. Athearn, Genesis and McHenry are registered trademarks of Horizon Hobby, LLC. The Union Pacific mark and other marks owned by Union Pacific are made under trademark license from Union Pacific Railroad Company. SoundTraxx and Tsunami are registered trademarks of Throttle Up! Corp. All other trademarks, service marks and logos are property of their respective owners. Final models may vary slightly from photos shown. 408551

Next, real forests have *color* and *texture* variations – remember I said to pay attention to that by studying real scenery photos?



3. Note the texture and color variations of a real forest. Modeling these variations with your puffball trees will give you a more realistic looking forest.

Randomly have a few trees with color variation, more yellow or a shade darker green.

Randomly have some random trees with fewer leaves (less ground foam).

Randomly have a few trees that use a finer grade of ground foam, and others that use a more coarse grade of ground foam.

This all said, you don't want to overdo this variation, however, or you may get a checkerboard or salt-and-pepper look to your forest.

In summary, random variation is the key to greater realism. Most model railroad puffball forests are far too uniform. Add variety!

You want bigger and smaller trees, you want trees with different amounts of ground foam on them, you want trees with different shades of ground foam on them, and you want trees with different *grades* of ground foam on them (some finer, some more coarse). And finally, add a few dead tree twigs here and there.

Bottom line: get and study *real photos* when you're doing scenery and model what you *observe* as to form, color, and texture. Do not trust your imagination alone to give you realistic scenery!

MAKING RAILROAD HISTORY
WALTHERS MAINLINE

Your Source For HO Boxcars

- 100+ boxcars now available!
- Nine authentic designs - choose from 60+ roadnames
- Limited edition - one time run of these roadnumbers!
- Thousands used in general freight service from the late 1930s to the present
- Correct turned metal wheelsets
- Affordably priced & built tough for years of dependable service
- Proto MAX™ metal knuckle couplers



40' AAR 1948 Boxcar **Just Arrived**

Roadnames: BAR, B&O*, GN**, PC, SP†, WAB



50' ACF Exterior-Post Boxcar **Just Arrived**

Roadnames: ATSF (RBOX patch), MP†/UP†, MRL, P&W, WSOR



40' AAR 1944 Boxcar **Just Arrived**

Roadnames: ATSF**, B&O, D&H, EJ&E, NYC* (Pacemaker), UP†



50' Evans Smooth Side Boxcar **In Stock**

Roadnames: USAX, B&M, BN***, CR, IC, RI



40' PS-1 Boxcar **November 2018 Delivery**

New Roadnames: CGW, MILW, MNS, NH, NYC, RUT



50' PC&F Insulated Boxcars **In Stock**

Roadnames: ATSF/SFRB, B&O, CB&Q**, CNW†, DRGW†, PRR, BAR, E-L. GN, PC, SOU, SP, UP

CLICK HERE TO LEARN MORE!

WALTHERS

Support your local hobby shop • visit walthers.com • call 1-800-4-TRAINS

Availability and prices shown were accurate at press time, for updates visit walthers.com. *CSX proprietary marks used by permission of CSX Transportation, Inc. **The ATSF, BN, CB&O, GN, NP and SP&S marks are licensed marks owned by the BNSF Railway Company. †Union Pacific licensed product. ©2018 Wm. K. Walthers, Inc.

Publishing more articles than ever

The page count of MRH magazine peaked in 2016 and so did the ad count. In the meantime, ad placements have been dropping some, and so has MRH's page count.

Even though we said "forever free" for MRH, did you really expect that to ever mean more free pages than ads would pay for? Most reasonable people get that the free magazine is funded by ads and the page count tracks directly to ad revenue.

MRH these days is running somewhere just under 250 pages per issue, which is about 100 pages smaller than we were at our peak in 2016.

Meanwhile, article submissions have increased, and we now have many great articles in our backlog. With fewer pages now in MRH, more of those great articles have been languishing, taking much longer before they finally see the light of day and get published.

It used to be an article in our backlog could take up to two years before it got published, on average. Now as MRH's page count has gone down with less ad funding, and as article submissions have increased, contributors may be looking at up to four years before their article makes it to publication!

That's approaching half a decade!

Fortunately, our new MRH *Running Extra* magazine (RE) solves this problem. These great articles wasting away in our backlog can finally get published a lot more quickly!

Since ads won't pay for these extra pages, you the modeler need to ante up a couple of dollars per issue to get all these extra pages. As we're saying, RE is more magazine than ads will pay for. When you buy a copy of *Running Extra*, keep in mind the majority of those funds go to pay the authors of the articles you're benefiting from.



DINE IN STYLE

**CLICK
HERE!**

CABOOSE™

Sharing Our Passion for Trains Since 1938



© 2018 John Harris Photography. All Rights Reserved.

CLICK HERE
for the
**Serious Modeler's
Resource!**

More than 148,721 items,
over 567 manufacturers,
**most at a discount from
full retail – all at
a fair price.**

**As always, in-stock orders of
\$100.00 or more ship free
within the Continental U.S.!***

*surcharges may apply for oversized items.

**10800 West Alameda Ave.
Lakewood, CO 80226
(303) 777-6766**

PUBLISHER'S MUSINGS | 6

Remember our contest

I want to also remind everyone we've got another design contest going this year. Unlike previous years, this is much more of an anything goes contest.

As we talked among the staff, we reflected on the type of layout designs we seldom get plans for but we often see in real life as layouts: the so-called California basement (aka, the garage).

In previous years, we've focused a lot on TOMA modular designs, but this time we're giving it a rest and you can do whatever you want!

Put your layout design thinking caps on, everyone. Let's get those contest entries put together!

The end of Reverse Running

We've decided to end our Reverse Running commentary column. Instead, we're adding a new small feature to *Running Extra* we're calling "The Ah-hah Moment."

Why drag track segments around?

Use 3rd PlanIt's powerful Design-by-Spline tools and focus on the track, not the pieces!

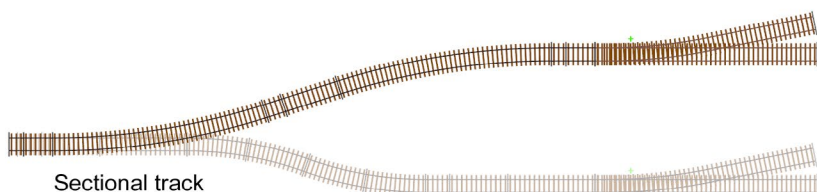

Sectional track

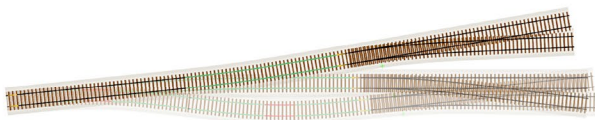

Flex track

SoftTrak can be changed to Sectional Track with a click of the mouse.

You define the critical positions and angles. SectTrak finds the best choice of any manufacturer's sectional track pieces to fit your spline. Create designs far more satisfying than you could by picking and moving every piece of track! You can even compare different product lines to find the best for you.

Look at the assortment of lengths and radii around the edges.

- Designed with HO scale Kato Unitrack in three minutes.
- The pieces were automatically selected.
- 8 nodes defined it all.

This is the best way to design.

Make the most of your sectional track!

3rd PlanIt 3D CAD
The ultimate track planning software

El Dorado
SOFTWARE

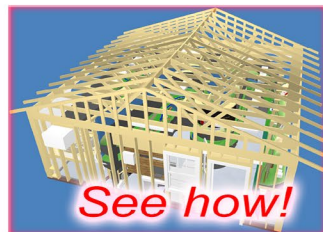

MRH CONTEST: "California Basement" Challenge

**\$1000 GRAND PRIZE • \$500 FIRST PRIZE
\$250 - Honorable mentions (two chosen)**

**Goal: Design a layout for a one- or two-car garage
(your choice). ENTRY DEADLINE: FEB 28, 2019**

**Two room-size
choices:**

**Single car garage
(14'x24')**

**Double car garage
(24'x24')**

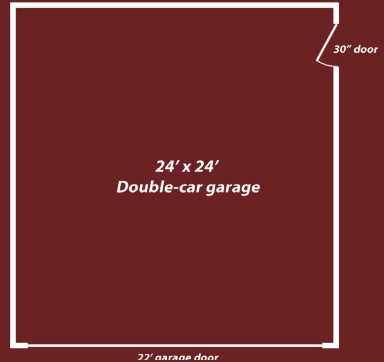
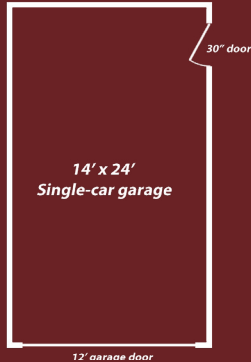

Note: This is a wide open home layout design contest using any design approach. This is not a modular-only contest like past contests.

CONTEST RULES

- Scale: Z-G, standard or narrow gauge.
- Draw up a final track plan and write up the design to be published. Extra points awarded for a high quality track plan, text, illustrations, photos, and captions.
- Describe the layout theme, rationale, and era (if any).
- Outline the basic construction methods you would take if you were to build this design. Extra points awarded for innovative thinking.
- The car does not need to go into the garage. You can use the entire space. However, the garage door does need to remain functional, it cannot be sealed shut, so describe what you will do to deal with that need.
- Beyond that, pretty much anything goes. Have fun and let's come up with some interesting track plans for a garage.
- All submissions must be publishable. If the submission is not formatted to be ready for publication, it will be disqualified. Take the time to be complete, provide captions, and to describe things completely in your text. See the [MRH submission guidelines for more information](#).
- The best submissions will be published and contributors paid for the article.

SUBMIT ENTRY (Choose "Contest entry")

We decided with page count being precious, we would prefer to do more modeling how-to's than spin our wheels debating deliberately controversial hobby concepts.

This new short column aims to feature some killer hobby technique we've seldom seen discussed in the hobby press. Short, sweet, and awesome is the goal of the new "Ah-hah Moment" feature in *Running Extra*. If you're paying money for those pages, you probably prefer that over yet another crazy hobby debate!



ADVERTISEMENT

END OF TRAIN DEVICE

NEW SAFETY GREEN

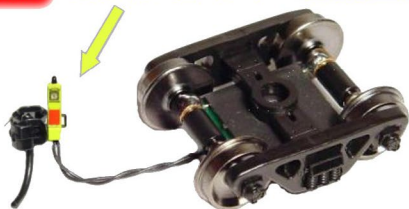

Bright Red Flashing Light!

**Installs in minutes!
No freight car
modification required!**

Patented Technology - US Patent 7,549,609

Does not affect Load!

↓ Car without Load ↓



↓ Car with Load ↓



**Click Here to
Learn More**

**RE RINGTM
ENGINEERING**



LAST ISSUE'S RATINGS

The five top-rated articles in the [October 2018 issue](#) of *Model Railroad Hobbyist* are:

4.7 First time resin casting

4.6 Signaling my layout, part 1

4.6 MRH Q-A-T: Naming trains & switches

4.5 Adding DCC and LEDs to Blue Box locos, part 1

4.3 Derailments

Issue overall: **3.9**

Please rate the articles! Click the reader comments button on each article and select the star rating you think each article deserves. Thanks! ■

Get the latest Model Railroading News, Tips, Reviews & Opinions

**CHECK
IT OUT!**



Our iTunes feed has changed search for
"Mike And Scotty Live" to receive the latest episodes!

www.themodelrailroadpodcast.com

Hosts:

Scott Mason: www.scottymason.com

Mike Rose: www.mrhobby.com

**Don't Miss our Monthly Interviews
& Product Announcements**

NOVEMBER
SPECIAL

Make it run like a

Dream

ROLLING STOCK

102 pages

By Joe Fugate

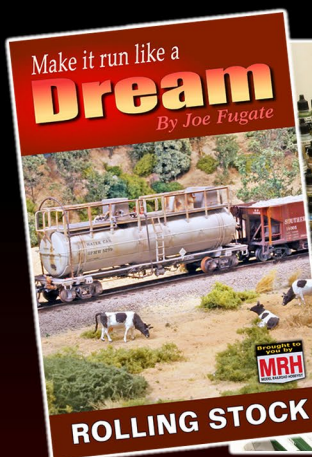

TOPICS INCLUDE: Setting standards • Building a test track • Wheelset/truck issues • Coupler issues • Carbody issues • Car weight considerations • Better maintenance procedures • Performance diagnosis & debugging • Special considerations

Click me to

Get eBook NOW >>

~~\$12.99~~ **\$11.49**

Format: Landscape and
Portrait PDF

Click me to

ORDER PAPERBACK >>

~~\$29.99~~ **\$28.49**

FREE shipping in US!
Foreign shipping 50%

Other books in this series: **TRACKWORK** (available now) and **LOCOS** (End 2019)

TrainMasters TV: WHAT'S NEW!



tank car weathering with oils



Customizing Tsunami2 diesel



Live steam rolling stock



Curt LaRue's Pennsy

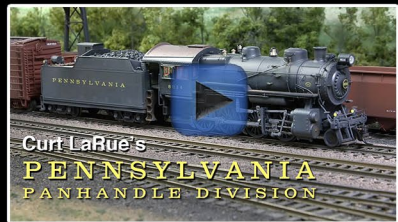

"The lighting, sound, graphics and overall content of TMTV have the feel of a network television show. If you've wished there was an 'HGTV' for our hobby, this is it." - Bill M.



Become a
TMTV member



MRH ... QUESTIONS, ANSWERS, TIPS



Model Railroad Hobbyist | November 2018 | #105

compiled by **JOE BRUGGER**

★★★★★
RATE THIS ARTICLE

Tips on dating rolling stock

Q. I'm planning an HO layout that will feature the Harlan & Hollingsworth rail car shops at Wilmington, DE circa 1925. It will include passenger and freight ops.

When I look at freight rolling stock in stores or online, I really have no idea what is or is not close to prototype for the time. I don't plan to count rivets, but I do want to know that any stock I run is at least close to the right period, not put into production 30, 40, or 50 years later.

Since most manufacturers don't seem to include this detail on the packaging (they should!) - any suggestions for finding period-specific stock? Especially freight?

—A Hansen



▶ **MRH QUESTIONS, ANSWERS, AND TIPS**



1. A freight yard in Washington DC circa 1917 shows a variety of steel and wood cars, many of them less than 40 feet long. Paint schemes are simple except for the billboard refrigerator cars at center-left and at the extreme right.

Library of Congress American Memory collection

A. Gary A: Eric Hansmann has good information at designbuildop.hansmanns.org/2016/08/06/decals-and-lettering and at [designbuildop.hansmanns.org/a-guide-to-1920s-era-ho-scale-plastic ...](https://designbuildop.hansmanns.org/a-guide-to-1920s-era-ho-scale-plastic...)

Dave Husman: If it's not a USRA design or has an internal height of more than 10 feet, it's probably too new for you. Look at the Westerfield Models website. He specializes in your era and gives build dates for the models. Even if you don't want to build those kits, they will show you what the cars look like. If the model has Andrews trucks, it's probably in your era.

The biggest and newest hopper you would have is the Athearn offset-side quad. The offset and rib-sided twin hoppers would be appropriate. Ironically, the composite wood-sided hoppers like Athearn's are cars built in the 1940s when steel was in limited availability. Except for hoppers, all steel cars would be brand new. Gondolas would be

mostly in the 40- and 46-foot length. A few 52'-6" and very few 60'-65' cars were around. Steel cars would be riveted and not welded.

Eric Hansmann:

Thanks for the

DesignBuildOp blog

mentions! I enjoy sharing rail info from the 1920s, so modelers can understand the railroads and industries of that decade.

As far as tips for dating rolling stock, start keeping notes. That is how the guide to 1920s-era plastic freight cars started. As more modelers inquired about the info, it became important to post it as a resource. I would invest in a mid-1920s Official Railway Equipment Register (ORER) so you gain an understanding of the in-service freight cars on several railroads. I summarized the 1926 Wheeling & Lake Erie fleet when that was my focus. I'm halfway done with a B&O version and hope to post that soon. The larger the railroad, the more detailed the summary.

Your interest in Harlan & Hollingsworth is interesting. By the 1920s, the company seems to have been a subsidiary of Bethlehem Steel, and mainly a shipbuilder. Check out the car builder history listed below for more. There would be lots of interesting inbound loads to a shipyard, but few outbound shipments.

Become a sponge for information and take notes. I find the research into the freight cars of the 1900-1930 years to be fascinating. Feel free to contact me directly through the ID here or via a comment on my blog. The 1920s are a fascinating era for rail and industry that have had little coverage in the hobby press.



J. Brugger

NOTE:

The Westerfield site lists historical society and modeling group links at www.westerfieldmodels.com/56701.html.

Dave Husman: Harlan & Hollingsworth was primarily a passenger car builder. I haven't really seen any freight cars they made.

Rob in Texas: Look at the build dates on the side of the model as well as the reweigh dates.

Irish Rover: On Accurail's website, they include the build dates of each car. Some will have a couple of build dates, but if you telephone to order, instead of ordering online, the folks there are wonderful and will get you cars with the right date. Very helpful people.

Any railroad's equipment roster can be useful, but there will be other cars on the line, of course. Old photos can help to get the right mix. Location is important, too. Twenty to a hundred miles distance can drastically change what traffic you see. For example:

- Dover, NH: Plenty of classic manifest freights with a good mix of cars – no intermodal, coil cars, or lumber cars that I saw.
- Rochester, NH: When I'd see a train, it was usually a gravel train.
- Manchester, NH: Coal trains for the power plant, with the occasional tank car.
- White River Junction, VT: Lots of cars carrying wood and wood products, plus assorted others.
- None of the above, in my experience, ever had an intermodal, coil car, or auto rack
- Springfield, MA: A lot of intermodal, some coil cars, as well as assorted cars of all sorts.

Gary: I enjoy reading Eric's blog, and anyone interested in modeling the 1920s or 1930s should check it out. I also look at steamerafreightcars.com, but it doesn't seem to be active anymore. Still tons of interesting data.

Highway 70: Check all dates printed on the sides of the cars.

"Right and Splice Clamps"™

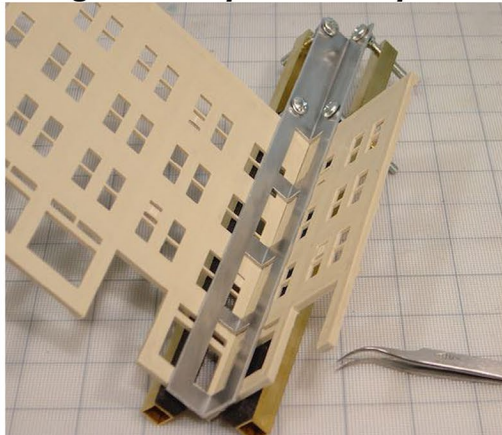

Quality Tools with Superior Versatility

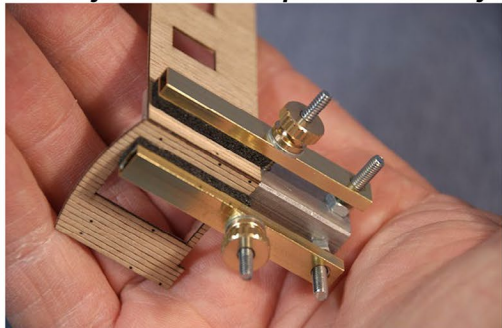

Essential Tools for Great Modeling

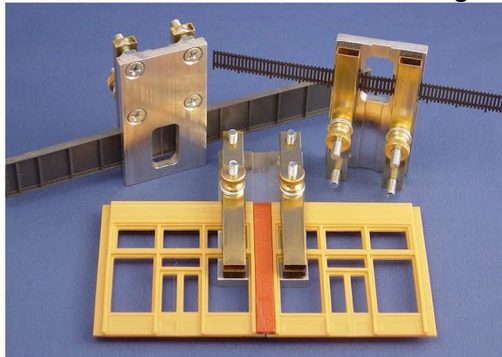

Coffman Graphic Solutions

1500 River Circle, Richmond KY 40475

[Click Here](#)

Visit our new Website:

www.coffmaneng.com

Make REAL Dry Transfer Graphics



... in less than 10 minutes!

Color
White
Metallic

DECALPRO_{fx}
(850) 926-2009 (9-5 MST)



ADVERTISEMENT



Archer

FINE TRANSFERS
PROUDLY SERVING MODEL BUILDERS SINCE 1989

THE ORIGINAL

SURFACE DETAILS™

WE NOW HAVE MORE
THAN 130 SHEETS OF
RIVETS, LOUVERS,
TREADPLATE, WELD
SEAMS AND MORE
CAST ONTO
MICROSCALE CLEAR
DECAL FILM

LOW SHIPPING:

DOMESTIC USA ORDERS
\$2.80

INTERNATIONAL ORDERS
\$9.95

"Archer Fine Transfers 3D decals have revolutionized kitbashing and scratchbuilding. Putting rivets or other low-relief details like louvers or weld seams on your models is now as easy as applying decals."

Joe Fugate,
Publisher/Editor
Model Railroad
Hobbyist



MADE IN THE USA

CLICK HERE TO
VISIT OUR WEBSITE!

Archer Fine Transfers • PO Box 1277 • Youngsville, NC 27596 • USA
(919) 570-1026 • info@archertransfers.com • archertransfers.com

Even if the car is correct for your era, it may possibly have a paint scheme that is too new. If the date is too new, further research is necessary. A car with an out-of-period date would be acceptable if the paint scheme is otherwise correct and the date doesn't bother you. You could change the date. A problem is that some model manufactures may use fictional dates. Look at prototype photos in books and online. While many are not dated, it may be possible to read the dates on the car with some magnification.

Graham L: When you're doing your research (or flipping through websites, books and magazines) keep a notebook handy to record what you find. On paper or electronically, record the car type, reporting notes and numbers, whatever you find helpful. Write down any date information you find, and where you found the information. It sounds tedious but is kind of fun once the data starts piling up. I always think I'm just going to remember this stuff and where I found it, but never do.

Richard Bale's series on details to help identify the general era of rolling stock:

Handbrakes: mrhpub.com/2013-11-nov/land#110

Car ends: mrhpub.com/2014-10-oct/land#92

Doors: mrhpub.com/2016-03-mar/online

Roofs: mrhpub.com/2016-12-dec/online

Trucks: mrhpub.com/2018-06-jun/online

Car data sources:

designbuildop.hansmanns.org/a-guide-to-1920s-era-ho-scale-plastic-freight-cars

designbuildop.hansmanns.org/wle-freight-car-fleet-of-1926

www.midcontinent.org/rollingstock/builders/

Build stuff like this?



Subscribe

Daniel Cortopassi Productions

LIGHTS4MODELS

LED's, Signs, and Sounds for
All Scales

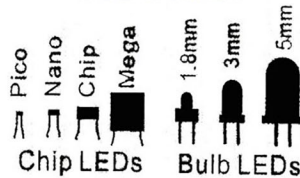

Miller Signs | Evan Designs
Iron Penguin | Ring Engineering
EZ Line | Tomar | ITT Sound Boards

www.lights4models.com

614-296-8691

Backdrop Junction

Your Stop for Railroad Backdrops

Click Here →

**For the Finest in Custom
Designed backdrop**



www.backdropjunction.com

**Lasercut structures. Highway,
storefront and billboard signs.**

Neat ag customer for your railroad:
Farmers Fertilizer Supply



**WHAT'S
NEW?**



Established 1993...

Blair Line

harlan-hollingsworth3.htm

resincarworks.com/about.htm

steamerafreightcars.com

steamerafreightcars.blogspot.com

groups.io/g/STMFC

www.google.com/search?q=usra+freight+car+drawings

www.sunshinekits.com

www.westerfieldmodels.com

Contribute to the thread at mrhmag.com/node/30709.

Priming for paint

Q. If you are using a dark spray paint, does it matter if you use gray, dark gray or white primer?

—KH25

A. Lou in Utah: It depends on how opaque the final coat will be. The general rule of thumb is to use dark primers under dark colors and light primer colors under light colors. However, if I know I'm going to apply several solid coats of a dark color, I just use the primer I have handy. For light colors I always use white or light gray.

Ventoux1: In the plastic model airplane hobby, we prime with a light silver color, such as aluminum. Metallic paint goes on very thin and is a good base for dark or light colors. Even white can cover in one coat.

Jose F.: Many model paints labeled “primer” are paint mixed to represent a primer color, like red oxide. Primer's function is to provide a sealed and bonded surface for your top color coat. The basic difference between paint and primer is that of resins versus pigments. Resins in primers seal porous surfaces and provide the bond



2. Using Paint 3D, here's a crude illustration of how primer can influence final paint color. The three horizontal stripes are varying densities of gray on a

white background. On the medium gray strip at the top, the top coat is dense and less brilliant. On the bottom stripe of light gray, the top coat's shift is hard to detect. Many gray paints have green, blue, and yellow elements that can shift the hue of the top color coat. Yellow and red paint are particularly transparent and are susceptible to color shifts unless multiple layers are built up. The color of the model's material can also alter the overall effect unless a neutral primer is applied.



to the surface. Some may contain filler material to eliminate pits, scratches, and tool marks. Primers containing filler material often have the word “surface” in their name. If you don't have unwanted scratches, etc. on your model, you don't need a surface primer.

Kriegwulfe: Spraying primer and then misting on a contrasting dust coat to show irregularities

3. Tamiya's Fine Surface Primer is available in red oxide, gray, and white. Testors, Vallejo, and Mr. Finishing also market primer for modelers.

is often called a guide coat. When using primers, I find myself having to guard against high-build primers that purposely create a thick coat so you can sand imperfections out. I use a thin primer called a sealer or etching primer for the first application. This is helpful when trying to maintain crisp detail, especially on brass models.

One thing I learned is to not get the paint so thick that it covers up details. Primer can affect how the top coat's final color may appear when we try to keep the color coats as thin as possible. Prime a car with black, try to color it with yellow, and the final color will change a bit [2]. Use a gray/green primer, and reds or yellows will change hue. I try to use a rusty red primer (red oxide) under reds and oranges, black for dark blues, greens and such, light gray for most colors, and white for anything close to a pastel or "bright" color.

Peter F.: I studied design in college. Classmates studied fine arts and illustration. I learned a few things from them, too. A field of black paint can be modified by the way the canvas is prepared. Most fine paintings have an underpainting that lends a base tone to the finish image. Make a field of red or blue or yellow under a topcoat of black and you will have a noticeable difference when finished. This is one reason to select the proper primer, either to match the topcoat closely, or to build up a multi-color finish with subtle tones.

Be careful to not obscure details. Thin primer and paint coats are usually best.

If you have an uneven surface that you're improving, a contrasting primer will more readily show defects. While building and improving the surface, a thin coat of primer that contrasts with the surface will show pocks and pits. Alternating light coats with dark primer coats makes the work easier. This is one of several reasons that primer is supplied in more than two colors. As you sand off the high points, the primer remains in the low points and defects become apparent.

Add to the discussion at mrhmag.com/node/32554.



GET PAID FOR YOUR TIP

We pay **\$25 per tip** we publish, or \$40 each if the tip also includes a photo or finished drawing. [Click here and select article type TIP.](#) ■

.....



RATE THIS ARTICLE



TIPS

Armband throttle holder



4. An inexpensive watch strap and a square or circle of Velcro material keeps a throttle within reach and away from delicate details. *Ron Christensen photo*

An extra hand is always handy. It seems that the throttle hanging from my neck often dangles into something like a car or some detail, tipping them over or worse. My friend Rod Thomson suggested an armband with Velcro to hold the throttle securely out of the way. With this gadget, it's always where I can find it and leaves the left hand available to hold something else. I made mine using a cheap wristwatch band and Velcro. It's easy to detach.

—Ron Christensen

From first train set to railroad empire...

*Our complete line of DCC products
grows with you. Discover the fun!*

- Designed and manufactured in the U.S.A.
- Preferred for ease of use and ergonomic design
- Unlimited scalability for any size model railroad
- Plug-and-play means more time running trains
- Great customer service and excellent support



See your dealer



Visit our new and improved web site for all your DCC needs!

- Get the latest new product announcements
- Watch our detailed how-to videos
- Browse the all-new Information Station
- Enjoy secure online sales, day or night!

Visit **ncedcc.com**



**WE
HAVE
PARTS!**



**Check out our
full line of Digitrax
& NCE products
at GREAT prices!**

**Lenz products
ARE available!**



Click here to visit our website:

**www.LitchfieldStation.com
sales@litchfieldstation.com | 623-298-7355**

ELECTRICAL IMPULSES

column



Model Railroad Hobbyist | November 2018 | #105

JASON MILLER LOOKS AT
SIGNAL SYSTEM INSTALLATION
IN PART 2 OF THIS 3-PART
COLUMN SERIES ...



LAST MONTH IN PART 1, I EXPLORED PLANNING layout signaling. I also reviewed early considerations needed to ensure the signaling installation will go smoothly.

In this second part, I cover the installation of the components discussed in Part 1.

This includes the installation of:

- detection hardware and its wiring network
- signal blocks and short management on the DCC bus
- signal drivers and their wiring network
- the signal heads themselves, which include dwarfs, masts, and signal bridges

Remember, this series shows the hardware and signals I installed on *my* layout. I'm writing these columns as a kind of "beginners walk-through" for others contemplating signaling on their layout.

▶ ALL-THINGS-ELECTRICAL FOR MODEL RAILROADING

Things to keep in mind

Signaling a layout is a *huge undertaking* and takes time to complete. Good realistic signaling is not a simple plug-and-play exercise, and not something you can rush.

Be under no illusion: doing a full layout signal install can be a total grind.

Sometimes I had to take a break from the installation. Now that my system is nearing completion, it has been a four-year adventure; definitely *not overnight*.

Working signals can be a large budget item for the layout. My combined signal system, as set up and installed, is the biggest cost item of my entire layout build.

A caveat about the details in this article: I keep things fairly basic. I do not cover every detail of my installation. That would be a fairly thick book and beyond the scope of these introductory articles.



1. In this column, Jason Miller walks through the installation of the signaling components he discussed last month in Part 1.



Southern Digital

WWW.SODIGI.COM

Celebrating 25 Years of serving you !

Go Wireless InfraRed Expanded Zephyr System



Everything you will need to run 2 DCC trains.



~~\$390.00~~ Value
\$310.00 Your Price
\$80.90 You Save



DCC Conversions, Service & Support

E-mail: sales@sodigi.com (770) 929-1888



For more of the gory details, consult the manuals that come with the circuit boards I have used.

This part shows photos of my installation, along with diagrams to help explain the connections and how the system works.

Basic components of a signaling system

To set the stage for the installation discussion, let's review the basic parts of a layout signaling system.

Recall that the track needs to be divided into signaling blocks, with each block having a detector that can see if a train is there.

The detector sends what it sees via a wiring network to a central computer running logic software.

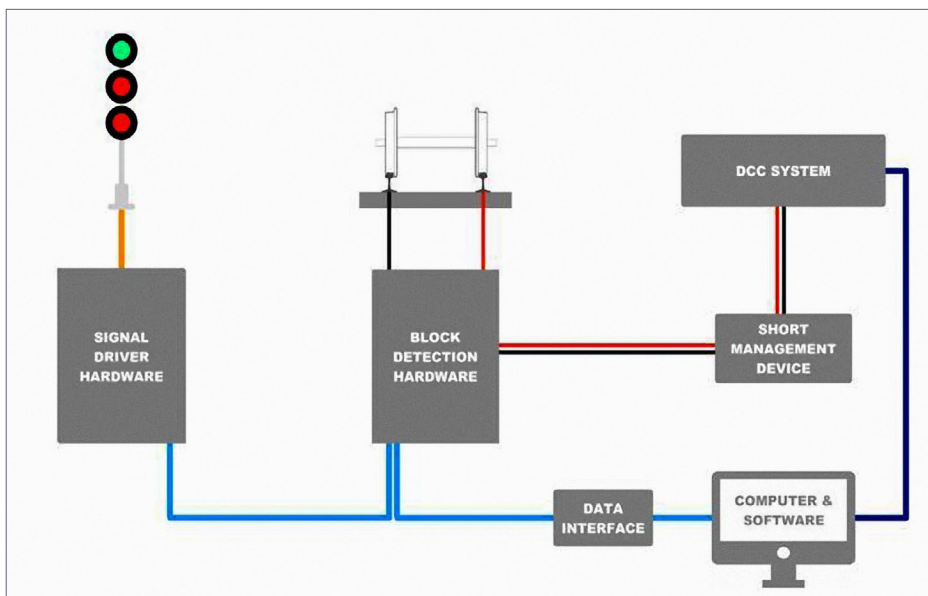

2. General arrangement of my basic signaling and detection system.

Don't settle for all your locos
sounding the same!

ESU now has **OVER 100**
"LokSound" files to choose from!

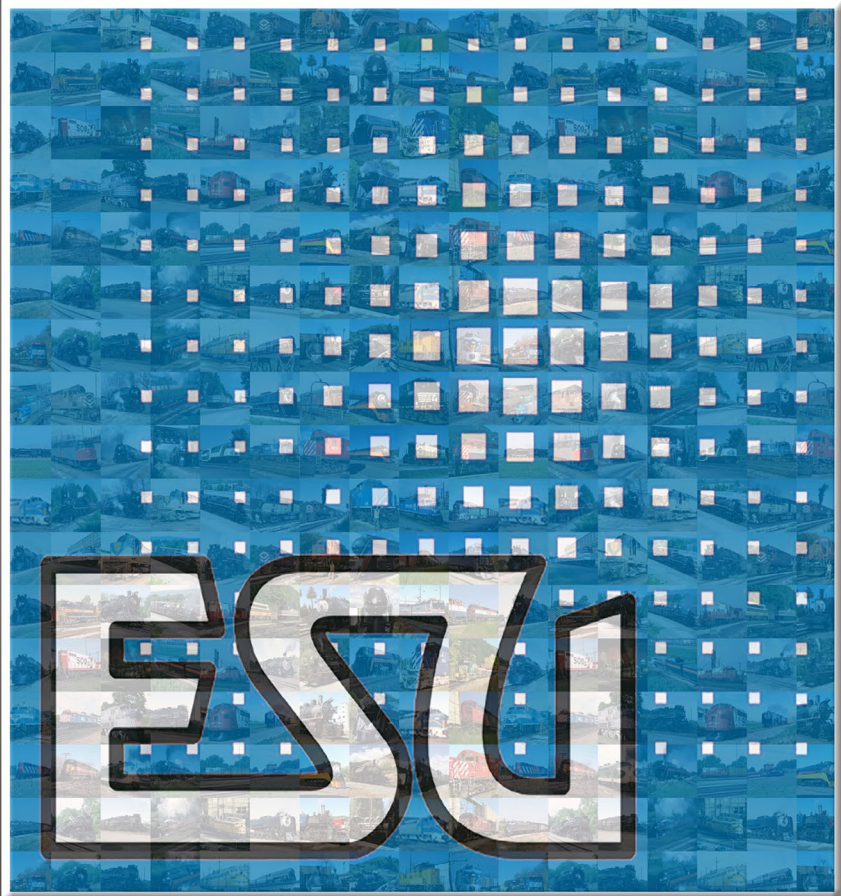

Because "Close Enough" is no longer
"Good Enough"

LokSound.com

The logic software looks at the layout track arrangement and turns the detector results into an aspect code sent to signal driver hardware via the wiring network.

The signal driver hardware at the signal then converts this aspect code into which LED needs to be which color (iaspect). My layout doesn't use semaphores, but if it did, the signal driver also would need to command servos to position the semaphore arms appropriately.

As an aside, the block wiring may also include some short management hardware between the track and your DCC system.

[2] is a block diagram showing the parts of my signaling system and how they interconnect. Remember, this is specific to my layout detection and signaling – other systems may differ somewhat.

THE INSTALLATION PROCESS

Step One: Material, tools, and hardware

Here are the materials and tools required for the signaling system I installed on my layout. You will need to purchase anything you do not have.

Different systems and other hardware may require other tools to complete the installation, so do not take this list as universally exhaustive.

Materials

- Wire – Various wire gauges to suit your DCC power bus, block detection, and layout capacity. I use 10AWG (2.5mm) house flex for the main DCC bus, 14AWG (1.5mm) for the DCC power sub-bus/detection common and 18AWG (1mm solid) bell wire for the track feeders.
- Signal Heads – 10-conductor flat ribbon cable, 10-pin insulation-displacement contact (IDC) connectors

- LocoNet – 6-conductor flat cable and 6-pin RJ12 connectors
- Terminal blocks – Various lengths to accommodate the multiple main bus, sub-bus wires, and track feeder wires
- Cable clips and cable ties

Tools

- Wire cutters
- Wire strippers
- Insulated screwdrivers
- Soldering iron
- Cordless drill
- Extended (extra-long) drill bit
- RJ connector tool for LocoNet cables
- Electrical hardware



3. Some of the hardware, materials, signal masts, and tools required to install the detection and signaling system on my layout.

- Block detection boards – Digitrax BDL168x16 detected blocks (via four zones, with four blocks per zone)
- Signal decoder boards – Digitrax SE8C, drives 32 Signal Heads and 8 Slow Motion Switch Machines
- Power and short-management boards – DCC Specialities PSX1, PSX4, and PSX-AR
- Power supply – 12V-16V AC or DC power supply for powering the BDL168s and SE8Cs, with a minimum of a 100mA per BDL and SE8C
- Computer-to-layout interface – RR-Cirkits LocoBuffer USB
- Signal heads, signal masts, and signal bridges – Tomar masts and dwarfs, IHC signal heads and bridges
- Tri-Colored LEDs – RR Cirkits SS-RGY-24 prewired LEDs

Step Two: Block detection and defining blocks

Key signal components are the block detection hardware that “see” a train on the track. These detectors send information to your layout panel software so you get a visual indication of where a train is on your layout.

I chose the Digitrax BDL168 as my detector for locomotives and rolling stock on the layout. In Part 1 (s3-us-west-2.amazonaws.com/mrhpub.com/2018-10-oct/online/index.html), I explained the basics of this hardware and some of the considerations for using it. Here I show how I installed them on my layout.

For more information and the manual for the Digitrax BDL168, see: www.digitrax.com/products/detection-signaling/bdl168,

To use this circuit you first need to break up your layout into blocks. Defining detection blocks could need an article all its own.

In my case, the blocks on my layout typically hold a single train consisting of one locomotive, around eight to ten 40-foot and/or 50-foot

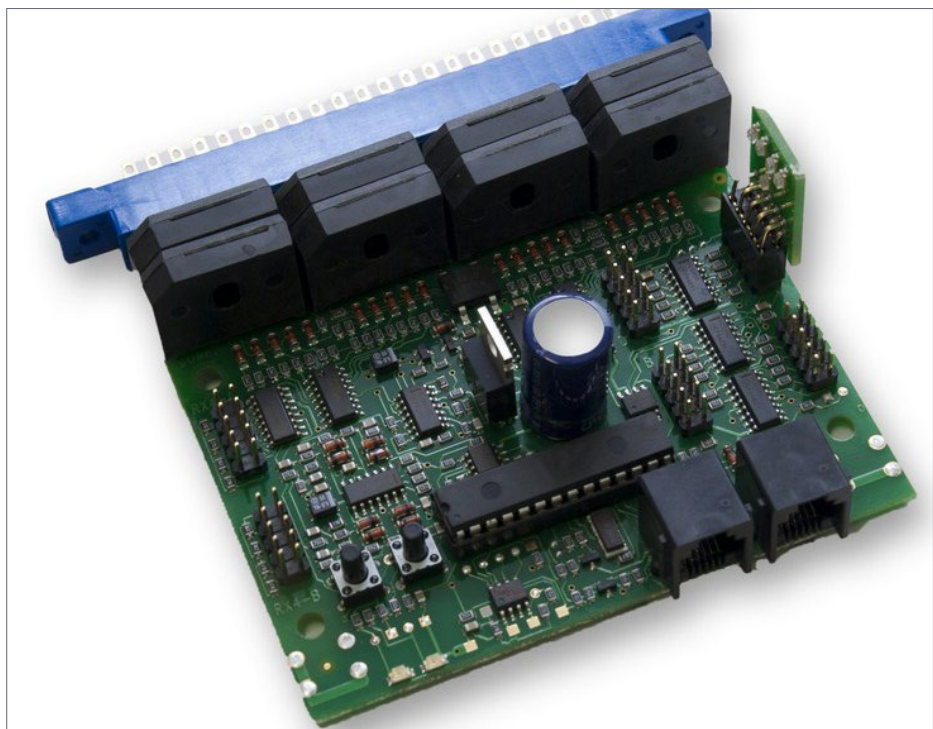

4. The Digitrax BDL168 is the heart of the detection.

long cars, plus a caboose. My passing sidings average around six feet long (1800mm).

I use Digitrax's recommended practice of "direct home wiring" per the Digitrax BDL168 manual.

One important note about the light-blue curved block section (LS57-AR) in the diagram [5]: I power this section of track through a PSX-AR (auto-reverser) because the inner loop of the center peninsula cuts back onto the outside loop of track, thus creating a reversing track polarity issue. The length of this reversing block section must absolutely *be longer than longest train* running on the layout.

The PSX-AR also can provide occupancy detection, but this does not run through a BDL168 like the rest of the layout [6]. Instead it is coupled as an output via a Digitrax SE8C.

Diagram [7] shows one of the four zones completed. It also shows how the non-Digitrax “pseudo ground” wiring in blue terminates the BDL168 ground through my NCE DCC system. This allows the BDL168 to communicate occupancy data back to PC with JMRI via the standalone LocoNet that has not associated Digitrax DCC system.

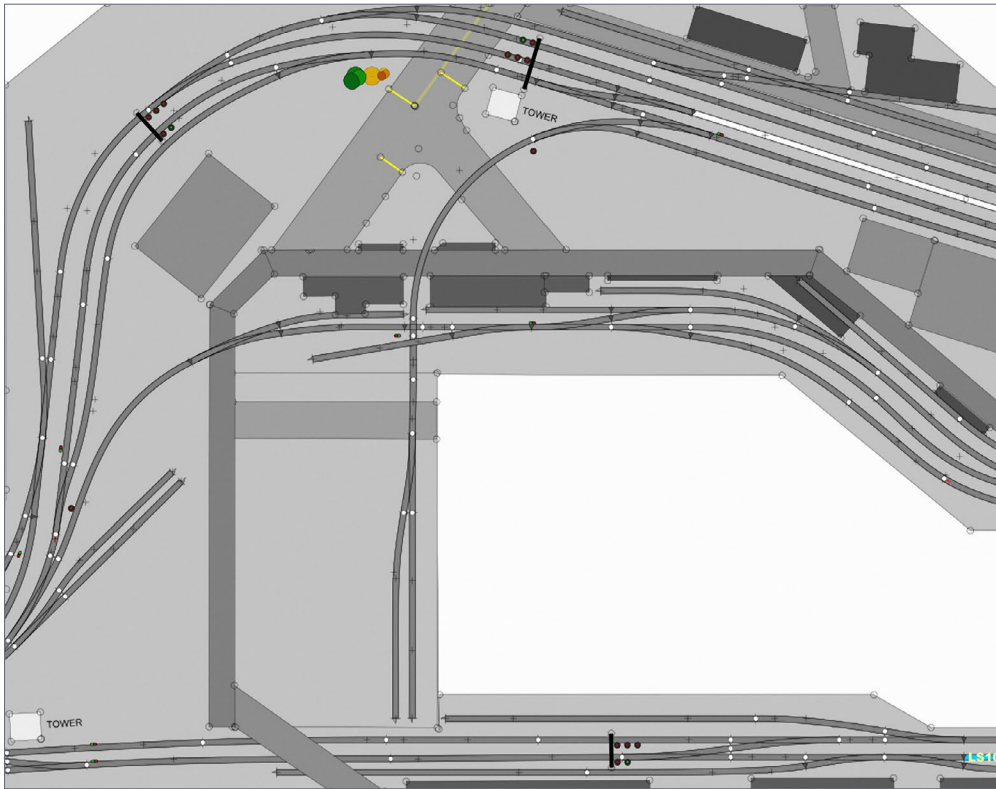

5. Here is a section of Harrisburg and Rutherford on the layout, showing some of the block lengths in different colors.

The wiring diagram [7] represents one zone of the four available on a BDL168. As drawn, it also represents the last BDL in the detection hardware line, since it has the BDL168 ground “terminating” back into the DCC bus.

The last BDL168 also must be set as the “LocoNet Master” in its internal settings for the termination to work correctly.

On the diagram [7] you see each block labeled, such as Zone A - LS49. The LS49 is the block naming convention I use in JMRI and PanelPro. When assigning a sensor in PanelPro to a piece of

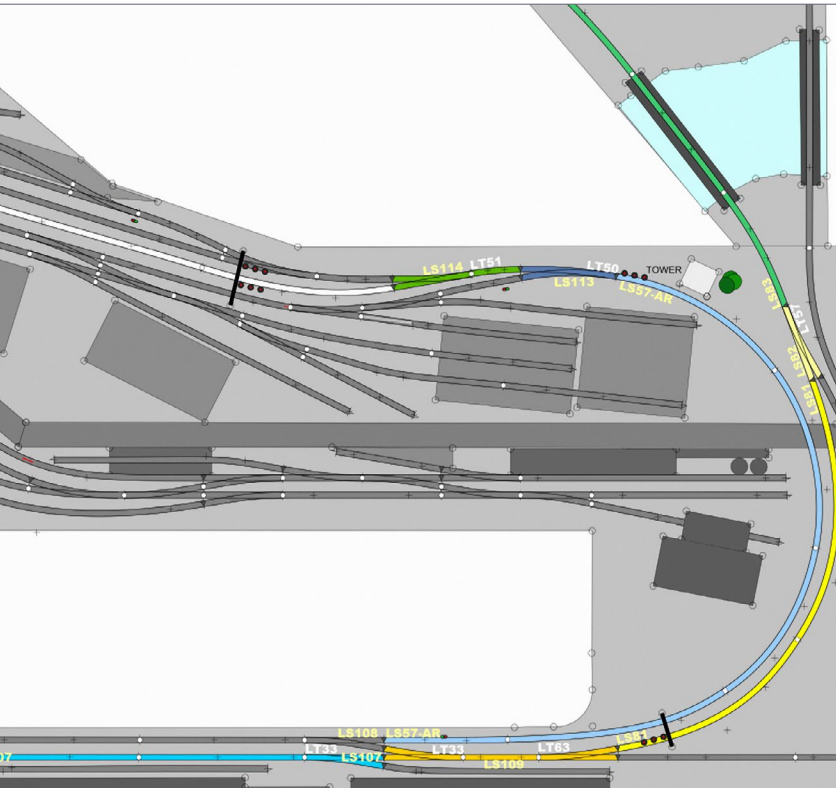

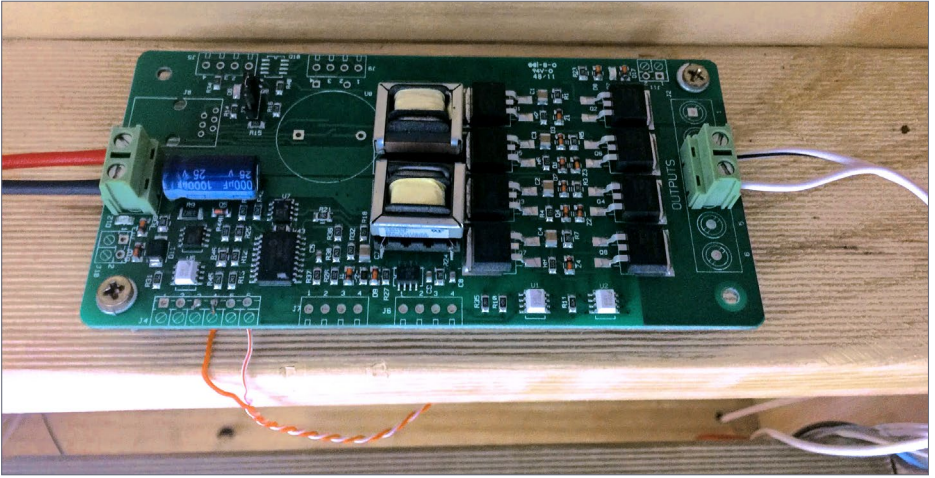

6. Here is the PSX-AR (auto-reverser) with occupancy detection connected.

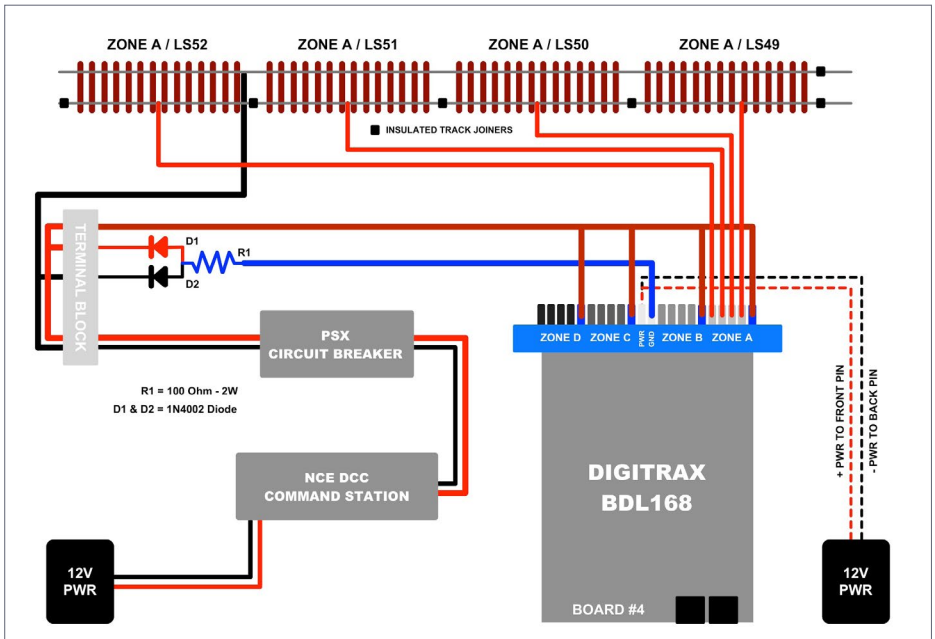

7. Direct home wiring.

track, it needs the internal LocoNet number for that sensor. The LS simply means its “L” = LocoNet and “S” = Sensor. I derived the 49 from the BDL168 board being programmed as board number four (4). Therefore my first detection block in Zone A is LS49.

For LocoNet, BDL168s, and SE8Cs to function properly on a non-Digitrax system, a RailSync signal/power source is required from the DCC bus. To accomplish this, I needed a short LocoNet cable with the blue RailSync wire connected to the DCC Rail A/Positive wire.

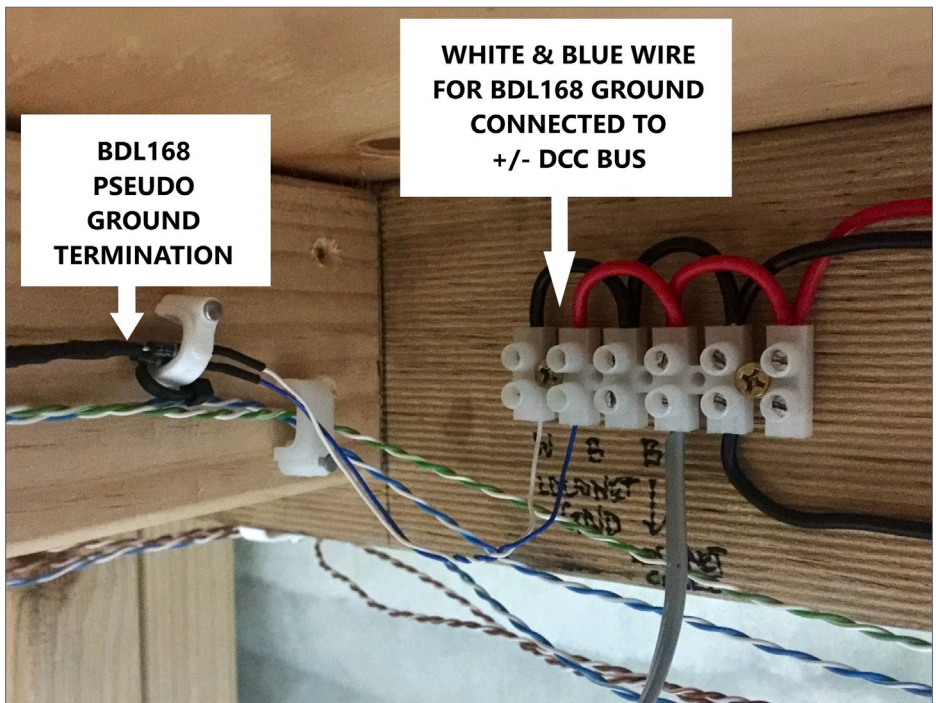

8. Here is a BDL168 pseudo ground termination installation on the layout.

LOCONET TERMINATION PROVIDING POWER TO THE LOCONET FROM THE POSITIVE DCC BUS

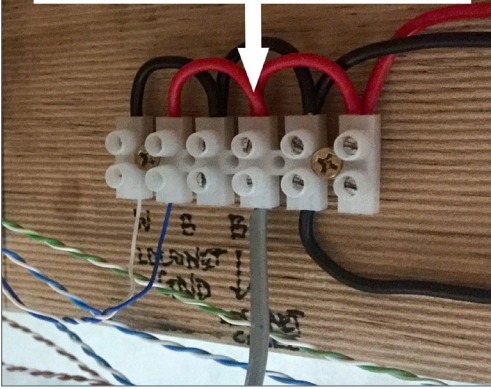

9. This photo shows the gray LocoNet flat cable, and the left most/blue LocoNet wire connected to the positive side of the DCC bus to provide the RailSync signal/power source for the LocoNet and BDL168 to operate correctly.

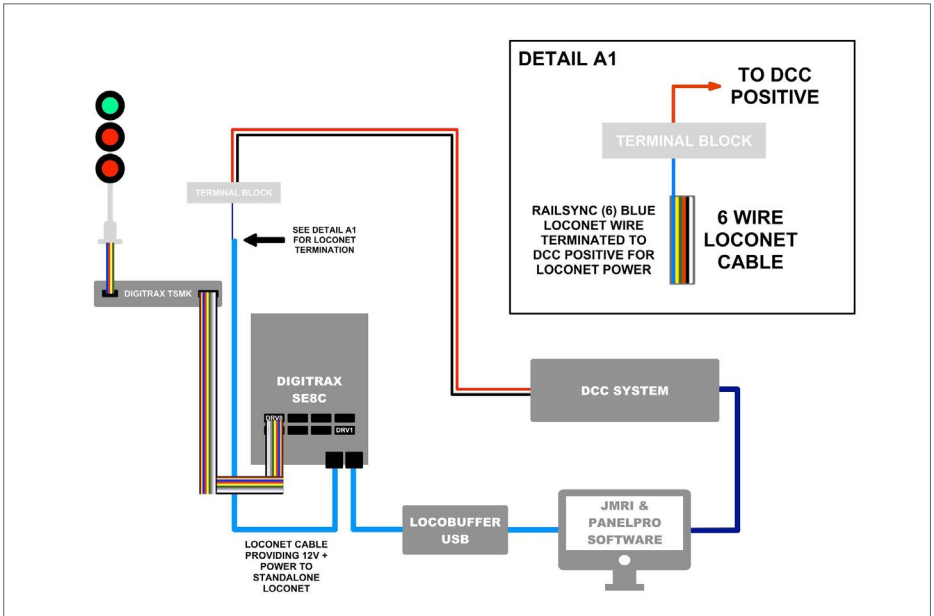

10. Here is an SE8C as the last device in the LocoNet before the termination. This is the setup on my layout. It could also be a BDL168 that is the last device before the termination.

As mentioned in Part 1, having a plan to work from is a good idea. This helps maintain a standard of wiring that comes in handy later if you need to do any fault-finding, repairs, or changes.

My layout plan [11] contains the locations of the BDL168s and PSXs. I have broken it up into the power districts, and also show the tracks I needed to double-gap (red dots) to keep the rails separate and ensure the correct operation of each PSX circuit breaker.

[12] is an example of the main bus feed going into a PSX, and then being distributed to a BDL168. The BDL168 sections are then routed to screwed terminal blocks that connect to the track feeders. The BDL168 in [12] uses an Accu-Lites breakout board for the block distribution.

ADVERTISEMENT

RailProTM

**NEW
TECHNOLOGY**

RE RINGTM
ENGINEERING

DCC + RADIO CONTROL HO Scale Locomotive Module

**ULTIMATE
SERIES
SOUNDS**

**TRUE
MOTION
TECHNOLOGY**

**LIGHT
EFFECT
EDITOR**

DIRECTTM
**RADIO
+NET**

New Sound Technology and Mathematical Model Motion Control + more!!!



+



Equals
"DUAL MODE"
Control by DCC +
Radio Control

**Click Here to
Watch Video**

For more information visit our Internet site: www.RingEngineering.com

Accu-Lites breakout board

Web: acculites.com/index.php?main_page=product_info&cPath=40_100&products_id=563

http://acculites.com/index.php?main_page=product_info&cPath=40_100&products_id=563

If I had to do the detection system again, I would use the Accu-Lites breakout boards everywhere instead of making my own. The cost of these boards is worth it, considering the time it took to make the boards myself.

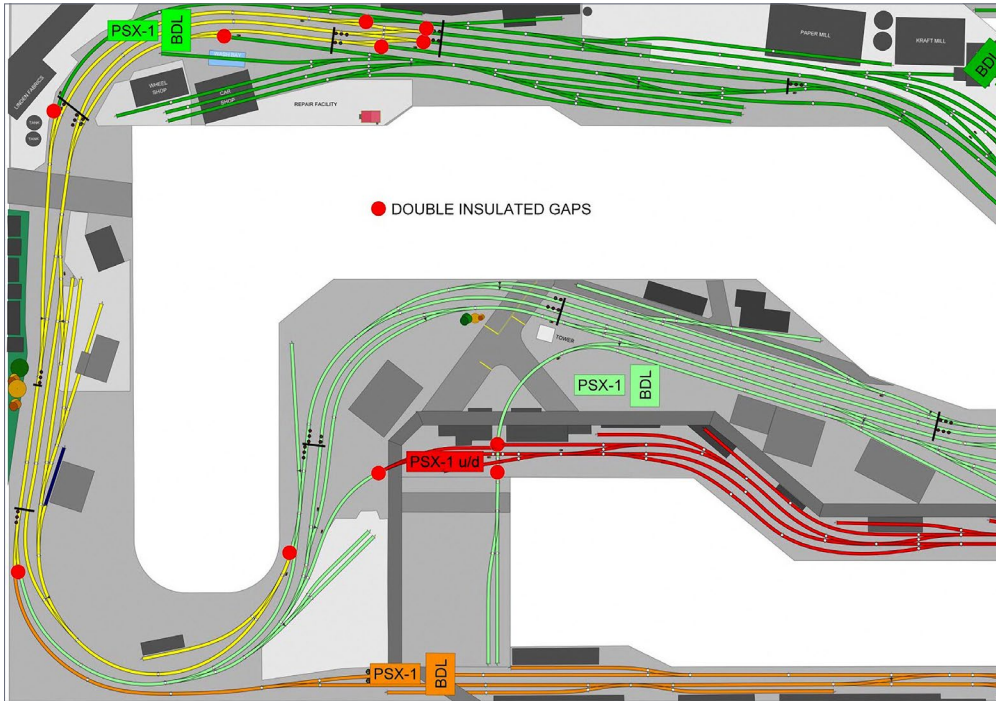

11. Double gaps must be placed at the locations of the red dots to keep the power districts separate and allow the PSX circuit breakers to function correctly.

Main DCC bus wiring configuration

When I decided to rewire the layout for detection and signals, I wanted to add all-electronic circuit breakers as part of this upgrade. Because I had already altered my layout wiring many times over the years, I had issues with multiple/crossed connections and stray current running into each power district. This sometimes would shut down multiple power districts at once, or worse, shut down the entire layout

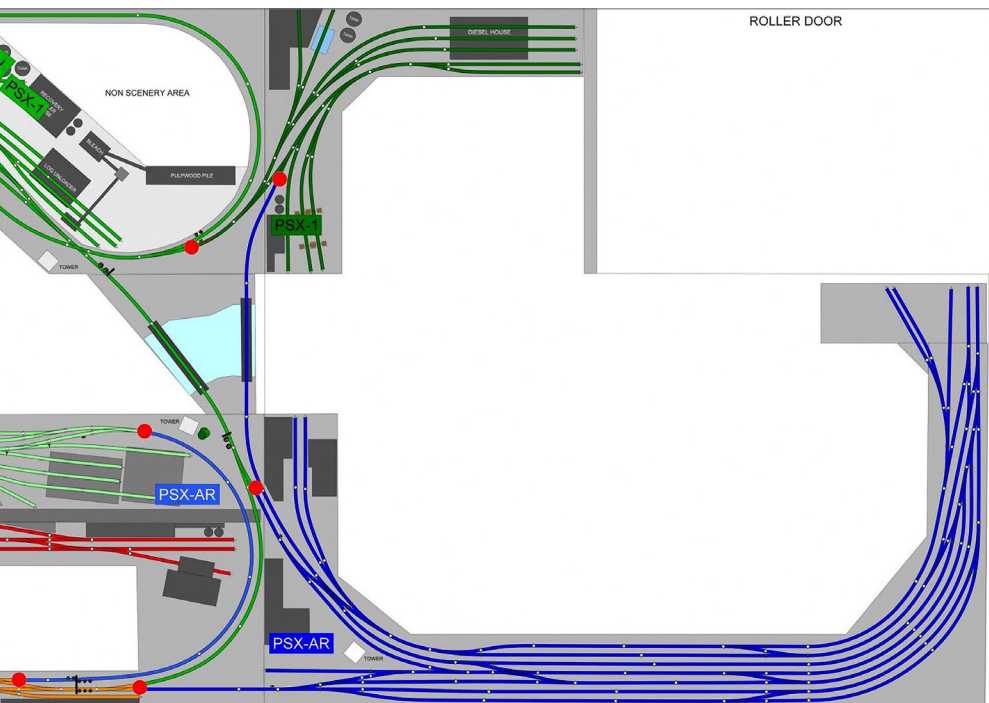

RATE THIS ARTICLE

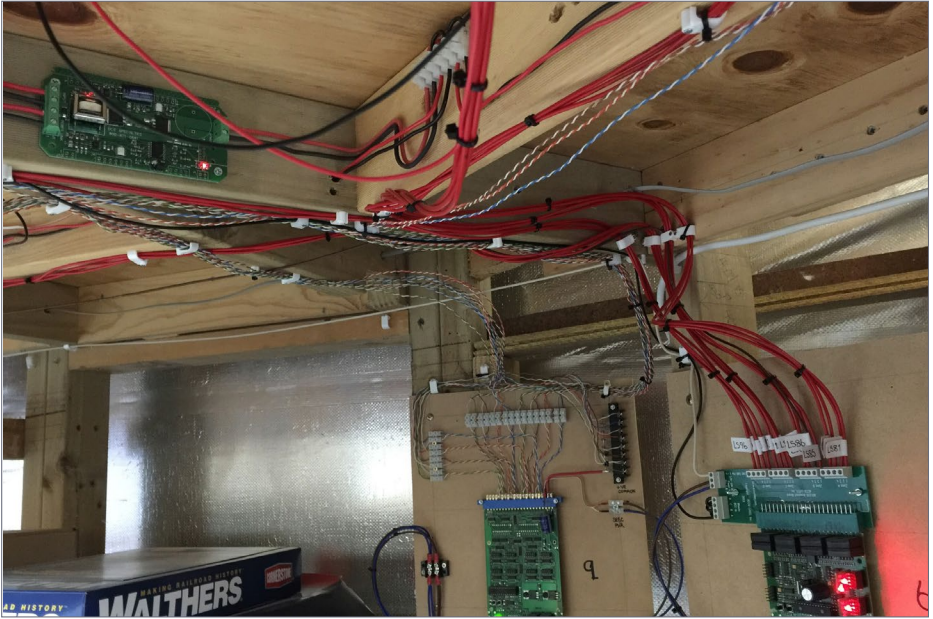

12. The main bus feed goes into a PSX (top left) and is then distributed to a BDL168 (bottom right).

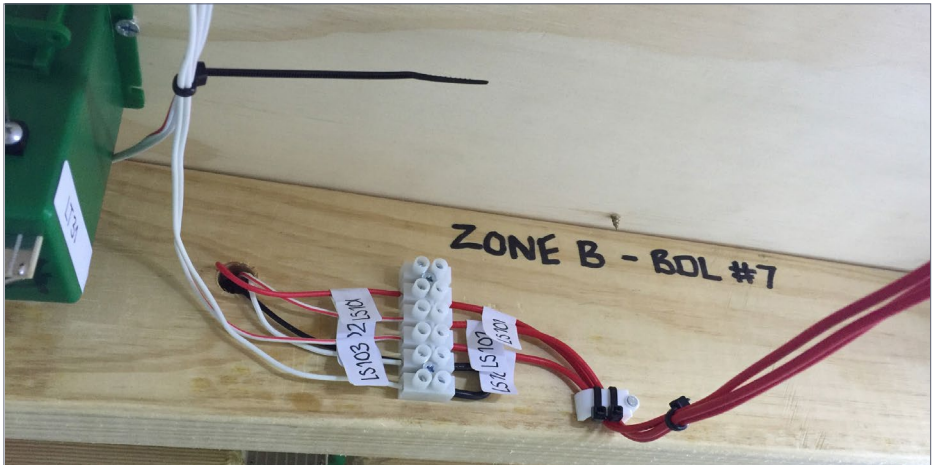

13. The BDL168 sections are routed to terminal blocks that connect to the track feeders.

To rewire and eliminate these annoying command station shut-downs, each power district with its BDL168 would now need to also have its own PSX Circuit Breaker.

I decided to run a dedicated main bus line to each PSX. I wanted to ensure that each power district would have its own feed. It also meant that I must double-isolate the detection common from each power district.

Using this wiring configuration means there is only one piece of wire between the NCE DCC booster and the PSX circuit breaker through the terminal strip. Each PSX then supplies the power to that power district's BDL168.

This approach required more wire, but I have not had any more issues with annoying shutdowns since [14].

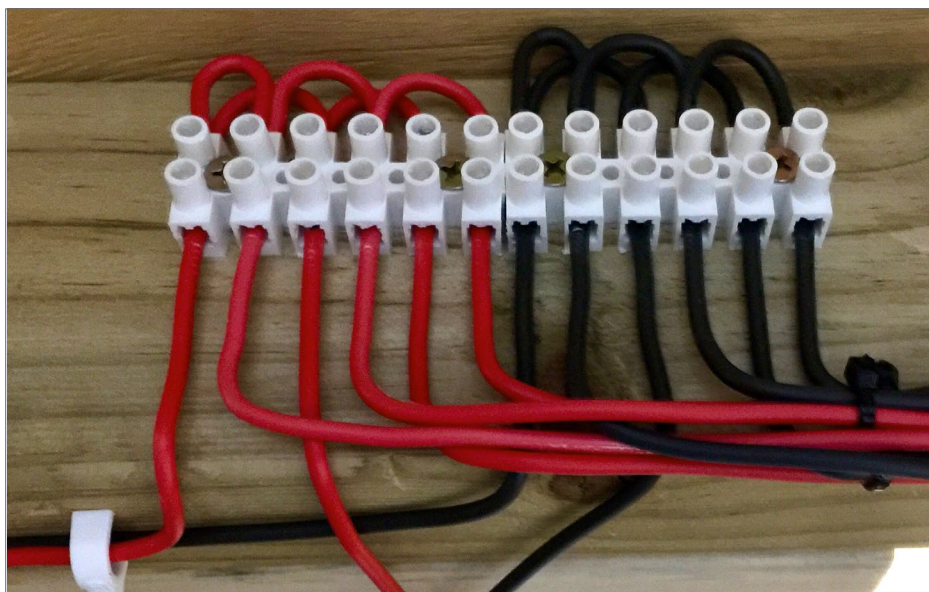

14. Adding dedicated feeds to each power district meant lots of terminal strips and associated wires such as you see here. It is extra work, but worth it.

Step Three: Mounting and wiring the BDL168

To easily access each BDL168 for installation and for maintenance or fault-finding, I wanted a mounting system permitting me to remove the BDL168. I decided to mount the 44-pin connector to a piece of 1/8" MDF board, and then mount the board underneath the layout on the benchwork.

To mount the 44-pin connector, I drilled holes through the outside edges, then placed 1/8" bolts through the MDF backing and secured them with nuts. I then placed the 44-pin connector over the bolts and secured these with more nuts. This method raises the board off the MDF backboard, and provides air movement behind it.

This allows easily removing the printed circuit board (PCB) from the 44-pin connector. The board needs to be moved with a side-to-side motion to break the grip of the connector pins.

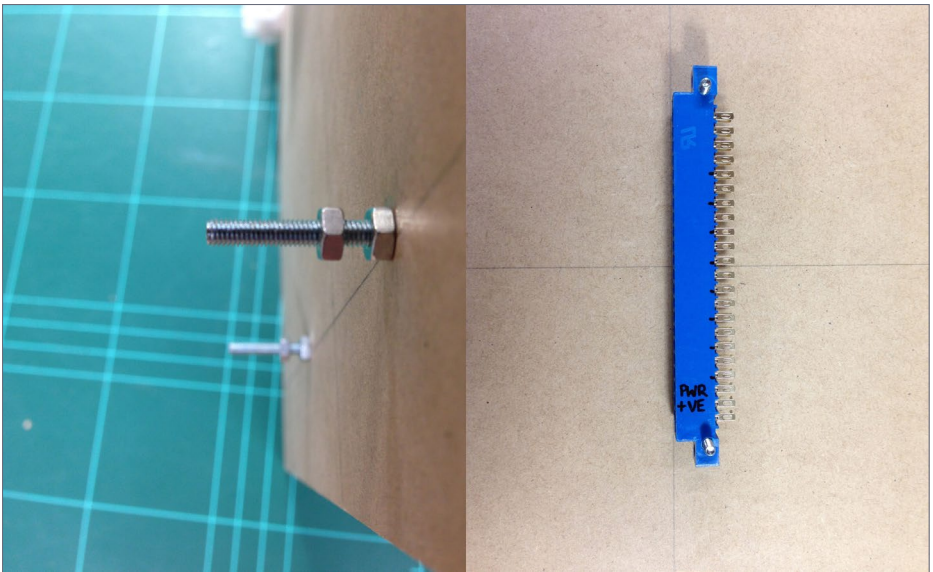

15. BDL 168 44-pin connector mounting method.

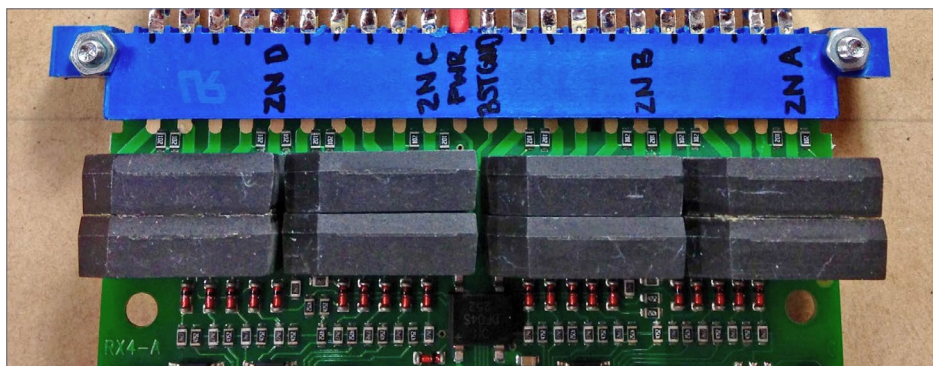

16. BDL168 pin positions marked on the 44-pin connector.

When the 44-pin connector is secured on the benchwork, I mark the positions for the BDL power (PWR), each of the four zone/detection section power feeds (ZN A, ZN B, ZN C, ZN D), and the booster ground pin (BST GND).

I used terminal blocks for easy connection of the detection section feeders to the BDL168. These allow wires to be easily attached or removed.

I mounted the BDL168 to the benchwork near the center of each power district.

In [17] you can see black wires representing the “common rail return” wire/zone power, the red wires representing the “detection section” wire/block power for the individual blocks, and the white “booster ground” wire. The BDL168 power feeds are the thinner wire located in the left terminal block.

The photo [18] shows the installed BDL168 underneath the layout, and wired into the common 12V power supply (blue/brown wire). The gray LocoNet cable attached has the input on the left, and the output to the next device on the right. All of the

connections to the BDL168 can be disconnected for easy removal of the entire board if needed.

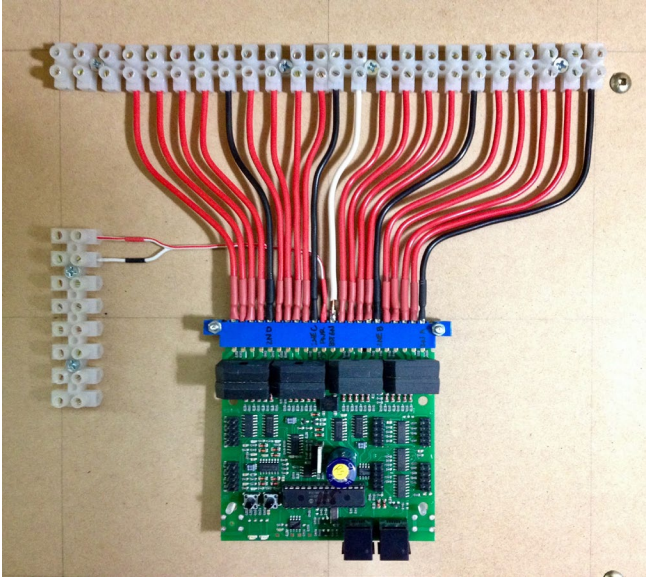

17. BDL168 wiring with the 44-pin edge connector and wire feeds out to terminal strips from the pins. This makes connecting things (and disconnecting for debugging) very easy.

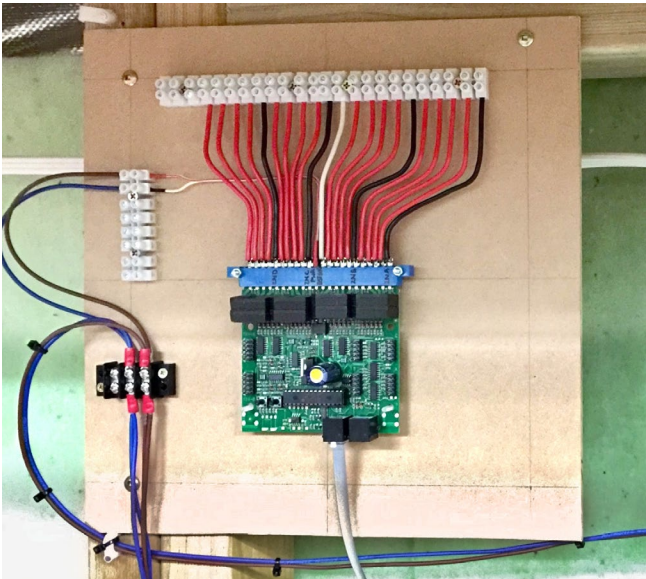

18. Here is the complete BDL168 mounting system with all the terminal strips in place. Board removal is easy.

Installing the detection section feeds

I recommend bundling and clipping the detection feed wires together for each detection zone in common runs. Once each

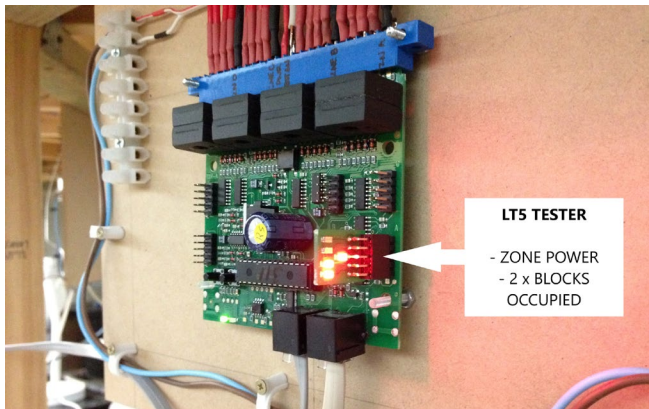

19. Using the LT5 tester in a BLD168 zone header to test the board function.

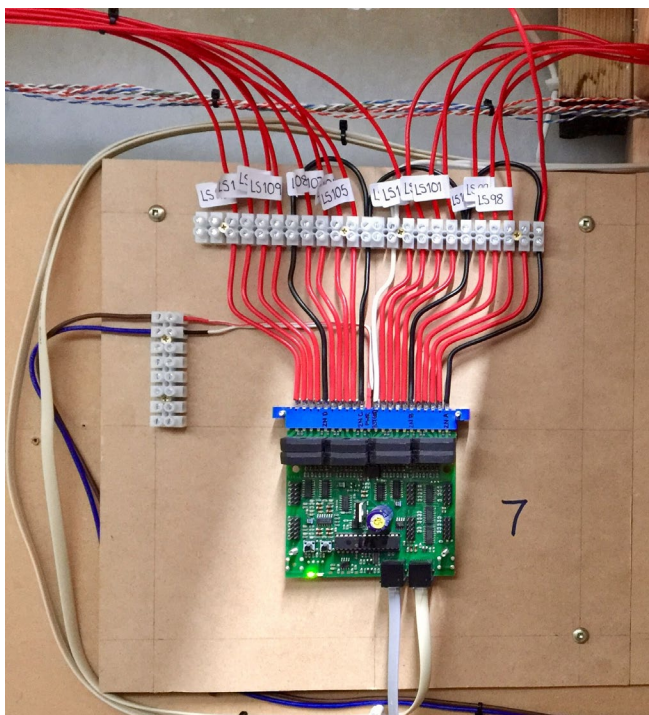

20. I kept the cable runs together and made sure to label both ends with a standard naming convention. I used red wire for the individual block wires.

detection zone has been wired, I test each block. Each BDL168 comes with a Digitrax LT5 tester.

Web: www.digitrax.com/tsd/KB588/bdl168-lt5-tester

When this tester is plugged into a detection zone socket on the BDL168, it will show that the zone is powered, and which one of the four blocks are occupied in that zone..

I made the connection between the detection section wires and the track feeders using screw terminal blocks. These can be cut to any number of connections. Remember to label both sides of the connections for easy tracing.

Isolating blocks and turnouts

To create a block in a section of track, or to isolate the turnouts, we need to gap both rails (rails A and B). The gaps placed in the

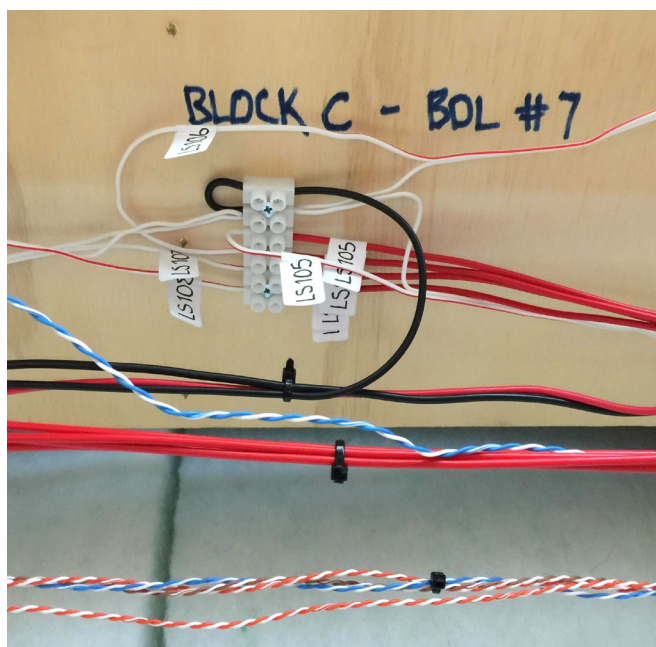

21. Block feeder terminal strips with everything labeled. This makes troubleshooting or repairs much easier.

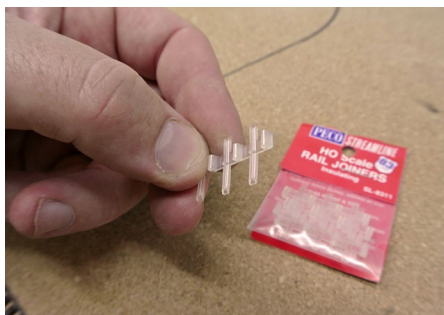

22, 23. The insulating rail joiners I used for the electrical gaps for detection. There is one gap in rail A (nearest to the fascia).

rail A section – usually the rail closest to the aisle – at the start and end of a detected block allow the BDL168 to show the occupancy for that section.

To achieve this, I used PECO Code 83 insulated rail joiners. These maintain a small gap with a small piece of plastic between each railhead to electrically isolate that rail and keep thermal expansion from closing the gap.

These joiners are virtually invisible as-is, but when painted cannot be seen without some effort.

Note how these gaps work. I must gap both rails A and B at the boundaries between power districts. But for signaling sub-blocks within a given power district, I need to gap only rail A for the detection to work.

Also note I wired my layout with each power each district to have its own PSX circuit breaker.

If the power districts are not isolated by gapping both rails, a short occurring in one power district will trip the local PSX and

also any PSXs in other power districts that have not been totally isolated by gapping both rails. This will shut down multiple power districts, and possibly the entire layout.

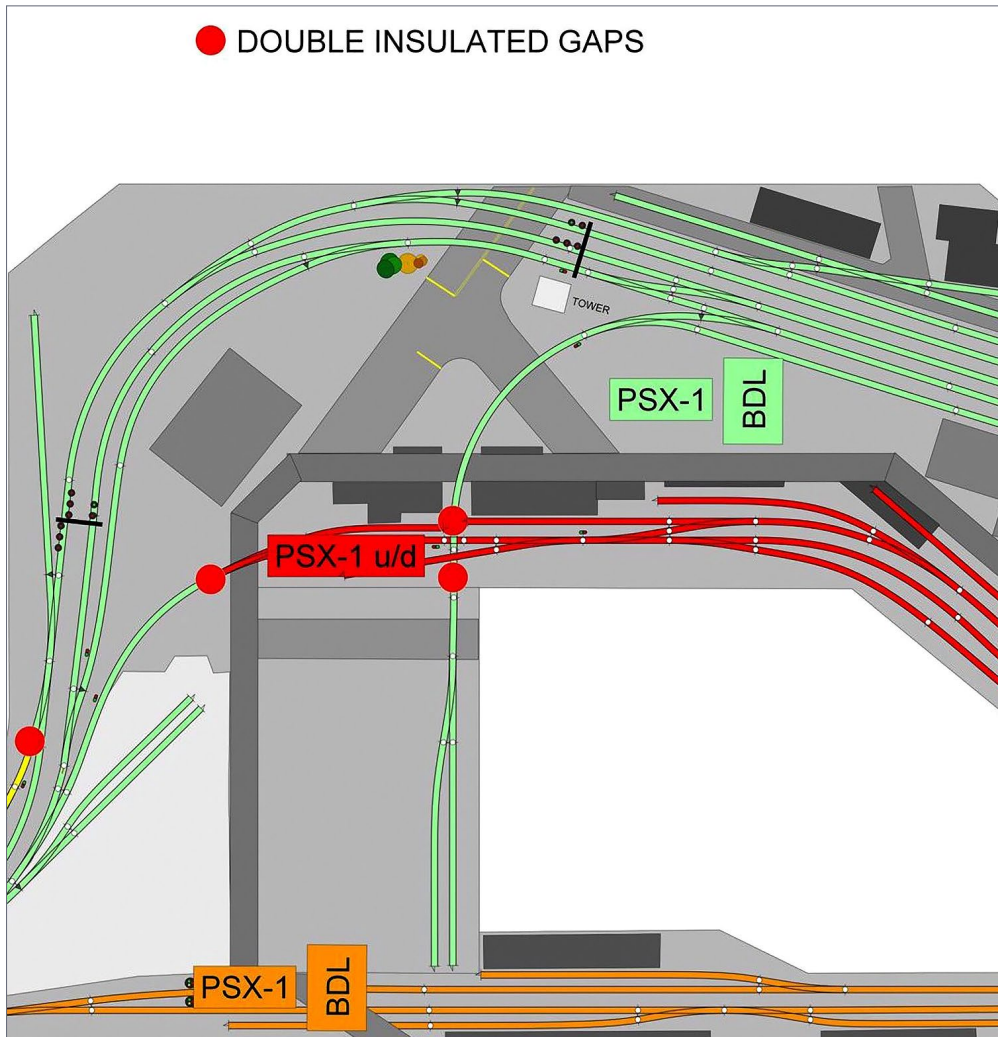

24. Note the red dots – these are the power district boundaries, and have gaps in both rails A and B. See [25] for a photo of the actual insulated block boundary.

The red dots in [24] show the required rail A and rail B isolation, so that each power district BDL168 and PSX circuit breaker are totally isolated from each other.

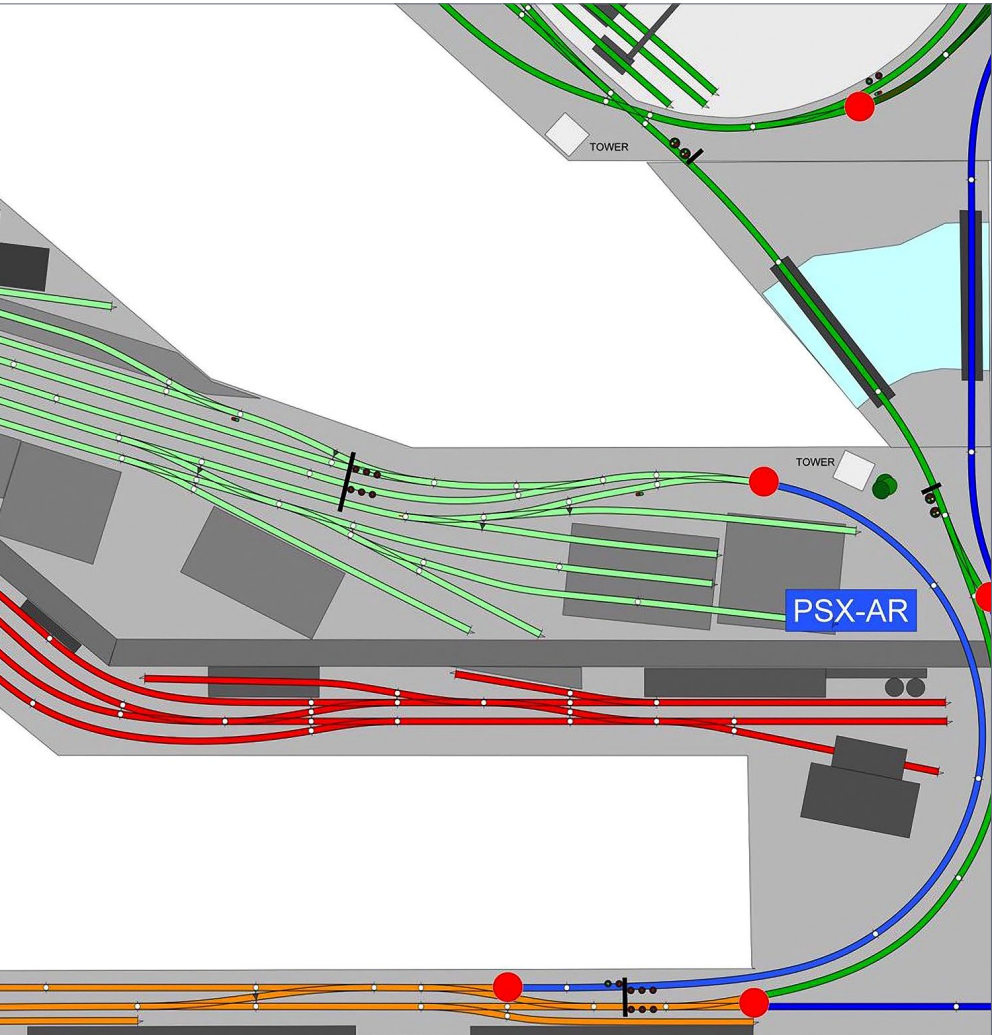

★★★★★
RATE THIS ARTICLE

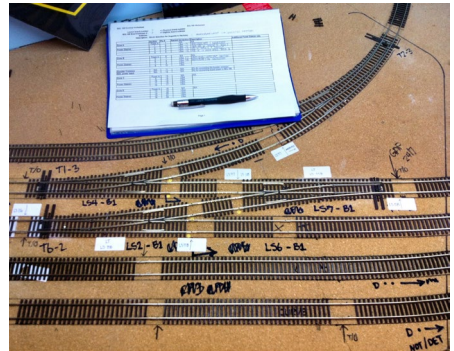
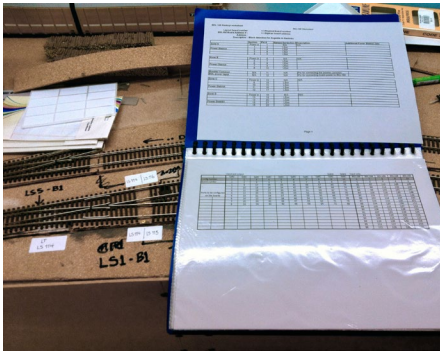

25. At the top is a double-insulated block boundary between two power districts. Rails A and B have both been isolated using PECO Code 83 insulated rail joiners. This will stop a short in LS159 from traveling into LS86 and tripping both districts' PSX circuit breakers.

26, 27. (Lower left, lower right) When installing detection and signals, make sure to record and label everything. Without some sort of organized record, it will be extremely hard to

Step Four: LEDs, signal heads, dwarfs, masts, and signal bridges

Once the detection system knows where the trains are, the computer logic software needs to translate detector input into signal aspect output back to signals on the layout.

There are many different styles of signal heads, dwarfs, masts, and signal bridges. Throw in semaphore signals, and there is a dizzying array of combinations.

I standardized on searchlight signal heads in dwarf, mast, and signal bridge configurations. I also use the G Type/tri-light head on a single signal bridge.

I based the aspect configuration I use on the NS2008 aspect tables located in JMRI. I will delve into the software logic programming of the aspects in Part 3 of this series. Here I want to focus on the signals themselves.

The searchlight aspect and the tri-color LED

To get the correct aspect colors in my searchlight and dwarf signals, I use the RR Cirkits tri-color LEDs. These display prototypical railroad colors for the three aspects of red, yellow, and green.

trace anything if a fault occurs. Since this track eventually will be ballasted and scenicked, photos of the labeled track before ballast and scenery as shown here can make a useful addition to your documentation.

They are also small enough to fit into any HO scale signal head, and could be used for N scale, too.

These LEDs come pre-connected with 24-inch 36AWG magnet wire leads. This makes threading multiple sets of wires

through masts and signal bridge frames easier. They are in my view the best LED choice for railroad signals.



28. One of the signal bridges on my layout.

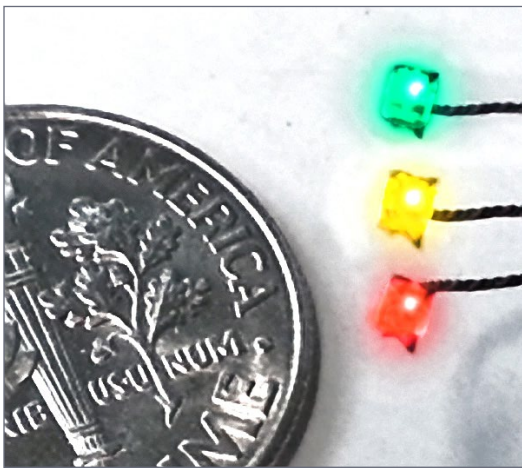

29. RR Cirkits tri-color LEDs showing their railroad-correct green, yellow, and red colors.

Specializing in DCC! ~ The Best for Less! ~ Sales-Services-Installation!



YANKEE DABBLER SPECIALS

Broadway Limited (SCALE=HO)

Challenger 4-6-6-4

Union Pacific UP \$425.00

Broadway Limited (SCALE=HO)

SP Cab Forward 4-8-8-2 AC4

Southern Pacific SP \$325.00

ATLAS 168-100 ATLAS 3' Code 100 Flex Track

Box of 100 Pieces (HO Scale) \$315.00

NCE OLD MSRP SAVINGS

TCS WOW SOUND

ESU LOK SOUND

SOUNDTRAXX TSUNAMI 2 V 1.2

DIESEL LOCOMOTIVES

Control your trains, your way!

Are you struggling with limitations on which buttons can control which effects?



Not anymore! Only SoundTraxx Flex-Map Function Mapping gives you control over all function assignments. Control any effect you want with any key you want.

Additionally, trigger a multitude of automatic sound and lighting effects based on your locomotive's movement!

Control your headlight & ditch lights with 1 key press instead of 3!

*Automatic
Emergency Stop Lighting*



SOUNDTRAXX™
www.soundtraxx.com

ADVERTISEMENT

Make LocoNet wiring extremely simple!



ACCU-LITES, inc

Your DCC Center!

Dealer Inquiries Accepted

PM42
breakout
board



BDL168
Multi-zone
breakout board



SE8C
breakout
board



BDL168
Single-zone
breakout board



Now Offering SNAPS! in packs of 6 or 12 pieces! [CLICK TO LEARN MORE ...](#)

MRHMAG.COM

[INDEX](#)

[TABLE OF CONTENTS](#)

As can be seen in [29], the colors of the aspects are perfect for model railroads, and are easily distinguishable from each other.

Dwarf and mast signals

I use dwarf and mast signals from Tomar. I have, however, upgraded the LEDs with the RR Cirkits Tri-Colored LEDs.

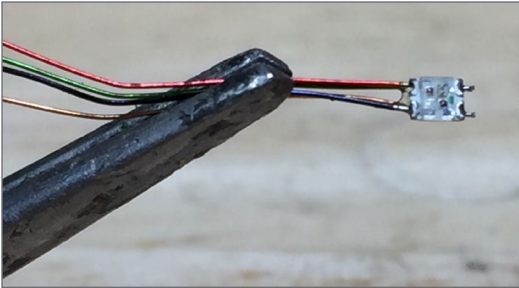

30. The RR Cirkits tri-color LEDs shown from the back. These LEDs are nice and tiny.



31. One of the mast signals.



32. A dwarf signal.

I wrote an article on the LED upgrade in the April 2017 issue of *MRH*. [mrhmag.com/magazine/mrh2017-04/dwarf-signals].

The Tomar mast signals use the same method as the dwarf conversion, but with the leads fed down through the mast brass tube. I secured the LEDs similarly, with the LED glued to the light pipe, and secured with superglue.

This takes patience, but when completed the results speak for themselves..

Signal bridges

Due to track configurations and structure locations, I used various signal types around the layout. I use dwarf and mast signals when there is sufficient spacing between tracks for proper train clearance.

Where space is more limited, I use a signal bridge.

www.SBS4DCC.com

Introducing the NEW
ZIMO MX660
Micro Sound Decoder



DELICATELY
NARROW

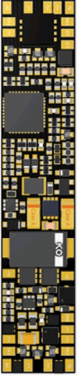

AMAZINGLY
THIN

48 x 9.5 x 2.2mm

0.7 amp
Continuous Current

6 Function Outputs w/
1k ohm Resistors

1.1 watt, 8 ohm Amp

Universal format with
Large solder pads for
easy connection

Flat for easy mounting

Full ZIMO Feature set

Available 2018

N – HO – HO_{n3} Scale Trains



Installing DCC sound just **NOT** your thing?

Trust Traintek for sales and installation of sound decoders from these fine vendors!



"Taking model railroad control
to the next level ..."



traintekllc.com

Click here for more details...



"Traintek was the
way to go!"



ADVERTISEMENT

Discover the wonders of TrainMasters TV ...

FREE peek >>



TRAINMASTERS.TV

www.trainmasters.tv



33. Here is the triple-head mast at Carlisle Junction.



34. A universal-style signal bridge can span two to four tracks.

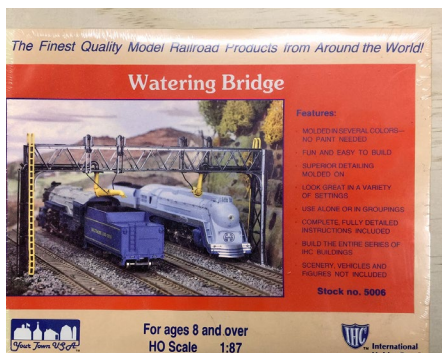

35, 36. I used International Hobby Corporation (IHC) plastic kits that are now out of production. Both the Signal Bridge and the Watering Bridge kit use the same bridge frame.

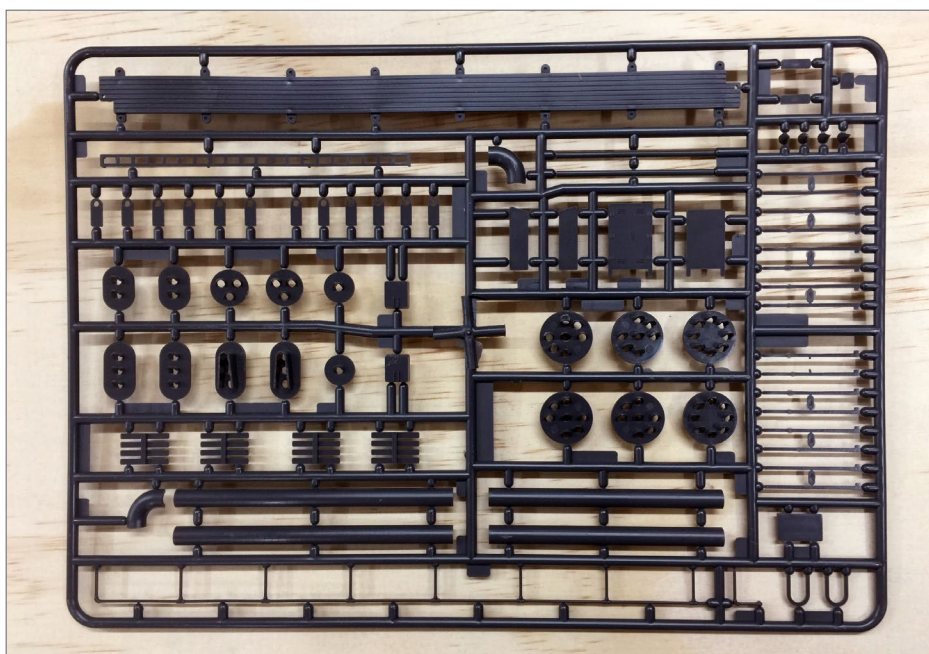

37. Fortunately, I found several complete "signal head" sprues from the IHC - Signal Bridge kit on eBay. These let me install both searchlight and tri-light head signals across the layout.

Great control in a tiny package



**Original
Touch Toggles**

- Touch Toggle™ plug in controls
- Bright clear indication
- Easy setup
- Flexible system

Stall Motors, Twin-coils,
Power, and Servos

Now for Tam Valley Depot
and MRservo too!

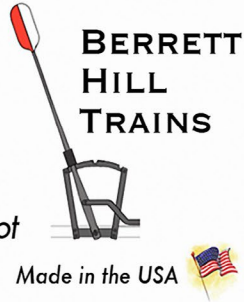

What will they think of next?

www.berrethillshop.com

ADVERTISEMENT

“That’s one **impressive** piece of hardware.”

– TONY KOESTER

“I’m having **more fun** with trains now
than I have in years.”

– PETE MULVANY

“Overall, this is **truly a game changer** for me...
that’s an investment worth making.”

– JAMES MCNAB

“...the only description I can think of is WOW!!!!
What a cool addition to any layout. **It was**
so easy to use and realistic to operate you
guys have hit a real home-run here.”

– LIONEL STRANG



LEARN MORE

ADVERTISEMENT

TamValleyDepot.com



Celebrating **10 Years**
of Serving the Hobby
2008 - 2018

Dual Frog Juicer

Automatic DCC Polarity
Reverser

Power Two Frogs

Crossovers

Crossings

Automatic Reverser for
Turntables

Wyes, Loops

Circuit Breaker



**MRH
Supporter
since 2009**

Use with 2-10 Amp Systems

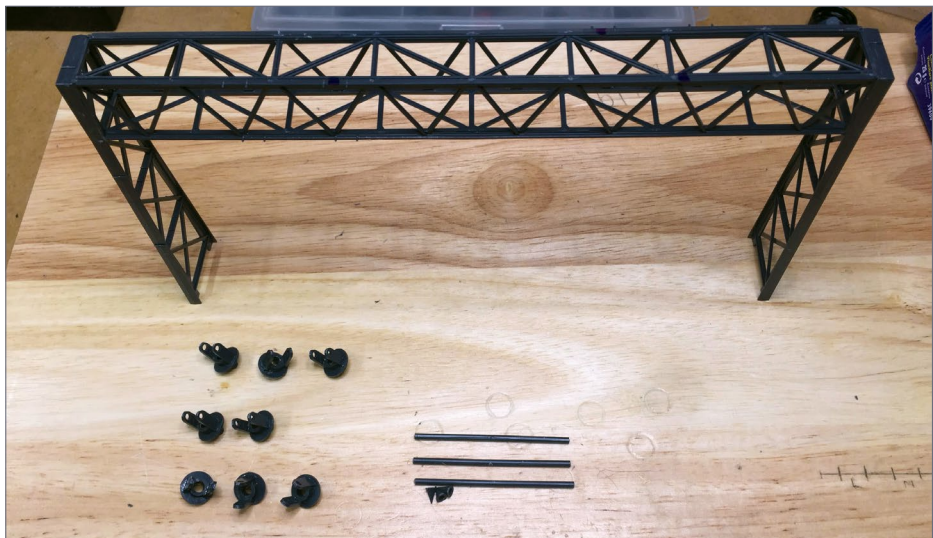

38. These kits go together easily straight from the box, and work well. Being able to construct different combinations of signal heads and bracket masts makes these kits extremely adaptable. Unfortunately, they're no longer in production and are becoming hard to find.

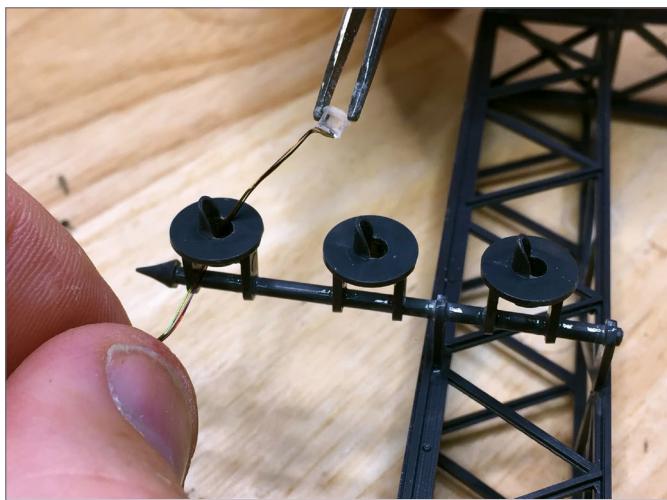

39. Installing the LEDs into the signal heads.

The construction of the signal bridge is fairly easy, and one can be completed in an hour. The use of 36AWG magnet wire coupled with plastic IHC signal heads creates a great-looking signal bridge. The LED is attached to a 1/8" light pipe with CA. This is then push-fit into the plastic IHC searchlight head.

Once the magnet wires are fed through the searchlight head, I feed them through some 1/8" black heat-shrink tubing and attach them to the signal bridge using black Kynar wrapping wire.

Once completed, the signal bridge is neat and unobtrusive.

Connecting the signals

The signals connect to a Digitrax SE8C signal driver. The signal logic computer connects to the signal driver and indicates to the signal driver which aspect the signal needs to display. That means we need a method of connecting the signal driver to the computer hardware via LocoNet.



RATE THIS ARTICLE

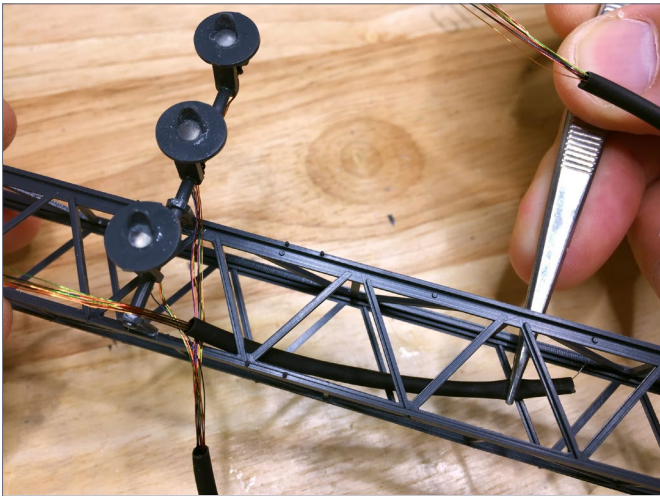

40. Routing the LED wires in the signal head.



41. Here is the final wired signal head before painting.

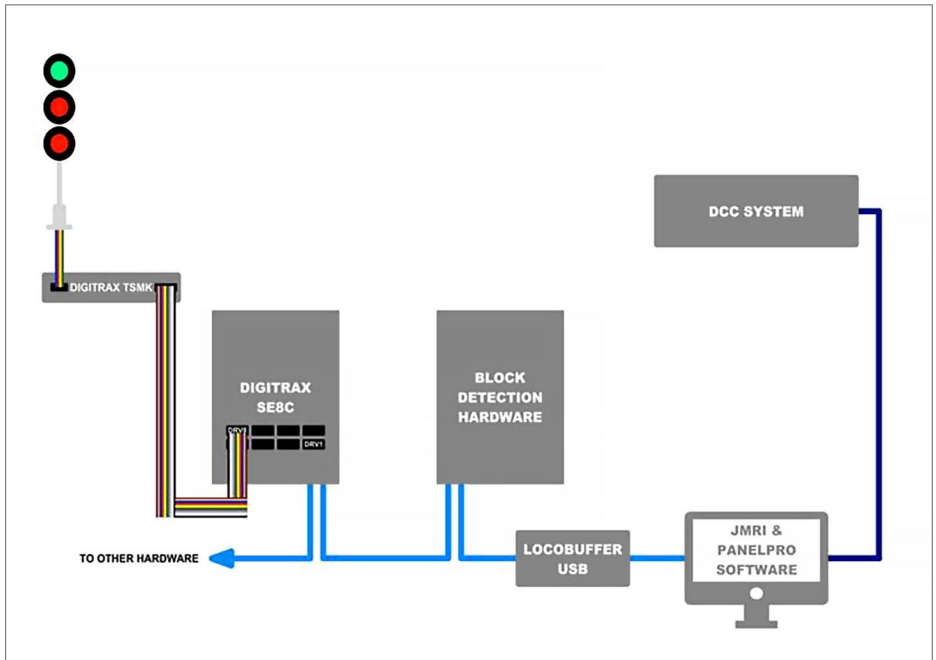

42. Diagram showing the signal-driving parts.

Diagram [42] shows how the LED signal heads connect to the SE8C, then to the LocoNet, and back to the signal logic computer running JMRI.

LocoNet requires a special data connection back to the DCC system when using the Digitrax SE8C and BDL168 on a non-Digitrax layout. Since my layout uses the NCE DCC system, I must use a RR Cirkits Locobuffer USB module for the LocoNet-to-computer-and-DCC-system connection.

The RR Cirkits Locobuffer USB module allows connecting LocoNet to a non-Digitrax DCC system through JMRI, and it translates the LocoNet data for use by the computer that is running JMRI.

The Digitrax manual [44] shows how to connect the LEDs of a signal to an SE8C signal driver board [43] using 10-wire flat cable and a Digitrax plug-n-play signal mast.



43. The Digitrax SE8C can drive 32 signal heads. It also can drive eight slow-motion switch machines. Each of the signal cable outputs can drive four separate LED signal heads.

www.digitrax.com/products/detection-signaling/se8c.

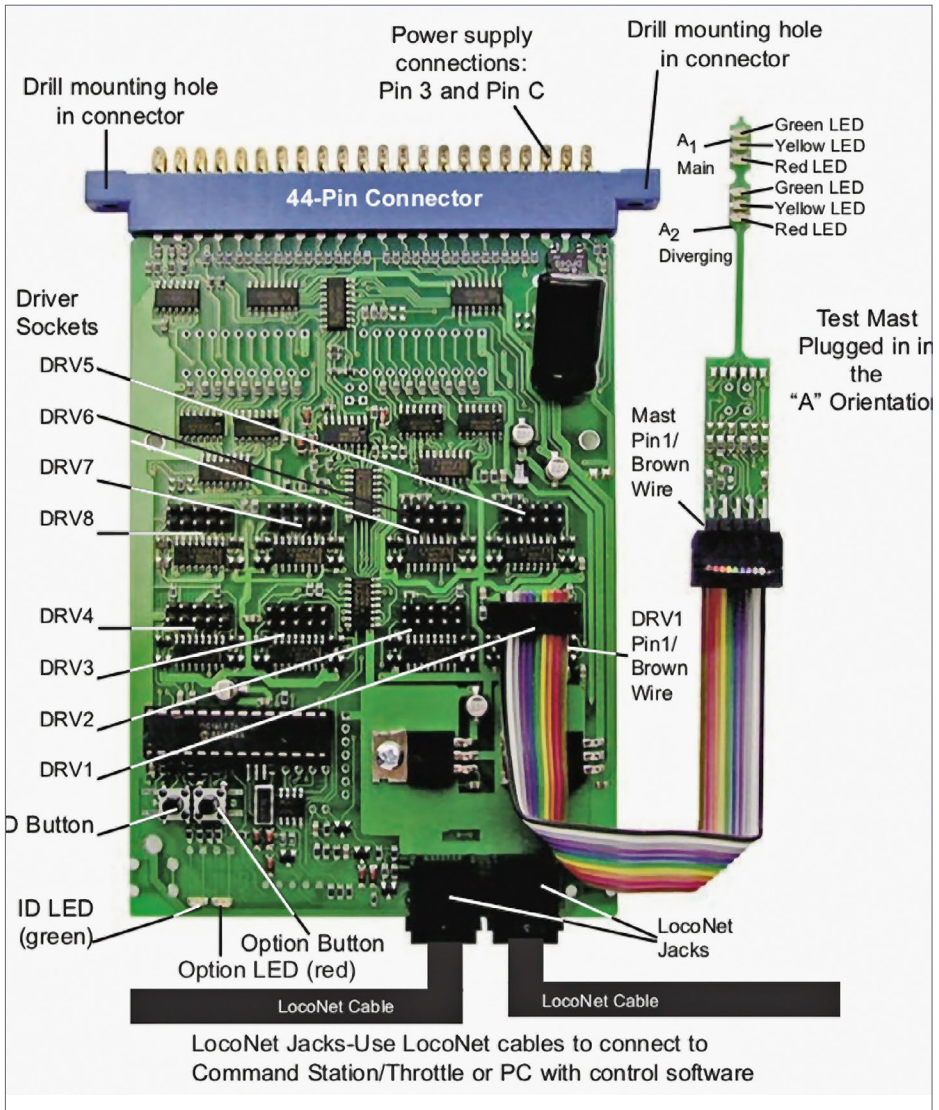

44. Page from the Digitrax manual showing how the SE8C connects to a Digitrax plug-n-play signal.

★★★★★
RATE THIS ARTICLE

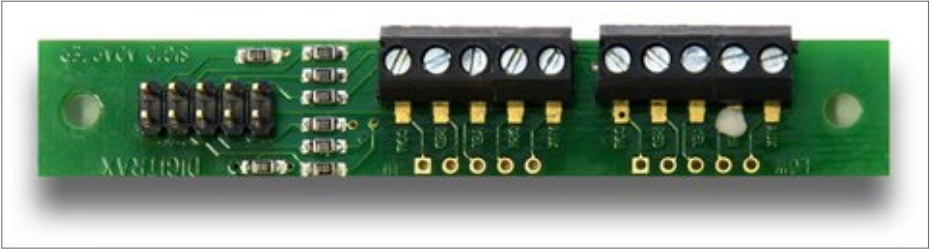

45. Digitrax signal driver Terminal Strip Mounting Kit (TSMK).

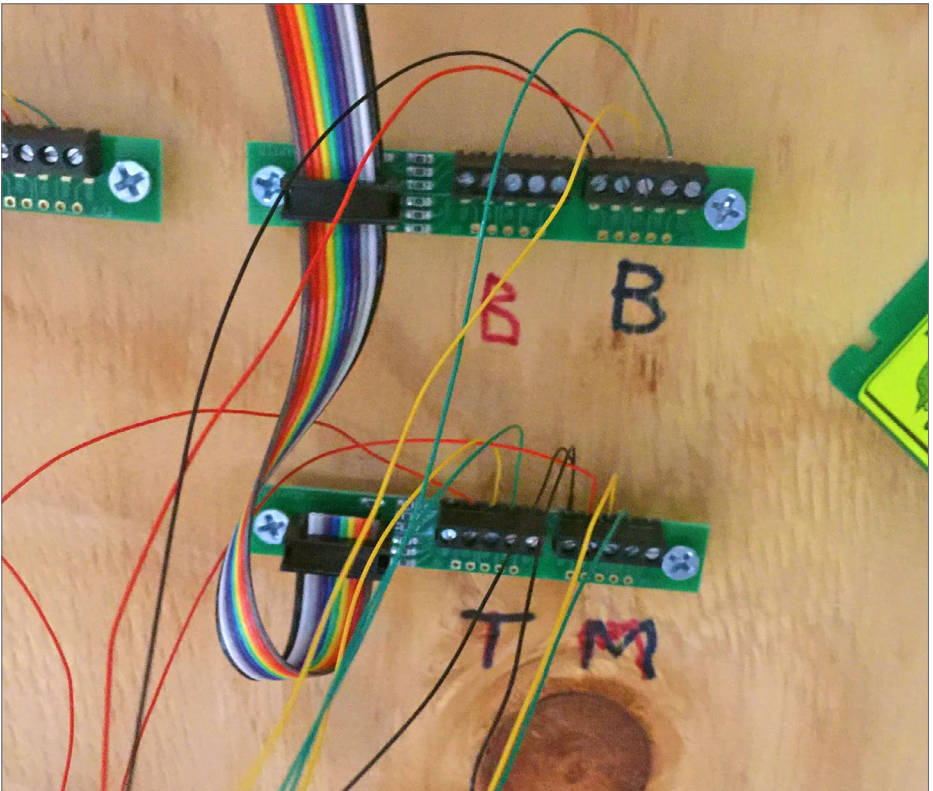

46. This is the TSMK wiring to drive a three-head signal. The black T, M, and B means the top, middle, and bottom head. Note one of the TSMK terminal blocks, the one with the red B, is not used when driving a triple-head signal.

I used a Digitrax Terminal Strip Mounting Kit (TSMK) to connect the signal masts to the 10-wire flat cable and SE8C.

www.digitrax.com/products/detection-signaling/tsmk.

The TSMK incorporates current-limiting resistors, which are required for any LED-based signals connected to a Digitrax SE8C. They also allow directly connecting an LED common-anode power wire, and provide individual aspect color wires for each signal head.

I need two TSMK's to drive one triple-head signal mast [46]. Each terminal block on the TSMK drives one searchlight head with the three required colors (red, yellow, green). The TSMK has two terminal blocks, allowing it to drive two heads.

I use a 10-pin flat cable to connect the TSMK to the SE8C driver pins [49]. I orient the cable so the dark brown wire goes to pin 1 [48]. In Part 3, I go into detail about programming the signal heads via the SE8C with JMRI/PanelPro.



47. To connect the TSMK to the SE8C driver pins, I use a 10-wire flat cable and 10-pin IDC connectors.

The Digitrax manual for both the SE8C and TSMK show the orientation for this.

www.digitrax.com/media/apps/products/detection-signaling/tsmk/documents/TSMK.pdf.

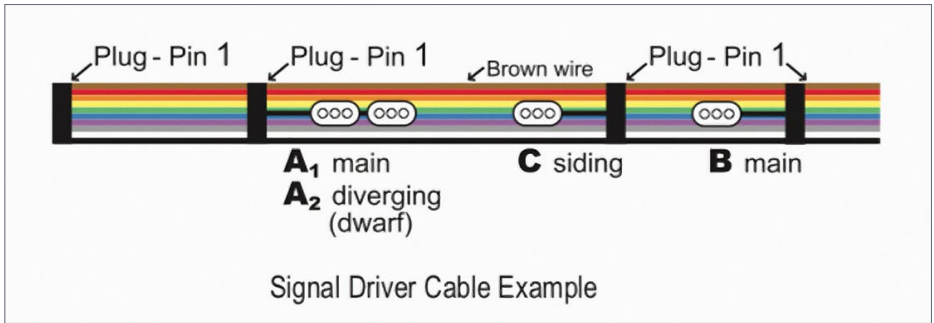

48. 10-pin flat cable orientation, with the brown wire on pin 1.

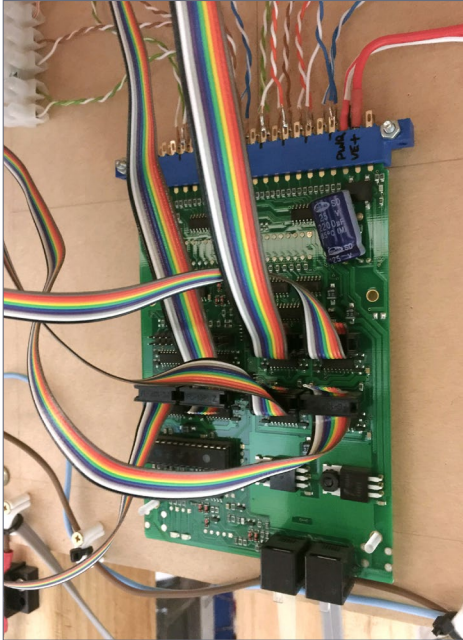

49. Multiple TSMK cable connections to an SE8C signal driver.

Conclusion

Now that we have installed the components for the detection system, block and power management, and the signal-driving hardware, we are ready to begin programming the computer signal logic.

The whole process for installing detection and signaling is a journey. It takes time to get your arms around – it needs to be thoughtfully planned, but it's quite exciting when that first signal displays the correct aspect!

Please join me next time as I delve into the actual programming, bringing train detection and signal aspects together. See you next month as we talk about adding blocks and signals to the JMRI Panel.



50. It's all clear ahead!

JASON MILLER



Jason lives in Diamond Creek, Victoria in Australia. He has been building his HO scale layout for the past eight years and attributes his start to his wife Linden, who said that he needed to get a hobby! What a wonderful wife....

Jason is a professional fire-fighter and has been doing this for 15 years. When not at work he enjoys spending time with his family and working on the layout. Jason and Linden have two boys Lachlan, 11, and Toby, 7, who are both showing a keen interest in the hobby.

When not working on the layout and spending time with the family, Jason likes to work in the garden of the family home, and also enjoys having a coffee with the family at one of the local coffee shops.

The layout is HO Scale and is based on the Reading Lines between the early to late '70s and the Conrail merger era. ■



Bowser

EXECUTIVE LINE

Cal Scale & Cary

Lost Wax Brass, Plastic Molded Detail Parts & Wire Form Parts

In Stock Now!!



Air Horns



Bells



Antenna Sets



MU Cables



Spine Car Trailer Hitches

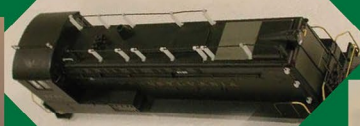

Winterization Hatches



Curved Roof Grabs

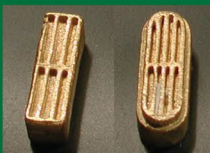

Exhaust Stacks



Foam Work Cradle
HO, N & O Scale



Ladders

HO Wheels & Trucks

Metal wheels with needlepoint axles: 33" & 36" packs of 20.



Freight Trucks with metal wheels:
Roller Bearing, Bettendorf,
Caboose, Semi Elliptical, Crown
& Arch Bar.



Plastic Utility Box



Click here to check out the details for these and other great Bowser products!



Complete Train Control

Introducing Wifi Interf

- **Wi-Fi interface to a Digitrax LocoNet for up to four compatible mobile Wi-Fi devices and Apps.**
- **Compatible with most Android and Apple devices running supported throttle apps**
- **Easy Setup and Configuration. A single LNWI works 'out of the box', with no additional configuration required.**



LNWI Locomotive
The LNWI allows
to LocoNet and r

Find out how eas

g the LNWI face



et Wifi Interface | **\$79 MSRP**
you to connect compatible WiFi devices
un trains using compatible throttle apps

y it is @ www.digitrax.com/throttleapps/

 NORTH AMERICAN RAILCAR CORPORATION
 NORTH AMERICAN RAILCAR CORPORATION



National Steel Car 5092 cf Combo Door Box Car 1971 - present



BCOL - light green, built 1972

12 Rd #s for each paint scheme



PGE - light green, built 1971



Accuracy and
Detail... in Scale



PGE - dark green, light green door, built 1971



BCIT - dark green, built 1972



BCOL - with underline, re-paint 1987



BCOL - large italicic lettering, re-paint 1986



BCOL - 80,000 series, re-built w/team door 1990s

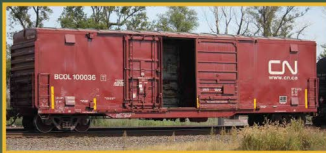

BCOL - brown, CN noodle & url, vents, shopped 2003



BCOL - 100,000 series, re-built 1990s w/vents, w/team door

CLICK HERE FOR
HO - 5092 Boxcar

CLICK HERE FOR
N - 5092 Boxcar

NARC Cars are sold
exclusively through

Pacific Western Rail Systems

WHAT'S NEAT

column



Model Railroad Hobbyist | November 2018 | #105

KEN PATTERSON AND HIS FRIENDS TACKLE KUDZU, TRUSS BRIDGES, AND MUCH MORE ...



RATE THIS ARTICLE

THIS MONTH, JEFF PARKER COMES BY THE STUDIO and spends three days building a 200-foot Central Valley Parker* truss bridge in HO scale. Campbell Rice shows us how to model kudzu, a vine that grows trackside – and everywhere else – in the southern parts of the US. We look at two Lego layouts, and Matt Hermann from ESU LokSound shows us their latest DCC throttle system.

Central Valley bridge build

Jeff Parker walks us through the process, from start to finish, of building a Central Valley through-truss bridge. He starts by laying all the parts out on a table, removing all the bridge parts from the sprues, and then sanding all the edges and cleaning to remove any mold parting lines.

▶ **PHOTOS AND VIDEO OF SUPERB MODELING**

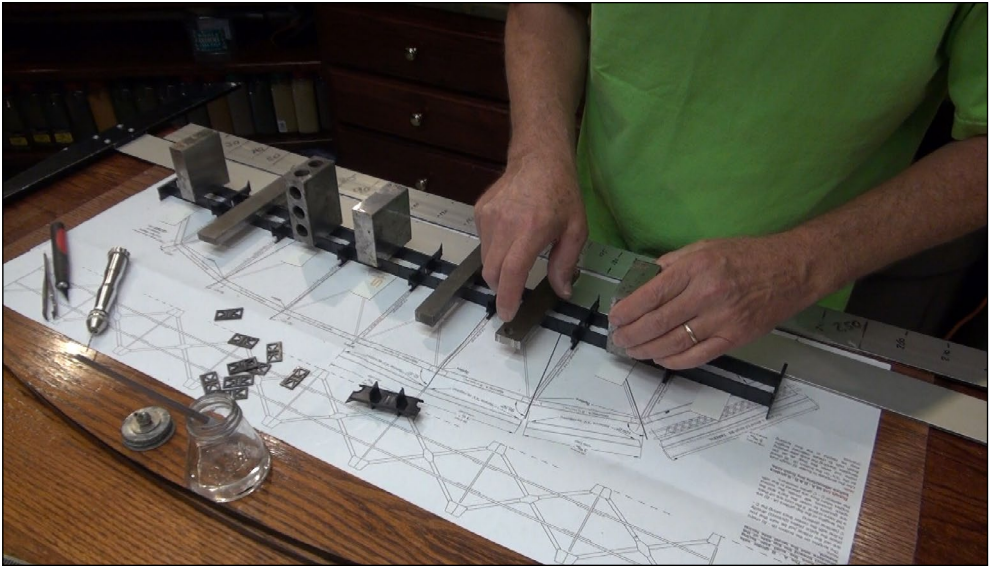

1. (Above) He then focused on the bridge deck, using the kit's supplied drawings as a flat surface to lay out the parts to match the drawings. This makes building the kit easy, without much chance of error.

* Charles H. Parker patented his truss design in 1870. It is a variation of a Pratt truss, except that the top and bottom chords are not parallel. A Parker truss uses less material than an equivalent Pratt but is more complex to build. Most Parker truss bridges are a through truss but can also be a pony truss or a deck truss.

2. (Top right) Once Jeff had the deck girders glued together, he proceeded to build the bridge's top deck. Jeff painted the deck surface with Rustoleum Camouflage Brown, then painted the rails a rust color. Jeff attached the rails to the bridge deck by using a small punch to bend the molded plastic spikes over the base of the rail, all the way across the bridge's length.

WHAT'S NEAT | 3

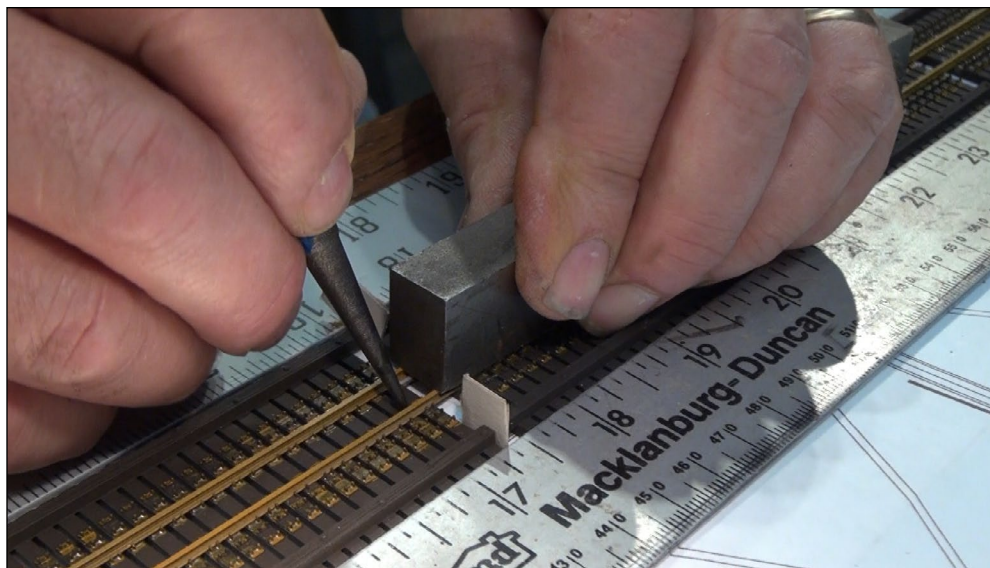

Watch on
YouTube

MRH
MODEL RAILROAD HOBBYIST
November
2018

MRH November 2018 issue:
Whats' Neat with Ken Patterson

WHAT'S NEAT | 4



3. (Above) Jeff then started cutting box girder sections to match the drawings and placed them on top of the plan until he had an entire bridge side roughed together with MEK solvent.



4. (Bottom left) Jeff then wire-brushed the bridge sides on the table to remove any glue spots on the sides of the girder sections.

5. (Top right) As Jeff built the second side of the bridge he used steel weights to hold everything flat and in place as the glue set up.



Also see the new "What's neat this week" weekly video podcast!

**WATCH
NOW >>**

WHAT'S NEAT | 6



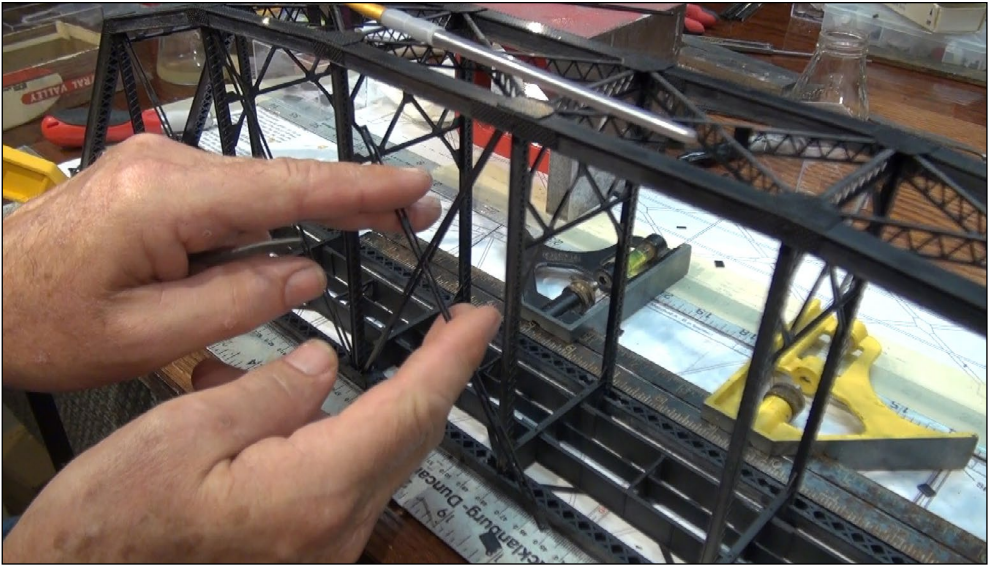

6. (Top left) Once Jeff had both side trusses built he started attaching the cross-lattice work in the inside of the trusses. This will hold both sides together with a very strong bond that makes it easy to handle the structure without damage.

7. (Bottom left) Once the center cross lattice braces were in place, Jeff started working across the top of the bridge to install the X-pattern cross lattice across the entire structure.

8. (Top right) The next step is to cut out a small section of cross lattice so the side steel cross bands can be slid into the space created in each corner of the bridge's box side structure. These cross bands intersect with each other in the box, forming an X-pattern on both sides of the bridge, all the way across.



Also see the new "What's neat this week" weekly video podcast!

**WATCH
NOW >>**



9. Once the glue dried, Jeff positioned the bridge structure across the bridge deck. It slips into place and stays put. Instead of gluing these two sections together, it is better to leave them loose for track cleaning and maintenance.



Also see the new "What's neat this week" weekly video podcast!



**N SCALE
ORDER BY
NOV. 19**



CLICK HERE



10. Here is an array of bridges that Jeff has built. Each is painted either black or silver, and some are weathered with brown paint sprayed lightly over the silver. One bridge is double track and one is HOn3/HO dual gauge. The N scale version of the 200-foot-long truss bridge is scratchbuilt using parts from three 150-foot truss bridges in Central Valley's N scale line.



Also see the new "What's neat this week" weekly video podcast!

**WATCH
NOW >>**

Lego layouts



11. We have two Lego layouts to look at this month. The first, named Artlug.org, is a small layout built at a low level so children can easily view it. It has tricked-out buildings and street scenes that all scale out with what I would call Lego realism. It has gas stations, cafes, and factories with actual operating machinery inside.



Norfolk and Western Historical Society



Looking for N&W or
Virginian models,
books or videos?

Check out the
N&WHS Commissary
for the best selection
anywhere!



Researching an N&W or VGN
project? Our Archives
probably has what you need.
We have well over 150,000
items already cataloged with
more added all the time.
Drawings, photos, diagrams
are just a few of the many
items in our collection.
*Consider joining for \$45 per
year. You get 4 high quality
magazines and members save
on items from the archive!*

[Click Here!](#)

Waiting a
MONTH

just too long?

Check out Ken Patterson's
**WEEKLY VIDEO
PODCAST!**



Watch on

**You
Tube**

Get your weekly
What's Neat
fix on YouTube!

[Check it out >>](#)

*Watch Ken's What's Neat This
Week video podcast on
YouTube each week!*



12. The second layout was made by modelers from all over the country. Texas, Illinois, Arkansas, Michigan, and California are some of the places mentioned in this month's video. The layout was built higher than the Artlug layout, more for adult viewing. Some of the taller buildings cost \$700 to \$1000 or more to assemble. Some of the buildings are taken apart and rebuilt as each modeler's skills advance. Some of the trains run on battery power and others pick up their power from the track rails. It was wonderful to discover the Lego layouts at the NMRA National Convention in Kansas City this past summer and understand the serious skill needed to build such magnificent art forms with little plastic bricks.



Campbell Rice plants kudzu



13. In this month's video, Campbell Rice creates scale-size kudzu, a fast-growing leafy vine that grows in the southeastern United States. Campbell says he has seen entire houses covered with this vegetation. When the vine catches fire, it usually burns out of control.

Campbell starts by spreading Woodland Scenics poly fiber pulled apart for a very fine but clumpy appearance to cover his scenery base. He then sprays the entire scene with Woodland Scenics scenic cement to wet it. He then sprinkles green Noch small leaves over the poly fiber, and then accents the leaves with larger cut paper leaves also made by Noch. These leaves are much like the leaves we made a few years back on What's Neat with a leaf punch. Once the glue is dry the leaves are firmly attached to the poly fiber to finish the scene.



Also see the new "What's neat this week" weekly video podcast!

**WATCH
NOW >>**

2003 Celebrating 15 Years! **2018**
OF TRACK BUILDING INNOVATION

FAST TRACKS

Build your own trackwork easily, quickly, and affordably.

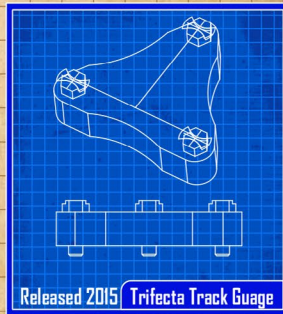
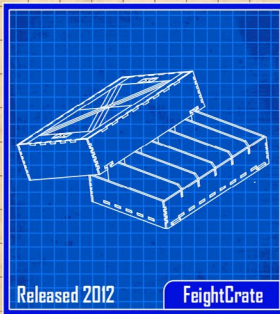
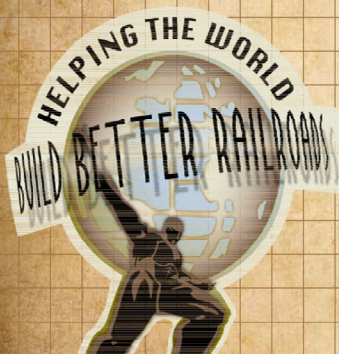
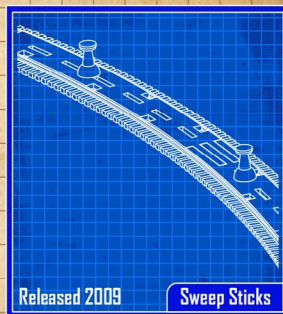
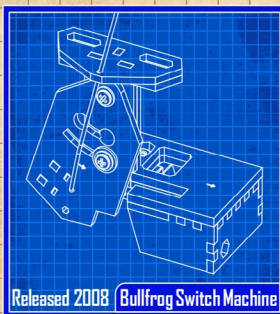
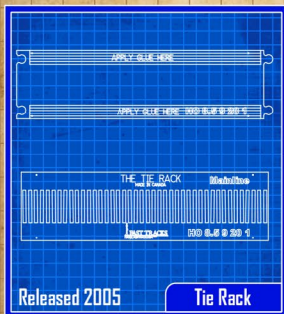
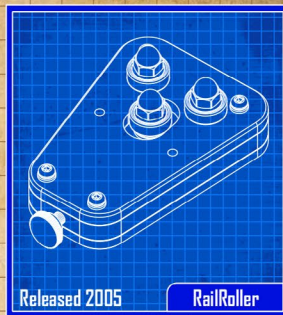
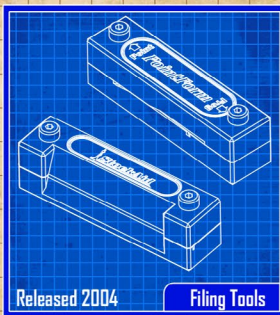
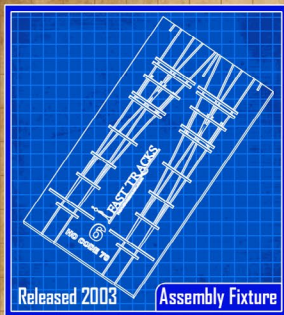

Easy ordering • Live online support • Earn Waypoints with every purchase

shop online 24/7 handlaidtrack.com

1-888-252-3895

service@fast-tracks.net

ESU LokSound DCC throttle system



14-15. (Above, and next page) Matt Herman from ESU LokSound stopped by the studio to show off the new Android-based ESU DCC throttle system that was all the rage at the NMRA national this summer. The system comes with a base station, power supply, and a throttle.

The throttle has a small flat touch screen and a large motor assist throttle knob. The buttons on the side of the handheld can be programmed to any function you wish. The system can be connected to a computer and be loaded with the latest software from LokSound. New features are frequently added as the throttle is constantly being improved.

The display can show all the locomotives on the layout as it detects them, then shows a picture of the locomotives on the screen. Matt said they tested 32 throttles with the base station and they were able to independently control all 32 locomotives. The handheld rechargeable throttle can be used with Digitrax and NCE via wi-fi, using an app like Engine Driver, JMRI, and other throttle apps out there.



14-15 (continued). Simply find the wi-fi signal and select the train you want to run – you're off to switch cars in just a few minutes. For further information watch this month's "What's Neat" video and check out the LokSound web site at www.esu.eu/en/start.



Also see the new "What's neat this week" weekly video podcast!



MRH MARKETPLACE



N SCALE OLD WEST BUILDINGS & SCENERY

REALISTICALLY DESIGNED & DETAILED
FULLY ASSEMBLED 3D LASER PRINTED PRODUCTS

* NO SMALL PARTS *
* NO GLUE * NO MESS – NO FUSS

CROW RIVER PRODUCTS

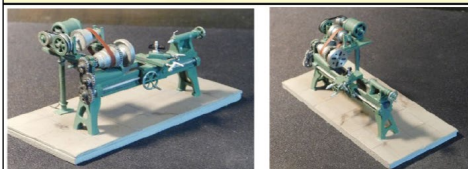

O Scale Kit 335-D

Motor Conversion for Machine Tools
Shown adapted to our 335-A Engine Lathe

Our Machine Tool kits are of the overhead belt type. This kit, allows for attaching an electric motor directly to the machine. The Kit includes a new style electric motor, A base and various pulleys and hardware.
Made in USA \$12.00

**HO & O Scale Machinery, Derricks,
Engines, Hardware & Waterfront Models**
Pawtucket, RI 02861 Tel 401-723-0065
www.crowriverproducts.com



Yarmouth Model Works

HO scale resin kits and detail parts

Tel. 519-633-7574

pierre.oliver@elgincarshops.com

www.yarmouthmodelworks.com

U.S.A. MAILING ADDRESS
2014 Holland Ave Unit 617
Port Huron, MI 48060

CANADIAN MAILING ADDRESS
263 Sunset Dr.
St. Thomas, ON N5R 3C4

MAIN STREET AMERICA HISTORIC ARCHITECTURE



MAIN STREET HERITAGE

www.mainstreet-heritage.com

CLICK
HERE
for all
our HO
& O kits



P.O. Box 6 Paonia, CO 81428

Ph. 970 527 4586

Made in The USA

Cast resin items for All Scales.
Tunnel portals, bridge piers, abutments,
culverts, and retaining walls.
Trackside details and sage brush tree
armatures.

"FREE SHIPPING see website for details"



USRA DS Express Box NWP Redwood Empire



westerfieldmodels.com



LOGIC RAIL™ TECHNOLOGIES

"Sophisticated
Model Railroad
Electronics"



Please visit our website and online store!

21175 Tomball Pkwy
Suite 287
Houston, TX 77070

Phone: (281)251-5813
<http://www.logicrailtech.com>
info@logicrailtech.com

LOOK
at what's new at
Black Cat this month

Click here for
our website

CP wood express
reefers from the 20's.
in Dulux gold or
gold leaf
lettering



Black Cat Publishing
(204)489-5005
ajfergus@mymts.net
blackcatdecals.com



ITLA Scale Models

Cooper's Alley
HO Scale - Precision Laser Cut Wood Kit



CLICK HERE FOR MORE INFORMATION
www.itlascalemodels.com



CLICK TO REGISTER NOW
- IT'S FREE!

**MONASHEE
LASER
ENGINEERING**

**COME VISIT
US HERE**



MANUFACTURERS OF FINE RAILROAD
STRUCTURES AND ROLLING STOCK MODEL KITS

IF WE CAN DRAW IT ...

MasterpieceModules.com

T-trak Module Kits & more
CNC machined precision finger joints
parts are self-locating & self-clamping
All hardware is included

**HOBBY
MARKETPLACE**
ads are
economical and
effective.

Click [HERE](#) to learn more.

Great Decals!™

FEC, Interstate, Virginian
Railway, & L&N Titles
After Hours Graphics Line
Coupler Gages and More
In O, S, HO, and N Scales



MOUNTAIN SUBDIVISION HOBBIES

www.modelrrsupply.com

FREE USA SHIPPING OVER \$39.00

NCE - SOUNDTRAXX - DIGITRAX - ESU LOKSOUND
SPROG - DCC SPECIALTIES - INTERMOUNTAIN - CMX
BAR MILLS - BOWSER - ATLAS - CIRCUITRON - PECO
RIX - PIKESTUFF - CENTRAL VALLEY AND MORE!!!

2019 TROLLEY CALENDAR

Full cover and 13 B & W photos
East Penn Traction Club
c/o Charles Long
227 Locust Road
Fort Washington, PA 19034

PRECISION DESIGN CO.
LASERCUT KITS - CUSTOM DECALS

PDC.CA

Authorized **RailPro** Dealer

FREE SHIPPING in the US and CANADA

Model Railroad Control Systems

Geoff Bunza Project Boards
DCC Occupancy Detectors
CMRInet Compatible Nodes
Layout Telephone Systems
RFID Switchlist Generator
Switch Machines and Drivers



Click Here

HO DIESEL SUPPLY

CUSTOM SOUND LOCO'S-REPAIRS-UPGRADES
Weathered New and Rebuilt Locomotives
Powered Chassis-Trucks-Motors-Handrails-Electronics
Parts Inventory Always Changing
www.hodieselsupply.com
email:gerry@hodieselsupply.com

Ultimate switching tutorial

Up close and personal ...

with Mike Confalone

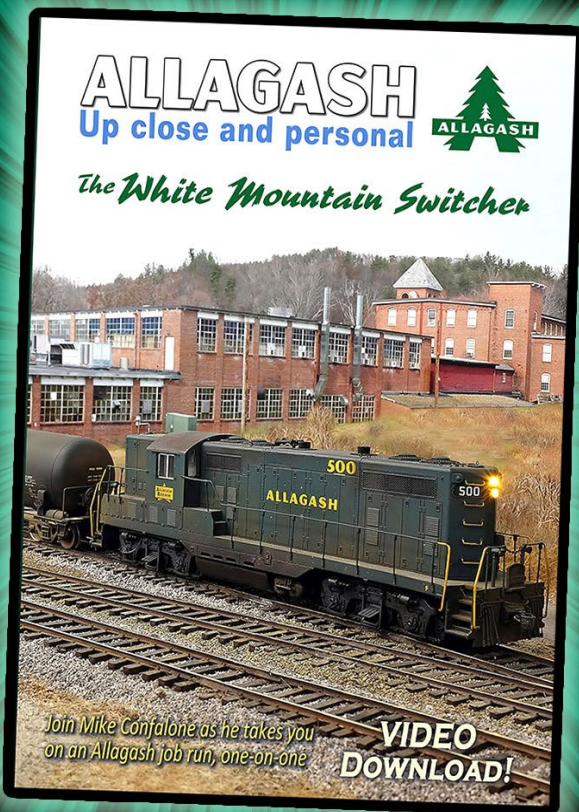

Pre-order
and **SAVE!**

DVD media
~~\$29.99~~

\$24.99

FREE shipping US
50% off shipping foreign

Video download
~~\$14.99~~

\$9.99

HD
format

Running time: 2 hours (Releases end of September)

 **Pre-order White Mtn Switcher**

from the
**Model Railroad
Hobbyist** *Store*

Adventures in Proto:48



*Jim LINCOLN upgrades a Hi-Rail Lionel
PS-5 gondola ...*

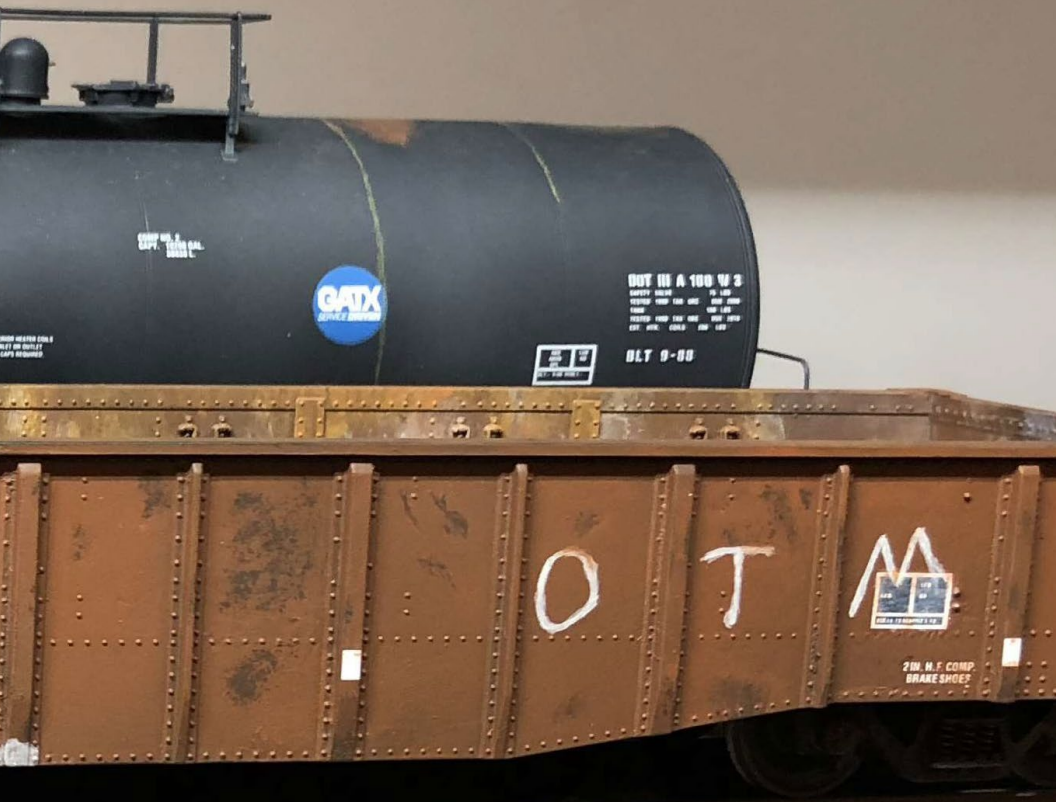

1. Follow along as Jim Lincoln takes a “toy train” Lionel model and upgrades it to this realistic Proto:48 model.



RATE THIS ARTICLE

WHEN YOU MENTION *LIONEL* TO MOST MODEL railroaders, it harkens back to their youth and toy trains circling the Christmas tree.

We generally do not use Lionel and the word accurate in the same sentence. Many modelers talk about the old days of “pizza cutter” flanges. One would never associate that with accurate modeling, right?

You might be surprised to find some of the most detailed models in the O gauge world come from Lionel! Sure, they make their living selling toy trains designed for tight curves: the “O-27” Hi-rail trains are designed for 27 inch radius curves, which is a 13.5” equivalent in HO!

However, when Lionel makes a model, apart from the trucks and couplers the model is typically to scale and quite accurate.

The GS-5 and Proto:48

I model in Proto:48. Regular 2-rail O scale uses a gauge rounded to 5 feet, which is about 3-1/2 inches too wide. Proto:48 uses the correct 56-1/2” distance between the rails, and more realistic wheel flanges.

Early in my Proto:48 adventures, I came across one of the Lionel PS-5 52’-6” gondolas. I had heard great stories about them and was told: *if you can find one, buy it.*



2. This is my first Lionel gondola fresh out of the box. Apart from the trucks and couplers, this is a wonderful model.

The stories were true: Lionel has produced an excellent, highly accurate model of a Pullman Standard drop-end gondola. Great! There's only one problem: Pullman Standard made over 1500 copies of the standard end PS-5 but only about 30 of the specific drop-end prototype that Lionel used.

All the prototype drop-end gondolas were sold to one railroad, the Colorado and Western. When I speak to people about this, I use the abbreviation, "C and W." Many reply "what's the problem with the Chicago and North Western?"

No, no – it's the "C and W," not CNW!" We generally get a good laugh about it.

I know why Lionel chose to model this more esoteric prototype. It has drop ends! The 3-rail toy train folks are most interested if there's cool stuff that moves on a Lionel car.

I do take to heart the thought of well-known modeler Allen McClelland: *Your layout will be more realistic if you focus on modeling the ordinary, rather than modeling the extreme or unusual.* So I wanted an accurate model of the standard PS-5, rather than the unusual drop end.

3D printing to the rescue

With the advent of 3D design and printing through Shapeways, correcting Lionel toy train “issues” has become much simpler. Once one learns the basic principles of drawing in 3D and printing a simple design, just about anything is possible for a reasonable price.

My project started with converting the PS-5 to use realistic Protocraft couplers and to ride on Proto:48 trucks. The approach would also work with Kadee couplers and standard O Scale trucks.

To accomplish this, I had to measure the underbody bolster and then design a new bolster that allowed the use of Proto:48 trucks. I also had to make sure the coupler draft gear pocket was realistic – it had to be at the correct coupler height when the car was riding on the correct 100-ton roller bearing trucks with 36” wheels.

This is relatively easy with 3D design. It also prompted me to design what are essentially copies of the AtlasO roller bearing trucks, since they are easier to replicate and will look good on the finished car. The trucks are a bit of a story in and of themselves – I will save that for another time.

Doing this in my 3D design software allows me to adjust the car bolster height until the car would ride at the correct height without having to do a lot of prints of the 3D models.

The trouble with using a 3D printing service (for example, Shapeways or Sculpteo) is the significant waiting time between the delivery of your model for printing and when you get it back. Sometimes that delay kills your creative drive for a particular project!

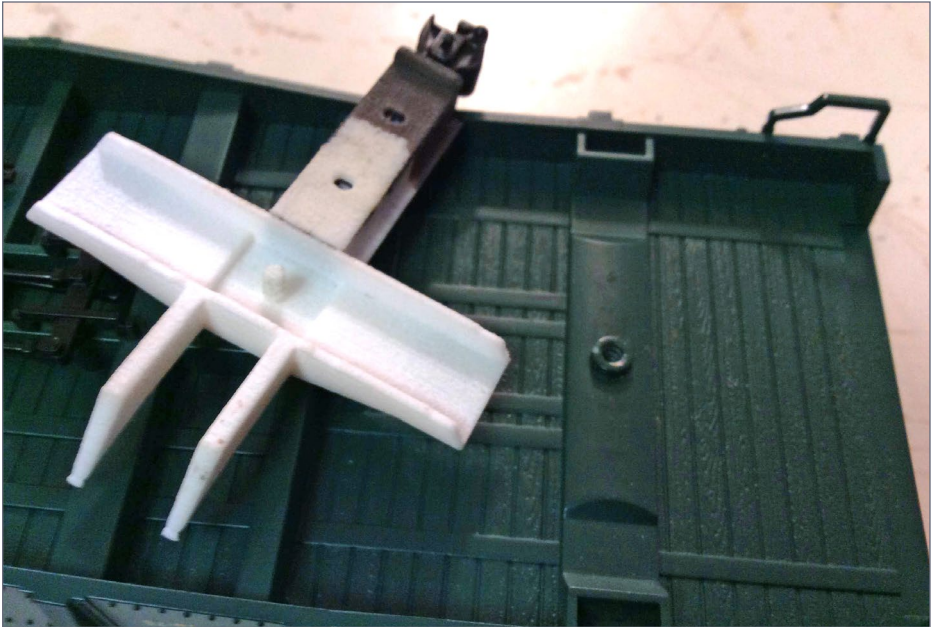

3. The first Shapeways test print of the car bolster, ready to fit over the truck mounting hole on the Lionel gondola. I designed it with the center hole to locate the bolster properly. I do *not* use any type of cement in the hole or on the locating pin. If I need to remove the bolster, I don't want to break off the pin in the hole after removing the part. I use the two holes in the channel between the bolster and the coupler box to screw the part to the car.

Since I didn't want to mount the bolster onto the car as a press fit, I designed the bolster with screw mounting holes similar to those used on Kadee coupler boxes [3].

I decided to drill [6] and tap for #1-72 screws. Kadee sells a drill and tap set for that. The Protocraft couplers came with screws, so I didn't need to go buy anything extra.

This process can be tricky – you will have to cut off the tip of the screw that extends into the gondola body. The screw isn't holding

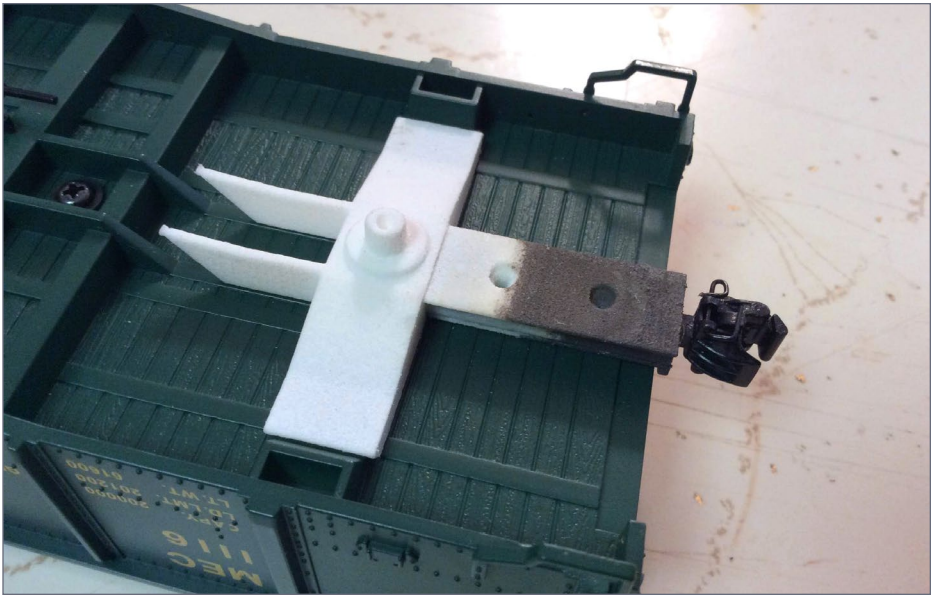

4. Here is an excellent example of how things can go wrong when doing conversion bolsters for cars like this. I intended the bolster end (left side in the photo) to fit tight against the frame rail pieces on the Lionel underframe. I did get the angle correct, but I made the part too short! I had to correct that and have the part reprinted. Even though I had this minor issue, the first try was a great proof of concept that the part would work.

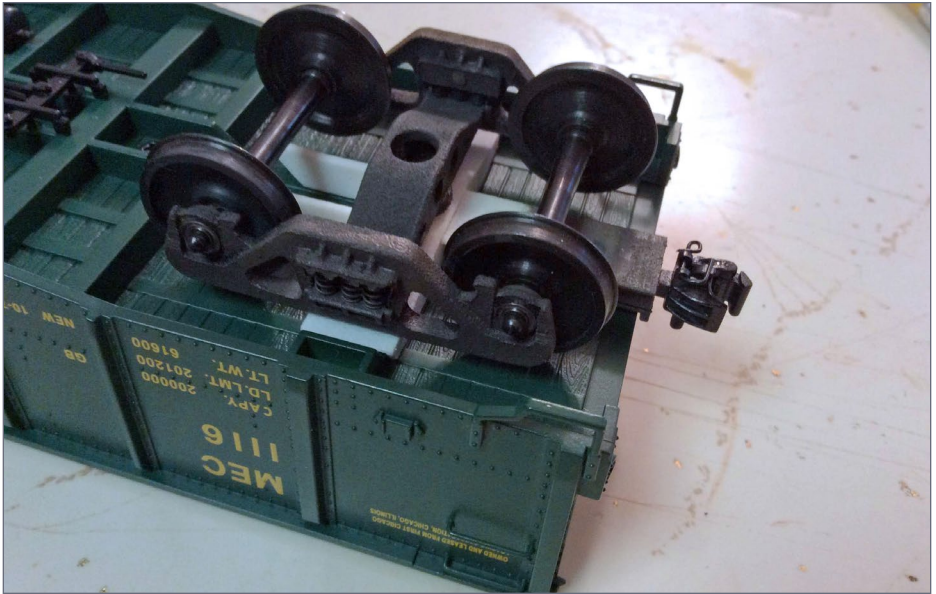

5. Here is the bolster with the 3D printed truck mounted. As you can see, everything looks pretty good, with the exception of the length of the frame rails, which aren't easily visible underneath the truck. As you will see in subsequent photos, I corrected that problem.

onto a lot of plastic, but I feel a lot better with screws holding the coupler and bolster in place, rather than just trusting any cement, even Cytop or other epoxies.

If you buy one of my bolsters from Shapeways to convert one of these cars to O scale, I do not recommend gluing it in place by means of the centering pin. If you want to add some cement, the top of the coupler pocket sits tight up against the floor of the car, so apply the cement there.

The *White Strong and Flexible* (WSF) material from Shapeways doesn't need to be tapped to mount anything using screws.

When I mounted the trucks in this test WSF piece, I used the screws from Lionel and didn't bother tapping the mounting post. You do need to drill and tap the plastic floor of the car, since the properties of styrene don't allow for reliable tapping with a regular screw. I also didn't want to bother finding the correct size self-tapping screw, if such a thing exists.

This isn't the case, however, with the *Frosted Ultra Detail* (FUD) material, which can crack from the pressure of a screw trying to force its way through the material. FUD holds fine detail, but it's also very brittle when used in the thicknesses we need for scale modeling.

For my finished model, I used a highly detailed bolster and coupler pocket made from FUD and all holes in that material must be drilled and tapped [6].

The mounting screws will alleviate some of the pressure on the coupler's pivot post. With the screws in place, that force will be supported when a train is pulled and you won't be counting on a 3D printed part and glue joint to take the weight of the train, particularly when that part may be fairly brittle.

This is less of an issue with WSF, but is a concern with FUD.

The 3D-printed truck and bolster put the car at the proper height as measured by my custom coupler height gauge. I set the coupler height at the middle of the prototypical coupler height range.

Prototype drawings will give the standard height from the top of the rails to the middle of the coupler. There is a range on the prototype because coupler height varies depending on whether the car is loaded or not. Leave it to a prototype railroader like me to point that out to modelers.

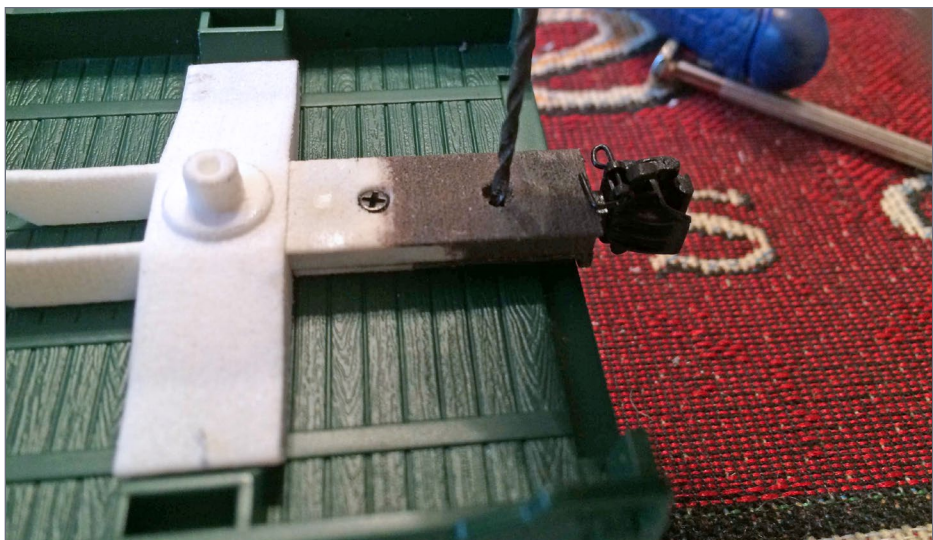

6. Drilling for the bolster/coupler box mount using the drill from Kadee.



7. The holes go all the way through the car floor. While this isn't desirable per se, I can easily snip off any portion of the mounting screws that protrudes through the floor.

Now that I know that the coupler height will be correct, I can set about the hard part: changing the ends!

Tackling the ends

I knew upgrading the end detail would be a lot of work and I really didn't want to break out serious tools to accomplish this.



J. Lincoln

NO SERIOUS TOOLS NEEDED

There is a perception that to work in Proto:48 or any size of proto fine scale modeling you need to have a complete machine shop. While that may help, most of the items you need to model in Proto:48 are available from a few manufacturers that cater to this specific market.



8. The molded detail for the drop ends is nice and substantial. The details are prototypical for a drop end gondola. Since the end does not provide the same support as in a standard gondola, it needs to be designed to maintain the structural integrity of the car. To convert to a

standard end, the extra support must be removed to about half-way through the end post, or even with the molded line to the right of the coupler mounting hole. The ladder and its surrounding detail must also be removed but I want to save the rivets.



9. I used a razor saw to cut most of the end beam off the end of the car. This was a pain because I was not using any clamping or guide. This will work better if you brace and guide everything. It can be done at the kitchen table, because that's where I did most of this work. However, I was living by myself at the time, so I wasn't irritating anyone by doing it on the table!

I started out using a razor saw to remove the ends. As I worked through that process, it was such a pain that I turned to the hobby mill that I have in my basement. So much for the “don’t need serious tools” comment.

True, I don’t want to go out and buy a bunch of new tools to model in Proto:48, but if I already have it, why not use it? The difference is in time and precision.

With a milling machine, you need to properly clamp and brace the model so you don’t destroy it. With a plastic model, this is particularly important because a milling machine is designed for

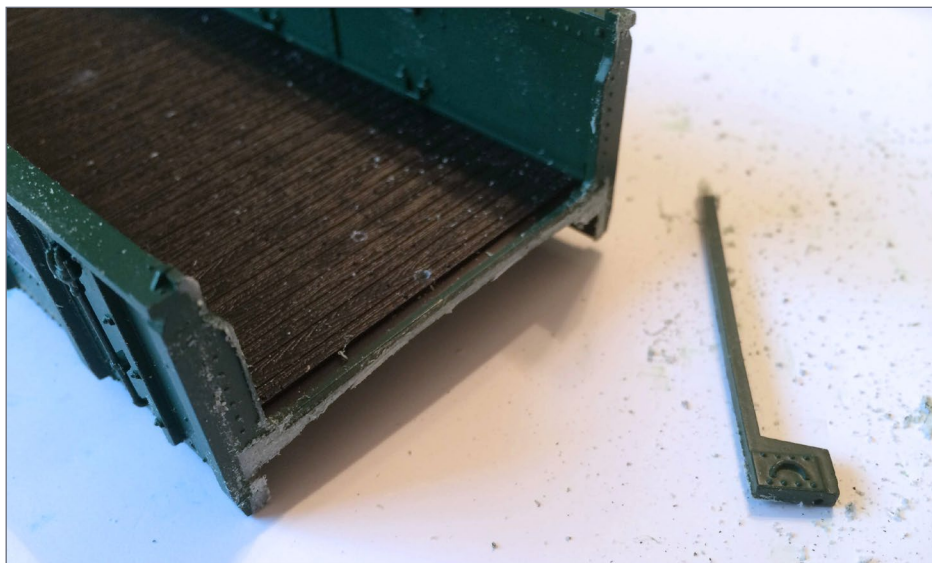

10. After cutting off a big chunk of detail, I realized I had to get the end beams off the *sides* of the car without destroying the existing end detail. That required using my Sherline end mill. I knew my razor saw skills weren’t good enough for me to save the detail. With great care I might have been able to, but I decided I didn’t want to risk it.



11. I created this fixture to keep the sides of the gondola from collapsing as I was milling it. With milling, you need to set up the model securely. The setup takes longer than doing the actual milling.

cutting steel or other hard metals and will rip through a plastic model like it isn't there.

Without proper clamping, the milling process will *pull* the model into the cutter and cause havoc with the details that you are trying to protect. How do I know this? Don't ask! Thankfully, I was able to control the havoc. Well, I was able to cover up the damage.

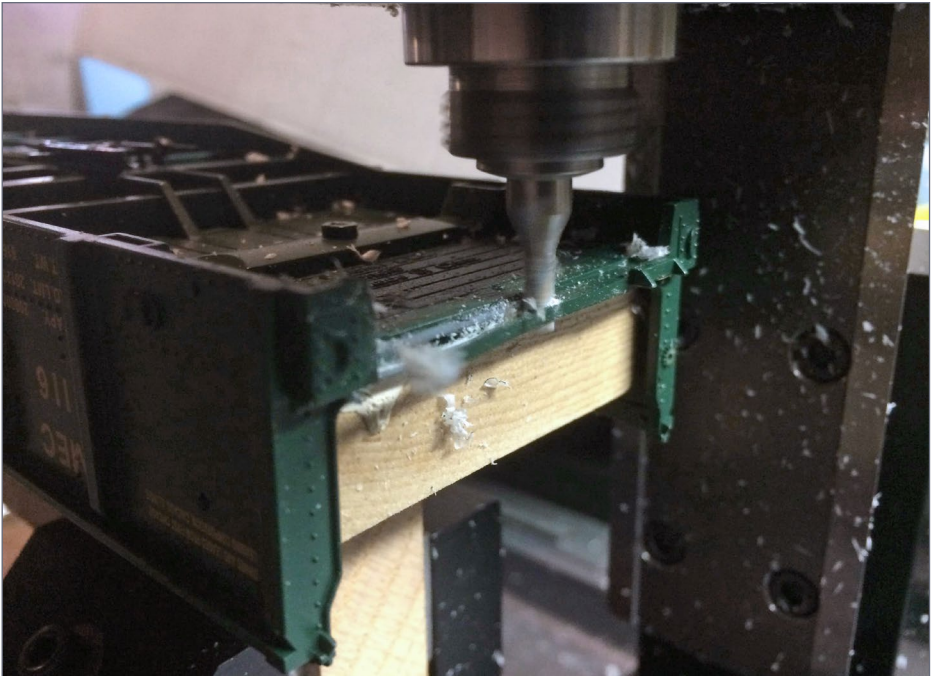

12. As they say in the machining world, "making chips." It is very satisfying and you can see the wood fixture holding the gondola in place.

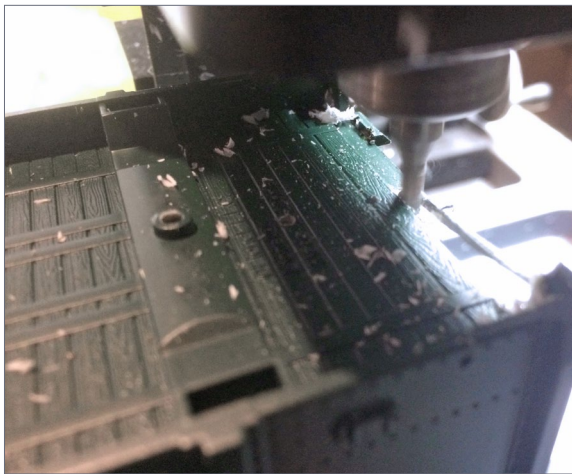

13. Even with the milling machine, I wasn't able to save all of the rivet detail. I had a lot of unwanted detail to remove and damaged some of the rivet detail. I also have holes to fill that are left over from that molded-on ladder post.

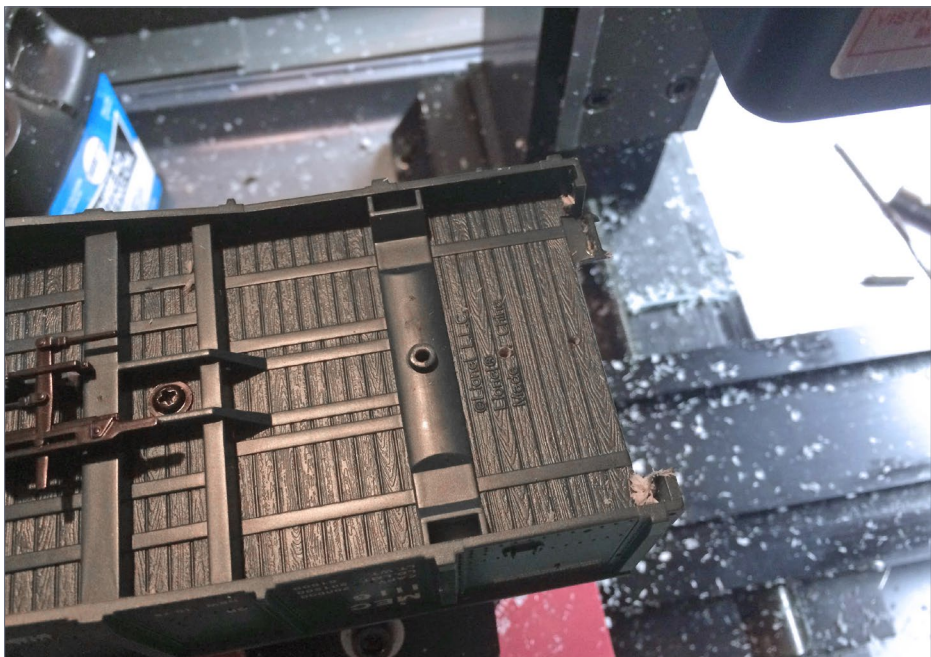

14. With the model out of the mill to check progress, we can see the line I am cutting along. The model will need to be cut all the way around and the end posts removed along this same line.

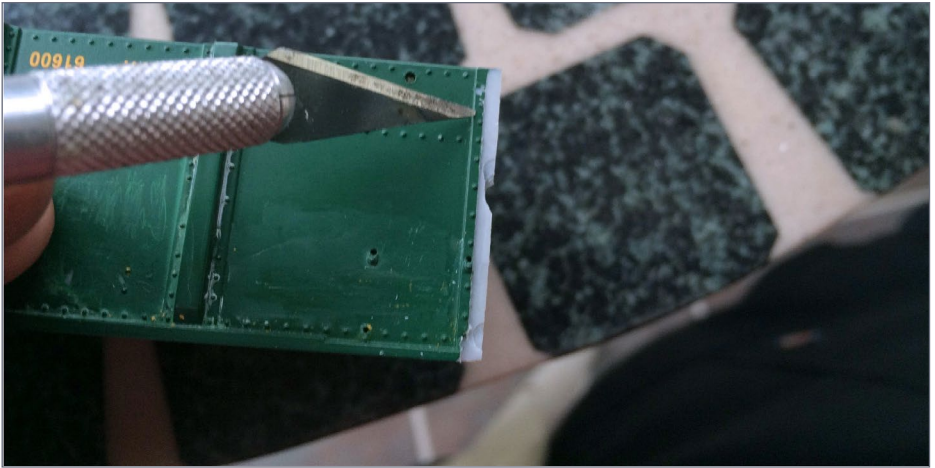

15. These unintended gouges are an example of how a milling machine can damage a plastic model. If this were metal, I might have broken the end mill.

Searching for a new prototype

At this point it is time to find a prototype gondola end from which to pattern a new end. Where I live, there are no industries that take gondolas these days. I prefer to find a car to study and photograph in person or at least find some good end photographs for a similar type of car.

Unfortunately, few people post end photos – plenty of car sides, but that’s no help. On a trip to the Buford, GA area (along the NS), I found this car all alone. It was probably a bad order car put there en-route or perhaps was in MOW service. Other track equipment was around, so it may have been used to haul ties. I’m not sure..

I went all around the car, but I was careful to trespass gingerly and quickly. I don’t recommend that, but it helps that I work for a railroad. If questioned, I often get more leeway as a railroad worker. I



16. Photo of a prototype gondola with fixed ends I can use as a pattern for my new gondola ends.

would get permission first if at all possible. In this case, there was no one around to ask.

I didn't climb on the car to look inside and went closer to the mainline for only brief periods of time to take quick photos. I did not take measurements, since that would involve getting too close to the equipment.



J. Lincoln

NOTE:

Do not trespass on railroad property without permission. If you do get permission, respect the equipment and stay off of it.

Most importantly, respect their jobs! If management finds you did something unwise or went some place that is off limits, they could be fired. Have common sense, show proper respect and you should get the access you need.

I extrapolated the measurements of the major elements of the end, and as a railroad worker I knew the measurements of some elements. I could also measure the O scale car end, so I aimed for measurements as close as I could so the end would look its best.

That may sound like a compromise. But if you draw things to exact scale, they still may not look right. I find we need to make adjustments much of the time so the car will operate reliably. In the end (no pun intended), I believe my end measurements came out extremely close and the resulting end looks quite acceptable.

Since I wasn't willing to climb up and look inside the car, I didn't design ends with ribs on the inside like the prototype. Frankly, the end is far stronger with the material being thicker. The ends are fairly robust, but the details are delicate. You don't want to bend or twist these ends, or they will break.

The extra details on the 3D printed ends are very brittle. I kept snapping off the brake wheel as I worked on the car. The bar strips for the end ladders do print, but I had to replace them with strip styrene. The 3D printed ones were too fragile [18].



J. Lincoln

WORKING WITH SHAPEWAYS

At times, the Shapeways algorithms have trouble converting a model saved in inches to millimeters. If that happens, go into your 3D design software and save the file in millimeters. That will generally correct any scaling issues.

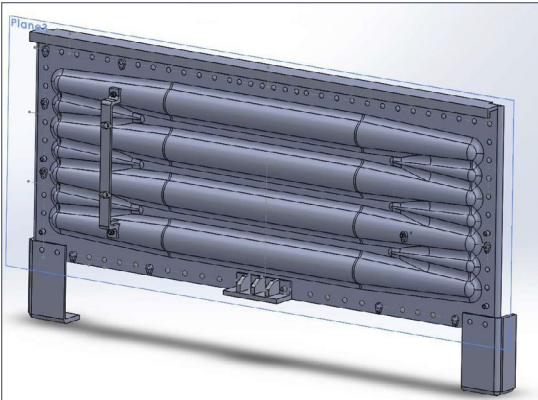

17. (Top two) The 3D end drawings are similar, with obvious differences. I printed the brake wheel, housing, and platform along with the ends. I put all the details shown into the 3D print files and printed them with the ends.

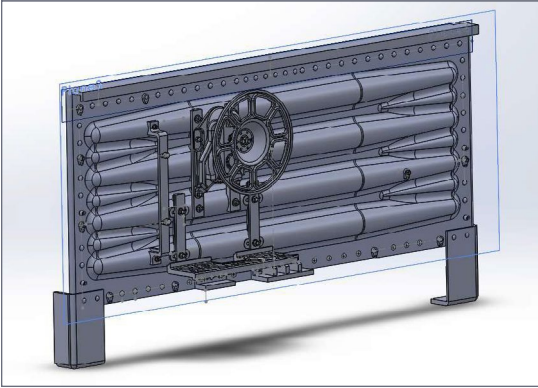

18. (Below) Here is the first test sample of the end – it didn't quite fit. I had to check if the problem was my error, or whether Shapeways failed to print it properly.

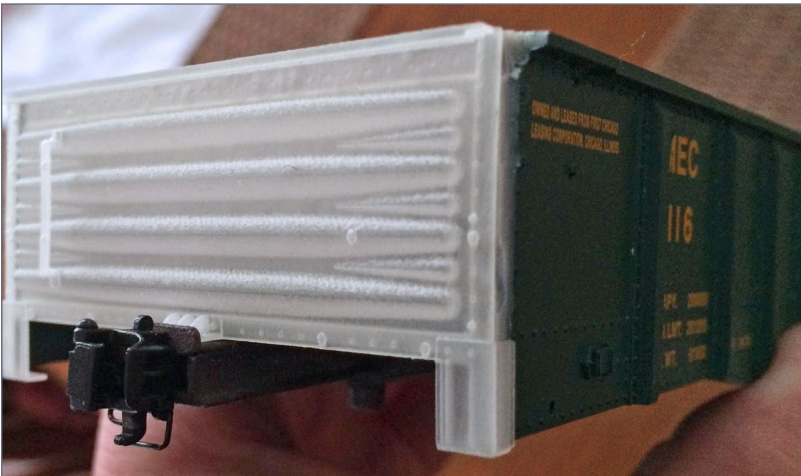

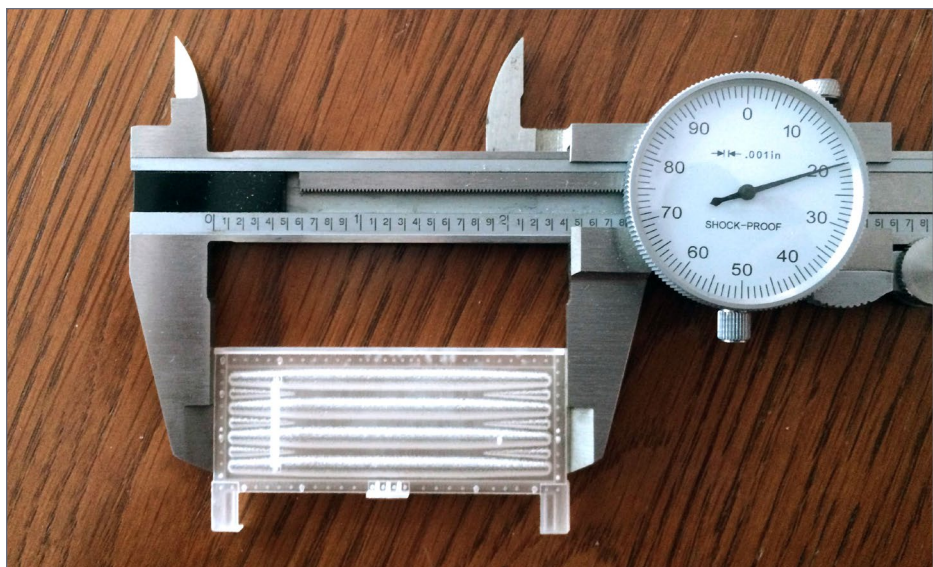

19. Using my trusty calipers I found I had scaled the end improperly. I corrected the problem and tried again. The revised ends that I received fit perfectly.

Smoothing the 3D printed ends

Sanding works great for removing 3D print banding when there are no details to avoid.

Along the ribs in the center, I was able to sand out the layer lines. I didn't want to go anywhere near that ladder, and I didn't even try to sand the ribs on the end with the brake wheel and platform.

In retrospect, perhaps I should have printed the details separately and added them later. Once the model is painted I can't see any issues with print lines so if you choose to do a project like this, the results should be satisfactory.

I wanted to increase the strength of the ends, so I coated them with a product [20] designed to smooth out the build lines of 3D printed items.

I am generally pleased with how they turned out [21]. I will say the coating rounded off the rivets so they're not as crisp as they were on the untreated end.

It doesn't matter if you can see perfect rivets if the end snaps off when handling the car!

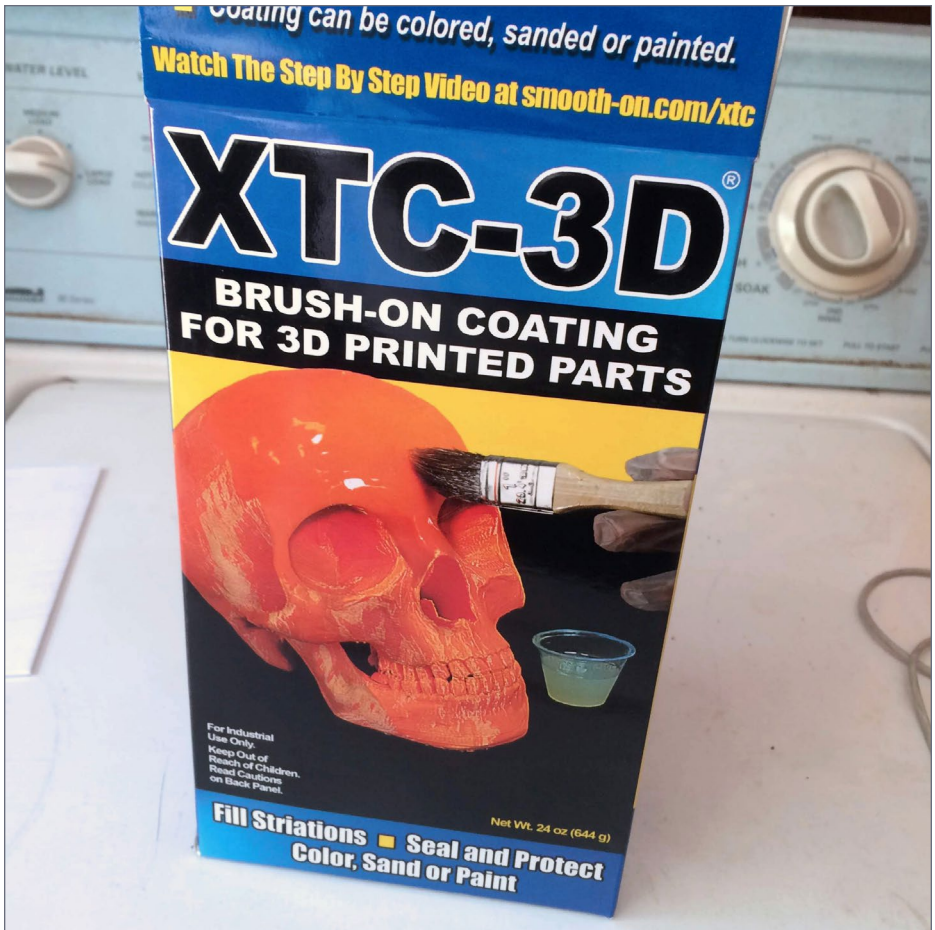

20. The XTC-3D filler epoxy from Smooth On is designed to remove 3D print banding. As the box notes, you can find a video explaining how to use it at www.smooth-on.com/xtc.

I believe it's a good idea to coat 3D printed parts like this, since any additional strength you can give to brittle Frosted Ultra Detail (FUD) parts is a good thing. In photo [23] you can see the effect of the sealing coating on the end details. It did thicken the ladder rib, but that didn't really alleviate the part's weakness. At the time, it gave me hope it might survive!

Adding the details

The next step in the building process was to add the various grab irons on the ends. I made sure to add all the grabs on the A-end (the end without the brake wheel) before installing the B-end onto the car. This was to avoid breaking details off the end of the car while trying to drill holes for grab irons in the opposite end.

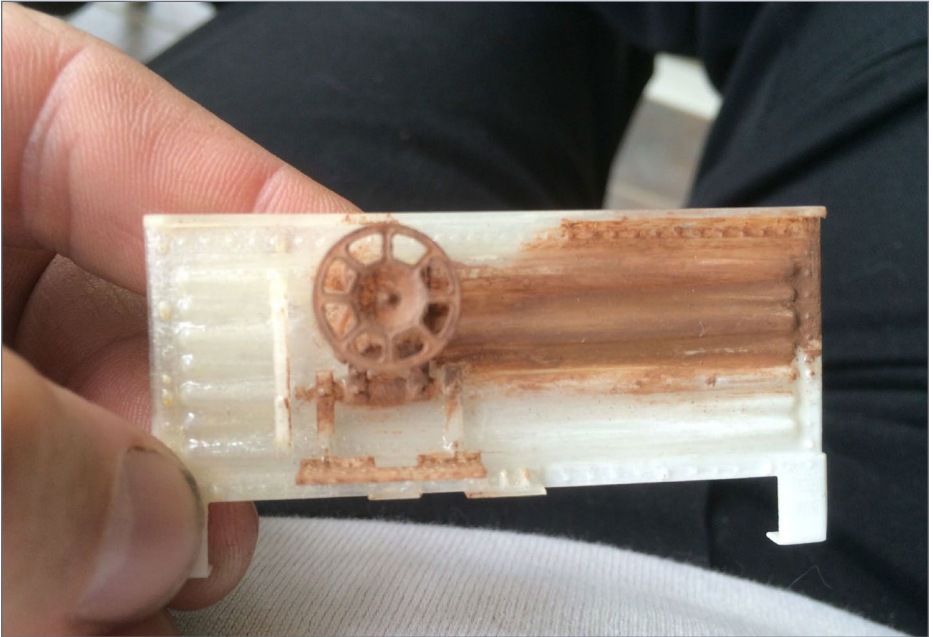

21. I dabbed a little paint onto the end to see how it would look after I coated it with the smoothing product in [20].

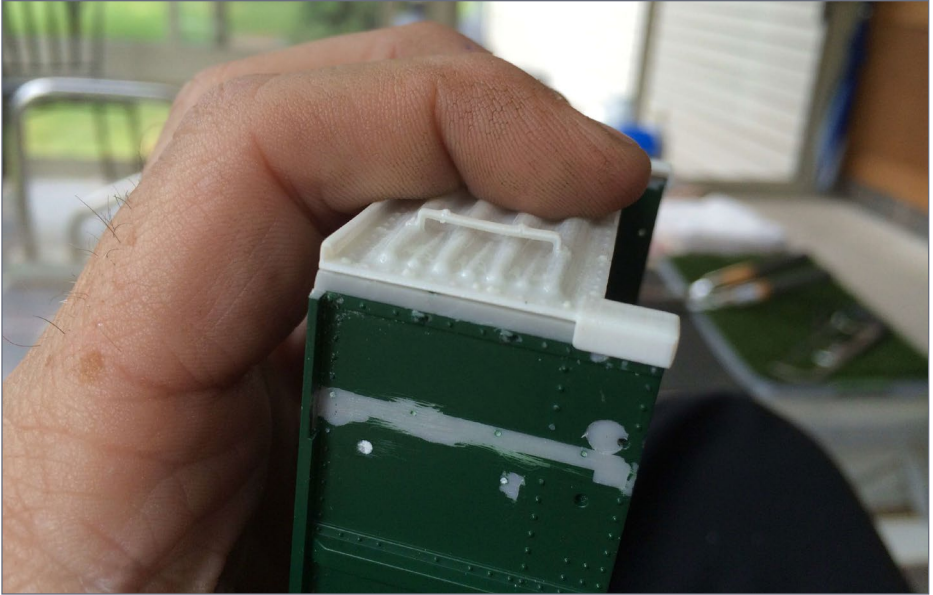

22. In test-fitting one end I discovered a small gap. I was not overly concerned since I use Cytop, available from Mike Rose Hobbies [mrhobby.com]. Cytop is quite strong and a great gap filler.

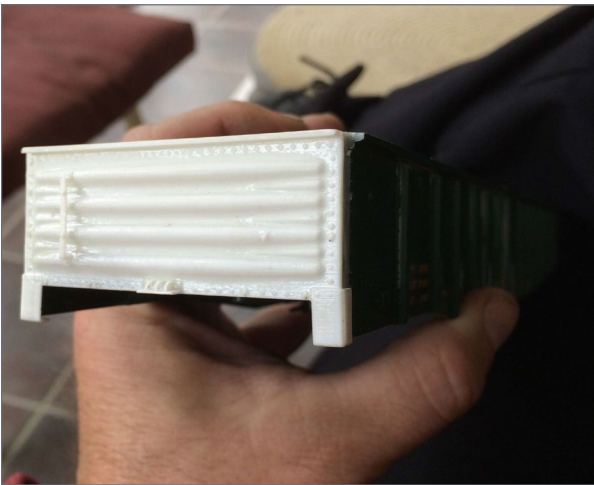

23. This photo shows the effect of the coating on the 3D printed end. With advances in 3D printing technology, it may be possible to print this with no lines and not need the added strength of the epoxy coat, but time will tell.

Even so, I broke something on the A-end and while trying to fix it, I did break off the brake wheel. I was able to successfully – it wasn't easy – install all the ladder rungs on the A-end without having to replace the metal strip that serves as the right side of the ladder.

Feeling very saucy, I went about the same project on the other end. At some point, I broke off the ladder strip and it went flying across the floor of my work area, never to be found. I might have found it with my foot and broke it. I don't remember. Either way, I had to fabricate a new ladder strip for the B-end, but it is stronger than the 3D printed one, so it isn't really a problem overall.



24. The irons begin to go on. As you can tell, I am working at the kitchen table using very basic tools.



25. I filled gaps with Bondo filler putty from an auto parts store. I started to strip the paint on the car but that Lionel lettering is pretty stout and resisted rubbing alcohol, so I tried stronger paint stripper. The paint stripper attacked the plastic side, and I resorted to Bondo on the damaged spots. Oops!



26. All of the end grabs are in! I used 0.015" wire for the grabs and bent them to fit. Most commercial grabs in O use .020" wire, which is essentially 1" around. Most prototype grab irons are 5/8" to 3/4" thick. I fitted the ladder rungs to rest against the side of the ladder strip

on the right. There was no good way of drilling a hole through the FUD material without destroying it.

Body bolster take 2

Since I was going the extra mile on this model, I decided to create a more detailed version of the body bolster / coupler mount box.

To have the detail I wanted print well, I needed to print it in FUD – which I don't trust as a structural material.

All the forces generated when moving a train go through the coupler, so this could be problematic. In practice, this hasn't been an issue, but I have never had this car in a long train so don't know if it will be okay long-term. So far, it has been fine.

The FUD allowed me to add brake line and draft gear key detail, which is very visible when working as a conductor on the ground. Just having draft gear keys on the model goes a long way to add realism.

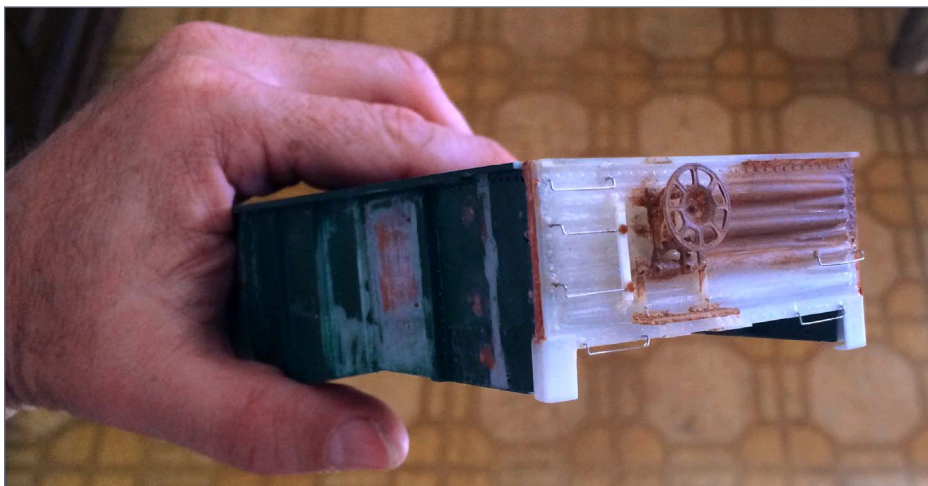

27. Here is the replacement ladder strip made from styrene. The replacement ladder rung bolt ends use spare Tichy bolts that I had on hand. All the details were printed in place. I applied paint to see how things would look, and to see if I could match the color on the prototype car I am modeling.

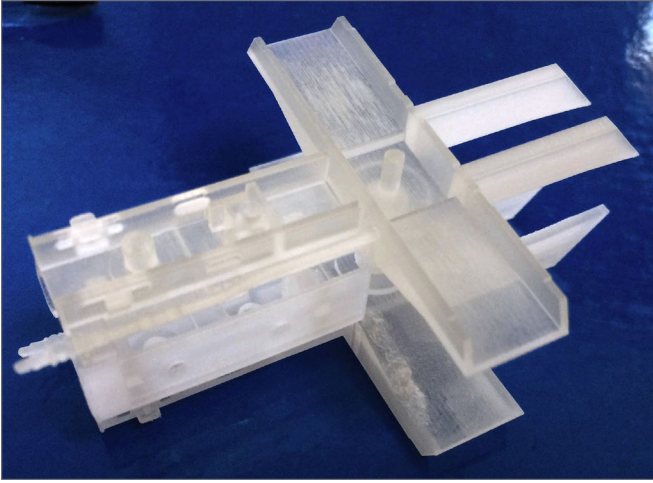

28. FUD is generally transparent, so it is difficult to see details without painting the part. This is how I received it from Shapeways.



29. FUD products can come with mold release on them that inhibits paint adhesion. Soaking the model in Bestine (rubber cement thinner) fixes this issue. Find Bestine on Amazon [a.co/d/4TV9nWQ] or at art supply stores. Cover

the soaking dish because Bestine evaporates quickly. Let the part soak for a while, then scrub it with a paint brush. Afterwards, wash the part with soap and water. The Bestine treatment also supposedly reduces FUD brittleness.

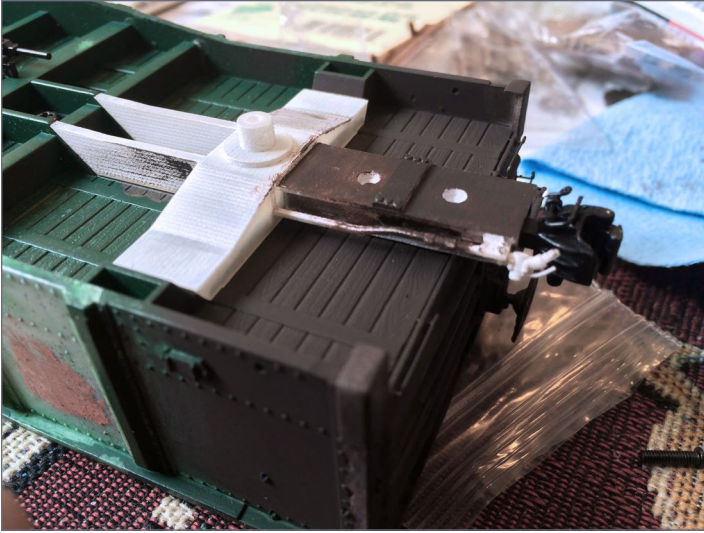

30, 31. These two photos show the detail on the new bolster and the corrected length so the part fits properly. As with all FUD parts, the angle cock detail looks great but it's delicate and I have broken bits off one end. On the car body I used Rustoleum Camo Brown and the bolster pieces are Vallejo Panzer Brown.

Indestructible stirrups and corner gussets

I had to think of a way to create stirrup steps for the model. I wanted custom ones and I wasn't comfortable with brass. I wanted to use actual rivets to hold the steps on and brass is hard to drill with tiny drills.



J. Fugate

SOFTENING BRASS

If you anneal brass, you can soften it enough so that's it quite easy to work. Just Google "annealing brass" and follow the directions.

I didn't want to use styrene because I didn't think it would last. I decided to give commuter ticket plastic a try. The price is right. Used tickets are free. The material is truly remarkable – you can see it in the photos.

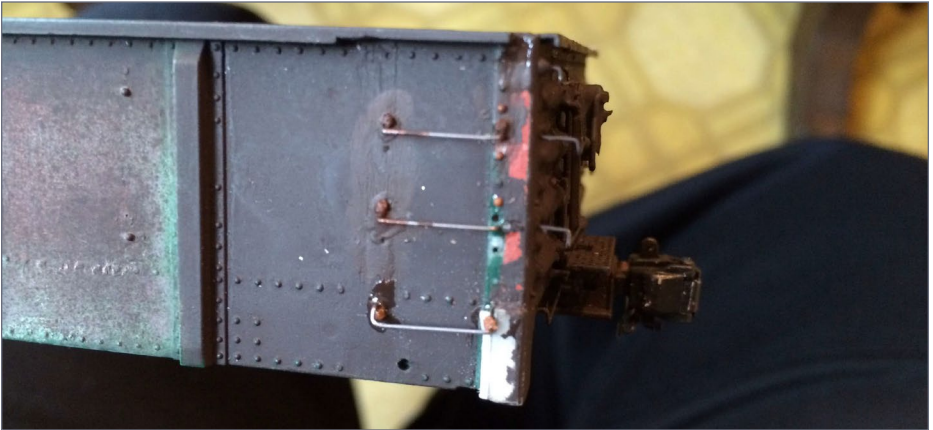

32. To add the end ladders and grabs I used individual Tichy rivets to replace details lost when the ends were milled. Also note, I have broken off the brake wheel!

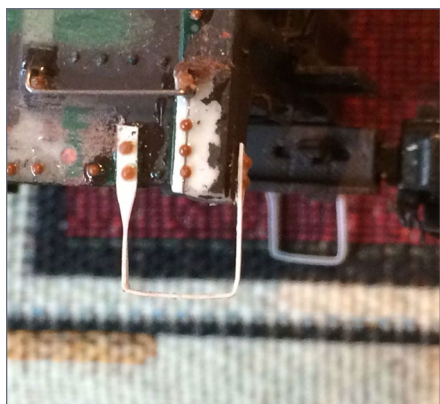

33, 34, 35, 36. This montage shows how the commuter ticket material can be twisted yet hold its shape. It is easily drilled. I work as a conductor for the Massachusetts Commuter Rail system and used tickets are free! I sanded the material slightly for paint to adhere. If you put calipers to it, it's 0.01" or a scale 1/2" thick in O scale.



J. Fugate

POLYETHYLENE SHEET

This ticket material sounds like thin polyethylene sheet, which is a tough flexible plastic. You can get 0.012" PE sheets from Amazon [a.co/d/gz9mhfC].

Another great use for the material is the corner gussets welded on the top rail connecting the ends to the sides. Unlike the Railgon style of gondola, these are just welded in place and do not need any additional fastener detail.

As with the stirrups, I lightly sanded the material on both sides to ensure that paint would stick to it. The tickets have a glossy coating that would make any paint peel off. Sanding takes care of this.



37. Cutting the corner gussets from one of the tickets. You can see the scuffing in the photo showing the level of sanding this material requires for paint to adhere. It isn't much.

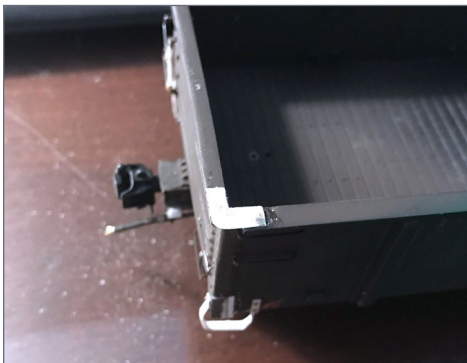

38. Here you see the corner gusset installed. While the ticket material is technically a plastic, I am not convinced standard plastic cements would work. I attached these with Cytopox, but any CA would work.

Note how the stirrup step is bowed. I dropped the car on the floor and this is the result – tough stuff!

The true history of this project

One thing you should know is something you cannot see from the photographs.

This project languished for two years between the adding of the stirrup steps and the adding of the top gusset plates. Why?

Mainly because I got analysis paralysis and wanted to do several things to the car that I had never done. I was concerned I might ruin the 3D printed ends.

For example, I wanted to dent the sides. I know how to do this on a styrene model using heat, but I wasn't sure how that would affect all the work I had done to this point.

What got me to finish the project? I finally just decided to not bother with dented sides and instead buy the books and products needed to produce the chipped paint on the prototype. That process ended up being very straightforward, using commercial products for the chipping.

I just wish I had done it sooner, rather than waiting for two years to get around to it. I will cover how I did the rusting and chipping later.

Painting and finishing

Once I had the corner gussets installed, I painted the model with Rustoleum Camo Brown rattle can spray paint. It makes a great, basic "old" rust color that I knew would match the prototype quite well. The paint can be a little hard to find, but I did recently find it at Wal-Mart.

I masked the couplers and made sure to paint *everything*. I knew I would be laying the paint on pretty heavy. I made sure to coat everything with the basic rust color. The prototype gondola in

question is fairly old at the point I'm modeling, so the car under-side would be good and rusty.



39. I put the paint on a bit thick, but it came out just fine. If you look closely, you can see a crack in the car side down low on the left center. That was caused by dropping the car three feet onto the floor.



40, 41. The left photo shows how paint adheres to the 3D printed end and why it is important to clean the Shapeways FUD parts with Bestine before painting them. This end was also coated with the epoxy coating and sanded. In the right photo, the paint irregularities show on the end that was not treated with the coating or cleaned with Bestine.

After painting the car with the Camo Brown, I did notice that there were slight issues with the paint not adhering properly to the end that I had neither cleaned with Bestine nor coated with epoxy [42]. This appears to be a problem only with the primer coat.

In recent inspection of the car in bright sunlight I noticed a slight problem with the paint adherence on the B-end of the car [43]. This isn't evident in the layout room and only shows up in close-up outdoor photos.

I know what it is, but it could also be attributed to weathering of the prototype car. It doesn't look ferociously awful, but upon close inspection, you can see it. Am I going to repaint the end? No.

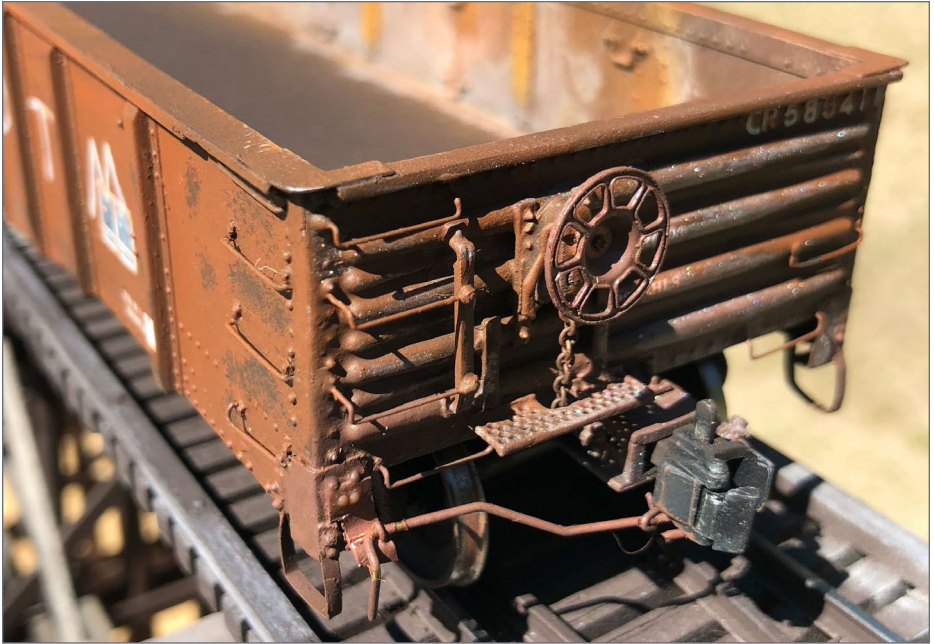

42. The grayness on the parts of the end means the underlying material is showing through. I don't have a problem with the effect since it is only evident in photos and in bright, outdoor sunlight. I do need to weather the couplers, however!

Rusting and chipping the car

I proceeded with getting the car ready for the weathering/chipping process. Instead of doing the “hair spray” technique, which would have accomplished the same thing, I opted for a product specifically designed for this purpose from Vallejo. I got this set from Amazon after seeing references to it on several YouTube videos about simulating rusting and chipping.



44. This is the rust/chipping effect airbrush color set from Vallejo. I purchased it on Amazon for around \$30 [a.co/d/7DE014i]. Vallejo colors go a long way, so that even though they seem pricy, the paint can be thinned quite a bit and still cover because of the quality of the pigments.

I followed the instructions that came with the Vallejo paints and sprayed a coat of the chipping medium over the base color after I gave it a light overspray with a couple other rust colors for a little variation later with the chipping. This wasn't necessary since the light amount of chipping doesn't make the color differences truly visible. Live and learn.

I painted the car with the base brown color. I just wanted to get a good surface to apply decals and get a fairly close match to the prototype car I was modeling.



J. Lincoln

FORGET EXACT COLOR MATCHING

As modelers, we need to learn more about color theory and not worry about getting an exact prototype color match. I didn't go looking through paint racks for a "Con-rail Gondola Brown." I found a color that was close and tweaked it. Since each car in your fleet should be a different shade, using seat-of-the-pants color tweaking like this is an advantage, not a problem.

As noted, I "chipped" the car sides following the instructions on the Vallejo package. This method works by mixing mediums. The top color needs to be a solvent-based paint. It doesn't work if you are applying acrylics to acrylics or enamels to enamels.

The instructions with the paints explain this in better detail. The effect is really good and in this case, fairly subtle, which is what I wanted.



RATE THIS ARTICLE



45. The “chipped” side. This process needs to be halted by applying a protective coat over it. I used a glossy clear coat because I would be applying decals over this.



46. This project languished for two years due to my concern over how to dent the inside of the gondola. I elected instead to rust it up and give it interesting weathering. I used a product from LifeColor called a weathering wash. The product goes on like paint, is thin enough to be airbrushed, but doesn't dry with an opaque finish. I used the “diorama dust” color for the inside of the gondola and I like the uniqueness of it.

Decaling

I then set about applying the decals for this car. It can be difficult to find the decals you want in O scale, since the selection is a lot more limited than in HO. I found several Microscale sets that gave me the parts that I needed and cut them up to get individual numbers and the like. The most important thing was getting the correct Conrail lettering. For a lot of the smaller items, I cannibalized other sets with the needed decals.

At this point, I was not going to let perfect get in the way of good enough. You just have to accept that you aren't going to get all of the details perfect, so get on with it! I was determined to get this project done!



47. An example of “picking and choosing” the decals necessary. Microscale makes a Conrail freight car set for O scale, so I cannibalized the sheets for this project. I have plenty left over to do a Conrail boxcar.



48. This is the almost-complete car side. Take your time and make sure everything is straight and level. Unless you have prototype pictures of the lettering being crooked on the car you are modeling, make sure everything

is straight. It is better to make a car look like a normal car rather than an oddball everyone will question.



49. I added a little bit of rust on the lettering, as per the prototype. This car didn't have bleeding lettering, but sections underneath the lettering had started to rust, so that's what I tried to emulate.

Finishing up

After applying the decals I realized I had forgotten to install cut levers for the couplers. Oops!

I wasn't going to let a little missing detail after painting the model stop me! I wanted to figure out how to create a working cut lever for the Protocraft couplers. The couplers on this model are modified slightly by Norm Buckhart and can be operated from above with a magnet wand, as opposed to using a working cut lever, which can be a little tricky in practice.



J. Lincoln

PROTOCRAFT COUPLERS

Modeler Bill Clouser created the original Clouser coupler design and sold it to Norm Buckhart at Protocraft [www.Protocraft.com]. The wheelsets and the couplers used to convert this car came from Protocraft.

I knew I needed a resilient material that I could drill easily for the cut lever brackets and chose my wonder material, the commuter rail ticket.

I *do not* suggest doing things in this order. I should have built and installed these cut levers before painting everything. The handling required to install the cut levers and brackets put a lot of the existing painted and weathered detail parts at risk. I broke off a brake line in the process of installing the brackets.

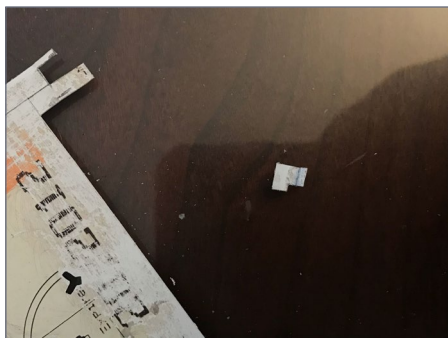

50. Cutting the bracket from the ticket material. A little thought had to be made to get the design correct so that the bracket would be able to support the torque created when operating the cut lever and still look realistic.



51. The two holes for this loop must be close together and the material needs to be strong enough to allow the small holes to be drilled close together.

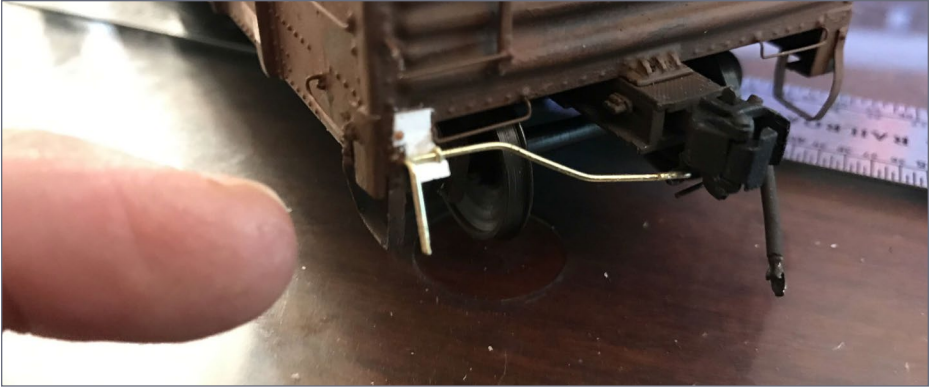

52. The installed cut lever, with a rivet drilled into the car end to provide some additional strength. The rivets can work to fasten things together or to provide added support for items that will naturally be prone to getting hit. You might damage the part accidentally, but it should not go sailing across the room, never to be found.



53. It's alive! The cut lever is doing its job and pushing up the pin to open the coupler.



54. For the second cut lever bracket, I drilled the holes and threaded the brass rod through the ticket material before cutting out the bracket. Doing it this way made cutting out the bracket a little more difficult but this was far easier overall.

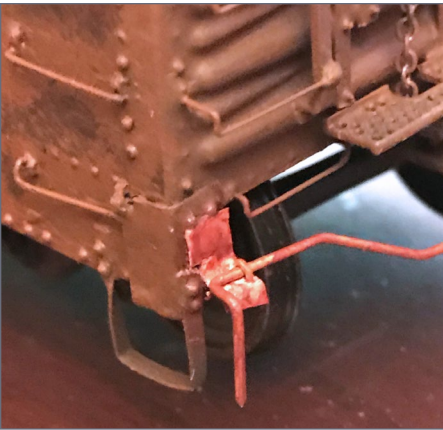

55. After installation, I primed the parts with Vallejo primer. It sticks very well to just about everything and can be brushed on. The part doesn't look too pretty at this point, but it blends in nicely and more importantly, it works!



56. With painting, the imperfections of the part fade away. I used a Dremel tool and a wire brush attachment to polish the wheel treads. One of the great things about Proto:48 is that it allows the use of prototypical width wheels. While the car has imperfections, overall it looks great and that is what you pick up on a layout. It is a great lesson to stop trying to be perfect. In so doing, *you may not get anything done!*

I hand-painted on the rather sparse graffiti seen on the prototype car. I don't mind over-the-top graffiti, but I am glad I didn't have to copy any in this case! I used the dust color from the Lifecolor set. It was the same intensity as the lettering on the original car. I thought that painting the graffiti in straight white would be overpowering. I like the resulting effect with the dust color.



57. The finished car at home on my module. I have run this car on other people's layouts and it deals quite nicely with 60" radius curves, comparable to 30" in HO. When I ran this car coupled to my other equipment on Jim Canter's portable Proto:48 layout with 40" radius curves, it would derail when coupled to my other equipment, which also has prototypical draft gear. This is the same problem the prototype faces when coupling short wheelbase cars to long wheelbase cars. I corrected the problem by spacing my cars with cars equipped with Kadee couplers, which seem to accommodate tighter curves a little better.



58. The obligatory “back porch” photograph! The model looks really good in the sun!



Concluding thoughts

I did enjoy this project, even though it took me three years to complete!

The lesson here is: don't let perfection be the enemy of "good-enough" and mire us in analysis paralysis. There is a lot of satisfaction in completing something, even if it's coming back to a project after years of sitting!

Get up, get off the couch, and build something! One of the great things about Proto:48 is that in most cases, it does force you to do to just that – *build*.

Many thanks to Norm Buckhart of www.Protocraft.com and Jay Criswell from Right-O-Way products (www.right-o-way.us) for supplying products to help those wanting to work in this most rewarding of scales.

I am also working on making entry into Proto:48 a lot less difficult so that you can make your projects as simple or as hard as you want. To that end, I am hoping that this is the first among many articles chronicling my "Adventures in Proto:48."

**Use our custom
Google search on the
MRH website to find
topics of interest**

CLICK TO FIND OUT MORE

JIM LINCOLN



Jim Lincoln has been interested in trains for his entire life. His first experiences with toy trains came with playing with his brother and his Lionel trains. The Lionel steamer was so beat up that the leading and trailing trucks had been broken off and they used to build ramps with the Lionel track and jump that engine across the basement!

Jim got his first HO scale train set for Christmas when he was 8 years old and received a second set the next year, both Tyco train sets. This migrated from the dining room table to a 4x8 sheet of lauan plywood on the floor. to several HO layouts throughout the years.

Jim has also modeled in N scale, but Proto:48 is the area that best “scratches the modeling itch.”

Jim has worked for CSX as a freight conductor and now works for Keolis Commuter Services for the Boston Commuter Rail system as a passenger conductor. He is also one of the co-hosts of the MRH audio podcast. ■





The Amherst Railway Society Railroad Hobby Show

Our 2019 Show will be

January 26 & 27, 2019

Save the dates!

**Click
to learn
more ...**



YES ... IT'S A MODEL



Model Railroad Hobbyist | November 2018 | #105

compiled by JOE FUGATE



We're doing *Yes, it's a model* a bit differently this month. Many of the photos we publish in this feature come from our website. This time, here are a couple website photo posts that caught our eye recently.

Some progress on scenery...

Fri, 2018-10-26 10:38 — Yannis

I placed temporarily a reefer, a car and a tree to see how the scenery progresses on the layout. The foreman came by for a quick inspection of the works.



My Layout: <http://model-railroad-hobbyist.com/node/32015>

WEB: mrhmag.com/node/34611?page=6#comment-360976

▶ MRH'S MONTHLY PHOTO ALBUM

Golden Pacific building is getting planted on the layout

Tue, 2018-10-23 00:15 — Rick Sutton

Finally.

Hope to be moving on to another building soon. Probably another week or two and this o



WEB: mrhmag.com/node/34748#comment-360486



out



ne will be finished.



GET PAID FOR YOUR PHOTO

We pay \$40 per photo we publish. If you would like to get your modeling in our photo feature, just start posting your photos on the *MRH* website, especially in the Weekly Photo Fun thread created each week.

See mrhmag.com/help for more on how to post an image. You need to be registered to post photos to our website, and registering is free, [just fill out this form here.](#) ■



Installing LED lighting in Blue Box locos



**STEP
by
STEP
1-2-3**

1. Les continues working on the loco from last month, this time adding LED lighting.

Model Railroad Hobbyist | November 2018 | #105



RATE THIS ARTICLE

LES GREEN installs LED lighting into an Athearn Blue-Box ...

WELCOME TO THE SECOND PART OF THIS blue-box loco electrical upgrade tutorial. In the first part we converted a blue-box loco into the equivalent of an ready-to-run loco with an installed a DCC decoder.

On to adding LED headlights as well as number board lighting!

Getting started: In this tutorial I use the Athearn Special Edition GATX SD40-2 set [2]. I show how to add the headlights and also how to do lighted number boards if you wish.



2. The locos we're using in this article, an Athearn GATX SD40-2 set.

I previously converted these locos to DCC using NCE D13J decoders. Here is the wiring schematic [3] taken from the NCE D13J manual for how the decoder and lights are wired to the motor.

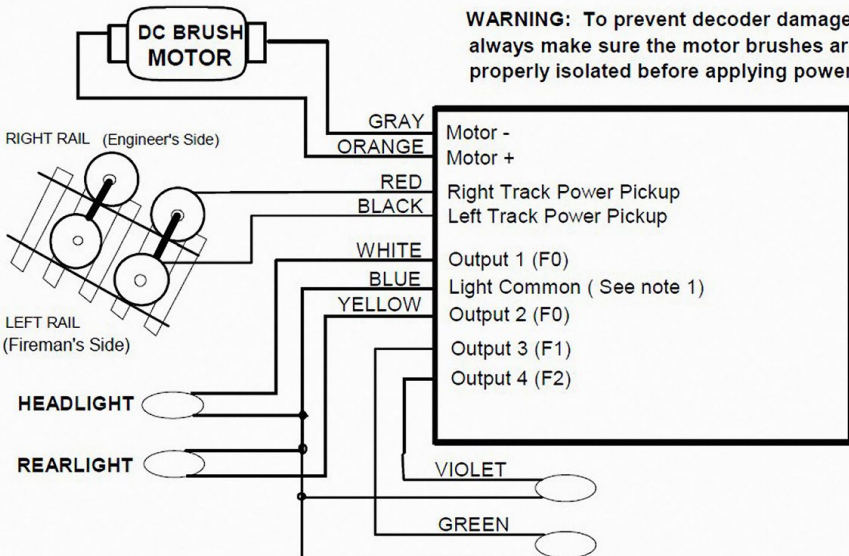

Note 1: The blue wire is positive polarity lead providing rectified DC voltage. The function output wires provide a "ground"

3. Wiring schematic from NCE D13J manual.

Tools and supplies

- 2mm LED lights [4]
Web: ebay.com/i/292564575960?chn=ps
- 620-ohm ¼-watt resistors
- 1K ¼-watt resistors
- Soldering iron and solder
- Wire cutters
- Flush-cut nippers such as Xuron 410s
Web: a.co/d/6NiwQgD (\$10, Amazon)
- A drill bit the size of the barrel on your LEDs (2mm or #46)
- ¼" heat-shrink tubing
- Flat black model paint
- Small paint brush (Dollar-store)
- 30 AWG decoder wire
- A way to test your LEDs before you install them.
See sidebar: “LED basics and an LED tester”
- Sanding sticks, emery boards, or sandpaper [5].



4. Here are the 2mm LEDs I use for lighting locos.



5. Emery boards from the Dollar-store.

STEP 1: TAKE OFF THE SHELL

The first thing you need to do is remove the body shell. See Part 1 last month for how to do this with Athearn blue-box locos.

Let's start where I left off last month – with the loco converted to DCC using the installation process I covered then.

6. Shell removed: Loco from Part 1, with the shell off and ready for the LED lighting installation.

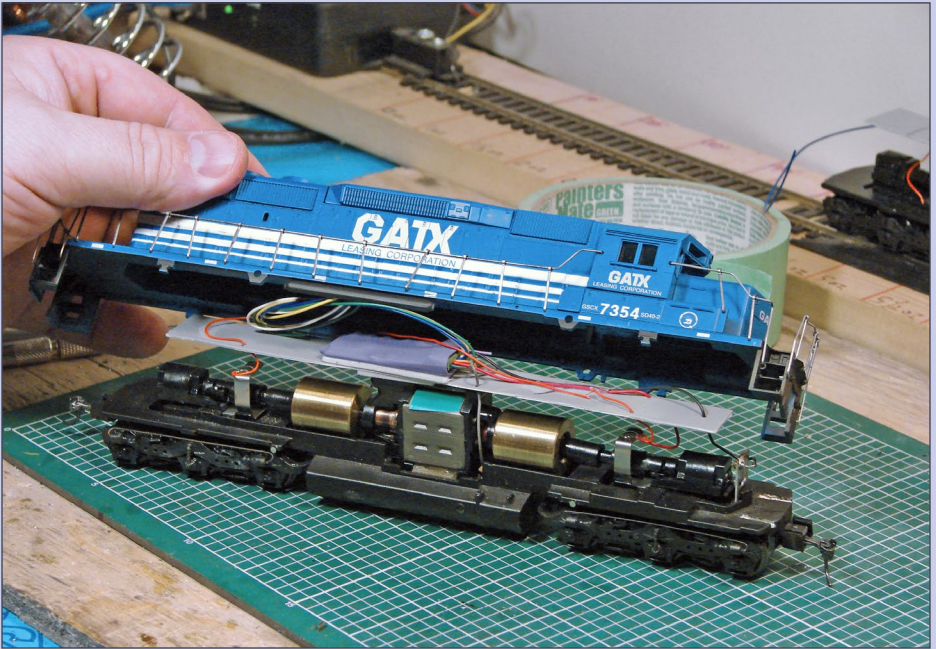

STEP 2: REMOVE LONG-HOOD HEADLIGHT LENSES

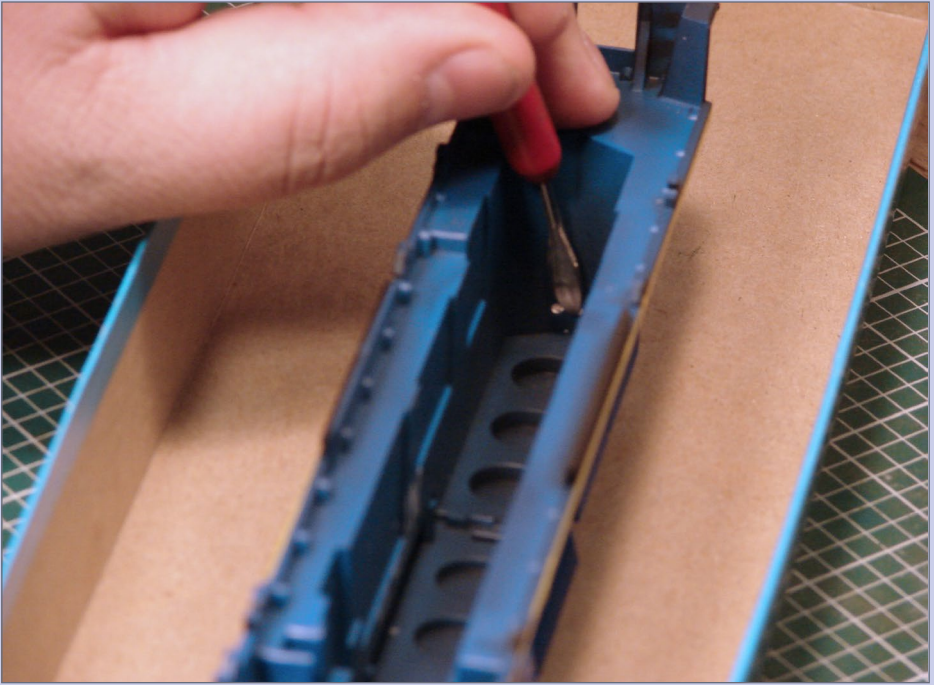

7. Remove rear headlight lens: Remove the lenses from the long hood by pressing them out with a blunt-tipped tool smaller than the mounting holes. The tool I use is a clay modeling scraper.

- I like to use the top of the loco box as a catch basin.
- These lenses can be hard to get out. If you see signs of glue, be very careful to not break the shell. Try soaking it in hot water to free it up.
- The last resort for removing stubborn lenses is to drill them out. Use extreme care on your prized locomotive to avoid drill slippage and shell damage.

STEP 3: REMOVE THE CAB

First, remove the handrails from the cab sides.

Note there are two types of handrails: metal and plastic.

The procedure is the same for both, but take extra care with the plastic ones. Many people glue the plastic handrails in place, which can make them harder to remove.



8. Remove cab handrails: Slip a hobby knife between the cab and the handrail. Gently rock the knife back-and-forth, pressing up and away from the cab until it comes loose. Take care not to scratch the paint. [Using the back of the knife blade will avoid accidentally slicing off the handrail pin – *ed.*]

- Repeat these steps on the other three handrails.
- With the handrails loose, rock the cab side-to-side slightly to break any paint bridging the gap between it and the body.
- Most locomotives I have converted had a factory paint bridge between the cab and the body shell. These can take a fair amount of pressure to break free. You can see the spot where my cab had adhered to the body shell in [13].

STEP 3: REMOVE THE CAB *CONTINUED* ...



9. Unfasten cab retainer latches: Loosen the cab from the body shell by pressing the rear retainer forward and away from you with a blunt tool. I used a small flat-blade screwdriver. Press the front cab retainer clip out in the same manner as the rear.

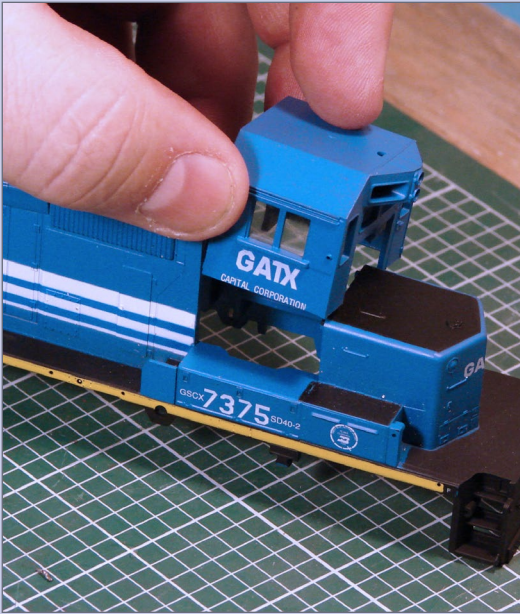

10. Remove the cab: Pull the cab from the body shell by rocking it side-to-side while pulling up. While removing the cab, make sure the handrails are free and do not scratch the cab. Metal handrails are particularly prone to scratching the cab paint if you're not careful.

STEP 4: REMOVE WINDOWS FROM CAB

First, I cut the rear portion of the window glass out on my models. The portion I remove does not affect the appearance, as it is hidden. This makes it easier to run the LED wiring through the cab later.

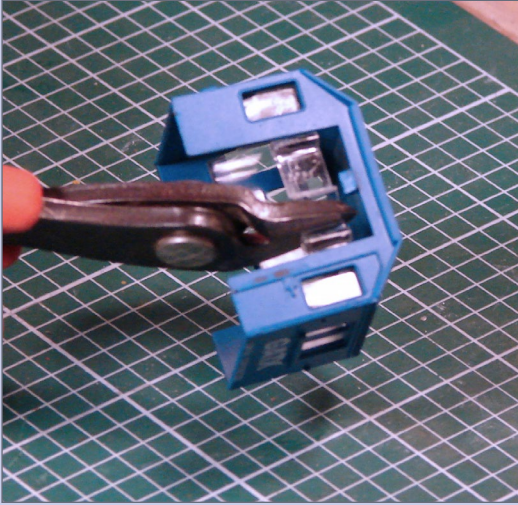

11a. Cut out rear center window glass: Using a pair of track nippers, I remove the rear portion of the window glass.

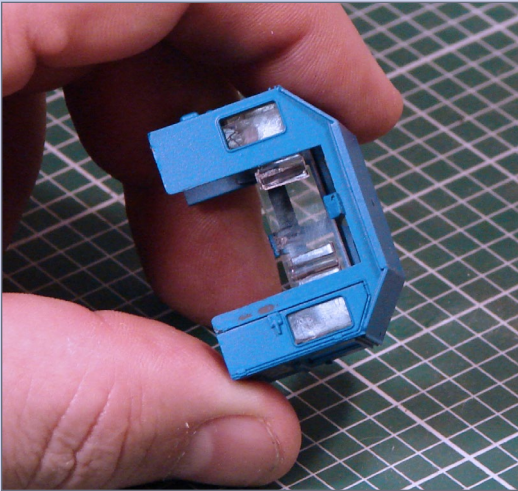

11b. Cab rear center window glass removed.

STEP 4: REMOVE WINDOWS *CONTINUED* ...

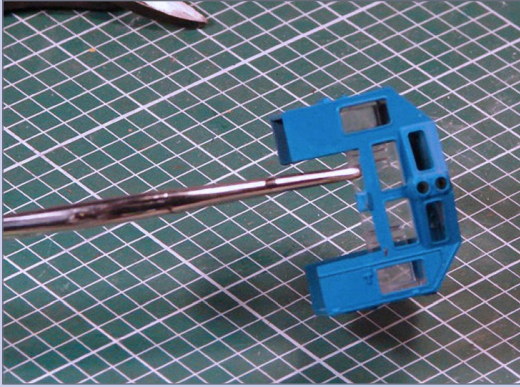

12a. Grab window glass with clamp: I use a hobby clamp (hemostat) to grip the window glass right under the front windows and pull it straight out.

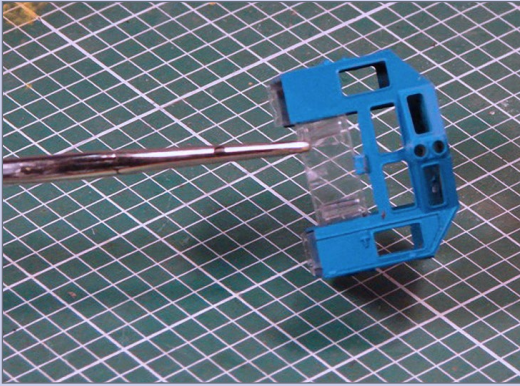

12b. Pull out glass: Pull the window glass completely out of the cab. If it won't pull out fairly easily, use something to get in and push the glass down from the roof of the cab.

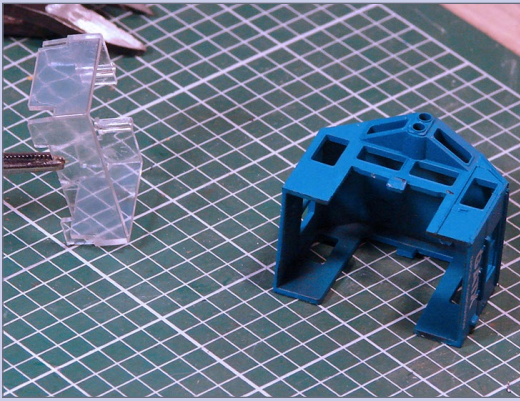

12c. Glass removed: Once the glass has been removed, set it aside for safe keeping.

STEP 5: REMOVE NUMBER BOARD INSERTS

Note: I have found some Athearn locomotives with opaque number board inserts. You may want to forego installing lighted number boards on these locos. That's what I typically do – just install headlights and call it good on these locos.

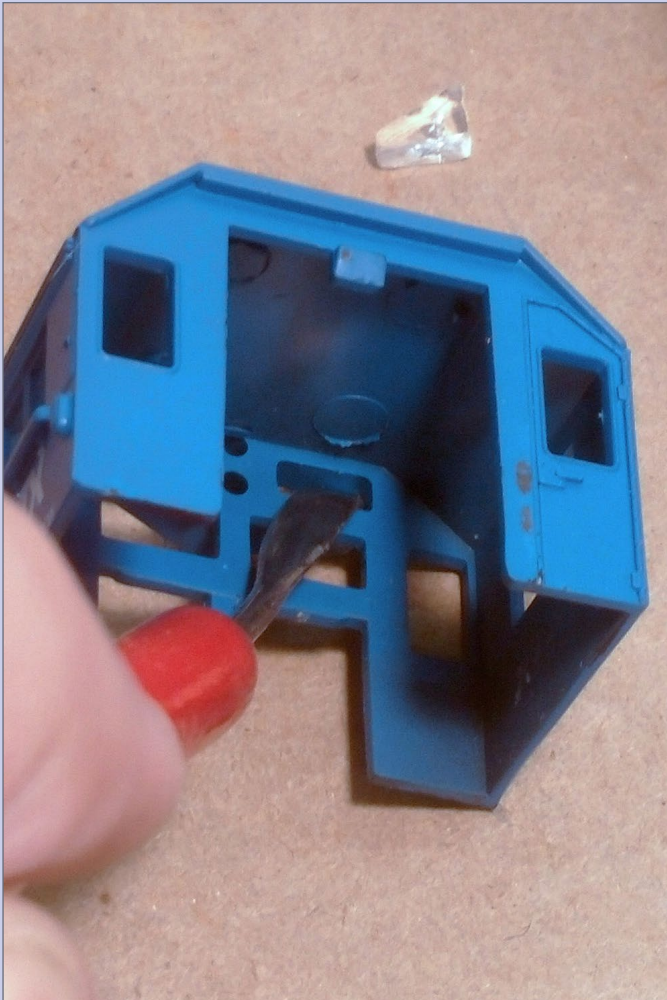

13. Push out number board lens: Remove the clear number board inserts from the cab by pressing them out with a blunt tool.

STEP 6: TEST THE LEDs

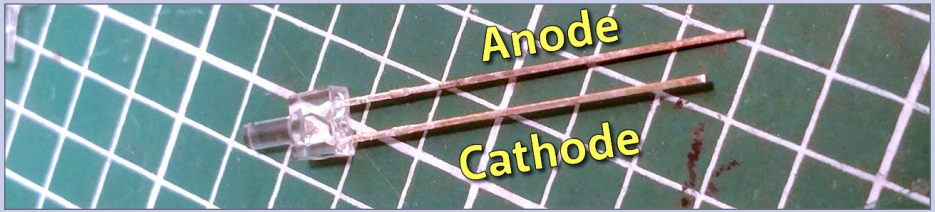

14. On LEDs, the longer lead is typically the anode, or positive. The shorter cathode lead is negative.

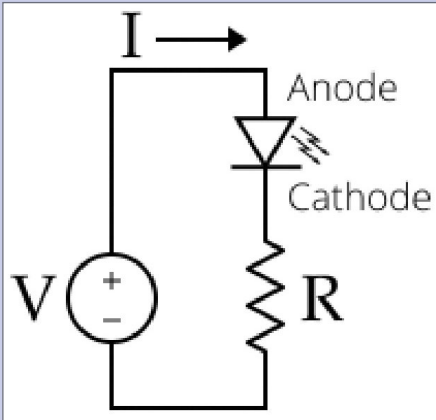

15a. Simple LED circuit.

V=voltage source

I=direction of current flow

R=resistor

See the sidebar “LED basics and an LED tester” for more on LEDs and how to test them safely without damaging them – and how to determine the resistance needed for your desired brightness.

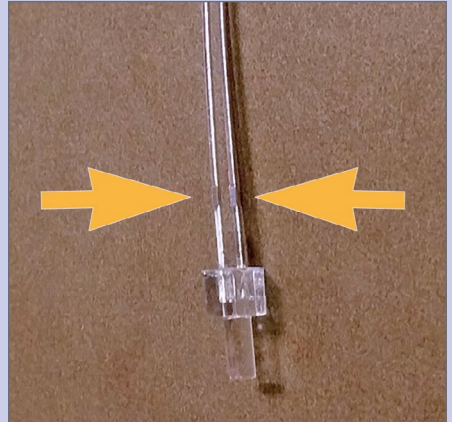

15b. Solder limits: If you solder too close to the LED, you can melt the lense or destroy the LED. The manufacturer has kindly notched the leads for you [see arrows] indicating you can safely solder to here, but no closer.

LED BASICS AND AN LED TESTER

BY MIKE DODD, MRH TECHNICAL EDITOR

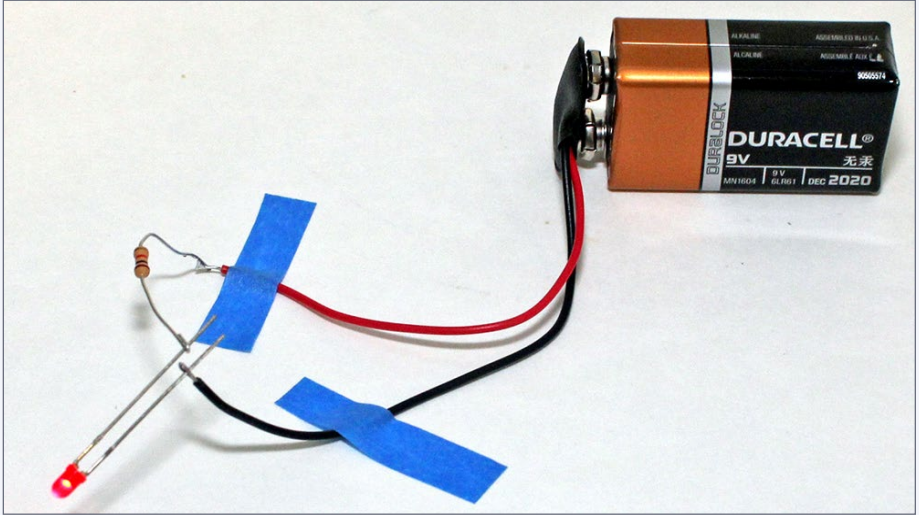

LIGHT-EMITTING DIODES (LEDs) CAN BE confusing to a modeler not familiar with electronics, but they're simple once you understand the basics.

How LEDs WORK

An LED is a semiconductor diode that passes current in one direction only, and emits light as the current flows. The more current that flows, the brighter the light.

1. As current passes through an LED, a forward voltage can develop between its two leads. This voltage remains nearly constant even as the current changes.
2. A resistor is required in series with an LED and the power source to limit the current through the LED, as seen in [15a].

3. Too much current will destroy the LED. Never connect an LED directly to a power source without a current-limiting resistor.
4. The key question when using LEDs in models is, how bright is it? You want an LED to be bright enough, but not so bright that it's unrealistic.
5. And the key to realistic brightness is choosing a resistor that limits current to a safe value.

What is a safe current?

Check your LED's specifications to learn the maximum forward current, then subtract 5 milliamps (mA) for a maximum safe current.

Typically, LEDs can handle up to 20 mA current, but 10mA or 15mA probably will produce enough light for models. For this discussion, let's choose 10mA as a safe current. We can increase it to 15mA if we want a brighter LED.

How to choose a current-limiting resistor

You can use Ohm's Law or an online calculator to determine the resistor's value, but why do that? The simplest way is to try different resistors until the LED lights to the intensity you want. You'll need to measure current through the LED with each resistor to be sure it's within the safe range.

Refer again to [15a]. Connect the multimeter between the LED cathode and the resistor, or between the resistor and the power source negative terminal. Begin with a 1.5K resistor to limit the LED current to 10mA or less. For power, use a DCC decoder function output or a bench power supply that delivers the same voltage.

That's it – you try a resistor, measure the current, and check the LED's brightness. If not bright enough, replace the resistor with one having a value about 10% lower. For example, if you started with 1.5K, replace it with 1.2K. Then try 1K, etc., until you get the desired brightness. Measure the current each time, and don't let it exceed 15mA. When installing the LED in your model, use a resistor with that same value.

A simple LED tester

It's a good idea to test an LED before installing it in a model. Here is a simple way to do that.

You need just a few components:

- 9V battery
- Connector with wires that snaps onto the 9V battery, such as this ink from Amazon with free shipping.

WEB: a.co/d/dXPKMwT

- 1K ¼-watt resistor

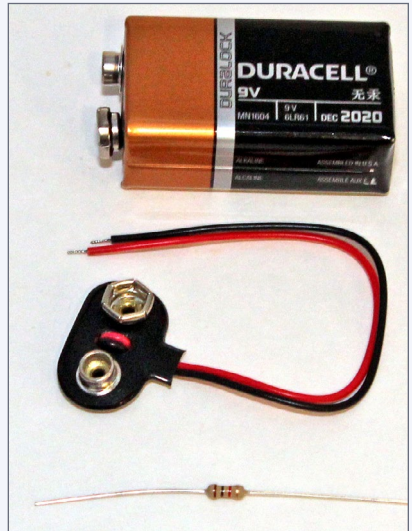

LED tester parts

Construction

Strip the insulation from the battery clip wires and tin the leads.

Solder one of the 1K resistor's leads to the battery clip red wire.

Use needle-nose pliers to bend the bare end of the battery clip's black wire back to make a hook to hold one of the LED's leads.

Do the same thing on the free lead of the 1K resistor.

You're all set and ready to test LEDs.

Using the tester

Do not allow the bare ends of the battery clip's red and black wires to touch while the clip is attached to the battery. This would create a short circuit and ruin the battery.

A good way to prevent this is to tape the wires to your workbench, as seen in this sidebar's lead photo.

Slip the LED's positive lead (usually the longer one) into the hook on the resistor. Slip the LED's negative lead into the hook on the black wire.

If the LED lights, it's good; if not, it's defective.

That's all there is to it, happy LED testing! ■

NOTES

1. The 1K resistor allows no more than 9mA to flow through the circuit – safe for any LED.
2. If you'd like a brighter LED, use an 820-ohm or 680-ohm resistor instead of 1K. They still limit the current to a safe value (under 10mA for 680 ohms).
3. Use care when connecting an LED to the tester. Usually the long lead is the positive lead. In theory, you can damage an LED by connecting it backwards. A typical spec sheet says max reverse voltage is 4V – much lower than the tester's 9V. However, I connected several LEDs backwards multiple times with this tester, and not one was damaged.
4. If an LED doesn't light, consider reversing the leads, but be mindful of the risk stated above. If the LED still doesn't light after reversing the leads, it is defective. If it does light, note which lead is connected to the resistor (positive), so you'll know which one to connect to positive when installing the LED in your model.
5. Using a pluggable breadboard for LED testing can be more convenient.

WEB: a.co/d/ccSzDeq (\$6, Amazon)



DCC FUNCTION LEAD VOLTAGE

Don't just assume your function lead voltage is 12V, you can test to be sure by just connecting a volt meter up to the blue (+) and white (-) decoder leads. With the loco/decoder on powered rails, address your loco decoder and then press the F0/headlight function to turn it on. Read the function voltage – in my case it's 14V, which is quite a bit more than an assumed 12V.

STEP 7: BUILD THE REAR LIGHT ASSEMBLY

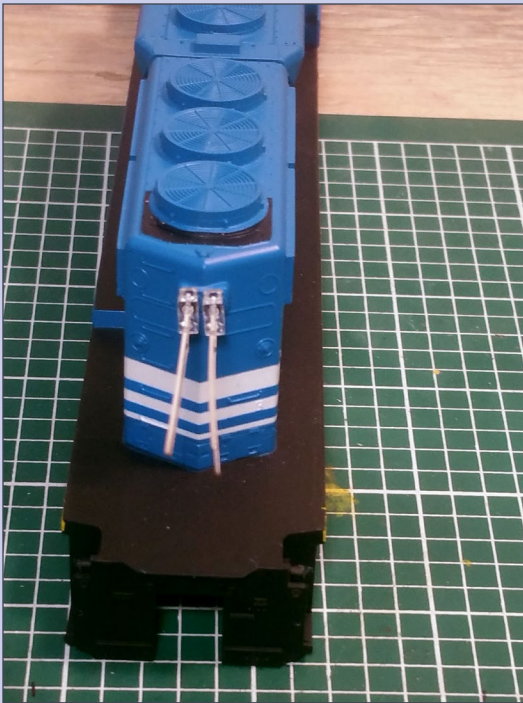

16a. Test fit rear LEDs outside: Place two LEDs into the light housing on the long hood from the outside. Make sure they fit into the holes. If they are too large, you can file the barrel using an emery board or sanding stick.

STEP 7: REAR LIGHT ASSEMBLY *CONTINUED ...*

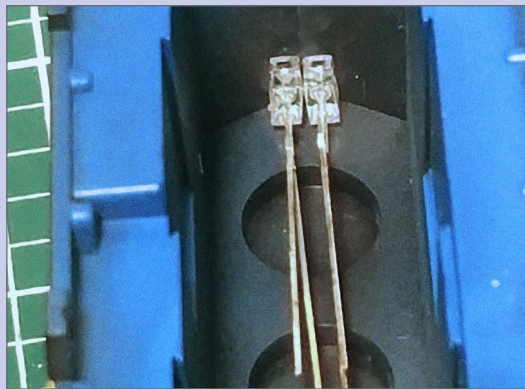

16b. Test fit inside: Move the LEDs to the inside and check to see how far they stick out [16c]. They should be about the same as the lenses you removed.

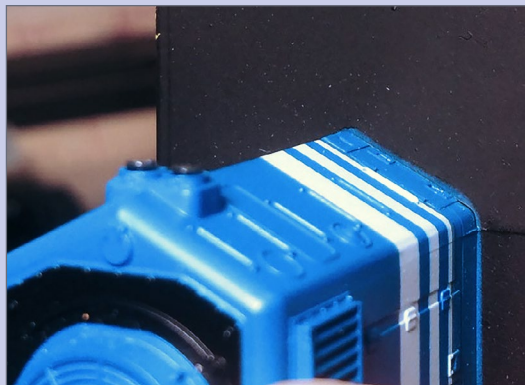

16c. Check LED barrel protrusion: If the LED barrels stick out too far, you can fix this by sanding them shorter. *Do not try clipping them shorter, the barrel may crack and chip (ask me how I know).*

If you sanded the LED barrels to make them shorter and/or you contoured the ends to look like the prototypical lights, you can make them clear again. Just add drop of CA adhesive to the tip. Sand any overage off the barrel sides after the CA dries, then test-fit again.

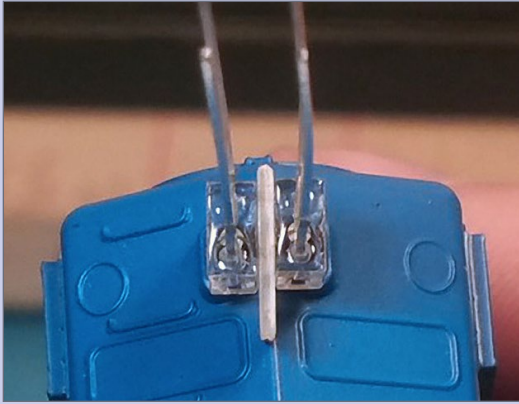

STEP 7: REAR LIGHT ASSEMBLY *CONTINUED ...*

17. Add styrene spacer: Place the LEDs back in the light housing from the outside with both anodes on the top. Cut a small piece of scrap plastic so it will fit between the two LEDs but be small enough not to interfere with any soldering.

- Clamp both lights together with the hobby clamp *very lightly!* If you try to clamp the lights *tightly* together before removing them from the body shell, you risk breaking off one of the barrels.
- Gently slide the lightly clamped LEDs from the body shell, *then* clamp them firmly together.
- Check to make sure the LED barrels are aligned parallel to each other and are the same length. Once you solder them together, it is too late to make changes!



18a. Bend anodes together and solder: Bend both anodes so they come together and solder them where they cross. Trim the anode leads after soldering. Hold the leads when clipping to keep them from flying.

STEP 7: REAR LIGHT ASSEMBLY *CONTINUED ...*

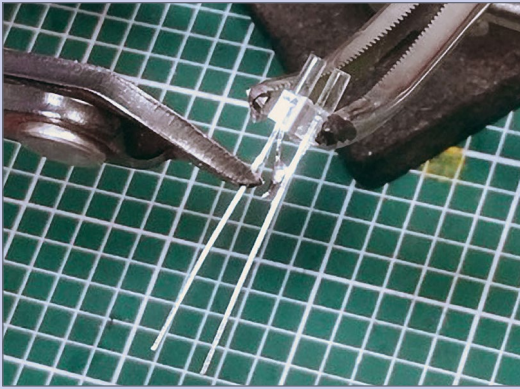

18b. Trim cathodes: Trim the cathode leads off at the minimum solder distance mark on both leads.



19a. Trim resistor lead on one end: Trim two 620-ohm resistors on one end to $\frac{1}{4}$ ".

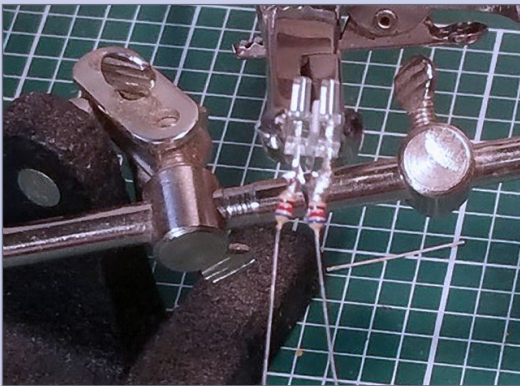

19b. Solder resistors to cathodes: Solder the resistors on to the cathode leads – one resistor per lead.

STEP 7: REAR LIGHT ASSEMBLY *CONTINUED* ...

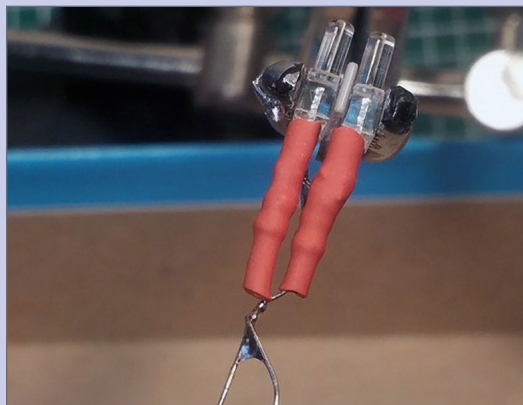

20a. Apply shrink tubing: Cut and place two lengths of shrink tubing over the resistors and the LED leads. Shrink the tubing with a heat source. Twist the two resistor leads together and solder.

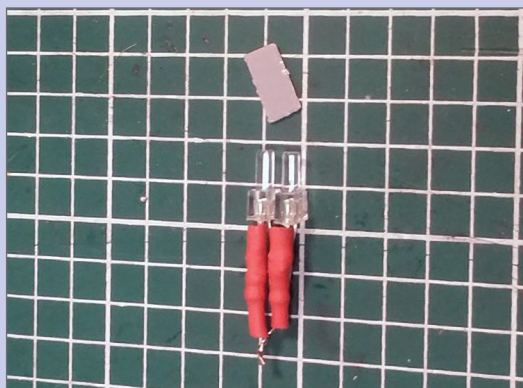

20b. Remove plastic shield: Trim the leads at the solder joint and remove the plastic spacer.



20c. Paint LED body inside shell black: Paint the part of the light assembly that will remain in the long hood with flat black paint and let it dry.

STEP 8: SOLDER REAR LIGHT TO DECODER WIRES

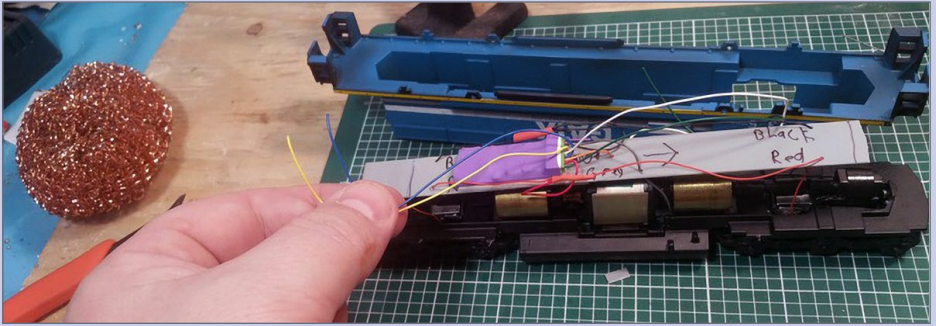

21a. Prepare yellow and blue wires: Place the chassis and the body shell next to each other with the shell upside down. Use the yellow and blue wires for the rear light – push the wires into the shell and mark them where they touch the rear light holes. Trim the two wires to length and strip the ends.

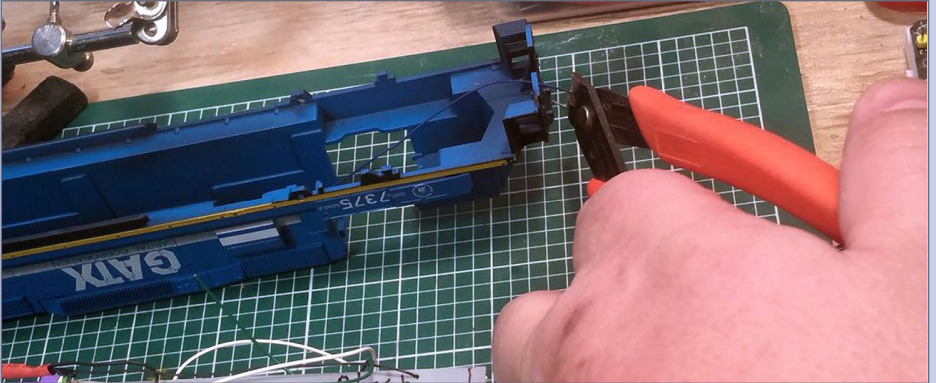

21b. Cut extra piece of blue wire: Take some extra 30 AWG blue wire and strip the free end. Hold the free end of this wire at the rear of the body shell, then pull the wire through the shell front coupler opening and cut it off the spool just past the pilot. This new front lighting feed wire is basically as long as the entire loco shell.

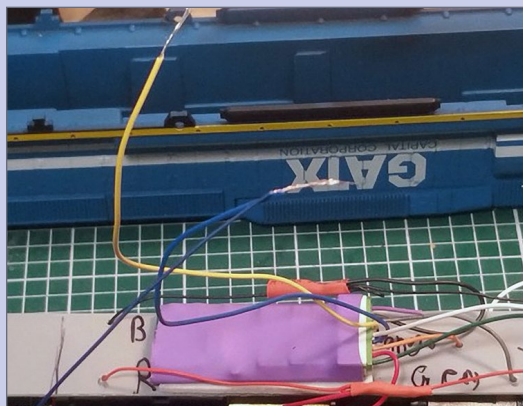
STEP 8: SOLDER REAR LIGHT *CONTINUED ...*

21c. Join to blue decoder wire and solder: Twist the blue decoder wire and this the new front lighting feed blue wire together and solder. Note, the extra blue wire goes to the front headlight.

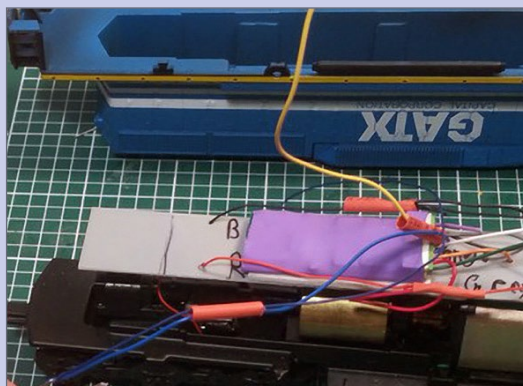

22a. Add shrink tubing: Cut 2 pieces of shrink tubing. Place one over the yellow wire and the other over the joined blue wires.

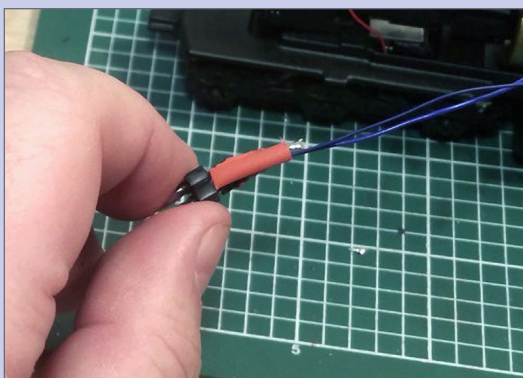

22b. Solder blue decoder wire to joined anodes: Solder the blue decoder wire end (middle joint with extra blue wire) onto the anodes – the leads that don't have the resistors attached. Slide the shrink tube over the solder joint and shrink it.

STEP 8: SOLDER REAR LIGHT *CONTINUED* ...

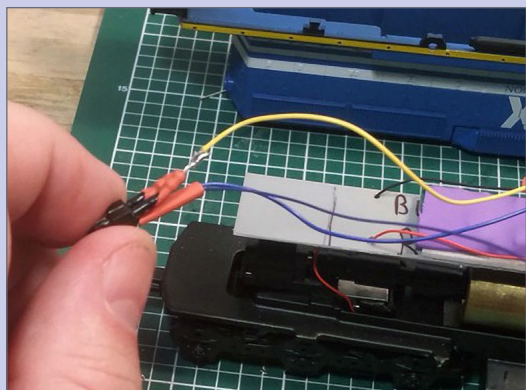

23a. Solder yellow wire to cathodes: Solder the yellow wire to the joined resistor leads on the cathode.

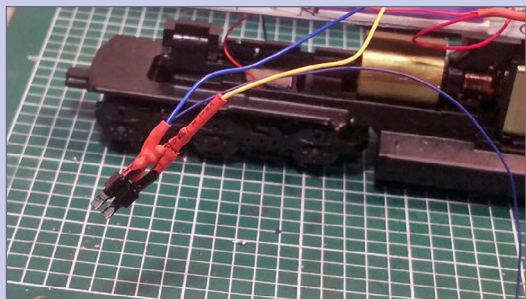

23b. Apply shrink tubing: Slide the shrink tube over the solder connection and apply a heat source to shrink.

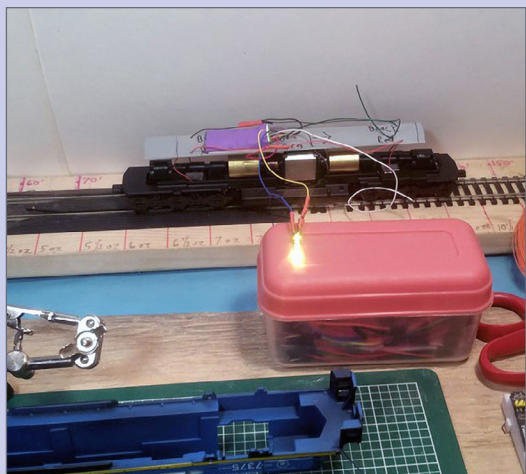

24. Test rear headlight: Put the loco on a test track, dial up the loco on the throttle, and test the light by pressing headlight and putting the loco in reverse.

STEP 9: INSTALL REAR LIGHTS IN SHELL

This is a tricky bit of work. You may find it easier to install the light assembly if you shine light into the holes from the outside of the body shell.



25. Stand up shell: Stand the body shell up on the end of the long hood with the rear lights down.

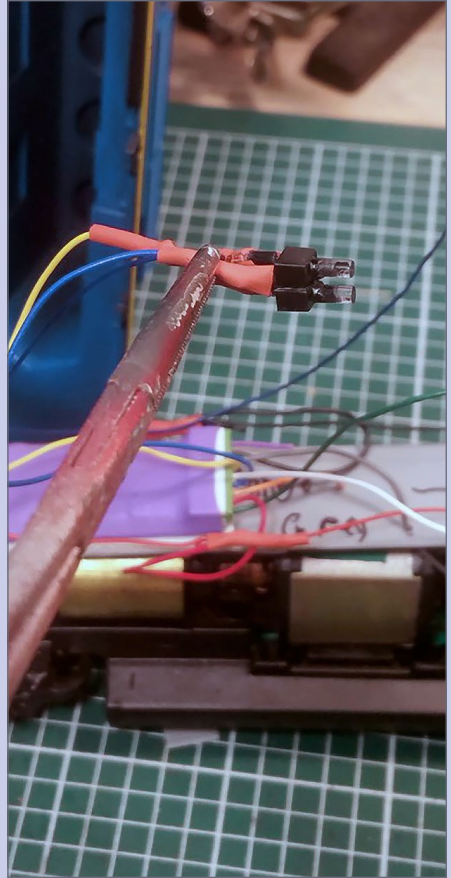

26a. Grab rear LEDs: Grip the rear light assembly by one of the leads.

STEP 9: INSTALL REAR LIGHTS *CONTINUED* ...

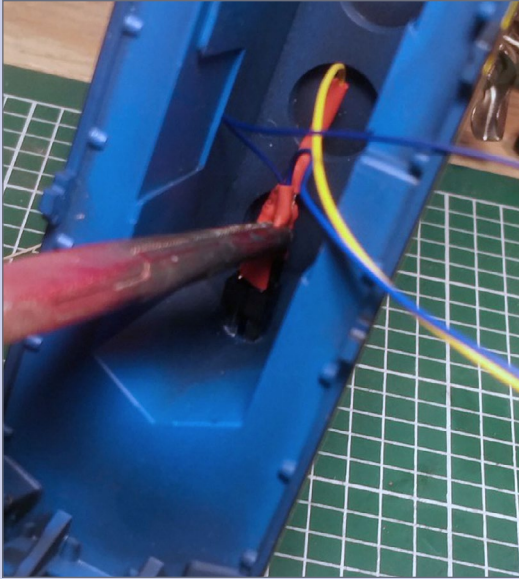

26b. Insert into shell: Place the tips of the light's towers into the mounting holes and push them into place gently.



26c. Rear light installed: Make sure the lights are in the proper position by looking at the body shell from the outside.

STEP 10: THREAD FRONT WIRES THROUGH

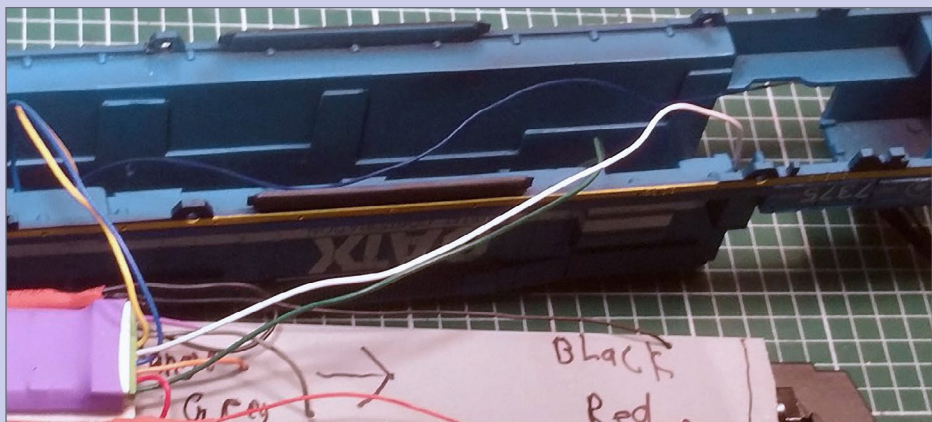

27a. Thread wires through cab opening: Take the white and green wires from the decoder and the extra length of blue wire off the rear headlight solder joint and pass their ends through the opening left by the removed cab.

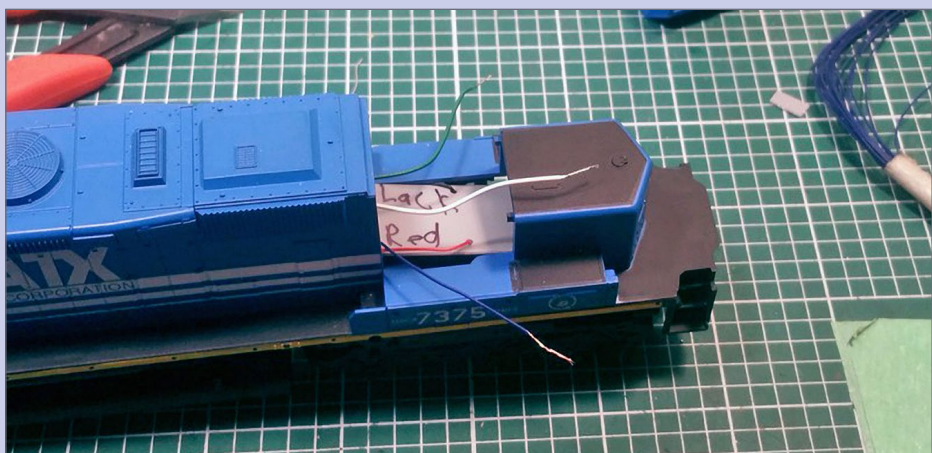

27b. Trim wires to length: Trim the three wires to length and strip the ends. The wires should reach at least halfway down the short hood. Lightly place the shell on the chassis.

STEP 11: PREPARING THE CAB

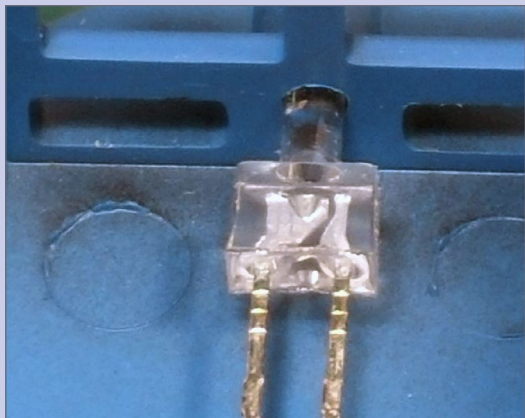

28. Test fit LEDs: Test fit the LEDs in the light holes on the inside of the cab. Most likely, the lights won't fit into one or both holes.



29a. Ream headlight holes if needed: Using a 2mm (#46) drill bit, ream out the holes on the inside of the cab until the lights just slide in.

- If a horn is installed on your model, you may knock it loose while reaming the upper light hole. You may need to trim the horns stalk so it will fit in without protruding into the cab interior.
- If the LEDs end up pushing on the cab headlight lenses from the back, trim them until they fit snugly against the inside cab wall without pressing on the headlight lenses.

STEP 11: PREPARING THE CAB *CONTINUED* ...



29b. Top hole fits:
Headlight LED now fits into the top cab headlight hole.

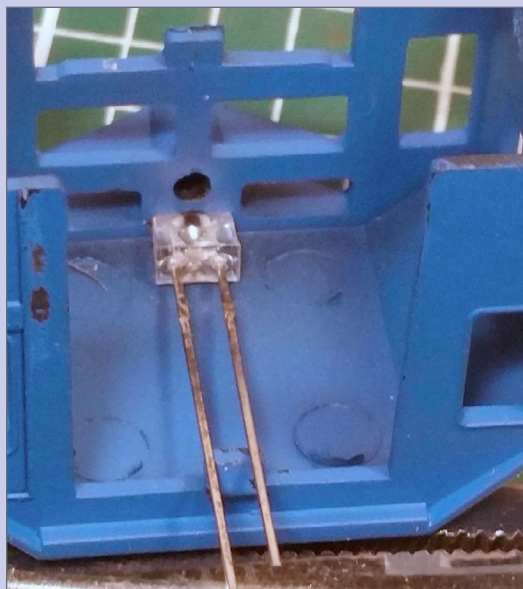

29c. Bottom hole fits:
Headlight LED now fits into the bottom cab headlight hole.

STEP 12: MAKE FRONT LIGHT ASSEMBLY

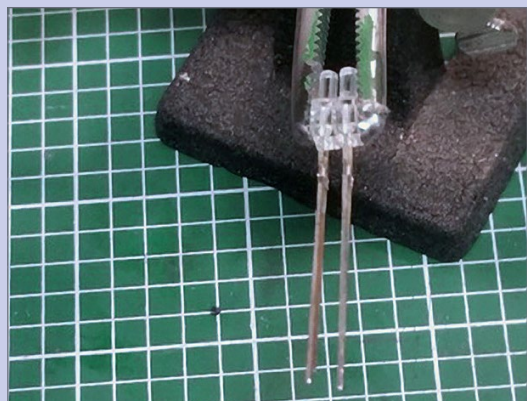

30a. Clamp two LEDs together: Take two LEDs and clamp them as you did for the rear lights, but without the spacer in between.

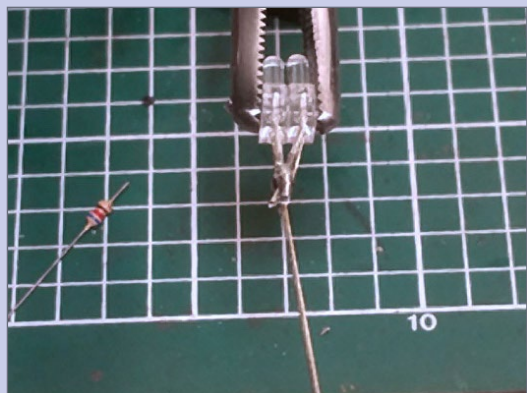

30b. Solder anodes together: Bend one of the anodes over the other and solder the anodes together – but do not trim! Trim off both cathodes at the minimum solder line just as you did for the rear lights.

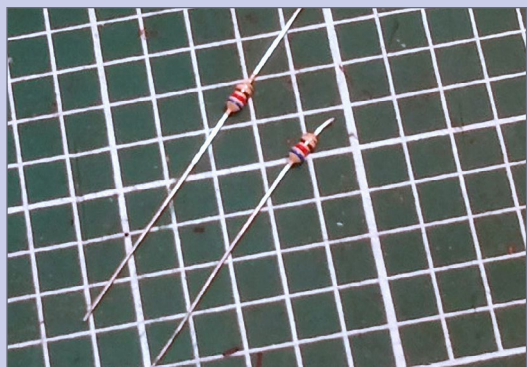

31. Trim resistor lead: Trim two 620Ω resistor leads (your resistor value may be different) to $\frac{1}{4}$ " on one end.

STEP 12: MAKE FRONT LIGHT *CONTINUED* ...

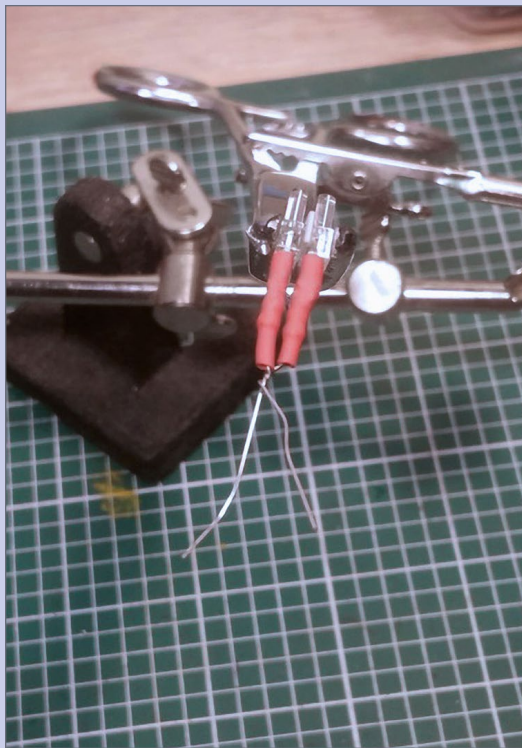

32a. Solder resistors onto cathodes: Solder one resistor to each cathode lead. Cut two pieces of the shrink tubing and cover the resistors and cathode leads. Shrink the tubing and twist the leads together.

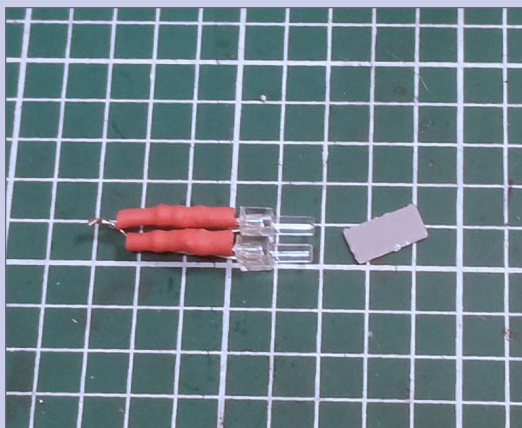

32b. Solder and trim leads: Solder the twisted leads and trim at the solder joint.

STEP 13: MAKE NUMBER BOARD LIGHTS

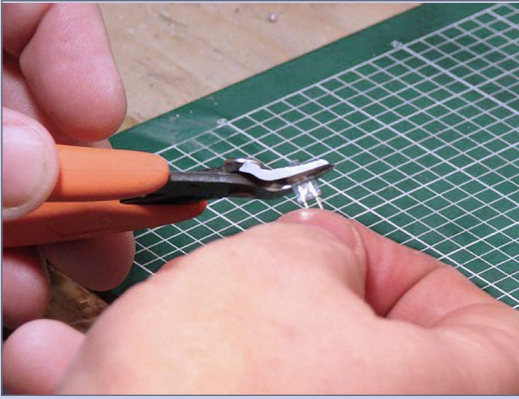

33a. Trim barrel off: Using a pair of flush-cutting nippers, trim the towers off both LEDs.



33b. Barrel removed: With the barrel removed, the face of the LED needs to be smoothed.

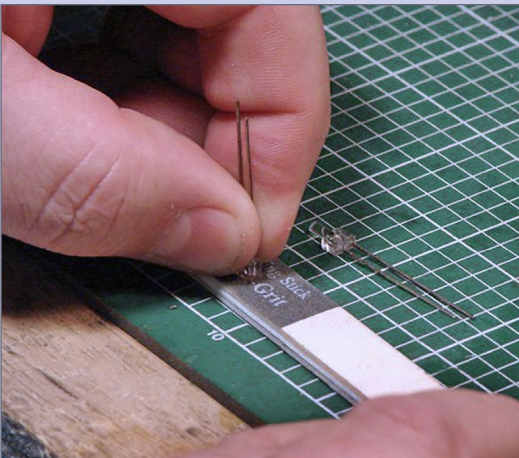

33c. Sand smooth: Sand the trimmed LED face until it is smooth.

STEP 13: MAKE NUMBER BOARDS *CONTINUED* ...

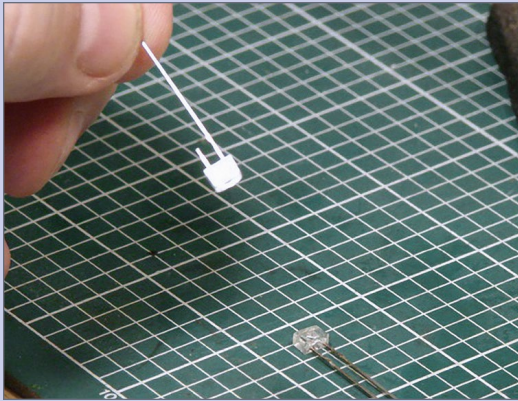

34. Trim cathode lead:
Take the LEDs and cut the cathodes off at the minimum solder line.

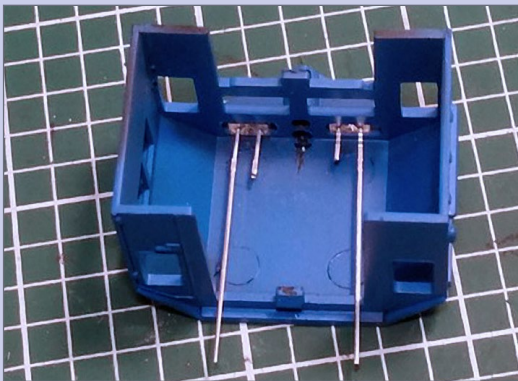

35a. Slip LEDs into number board slots:
Temporarily slip the LEDs into their mounting holes inside the cab with the trimmed cathodes facing the middle.

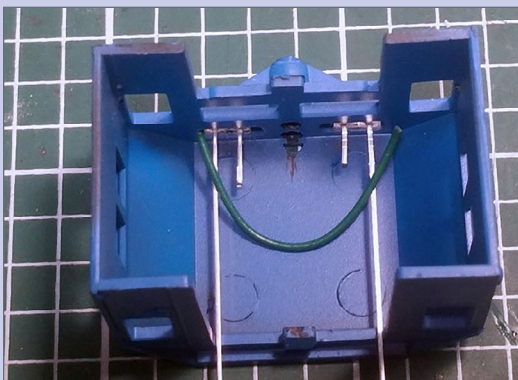

35b. Cut piece of wire:
Cut a piece of wire long enough to go between the cathodes in a loop as shown.

STEP 13: MAKE NUMBER BOARDS *CONTINUED* ...

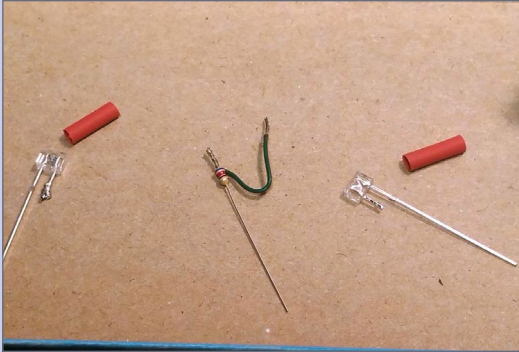

36a. Add wire to resistor: Strip the ends of the wire and prepare a resistor by trimming one lead to $\frac{1}{4}$ " long. Twist one end of the wire and the cut end of the resistor together.

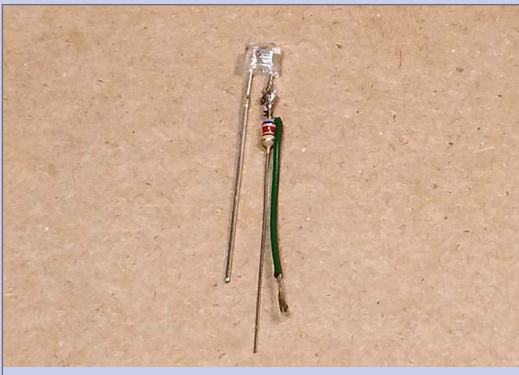

36b. Solder to short LED lead: Solder the wire and resistor to one of the number board LED light short leads.



36c. Add shrink tubing: Install a piece of shrink tube over both the wire and the resistor, then shrink the tubing.

STEP 13: MAKE NUMBER BOARDS *CONTINUED* ...

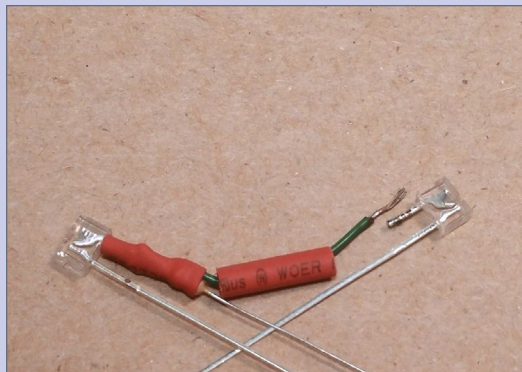

37a. Add second piece of shrink tubing then solder: Place the another piece of shrink tubing over the wire. Solder the wire onto the cathode on the second LED on right.

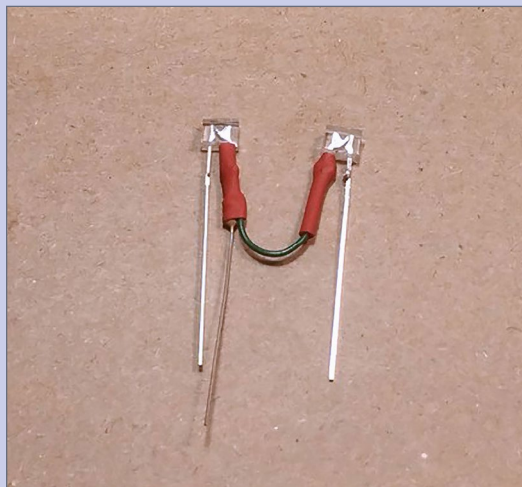

37b. Shrink the tubing: Slide the shrink tube over the solder joint and shrink it.



STEP 14: FIT THE LIGHTS INTO THE CAB

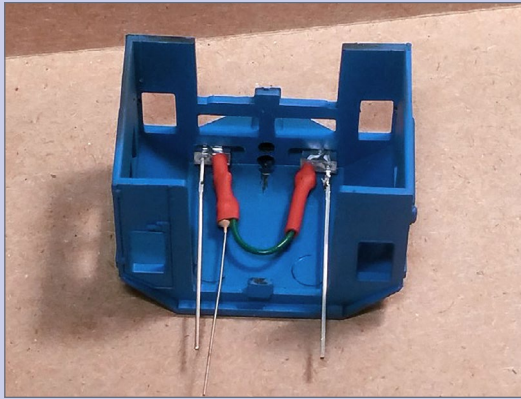

38a. Reinstall number board LEDs: Reinstall the number board assembly into the cab.

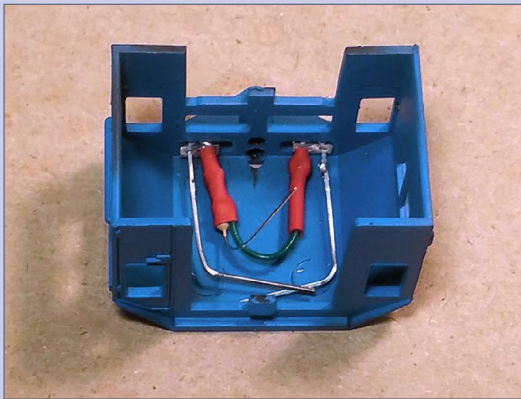

38b. Overlap anodes: Now for the fun part! Bend the anode leads so they overlap and form a loop.



39. Remove and solder: Make the leads cross each other and then solder them just where they cross so the excess part of the loop beyond the joint acts like a kind of spring on the LEDs, holding them in place.

STEP 14: FIT LIGHTS IN CAB *CONTINUED ...*

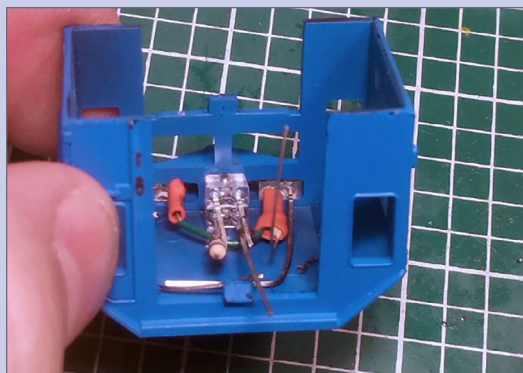

40a. Put number board and headlights in place: Place the number board assembly back in the cab, then place the headlight assembly in its place on top.



40b. Trim lead excess: With all the lights in place, trim the anode on the light assembly so it just reaches the number board anodes.

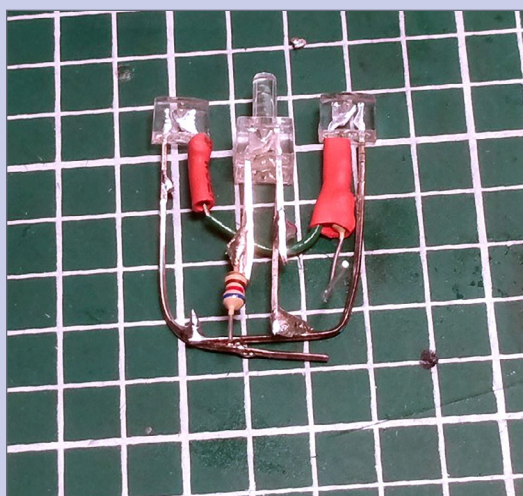

40c. Solder all anode leads together: Remove everything from the cab and solder the headlight anode to the anode loop on the number boards.

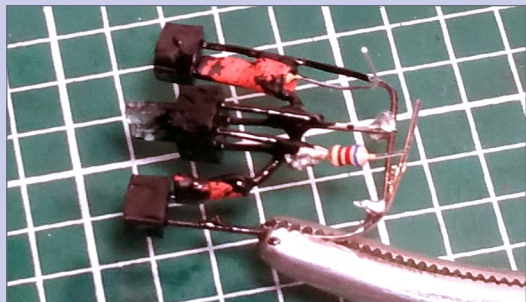
STEP 14: FIT LIGHTS IN CAB *CONTINUED ...*

41. Paint back of LEDs flat black: Paint flat back paint on all the LEDs so no light escapes into the cab interior. Keep paint off the number board fronts and off the headlight barrels.

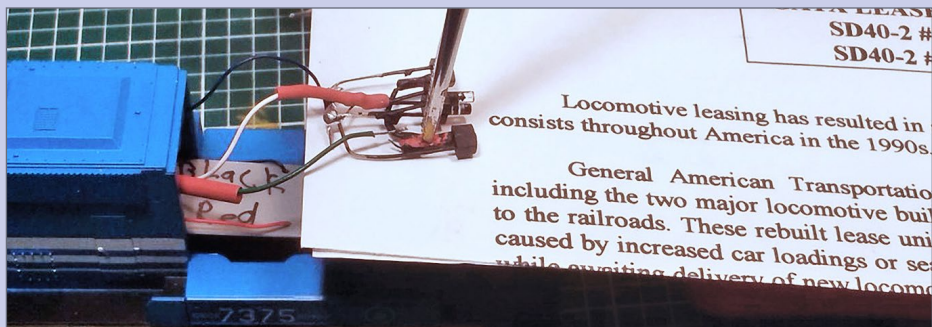

42. Solder assembly to decoder: Once the paint is dry, attach the front light assembly to the decoder. Place the light assembly on the short hood. I use a piece of paper under the assembly to catch any dripping solder.

Solder the blue wire onto the anode assembly.

Add a piece of shrink tube over the white wire and solder the white wire onto the resistor lead on the headlights.

Place a piece of shrink tube over the green wire and solder it to the the number board resistor lead.

- **CAUTION!** You risk melting the solder holding all the lights together if you aren't careful! Pick a spot as far from the other solder connections as you can for the decoder wires.

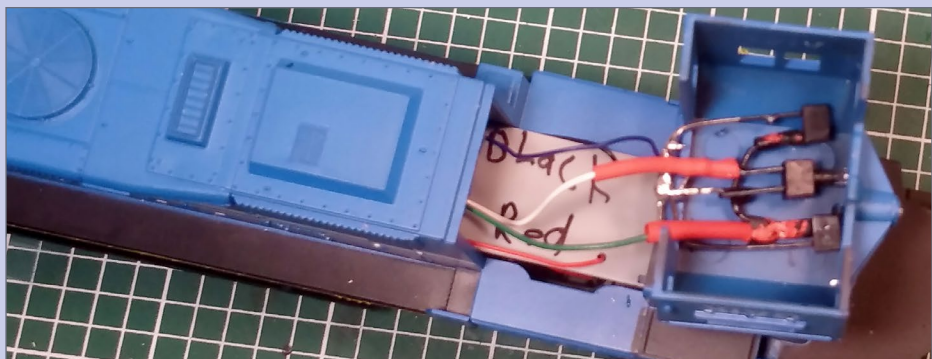
STEP 14: FIT LIGHTS IN CAB *CONTINUED ...*

43. Apply shrink tubing and press lights in place: Slide the shrink tubes into place and apply heat to shrink them. Slide the cab under the light assembly while holding the cab upside down. Press the headlights and number board LEDs into place. This final fitting takes concentration and fine finger work – just remain calm and avoid excess force when pressing the lights into place!

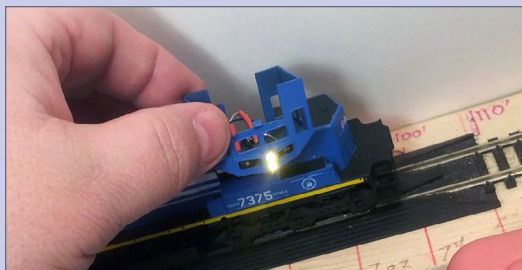

44a, b. Test the lights: Finally, before putting the cab in place, test the lights. Put the loco chassis on the track and dial up the loco on your throttle. Press F0 to turn on the headlights and press F1 to test the number boards.

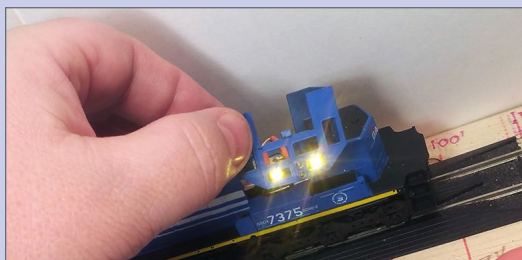

STEP 15: PUT CAB ON SHELL

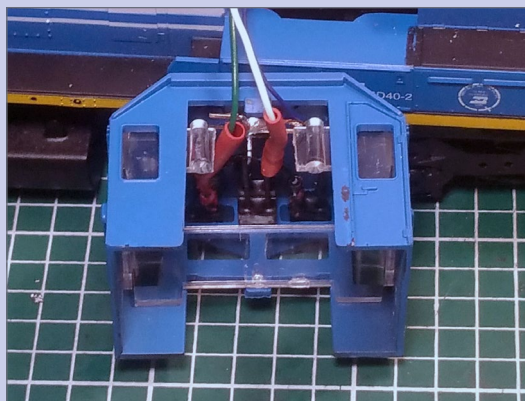

45. Reinstall cab windows: Reinstall the windshield glass. If you trimmed the glass out at the back of the cab [11a, b], the window glass should go in around the LED wiring.



46a. Rotate cab upright: Carefully rotate the cab upright. Do not snap it in place just yet.



46b. Press cab in place: Push rear of the cab onto the body shell making sure the wires are not pinched, then carefully press the cab into place.

STEP 15: PUT CAB ON SHELL *CONTINUED ...*

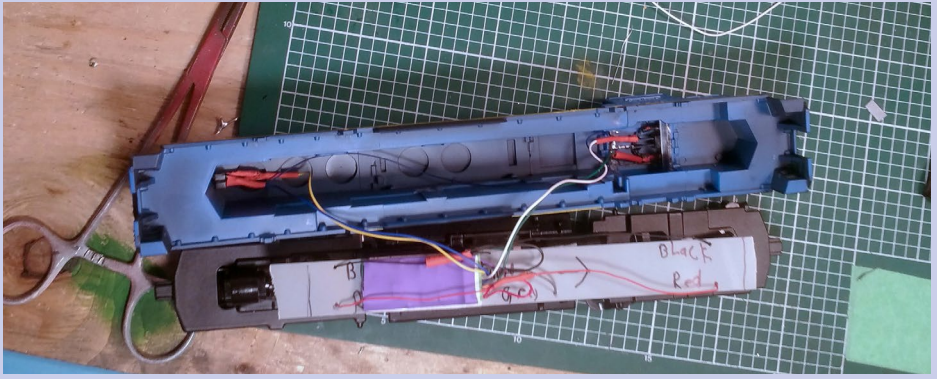

47a. Slide body shell off to one side: Lift the lightly placed body shell off to one side, making sure to not pull on the wires.

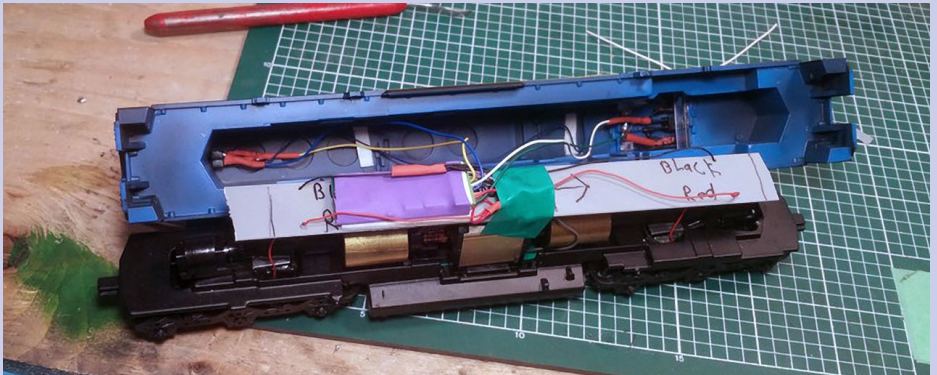

47b. Add foam tape to shell inside: Cut and place some foam tape on the inside of the body shell, then press the lighting wires into the foam tape. This helps keep these wires in place and makes installing the shell easier.



RATE THIS ARTICLE

STEP 15: PUT CAB ON SHELL *CONTINUED ...*



48. Enjoy your new lights: Replace the body shell back on the chassis making sure no wires get caught under the wire shield or between the motor and the body shell.

Reinstall the number board glass on the cab outside. They may be a little tough to push in, but should stay in place when all the way in. This would be a great time to apply paint and numbers to the number boards.

Now you are done [48]. Take it to your layout and enjoy your newly lighted masterpiece! ☑

Final note: If you would like me to make a tutorial for other manufacturers just ask on the comment thread to this article. I would be glad to make more of these lighting and DCC installation tutorials.



Tell your friends about MRH!

We depend on word-of-mouth to grow ... if you don't share us, we don't grow

LES GREEN



Les had a few locomotives and some track as a kid but they didn't last long and Les moved on to other interests.

Les worked in the autobody and towing industries for years until one day he met his friend Scott.

Scott showed Les his 9' x 15' layout and Les became hooked again on the hobby, helping Scott expand his layout.

Before long, Les started an HO 6' x 10' switching yard with a locomotive service and fueling area. He has continued to expand it with additional benchwork and more levels.

Over his years in the hobby, Les has developed an interest modeling CP and CN diesels, although he does harbor a secret love for the AT&SF. He has also developed an interest in doing DCC conversions.

Les finds his autobody experience handy when it comes to working on plastic models and painting them.

Les is currently installing tortoise switch machines on his layout and controlling them with an Arduino Mega and relays, and becoming conversant with writing code in C++.

Les' other hobbies include 1:24 scale model building, motorcycle restoration and riding, wood working, metal working, and working on full sized (not model) cars and trucks, both mechanically and doing body work. ■



RATE THIS ARTICLE

**THE FINE SCALE
MODEL EXPO
2018**

November 1st - 3rd,* 2018
Albany, New York

**The vendor show opens at noon on Friday!* at the Hilton Hotel



THE ONLY SHOW DEDICATED
TO THE ART OF SCALE MODEL
STRUCTURE BUILDING

**\$1000 CASH PRIZE
MODEL CONTEST**

CLINICS & WORKSHOPS

AWARDS DINNER

DIORAMA DISPLAYS

LAYOUT TOURS

FINE SCALE MODEL VENDORS

REGISTER TODAY!

**Participate in the Expo Model Contests
and have a chance to win cash!**



**\$1000 CASH
GRAND PRIZE
FOR BEST OF SHOW**

SPONSORED BY THE
SUNCOAST CENTER FOR
FINE SCALE MODELING



NOVEMBER NEWS

column



Model Railroad Hobbyist | November 2018 | #105

RICHARD BALE and
JEFF SHULTZ report the
latest hobby industry news



NEW CLUB CARS

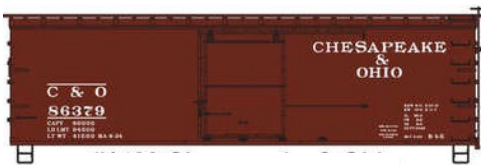

The Chesapeake & Ohio Historical Society is offering an HO scale kit for a 36-foot double-sheathed wood boxcar with steel ends

and a straight steel underframe. The model is based on C&O car Mo. 86379 that was built in 1923 by American Car & Foundry. It was retired in 1952. The custom kit was produced for C&OHS by Accurail and includes appropriate trucks and Accumate knuckle couplers. For ordering information visit chessieshop.com/index.php?main_page=product_info&products_id=3480.

.....

The New York Central Historical Society is selling both N and HO scale versions of a Pullman-Standard PS2-CD covered hopper. Six road numbers are available. The custom decorated

▶ THE LATEST MODEL RAILROAD PRODUCTS, NEWS & EVENTS



cars were produced for the NYCHS by InterMountain Railway. To order visit [www.nycshs.net/Intermountain-N-Scale-PS2-CD-Covered-Hopper- p 887.html](http://www.nycshs.net/Intermountain-N-Scale-PS2-CD-Covered-Hopper-p_887.html).

NEW PRODUCTS FOR ALL SCALES



Atlas has introduced a series of 3D printed scene accents in N, HO and O scale. The items

include a fire hydrant, cinder block, acetylene tank, propane tanks, and wood pallets. For additional information contact a dealer or visit atlasrr.com.



New electric animated signs from **Miller Engineering** include a rooftop billboard for Sunbeam Bread. The model is based on a sign on the roof of Perfection Bakeries in Fort Wayne, Indiana. A 2.2 x 2.15-

inch version of the Sunbeam sign is suitable for N or HO scale use. For larger scales a 4.5 x 6.25-inches is also available.

Also new is an electric sign for York Peppermint Pattie Candy. This sign is also available in two sizes: 4.4 x 3.6-inches and 2.2x1.8-inches. To view a demonstration of the sequencing electric signs visit www.microstru.com/Coming-soon.html.

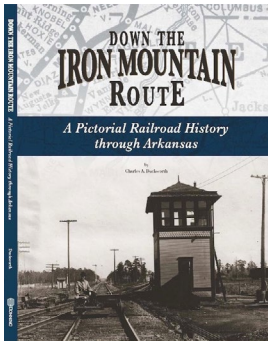

The Missouri Pacific Historical Society has released *Down the Iron Mountain Route*, by noted modeler and author Charles A. Duckworth. Subtitled *A Pictorial Railroad History Through Arkansas*, the 152-page hardcover book documents the history of the St. Louis, Iron Mountain & Southern Railroad. A majority of the 250 illustrations are period photographs of StLIM&S structures taken before 1925. The remaining

illustrations are maps and period brochures. For additional information email marketing@mopac.org.

.....

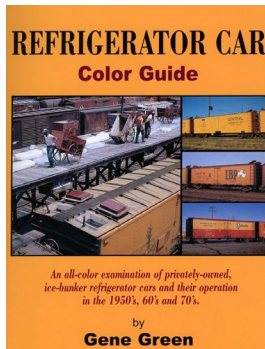
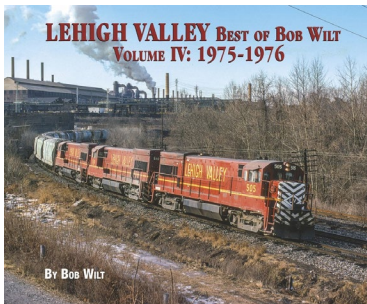

New books available from **Morning Sun** include *Lehigh Valley, Best of Bob Wilt Volume IV*. In the final

two years before its inclusion in Conrail, the Lehigh Valley Railroad strove to improve its image with boldly repainted equipment. Wilt's camera captures the colorful last hurrah in this digital reprint.

Gene Green's *Refrigerator Car Color Guide* is a valuable reference for modelers. Originally published in 2005, it is now available as a digital reprint. The book provides a detailed look at the operation and roster of privately-owned ice-bunker reefer cars. Included is a fascinating sequence of the icing process atop

an icing dock in 1962. For information contact a dealer or visit morningsunbooks.com.

.....



Woodland Scenics has introduced N, HO, and O scale versions of a community water tank. The ready-to-use model has a rustic finish and features a flashing LED aircraft warning light at the peak of the tank. Additional details include metal cross cables and trusses for stability, and a free-standing pump house. For more information contact a dealer or visit woodlandscenics.com.

.....

O AND S SCALE PRODUCT NEWS



Atlas O has introduced new paint schemes on its 50-foot 6-inch boxcar. Features on the O scale Trainman series model include separately-applied end ladders, brake wheels

and end platforms; non-terminating corrugated ends, diagonal paneled roof, 10-foot Youngstown sliding doors, and roller bearing trucks with rotating caps. Road names are Burlington Northern, Union Pacific, Berlin Mills, Green Bay & Western, Susquehanna, Santa Fe (ex-Railbox), BNSF, and a pink Railbox featuring an On Track for a Cure slogan. All Atlas O models are available for either 3-rail or 2-rail operation. For additional information contact a dealer or visit atlaso.com.

.....

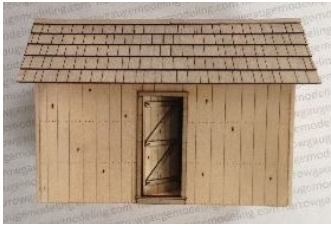

Narrow Gauge Modeling Company is selling a basic laser-cut kit for an O scale logging camp cabin. The design is based on

an actual cabin that has been slightly modified to fit comfortably on a Bachmann On30 log car. The kit has a laser-cut wood roof and sides with knots and nail holes. For additional information send an inquiry to sales@narrowgagemodeling.com.

.....



Rusty Rail is selling an O scale junk pile suitable for any industrial site. The resin casting can be painted and aged in a variety of effective styles. For additional information visit rustyrail.com.

.....



Pre-Size Model Specialties has released a kit for a TTX 60-foot flat car. The S scale model is based on the OTTX

and HTTX versions of the more than 6,000 cars TTX built starting in 1964. The kit consists of a cast-resin frame, laser-cut wood deck, brake wheel, grab irons, brake details, and decals. Trucks and couplers are not included. To order visit www.pre-size.com.

.....

HO SCALE PRODUCT NEWS

Accurail is expected to release its new Milwaukee Road rib-side steel boxcar during the Milwaukee-area Trainfest.



The initial release will be HO scale kits for a 40-foot Phase 1 car with single sliding doors and long ribs. The release will

include cars decorated with large billboard lettering representing equipment from the 1963-67 era (above).

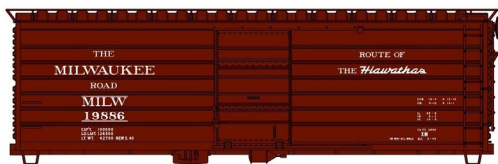

Cars from the 1939/1940 period with *Route of the Hiawathas* slogan will be available (above) as well as cars displaying the

Electrified Olympian slogan (below)

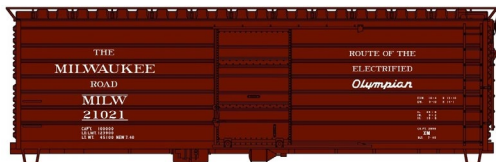

An undecorated kit will also be available.



New kits available from Accurail include a New York, Susquehanna & Western USRA twin-bay hopper car. The HO scale model is based on a

coal hauler built in 1917 and rebuilt in 1939. It is available in a 3-car set with different road numbers.

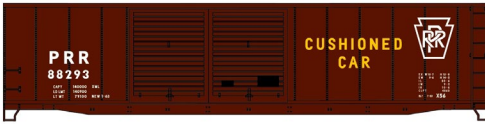

Also new is a 50-foot Pennsylvania class X56 steel boxcar with double Youngstown sliding doors.



This 40-foot wood refrigerator car decorated for Chicago Great Western is based on an early prototype that was rebuilt in 1922 and

continued in service through WWII.



Accurail's HO scale kit for this Boston & Maine 40-foot boxcar with Youngstown sliding doors follows a steel prototype built in 1942.



The Cleveland, Cincinnati, Chicago & St. Louis Railway, aka The Big Four, was acquired in 1906 by the New York Central which oper-

ated it as a separate entity until 1930. Accurail's HO scale kit represents a 36-foot double-sheathed wood boxcar built in 1914 for CCC&StL with steel ends and a steel fishbelly underframe.



This 36-foot Fowler single-sheathed wood boxcar with a horizontal brake wheel mounted on a vertical shaft entered service on the PGE in the teens. All Accurail kits

include appropriate trucks and Accumate knuckle couplers. For additional information contact a dealer or visit accurail.com.

.....



Athearn has announced plans for another production run of

Genesis series EMD GP9 diesel locomotives. The run will include a Canadian National version oriented with the long hood forward in the road's distinctive green and yellow livery. Additional features on the Canadian GP9s will be large barrel headlights, special MU stands, and handrails with the unique CN configuration.



The production run of the HO scale GP9 will include Union

Pacific and Southern Pacific versions with dynamic brakes and Pyle headlights.



Completing the list of GP9 road names is a Seaboard Air Line version equipped with a MARS headlight. Athearn Genesis GP9s are scheduled for release in October 2019. All units will feature MU stands and trainline

hoses, coupler lift bars, nub-style walkway tread, wire grab irons, windshield wipers, full cab interiors, LED lights, and Blomberg-B trucks detailed with sander lines. Both DC and DCC units with sound will be offered.

Also scheduled for release in October of 2019 is a Genesis series EMD SDP45. The HO scale locomotive will feature a new 645E3 20-cylinder prime mover recording by SoundTraxx. Road names



will be Erie Lackawanna, Conrail, Southern Pacific Morrison-Knudsen, and Great Northern.

will be Erie Lackawanna, Conrail, Southern



Athearn has pledged to donate a portion of the proceeds from the sale of the Erie Lackawanna and Conrail models toward preserving the prototype locomotive for eventual display at the Marter Yard Railroad Museum in Youngstown, OH. For more information on the preservation project go to www.extra3639north.org.



Athearn Ready-to-Roll freight cars scheduled for release next fall include a group of



Maxi I five-unit well cars. Road names will be Southern Pacific, DTTX (above), TrailerTrain

TTX, Maersk (below), and Santa Fe Leasing (ex-Maersk). The SF cars will be decorated in Athearn's Primed for Grime scheme. Notable features on the five-unit articulated cars include wire grabs, etched walkways, detailed cross-bracing on the floor, and machined nickel silver 33-inch and 38-inch wheelsets.



RATE THIS ARTICLE



Also due for release next October is a new run of 57-foot mechanical refrigerator cars. Athearn's HO scale Ready-to-Roll model is based on a series of cars built by Pacific Car & Foundry in the late 1960s. Many of the prototypes have been rebuilt and continue in service today.

Road names will be Pacific Fruit Express, BNSF, Lamb Weston, Maine Central, REMX, and Milwaukee Road.



Roundhouse Brand models in Athearn's October 2019 production schedule include this 50-foot ACF outside post boxcar. In addition to the Canadian National car shown, road names will be CSX, Ferromex, Norfolk Southern, Union Pacific, Railbox, BNSF, and Santa Fe. Features on the HO scale ready-to-run model include positionable sliding doors and machined metal wheelsets.



Athearn HO scale items scheduled to arrive at dealers this month include ES44AC diesels (see MRH December 2017 for details), 53-foot Wabash plate trailers (see MRH September 2017 for details), GP7/9 diesels (see MRH November 2017 for details), and Bethgon Coalporters (see MRH August 2017 MRH for details). For additional information on Athearn and Roundhouse products contact a dealer or visit athearn.com.

.....



Atlas has released information on a Master series 73-foot center partition car. The HO scale ready-to-run model is based on a unique prototype designed for transporting lumber and gypsum board.



Road names include Atlantic & Western, Canadian National, COE Rail, Florida Central, First Union Rail, Desticon-NOKL,

and TTX. Details include simulated tie-loops, partition cable hooks, etched cross-over walks, wire grab irons, and newly tooled 286k (100-ton) trucks. A minimum radius of 22-inches is recommended.

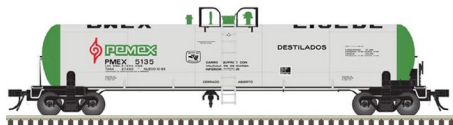

Also new from Atlas is a Master series 20,700 gallon tank car. The HO scale model is based on a general-purpose,

non-insulated, non-pressure prototype introduced in the mid-1960s by General American Transportation Corporation. Atlas offers models with both Type-10 and Type-20 saddles and two platform variations.



Road names include GATX, Hooker Chemical, Montfort Packing, Pemex, Canadian National, Dow Chemical,

Relco Tank Line, and S.M. Brooks.



Atlas is selling HO scale Ford F-100 pickup trucks decorated for a selected group of railroads. The ready-to-use vehicles feature interior details,

side view mirrors, headlight glazing, and a moveable tailgate.



Road names are Richmond, Fredericksburg & Potomac; Canadian National, Penn Central, Chessie System, and Milwaukee Road. For additional information contact a dealer or visit atlasrr.com.



Broadway Limited Imports is scheduled to release several ver-

sions of the P5a Boxcab Electric Locomotive in December. The Pennsylvania Railroad received 92 P5s during the early 1930s. Intended for passenger service, the success of the subsequent GG1 electric relegated the aging P5s to mostly freight service. BLI's passenger versions of the HO scale model come with a brown roof and gold leaf Roman lettering. Freight versions have buff-yellow lettering and the roof is the same color as the body. All versions of BLI's ready-to-run model feature Paragon3 Sound and control system for DC and DCC. For more information on all BLI products contact a dealer or visit broadway-limited.com.



Con-Cor has released its HO scale Christmas car for this year. The ready-to-run model is based on a popular 40-foot plug-door boxcar.

The car is decorated for Rudolph and represents the final car in Con-Cor's long-running series of seasonal Reindeer Cars.



To accompany Rudolph, Con-Cor is offering a second 2018 Christmas car that features Santa and his sleigh on the side of the car. For those who

have collected a complete set of Reindeer cars, this new 2018 Santa car can serve as a “caboose” for either a static display or a train of Reindeer cars operating on a layout. The models are available with or without a display track. For additional information visit con-cor.com.

.....



Digital Fox Services is selling an HO scale kit of an ACF Central Soya covered hopper with triple discharge bays. The kit is available in four different road numbers. The kit was produced for DFS by Accurail and includes Accumate magnetic couplers and Delrin wheelsets. For additional information visit digitalfox.com.

.....



ExactRail has released another production run of its HO scale Magor 4750 cu. ft. covered hopper car. The Platinum series model faithfully replicates the prototype introduced in 1966.



Road names include ACL, Conrail, Pennsylvania Railroad, SAL, Western Pacific, and two Burlington Northern schemes.

ExactRail’s HO scale model is loaded with details including formed wire grab irons, brake rods, and uncoupling levers; separately applied air hoses, etched metal Morton-style roof walk and brake platform, narrow-style draft box with shank wedges, striker casting with nut and bolt detail, ASF 100-ton Ride Control trucks with 36-inch machined metal wheelsets with metal axles, and Kadee #58 couplers. For additional information visit exactrail.com.

.....



Milwaukee Road herald. The late body style is available with a black logo in two road numbers.

Fox Valley Models has issued a re-run of its HO scale orange transfer caboose. The early body version of the model is available with maroon lettering and black numbers and tilted



An unlettered car with a white body is also available. For information visit foxvalleymodels.com.

.....
InterMountain Railway has completed arrangements with a new manufacturing partner in China and is moving forward with production commitments. Specific products and scheduled release dates are expected to be announced in the next few months.



InterMountain is taking reservations for a new run of a 10,000-gallon tank car. The HO scale model will be available in 12 paint schemes with six new numbers.



Road names will be Shippers Car Line-SHPX, Gulf-WRNX, Gulf-GRCX (repaint), United States Army, Frontenac-FPLX, GATX, Belcher Oil-BEPX, Semet

Solvay-SSLX, Shell Chemical-SCMX, and Tidewater Associated Oil-TWOX. The ready-to-run model will have trucks with metal wheelsets and Kadee couplers.

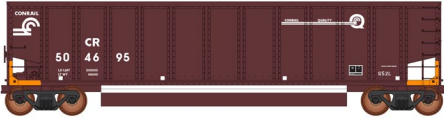

InterMountain is also taking reservations for future delivery of an HO scale 13-panel Coalporter. The ready-to-run Value Line model will be available singly and in six-packs with different numbers. Decorating schemes include five variations for Conrail including the one shown above with orange end detail.

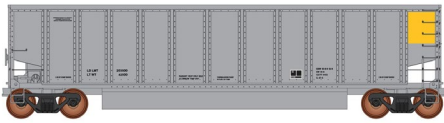

Additional paint schemes include two for CSXT and three data only with yellow (above), red, or blue ends. For additional information on InterMountain Railway contact a dealer or visit intermountain-railway.com.



Kadee has released three new HO scale ready-to-run freight car models. They include this 50-foot PS-1 boxcar lettered for Western Pacific, a scheme that includes the distinctive silver feather logo. The model accurately represents a prototype built in 1954 with a pair of Youngstown sliding doors covering a 15-foot opening. The car is equipped with an Apex metal running board and a Miner geared hand brake. The boxcar red paint scheme is capped with a galvanized roof.



This 40-foot PS-1 boxcar, decorated for Richmond, Fredericksburg & Potomac, accurately represents a freight car built by Pullman-Standard in 1952. The RF&P

prototype was shopped and repainted in November of 1965. Notable features include full height ladders and a 6-foot Youngstown sliding door.



Kadee's latest group of releases concludes with this PS-2 covered hopper car. Spotting features include channel side ribs, eight round loading hatches, and twin

discharge hoppers. The HO scale ready-to-run model replicates a prototype built by Pullman-Standard in 1956. The model is painted in the original light gray alkali resisting paint. All Kadee HO scale models feature two-piece self-centering trucks and Kadee knuckle couplers. For additional information contact a dealer or visit kadee.com.

.....



KC's Workshop is selling a craftsman-style kit for an extensive complex called Steelton Wharf.

The HO scale waterfront scene features four structures centered around the Steelton Cannery. The kit includes laser-cut wood clap-

board and scribed walls, laser-cut shingles, corrugated roofing, laser-cut roof signage, and over 50 detail parts composed of metal, resin, and labstone.



Additional details include laser-cut sea walls, color signs, and plastic windows and doors. Assembly instructions and construction templates complete the kit. Boats

and figures are not included. The overall footprint of the completed complex is 15 x 20-inches. For additional information visit kcworkshop.com.

.....

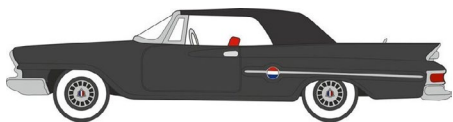

Oxford Diecast has released three new HO scale vehicles including this black 1961 Chrysler 300 convertible.

Details include a red interior, special side emblem, and wide whitewall tires.



Another new 1961 convertible from Oxford is this Chevrolet Impala with a purple flame paint job.



Oxford's 1946-48 DeSoto Suburban sedan is available decorated as a taxi. The decoration is based on a San Francisco taxi however the

lettering is small enough that the model is suitable for most period scenes. For additional information contact a dealer or visit walthers.com.

.....



Ragg's To Riches is selling a craftsman-style HO scale kit for Crested Butte Depot. The model closely replicates the prototype structure which has been fully restored in Crested

Butte, CO. The model uses an inner plywood core with interior

walls and flooring for both support and view blocking. Components include wainscoting and aged clapboard peel-and-stick siding, extensive trim material, a cast chimney, textured peel-and-stick shingle material, and window curtains. The 41-page spiral-bound instructions include numerous photos as well as tips on adhesives, tools, and painting. The completed model has a footprint of 5.625 x 11.5-inches. For additional information visit raggstoriches.biz.

.....

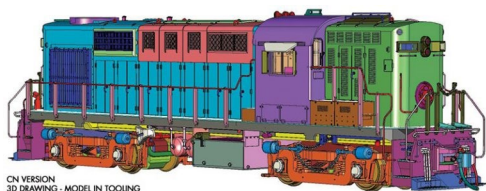

CN VERSION
3D DRAWING - MODEL IN TOOLING

Work continues at **Rapido Trains** on the development of the RS-18 Canadian general purpose road switcher as built by the Montreal Locomotive Works. To ensure

that their HO version of the MLW Canadian Pacific RS-18 will have accurate dimensions including correct hood radius, Rapido's designers began the project with a 3D laser-scan of the real thing. In addition to an accurate as-built RS-18, Rapido will also offer the Canadian National conversion. These computer-generated renderings illustrate the variations in tooling for the CN and CP versions of the RS-18.



CP VERSION
3D DRAWING - MODEL IN TOOLING

Standard versions of the RS-18 were delivered with Dofasco Type B trucks with a wheelbase of 9-foot 4-inches.

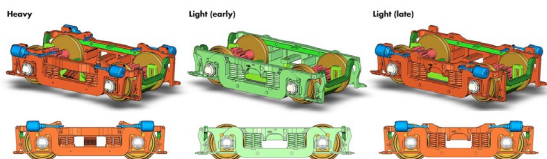

Lightweight versions of the locomotive rode on one of two types of Canadian Steel Foundry lightweight

trucks. Rapido is tooling all three types of trucks as seen in the above computer rendering.

A range of Canadian National and Canadian Pacific paint schemes will be offered on the initial production run of the HO scale model. Other Canadian road names, such as Pacific Great Eastern, will follow in the future if there is demand. The order deadline for the first run is Nov. 19, 2018. Delivery will be in mid-2019. For information contact a dealer or visit rapido-trains.com.

.....



Rusty Rail sells a set of resin castings for an HO scale dock scene. Castings include a stack of rowboats, and individual as well as stacked lobster traps.

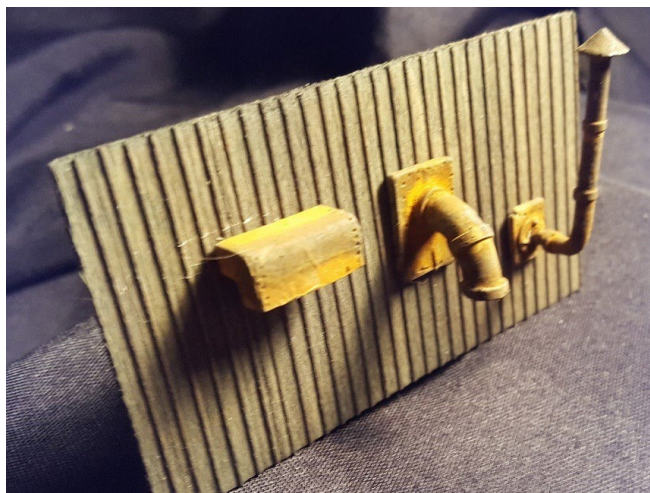

Also new from Rusty Rail is a group of three HO scale cast resin vents for industrial buildings. The assortment includes two of each item illustrated. (O scale version is shown). All Rusty Rail resin

castings come unpainted. A downloadable tutorial on painting

and weathering resin castings is available free at rustyrail.com/ResinCastingPainting.pdf.

.....

Tangent Scale Models has released a new production run its HO Scale Bethlehem Steel 3600 cu. ft. quad hopper. First released by Tangent in 2010, the highly-acclaimed model is now available in 12 new decorating schemes -- three are reruns with new numbers, nine are all new. A black unlettered car is also available.



New schemes for the ready-to-run models include 1986 repaints in red with two variations in the positioning of the lettering. A 2005-era red repaint is available with vertical conspicuity stripes.



Also new is a 1997-era black repaint available with and without the UP shield.



Tangent's re-run includes Union Pacific's 1978 version of the H-100-17 with a single yellow end. Adherence to prototype practice includes

printing the car number on the trucks. These cars initially operated in unit train service and are available in 12 new numbers. A car with double rotary ends is also available in two numbers.



Reruns include the original 1977 H-100-16 in the as-delivered freight car red with bold Union Pacific lettering. This

version is available in 12 new numbers. Notable features on Tangent's 3600 cu. ft. quad hopper include painted scale-sized wire grab irons, wire uncoupling bars, air hoses, etched metal brake platforms, interior bracing detail, 100-ton N-11 trucks with machined 36-inch wheelsets, and Kadee couplers. For information visit tangentscalemodels.com.

.....

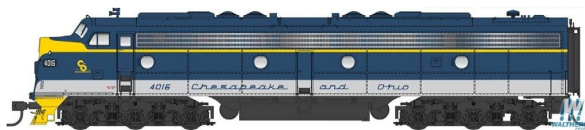

Walthers is scheduled to release three versions of the EMD E8 diesel unit in late February. Road names will be Chesapeake & Ohio, Illinois Central, and Southern Railway. The HO scale Proto series model will be available in E8A, E8A-A, and E8A-B configurations.



All units will have wire grab irons, spark arrestors, flush number boards, freight-type pilots, and Farr side grilles.



Unique to the SR unit are de-skirted fuel tanks, a Nathan type M air horn, and air tanks mounted on the roof. C&O and IC units will have skirted fuel tanks, dual lens on the lower door light, and Nathan five-chime horns.

Also scheduled for release in late February is an upgraded version of Walthers Proto EMD SW1200 diesel switcher.



Modifications include improved body tooling and new sill-mounted handrails.



The ready-to-run HO scale locomotive will come with either Flexicoil or AAR Type-A truck sideframes with solid or roller bearings as appropriate to the practice of the road name being modeled.



Road names will be Canadian National, Great Northern, Denver & Rio Grande Western, Illinois Terminal, and New Haven. Both the E8 and SW1200 locomotive

models will be available with DC and with ESU LokSound Select Sound with integral DCC decoder.

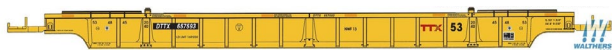

Walthers plans to release a group of 53-foot NSC well cars in March. The Mainline series models will be available as stand-alone cars and as three-car articulated units. The stand-alone version will be available for TTX in four different numbers.

Walthers plans to release a group of



The three-unit well cars will be available decorated for BNSF and TTX.

A new run of the Trinity 30,145-gallon tank car has been scheduled for release late this month. Walthers Proto series model



ing to comply with FRA mandates. Features include see-through photo-etched metal end shields, walkways, and end platforms; factory-installed grab irons, and a nicely detailed underbody with separate brake cylinder, brake pipe and rigging.

is based on a 55-foot prototype modified with reinforced ends, revised end platforms, and multi-valve housing



Leasing TILX. For additional information on Walthers products contact a dealer or visit walthers.com.

Road names will be Conoco Phillips PPRX, CIT Group CBTX, PBF Holding DPRX, Shell Oil SCMX, and Trinity

N SCALE PRODUCT NEWS

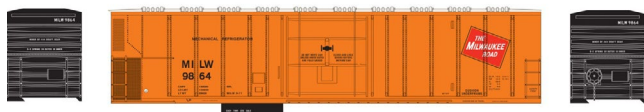

Athearn's
October 2019
production sched-
ule includes this

57-foot mechanical reefer. The N scale model is based on a prototype built in the late 1960s by Pacific Car & Foundry. In addition to Milwaukee Road as shown above, road names will be

Southern Pacific, Pacific Fruit Express, BNSF, Lamb Weston, Maine Central, and REMX.

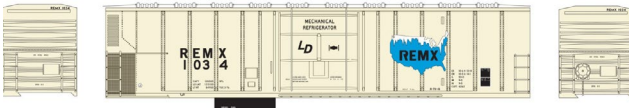

Athearn N scale items scheduled to arrive at dealers this month

include 53-foot GSC flat cars (See MRH November 2017 for details). For information on Athearn products contact a dealer or visit athearn.com.

.....



Atlas is booking dealer reservations for a new production run of an N scale 50-foot RBL boxcar.

The injection molded model will have separately applied wire uncoupling levers, etched metal running boards, and etched metal crossover platforms..

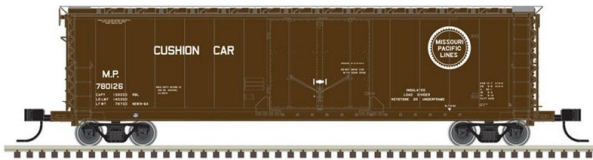

Road names will be Milwaukee Road, Wabash, Delaware & Hudson, Conrail (no running board), and

Missouri Pacific.



Atlas has announced new paint schemes for its N scale 20,700 gallon tank car. The Master series model

is based on a general-purpose, non-insulated, non-pressure prototype introduced in the mid-1960s by General American Transportation Corporation.

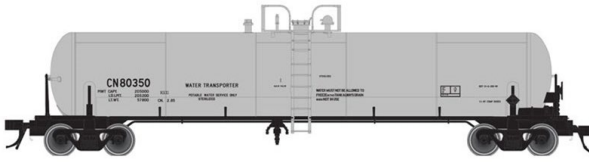

Road names include Hooker Chemical, Montfort Packing, Pemex, Dow Chemical, GATX,

Relco Tank Line, S.M. Brooks, and Canadian National.



Atlas is selling N scale models of 1973 Ford F-100 pickup trucks decorated as railroad maintenance vehicles.



Decorating schemes are road names include Richmond, Fredericksburg & Potomac; Chessie System,

Canadian National, Penn Central, and Milwaukee Road. For additional information contact a dealer or visit atlasrr.com.

.....



Con-Cor has released its N scale Christmas car for 2018. The ready-to-run model is based on a

50-foot boxcar with double plug doors. The car is decorated for Rudolph and represents the final car in Con-Cor's long-running series of seasonal Reindeer Cars.



To accompany Rudolph, Con-Cor is offering a second 2018 Christmas car that features Santa and his

sleigh on the side of the car. For those who have collected a complete set of Reindeer cars, this new 2018 Santa car can serve as a “caboose” for either a static display or a train of Reindeer cars operating on a layout. The N scale models are available with or without a display track. For additional information visit con-cor.com.

.....

Eastern Seaboard Models is preparing new tooling for N scale ASF Ride Control 70-ton trucks. The New Jersey-based firm will also machine its own 33-inch metal wheelsets. The decision to produce its own trucks in the U.S. was prompted by the shutdown of ESM’s former Chinese supplier. Micro-Trains couplers will be used on all future N scale rolling stock projects.

The unexpected closing of a manufacturing partner in China has pushed the release date of ESM’s X72, X65, and X58 boxcars out six months to June 2019. ESM has placed the ACF Type-27 Class 103B 8,000 gallon acid tank car project on hold indefinitely, and the 2018 Christmas car has been cancelled. The art work will be modified and used for a 2019 Christmas car. For additional information including current availability of products visit esmc.com.

.....



Fox Valley Models has issued a re-run of its N scale orange transfer caboose. The early body version of the model is available with maroon lettering and black numbers and tilted Milwaukee Road herald. The late body style is available with a black logo in two road numbers.



An unlettered car with a white body is also available. HO scale versions are shown. For information visit foxvalleymodels.com.

.....

InterMountain Railway is taking reservations for future delivery of an N scale 13-panel Coalporter. InterMountain's ready-to-run Value Line model will be available singly and in six-packs with different numbers.

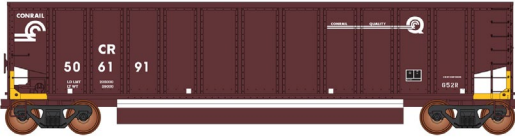

Decorating schemes include five variations for Conrail including the one shown above with yellow end detail.

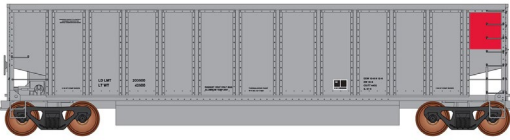

Additional paint schemes include two for CSXT and three data only with red(above), yellow, or blue

ends. For additional information on InterMountain Railway contact a dealer or visit intermountain-railway.com.

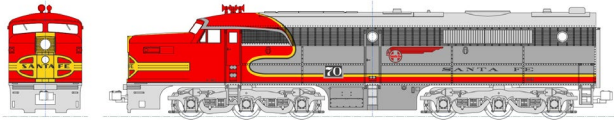

KatoUSA has announced it is working on a new release of the

Santa Fe El Capitan high-level train. A total of 12 El Capitan cars, along with Alco PA and PB locomotives, all correctly decorated for El Capitan service, are scheduled for release next April.



The basic 10-car set will include a baggage car, a baggage-dormitory transition car, two step-down coaches, four mid-train coaches, a diner, and a lounge car. A two-car

set consisting of a standard height mail storage car and a hi-level coach will also be available.

Note: The El Capitan Hi-Level cars were the first of their type to be used in long distance service. The design pioneered today's modern Amtrak Superliner fleets. In January 1958 the "El Capitan" and "Super Chief" trains were consolidated to run together, though in peak traffic times such as Christmas and summer, the two would operate separately. Kato's El Capitan project coincides with the new Santa Fe Super Chief release announced last month. The N scale trains can be operated independently or combined for an impressive, prototypically correct, Santa Fe name-train consist.

To ensure smooth operation each car will be equipped with Kato's shock absorber system. The car interiors have been redesigned with colors reported to be a closer match to the prototype. Optional interior lighting kits will be sold separately. The end coach will have illuminated marker lights and a lighted El Capitan conquistador drumhead. The Alco Warbonnet locomotives will be available for DC operation and with ESU LokSound DCC. For additional information contact a dealer or visit katousa.com.

.....



New models recently introduced by **Micro-Trains Line** include this Canadian Pacific 50-foot steel boxcar with an 8-foot plug door. The N scale

model follows a prototype built in 1967 that was later upgraded with the running board removed and the ladders lowered.

Micro-Trains New York Central 78-foot heavyweight coach represents a paired-window prototype built by Standard Steel Car Co. in



the 1920s. In the early 1950s the car was repainted in NYC's two-tone gray scheme.



This 40-foot stock car is decorated for Swift Live Stock Express. The N scale model follows a wood prototype with Murphy corrugated steel ends.



This 33-foot twin-bay rib-side hopper is based on a prototype the Rock Island Railroad re-painted in the road's blue "new image" scheme in 1977.

MT's N scale model comes with a removable coal load. For additional information contact a dealer or visit micro-trains.com.

.....



N Scale Works has added yellow oval targets to its selection of N scale dummy switch stands. Round targets are also available in either red or yellow. The base of the model is produced by 3D printing. It is patterned after a US prototype with a cast iron base. The base is designed to

match the tie-spacing of Atlas code 55 N scale turnouts. For additional information visit nscaleworks.com/shop.

.....

Tangent Scale Models has entered the N scale market with the release of a Bethlehem Steel 3600 cu. ft. quad-bay hopper. The new

N scale version is a match for the highly-acclaimed HO scale model Tangent introduced in 2010. The new 1:160 scale model is available authentically decorated in 12 different Union Pacific iterations. A black unlettered car is also available.



N scale versions are available decorated in the original 1977 H-100-16 as-delivered freight car red scheme with bold Union Pacific lettering. This

version is available in 12 new numbers.



Also available in 12 numbers is Union Pacific's 1978 version of the H-100-17 with a single yellow end. A black car with

double yellow rotary ends is also available in two numbers.



Additional paint schemes include two red 1986 repaints with variations in the positioning of the lettering. A 2005-era red repaint is available with

vertical conspicuity stripes. A similar lettering scheme is available on a 1997-era black car with a single yellow end. For additional details on Tangent's new N scale model, including historical information, visit tangentscalemodels.com.

NEW DECALS, SIGNS AND FINISHING PRODUCTS

Modelers looking for **C-D-S- Dry Transfers** will be pleased to learn that Des Plaines Hobbies, of Des Plaines, Illinois, has recently acquired the sizable inventory of a former C-D-S

distributor. According to Ron Sebastian, the purchase included about 90 percent of the HO line as well as a significant number of N, S, and O scale lettering sets. Although it may be some time before the lot can be posted and offered on Des Plaines on-line store, email inquiries regarding specific items are welcome. Inquiries should be directed to dphobbies@earthlink.net.

EJ&E ELGIN JOLIET & EASTERN RY. **EJ&E** ELGIN JOLIET & EASTERN RY. **EJ&E** ELGIN JOLIET & EASTERN RY. **EJ&E** ELGIN JOLIET & EASTERN RY.

60009 60008 60025 60026

Set # 87-4396
Elgin, Joliet & Eastern
Chicago 40' Boxcar - Triphala Loading

Mask Island Decals has HO scale lettering sets for Elgin, Joliet & Eastern 40-foot orange boxcars. Logos with both the *Outerbelt* and *Not-Thru* slogans are included. The set includes sufficient material to decorate two cars.

60299 1234567890 CHIC AGO & N ORTH WES TERN

60299 1234567890 CHIC AGO & N ORTH WES TERN

1234567890 CHIC AGO & N ORTH WES TERN

1234567890 CHIC AGO & N ORTH WES TERN

64247 64247

As delivered 1927

Set # 87-0391
Chicago & Northwestern
Quad Hoppers

HO scale lettering sets for Chicago & North Western quad-bay hoppers built in 1937 and 1940 are also available from Mask Island. The set includes heralds for Chicago Northwestern Line, and Northwestern Line with CNW beneath. For more information visit maskislanddecals.com.

Microscale Industries has lettering sets for Canadian Pacific AC4400CW diesel locomotives appropriate for the units CP

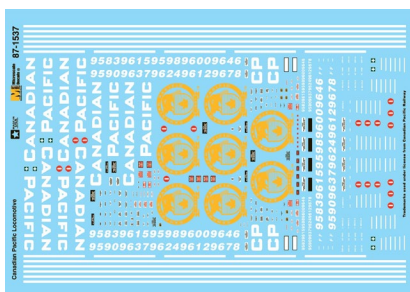

purchased from GE in the early 1990s. The waterslide decal is available for both N and HO scale. For information contact a dealer or visit microscale.com.



Speedwitch Media has HO scale decals for the Northern Pacific 1947 (R-40-23 clone) and 1949 (R-40-25 clone) steel reefers built by Pacific Car & Foundry. Although not shown here, the set includes four Monad emblems. The set will letter two cars.



This Speedwitch decal has material to accurately letter two Great Northern double-sheathed wood boxcars from the 1937-1942 period.



This HO scale decal set can be used to correctly letter either two 40-foot XM-32s boxcars, or one 40-foot XM-32 and one 50-foot XM-33 boxcar owned by CB&Q, FW&D, or C&S. For additional information visit speedwitchmedia.com.

SEND US YOUR PRODUCT ANNOUNCEMENTS

If you are a hobby manufacturer with a product announcement, just [click here](#) and submit your announcement to us. Our web site and free magazine reach continues to grow, so get on board this new media train! ■

DOWNLOAD ISSUE

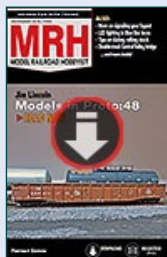

DOWNLOAD PORTRAIT



DOWNLOAD LANDSCAPE



BRIEFLY NOTED AT PRESS TIME ...

Bowser has recently received a container from its Chinese manufacturing partner that includes more than 240 new freight car models. A variety of decorating schemes and road numbers are available for HO scale 40-foot boxcars, 70-ton 14-panel hopper cars, 50-foot flat cars, and GS gondolas. The shipment included both HO and N scale versions of a Gla twin-bay hopper ...

Tangent Scale Models has released three new road names for its HO scale GATC 4180 cu.ft. Airslide covered hopper cars. They are GACX-Dawson Soy, CCLX-Corn Products, and CACX in 1992 light blue repaint. These models are in addition to the release of 4180 Airslides Tangent made in September ...

ScaleTrains.com is shipping a new release of its HO scale SD40-2 diesel locomotive. Road names still available at press time for the Rivet Counter series model include BNSF, Conrail, N&W, BN, UP, CSX and Milwaukee Road ...

A **SoundTraxx** video showing step-by-step installation of a Tsunami2 TSU-1100 and a CurrentKeeper into a Blackstone K-27 can be viewed at <https://youtu.be/MOmtficjkqo> ...

Summit USA has a new kit for a modern two-story office building. Principal components in the HO scale model are milled styrene and laser-cut acrylic. A special feature are copper-tinted mirror glass windows ...

Digitrax reports that a sizable portion of its main building suffered substantial damage when Hurricane Michael slammed into Panama City, FL on October 10, 2018. The facility had been evacuated and no employees were injured. Key operations are being moved into a secondary building.

Digitrax indicated that all customer items on hand for repair have been accounted for. Once power is restored and the move completed, normal operations, including the phone service help desk, will be re-established ...

★★★★★
RATE THIS ARTICLE

ADVERTISEMENT

LAST CALL!

FINAL KIT!



FINE SCALE MINIATURES

FSM is closing its doors after 50 years of business!

Model by Frank Bernard



ONCE GONE, THAT'S IT!

Brought to you by the MRH Store: store.mrhmag.com

I.M. Dunn Co.
\$280 + S&H



Destined to become an instant collector's item

BUY NOW >>

SELECTED EVENTS



Model Railroad Hobbyist | November 2018 | #105

NOVEMBER 2018

(Many events charge a fee. Check individual info website for details.)

CANADA, ONTARIO, FENWICK, November 17, 18, 24, 25. Open House at Greater Niagara Model Railroad Engineers, 1141 Maple Street (rear). Info at www.gnmre.ca/contact.asp.

CALIFORNIA, ROSEVILLE, November 10-11, International Railfair Model Railroad Show, at Placer County Fairgrounds, 800 All American City Boulevard. Info at internationalrailfair.com.

CALIFORNIA, SANTA CLARA, November 3-4, Fall Train Show sponsored by South Bay Historical Railroad Society at 1005 Railroad Avenue. Info at sbhrs.org/event-2252342.

MAINE, BREWER, November 12, Train Show sponsored by Eastern Maine Model Railroad Club at Jeff's Catering, 15 Littlefield Way. Request info from Geoff Anthony at dahak@roadrunner.com.

MICHIGAN, ANN ARBOR, November 25, Model Train Show sponsored by Rails On Wheels, at Washtenaw Farm Council Grounds, 5055 Ann Arbor Saline Road. Request info from Walt Trancygiere at trancywj@gmail.com.

MICHIGAN, EAST LANSING, November 11. Model Railroad Show & Sale, sponsored by Lansing Model Railroad Club, Michigan State University Pavilion, 4301 Farm Lane. Info at lmrc.org/trainshow/index.shtml.

MISSOURI, WEST St. LOUIS COUNTY, November 3, St. Louis Train Show, sponsored by NMRA Gateway Division, at Trinity Lutheran Church, 14088 Clayton Road. Info at www.gatewaynmra.org/st-louis-train-show.

NEW JERSEY, PARSIPPANY, November 3, Mass Transit & Trolley Modelers' Convention, sponsored by New York City Model Transit Association, at Parsippany PAL Center, 33 Baldwin Road. Info at www.nycmodeltransit.org/2018details.htm.

NEW YORK, ALBANY, November 1-3, Fine Scale Model Expo 2018, Hilton Hotel, 40 Lodge Street. Info at info@ModelRailroadEXPO.com.

NEW YORK, BATAVIA, November 11, Greater Batavia Fall Train Show, sponsored by Genesee Society of Model Engineers, at Genesee Community College, Richard C. Call Arena. Info at gsme.org/home-1.

OHIO, BROWNSVILLE, November 4, Swap Meet sponsored by NMRA MCR Division 6, at Bowling Green Township Community Building. Request info from Greg at 740-607-3223.

PENNSYLVANIA, ALLENTOWN, November 10-11, First Frost Train Meet, Allentown Fairgrounds, 1920 W. Chew Street. Info at allentowntrainmeet.com.

SOUTH CAROLINA, NORTH CHARLESTON, November 17-18, Fall Train Show, Danny Jones Armory Complex, 5000 Lackawanna Blvd. Info at camrc.club.

TENNESSEE, MEMPHIS, November 17, Train Show & Open House, sponsored by Memphis Area Model Railroaders, at 4445 Malone Road. Info memphismodelrailroaders.com.

UTAH, ST. GEORGE, November 9-12, Annual Layout Tour sponsored by Color Country Model Railroad Club. Info at See www.color-countrytrains.org.

VERMONT, BARRE, November 17, Model Railroad Show sponsored by North West Vermont Model Railroad Association, at Barre City Auditorium , 20 Auditorium Hill. Info at www.nwvrailroad.org.

WISCONSIN, WEST ALLIS (Milwaukee), November 10-11, Trainfest 2018, at Wisconsin State Fair Park. Info at trainfest.com.

December by location

MASSACHUSETTS, MARLBOROUGH, December 1-2, New England Model Train Expo, hosted by NMRA HUB Division, Best Western Royal Plaza Trade Center, 181 Boston Post Road. Info at hubdiv.org.

MASSACHUSETTS, ROSLINDALE (Boston Metro area), December 1-2, Holiday Model Train Show, sponsored by Bay State Model Railroad Museum, at 760 South Street. Info at www.bsmrm.org.

NEW YORK, ALBANY, December 2, Annual Great Train Extravaganza hosted by NMRA Hudson-Berkshire Division, Empire State Convention Center. Info at gtealbany.com.

OHIO, LIMA, December 15, Train Town Show & Swap Meet, sponsored by NMRA NCR 3 Rivers Division, at Merchants Building at Allen County Fairgrounds, 2750 Harding Highway (St Rt 309). Request info from Chuck White at railcarman@frontier.com.

Future 2019, by location

AUSTRALIA, CANBERRA, KALEEN, March 30-31, 31st Annual CMRCI Model Railway Expo, sponsored by Canberra Model Railway Club, at UC High School, Baldwin Drive. For details phone Anthony Hunt at +61 0414 730 824.

FLORIDA, COCOA BEACH, January 10-12, 2019 Prototype Rails RPM Meet, hosted by Mike Brock. Info at www.prototype-rails.com.

MASSACHUSETTS, WEST SPRINGFIELD, January 26-27, Amherst Railroad Hobby Show, sponsored by Amherst Railway Society, at Eastern States Exposition Fairgrounds, 1305 Memorial Avenue. Info at www.railroadhobbyshow.com/aboutus.php.

OHIO, GREENVILLE, March 3, 2019, 38th Annual Model Railroad Swap Meet, sponsored by the Darke County Model Railroad Club at Youth Building, County Fairgrounds, 800 Sweitzer Street. Request info from Joe Worz at josephbw@hughes.net.

OREGON, PORTLAND, February 9, 2019, 2nd Annual Portland RPM Meet, Shilo Inn & Suites, 11707 NE Airport Way.

PENNSYLVANIA, GREENSBURG, March 22-23, 2019, RPM East. Details TBA.

TEXAS, STAFFORD (Metro Houston), February 16, 2019, Greater Houston Train Show, sponsored by San Jacinto Model Railroad Club at Stafford Centre, 10505 Cash Road. Info at san-jacmodeltrains.org.

UTAH, SALT LAKE CITY, July 7-13, 2019, NMRA National Convention and National Train Show. HQ at Little America Hotel. Info at nmra2019slc.org.

WISCONSIN, STEVENS POINT, February 2-3, 22nd Artic Run Model Railroad Show & Sale, sponsored by Central Wisconsin Model Railroaders Ltd, at Stevens Point Holiday Inn and Convention Center, 1001 Amber Avenue. Request info from Jim Miller at jimbro67@gmail.com.

Beyond 2019, by date

MISSOURI, ST. LOUIS, July 12-18, 2020, NMRA National Convention and National Train Show. HQ at Hilton St. Louis at the Ballpark. Info at gateway2020.org.

CALIFORNIA, SANTA CLARA, 2021, NMRA National Convention and National Train Show.

ENGLAND, BIRMINGHAM, 2022, NMRA National Convention and National Train Show. ■

DERAILMENTS



RATE THIS ARTICLE

Model Railroad Hobbyist | November 2018 | #105



Slow down at railroad crossings!

Watch this person go racing across the railroad tracks and completely destroy the suspension on their vehicle! Wherever they were headed in such a hurry, they certainly got there late, if at all. The moral of the story is simple, slow down at railroad crossings, please. The ditty of stop, look, and listen would have been good advice in this instance! ■



▶ **BIZARRE FACTS AND HUMOR (SUPPOSEDLY)**

CLICKABLE ADVERTISER INDEX

[Accu-Lites](#)

[Amherst Railway Society](#)

[Archer Fine Transfers](#)

[Athearn](#)

[Atlas Model Railroad Co.](#)

[Bachmann](#)

[Backdrop Junction](#)

[Berrett Hill Trains](#)

[Black Cat Publishing](#)

[Blair Line](#)

[Bowser](#)

[Caboose](#)

[Canyon Creek Scenics](#)

[Coffman Graphics](#)

[Crow River Products](#)

[Daniel Cortopassi Productions](#)

[Digitrax \(2 page spread\)](#)

[East Penn Traction Club](#)

[El Dorado Software](#)

[ESU LokSound](#)

[Fast Tracks](#)

[Fast Tracks \(Scale Lumber\)](#)

[Fine Scale Miniatures](#)

[Fine Scale Model Expo](#)

[Great Decals](#)

[HO Diesel Supply](#)

[Iowa Scaled Engineering \(ISE\)](#)

[ITLA Scale Models](#)

[Lights 4 Models](#)

[Litchfield Station](#)

[Logic Rail Technologies](#)

[Main Street Heritage Models](#)

[Masterpiece Modules](#)

[Micro-Trains Line](#)

[Mike & Scotty Live](#)

[Model Railroad Control Systems](#)

[Monashee Laser Engineering](#)

[Mountain Subdivision Hobbies](#)

[MRH Store \(1\)](#)

[NCE \(2 page spread\)](#)

[Norfolk & Western Historical Society](#)

[North American Railcar Co.](#)

[Old West Scenery](#)

[Pre-Size Model Specialities](#)

[Precision Design Co.](#)

[Pulsar Pro Decal FX](#)

[Rapido \(1\)](#)

[Rapido \(2\)](#)

[Ring Engineering \(1\)](#)

[Ring Engineering \(2\)](#)

[Scale Trains](#)

[Soundtraxx \(Blackstone\)](#)

[Southern Digital](#)

[Streamlined Backshop Services](#)

[TAM Valley Depot](#)

[TrainMasters TV \(1\)](#)

[TrainMasters TV \(2\)](#)

[Traintek](#)

[Walthers](#)

[Westerfield Models](#)

[Yankee Dabbler](#)

[Yarmouth Model Works](#)

[Clickable "other" index](#)

[Other – Contents](#)

[Other – Cover](#)

[Other – Derailments](#)

[Other – MRH Marketplace](#)

[Other – MRH Sponsors](#)

COMING NEXT MONTH IN MRH ...



Eric Miller kitbashes a C39-8E ...



Jason Miller: How I did my layout signaling, part 3 ...



HAVING FUN WITH TRAINS
DECEMBER 2018 | FREE

MRH

MODEL RAILROAD HOBBYIST

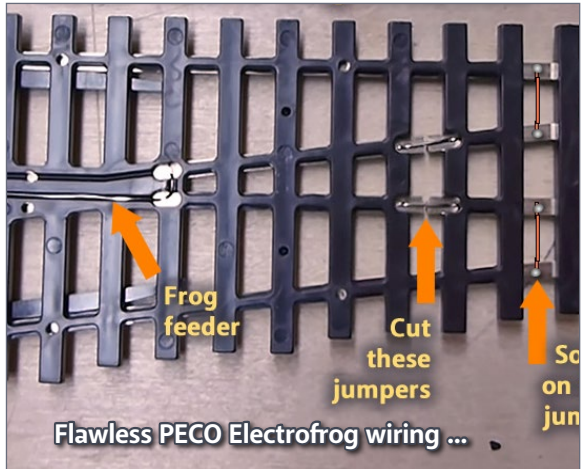

**Eric Miller
Kitbashes a C39-8E**
▶ **READ NOW**



... coming in the
December MRH

COMING NEXT MONTH IN *RUNNING EXTRA* ...

... all the MRH articles and ads, *PLUS*:

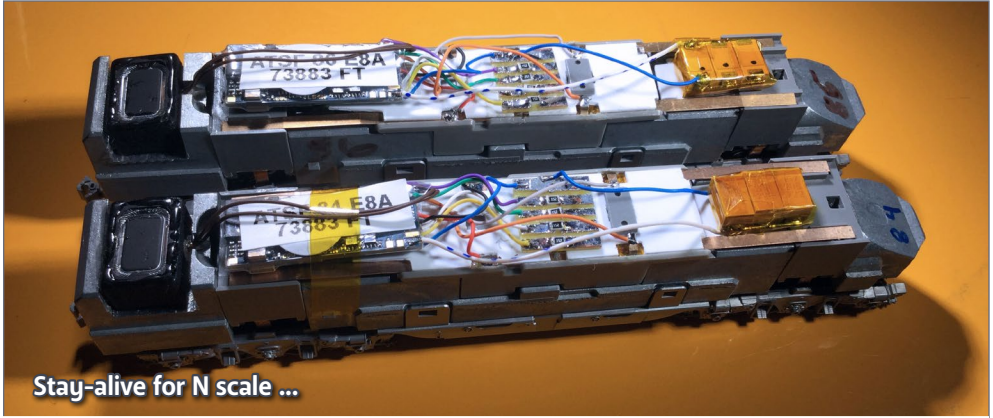

December 2018 - \$1.99

MRH **RUNNING**
EXTRA
More modeling every month



Eric Miller
Kitbashes a C39-8E
[▶ READ NOW](#)



Also these articles:

- Lorem ipsum dolor sit amet
- Consectetur adipiscing elit morbi
- Vestibulum tempus vehicula
- Mauris tempor libero ipsum pellentesque
- Nullam porta ut arcu at lobortis

... and much more!

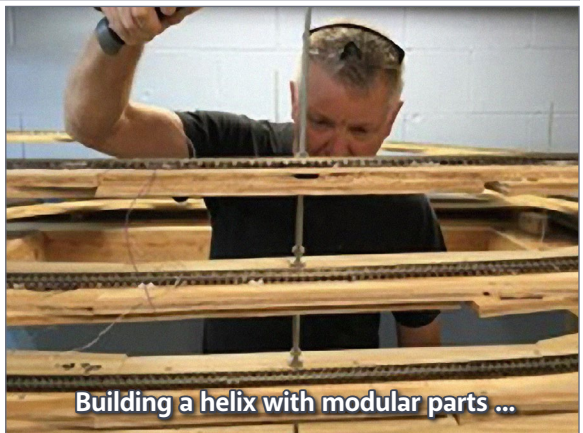

... all this and much more!

SUBSCRIBE: 1 YR \$19.99