

HAVING FUN WITH TRAINS

JUNE 2019 | FREE

MRH

MODEL RAILROAD HOBBYIST

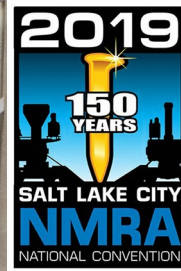

ExactRail's

Pelle Søbørg layout

▶ **READ NOW**

ALSO:

- More convenient loco storage
- Building your own stay alive

- Clever steam loco paint stand
 - Overcoming the "Texas syndrome"
- ... and more inside!*



LANDSCAPE EDITION



DOWNLOAD



REGISTER
(free)

Coming Soon From



ATLAS MASTER® N 4180 AIRSLIDE COVERED HOPPERS



FRISCO



GULF, MOBILE & OHIO



ROCK ISLAND



SOUTHERN



WESTVACO

SLIDE ON DOWN TO GRAB
A FEW CARS TODAY!

CLICK HERE!

FOR MORE INFORMATION OR TO LOCATE A DEALER, PLEASE VISIT WWW.ATLASRR.COM.
ATLAS MODEL RAILROAD CO., INC. • 378 Florence Ave., Hillside, NJ 07205

STAFF



Model Railroad Hobbyist June 2019 | #112

(Updated 06/03/19)



ISSN 2152-7423

Editorial Staff



Joe D. Fugate, Publisher and Editor



Patty Fugate, Pasteup and Layout



Richard Bale, News and events



Jeff Shultz, News and events, Tech Assistant



Joe Brugger, Copy Editing



Mike Dodd, Copy Editing

Advertising

Les Halmos, Account Manager
Jean-François Delisle, Marketing Assistant

Regular contributors

Eric Hansmann, Editor-at-Large
Larry Smith, Narrow Gauge/Shortlines
Jim Six, Limited Modeler column
Ken Patterson, Reporter-at-Large

Rotating Columnists

Jack Burgess, Getting Real column
Nick Muff, Getting Real column
Mike Rose, Getting Real column
Tony Thompson, Getting Real column
Rob Clark, Imagineering
Dave Meek, Imagineering
Ray Dunakin, Imagineering

Issue password: Jun2019

Published for the glory of God. [What's this?](#)

MRH SPONSORS



Model Railroad Hobbyist | June 2019

A - M



acculites.com



railroadhobbyshow.com



archertransfers.com



athearn.com



www.atlasrr.com



bachmanntrains.com

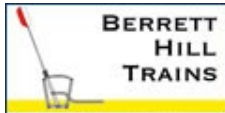

berretthill.com/trains



blairline.com



bowser-trains.com



mycaboose.com



coffmaneng.com



www.digitrax.com



trackplanning.com



esu.eu/en



handlaidtrack.com



iascaled.com



lineswestproducts.com



litchfieldstation.com



micro-trains.com



ModelRailroadConstruction.com



store.mrhmag.com



handlaidtrack.com/mt-albert-scale-lumber

[Vendors: Get your clickable logo here ...](#)

MRH SPONSORS | 2

N - Z



nngc-2019.com



ncedcc.com



www.pwrs.ca/main.php



rapidotrains.com



ringengineering.com



roometteslighting.com



scaletrains.com



soundtraxx.com



sodigi.com



sbs4dcc.com



tamvalleydepot.com



trainfest.com



traintekllc.com



walters.com

[Vendors: Get your clickable logo here ...](#)

Looking for something? Check the MRH Marketplace!



Take me there!

TABLE OF CONTENTS | MRH

June 2019



RATE THIS ISSUE

Discount code / Bonus Extras



Publisher's Musings: Battling the Texas Syndrome ...

NICHOLAS KALIS



MRH Website this month: Hills Line signature scene, and more!

Compiled by JOE FUGATE



What's Neat: Rand Hood's layout plans, and lots more ...

KEN PATTERSON



Build your own stay alive

MARCUS AMMANN and The MRH Staff



Pelle Søbørg's Daneburg Subdivision

The MRH STAFF



More convenient loco storage

BRENT CICCONE



First Look: Digikeijs DR5000

JEFF SHULTZ



Savvy Modeler online: Steam loco paint stand

Compiled by the MRH STAFF



June 2019 news and events

RICHARD BALE and JEFF SHULTZ

In MRH **RUNNING** **EXTRA**

This month ...



Buy Issue: \$1.99 >>

store.mrhmag.com

TABLE OF CONTENTS | RUNNING EXTRA

June 2019



RATE THIS ISSUE

More content than ads will pay for ...



Publisher's Welcome: Powered pin vise take 2

JOE FUGATE



Limited Modeler: Limited manpower

JIM SIX



Getting Real: IKEA benchwork

MARTY MCGUIRK



How a module created a layout

JASON MILLER

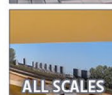

Making layout photo backdrops

BILL BRILLINGER, SCOTT THORNTON, and JIM SIX



The Internet for model railroaders

The MRH STAFF



Ah-Hah Moment: Universal modeling sizes chart

JOE FUGATE

FIRST TIME

CSX SD40-3 Boxcar Logo

(Actual Models Shown)



ORDER NOW

© 2019 ScaleTrains.com, Inc. ScaleTrains.com, Rivet Counter, and respective logos are trademarks of ScaleTrains.com, Inc. ScaleTrains.com, Inc. 7598 Highway 411 Benton, TN 37307 844-9TRAINS 844-987-2467 International 423-299-3689

Scene and photography
by Ken J Johnson
First test model shown



PUBLISHER'S MUSINGS



Model Railroad Hobbyist | June 2019

NICHOLAS KALIS: COMBATING THE
"TEXAS SYNDROME" (JOE HANDS OFF
THIS MONTH'S EDITORIAL TO A GUEST)



WOULD BANISHING "DREAM LAYOUT" FROM OUR vocabulary help our hobby? I sometimes think so. Dream layouts are often just that, a dream. They rarely get finished and in too many cases, never really started.

I come to this conclusion from serving many years as the layout tour coordinator for my Potomac Division of the Mid East Region.

What is our challenge? I sometimes call it the "Texas syndrome" – the feeling that bigger or biggest is best. They say proudly that everything is bigger in Texas – that's fine with me.

Striving for the best is in the American DNA (or even in the human DNA). And that's fine. But do dreams of basement empires suit most modelers? I think not. Do not get me wrong, I love visiting a basement empire and have done so many times. Visitors are charmed and hosts are fulfilled.

As a serving NMRA layout tour coordinator, I have gladly signed up owners of basement empires as hosts for our layout tours. Nothing I write here should be misconstrued as some attack on the basement empire.

PUBLISHER'S MUSINGS | 2

Keep building them and they will come – to paraphrase a line from a popular movie. If you have the talents to build a basement empire, all power to you! Do it and don't look back.

All I seek is a frank discussion of what the rest of us can do to get out of our armchairs.

Reading overseas model railroad magazines and comparing them with those published here in the states, I cannot help but see a great difference. Our American modeling magazines celebrate 'bigger is better.' It is hard to quarrel with that. Even when they run an article about a supposed small layout, it is not that small.

In contrast, many overseas magazines – and Bob Brown's *Narrow Gauge and Shortline Gazette* * – can devote an article of several pages to a layout a mere one foot by four feet.

ADVERTISEMENT

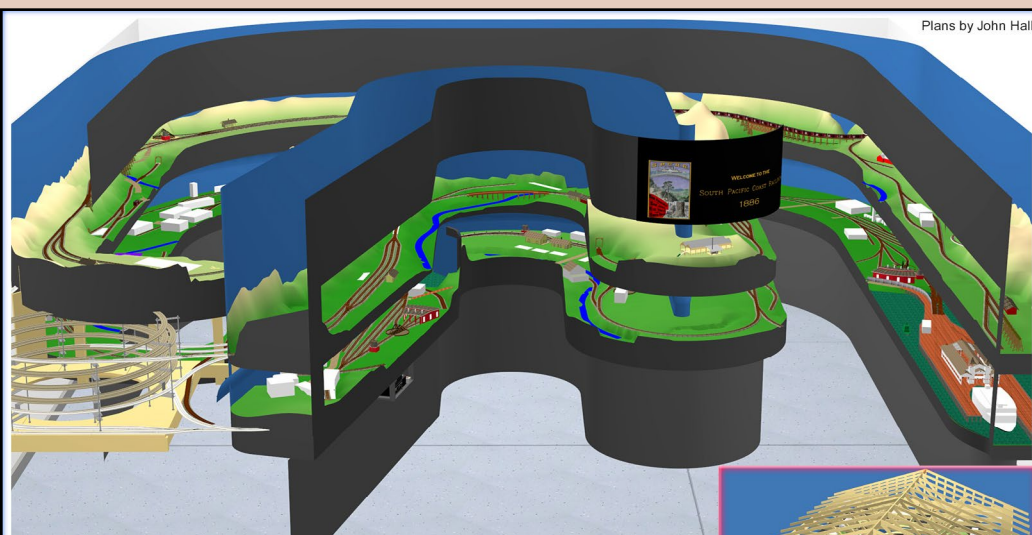

How will you plan your layout?

3rd Plant 3D CAD
The ultimate track planning software

El Dorado
SOFTWARE



MRHMAG.COM

✉ REGISTER
(free)

REALISM REDEFINED

Originally introduced in 1999, Athearn's Genesis® line pushed the level of fidelity with advancements in technology and tooling.

Twenty years later, Athearn is redefining realism with

GENESIS 2.0™



**Outstanding Realism.
Better than Brass Detail.**

ATHEARN

©2019 Horizon Hobby, LLC. Athearn, Genesis, Genesis 2.0, "As Close to Real as It Gets", Ready To Roll, Roundhouse, McHenry, and Trains in Miniature are registered trademarks of Horizon Hobby, LLC. All other trademarks, service marks and logos are property of their respective owners. Final models may vary slightly from photos shown. 6158



[INDEX](#)

[TABLE OF CONTENTS](#)

WEATHERED GONDOLA TIE LOADER PACKS

**CONRAIL 3-PACK
COMING OCTOBER**

**UNION PACIFIC® 3-PACK
COMING NOVEMBER**

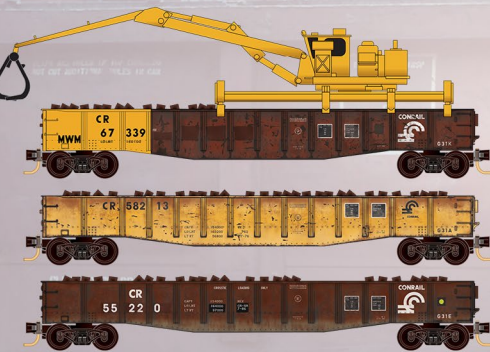

**MICRO-
TRAINS®
LINE**

CLICK HERE FOR MORE INFO

**N
SCALE 1:160**

PUBLISHER'S MUSINGS | 3

Overseas model railroad magazines seem better at encouraging smaller layouts that celebrate creativity and a host of other goals we seek as model railroaders.

I firmly believe that the modeling press' short run goals of selling magazines to those who enjoy basement empires is at cross purposes with the publishing houses' long-term interest in a growing subscriber base rather than a dwindling one.

How many of you have overheard at a train show one fellow telling another that he will never build a layout? How many of you have heard a fellow modeler remark something to the effect "well, his layout is mighty big, but when I build mine, it will be bigger."

From where else might I draw my observations, besides contrasting domestic and foreign magazines or statistics that showing falling membership in groups like the NMRA?

**HO
SCALE**

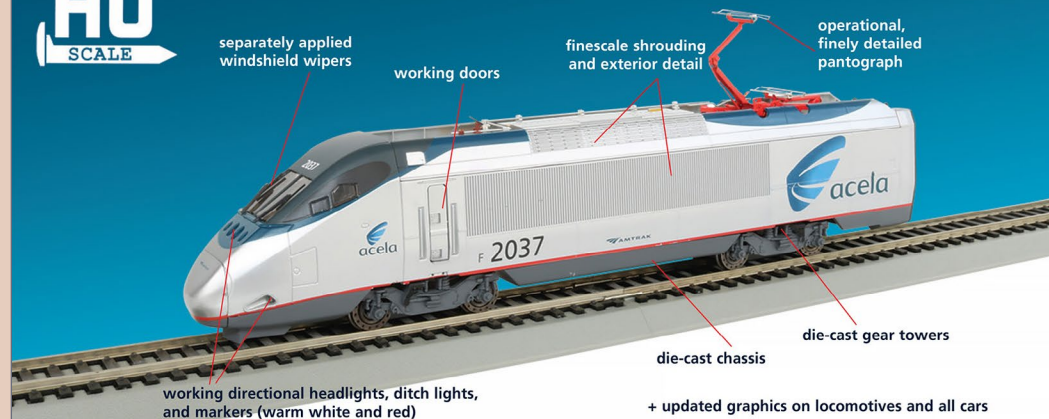

NOW ARRIVING ON TRACK 1: THE UPDATED ACELA EXPRESS® SET!

The high-speed passenger train that revolutionized U.S. rail travel is now available with a paint scheme that includes updated graphics, new car and locomotive numbers, and WiFi symbols. Also updated are warm white headlights and ditch lights. As an official Amtrak licensee of the Acela Express® train, Bachmann is proud to present this DCC-equipped* model in our award-winning Spectrum® line. Our Acela Express® features dual locomotives (one powered, one non-powered) that can reach scale speeds of 150 mph. The Acela Express® set comes complete with first class passenger car; end business class passenger car; Café Acela® car; 22" radius, 81" x 45" nickel silver E-Z Track® oval; and power pack and speed controller. Look for the new Acela Express® set's arrival at your favorite hobby dealer today!

Spectrum®

**DCC
ON BOARD**



Locomotive features:

- DCC-equipped for speed, direction and lighting
- interior selector switch for choice between rail and pantograph operation
- die-cast gear towers and chassis
- precision motor
- working directional headlights, ditch lights, and markers (warm white and red)
- operating doors

Passenger Cars feature:

- tilting chassis to travel smoothly around curves at high speeds
- flush windows
- lighted interiors
- blackened RP25 wheels
- photo-etched, blackened brass inserts on air ducts
- finescale interior detail, including passenger seats and tables

OFFICIAL
LICENSEE
of
AMTRAK

Click to learn more SHIPPING NOW! MSRP \$579.00
Item No. 01205 • Acela Express®

*Bachmann E-Z Command® or other NMRA-compliant digital control system required for DCC operation. An analog controller is included with this set for standard DC operation.

Amtrak, Acela, Acela Express and the Acela logo are registered service marks of the National Railroad Passenger Corporation.



Bachmann Industries, Inc. • 1400 East Erie Avenue • Philadelphia, PA 19124 USA • www.bachmanntrains.com

Click for more information.

MRHMAG.COM

REGISTER
(free)

[INDEX](#)

[TABLE OF CONTENTS](#)

PUBLISHER'S MUSINGS | 4

NMRA membership numbers are down, *Model Railroader* pages are down, *Model Railroader* subscribers are down. Magazines many of us enjoyed have folded. Before you accuse me of being Chicken Little shouting “the sky is falling”, let’s have a candid discussion of what ails us.

I have shared these thoughts elsewhere and can predict the reaction to my message. One fellow once wrote that I must be one of those folks against grading for school children – his message was that since I encourage building small layouts, I must be an advocate for mediocrity. How wrong he was and is!

The most troubling aspect of hostility to smaller layouts seems to be that a small, vociferous minority in our hobby are confirmed armchair modelers. They will never be coaxed out of their armchairs; rather, they want a steady supply of basement empires to visit either vicariously through publications or through an actual open house during a layout tour.

The NMRA is a big tent – the confirmed armchair modelers should be as welcome as the builders of basement empires. What should not be tolerated is a negative bias toward small layouts.

Another source of my view comes from my annual visits to the Northern Virginia IPMS’s show at Fairfax High School. Most NMRA folks I have met have never even heard of the International Plastic Modeler’s Society; I was introduced to them by Ari Pappas.

Without getting too dramatic, I would implore model railroaders and my fellow NMRA members to attend a local IPMS show. You will confirm what I see – those attending such shows are one or two generations younger than many of us. And they spend – witness the bags of goodies each one seems to be carrying in the parking lot as they return to their cars. They also seem to be active builders.

It does us no good to contrast their hobby. Some are military modelers but there is much more – fantasy subjects, dioramas, civilian

Take time to dream

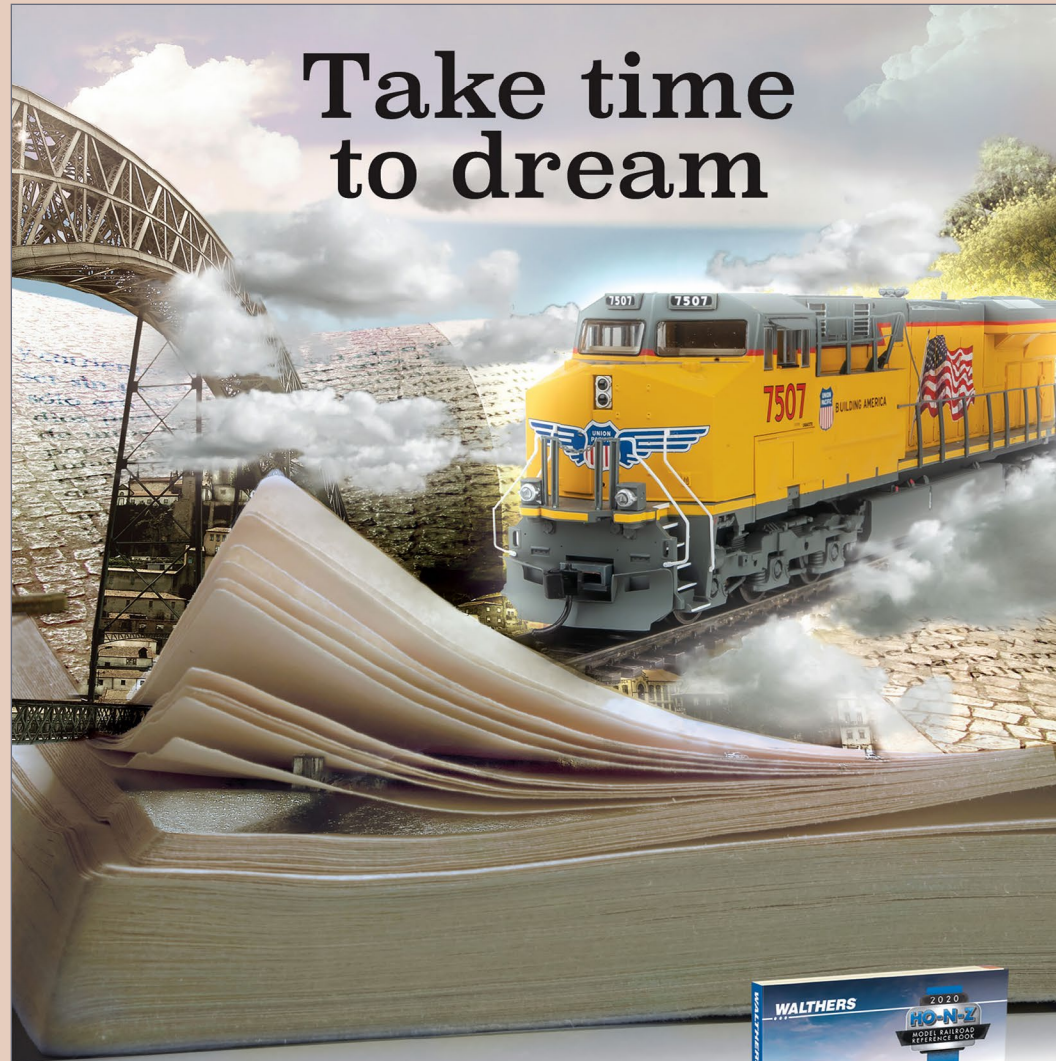

Dreaming up your next big project can be exciting, and *Walthers 2020 Model Railroad Reference Book* will help your imagination soar. When you're ready to come down from the clouds and belly up to the workbench, we're here for you too, with thousands of products to help you build a great model railroad.

2020 HO-N-Z Reference Book

913-220 \$17.98 Fall 2019 Delivery

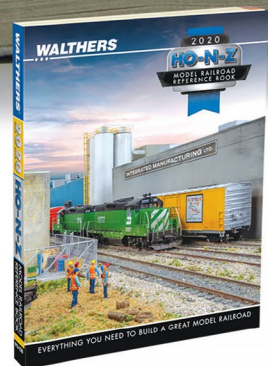

WALTHERS

Visit walthers.com/reference-books to find out more!

Order your book today! Visit your participating hobby shop, call us at 1-800-4-TRAINS or visit walthers.com ©2019 Wm. K. Walthers, Inc.

PUBLISHER'S MUSINGS | 5

vehicles, etc. Some folks say NMRA membership is dwindling because fewer of us are exposed to trains now than in generations past. This argument loses credibility when we consider that few members of the thriving military modeling community have seen a tank rumble down their street.

Some say we have all heard this before, that “our hobby is dying” is a well-worn canard and they scoff at this supposed problem. They point to modelers getting information from the internet and to the great growth in product availability.

I concede both those points but why do we have fewer members in the NMRA? Why does our average age seem to creep higher and higher? Some contend that an aging membership is natural – that the hobby appeals to folks who have leisure time in retirement to pursue a passion.

How can we dodge the challenge of the internet? We can't. Could it be those who say an aged membership is natural are in error? What about the challenge that modeling does not equate with grey hair – the IPMS members I have observed prove this contention false.

What can we modelers do? Voice your opinion to your fellow modelers and NMRA members and leaders to encourage more armchair modelers to become active hobbyists through smaller layouts.

Encourage publishers to give us more articles about micro layouts, exhibition layouts, and even just smaller layouts. Get your division and region to offer prizes at conventions to the best exhibition layout entered in its contests.

And if you are an armchair modeler, get out of your armchair and build an exhibition layout – and subscribe to a magazine that encourages this sort of modeling. Visit YouTube and search for exhibition model railroads. Some neat ones are exhibited at the OnTrax annual show at the Spoorwegmuseum in Utrecht, Netherlands – videos

Bowser

HO 40' Boxcars

Ready to Run. Features: Crisp details and sharp painting and printing, metal wheels and knuckle couplers.

Road Names: Atlantic & Danville, CN Noodle, CP Rail, Genesee & Wyoming, GN, LV Flour Loading, Linde Liquefied, L&N, MEC, Mississippi Central Natchez, MoPac Eagle Merchandise Service, Ontario Northland, SAL Beer Car, NYSW Sysquehanna, Wabash, WAG & Canada Southern



HO Wheels & Trucks

Metal wheels with needlepoint axles. Non Magnetic.

Size: 33" & 36"

Roller Bearing, Semi Elliptical, Caboose, Bettendorf, Crown, Arch, & Roadrailer



Click here to check out the details for these and other great Bowser products!

CABOOSETM

Sharing Our Passion for Trains Since 1938



© 2018 John Harris Photography. All Rights Reserved.

CLICK HERE
for the
Serious Modeler's
Resource!

More than 148,721 items,
over 567 manufacturers,
most at a discount from
full retail – all at
a fair price.

As always, in-stock orders of
\$100.00 or more ship free
within the Continental U.S.!*
**surcharges may apply for oversized items.*

10800 West Alameda Ave.
Lakewood, CO 80226
(303) 777-6766

PUBLISHER'S MUSINGS | 6

abound showcasing the layouts
to be seen at this show.

Perhaps the best thing you can
do as an ex-armchair modeler
is to bring a module or two to a
convention or to host an open
house at your residence. Let's
get everyone doing the hobby
and celebrate all scopes of effort,
especially at the smaller end of
the scale.

- *Narrow Gauge and Short
Line Gazette* is now pro-
duced by White River Publi-
cations.



THE LIMITED MODELER
Jim Six: Getting the most out
of limited manpower help.

Buy Issue: \$1.99 >>

In **MRH** **RUNNING**
EXTRA

DINERS
DINERS
diners
DINERS

CLICK HERE



NEW, LIMITED-RUN MICRO-TRAINS CARS

PWRS

Canadian Pacific (CP) "Newsprint Only" 40' Boxcar - 4-Pack



CLICK HERE FOR CP 40' BOXCAR

- Door print, Circle P, Newsprint shield
- Circle reflectors and end road #
- ACI
- Light to moderate weathering

AVAILABLE JAN 2020

Ontario Northland (ON) "Newsprint Only" 40' Boxcar - 4-Pack



CLICK HERE FOR ON 40' BOXCAR

- Circle reflectors above sill
- Door print
- ACI
- General light-to-moderate airbrush weathering on sides, ends and roof

AVAILABLE DEC 2019



Pacific Western Rail Systems

LIMITED RUN OF MINIMUM 50 SETS-MADE EXCLUSIVELY FOR PWRS BY MICRO-TRAINS



MRHMAG.COM

REGISTER (free)

PUBLISHER'S MUSINGS | 7



J. Fugate

THOUGHTS ON LAYOUT SIZE

Having built a larger layout myself and having toured a lot of layouts, I can testify to the huge effort commitment of a larger layout, and to the massive Plywood Pacifics I've seen that end up still-born. The modeler just didn't realize what they were signing up for, and although they believed larger just had to be better, the huge project scope ultimately overwhelmed them. Sadly, more than a few of these disenchanting modelers have left the hobby.

That's why we do our small room layout contests, and why we promote the TOMA (The One Module Approach) concept so much. The idea is to apply modular methods to a single-owner home layout rather than just to a club multi-member show layout. You can dream big, but your chances of success are much better if you start small with just one or two modules and build them to completion: then add staging and run trains.

With TOMA you can grow the scope incrementally, testing all along the way until you find what maxes you out before it becomes too much to handle. All along the way, you have a finished, operational layout to enjoy, too!

For more on TOMA, see our bibliography in the August 2017 MRH: [mrhmag.com/magazine/2017-08/online/22].

MRH product awareness survey

Take survey now

Chance to win \$125 worth of these cool products!

click here (takes ~5 min)



Seems like almost everyone wants a chance!

VIEW READER COMMENTS

[INDEX](#)

[TABLE OF CONTENTS](#)

★ LAST ISSUE'S RATINGS

The three top-rated articles in the [May 2019 issue](#) of *Model Railroad Hobbyist* are:

- 4.9 Publishers Musings: Keeping track clean longer?
- 4.7 May 2019 news
- 4.6 Tool shed: Chopper improvements

Issue overall: **3.5**

Please rate the articles! Click the reader comments button on each article and select the star rating you think each article deserves. We depend on these ratings to help us determine which articles to publish, so your rating matters! ■

Get the latest Model Railroading News, Tips, Reviews & Opinions

CHECK IT OUT!



Our iTunes feed has changed search for "Mike And Scotty Live" to receive the latest episodes!

www.themodelrailroadpodcast.com

Hosts:

Scott Mason: www.scottymason.com

Mike Rose: www.mrhobby.com

Don't Miss our Monthly Interviews
& Product Announcements

MRHMAG.COM

✉ REGISTER
(free)

Been thinking of subscribing to

MRH **RUNNING**
EXTRA ?

Subscribe today

... and for 75 cents each, get all
seven back issues too!

YES!
Subscribe Now

ALL THE DETAILS:

\$1.99 per issue



Subscription starts with the June issue ...

... and get these 7 back issues for 75 cents each:

~~\$37.81~~ for 19 issues

\$25.24 for 12 issues
+ all 7 back issues!

33% savings!

Subscribe: **\$25.24** >>
12 issues + 7 back issues

store.mrhmag.com



Nov 2018



Dec 2018



Jan 2019



Feb 2019



Mar 2019



Apr 2019



May 2019

50 additional
ad-free articles
for just 5.25!
(all meat)

[INDEX](#)

[TABLE OF CONTENTS](#)

New how-to videos!



Over four hours of insights

We've selected ten Backshop Clinics rated 4.5 or better (out of 5) for this special collection (a few even rated a perfect 5).

Video download: \$16.49

DVD (3 disks): \$29.99

DVD preorder : expected to ship late June.

FREE shipping US
50% off shipping foreign

12 more awesome layouts!

See twelve more inspirational layout stories and learn the backstory of each one while watching gorgeous footage.

Video download: \$16.49

DVD (3 disks): \$29.99

DVD preorder : expected to ship late June.

Order Videos!



from the
**Model Railroad
Hobbyist Store**

MRHMAG.COM

REGISTER
(free)

Best of the

MRH WEBSITE



Model Railroad Hobbyist | June 2019



RATE THIS ARTICLE

compiled by **JOE FUGATE**

The Hills Line - Starting the Signature Scene

Mon, 2019-05-27 16:24 — jfmcnab

First steps are underway for the signature scene on The Hills Line, the Iowa Interstate's bridge over the Iowa River and the CIC Hills Line in Iowa City. More than any other locale on the prototype, the former Rock Island bridge could reasonably be considered the signature scene for the entire IAIS Railroad.



1. Who says the magazines are afraid to show under construction photos? We like this shot by *jfmcnab* and his thread where he discusses his new layout and developing its signature scene ...

► **MRH'S MONTHLY GREAT MODELER POSTS**

[INDEX](#)

[TABLE OF CONTENTS](#)

Switch stand targets

Mon, 2019-05-20 20:08 — ctxmf74 Track and electrical/DCC Trackwork

I use the Caboose Industries 204S switch stands on my S scale layout. They have plenty of throw for S scale and look decent when weathered. I don't like the plastic targets that come with them and have to be glued to their wire staff so I make new targets from thin brass sheet and .028 brass wire. I made a simple jig to hold the pieces while soldering them. The brass wire is nice as it will bend if hit and lessen the strain on the plastic stand. Photos show jig, a pile of targets, and a stand with the brass wire and target installed....DaveB



2. MRH forum member *ctxmf74* makes his own switch stand targets from brass and then attaches them to Caboose Industries ground throws for a more authentic look ...

Essential tools for great modeling!

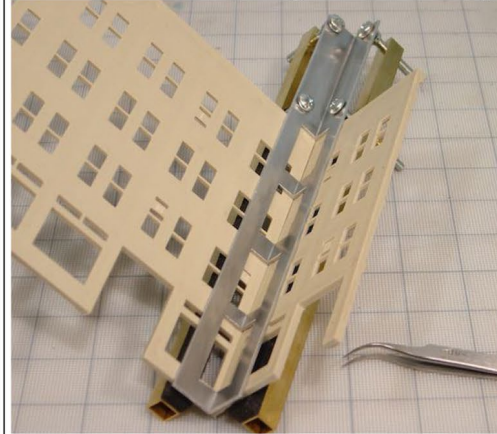

Quality tools with superior versatility!

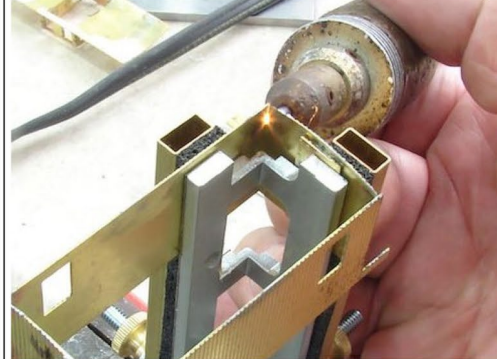

Clamps for soldering and gluing!

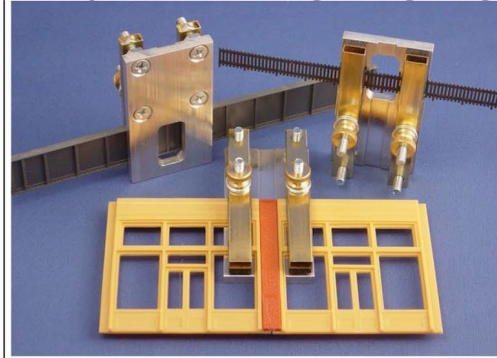

"Right and Splice Clamps"™
Coffman Graphic Solutions
 1500 River Circle, Richmond KY 40475
www.coffmaneng.com

FREE SHIPPING
 CHECK 'EM OUT

LET'S GET LIT!

Roomettes
 Bring Your Structures to Light

Lasercut structures. Highway, storefront and billboard signs.

Neat ag customer for your railroad:
 Farmers Fertilizer Supply



WHAT'S NEW?
 Established 1993...
Blair Line

Getting Started with the Model

Wed, 2019-05-22 09:54 — emillerz

I have actually modeled a C415 before, twice. About 10 years ago, I purchased an IHC C415 and repainted it Rock Island blue/white to go with what I was modeling back then. I added DCC to it and it ran terribly, so I shelved it for a while. I brought it back out in 2013, replaced the drive and part of the chassis with parts from an Atlas/Kato RS3, added some new details to the shell and replaced the handrails, and added sound. At this time, it was going to be a transfer run from South Omaha as part of my fantasy Omaha Terminal concept.



This only lasted a few months and then I used the drive and decoder to build an Iowa Interstate RS36:

<https://model-railroad-hobbyist.com/node/26187>

This idea also did not last long and the RS36 is long gone from my roster.

So I dug through my parts bin, figuring out what I still had to build this C415 for the third time. I still had the shell, although it was not in the best shape, and the chassis was a complete wreck. However, this gave me an opportunity to do an even better job at modeling the chassis. After thinking about it, I settled on two options: I could go with the Atlas/Kato drive and trucks again, or I could use a drive and trucks from a Stewart/Kato F7, swapping the sideframes for a set of AAR-B truck sideframes that I had on hand. While the Stewart/Kato U25B AAR-B truck sideframes are not a perfect size for the real trucks, they are very close and the bearings match those of the C415s in the later years. Plus, the slightly shorter truck length is a little more forgiving under the chassis. I decided to buy a few parts and try things out, then sell what I didn't need.

Here is a photo of (from top to bottom) the Atlas/Kato RS3 chassis, the Stewart/Kato F7 chassis (milled down, from a slug project that I never completed), and a frame from a Proto 2000 FA, which has very similar dimensions to the C415.

3. Eric Miller, aka *emillerz*, has changed his modeling direction (was doing the SPSF) and decided to model this Alco C415. He describes the prototype and then launches in modeling it ...



RailroadBackdrops.com
#1 Backdrop Source



RailroadBackdrops.com
CLICK HERE



Enter Code MRH100
For 20% Off



MODEL RAILROAD
Construction
PROFESSIONAL DESIGN
& CONSTRUCTION OF
PREMIUM LAYOUTS.

844-872-4670

CLICK HERE
FOR MORE INFO

car cards it is then

Tue, 2018-06-26 09:41 — mesimpson Operations



I've finally decided to go the car card route for the Hudson Bay Railway. I have waffled between using switchlists, car cards, even tabs on car. I have used all three methods on other layouts I operate on, and all have their advantages and disadvantages. I elected to go with car cards for a couple of reasons, the main one being that the pool of operating layouts in the greater Vancouver area overwhelmingly use this system so the pool of operators available are quite familiar with this system. The switchlist approach is attractive from a prototypical viewpoint but only a couple of layouts here use this system. One local modeller has developed an interesting system that he is willing to adapt to other layouts but there are still some bugs to work out. I may eventually change over to a switchlist system but for now I'm scribbling up cards as I ride the West Coast Express to and from work. I railfan and work on the layout at the same time. Good way to spend my commute.

Marc Simpson
mesimpson's blog

Comments

4 move

Tue, 2018-06-26 10:02 — dave1905

Just remember that you don't HAVE to use all 4 moves, most of my waybills are 1 or two moves. On a smaller layout, the 2 move waybills can be more flexible and easier to balance flows.

Dave Husman

Modeling the Wilmington & Northern Branch in 1900-1905



4. In his blog, *mesimpson* describes his decision to finally go with car cards for operation versus other methods. Other comments in the thread give some great car card ops details ...

"the Magic of the Night"

Mon, 2019-05-27 19:52 — dolson

Figured it was about time to take a few night shots of the Ruphe & Tumbelle Rwy.

A quiet night in the roundhouse



Dawn is breaking on the other side of the yard



5. A recent Weekly Photo Fun thread has some cool night photos by forum member *dolson*. Click this page and go have a look, that's some nice work there ...





Dang. Not again!

“Persistence isn’t needed when you know how to do it right the first time.”

TRAINMASTERS TV

Learn how to do it right from the start.



Brought to you by

MRH
MODEL RAILROAD HOBBYIST

Join the TMTV family



WHAT'S NEAT

column



Model Railroad Hobbyist | June 2019 | #112

KEN PATTERSON AND FRIENDS CHECK IN ON RAND HOOD'S LAYOUT PROGRESS, MEET THE NEW MEXICO MODULAR RAILROAD CLUB NARROW GAUGERS, VISIT SAM SYZDEK AND HIS HIGHLY DETAILED RAILROAD, AND TALK WITH THE PEOPLE EXPANDING THE SAN JUAN MODEL COMPANY ...



RATE THIS ARTICLE

THIS MONTH WE'VE GOT A GREAT SHOW!

Rand Hood shows us several buildings he has scratchbuilt for his planned layout.

- At the Rocky Mountain Train Show we talk to members of the New Mexico Modular Railroad Club.
- Campbell Rice shares with us Sam Syzdek's beautiful layout and craftsman structures.
- We interview Doug Junda and John Engstrom of San Juan Model Company about their plans for the companies they have purchased.
- Drayton Blackgrove shares more of his drone footage in "Modeling Ideas from Above."

▶ PHOTOS AND VIDEO OF SUPERB MODELING

Railroading with Rand Hood



1. Rand Hood is already building structures for his new railroad, including the section house and foreman's house in Pinecliffe CO. He's still working on layout plans, but it's probably going to look like the Colorado Rockies.

While his layout is still in the planning stages, Rand Hood is building structures and other models for it. In Austin Allard's interview, see what Rand is both building and planning for his next layout.



Also see the new "What's neat this week" weekly video podcast!

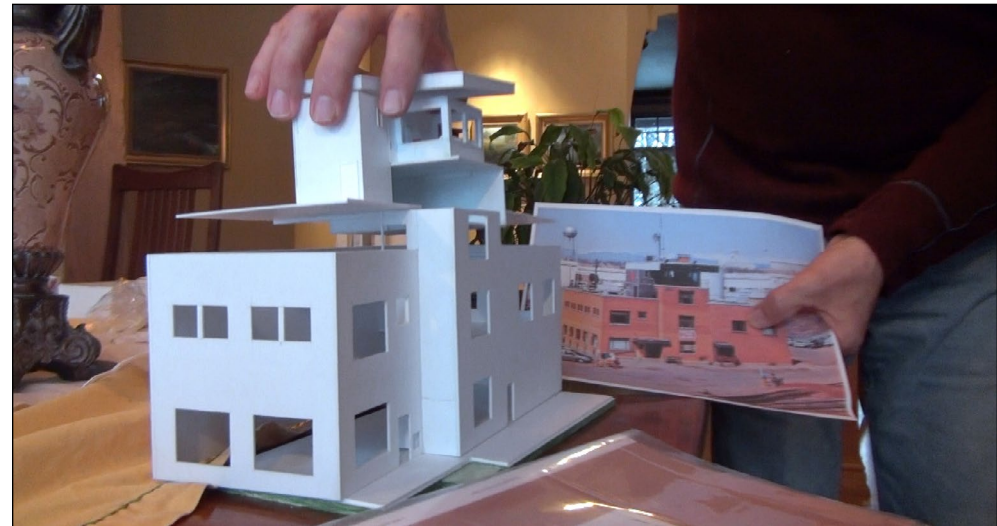

2. North Yard Tower in Denver, Colorado will immediately set the scene for Rand's latest project.

MRH product awareness survey

Take survey now

Chance to win \$125 worth of these cool products!

click here (takes ~5 min)



Seems like almost everyone wants a chance!

New Mexico Narrow Gauge Modular Railroad Club



3. Rocky Mountain Train Show visitors are fascinated by the New Mexico Modular Railroad Club's work.

During Ken Patterson's visit to the Rocky Mountain Train Show, he took the opportunity to visit with members of the New Mexico Modular Railroad Club, who describe their detailed modules and module standards -- including their use of 5000K lights, both for the daylight effect and their ability to allow viewers to take photos of the layout.

Also see the new "What's neat this week" weekly video podcast!



4. Clark O'Byrne says the club started in 2004 and is now on its third iteration, with three brand new segments displayed for the first time at the Denver show.

A MODULE CREATES A LAYOUT
 Jason Miller shows step-by-step how starting with a single module ultimately lead to an entire layout.

Buy Issue: \$1.99 >>

In **MRH** **RUNNING** **EXTRA**



Also see the new "What's neat this week" weekly video podcast!



Cheryl Lavender's Hermosa



5. Small wood frame buildings and a rushing creek set a mountain hamlet scene on the New Mexico club's Hermosa module.

A member of the New Mexico Modular Railroad Club, Cheryl Lavender's model of the Hermosa Creek bridge was what got her started in the hobby. She also specializes in figure painting, enjoying the detail work involved in faces and colors.

Also see the new "What's neat this week" weekly video podcast!



6. Cheryl Lavender got her model railroading start building the Hermosa Creek bridge.

THE LIMITED MODELER
Jim Six: Getting the most out of limited manpower help.

Buy Issue: \$1.99 >>

In **MRH** **RUNNING** **EXTRA**



Also see the new "What's neat this week" weekly video podcast!



WHAT'S NEAT | 8

Sam Syzdek's HO layout



7. Lots and lots of expertly built kits make up the cities on Sam's railroad.

Model	Scale	Length	Width	Height	Weight
1/4" Scale	1:48	1.5"	0.75"	0.75"	0.5 lbs
1/8" Scale	1:96	0.75"	0.375"	0.375"	0.25 lbs
1/16" Scale	1:192	0.375"	0.1875"	0.1875"	0.125 lbs
1/32" Scale	1:384	0.1875"	0.09375"	0.09375"	0.0625 lbs
1/64" Scale	1:768	0.09375"	0.046875"	0.046875"	0.03125 lbs

THE Ah-HAH MOMENT

Joe Fugate: Rapid modeling measurement answers with our Universal Modeling Sizes chart!

Buy Issue: \$1.99 >>

In **MRH** **RUNNING**
EXTRA



Also see the new "What's neat this week" weekly video podcast!



COME EARLY. STAY LATE!

COME JOIN US IN CALIFORNIA



39th National
Narrow Gauge
Convention

September 4-7, 2019
Sacramento, CA

CLICK HERE TO LEARN MORE

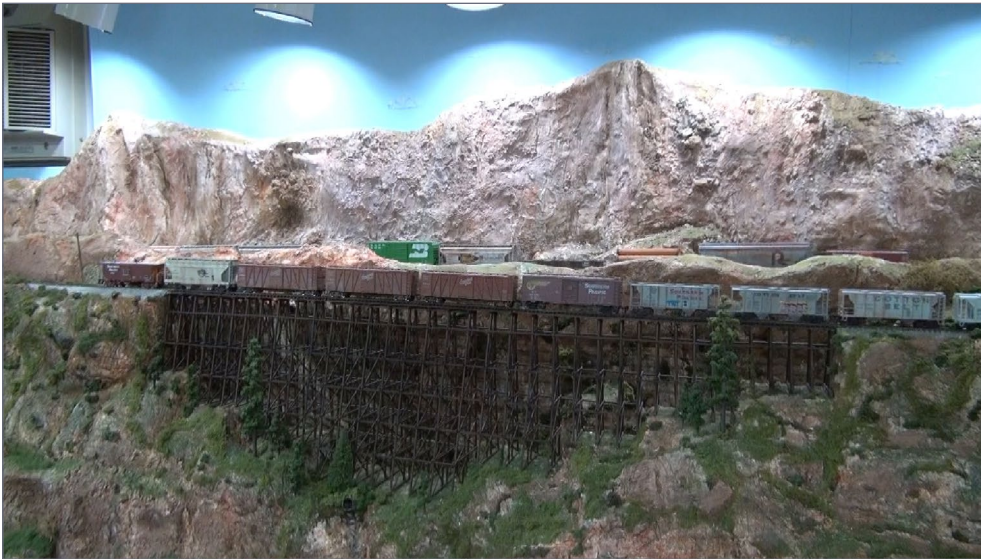

8. The trestle was built using two plastic kits. Sam rescued it from his layout in Texas when he made the move to Colorado.



9. A photo in a book inspired the wayside tavern which is one of Sam's few scratchbuilding projects. Blair Line's owner spotted it and turned it into a kit.



10. Cars, trucks, sidewalks, buildings, and traffic signals give life to street scenes.



INTERNET FOR MODELERS
The MRH Staff provides quick-study insights on how to turbocharge your time online.
Buy Issue: \$1.99 >>

In **MRH** **RUNNING** **EXTRA**



Also see the new "What's neat this week" weekly video podcast!





11. After too many hot summers and cold winters, Sam Syzdek (left) turned his garage workshop into a climate controlled getaway. Interviewer Campbell Rice (right) is impressed and a little envious.

Campbell Rice's interview of Sam Syzdek covers what he enjoys doing in the hobby, including the many varied building kits and scratchbuilt details like traffic signals. He shows how details such as cars and people bring buildings on his layout to life, making it look like they're doing something. Sam has also converted his garage into a shop area that is insulated so that he can comfortably work in it year-round.



Also see the new "What's neat this week" weekly video podcast!

WATCH NOW >>

San Juan Model Company



12. Ken Patterson questions John Engstrom (center) and Doug Junda about San Juan Model Company's plans.

Doug Junda and Bob Stears are showing their passion for trains by purchasing American Limited Models, San Juan Decals, San Juan Model Car Company, Grandt Line and Rail Graphics to join their own Leadville Shops. The combined company is called San Juan Model Company (sanjuanmodelco.com) and their goals include bringing many out of production items in several scales back into production. The individual companies will still maintain their individual identities, and you can get to their websites from the main San Juan Model Company site.



Also see the new "What's neat this week" weekly video podcast!

WATCH NOW >>

Modeling Ideas from Above



13. Drayton Blackgrove shares more drone footage and "Modeling Ideas from Above" in the video this month. Pay attention to the height of the trees next to the Quincy High Bridge and imagine, as you look at the Ohio scenery, how this could be built into a nice shelf layout. The drone footage gives great ideas to folks out there.



Also see the new "What's neat this week" weekly video podcast!



Watch on YouTube

MODEL RAILROADING GALORE!

what's neat in model railroading **MRH**

June 2019 show

MRH product awareness survey

Take survey now

Chance to win \$125 worth of these cool products!

click here (takes ~5 min)



Seems like almost everyone wants a chance!



Also see the new "What's neat this week" weekly video podcast!





Zephyr Express, the Fast Track to Digitrax Complete Train Control

- **3.0 Amp LocoNet Command Station, Booster, & Throttle**
- **Color 2.4" LCD Screen**
- **Large Backlit Keypad**
- **Runs up to 20 Loco addresses and throttles**
- **Integrated USB Computer Interface**
- **Control lights and sound with 29 functions**
- **Simple Set-Up with Easy to read display**

Introducing



Find out more @ www.digitrax.com/dcs52

\$235.00 MSRP

Don't settle for all your locos
sounding the same!

ESU now has **OVER 100**
"LokSound" files to choose from!

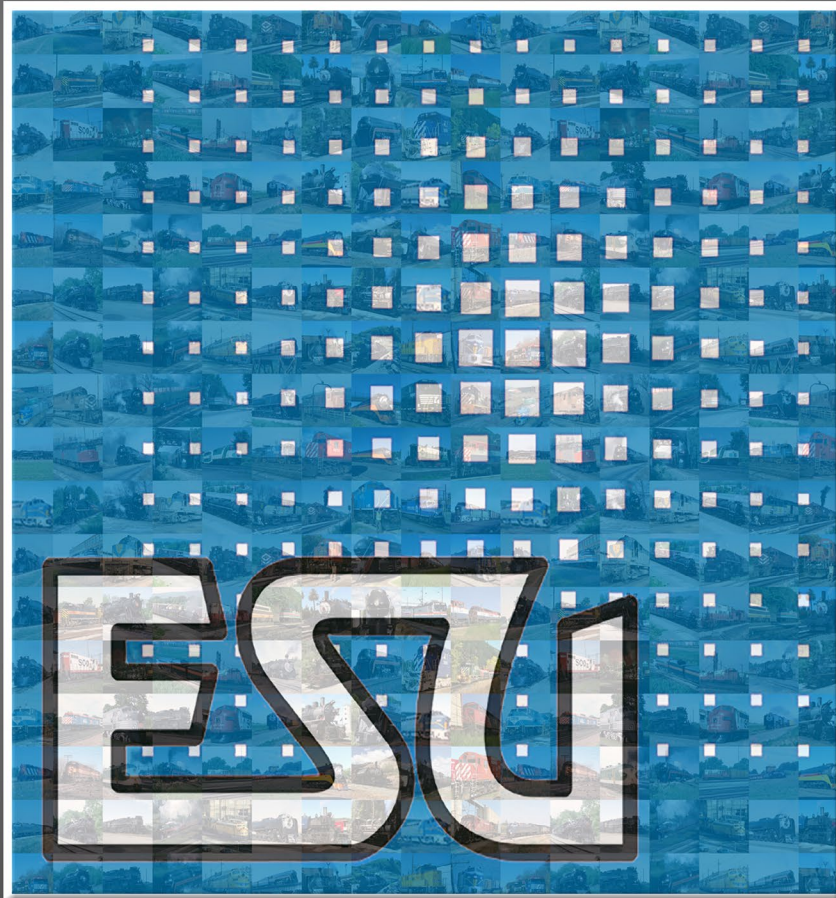

Because "Close Enough" is no longer
"Good Enough"

LokSound.com

Making your own DCC stay-alive

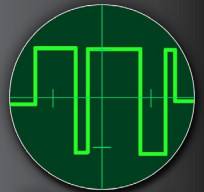
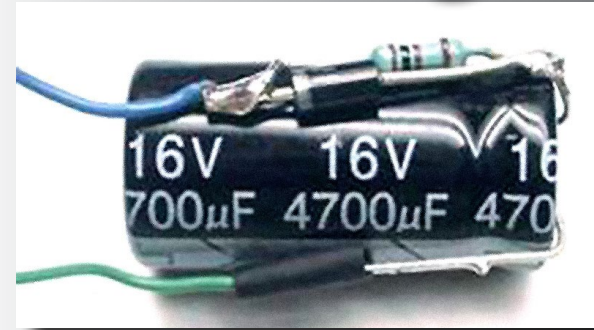

Electrical
Impulses

Model Railroad Hobbyist | June 2019 | #112

**JOE FUGATE AND MARCUS
AMMANN** delve into making
your own stay-alive ...

1. Marcus built his own stay-
alive circuit using a 4700uF
electrolytic capacitor plus a
diode and a resistor.

LAST MONTH WE DEALT WITH USING COMMERCIAL
stay-alive decoder add-ons.

One not-insignificant aspect of stay-alive add-ons – they're not
inexpensive.

Depending on the vendor and format, they can cost you any-
where from \$20-\$40 each.

If you build a stay-alive yourself, it will generally cost you from
\$5-\$10, a significant savings. Let's show
you how to do just that.

RATE THIS ARTICLE

Single electrolytic capacitor

When first introduced about seven years ago, the earliest stay-alive circuits used a single small electrolytic capacitor. That's still a viable option using the circuit shown below.

Marcus used a 4700uf capacitor [3] for his build of this circuit. 4700uF provides about 1 to 1.75 seconds or so of motor+sound+lighting power. You can find this capacitor at electronic supply online stores for around \$2.00.

The diode and resistor help minimize the in-rush current problem. An empty capacitor charging up can trick the DCC system booster or circuit breakers into thinking there is a short-circuit when power is first applied – either when you first turn on the layout or when you first place a stay-alive-equipped locomotive on powered track.

Connecting a 100-ohm ½-watt resistor in parallel with a 1-amp diode reduces the charging in-rush current, lowering it enough that it no longer makes the booster or circuit breaker trip as

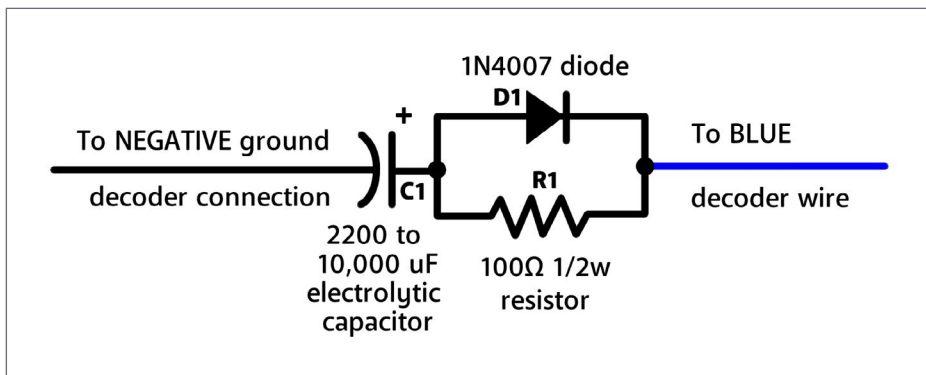

2. Circuit for a simple stay-alive using a single electrolytic capacitor. See [3] for a recommended capacitor.

www.SBS4DCC.com

ESU TCS WOW Sound OSI Solutions ZIMO

SOUNDTRAXX

NCE The Power of DCC DIGITRAX

DCC Specialties INNOVATION FOR DCC MRC Model Rectifier Corporation

ACCUTRACK II SPEEDOMETER SPROG DCC the DCC Programmer and Control Family Digital plus by Lenz

TAM VALLEY DEPOT TEAM DIGITAL, LLC Improving the world of DCC

N - HO - HO_{N3} Scale Trains

Avoid an accident!

Install a time lock on your layout...

LEARN MORE

SE

Great control in a tiny package

- Touch Toggle™ plug in controls
- Bright clear indication
- Easy setup
- Flexible system

Original Touch Toggles

Stall Motors, Twin-coils, Power, and Servos

Now for Tam Valley Depot and MRservo too!

BERRETT HILL TRAINS

Made in the USA

What will they think of next? www.berrethillshop.com

MAKE YOUR OWN STAY-ALIVE | 3

if there is a short. This also slows down the charging rate. The diode “bypasses” the 100-ohm resistor when the capacitor discharges during a “stay-alive” situation.

When connecting the stay-alive to a decoder, if the decoder has no stay-alive solder pads or identified connection locations in the instructions, see last month’s article on locating a decoder’s negative ground. The blue wire just connects to the decoder’s blue wire.

Super-capacitor array

Most modern stay-alive products use an array of super-caps to put a lot of capacitance in a small package. [4] shows a diagram for this type of array stay-alive circuit.

This circuit is more fiddly to build because of all the parts, but the combined 200,000 microfarad capacitance (from five 1F capacitors in series) provides motor+sound+lighting for well over 10 seconds. This circuit also benefits from adding a shrink-tubing cover – see the note on this.

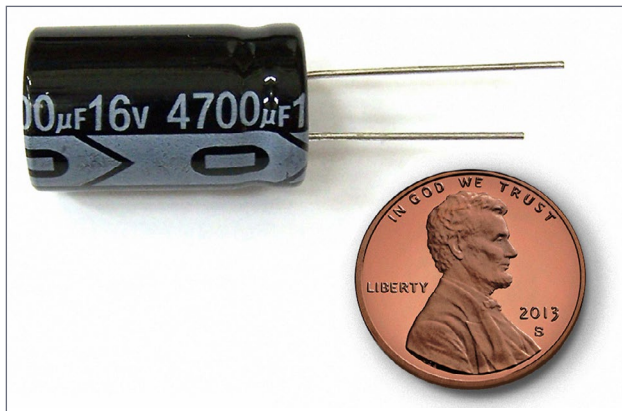

3. Recommended capacitor: We recommend a 4700 uF 16V capacitor made by Panasonic, part number EEU-HD1C472B. This capacitor is just 12.5mm x 25mm (0.5" x 1.0").



Southern Digital

WWW.SODIGI.COM

Celebrating 25 Years of serving you !

Complete wireless Wi-Fi Smart Phone Interface Digitrax Zephyr Set
Supports up to 5 phone throttles at a time!

Software Downloads for both Android (Engine Driver) or Apple (WiThrottle) cell phones. Free Lite version or Advanced paid versions available.



\$336.95 Value
\$265.00 Your Price
\$71.95 You Save

DCC Conversions, Service & Support
E-mail: sales@sodigi.com (770) 929-1888



5. Recommended super-cap: We recommend a 1F 2.7v super7-cap made by Nichicon, part number JUWT1105MCD. This capacitor is

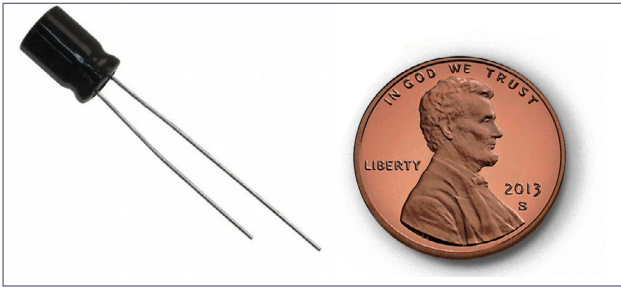

just 6.3mm x 10.5mm (0.25" x 0.41"), making a five-array set about 32mm long x 11mm wide x 6.3mm thick (1.25" x 0.43" x 0.25"). These are about 70 cents each, so a set of five costs about \$3.50.

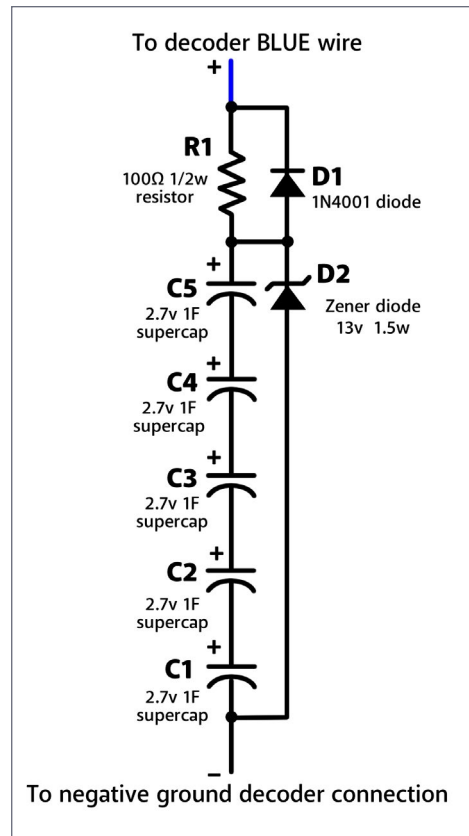

Again if you aren't sure where to connect up this circuit to the decoder, see last month's article on locating a decoder's negative ground. The blue wire just connects to the decoder's blue wire.

YouTube has two very good stay-alive build videos using super-caps [6, 7].

4. Stay-alive circuit using five super-caps, plus a diode, resistor, and a Zener diode to regulate voltage.



6. George Nefstead (Milwaukee-area modeler) builds a super-cap array stay-alive using surface-mount diodes and an SMD resistor. [link: youtu.be/WY_dmiapuvo]



7. Larry Puckett [DCC guy], contributing editor and the DCC Corner columnist for Model Railroader magazine, builds a super-cap array stay-alive. [link: youtu.be/EOE0BCVj0IU]



8. DCC Concepts' zen stay-alive circuit is a very affordable \$19 US, or \$17.50 in packs of three. Watch the video [9] →

Web: www.dccconcepts.com/product/zen-super-high-power-stay-alive-x-1.



Another option: DCC Concepts

Recently we found DCC Concepts (European company) offers a built-up five-super-cap stay-alive circuit for less than \$20, so if you're just not up to building one of these yourself, but you want something at low cost, then check these out [8, 9]. ✓



J. Fugate

SHRINK-TUBING COVER

You can get large shrink-tubing sleeves on Amazon for encasing a super-cap stay-alive array, keeping it insulated and integrated into one professional-looking package.



Here is a roll that's 10 meters of wrap for \$7 with free shipping to Prime members.

WEB: amzn.com/B071L82PCR

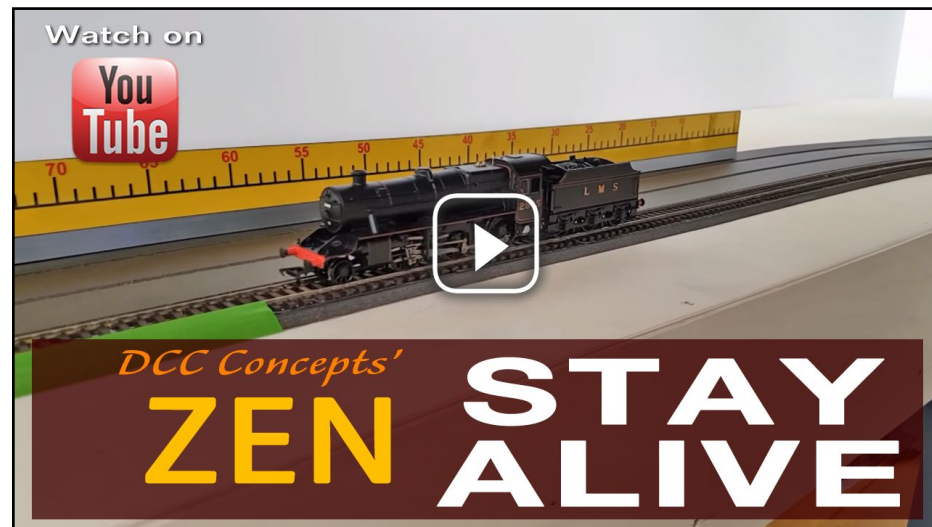

9. DCC Concepts demos their zen stay-alive circuit in this video. [link: youtu.be/QBcZmlLS3vw]

ADVERTISEMENT

Make tortoise wiring more modular!



Dealer Inquiries Accepted

TORTOISE edge card connector

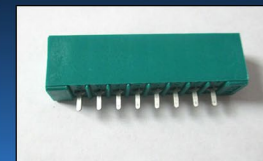
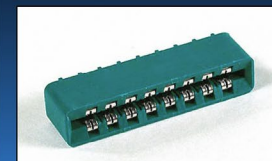

Our Edge Connector redesigned for a SNUG fit!

[CLICK TO LEARN MORE ...](#)

From first train set to railroad empire...

*Our complete line of DCC products
grows with you. Discover the fun!*

- Designed and manufactured in the U.S.A.
- Preferred for ease of use and ergonomic design
- Unlimited scalability for any size model railroad
- Plug-and-play means more time running trains
- Great customer service and excellent support



Visit our new and improved web site for all your DCC needs!

- Get the latest new product announcements
- Watch our detailed how-to videos
- Browse the all-new Information Station
- Enjoy secure online sales, day or night!



See your dealer

Visit **ncedcc.com**



MRH MARKETPLACE



MAIN STREET AMERICA HISTORIC ARCHITECTURE



MAIN STREET HERITAGE

CLICK HERE for all our HO & O kits

www.mainstreet-heritage.com



Yarmouth Model Works

HO scale resin kits and detail parts

U.S.A. MAILING ADDRESS
2014 Holland Ave Unit 617
Port Huron, MI 48060
Tel. 519-633-7574
pierre.oliver@elgincarshops.com
CANADIAN MAILING ADDRESS
263 Sunset Dr.
St. Thomas, ON N5R 3C4
www.yarmouthmodelworks.com

REMEMBER TO MENTION MRH WHEN SPEAKING TO HOBBY VENDORS!

LOOK at what's new at Black Cat this month [Click here for our website](#)

TH&B cabooses in the tiger cat scheme (post 1957). Set will do wood or steel vans.



Black Cat Publishing
(204)489-5005
ajfergus@mymts.net
blackcatdecals.com



BenchWork.com

To build your dreams, You need a plan!
Affordable track planning
Starting at only \$250

[CLICK ME to get started!](#)

MasterPieceModules.com

NEW!!!
Z scale T-trak Module kits
23 sizes & configurations

CNC Precision cut finger joints give you precise assembly. All hardware included.

MRH MARKETPLACE | 2



USRA DS Express Box
NWP Redwood Empire



westerfieldmodels.com



P.O. Box 6 Paonia, CO 81428
Ph. 970 527 4586
Made in The USA

Cast resin items for All Scales.
Tunnel portals, bridge piers, abutments, culverts, and retaining walls.
Trackside details and sage brush tree armatures.

"FREE SHIPPING see website for details"

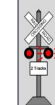

LOGIC RAIL™
TECHNOLOGIES

"Sophisticated Model Railroad Electronics"



Please visit our website and online store!

21175 Tomball Pkwy
Suite 287
Houston, TX 77070

Phone: (281)251-5813
<http://www.logicrailtech.com>
info@logicrailtech.com

MONASHEE LASER ENGINEERING
OFFERING NEW SERVICES
MANUFACTURERS OF RAILROAD STRUCTURES AND SCENIC STOCK MODEL KITS

COME VISIT US [CLICK HERE](#)



PRECISION DESIGN CO.
LASERCUT KITS - CUSTOM DECALS

PDC.CA

Authorized RailPro Dealer

FREE SHIPPING in the US and CANADA

MOUNTAIN SUBDIVISION HOBBIES

www.modelrrsupply.com

FREE USA SHIPPING OVER \$49.00

MRH Readers save with code:

MRHMAG19

HO DIESEL SUPPLY

CUSTOM SOUND LOCO'S-REPAIRS-UPGRADES
Weathered New and Rebuilt Locomotives
Powered Chassis-Trucks-Motors-Handrails-Electronics
Parts Inventory Always Changing
www.hodieselsupply.com
email:gerry@hodieselsupply.com

MRHMAG.COM

REGISTER (free)

[INDEX](#)

[TABLE OF CONTENTS](#)

Waiting a
MONTH

just too long?

Check out Ken Patterson's
**WEEKLY VIDEO
PODCAST!**



Watch on

**You
Tube**

Get your weekly
What's Neat
fix on YouTube!

Check it out >>

Watch Ken's What's Neat This
Week video podcast on
YouTube each week!

Your ad could be in
this space for as low
as **\$88 a month.**

Click to learn more ...

Model Railroad Control Systems

Geoff Bunza Project Boards
DCC Occupancy Detectors
CMRinet Compatible Nodes
Layout Telephone Systems
RFID Switchlist Generator
Switch Machines and Drivers

Click Here



Your #1 source for **TOMA** Benchwork
250+ shapes & sizes!
Built to order benchwork also available! (224)201-9868

Great Decals!™

FEC, Interstate, Virginian
Railway, & L&N Titles
After Hours Graphics Line
Coupler Gages and More
In O, S, HO, and N Scales

You asked for it: so here it is!

Now available

Best of MRH in paperback! (with no ads)



~~\$29.99~~

\$24.99

FREE shipping US
-50% shipping foreign

More volumes
coming ...

Order my copy now >>

store.mrhmag.com

Pelle Søbørg's Daneburg Subdivision



Also on TMTV!

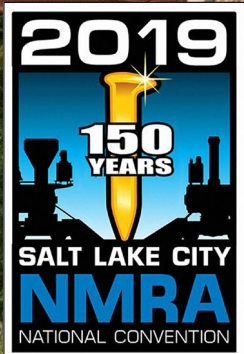

Visit this layout at the Salt Lake City NMRA convention this coming July.

THE MRH STAFF tours Pelle's Nebraska-based layout while Chris Brimley tells how it came to the US from Denmark ...

1. In the summer of 2017, Pelle Søbørg had some life-changing events that meant he needed to dispose of his current layout. ExactRail got wind of this and made Pelle an offer. The story of what happened next is rather amazing ...



RATE THIS ARTICLE

MRH: HELLO, CHRIS! WHAT IS IT YOU DO FOR ExactRail?

Chris Brimley: I'm the Vice President of Product for ExactRail, and I also have a dual role with TrainLife. I oversee what product we bring in for our company, and then also I'm the overseer and the caretaker of Pelle's layout.

MRH: So take us back to the beginning – how did ExactRail get the idea of acquiring this layout?

Chris: As ExactRail and TrainLife, we've always wanted to build or have a layout in our store for displaying product, or just something that we could have in here for fun. During the summer of 2017, Pelle Søeborg announced a pretty major life change and unfortunately he would be moving and his layout would no longer have a home.

So Pelle announced the sale of the layout. Initially I think there were a few offers that fell through on it. It was known going in that he would have to part the layout out if it didn't sell. Some modules were going to go to some people, some to other people – but his preference was to sell the layout as a whole.

MRH: What did you guys do then?

Chris: So we just kind of threw an offer out there, not really thinking that it would go anywhere. It became more and more serious as we communicated and ended up he chose us as the new home for his layout!



2, 3. Pelle has done such a nice job with the scenery on this layout – no matter where you place the camera, you can't find a bad angle!

THE ULTIMATE SECTIONAL LAYOUT TEST

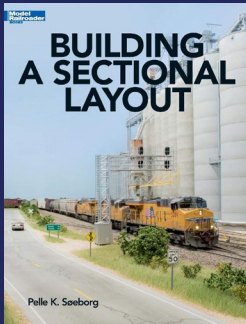

Pelle documented building his Daneburg Subdivision layout in his Model Railroader book "Building a Sectional Layout" (available from the TrainLife Store via this link: mrhmag.com/magazine/url/pelle-daneburg-sub-book).

By selling his layout to ExactRail's TrainLife store in Provo, Utah, Pelle's sectional layout got its ultimate test by sailing a third of the way around the world on the high seas in a shipping container!



4. Pelle took the layout sections and carefully packaged them up for the 8000-mile trip through two oceans in a shipping container!

It just moved forward from there. Pelle began to disassemble the layout – fortunately he had designed it in a modular way and he was able to easily take it apart [4], to package it up in a container, and then ship it off to us.



5, 6. Unlike the western desert and mountain scenery of Pelle's previous layouts, on this layout he chose to model the fertile US heartland.

MRH: How did it get packed, and how was it shipped?

Chris: Pelle had a 20-foot container delivered to his home. He disassembled the layout module by module. For some of the modules, he built a basic frame so he could stack the modules on top of each other. Some of the sections, such as the staging yard were a single large piece on his layout, so he cut it in half so it would fit into the container. He had the staging tracks leaning up against one of the container side walls.

The rest of the layout was pretty much just on the floor with some foam dunnage so it wouldn't shift around within the container, and it pretty much just stayed put on the bottom floor. It was a light load and it didn't take up much room: it only took up the bottom three-four feet of the container. The rest of the container was just air space.



7. Pelle mastered the look of contemporary railroading in rural Nebraska on the layout, such as country road crossing. It just looks so natural!



8. Pelle convincingly captured the look of rolling Nebraska hills near a watercourse with this bridge scene.

Once Pelle had it all loaded, they picked up the container at his home and hauled it to port and onto a container ship in Denmark. From Denmark it stopped at a few other ports in Europe, then it went to Savannah, Georgia in the US. From there the ship went to the Panama Canal, and then it came up the west coast and offloaded in Oakland, California.

There they loaded the container onto a train and brought it to Salt Lake City. At Salt Lake it got offloaded onto a chassis, and then we unpacked into our facility here.

MRH: What was it like when you received it?

Chris: Upon receiving it, we took maybe an hour to unload it out of the container.



9, 10. Pelle built this grain elevator complex using one at Lexington, Nebraska as his inspiration. Even though it is selectively compressed quite a bit, it still dominates the scene.

But in the meanwhile, when the layout was still in transit, we had to build supporting benchwork for it since that was one of the items that was *not coming* with the layout. All we were getting was each modular section and the skyboard of the layout.

We prebuilt the benchwork so that once it came in, we just offloaded each section and placed it at its proper location on our new benchwork.

Everything went together rather quickly – most of the time spent was mating up each module, getting the alignment of the track correct, and then placing the skyboards that Pelle had sent.

Everything ended up being surprisingly plug-and-play, with us having the layout running within a few short hours of unloading the container.

MRH: Why *this* layout? Why not something else?

Chris: It's a well-known layout and Pelle has a pretty large following. If we weren't going to build it ourselves then we wanted something first class. This is a relatively new layout. Pelle had only finished it – or mostly finished it – the year that he sold it off to us.

We wanted something that we'd be proud of, and something that would bring people into the store. So, it's not just something for us to play trains on, it's a great marketing tool for us as well.

MRH: What kind of response are you seeing with the layout in your store?

Chris: The response has been very positive with us saving the layout. A lot of people were concerned that the layout was just headed to a dumpster. It's not a historically known layout

because it's so new. But nobody wants to see a layout go to the trash if it *doesn't have to!* I suppose pieces of it would have been saved, but to keep it as a whole – people were excited. And then also there's the fact that even though Pelle is Danish, he's modeling a section of the US, specifically Nebraska.

A lot of people wanted to see the layout and so to bring it to the States excited quite a few people. It made it so much more accessible. People have been thrilled about that.

What has been surprising for us is that not only has the layout brought in a lot of people from the states, we've had multiple people from around the world who have visited. It's been exciting to have people come from Australia, Europe, and Asia stop by to see it.

MRH: Tell us more about the layout – what exactly has Pelle built here?

Chris: Pelle has modeled a fictional portion of Nebraska. He has a town on it that he calls Daneburg, which is not a real town. Pelle based this town on areas in Nebraska that he drove around to photograph and document prior to doing the layout.

Pelle took aspects that he liked from the US heartland and made it work for the space he had, which is 11 x 22 feet. The basic design of the layout is a loop that's folded onto itself.

It's a double-track layout, so it's not really an operators' layout – but you could turn it into an operators' layout. It has only a few industries that can be switched on it, so it's mostly a layout to railfan. It's a layout to enjoy watching the trains go through the gorgeous scenery that Pelle built.

MRH: How does TrainLife fit into the picture with this layout?



11. The UP train blasts for the main street crossing in Daneburg, the namesake town for Pelle's layout. Putting the track halfway into the scene provides some room for scenery between the track and the fascia. The side street implies approaching civilization and gives a sense of locale.

Chris: TrainLife is a sister company to ExactRail. We wanted our own hobby store. It's something that we had wanted to do for a very long time and so we were building it out and bringing in new product.

Having this layout seemed to pair nicely with our store. TrainLife as a store is only about three years old. Having this layout would bring attention to TrainLife and help with getting TrainLife better known.

As we continue to grow TrainLife, we're running out of space. We will be expanding into a neighboring space because we want to keep growing this. It's been very successful and we are thrilled with what we've done so far.

ExactRail manufactures HO and N scale rolling stock. It was founded by John Pestana and Chris Clune in 2007 and the first products were released early 2008.

ExactRail strives to produce some of the best rolling stock on the market. We produce products that are scattered over three different product lines. First there's your more basic rolling stock, and then there's middle range cars, and then we have our Platinum Level – our highest detail, highest-fidelity-to-the-prototype cars. We've stayed with freight cars, largely, in what we offer today.

We're excited about the future, and there's a lot of new things coming right now. And with the move of putting TrainLife into the neighboring space, it's also giving ExactRail the needed space for the growth that we're planning over the next several years.

MRH: Can you summarize for us again how TrainLine and ExactRail are connected?

Chris: ExactRail and TrainLife are owned by the same person, John Pestana. TrainLife was originally eight years ago an online archive of magazines. We had a few of our own articles that we had produced, and we also had an online forum. But new directions at ExactRail took a lot of the attention we had been putting into TrainLife and focused them on ExactRail instead.

Unfortunately TrainLife became bit of a stepchild and it wasn't getting the attention it deserved. We've since rebuilt the magazine archives so they're easier to navigate, easier to view, and



12, 13. The Daneburg main street crossing scene has a strong rural middle America feel to it that Pelle captured well. There's only one structure on each side of the street against the backdrop – the photo backdrop provides the rest of the town!

then turned TrainLife into a hobby store. It's not just online only, but it's a brick and mortar store too. You can stop by and visit the TrainLife store anytime, and see the layout as well. The layout is always open to come see during business hours.

ExactRail and TrainLife are two separate companies and they just share the space, running side by side with each other. Pretty much everybody that works for ExactRail also has a role within TrainLife as well.



14. After passing through Daneburg, the town quickly gives way to rural farmland, this time with a cornfield between the track and the fascia. The track runs a few inches in front of the backdrop and there's just enough room for some bushes or small trees to disguise the joint with the photo backdrop. That leaves a lot of room for scenery in front of the track.



15. Here's another view of the first rural farm scene after leaving Daneburg, behind a nicely weathered red barn. Hidden behind the trees on the far left is the entrance to staging at the other end of the line.



16. Here is the entire Green River bridge scene. The design of this scene allows the tracks underneath to realistically and conveniently disappear into staging.

PELLE SØEBORG'S DANEBURG SUBDIVISION | 17

MRH: People who come to the convention here in Salt Lake this summer, what can they do regarding this layout?

Chris: During the 2019 convention in July, our store will be open and we're planning on some giveaways if people come down to the store. We plan to stay open late, for as long of hours as we can, to make it possible for people can come by to shop the store and see the layout.

The layout will be up and running. We'll be kind of split between the show, the convention, and the store. It's going to be a busy week but we're very excited – we expect it to be a fun week! ☑

★★★★★
RATE THIS ARTICLE

ADVERTISEMENT

RailPro™ **RE RING™**
ENGINEERING

NEW TECHNOLOGY

DCC + RADIO CONTROL

HO Scale Locomotive Module

ULTIMATE
SERIES
SOUNDS

TRUE
MOTION
TECHNOLOGY

LIGHT
EFFECT
EDITOR

DIRECT™
RADIO
+NET

New Sound Technology and Mathematical Model Motion Control + more!!!

+

Equals
"DUAL MODE"
Control by DCC +
Radio Control

Click Here to Watch Video

For more information visit our Internet site: www.RingEngineering.com



WHAT'S NEW on TMTV!



CASTING PARTS WITH MOLDS - 2

Miles Hale makes a good impression by casting his own coal loads. Part 2 of 2.



ADHESIVES FOR ROLLING STOCK

Don't get stuck using the wrong adhesive for rolling stock parts. Top 10 best adhesives.



HELPFUL DCC INSTALL TOOLS

If you do your own DCC installs, here's the top suggested tools from an install professional.

Become a member >>



GET 10% OFF!

Registered MRH readers get 10% off with this special coupon code:

Get Subscriber 10% off code

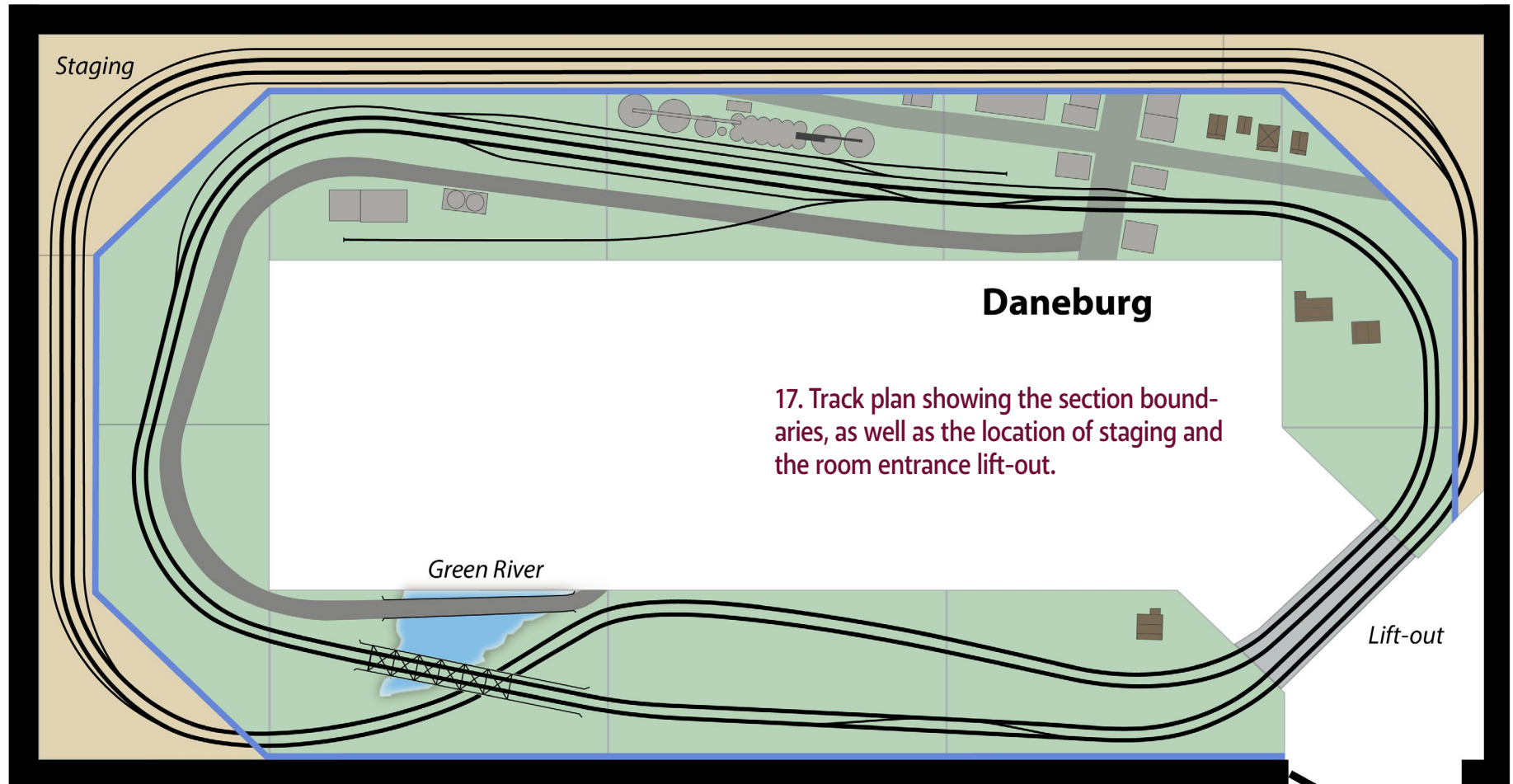

17. Track plan showing the section boundaries, as well as the location of staging and the room entrance lift-out.



Pelle Søborg's
**Union Pacific
 Daneburg Subdivision**

HO Scale - Size: 11' x 22'

18. The Green River bridge scene [16] has enough elevation for the tracks to pass over each other. On his field trips, Pelle observed that watercourses in Nebraska often run in a gully lower than the surrounding terrain. That makes this clever "flatland" layout design trick quite believable. Nice job, Pelle!





More convenient loco storage

Model Railroad Hobbyist | June 2019 | #112



RATE THIS ARTICLE

BRENT CICCONE devises a hands-off way to get locos on or off the layout ...

LIKE MANY MODEL RAILROADERS, I HAVE AN ABUNDANCE of locomotives. My layout is a small around the walls shelf layout that probably needs a grand total of two locomotives to operate.

Last time I counted, I own at least a dozen locomotives of various types and descriptions. Probably more if I searched through my closet, but don't let my wife know!

I like to switch them around periodically and run different locomotives, but since I am running mostly steam, this creates problems in handling the locomotives with a tender;

1. A locomotive happily parked inside its protective case, safe from dust and prying hands.

getting all the wheels on the locomotive, tender, pilot trucks and trailing trucks on the rails every time, and potentially breaking off detailed bits and pieces as they are manhandled on and off the layout.

Originally, I had built a turntable at one end of the layout using an Atlas turntable as a base. It worked okay but sometimes had alignment issues. The biggest issue with a turntable and associated locomotive tracks is the space that they occupy.

Even with the turntable, I still only had room to keep about four or five locomotives on the tracks; the rest had to be stored in boxes.

I eventually tore that turntable out and replaced it with a stub-ended yard. That has proven to be far more useful than the turntable ever was. The problem now was: how to turn the steam locomotives around? This problem is not restricted to the steamers as many diesels are also single-ended.

I pondered this for a while and searched around the Internet for ideas. I found the PECO loco lift at peco-uk.com/products/loco-lift-and-storage-unit and bought one of those. If you haven't seen one, it is a cradle that fits over the rails and allows you to drive the locomotive onto the lift and then lift it up, turn it around, and drive it off again. It's quite clever.

Please click on the ads!



2. Peco LocoLift in use on the layout.

It works well but sometimes bits of ballast or other scenic materials get in the way and it fails to make electrical contact. Overall, a good device but then I got thinking, what if I had something like this for every locomotive and it had solid sides and a top so that the locomotives can be stored in it?

Enter the Twiddle

So I started tinkering around with designs and came up with what I have labelled as the “Twiddle.” That’s a cross between a Turntable and a Fiddle yard, with storage and display case functions thrown in as a bonus.



B. Ciccone

TWIDDLING AROUND

Twiddle, verb : to rotate lightly or idly (from the Dictionary)

noun, cross between a Turntable and Fiddle Yard (my definition).

My first problem was where to locate this device. It needed to be a spot with easy access. I originally thought it needed to be on a passing siding where the trains could drive right through it.

While a passing siding might work, upon further thought I only had one spot where this was going to work the very best: an unfinished track that ran to the edge of the layout.

By placing the device at the layout edge, I could easily move the Twiddle on and off the layout. And I could easily turn it around to send the locomotive running again off in the opposite direction.

MORE CONVENIENT LOCO STORAGE | 5

The following pictures and video show the Twiddle in operation:

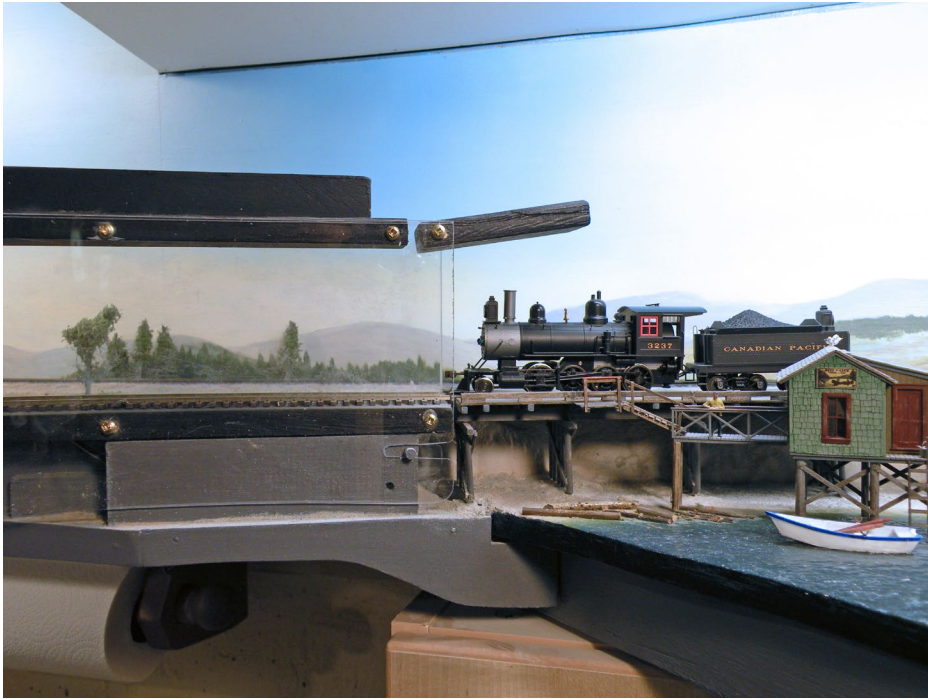

3. Here I have the Twiddle storage case in place with a locomotive about to run into it. The doors are critical and keep you from accidentally running the loco out the other end onto the floor. Only open the one door at a time – don't ask how I learned *that* ...



MORE CONVENIENT LOCO STORAGE | 6

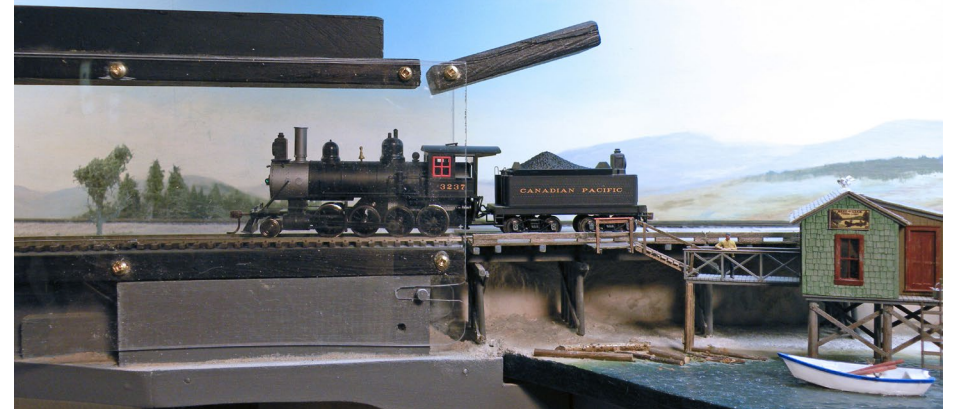

4. Here I am running the loco into the Twiddle case. If I like, I can close the door, pick up the Twiddle and turn it around.

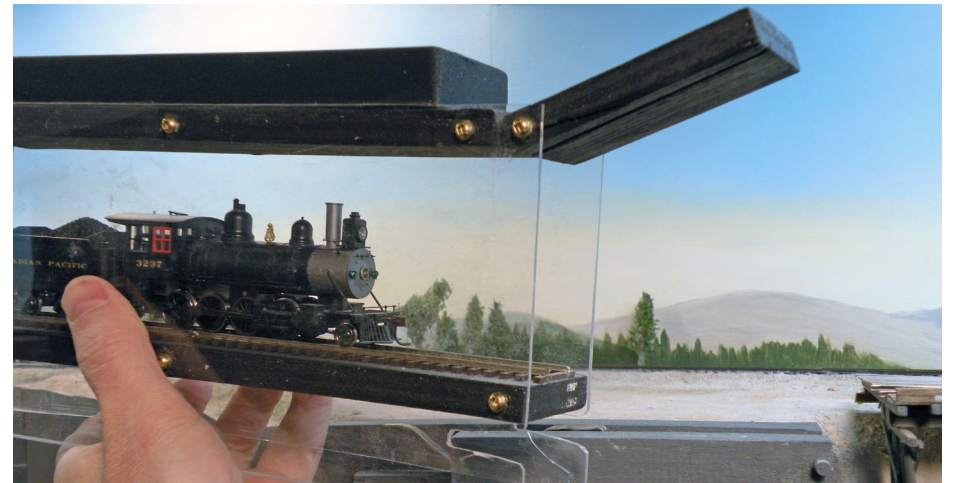

5. Oops, I said close the door! Otherwise the loco might slide out onto the floor. On the layout is a dowel pin that fits into the corresponding slot on the case, holding the case in place. This serves several functions: it prevents the case from tipping up, it aligns the tracks and it holds the case down so that it is making good electrical contact with the contact strips on the bottom.

MORE CONVENIENT LOCO STORAGE | 7

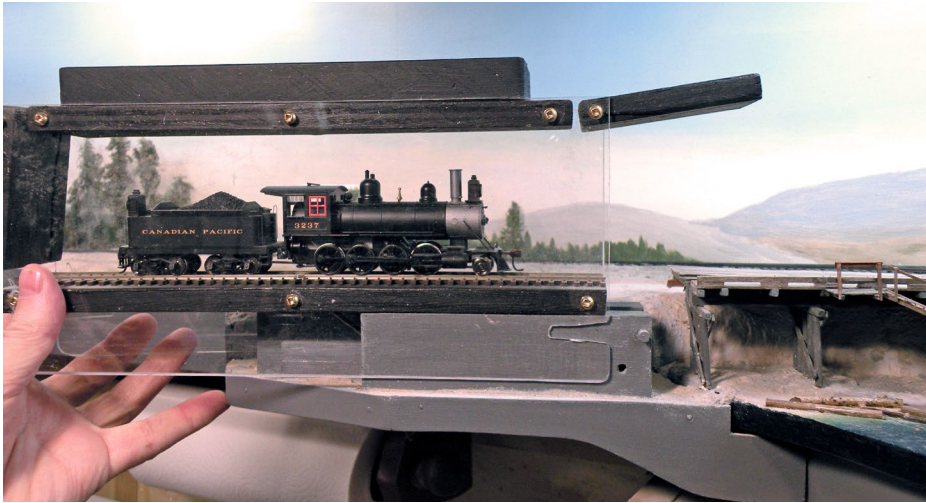

6. Slide the case in place fitting the slot over the dowel pin and slide the case back up so the rails in the case meet up with the rails on the layout.

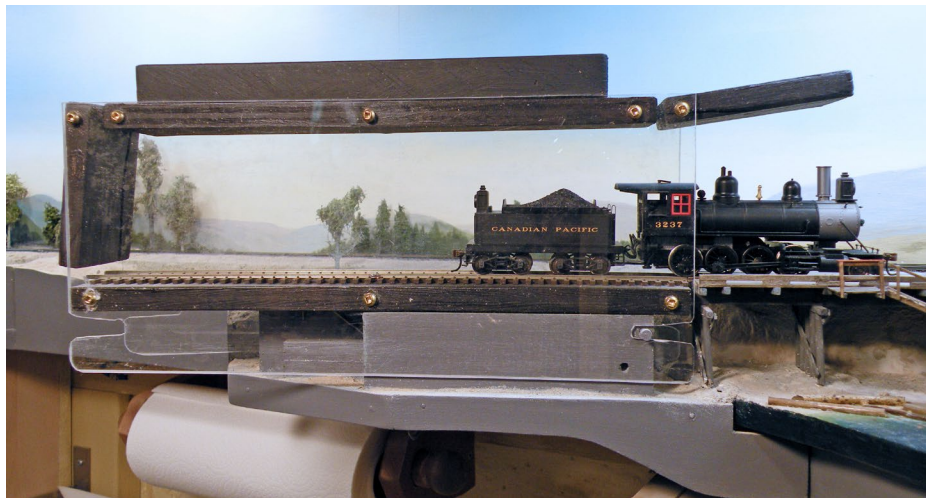

7. The locomotive has been turned around without touching it and without removing it from the rails, and it now runs out of the case back onto the layout.

MORE CONVENIENT LOCO STORAGE | 8



8. Here is the docking base showing the two blocks of wood I used and the rather crude electrical contacts. It's located at the end of a trestle that runs along the lake shore. The plan is to eventually build a station alongside this track, hence the boardwalk.





9. I put this dummy track cover over the docking base when not in use. It is unpowered just in case I forget and run too far onto it! This will include the station when I get it built.

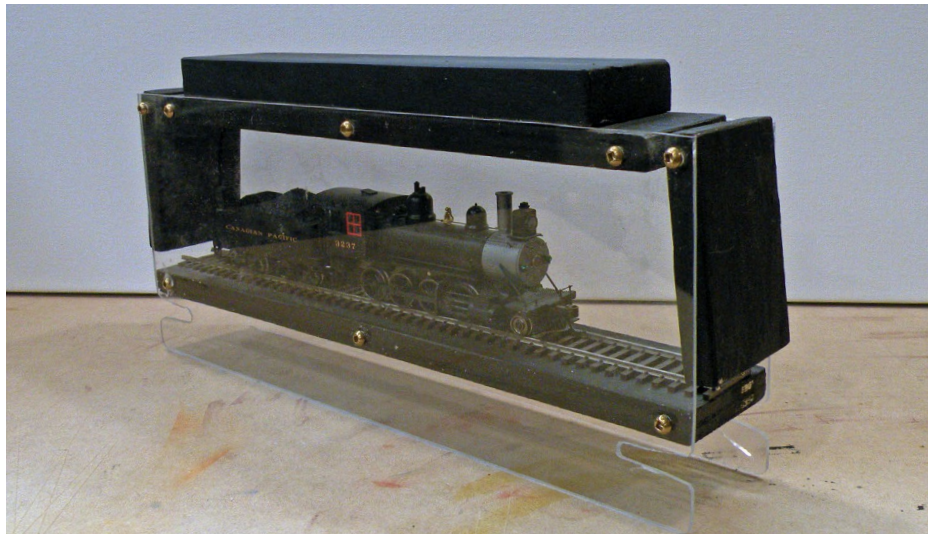

10. The Twiddle case is great for storing the locomotive and keeping dust off it.

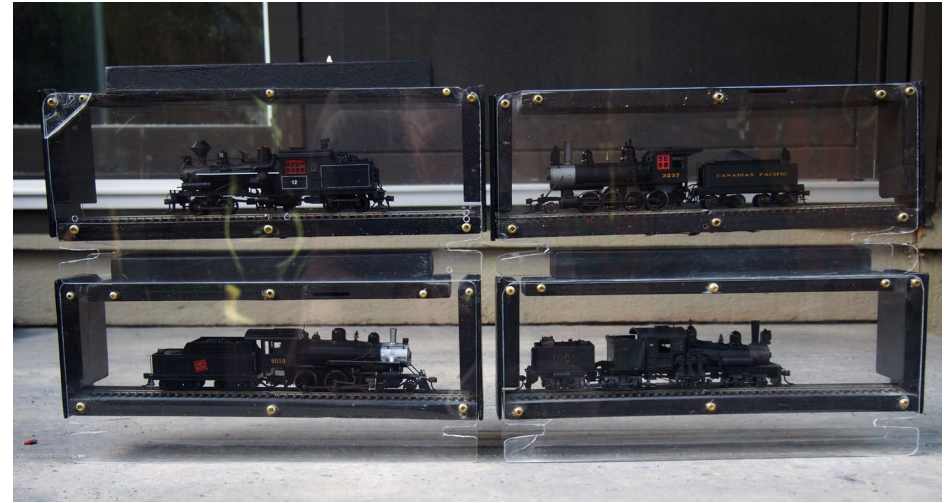

11. Adding a block of wood on top allows the cases to stack together for storage and display. You could place a strip of wood on a shelf and line up all your locomotives up for display, each in its own Twiddle case. It's also ready to be picked up and moved onto the layout at your whim, all with minimal effort!

Twiddle construction

My construction is not always the tidiest. I was experimenting while developing this system and didn't know what was going to work, so it evolved as I went along.

The clear acrylic sheet is expensive, so I continued to use pieces that I cut wrong or they cracked while cutting and drilling. If I knew then what I know now, I could make it much better looking, but I am mainly concerned with function and it does function well!

Most of the dimensions for the Twiddle are not critical. You can build it to suit your locomotives and scale. The important

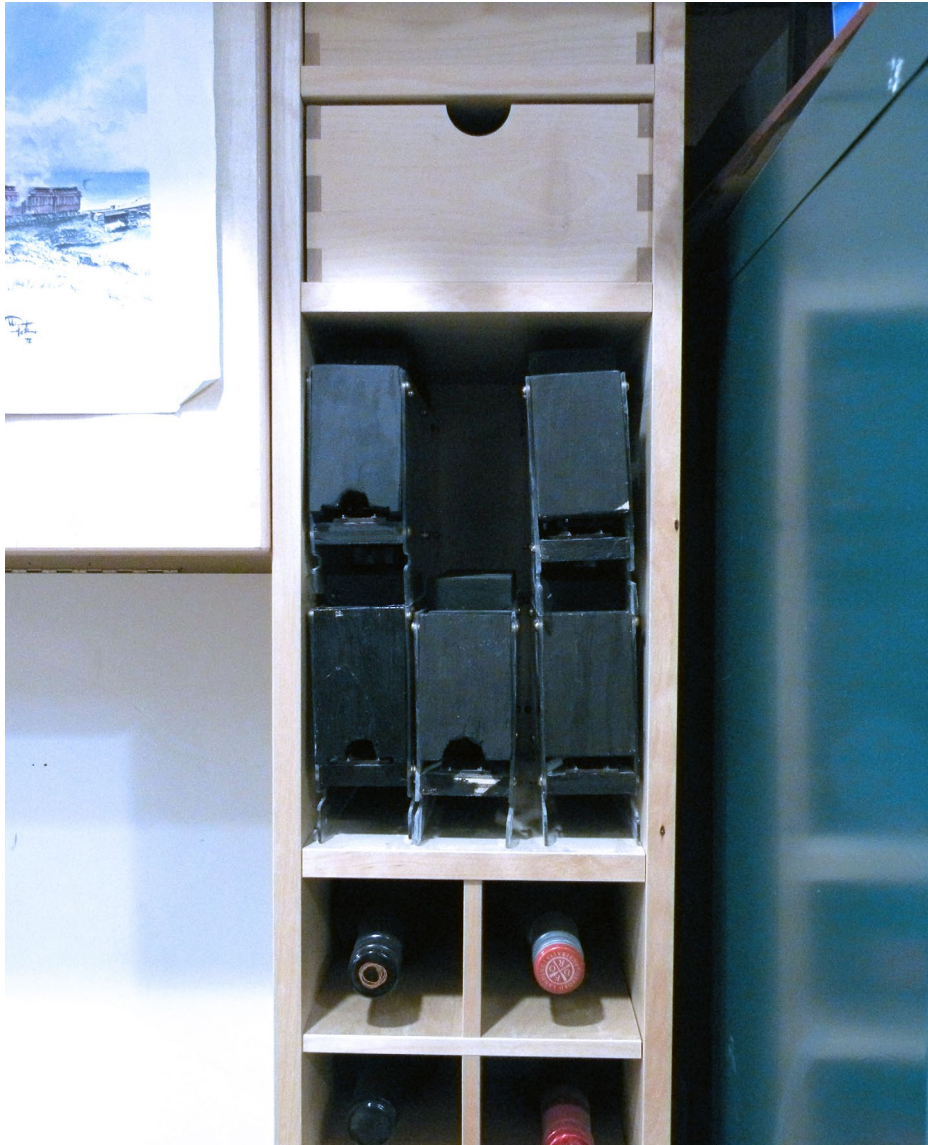

12. I keep my Twiddle collection stored in this IKEA shelf complete with wine rack. Talk about convenience! Sometimes it is hard to decide whether to pull out the bottle of wine or the locomotive ...

requirement is that your locomotives fit inside the case. I would suggest using the NMRA clearance standards as your guide and making sure the cases fit snugly on the docking base.

The most important dimension is the distance from the top of the rails to the bottom of the slot for the dowel in the docking base, this dimension must match for the slot to perform its functions. I will give the dimensions I used, but you can use something else if the docking base and the case match.

I start with the docking base, and then make all the cases to match. I use two pieces of hardwood; I recommend birch, maple, or some other fine-grained hardwood. The hardwood will stand up to years of use without wear and still retain the critical dimensions.

I use two pieces and a small filler piece in between to hold the electrical contacts. The overall width of the three pieces layered together needs to match the width of your NMRA clearance gauge for your scale.

In my case, for HO scale, it was 2" total width. I use two pieces of $\frac{3}{4}$ " birch for the outside pieces (1- $\frac{1}{2}$ " total) and then cut down another piece to $\frac{1}{2}$ " thickness for the center, which gives the 2" total width.

I mount the electrical contacts on this center piece [13]. Note that I offset the ends of my two side pieces because I need to orient the docking base at an angle to the benchwork.

For the electrical contacts I use heavy brass strips bent to shape so that they contact the bottom of the cases.

I attach the contacts to the center block and drill holes for wires to drop down and connect to the DCC bus wires below the layout. With DCC you don't have to worry about the

polarity; the engine will run forward regardless. If you are running DC, flipping the case around will reverse the wiring, which is just what you want, so you don't need to worry about polarity in that instance either.

As mentioned, there are only two critical dimensions: the width of the docking base (and matching your cases to that), and the positioning of the alignment dowel with the corresponding slot in the side of the cases.

In my build, I put a 3/8" hardwood dowel in the top corner, placing it 1/4" in from the end and 3/8" down from the top.

I made a mistake while drilling the hole for the dowel. I attempted to drill straight through the entire 2" thickness of the docking base at once. I thought I was being careful and had the drill aligned level, it deviated slightly when it came out the other side. This has proved to be a real pain in the butt, as the slot cut in each side of the case must to be custom cut to fit that side, with one side fractionally higher than the other.

You could use a steel or brass rod for the dowel, but I find hardwood easy to work with and haven't noticed any wear after years of use. I used the 3/8" dowel because that is what I had on hand. A larger size would work but I wouldn't want to go smaller unless you are in N scale. Even then I wouldn't go smaller than 1/4".

I mounted the docking base to a piece of plywood attached to the workbench. I left a gap of about 3/4" between the end of the docking base and the connecting approach track. This makes it easier to get the case lined up on the docking base before pushing it that last 3/4" to meet up with the approach track.



13. Closeup of the docking base with its electrical contacts. Crude, but it works!

MORE CONVENIENT LOCO STORAGE | 15

As you push the case into place, the slot in the case sides matches up with the dowel and it slowly pulls the case and track inside into alignment with the approach track on the layout.

If you have built everything to match, the dowel will pull the case and track down into vertical alignment and the width of the docking base will force it into horizontal alignment. The electrical contacts will contact the connections on the bottom of the case and you will be able to simply run the locomotive out of the case and onto the layout – or vice versa!



14. All the pieces for two cases, a top, bottom and two end doors and acrylic sides plus various screws.

MORE CONVENIENT LOCO STORAGE | 16

My approach track runs on a trestle, but this is not necessary and it suits the waterfront location on my layout. You could just as easily have regular roadbed come to the layout edge with a space for the Twiddle. It would be a good idea to allow a little overhang at the end of the roadbed so that you can nestle the case up tight without the edge hitting on any scenery.

For the cases I used clear 0.080" acrylic for the sides and ½" plywood or MDF for the tops, bottom and end doors.

The width of the case is the same as your docking base. For HO scale that's 2". The length can vary to suit your locomotives. Most of mine are 12" long but I have made some 15" for a diesel A/B set and shorter 8" and 6" ones for some short steamers.

You could make your life easier by making them all a standard size, but where would be the challenge in that? If you make the cases much longer, then you should make your docking base longer as well to provide more support.

Cutting acrylic sheet

Cutting the acrylic proved to be a bit of a problem.

The acrylic sheet instructions say to use the score and snap method. While this works, sometimes, I found that it didn't always snap off where it should. This meant wasting pieces of the acrylic sheet, and this stuff is expensive!

In the end, I found it can be cut on the table saw with a fine-toothed blade. You must cut slowly to prevent melting or burning the acrylic sheet.

Acrylic is prone to crack while working with it. I cracked some pieces when drilling holes, which is annoying since I had

worked out the size of the acrylic sheet to give me just enough for a half dozen cases.

I was able to use scraps to repair them, but those cases don't look as nice as the others. I don't know if thicker acrylic would be less prone to cracking. It was twice the price, so I haven't tried it.

The slot in the sides must be cut carefully, as it is a critical dimension. I used a Rockwell Blade Runner, which is basically an upside-down jig saw, to cut the slots. I then finished the slots with a Dremel tool with a reinforced fiberglass cut-off blade, and files.

Taper the opening of the slot so that the case slowly gets pulled into alignment as you slide it into place. I also rounded all the corners of the acrylic with the Dremel tool.

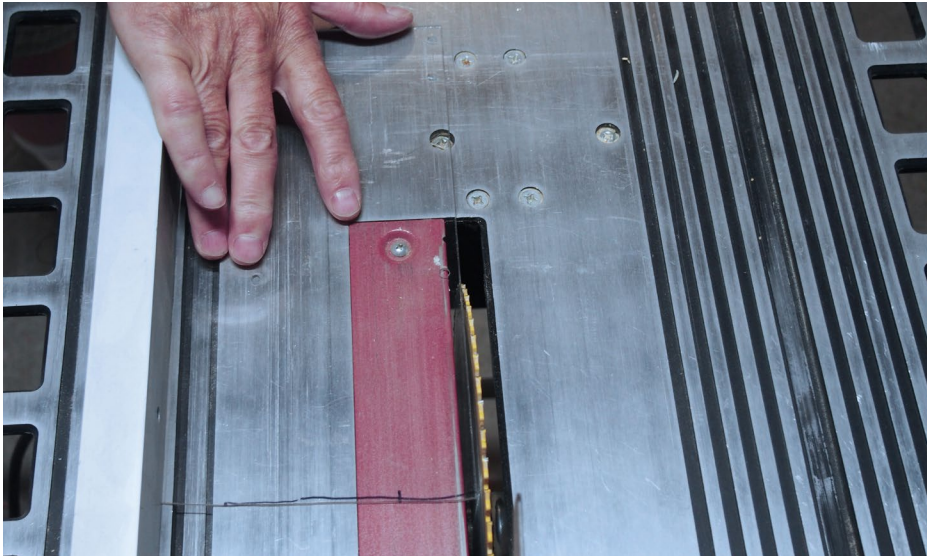

15. Blade guard removed for clarity. I would also normally leave the plastic covering on the acrylic sheet while working with it.

The case dimensions are shown in the drawing at the end of this article. I painted all the wood pieces black, but the next ones I build will use my railway's colors! I don't know why I didn't think of that the first time.

Cutting acrylic sheet

For the electrical contacts on the bottom of the case you could use strips of brass or copper tape. In my case, I did nothing fancy – I simply stripped the insulation off some wire and ran it along the bottom, attaching it with brass flat head screws. I put a few zigs and zags in it so that some part of it should contact the brass strips in the base.

Because I use cases of different lengths and they are all longer than my angled docking base, I didn't use a consistent position for these wires and screws. These could probably be made tidier by working out exactly where the contacts should be, but no one can see them and they need to work in both directions. I soldered these wires to the rails on a length of flex track inside the case. The main thing is, they work!

Final assembly

I wanted final assembly to be quick and easy, so I prepped everything ahead of time, drilled for the brass screws, and soldered the wires to the track.

I used either "No More Nails" adhesive or simple white glue to hold down the track. If I leave the top off the case, I can then quickly place the case on the docking base before the glue holding the track dries and then ensure that the track lines up with the approach track. I placed a full-sized railway spike on

MORE CONVENIENT LOCO STORAGE | 19

the track for weight to hold it in position, then pulled the case off the docking base and clamped the track into position.

I then flipped the case around and did the same thing with the other end, then clamped that end and left it to dry with the weight still on the track.

Once this dried, I could attach the end doors. These need to be slightly shorter than the opening so that they don't hit the rails. I improved the doors later by gluing on a piece of 1/8" hardboard slightly wider than the opening's width. This serves as a handle for opening the doors and makes it easy to close them up tight.

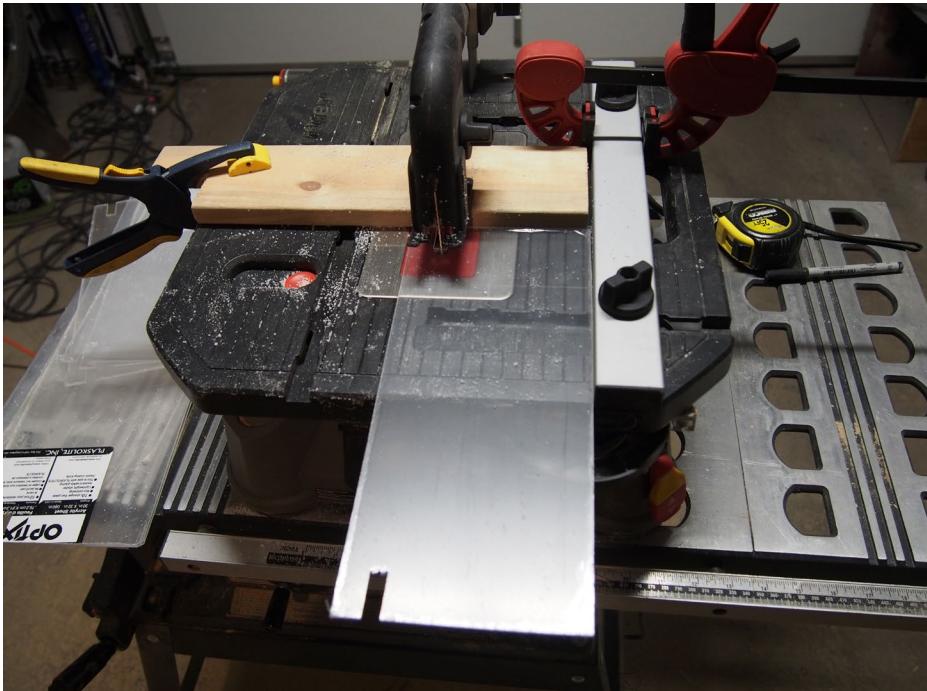

16. Cutting the slot in the sides.

MORE CONVENIENT LOCO STORAGE | 20

I also put together a video to demonstrate using one of the Twiddle cases (see following video).

I later put a second block of wood on the top of many of the cases, allowing them to be stacked together [11]. I store most of my Twiddle cases in an Ikea wine rack [12], but you could build a nice display shelf with a block of matching width wood to hold the Twiddles.

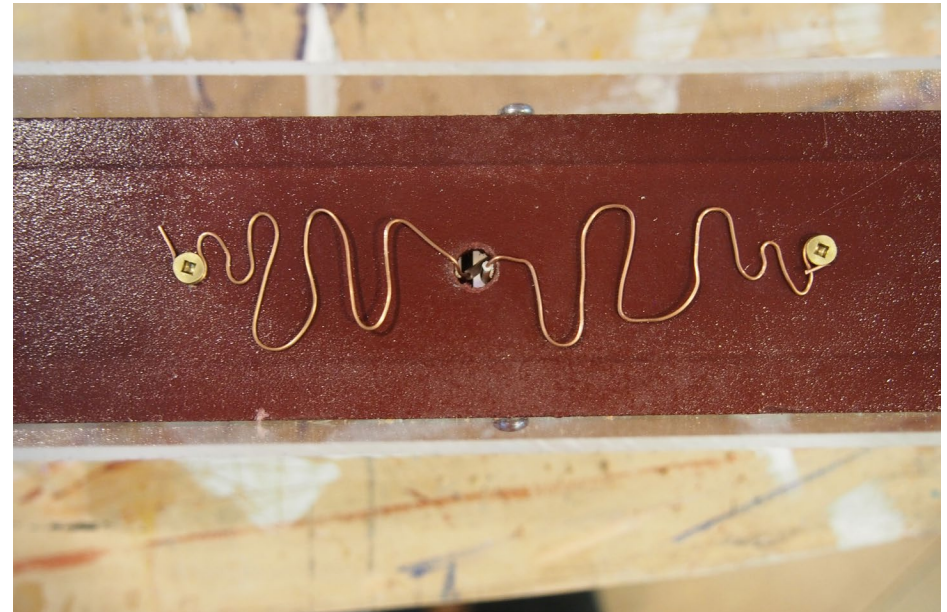

17. Showing the bare wires that make electrical contact. These are soldered to a piece of track, which needs to be put into place first. They are deliberately made wiggly to increase the chance of the wire making electrical contact with the base.

Epilogue: *I was congratulating myself on my brilliance for coming up with this idea. Then I found out that I am not the first person to think of this! The following website in Germany sells a very similar system, much fancier than mine, and long enough to take an entire train. It is also much more expensive than my version, but if you don't want to build your own, you could consider ordering this system: shop.train-safe.de/en/home.*



18. The end door construction. A piece of 1/8" hardboard, cut over-sized so it overlaps the sides. This provides a stop for the doors and a handle for opening them.



19. Aligning the track before the glue dries. I pulled the case off and clamped the track down once I had it lined up.



More convenient loco storage! June 2019 

20. Video: Demonstration of using a Twiddle loco case.

ADVERTISEMENT



Introducing THE LUMBER STORE

ROTATING STORAGE RACK
On its own, or fully loaded with Mt. Albert Scale Lumber!

handlaidtrack.com **1-888-252-3895**

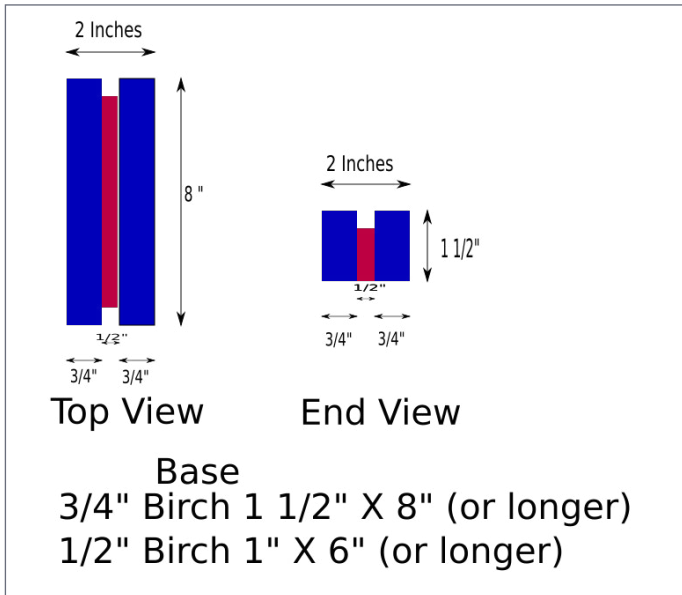

21. Suggested dimensions for the docking base.

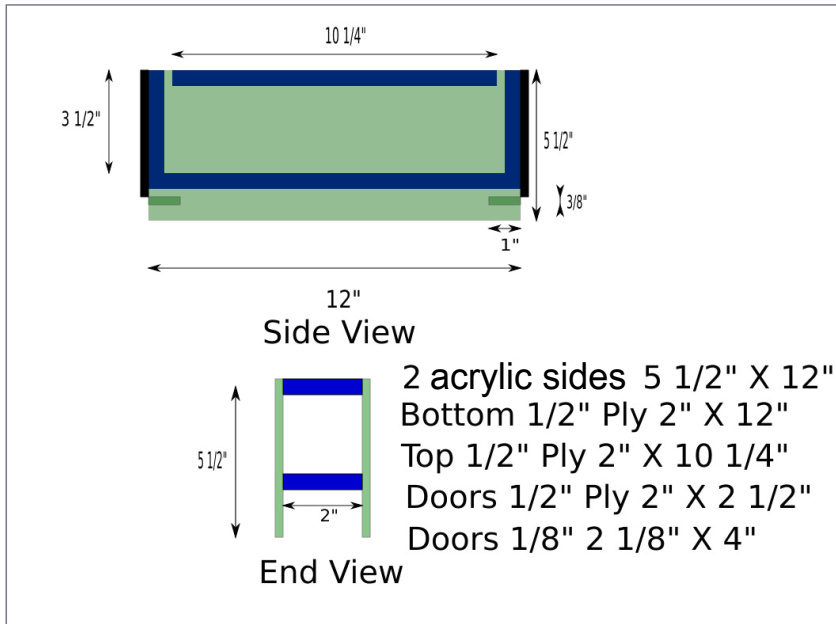

22. Suggested dimensions for the Twiddle case.

PARTS LIST FOR ONE TWIDDLE CASE

- 2 acrylic sides 12" X 5 1/2"
- Bottom 1/2" plywood 2" X 12"
- Top 1/2" plywood 2" X 10 1/4" (shorter than the bottom to allow for the swing of the doors)
- Doors 1/2" plywood 2" X 3 1/2" + 1/8" hardboard 2 1/8" X 4"
- Brass screws, round head #4 X 5/8"
- 12" piece of flex track
- Wire
- Brass screws, flat head #4 X 3/8" ■



BRENT CICCONE



Brent is retired from working as a production analyst with Shell Canada. He is currently the editor of the Calgary Model Railway Society's publication "The Order Board." Brent also belongs to the Bow Valley Model Railroad club.

Brent's other hobby interests including oil painting and he runs an art school in Calgary. He enjoys hiking and cross-country skiing in the mountains outside Calgary with his wife of 37 years. ■



**Don't miss out on our full line
of DCC Products at GREAT Prices!**

**Digitrax, NCE, SoundTraxx,
ESU LokSound, TCS, TVD, Speakers**

Click here to visit our website:

www.LitchfieldStation.com
sales@litchfieldstation.com | 623-298-7355



Model Railroad Hobbyist | Junel 2019 | #112

JEFF SHULTZ: MULTI IS THE WORD WITH DIGIKEIJS ...



1. The DR5000 comes out of the box ready for international usage.

DIGIKEIJS IS A DUTCH COMPANY THAT APPEARS to be working on the Holy Grail of DCC – the ability to use any manufacturer’s accessories, like throttles, with their DCC command station. They’re not quite all the way there – NCE is noticeably missing – but they have come closer than anyone else I’ve seen.



The DR5000 Digicentral command station measures 7.25" long, including the screw eyelets, and 3.5" wide. It weighs only 6 ounces, so it can be mounted nearly anywhere.

Protocols built into the DR5000 include:

- Roco multiMaus Wi-Fi throttle protocol
- Lenz XpressNet
- Digitrax LocoNet – both throttle and booster
- S88n
- Roco R-Bus
- Roco B-Bus
- Lenz RS-Bus
- USB
- 100BaseT
- 802.11 b/g/n Wi-Fi.
- InfraRed Control

Both Loconet and XpressNet can be used over the USB and Wi-Fi/LAN. The Roco multiMaus works over the integrated Wi-Fi, which can also function as a wireless router.

The USB port can communicate with a computer, and is also used for firmware updates and as a virtual serial COM port, with configurable baud rates.

Further, the USB port can be configured to “appear” as if it’s one of several types of Digitrax command stations for use with JMRI WiThrottle, Decoder Pro, or Panel Pro.

The DR5000 also includes an integrated 3-amp booster and programming track output. The included 100V-260V power supply

can be configured for output voltages from 15V to 24V. The power supply also includes a 5V 1A USB port, so you can power another small device with it as well.

Digikeijs US importer, Iron Planet Hobbies [www.ironplanethobbies.com] has several instructional videos on their YouTube channel: www.youtube.com/channel/UCN7ByGL5Aw8fCOPy9D75S6A.

I also recommend checking out the DR5000 manual at: support.digikeijs.com/display/DS/DR5000-ADJ.

Just find the newest version in your preferred language and download it. You can also download the latest firmware from there.

One note of reassurance: Even though the screenshots in the manual are frequently of the Dutch or German version, the DR5000 program’s screens are all in English when that language is selected.



2. All the ports on the DR5000 are clearly marked on the top.

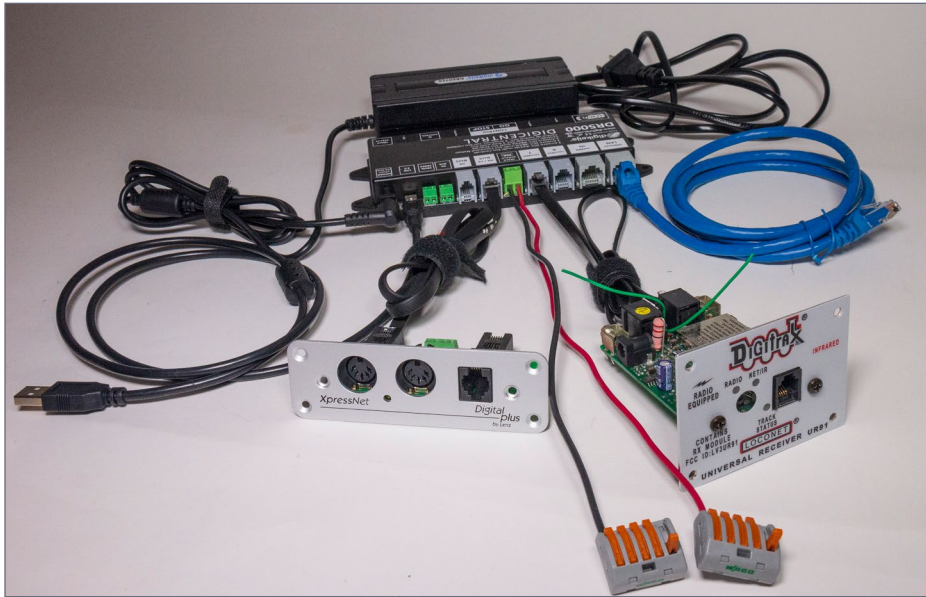

3. With multiple manufacturers' hardware connected to the DR5000, as well as the power and networking connections, the space in back needs to be well organized.

While the DR5000 can be used without a computer once configured, it's helpful to have the command station echoed to a handy laptop over a LAN connection.

The DR5000 configuration program mirrors the appearance of the command station and allows configuring the individual ports by clicking on them. You can also turn the track power on and off independently of the command station power. The individual ports have plenty of configuration options, but most of them work fine with the factory-default configuration.

Getting the Digikeijs running isn't very difficult – connect the track wires, connect the USB to a computer, and plug in the

power and fire up the Digikeijs software. There was a firmware update for my system, so I applied it first.

Since I didn't have one of the Z21 wireless throttles – and didn't discover the Z21 Android app for a while – I started by having the DR5000 identify itself as a Digitrax command station over USB and running JMRI WiThrottle on the connected computer.

Within minutes I had Engine Driver on my phone and my ProtoThrottle running locomotives. I later added a Digitrax LNWI to the Loconet port on the command station and used it instead of JMRI. I also added a Lenz LA152 XpressNet panel to the XpressNet port and connected a ProtoThrottle Lenz/NCE receiver to it, using my ProtoThrottle through it. I was also able to use a tethered Digitrax throttle with it.

ADVERTISEMENT

END OF TRAIN DEVICE

NEW SAFETY GREEN

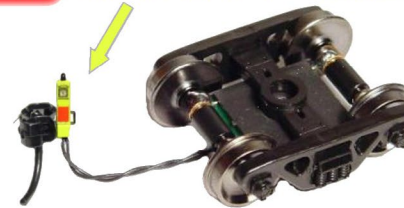

Bright Red Flashing Light!

**Installs in minutes!
No freight car modification required!**

Patented Technology - US Patent 7,549,609

Does not affect Load!

↓ Car without Load ↓

↓ Car with Load ↓



Click Here to Learn More

RE RING ENGINEERING

FIRST LOOK | 6

In an attempt to both stress-test the system, as well as demonstrate its flexibility, I recorded myself running five separate locomotives or consists simultaneously with four different DCC throttle inputs (Z21, Lenz, Digitrax LNWI, Digitrax tethered), and a separate RailPro-equipped locomotive that was just using the command station for power. The video can be seen at www.youtube.be/3tYQ2dKRL5c.

In a club or operating crew, there may be members who have their own favorite throttles they use on their own layouts – here is a system that can accommodate many of these different throttles.

With the addition of a Digitrax LNWI or a computer running the JMRI WiThrottle, the DR5000 supports two of the most popular Wi-Fi throttle standards in use.

If starting fresh, or faced with a failing current DCC system, the DR5000 should be given serious consideration as a layout DCC system.

MRH product awareness survey

Take survey now

Chance to win \$125 worth of these cool products!

click here (takes ~5 min)



Seems like almost everyone wants a chance!

MRHMAG.COM

 REGISTER
(free)

Please mention MRH when speaking with advertisers.

ADVERTISEMENT

TamValleyDepot.com



Home of the Frog Juicer

Our best-selling Micro Switch Machine

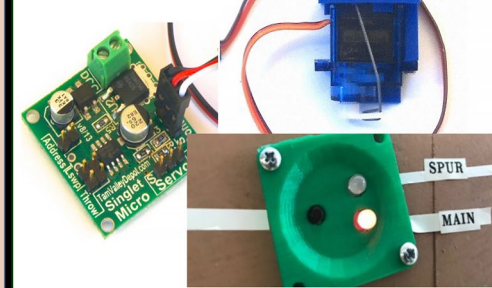

3D Printed Switch Machines and Fascia Controllers now available

ADVERTISEMENT

Make your Trains More Fun to Run!

Tsunami² provides interactive features that give you more control over your trains! Now available for O Scale and larger locomotives, the TSU-4400 provides awesome sound indoors or out!

- 4-amp motor drive
- Superior motor control
- Tons of realistic sounds
- Better features



SOUNDTRAXX™
www.soundtraxx.com



[INDEX](#)

[TABLE OF CONTENTS](#)

EAST TRACKS

Build your own trackwork easily, quickly, and affordably.



TRACK BUILDING SYSTEM

★★★★★ Precision milled pockets accommodate PC Board ties that are soldered to the rails.

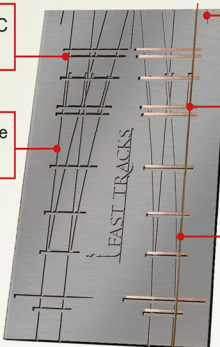

★★★★★ Guard rail forming grooves are provided to precisely shape the guard rails.

★★★★★ Track slots ensure perfect alignment while soldering the rails to the PC Board ties.

★★★★★ PC Board ties are soldered to the rails using a standard 35 watt soldering iron.

Each turnout fixture can be used to construct both right and left turnouts that are DC and DCC compatible.

★★★★★ Rails are inserted into the fixture right side up, making it easy to confirm alignment.

★ Fixtures are machined out of a solid piece of high grade 6061 aluminium stock and will last for thousands of uses.

Turnouts are built using pre-cut PC Board ties dropped into pockets cut into the fixture.

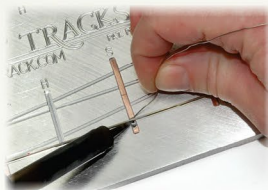

The Fast Tracks PointForm tool makes it fast and easy to file perfect frog and switch points for the turnout.



Held in precise alignment, rail is then soldered in place onto the ties.

Just insert the rail into the tool and file.

Finishing the turnout is simple with QuickSticks laser cut wood ties.



Simply glue the soldered trackwork to the wood ties, break off the frets, and your turnout is ready to be installed onto your layout!

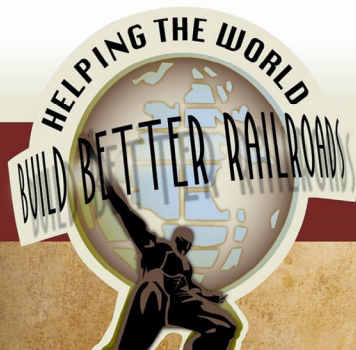

All Fast Tracks track fixtures and tools are NMRA compliant



• Easy ordering •

Earn Waypoints with every purchase

shop online 24/7 handlaidtrack.com

1-888-252-3895 service@fast-tracks.net

SAVVY MODELER Online



Model Railroad Hobbyist | June 2019

★★★★★ RATE THIS ARTICLE



CHECK IT OUT!

Steam loco painting setup

For *Savvy Modeler Online* this time, take a look at this clever steam locomotive paint stand by YouTube modeler *railfanreading*. Once you see how it works in the video, the light bulbs will come on for sure! However for this to work, the tender and/or the leading/trailing wheels need to pick up power from both rails. ■



▶ GREAT MODELER VIDEOS ON THE WORLD WIDE WEB

You're the kid.



Welcome to the candy store.

July 12-14, 2019

**Mountain America
Exposition Center**
Salt Lake City, Utah

For more information,
click here to visit:

NationalTrainShow.org



**CLICK HERE
FOR ALL THE
DETAILS!**

www.nationaltrainshow.org

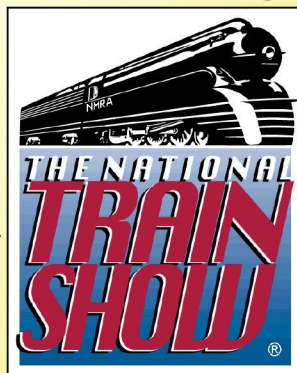

JUNE NEWS

column



Model Railroad Hobbyist | June 2019 | #112

RICHARD BALE and
JEFF SHULTZ report the
latest hobby industry news

★★★★★
RATE THIS ARTICLE

INDUSTRY NEWS

Tennessee-based **ScaleTrains.com** is interviewing candidates for the position of national marketing manager. The individual will be responsible for advertising programs, website content, trade shows, social media, and national marketing campaigns utilizing e-mail newsletters, printed materials, press releases, and so on. Qualified individuals are invited to e-mail a resume with a cover letter to Careers@ScaleTrains.com ...

Soundtraxx has several job openings, including a systems engineer responsible for the design, development, testing and documentation of new software, firmware, and hardware systems for SoundTraxx products. A position is also open for a product specialist responsible for supporting the sales process by educating both the retailer and the consumer about all SoundTraxx products. Soundtraxx is also accepting

► THE LATEST MODEL RAILROAD PRODUCTS, NEWS & EVENTS

applications for an experienced assembly position. For additional information go to www.soundtraxx.com/jobs.php.

NEW PRODUCTS FOR ALL SCALES

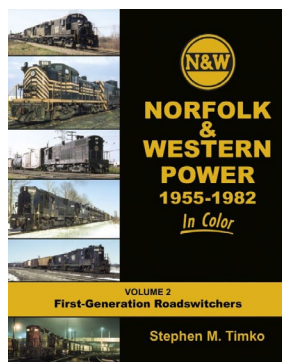
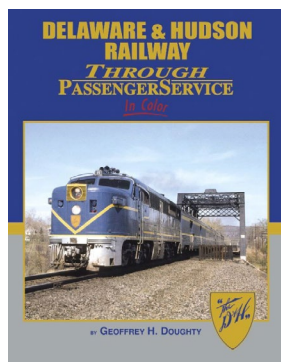

New hardcover books coming from **Morning Sun** this month include *Delaware & Hudson Railway Through Passenger Service*, by Geoffrey H. Doughty; and *Norfolk & Western Power 1955-*

1982 Volume 2, by Stephen M. Timko. For additional information contact a dealer or visit morningsunbooks.com.

O SCALE PRODUCT NEWS

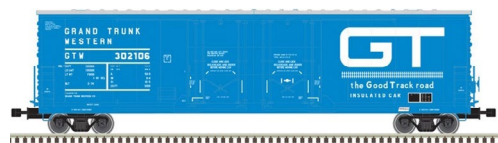

Atlas O plans to release two new Master Series freight cars during the 4th quarter of this year. The O

scale ready-to-run models include a 53-foot Evans steel box-car with double plug doors. Road names will be Grand Trunk Western, Chicago North Western, BC Rail, Weyerhaeuser, and Union Pacific.

Decorating schemes on Atlas O's 40-foot wood refrigerator car coming late this year include Producers Produce, ART Ice Service, Milwaukee Road (ice service), Missouri-Kansas-Texas,

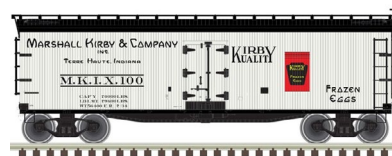

Rath's Black Hawk Bacon, and Marshall Kirby Frozen Eggs. Features on the reefer car include opening doors and working roof hatches. The ladders, grab irons, coupler lift bars, diecast metal stirrups, door hinges and hardware are all separately applied to the model. The trucks will be 40-ton Bettendorf-style with diecast frames and metal wheels.



A new operating oil pump available from Atlas O can be viewed at <https://www.youtube.com/watch?v=O1cwhFQvIH0>. For additional information contact a dealer or visit atlaso.com.



Berkshire Valley Models is selling a kit for an O scale photography wagon. The kit is comprised of laser-cut wood parts and cast white metal details. Decals, a box camera, and a tripod are included. The horse and driver are sold separately. For information visit [berk-](http://berkshirevalleymodels.com)

[shirevalleymodels.com](http://berkshirevalleymodels.com).



Lambert Locomotive Works is selling O scale arc-style headlights. The 3D printed lights are available with (left) and without

number boards. Each headlight comes with a clear lens and a 3mm white LED. The headlights are flat on the bottom which simplifies gluing them in place. For additional information visit lambertlocomotiveworks.com.

HO SCALE PRODUCT NEWS



New HO scale kits available now from **Accurail** include this 36-foot Denver & Rio Grande double-sheathed wood boxcar. The model is based on a prototype built in June 1909 by American Car & Foundry.



ACF also built the prototype of this Burlington Northern triple-bay covered hopper car. Accurail's HO scale kit includes roller-bearing trucks.

ACF also built the prototype of this Burlington Northern triple-bay covered hopper car. Accurail's HO scale kit includes roller-bearing trucks.



Accurail's kit for this HO scale 40-foot Northern Refrigerator Car assigned to the Banana Distributing Co. of New Orleans, is based on a wood prototype Pullman-Standard built at its Detroit, Michigan shops in the summer of 1929.

Accurail's kit for this HO scale 40-foot Northern Refrigerator Car assigned to the Banana Distributing Co. of New Orleans, is based

Additional HO kits just released by Accurail include an SCL triple-bay covered hopper, a 50-foot Monon insulated steel boxcar with plug doors, and a special three-car set of 36-foot Fowler boxcars decorated for Canadian National. All Accurail HO scale kits come

with Accurate knuckle couplers and appropriate trucks. For additional information contact a dealer or visit accurail.com.

IKEA LAYOUT BENCHWORK
Marty McGuirk relates how his pursuit of better benchwork lead to IKEA.
Buy Issue: \$1.99 >>

A MODULE CREATES A LAYOUT
Jason Miller shows step-by-step how starting with a single module ultimately lead to an entire layout.
Buy Issue: \$1.99 >>



R. Bale

EMD SDP40F AND SDP40-2 DIESEL LOCOMOTIVES

Shortly after taking over the operation of America's passenger trains in 1971, Amtrak worked with GM's ElectroMotive Division to develop a new passenger locomotive. The result was the SDP40F. The 150 SDP40Fs EMD built in 1973-1974 became the backbone of Amtrak's long-distance passenger fleet heading trains from San Diego to Washington DC and from Seattle to Miami. In 1984, Santa Fe acquired 18 SDP40Fs and rebuilt them for freight service. Their new designation was SDF40-2. Although most of the changes were internal, spotting features for the Dash 2 freight locomotives include notching the front nose to improve boarding access and the addition of a front platform and steps. The original short rear platform was retained.



Athearn plans to introduce a Genesis2 EMD

SDP40F diesel locomotive in April of 2010. The HO scale model will be available in Amtrak's Phase I paint scheme from 1972 (above) and the Phase III scheme introduced in 1975 (below).



Identifying details of Amtrak's SDP40F passenger locomotive include a flat nose, no front platform or steps, a steam line access door, and a snowplow pilot.

Spotting features of the rebuilt Santa Fe SDF40-2 units include a front platform with handrails, front steps, a modified nose, and an air conditioner on the cab roof.



The air conditioner has been removed on the patched BNSF Primed for Grime unit but all other features are the same as the ATSF SDF40-2 rebuilds.



The Maersk Sealand paint scheme on SDF40-2 No. 6976 commemorates the opening of the world's largest container terminal in Los Angeles in 2002. The locomotive was loaned to Maersk for promotional events but retained BNSF reporting marks and road number. Visible details are the same as the ATSF units. Athearn's SDF40F and SDF40-2 locomotives will be available for DC operation and for DCC operation with factory installed decoder and SoundTraxx Tsunami2 with twin 28mm speakers.



Athearn's April 2020 production schedule includes a Trinity triple-bay covered hopper. Features of the Genesis series model include etched roof walk and end platforms, separately applied end cages, wire brake plumbing, air hoses, uncoupling bars, and 100-ton trucks with 36-inch machined metal wheelsets with rotating bearing caps. In addition to the BNSF Frisco Heritage scheme shown above, road names will be GACX Potash, GACX Lease, Norfolk Southern, Union Pacific/CMO, and FXE Ferromex.

Ready-to-Roll models in Athearn's April 2020 release include this 40-foot modernized boxcar. The models will be available in two 3-packs for a total of six unique road numbers.



The model will be available decorated for Illinois Central, British Columbia Railway, CP Rail,

Esquimalt & Nanaimo, Union Pacific, Pickens Railroad, Northern Pacific, and Louisville, New Albany & Corydon.



Additional freight cars in Athearn's April 2020 release include a 52-foot mill

gondola. Road names on the Ready-to-Roll HO scale model will be RailGon, BNSF, Oregon Steel Mills, Transportación Ferroviaria Mexicana, Gondola Connection, RJ Corman, and Herzog.



Athearn plans to release a Kenworth semi-truck with a sleeper in six decorating schemes. Railroad

related names on the HO scale vehicle will be Burlington Northern, Canadian National, and Union Pacific.

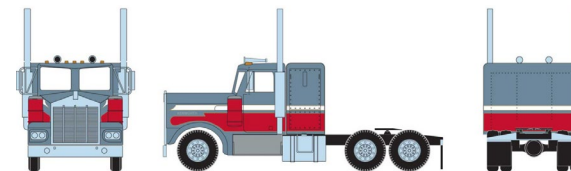

Color combinations without lettering include orange and black, green and gold, and blue and red.

Features include rubber tires, clear window glazing, and molded cab interior with separately applied steering wheel.

Roundhouse brand models coming from Athearn next April include an Alco RS-3 diesel road switcher. Features on the HO scale model include metal grab irons, fine scale handrails, see-through etched metal radiator fan, LED lighting, and DCC-ready Quick Plug technology with a 21-pin NEM plug.



Road names will be Spokane, Portland & Seattle; Chicago & North Western,

Central Railroad of New Jersey, Delaware & Hudson, Milwaukee Road, Rock Island, Providence & Worcester, and Cotton Belt in the road's orange and black Halloween scheme.

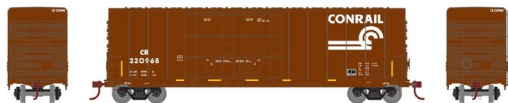

Completing Athearn's April 2020 product release is a Roundhouse 59-foot high-

cube boxcar with double plug doors. Road names include Santa Fe, Union Pacific, Conrail, Norfolk & Western, Penn Central, Southern Pacific-Santa Fe, and three different Western Pacific schemes. For additional information on Athearn and Roundhouse brand products contact a dealer or visit athearn.com.

INTERNET FOR MODELERS
The MRH Staff provides quick-study insights on how to turbocharge your time online.

Buy Issue: \$1.99 >>

In **MRH** **RUNNING** **EXTRA**



R. Bale

GE U23B LOCOMOTIVE

During its 10-year production from 1968 through 1977, General Electric's U23B diesel locomotive competed directly against EMD's GP38 and GP38-2. A total of 481 units of the intermediate-sized four-axle road switcher were built, making the U23B, at that time, the second best-selling GE locomotive. Primary spotting features of the U23B are the stepped-out radiator end section and two sets of three tall access doors near the center of the long hood. GE sold the U23B with various truck side frames including AAR-style trucks, GE's own four-axle FB2 trucks, and Blomberg trucks refurbished from EMD trade-in locomotives.



Atlas will release its Master series GE U23B during the 4th quarter of this year. Details on the

HO scale model include separate windshield wipers, metal grab irons, uncoupling levers, multiple-unit hoses, trainline hoses, fine scale handrails, drop steps, cab interior with crew, and directional lighting with golden-white LEDs. The model will be fitted with a snow plow pilot when correct for the prototype road being modeled.



Road names will be Southern Railway, Conrail, Missouri Pacific, Lehigh Valley, Delaware

& Hudson, C&O Chessie System, and Santa Fe. Atlas Silver series DC models will be DCC-ready with a 21-pin socket for an aftermarket decoder. Gold series models will have a factory-installed DCC decoder.



Atlas' 4th quarter production includes a Master series HO scale Railway Express Agency express refrigerator car. Road names will be REA (as delivered, above), REA (early 1950s, middle photo), and REA (early 1960s bottom photo). Additional road names include US Department of Transportation, Seaboard Coast Line, and Santa Fe REX.

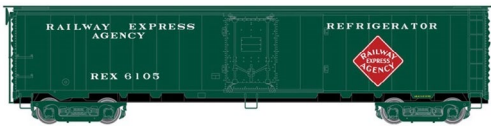

Designed for front-end service, express reefers were equipped with high-speed trucks, and steam, air, and trainline hoses for consisting with passenger equipment. Collapsible ice bunkers allowed the cars to carry refrigerated lading as well as LCL parcel loads.

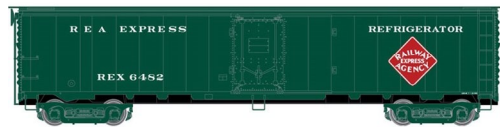

The prototype REA cars were built by ACF with welded steel sides, 3/3 Improved Dreadnaught

ends, and a distinctive arched roof.

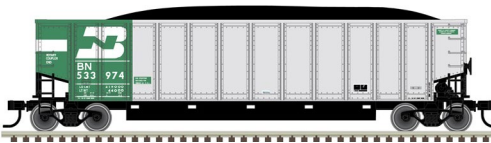

Also coming from Atlas in the final quarter of 2019 is a run of aluminum coal gondolas. The painted end

indicates the presence of a rotary coupler for rotary unloading. In addition to the Burlington Northern car shown, road names on this release of Atlas's Trainman series model will be Canadian National, Reading Northern, Norfolk Southern, EGSX, and CSX.

Completing Atlas' new HO scale product releases for the 4th quarter is a Master series 45-foot container with corrugated



sides. Carrier names will be P&O Nedlloyd, Safmarine, ONE-Ocean Network Express, NYK

Line, Triton, Sea Castle, Maersk, and Matson. Two 3-packs will be available for each carrier name for a total of six unique numbers. For additional information on Atlas products contact a dealer or visit atlasrr.com.



Photo courtesy Siemens Mobility, Inc.

Bachmann is developing an HO scale Charger SC-44 passenger locomotive. Delivery is planned for 2020. The HO scale ready-to-run model is based on the state-of-the-art prototype currently being manufactured by

Siemens Mobility. Bachmann also plans to offer a single-level mainline passenger car to compliment the SC-44.



Bachmann has also announced plans to produce an HO scale model of Siemens Mobility's S70 low-floor light rail vehicle. The ultra-modern S70 street car is currently in use in Houston TX, San Diego CA, Charlotte NC, Portland OR, Salt Lake City UT, Atlanta GA, Seattle

WA, and Orange County, CA. Siemens builds the full-size S70s in Florin, CA, a suburb of Sacramento. For additional information contact a dealer or visit bachmanntrains.com.



Bowser Trains is taking reservations for three styles of HO scale ready-to-run PRR way cars. Bowser's HO scale version of the Class N5 steel caboose, originally

introduced in 1914, will be available in the Pennsylvania schemes of early lettering with black roof (above), PRR early lettering with train phone antenna, PRR early lettering with brown roof, plain Keystone, Keystone with orange body, Keystone with yellow cupola, Shadow Keystone Lake Region, Shadow Keystone Railway Express Agency, and Shadow Keystone Western Region with antenna.



with windows blocked.



The N-5C cabooses will be available decorated for Conrail, Conrail brown body designated for Pennsylvania Power & Light coal service, Penn Central brown body designated for PP&L coal service, and Penn Central.



PRR Shadow Keystone with yellow cupola and antenna, PRR Shadow Keystone Buckeye Region, and PRR Shadow Keystone Northern Region.

Non-PRR schemes on Bowser's class N5 cabooses include B&M Minute Man, Conrail, Conrail MOW, Penn Central, Pennsylvania-Reading Seashore Lines, and Reading & Northern

Bowser is also taking reservations for a circa-1942 class N5C steel caboose. Features on the HO scale ready-to-run model include separate grab irons, knuckle couplers, and appropriate trucks with metal

Pennsylvania Railroad decorating schemes on the N5C cabooses include: PRR early lettering NY Zone, PRR early lettering Pittsburgh Region, PRR early Western Region with antenna, PRR Keystone orange



wheels, and knuckle couplers. Road names will be ICG, Conrail (blue), and Penn Central.



antenna (above), Circle Keystone Eastern Region with antenna, plain Keystone with orange body and antenna, plain Keystone with yellow cupola and antenna, Shadow Keystone Lake Region with antenna, Shadow Keystone Pittsburgh Region with antenna, Shadow Keystone Pittsburgh Region with yellow cupola and antenna, and Shadow Keystone.



Shawmut scheme shown, road names will be Chessie WM, Conrail, Delaware & Hudson, Detroit & Mackinac, Durham & Southern, Great Northern, Montour, Penn Central, Santa Fe, and C&EI. The ready-to-run hopper cars will come with knuckle couplers and 70-ton AAR trucks.



contact a dealer or visit bowser-trains.com.

The third PRR caboose coming from Bowser is a class N8 steel car. Features of the HO scale ready-to-run model include window glass, separate curved grab railing, metal

Pennsylvania Railroad schemes on the 1950-built class N8 caboose include Circle Keystone Eastern Region with antenna, Circle Keystone Chesapeake Region with

Reservations are also being accepted by Bowser for a 70-ton 14-panel triple-bay coal hopper car. In addition to Pittsburgh &

All of the Bowser models mentioned in this report are scheduled to be released in April 2020. For additional information



Broadway Limited Imports has released to dealers four versions of Pennsylvania Railroad's famous K4 4-6-2 steam locomotives. The HO scale model is available as it appeared before World War II (above) and in its postwar configuration (below). Spotting features between the two periods include the location of the headlight, generator location, and the type and location of the marker lights.



The pilots also differ from the earlier version of the K4 having a fabricated strap type while the postwar locomotives has a cast steel pilot.



The prewar and postwar versions are also available with a long distance tender (left). Broadway Limited's PRR K4 steam locomotive comes

with the Paragon3 Sound & Operation System which includes Rolling Thunder sound and operation in both DC and DCC environments. For additional information contact a dealer or visit broadway-limited.com.



Classic Metal Works has three new 1:87 scale trucks including a 1941-46 Chevrolet bottle truck decorated for

Coca-Cola, O-So Grape and Whistle.



Also new is a 1955 Chevy box truck decorated for Planters Peanuts, Fresh Fish, and Turtle Wax.



Completing this release of 1:87 Mini Metals is a 1960 Ford pickup with a camper. Color schemes include white over yellow, white over turquoise, and white over blue. For additional information contact a dealer or visit walthers.com.



Division Point has announced plans to produce five versions of Southern Pacific's 4-8-8-2 AC class Cab Forward steam locomotives. Fifteen

each of classes AC-7, AC-8, AC-10, AC-11, and AC-12 will be produced for a total of just 75 models. Three engine numbers will be available for each class, and all will be in the postwar paint scheme with the silver panel on the cab front. All the cab-forwards will come with SP's large 220-R-2 rectangular tender. The HO scale brass models will be crafted in Korea by Boo-Rim. Pricing has not been finalized but is expected to be in the low \$4,000 range. For additional information contact a dealer or visit divisionpoint.com.



InterMountain Railway has released HO scale 4650 cu. ft. triple-bay covered hopper cars. Road names

include Sclair Polyethylene, Burlington Northern, Southern Pacific, Sterling Salt, SSW-Cotton Belt, Norfolk Southern, Soo Line, French's, ATSF, and Wisconsin Central (CN). For additional information contact a dealer or visit intermountain-railway.com.



New HO scale models from **Kadee** include this 40-foot Chesapeake & Ohio PS-1 boxcar. The ready-to-run model has PS ends and 8-foot Youngstown sliding doors. Kadee's

HO version is based on a prototype built in 1951 that was completely rebuilt in May of 1965.



Also new from Kadee is a 50-foot PS-1 boxcar decorated for Denver & Rio Grande Western. The prototype was built in 1957 with dual Youngstown sliding doors closing

a 15-foot opening. All Kadee ready-to-run models come with Kadee knuckle couplers and two-piece self-centering trucks. For more information contact a dealer or visit kadee.com.

Monashee Laser Engineering has released an HO scale kit of a Canadian Pacific Railway #3 Section House with rear annex (108-HO). The kit includes laser-cut floors, walls, windows, and doors as well as accurate drop siding, trim, shingles and chimneys.



An optional interior detail kit will be available that includes interior walls, stairs, railings, doors, furniture and other details. The building's footprint, minus the eaves, is 3 x 4 inches. For more information visit www.monasheelaserengineering.ca.



New 1:87 vehicles announced by **Oxford Diecast** include a 1961 Chevrolet Impala convertible with a flaming Hot Rod paint job. A 1957 Chevy Nomad station wagon is also decorated with Hot Rod flames.



Oxford has released a pink Volkswagen Beetle and a 1965 Chevrolet Stepside Pickup truck. For additional information contact a dealer or visit walthers.com.

Rapido Trains has added several new paint schemes to the second production run of its HO scale Alco/MLW FA-2 and FPA-2 diesel locomotives. The run includes both A and B units. The



deadline for orders is June 24, with delivery scheduled for late this year. In addition to new paint, this production run offers extra horns, a variety of grab iron arrangements, road-specific

nose ladders, spark arrestors, sunshades, and other parts designed to accurately represent the units at specific periods in their two decades of service. In addition to the PRR unit equipped with a Train Phone antenna shown, road names in this release include CP Rail's Multimark scheme, below.



FA-2 units decorated for Missouri Pacific and the Wabash Railroad are included in this run. Completing the list of available road names are Ann Arbor, Chicago &



North Western, Erie Lackawanna, Long Island Railroad, Louisville & Nashville, New York Central (cigar band), Penn Central (ex-NYC cigar band), Penn Central (black with red "P"), Burlington Northern, Western Maryland (speed lettering), and Spokane, Portland & Seattle.



Special features on Rapido's FA-2 and FPA-2 models include correct nose and roof

profiles achieved through 3D scanning of the prototype, operating number boards, and working headlights and classification lights. Features shared on both the A and B units include separate grab irons, and full underbody piping and conduit. Road specific details

appropriate to the prototype being modeled include dynamic brake housing, correct size fuel tanks, Farr or chicken wire etched-metal grilles, and oscillating Gyalite or red Mars emergency light.

The HO scale models will be available in a choice of DC/Silent (with a DCC-ready 21-pin connector for installation of an after-market decoder) or ESU LokSound DC/DCC/Sound with sounds recorded from a real Alco 244 prime mover. For additional details including reservation information contact a dealer or visit rapido-trains.com.



Roomettes has released three new laser-cut kits of building interiors. Art's Hobby Shop (above left) includes a store counter, model railroad display and product shelves for three rooms. This kit is designed to fit the interior of Woodland Scenics' Skip's Chicken & Ribs, or Margaret's Market. A kit for Borgo Auto Loans (above right) includes laser-cut material for three rooms. The kit will fit Woodland Scenics' Pam's Pet Shop, or Dad's Museum.

Roomettes' kit for Gem Warehouse provides laser-cut interiors for five industrial rooms. The kit will fit Walthers REA Transfer Building or Walthers Commissary Freight Transfer. Roomettes kits include a warm white LED for each room. The LED has a plug that



is compatible with the Woodland Scenics Just-Plug and NCE Corporation plugs. For additional information visit room-etteslighting.com.

.....

ScaleTrains.com has released its Rivet Counter series of GATC 4180 cu. ft. Airslide covered hoppers. Features include stainless steel photo-etched Apex or Morton roof walks depending on the practice of the prototype being modeled. The end bracing and other details vary per the prototype road name.



Road names include a BNSF patched car in buffer service, and Western Pacific. Both cars have Morton (round hole) roof walks.



Additional road names include CSXT Phase HC cars in beige repaint and a GACX car decorated in the Service Driven blue dot scheme, below. Both cars have Apex (slotted) etched metal roof walks.



The Katy car in Barringer red and the Norfolk & Western version are based on prototypes that had Apex roof walks. This production run will include undecorated models.



Additional features on ScaleTrains.com's Rivet Counter 4180 cu. ft. Airslide include metal grab irons and uncoupling levers, complete trainline piping, full brake details, and photo-etched end crossover platforms. The HO scale ready-to-run models ride on Barber S-2 100-ton trucks with rotating bearing caps, truck-mounted brake beams, and 36-inch machined metal wheelsets. For additional information visit scaletrains.com.

.....



Tangent Scale Models has introduced a new HO scale GATC 8,000 gallon welded general-service tank car. The ready-to-run model is based on a prototype built in 1952. Tangent's initial release is for three decorating schemes including a GATX Dow Chemical car from the 1964-era.



Additional decorating schemes include GATX Diamond Chemicals and UCLX Vulcan Materials Company.



Tangent's new model features see-through dome platform and running boards, separate air hoses, wire grab irons and coupler lift bars, Kadee couplers, and ASF

spring-plank trucks with 33-inch machined wheel sets. For additional information visit tangentscalemodels.com.



R. Bale

GATC 1952 WELDED TANK CARS

The safety platforms installed around the dome of these GATC cars and the smooth appearance of their welded construction makes them look more modern than their 1952 build date would suggest. Many of these common non-insulated tank cars remained in service into the 1990s handling a range of products including corn syrup, caustic soda (sodium hydroxide), fatty acid, molasses, sodium chlorate, vinegar, carbon disulfide, fuel oil, and other petroleum products.

Walthers' next name-train project will be based on the Milwaukee Road's famous Twin Cities Hiawatha. The models will be available in orange and maroon as well as in the later yellow and gray paint scheme. Details on the eight different HO scale cars include tinted windows, and factory installed grab irons. In addition to factory printed names and/or numbers, Walthers will also offer the cars with decals that include a full set of names and numbers. A minimum 24-inch radius is recommended. For modelers operating on tighter curves, optional extended drawbars will be included with each car.



Availability is scheduled to begin in February 2020, with the release of this 85-foot 52-seat coach.



A 63-foot Railway Post Office car (top) and an 85-foot 26-seat tap lounge car (left) are set for release next May.



A June 2020 date has been set for the release of a 75-foot express car (left). Milwaukee Road's 85-foot skirted Super Dome, built by Pullman-Standard (lower left), will be released in July 2020.



August 2020 will see the arrival of this 85-foot 48-seat diner (upper left), followed in September by an 85-foot 30-seat parlor car (lower left).



The eight-car train set will be completed in October 2020 with the release of Milwaukee Road's distinctive 85-foot Skytop lounge-observation car.



The orange and maroon cars with black roofs are typical of 1952-1956 equipment in service until repaints began in 1955. Notable details include black trucks, folded steps, straight side sills, and original ends without lift rings. The yellow and gray cars match Union Pacific equipment after the Milwaukee Road assumed operation of Chicago-Omaha trains in late 1955. The scheme became the standard on Milwaukee equipment into the

1970s. The yellow and gray cars will have silver trucks with disc brakes, notched side sills (except the Super Dome, which was not modified) fixed car steps, end lift rings, and updated diaphragms (the Super Dome retained its originals).

A special limited-run deluxe edition of the train sets will be available with 160 Preiser passenger and crew figures, LED interior lighting installed, and appropriate names and numbers applied to each car. The deluxe edition will be limited to 300 sets with each car arriving the same month as the standard models.



To lead the Twin Cities Hiawatha Walthers will release EMD FP7A and F7B units appropriately decorated in both the orange and maroon (1950-1953) and the post-1955 yellow and gray livery. The diesel models will be available for DC operation and with ESU LokSound 5 Sound and DCC.

Model	Length	Width	Height	Weight	Wheelbase	Truck Spacing	Truck Type	Truck Spacing	Truck Type
1:200	100	10	10	10	10	10	10	10	10
1:160	125	12.5	12.5	12.5	12.5	12.5	12.5	12.5	12.5
1:125	150	15	15	15	15	15	15	15	15
1:87	200	20	20	20	20	20	20	20	20
1:71	250	25	25	25	25	25	25	25	25
1:63	300	30	30	30	30	30	30	30	30
1:50	375	37.5	37.5	37.5	37.5	37.5	37.5	37.5	37.5
1:43	450	45	45	45	45	45	45	45	45
1:35	525	52.5	52.5	52.5	52.5	52.5	52.5	52.5	52.5
1:28	600	60	60	60	60	60	60	60	60
1:22	750	75	75	75	75	75	75	75	75
1:18	900	90	90	90	90	90	90	90	90
1:15	1050	105	105	105	105	105	105	105	105
1:12	1200	120	120	120	120	120	120	120	120
1:10	1500	150	150	150	150	150	150	150	150
1:8	1800	180	180	180	180	180	180	180	180
1:7	2100	210	210	210	210	210	210	210	210
1:6	2400	240	240	240	240	240	240	240	240
1:5	3000	300	300	300	300	300	300	300	300
1:4	3600	360	360	360	360	360	360	360	360
1:3	4200	420	420	420	420	420	420	420	420
1:2	4800	480	480	480	480	480	480	480	480

THE Ah-HAH MOMENT
 Joe Fugate: Rapid modeling measurement answers with our Universal Modeling Sizes chart!

Buy Issue: \$1.99 >>

In **MRH** **RUNNING** **EXTRA**



R. Bale



E. Hansmann

USRA BOXCARS

At the start of World War I, American railroads were in disarray. Against the background of a war emergency, the U.S. government nationalized the railroads in December 1917. Taking control

was the newly-established United States Railroad Administration (USRA). To modernize the fleet and relieve the shortage of usable freight cars, the USRA designed two common boxcars: a single-sheathed (SS) wood car and a double-sheathed (DS) wood car. Double-sheathed boxcars are fundamentally wooden boxes so all the support had to come from the underframe. To meet the need for a strong frame, a heavy fish belly design was specified. Single-sheathed cars are like truss bridges with metal side bracing acting as the main structural support. Since the steel side bracing in a Howe truss pattern supported much of the SS cars structure, a lighter, simpler frame was deemed suitable. There was no consensus among the railroad industry on which was a better design, so the USRA ordered both SS and DS boxcars. Between late 1917 and the end of USRA control in March 1920, over 100,000 USRA-designed freight cars were built. The majority of them were boxcars. Cars built subsequent to USRA control were strongly influenced by the wartime designs. Some USRA boxcars were rebuilt with steel sheathing in the 1930s. Due to different approaches to installing steel sheathing on the prototype cars the variations were numerous.

Walthers has announced plans to release a new Mainline series of HO scale freight cars. Although they do not adhere rigidly to USRA designs, the new Walthers models appear to be influenced by prototypes of the WWI-era. The ready-to-run models will be equipped with Andrews solid-bearing trucks with machined metal wheelsets. Walthers reports that undecorated models will be available for each body type in this new series.



Availability of the models begins next month with the release of 40-foot double-sheathed wood boxcars with a USRA-type fishbelly under-

frame. Features include 5-5-5 Murphy steel ends, a wood running board, and a horizontal brake wheel mounted on a vertical brake shaft. Road names will be Chicago, Burlington & Quincy; Santa Fe, Great Northern, Union Pacific, Wabash, and Toronto, Hamilton & Buffalo.

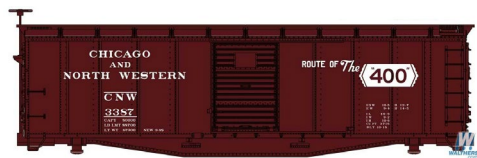

Also scheduled for release in July is a 40-foot USRA-style boxcar that has been rebuilt with steel sides. Road names will be Chicago & North

Western, Delaware, Lackawanna & Western; Detroit, Toledo & Ironton; Elgin, Joliet & Eastern; Grand Trunk Western, and St. Louis-San Francisco.



Walthers Mainline series 40-foot wood refrigerator cars with a steel fishbelly underframe are scheduled for release in August. The HO

scale ready-to-run models have double sheathed wood ends, ice hatches, and a wood running board and latitudinals.

Decorating schemes will include American Refrigerator Transit, Merchants Despatch, North Western Refrigerator Line, Pacific Fruit Express, SFRD Santa Fe, and SRLX-Swift Refrigerator Line.

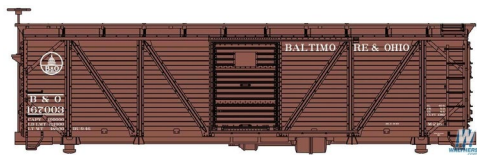

The series will be completed with the September release of a 40-foot single sheathed wood boxcar with a straight steel underframe.

Although influenced by the USRA design, the external side

braces of the model are in a Pratt truss pattern rather than the Howe truss design of the USRA prototype. Road names for the HO scale ready-to-run model will be Baltimore & Ohio, Maine Central, Milwaukee Road, New York Central, Pennsylvania, and Southern Pacific. For additional information contact a dealer or visit walthers.com.

N SCALE PRODUCT NEWS



Athearn has scheduled the release of an N scale 52-foot mill

gondola next April. The injection-molded model will have body-mounted knuckle couplers and screw-mounted 100-ton roller-bearing trucks. In addition to RailGon, the ready-to-run model will be available decorated for BNSF, Oregon Steel Mills, Transportación Ferroviaria Mexicana, Gondola Connection, RJ Corman, and Herzog. For more information contact a dealer or visit athearn.com.



Atlas will release its Master series GE U23B during the 4th quarter of this year.

Both DC/DCC-ready and ESU DCC Sound equipped versions will be available. In addition to the Conway Scenic decorating scheme shown, road names on the N scale model will be Delaware & Hudson, Lehigh Valley, Missouri Pacific, Penn Central, and C&O Chessie System. See the HO scale section of this report for information about the prototype U23B locomotives.

Atlas is preparing a series of 60-foot heavyweight passenger cars for release during the 4th quarter of this year (next page top).



Coaches, RPO cars, baggage cars, a combine, and an open-end observation car will be available in four-car sets and individually decorated for Norfolk & Western, Monon, Lackawanna, and Chicago Great Western.

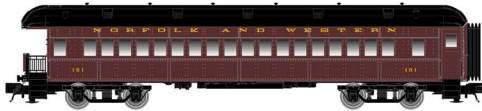

Individual coaches will also be available for Burlington, Conrail, and Conway Scenic.

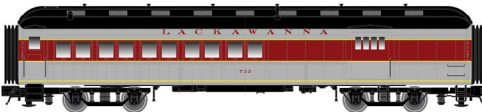

A Master series N scale 50-foot single-sheathed wood automobile boxcar is included on Atlas's 4th quarter release.

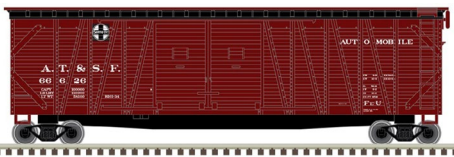

Cars with end doors for loading automobiles will be available for Western Pacific, Missouri Pacific, Texas & Pacific, and ACY. Road names for cars without end doors include Great Northern and ATSF.



Atlas' 4th quarter production schedule includes 45-foot containers with corrugated sides. Carrier names will be Safmarine, NED Lloyd, ONE-Ocean Network Express, and NYK Logistics.

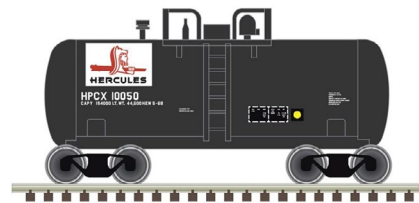

Completing Atlas' 4th quarter release of N scale models is a "Shorty" tank car. Road names on the Trainman series model will be HPCX-Hercules, UTLX, San Angelo, MONX-Monsanto, GATX-

General Molasses, CGTX-Canadian General, SHPX-Wyandotte Chemicals, SCLX-Standard Chemical, and GATX-Hooker

Chemical. For additional information contact a dealer or visit atlasrr.com.



Bowser is taking reservations for three classes of N scale steel cabooses with delivery planned for April 2020. Class N5C steel cabooses, based on a 1942 prototype with round porthole windows, will be available decorated in the following Pennsylvania Railroad schemes: PRR early NY Zone, PRR early Pittsburgh Region, PRR early Western Region with antenna, Keystone orange with antenna, Shadow Keystone with yellow cupola and antenna (above), Shadow Keystone Buckeye Region, and Shadow Keystone Northern Region.



Non-PRR road names for Bowser's N scale class N5C cabooses will be Conrail (left), Conrail (brown Pennsylvania Power & Light coal service), Penn Central (green), and Penn Central (brown PP&L coal service).

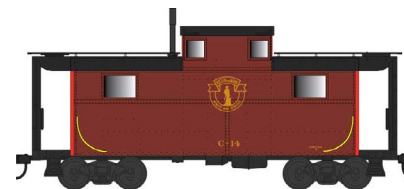

N scale Class N5 steel cabooses with rectangular windows coming from Bowser will be decorated for B&M Minute Man (left), Conrail, Conrail MOW, Penn Central, Pennsylvania-Reading Seashore

Lines, and Reading Northern. The HO scale model is based on a prototype introduced in 1914.



Class N5 cabooses decorated for Pennsylvania Railroad will be available in the following variations: Early PRR scheme with train phone

antenna, PRR early scheme with black roof, PRR early scheme with brown roof, PRR Keystone orange, PRR Keystone with yellow cupola, PRR Keystone, Shadow Keystone REA, and Shadow Keystone Lake Region.

Bowser's N scale class N5 and N5C cabooses will have body-mounted knuckle couplers, and trucks fitted with Fox Valley Models metal wheels. All of the Bowser models mentioned in this report are scheduled to be released in April 2020. For additional information contact a dealer or visit bowser-trains.com.



Coca-Cola (left). The same truck is available decorated for O-So Grape, and Whistle. Also new are three roadside billboards. In addition to Hostess Cakes, billboards will be available for Coca-Cola, and Planters Peanuts.

New N scale items coming from **Classic Metal Works** include a White bottle truck decorated for



Classic Metal Works is preparing to release a package of gas station details that contains two tank trucks, a gas pump island, and a station sign. Gas company names are Conoco, Union 76, and Standard. For additional

information contact a dealer or visit walthers.com.

InterMountain Railway is preparing to release a large group of Trinity 5161 cu. ft. covered hopper cars. The N scale models are



currently in production; however a firm delivery date has not been announced.



Road names include Dakota, Minnesota & Eastern; CSX, Norfolk Southern, Canadian Pacific/Soo, AGP, ADM Leaf, Potash, Union Pacific/CMO, Kansas City Southern, and TILX-Imperial Sugar.



Nine BNSF Heritage cars are also in this production run. They will be decorated with tribute heralds for Great Northern, Spokane, Portland & Seattle; Frisco, Burlington Northern, The Denver Road, Northern Pacific, Burlington Route, Colorado & Southern, and Santa Fe. HO scale models are shown in this report. For additional information contact a dealer or visit intermountain-railway.com.



KatoUSA is releasing a special FP7A - F7B diesel set decorated in Olympian Hiawatha livery. The N scale models will reflect specific details unique to prototype locomotives No. 90A and No. 90B including a winterization hatch on the B unit. The models will be released in three stages beginning with an A/B set for DC operation in June. A second F7B unit numbered 90C will also be available in June.



In July, an A/B set and an individual B unit with TCS DCC K0D8-F decoders will be available. The final FP7A, F7B diesel set and extra F7B will come with factory installed ESU LokSound DCC. They are scheduled for release in early August.



KatoUSA announced that they will be producing ACF 2-bay covered hoppers in N scale. The cars will be equipped with ASF

Ride Control trucks and semi-automatic Kato knuckle couplers. Available in November 2019, they will be produced in two eight-car sets for Santa Fe, CB&Q, Chesapeake & Ohio, and Union Pacific. For additional information contact a dealer or visit katousa.com.



Micro-Trains Line has released several new N Scale ready-to-run models including this Northern Pacific

RPO car. Built in 1914 the short, heavyweight car wears NP's classic two-tone paint scheme created by industrial designer Raymond Loewy. The prototype car continued in service through the mid-1960s.



The prototype of this Canadian National 89-foot tri-level closed autorack was built by National Steel Car in

1976. The enclosed design protected vehicles from the elements and greatly reduced vandalism.



Micro-Trains 50-foot Southern Pacific standard boxcar with single Youngstown sliding doors is based on a prototype built in 1957. SP's marketing department used the bold lettering to call attention to the Hydra-Cushion underframe and DF loader systems.



This Erie Western triple-bay covered hopper was built by Evans Railcar in 1978. EW was established in 1977 and operated 158 miles of track

from Ohio to Indiana until 1979 when the railroad ceased operations. Like the prototype, Micro-Trains N scale version rides on Barber roller-bearing trucks. For additional information contact a dealer or visit micro-trains.com.



Monashee Laser Engineering has released an N scale model (kit #102A-N) of a Canadian Pacific Railway Type 12 #5 Standard Station. Commonly found across Canada, the kit was designed

using original CPR drawings and includes laser-cut floors, walls, windows/doors, roof, trim, shingles and chimneys. Both drop and clapboard siding are included, as is stripwood to build the platform. The completed model, including platform, measures 3.75 x 2.875-inches in size. For more information visit www.monasheelaserengineering.ca.

NEW DECALS, SIGNS AND FINISHING PRODUCTS

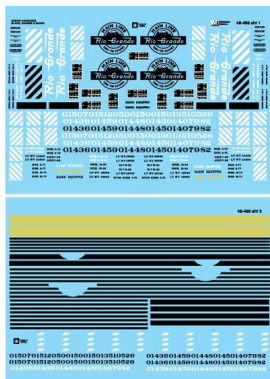
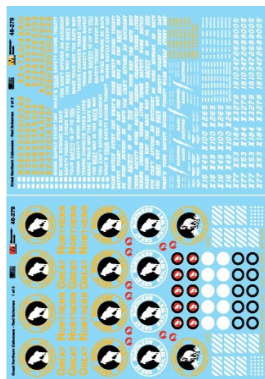
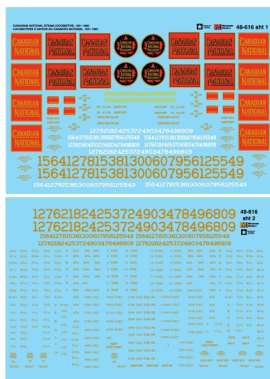
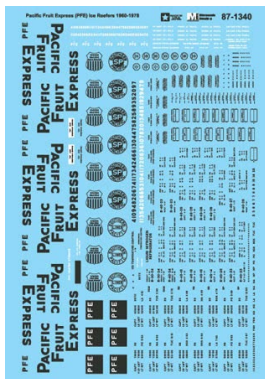

reer sets are also available now. For additional information contact a dealer or visit microscale.com.

Microscale reports that inventory of several popular decal sets has been replenished. O scale decal sets back in stock include Pennsylvania Railroad pre-1948 steam locomotives, New Haven McGinnis and Alpert schemes for hood diesels, Reading diesels, Rio Grande narrow gauge steam locomotives, and Canadian National steam locomotives. HO scale decal sets for PFE ice reefers, and Pennsylvania Railroad steam locomotives are again available. N scale PFE ice

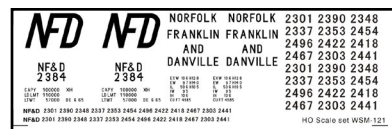
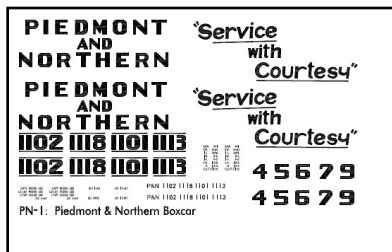

Great Decals sells a wide selection of lettering systems for class A carriers as well as many lesser known regional railroads. Typical of the small lines are these decals for Hinckley & Schmitt, Piedmont & Northern, and Norfolk, Franklin & Danville. For additional information visit www.greatdecals.com.

DISCLAIMER

The opinions expressed in this column are those of the writer and do not necessarily reflect the opinion of *Model Railroad Hobbyist* or its sponsors. Every effort is made to provide our readers with accurate and responsible news and information, however, neither *Model Railroad Hobbyist* or the writer of this column can be held responsible for any inaccuracies or typographical errors that may inadvertently appear in this column.

DOWNLOAD ISSUE



DOWNLOAD PORTRAIT



DOWNLOAD LANDSCAPE

i SEND US YOUR PRODUCT ANNOUNCEMENTS

[here](#) and submit your announcement to us. Our web site and free magazine reach continues to grow, so get on board this new media train! ■

JUNE NEWS BRIEFLY NOTED | 36

! BRIEFLY NOTED AT PRESS TIME ...

Accurail's mid-summer release of HO scale car kits includes USRA double-sheathed wood boxcars in several road names, and SFRD 40-foot wood refrigerator cars decorated for Santa Fe's Super Chief, Grand Canyon Line, Scout, and El Capitan – all in new road numbers...

KatoUSA has posted a how-to video on Youtube that describes the installation of a new HO coupler adapter that allows mounting Kadee knuckle couplers on Kato's HO Bi-Level and Superliner passenger cars. This is especially helpful for members of clubs that require Kadee couplers on all cars. Check out the video at www.youtube.com/watch?v=So4TYXN5oRk...

Morning Sun has released both softcover and eBook versions of Volume 1 of Matt Herson's *New York City Subways...*

Walthers plans to introduce an HO scale Proto Series EMD FP7 passenger diesel late next year. An economy priced WaltherTrainline Series GP15-1 should be ready for release by October of this year. Look for full details on both new locomotives in the July edition of *Model Railroad Hobbyist...*



CO ALCO ALCO FA-2 FB-2 FPA-2 FPB-2 ALCO ALCO AL
RESERVE BY JUNE 24. CLICK HERE.



PUBLISHER'S WELCOME
Joe Fugate: Powered pin vise take
2: goes down to #97 drill bit!

Buy Issue: \$1.99 >>

In **MRH** **RUNNING**
EXTRA



SELECTED EVENTS



Model Railroad Hobbyist | June 2019 | #112

JUNE 2019

(Many events charge a fee. Check individual info website for details.)

AUSTRALIA, QUEENSLAND, TOOWOOMBA, June 1-2, Model Trains & Hobby Expo, sponsored by Toowoomba Model Railway Club, at Toowoomba Showgrounds, Glenvale Road. Request info from Ted Freeman at tmrcexpo@gmail.com.

CALIFORNIA, CROCKETT, June 8-9, Carquinez Model Railroad Society Open House, at 645 Loring Avenue. Request info from Dave Tateosian at davetateosian@sbcglobal.net.

CALIFORNIA, RICHMOND, June 15, San Francisco Bay Area Prototype Modelers Meet, at St. David's School Hall, 871 Sonoma Street. Info at www.bayareaprototypemodelers.org.

ILLINOIS, ROSEMONT, June 26-30, National N Scale Convention at Crowne Plaza Hotel at O'Hare, 5440 North River Road. Info at www.nationalscaleconvention.com.

INDIANA, INDIANAPOLIS, June 15, Yard Sale & Father's Day Open House, sponsored by Naptown & White River Model Railroad Club, 1115 McDougal Street. Info at naptownrr.org.

KANSAS, MERRIAM, June 8, Annual Narrow Gauge Meet, hosted by Kansas City Area Narrow Gaugers, at Johnson County Library, Antioch Branch, 8700 Shawnee Mission Parkway. Advance registrations are required by June 4. Request info from Larry Alfred at captlalfred@gmail.com.

SELECTED EVENTS | 2

KANSAS, WICHITA, June 20-21, NMRA Mid-Continent Convention, hosted by Chisholm Trail Division, at Double Tree by Hilton, 2098 Airport Road. Info at wichitamcor2019convention.tripod.com/mainx.html.

KENTUCKY, LOUISVILLE, June 16 thru 30, Bon Air Model Train Show, sponsored by K & I Model Railroad Club, at Bon Air Library, 2816 Del Rio Place. Info at www.kandimrr.com.

TEXAS, FRISCO, June 27-30, Texas Special NMRA Lone Star Region Convention, at Drury Inn & Suites, 2880 Dallas Parkway. Info at www.2019TexasSpecial.com.

WISCONSIN, WAUPACA, June 15-16, Strawberry Fest Train Show & Model Contest, at Waupaca Recreation Center, 407 School Street. Info www.wamrltd.com.

July 2019, by location

CALIFORNIA, McCLELLAN (metro Sacramento), July 10-14, National Summer Steamup (small-scale live steam), at Lions Gate Hotel, 3410 Westover. Info at www.steam-events.org.

ILLINOIS, COLLINSVILLE (metro St Louis), July 26-27, St. Louis RPM Meet, at Gateway Convention Centre. Info at www.icgdecals.com/stlrpm.

UTAH, SALT LAKE CITY, July 7 – 13, NMRA National Convention, Little America Hotel, 500 South Main Street. More information at www.nmra2019slc.org.

UTAH, SANDY (metro Salt Lake City), July 12-14, Mountain America Exposition Center, 9631 State St. Info at nmra.org/events/2019-national-train-show.

Future 2019, by location

ARIZONA, MESA, (Metro Phoenix), September 25-29, Arizona Junction, 2019 NMRA Pacific Southwest Region Convention, hosted by PSR Arizona Division, at Sheraton Mesa Hotel at Wrigleyville West, 860 North Riverview Mesa. Info at azdiv-nmra.org/psr2019convention.

SELECTED EVENTS | 3

CALIFORNIA, OCEANSIDE, October 12, Train Show & Swap Meet, sponsored by North County Model Railroad Society at Heritage Park, 230 Peyri Drive. Info at swapmeetinfo@ncmrs.org.

FLORIDA, THE VILLAGES, July 8-10th, Train Show & Sale, at Savannah Regional Recreation Center, 1545 Buena Vista Blvd. Info at www.thevillagesmodeltrainclub.com.

INDIANA, INDIANAPOLIS, September 14, Train Show & Sale, sponsored by Naptown & White River Model Railroad Club, at Emmerich Manual High School, 2405 S. Madison Avenue. Info at naptownrr.org.

MARYLAND, LINTHICUM HEIGHTS (Metro Baltimore), September 19-22, Mid Atlantic RPM Meet, at Double Tree by Hilton, BWI Airport, 890 Elkridge Landing Road. Info at marpm.org.

MASSACHUSETTS, GARDNER, October 5, Southern New England 2 Rail O Scale Fall Show, at United Methodist Church, 161 Chestnut Street. Info at www.snemrr.org.

MICHIGAN, EAST LANSING, November 10, Model Railroad Club Show and Sale, sponsored by Lansing Model Railroad Club at Michigan State University Pavilion. Info at www.lmrc.org.

MICHIGAN, TROY, November 7-10, NMRA NCR North Central Region Convention, at Troy Community Center, 3179 Livernois. Info at www.div8.ncr-nmra.org/ncx-2019.

MISSOURI, SPRINGFIELD, September 7, Fall Train Show, sponsored by Ozarks Model Railroad Association, at East Hall Ozark Empire Fairgrounds Eplex, 3001 N. Grant Ave. Info at www.omraspringfield.org.

NEW YORK, LIVERPOOL (Metro Syracuse), September 19-22, NMRA Northeastern Region Empire Junction 2019 Convention, at Holiday Inn, 441 Electronics Parkway. Info at empirejunction.org.

OHIO, CAMBRIDGE, October 20, NMRA MCR Division 6 Swap Meet, at Pritchard Laughlin Center, 7033 Glenn Highway. Info at div6-mcr-nmra.org/TimeTable_Page.html.

SELECTED EVENTS | 4

OHIO, MARION, August 10, Summerail 2019, sponsored by Marion Union Station Association, Marion Palace Theatre, 276 West Center Street. Info at www.summerail.com.

OREGON, PORTLAND, August 27-31, 35th National Garden Railway Convention, hosted by Rose City Garden Railway Society, at DoubleTree by Hilton Hotel, 1000 NE Multnomah Street. Info at www.ngrc2019.org.

PENNSYLVANIA, ALTOONA, August 3-4, N-Scale Weekend & Model Train Show, sponsored by Bedford Model Railroaders at Altoona Jaffa Shrine Centre. Info at www.n-scaleweekend.com.

PENNSYLVANIA, EASTON, October 6, 43rd Annual Lehigh Valley Regional Train Show & Expo, at Charles Chrin Community Center, 4100 Green Pond Road. Info at www.lehighlines.org/events.html.

UTAH, SALT LAKE CITY, July 7-13, NMRA National Convention and National Train Show. HQ at Little America Hotel. Info at nmra2019slc.org.

WASHINGTON, BATTLE GROUND, September 28, 46th Great Train Swap Meet, sponsored by Southwest Washington Model Railroaders at Battle Ground High School Gymnasium, 300 West Main Street. Request info from Larry Sprenkel at Larry.sprenkel@gmail.com.

Beyond 2019, by date

MISSOURI, ST. LOUIS, July 12-18, 2020, NMRA National Convention and National Train Show. HQ at Hilton St. Louis at the Ballpark. Info at gateway2020.org.

CALIFORNIA, SANTA CLARA, 2021 NMRA National Convention and National Train Show.

ENGLAND, BIRMINGHAM, 2022, NMRA National Convention and National Train Show. Info at www.nmra2022uk.org. ■

AMERICA'S LARGEST OPERATING MODEL RAILROAD SHOW

48TH ANNUAL

Trainfest®



NOVEMBER 9 & 10 MILWAUKEE

POPULAR
**PRIME ACCESS
TICKETS**

GET AN
EXTRA HOUR OF TRAIN FUN
ON SATURDAY BEFORE EVENT
OPENS TO GENERAL PUBLIC

**4 FOOTBALL FIELDS
OF SERIOUS TRAIN
ENTHUSIAST FUN**

70 SPECTACULAR, HUGE
RUNNING RAILROADS

110 MANUFACTURERS &
HOBBY DEALERS

NEW PRODUCTS
UNVEILED

**EVERYTHING TRAIN.
RUN. RIDE. LEARN.**

STAGED BY THE
NMRA WISE DIVISION

Trainfest Goes Global

HELP TRAINFEST OPEN A
NEW INTERNATIONAL
RR EXHIBITION

Layouts from around the world are invited to
Trainfest 2020. Show your support. Help us
pay the transportation fees of the int'l railroads.
Donate at <https://igg.me/at/trainfest2020>

Free
TRAINFEST
MERCHANDISE
OR A BRIDGER TRAINSET

WWW.TRAINFEST.COM

HUNDREDS OF FREE CLINICS & DEMOS



HUGE CB&Q DISPLAY SPONSORED
BY THE BNSF FOUNDATION

CLICKABLE ADVERTISER INDEX

[Accu-Lites](#)

[Archer Fine Transfers](#)

[Athearn](#)

[Atlas Model Railroad Co.](#)

[Bachmann](#)

[Berrett Hill Trains](#)

[Black Cat Publishing](#)

[Blair Line](#)

[Bowser](#)

[Caboose](#)

[Canyon Creek Scenics](#)

[Coffman Graphics](#)

[Digitrax](#)

[ESU LokSound](#)

[Fast Tracks](#)

[Great Decals](#)

[HO Diesel Supply](#)

[Iowa Scaled Engineering \(ISE\)](#)

[Lines West](#)

[Litchfield Station](#)

[Logic Rail Technologies](#)

[Main Street Heritage Models](#)

[Masterpiece Modules](#)

[Micro-Trains Line](#)

[Mike & Scotty Live](#)

[Model Railroad Benchwork \(1\)](#)

[Model Railroad Benchwork \(2\)](#)

[Model Railroad Construction](#)

[Model Railroad Control Systems](#)

[Monashee Laser Engineering](#)

[Mountain Subdivision Hobbies](#)

[MRH Store \(1\)](#)

[MRH Store \(2\)](#)

[MRH Store \(3\)](#)

[MRH Store \(4\)](#)

[Mt. Albert Scale Lumber](#)

[National Narrow Gauge Convention](#)

[National Train Show \(Salt Lake City\)](#)

[NCE \(2 page spread\)](#)

[North American Railcars](#)

[Pre-Size Model Specialities](#)

[Precision Design Co.](#)

[RailroadBackdrops.com](#)

[Rapido \(1\)](#)

[Rapido \(2\)](#)

[Ring Engineering \(1\)](#)

[Ring Engineering \(2\)](#)

[Roomettes](#)

[ScaleTrains.com](#)

[Soundtraxx \(Blackstone\)](#)

[Southern Digital](#)

[Streamlined Backshop Services](#)

[TAM Valley Depot](#)

[Trainfest](#)

[TrainMasters TV \(1\)](#)

[TrainMasters TV \(2\)](#)

[Walthers](#)

[Westerfield Models](#)

[Yarmouth Model Works](#)

[Clickable "other" index](#)

[Other - Contents](#)

[Other - Cover](#)

[Other - MRH Marketplace](#)

[Other - MRH Sponsors](#)

COMING NEXT MONTH IN MRH ...



Rob Spangler's Western Pacific 8th Sub ...



Build an RDC camera car ...

HAVING FUN WITH TRAINS
JULY 2019 | FREE

MRH
MODEL RAILROAD HOBBYIST

2019
SALT LAKE CITY
NMRRA

Rob Spangler's
Western Pacific 8th Sub
[▶ READ NOW](#)

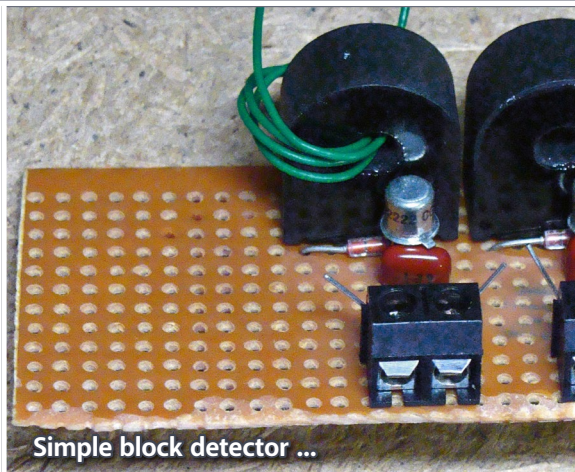

Simple block detector ...

... coming in the
July MRH

COMING NEXT MONTH IN *RUNNING EXTRA* ...

... all the MRH articles and ads, *PLUS:*



Progress update on Mike Rose's Lehigh Line ...



Better methods for weathering wheels ...

June 2019 - \$1.99

MRH *RUNNING* EXTRA
More modeling every month

Mike Rose progress report:
Lehigh Line build-out
[▶ READ NOW](#)

Also these articles:

- Lorem ipsum dolor sit amet
- Consectetur adipiscing elit morbi
- Vestibulum tempus vehicula
- Mauris tempor libero ipsum pellentesque
- Nullam porta ut arcu at lobortis
- ... and much more!



Modeling bushes using rope ...

... all this and much more!

SUBSCRIBE: 1 YR \$19.99