

# Model Railroad Hobbyist magazine™

The model-trains-video.com mediaZine

PREMIUM Edition

Second Quarter 2009

**SERIES PART 2: Track Planning  
on Computer using 3rd PlanIt**

**Getting  
started  
in DCC**

**Panel-  
side  
hopper  
history**

**Build your own  
manual turnout  
throws**

**Superdetail  
a Conrail resin kit caboose**



# BACK TO BASICS



In such a busy world, it's easy to forget about the simple things in life. Let BLMA Models take you back to that safe spot... back to real model railroading... back to the fun of this great hobby.

It's simple. Sit back, enjoy yourself, and please take a few moments to check out our new products, watch the videos, and see how BLMA Models is changing modern model railroading!



- New Product Reviews
- Upcoming Previews
- Behind the Scenes
- Trackside Footage
- Incredible Home Layouts
- Installation Tutorials

[www.youtube.com/blmamodels](http://www.youtube.com/blmamodels)

**NEW! Modern Dual-Head Block Signals**



This all-new model features TWO operating signal heads (6 micro-LED's!), super-fine detail, etched-metal components, and more!

**HOSCALE #4035**  
In Stock \$44.95

**Wrought Iron Fencing NEW!**

Like our ultra-popular Chain Link Fence, this all-new fencing closely matches the ubiquitous prototype, giving you that industrial, yet open feeling.

**HOSCALE #4205**      **NSCALE #705**  
70 Feet - \$18.75      210 Feet - \$18.75



**NEW! Modern Billboards**



Pre-assembled, painted brown, and including TEN pre-printed, die-cut advertisements!

**HOSCALE #4320**      **NSCALE #520**  
Fall, 2009 \$TBA      In Stock \$39.95

**NEW! 150' Brass Truss Bridges**

These pre-assembled brass models feature superb rivet detail, exact scale dimensions, double-stack clearance, and so much more.

**HOSCALE #5000**      **HOSCALE #5001**  
SILVER \$325      BLACK \$325



Order today through your favorite dealer.

[Visit the BLMA web site](http://www.blma.com)

[Contents](#)

[Index](#)



ATLAS CODE 100 FLEX TRACK: \$3.05

CIRCUITRON TORTOISE SLOW-MOTION SWITCH MACHINE: \$13.28

WALTHERS CORNERSTONE MOTORIZED 130' TURNTABLE, ASSEMBLED: \$223.19

KEEPING PRICES LOW BY RIPPING OFF SOMEBODY ELSE'S ADVERTISING CAMPAIGN: PRICELESS

Visa, Discover, American Express and, of course, MasterCard accepted.

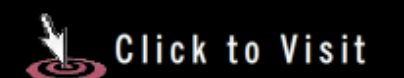



## ASSEMBLY FIXTURES

Create **rock solid** trackwork that never goes out of gauge.

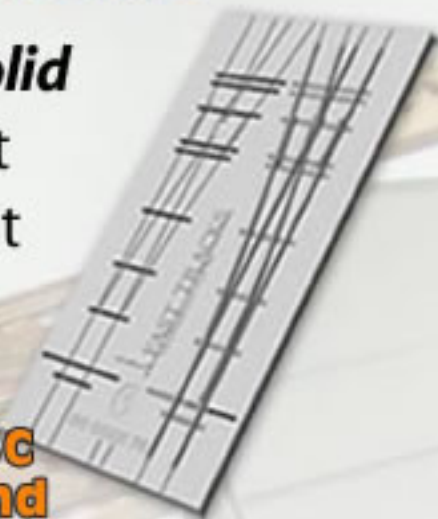

▶ Press ESC to rewind

## FROG/SWITCHPOINT JIGS

Build **perfect frog and switch points** in minutes.



▶ Press ESC to rewind

## QUICKSTICKS LASER TIES

Ready to use **laser cut ties** completes your trackwork in one easy step.



▶ Press ESC to rewind

# Experience the satisfaction of building your own trackwork that:

- ✓ **Performs Perfectly** - Completely eliminates derailments
- ✓ **Is Highly Accurate** - Build Turnouts that stay in perfect gauge - **permanently**
- ✓ **Is Economical** - Build hundreds of switches with a single fixture
- ✓ **Is Easy To Build** - No special skills needed
- ✓ **Can Be Built Quickly** - Build a Turnout in less than an hour!
- ✓ **Looks Great!** - Get results that rival even the most experienced modelers
- ✓ **Lets You Work in Comfort** - Build trackwork at your workbench
- ✓ **Is NMRA Compliant** - Works with any NMRA compliant equipment
- ✓ **Is DC and DCC compatible**

Tools & supplies are available for all popular track scales, types & gauges



Visit us at [www.fast-tracks.net](http://www.fast-tracks.net) to learn how Fast Tracks can help you build better railroads!

HELPING THE WORLD  
BUILD BETTER RAILROADS

FAST TRACKS

[www.fast-tracks.net](http://www.fast-tracks.net) • [service@fast-tracks.net](mailto:service@fast-tracks.net)



# Feature Articles

## 26 Superdetail a Conrail Resin Kit Caboose

M.R. Snell demonstrates the steps needed *by Matt Snell* to build a super-detailed Conrail caboose from a resin kit. Learn tips and techniques you can apply to any resin kit you may chose to build for your layout.

HO

## 37 Track Planning using 3rd PlanIt, part 2

Our rich media tutorial on using *by Ryan Boudreaux* the popular 3rd PlanIt CAD program continues, with part 2 covering more advanced how-to topics.

Any Scale

## 52 Panel-Side Hopper History *by Richard Hendrickson*

Well-known model railroader and historian Richard Hendrickson delves into the historical details of panel-side hoppers.

Any Scale

## 56 Do-it-yourself manual turnout controls

Would you believe a manual turnout *by Charlie Comstock* throw for only \$1? For the investment of a little sweat equity, you too can build these inexpensive “knobby” turnout throws.

Any Scale

## 76 Getting Started in DCC *by Joe Fugate*

Joe Fugate shares some of his insights on why to go DCC, and also recommends what to look for in a DCC system when you're just starting out.

Any Scale





# Editorials & Columns

## **11 PUBLISHERS EDITORIAL: Is the hobby dying?**

Our publisher gives his take on the question frequently posed on model railroading forums: how's the health of the hobby these days? Does it have a future or are model trains on the way out? *by Joe Fugate*

## **86 THE LITE AND NARROW: Creative model engineering**

Our narrow gage and branchline columnist reviews a number of creative On30 engineering examples, from freelanced locomotives to scenic dioramas. *by Lew Matt*

## **100 UP THE CREEK: Plate tectonics**

Our layouts columnist explains how he built a lift hatch and a swing gate on his Bear Creek & South Jackson layout. *by Charlie Comstock*

## **110 GETTING REAL: Rolling trees**

Need more rolling stock for your prototype-based layout but pressed for time? Learn decal detailing tricks and easy weathering techniques to build some quick "trees" to fill in your rolling stock "forest". *by Marty McGuirk*

## **117 COMME-N-TARY: Changing of the guard**

Our new N scale editor comments on what happened to Bernie and gives us a taste of layout planning, N scale style. *by John Drye*

## **123 PARALLEL LINES: Building a stub turnout**

Hobbyists who model the early days of railroading know that early turnouts used a stub points design. Our trackwork columnist explains how to built reliable and great looking stub turnouts. *by Tim Warris*

## **127 THE NEW MEDIA: Online goodies galore!**

Our resident new media expert introduces you to the Scotty Mason show, The Housatonic web site, and Clover House. *by Ryan Andersen*

## **130 REVERSE RUNNING: Model Railroading and the Economy**

With the global economy drastically down and unemployment looming, what's happening to the model railroading hobby? *by Jason Shron*





# Bonus Features

## 15 April Model Railroading News and Events

We've incorporated our April monthly newsletter in this issue of Model Railroad Hobbyist – see the hobby scuttlebutt you're missing each month if you haven't been reading our newsletter!

*Any scale*

## 22 Best of the West

Byron Henderson wrestles with how to design *by Byron Henderson*  
a layout for a modeler who liked a number of western roads. Check out  
his clever track planning solution!

**HO**

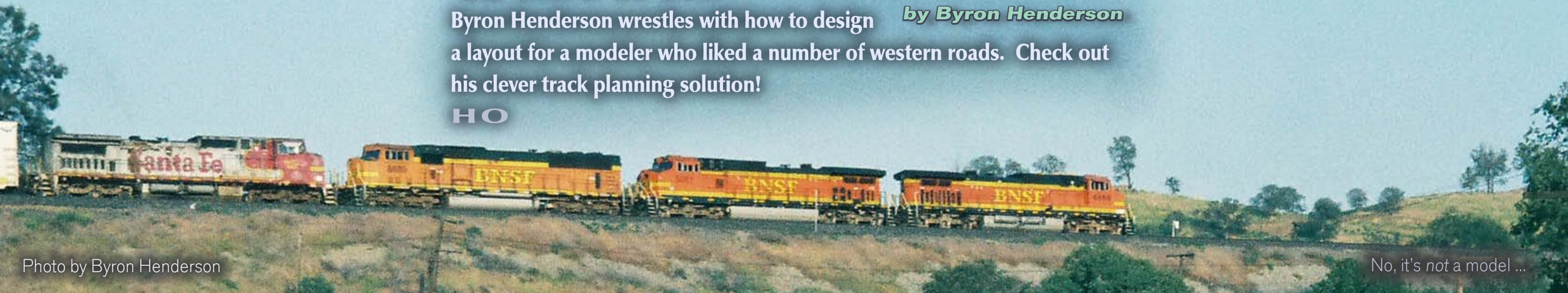

Photo by Byron Henderson

No, it's *not* a model ...



# DECALPRO<sup>®</sup>fx

Make Your Own **REAL** "Dry Transfer" Graphics In 8 minutes!



Use your laser printer (or copier) to turn black toner white or any of 12 metallic colors & full-color from any color laser or copier!

**Pulsar**  
PROFESSIONAL fx

21 Carriage Drive, Crawfordville, FL 32327-2496  
Phone: (850) 926-2009 eMail: mail@pulsarprofx.com

[www.DecalProFX.com](http://www.DecalProFX.com)

Powerful Capability for  
the Serious Hobbyist



Complete  
Starter Kit &  
Applicator  
\$159.<sup>99</sup>



## Model Railroad Hobbyist magazine



**Front Cover:** To model a given road's caboose accurately, scratchbuilding or kitbashing may be required. In this issue, expert modeler M.R. Snell demonstrates detailing a resin kit caboose for Conrail.

### ISSN Pending

Publisher/Editor  
Joe D. Fugate

Columnists  
Ryan Andersen, New media  
Richard Bale, News and events  
Charlie Comstock, Building layouts  
John Drye, N scale  
Lew Matt, Narrow gage and shortlines  
Marty McGuirk, Prototype modeling  
Tim Warris, Trackwork

Special Correspondents  
Jim Duncan, Layouts and operations  
Byron Henderson, Layouts and track planning

Production  
Patty Fugate, pasteup and layout  
Joe Brugger, copy editing  
Mike Dodd, copy editing

Technical Assistant  
Jeff Shultz

Advertising Account Manager  
Les Halmos

### Coming next issue

- Using servos for turnout control
- Upgrading the Kato covered hopper
- Build your own deluxe track cleaning slider car
- Part 3 of Track Planning on computer using 3rd PlanIt
- Another Byron Henderson track plan

... and lots more!



**For the love of model trains**



# Most. Detailed. Caboose. Everrrr.

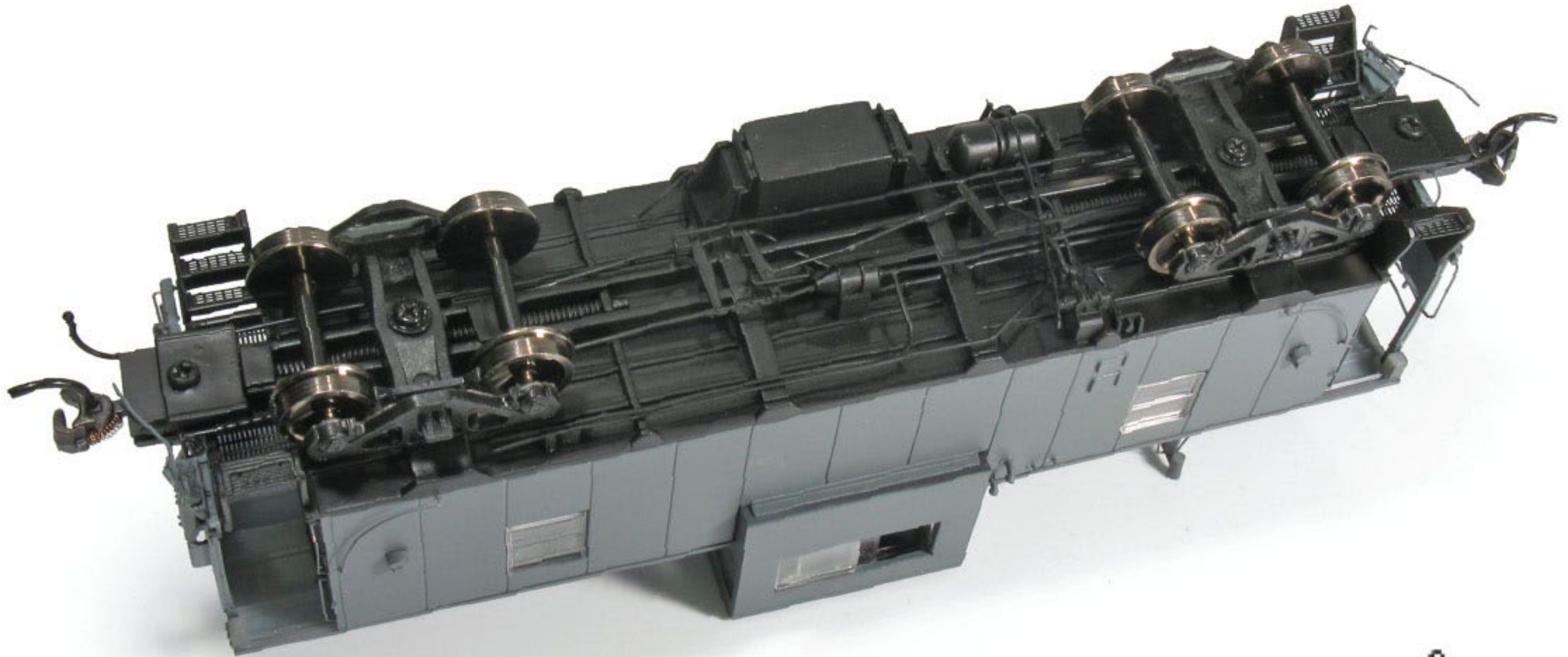

**Click  here**  
**for more info.**



# Sounds of Perfection!

Put the "Quantum Revolution-A" on your list!  
Thousands sold to our happy users!



- 2 Amps, HO/S Scale
- 6 Lite Functions, 28 Total
- Advanced Analog™ DC with Quantum Engineer
- System & Specific Volume Controls
- Sound-of-Power™ Sounds of locos under load
- Pro-Power™ Reduces shorts/opens
- Regulated Throttle Control™ / BEMF (Super Smooth)
- Quantum Air Brakes
- Stat Chat™ Verbal Feedback
- Magnetic Wand™ Reset and Volume
- Quantum Doppler™ Effect
- Quantum Download - Edit and Install Sounds
- New Sound Effects
- Co-Processors: 16+8 Bits
- List \$109.95



**QSI Solutions.com • (800) 671-0641**

*The only manufacturer to offer a two year unconditional warranty!*



# PUBLISHER'S EDITORIAL: Is the hobby dying?

Musings from the MRH founder

## About the Publisher



**Joe Fugate** is the featured expert in many [Model-Trains-Video.com](http://Model-Trains-Video.com) videos, and he's also the founder and publisher of **Model Railroad Hobbyist Magazine**.

Joe has been a model railroader since 1967, when he saw his first copy of **Model Railroader Magazine**. Joe currently models the 1980s Southern Pacific in HO scale. Joe's background is in computer software and database design, and he's also been a professional magazine publisher for science-fiction games.

## When was the last time you saw a model train set on the top of Santa's list?

**H**ardly a week goes by on model railroading online forums without someone posting an "Is the hobby dying?" thread.

Those who post to these threads offer various theories why the hobby isn't what it used to be:

- Hobby shops are closing in ever-increasing numbers.
- *Model Railroader magazine's* circulation has dropped by more than 25% since the 1980s. In the last two years, three well-known second-tier model railroading magazines have folded: *Mainline Modeler*, *Model Railroading Magazine*, and *Railmodel Journal*.
- When you visit a convention, the majority of the attendees are near or at retirement age.
- Train sets are passé compared to all the modern toys and computer games that capture kids' attention.
- Rail lines have been closing in ever-increasing numbers since the 1970s. Today's kids just don't see trains that much.

To all that, we say:

- New online hobby ecommerce web sites open every month.

■ Since the 1980s, scale-specific and niche-specific magazines have proliferated. Thanks to modern internet technology, we could launch our forever free mediaZine, *Model Railroad Hobbyist*.

■ Demographics experts now tell us the most recent generation born since 1985 is larger than the boomers - that's right, *larger!* Model railroad events open to the public see record numbers of families with children attending. The general public appears to still be very much in love with model trains as a family outing.

■ Reuters has reported that the sales of train sets at Christmas have increased since 2005.

■ As one of the most energy-efficient modes of transportation, the miles of rail lines in the US are once again growing! Experts in mass transit say the interest among urban planners in modern high speed rail travel has never been higher.

With apologies to Mark Twain, "The rumors of the death of model railroading have been greatly exaggerated."

If you truly look at *all* the facts, I don't think you can say conclusively that the hobby of model railroading is on the

way out. In fact, there's more than a little evidence that model trains are making something of a comeback.

The supporters of the "hobby is dying" theory quickly point out that train sets no longer make the top of Santa's list.

True enough – but I think model trains were a fad toy of the late 50s and early 60s, in the same category as Davy Crockett coon-skin caps and Roy Rogers six shooters. While we can enjoy a fad for as long as it lasts, you can't consider that "normal".

No one seems to account for market demographics in their thinking. Marketing 101 says if your market is larger, you'll probably sell more stuff. Conversely, if your market is smaller, you'll sell less.

If we look at the size of the various generations, we'll see that the baby boomers generation (born 1945-1965) was the largest generation in the last century. And hey – what do you know! As that generation came of age (the 1950s and 1960s), model railroading enjoyed a golden era.

Generation X (born 1965-1985), is much smaller than the Boomers. As Gen X came of age in the late 70s and on into the 90s, you would expect the sales of model trains to drop.



Taking into account the fad component of train sets in the mid-50s to mid-60s, you'd expect the interest in model trains to drop like a rock among the Gen X'ers. And guess what: that's just what happened in the 70s and 80s.

Now enter Generation Y (born since 1985). Gen Y has eclipsed the boomers as the largest US generation in history! The oldest of the Gen Y's are just now starting families, buying homes, and earning money.

As this groundswell of youngsters born in the last 20 years passes through the magical age of 8-12, you'd expect to see the sales of train sets to be on the rise again – and what do you know – that's just what Reuters tells us has been happening since Christmas of 2005.

It's just Marketing 101 – Gen X was way smaller so you sold fewer train sets.

Gen Y is way larger so you sell more train sets. It's not rocket science, folks!

I don't expect model trains to ever again become the fad they were in 50s and 60s. But I do think we can expect a healthy growth in train set sales for the next decade or so while this mass of Gen Y youngsters comes of age.

In next issue's editorial, I want to address the *Model Railroader* circulation drop off and some facts I think have been overlooked. See you then! 

## Model Railroad Hobbyist Issue 1 feedback

**I**ssue 1 generated a lot of buzz and broke all our download expectations! We projected 20,000 downloads by the end of Q1, 2009 – and in fact we hit 20,000 downloads *a mere 12 days into the release of issue 1.*

Plus it looks like we'll exceed 30,000 Issue 1 downloads for the quarter.

Some may be multiple downloads by the same person (both our LITE and PREMIUM Editions, for instance). We've also received emails from modelers who are burning Issue 1 to a stack of CDs and handing them out at the club or leaving them in local hobby shops.

We suspect that any “double downloads” and this extra distribution of MRH on CD that's “off the record” tend to cancel each other out, which makes the 30,000 number a reasonably solid count of our *actual circulation.*

At various train shows and events recently, and we're finding very few (less than 1 in 10) modelers who know about MRH. So we've got plenty of room to grow!

### When a pig flies

Many expressed amazement that a magazine of our quality could be free. Here's one of my favorite responses:

*“I was reading the recaps of conferences at the 50th Anniversary of Model Railroader (1984) and one of the panel discussed the future of the model rail press as an electronic medium.*

*Being the Neanderthal I am, I thought ‘yeah, when a pig flies...’ Today, the pig went past the window.*

*Thank you for an outstanding publication and best wishes for many, many years of success!”*

**JP, Edgewater, MD**

Before we dislocate our shoulder patting ourselves on the back, I feel issue 1's content was okay, but we can and will do even better.

As a new magazine, we don't have an article backlog that allows us to balance the content in each issue as precisely as I'd like. To put it in plain English: we *need* articles – *lots of articles.*

Note that ***we do pay for articles.*** And With no backlog yet, you may get published sooner!

### Glitches

While having interactive content in MRH is very cool, we discovered some hiccups with Issue 1's rich media.

Mac users, for the most part, could not view issue 1, so we hastily produced a more Mac-friendly LITE Edition. Also, a number of people had download problems.

Thanks to the help of great volunteers who are also model railroaders, we're addressing these glitches with issue 2:

- We've gone to all-native PDF files and discontinued doing zipped or archived files.
- Opening large rich media PDFs over the internet can be problematic, so we've changed our download process to recommend you SAVE the PDF to your computer first, rather than trying to open it directly over the internet.
- We've redesigned our LITE Edition slightly to make it more Mac-Preview friendly.
- We've moved to a dedicated web server with much more bandwidth, so we shouldn't have the web site overload issues we saw with issue 1.

We're committed to making MRH available to anyone on the planet with an internet connection who has an interest in model railroading!

### Clicking on Ads

Clicking on ads and visiting our advertisers' web sites generates advertising revenue for us and helps us keep MRH coming to you *forever free.*



To make it obvious where to click (and to remind you to *click* our ads), we're adding this bulls-eye logo to *all* advertisements. ***When you see this logo, remember it means: “click here to visit the vendor's web site!”*** ■



**Article feedback!**  
CLICK HERE for reader comments  
on this article ... 



# Model Railroad Hobbyist's First annual reader online survey!



**Help us get a better idea of who's  
actually reading MRH ...**

Want to help Model Railroad Hobbyist succeed in getting more hobby advertisers? Participate in our online anonymous reader survey! Armed with *actual reader demographics* when speaking with advertisers, we can more easily show hobby vendors why they need to be placing ads in MRH.

## MRH First Annual Reader Survey

### Who's reading MRH?



We're conducting a survey of our readers so that we can get a better idea of who our readers are, and have demographics to give our advertisers. Please answer the questions below - all results are totally anonymous.

On each question, pick your choice(s) and then click "Cast your vote". Repeat this process with each question.

**CLICK HERE to take the survey**

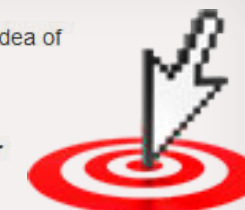

Online Surveys & Market Research

What's your age?

Please select 1 answer.

- Under 20
- 20-29
- 30-39







**Quality**

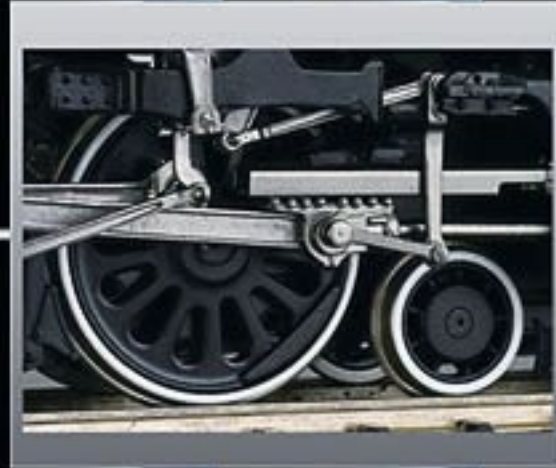

**Precision**



**Detail**

# Don't just buy brass *INVEST IN BRASS*

You can trust your investment  
when you purchase a model  
from Division Point

Canadian National Railway  
U-2-f 4-8-4  
2008 Release - Sold Out



 **Division Point**  
www.DivisionPoint.com      orders@DivisionPoint.com  
Ph. 303-499-5909

Visit our website or contact your favorite  
Division Point Dealer today to see our full product line



# Model Railroad Hobbyist newsletter™

April 2009

*The Old Yardmaster*



## News and views from up and down the line...

**B**owser Manufacturing Company has stopped production of its entire line of HO scale steam locomotives including products with the familiar brand names of Bowser, Bowser of Riverside, Penn Line and Varney.

The announcement came from company president, Lee English, who said production of standard gauge and O gauge wheel replacements as well as turntables also ended in February. Bowser will continue to offer HO scale diesel locomotives, trolleys and freight cars and N scale freight cars.

Bowser will also continue producing its extensive line of detail parts sold under brand names Cal Scale, Selley and Cary. During the past decade the market for steam locomotive kits based on cast boilers with limited details and decades-old drive systems has been sidetracked by well-detailed ready-to-run models utilizing newer technology.

In response to the announcement some industry watchers said the real surprise is that Bowser did not drop the category years ago.

Tooling for the discontinued Bowser locomotives will apparently

be made available to **Eddystone Locomotive Company**, an established custom locomotive builder having a long-standing relationship with Bowser. Eddystone owner David Grover said he will continue to accept commissions to create models of PRR locomotives using existing or modified Bowser tooling as needed, adding that he has no interest in producing kits.

Grover said his goal is to offer accurate composite models of the PRR E6 Atlantic, G5 Pacific and H8 and H10 Consolidations.

Eddystone will continue to produce custom-built locomotives and limited production runs of northeast anthracite railroad locomotives.

Grover said he is also committed to developing certain PRR tenders in collaboration with the Pennsylvania Railroad Technical and Historical Society. Additional information is available at [www.eddystoneloocomotives.com](http://www.eddystoneloocomotives.com).

Continuing to aggressively maintain its position as the nation's largest supplier of model railroad products, **Walthers** has

just completed an agreement with Lionel LLC of Chesterfield, Mich., to distribute the complete line of Lionel O scale models beginning with new releases for 2009.

According to the announcement, over 500 new items are planned for release this year, however, production will be based on dealers placing advance orders by April 8. Walthers has informed dealers that orders for Lionel's new Vision line are due by April 30, 2009.

In other news, Walthers continues to refresh its inventory of ACF-built 70-Foot heavyweight head-end cars that, depending on the operational needs of their owners, were assigned to some combination of one or more duties including baggage, express or mail storage service.

Scheduled to be replenished in April and May are several road names that have been out of stock, including Missouri Pacific, Great Northern, Union Pacific (yellow) and an undecorated model. Although firm dates have not been announced, ATSF, CB&Q, PRR, UP (grey),



**Walthers undecorated 70-foot ACF heavyweight head-end car is ready for the paint shop.**



CNW (yellow), NYC, SP (grey), B&O (blue/white) and Milwaukee (orange/maroon) versions are planned for later this year. Priced at \$49.98, the HO scale ready-to-run heavyweight cars require a minimum 24-inch radius for operation.

**Rapido Trains Inc.** is nearing completion of all pre-production work on its new Wide-Vision Caboose in the Transcona Yard series. The authentically scaled HO model will adhere closely to the prototype that was built at CP's Angus Shops.

The model has a wide range of detailed features including a fully detailed underbody with separate air and brake piping; accurately-detailed Barber-Bettendorf caboose trucks with in-line brake shoes; multi-colored interior with proper floor texture;

interior handrails and functioning windows in the cupola; see-through, etched metal end platforms and steps; uncoupling levers; separate factory-installed grab irons; operating marker lights; interior lighting with all-wheel pickup and metal Macdonald-Cartier knuckle couplers.

This is the first project released in Rapido Trains' recently-announced Transcona Yard series of freight cars. Delivery of the initial run is set for this Fall with quantities and road names reflecting factory orders received from dealers by May 1.

A schedule of available paint schemes and car numbers has been sent to all dealers. The schedule is also available for review at [www.rapidotrains.com/tyard01.html](http://www.rapidotrains.com/tyard01.html).

**ExactRail**, the new company that began business in February with three HO scale cars, has announced the introduction of three N scale products. The initial trio includes a PC&F 6033 cubic foot Hy-Cube box car, a Vert-A-Pac Automobile Car and a Trinity 5161 Covered Hopper. Co-founder John Pestana said the cars are available now in a range of paint schemes and road numbers. For additional details visit [www.exactrail.com](http://www.exactrail.com).

All operations at **Great Western Passenger Car Details** will shut down at the end of March, according to company founder Fred Shannon, who said that despite his best efforts, the business has not been able to recover from a fire last December. In addition to structural damage, the cost of replacing tooling, fixtures, equipment and materials exceed available resources. The small nine-year old company specialized in detail items for CNR, ONR, ACR and other Canadian railways.

**InterMountain** has just completed tooling for its new N scale FP9A and FP9B locomotives. The first road names should be announced soon but don't look for delivery before Fall.

### Scale Color Key:

**N scale news**

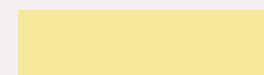

**HO scale news**

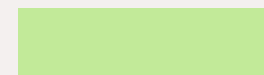

**S scale news**



**O scale news**



To highlight the news by scale, click the appropriate scale button below.



**Unpainted pilot model of HO scale Wide-Vision Caboose coming from Rapido's Transcona Yard series.**



Roofing Tarpaper is among the newest items from the creative minds at **Rusty Stumps Scale Models**. The tarpaper sheets come in black, grey, red and green which are laminated to a newsprint backing sheet to give them body.

Since the material effectively represents aged tarpaper, users may find occasional holes or small wrinkles in the material, all of which add to the realistic look of old tarpaper. \$8.95 will bring you a packet of four sheets approximately five inches square. The material is suitable for use in all scales.

Rolling stock decorated in a variety of authentic Baltimore & Ohio schemes

will soon be available from **Keyser Car Shops**. The first product offered by the new firm is a Red Caboose HO scale model decorated as a B&O M-26b Time-Saver Service Car as applied 1957-1962. The car is painted in bright oxide red and includes a body patch panel commonly seen on the prototype by the 1950s. Twelve road numbers are available. For full details visit [www.keysercarshops.com](http://www.keysercarshops.com).

**Plano Model Products** has two versions of a one-time kit with enough components to recreate an authentic HO scale model of virtually any road-specific PS2600 covered hopper.



### **B&O Time-Saver Box Car coming soon in HO from Keyser Car Shops.**

The difference in the two kits is in the walkway, with kit number PS26001 having a center-mounted version, and kit PS26001 having a through-hatch style walkway. The kits use undecorated Athearn body components with the addition of Plano walkways and brake platforms.

Although assembly instructions will be minimal, Plano will support the special project through its web site that will include a roster of prototype PS2600s compiled by James Eager. Visit [www.planomodelproducts.com](http://www.planomodelproducts.com) for full details on this prototype modeling project.

**Turner Model Works** has recently added Sequoia Scale Models and Muir Models to its growing family of brand names. Both product lines were acquired from J&M Distributing Company in 2008.

For several years Turner has been manufacturing products sold under the brand names of Mile Post Model Works, Mini-Structures and FinestKind Models, all of which were previously manufactured by JAKS Industries.

Based in Athens, Tenn., Turner also owns Smokey Mountain Model Works bridges and buildings; Rail Systems structures; Limited Editions HO passenger cars and Z scale structures and Gloor Craft structures. For additional information visit [www.TurnerModelWorks.com](http://www.TurnerModelWorks.com).

Slowly but surely, the old **Roundhouse** (Model Die Casting) line of HO products is being upgraded and reissued as fully assembled ready-to-run models.

On the production list for delivery in September is a drover's caboose decorated for Canadian Pacific, Central Pacific, Southern Pacific, Union Pacific and CB&Q. Now a division of Athearn, the Roundhouse models will feature machined 33-inch metal wheels, metal truss rods, new clear window glazing and knuckle spring couplers.



**Modeler Mike Chambers created and photographed this realistic shed roof. The techniques Mike used, along with additional information on ordering the new Tarpaper can be found at [www.rustystumps.com](http://www.rustystumps.com).**

**Like Model Railroad Hobbyist magazine being free?**

**Want to keep it that way?**

**... then click the ads!**





**Completed model of PRR Coil Steel Gondola built from Rail Yard Models kit.**

Rail Yard Models has released a Pennsylvania Railroad G41A coil steel gondola car. The HO scale kit is composed of a single piece body, a separate underframe, a variety of both cast and etched detail parts. The coupler pockets that will accept Kadee #78 couplers.

Also included are 125-T trucks with 38-inch wheelsets. The kit is offered either with or without hoods and with either PRR, Penn Central or Conrail decals. A mini CD-ROM with assembly instructions, photographs and prototype his-

tory is included. Visit [www.railyardmodels.com](http://www.railyardmodels.com) for ordering information.

Southern Car & Foundry has released resin kits for two HO scale prototypically accurate radial course Class ICC 103 tank cars. The kits consist of a two-piece cast tank with the domes cast in place. The car frame and running boards are individual one-piece castings and the stirrup steps are bend-and-fold etched brass with the fold line etched in place to eliminate guessing. The kits are priced at \$49.00.



**This radial-course version of the SC&F HO scale tank car is ready for the paint shop.**



**Ted Culotta used preproduction components from SC&F to build this radial-course Spencer-Kellogg tank car for an article that appeared last year in *Railroad Model Craftsman*.**

Also new from Southern Car & Foundry is an O scale resin kit for a 40-foot Harriman combination baggage/RPO Car. The principal components are a one-piece body and one-piece cast underframe, plus laser-cut acrylic windows, cast steps and brake rigging details. The prototypically-accurate car kit sells for \$125 plus \$10 shipping and handling.

The patterns and molds for this unique prototype were developed by SC&F founder Jon Cagle using data from the Southern Pacific Historical Society

with an assist from Jack Burgess who climbed beneath an aging prototype to measure the underframe.

Coming up next in the SC&F Harriman series are a 60-foot baggage car and a 60-foot RPO. Visit [www.southern-carandfoundry.com](http://www.southern-carandfoundry.com) for full details.

 **Newsletter feedback!**  
**CLICK HERE** for reader comments on newsletter ... 



**The pilot model of Southern Car & Foundry's new O scale 40-foot head end car successfully captures the distinctive "Harriman" look.**





**Here's a look at the preproduction sample of a new O scale SP G50-23 gondola coming in May from San Juan Car Company.**

Look for **San Juan Car Company** to begin shipping its new Southern Pacific Class G50-23 drop-bottom gondola about May 1st. The 1/4-inch scale kit will consist of accurately-detailed injected-molded styrene body components, trucks, couplers and decals. The initial kit release will

be for a standard gauge model in both O scale and Proto 48 versions at \$79.95 each.

**Gugisberg & Sons Machining** is among the latest HO scale kits from the fertile mind of Randy Pepprock, founder of **Downtown Deco**. Although imposing in appearance, the model has a footprint of just 5 by 8 inches.

Priced at \$99.95, the kit is composed of cast Hydrocal plaster walls, plastic doors and windows, full -color paper signs, and awnings. The step-by-step assembly guide includes complete painting and aging instructions. Details are available at [www.downtowndeco.com](http://www.downtowndeco.com).

**HO scale Gugisberg & Sons Machining complex available now from Downtown Deco.**



**Atlas** is working toward a July release date for its new N scale general-purpose 20,700 gallon tank car based on the five section non-insulated body of the prototype developed in the mid-1960s by GATX - General American Transportation Corporation.

The Atlas model replicates cars with both Type 10 and Type 20 saddles as well as both one- and two-piece loading platforms. Decorating schemes for cars with Type 10 saddles will include GATX Target, GATX Service Driven and Pennzoil with the traditional yellow football logo. Cars with Type 20 saddles will be offered for RTLX Relco, DOWX Dow Chemical, GATX Quality Liquefied Feeds, and GATX Montfort Packing.

For the O scale crowd, **Atlas-O** will release Phase 3 versions of its ALCO C-424 locomotive decorated for Apache, Canadian National and CP Rail. The locomotives will arrive in June along with a C-424 Phase 1 decorated for Reading.

**Adair Shops** has a new adaptor kit to convert IHC passenger cars to use Kadee or McHenry couplers. Couplers are not included in the \$3.98 adaptor kit. See your dealer.



**Dow Chemical is one of eight decorating schemes for a new 20,700 gallon N scale tank car coming in July from Atlas.**

**About our news and events editor**



**Richard Bale** writes our news column under the byline of *The Old Yardmaster*. He has been writing about the model railroad trade for various hobby publications since the 1960s.

Richard is currently introducing 3 of his grandsons to the hobby by involving them in the construction of his fifth layout. He enjoys building models, particularly structures, some of which appeared in the June 2006 issue of *Model Railroader* magazine.





## Selected Events

### April 2009

**ARIZONA, WINSLOW**, April 17, 18, and 19, SouthWest Free-Mo, at historic La Posada Hotel & Depot. Sponsored by intermodal group with adjunct participation by Santa Fe Railway Historical & Modeling Society. Attendance is by invitation. Interested parties should contact Eric Hiser

(ehiser@msn.com) for availability of tickets.

**INDIANA, EDINBURGH**, April 25, Second Annual Hoosier On30 Mini-meet, Johnson County Park (35 miles south of Indianapolis), hosted jointly by the Columbus Area Railroad Club and the Hoosier Narrow Gauge Guild.

**INDIANA, SOUTH BEND**, April 17 & 18, 18th Great Lakes Model Railroad Symposium, South Bend Firefighters Union Hall, 4025 Lincolnway West. Presenters include Tony Koester, Jared Harper, Frank Hodina, Ted Culotta, Mike Rose and more. For details contact Jim Six at [www.glrmmrs.ning.com](http://www.glrmmrs.ning.com).

**MARYLAND, TIMONIUM**, April 4-5, The Great Scale Model Train Show, Maryland State Fair Grounds. Held several times a year ([see website for details](#)).

**NEW YORK, GARDINER**, April 17-18, Mid-Hudson On30 Meet. Contact Allen Littlefield at: [aklon30@yahoo.com](mailto:aklon30@yahoo.com) or 845-255-0974 for details.

**NORTH CAROLINA, HICKORY**, April 4, 7th Annual NC Railroad Extravaganza. For details call 828-325-4977 or contact [info@tarheelpress.com](mailto:info@tarheelpress.com).

**OHIO, COLUMBUS**, April 30-May3, NMRA Mid-Central Region "The 21st Century Limited" Convention. Ramada Plaza Hotel, 4200 Sinclair Road, Columbus, Ohio 43229.

**PENNSYLVANIA, DOYLESTOWN**, April 17-19, East Coast Santa Fe Modelers Meet on the Campus of Delaware Valley College. Includes ATSF model contests in several categories. Contact Stephan Parachuk at [sparachuk@hotmail.com](mailto:sparachuk@hotmail.com) for details.

**WASHINGTON, KENT (Seattle area)**, April 18, 10th Annual Northwest Santa Fe Mini-Meet, in conjunction with the annual open house of the Boeing Employees Model Railroad Club in the Boeing Recreation Activity Center (22649 83rd Avenue South. Presenters include ATSF specialists Bill Messecar, Robert Hoffman, John Thompson and Doug Nighswonger. For details and a registration form contact John Thompson at [JThomp1945@aol.com](mailto:JThomp1945@aol.com). ■

**UP** bids.net

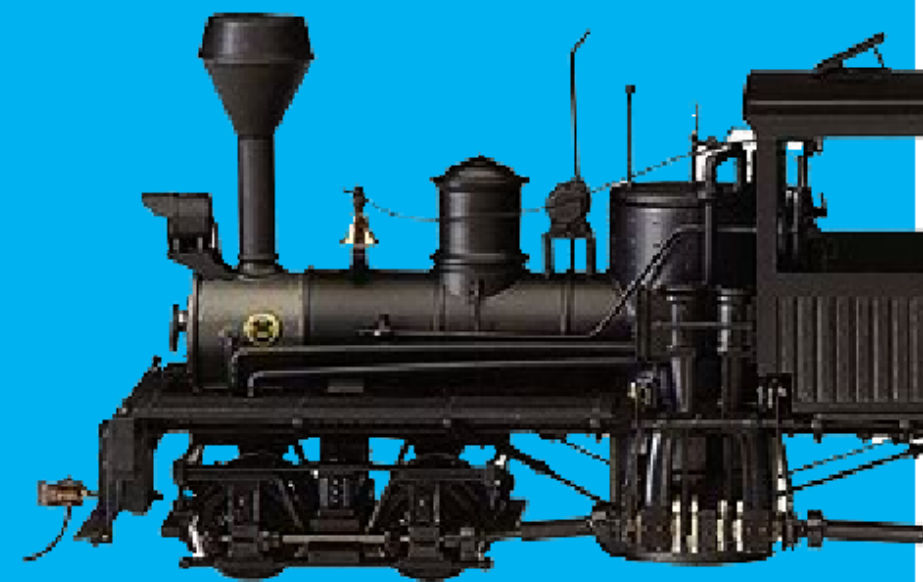



# MRH Sponsor Spotlight: Pulsar Professional FX



Welcome to...

## DECALPRO<sup>®</sup> fx

The most powerful graphics tools to come along in years!

Make REAL

Dry Transfer  
Graphics



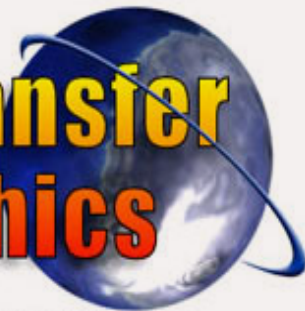



... in less than 10 minutes!



DecalPRO<sup>®</sup> is the only product on the market where you can make your own real "dry transfer" text and graphics in minutes for an unlimited number of applications and surfaces... from stainless steel to cardboard.

- Any graphic (even a signature!)
- Any color (plus metallics & white)
- Any surface ... all "on demand"

### KITS & LAMINATOR

KIT TYPES:	PRODUCT	DESCRIPTION	PRICE	PUR
	<b>COMPLETE Kit</b> Continental 48 U.S. States. <b>Ground UPS ONLY!</b>	Continental 48 U.S. States (Ground UPS Only!)  <a href="#">See "UPS Zone Chart" for number of days in transit for Ground Service</a>  Includes everything you will need, except for the unique laminator (below), a hot air gun and common miscellaneous supplies.	\$89.95	  
	<b>EXPORT/AIR Kit</b> For all "air"	You must locate the "KK-2000" adhesive. In the USA, contact any <a href="#">Jo-Ann's Fabrics</a> stores.		 

Pulsar Professional FX is one of *Model Railroad Hobbyist's* newest sponsoring advertisers.

If you're looking for a great system for making your own decal transfers, look no further than Pulsar's DecalProfx.

Ever since the ALPS printers disappeared from the market, modelers have been waiting for a method of producing their own decals using white or metallic colors. Well the wait is over, thanks to Pulsar!

Once you get to their web site, select the "Store" icon at the bottom of the left hand menu to shop for their various kits and supplies.

[Click here to visit Pulsar's web site.](#)

# Model Railroad Hobbyist magazine™

Issue 3 sneak peek ...

## Sergeant Couplers

First Look

— by Jeff Shultz  
Photos by the author

Sergeant Engineering, a Knoxville, Tennessee based company, has been manufacturing a line of HO scale knuckle couplers since 1999. Functionally incompatible with Kadee couplers, Sergeant couplers have smaller coupler heads than even the Kadee #58 series, as well as more detail on the head and knuckle. They represent a "bottom operating" type-E coupler. For the engineering minded, they are covered by patent #6308845.

The couplers come in 3 different working models – the EC87 "Compatible Shank," the EN87 "Narrow Shank," and the ES1P87 Steam Coupler/Pocket. Additionally, Sergeant Engineering offers Frank Glatz's operational rotary and dummy couplers, both of which



Figure 2: AFC coupler assembly jig with instructions and removal toothpicks. Used with EC87K normal shank coupler kits.

are compatible with the working couplers. The rotary coupler is a dummy head coupler mounted in a special rotary draft gear box. The EC87 and EN87 couplers are available both assembled and as kits, and the ES1P87 is only available as a kit. Assembly jigs are available for both the EC87 and the EN87 – called the AFC and the AFN respectively.



Figure 1: From left to right, a Kadee 148 "whisker" with #5 head, a #156 "long shank" with #58 head, and a Sergeant EC87A.

The AFC and AFN assembly fixtures are not interchangeable, being sized specifically for either the compatible or narrow shank couplers. The fixtures include some toothpicks, which are there to be used in prying the coupler out of the fixture after gluing. Detail parts include the BCL87 brass cut lever linkages (cut levers not included) that fit into slots on the bottom of either the EC87 or EN87 couplers to support cut levers. For those who want "top operating" type-E couplers, Sergeant Engineering will drill #80 holes in the top of the couplers for an additional fee.

The couplers are die-cast in a non-magnetic zinc material, with a rust colored finish, consisting of three parts – the top, bottom, and knuckle. In the middle is a steel ball that holds the knuckle closed – when a magnet is applied to the top, the steel ball lifts into a recess, and the knuckle opens when pulled on.

## Model Railroad Hobbyist magazine

The planet's most popular model railroading mediaZine!

Issue 3 release date:  
July 2009

Subscribe to **Model Railroad Hobbyist magazine™**  
[click here](#)



# Best of the West

## HO railfan sampler in a wide-open space

— by **Byron Henderson**  
photos by the author  
[www.LayoutVision.com](http://www.LayoutVision.com)

featuring California's famed Tehachapi Loop and some nearby scenes.

This is a favorite railfanning location for the client and with about 1700 square feet of useable space, I had no trouble creating a conceptual sketch comprising a spectacular version of Walong (The Loop), Caliente, Mojave Yard, a couple of connecting scenes, and space for staging.

But that sketch reminded the client of other favorite railfanning trips. And before you could say "scope creep",

**M**odel railroad layout concepts always seem to expand to just exceed the available space. And this project proves that this can be true no matter how large a space there is to begin.

Oh, it all started innocently enough. One floor of a commercial office building had been set aside for an HO model railroad



A long BNSF Trailer-on-Flatcar train approaches Caliente from the location of the former Tunnel #1/2. We're looking across the watercourse, fairly dry for most the year, shown on the layout plan.



**BNSF GE C44-9W #4686 leans into the curve just below Tunnel #9 as it leads a mixed freight consist toward The Loop in May, 2007. The oak grassland environment is typical of the area and the background looks almost as if a model railroader had painted it on a backdrop (note the purple and blue hues of the most distant hills).**

California's Cajon Pass, a stretch of the ATSF along Route 66 in the desert Southwest, and even a patch of snowbound Canadian Pacific rails had been added to the "must have" list.

And did I mention that some of the stiffer brass motive power in the extensive collection demanded a 38" minimum radius? The client also wanted

**"Clearly, a new strategy was in order. Even in a space this large, there was no easy way to make ... scenes flow smoothly ..."**

to maintain #10 turnouts for mainline sidings and #8s elsewhere.

### **More compression and abrupt transitions**

Clearly, a new strategy was in order. Even in a space this large, there was no easy way to make these very different scenes flow smoothly from one to the next.

Instead, I chose to isolate the scenes from one another visually, even though trains would pass directly between widely separated geographies. There was no call for industry switching or  
*Continued on page 22 ...*



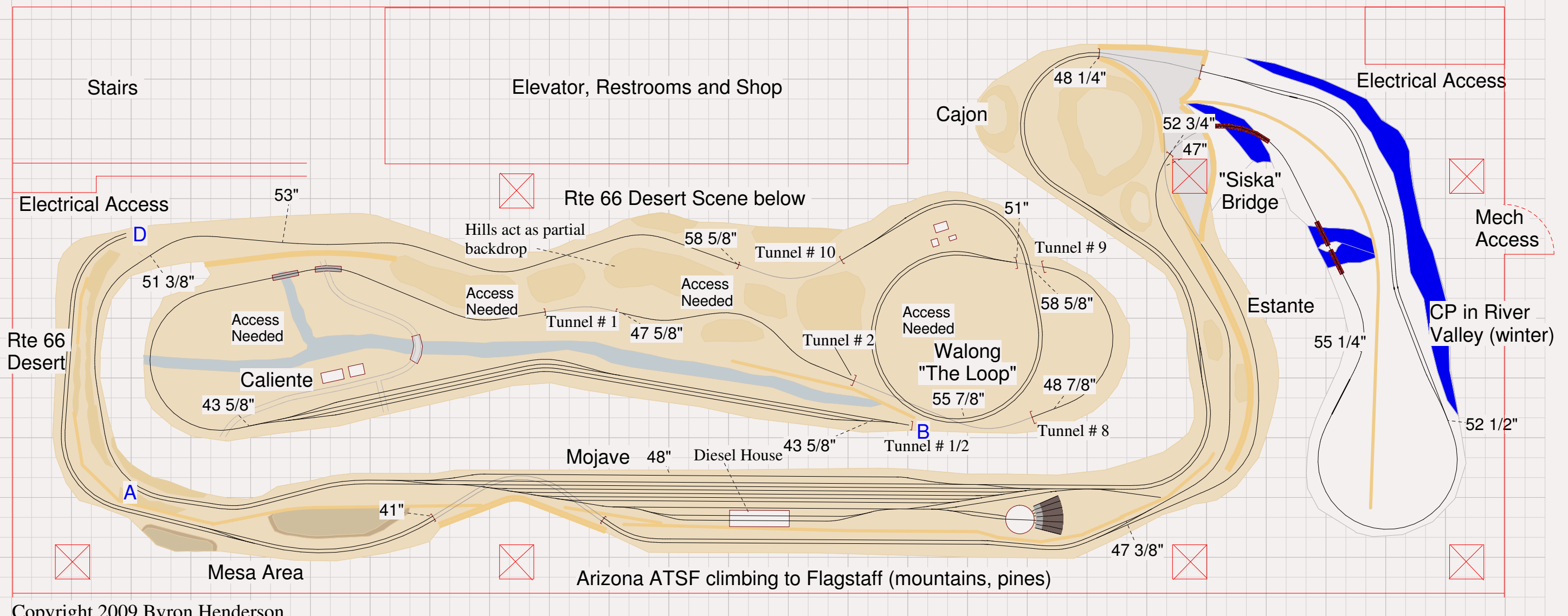

Copyright 2009 Byron Henderson

1-foot grid  
 HO Scale, room size 74' X 29' overall  
 42"R min. visible track, 38"R min. staging  
 Mainline turnouts #10  
 Yard & staging turnouts #8  
 Maximum visible grade 2.5%  
 Maximum hidden grade 1.8%

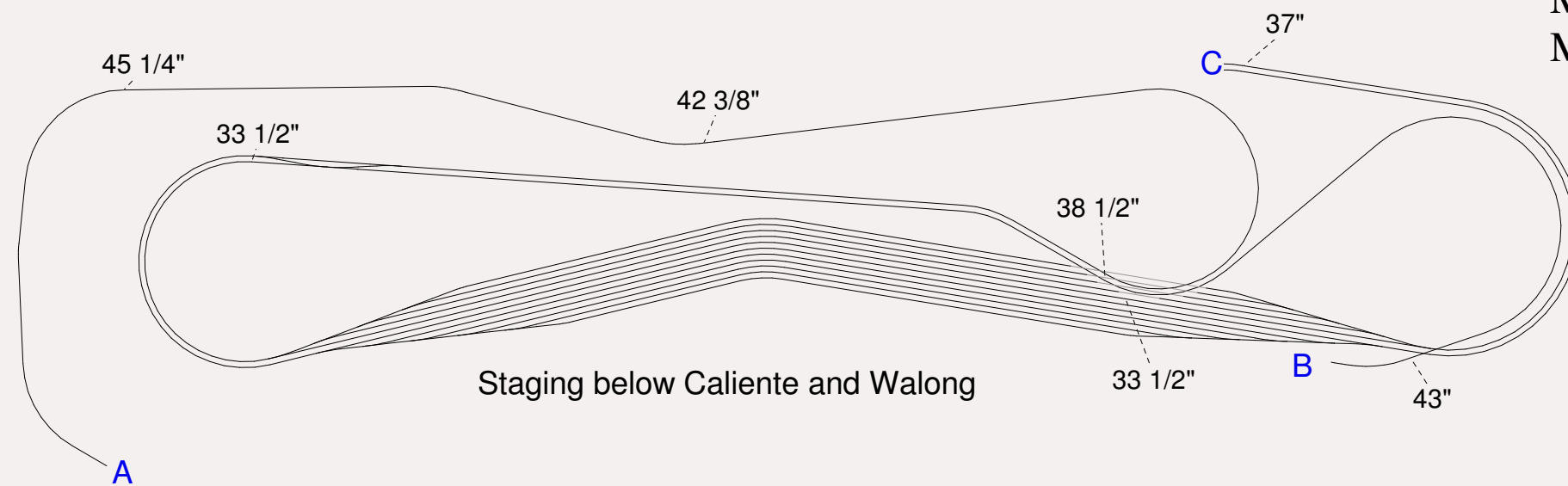

 **Article feedback!**  
 CLICK HERE for reader comments  
 on this article ... 



more urban scenes, but I left a spot here and there for future development.

The layout is on an upper floor of a multistory building outside the US, and local fire codes demand that areas inside the windows lining the bottom and left-hand side of the drawing be clear so that they may be used as entrances by emergency personnel from the outside.

So we'll use space along those walls and in front of other access areas for aisles. Substantial columns also complicate our planning.

The client's primary interest is in the current day operations of the Union Pacific and Burlington Northern Santa Fe, but the motive power spans a wide

range of eras. So some elements were mixed from old and new in the layout plan itself. Beginning in Mojave, there are both diesel and steam servicing facilities.

Aisle width needs don't leave any room for the town of Mojave (which would be in the aisle here); made modestly famous by [Pelle Sjøberg's](#) modeling.

Mojave, the major yard on the layout, will let the owner swap locos and make up and break down trains.

For most of its life, the real Mojave had no yard lead. The The layout design replicates its short switcher pocket near the roundhouse, which gave switch crews a place to duck out of the way.

## **Deep scenes trade off with linearity and access**

Moving clockwise from Mojave the mainline splits, with one leg diving behind some hills and a backdrop to descend to staging. We'll follow the other line as it climbs toward the famed Loop.

Through this area, rolling hills form a partial backdrop, with the distant, higher trains visible through the valleys from the aisle near Caliente.

This hide-and-seek creates a broader overall scene while still maintaining some sense of separation. Access hatches will be needed at multiple locations, trade-off the owner will accept in the interest of the deeper scenes.

Viewers move to the right along the aisle in front of Caliente. The tracks at the far side of the layout duck through Tunnel #10 before entering Walong siding and crossing over themselves at Tunnel #9.

As the trains circle, viewers can move around the scene for a full appreciation. Even compressed to accommodate the addition of other favorite locales, the loop's diameter is nearly 60% of its real-life counterpart.

And speaking of compression, trains next enter Tunnel #8, duck under the loop, and emerge from Tunnel #2, cutting out miles of intervening main line.

Now trains contour gently above Caliente and through Tunnel #1 before descending through the well-known horseshoe curve itself.

At Caliente, we represent the few (but often photographed) buildings of the prototype, along with a track or two more than are actually in Caliente today, because we need them for another place to meet and pass a train or two in this single-track stretch. Trains naturally reverse their direction relative to the loop.

## **Substantial staging for consist variety and storage**

Although in real life it has been "day-lighted" for years, we resurrect Tunnel #½ as another portal to subterranean staging.

Trains curve in a helix-free descent to the staging yard where 11 tracks range in length from 17 feet to over 30 feet long, allowing for a wide variety of consists to take their turns in the "best western" parade.

Grades are more gentle in the hidden trackage than in visible trackage to reduce operating problems.

On this layout, staging serves as more of a storage area than an operating destination, and its placement at this point in the layout schematic helps to separate the Tehachapi scenes from the geographical leap that is to come.

Trains emerge again on a separate narrow shelf tucked below the Tehachapi hills along the top of the layout drawing (point C to point D).

This double track stretch represents a bit of the BNSF/ATSF run across the



**The same train is now traversing The Loop for the obligatory railfan shot of the lead power crossing over the train, which could be recreated from the aisle on the layout. The trailing ATSF Super Fleet unit looks a little warweary, but still outshines the morerecent paint schemes, in my view.**



Southwestern Desert. The track continues counter-clockwise around the left side of the layout and through a defile between two mesas before tunneling briefly under Mojave yard to avoid a column.

The track then climbs through hills which might be dotted with evergreens to suggest the Flagstaff area.

### **Cajon ... and Canada!**

The double tracks part, with one track climbing to appear at the rear of the Cajon scene in the next aisle over, suggesting the distant SP mainline. This track then ducks out of sight before catapulting across a bridge in a snowy winter scene reminiscent of the Canadian Pacific's famous Cisco Crossings bridge.

This track continues around a long snowy lobe into a picturesque scene along a passing siding. The other track traverses a rock-cut ledge (Estante) before ducking out of sight and reappearing in the Cajon scene "around the corner".

Both of these tracks come together again as the lower double track main through the Cajon scene and then on to Mojave, completing our round trip. Space is set aside to replicate the bulbous rock formations typical of Cajon Pass.

Visitor aisle paths are deliberately non-linear here to create some "viewing space" between the snowy Rockies and dry Southern California desert

scenes. It's anticipated that most visitors will take in the layout scene-by-scene, rather than actively following a specific train.

The resulting layout includes as many of the owner's favorite railfan scenes as possible, at the cost of linear walkaround aisles in some places and virtually any traditional switching trackage.

While the single-minded model railfan focus may be an unorthodox approach, it does make for an appealing sampler of some of the West's most famous mainline locales.



Byron Henderson is a custom model railroad layout designer from San Jose, CA. His own under-construction proto-freelance N scale layout, the [Oakland Harbor Belt](#), is focused on waterside freight terminal operations near Oakland, CA in 1955. Byron is a member of the [Layout Design SIG](#) and [Operations SIG](#), and is a past editor of the LDSIG's [Layout Design Journal](#).



**S T A T I O N**

**With print media we  
can only have so much**



**CLICK HERE to see what  
this electronic media offers!**

**Making DCC Fun!**

**[www.Mr-DCC.com](http://www.Mr-DCC.com)**

**623-298-7355**





# Superdetail a Conrail Resin Kit Caboose

– by M.R. Snell

Photos by the author



One of the pitfalls of prototype modeling is the need for model replicas of sometimes obscure prototypes. While the 'Big 3' of model manufacturing concentrate on making models with broad market appeal, many smaller manufacturers are stepping in with niche products. These are often true craftsman style kits, cast in resin with accompanying etched metal or styrene parts.

Many of us have looked at resin kits only to walk away from them, feeling that some form of modeling superpowers were needed to build them. Resin kits were a mystery to me until I needed an ex-Erie Lackawanna caboose and turned to the resin kit marketplace. After constructing the resin kit I realized that there is really no mystery here

– just a few different methods & tools – and once completed a resin kit can look as good or better than a mass produced styrene piece.

To successfully construct a resin kit, there are several things which a modeler must understand about the medium they are working in. First, familiarize yourself with all the parts included in a kit. While this should be a standard practice when constructing any kit, this is absolutely necessary given the parts included in a resin kit.



Test fit the parts prior to beginning assembly so you'll have a better idea of how things will go together before the glue goes on.

The second step in constructing a resin kit is to clean all the parts. Resin parts are cast in a mold with a mold release agent. To be sure glue and paint adhere correctly, the release agent must be cleaned from the parts.

Soap and water can be used in some cases, while other situations may require specialized release agents such as Sylvan's Resin Prep or even Floquil DioSol. The instructions included with the kit will generally tell the products the manufacturer feels are safe to use with their kits. No matter what you use, the final cleaning step in cleaning is to rinse them in warm water.

Once the parts have been cleaned inspect them for warping, air bubbles or raised areas on the castings. Slightly warped parts can often be straightened by covering the part with hot water, then laying the part flat to dry with pressure applied.

Air bubbles can be filled with either a mixture of gap filling Superglue and talc (or corn starch) or a commercial body filler – such as Testors Contour Putty or Squadron Green Putty. Raised areas can be sanded smooth with fine grit paper (1200-1600 grit), insuring the castings will not have deep scratches.

Flash is much more common in resin kits than in conventional styrene

kits, especially in open areas such as windows.

Flash can be trimmed away with a sharp #11 blade, and caution should be exercised when working with small or thin parts. Resin is much more delicate than styrene and properly supporting the part while trimming the flash will insure it is not damaged.

Successfully assembling a resin kit may also require us to change the tools we use – for example the cement we use to assemble models. Unlike styrene cements which form a bond by dissolving thin layers of the styrene, resin kits must be assembled using Superglue, preferably with a gap filler.



Superglue does not bond well with itself. When cementing pieces together, apply cement to one part only, then hold the 2 pieces together for a few seconds until the joint is set.

Keep your fingers or clamps well away from the joint, or Superglue will flow underneath and leave marks on the finished model.

One useful technique in constructing resin kits is 'tacking' parts such as walls together by applying cement in several places along the seam. Once the joint has set, it can be reinforced by applying a bead of cement along the joint.

Now that we've had a basic overview of working with resin kits, I'll share how I modeled Conrail 46111 – an

ex-Erie Lackawanna caboose. The resin kit is made by JLL Models, which offers kits for both the riveted and welded versions of this ex Erie / Erie Lackawanna caboose.

 **Article feedback!**  
[CLICK HERE for reader comments on this article ...](#) 

## The Prototype: Conrail's N-3 and N3A

The Conrail N3 class was a riveted steel cupola type caboose, built in 1941 by the Erie Railroad (ex EL / ERIE C-100 to C-169). The N3 served both the Erie and Erie Lackawanna and Conrail, but only 3 of these cars received the standard Conrail blue and black revenue scheme. The balance of the N3 fleet was painted into the grey and black MW scheme and assigned to maintenance of way service.

The N3A class was similar, but welded, constructed by the Erie in 1945 and 1946 (ex EL (ex ERIE) C-170 to C-269). This was the last class of of cabooses, constructed in the Erie's Dunmore Pa. shops. The bulk of the N3A cabooses were placed



into revenue service with only a single caboose assigned to MW service.

To find a full description of the N3 and N3A, as well as photos and drawings, see the Conrail Caboose Home Page (<http://crcaboose.rail-fan.net>) on the web. ■

**See the step-by-step construction of this caboose from a resin kit on the following pages ...**





## STEP 1: Constructing the Model – Getting Started

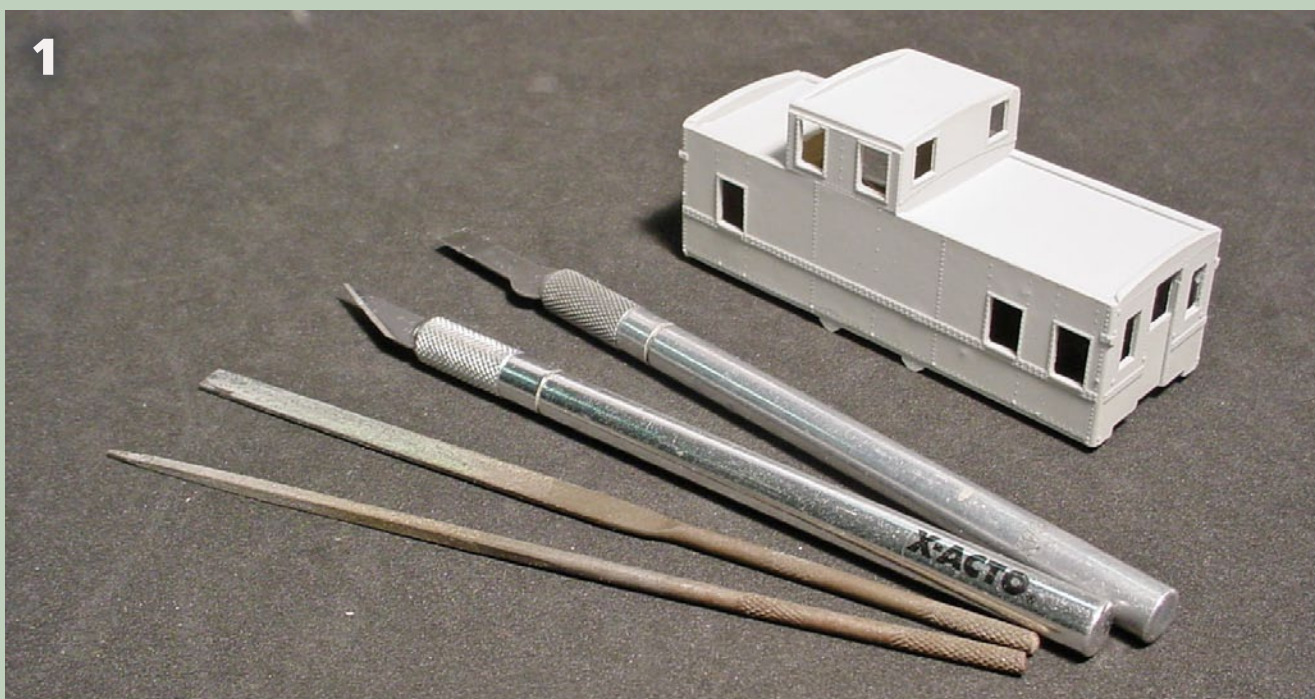

I chose to build an N3 class assigned to MW service, based on a photo in the Conrail Color Guide, by Morning Sun Books. Prior to starting construction on the model, the various parts were cleaned and the flash in the window and door openings was removed from the one piece body casting using a sharp #11 X-Acto blade, a #17 X-Acto chisel blade and needle files.

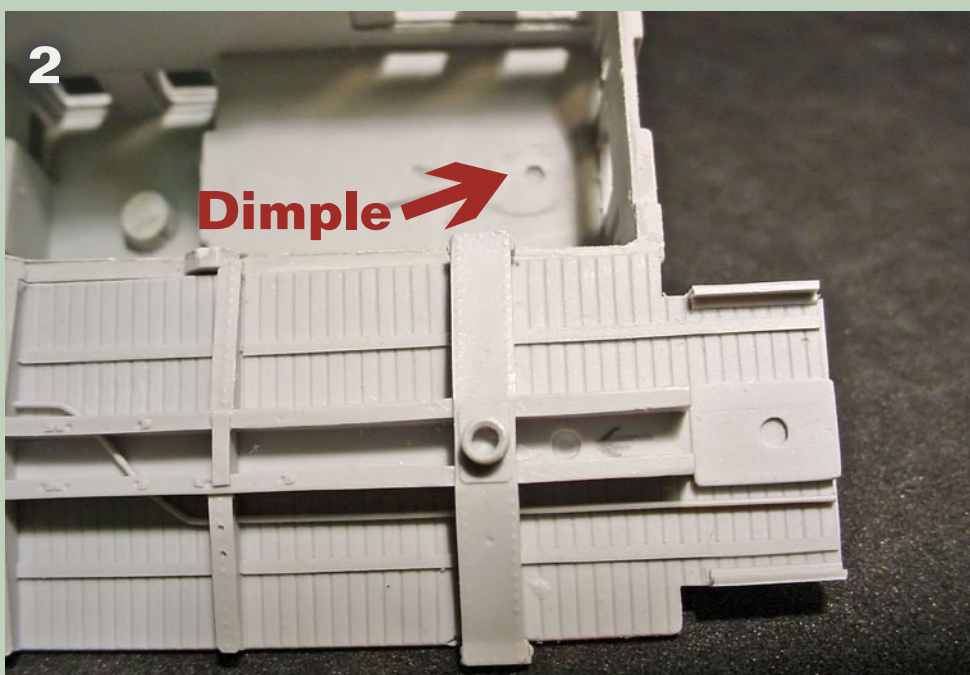

The kit floor includes a thin “sprue offshoot” with the end beam castings. Remove the floor and clean the edges up with a knife and file. Then locate and mark the dimples on both the floor and underside of the caboose body. These dimples are both located at one end of the castings. Insuring that both sets of dimples are at the same end of the caboose is required for proper assembly.

## STEP 2: The Caboose Underframe

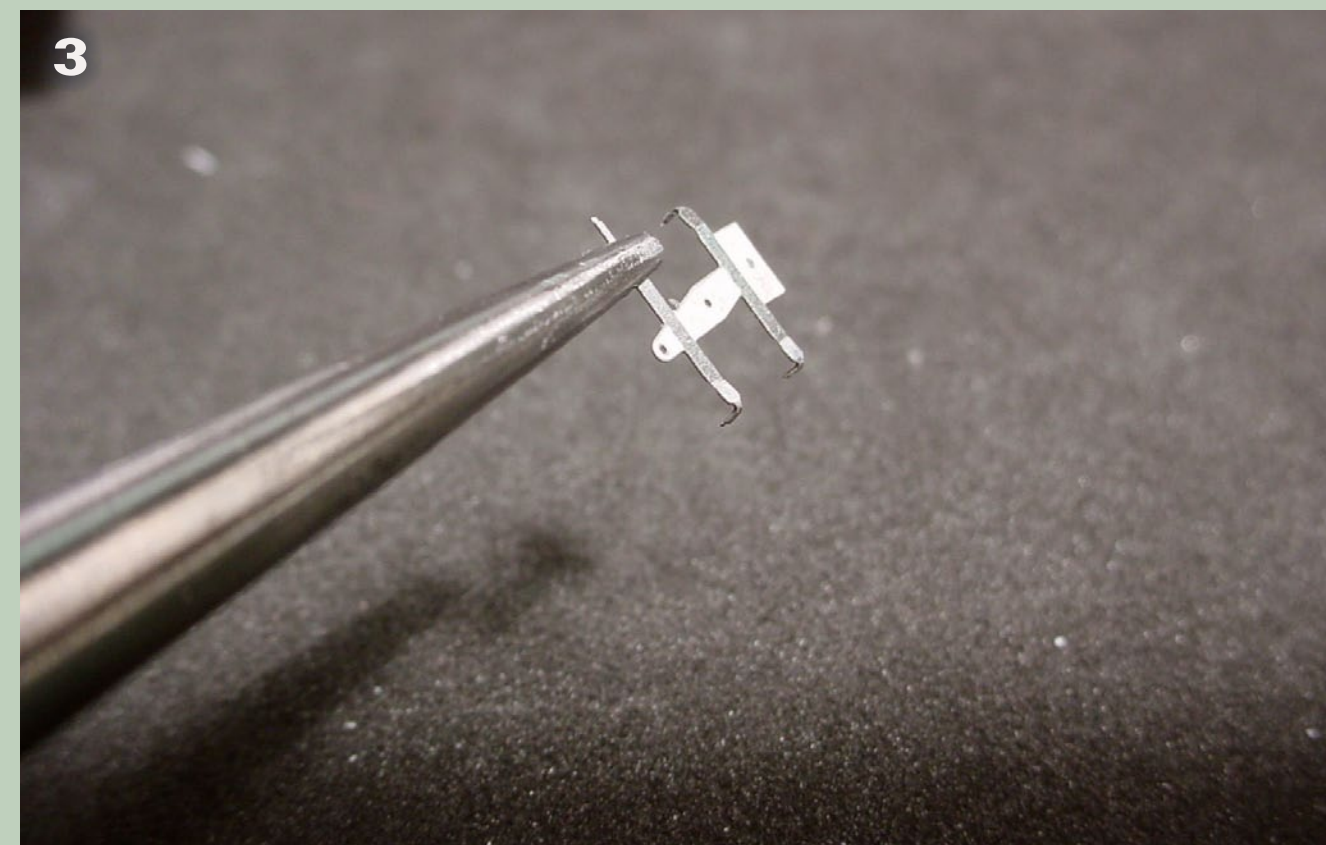

The JIL Models kit comes with a fret of metal etchings to be added to the body, ends and underframe (carefully remove the metal parts with flush cutters to avoid distortion of the parts). Remove the underframe brake rigging components from the sprue and bend the outer edges of each leg at the crease line. Using a pin vise, drill a #78 hole at each dimple on the underframe, then insert the etchings into the holes and cement them in place.



### MODELERS TIP

To keep excess cement off the model I recommend making a small puddle of cement on a piece of scrap plastic and then dipping a thin piece of wire into the cement. The cement can then be transferred to exactly where you want it by carefully touching the cement-coated wire to the joint between the etching and shell, or by applying the cement to the etching prior to placing it on the model.

Use this method for construction of the entire model where cement cannot be applied from the interior of the shell. You can use this method in your other modeling projects as well.



## STEP 2: The Caboose Underframe (continued)

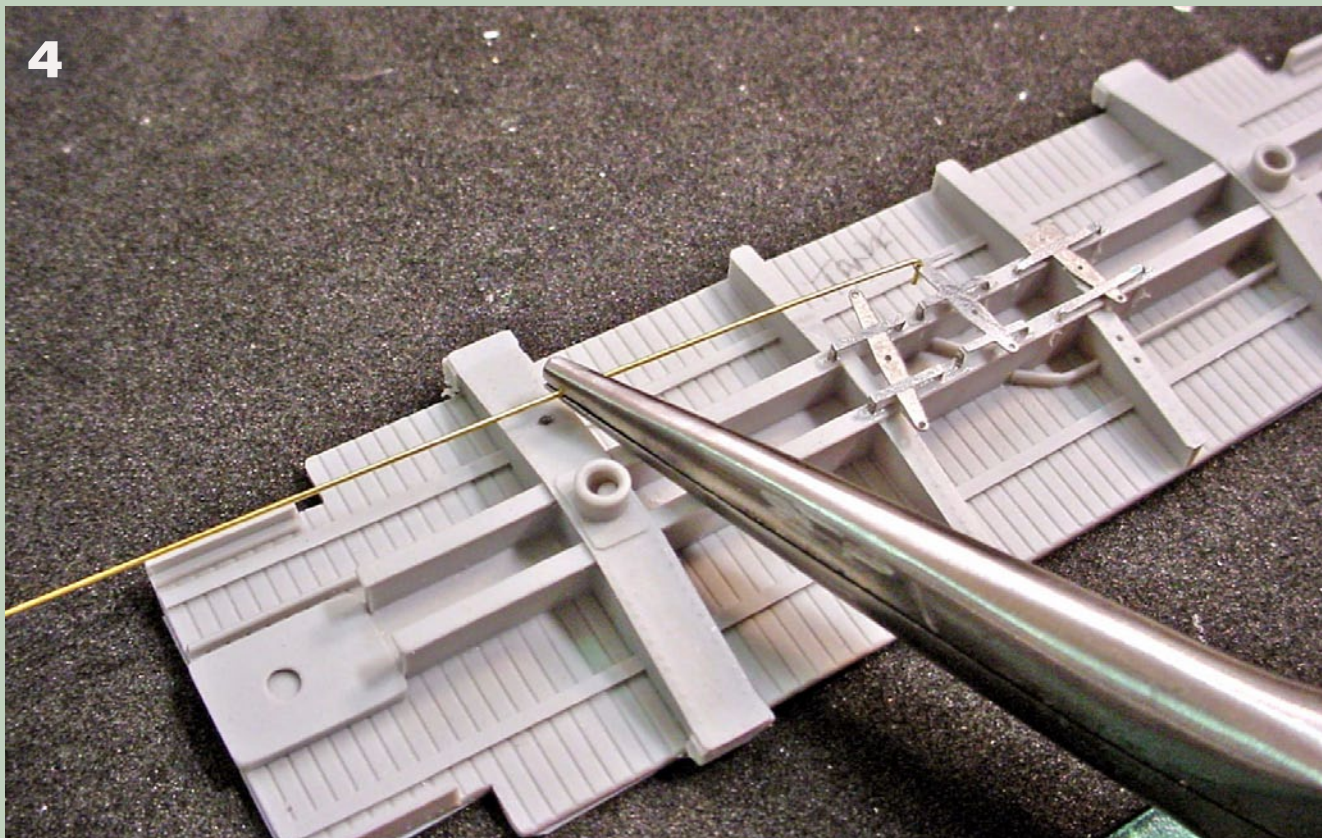

To simulate the underframe rigging and piping, Detail Associates #2505 brass wire can be cut to length, then easily bent to shape and installed using the guide in the instructions as a template. When installing the wire it is important to insure that the wire will not interfere with truck swing and thus derail your model. This caboose has an extremely short wheelbase and will require substantial truck swing in tight radius curves. Once you are satisfied with the alignment of the piping and rigging, drill the appropriate holes, insert the wire and cement each in place.

After the underframe brake rigging is complete, drill out the bolsters and coupler pockets using a #56 drill, taking care not to drill through the top of the floor of the end platforms. Tap these by gently inserting the screws provided with the kit. Test fit the Kadee coupler boxes and your choice of trucks from Bethlehem Car Works, Atlas, Athearn, or several brass manufacturers.

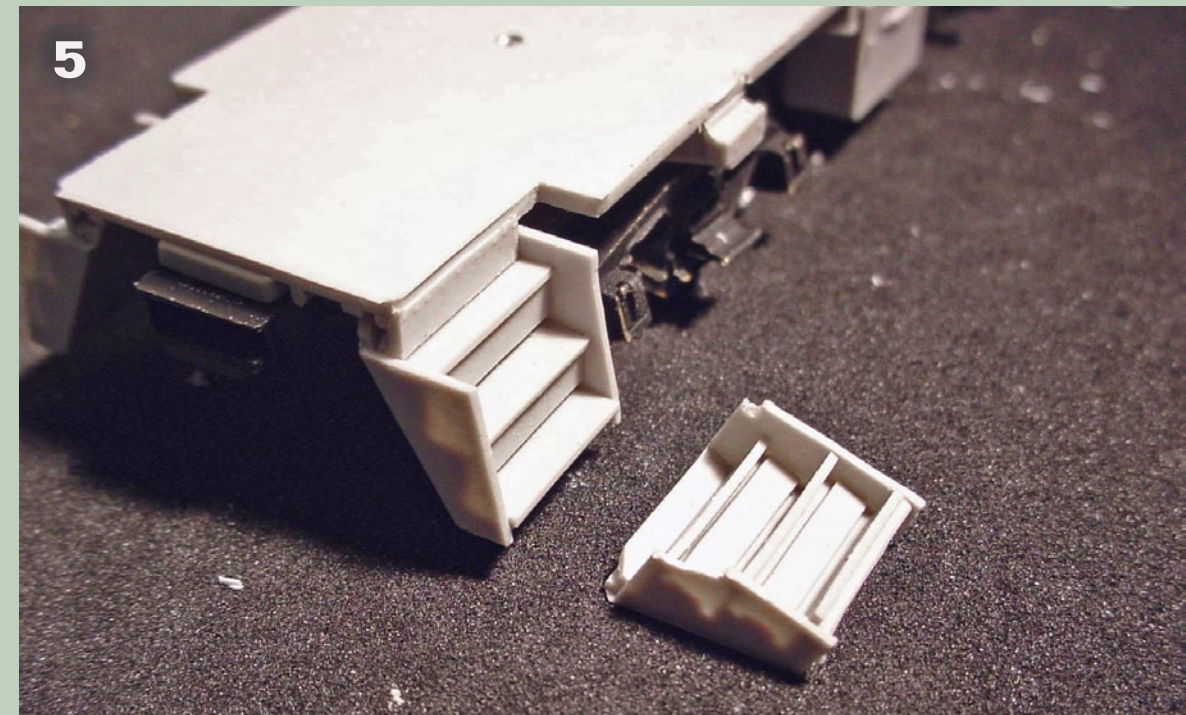

The final step in underframe construction is to add the steps and brake gear. The steps are notched at one end and the notched end should be placed inward, toward the center of the caboose. When the steps are properly aligned a small portion of the top of the step casting will align with the bottom of the end of the car as shown in the photo.

The steps may be cemented in place by applying cement along the top edge of the step and aligning the top edge behind the bottom edge of the floor. To complete the underframe, the brake tank and valves may be cemented in place. If your specific prototype was equipped with a battery box it may be cemented in place at this time.

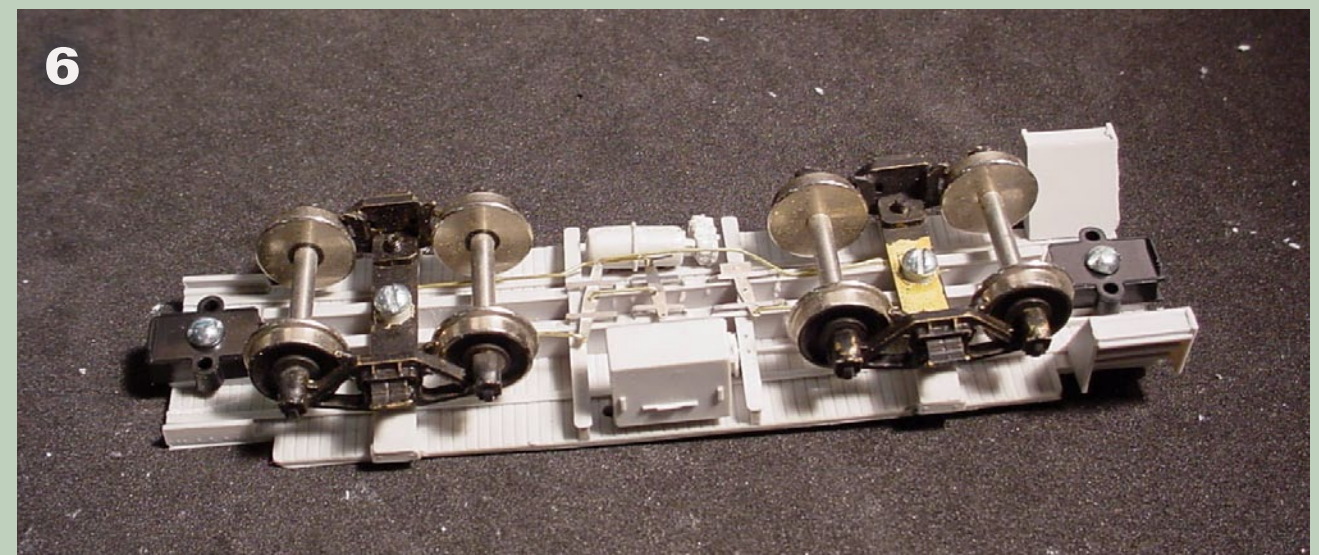



## STEP 3: Constructing the Caboose End Beams



With the underframe complete, we can begin building up the top of the model, beginning with the end beams which consists of 3 separate parts, along with detail parts such as grab irons and brake wheels.

To begin constructing the end beams, remove the end beam and ladder etchings from the sprue of metal parts. Then clean up the resin end beam castings with a file.

Place (but do not cement) the caboose body onto the floor, then remove the metal end beam etchings from the sprue. Bend the tab at the top edge of the upright inward towards the caboose body, then cement this in place on the end of the caboose floor as shown in the photo above.

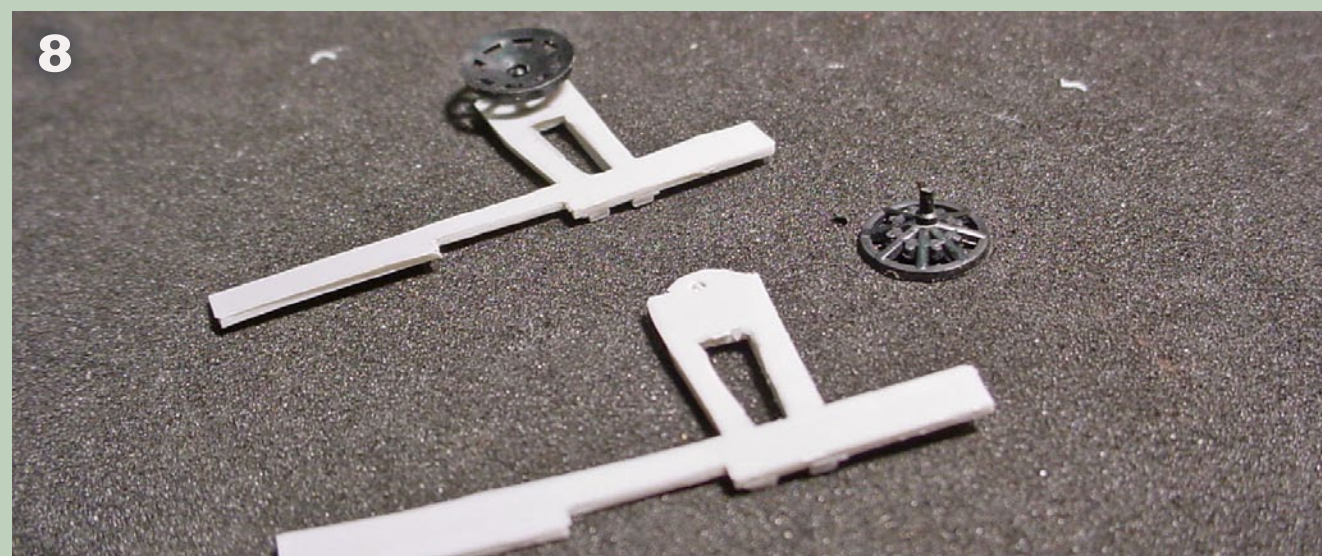

The final step in underframe construction is to add the brake wheel and its supports. Drill holes in the resin castings, then cement the brakewheels in place on the resin castings and cement the resin end beam casting in place over the metal etching which was installed earlier.

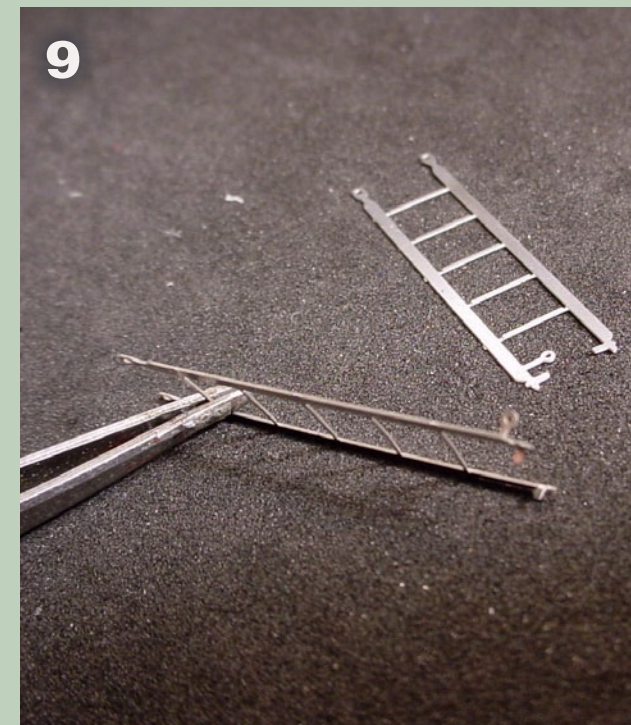

Remove the ladder etching from the sprue. Bend the ring on the ladder etching outward and bend the mounting tabs inward. This ring will support the cut bar, which will be installed later. Finally, drill out the holes in the resin end beams for the ladder tabs and cement the ladder in place.

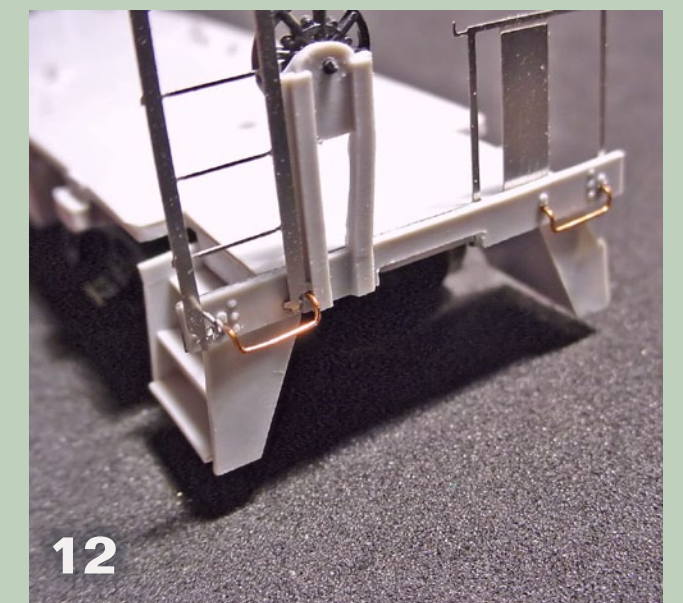
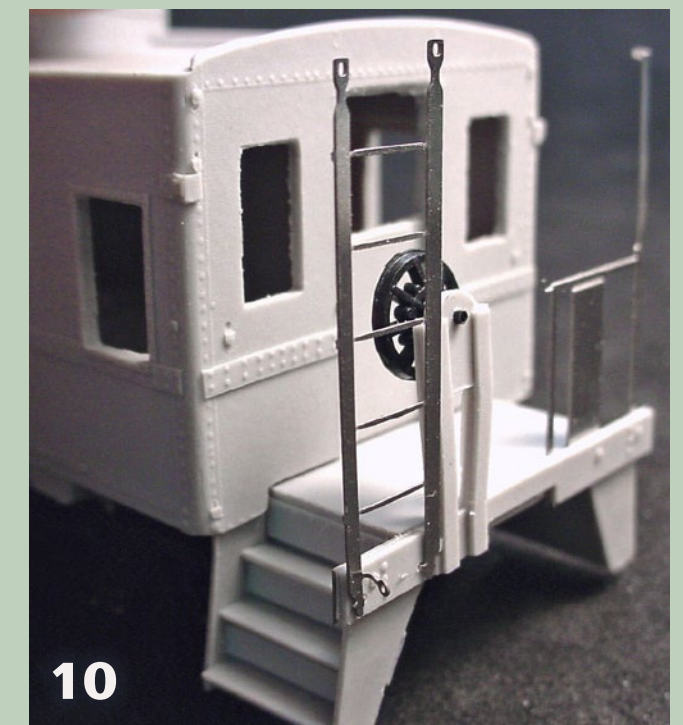

The kit also contains grab irons to install on the resin end beam. Drill out the dimples using a #80 bit, then cut down the grab iron mounting legs so the grabirons will not protrude excessively inside the end beam when installed. Cement the grabirons in place on the end beam. Remove the body shell and set the floor assembly aside.



## STEP 4: Detailing the Caboose Body

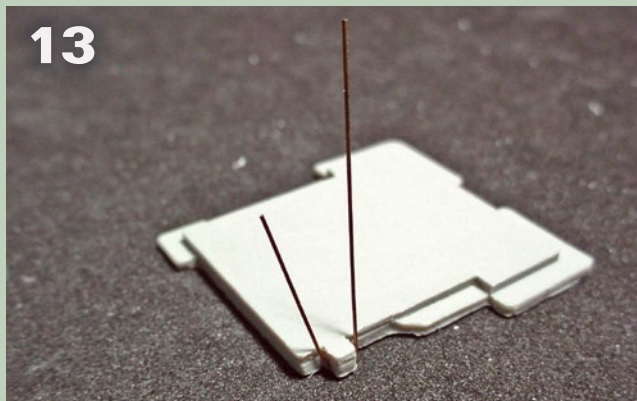

13



14

The JLL Models kit comes with most of the detail parts you'll need, but there are 2 parts which will need to be fabricated from wire. Prior to installing any detail parts we'll fabricate the 4 small upright grabs which will mount on the ends of the caboose.

Cut a 3" length of brass wire and bend this as shown above in picture 13 using the jig supplied with the kit. Once the 4 grabs have been bent, cut the grab legs down to a size suitable for installation on the model.

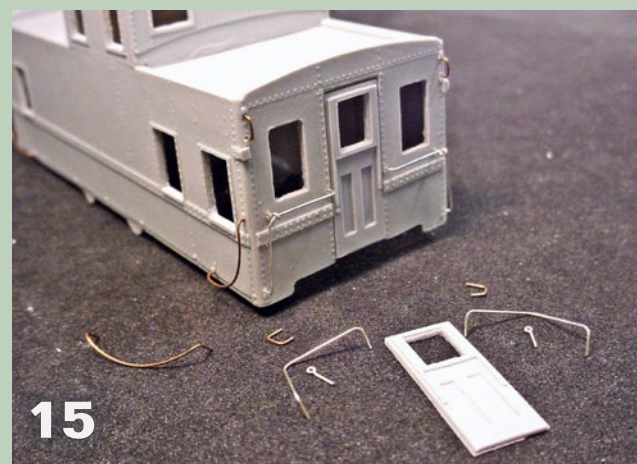

15



16

To begin detailing the caboose ends, drill out the dimples for the "L"-shaped grabs using a #80 bit. In addition to the 2 dimples located at each end of the L-shape you will also see a dimple located in the bend forming the "L". Drill this out as well, so an eye bolt can be inserted in this hole. Thread an eye bolt over the "L"-shaped grab and insert the bottom leg of the grab in the bottom hole. Moving upwards insert the eye bolt leg and finally the top leg of the grab in the remaining holes.

Drill out the dimples for the upright grabs (located higher than the L-shaped grabs) and install the parts which were fabricated earlier onto the caboose ends. Once you are satisfied with the alignment of the detail parts, cement each in place and finish the end detailing by cementing the

door in place. Moving to the sides of the caboose, drill out the dimples for the curved grab irons and install and cement these in place.

Conrail cabooses that were received from the Erie Lackawanna generally retained the window screening and guards applied by the E-L and one of the most appealing features of this kit is that each has been included as a metal etched part.

Remove these parts from the sprue and cement the end window guards in place. The easiest way to cement these in place is by holding the screening with a tweezers and applying cement to the backside of the one end of the etching using the wire technique. After the first end has been aligned on the body, add cement to the opposite end then press the etching in place.

Using prototype photos as a guide, install the side and cupola screening by cementing these in place. Placement variations exist as parts were removed due to damage, so always refer to photos when adding these parts.

E-L MODELERS: Do not add these now. The car should be painted first and the window screening is painted a different color!)

The best way to cement these to the body is to follow the same procedure used on the end windows. Apply cement to one end of the screening, hold it in place on the model, and apply cement to the opposite end using the wire technique.

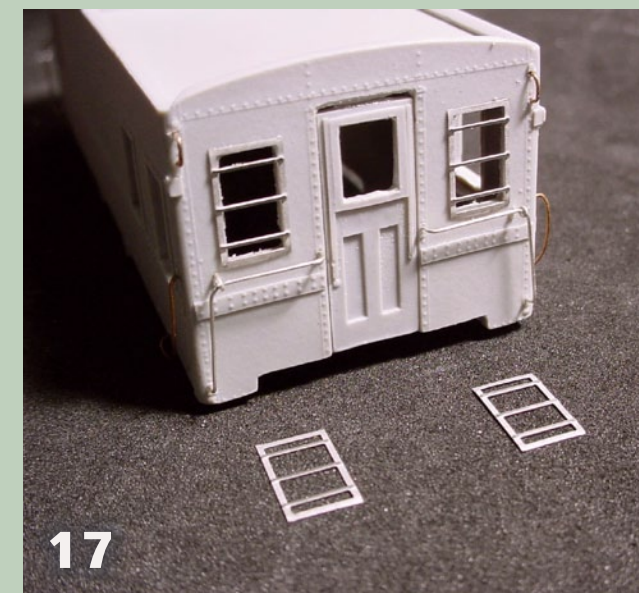

17



18



## STEP 4: Detailing the Caboose Body (continued)



If the specific caboose you are modeling was equipped with rain guard strips over the windows these have been included with the kit as well.

Remove these from the sprue and drill the appropriate mounting holes on the caboose body and cement these in place from the inside of the caboose body. Once the rain guards are in place, bend them at a slight downward angle to match prototype photos.

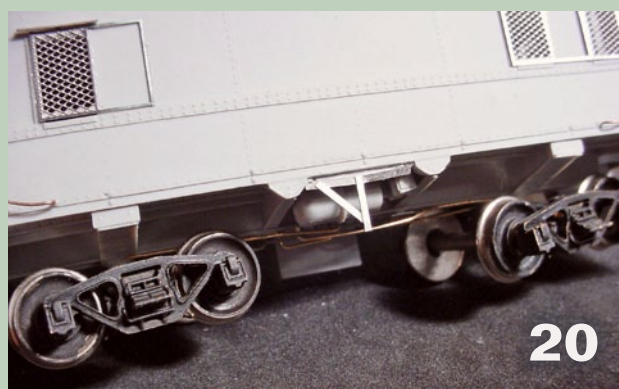

To finish detailing the body, cut the etched triangular brace from the sprue and cement it in place on the side of the caboose, recessing it behind the triangular plates which extend below the sidesill.

## STEP 5: Assembling the Roof

One nice feature of the kit is that the roof is 3 separate molded parts, which means the car can be painted without masking. The roof will be assembled off the car and added after the car is painted.

The roof consists of 3 rounded top sections, a smoke jack, and etched roofwalk parts. The grabs which are mounted on the top of the cupola are not included, but can be bent from wire. Also not included is the firecracker antenna applied to many E-L cabooses. If the caboose you are modeling requires a firecracker antenna these are available from Detail Associates and Details West, among other manufacturers.

To bend the grabs required for the top of the cupola, begin by drilling out all the dimples with a #78 drill (3 per grab). Bend a length of wire at a right angle, insert it into the first hole, and align it with the edge of the roof (below left). With needle-nosed pliers hold the wire where the corner bend should be and gently bend it so it forms a corner (picture 22).

Make another bend where the second leg will insert into the third hole. Press fit the wire into the holes, but do not cement this in. Perform the same procedure for the other corners, then remove all the newly formed corner grabs and cut the grab legs to length.

Thread a Detail Associates #2206 eye bolt over each of the grabs and cut the mounting leg down so it is even with the mounting legs of the grabs. You may then reinstall the grabs using the eye bolt in the center hole. Once all the grabs have the same height alignment they may be cemented into the roof from the underside.

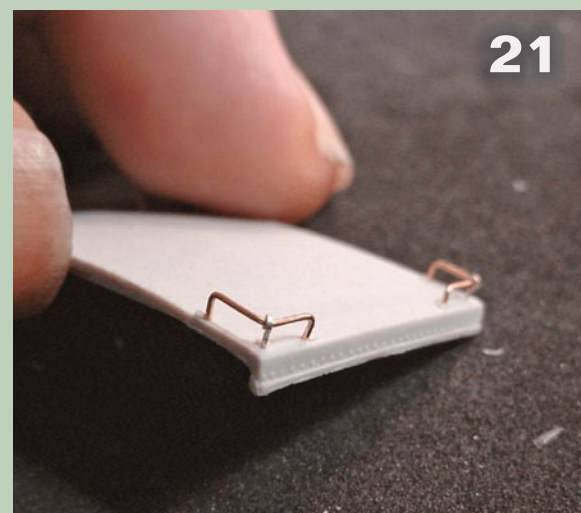

While most of the N3 & N3A cabooses conveyed to Conrail had their roofwalks removed prior to 1976, the kit does include etched roofwalk supports and roofwalks. I chose to model the roofwalk supports only, representing the removed roofwalk.

To add the roofwalk supports drill out the jig included with the kit using a #77 bit held in a pin vise. Place the long roof section into the jig and drill the holes for the roofwalk supports, then repeat this for the short roof section.

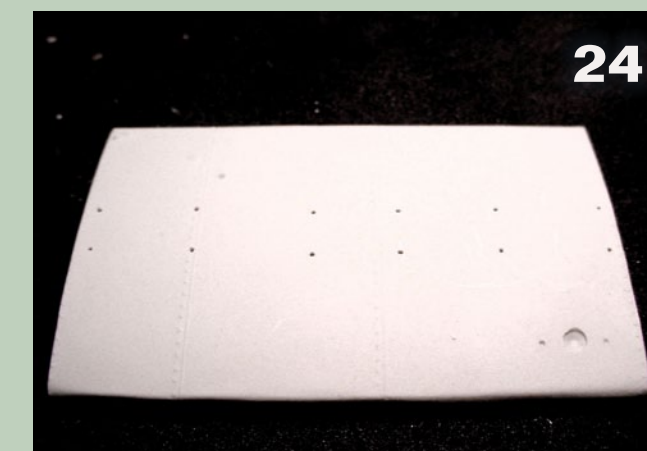
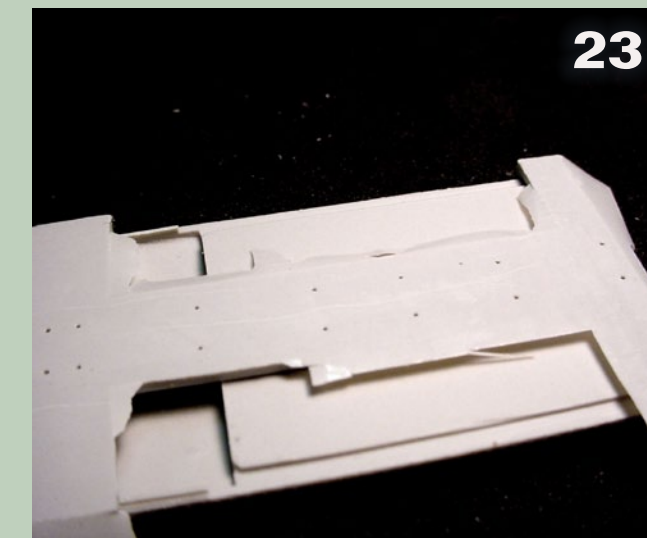



## STEP 5: Assembling the Roof (continued)

25



The last step in constructing the roof is to add the smokejack. Drill the holes in the roof for the smokejack and guy wires, and also drill a hole through the smokejack for the guy wire.

Cut a length of wire approximately 3 times the height of the smokejack and insert the wire through the smokejack. Bend both ends at a downward angle (picture 27) and cut the wire so it is approximately ¼" longer than the length of the smokejack.

26

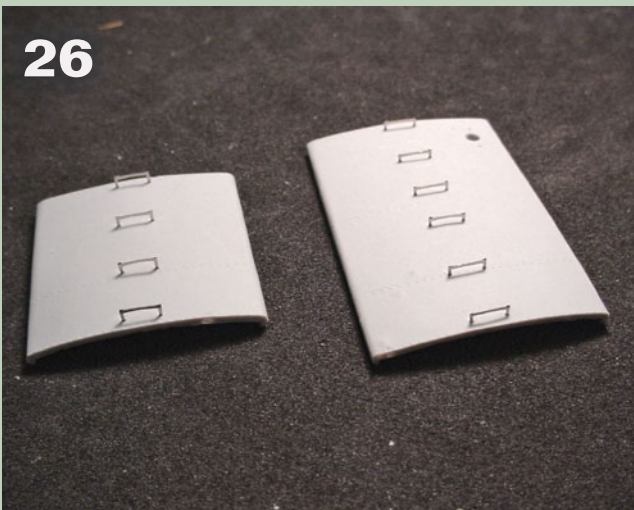

Cut the roofwalk supports from the sprue and either bend the flat support sections at a right angle or remove them entirely to represent a roofwalk which was torched off. Install the supports into the holes and align them so all have the same height above the roof, then cement them in place from the underside of the roof.

Insert the smokejack into the roof, beginning with the two guy wires. After the smokejack is in place, pull the guy wires tight from the underside of the roof using pliers. Cement the entire assembly from the underside of the roof and then cut off all the excess so it is even with the underside of the roof.

27



28

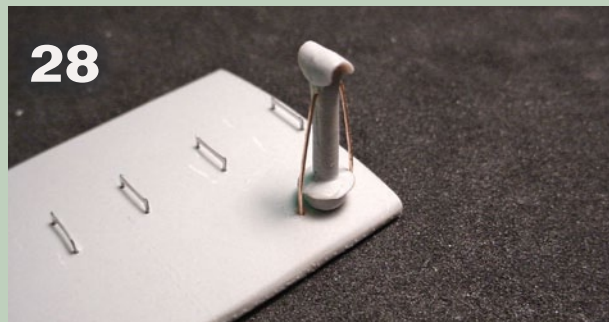

# New York Railway Supply



A nice turntable model ...

... plus our turntable motorizing products – means the *best* turntable operation in the hobby!



Click to learn more ...



## STEP 6: Painting the Model

Painting a resin kit is slightly different from a styrene kit but the same general principles apply. Prior to painting the caboose wash it to remove any oils or dirt. The best results I have achieved when painting resin are with solvent based paints.

When painting with water-based paints, first prime the model. When painting multiple colors which require masking, always remove some of the adhesive from the tape prior to applying it to the model. To prevent damaging previously applied paint remove the masking tape as soon as possible.

For Conrail 46111, I airbrushed Floquil SP Lettering Grey for the body and

Engine Black for the roof, underframe, steps, and trucks. As the kit was designed so little masking would be required the roof was painted black and installed after painting.

Once the paint had dried, the steps and end platform walkway were brush painted black and the bolster rivet plates (rectangular plates upright on the side of the floor) were painted grey.

All the grabs on the body (side curved grabs, L-shaped grabs, and upright grabs) as well as the grab irons on the end beams, the lower half of the end uprights and outer edge of the ladders were hand painted white using a 00 brush.

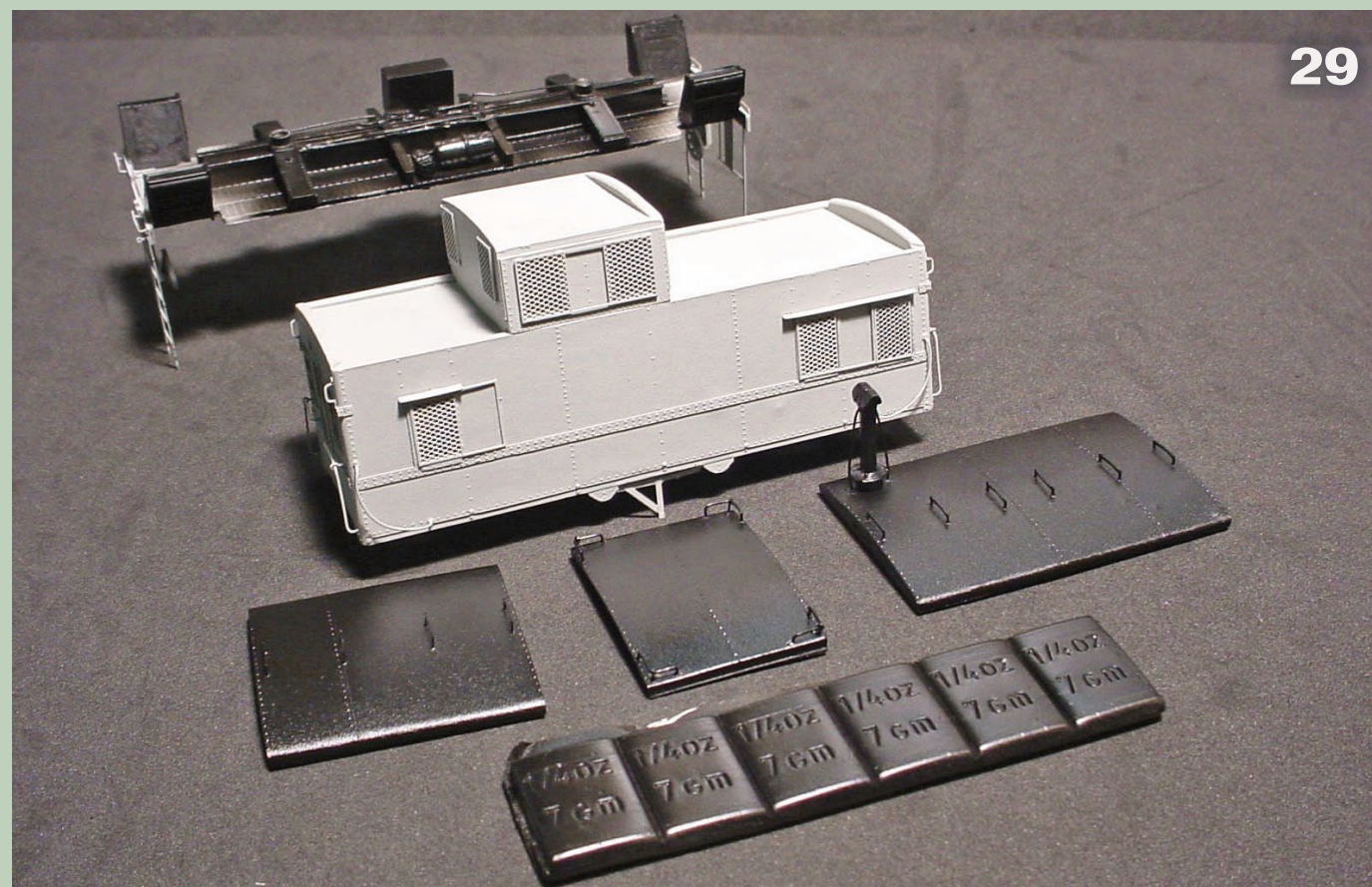

**THE BEST MODEL RAILROAD DVDS IN THE WORLD!**



**TOM MILLER'S  
FABULOUS F-SCALE LAYOUT**

**The Hobby Run Amuck**  
Building A Live Steam Railroad  
With Master Model Builder

**Tom Miller**

**Riding the Rails**  
on  
**Tom Miller's Fabulous  
F-Scale Layout**

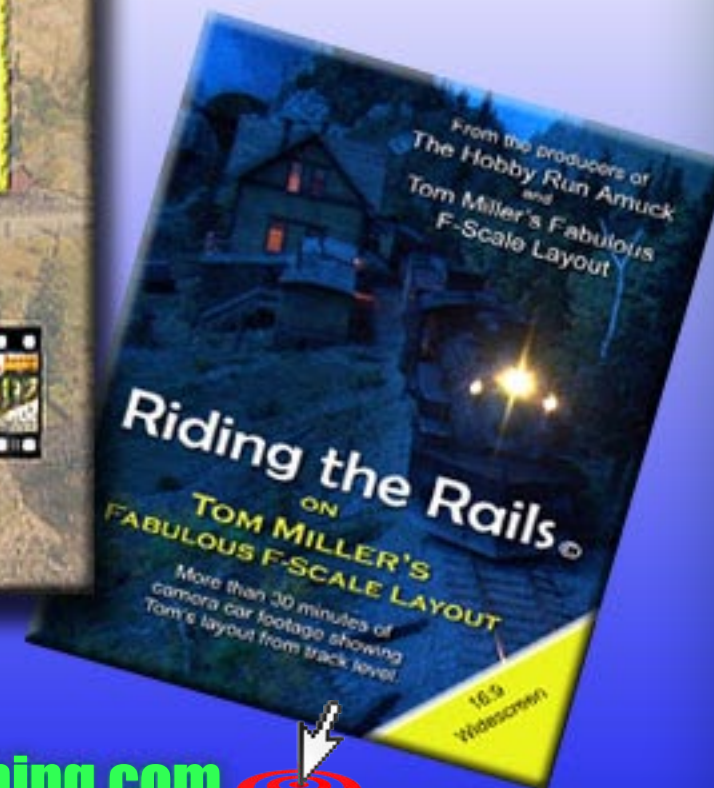
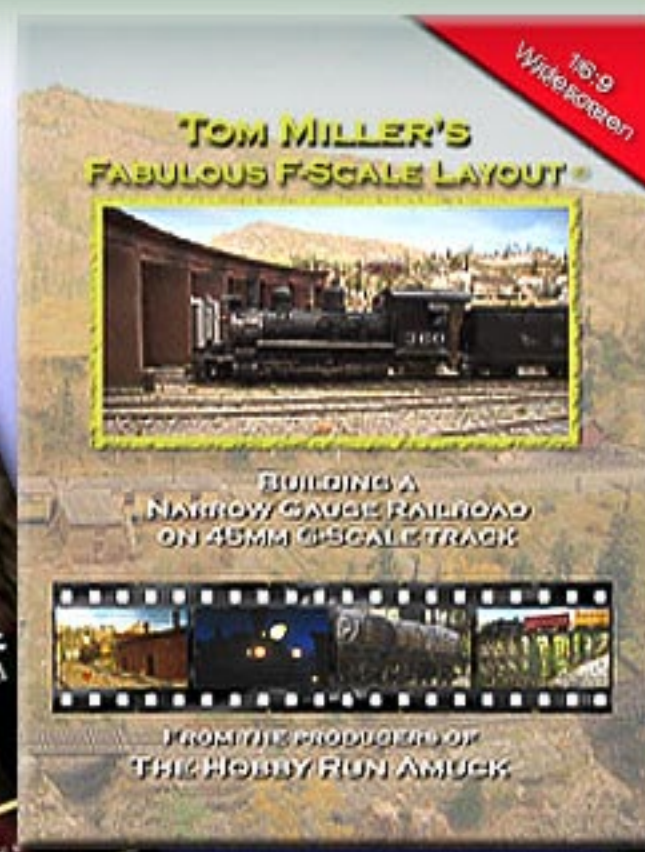
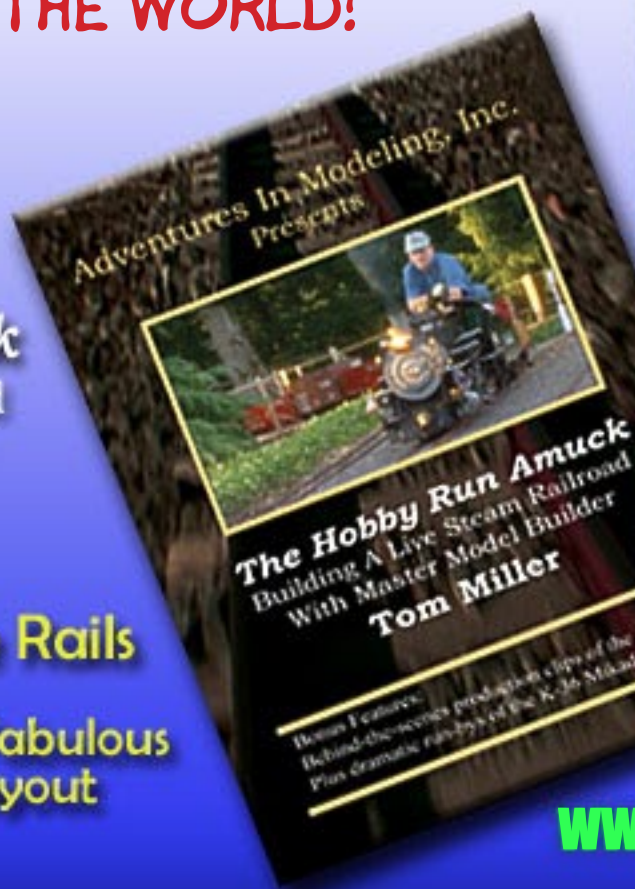

[Click for Previews](#)

"I really enjoyed this DVD...  
It shows model railroading  
at its best."

Bob Brown, Editor  
Narrow Gauge and  
Short Line Gazette

[Click for Reviews](#)

Order Direct at:

[www.pacificvistapublishing.com](http://www.pacificvistapublishing.com)



## STEP 7: Final Assembly and Decals



Once all the paint had dried the trucks and stick on weights were installed in the center of the floor. Clear window glass cut from Evergreen #9005 clear styrene was installed into the window openings on the inside of the caboose, held in place by the plates included on the etched parts sprue.



The body was placed onto the floor and secured with a drop of cement at each corner. Assembly was completed by cementing the roofs in place, using care to keep any excess cement from oozing over the roof edges onto the body.

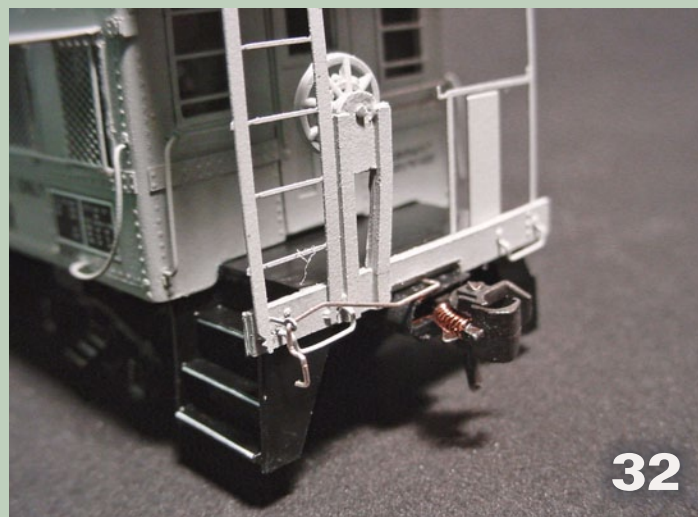

This version of the caboose was decaled using SMP set #5823 which includes both the black lettering & logos suitable for Conrail MW service, as well as the standard blue revenue service scheme.

Modelers of Erie and Erie Lackawanna can find suitable decals at both Microscale and Prime Mover Decals (8 Fawnridge Drive Long Valley NJ 07853 [www.primemoverdecals.com](http://www.primemoverdecals.com)). The white step safety striping may be added using Microscale 2" white striping and various wheel inspection, lube plates, and ACI labels are available from Microscale or can be taken from various decal sets.



I encourage all modelers to try a resin kit to add a previously unavailable piece of equipment to your roster.

Once the cloak of mystery was removed the kit went together quickly and easily in only two afternoons, allowing the addition of a previously unattainable piece which filled a void in my prototype roster.

See a 3D click and spin image of the finished caboose on the next page. ►



M.R. (Matt) Snell has been a model railroader and railfan for 30 years. His interest in railroading blossomed while growing up in New Jersey surrounded by multiple freight and passenger rail lines including Amtrak's Northeast Corridor.

Presently residing in Ohio far from his railroading roots, Matt & his wife Debie share the hobby, modeling the area he grew up in: north-central Jersey.

Their "Conrail New Jersey Division" layout has been featured in *Great Model Railroads*, *Rail Model Journal*, and in the Allen Keller *Great Model Railroads* DVD series. Matt has had articles in *Railroad Model Craftsman*, *RailModel Journal*, *Scale Rails* and *Model Railroader*, as well as online at [railroad.net](http://railroad.net).





## Finished Conrail Resin Kit Caboose





# Track Planning on Computer Using 3rd PlanIt

## PART 2: Learn the basics of using this popular track-planning software

— by Ryan Boudreaux



FIGURE 1: This track plan by Chris Marco demonstrates the powerful plan rendering capabilities of 3rd PlanIt. See the [TrainPlayer web site](#) for more info.

In this tutorial I'll be using the latest version of *3rd PlanIt Track Planning Software*, version 8.06.001.1349 which is created and distributed by El Dorado Software. While most of the techniques and procedures are still the same as version 7.10, I've produced all of the screen shots and movie segments with the latest version.

This version of 3rd PlanIt requires a personal computer running Windows 98, ME, NT 4.0 (SP5), 2000, XP, or Vista, with at least 64MB of RAM and 60MB hard drive space. Of course a faster processor and more memory will certainly optimize the performance of the program.

### Recap of the first segment

In our first segment we explored organizing track plan ideas and putting them into a drawing that represents our dream layout. We learned how to measure the room and layout space, and how to create a room template based on our givens using the Layout Design Wizard.

We also saw how to manage the file structure for track planning versioning and file-saving techniques. We learned how to create landscape mesh to represent benchwork, and also how to attach them together.

We finished up the first segment by adding turnouts and then running a virtual consist to test our initial track plan.

### What's covered in this segment?

I'll start with an overview of the controls, menu commands, toolkit controls, the object data window, and the various layers and layer properties. There's no need to memorize all these now – just follow along as I demonstrate each of the tools.

The key to mastering 3rd PlanIt is using the software and practicing with it often. Reviewing the controls now will help you later when you're getting into the nuts and bolts of designing your dream layout. Remember, no programs can build your layout for you, but track planning software does give you the tools you need to draw your own designs and helps you to see the possibilities of what can become your dream model railroad layout.

I will also go into more detail with the sectional builder tool, and I'll show how to filter layers to render various printing options and how to print 1:1 templates for assisting with actual track placement on the layout benchwork.

I will wrap up this segment with a preview of the next installment to get you primed to learn more of the "how to" spirit of track planning and not just the mechanics. So, let's get started!

I want to highlight some of the most commonly used menu items – the ones that I find most useful when creating track plans. This will help



build your confidence and skill one step at a time.

## Menu Bar Commands

The 3rd PlanIt menu bar in Figure 2 shows these commands: File, Edit, View, Action, Tools, Window, and Help.

The File menu contains many of the typical file and save options that most applications feature such as New, Open..., Close, Save, Save as..., Print..., Send..., Import, Export, Settings..., Utilities, and Exit (see Figure 3).

Notice that most menu items have one character that is underlined. This indicates a "Hot Key" shortcut and can be especially helpful if you like to use the

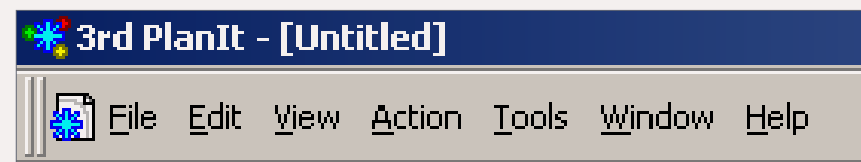

FIGURE 2: The Menu Bar.

keyboard to execute a command quickly. On the right of the menu you can often find Ctrl key shortcuts as well.

For example, pressing the Ctrl key in combination with the "P" key (Ctrl + P) brings up the Print Page setup dialog box. In Appendix A, I've included a "Hot Key" summary for 3rd PlanIt.

I like the Export feature, since it allows exporting the current track plan as a JPEG image, which can be

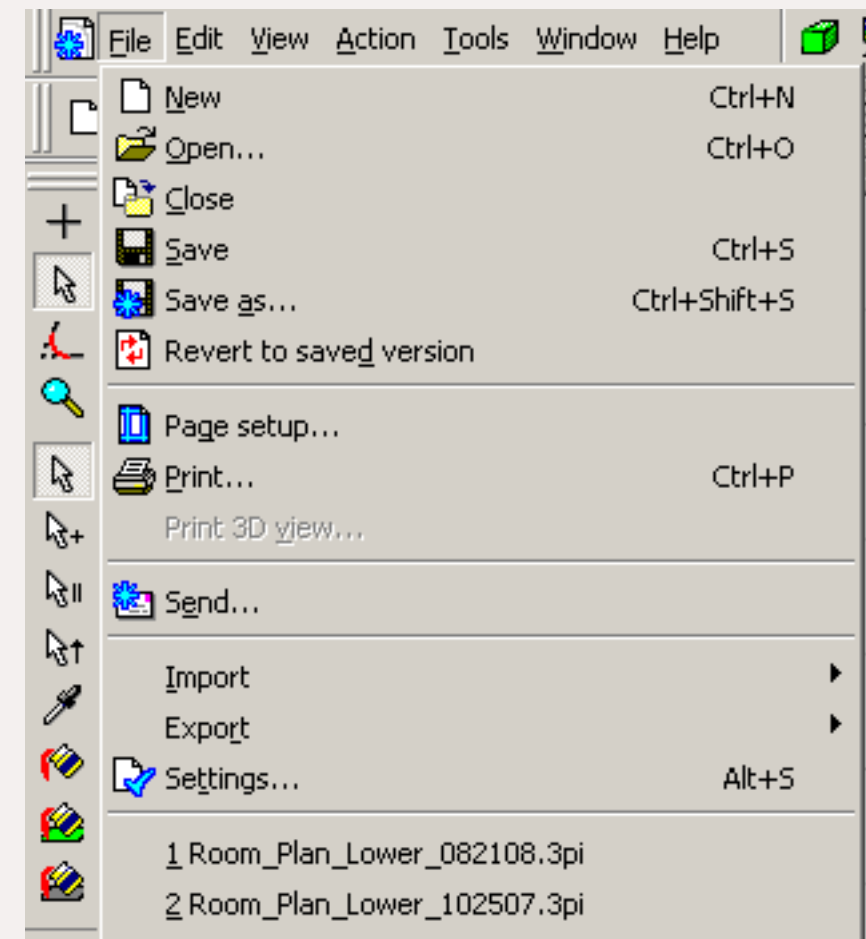

FIGURE 3: File menu selections.



**FEELING DOWN?**

**YOU WON'T BE LET DOWN WITH CF SHOPS!**

**WE'LL GO TO THE ENDS OF THE GALAXY FOR OUR CUSTOMERS!**

**Cf Shops is an on-line, CUSTOMER ORIENTED Direct Order Hobby Shop.**

We are Model Railroaders Too and we treat every customer the way we want to be treated.

**WITH OUTSTANDING CUSTOMER SERVICE AND RESOURCES, BEYOND YOUR OUT-OF-THIS-WORLD EXPECTATIONS MENTION MODEL RAILROAD HOBBYIST MAGAZINE FOR AN ADDITIONAL 10% OFF YOUR FIRST ORDER**



very handy for sharing a track plan over the internet.

Export also can output a DXF or a DWG file. DXF (Drawing Exchange File) and DWG (Drawing File) are used in AutoCAD and other computer aided drawing software like the free Google SketchUp.

The Edit menu, by default, has all of the selections grayed out (see Figure 4). You cannot select the Edit menu items unless you first select an object on the track plan. Once you've selected an object in the track plan, then you can make edits to that object.

In Figure 5, I've selected a section of track on my track plan and notice the Edit menu the items are now active (not grayed out).

Once you have selected an object on your track plan, 3rd PlanIt provides options to edit the shape. You can flip it, rotate it, tilt it, roll it, cut the object with the slice tool, or move the object layer from front to back or from back to front. I demonstrate some of these features in the videos accompanying this article.

One of the hardest concepts with any CAD drawing software is to think in flat 2-D but to visualize the plan in three dimensions. 3rd PlanIt lets you add elevations to your track plan, and using the computer to think in 3-D can be a big plus when it comes to creating grades and landscape contours.

This Edit menu gets used a lot when shaping, forming, and moving objects in the 3-D environment on the computer. One of the options on the Edit menu that I use often is Group.

Group can be especially helpful when creating 3-D objects. I will demonstrate

**FIGURE 4: Edit menu items grayed out.**

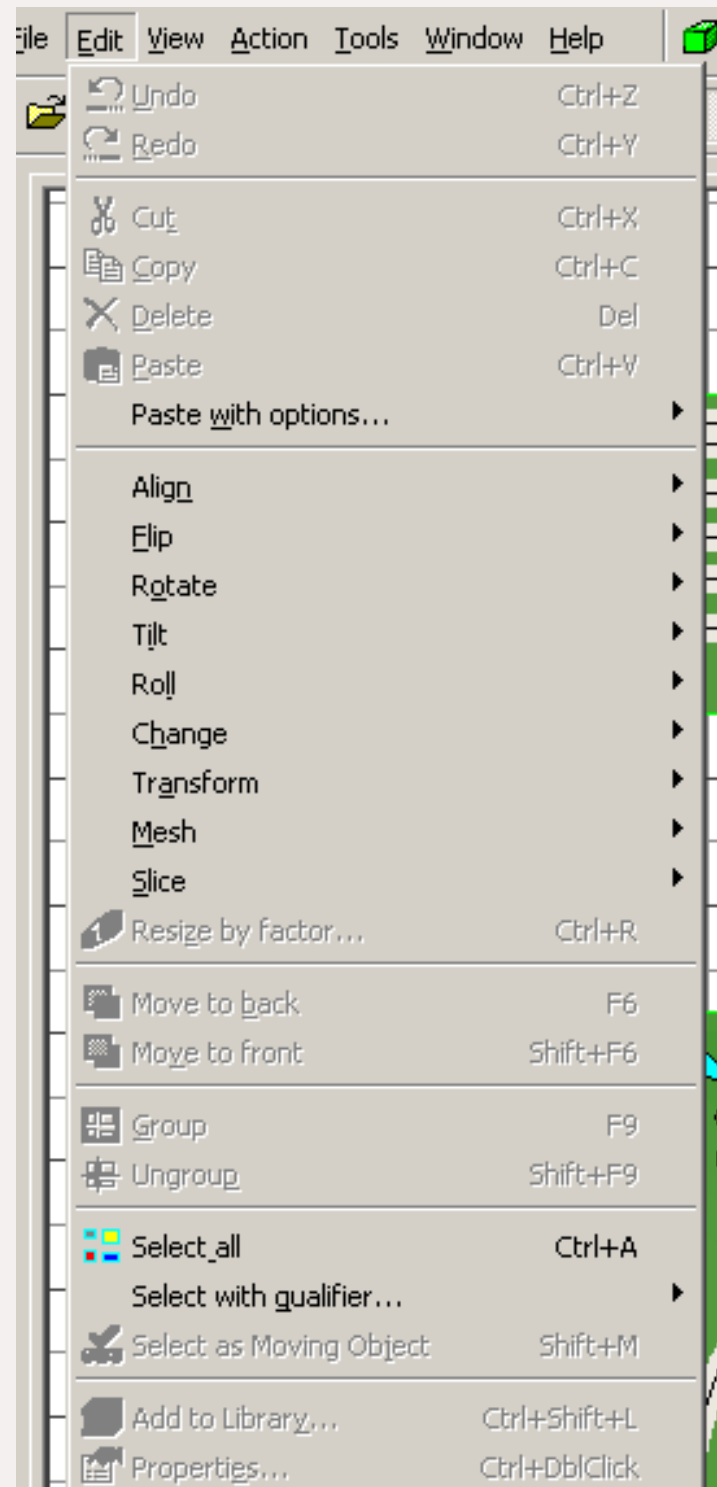

creating your own 3-D objects in part 3 of this series.

Next comes the view menu (Figure 6). The view menu lets you toggle between 2-D and 3-D views as well as access the Stereo views: Anaglyphic (Alt + 9) and Stereographic (Alt + 8).

**FIGURE 5: Edit menu items now available.**

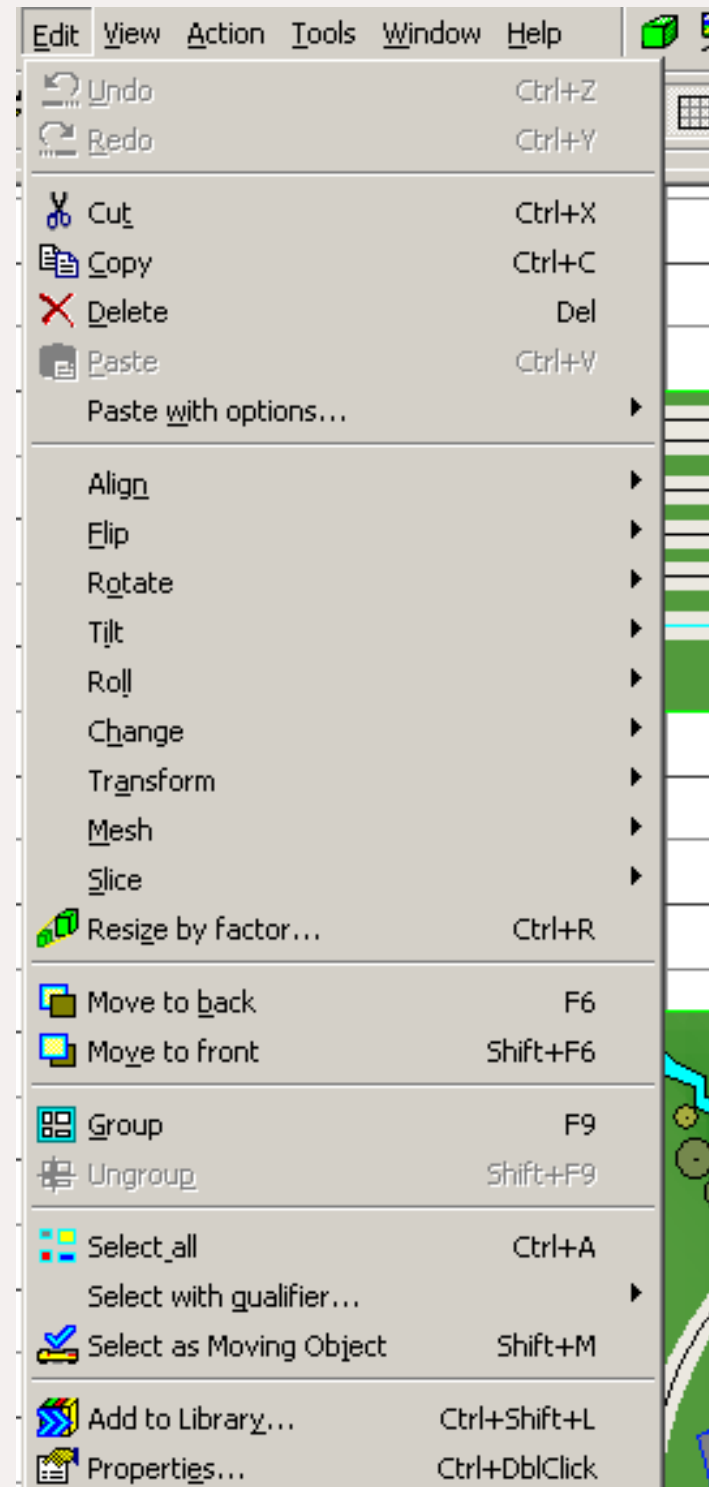

3rd PlanIt includes three moving-object views so you can follow along with the virtual consist (a train running on from the various angles or points of view.

You can adjust the Engineer's view of the track and set the cab height; these are

**FIGURE 6: View menu items.**

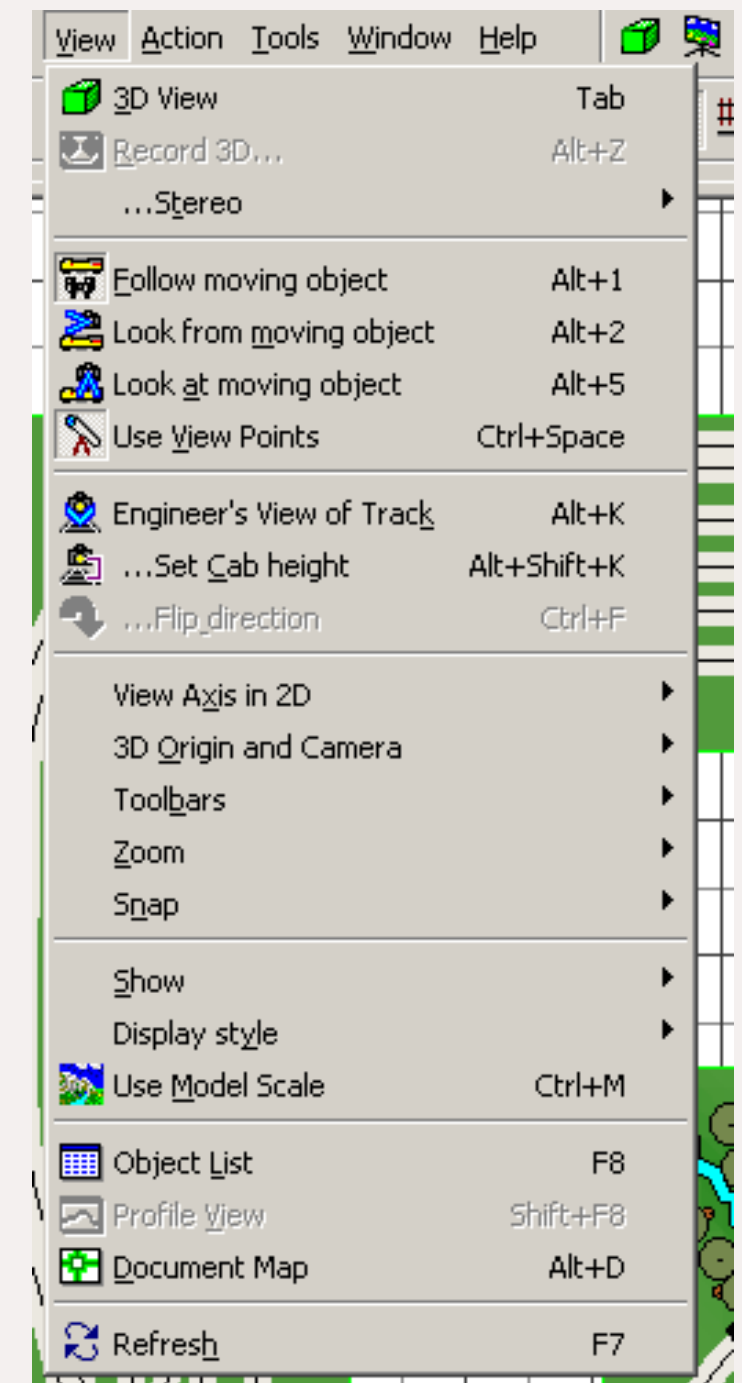



features that modify the way you view the virtual consist while running in 3-D.

I find the View menu's Object List (F8) to be especially useful (see Figures 7 and 8). Using an Object List, you can export a list of all the track plan objects to a CSV file (Comma Separated Values), which you can then open in a spreadsheet program such as Excel.

If you check Summarize by groups, 3rd PlanIt gives you the object Name, Part #, Count, and Cost (if available). Once you've created your plan, this Object list allows you to create a shopping list and even a summary of the track cost!

The object list shown in Figure 7 (using an example track plan I have) shows 24 pieces of 9" Atlas Code 83 track, for instance. By selecting Turnouts instead of Groups from the dropdown, I get the list of turnouts shown in Figure 8.

The Action menu has the button commands also found on the Toolkit Control Bar but in a list format with drill-down capability.

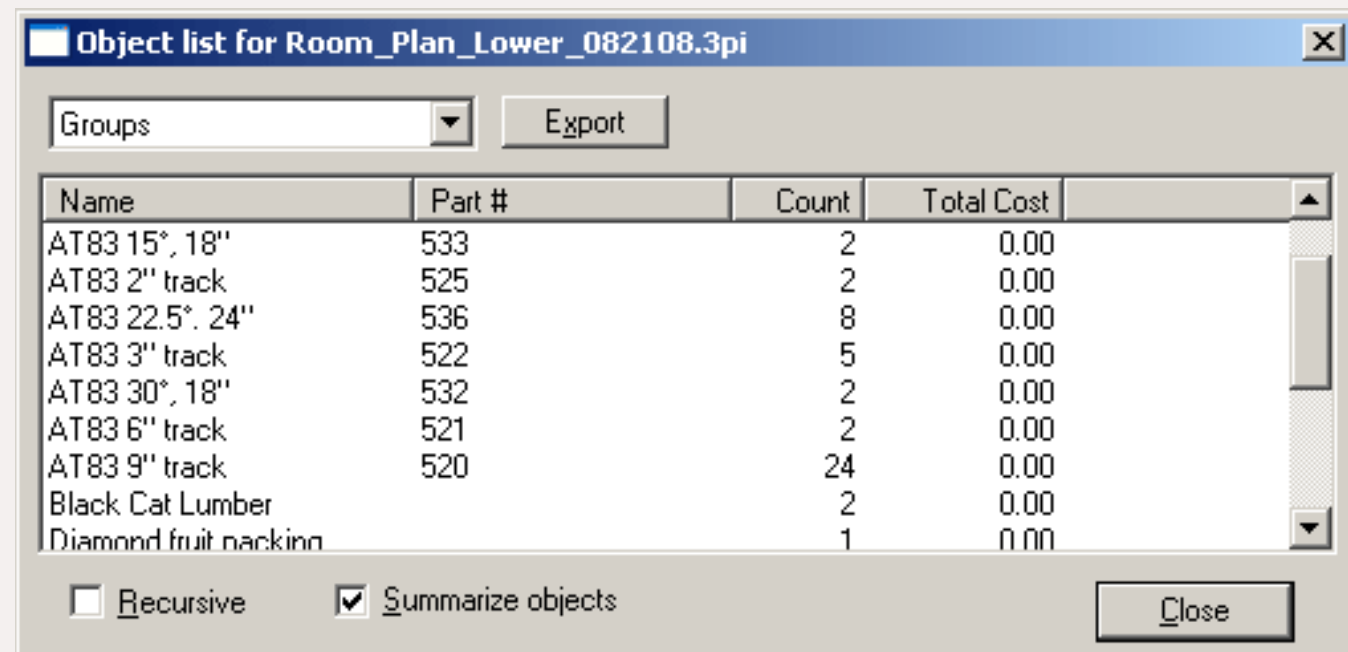

FIGURE 7: Object list with summarized group objects.

For example, Figure 9 shows the drill-down for the Action > Draw > Turnout selection on the menus. I might use this selection to add a turnout from the track library.

From Figure 9 you can see there are dozens of different actions. You can draw lines, circles, add text, place turnouts, draw a helix or a polygon, just to name a few.

Polygons help with placing the landscape mesh and for drawing 3-D objects. You can add images, modify the mesh, and add tunnel openings and trees. I'll be covering these actions in part 3.

The Action menu permits accessing and modifying the Layers on your plan, setting elevations, and so on. More about these actions in just a moment.

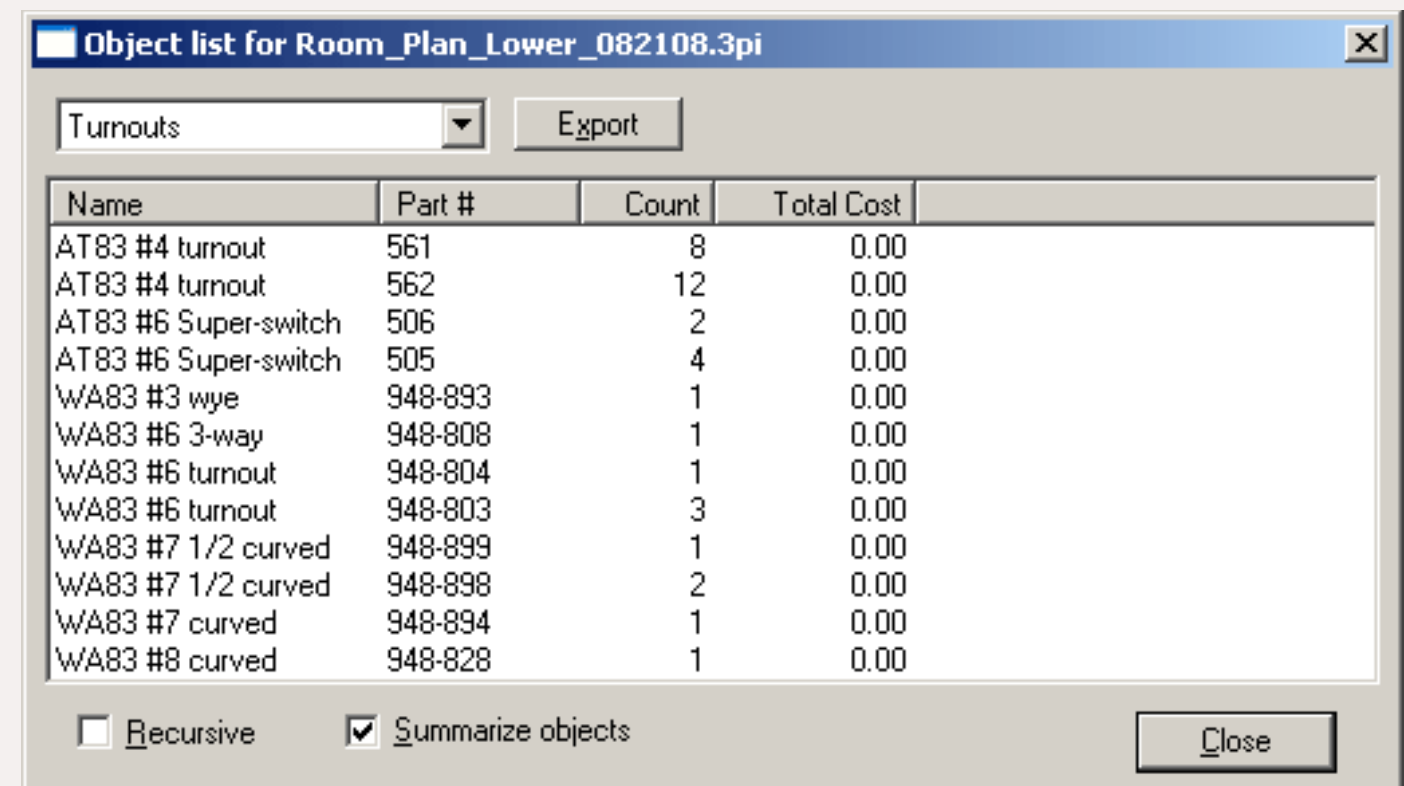

FIGURE 8: Object list with summarized turnout objects.

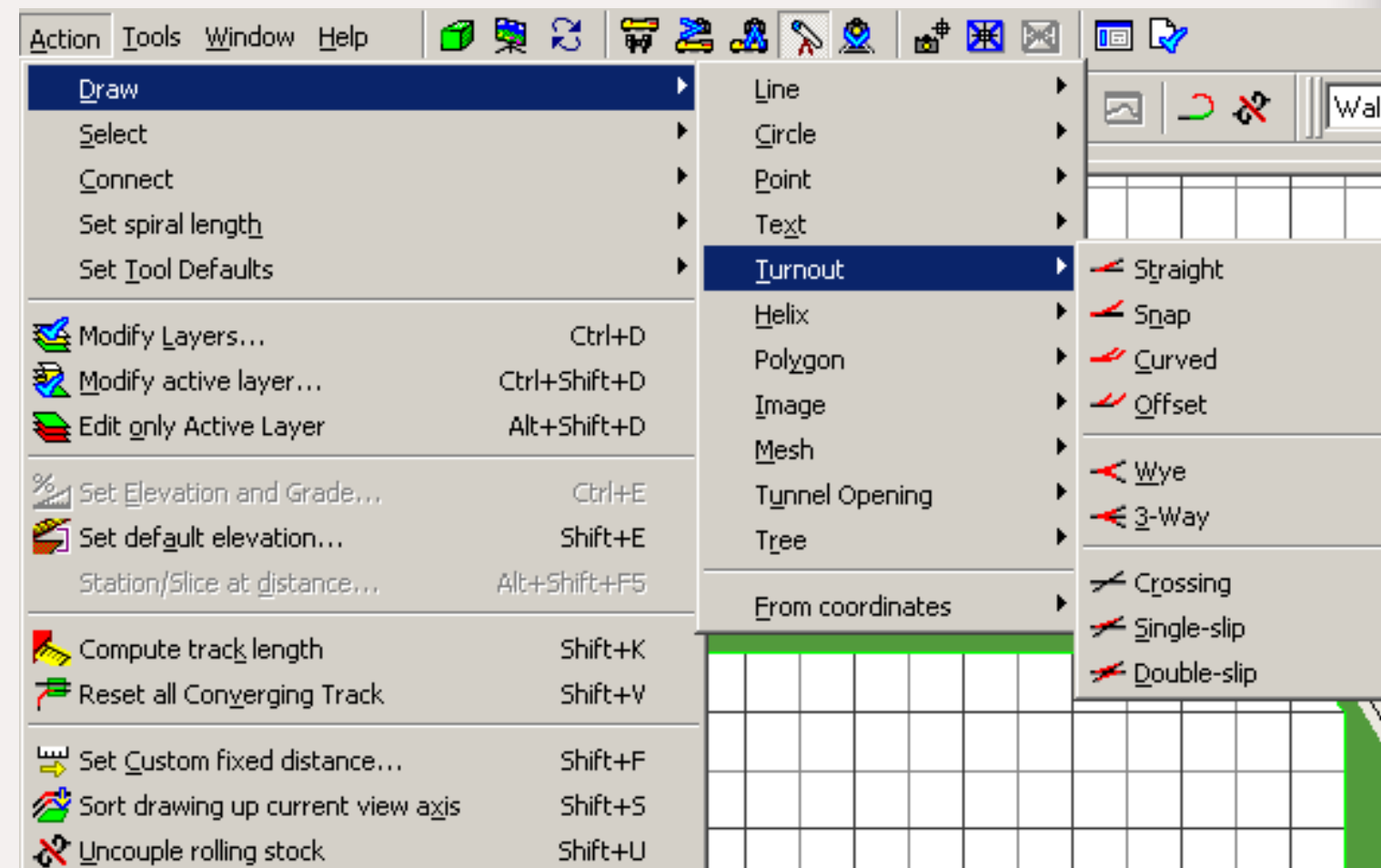

FIGURE 9: Action menu with Draw and Turnout selected.



But first, let me mention the Compute track length (Shift + K) option on the Action menu.

Just press the Shift + K key combination and 3rd PlanIt displays the total track computed length – in both flex track and sectional track sections.

Features like this make track planning on a computer a real delight. Using a sample track plan, Figure 10 shows the computed track length of flex track is 2908" inches (dropping the 5/8" fraction).

To convert this to 3' flex track pieces, divide by 36". I like to add a factor of 5% to account for a margin of error.

The plan needs about 85 pieces of 3-foot flex track. Very convenient!

A side note: Figure 10 also shows sectional track pieces because I use sectional track on occasion since it can help make things fit quickly, even though I won't be using sectional track pieces when I build the layout.

To account for the sectional track length and convert it to a flex track equivalent, I take the inches indicated for the sectional track length and perform the same calculations.

The 572" of sectional track adds another 17 pieces of 3-foot flex track to this plan, for a total of 102 pieces.

When you select Options (Alt + O), 3rd PlanIt presents a dialog box that lets you configure the 3rd PlanIt environment to your liking (see Figure 12).

Available options include 3D Settings, Colors, Controls, Drawing Style, Environment, Mouse Wheel, Startup, and Tools.

While daunting at first, you'll find 3rd PlanIt comes with many sensible default settings. If you want to experiment with these settings, you can, but that's a more advanced

**FIGURE 10:**  
**Computed track length.**

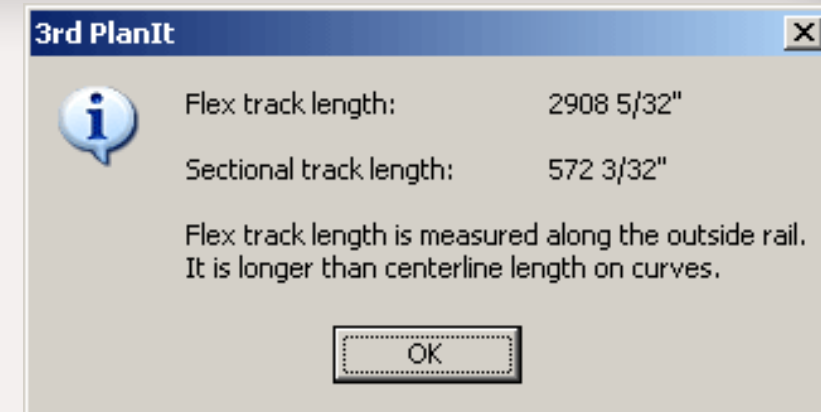

**FIGURE 11:**  
**Tools menu items.**

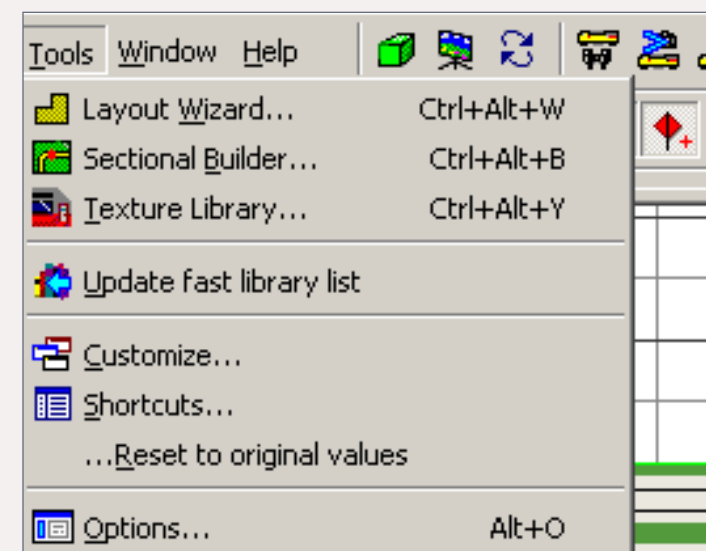

**MODEL TRAINS WEATHERED .COM**  
**THE WORLD'S ONLY WEATHERER'S NETWORK FORUM**  
**STOP BY TODAY AND INQUIRE ABOUT MEMBERSHIP**

The advertisement features a detailed model of a blue and white locomotive with the number 2076 on its front. The locomotive is positioned on the left side of the ad. The background is a weathered, industrial-style building with a large window showing a view of a landscape. The text is overlaid on the image in a bold, white, sans-serif font. A red bullseye graphic with a white mouse cursor arrow pointing to it is located near the bottom right of the text.



activity. I'll cover just a few of these options you may find especially useful.

I recommend adjusting your Startup options to turn off the Layout Wizard so it won't pop up *every single time* you start up 3rd PlanIt.

Click Tools > Options, and then click Startup (see Figure 13). Uncheck "Present the Startup Wizard when 3rd PlanIt is started". Also click "Open the most recently used drawing". Then click OK – now the next time you start 3rd PlanIt it will open to your last track plan or drawing file.

Click the Menu Items button here to see a video that demonstrates using the features we've covered so far.

## Toolkit Control Bar

The Toolkit Control Bar (Figure 14) is the "menu bar" you'll use the most when track planning. This bar has the tools to draw and modify track, add and connect segments, draw circles,

points, text, turnouts, a helix, polygons, landscape objects (like trees), place an image on the track plan, draw mesh, and draw a tunnel opening.

I highlight some of the Toolkit control features in the "Tool Kit" movie.

## Data Object Window

The Object Data Window shows the details of the currently-selected object. It also helps when making manual adjustments to the object. You can alter object attributes such as length, width, height, elevation, and radius.

Click on any line object and 3rd PlanIt displays the details about it (see Figure 15 next page), including the object name and number, the layer it's in, the positions in dx, dy and dz as well as the Azimuth, the Grade – and the X, Y and Z coordinates with respect to the entire drawing.

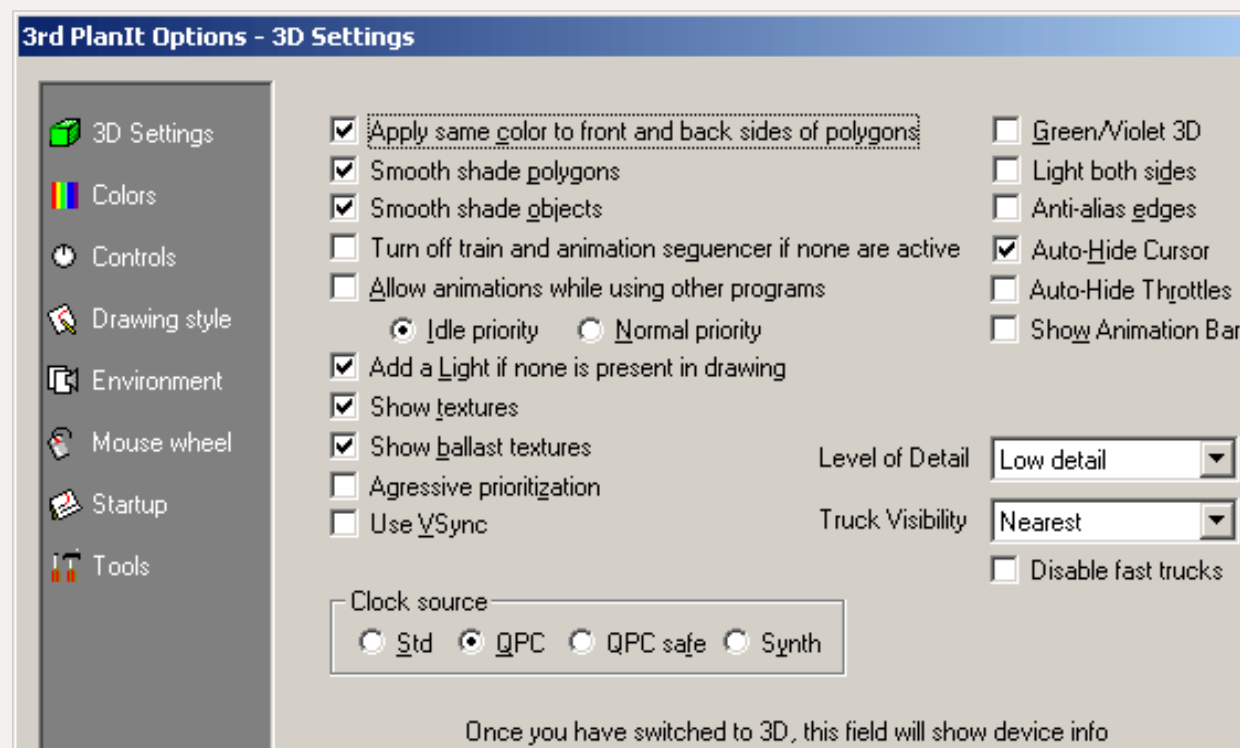

FIGURE 12: Options Dialog Box.

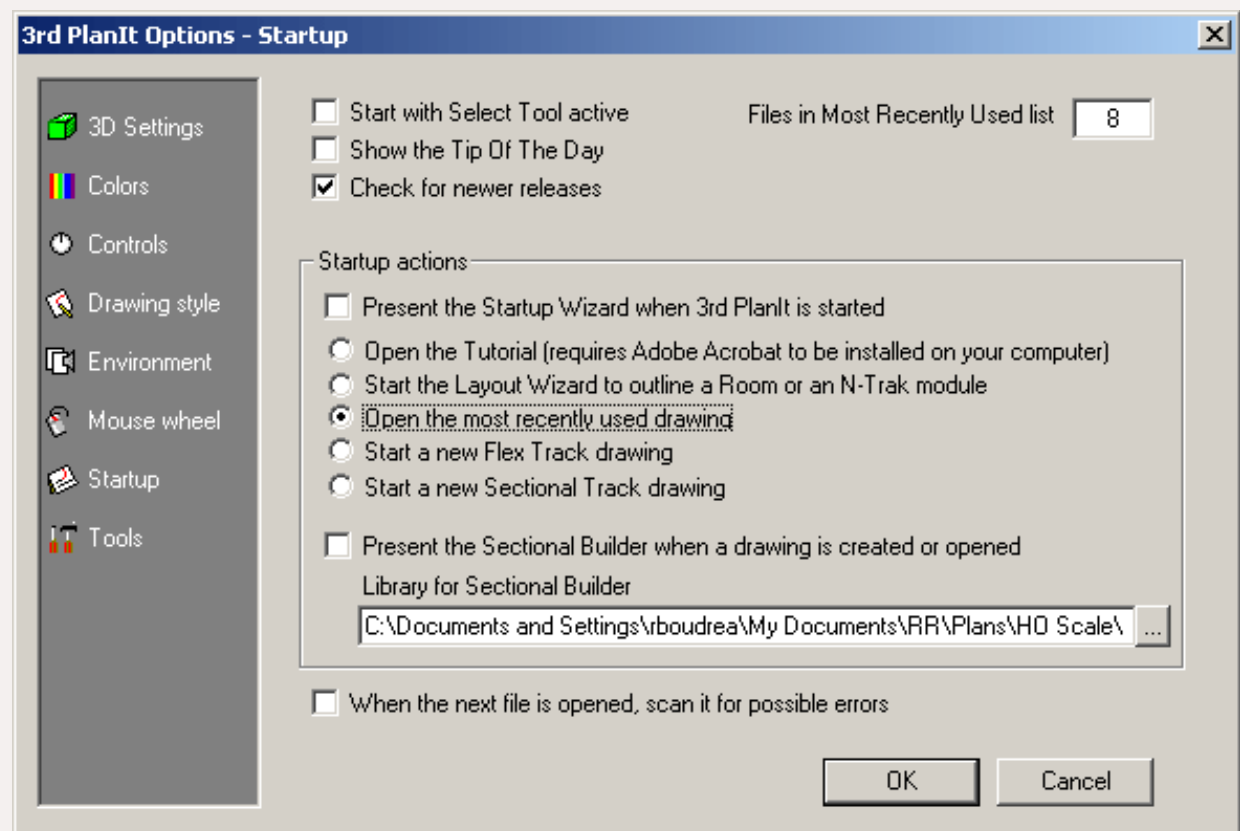

FIGURE 13: Startup Options Window.

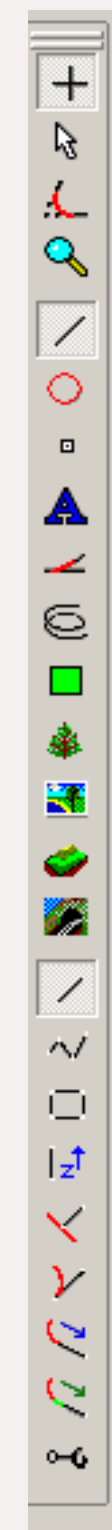

FIGURE 14: Toolkit Control Bar.

Advertisement

**www.CVMW.COM**

**CENTRAL VALLEY MODEL WORKS  
FOR DETAIL AND REALISM IN  
H-0 scale TRACK AND BRIDGES  
THERE IS NO NEED TO LOOK ANY FURTHER!**

PHONE: 805-489-8586 | EMAIL: info@cvmw.com  
CVMW: 1203 PIKE LANE, OCEANO, CA 93445



In Figure 15 you see a Walther's Code 83 #6 Double Crossover on my Piedmont Division lower deck track plan (highlighted in blue on the track plan). The object data window displays object position and size details, as you can see from the Figure.

If you select curved track, then in addition you get the total angle plus the start and end azimuths of the circle object (see Figure 16).

Notice in Figure 16 the circle track object has a radius of 34" and a circular length of 32 5/8", with an elevation grade of 1.942%.

When you draw an object, the Object Data Window updates the information for that object in real time. This makes it easy to monitor your drawing activities, as I show in the "Object Creation" movie here.

## Layer and Layer Properties

In part1, we started a new plan with the Layout Wizard, and checked the layers we wanted to create (see Figure 17).

Let's review these specific layers in more depth, and consider a few tips on how to use layers effectively.

I typically select all of the available layers. Even though 3rd PlanIt defaults to some layers already checked, I usually add all the others. I find it's easier to have *all* the layers *available*, even if I don't use them.

You can add layers later, if you prefer. From the Action option, select Modify Layers (Ctrl+D), Modify Active Layer (Ctrl+Shift+D), or Edit Only Active Layer (Alt-Shift-D).

**FIGURE 15:**  
Data Object Window with Double Crossover Line Object Selected

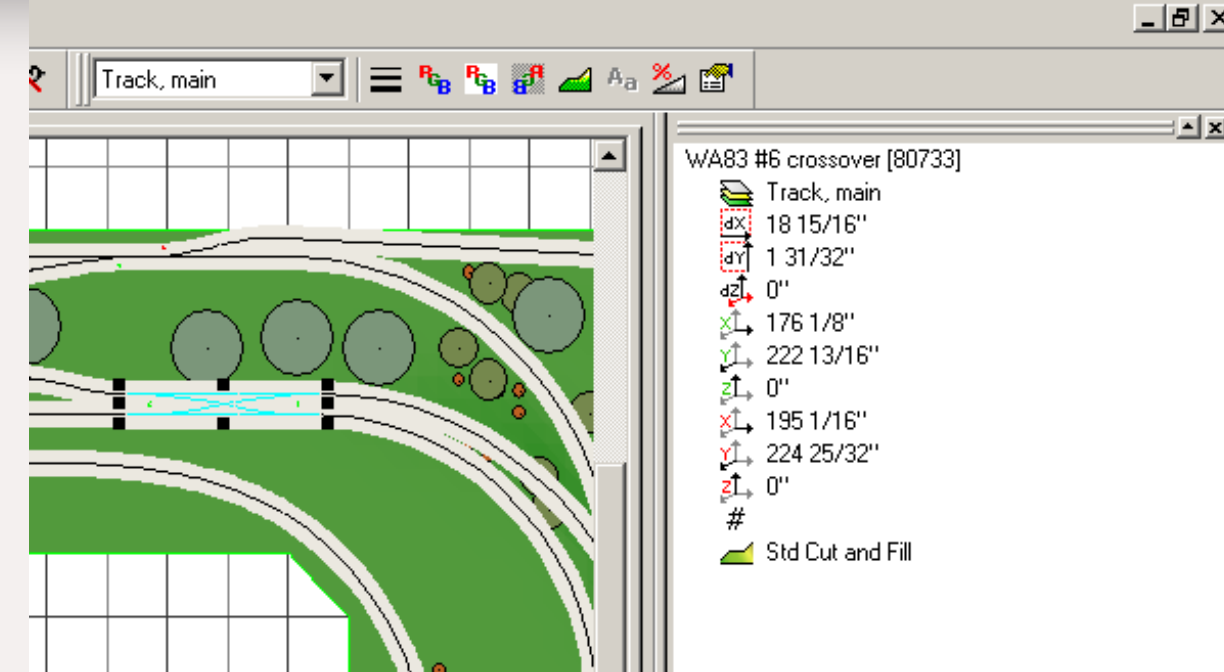

**FIGURE 16:**  
Data Object Window with Circle Object Selected.

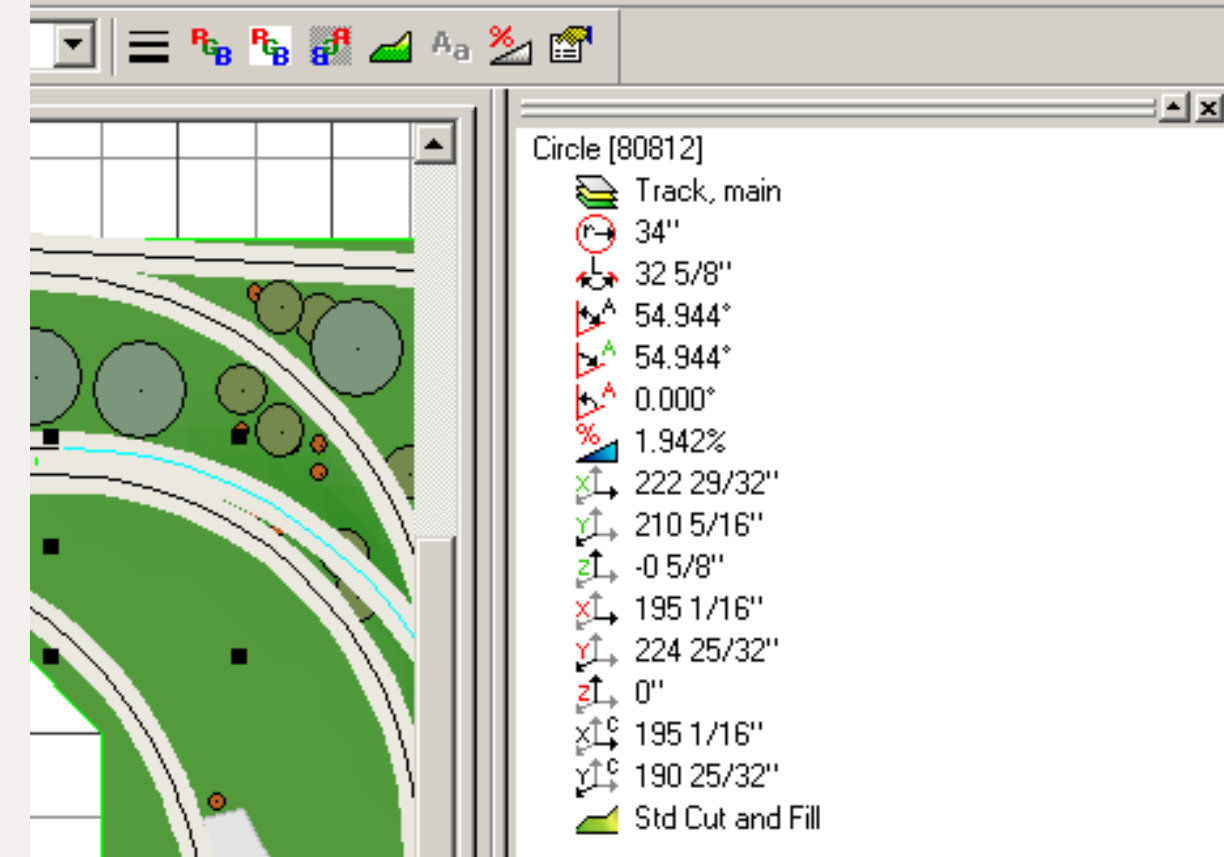

**FIGURE 17:**  
Layer Creation Selection During Layout Wizard.

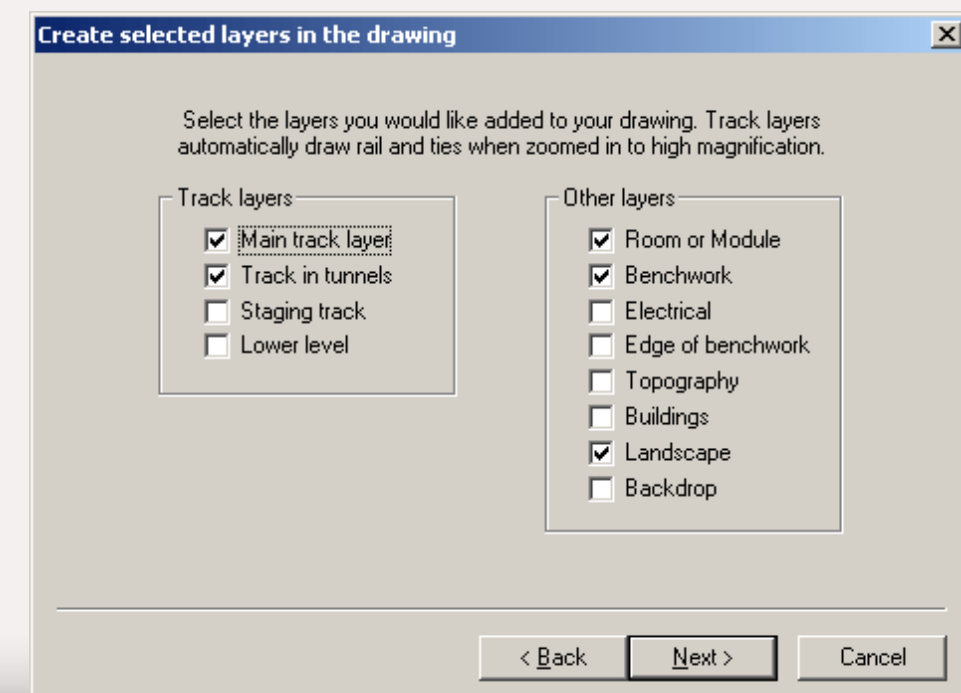



You can also use the handy toolbar icons at the top of the screen (Figure 18). From left to right the icons are: Modify Layers, Modify Active Layer, and Edit Only Active Layer.

To find the current active layer, look at the top-right of the 3rd PlanIt window. This is the “Active Layer pull down list” and 3rd PlanIt highlights the active layer as shown in Figure 19.

This list show many layers. 3rd PlanIt generates some of the layers from structure objects that it imported into the Standard Library. I will cover the Standard Library in more detail in part 3.

When you click on the Modify Layers Icon, the Enable Layers window pop-up appears (Figure 20).

Most of the layers are checked, which means they’re available for use in the plan. Also note that Room is red – that means it’s the Active layer.

## Using the Sectional Builder, in Depth

The Sectional Builder tool (Tools > Sectional Builder... or Ctrl+Alt+B) makes it easy to add specific pieces of commercial track and turnouts to your plan (Figure 21).

Sometimes I’ll add sectional track to my plan and modify it via the Object Data Window to fit my particular use. I seldom use sectional track when building a layout – I prefer flex track.

I find this trick makes building a track plan go much faster than trying to do everything in 3rd PlanIt with flex track.

For example, turnout alignment with flex track can be finicky, so I’ve used this sectional track technique to get things to fit quickly. I like to test such alignments by running a short virtual consist through them to see how they will work on the layout when actually built.

When you open the Sectional Builder, 3rd PlanIt displays a small red box on the plan. This indicates where the next section will be placed. You can move this marker just by clicking. See the “Sectional Builder” movie for a demonstration of these techniques.



FIGURE 18: Layer Options.



FIGURE 19: Active Layer Window.

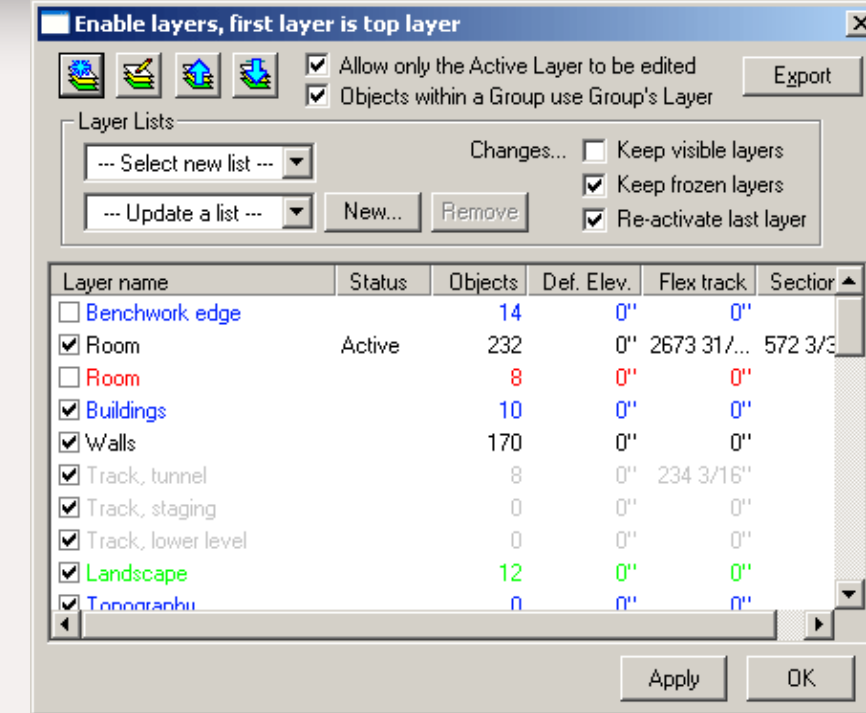

FIGURE 20: Enable Layers Window.



FIGURE 21: Sectional Builder with Atlas 83 Library selected.



## Adding Crossover Tracks

A crossover can be tricky to add to a drawing, especially if you're placing one after most of the track has been drawn.

It's the four track alignments that make things tougher than normal. Each of the four tracks must line up precisely for flawless train movement. See the "Double Crossover" movie for a demonstration of this technique.

## TIP – Layer Management

Let's say you want to view *only* the track layer in order to determine where power booster section boundaries should be. From there, you'll know where to place your power feeds.

With the Modify Layers button clicked and the Enable Layers Window open, uncheck all the layers except the Room layer and the Track layers. Then click Apply and your track plan will look something like the image in Figure 22.

This tool also helps when printing your 1:1 track plan as a master for cutting sub-roadbed and laying track on the layout. See *Printing a 1:1 Template* next. ■

## Selecting track libraries

In the Sectional Builder you select the track library you want by clicking on the Library button, browsing to the default track library location and picking your desired track (See Figure 23).

I've also provided a complete list of the commercial track libraries available for 3rd PlanIt in Appendix B. View the "Track Library" movie to see a demonstration of selecting various track libraries.

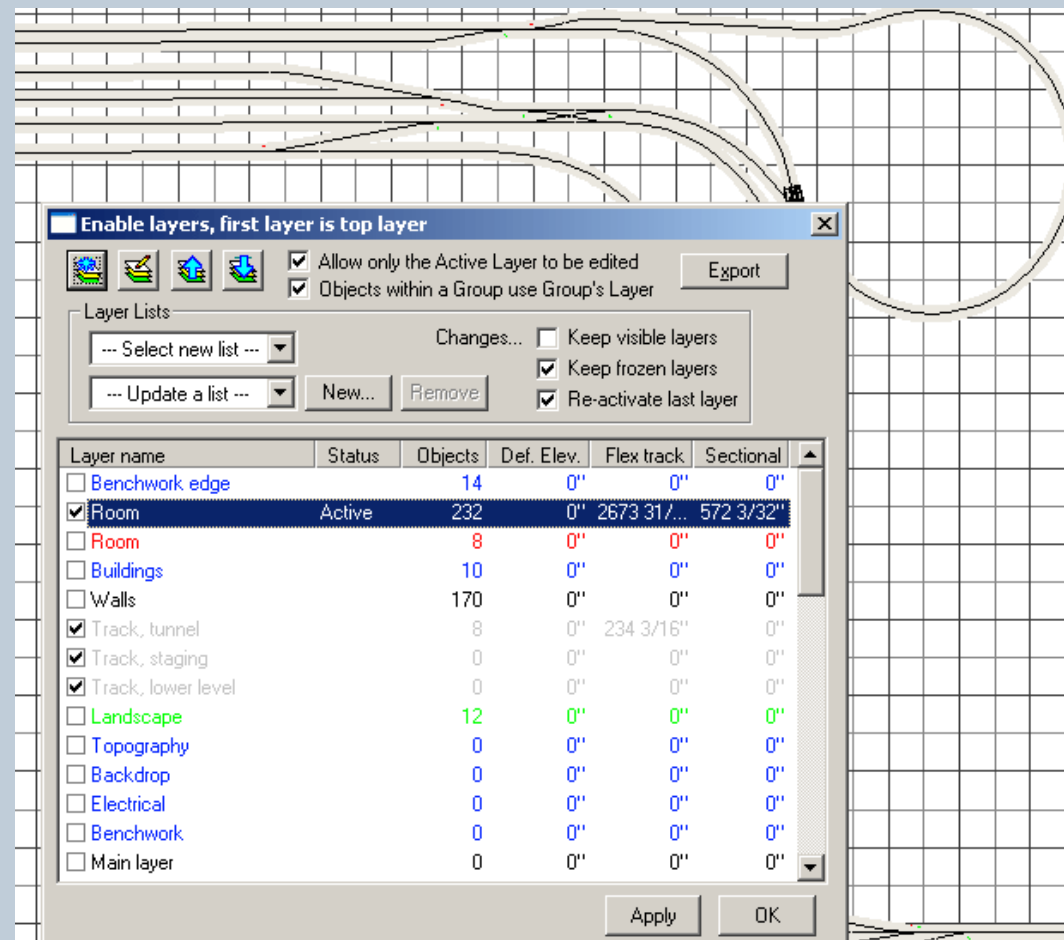

FIGURE 22: Modified Track Plan.

[Click to play video](#)

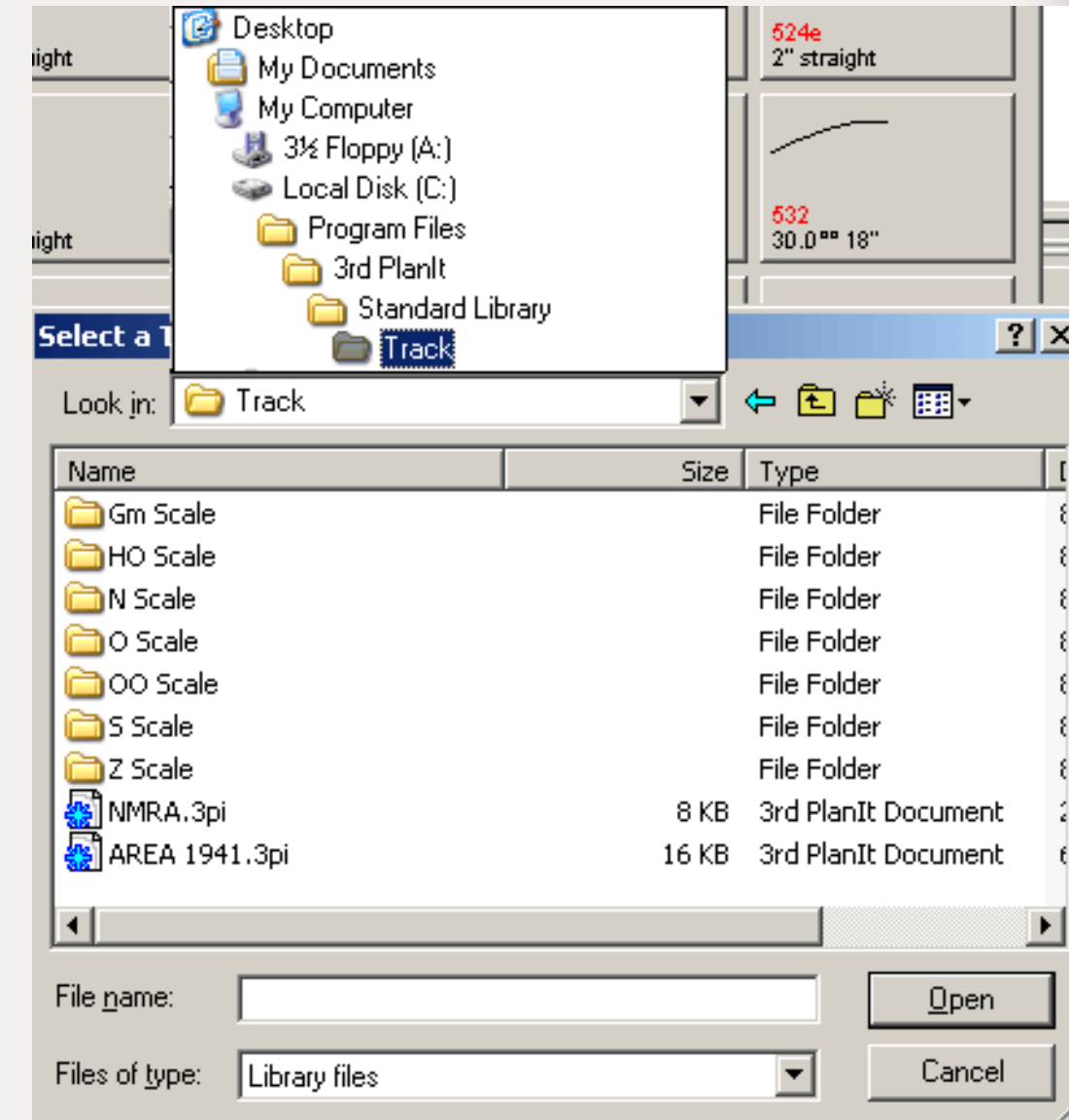

FIGURE 23: Track Library File Path.

[Click to play video](#)

[Click to play video](#)



## Printing a 1:1 Template

You can have 3rd PlanIt print your track plan at full size. In fact, any scale can be printed. An HO or N scale track plan, when printed at a 1:1 ratio, track components are printed at their *exact size*!

Some people use a special 3rd PlanIt plug-in to convert the print file for output on a plotter. The plotter's

room and track to ensure that I print only track sections. This also saves ink.

I open the track plan, then I select File > Print from the main menu. The Page setup dialog box will appear (see Figure 24).

Notice the Output scale data field, showing 1: X (where X is some number). Also notice that the green box surrounding the entire layout plan.

Highlight the number in the Output

**“Some people use a plug-in that converts the print file so that it can be formatted for a plotter and printed out on a continuous 3’ wide sheet of paper. Kinko’s or other print shops will print out the file, but this can be quite expensive ...”**

continuous 3’ wide sheet of paper means you have fewer pieces of paper to tape together.

Kinko’s or other print shops can output this plotter file, but this can be quite expensive. I find the 1:1 printout on standard 8-1/2” X 11” paper to be practical and convenient.

Before I start with the print and page setup, I uncheck all the layers except the

scale field and then type the number 1. Then click the Set button on the right of the field. The print Page setup display now changes to this what you see in Figure 25.

The green box is much smaller, now that the output scale has been set to 1:1. Also notice the Rows and Columns fields.

Using the Rows and Columns fields, you can set how many rows and columns of pages you want to print.

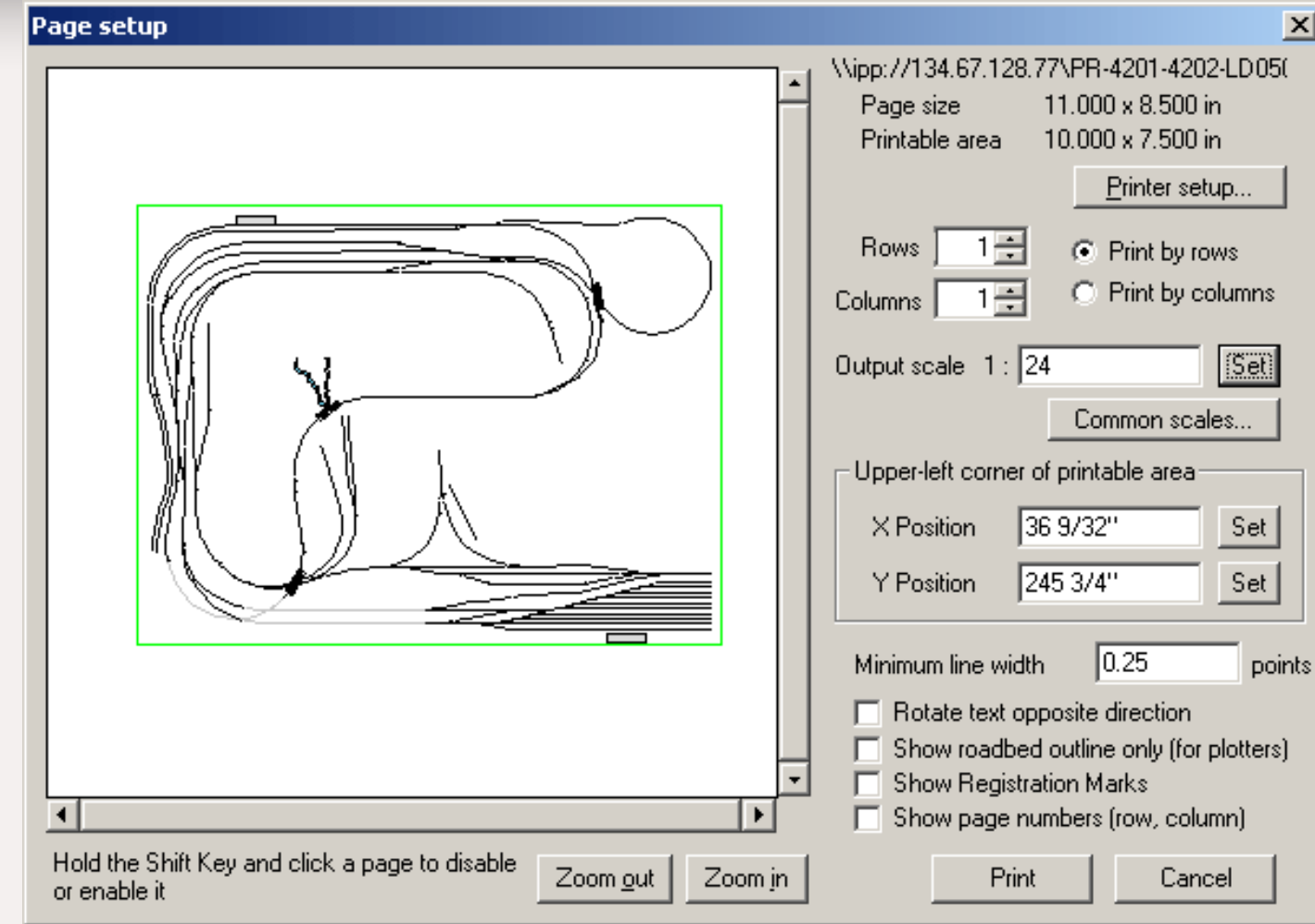

FIGURE 24: Page setup dialog box.

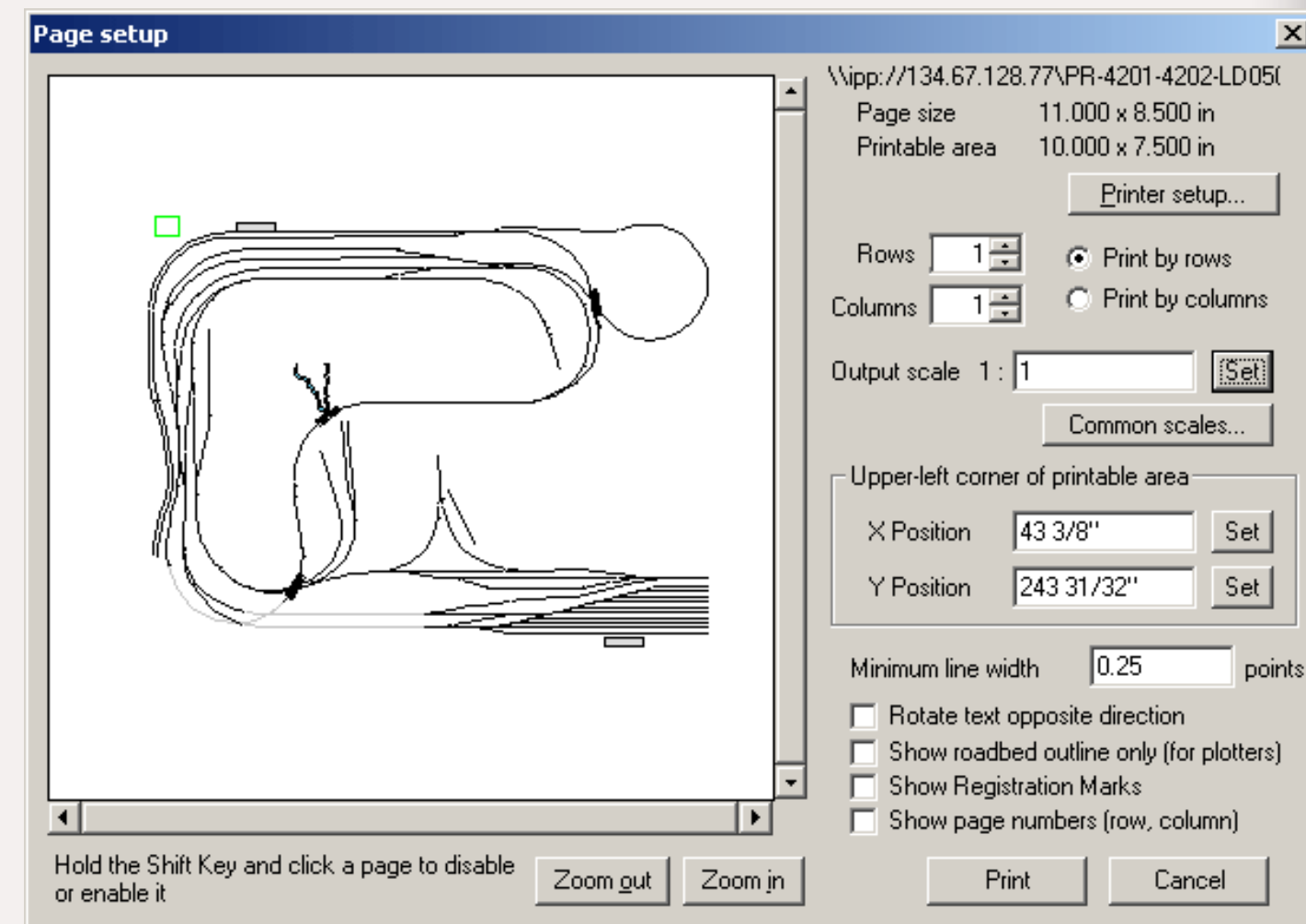

FIGURE 25: Changing the Output scale to 1:1 ratio.



I like to zoom in the viewable area to get a closer view of what pages I'm printing. Click the Zoom in button a few times and move the scroll bar over so the view appears as in Figure 26.

If you want to change the page orientation between portrait or landscape, click the "Printer setup ..." button.

I usually cut off and trim the excess paper from one or more sides of the pages to make it easier to match them up side-to-side and top-to-bottom.

Now you're ready to open up 3rd PlanIt and start printing your own 1:1 track templates – yet another advantage of track-planning on a computer!

**“... select how much of the layout you want to print to paper in your first print job ... I usually trim the excess paper from the pages and match them up with each other ... to get a full-sized layout template to work with.”**

Use the Rows and Columns fields to select how much of the layout you want to print at a time. Use the mouse to drag the highlighted green page boxes to the area of the track plan that you want print.

For example, in Figure 27 I have selected 4 Rows and 3 Columns.

Once I was happy with my selection, I clicked the Print button. In a few moments I had 12 pages of my layout on paper, full-sized.

If you check Show page numbers (row, column), this helps to align the pages when taping them together.

Advertisement

**If you are looking for a great way to display your N, HO and O trains, try grooved ShelfTrax.**

**Attaches to the wall without brackets.**

**Learn more at [www.shelftrax.com](http://www.shelftrax.com)**

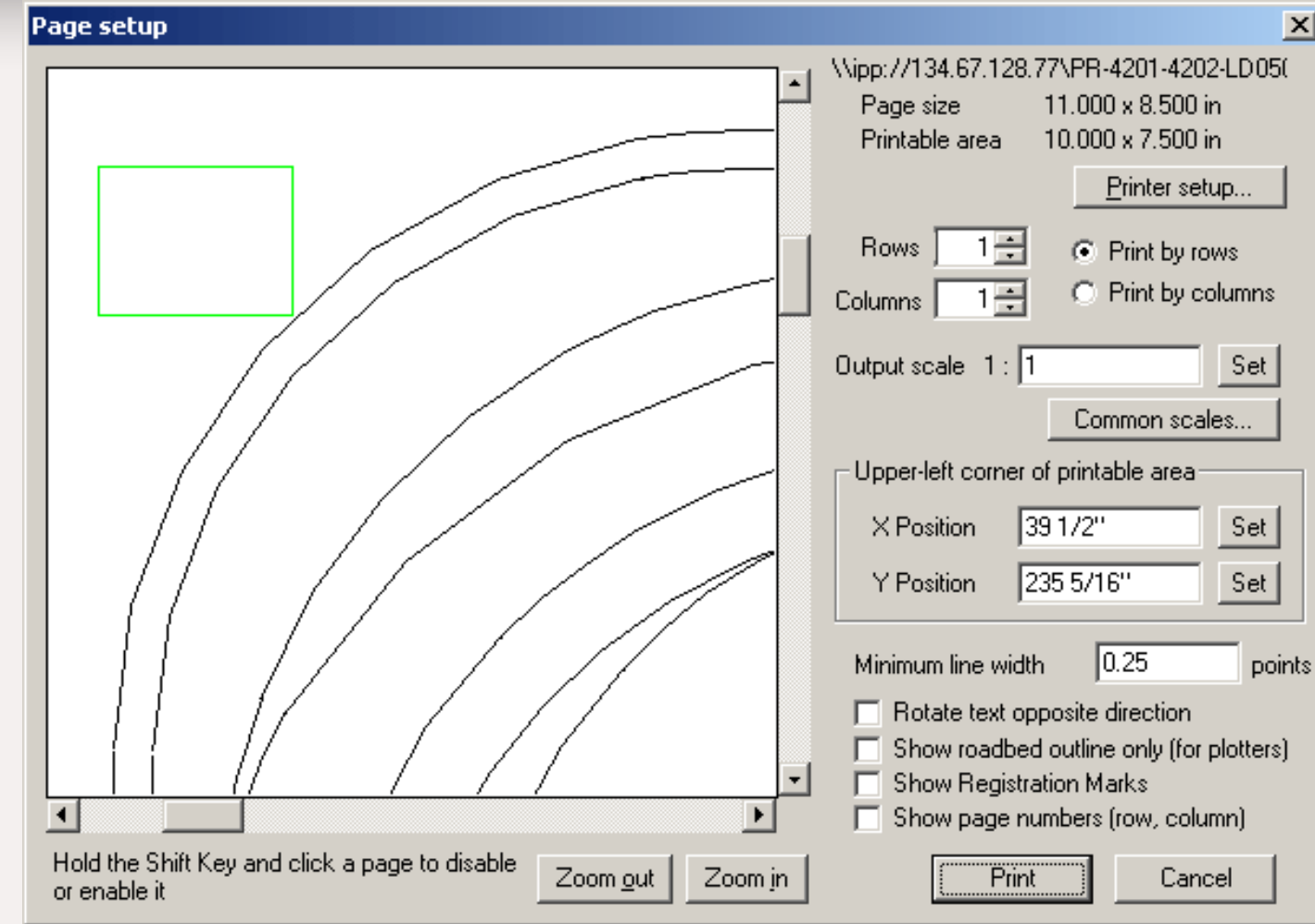
**FIGURE 26: Orienting the zoom in view for starting your print sections.**

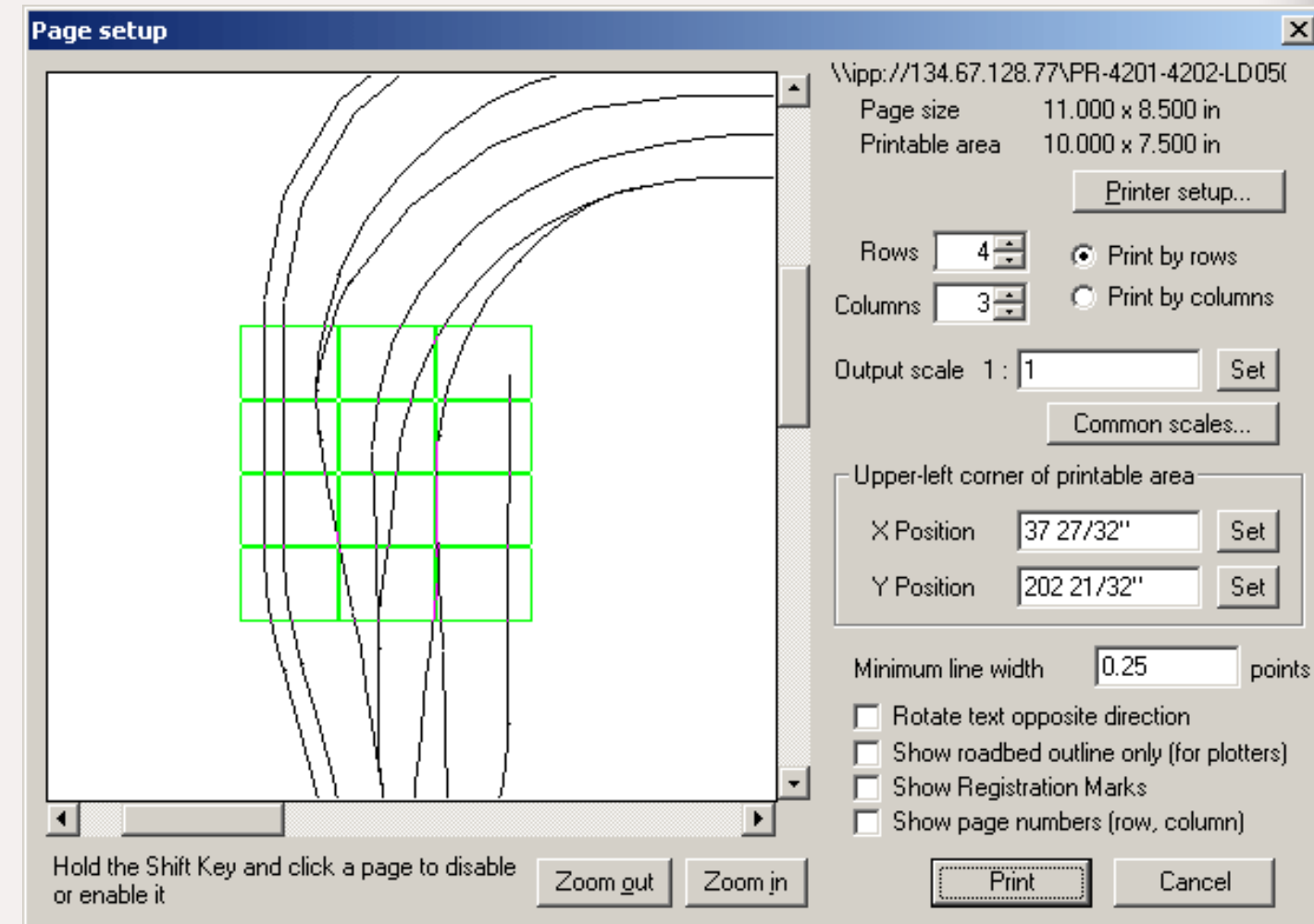

**FIGURE 27: Setting the columns and rows for the first print job.**



## My 1:1 Templates

To better illustrate the use of full-sized paper templates printed out by 3rd PlanIt, here are some of mine.

I printed out and I taped together these templates for the lower level deck on my layout. I positioned the paper template over a section of sub-roadbed plywood and used a hobby knife to make short 1" cuts about every 6 inches or so down the centerline (see Figure 28).

I marked the plywood through the 1" template cuts using a pencil. Then all I had to do was remove the paper and "connect the dots".

These guides helped me precisely locate where to put my cork roadbed, exactly according to my track plan.

For my "cookie cutter cuts" in the plywood, I cut the edges of the paper template to produce a pattern for cutting the plywood.

Using a black marker, I traced around the edges of the template cut out. These marks tell me where to make my saw cuts in the plywood (see Figure 30 - following page).

The photos show my paper templates trimmed and positioned for marking the centerline (see Figures 31 and 32).

*Continued on page 50 ...*



Figure 28: I make cuts every 6 inches down the centerline.



## TIP – Grid Size Adjustment

Before you go to the print stage, with the track plan file open, and from the main 3rd PlanIt screen toolbar click on File, then Settings, and then click the Grid tab and modify the grid settings (see Figure 29).

The defaults are shown below, but before I make my print out I change the

Major grid lines spacing to 6" on the X and Y Spacing settings, then I change the Minor grid lines Spacing settings on the X and Y to 3" each.

This helps greatly in lining up the individual printed pages when you are taping them together. ■

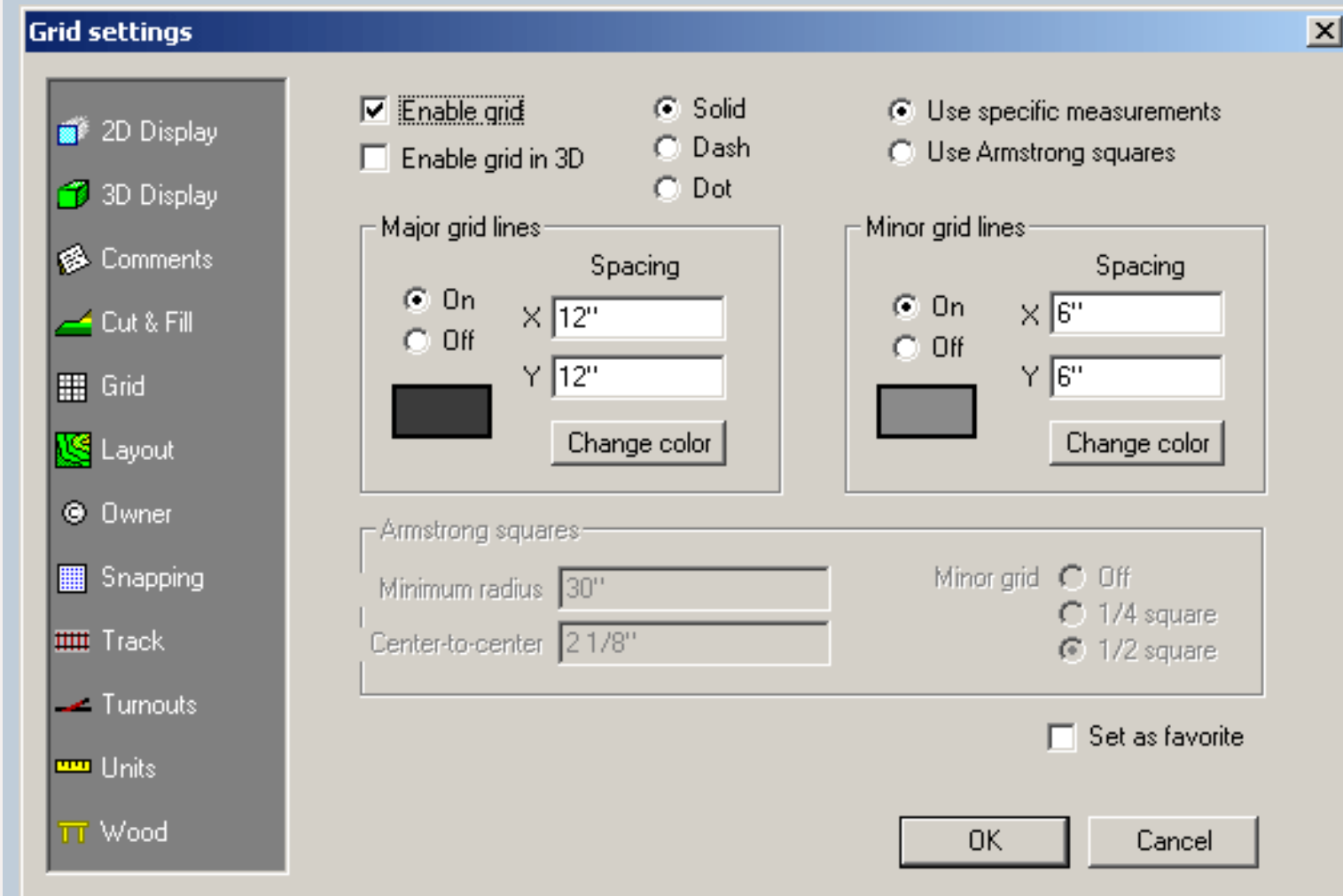

FIGURE 29: File settings for grid size adjustments.





**Figure 30**

Figure 30: I use a black marker to trace around the edges of the paper template cut out. This marks where I will make my saw cuts on the sub-roadbed plywood.



**Figure 31**



**Figure 32**

Figures 31 and 32: Sub-roadbed cuts with the templates in position for marking the centerline.



See the “Printing Templates” movie below for a demonstration of printing.

## Conclusion

I hope part two of this series helped fill in some gaps in your 3rd PlanIt knowledge as we took a closer look at the menus and tools available in the program.

Appendix A lists the 3rd PlanIt Hot Keys and Appendix B has a complete commercial track library list.

In part 3, we’ll delve into modifying track segment properties once they’re placed on the track plan. We also will add buildings and structures to a layout plan and discuss the track placement considerations.

Finally, we’ll add terrain and contour features, water, a backdrop, foliage and trees and then review the plan in the 3-D view – 3rd PlanIt’s *pièce de résistance*. 

[Click to play video](#)



**When you see this symbol, it means:**

**“Click here to visit the web site!”**

## Appendix A

### 3rd PlanIt “Hot Key” list

#### Colors

Layer determines object color **Alt+L**

Monochrome **Alt+M**

Native object colors **Alt+N**

Questionable Track Display **Alt+Q**

Rail colors **Alt+R**

Type of object determines color **Alt+Y**

#### Display

3D view or 2D view **Tab**

3D Origin and Camera on/off **Alt+C**

Armstrong squares on/off **Ctrl+Q**

Snap on/off **Ctrl+G**

Grid lines on/off **Alt+G**

Model Scale on/off **Ctrl+M**

Native line widths on/off **Ctrl+W**

Refresh screen image **F7**

Track details on/off **Ctrl+K**

#### File

New file **Ctrl+N**

Open file **Ctrl+O**

Print **Ctrl+P**

Save file **Ctrl+S**

Settings **Alt+S**

#### Rotate, Tile and Roll

Roll selection, prompt for angle **Shift+G**

Roll selection, use last angle **G**

Rotate, prompt for angle **Shift+R**

Rotate using last value **R**

Tilt selection, prompt for angle **Shift+T**

Tilt selection, use last angle **T**

Tilt down **Ctrl+I**

Tilt up **Ctrl+U**

#### Object manipulation

Add object to Library **Ctrl+Shift+L**

Convert object to lines **Ctrl+L**

Copy to clipboard **Ctrl+C**

Cut to clipboard **Ctrl+X**

Flip right/left **Shift+F11**

Flip top/bottom **F11**

Elevation and grade **Ctrl+E**

Group objects into single object **F9**

Ungroup objects **Shift+F9**

Move object to back **F6**

Move object to front **Shift+F6**

Paste from clipboard **Ctrl+V**

Paste into same position **Ctrl+Shift+V**

Paste into selected group **Ctrl+Alt+V**

Resize by factor **Ctrl+R**

Select all objects **Ctrl+A**

#### Polygons, Polylines and Contour Lines

Change polygon front surface **Alt+Shift+C**

Contour line profile adjustment **Ctrl+H**

Interpolate vertices **Alt+Shift+I**

Make object into 3D Solid **Alt+3**

Randomize contour line height **Alt+Shift+H**

#### Slicing Object

Slice at end of another object **Shift+F5**

Slice at intersection of an object **F5**

Slice into segments **Ctrl+F5**

Slice where selected **Alt+F5**

#### Tools

Double-click of left mouse button **Space**

Right-click while left button down **Space**

Draw Freehand Line **L**

Draw Perpendicular Line **Q**

Draw Tangent Line **D**

Draw Freehand Circle **O**

Draw Freehand Point **P**

Draw Text **A**

Connect **C**

Connect with Easements **E**

Path **U**

Crooked path **W**

Options **Alt+O**





# Appendix B

## Track Library List

### 1. G Scale

LGB  
Micro Engineering  
Aristo G Brass  
Aristo G Steel

### 2. HO Scale

Atlas 100  
Atlas 83  
Bachmann EZ Track  
Bemo H0m Code 70  
Bemo H0m  
Bemo  
BK Enterprises  
Central Valley 70  
Central Valley 83  
Central Valley Imperial  
Central Valley Metric  
Fast Tracks HO complete  
Fast Tracks HO sectional  
Fleischmann Model track  
Fleischmann Profi track  
Kato Unitrack  
Märklin C  
Märklin K  
Märklin M  
Micro Engineering  
Peco 100  
Peco 75  
Peco 83  
Peco Setrack  
Piko A-track  
Pilz Elite  
Roco geoLINE  
RocoLine  
Shinohara 100  
Shinohara 70

Shinohara HOn3  
Tillig H0m  
Trix Express H0  
Walthers 83

### 3. N Scale

Atlas55  
Atlas  
Fleischmann Piccolo  
JHM DB standard gauge  
Kato Unitrack  
Micro Engineering  
Minitrix  
Peco 55  
Peco 80  
Shinohara

### 4. O Scale

Atlas O  
GarGraves  
Lionel  
Old Pullman Code 100  
Old Pullman Code 125  
Old Pullman Code 148

### 5. OO Scale

Hornby

### 6. S Scale

Gilbert  
Shinohara Sn3  
Tomalco Sn3

### 7. Z Scale

Märklin  
Micro-Trains  
Peco Streamline



**Article feedback!**

**CLICK HERE** for reader comments  
on this article ...



Ryan Boudreaux got a boxed HO scale train set from his parents as a pre-teen and shortly thereafter his dad built Ryan a C-shaped 4X8 layout to get the trains off the carpet.

Ryan's current modeling passion is the Southern and Norfolk Southern, specifically the [Piedmont Division](#). Ryan's layout, still in the early stages, combines a mix of prototype operation with freelanced locations and scenery.

Ryan works as an EPA contractor in the National Computing Center at Research Triangle Park, North Carolina.



# PANEL SIDE REBUILT HOPPER CARS of the 1930s Through 1950s

As Modeled by Micro-Trains in N Scale, Accurail in HO Scale,  
S-Helper in S Scale, and Atlas in O Scale



Figure 1: The Delaware & Hudson got a thousand USRA twin hoppers immediately following World War I and numbered them 3201-4200. In the 1930s, more than 300 of them were rebuilt with panel steel sides. Only a month after being rebuilt at the Oneonta, NY shops, D&H 4189 was at Binghamton, NY in September, 1936. Panel sides increased its cubic capacity from 1880 cubic feet to 1940 cubic feet. Note its original USRA Andrews trucks. –Keith Sirman collection

Panel-side hopper cars became popular with the railroad industry as a direct result of the economies forced upon the railroads by the severe depression of the 1930s. Early in the 20th century,

many railroads purchased large numbers of all-steel hopper cars to transport coal and similar bulk minerals. By the 1930s, the wear and tear of this service had made it necessary to begin replacing these

cars, but the nation's economy was in such disarray that most railroads were unable to afford new cars.

The next best thing was to rebuild existing cars, including replacing their worn and rusted side sheathing and slope sheets.

For this purpose, the Union Metal Products Co. (later the Standard Railway Equipment Co.) produced pressed steel replacement side sheets that bulged outward between the side posts, thus increasing the cubic capacity of the cars as well as providing them with new side sheathing.

Often the cars that received these new side sheathing sections were of USRA twin hopper design; 22,500 of these cars had been built for the United States Railway Administration during World War I and assigned to a large number of railroads, and thousands more were built in the 1920s. However, the size and configuration of the new side sheets could be adjusted to fit any steel

– by *Richard Hendrickson*

hopper car, and they were used on cars of other designs as well.

The rebuilding of hopper cars with panel sides gave them a new lease on life, and many lasted into the 1950s, with some surviving in revenue service even as late as the 1960s.

Since the panel side hopper cars were rebuilds, it's difficult to compile a complete list of the railroads that owned them. They ranged in size from the giant New York Central through the Frisco, Missouri Pacific, and Wabash to smaller lines like the Delaware & Hudson and Central of Vermont.

At least two railroads, The Pennsylvania and the New Haven, converted only one car each and then decided not to rebuild additional hopper cars with panel sides.



## Models

Ready-to-run models of the panel side hopper cars are available in N scale from Micro-Trains, in HO scale from Accurail, in S scale from S Helper Service, and in O scale from Atlas.

These cars can also be kitbashed in HO scale using the molded resin panels offered by Stan Rydarowicz of Resin Parts, 165 Manchester Av., Youngstown, OH 44509. 



Figure 2: The New York Central and its subsidiaries were assigned 2,500 USRA twin hoppers by the United States Railway Administration during World War I. Then in the early 1920s more than 8000 additional cars of this design were delivered to the NYC, Big Four, Michigan Central, and Pittsburgh & Lake Erie.

In the mid-1930s almost 1,800 of these cars were rebuilt with panel steel sides and renumbered, and almost 800 similar cars built in 1917 also got panel sides and new numbers. NYC 850126 of the 85100-85167 series, built in 1918 and rebuilt at Beech Grove (Indianapolis) in 1936, was photographed at East Buffalo, NY ca. 1940. –Keith Sirman collection



Figure 3: Another New York Central System panel side hopper, P&LE 37314 was at Kendallville, IN in the spring of 1937, having just been rebuilt at the Despatch Shops in East Rochester, NY. It was originally a USRA clone built for the Pittsburgh & Lake Erie in April, 1921.

A total of 1,419 P&LE hoppers were rebuilt with panel sides in 1937 as lot 651-H and renumbered into the 37000-38418 series. Panel sides increased their cubic capacity by a hundred cubic feet from 1880 to 1980 cubic feet.

–Keith Sirman collection



Figure 4: The application of replacement panel sides wasn't limited to twin hoppers. NYC 903012 was a USRA 70-ton hopper purchased second-hand in 1929, updated by the replacement of its original pair of shallow clamshell center hoppers with a single sawtooth hopper, and then rebuilt with panel sides at the NYC's Avis, PA shops in November, 1937. It's shown here at Buffalo, NY in June of 1938 reclassified lot 588-H and renumbered into the 903000-903449 series. In 1939 the Pittsburgh & Lake Erie rebuilt 97 of its USRA 70-ton hoppers in the same fashion at its shops at McKeesport, PA, reclassifying them lot 543-H and renumbering them 67900-67996. –Joe Collias collection





Figure 6: Missouri Pacific MP 58678 was one of 190 cars in the 58000-58749 series built as USRA clones in April, 1927 and rebuilt with panel sides and Commonwealth cast steel hoppers at the DeSoto, MO shops in October, 1936.



Figure 5 & 5a: The Central Vermont owned 200 steel hopper cars, built in 1912 and numbered 20000-20199, which were slightly smaller than the USRA hoppers. Starting in the mid-1930s, these cars were rebuilt with panel sides, new AAR cast steel trucks, and geared hand brakes. CV 20005 was photographed fresh from the St. Albans, VT shops after being rebuilt in January, 1937. Not all of the CV hoppers got complete sets of panel sides; when photographed in the early 1940s, CV 20030 had only four replacement panel sections. –Both, author's collection

The rebuilding increased their capacity from 1880 to 1940 cubic feet. Photographed at East St. Louis in 1938, this car was already heavily weathered and dirty, typical of freight cars (and especially hopper cars) in the steam era. –Joe Collias collection.



Figure 7: The Wabash received 1000 twin hoppers from the USRA and then purchased additional cars of similar design in the early 1920s. The Wabash was so enthusiastic about replacement panel sides for its twin hopper cars that it not only rebuilt almost all of them as panel side cars in the 1930s but, beginning in 1937, constructed almost 2000 new panel side hoppers in its own Decatur, IL shops. WAB 34215, originally one of 750 31000-31749 series USRA-design cars built in 1923, is shown here at East St. Louis, IL in 1938 after being rebuilt with panel sides at Decatur in November, 1937 and renumbered into the 34000-34499 series. –Joe Collias collection.



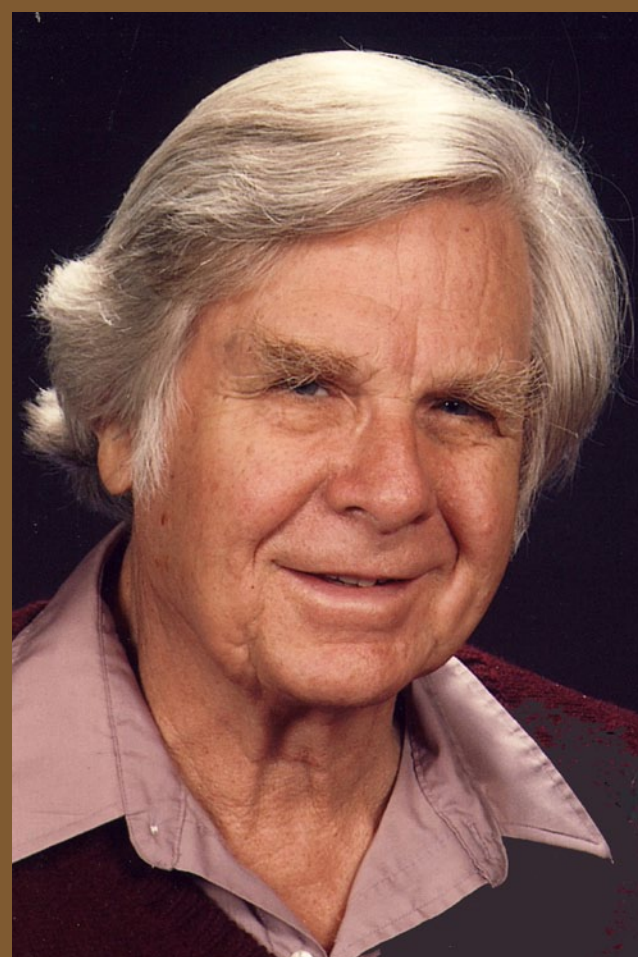

Figure 8: Rebuilt at the Frisco's Yale Yard (Memphis) shops in June of 1942, SL-SF 86941 was photographed just after it was rolled out of the paint shop and before it had been weighed and the weight data stenciled on it. The Ajax geared hand brake was new, but the ARA trucks and KD air brakes were original.

The Frisco owned 3,500 USRA-clone twin hoppers, all built new in the early 1920s. More than 1,500 of them were rebuilt with panel sides before and during World War II, and the Frisco also applied panel sides to a large number of its aging gondola cars. *—Joe Collias collection*



Figure 9: A Micro-Trains N scale model with simulated coal load painted and lettered to represent a Frisco USRA-design gondola in the 86000-89499 series as it appeared after rebuilding with panel steel sides. *—Richard Hendrickson*



Richard Hendrickson grew up around the Santa Fe Railway in Southern California during and after World War II, when most trains were still steam powered.

Richard has authored or co-authored several books, several hundred periodical articles, and numerous seminar clinics.

When not busy with research and writing activities, Richard works on an operating diorama representing Rivera, CA on the Third District of the Santa Fe's Los Angeles Division in October of 1947.

Since the turn of the century, Richard and his wife Sandra have lived in Ashland, Oregon.



Figure 10: An Accurail HO scale model of a New York Central panel side hopper.

*—Richard Hendrickson*

 **Article feedback!**  
[CLICK HERE](#) for reader comments on this article ... 



# Do-it Yourself Manual Turnout Control

## Finding the optimum Bear Creek & South Jackson turnout control

– Charlie Comstock

Photos by the author

### What didn't work for me

I've spent a lot of time thinking about turnout controls (switch stands) for my model railroads. I prefer a dark (unsignalled) railroad and that means I've no need for CTC control of turnouts, where the dispatcher is able to throw switches from his console. I also am not interested in using a DCC throttle to throw turnouts.

Sometimes even careful operators mis-dial the address of a locomotive — when they advance the throttle, a loco other than the one they were expecting takes off! With throttle-operated turnouts an operator can accidentally throw a switch underneath someone else's in-motion train, causing a derailment or collision.

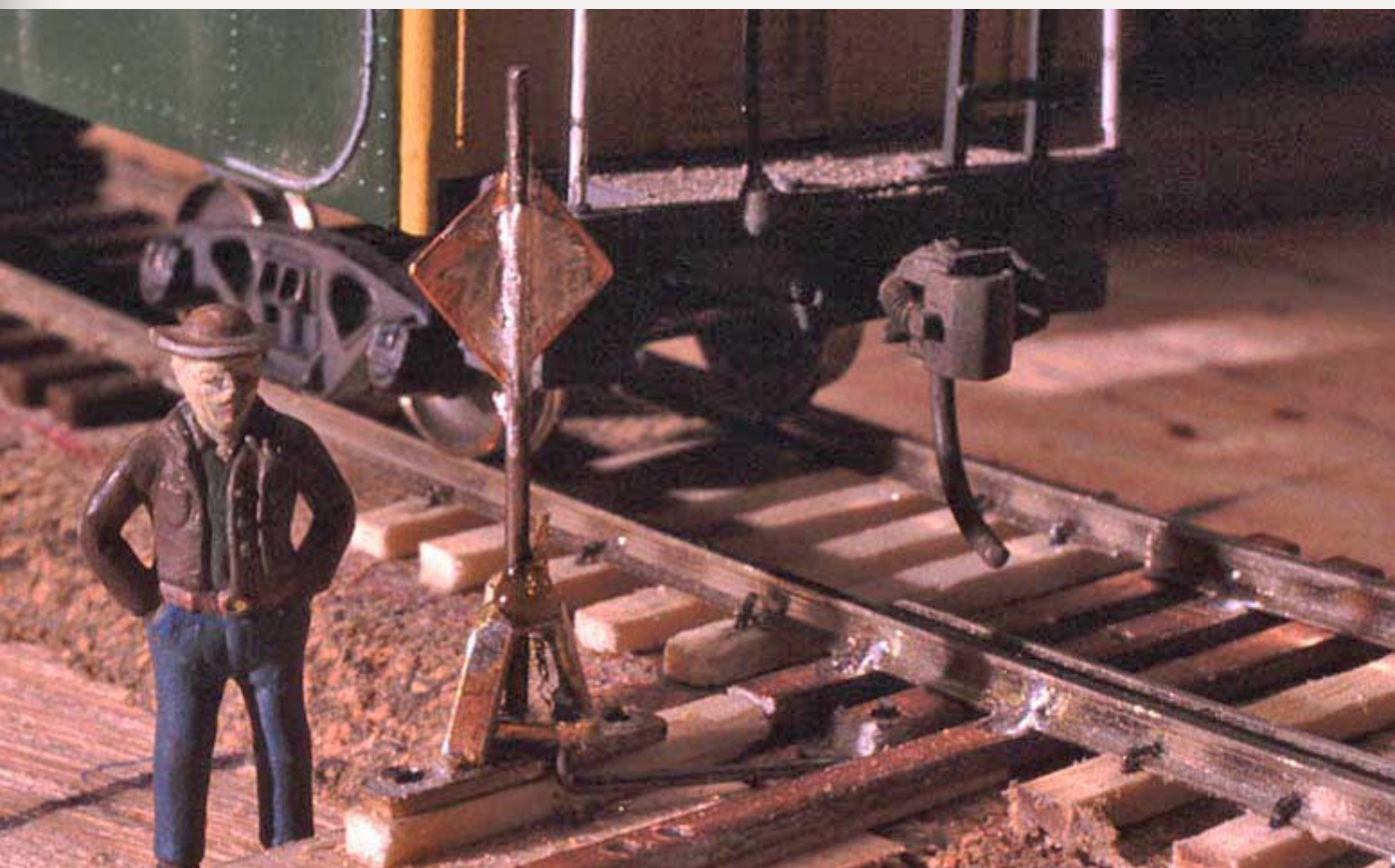

FIGURE 1: Brass semi-scale switch stand.

I'm also not keen on the cost of this technology! Tortoises are already more expensive than I like. Adding DCC electronics to them doubles or more the cost of throwing switches that way. Plus I just plain like having the crews getting their hands 'dirty' throwing switches when they come to them.

I've used Caboose Industries ground throws but found their way-too-big-for-scale-size off putting. Plus they cost a couple of bucks each and are fragile (I need to repair or replace one about every other op session). I tried scratch building brass semi-scale, operating switch stands.

To throw the switch you'd grab and twist the switch stand target. They were a bit overscale but didn't look too bad. Throwing a switch by rotating a scale switch stand seemed like a great idea. But they suffered from reliability issues (critical pieces kept coming unsoldered), were tricky to make, and having to reach into the scene to operate 'em didn't always work too well (it's hard to know where to reach when a train is in front of a switch stand, obscuring it).

With a train in the way, it also wasn't easy (or sometimes possible) to tell which route a turnout was lined for! They easily snagged errant shirt sleeves! So I reluctantly gave up on them and continued my quest for a perfect switch machine.

### Something simple and robust (and cheap)!

I needed something simple to build, that would be robust and reliable, was operated from the fascia (making it easy to find the switch stand), was a visible indication of the direction the turnout was lined, and was cheap to build. My cost goal was under \$1 per turnout!

I've seen and used Joe Fugate's deadbolt-based turnout controls. They look a bit strange but they work great.

Joe runs non-stretch fishing line between the controls and actuators (a piece of vertically mounted piano wire). Throwing the deadbolt down pulls on the fishing line and moves the points. Moving the deadbolt up releases the tension on the





**FIGURE 2: Deadbolt switch control on Joe Fugate’s Siskiyou Line.**

fishing line and the springiness of the piano wire returned the points to their original position.

While Joe’s turnout controls did provide part of the answer I was looking for, when I started pricing deadbolts I quickly found that they would set me back at least a couple of bucks each. I felt like I could do better. I had many delusions about fabricating something from brass but they were all either too complex, too flimsy, or too expensive.

Joe’s turnout controls did provide part of the answer I was looking for — he operates most of his turnouts by running non-stretch fishing line between the controls (deadbolts)

and actuators (a piece of vertically mounted piano wire).

Throwing the deadbolt down pulls on the fishing line and moves the piano wire, which moves the points. Moving the deadbolt up releases the tension on the fishing line and the springiness of the piano wire returned the points to their original position.

A year or so ago I was installing the fascia at Oakhill area of the BC&SJ when I had a thought — could I use two pieces of dowel to make a knob assembly, mount it in a piece of 3/4” plywood, then wrap the fishing line around the dowel/knob assembly to translate rotation into pulling on the line and thus the turnout points?

I built a prototype, installed it on the east Oakhill turnout and it worked! I built another one and installed it to control the turnout at the Oakhill logging spur. It took some adjustment but it worked too!

When I relaid the track in Redland I decided to control all the turnouts there using my new “knobby” switch controls.

It’s a bit over my \$1 target cost (add a little more money for paint if you don’t want ‘em plain wood color). But this compares favorably to \$13 for a Tortoise (in bulk and not including wiring or switches to operate it) or even \$3 for a Caboose Industries ground throw.

Here’s a parts list for my switch controls:

<b>Table 1. Knobby Turnout Control Parts List</b>			
<b>Component</b>	<b>Qty</b>	<b>Description</b>	<b>Cost (est.)</b>
Shaft	1	2 1/4 of 3/8 dowel	\$0.20
Knob	1	7/8 of 1 dowel	\$0.15
Set screw	1	#4 x 1/2 flat head wood screw	\$0.03
Locking pin	1	7/32 piece of 10d finishing nail	\$0.02
Mounting Panel	1	2.5x5 3/4 plywood	\$0.09
Travel Limit Pin	1	1 piece of 6d finishing nail	\$0.02
Travel Stop	2	1 piece of 6d finishing nail	\$0.04
Bracket vertical	1	4 x 1.75 pine	\$0.04
Bracket mount	1	2.5 x 1.75 pine	\$0.03
Bracket screws	3	#8 1 1/4 deck screw	\$0.12
Panel mounting screws	2	<#8 2 1/2 deck screws	\$0.10
Fishing Line	1	Avg 1.5’ of 30lb non-stretch fishing line	\$0.10
Line locking pin	1	Atlas Track nail	\$0.01
Fishing Line Guides	1	Small Cup Hooks	\$0.03
Turnout actuator	1	6 of .039 piano wire	\$0.20
Actuator Locking Screw	1	1/2 #8 pan head sheet metal screw	\$0.03
Turnout Return Spring	1	A small coil spring with hooks on the ends	\$0.05
Spring Mount	1	Atlas Track Nail	\$0.01
<b>Total</b>			<b>\$1.26</b>





## How they work!

Here's how they work. Under the turnout I follow Joe's practice and mount a wooden bracket to hold a vertical length of .039" piano wire that goes through a hole drilled in the turnout throwbar.

Close to the bottom surface of the roadbed (where the piano wire goes through a hole in it) I tie on some 30 lb. non-stretch fishing line. The fishing line leads to the fascia (as directly as possible) where it is routed (via a cup hook) down to the rear of the dowel/knob assembly. The fishing line is wrapped around the dowel a few times, then threaded through a .037" hole in the end of the dowel.

At first I used Joe's method of letting the spring in the piano wire return the piano wire (and switch points) to their 'default' position (away from the aisle). But this required some very precise adjustment of placement of the piano wire and its support (the tension required in the piano wire made it 'bow' significantly) so I started adding a small return spring to the end of the fishing line. I used an Atlas track nail to 'lock' the fishing line in place once everything was adjusted.

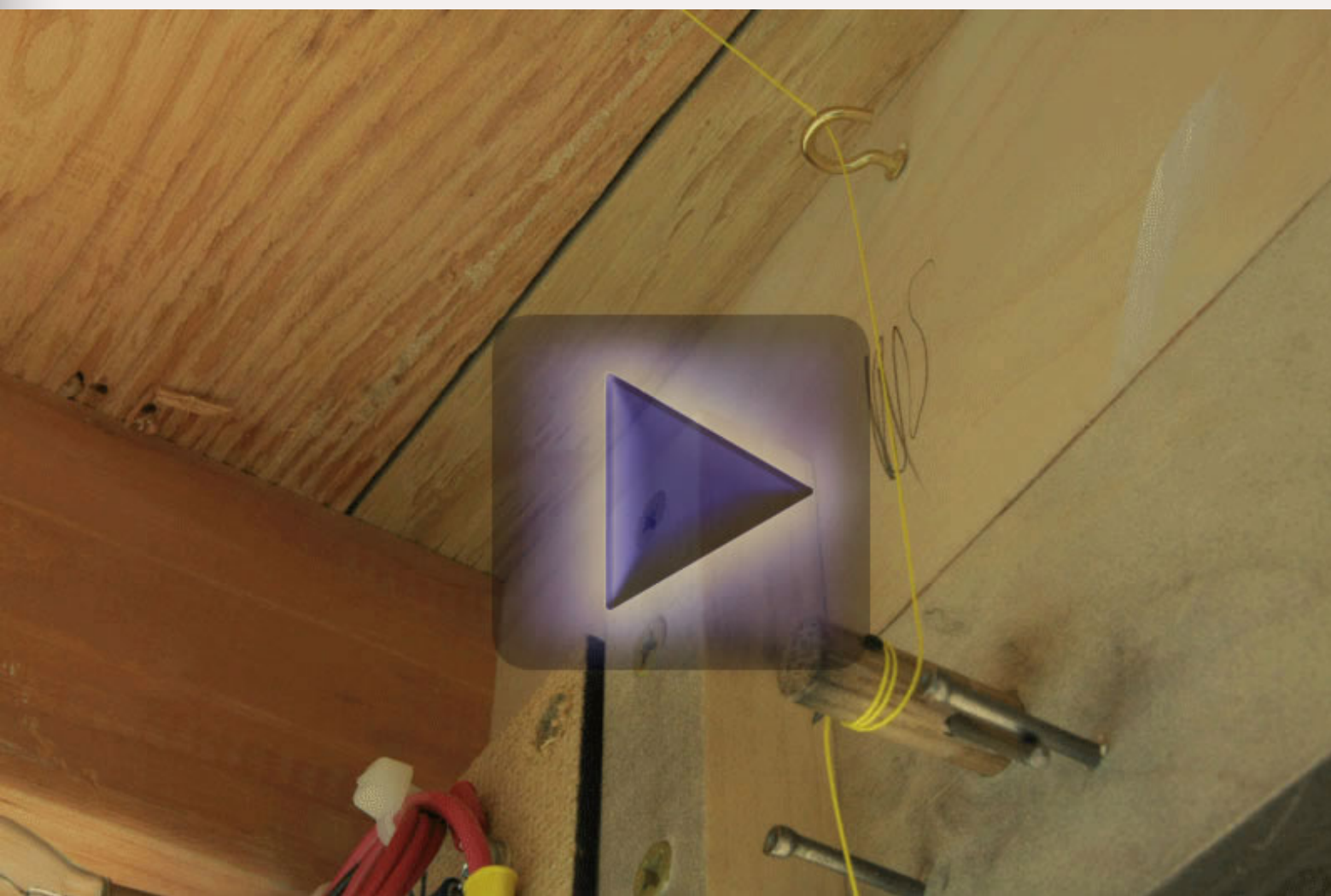

Figure 2a: Turnout control operation – back side (stop motion movie)



Figure 2b: Turnout control operation – fascia side (stop motion movie)

## Rotation limits

A tricky part of manufacturing these switch control was limiting the rotation of the dowel/knob assembly. Turning the knob too far could do bad things to the mechanical alignment or even snap the fishing line.

On my controls a user pulls the knob out from the fascia to unlock the control, twists the knob to throw the switch, and shoves it back in to lock the control in its new position.

The locking is accomplished by a pin on the rear of the knob that fits into locking holes drilled (carefully using a jig) in the mounting panel. I make my pins from a short length of a 10d finishing nail. Cheap, easy to make, and strong.

To keep operators from over-twisting the control I install travel stops behind the mounting panel. This stop is pretty simple too. I drill a hole in the dowel assembly about 1/4" behind the panel and put a piece of 6d finishing nail in it. Then I drill two holes in the back of the panel to accept two more pieces of 6d finishing nail for the stops.

NOTE: For precision, panel and knob holes are made using a drill press ensuring vertical alignment.



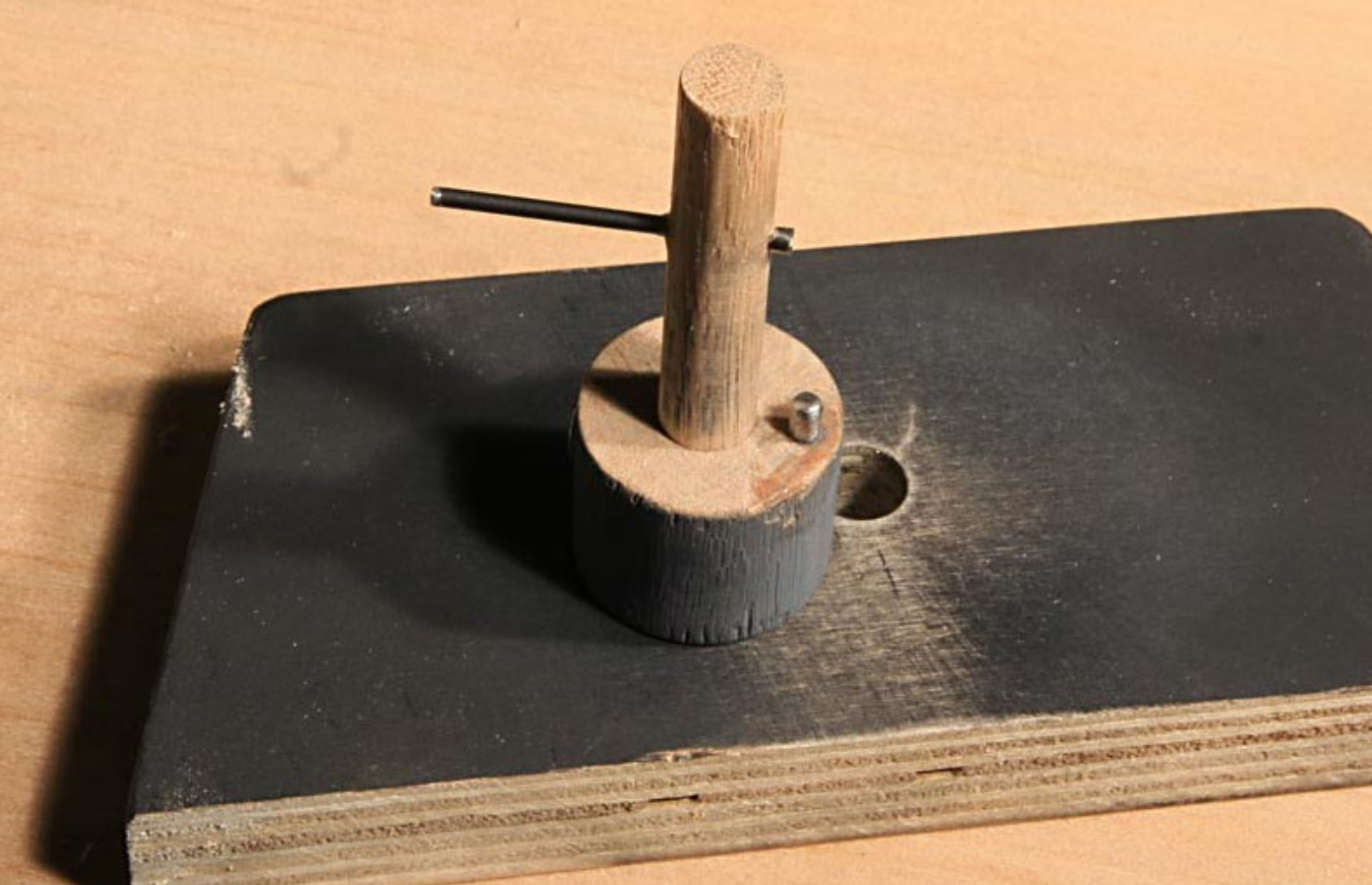

Figure 3: Knob/Shaft assembly



Figure 4: My bench top drill press

All this may sound like a bit of work and I'll admit there is some effort involved. But the result is a solid turnout controller that can easily withstand a big operator bouncing a hip on it and it has a nice solid (even a bit railroady) feel.

I mass produce the controls using a number of jigs to speed the process. One tool that is definitely needed to build these is a drill press. It can be small but needs to be able to handle a 3/8" drill and a 1" forstner bit. My Delta bench top drill press works fine.

If you don't have a drill press you can probably find someone nearby who does and will let you use it to do the hole drilling.

## I use jigs to speed production of the pieces

The word 'jig' often brings butterflies in the hearts of a model railroader. They bring up visions of expensively

tooled fixtures that are complicated and hard to use. Let me assure you this is not the case here! In fact, my jigs look like scraps of wood. Let's discuss them.

### STEP 1: Shaft Hole Location Jig



Figure 5: Shaft Hole Jig - drilling the hole to hold the knob.

The first jig is the one that allows me to drill the 3/8" diameter hole in the center of the knob (1" dowel). I start with a small piece of wood about 2" square by 3/4" thick. I use a forstner bit to bore a 1" diameter hole about 3/8" deep. the Forstner bit leaves a dimple in the center of the hole. I use this dimple to center a 1/8" bit for a pilot hole and then drill the pilot hole out to 3/8" (the size of the dowel I use for a shaft).



## STEP 1: Shaft Hole Location Jig (continued)



Figure 6: Pilot hole for the shaft.



Figure 7: Completed shaft hole jig.

## STEP 2: Making the Basic Knobs



Figure 8: Setting up the chop saw to cut knobs.

I cut the basic knobs from a length of 1" dowel, making each dowel about 7/8" tall. I use a stop on my chop saw to make this go faster. Because the knobs are small, care must be taken to avoid having them 'jam' against that saw blade and go flying. NOTE: I use a stick to hold the knobs in place after they are cut, so they don't jam in the blade and go flying.



Figure 9: Cutting a knob from a 1" dowel.



## STEP 2: Making the Basic Knobs (continued)

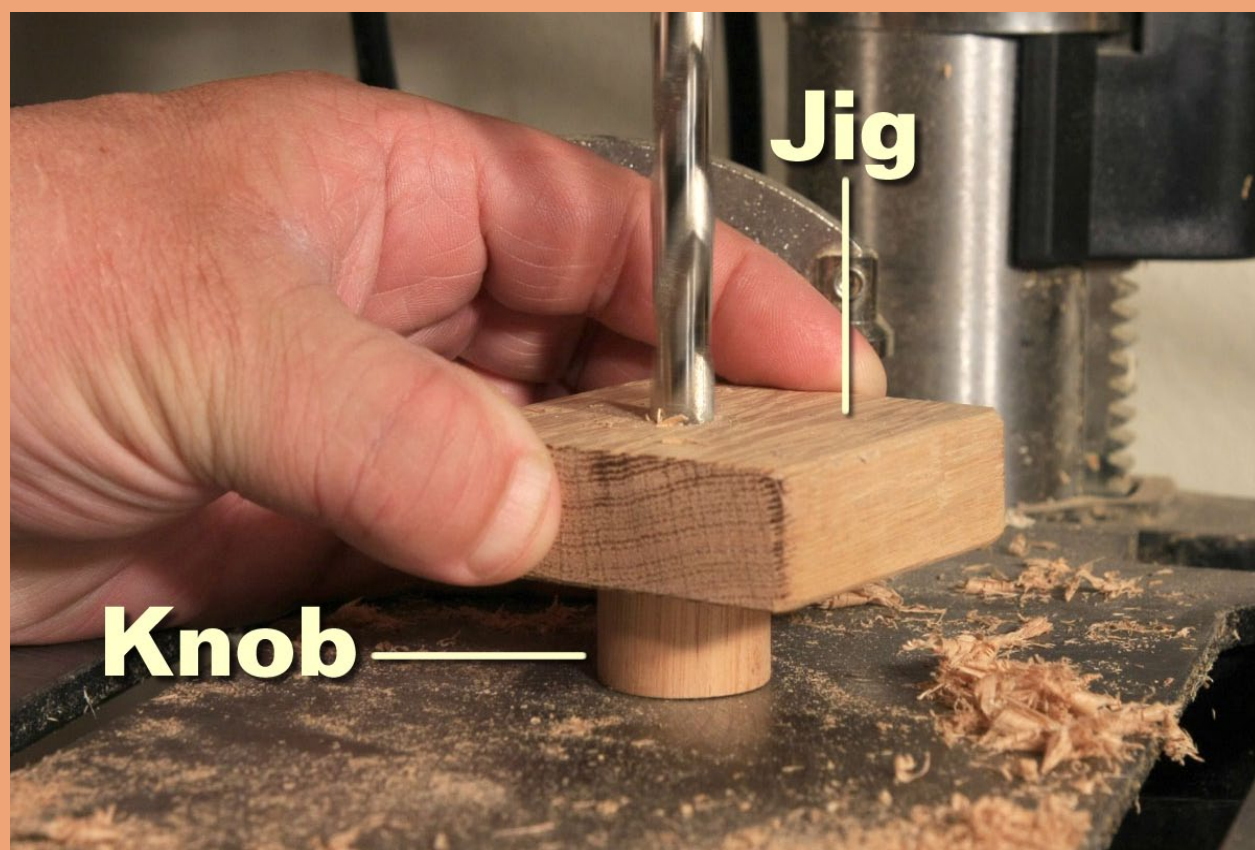

**Figure 10: Drilling a shaft hole in a knob using jig.**

Then I put the shaft-hole-location-jig over the top of a knob and use the 3/8" hole in it as a guide for boring the 3/8" hole to accept the 3/8" dowel shaft. I set the stop on the drill press to limit the hole depth to about 1/2".



**Figure 11: Knob with shaft hole and jig.**

NOTE: The knob may try to spin when boring the hole in it. If this is a problem try putting a sheet of 220 grit sandpaper (grit up) underneath the knobs to give a bit more traction.

Once the main holes are bored in the knobs stick them on piece of 3/8" dowel chucked in a drill motor and sand off the rough edges on them.

If you're planning to paint your knobs now is the time to apply the base coat. I use inexpensive gray spray paint on mine.



### STEP 3: The Locking Pin Hole Location Jig

The second jig I use helps me make the holes for the locking pins the same distance from the shaft in both the knobs and the panels.

NOTE: the holes must be precisely located or the pull-push unlock/locking of the knobs will be compromised.

I make this jig by taking another piece of 3/4" thick stock about 2" square and bore a 3/8" hole roughly in the middle of it. I take a short piece of 3/8" dowel (the material for the shaft) and press it into the hole just bored. It should stick out about 1/8" on either side of the 3/4" jig material. With the piece of shaft in place I invert a knob (with hole in the end) over it and use a pencil to mark around the diameter of the knob on jig.



Figure 12: Locking pin jig with shaft installed.



Figure 13: Tracing around knob on jig.



Figure 14: Drilling the locking pin guide hole (halfway between the outline and the shaft).

I take the clearance drill for the 10d finishing nail locking pin (I use 1/8" but you should check the size of your locking pins and select a drill size accordingly) and make a hole all the way through the jig about half way between the shaft dowel (in the jig) and the pencil outline of the knob.

This jig is now ready for action.



## STEP 4: Drilling the Locking Pin Holes in the Knobs



**Figure 15: Setting locking pin hole depth.**

Set the drill press depth-of-hole stop to be about 3/16" below the surface of the knob. Since the Locking Pin Jig will be on top of the knob when the hole is drilled it is necessary to set this up now. If your drill press doesn't have a hole depth stop, add on the thickness of the jig and wrap a piece of tape around the drill bit.

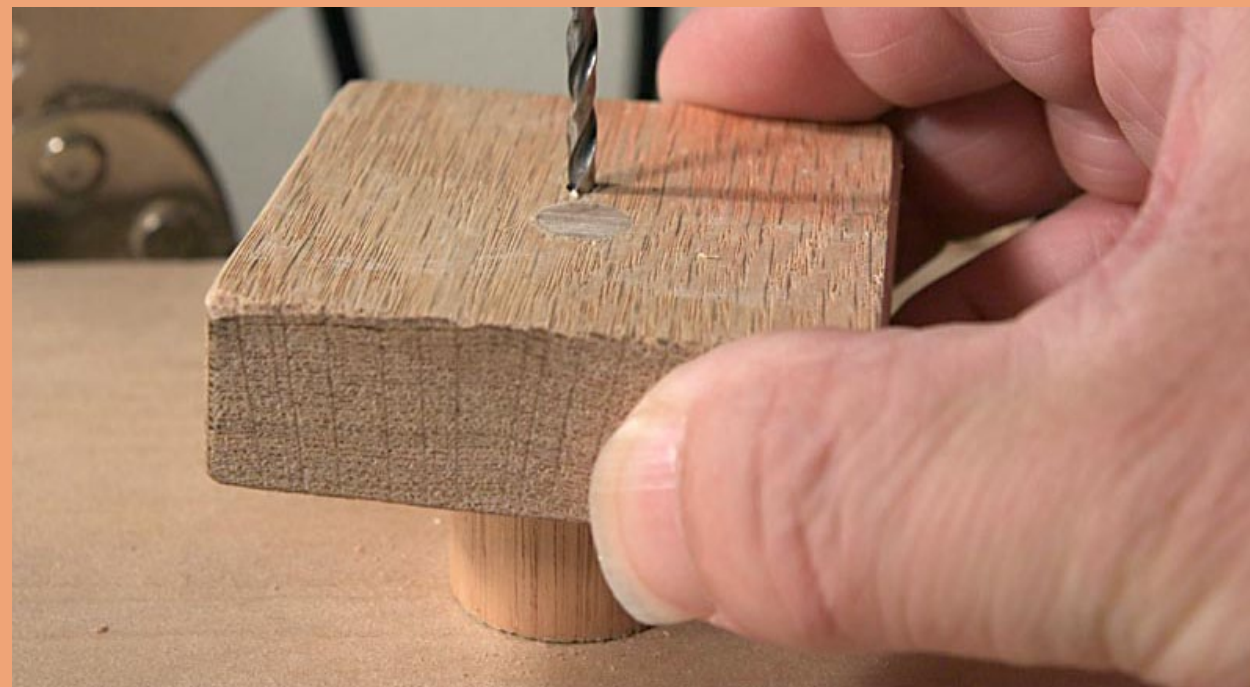

**Figure 16: Drilling locking pin hole in a knob using the jig.**

Now fit the locking pin hole jig over the top of a knob and using the hole in the jig as a guide, drill a hole in the rim of the knob to receive a locking pin.

## STEP 5: Locking Pins for the Knobs



**Figure 17: 10d finishing nails.**

Cut locking pins from 10d finishing nails (smooth finish, *not* galvanized!). These should be about 7/16" long and fit smoothly into the locking pin holes in the knobs. I use heavy electrician's pliers to cut the nails to rough length, then chuck the pieces in a cordless drill and file their ends smooth while the drill spins the locking pins. 1 per turnout control.



**Figure 18: Cutting a locking pin from a 10d nail.**



## STEP 5: Locking Pins for the Knobs (continued)



**Figure 19: Deburring a locking pin.**

Once the locking pins are ready I mix up a small batch of 5-minute epoxy. I dip one end of the pin in the epoxy, then shove that end into a knob. If all went well, there should be about 3/16" of pin left sticking out of the knob.



**Figure 20: Knobs with locking pins epoxied in place.**

Once the epoxy sets up, dress the pin/knob joint with a file to remove any excess epoxy.

## STEP 6: Making the Turnout Control Panels

I cut my panels from good quality 3/4" plywood. I use plywood because I don't want the expansion and contraction of dimensional wood to pinch the control shaft. I make my panels about 2" tall with the width to suit. Some panels are for a single turnout control. If multiple controls are closely spaced I use a single panel to hold them all. Access to a shop with a table saw and chop saw is helpful here.

I carefully figure out where each control will be mounted on the fascia and determine how many turnout control panels I'll need and where the knob/shaft assemblies should be placed in them. I rip out lengths of 3/4" plywood and cut them to length. I use a 100 grit sanding sponge to take the rough edges off them.

Next I mark where the holes for the shafts should be — I put my holes halfway between the top and bottom. Now I take the panel blanks over to the drill press and carefully bore 3/8" holes to accept the shafts.

Once the 3/8" holes are bored, I use the locking-pin-hole-jig and make two holes for the knob locking pins to fit into. These should be 90 degrees apart from each other (the knobs should twist 90 degrees). It's ok to guesstimate the 90 degrees.



**Figure 21: Drilling a locking pin hole in a panel.**



## STEP 6: Making the Turnout Control Panels (continued)



**Figure 22: Panels with shaft and locking pin holes.**

I sand off any rough edges around the holes and paint the panels using inexpensive black spray paint (you can use what ever color you like). For panels that will be (mostly) covered by a fascia board.



**Figure 23: Turnout control installed behind fascia.**

I just paint the area directly around the shaft. For panels that will be free standing I paint all visible surfaces of the panel. Let the paint dry thoroughly, then GENTLY run the drills through the holes in the panel to clear out any paint.



**Figure 24: Turnout control installed below fascia.**

Set the panels aside for now.



## STEP 7: Making the Shaft Blanks

I figure the lengths of my shafts. depth-of-knob-hole + thickness-of-panel + extension-behind-panel = Shaft-Length

For my controls this works out to

$$0.5'' + 0.75'' + 1.55'' = 2.75''$$

So I cut as many shafts as needed for the knobs (and panels) out of 3/8" diameter dowel. I use good quality dowel (oak) for this as it's important that the shafts be (at least close to) round. Then I chuck each shaft in a drill motor and spin it while applying 220 grit sandpaper. This smooths the grain and slightly reduces the diameter of the shaft. I don't want a press (tight) fit of the shaft in the panel hole as this will make operation of the control rather difficult. Instead, I'm going for a 'running' fit - it should slide freely but still have a bit of resistance.



Figure 25: Sanding a shaft using a drill motor.



Figure 26: Burnishing a shaft in a panel hole.

To achieve a running fit, when I finish with the 220 grit sandpaper I press the shaft into its panel hole with the drill motor running and run it back and forth burnishing both the shaft and the hole. Finally I pull it out of the hole and rub the shaft with a bit of candle wax as a lubricant. At this point the shaft should turn relatively freely in the hole but there shouldn't be very much 'slop' in the fit.



## STEP 8: Travel Stop Pin Hole Jig

The travel stop pins are used to limit both the knob rotation and how far the knob may be pulled out from the panel. These pins will be mounted directly through the shafts. To accomplish this we'll need to drill a hole through each shaft. This hole should be located so that with the knob fully pulled out, the locking pin clears the panel and the travel limit pin is against the back of the panel (preventing the knobs from being pulled out farther). Use a drill bit the correct size for making the travel stop pins a press fit in these holes (depends on the size of the pins).

A very simple jig makes drilling holes in lots of shafts easy. The jig itself is nothing more than a scrap of 1x2 stock with a 1/4" x 1/4" dado cut on my table saw. The shaft will lay in this slot (dado).



Figure 27: Setting up the travel stop pin hole jig.

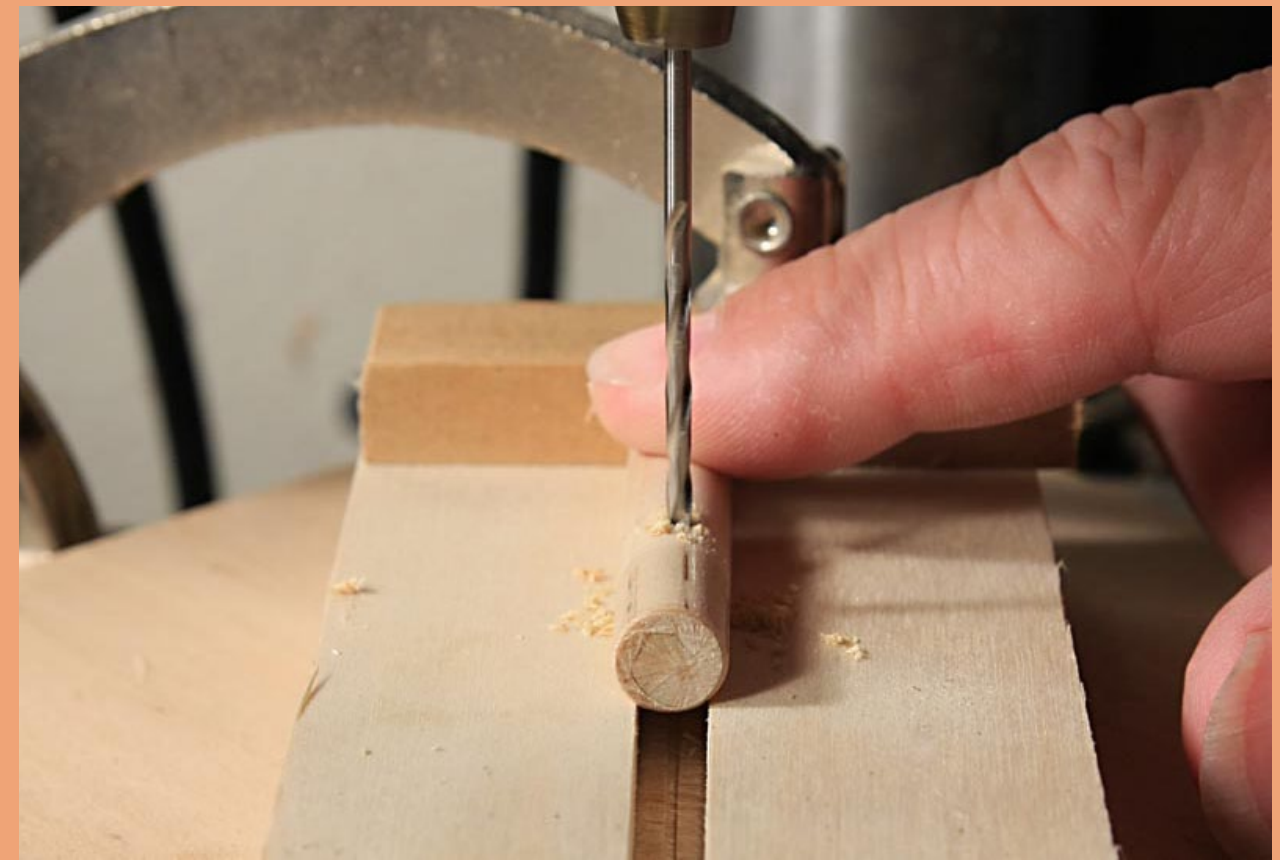

Figure 28: Travel stop pin hole jig in use.

I clamp this onto my drill press table so that the drill bit comes down as close to the center of the slot (dado) as I can eyeball it.

NOTE: This can be tricky so I take my time.

I calculate how far the Limit Pin hole needs to be from the front end of the shaft. This distance is depth of the hole in the knob + thickness of the panel + 1/4" = 1/2" + 3/4" + 1/4" = 1.5"

I clamp a small block of wood on top of the hole jig so when I put a shaft dowel in the slot and press it up against the stop, the drill press will make a hole 1.5" from the end of the shaft.



## STEP 9: Travel Stop Pins



Figure 29: Nails for travel stop pins and travel stops.

Cut the travel stop pins from 4d finishing nails about 1" long leaving the nail head on. I use an old wire stripper for this (a pair of pliers with threaded holes for cutting off screws).



Figure 30: Old wire stripper.

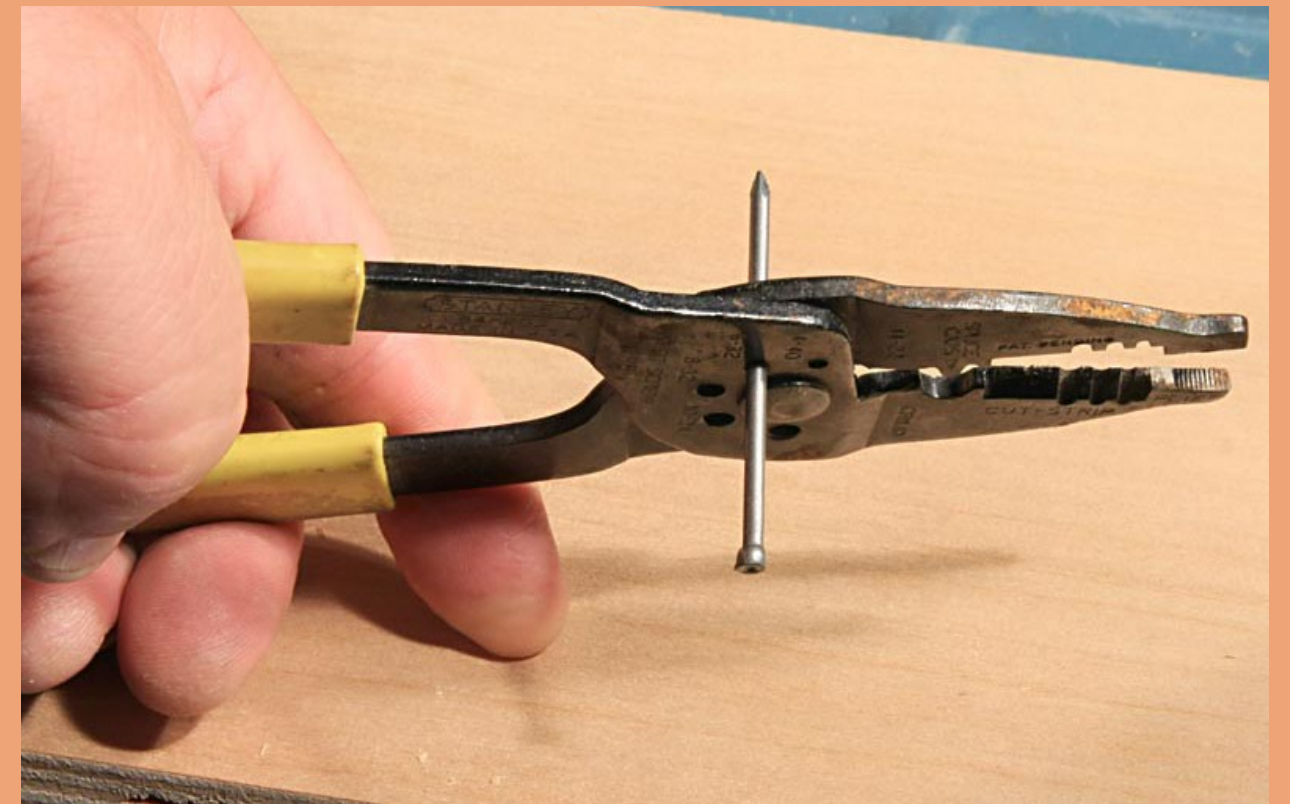

Figure 31: Cutting travel stop pins with wire stripper.

The 4d finishing nails fit in the hole for 6/32 machine screws and the screw cutter didn't seem to mind that they weren't screws and clipped them off fairly cleanly. I suppose this isn't doing the screw cutter part of my wire stripper any good but I've got another one for when I need to cut screws. Electricians pliers could also be used.



## STEP 9: Travel Stop Pins (continued)



**Figure 32: Knob, shaft, and travel stop pin assembly.**

After cutting the pins, I file off the rough edges (so nobody cuts themselves on them later on). Then I press the pins into the shafts so the nail head is up against the shaft. I use a small hammer to do this.

## STEP 10: Travel Stops and Mounting the Knob/Shafts in the Panels

### Travel Stops

The travel stop pin limits shaft rotation by bumping against a pair of travel stops. The travel stops are also made from 6d finishing nails.

Cut the travel stops from 6d finishing nails about 3/4" long leaving the nail head on. Very similar to cutting the travel stop pins but don't bother filing them smooth. We'll be hammering them into the back of the mounting panels.

### Mounting the Knob/Shaft in the Panel

Put a shaft through its panel. Make sure the correct end is protruding on the front (knob side) of the panel (the front of the panel is the side with the locking pin holes in it). The shaft should be protruding roughly 3/4". Press fit a knob onto the shaft.

Now push on the knob and twist it until the locking pin engages one of the locking holes in the panel. While keeping the knob and locking pin engaged, twist the shaft to line up the travel stop pin where you'd like it to be. Next pull on the knob to release the locking pin and rotate the knob to line up the locking pin with the other locking hole (should be about 90 degrees of rotation).

Check to see if the travel stop pin is where you expected it to be. If not, twist the shaft and re-check. With a pencil, mark the limits of rotation on the back of the panel.

Once the shaft and knob are aligned, test drill a pilot hole through the knob into the shaft and install a #4 flat head wood screw to lock them together. Re-check that the knob/shaft assembly rotates correctly.



## STEP 11: Mounting the Travel Stops



**Figure 33: Travel stop range marked behind panel.**

Turn the panel upside down (knob protruding downward) and take it to the drill press. You'll need to put some blocks of scrap on the drill press table to keep the knob from hitting the table and making the panel assembly 'wobbly'.

Align the knob/shaft assembly with the two locking holes. Note carefully the travel of the pin through the shaft. Using the travel stop pin as a guide I drill a hole for one of the travel stops.



**Figure 34: Drilling a travel stop hole.**



**Figure 35: The travel stops installed in the holes.**

Now, move the knob/shaft to its other locked position and drill another travel stop hole. If done correctly the travel stop pin should be just kissing each of the travel stops when the locking pin is lined up with a locking hole in front side of the panel.



## STEP 12: Finishing the Shaft Assembly and Mounting Brackets

### Finishing the Shaft Assembly

Drill a .037" hole about 1/4" from the end of the shaft for the fishing line to go through. The fishing line will be wrapped around the shaft several times, then threaded through this hole and an Atlas track nail will be pressed into the hole to keep fishing line from slipping.

*At this point you may choose to paint the sides of the knobs different colors. In the position lined for the diverging route you can paint the left and right sides of a knob red or yellow (mimicking the colors of a prototype switch stand target). As a train crew approaches a turnout the engineer can see the red or yellow and know if the turnout is set for the diverging route.*

Alternatively, turnout position can be indicated by painting an arrow on the flat end of the knob. Be consistent, either all turnout control knob arrows should be the route selected, or they should be the direction of the points.

### Mounting Brackets

I cut all the pieces for the necessary mounting brackets out of 1x2 stock. The two pieces are 4" and 2.5" long. Screw and yellow glue them together making L-shaped brackets.

Note: If you have a nail gun you could use that instead of the screws to hold the pieces together while the glue dries.

### Turnout Actuators

Cut the turnout actuators from .039" piano wire. The length should be 4" plus the thickness of all roadbed layers plus 1" (it should protrude above the turnout about 1"). I use 3/4" plywood in towns and places where there are turnouts and often have 1/4" of cork on top of that so I cut my wires about 6" long. Using electricians pliers make an L bend in one end of the actuator wires about 1/8" from one end.

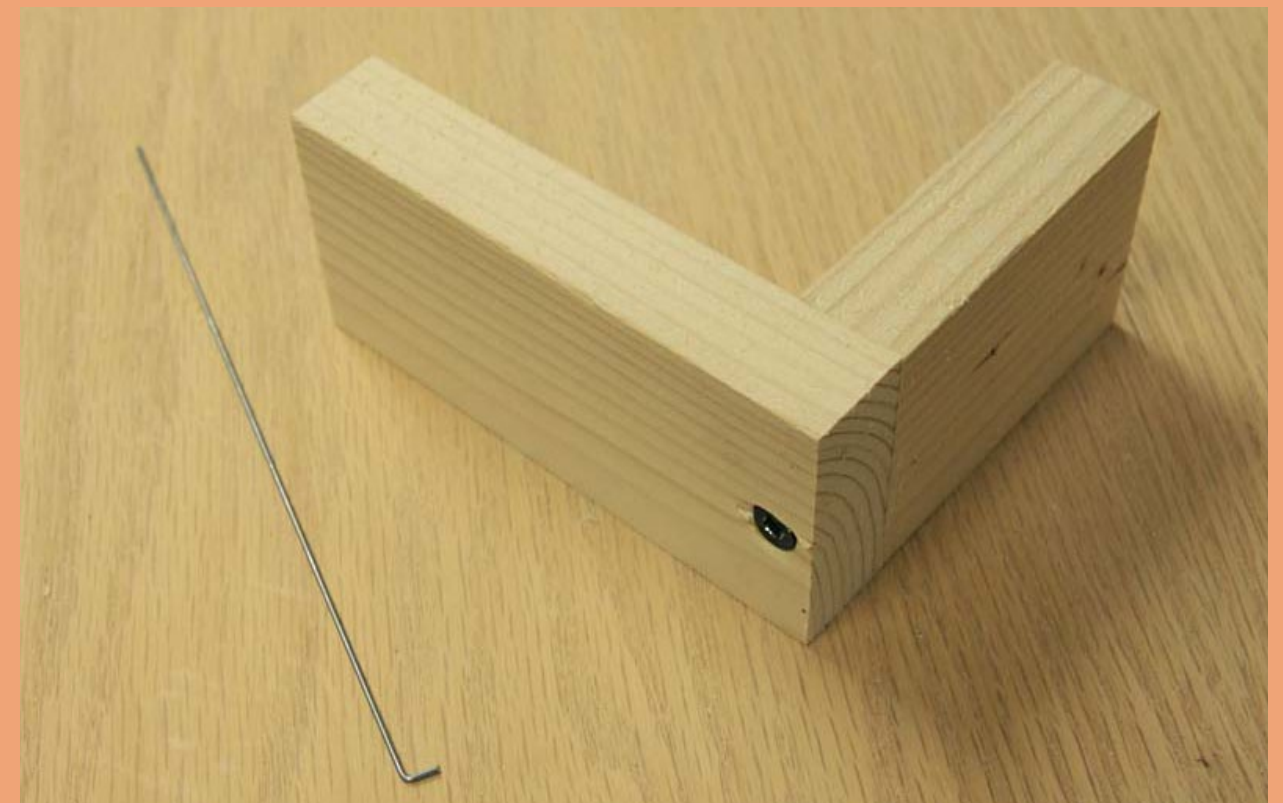

Figure 36: Mounting bracket and actuator wire.



## STEP 13: Actuator Assembly



**Figure 37: Drilling actuator wire hole in mounting bracket.**

Once the glue has dried on the mounting brackets drill a .040" hole near the bottom (end of the long leg of the L) of the bracket assembly to hold the turnout actuator wire's 1/8" L bend. Put the wire in the hole, then drill a 3/32" hole next to the wire and use a #8 1/2" pan head sheet metal screw to lock the wire in place. The turnout actuator wire should be pressed into the wood a little.



**Figure 38: Actuator wire installed.**



**Figure 39: Attach fishing line to actuator wire.**

Tie a length of fishing line around the actuator wire leaving about 6" of fishing line beyond the wire. I find a double overhand knot works well for me with the fishing line I use. I yank on the line a bit to make sure the knot is tight. I tie a small spring onto the free end of the fishing line.

The distance of the spring from the actuator wire depends on where it will be installed. I try to pick a length so that the spring won't interfere with wiring or other under layout stuff when installed. Finally, I estimate how much fishing line is required between the actuator assembly and the knob/shaft for this turnout and cut it allowing extra, just in case.



## STEP 13: Actuator Assembly (continued)

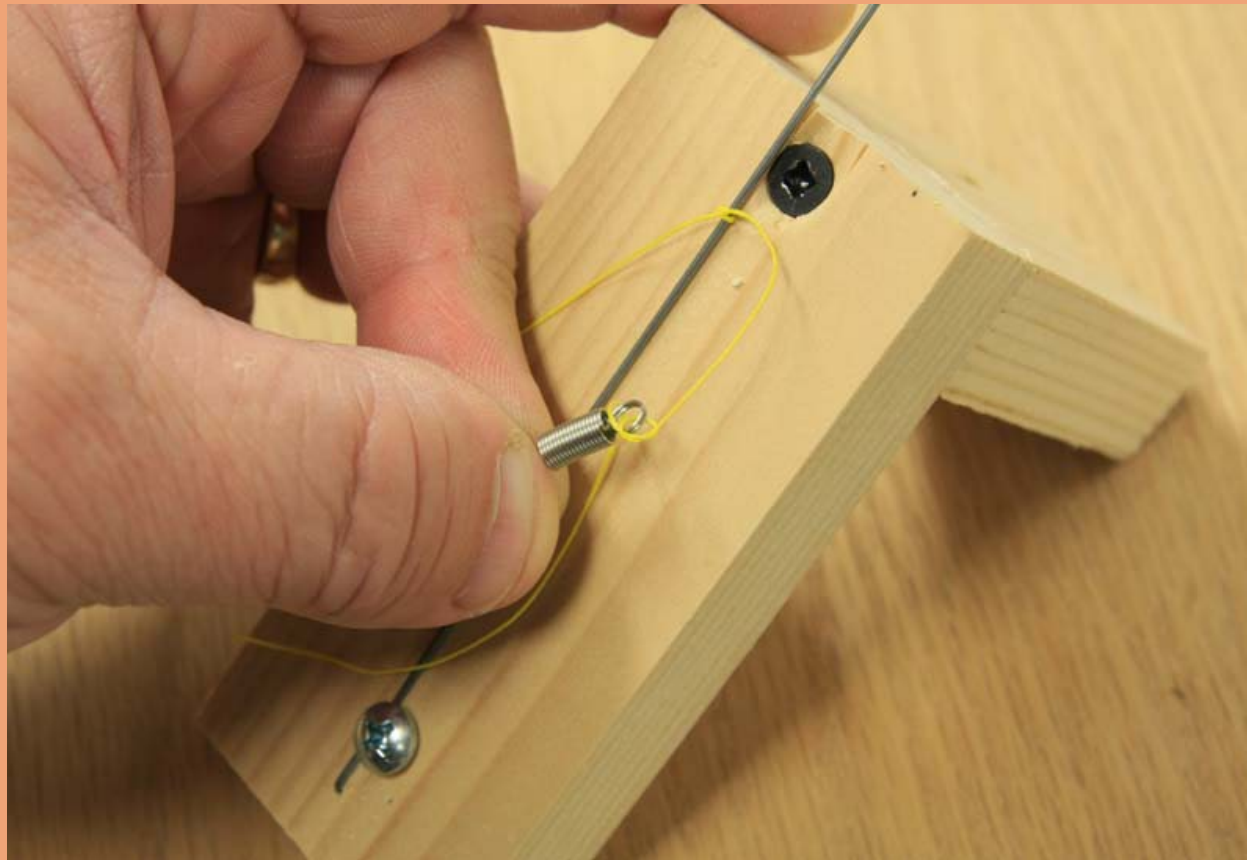

**Figure 40: Tying line to spring.**  
The actuator assembly is now complete.

## STEP 14: Mounting the Panels

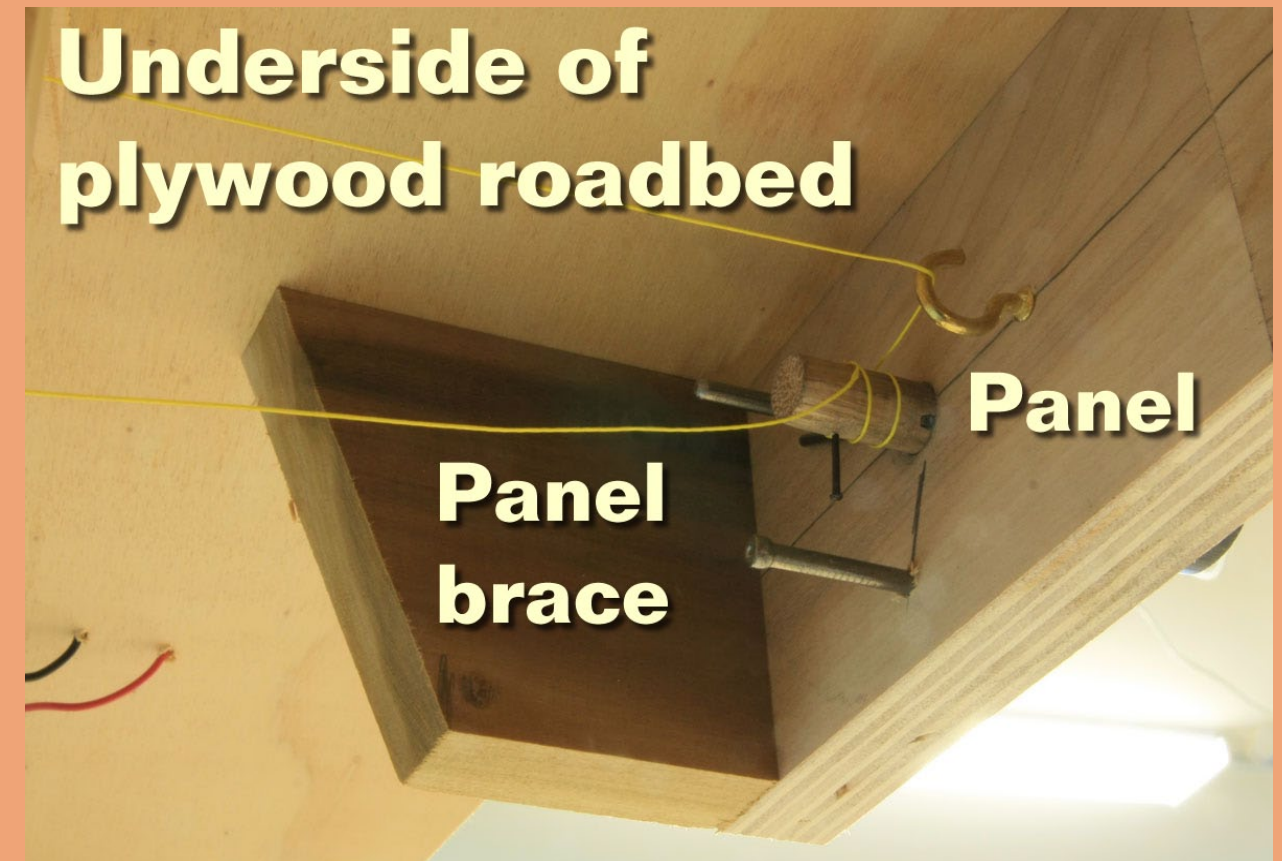

**Figure 41: A panel mounted to the underside of plywood roadbed.**

I mount my panels one of three ways:

- Extending below the fascia using a pair of 1x1 to hold them in place
- Screwed to the bottom of the 3/4" plywood roadbed using a small plywood gusset to stiffen them.

However they are mounted be certain the panels are well attached and stiff. There will be some overeager brakemen yanking on these so a flimsy mounting will be a problem.



## STEP 15: Mounting the Actuator Assemblies and Connecting It All Up

### Mounting the Actuator Assemblies

This is where I find out if I remembered to cut a hole in the roadbed for the turnout actuator wires before I installed the turnouts. Take my word for it, drilling the holes BEFORE installing the turnouts is much better than trying to drill an actuator hole afterward. Don't ask how I know this.

Assuming there is an actuator hole under the throwbar of the turnout to be controlled, I carefully drill a 0.42" hole in the throwbar to accept the actuator wire and poke the Actuator Wire up through the hole in the roadbed and thread it through the hole in the throwbar. This often takes some patience. I stick a spring clamp on the protruding actuator wire to keep it from falling out.

I move the turnout points to roughly their center of travel and try to align the mounting bracket so that the actuator wire extends vertically downward from the throwbar. The bracket should be far enough away from the wire so as to not snag it (about 1/8").

### Connecting It All Up

I push the fishing line up the actuator wire until it is just under the roadbed but clear of all obstacles such as wiring or other benchwork pieces. Then I take an Atlas track nail and stick it through the loop at the far end of the spring, stretch the spring so it puts tension of the actuator wire moving the turnout points so they are against the stock rails away from the aisle (two people make this easier!)

I drive the track nail into the bottom of the benchwork. It's easy to bend those nails so sometimes I need to do this a couple of times before getting it right.

Then I take the fishing line from the actuator and route it to the shaft with it going through a cup hanger or two for direction changes. I wrap it three or four times around the shaft and thread it through the hole in the end of the shaft.

Note: Since the rotation of the knob will be used to indicate the direction of the turnout's points the direction that the line is wrapped around the shaft matters. Think about it a bit before doing the wrapping!

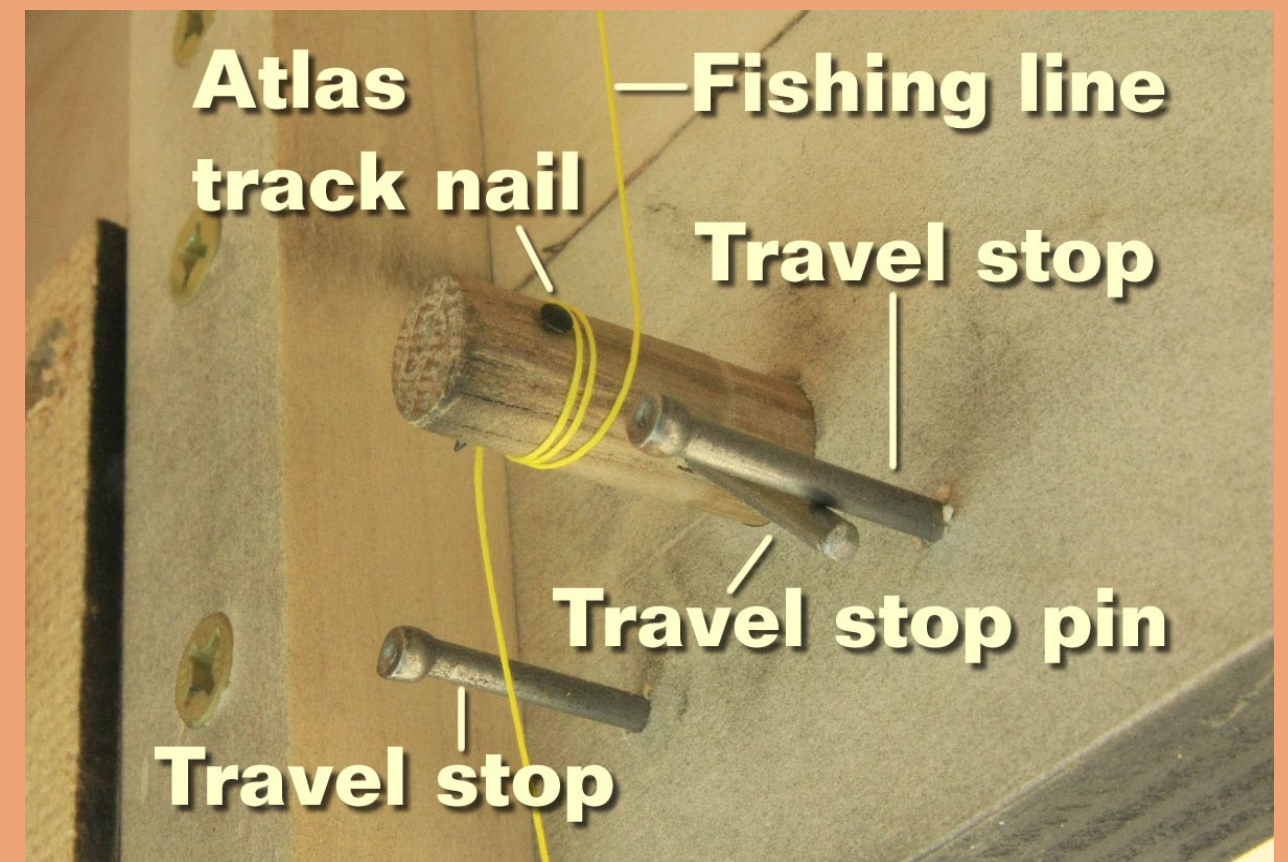

Figure 42: Line wrapped around the shaft.

I grab the free end of the line with one hand and gently tug on it. With the other hand I pull, coax, and massage the fishing line until it is nearly taut. Then I put an track nail in the hold through the shaft to lock the line in place. It doesn't need to go all the way through the hole to do a good job of locking.



## STEP 15: Mounting the Actuator Assemblies and Connecting It All Up (continued)



**Figure 43: Switch points pulled by knob and shaft.**

Then I test the turnout control to make sure it is moving the turnout points fully between the two stock rails. If it's not out comes the track nail and I 'adjust' things a bit more.



**Figure 44: Trimming the actuator wire above the throwbar.**

Once the turnout control is installed and working then I use a cut-off disk in a moto-tool to trim off the actuator wire above the turnout's throwbar. After trimming I vacuum the turnout and pass a Kadee magnet over it to pick up any magnetic particles remaining.

## STEP 16: Fascia Installation



**Figure 45: Hole cutter used when cutting knob-holes in fascia for behind the fascia mounting.**

If I'll be mounting a fascia over the panels/knobs I carefully measure where the knobs are located (horizontally and vertically. Then I carefully measure out their positions on the fascia panel (I use 3/16" masonite) and use a hole cutter to make a hole through which the knobs will protrude. NOTE: Don't use a forstner bit for this as drilling masonite will quickly dull it. The part of the fascia near the knob should be painted prior to mounting the fascia.

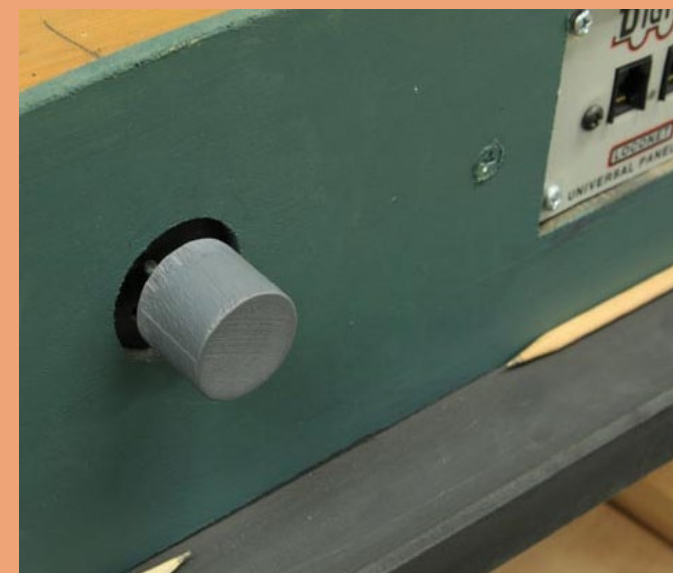

**Figure 46: Hole in Fascia for knob.**

Now its time to kick back with something nice and cold to drink or maybe run some trains and use all that nice work you've just done. My op session crews like mine. Your friends (and you too!) will probably like yours.



**Article feedback!**

**CLICK HERE** for reader comments on this article ...





# Getting started with DCC:

## Some helpful insights from a 15-year DCC veteran

– by Joe D. Fugate Sr.  
Photos by the author

**D**CC – Digital Command Control – has transformed the operation of model trains since its introduction in the early 1990s. I have worked with DCC since 1993 and will be sharing many how-to tips and hints in a series of DCC articles here in the pages of MRH. These insights come not only from my good experiences, but also from the not-so-good ones – and yes, even from a few horror stories. Often, the greatest lessons come from less-than-wonderful experiences – so let's hope my mistakes can save you from the same grief.

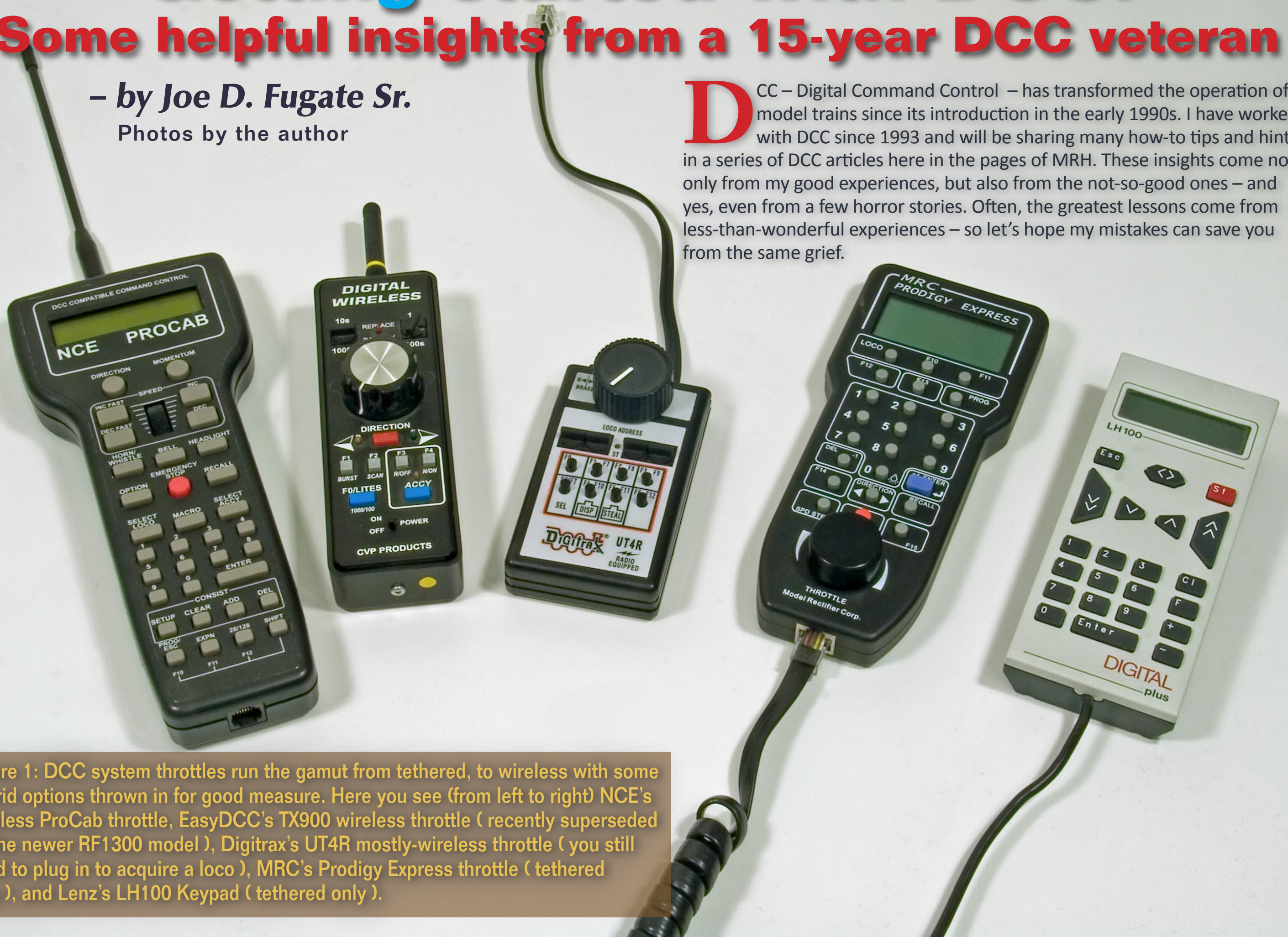

Figure 1: DCC system throttles run the gamut from tethered, to wireless with some hybrid options thrown in for good measure. Here you see (from left to right) NCE's wireless ProCab throttle, EasyDCC's TX900 wireless throttle (recently superseded by the newer RF1300 model), Digitrax's UT4R mostly-wireless throttle (you still need to plug in to acquire a loco), MRC's Prodigy Express throttle (tethered only), and Lenz's LH100 Keypad (tethered only).





**Figure 2: Joe Fugate has been using DCC in some form on his HO Siskiyou Line since 1993. Joe has used Lenz, EasyDCC wireless, and most recently NCE wireless on his layout and has produced two DVDs about DCC. Joe also posts extensively on many online model railroading forums on DCC and other model railroading subjects. In this article, he shares some of his insights and suggestions on how to get started with DCC.**

Along the way, I discuss the pros and cons of various DCC products and explain why I like or dislike a given product or approach. I want this discussion to be useful, honest and open. And please do not interpret any of my comments as product bashing.

Reality is, there is no flawless product or approach that's the clear best for everyone. There's only the best product or approach for you.

If you're new to DCC, you may have a lot of questions. I frequent many model railroading forums on the internet, and I see plenty of DCC questions from newcomers.

Here are the most common questions I see and my answers to them.

## What is DCC?

DCC is to model trains what radio control is to model airplanes and model cars, except the signals to the trains go through through the rails, not through the air. The receiver in DCC is called a decoder and each locomotive gets one.

With DCC you independently control each locomotive while operating it. Prior to DCC, if you wanted to independently control more than one train on the track at a time, you had to resort to complex wiring solutions using toggle switches or relays.

With DCC you can also do more than control locos. You can use DCC to control other devices like turnouts – or even fun things like unloading equipment, a drawbridge, or crossing gates.

While it's possible to get a measure of independent control using the older methods like cab control, you always had to keep in the back of your mind where the “power blocks” were, so you didn't accidentally get two locos into the same power block.

If this happened, you would lose control of one of the two locos and would need to physically remove one from the track to restore independent control.

Who today would even consider model airplanes without radio control? I believe we're headed to the same place with model trains and DCC.

## Why DCC?

The first question I see on the model railroading forums is “Should I consider going with DCC?”. Other related questions are: “Isn't DC cheaper/simpler?” or “I have a lot of non-DCC locomotives, so what compelling reason would there be for me to go DCC rather than just staying with DC?”

First off, DCC gives you independent loco control with only two power feeds from the DCC system to the track.

If you have a layout large enough to be running many trains at the same time, the advantage of DCC is obvious. DCC is simpler, and the wiring's actually cheaper than multi-block wiring.

Another DCC advantage that's growing in value each year is DCC sound. DCC gives you the most options when

it comes to rich, robust locomotive sound.

Once you've run a train with a nice sound decoder, you will find running a train without loco sound just isn't the same. If you want to have lots of fun running trains, the element of sound bumps the operating pleasure meter up several notches.

A less obvious advantage of DCC is the ability to individually tune loco performance. While it's possible to emulate independent loco control in straight DC with cab control wiring, it's virtually impossible with straight DC to duplicate the level of loco performance tuning DCC gives you. And to top it off, DCC lets you tune the loco performance while leaving the loco shell on!

If you care a lot about having the best possible loco performance, DCC's ability to tune performance should be a significant reason for you to consider going with DCC. With DCC you can, at minimum, set these loco performance features:

- Starting voltage – allows setting a loco to start moving right when you first crack the throttle.
- Top voltage – sets a loco's top speed to a realistic maximum.
- Mid voltage – sets the rate of speed increase as you advance the throttle
- Kick start – sets the voltage spike to give the loco to overcome initial starting resistance.



- Reverse adjustment – adjusts the reverse speed performance of a loco (if it differs from how the loco behaves when going forward) so it more closely matches the forward speed performance.
- Startup acceleration – sets the acceleration momentum in the locomotive, making it possible to smooth out loco performance when advancing the throttle, or to simulate starting a heavy train.
- Stopping deceleration – sets the deceleration momentum in the locomotive, which can help smooth out loco “braking” performance when reducing the throttle, or to simulate the stopping action of a heavy train.

Many loco decoders also include a pulse-power like “torque compensation” to enhance slow-speed loco behavior. Some loco decoders include Back Electro-Motive Feedback or BEMF to maintain a constant speed through tight track or to compensate for the effects of a stiff mechanism. I think the constant speed on grades is a key benefit of BEMF decoders.

The combination of these loco-tuning capabilities makes it possible to get your loco fleet to perform better and more consistently than you can ever get on straight DC alone.

## **Isn't DC simpler?**

If the budget is tight and cost is the most important, then I can't argue with

you that DC is cheaper for running only a single train at a time. But if you want to run multiple trains at a time, it's easy to make the case that DCC wiring is simpler than straight DC.

If having totally independent control of each train is most important, then DCC is hard to beat.

Most of the DCC wiring practices simply add robustness to the wiring to make it reliable, and make debugging problems easier. Little extra work is needed, and it pays off with fewer problems and easier debugging later. One of my modeling friends and I completely rewired the power feeds on the Siskiyou Line to add short-circuit protection using automobile taillight bulbs, and it took us only three 8 hour days to do it, at a cost of just \$100 in new parts and materials.

The result is a very short-resistant and reliable Siskiyou Line layout.

If you watch the ads for analog wireless throttles – you'll find you pay nearly as much as you would for a DCC system, and you won't have the operational flexibility DCC gives you.

In a recent *Layout Design Journal* (publication of the *Layout Design SIG*), modeler Peter Brahan reported his *Layout Design Lessons Learned*. In the article, Peter told of his experience on the DC versus DCC question:

“I decided to save a few bucks and go DC [on my previous layout]. Therefore my layout had over 100 toggle switches and saying it was a complete mess to



**Figure 2: One of the more power features of DCC that's not as often discussed is the ability to tune individual loco performance on-the-fly without having to remove the loco shell. In this photo, Mark Brown is running a train on Joe Fugate's Siskiyou Line using a massive 5-unit DCC consist, with each loco individually tuned so all the locos pull consistently and run well together. DCC gives a new level of individual loco performance tuning that's just not possible with straight DC.**

run would be an understatement. It used to take 30 minutes to train new operators to even get a train running, and my operators were all nuclear engineers – no kidding.

I am going to make the transition to DCC on my new layout. This is a no-brainer for many people, but it's not worth the up front savings of money for all the headaches of DC when it comes to installation, troubleshooting, and ease of operation.”

## **DCC on a small layout?**

What if you just have a small layout and expect to be running only one train most of the time? Is it worth considering DCC?

I think so, if for no other reason than the great loco tuning features DCC gives you. Your one-at-a-time loco, with some judicious tuning, can be made to run exactly as you want it to run, and do that consistently.



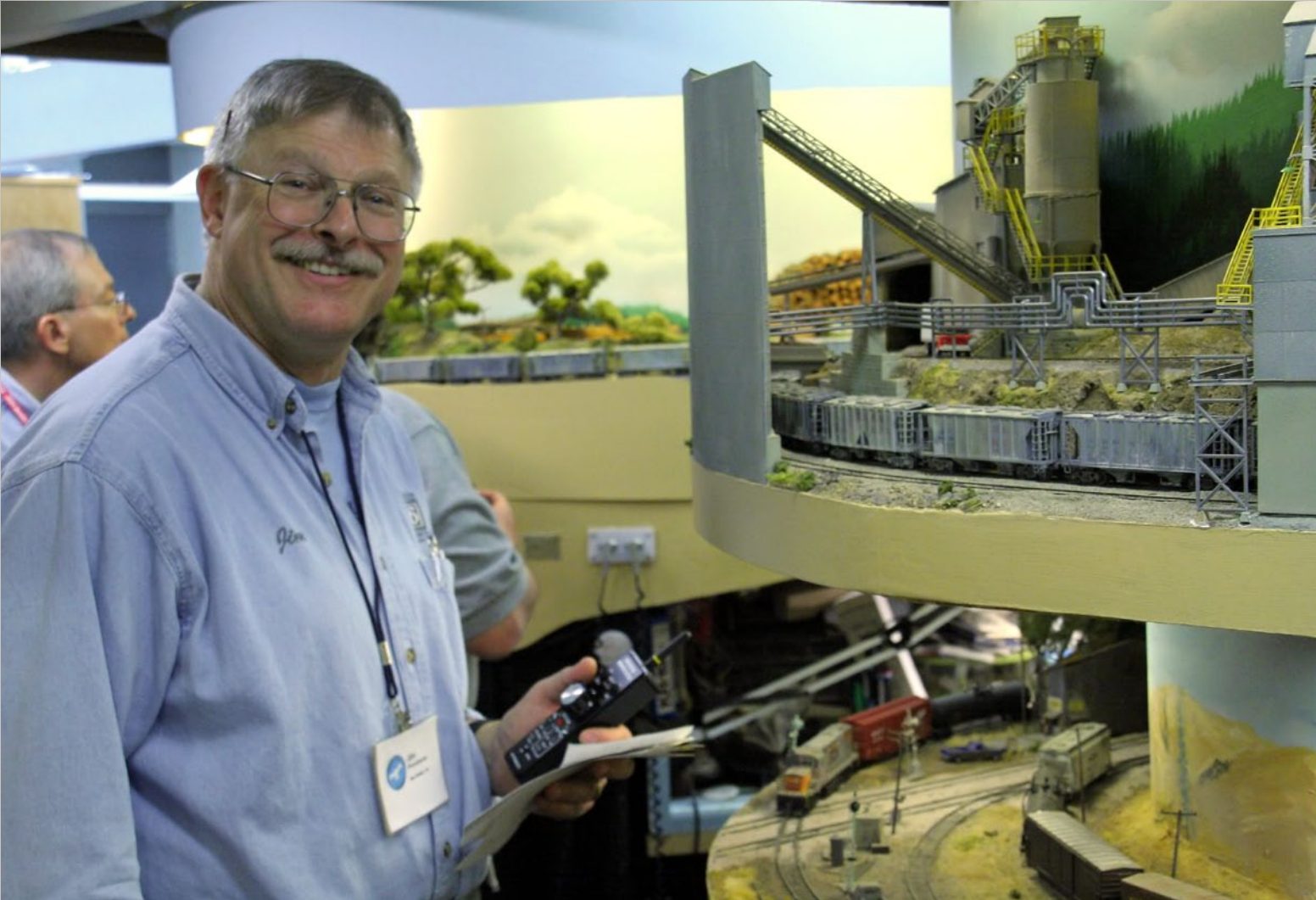

**Figure 4: It's hard to imagine operating Jim Providenza's 1970's era Santa Cruz Northern without using DCC. Jim, obviously having a great time here running a train on his layout, uses Timetable and Train Order (TT&TO) operation. If you had to also keep track of power routing and cab control blocks along with all the other considerations needed with TT&TO, the complexity would be overwhelming. Under DCC, Jim just hands you a throttle, and says "go dial up your loco number, read your timetable, and good luck!" No other layout orientation is really needed or necessary, thanks to DCC.**

Since it's the decoder inside the loco that remembers the settings, the loco will behave the same every time you put it on the track.

No more fiddling with power pack settings to try and get the best performance out of each-and-every loco or trying to remember what settings worked best last time with this loco.

No more concerns about compensating for a stiff mechanism or tight trackwork

by cranking up the throttle briefly while starting out your train or while running the train through the yard ladder.

And no need to pull off the loco shell to adjust loco performance by fiddling with the mechanism. You can easily adjust loco performance settings while it's on the track.

If you intend to independently control more than one train at a time on any-size layout, I recommend going with DCC

from the very beginning. Otherwise, you have to buy multiple power packs and multiply the feeder wiring to the layout by the number of power packs you've just added.

It doesn't take very long before the complexity factor and the cost of all the extra toggle switches, wiring, cab control panels, and so on makes DC eclipse the cost and effort of installing DCC. The larger the layout, the larger the savings.

If you do an honest comparison of high end power packs (with momentum features if you want something comparable to what you get with DCC), along with block wiring and toggles, you'll probably be approaching \$100 per train you want to run.

A good starter DCC system (the NCE PowerCab or the Digitrax Zephyr) will cost you about \$150 and they support independent control of at least two trains.

And with nice fleet decoders costing only about \$12 each in quantity, you get independent loco control right out of the box, and be able to independently tune each loco's performance as well. I don't think it gets much better than that!

Most of the large layouts I've operated on in recent years have been DCC. But recently at BayRails, I operated on a large DC layout using progressive cab control.

Power was automatically routed to trains by a dispatcher, and you followed signals to know when to go into the next block. While it worked very well, I quickly remembered why I like DCC so much.

**“It doesn't take very long before the complexity factor and the cost of all the extra toggle switches, wiring, cab control panels, and so on makes DC eclipse the cost and effort of installing DCC.”**

We had to stop and think about the moves we wanted to make and be careful to not get two locomotives into the same power block by accident.

We were often doing very unprototypical things like getting a long cut of cars from somewhere to use as a "handle" to pass off the two cars from a through train to the local switcher – all in order to keep two locos separated enough so they wouldn't accidentally get into the same power block.

With DCC, you never worry about such things. Just do what it makes sense to do and think like the prototype would think, without having to be reminded these are just some toy trains running on 12 volt DC.

If you are new to the hobby and you want to go beyond trainset level



operation, don't even give straight DC serious consideration. DCC just has too much to offer these days for newcomers who want the option to expand later into more extensive operation.

## **I have too many locos**

The more locomotives you have before you go to DCC, the harder it is to make the switch later, because each loco will require a decoder.

## **Where to get great prices on DCC stuff**

Here are three online vendors for DCC decoders, systems, and information that have great prices:

1. [Litchfield Station](#)  
(Bruce Petrarca)
2. [Tony's Train Exchange](#)  
(Tony Parisi)
3. Empire Northern Models  
(Tim Smith)

Any of these sites have great deals and are happy to answer your DCC questions – I have placed orders with all of them.

They have lots of DCC experience and their respective sites contain many helpful hints and tips.

Tonys and Litchfield Station are both MRH sponsoring advertisers, so I would recommend you shop with either of them first.

Even for fleet decoders, that's \$12 times the number of locos you have – and if your fleet is very large, that will be a significant expense to swallow all at once. But that's only if you want to run all of those locos on the layout *at the same time*.

Even though you may own say, 70 locos, it's a pretty good bet you don't run all 70 at once. You most likely have favorites you run, and you will be running one or two locos at a time in most cases. You can convert the first dozen of your favorite locos for less than the cost of another loco, then gradually convert the others over time.

Now for those first dozen locos, you can independently tune them to get top-notch performance from each one. Imagine, your 12 favorite locos, each running better than ever!

At \$12 per loco for fleet level decoders, the cost of converting an entire fleet of 70 locos is only the cost of one nice brass loco – so rather than add another loco to your fleet, why not upgrade the quality your entire current fleet of 70 locos? Or put another way, for \$120 a month, your entire fleet of 70 locos will be converted in 6 month's time.

Or take a few of the locos you never run and sell them on ebay, and use the funds to upgrade the rest of your fleet to DCC. Convert a few of your collection that you never run into ready cash so you can get the rest of your fleet to run better than ever under DCC!

One other note – for those locos that don't run well on DC, I'd recommend



**Figure 4: There's nothing like the operating freedom you get with wireless DCC. Here, Rod Loder runs a local on John Zach's Sierra Railroad using an EasyDCC wireless throttle and he seems completely focused on his train. With DCC wireless, you simply run the trains and seldom have to think any model railroading thoughts like "Okay, where's that next throttle chord socket before my train gets out of sight?" As far as I'm concerned, model railroad operation doesn't get much better today than wireless DCC!**

you not convert them to DCC but turn them into shelf models or sell them. If you do want to run them on DCC, then upgrade the mechanism.

DCC will not make a bad running model run much better, and things like BEMF may make it run even worse – bucking and jerking something awful as the decoder tries to automatically compensate for a poor mechanism.

Everyone I've spoken with who finally has tried out DCC wonders why they

waited so long. Once they see how nice their locos run, they never look back.

So to those of you who own a large fleet of DC locos today, I ask you: Would you be willing to pay the cost of one or two brass locos in order to greatly enhance the operating satisfaction you get from running your entire current loco fleet? If the answer is yes, then DCC is how it's done.

Some DCC systems have a setting that allows you to run a straight DC loco



lashup without decoders. But that's only one lashup, and you do not get very fine control of the loco speed using this technique. The non-DCC lashup makes odd and sometimes annoying sounds as you adjust the throttle, and this practice can cause loco motors to heat up more than usual.

Using this method to run one non-DCC loco set should not be routine practice, and the ability or lack of ability to run a straight DC loco in this manner should not be a deciding factor when choosing a system.

At best, this system option is more of a stunt than anything else and not especially useful for general train running.

## **“Any system feature comparison matrix typically doesn't list the important considerations I cover here. About the only way you will get a definitive answer on these questions is to ask others who have the system ...”**

If you already run more than one train at a time on DC using power blocks and toggle switches, then you have the ability to select between different power sources, so you could replace one of those straight DC power packs with a DCC system.

Now you can take your pick – throw all the toggles one way and you can run DCC, throw all the toggles the

other way and you can run straight DC. (However, don't try to run DC and DCC trains at the same time because a short between the two power sources could blow your DCC system.)

## **Buying a DCC System**

One of the most common questions on model railroading forums is “what's the best DCC system to buy?” Of course that's like walking into a room and asking the people there, “what's the best car to buy?”

People will immediately begin asking you, “what do you want this car for? To commute? To go exploring on back roads? To haul the family on vacation?

Do you need better gas mileage or do you prefer power for pulling a boat or trailer?” Best really depends on your needs and personal preferences.

It's exactly the same with a DCC system. “Best”

depends on your needs and personal preferences. The trouble is most people who ask this question don't even know what the DCC considerations are, and that's part of the problem. Everyone's familiar enough with cars to know what the trade offs are. Not so with DCC.

Any system feature comparison matrix typically doesn't list some of these important considerations I cover here.

About the only way you will get a definitive answer on these questions is to ask others who have the system and have used it for some time, generally at least 2 or more years. Let's look at some of these considerations.

## **What's available locally?**

Is the system used by other modelers or clubs in your area? This can be important because there's nothing like first-hand advice when you get an issue. Obviously this will vary depending on where you are located.

It's helpful to know which systems are popular with other modelers in your area. In many areas Digitrax is #1, followed by NCE, but EasyDCC is the system of choice in other regions.

If you use the same system as other modelers in your area, then everyone can bring their throttles to operating sessions. This is a great way to save money and to immediately feel comfortable running the trains.

If you don't know what's available locally, then before you buy a system, go find out!

## **Does the Local Hobby Shop (LHS) carry it?**

If the local hobby shop carries the DCC system, all the better. This makes it easy to get parts, advice on usage, and so on. Besides Digitrax and NCE, MRC and Bachmann may also be something you find at your LHS because the entry price is so low.

Lenz tends to not have as much hobby shop penetration, and EasyDCC is only available via mailorder direct from the manufacturer, so it's one system you will never find at your LHS. Zimo is popular overseas, and although they have a North American distributor, Zimo has not penetrated the US market as much because of its premium pricing.

If the LHS doesn't carry the system you are interested in, then ask the manufacturer if it's usually in stock for immediate shipment or often backordered. It can be annoying when you are finally ready to order your system if you have to wait weeks or even months before you see anything.

The hobby is just small enough that DCC manufacturers don't always have some system parts in stock, but instead wait until they get a critical mass of orders before they fill the backlog. It's best to first email or call the manufacturer and ask what their typical turnaround is for a new system order.

## **Is it easy to use?**

This is one you won't see on anyone's feature matrix. It can be pretty subjective, but as a professional software developer who has been in the business for nearly 30 years, let me define it this way:

“How easy is it to just guess how to do something by looking at the command unit, and not using the manual?”

*Continued on page 83 ...*





What about when the crew is done with the throttle? Must they “dispatch” the loco (tell the system it’s no longer in use) or can they simply turn off the throttle power? With some DCC systems, if a crew forgets to “dispatch” a loco, a later crew member will be unable to assign it to their throttle without someone (you, the system owner) intervening.

**“My original Digitrax throttles had knobs that were too small to turn with just my thumb, so I put rubber grommets on them to allow one-thumb speed control.”**

### SPEED CONTROL

DCC throttles use either a knob or pushbuttons for speed control. Either way, I think it’s vital that the speed control can be operated with the same hand that’s holding the throttle. Often you’re carrying paperwork in your other hand, or need to reach into the layout to uncouple cars. Why be forced to use both hands just to move your train?

My original Digitrax throttles had knobs that were too small to turn with just my thumb, so I put rubber grommets on them to allow one-thumb speed control. My current EasyDCC throttles have a large knob easily turned with a thumb.

### SWITCHING DIRECTIONS

How easy is it to switch between forward and reverse? Do you

prefer separate “forward” and “reverse” buttons, or are you satisfied with a single button that toggles between forward and reverse each time you press it?

Does the throttle have an easy-to-see indicator that shows the current direction? It’s a great comfort

to quickly glance at the throttle and see which way the train will move when you crack the throttle.

### HEADLIGHT, WHISTLE, BELL

Are the throttle buttons that control these clearly labeled? Can you perform each operation with a single button-press, or does it take two?

The headlight is typically assigned to function 0, but it’s handy to have that button labeled “Headlight” instead of “F0.” Most DCC decoders allow assigning the bell and whistle to any function you prefer, so some throttles don’t label buttons for these.

I’ve found it helpful to standardize on F1 for the bell and F2 for the whistle, and to include a note

on locomotive cards indicating these buttons.

### GOTCHAS

Finally, are there any booby-traps waiting to snag unsuspecting crews? When I was using a Digitrax system, crews would often press a particular button on the radio throttle that would cause them to lose control of their locomotive.

My current EasyDCC radio throttles have a button that causes the throttle to stop responding. I glued a cylindrical guard around this button to prevent it from being pressed.

The best way to find out about “gotchas” like this is to ask other modelers in your area or in on-line user groups.

### WHAT’S EASY?

So is it important to be able to easily make up a consist of locos? Of course, and it’s even more important if you expect your crews to do it during an operating session. But I think it’s far more important for crews to be able to easily perform the basic operations needed to run a train.

When my crews gather before an operating session, it takes me less than 60 seconds to hold up a throttle and show them everything they need to know.

Now, that’s “easy.” ■

### The Old-Timer says ...

The author here talks about making up a consist as a good test of how easy a system is to use. How often do you do that?

To me, “easy-to-use” means *how easily crews can run trains*. I don’t much like computers, but I love DCC because of how it lets me run the trains.

I look at how easy it is to assign a locomotive to a throttle, control loco speed, switch between forward and reverse, turn on the headlight, blow the whistle, and ring the bell.

### ASSIGNING LOCOS

Each time a crew reports for duty, their throttle must be set to the locomotive’s decoder address. Can a visiting crew easily do this, or must the system owner always set the address?





**Figure 6: Ease-of-use is an important consideration when selecting a DCC system. Here we see Jeff Shultz using an NCE Cab 04R wireless throttle on Joe Fugate's HO Siskiyou Line layout. The NCE system uses plain English button labels like "Select Loco" on their throttles, which helps visiting operators like Jeff know exactly where to start in order to assign their throttle to a locomotive and run trains on Joe's layout.**

The easiest way to test this is to use the one I like to try: making a lashup of diesel locos (a consist to use DCC terminology).

Just look at the command unit, and now without checking the manual, can you figure out how you would make the consist? What if you wanted to later add or drop a loco from the consist, can you guess how you would do it just by looking at the command unit?

This one simple test will tell you a lot about ease of use, or "user friendliness"

as it's called in the computer software world. We'll delve into this question in more detail shortly.

### **Is it reliable?**

To me, this really gets to the heart of the "best system" question. The system can have a ton of cool features, be super easy to use, but if it's not reliable, I hardly would call it the "best".

About the only way you will get a good answer to this question is to ask people who have the system and who have

used it regularly for a while. I say the person needs to have used the system for at least two years before you will get a good sense of how a system performs in this area.

If there are no local modelers who regularly use the system, go online and watch the support forums for each system. What kinds of problems are typically discussed on the support forums for each system? You'll learn a lot if you lurk for even a week or two.

Does the system have quirks? It might be reliable, but it also might have some unexpected normal behavior that can get annoying. This needs to be called out!

## **Online DCC system support forums**

Here's the support forum URLs for many common DCC systems:

Digitrax:

<http://groups.yahoo.com/group/Digitrax>

NCE:

<http://groups.yahoo.com/group/NCE-DCC>

Lenz:

<http://groups.yahoo.com/group/DigitalPlusbyLenz>

EasyDCC:

<http://groups.yahoo.com/group/easydcc>

MRC-DCC:

<http://groups.yahoo.com/group/MRC-DCC>

Bachmann:

[http://groups.yahoo.com/group/Bachmann\\_DCC](http://groups.yahoo.com/group/Bachmann_DCC)

Zimo:

<http://groups.yahoo.com/group/Zimo-DCC>

You can also get a sense from looking at the size of the Yahoo support forums as to which systems have sold the most. Here's the size of the various support forums as of early 2008:

■ Digitrax: 7853

■ NCE: 3465

■ Lenz: 2176

■ MRC: 1111

■ EasyDCC: 617

■ Zimo: 409

■ Bachmann: 236

■ Atlas: [none]

This does not necessarily mean Digitrax is the best system, or that Atlas is the worst system – but you can see Digitrax has done an effective job marketing their system. To a certain degree this also shows how long the various systems have been on the market.

For instance, the first DCC systems to market in 1993 were Digitrax and Lenz, followed by System One (precursor to NCE), while Bachmann is a more recent entry into the DCC market.

Recent developments in complex sound decoders (like the new Broadway Limited BlueLine decoder series) show that owning Digitrax or NCE (the top two system vendors) has advantages. BLI made sure their decoders program properly with Digitrax and NCE, but they have not given any consideration to issues that might exist with EasyDCC, for example.



Since EasyDCC has less than 5 percent of the market, manufacturers may ignore EasyDCC quirks with their decoders as long as things work well with NCE and Digitrax.

If I wanted to be cynical, I could say the size of the support forums give some indication of how much support a system needs! I don't think that's necessarily true, but it may be a factor behind the membership numbers.

Hang out on the forum for a system you were interested in, and watch what kinds of questions get posted. You'll get a feel for the level of support the system needs, plus a sense of how easy it is to set up and use. 

## My favorite decoders

### Barebones fleet decoder (\$13):

My favorite "barebones" fleet decoder is the D13SRJ from NCE. Not only is this decoder available for \$13 or less in quantity (making it a great fleet decoder), I find the torque compensation feature to be outstanding.

Torque compensation means you can program the decoder to deliver pulse spikes at startup and yield some very nice slow-speed loco performance. As the loco speed increases the extra pulse spikes die away into normal pulse modulated DCC power to the motor, so it runs smooth, cool, and quiet.

The one great weakness of the D13SRJ decoder is its lighting functions – they're nothing to write home about. The D13 does have lighting functions, they're just not very convincing or configurable. For the next step up in fleet decoders, take a look at the TCS T1 decoder (more on that below).

It's also very easy to add a "keep" alive circuit to the D13SRJ decoder to keep the loco moving on dirty track and across dead frogs without ever stalling. [Here's a link](#) on how to add keep alive to these decoders.

NOTE: I got 10 locos-worth of parts for a keep alive circuit from MouserElectronics and paid \$8. That's right, 80 cents per loco!

**Feature-rich fleet decoder (\$17):** The Train Control Systems T1 is a very nice decoder with back EMF, and for \$17 each in quantity, it's a fleet level decoder with premium features. The lighting functions on the T1 are sweet, with lots of ability to tune and tweak the effects to get just what you want!

I find back EMF is most helpful at the very low end of a loco's speed curve. Fortunately, the TCS T1 decoder allows you to set the speed step at which BEMF will be cut out.

For my Athearn locos with stiff mechanisms (like the new Tunnel motors), the T1 with BEMF works wonders to get a very nice slow crawl out of these locos. I run the locos in 28 speed step mode, and I set the T1 to cut out the BEMF at step 10. I also set the T1 to not use BEMF in a consist. The end result is very silky smooth operation of these new Athearn Tunnel

Motor locos at slow speeds like in a yard or when switching. Yet when they get up to speed, like when pulling a train, the BEMF fades out and I don't get the unrealistic "cruise control" effect that you can sometimes see when a loco has too high of a BEMF setting.

The TCS T1's have excellent lighting features. I use the rear headlight tabs on the Athearn board in the loco, and connect those tabs instead to the cab gyralights. Then I set the yellow wire to be always on, controlled by F1. I don't use rear headlights in my locos so I never miss the fact the rear lights are now basically dummies.

Instead with this arrangement I have gyralights that work independently of the nose lights when I press F1, and I didn't need to do any extra wiring of resistors. It works great! ■

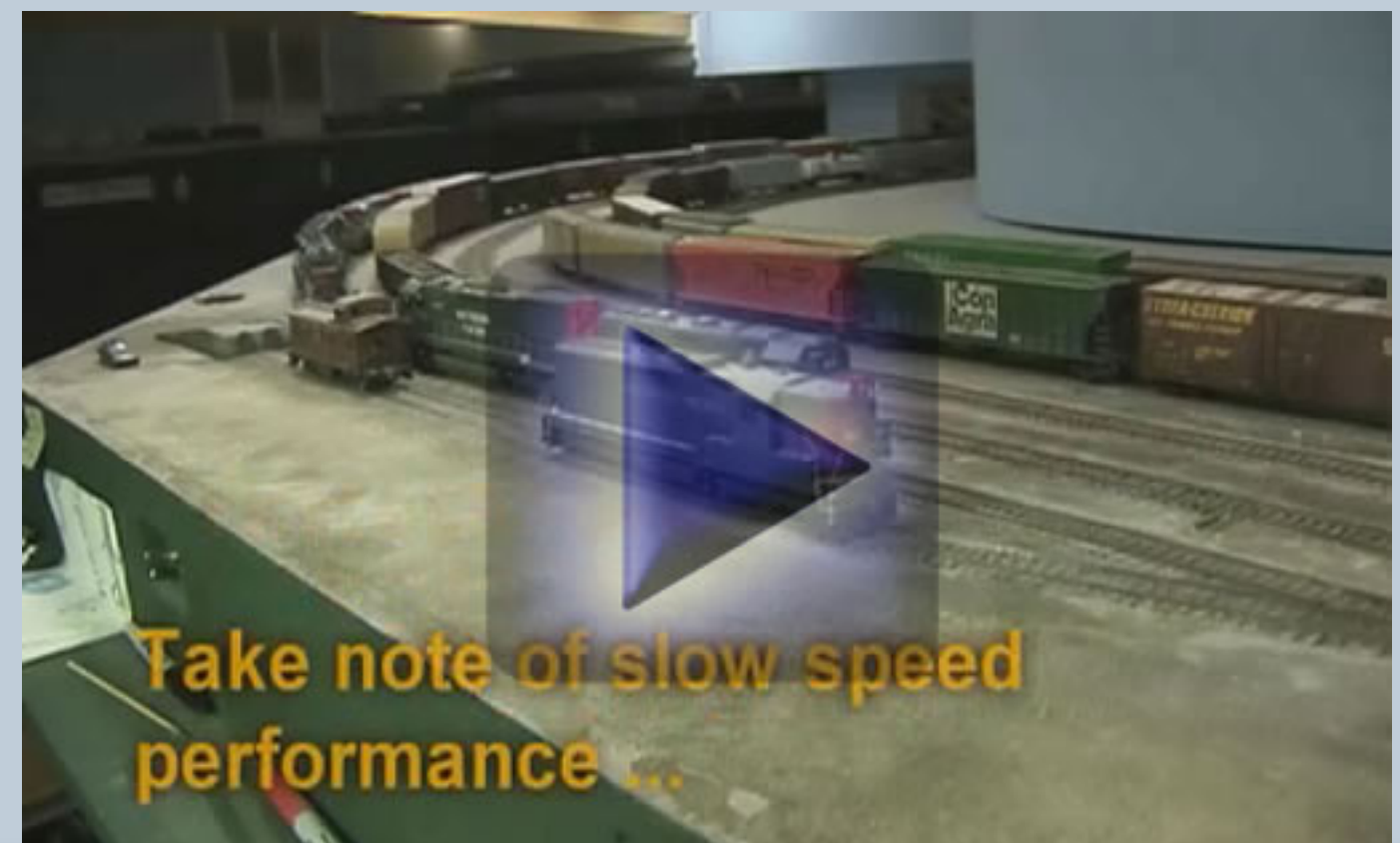





**Figure 6: Jim Moomaw enjoys running trains on Charlie Comstock's Bear Creek & South Jackson using Digitrax DCC, both tethered and wireless. Digitrax has the advantage that it's the most widely marketed DCC system and was one of the first vendors to market with a system back when DCC started in the early 1990s. Digitrax's support forum on Yahoo Groups, for instance, is far larger than any other DCC system's online support group – and chances are if you buy a Digitrax system, there will be other modelers in your area who can give you first-hand support if you have issues.**

 **Article feedback!**  
[CLICK HERE](#) for reader comments  
on this article ... 

## **Back EMF in decoders - is it necessary?**

Back EMF is a feature of fancier decoders that can help smooth out the loco's performance. With Back EMF (BEMF), the decoder senses when the motor is lugging and gives it more voltage to compensate.

Minimal settings of BEMF act to smooth out a loco's slow speed response so that it keeps running through switches and complex trackwork smoothly, as if the loco has great mass. BEMF works good for this and can smooth out any loco's performance in such situations – although if the loco already runs well at low speeds (like Kato and Atlas units tend to do), BEMF is an extra expense that isn't all that necessary.

Higher settings of BEMF can make the loco operate like it's on cruise control – through curves, up hills, down hills – all at the same speed. It's a cool trick, but it's not realistic. Real locos need you to work the throttle when you go through curves, up hills or down hills. That's part of the fun of running trains. Trains on cruise control is just plain boring.

Even more important, you want to avoid using BEMF in a consist. Since BEMF wants to keep the motor running at a constant speed, if you grab and hold the coupler on a loco with BEMF set on, you will notice the wheels start turning faster as the decoder tries to compensate. If you put two locos in a consist and both have BEMF, when the lead loco enters a curve and starts to lag, the two locos will begin to fight each other, bucking violently.

The rear loco is trying to push harder to make the front loco speed up and keep

the speed constant, while the front loco is trying to slow down to keep the the rear loco from making it go faster. As the locos alternately try to speed up and slow down each other, the BEMF compensation tries still harder to fix the speed difference and violent bucking is the result. As a rule, you want to turn BEMF off in consists.

You really don't need BEMF in consists either. The other locos in the consist tend to smooth out any speed difference between the locos as long as all the members of the consist are fairly closely matched. Using DecoderPro, you can easily bring up the speed tab for two locos as side-by-side windows and accurately speed match a couple of locos in just a few minutes using programming on the main.

Tunnel Motor locos at slow speeds like in a yard or when switching. Yet when they get up to speed, like when pulling a train, the BEMF fades out and I don't get the unrealistic "cruise control" effect that you can sometimes see when a loco has too high of a BEMF setting.

The TCS T1's have excellent lighting features. I use the rear headlight tabs on the Athearn board in the loco, and connect those tabs instead to the cab gyralights. Then I set the yellow wire to be always on, controlled by F1. I don't use rear headlights in my locos so I never miss the fact the rear lights are now basically dummies.

Instead with this arrangement I have gyralights that work independently of the nose lights when I press F1, and I didn't need to do any extra wiring of resistors. It works great! ■





## About our narrow gage and branchline columnist



**Lew Matt** began the hobby with American Flyer, experimented with O narrow gage using TT track/mechanisms – then converted to O scale (On30) on his freelance Lancaster Oxford and Southern. Lew did all this while modeling the PRR in HO using the freelance Conestoga Valley, complete with heavy electrics and overhead catenary!

Lew is a published writer, photographer, and illustrator whose work has appeared in many model railroad hobby magazines.

# THE LITE AND NARROW: Creative model engineering

## Ramblings on Narrow Gage and Branchline Modeling

### Creative thinking + imagination = Imagineering

**C**reatively thinking and planning with generic or freelance rail-roading in On30 can offer any modeling scenario you can imagine, incorporating all aspects of the genre that you like most. What will you have: desert, mountain, seashore, eastern farmland, swamp, harbor or city - it's all just a thought away.

Sometimes creative imagineering can take us to a place no modeler has ventured before, where we can create plausible locomotives and rolling stock previously never seen.

The operational prospects of your generic railroad are unlimited when you control the entire process and build the economy, commodities, population, city and countryside from the ground up. You don't need to compromise your imagination.

Let's begin our investigation of imagineering with some unconventional yet still conventional motive power.

### Generic Steam Locomotives in On30

Imagineering locomotives can be a lot of fun. As an example of a creatively designed generic locomotive, Dave Butler did an excellent kitbash of a Bachman Porter into a small Forney using the tank conversion kit from



**FIGURE 1: Dave Butler's kitbash of an On30 Bachman Porter using Backwoods Miniatures parts and a cut-down Forney cab results in a very elegant critter, almost too good looking! Photo by Dave Butler.**

Backwoods Miniatures, a Bachman Forney cab and various parts. See: [http://www.railcar.com.au/bachmann\\_porters.htm](http://www.railcar.com.au/bachmann_porters.htm) or <http://www.backwoodsminiatures.com/index.htm> (The kit is available in the UK at a cost of £28.00 or approximately \$40.00 U.S.D.).

Dave said that this was a really simple kit to put together. "The Backwoods kit went together in about 10 minutes! - there's only 3 parts to glue together!"

### Buying Parts Outside of the U.S. is Easy

US and Canada orders made by credit card can easily be converted from dollars to GBP by the credit card company within the transaction, at a cheaper rate than the cost to buy and send an international money order. (Shipping by airmail is about £10.00 or approximately \$15.00 U.S.D.)



He used only a bare minimum of the Backwoods kit parts for his conversion and had many extra detailing parts left over for other projects.

Dave started with a Bachman Porter that was modified with a cut down Forney cab.

“The Forney cab had the rear cut off from the door on back, the roof shortened and the finished item repainted inside and out.”

“The cab floor was widened to accommodate the new cab and the rear bunker was scratchbuilt using the old one as a guide.”

“The wood load came from a Forney and was reduced to the front half of the load to fit under the shield and not intrude into the cab.”

Dave reused the Bachman Porter headlamp in this model; a job that entailed removing the motor to get to the lamp wiring.

**FIGURE 2:** This isometric view clearly shows the details of the tanks, domes and pilot beam. There is plenty of room to fit the Bachman Porter headlamp to the kit smokebox the same way as on the original Bachman Porter. Dave removed the original bulb and replaced it with a 16V grain of Rice bulb. Photo by Dave Butler.

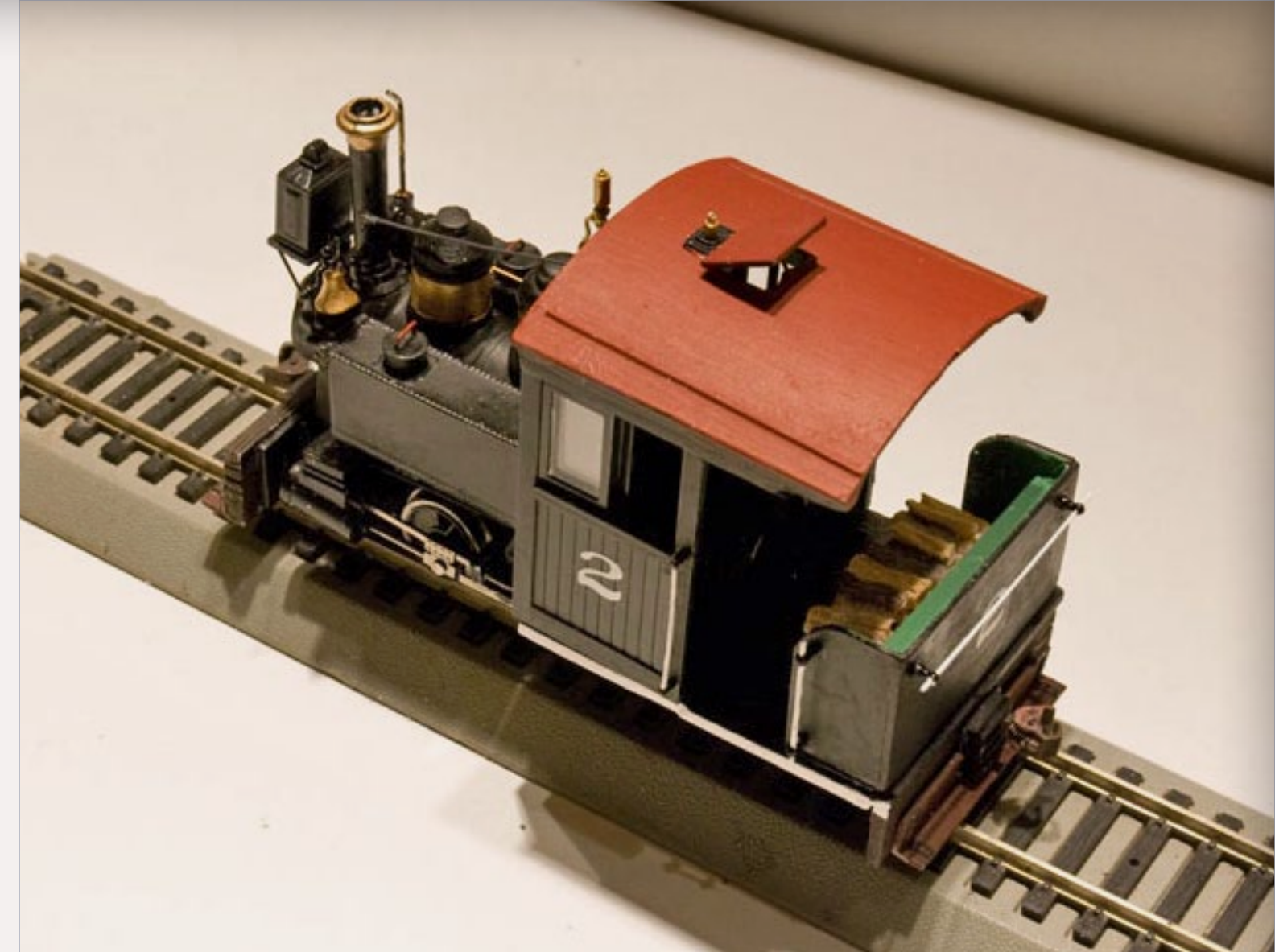
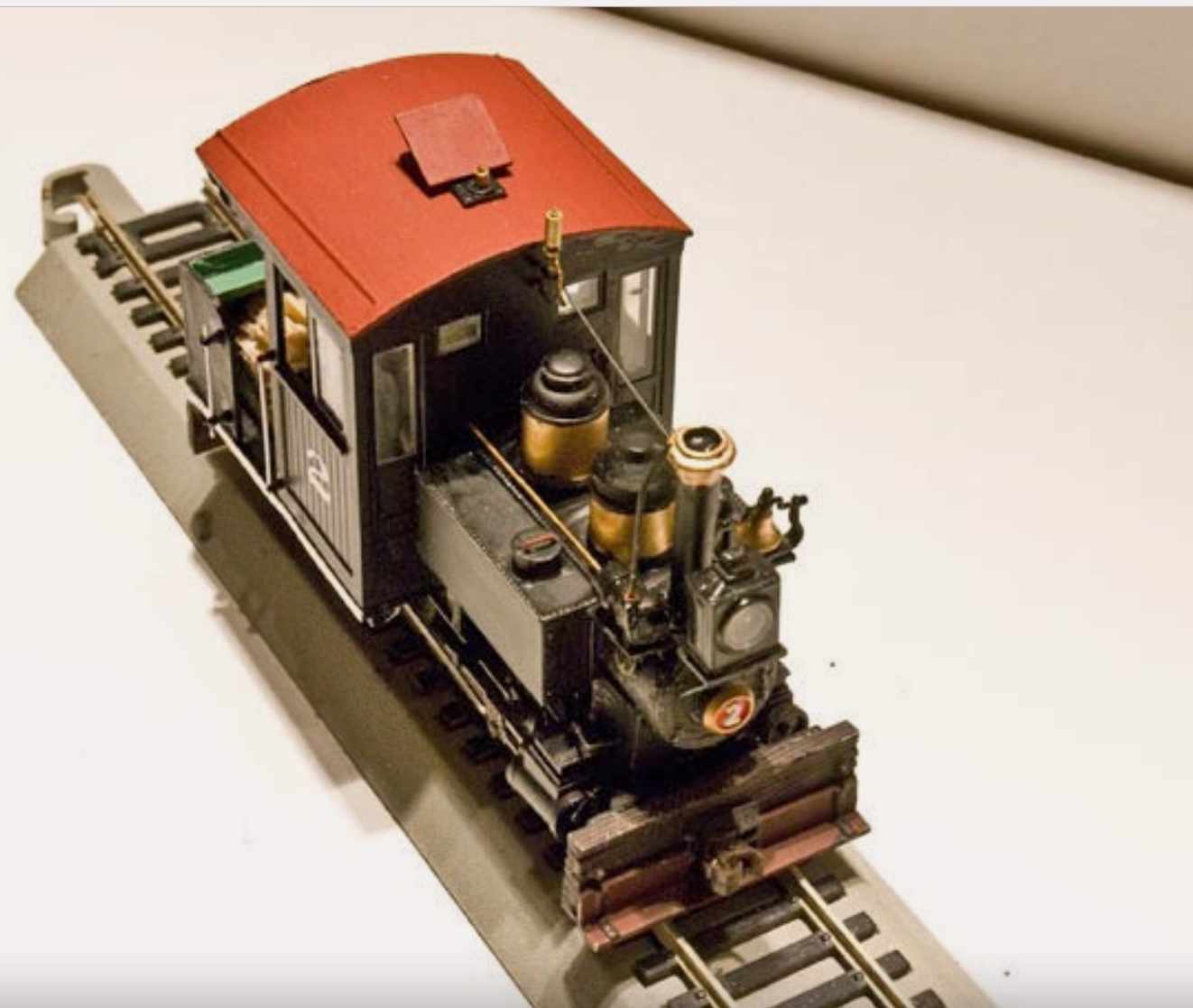

**FIGURE 3:** The Forney cab and fuel bunker are easily seen in this view. Dave cut off the rear of the Forney cab from the door back and shortened the roof. The rear bunker was scratchbuilt based on the dimensions of the old one and the wood load came from a Forney but was reduced to only the front half of the load. The interior of the wood pile and the underside of the roof may be usable locations for decoders and speakers. Photo by Dave Butler.

There is plenty of room to fit the Bachman Porter headlamp to the kit smokebox the same way as on the original model.

“There was more of a time investment in fitting the original Porter headlamp onto the kit; this involved removing the motor to access the lamp wires.”

“I removed the original bulb and replaced it with a 16V grain of rice

bulb. If you get to this stage, now’s the time to look at fitting DCC as it so easy now to break into the pick-up leads to the motor and route the decoder leads out from the cab.”

Although Dave didn’t convert to DCC at that time, he did note that rewiring the light gives easy access to the motor leads. Some Porter modelers have hidden a Z scale DCC decoder under the roof and the Forney fuel



bunker may be a good place for a miniature speaker.

A French language site shows how to install DCC in a Bachman Porter (see: <http://us.leforum.eu/t1208-On30-Une-Porter-DCC-1ere-partie.htm>). The pictures are informative and helpful even if you don't read French.

Backwoods Miniatures provides two sets of domes, stacks etc., old time and modern. Dave says the cast white metal domes are really needed to add weight to the loco. He added some liquid lead to the inside of the stack, too.

"The front pilot and steps had to be cut back for the cast pilot from the kit to be fitted. I made my own rear beam due to the extended width of the cab."

**FIGURE 4: This is a display of the parts that come with the Back Woods Miniature kit to dress up the Bachman Porter. See: <http://www.backwoodsminiatures.com/On3kits.htm#Side Tank Conversion Kit>. Photo by Dave Butler.**



The new rear beam provides a solid platform for attaching the rear coupler. There is no need to change the motor mounting, unless when you remove the motor you can't get it to return to its seat properly.

Dave says that the boiler just "plonks" on and the tanks are secured by the original saddle tank screws. He found that the screw holes were a bit close to the inside edge of the tanks and was worried about their security.

He ran a screw into the smoke box mount which does the job, as the rest of the boiler fits tightly over the Porter chassis and butts right up against the Forney cab.



**FIGURE 5: Dave created this On30 Mikado on the Athearn HO 2-8-2 mechanism. Photo by Dave Butler.**

"I started on Friday evening and the photos were posted to various groups on Sunday evening, so around 8 hours allowing for meals, honey-dos and shopping. ...the 0-4-0 and 0-4-2 would take you even less [time] if you retained the original cab."

Dave did a great job painting this loco too. It's all brush painted. The locomotive body is Tamiya Flat Black with

a coat of Humbrol Satincote varnish - The roof is Anita's Acrylic Wine and the cab interior is Apple Barrel Kelly Green. Brass work is Revel Gold.

This generic engine looks VERY narrow gage, almost the epitome of narrow gage-ness. Thanks to Dave for showing us one method of creatively creating a plausible freelance or generic locomotive in On30.

**FIGURE 6: This HO On30 loco was converted from a Hornby 2-4-2 with kit and scratchbuilt parts. Photo by Dave Butler.**





(Dave's work has inspired me to send for a Backwoods Miniature kit to experiment with an unusual locomotive.)

Dave is working on two more kitbashes. The Athearn 2-8-2 will work well for those heavy freight hauls.

## Les Davis' Articulated Engine

Les Davis, noted for his interesting loco designs, cleverly imagineered a rather large generic articulated loco in On30. He recently brought his latest kitbashed marvel to a Minibunch operating session on Steve Fisher's Deep Creek Railroad.

Geren Moreson happened to be there with his camera and took a few pictures of Les' loco. This interesting locomotive is an HO Mantua 2-6-6-2T converted to On30," with a LokSound Decoder and O scale detail parts. The kitbashed loco runs very nicely. He added a Bachmann Forney cab.

New tanks, stack and domes made up the rest of the conversion with a large number of details added.

To see how the loco was constructed, go to: <http://www.railroad-line.com/> then click on All Forums; Model Railroad Forums; On30 Forums, and finally click on Les Davis's Locomotives.



**FIGURE 7:** Les Davis' 2-6-6-2T, built on a Mantua articulated frame, gets ready to load up at the water tower on Steve Fisher's Deep Creek Railroad. Steve scratchbuilt the water tank. Photo by Geren Morrison.



**FIGURE 8:** Les Davis' articulated engine crosses Deep Creek with a string of logging cars, on Steve Fisher's Deep Creek Railroad. This locomotive is an HO Mantua 2-6-6-2T converted to On30, with a Decoder and the adroit use of O scale parts. The kitbashed loco runs very nicely. The cab and back end were altered with the addition of a Forney cab. New tanks, stack and domes made up the rest of the conversion with a large number of detail parts added. Steve Fisher scratchbuilt the truss bridge. Photo by Geren Morrison.



**FIGURE 9:** Les Davis' 2-6-6-2T comes around the curve just past Deep Creek. He recently brought his latest kitbashed marvel to a Minibunch operating session on Steve Fisher's Deep Creek Railroad. Photo by Geren Morrison.



Junior Yamachi, of Nishinoiya, Hyogo, Japan, developed an interesting line of very small On30 locomotives – called critters - that are powered not by steam or diesel, but by overhead electric. These diminutive scale locos have trolley poles that reach up to collect scale power from overhead catenary.

Although the prototype Pacific Electric and Sacramento Northern interurban railroads had small electric locos to pull freight, those engines were many times larger than Junior's narrow gage critters.

Junior uses 2-rail DC and hides his motive power under the floor using Tenshodo SPUD power trucks nestled inside various kitbashed and other side frames.

## Electric Critters of the Wills Creek Railroad

Because Junior has little room for a layout, he builds small but highly detailed dioramas. The Wills Creek Railroad story began 10 years ago when Junior was an HO traction modeler and belonged to a traction club that held their meetings in the



**FIGURE 10: Pacific No. 16 is the newest 4 wheel truck steeple cab for use on the Surfeside Traction Co. Photo by Junior Yamachi.**



**FIGURE 11: Surfeside Traction Co. No. 2 is a kitbashed trolley made from an LGB "Gnomy" toy with a SPUD power truck and a shortened Brill side frame. The background is a 5 inch by 24 inch Surfeside City diorama. Photo by Junior Yamachi.**

Modern Transportation Museum in Osaka, Japan.

One of the members came to a meeting and displayed a tiny O scale trolley car kitbashed from a "Gnomy" toy tram and powered by a Tenshodo SPUD power truck. (Gnomy was the brand name of plastic toy push trains manufactured by LGB in approximately O scale. They are still available for sale at some stores)

The diminutive trolley created a sensation among the membership. A great deal of discussion occurred over coffee of how many ways the toys could be kitbashed into freelanced

prototypical models. The Gnomy line of toys was sold at the museum's gift shop but was soon sold out. Junior purchased one of the toys and within 2 weeks had built a four-wheel, California street car for the Surfeside Traction Co. and powered it with a Tenshodo Spud #WB-35 with 14mm (scale 26") diameter wheels.

The power mechanism was built into a 1:45 scale plastic Brill 21 E truck. The frame of the truck was shortened from 46mm to 35mm (7' - 3" to 5' - 5"). This marked the starting point of Junior's On30" electric railway modeling.

The beginning venture of the On30" Surfeside Traction layout included



building 2 modules, 120mm by 600mm (5" by 24"), 2 Gnomy-bashed trolley cars and a double truck gondola car. After completing these, Junior left the club and stopped modeling for a while, but started again 3 years ago.

Having been bitten by the traction bug, and bewitched by the angular beauty of the Pacific Electric engines, Junior

decided to build a model of a standard gage PE shop locomotive in On30, his Switcher No. 19. Without access to scale plans, Junior drew his own from the pictures in the book "Pacific Electric in Color." (Pub. By Morning Sun, ISBN-13: 9781878887887)

This construction project is more of a semi-scratchbuilt engine than a



**FIGURE 12:** These two photographs depict the California Surfeside community served by the trolley line. Each diorama is only 5" from front to back. Photo by Junior Yamachi.



**FIGURE 13:** No. 19 of the Surfside Traction Co. is parked outside the freight depot today. The trolley pole is up so the motor will probably only be here for a short time before going back to work. The vegetation around the building is very well done and convincing. Photo by Junior Yamachi.

kitbash, as all of the parts came from Junior's junk box.

The list of parts reads like a scavenger hunt's list: a pair of HO scale MDC Harriman passenger car trucks, etched brass mesh, plastic tube, brass strips, O scale traction parts, pushpin (for the gong), HO scale tool box, small brass nails, a pair of Kadee couplers, scale lumber, Bachman trolley pole, On3 Grandt Line coupler pockets and the Tenshodo SPUD #WB-31 with 14mm (26") diameter wheels.

The chassis and floor were fabricated from cyprus wood strips and bars. The cab sides are made from basswood siding and the wooden roof is supported on brass tubes.

A Bachman trolley pole caps the roof. The car was painted with Tamiya red paint. With the completion of loco 19, the Surfside Traction Co. went out of business and Junior moved to the arena of the electric lite rail mining railway.

*Continued on Page 93 ...*

Advertisement

Reach over 30,000 model railroaders for as little as \$15 with a text-only ad just like this one.

[Click to learn more ...](#)



(small text only)



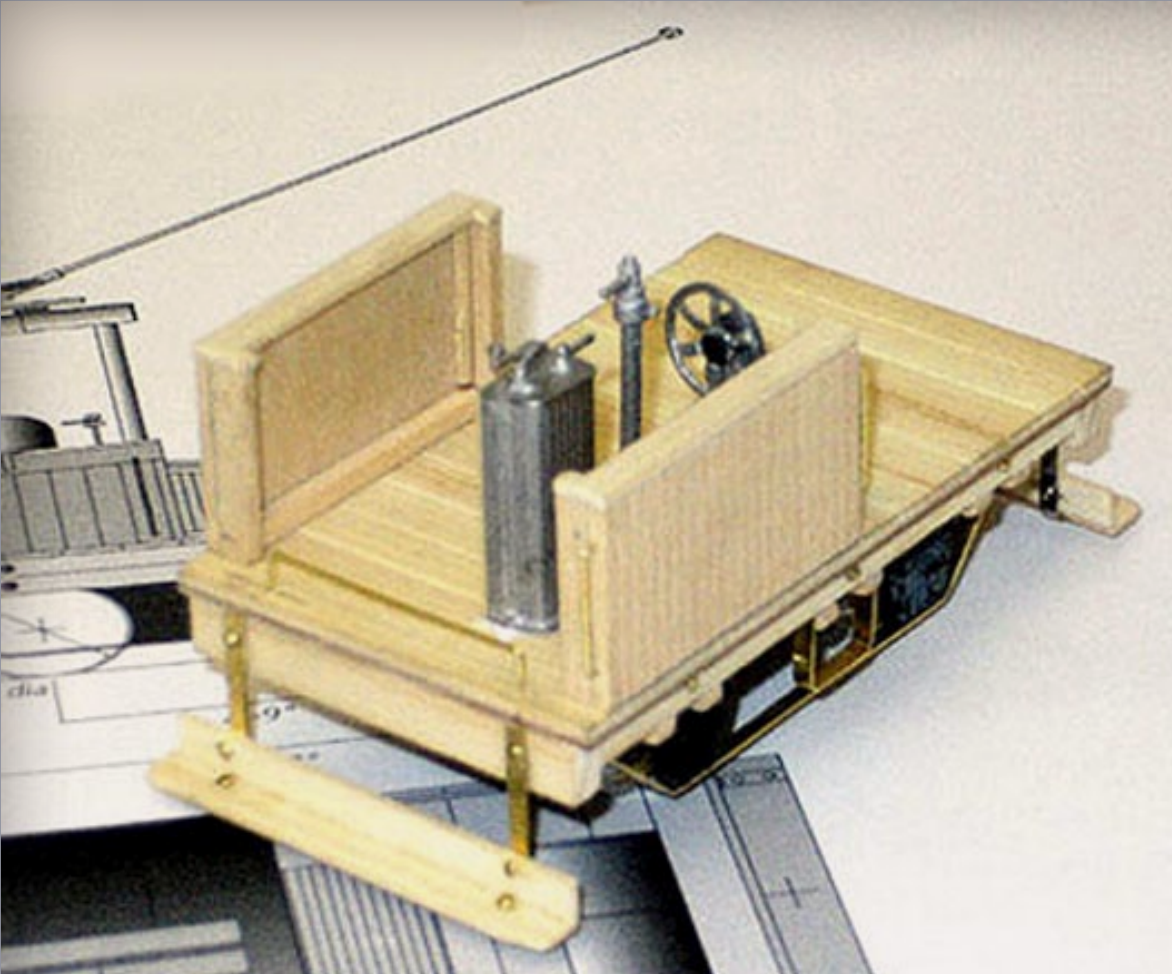

FIGURE 14: The cab sides are made from basswood siding and we can see the castings for the throttle, airbrake and mechanical brake. Plastic strips create the bar frame around the axle journals. Brass strips detailed with escutcheon pins securely fasten the pilot steps to the chassis. Photo by Junior Yamachi.

FIGURE 15: The evolution of the detailing sequence is very evident in this view compared to the previous view of the partially completed interior. The motorman is just a dramatic touch but the details like the bell, boxes, air tank and vents around the motor and the extra grabs and handrails begin to bring out the "critter" character so desirable and endearing to the modeler in the On30 genre. Photo by Junior Yamachi. ►

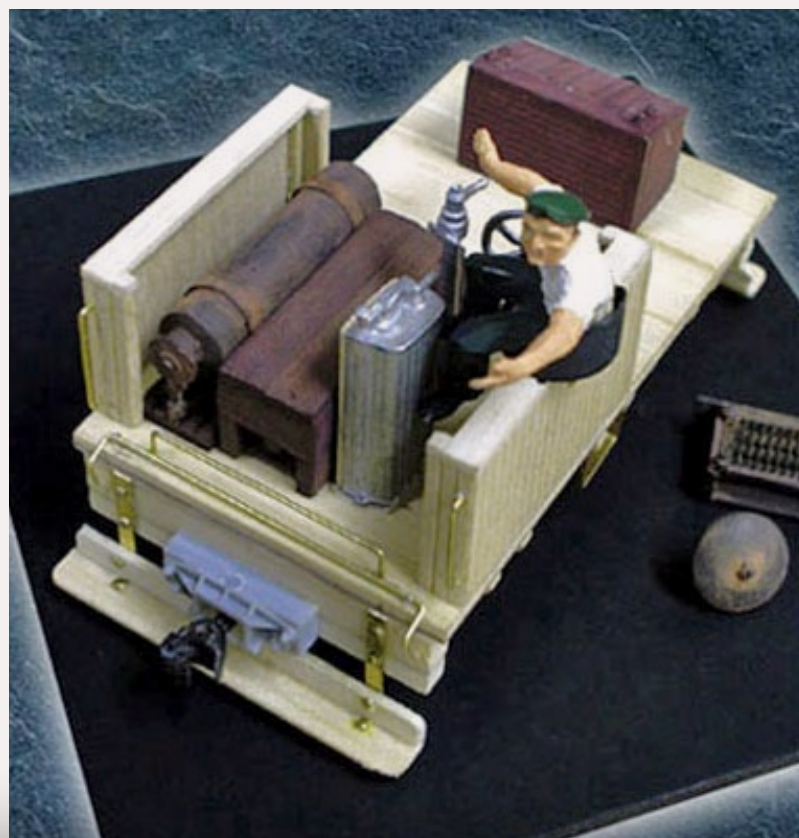

FIGURE 16: This is the early part of the construction, showing the deck over the SPUD power truck upon which No. 19 will be built. The chassis and floor were fabricated from cyprus wood strips and bars. Photo by Junior Yamachi.

Advertisement

Reach over 30,000 model railroaders with your 1/4th page ad in this space for as little as \$150.

Your web site's always just one click away from our ads – talk about *instant gratification!*

Click to learn more ...



(1/4 page square )



## Electric Mining Locomotive No. 1

Junior was concerned that a narrow gage mining railroad would be very unusual in America, but if it existed, and connected to the Surfside Traction Company, it too would be 30" gage.



**FIGURE 17:** This diminutive steeple cab loco was the first mining motor built after the Surfside Traction Co. venture. This unit, seen from the right side, is smaller than the STCo. Trolleys. Photo by Junior Yamachi.

Thus began the Pacific Metal and Mining Company, an electrified narrow gage, mining railway running along the canyon of Wills Creek to carry ore from the mines to Port Monroe, the right-of-way of the Surfside Traction Co.

In Junior's seemingly bottomless parts/junk box, he found what he



**FIGURE 18:** No. 1 electric motor began the mining industry expansion. Shown from the left side, the details are quite cleverly done. The pantograph is a Rivarossi part and the compressed air tank is an N scale container. No matter where you look, on this small model, there is detail for the eye to dwell upon. Photo by Junior Yamachi.

needed for the new locomotive: a SPUD #WB-26 power truck, a pantograph from an old HO scale Rivarossi electric motor, a small bell, a window from an O scale structure, 2 different locomotive headlights, some HO scale diesel grabirons, a sheet of Evergreen V-groove styrene siding, plastic angles and channels and an N scale tank container - which became No.1's compressed air tank.

As a preference, Junior wanted to build this motor smaller than switcher #19, because it was a mining locomotive and not part of the trolley system. The body size of the motor was determined by the SPUD power unit.



**FIGURE 19:** No. 1 under construction has a window from an O scale structure, Evergreen V-groove siding, plastic angles and channels and an N scale tank container. Note the styrene axle bearings from a 1:80 scale diesel. Photo by Junior Yamachi.

The locomotive was finally designed to be 35mm by 68mm (5' - 5" X 10" - 8"). The only new parts that Junior purchased for this engine were the axle journal boxes in 1:80 scale. The complete motor only took 2 days from start to finish. Junior airbrushed it with Tamiya Olive Drab and numbered it 1. Junior remarked, "Easy to build and cheaper than No. 19."

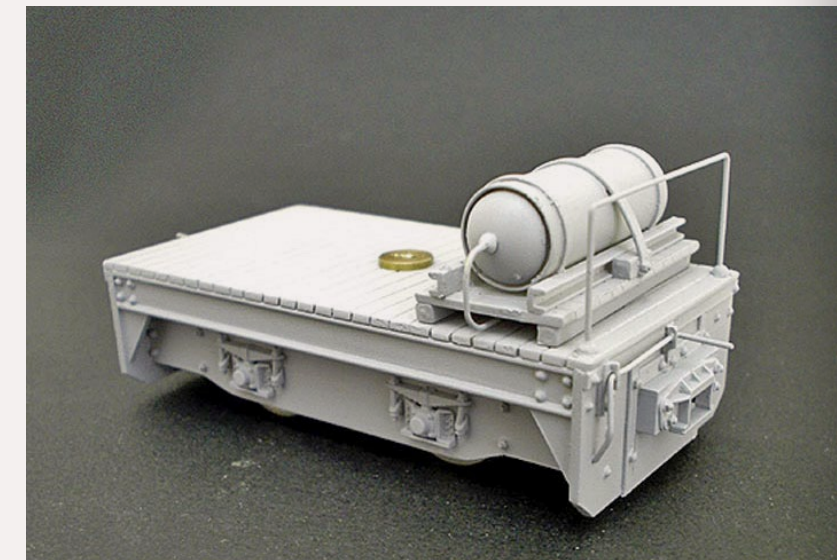

**FIGURE 20:** No. 1 was built on a platform housing the Tenshodo SPUD unit. The axle bearings and Grandt line casting on the pilot set the tone for small but powerful. Photo by Junior Yamachi.



Reach over 30,000 model railroaders with your 1/6th page ad in this space for as little as \$113.

Your web site's always just one click away in MRH – now that's *instant gratification!*

Click to learn more ...



(1/6 page horizontal )

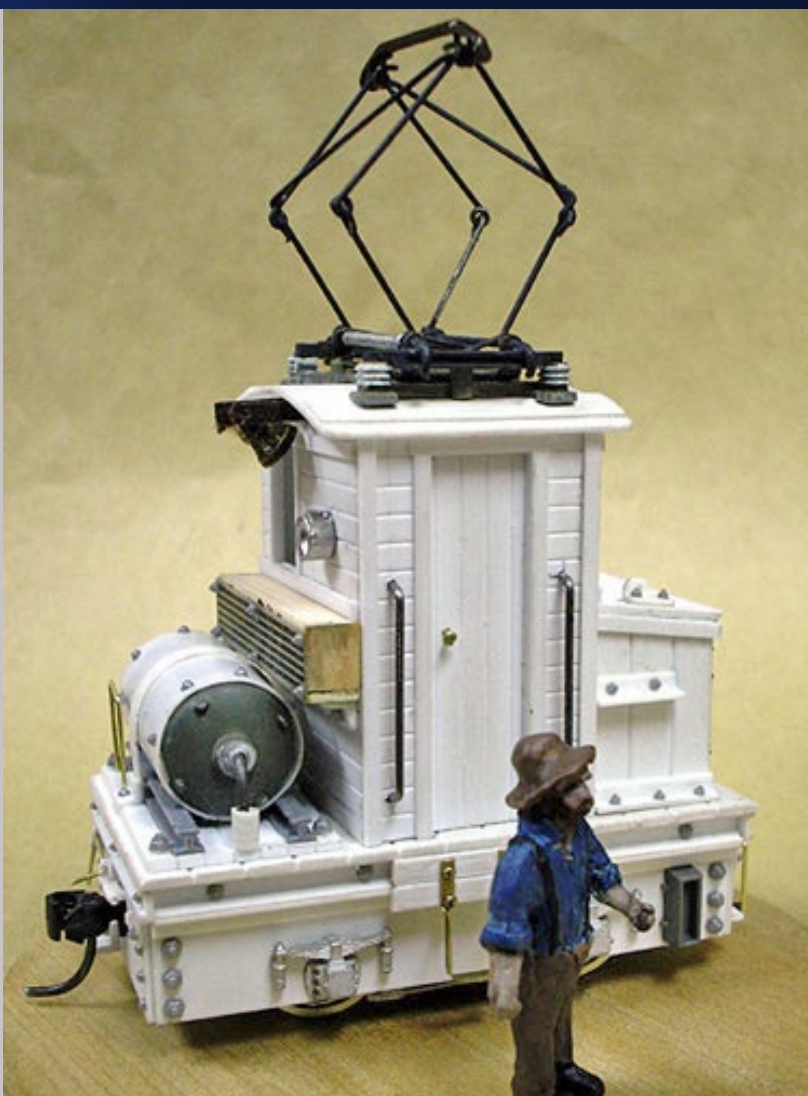

FIGURE 21: No. 1 is nearing the end of its construction. Smaller details: bell, HO headlamps and HO tool box etc. are added. Note the use of brass pins to simulate large rivets and the prolific use of nut-bolt-washer castings. Photo by Junior Yamachi.



FIGURE 22: The left side and front of No. 1 as it sits ready for painting. The unit was sized to fit the SPUD power unit. Photo by Junior Yamachi.

## Electric Mining Locomotive No. 3

Junior had an older power unit that was a commercial model maker's pilot model with a wheel base of 22.5mm (3' – 6" and a wheel diameter of 10.5mm (19"). This tiny unit would form the basis for the next motor, Electric Mining Locomotive No. 3. Wanting to do something different, he created an "L" shaped cab floor plan.

Using an N scale plate girder bridge for the sides, 1:80 side frames (manufacturer unknown), O scale Grandt



FIGURE 23: The front end of No. 3, considering its small size, is still very impressive. It is shown just outside the mining company's engine shed. Photo by Junior Yamachi.

line structure window frames, HO scale pantograph (from a South Shore steeple cab) and a Maerklin pantograph and trolley pole, Junior scratchbuilt a freelance model.

"This is fun and easy" Junior said, "The design can easily be changed. First, I'd like to fit it with a trolley pole...but I changed my mind to fit it with a Maerklin pantograph. Mmm. It looks toy like... Finally I put a South Shore pantograph on it." Now it is a dummy locomotive working with No. 1.



FIGURE 24: No. 3 was originally outfitted with a Maerklin pantograph but Junior decided that it was just a little toy-like in appearance and was subsequently discarded. The "L" shape design of this motor is nicely portrayed in this rear end view. Photo by Junior Yamachi.



# Under-construction photos of Junior Yamachi's On30 Electric Mining loco number 3 ...

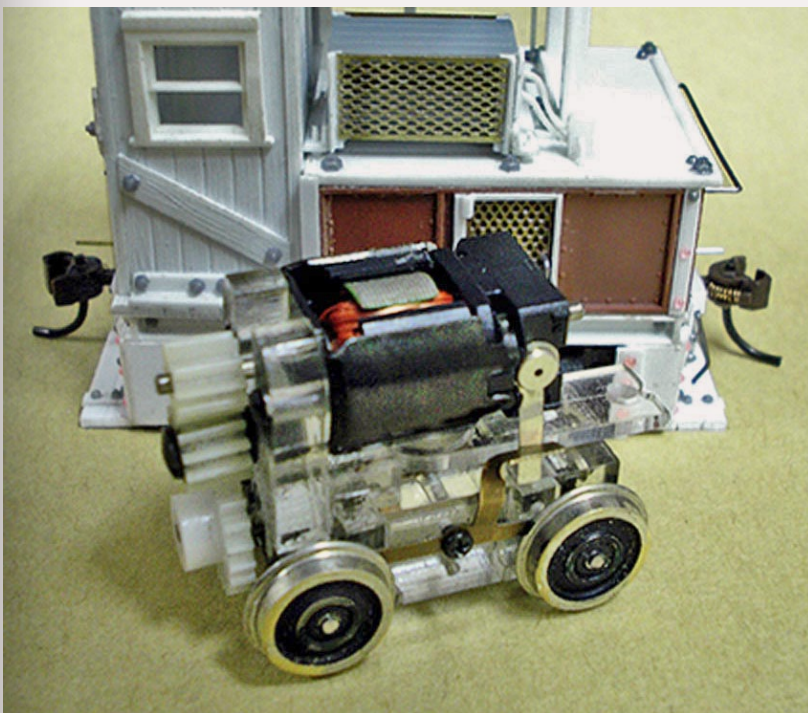

FIGURE 25: Junior has a handmade preproduction power truck that forms the basis for the electric critter No. 3. This power truck has a wheel base of only 3' - 6" and wheels of 19" diameter. Photo by Junior Yamachi.



FIGURE 26: The front view of No. 3 with a trolley pole. This version just didn't make it into production. Photo by Junior Yamachi.



FIGURE 27: This early version with a trolley pole was examined and then the idea was discarded in favor of using a pantograph. Photo by Junior Yamachi.

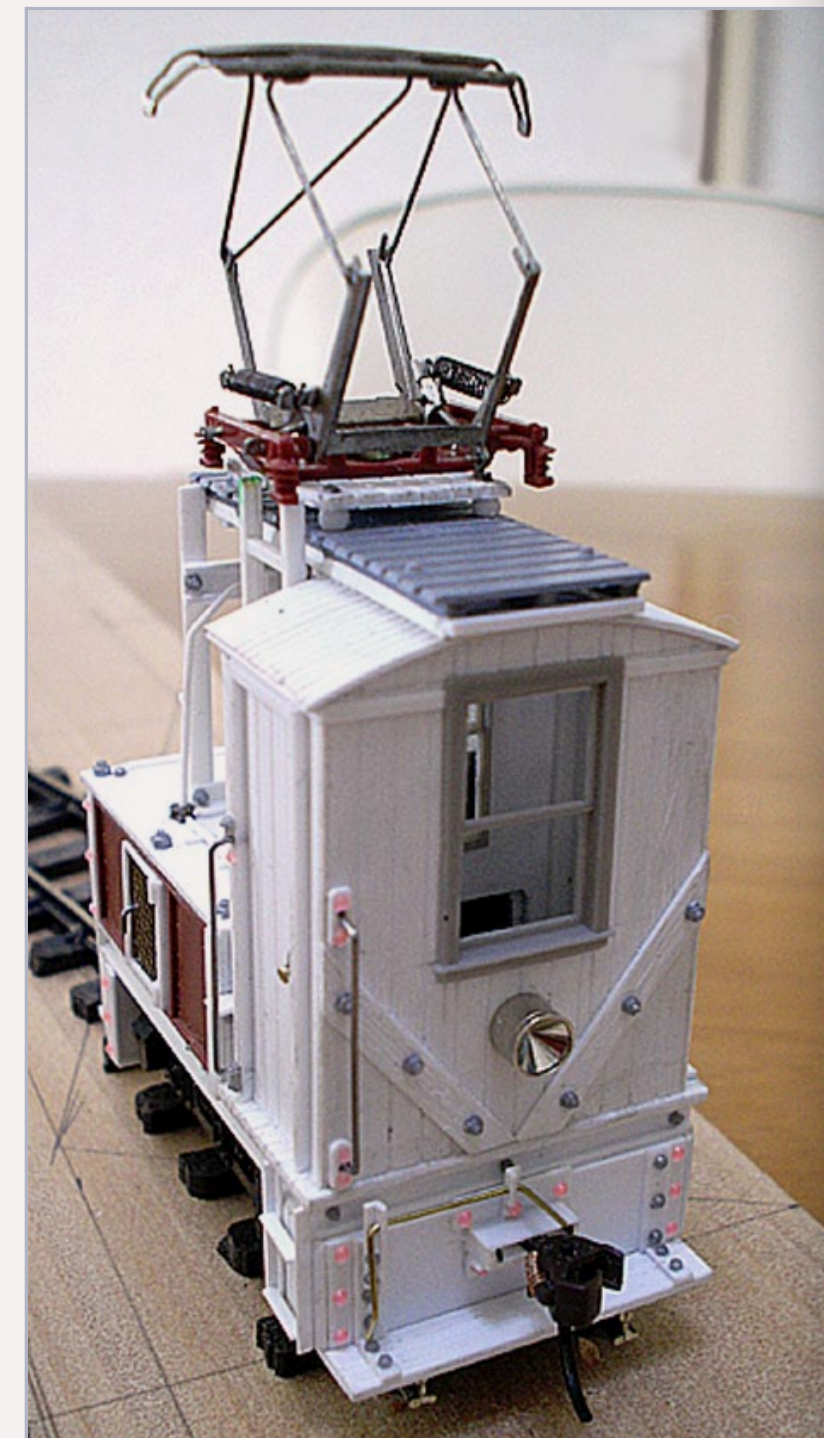

FIGURE 28: No. 3 in its final form sports a South Shore pantograph. Photo by Junior Yamachi.

**Support Model Railroad Hobbyist! Look for this logo on any ad:**

It tells you *where to click* to visit the advertiser's web site.  
And tell them: "Thanks for bringing me MRH completely free!"





## Steeplecab Electric Locomotive No. 4

“My fourth critter is steeplecab electric No. 4. The inspiration for this locomotive came to me from a picture of a 42” gauge Fukui Railway steeplecab that I took many, many years ago. That was a double truck locomotive.”

Junior wanted No. 4 to look like a mainline locomotive not a mining loco, but was disappointed because



**FIGURE 29:** Running backwards at speed, motor No. 4 returns a load of empty side dump ore cars to the mine in exchange for a loaded run back. The overgrown native vegetation almost obscures the motor in this scene. Photo by Junior Yamachi.

the short wheelbase made the loco look toy-like. The SPUD #WB-26 was adapted as the power for No. 4. He eventually wants to rebuild the loco to a double truck version.

The body, truck side frames, end beams and platform are made of styrene car siding. Again, the 1:80 scale diesel locomotive axle bearing boxes were used. A pair of 1:50 scale structure windows were glued to opposite ends of the cab. The pantograph was left over from an HO scale Sydney suburban electric railcar.

Junior notes that “If you want to get pantographs for your electric critters, you can buy (them) from Germany. ... German-made Sommerfeldt HO scale



**FIGURE 30:** No. 4’s blower motors are whooshing as the little critter struggles along the cliff face with a string of ore cars from the mine. Hopefully that chain is strong enough to secure the heavy 55 gallon drum on the front deck during braking. Photo by Junior Yamachi.

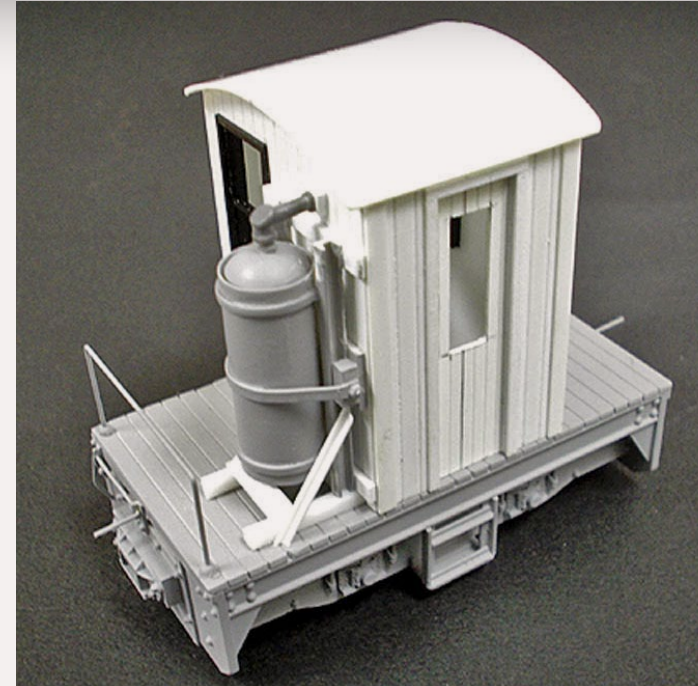

**FIGURE 31:** No.4 under construction shows the vertical compressed air tank, made from an N scale container, on the back platform of the motor. The well detailed frame design is consistent with all of Junior’s motors. Photo by Junior Yamachi.



**FIGURE 32:** The roof detail is yet to be completed, but the screens, vents and the sun shade add the visual clutter that makes these critters so endearing. Photo by Junior Yamachi.

locomotive pantographs are good for On30 electric critters, but (are) ...European styled. See: <http://www.eurorail-hobbies.com/erh/sommerfeldt.asp>.

“I bought a pair of them for my next pantograph-equipped electric critters. . . . I’m building the new electric critter No. 16, that is. And I have plans for electric critters, four-wheeler and double truckers. I have just started building an On30 pike.”

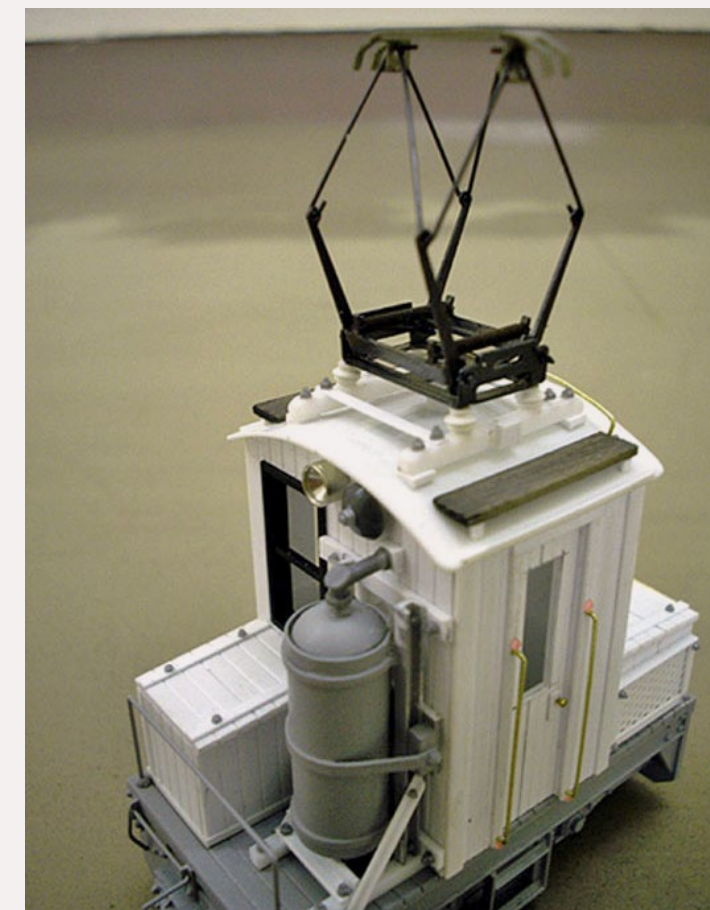

**FIGURE 33:** In the on-going construction, the back of the cab has received more details and a pantograph is attached to the roof. A plentitude of small details such as the nut-bolt-washer casting at the ends of every grabiron and the brass pin for a door knob begin to shape the character of this small motor. Photo by Junior Yamachi.



## Dioramas

When Junior started modeling again 3 years ago, he extended the Surfside Traction Co., and built some building fronts to create a town atmosphere. Changing to a mining theme changed his direction and he planned a new and different module.

First, he built an engine shed diorama for the mining locomotives that would eventually become part of the mining modular layout. The engine shed diorama was sized to 100mm by 300mm (4" by 12") and all structures on the diorama were scratchbuilt using basswood siding and HO scale windows, except the factory front that was made with O scale styrene brick



**FIGURE 34:** This plywood base forms the On30 diorama of the Cliffside scene, which is the same size as the engine shed diorama, 4" x 12". The rails and overhead wire are the starting point for the rest of the scene.

pattern sheets and HO scale windows from the Volmer factory kit.

The proposed modular layout will be a point-to-point design, similar to the Surfside Traction Co. A short tunnel in the middle of the layout will divide the territory into 2 scenes, a town on one side and the mountains, with the mine, on the other.

Junior built the mountain scene and a separate mine diorama. The mine diorama served 2 purposes. It was a pilot diorama project and made a nice gift for a friend. The diorama was only 100mm by 150mm (4" by 5"), the size of a standard Japanese post card. The tunnel was made from balsa sheet and



**FIGURE 35:** The cliff face is made from painted and drybrushed cork bark and the retaining walls are balsa sheets and timbers. The subtle use of color and weathering is Junior's trademark on all of his work. I hope he shares his secret for vegetation. The green growth is very impressive. Junior says that building this module was very easy and only took 2 days.

square timber pieces, cut and stained to make the retaining wall and portal.

Junior's third diorama was the freight depot he built for another friend. (With the quality of his work and his apparent generosity, it kinda makes you wish you were one of Junior's close friends, doesn't it?)

The friend has a plan for an On30 traction layout, too, and the freight depot will eventually be part of his layout. The freight depot was built on a board



**FIGURE 36:** Engine No. 3 hums its way back to the mine with a string of empty Bachman side dump cars. The rail is code 100 laid on individual wooden ties. The weathering and the scale of the vegetation bring everything together in this scene.

150mm by 450mm (6" by 18") and has an abandoned siding. All the structures were scratchbuilt, painted and weathered to suit the scene.

The latest On30 diorama is the Cliffside scene, which is the same size as the engine shed diorama. The cliff face is made from painted and drybrushed cork bark and the retaining walls are balsa sheets and timbers.

Junior says that the work was very easy and only took 2 days. He has just started to build the Wills Creek Railroad, which will not be modular. It is 450mm by 760mm (18" by 30") with an oval, very simple and small.

Eventually, Junior would like to try and power his locos from the overhead wire but will use conventional 2 rail DC for now. The cliffside diorama will become a major feature along with the tunnel to divide the scene.

*continued on page 99 ...*



**FIGURE 37:** Overview of the engine shed facility on the 4" x 12" diorama. Photo by Junior Yamachi.





**FIGURE 38:** The engine shed diorama was the first mine project and was sized to 4" by 12." All structures on the diorama were scratchbuilt using basswood siding and HO scale windows, except the factory front is O scale styrene brick sheet. Photo by Junior Yamachi.

**FIGURE 39:** The Engine shed diorama showing motor No. 1  
Photo by Junior Yamachi.



**FIGURE 40:** An overview of the freight depot, the largest of the dioramas. The freight depot was built on a board 6" by 18." All the structures were scratchbuilt. Junior built this diorama as a gift for a friend's layout. Photo by Junior Yamachi.

## Narrow Gage News

**W**hat's happening in America and around the world in narrow gage railroading?



The British e-zine, *Railway Journal*, a magazine of prototype British Railroads, has graciously allowed *Model Railroad Hobbyist* to reprint articles from their Narrow Gage News. Check them out at: <http://www.railwayherald.co.uk>

Their magazine is free, too. Now MRH can give you up-to-date information on narrow gage happenings from around the world.

On the home scene, Roger Cutter, of RGS east, announced that he received a letter from the Colorado Railroad Museum about Rio Grande Southern #20, that will be restored at the Strasburg Railroad shops, in Strasburg, PA.

### Colorado Railroad Museum, Jan 2009

Locomotive 20, built in 1899, is currently undergoing a complete restoration to bring it back to service at the Museum. The work is being done by the shops of the Strasburg Railroad in Pennsylvania under the direction of Linn Moedinger. We here at the Colorado Railroad Museum appreciate the care and meticulousness that Linn Moedinger has taken in the restoration of this storied locomotive.

It is an expensive, labor and materials intensive process. We have recently received a challenge donation of \$250,000 to help defray the costs of the restoration. We have received nearly \$50,000 in donations to meet the match, but we have a long way to go.

As friends of the museum, we would like you to please consider a donation to the Locomotive 20 matching fund. You'll have the satisfaction of knowing that your contribution helped restore this important icon of narrow gauge railroad history.

Please call the museum at 303.279.4591 or toll free at 1-800-365-6263 with your pledge of support, or you can mail a check to the Colorado Railroad Museum, 17155 W. 44th Ave., Golden, CO 80403. Donald Tallman, Director.

Donations will be accepted at the Mid-Atlantic Narrow Gauge Annual Module Meet in Kimberton, PA (<http://midatlanticng.railfan.net>), May 15 to 17, or send your donations directly to the museum. ■

Advertisement

Reach over 30,000 model railroaders with your 1/12th page ad in this space for as little as \$71.

Click to learn more ...

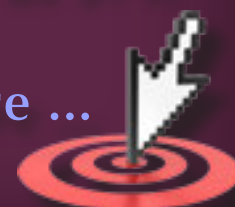

( 1/12 page )





Junior wistfully imagines the sight of the ore trains running along the cliff, passing through the tunnels, but he doesn't have any ore cars yet. That may be another story!

## Share your creativeness

Share your Imagineering creativeness. Tell us what's happening and what you are doing in Narrow Gauge in your area and I'll spread the word through this column: The Lite and Narrow in *Model Railroad Hobbyist*. [lmatt@model-railroad-hobbyist.com](mailto:lmatt@model-railroad-hobbyist.com).



**FIGURE 42:** After seeing the close-ups of Motor No.1 in the mine entrance it is hard to believe that this diorama is only 4" x 5" in size. The tunnel was made from balsa sheet and square timber pieces, cut and stained to make the retaining wall and portal. Photo by Junior Yamachi.

**FIGURE 41:** Motor No. 1 is just exiting the mine portal. The vegetation forms a very natural frame around the portal of the mine entrance. This view gives us a close look at the timber retaining wall around the mine opening. Photo by Junior Yamachi.

Have you done some creative model work designing and building railroad locos, trackwork, structures, cars, layouts, modules and equipment? Are you doing some interesting operation? Have a new card system?

Photograph your endeavors and tell us about them. Send your information and unpublished photos to MRH, check out the contributor's information link on the menu or go to <http://model-railroad-hobbyist.com/contribute>.

 **Article feedback!**  
 CLICK HERE for reader comments on this article ... 



**FIGURE 43:** The passenger shelter forms a nice study in industrial clutter! Eventually, this structure will service passengers heading to the mine. Photo by Junior Yamachi.



**FIGURE 44:** Photographing the freight depot with the passenger shelter placed in front makes for a breathtaking scene. The juxtaposition of the two dioramas creates a great depth of field. Photo by Junior Yamachi.



**FIGURE 45:** Using a realistic low camera angle to shoot across the two dioramas effectively captures the clutter in the foreground. Motor No. 19 stands out well with its signature red paint framed by the foreground structures. Photo by Junior Yamachi.



Charlie Comstock is ...

## UP THE CREEK: Plate Tectonics

A regular report on the construction of a 1950s-something layout

A clipping from the *South Jackson Gazette* ...

### Strange Cracks in the Ground Alarm Oakhill Residents!



spokesperson of the Bear Creek area, “Them cracks sure are kind of strange, yessiree. Most cracks in the ground tend to meander around alot but these are different — they look almost like they was made on purpose!”

The scientific crew when reached at Oakhill was muttering about subterranean mechanics and something called ‘plate tectonics’. Apparently they believe that the plywood of which all terrain roundabouts is made is floating on a core of molten plaster.

As the plaster swirls and shifts in response to the gravitational pull of the moon and sun so do the plywood tectonic plates, causing fracture zones to appear between them.

Said an unnamed scientist on condition of confidentiality because he was not authorized to speak on this mat-

ter, “Those pieces of plywood under Oakhill that everybody thinks are solid - well they’re not really solid at all. They’re trying to move relative to each other all the time with only the thin layer of rocks and weeds on top of ‘em preventing it from happening.

“But watch out because when the pressure builds too high they’re gonna shift big time creating massive earthquakes and who knows what else.”

Said another, “Why I wouldn’t be too surprised if the subterranean forces at work here were powerful enough to move that hill over there straight up in the air!”

In fact, local rumor has it that one of the hills near Oakhill does in fact move up and down although no one seemed to have documented evidence of such behavior.

This reporter certainly hopes to be long gone before they move again.

## About our layouts columnist

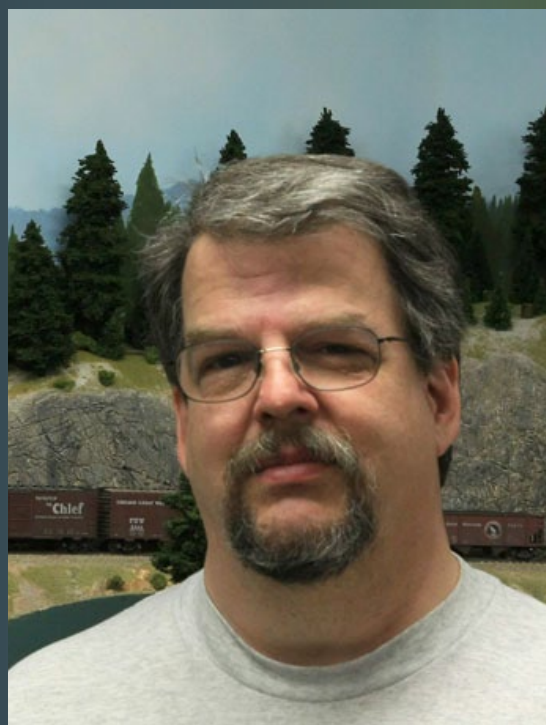

**Charlie Comstock** is our layouts editor and columnist. An award-winning model railroad photographer, Charlie became interested in serious layout design in the late 1990’s when he was designing the second Bear Creek and South Jackson.

Charlie’s column, *Up the Creek*, tells design and construction tales of the newest and best BC&SJ yet – a single-track freelanced class 1 railroad, set in western Oregon circa 1952.

Scientists from South Jackson are again in the news. This time they were called in when train crews reported seeing a pair of alarming cracks beneath the tracks.

Said Horace Fithers, unofficial and (highly) vocal



**L**ayouts need to be accessorized – not by putting color coordinated stuff on them, but by providing a way to get to everywhere on them. Failure to do so can (and usually will) result in frustration when things needing maintenance can't be reached, etc.

This is the second of a series of columns about the my Bear Creek and South Jackson Railroad. Expect some factual information, some speculation, and a good bit of USDA certified prime malarky.

## Accessibility

As the design of the third Bear Creek progressed it became clear that while most locations would be easily accessible from the aisles there were some areas where that was not the case. The two I've addressed so far are

- The Oakhill wye tail track
- Track spanning the entry door to allow duckless entry/egress.



**FIGURE 1:** It's a long reach from the aisle to the tail track of the Oakhill Wye necessitating another way to get access there for construction and operation. Can you pick out where the hatch stops and solid ground starts?



**FIGURE 2:** The access hatch in its raised position shows the importance of knowing your vertical clearance. There are only a couple of inches between the tree tops and the ceiling.

## Getting a lift

The tail track of the Oakhill wye was a difficult case. I needed the wye there to turn helpers (it also makes it possible for the Oakhill Turn to switch Oakhill without using the main-line). But the tail track would be nearly 5' from the aisle and with the benchwork 63" off the floor it would be quite inaccessible.

Obviously some kind of pop up access was needed. I know of a few types:

- An open hole in the scenery - hard to disguise unless it can be hidden behind a hill or building

**“Any spot on a railroad you can't get at without contortions, elastic arms, a cherry picker, or remotely operated robot, will almost certainly become a spot of frequent derailments, tricky maintenance, and construction issues. Best to ensure there is decent access.”**

**– Abe Euhnett, engineer on the Bear Creek and South Jackson Railway Co.**

- A hole with a removable hatch — the hatch needs to be manually



removed before the access opening is usable leaving the question, where does it go when not in use?

- An access hole with a raiseable hatch.

Years ago I'd seen a photo of John Allen standing in an access opening in the town of Port on his Gorre & Daphetid with the scenery raised up above his head. It appeared John was using some kind of slides to raise that

part of Port into the air. I figured if it worked for him it could work for me.

My problem was a bit more complex as the 2 track Deschutes staging area is along the wall under the hatch.

I mounted my hatch on a pair of vertically oriented steel drawer hinges to guide that hatch cover up out of the way, eliminating the issue of what to do with it when it wasn't in place.

A big question with a lift hatch is 'How much vertical space is above it?' The ceiling in my train room is 97" from the floor. The base elevation of the hatch is at 63" leaving 34" for the hatch to

operate. This sounds quite workable, but is it really?

The hatch would be in the side of a hill (height of 5") with trees on it (6" tree height). That meant the hatch could only be raised 23" (34" - 5" - 6") before hitting the ceiling. Subtract another 4" for the bracing underneath the hatch and the distance between top of benchwork and bottom of hatch is down to 19".

Would this be enough clearance to allow someone to pop up from "the underworld", throw switches, couple or uncouple cars, rerail errant rolling stock, clean the track, repair the turnout,



FIGURE 3: The right hand support leg of the hatch. Note the 'cleat' under the hatch 'leg' holding it in the 'up' position.



FIGURE 4: An extended drawer slide is clearly visible here as is a 'cleat' holding up the hatch 'leg'. The cleat pivots around the single screw attaching it.



FIGURE 5: The hatch top after some paint, spackle, and rock carving. After the rocks are stained it will receive one more coat of dirt paint before being reinstalled.



and build scenery in this otherwise inaccessible area? Experiments showed the answer was 'Yes!'

I use 3/4" plywood as the substrate in my town areas. When I installed the plywood in Oakhill I cut out the opening for the access hatch in one piece which I set aside for use when I started building the hatch itself. Later, when it was time to install the lift up hatch I already had the base for it — cut perfectly to size.

I mounted heavy duty steel drawer slides to four pieces of plywood — two below the hatch and two more extend-

ing down from the benchwork. These made good mounting surfaces for the slides and the result was a pair of plywood/slide/plywood sandwiches.

Using strong drawslides help avoid the 'leaning tower of Pisa' appearance.

I was careful to thoroughly brace the hatch / drawer slide assembly under the hatch to limit twisting or flexing as it was raised and lowered.

To keep the hatch open (up) I added a couple of twistable cleats pivoting on #8 screws to hold the legs of the hatch from dropping.



**FIGURE 6: It works! I can pop up through the hatch and reach the otherwise unreachable Oakhill wye tail track!**



**FIGURE 7: With careful fitting of the hatch to the surrounding terrain the 'fault zones' can be kept relatively inconspicuous.**

Check out the video clip to see how all this works.

But I forgot something... The visible surface of a liftup hatch needs to match the contours, texture, and color of the surrounding scenery if it's going to blend in. And I'd installed the Oakhill plywood substrate all the way to the aisles! Arghh! It looked like I might need an access hatch to work on the access hatch!

and one right. Then I did the same for the hatch base. Keeping the right and left edges of the hatch straight, instead of curved, made installing them a lot easier. The curved front edge is hidden by the roadbed for the wye.

**Be very careful when installing a lift hatch next to a wall with a backdrop painting. The hatch *must not* rub on the wall or the backdrop will quickly be ruined! I left a 1/4" gap between the back of my hatch and the wall to prevent this from happening.**

I worked around this problem by cutting 2 pieces of pink foam to fit on top of the plywood substrate — one left



With the hatch base removed I held the foam in place on the substrate next to the hatch opening and carefully marked where the land form contours would be. I removed them and carefully cut them to shape. Then I used them as templates to cut the pieces that would sit on top of the hatch base, cutting them to match.

Then I glued the first 2 pieces in place on the substrate being careful to align them vertically (plumb). Next I glued the other pieces onto the hatch base (again being careful to align them vertically). Once these were in place I

filled in the rest of the pieces on the hatch cover.

I coated the contoured pink foam on the hatch cover with brown latex house paint. After that, I dry-coated it with a very thin coat of spackle. The spackle won't stick to pink foam very well. The brown paint provides it with something to cling to.

Once the spackle was dry I installed the hatch to double check how it matched with the contours of the scenery around it. I got lucky and it matched pretty well. Then I removed the hatch to add a rock carving on



**FIGURE 8:** The hatch supports with the hatch top removed. Note the bracing at the top which helps keep this assembly relatively stiff.



**FIGURE 9:** A view under the lowered hatch. Be sure to allow space for those drawer slide assemblies - they project downward 18"! Deschutes staging (2 tracks) is under the hatch necessitating the shelf above as protection from errant elbows and hips. Note the position of the disengaged locking cleat allowing the drawer slide assembly to move past it.

top of it (using the carving methods described by Joe Fugate in his Volume 4 - Scenery DVD - see [model-trains-video.com](http://model-trains-video.com) for more).

I reinstalled the hatch and put another coat of brown paint on it and the surrounding terrain before using my Noch Grassmaster to add some basic flora to the area (I taped the Grass Master to the end of a stick so I could sprinkle the entire area at once, adding static grass to the hatch and several inches around it. Then I raised the hatch and let the paint dry (so the hatch wouldn't get painted shut).

Finally, I built a shelf above the two-track Deschutes staging yard so errant elbows, hips, and knees wouldn't knock any parked rolling stock onto the floor.

The result is that the hatch operates smoothly and easily. There's enough room for an operator to pop up and do what-needs-to-be-done and when the hatch is lowered it's not easy to tell that there is a hatch there (until you look underneath).



## Learning Points: Access Hatches

- Is the access hole big enough for you and others to pop up and still have the use of your arms?
- Is there enough up-and-down space to raise the hatch without bumping the ceiling?
- Is it close enough to the areas being accessed to be useful?
- What's underneath it? Is there a reasonable way for you or others to get to the hatch from below?

- If there are lower-level tracks beneath the hatch, can they be protected from 'bumping' with various body parts?
- How will the scenery on top of the hatch be installed and fitted to match the adjoining scenery?

## Let's swing

The entrance to the BC&SJ train room presented a different access issue. The railroad crosses the entry door at a track height of 63". This is fairly high but still requires an exaggerated 'nod'

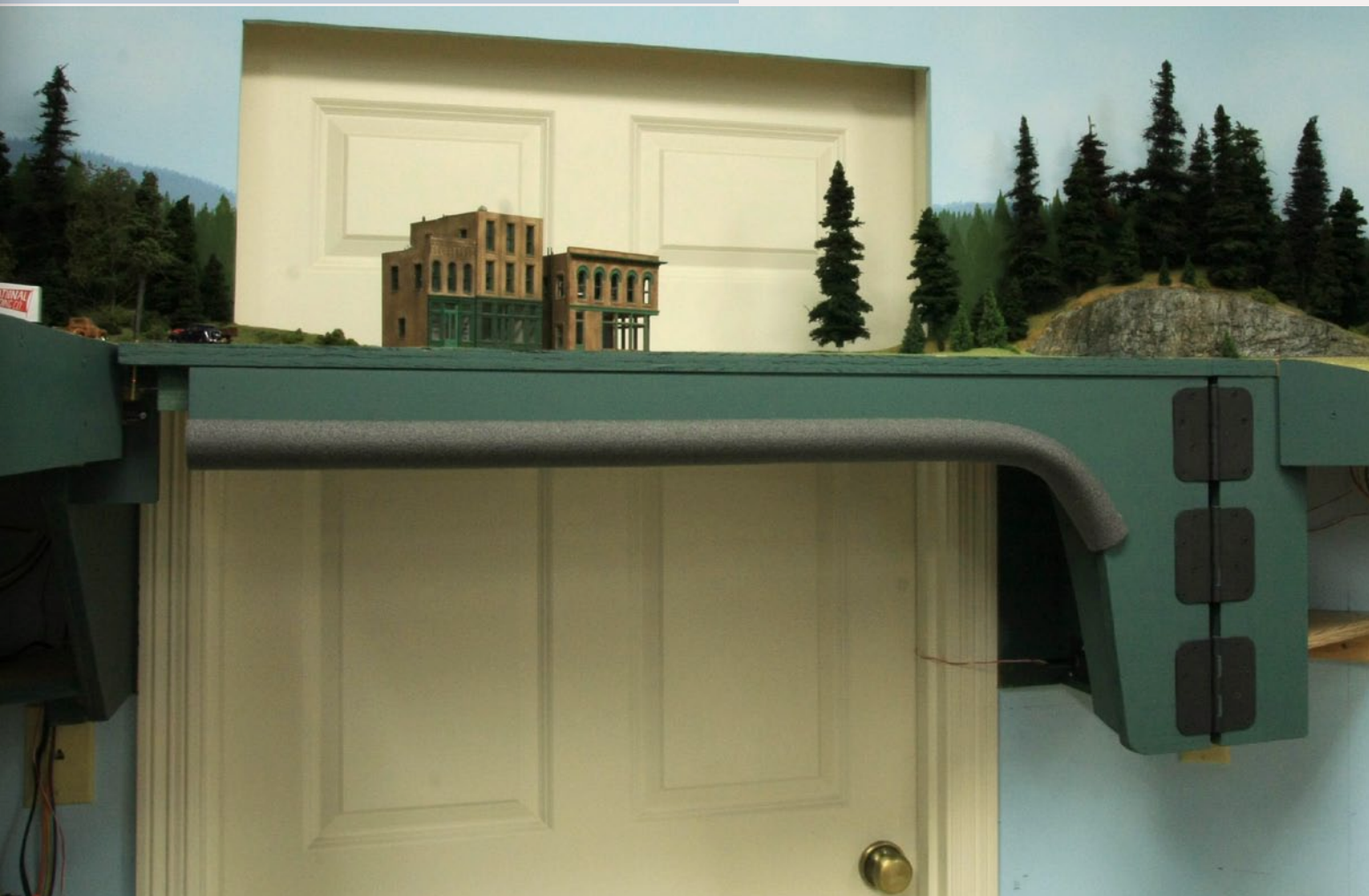

**FIGURE 10:** The Bear Creek and South Jackson spans the entrance to its train dungeon on this swing gate. The track is at an elevation of 63" here so it's possible to 'nod' under when the bridge is closed. Note the foam on the bottom of the bridge for when people come up too soon after ducking!



**FIGURE 11:** I drove #4 flat-head wood screws into the roadbed before laying the track across the swing bridge (and its abutments). I soldered the rails to the screw heads before cutting gaps in the rails. This keeps the track in good alignment and allows for easy adjustments if the need should arise.

to get past it. I determined to make the bench work spanning the door as a swing gate (bridge).

When needed the track and benchwork can be swung out of the way — handy for those guests unable to nod underneath or for lugging 4x8 sheets of plywood into the train room.

Experience on my previous layout showed me that for a swing gate to work well the abutments for it must be solid. If they move back and forth the swing gate will have alignment issues.

I built my abutments using a 'box' construction style bolted to the walls to

make them solid. I also screwed a U-shaped piece of plywood around the top of the door to help prevent the distance between the abutments from breathing.

I built the abutments using a level to ensure their tops were at the same height (and that the face where the hinges would attach was straight up and down). Then I laid a length of 3/4" plywood across the abutments, screwing it in place. Then I added the ribs and braces under the bridge, working downward. Then I installed the hinges.

*Continued on page 8*





FIGURE 12: If a court were to investigate the manufacture of this bridge it would be an “open and shut” case!



FIGURE 14: Plumbing insulation foam makes good head protection for early risers.



FIGURE 13: These cleats on the hinge side of the swing gate guarantee good vertical alignment when the bridge is closed.

FIGURE 15: When closed, the bridge is locked in position with this pin. I made the pin from 1/8” brass rod which is inserted through brass sleeves pressed into the plywood. Using the sleeves avoids wearing the holes away by removing and installing the pin. The locking pin must be fully inserted to let the micro switch below route power to the tracks - a safety measure to prevent trains from taking a trip into the Gorge of Eternal Peril. I topped the locking pin with a small tree to disguise it.





Because the swinging end of the bridge slides on a support shelf I very carefully used a trammel to draw an arc across the plywood bridge top with the center of the arc being directly above the hinge pivot point. Then, with the bridge fully constructed under the top plywood I used my sabre (jig) saw to (carefully!) separate the bridge surface from the abutments. Because everything was built in place it fit perfectly. Then I added the shelf to support the bridge at its swinging end.

To ensure the tracks are aligned horizontally I used a locking pin made of 1/8" brass rod that slides into a piece of brass

tubing to hold the bridge securely in alignment.

I clamped the bridge to its support shelf and carefully drilled a hole large enough to take the tube. Then I press fit two pieces of tubing into the bridge surface and the support shelf. The pin slid in perfectly. Don't try to drill these holes separately — you'll never get them to line up properly.

I handled vertical alignment with the hinges (another reason to use good quality hinges!) and a set of cleats at the hinged end. At the swinging end the



**FIGURE 17:** The moving end of the swing gate rests on a 'shelf' I screwed under plywood roadbed surface to hold the gate in proper vertical alignment when the bridge is closed.

bridge rides on its support shelf that keeps it at the right height.

I marked out where the track would go on the bridge and glued down the cork roadbed, laying it right over the gaps on either side of the bridge. A major issue to be addressed is anchoring the ends of the track at the gaps.

wood screws. Only *after* soldering the rails did I cut gaps in the track and the cork roadbed. The wood screws anchor the track firmly in place.

**Abutments for a swing bridge must be solid. If they move the bridge will not swing properly — either sticking in place, failing to close or having huge gaps in the tracks or even misaligned tracks.**

I drove #4 flat head wood screws into the subroadbed close to the gaps, making sure the tops of the screws were just beneath the railbase height. Then I installed the track right across the gaps and soldered the rails to the tops of the

If the track ever needs realigning I can unsolder the rail to screw head joint, move the rail(s) as needed and resolder. Finally I filed small chamfers in the ends of the rails to ease wheelsets across the gaps.



**FIGURE 16:** I used stranded wire between the barrier strips to power the bridge tracks. This is more reliable electrically than some sort of 'contacts'. Note the color coded wires.



I left an expansion joint in each rail on the swing gate and on either side of the abutments. This prevents expansion and contraction of the rail and benchwork from causing the rails to break loose from the wood screws. Perhaps this wasn't needed but I felt it better to be safe than sorry.

I fed power to the track on the swing gate by using flexible wires attached to some barrier strips at the hinge end abutment and the bridge.

I didn't want the bridge to carry power or other wiring from one side to another

so I set up a kind of conduit that goes up over the doorway (hidden by the backdrop) and ran my wiring through that.

### **Where is a swing gate inappropriate?**

Places where there is a high volume of train and foot traffic. Opening and closing the swing gate for people will disrupt train operation or worse, someone may open the gate while there's a train on it!

Locations with complex trackage. Each track traversing from the swing gate to its abutments will need to be aligned.

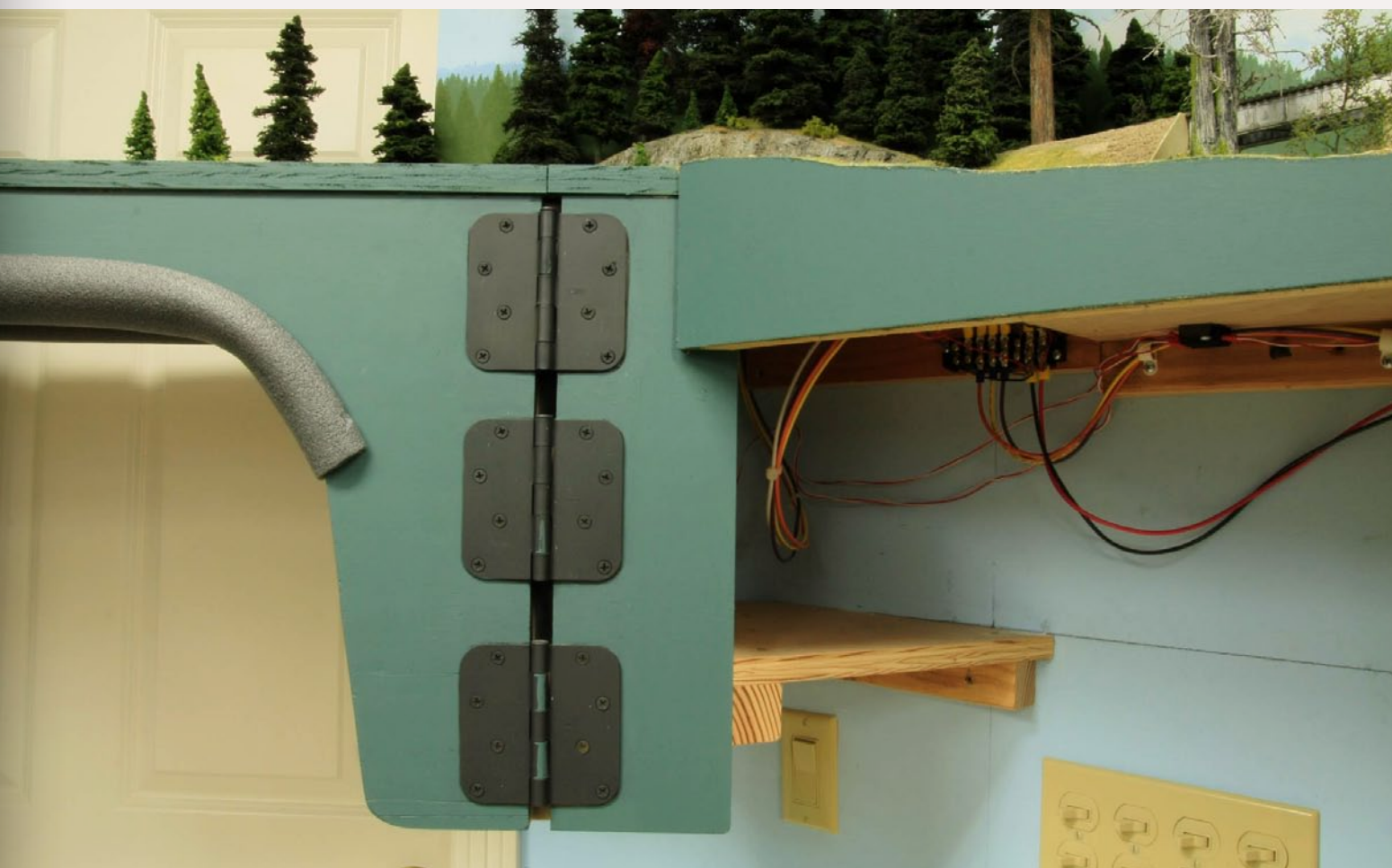

**FIGURE 18: A movable bridge with track on it requires secure abutments. I used 'box' style construction to build mine. Note the three hinges. They need to be good quality because they set the horizontal alignment at the hinge end. If they get sloppy the tracks won't line up right. The axis the gate pivots on should be absolutely vertical.**



**FIGURE 19: I ran 'ribs' down the front and back of the bridge to avoid sagging. These got covered with grey foam pipe insulation (to protect heads!). Note the locking pin with the tree on top at the far right.**

If there are lots of tracks keeping everything aligned could become a chore. Try hard not to split turnouts or crossings!

Places where it's difficult to build solid abutments or add a stiffening plate to hold the abutments securely in alignment.

My swing bridge has been in place for 4+ years now and has given very little trouble (sometimes it's a bit challenging to get the locking pin out). Would I do it again? Yup.

**When a swing/drop down/lift up/lift out bridge is not in place there is a tendency for rolling stock to seek the "Gorge of Eternal Peril." I use a micro switch under my locking pin to sense when the bridge is absent and remove all track power for a train length in either direction to prevent inadvertently driving or backing a train into The Abyss. If the pin isn't fully inserted there's no track power.**



## Learning Points: Swing Gates

- Is there room for the gate/ bridge to swing out of the way? Can it open wide enough to be useful for entry/egress?
- A swing gate that blocks aisles when it's open will be a problem to use.
- Can the abutments for it be made solid?
- How will wiring (like track power) be carried around the bridge? Don't rely on the bridge itself to carry track power from one side to another.
- Is it too deep? That is, how far must one duck to pass under the bridge when it's closed? Is ducking going to be permitted while trains are running? Consider adding a hand rail for the less spry crewmen.
- Build the swing bridge in place so it will fit properly. Don't expect to build it in your shop then bring it to the train room and have it fit properly.
- Don't forget head protection under the bridge! In addition to leaving blood stains, a good whack with the ol' noggin is likely to derail trains on and near the bridge.
- Use alignment devices to lock the bridge in place horizontally and vertically when closed.
- Use a microswitch to turn off track power for a train length on either side of the bridge when it's open to avoid driving trains into The Gorge of Eternal Peril.



**Article feedback!**  
CLICK HERE for reader comments  
on this article ...



## Who's reading MRH?



## Take our Reader Survey!

*When you take the  
survey, you also get  
a chance to see the  
results of the voting so  
far.*

**Click here to**  **take the survey.**

# The Model Railcast Show

**Keeping  
you  
on the  
RIGHT  
TRACK!**



**Click here to  
learn more ...**



# GETTING REAL: Rolling Trees

## Adventures in Prototype Modeling

About our  
prototype modeling  
columnist



**Marty McGuirk** is a well-published model railroad author: he has been an editor for Kalmbach on *Classic Toy Trains* and *Model Railroader*, and was the VP of Product Development for Intermountain Railway Company from 2001-2005.

Marty's an avid Central Vermont fan, modeling the "Southern New England" – an HO scale proto-freelanced railroad set in the 1950s and based in part on the real Central Vermont Ry.

### Decal "detailing" and easy weathering to build up a freight car fleet

**B**efore we jump into this edition of *Getting Real*, let me put things in context. Since I got a few questions from the last issue asking how I weathered the Central Vermont hopper, I thought it would be an ideal time to show my basic weathering approach, including adding chalk marks and reweigh dates to my freight cars.

The models that are the subject of this column can be described a lot of ways, but "detailed prototype models" isn't one of them. I call such cars "rolling trees;" in this case a trio (fig. 1) of Branchline's HO scale "Yardmaster" boxcars.

Why not a highly detailed resin freight car or structure? Well, the problem is one of time. Oh, I've been lucky enough to spend lots of time in the basement lately – which means focusing on benchwork, track, and wiring – anything, it seems, except building detailed models. But it strikes me that I'm not alone in this regard.



**FIGURE 1: Branchline's Yardmaster series doesn't have individual grabs, ladders or other separate details but they make excellent filler cars that won't detract from the more detailed members of the roster.**

Balance is one thing that must be mastered if you are going to have any chance of getting a large layout built. So although I'd love all my rolling stock to be super-detailed models of actual cars, it's hard to justify spending a lot of time on a single car when there's a railroad waiting to be built.

To be sure, I have a fairly decent roster of detailed rolling stock, built for smaller, previous layouts and during those times I've been "between" layouts. The problem is I don't have enough of those cars. That leads to the concept of "rolling trees." I model New England, which I've found really means I model trees.



If you've unfamiliar with the New England landscape let me describe it. Any piece of ground not covered with a rock, road, building, river, or track has a tree - or a sapling that will one day become a tree.

Needless to say I need lots and lots of trees. And although I've built a few "foreground" specimens over the years most of the trees I make are fillers – many don't even have trunks. They are meant to convey the idea of "tree-covered landscape" in the viewer's mind.

So, applying the same idea to freight cars, "rolling trees" are fillers or placeholders for those more detailed models I hope to build "someday." No bets on when, and if, "someday" will ever get here. In the meantime the trains will look complete.

It's important these cars don't detract from the more detailed examples on the roster. Most, like the Branchline Yardmaster series cars shown here, have molded grabs, and very often ends, doors, and roofs that are not correct for the prototype they're lettered for.

Since I don't want these cars to stand out I stick to "boxcar red" boxcars, black or red gondolas, and yellow refrigerator cars and avoid colorful schemes (such as Monon "Hoosier Line" or Bangor & Aroostook red, white, and blue "State of Maine").

Most of the effort to place these cars in service involves decals and weathering. I typically build 3-6 cars at a time and find they make a low-key modeling project that provides an ideal break from tracklaying and wiring.



**FIGURE 3: Microscale Micro-Gloss applied with a small paintbrush leaves a good surface for decals. In this case the "New" date is too old for the author's era so he'll replace it with a decal "patch" and new reweigh date.**

The contents of the Branchline kit (fig. 2) will look familiar to anyone who's ever built a "shake the box" kit. Branchline provides an unusual weight – a pair of lug nuts. I secured these to the inside of the car with adhesive caulk (double-sided adhesive tape also works).

I went ahead and painted one pair of trucks and set of underframe parts with Floquil Boxcar Red so the trucks on one car would look as if they were painted the body color.

I didn't waste any time trying to match the body color precisely since the weathering will blend everything together. For the remaining two cars I painted the trucks and underbody components Flat Black.

I used "The Exxact Tool" from Reboxx to ream out the inside of the journals. Then I removed the post in the coupler box designed to hold the coupler box in place with cement and drilled and tapped for a 2-56 screw.

I've found over time with glued coupler box lids the question is not if the lid will fall off, but when. Using a screw to hold the coupler lids in place also facilitates adjusting or replacing couplers in the future.

### **Changing the reweigh dates**

One easily added detail that you won't see on a lot of models is an updated reweigh date stencil. (See the reweigh sidebar, on the next page).

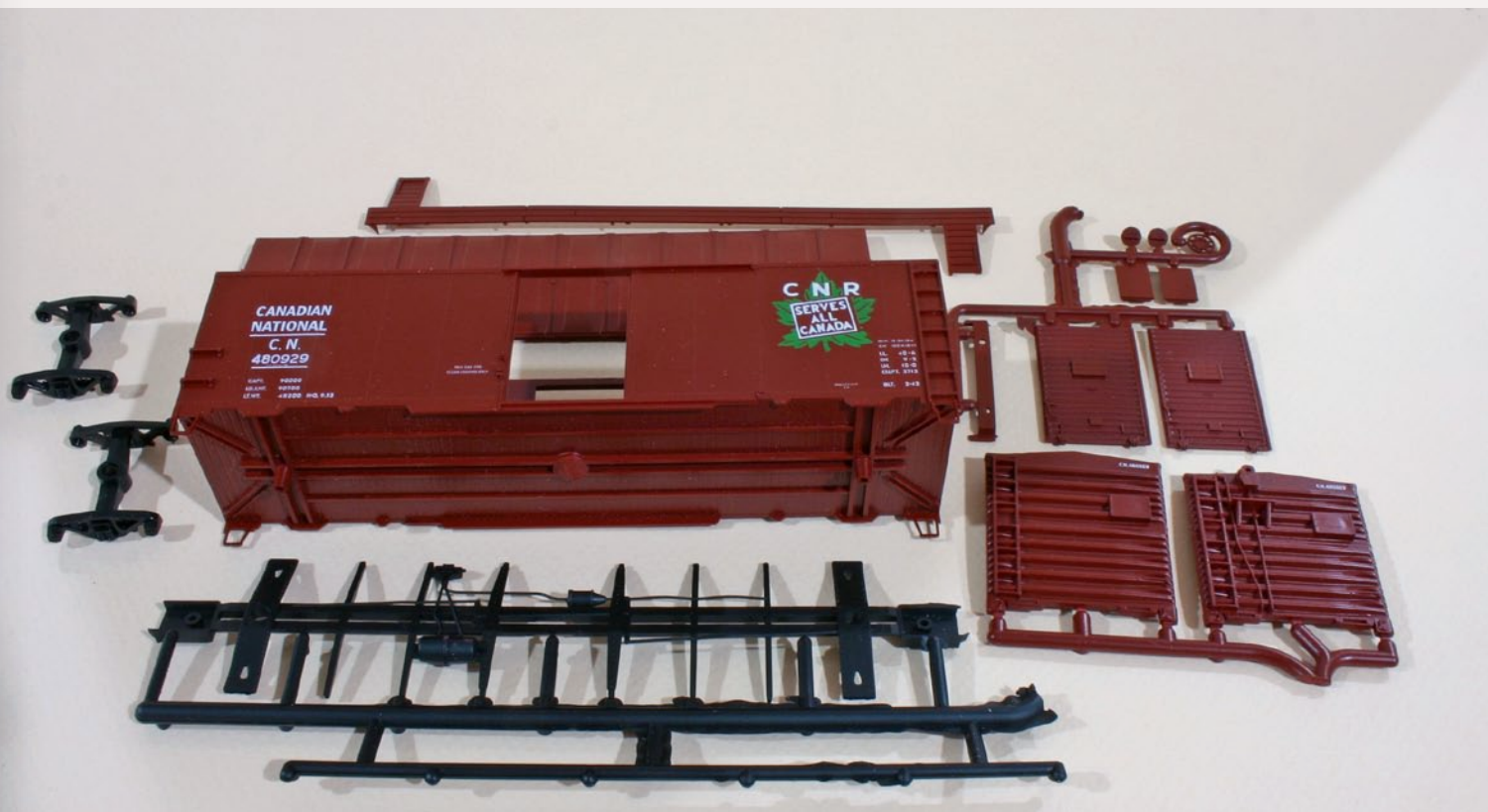

**FIGURE 2: The parts for these cars should be familiar to anyone who's ever built a shake-the-box kit.**



The WM and NP cars come factory printed with reweigh date of 5-41 making them “illegal” for my era and offering a golden opportunity to add some history to the models with decals.

Because decals need a glossy surface I used to spray the entire car with a Glosscote. It’s much easier and quicker

to simply brush a light coat of gloss finish, in this case Microscale Micro Gloss, to the section of the car side that needs to be restenciled (fig. 3).

I also painted small areas with Micro Gloss where I planned to add chalk marks (see above).

Sunshine Models, makers of a wide range of HO scale resin freight car kits, offers reweigh date decals (fig. 4 next page) with colored decals. Champ also offered a wide selection of reweigh dates. Both manufacturers arrange these decals by region of the country and specific roadname.

The reweigh stencils included with that roadname represent specific stations on that railroad (although there is no requirement that a car be weighed on its home road).

Sunshine includes decal sheets in various car colors (boxcar red, black, yellow, orange, etc . . . ) If you’re using Champ decals you’ll have to create your own paint outs.

Either paint over the existing reweigh date (like the prototype did), or use Microscale trim film in an appropriate color. You could also make your own decal sheets by painting blank decal paper.

No matter what approach you use, don’t spend time worrying about matching the car color exactly. In fact, a slight mismatch makes them look better.

Once the gloss coat dried, I added the red patch decal and reweigh data that was appropriate for my era. Because one of the cars I was stenciling was a Northern Pacific boxcar I used a reweigh stencil from the NP section of the Sunshine sheet.

I repeated this process for the WM car. The reweigh date printed on the CN car fit within my era, so I left it alone.

## Chalk marks

The next step was to add chalk marks to the cars. These markings were used by train crews on the ground to indicate where cars were to be spotted, what

## PROTOTYPE MODELERS DICTIONARY: Reweigh Dates



**W**hat are reweigh dates? As the name indicates, reweigh data indicates

the last time and place a freight car was weighed empty.

Because railroads charged for shipments based on weight, it was critical cars be weighed empty on a regular basis. Subtracting the empty car weight (which is also stenciled on the car side) from the total weight of the loaded car gave the total weight of the shipment.

The time period between mandatory reweighing of freight cars varies slightly by era. In the late steam era, which I model, cars (except tank and live poultry cars) had to be reweighed every 30 months. So, if your layout is set in October 1953, none of the cars should have a reweigh date older than April, 1951.

In addition, cars were required to be reweighed empty whenever they received repairs or alterations that might change the light weight, such as the replacement of a wheel set

or truck or replacement of K type air brakes with AB equipment.

Standard practice was to paint over the old data and stencil the new reweigh station symbol and date over it (and a new light weight and load limit, if those had changed) – unless, of course, the entire car needed to be repainted.

Each reweigh station had a code (there was some overlap, as I found with my WM model!) that ranged between one and four letters (most were two or three).

The Pennsylvania RR, ever the oddball “Standard Railroad of the World,” used the letter “P” with numbers as its reweigh station code. (For example, “P85” was the Wilmington (Delaware) Shops.

The railroad reporting marks, or initials, should not be confused with reweigh station codes. The reweigh station code “BO” does not indicate the car was weighed on the Baltimore & Ohio but instead indicates BOWest Yard in Connellsville, Penn., and “EL” is not “Erie Lackawanna” but East St. Louis, Illinois on the Baltimore & Ohio.

The main thing to remember is these are not as you may hear them (incorrectly) described, “repaint” dates. The railroad, for the most part doesn’t care when a car was painted or repainted.

Somewhere along the line model railroaders started thinking these reweigh dates indicated a month and year the car had been repainted, figuring it was one way to ensure a car was correct for their era. Although it’s possible that a car would be reweighed after it had been shopped (and cars often were reweighed when shopped, regardless of whether or not they were repainted, there is no connection between the reweigh date and the paint scheme on the car.

Because model railroad manufacturers typically use prototype photographs to letter cars, the reweigh date may read (for example) “4-55” when in fact the paint scheme would have been on the car 7, 10, or even more years prior to that date. ■







## Weathering

With the decal “detailing” complete, it’s time to add some signs of aging to the cars. I don’t claim to have invented any of the techniques I’m going to describe, and there are certainly other approaches. These simply produce predictable results that I’m happy with.

As roofs are often the first thing we see on a model railroad, it pays big dividends if we take the time to make roofs more realistic. Although steam era cars didn’t exhibit the extensive rusting and weathering seen on contemporary freight cars, the roofs were exposed to the elements, coated by steam locomotive soot, and in general took a beating.

I wanted to find an easy way to make the roofs look weathered.

I started by dabbing some gray paint (I used two colors of Vallejo acrylics, but any paint would work) on the roof (fig. 5 - see previous page). I’ve found by that the running boards not only highlights the individual boards but the finished model looks more like real wood (fig. 6).

Rather than finishing the roof weathering at this point, I add the rest of the weathering in one step. I use oil paints and odorless mineral spirits (the paint thinner shown here contains mineral spirits).



**FIGURE 7:** An assortment of inexpensive oil paints, some odorless mineral spirits, and a few brushes are the tools needed to add some weathering washes.

I purchased a reasonably priced starter set of artist’s oils at a local craft store for less than \$15 – you certainly don’t need high-quality paint for weathering. I also use an assortment of small brushes and, perhaps most important, a large flat brush. A small palette or other non-porous surface rounds out the tools and materials needed (fig. 7).

The idea is to duplicate the way rain would wash dirt from the roof of the car along the side. Because water follows the path of least resistance, it will have

a tendency to follow the weld (or rivet) lines down the car sides.

Start by placing a small dab of paint (in this case an unscientific mixture of Burnt Umber, Raw Sienna, and a dark red close to the color of the car) along the roofline above each weld line (fig. 8 - next page). Then dip that wide, flat brush in mineral spirits, wipe off most of the liquid until the brush is moist, but not “wet,” and starting at the top of the car drag the brush down the car side (fig. 9 - prior page).

*Continued on page 116 ...*



**FIGURE 6:** Here’s the WM roof after the gray paint dried. It doesn’t look all that great at this point, but we’ll blend it in shortly. Notice how some of the individual running boards have gotten a drybrush treatment.





FIGURE 8: Start by dabbing a small amount of oil paint (in this case a mix of Burnt Umber and Raw Sienna) to the top of each weld line along the roofline of the car.



FIGURE 10: The oil paint alone can look streaky and unrealistic. Bragdon weathering powders in assorted colors will blend the oil paint weathering and add some subtle highlights to the weathering.



FIGURE 9: Using a flat brush moistened in mineral spirits, carefully drag the brush vertically down the side of the car. Repeat as needed – rinsing the flat brush if too much paint remains on the side of the car.



FIGURE 11: Here's a closeup view of the roof of the W.M. car after the oil paint washes, followed by some blending with Bragdon powders, has been applied over the dabs of gray paint shown in Fig. 6.



The mineral spirits blend the paint. Repeat as needed, keeping in mind the paint will dry darker than it looks when wet. And, with most weathering, it's always easy to go back and add more color and more complicated to remove dried paint (although it can be done if you use enough mineral spirits and if you sprayed the car Dullcote prior to applying the oils).

Allow the oil paint to dry overnight. The result will often look like someone streaked paint down the sides of the car. The key is to blend the coloration.

For this I use Bragdon weathering powders. This is also an idea time to add some variation in color to the weathering.

I added some earth-toned powders to represent spray from the right-of-way

along the sills, some black to the roof, and some powders close to the body color to the sides. These blend the oils and fade individual body panels (fig. 10 - prior page).

A word of warning – it is really easy to overdo this step and end up with an over-weathered caricature. . So, take it slow and keep in mind that most freight cars in the steam era were not rolling rust buckets.

After I applied the oil paint wash and the various shades of weathering powders to the roof of the cars they looked much better than the splotchy gray blobs I started with (fig. 11 - prior page).

Finally, on a couple of cars I used a fine-tipped artist's pencil (fig. 12) to add custom chalk marks.



**FIGURE 12:** Although most of the chalk marks on these cars were done with decals, it's easy to add custom chalk marks with a sharp artist's pencil. Gray, white, or even a cream color, as shown here, are all good choices.



**FIGURE 13:** A quick overspray of Dullcote and one “rolling tree,” ready for service on the railroad. Someday this car will be replaced with a detailed resin model that exactly duplicates a WM prototype. In the meantime this car will blend nicely into the rest of the roster.

That's it, a couple of evenings of light modeling time and I had three more cars ready for revenue service. These are great projects for short modeling sessions during the week.

As I said, while these rolling trees are certainly not detailed prototype models, they are great fillers that won't detract from the rest of the fleet (fig. 13). Now, if you'll excuse me, I have about 40 more feeders to install. See you next time.

## TRIVIA TIME

**T**he reweigh dates on the three cars shown in this article are:



- CN “HQ 3-53”
- WM “LR 10-52”
- NP “HL 7-54”

Care to guess what prototype locations these represent?

**Click here for the answers ...**



**Article feedback!**

**CLICK HERE** for reader comments on this article ...





# COMME-N-TARY: Changing of the Guard

## Modeling in the hobby's most eNgaging scale

### About our N-scale columnist



**John Drye** has been model railroading since receiving the traditional Lionel set at age 8.

John is currently building two layouts: an N scale switching module based on the modern Norfolk Southern, and a basement layout based on the transition-era Pennsylvania Railroad.

When not doing trains, John works as a contractor for the US Navy and volunteers for the American Red Cross and Operation Lifesaver.

### Designing a layout for Bernard Kempinski's former basement ...

**W**here is Bernie? And who is that building a layout in his basement?

I'm sorry to be the one to tell you that Bernie Kempinski is no longer authoring this column. He has taken a government job that does not permit him to continue to provide his superb perspective on N scale model railroading in this forum.

I've known Bernie for years and understand as well as anyone that his shoes, even in N scale, will be difficult to fill. However, I am the current owner of his former basement and am in the process of building the third or fourth (we've lost count) N scale layout in that location. This does not count the many additional layouts we each have designed to fit in that space.

I hope to continue this column with perspectives on designing and building a layout room and layout from scratch, as I'm pretty much in the middle of that process right now.

When Bernie and his wife Alicia were looking to move to a larger house a few years ago, I jumped at the chance to acquire a great layout room with a "thick ceiling". The fact that the partially-completed layout then in the basement was modeled on the DRGW in Utah, and that I was going to build the PRR line from Harrisburg to Buffalo didn't matter.

Bernie and I had already built two smaller layouts together, along with a dozen or so NTRAK Modules of various sorts. It wouldn't be a problem for us to "move" the layout a thousand miles or so to the east. So, Bernie moved the DRGW to his new basement and the PRR took its place.

**"I am the current owner of [Bernie's] former basement and am ... building an N scale layout in that location."**

This layout used the existing benchwork and was basically a folded dogbone running from staging to PRR's yard at Williamsport, PA, passing through a few small towns along the way.

The objective was to operate locals out of the yard in each direction, with through trains feeding cars to the way freights. It was a pretty good plan and over the course of two years, along with a small group of friends, we got it up and running and began on scenery.

Then, disaster struck while I owned the house. A fire consumed much of the "thick ceiling" of the house and water and smoke damage destroyed the layout. Fortunately, no one was badly hurt although two firemen ended up

in the hospital with burns suffered fighting the fire.

Insurance eventually rebuilt the house and layout room and that's how I came to be building a layout in "Bernie's" basement.

I would be remiss if I didn't share a few of the lessons learned from the fire. First and foremost: make an inventory! There are lots of commercial products designed to do just that. Since

the layout was not yet fully operational, much of the rolling stock and most of the structures were still packed in large plastic storage containers, so escaped damage and were easy to count. Elsewhere in the house, that wasn't so easy. Take photos of everything (before the fire). This will make it easy to reconstruct what was there.

Show the photos and inventory to your insurance agent and find out exactly what is covered. You can obtain supplemental insurance from your agent or from the NMRA, if necessary.

It's easy to insist "it will never happen to me", and I sincerely hope it never will, but if it does, you'll be glad you were prepared. Finally, thank a firefighter. On the new layout, there will be at least one



firehouse as a reminder of their courage and commitment.

Post-fire refurbishment is not a recommended approach to a new layout room, but a complete rebuild does offer the opportunity to re-think pretty much everything about the room.

Here are a few ideas.

- **Lighting:** Track lighting or recessed ceiling lights are easy to install during (re)construction and flexible enough to accommodate an any layout design.
- **Floor:** there are lots of options for a soft tile floor that is easy to keep clean. Choosing a lighter color also brightens up the room and helps location of dropped tools and track nails...
- **Walls:** painting the whole wall a light sky blue looks pretty good on its own and blends well with a backdrop.
- **Electrical:** the electrical panel can be outside the layout room to avoid interference with track planning.
- **Utility Room:** installing a small stacked washer / dryer unit upstairs in the bedroom area might be popular with the rest of the family and opens up more layout space. If there are already electrical and plumbing connections in place, they can be left in case Bernie moves back .



**FIGURE 1: Nice new basement to fill full of layout!!**

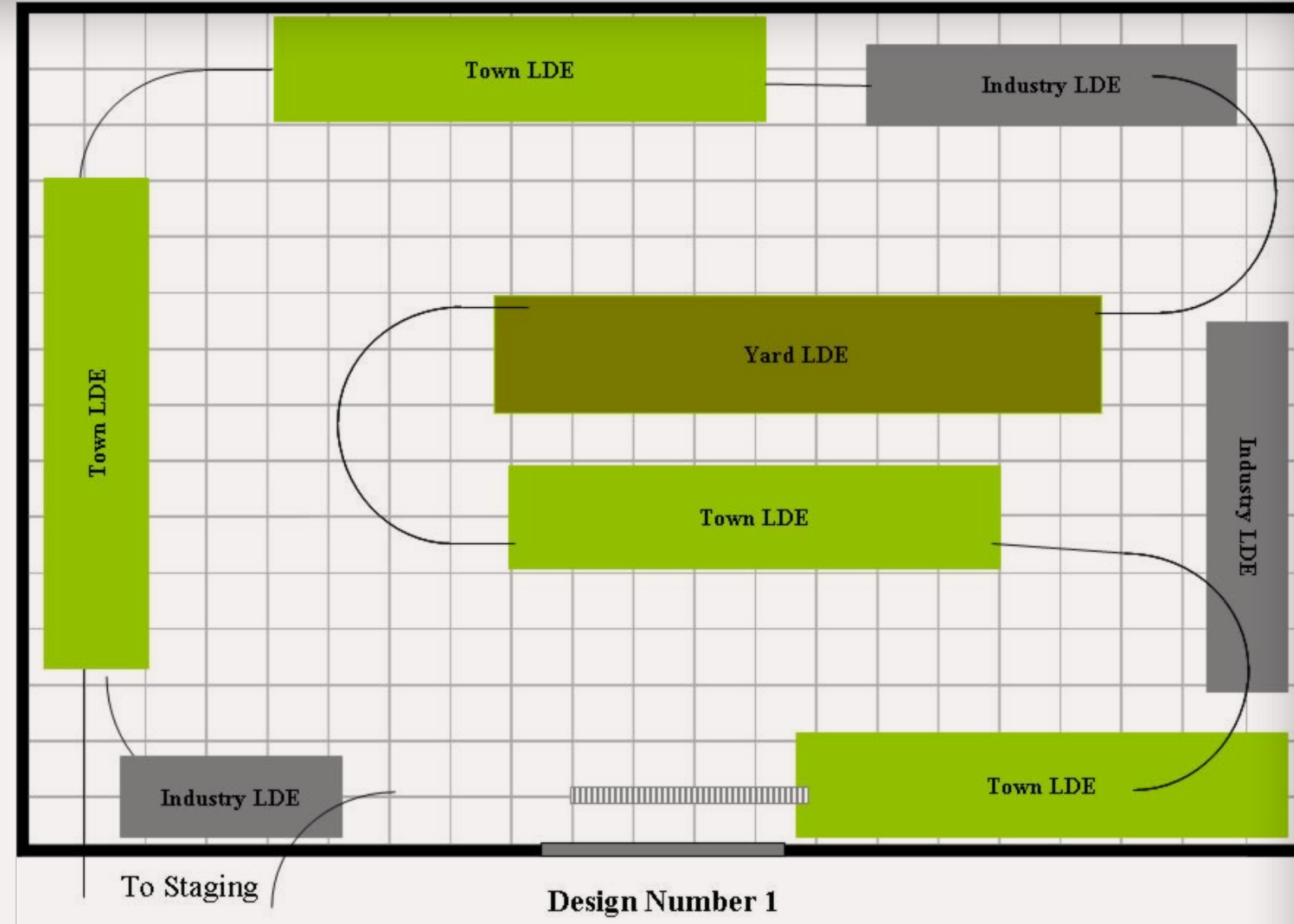

**FIGURE 2: Layout design #1.**

Waiting for the reconstruction to proceed allowed plenty of time to design the new layout. Even given the chance to start completely over, the era (1956) and railroad (PRR) would remain the same. Thanks to the storage boxes, most of the motive power and rolling stock were still around.

The layout concept would still be through trains feeding locals, and a new design would allow a “sincere” track plan. “Sincere” is a term coined by John Armstrong, the dean of track planners, to indicate a design where the main line runs through each scene only once.

Such a design would be a major improvement over the previous layout. The track plan would represent the

1956 PRR as closely as possible, but locations and trackage would be selectively compressed.

The process would use the Layout Design Element (LDE) concept where the major components of the layout (classification yard, major industries and towns) could be represented by appropriately-sized building blocks and placed in the layout area. Turnout-by-turnout design could come later.

The layout room is 15 x 21 feet, with a doorway halfway along one of the long walls. The utility room abuts that wall and provides a 10 x 20 area for staging. The main line will exit staging and run through the room, crossing the doorway



on a lift bridge before returning to staging.

The continuous run design allows immediate re-staging of the open-top hoppers that are a staple of the 1956-era Pennsylvania Railroad. No. 7 turnouts, code 55 track with 24" radius curves would permit smooth, great-looking operations.

Several designs were considered and compared – lots more than the four shown here. But these designs provide a good basis for comparison.

Design #1 (previous page) uses a long peninsula down the center of the room

and #2 uses shorter peninsulas abutting from adjacent walls. Each provides for the required classification yard and seven separate locations (town or industries) for local switching. Design #2 is “curvier,” better representing the PRR flowing through the mountains of central Pennsylvania. There’s no one spot where the entire layout would be visible, helping the layout seem larger.

Placing the yard in the middle of the main line run allows locals to operate in both directions, providing job opportunities for two crews. An alternative would be to place the yard along

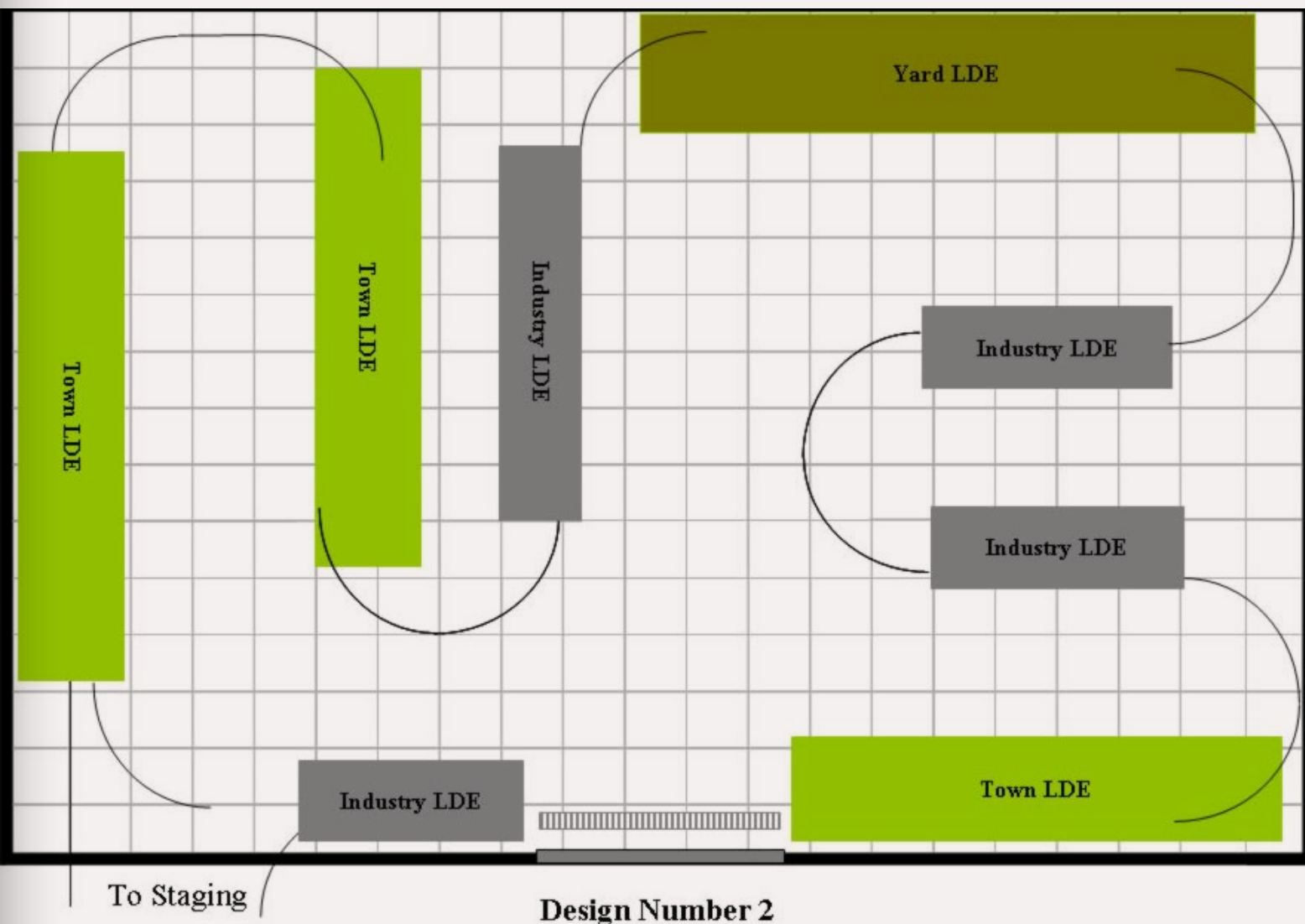

**FIGURE 3: Layout design #2.**

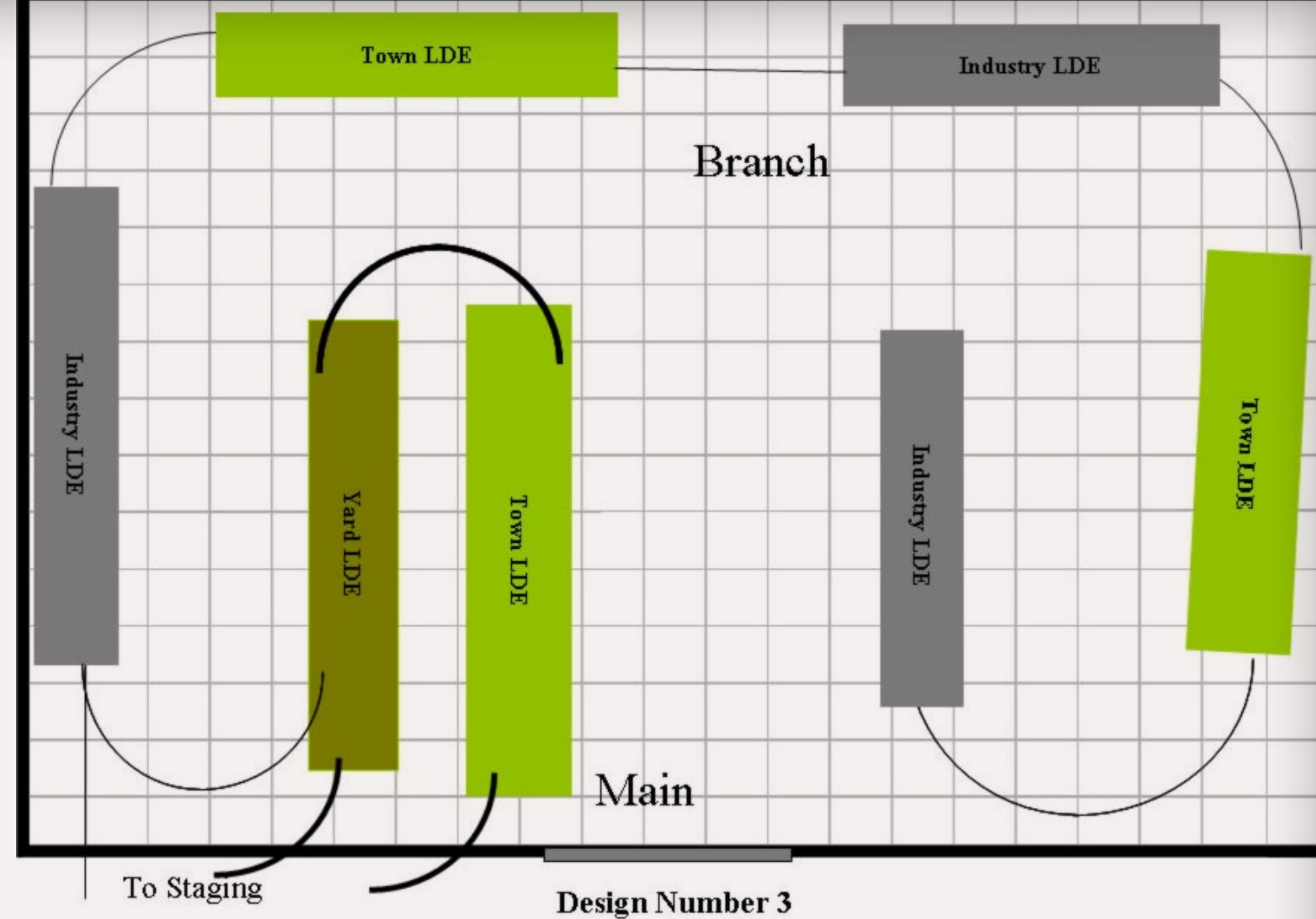

**FIGURE 4: Layout design #3.**

the left wall and have all locals travel “south”, but have a longer run.

Design #3 shows a slightly different approach. The main line circles only one peninsula before returning to staging. The rest of the layout represents a branch line which circles the room and deadends. This design avoids the duck-under but does not allow immediate re-staging of open topped hoppers. It does provide a long run for the local with lots of pickups and setouts.

Any one of the industries in each of these designs could be large enough to justify a dedicated train. Central Pennsylvania includes steel, paper, coal and other potential industrial opportunities.

The final design is a variation of #2, with both peninsulas extending from the long walls. This design is still “curvier” and breaks up the room even further. It turned out to be the winner.

At this stage, more detailed designs for each of the LDEs can begin. Since the PRR interchanged with a number of other railroads in this area, at least one of the LDEs would include an interchange. Another would include a major industry.

Linden, Indiana is certainly not in central Pa nor on the PRR. However, the trackplan and interchange between the Nickel Plate and Monon has been well described in the Model Railroad-ing press. With a few modifications,



and changing the station signs, it would fit perfectly.

Winchester, VA is located on the PRR, and the Reid Brothers included it on their great N Scale PRR Cumberland Valley RR. As it turns out, the track plan is based on an NTRAK module and not particularly faithful to the prototype, but it looks great and has good operating potential, so borrowing that plan would work, too.

Finally, Milton PA, is indeed on the PRR in PA, and located on this particular line. A plant visit confirmed the idea of RR tank car construction as a great heavy industry for the layout.

In the 50s, ACF turned out hundreds of tank cars a year, providing a unique “loads in-cars out” industrial location.

By the time the house was ready to re-occupy, planning was finished and layout construction began. As it turned out, the actual layout isn't going to be even close to any of these designs, but that's another story for a future column.

 **Article feedback!**  
[CLICK HERE](#) for reader comments on this article ... 

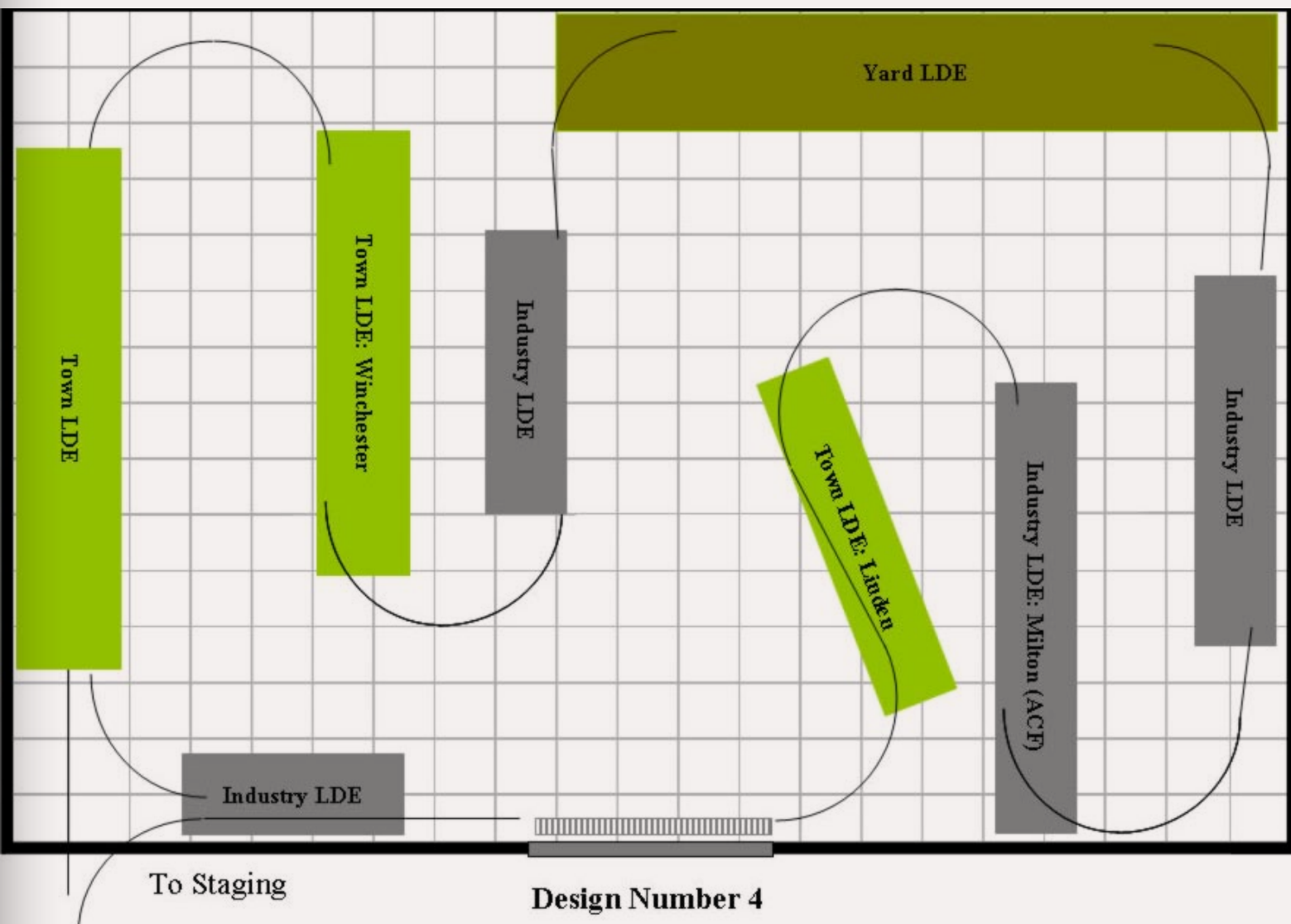

**FIGURE 5: Layout design #4.**



**FIGURE 6: Layout as of February of 2009.**



**FIGURE 7: Layout as of March of 2009.**



# Layout Design Elements: LDEs – A Prototypical Approach to Layout Design

The details of each layout town, junction or industry support enjoyable operations if they do a good job of representing the prototype. If the track arrangement works (or worked) for the prototype, it should work for the layout.

This is the logic behind Layout Design Elements (LDEs), a concept coined and described by Tony Koester. Track layout is easy to find for prototypes based

on today's railroading. Google Earth™ is a great tool to find current track arrangements.

Earlier arrangements were well documented by the railroads and can be found at Railroadiana shows and on line.

*Sidebar continues on the next page ...*

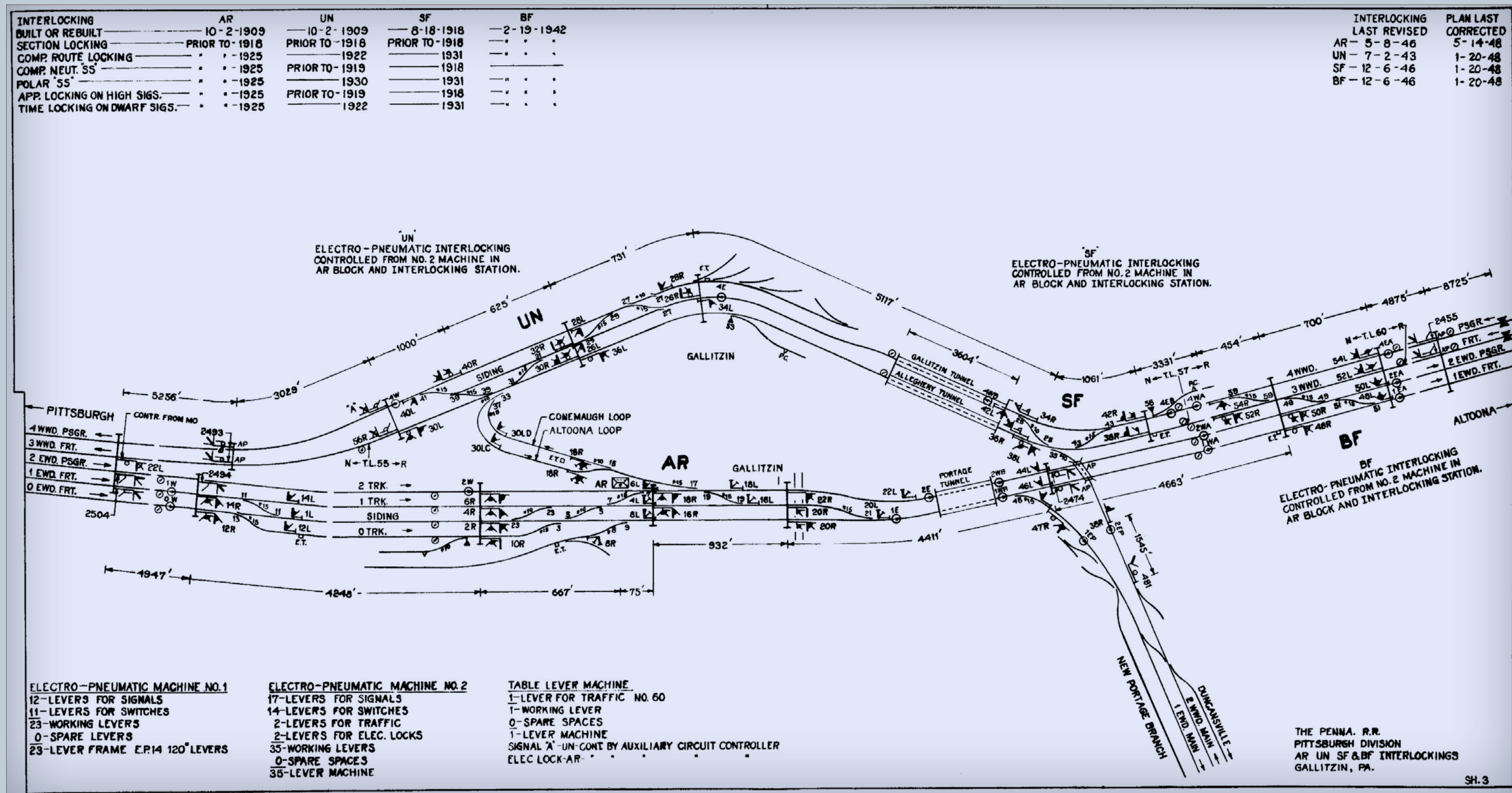

FIGURE 8: PRR Track Arrangement at Gallitzin, PA—ca. 1945.



## Layout Design Elements: LDEs – A Prototypical Approach to Layout Design . . . continued

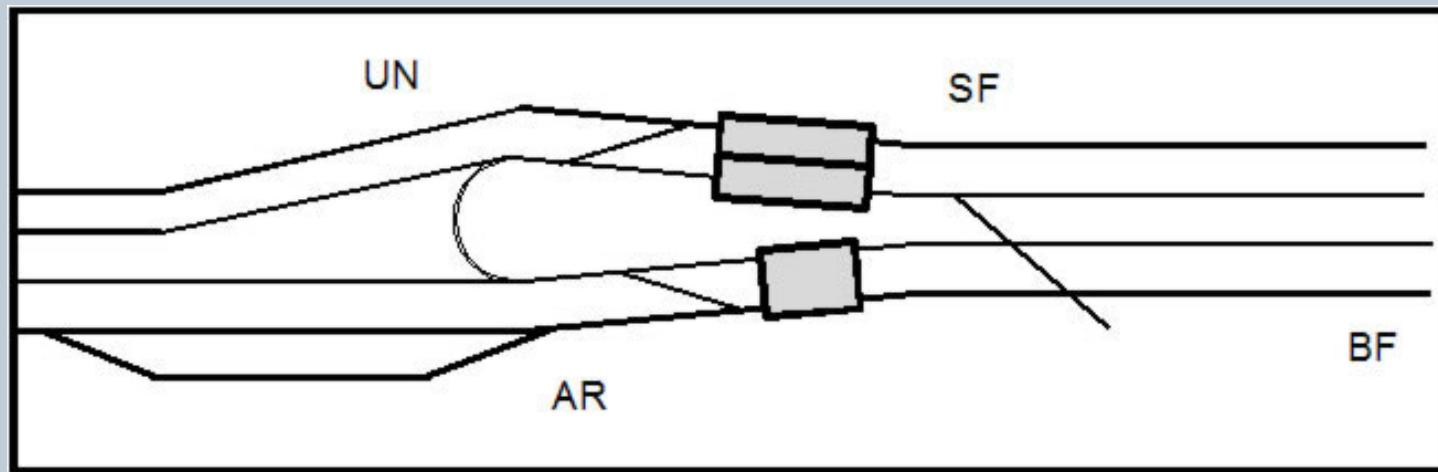

FIGURE 9: Simplified Gallitzin trackage.

The prototype arrangement is often way too large to fit even the largest layout. PRR's Gallitzin trackage, located at the summit of the railroad's four-track mainline west of Altoona and Horseshoe Curve, would cover more than 100 feet if modeled to scale in N.

The key to creating successful LDEs is to retain sufficient elements to allow prototype operations. This usually begins with deleting parallel tracks which reduces capacity but permits the full spectrum of operations.

The key elements at Gallitzin are the four mainlines tunneling through the top of the Alleghenies and the loop between AR and UN (the towers that controlled operations here) which permitted helpers to return down the hill. Crossovers between the four tracks permitted trains and helpers to efficiently move up and down grade.

This simplified arrangement could be modeled in 15-20 feet in N and still allow helpers to assist trains uphill, cut off at UN and return downhill. The number of tracks and crossovers has been reduced, but prototype operations can still be represented in a selectively compressed way with the shorter trains we typically run on a layout.

Trying to run 100+ trains a day through my compressed version of the Gallitzin trackage, however, might be a bit much! ■

Also check out our monthly newsletter ...

The screenshot displays the Model Railroad Hobbyist newsletter website for December 2008. The main header reads "Model Railroad Hobbyist newsletter™ December 2008". Below the header, there are several featured articles and advertisements:

- The Old Yardmaster:** An article about a narrow gauge car, mentioning Blackstone's new HO N3 D&RGW High Side Gondola.
- News and views from up and down the line...:** A section with text about factory representatives from Kadee and Blackstone Models, discussing new truck designs and reservations for narrow gauge cars.
- Free Shipping! on all US\* orders the month of December:** A promotional banner for a 50% off shipping offer on overseas orders.
- Subscribe to our NEW free mediaZine:** An advertisement for a new free mediaZine, featuring a stack of magazines and the text "It's completely free!".
- Pre-production sample of Division Point's O scale Class U-2E 4-8-4 Northern:** A photograph of a model locomotive with the text "Northern is decorated as Canadian National number 6167."
- An N scale version of this HO GE 8-40 CW locomotive is scheduled for release from Atlas next year.** A photograph of a blue and white locomotive.
- Model Railroad Hobbyist: lean, mean, and green:** A small advertisement for the magazine.

At the bottom of the page, there are navigation buttons for "N", "HO", and "O" scales, and a "Page 1" indicator.

- Product announcements
- Important hobby event announcements
- MRH Sponsor spotlight
- Next magazine issue sneak peeks

## Model Railroad Hobbyist newsletter

The planet's most popular model railroading news mediaZine!

[Click here](#) to download a recent newsletter.

MRH subscribers get notified by email when the next newsletter is available.



# PARALLEL LINES: Building a Stub Turnout

## Pursuing more reliable and better-looking trackwork

About our track modeling columnist



Tim Warris is a long time model railroader and co-founder of Fast Tracks, a trackwork fixtures company. Tim first developed his track assembly fixtures out of a desire to find a better way to hand-build reliable turnouts and crossings.

Since March of 2007, Tim has been constructing the 1930's CNJ Bronx Terminal in both HO and N scale.

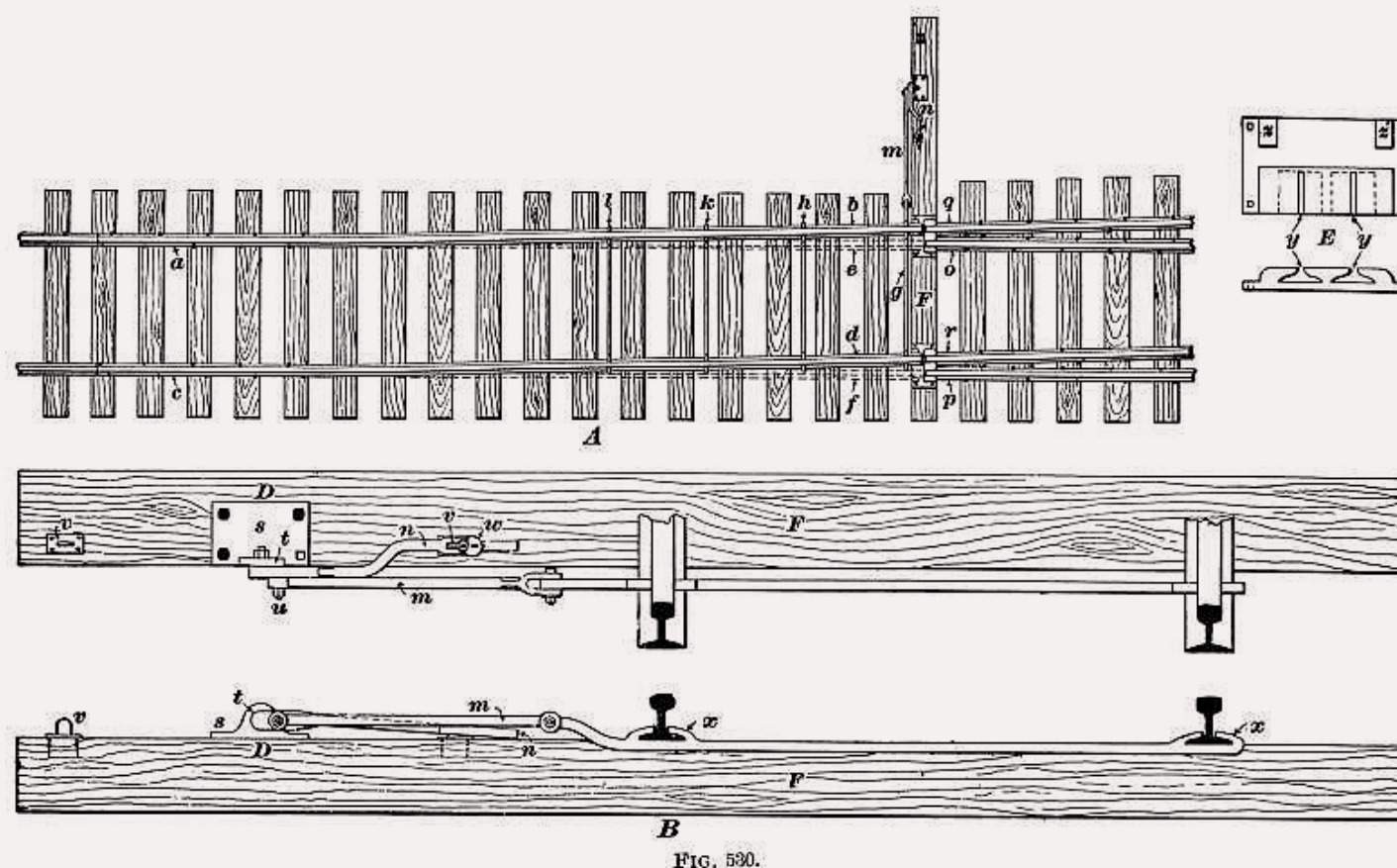

FIGURE 1: Original patent drawing of a typical stub switch. Notice the detail view showing the casting used to align all the rails.

Weekly, almost like clockwork, I get an email from a modeler asking if I can provide instructions on how to build a stub turnout. I have my standard paragraph long response describing in general how to go about it, but every time I send out a reply I mumble to myself that I really need to write a proper document with detailed, step-by-step instructions.

So after sending out probably my nine hundredth reply the other day, I thought that it's about time I stop procrastinating and do it!

Stub Turnouts, or the more generic term, "Stub Switches", are the precursor to today's modern turnouts. Stub turnouts are different from modern turnouts in that there were no moving switch points. Instead, brakeman would use a manually operated switch stand and some real muscle to physically "warp" the rail leading into the turnout.

Stub switches were much easier for the railroads of the day to build, but

had a number of major drawbacks. They were very rough to travel over. The hard banging of wheels onto the ends of the rails caused damage and the rail had to be frequently repaired. And trains could only operate at low speed through the turnout as it was a bone-jarring bump from one route to another.

Around the turn of the century most stub switches were replaced with their modern moveable switch point counterpart, eliminating all of the problems associated with stub switches. However backwoods logging and coal operations continued to use stubs long after other types of operations dropped them, some are even still in use today!

Building a model of a stub switch is completed in two parts. Part one is to build or prepare the upper portion of the turnout. In this article I am building an HO, #6, code 70, stub turnout using a Fast Tracks fixture and QuickSticks laser cut wood ties.

**"Stub turnouts are different from modern turnouts in that there were no moving switch points. ..."**

If you prefer, you can use the turnout construction method of your choice, or you can even use a ready-to-run commercial turnout. Just cut the bottom of



the turnout off at the location shown in these instructions.

The second part is building a movable bridle - the part of the turnout that actually moved back and forth to select the route.

What makes stub turnouts a bit more difficult to construct is the need for a mechanical stop. Unlike a turnout with switch points, stub switches have to have something to physically stop the movement of the bridle when it is in position.

The prototype used a cast part to hold the closure rails in place, and cast into this part are stops. Unfortunately nothing like this exists for our models, so I will describe a simple but effective method for building stops.

**“What makes stub turnouts a bit more difficult to construct is the need for a mechanical stop. ...”**

Prototype stub switch bridles also have a series of bars fastened to the rails to hold them in place so they can be switched as a single unit. For our model we will be using a single PC Board



FIGURE 2: Stub switches, once common at the turn of the century, are now relegated to museums and tourist railroads.



FIGURE 3: Instead of moveable switchpoints, stub switches have a “bridle” section leading into the switch. This section of track is literally bent into position to line up the rails with the switch. Shown above, the straight route is selected.



FIGURE 4: To switch routes, the rails of the bridle are slid into position to match the route on the turnout. The curved route has been selected here.



tie with rail joiners soldered onto it to allow the rails to properly slide back and forth.

This is a compromise that has to be made as there is no material that I am aware of that could be used to model the bars accurately and still have the necessary strength to keep the rails aligned and electrically isolated from each other. One of these ties will be extended out to the side of the turnout to allow it to be reliably

connected to either a switch machine or a ground throw.

A prototype stub turnout typically has only a single head tie (the long ties

**“The slideshow includes more than 45 images and text that explains how to build a reliable stub turnout. ...”**

where the switch stand is held), so our model will also use a single head tie.

The still image slides how on the next page includes more than 45 images

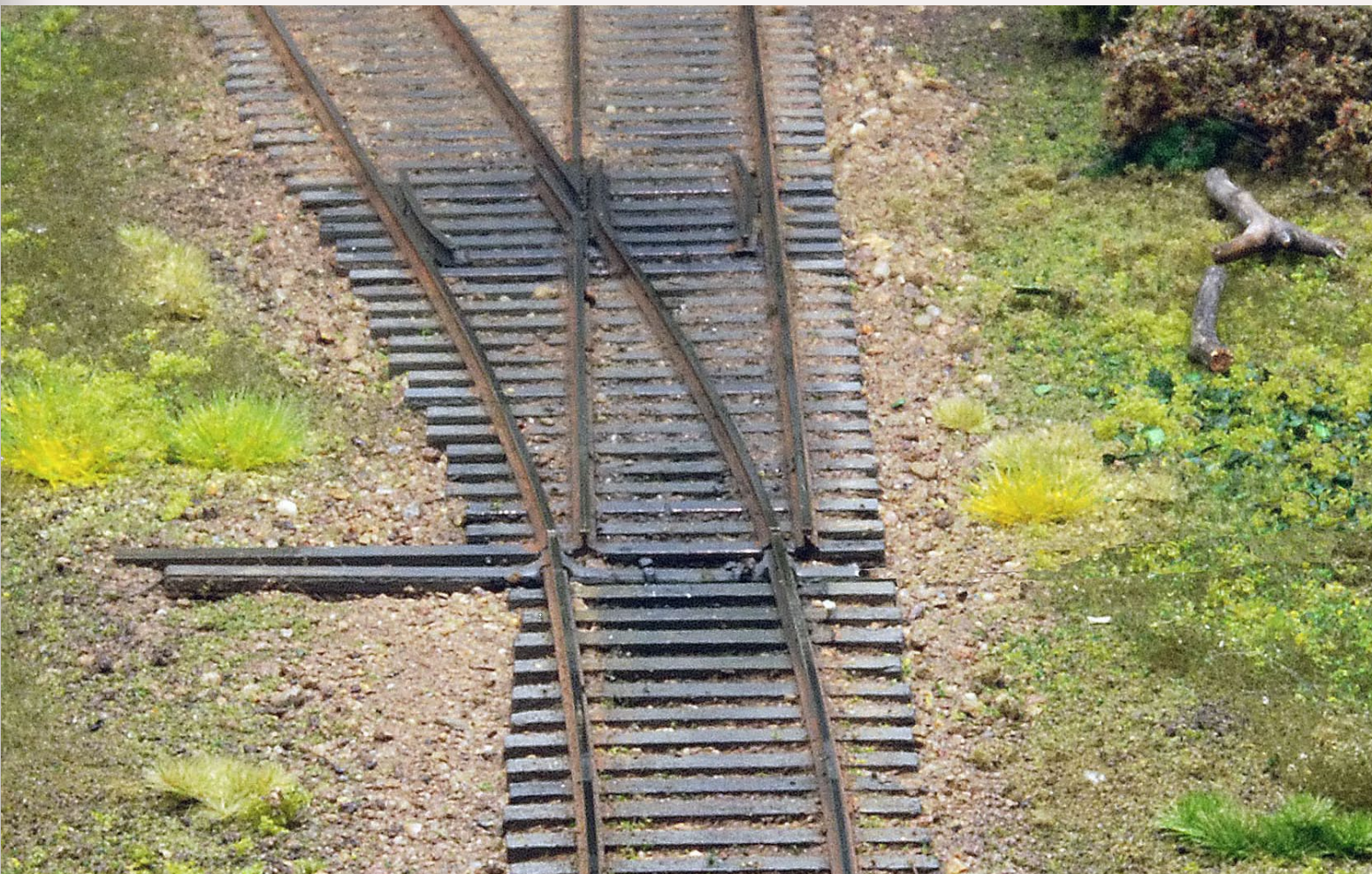

**FIGURE 5:** The bridle portion of a stub switch acts as a spiral easement into the curve of the diverging route by providing a larger radius at the start of the arc, and spirally getting sharper as it enters the frog of the switch.



**FIGURE 6:** The “switch” portion of a stub switch is the same as a modern turnout, missing are the moveable switchpoints, instead a moveable bridle was used.



**FIGURE 7:** Alignment between the bridle rails and the rest of the turnout is critical in a stub switch. The prototype used a cast metal bracket to hold the ends of the rail of the turnout in correct gauge, and cast into this was a stop that would align the moveable rail of the bridle. For our models a different approach is needed, which the author covers in this article.





**FIGURE 8:** ▲ Completed stub turnout, painted, ballasted and scenicked in place.

**FIGURE 9:** Click through this still ► image slide show to see all the steps needed build one of the author's great-looking stub turnouts!

and text that explains in detail how to build a reliable stub turnout.

I recommend going through the slides several times to get a good idea of the process before you start construction.

Some steps may seem a bit confusing at first, but when you have reviewed the entire process, it should all make sense.



**Article feedback!**

CLICK HERE for reader comments on this article ...



Advertisement

Put over 30,000 model railroaders **one click away** from your web site with your ad here! (For as little as \$206)

Click to learn more ...



( 1/3 page horizontal )



## About our new media modeling columnist



Ryan Andersen is a relative newcomer to model railroading, but he's anything but a newcomer to modern new-media technology. In October 2007, Ryan started the Model Railcast Show, a weekly model railroad-focused podcast available from iTunes.

Ryan built his first 8 by 5 HO layout in 2007 and still uses this layout for improving his modeling skills and techniques. Ryan is planning his next railroad to be set in the late 1800's.

# NEW MEDIA MODELER: Online goodies galore! Model Railroading in the Internet Age

In this age of the Internet, things seem to change faster than ever before ...

Nothing like getting something wrong in your first article; well kind'a wrong. I mentioned Leo Bicknell's show, Reality Reduced, but by the time the first issue of Model Railroad Hobbyist hit the "stands" Leo had decided to fold up shop.

In this age of the Internet things seems to change faster than ever before. However, never fear, I am here to keep you posted on the ever-changing Internet and new media as it relates to our favorite hobby. So, in this issue let's discuss a groundbreaking new show for Model Railroad podcasting.

## The Scotty Mason Show

In the last issue I talked about podcasts and mention my show and Leo's show, but only briefly mentioned Scotty Mason's show.

However, I would be remiss if I did not give Scotty's show the attention it deserves. If it were not for Scotty's Show, I may not have started the Model Railcast Show. If you have not heard of the Scotty Mason Show, then head on over to [www.ModelRailRoadPodcast.com](http://www.ModelRailRoadPodcast.com) and check it out.

Scott Mason, a master at building craftsman kits, hosts his show along with the very well known master modeler and author, Mr. Scenery ([www.MrScenery.com](http://www.MrScenery.com)) himself,

Dave Frary, and Doug Foscale (yes, of Foscale limited [[www.foslimited.com](http://www.foslimited.com)]), and Jimmy Deignan (of [www.craftsmankits.com](http://www.craftsmankits.com)).

The screenshot shows the Scotty Mason website with the following elements:

- Header:** WELCOME TO MODEL RAILROADS BY SCOTT MASON. HOME OF THE BUILDING CRAFTSMAN STRUCTURE KITS DVD SERIES. [www.scottymason.com](http://www.scottymason.com)
- DVD's Section:** A grid of DVD covers including:
  - PAINTING FIGURES - DAVE REVELIA
  - Painting and Weathering Detail Castings - With Dave Revelia
  - Building Craftsman Structure Kits Volume 4 - Scotty Masoning Techniques - With Brian Nolan
  - Dick Elwell's Hoosac Valley Lines - ON SALE NOW \$29.95
  - Weathering Freight Cars Volume Two - With Scott Mason
  - Weathering Freight Cars Volume One - With Scott Mason
  - Building Craftsman Structure Kits Volume Three - Screen Technique for Building Structure Kits - With Steven Gaudet and Rob Van Gelder
  - Building Craftsman Structure Kits Volume 2 - With Scott Mason
  - Building Craftsman Structure Kits - With Scott Mason
- Featured Product:** Jordan Highway Miniatures Erie B-2 Steam Shovel. NEW! by Karl Osolinski.
- Navigation:** EXPLORE ScottyMason.com, Sold Exclusively by ScottyMason.com, The Store / Shopping Cart.
- Footer:** The Scotty Mason Blog: Follow along as Scott chronicles 2008/2009 as a professional model builder. Leave your comment on his rantings!

FIGURE 1: Scotty Mason's Web site lists a nice collection of videos, with the emphasis being craftsman kits and detailed rolling stock. Scotty's site also lists his podcasts, which are well worth downloading and listening to.



I found the Scotty Mason show very soon after getting my iPhone.

As one who spends nearly 2 hours a day in his car commuting, podcasts are an awesome resource and alternative to radio, CDs or satellite radio. Now being the Internet and media junkie that I am, I have at least 20 different podcasts I listen to every week. Most of them are technology related, like: This Week in Tech, Buzz Out Loud and Mac Break Weekly to name a few.

When I started listening to Scott's show in the summer of 2007, it focused mainly on craftsman kits. I quickly became a fan of craftsman kits and started building them after listening to his show. Scott and gang do a great job of explaining the techniques from the basics to the advanced.

Dave Frary usually chimes in with great scenery tips, (don't take notes while driving). Better still, save yourself the trouble and buy one of his many creative scenery books.

Doug Foscale offers a great inside view of craftsman kits and as a craftsman kit manufacturer he offers an insight into what it takes to design, create and build (and market) a craftsman kit from scratch.

Jimmy, like me, seems to be an Internet junkie. From what I understand

he has created most of the awesome websites for each of the above mentioned hosts.

Jimmy seems to do most of the brute-force work required to produce and run a podcast show. He also has his own website selling hard-to-find craftsman kits.

Not only does Scott and his gang produce videos on DVD, available from his website, but they also create, host and manage a yearly craftsman structure

**“At the time I started listening to Scott's show, it focused mainly on craftsman kits. I quickly became a fan of craftsman kits and started building them ...”**

show. With all the things these guys have going on and all the wonderful information, support and content that they offer to our hobby it's no wonder the show is monthly as opposed to weekly. :o)

There are two ways to hear Scott Mason: download his show from his website or download Model Railcast Show #53 and check out my two-hour interview with Scott.

**FIGURE 2: Craig Bisgeier's Housatonic Railroad web site displays a very well-thought-out example of 1890s model railroading, covering everything from benchwork to operation. Many of the ideas presented apply to any era of modeling and are well worth a look.**

## **The Housatonic Railroad Company**

Craig Bisgeier's [www.Housatonicrr.com](http://www.Housatonicrr.com) is a wealth of information. Just his construction and operating journals are enough to keep you busy for weeks. Craig and his team of model railroading enthusiasts have built a beautiful railroad, and as they built it, they documented their progress in great detail.

The Housatonic site has everything from benchwork to operations, from wiring fuses to the 10 commandments of yard design, plus reviews of products and DVDs. If you have questions, Craig's website most likely has an answer for you.

**“The Housatonic site has everything from benchwork to operations. From how to install and wire fuses to the 10 commandments of yard design ...”**



**FIGURE 3: Clover house sells a host of useful model railroading products, including detail parts, dry transfer lettering, printed circuit ties, and sheet metal.**

Do yourself a favor and check out Craig's site. He is also a frequent guest on the Model Railcast show.

I understand that the owners are selling Clover House, so if you happen to be looking for a model railroading business, check out the site for more details.

## Clover House

I would also like to mention Clover House ([www.CloverHouse.com](http://www.CloverHouse.com)). Clover House sells model railroading supplies, including hard-to-find dry transfer lettering and printed circuit board ties.

Until next time guys, tune in to the Model Railcast Show for more Model Railroad-related links. 

**“I would also like to mention Clover House. Clover House sells model railroading supplies, including the hard-to-find dry transfer lettering...”**

They don't sell over the internet, but you can fax an order to: 707-823-7301.

 **Article feedback!**  
 CLICK HERE for reader comments on this article ... 

Advertiser Index	Page
<a href="#">BLMA</a> .....	2
<a href="#">Canyon Creek Scenics</a> .....	51
<a href="#">Central Valley</a> .....	42
<a href="#">CF Shops</a> .....	38
<a href="#">Dallas Model Works</a> .....	3
<a href="#">Division Point</a> .....	14
<a href="#">Fast Tracks</a> .....	4
<a href="#">Layout Vision</a> .....	7
<a href="#">Litchfield Station</a> .....	25
<a href="#">Model Railcast Show</a> .....	109
<a href="#">Model Railroad Hobbyist (1)</a> .....	21
<a href="#">Model Railroad Hobbyist (2)</a> .....	122
<a href="#">Model Railroad Tips</a> .....	16
<a href="#">Model Trains Video</a> .....	131
<a href="#">Model Trains Weathered</a> .....	41
<a href="#">MRH Reader Survey</a> .....	13
<a href="#">New York Railway Supply</a> .....	33
<a href="#">Pacific Vista Publishing</a> .....	34
<a href="#">Pulsar Professional FX</a> .....	8
<a href="#">QSI Solutions (Tony's Trains)</a> .....	10
<a href="#">Rapido Trains</a> .....	9
<a href="#">ShelfTrax</a> .....	47
<a href="#">UPBids.net (1)</a> .....	13
<a href="#">UPBids.net (2)</a> .....	20
<a href="#">Vernonia Northern</a> .....	16



# REVERSE RUNNING: Model Railroading and the Economy

Stepping outside the box with a contrary view



— by Jason Shron ([Rapido Trains, Inc.](#))

As we all know, the global economy is in the toilet. We've been bombarded for months about how bad it is, but there has been little mention of model railroading.

I'm going to break all the rules of marketing and be totally straight. I know some of you have been hit pretty hard by this recession, and I hope that my words don't strike a raw nerve. If they do, please accept my apologies in advance.

In reality, the economy affects our hobby as well. Many manufacturers, distributors and retailers are having trouble selling inventory.

By inventory, I don't mean the new stuff that comes in and goes out the door right away. I mean the stuff that

is currently on the shelves and that nobody is buying.

Too much inventory can have a detrimental effect on cash flow. A company can be profitable on paper, but without a steady cash flow, it can't operate. So it's tough right now for a good chunk of our industry.

**Is it all doom and gloom?** Actually, no. Several hobby shops are starting to report an increase in sales over last year: just a few for now, but I'm willing to bet that number will increase. And this is the wonderful thing about hobbies.

When the economy slows down, people look inward – and hobbies such as model railroading are an “inward” activity. They are a relatively inexpensive way to spend the evening, to escape the rough week at the office and take comfort in a productive and rewarding activity.

That \$250 locomotive will last a lifetime but that \$3000 trip to the tropics will only last a week. A close friend and I were talking about this the other day. He pointed out that dinner and a movie can cost what - \$60 or more? That's the price of a kit that can keep you busy for a week or two and will last forever on your layout.

As more people realize this, the model railroading business will pick up. I'm confident that it will. In the meantime, what can we do?

If your budget will allow it, you can help out by taking advantage of the incredible sales being offered right now. You can find some great deals on products from just about every manufacturer, and by picking up some bargains on older merchandise, you give your local hobby shop the resources to keep bringing in the new stuff.

Even if your model railroading budget has been hit hard or depleted completely by this recession, there are still things you can do to help keep your favorite hobby alive for yourself and for others.

The first and most obvious thing is to *get working* on your layout. If you are like me, you have dozens of unopened cars and locos in your basement or workshop. Get them opened, prepped and detailed. Maybe do some weathering.

Build some of those kits, or trade some of them with your modelling buddies for something that *will* keep you focused and busy.

I know it's a cliché, but spreading the word about model railroading *does make a difference*. Host a layout open house. Build a small diorama and leave it on your desk at the office. Let your friends, family and colleagues know your hobby brings you relief from these tough times, and maybe you can bring others into this fine pastime.

These are just my thoughts on this issue which is affecting all of us – they don't necessarily reflect the views of other manufacturers or other people in the industry.

If we all stick together and remember why we got into model railroading in the first place, our hobby will come through this recession *stronger than ever*. ☑



**Article feedback!**

[CLICK HERE](#) for reader comments on this article ...



## Reverse Running?



Reverse running is a term applied to railroad double track mainlines. Most double track main lines in the US have a “keep to the right” rule for the double track main, and if a train is running on the left hand track, it's on the “wrong track” and is “reverse running.”

*Reverse Running* is our regular column where we encourage something of a contrary view to the hobby, with the intention of learning some new insights from stepping outside the box. We invite other modelers to submit a thought-provoking piece for Reverse Running. — J.F.



# model-trains-video.com

*Get your LIVE op session videos here ...*

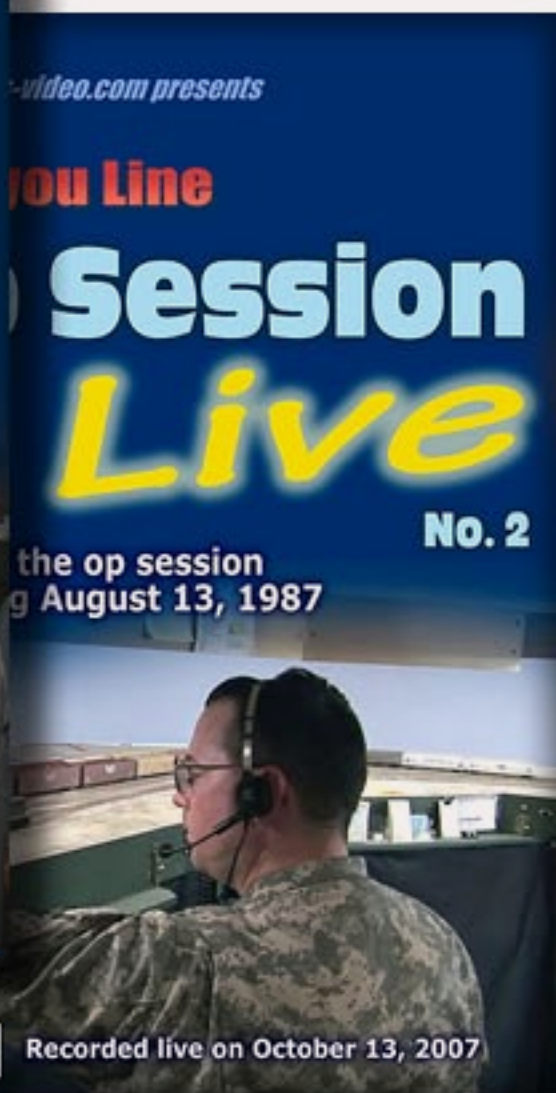

**Joe Fugate's  
1980's Siskiyou Line**

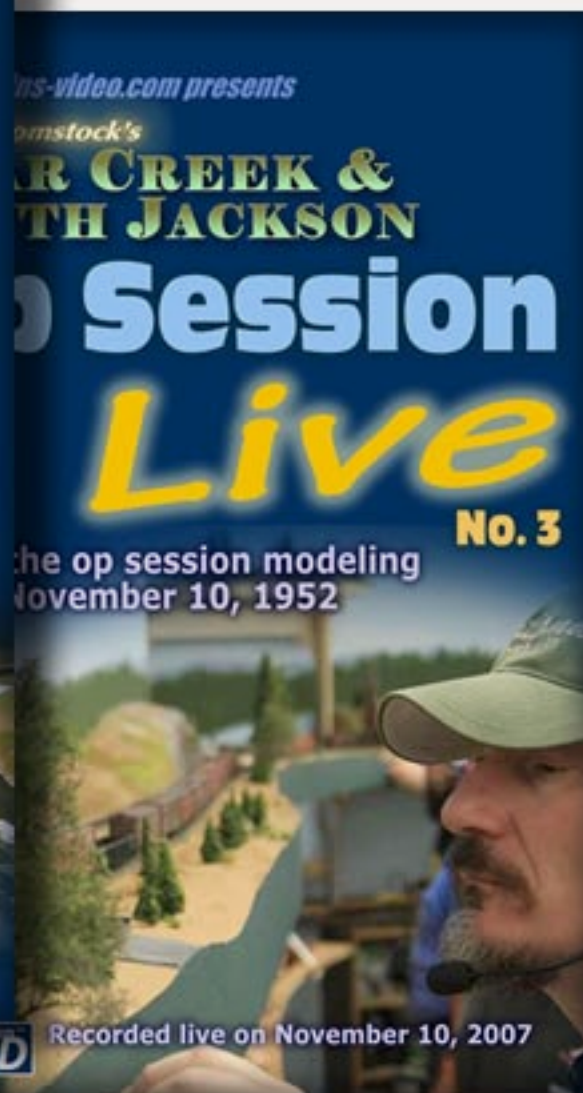

**Charlie Comstock's  
1950's BEAR CREEK &  
SOUTH JACKSON**

**\$40 TAKES ALL FOUR! Free shipping!**  
Preorder today and ships in May when No.4 is released

*click here*  
**LEARN  
MORE**





# DASHBOARD

[Clickable ISSUE INDEX](#)

[DCC - Getting started in DCC](#)

[Editorial - Publisher's Editorial](#)

[Editorial - Reverse Running](#)

[N Scale - Comme-N-tary](#)

[Narrow Gage - The Lite and Narrow](#)

[News - April Newsletter](#)

[News - New Media Modeler](#)

[Layouts - Build your own manual throws](#)

[Layouts - Parallel Lines](#)

[Layouts - Track planning with 3rd PlanIt](#)

[Layouts - Up the Creek](#)

[Rolling stock - Conrail caboose](#)

[Rolling stock - Getting Real](#)

[Rolling stock - Panel side hoppers](#)

[Trackplan - Best of the West](#)

---

[Other - Advertiser's index](#)

[Other - Back page](#)

[Other - Cover](#)

[Other - Table of Contents](#)

## SPONSORING ADVERTISERS



[click to learn more about this sponsor](#)

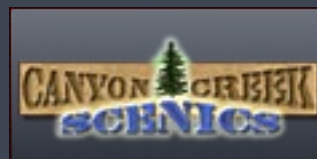

[click to learn more about this sponsor](#)



[click to learn more about this sponsor](#)



[click to learn more about this sponsor](#)



[click to learn more about this sponsor](#)



[click to learn more about this sponsor](#)



[click to learn more about this sponsor](#)



[click to learn more about this sponsor](#)



[click to learn more about this sponsor](#)



[click to learn more about this sponsor](#)

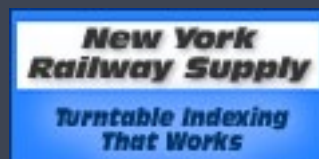

[click to learn more about this sponsor](#)

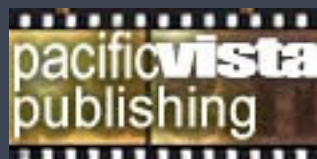

[click to learn more about this sponsor](#)



[click to learn more about this sponsor](#)



[click to learn more about this sponsor](#)



[click to learn more about this sponsor](#)



[click to learn more about this sponsor](#)

### Answers:

CN HQ 3-53: Point St. Charles, Quebec

NP HL 7-54: Helena, Montana

WM LR 10-52: This is a tricky one as "LR" was used for both Lariviere, MB on the Canadian Pacific and Laurel Shops, Minnesota on the Northern Pacific. I'm going with Laurel Shops in this case!

[CLICK HERE TO RETURN TO ARTICLE](#)