

Model Railroad Hobbyist magazine™

Price:
Forever Free

STANDARD
Edition

The model-trains-video.com mediaZine

May/June 2010

Modeling the Modern Era

by Lance Mindheim

Diesel Detailing
for Beginners!

LED lighting for
structures

My Modular Adventure -
Run around track and turnouts

Jim Dias'
Western Pacific

And much more ... *inside!*





Front Cover: A B23-7 switching some industries on a branchline in Florida on Lance Mindheims HO scale CSX layout. Lance makes the case for modeling a modern time-frame with his highly detailed models and scenery.

ISSN 2152-7423

Editorial Staff

Joe D. Fugate, Publisher
Charlie Comstock, Layouts and media editor

Columnists

Ryan Andersen, New media
Richard Bale, News and events
John Drye, N scale
Lew Matt, Narrow gauge and shortlines
Marty McGuirk, Prototype modeling
Les Halmos, Modular railroading
Tim Warris, Trackwork

Special Correspondents

Jim Duncan, Layouts and operations
Byron Henderson, Layouts and track planning

Production

Patty Fugate, pasteup and layout
Joe Brugger, copy editing
Mike Dodd, copy editing

Technical Assistant

Jeff Shultz

Advertising Account Manager

Les Halmos



Click to learn more about this sponsor



Click to learn more about this sponsor



Click to learn more about this sponsor



Click to learn more about this sponsor



Click to learn more about this sponsor



Click to learn more about this sponsor



Click to learn more about this sponsor



Click to learn more about this sponsor



Click to learn more about this sponsor



Click to learn more about this sponsor



Click to learn more about this sponsor



Click to learn more about this sponsor



Click to learn more about this sponsor



Click to learn more about this sponsor



Click to learn more about this sponsor



Click to learn more about this sponsor

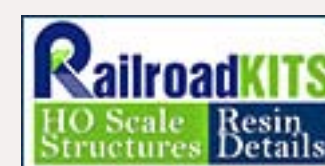

Click to learn more about this sponsor



Click to learn more about this sponsor



Click to learn more about this sponsor



Click to learn more about this sponsor



Click to learn more about this sponsor



Click to learn more about this sponsor



Click to learn more about this sponsor



Click to learn more about this sponsor



Click to learn more about this sponsor



Click to learn more about this sponsor

Sponsoring Advertisers - Visit them and say: *"Thanks for bringing me MRH completely free."*

Your logo could be on this page, putting your web site just one click away from tens of thousands* of readers!

Our click tracking indicates sponsoring advertisers get up to *double* the clicks ...



[Click here](#) to learn how to become a *sponsoring advertiser*.

* Our oldest issue, released in January 2009, has now had nearly 50,000 downloads – and continues to get hundreds of new downloads per month even now. Sponsoring advertisers who've been with us since issue 1 are still getting clicks from all our back issues, from their logo on our web site, *as well from as our current issue*. A sponsoring ad with MRH is truly an *investment* in growing your business.

INTRODUCING THE ALL-NEW

F89-J



Photo by Gareth Bayer

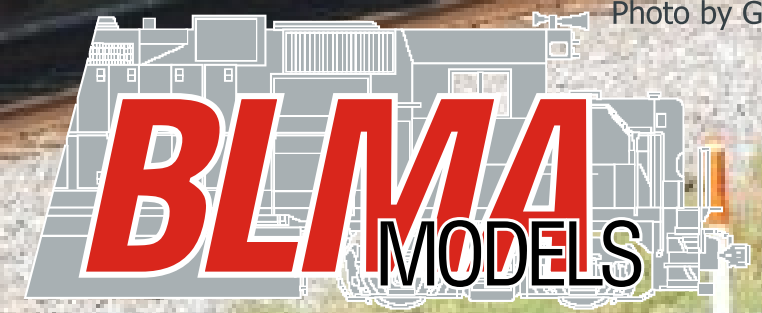

HO & N

ACF-89' F89-J Flat Car

Built for Trailer Train by ACF between 1966-68, the visually unique **"F89-J" 89' Flat Car** was produced for TOFC service. Easily identified as a common asset in the vast TTX car fleet, over 1,600 F89-J's haul trailers, pipe, rail, bulk loads, and hundreds remain in service today! Not easily confused with any other 89' flat car, pre-order your F89-J's and add flair to your roster!



Photo by Chad Hewitt

PRE-ORDER NOW THROUGH YOUR FAVORITE DEALER



HO SCALE \$34.95 N SCALE \$26.95

HO		N	
#51001	#13001	RTTX	#600963
#51002	#13002	RTTX	#601171
#51003	#13003	RTTX	#601520
#51004	#13004	RTTX	#601816
#51005	#13005	RTTX	#601967
#51006	#13006	RTTX	#602068

Delivery: 4th Quarter, 2010

ORDER NOW AT

BLMAmodels.com

Phone: 562-712-7085
sales@BLMAmodels.com



My Railroad

Fast Clocks

Are Here!

Online

Free to Use

6:1 Ratio

4:1 Ratio

3:1 Ratio



Only the coolest kids are Dallas Model Works Members!



THE

BULLFROG

NEW

MANUAL THURNOUT CONTROL



- ✦ **Inexpensive**
- ✦ **Integrated Control Rod Mount**
- ✦ **Automatic Power Routing**
- ✦ **Full Selection Of Supporting Products**



\$9

**Ready
To Install**

You Assemble It



\$6



Order online now at:
www.fast-tracks.net/bullfrog

We're here to give you a hand



Click to 
learn how ...

Do more. Spend less.



model-trains-video.com

**It's a
real crime
when
you miss
out on a
limited
run
model ...**



***to the
rescue!***



**Click here to learn
how to prevent
this crime!**

Main Features

Table of contents

Columns

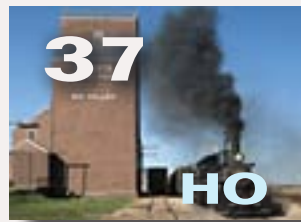

37 **Canadian Prairie Crossing**
An Alberta intersection Track plan
by Byron Henderson



70 **Basic Diesel Detailing**
Introduction to super-detailing
by Matt Snell



43 **Pink Foam Retaining Walls**
Scenery Scene: one evening project
by Rick Wade

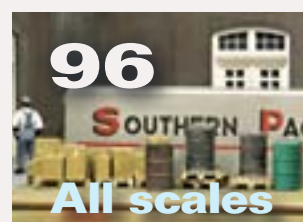

96 **Detailing Loading Docks**
Scenery Scene: one evening project
by Charlie Comstock



46 **Jim Dias' Western Pacific**
A gorgeous, prototype-based layout
by Charlie Comstock

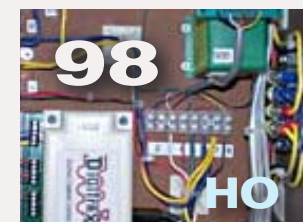

98 **My Modular Adventure**
Runaround track and turnouts
by Les Halmos



58 **Modeling the Modern Era**
The benefits of modeling 'now'
by Lance Mindheim



119 **LED lighting**
Light up your buildings at night!
by Ken Ferguson

23 **May Model Railroading News**
MRH News and Events
by Richard Bale

126 **Roadwork**
Up the Creek
by Charlie Comstock

134 **Sea-Trials - the SNE's first op session**
Getting Real
by Marty McGuirk

141 **Modeling PRR's Horseshoe curve**
Comme-N-tary
by John Drye

146 **Now you see it, now you don't**
Reverse Running
by Charlie Comstock

18 **Bonus downloads this issue!**

Other Features

12 **A history of 43 years doing the hobby**
Publisher's Editorial *by Joe Fugate*

17 **Staff Notes**
Looking forward in MRH

22 **Dept of Corrections**
Oops... we goofed - corrections

32 **MRH Q - A - T**
Questions, Answers and Tips

69 **Derailments**
Humor



NEW SLEEPWEAR

CLICK HERE!

Errr.... Sorry, that's SLEEPER.
Our mistake.



Digitrax UT4D Duplex Equipped Utility Throttles

Select, Run and Dispatch

Without Plugging In!

Shipping Now! The UT4D is the latest in the UT4 series of Digitrax Utility Throttles. Operators from around the world asked for a simple to use, affordable throttle with intuitive operation & rock solid design. Based on operator input, Digitrax created the UT4 throttles.

UT4D is Duplex Equipped to work with the UR92 Duplex Transceiver. It can also be used as a walk around throttle with UP5 or as InfraRed with any Digitrax InfraRed Receiver.

For UT4 & UT4R upgrade information visit
www.digitrax.com/ut4upgrades

Digitrax, Inc. 2443 Transmitter Road, Panama City, FL 32404
Phone 850 872-9890 / Fax 850 872-9557 www.digitrax.com

UT4D \$135.00 msrp



TELL US WHAT YOU WANT. WE'LL HELP YOU FIND IT.

SPECIALISTS IN HO, O AND N SCALE HARD-TO-FIND ITEMS

BPL Brassworks' sophisticated Want List system "sends up a flare" when a new collection comes in with just what you're looking for, and we send you a "heads up." You won't miss out on the opportunity to add that sought-after item to your own collection. You know what to look for, and we provide crisp, detailed photos to give you confidence in the quality and value of our offerings.

FINE DOMESTIC AND IMPORTED BRASS MODELS FOR DISCRIMINATING COLLECTORS AND OPERATORS.

- All major importers and domestic manufacturers
- Newest manufacturer offerings
- Want List system for special requests and hard-to-find items
- One-to-one personal service
- More than 15 years of railroading study and experience
- A boss who's as passionate about brass and trains as you are
- Order confirmations, layaway and prepayment options available

Make our web site your first stop for the newest offerings.



2 6 2 - 3 7 5 - 1 1 0 7

CLICK FOR MORE INFO



About the Publisher



Joe Fugate is the featured expert in many Model-Trains-Video.com videos, and he's also the founder and publisher of **Model Railroad Hobbyist Magazine**.

To learn more about Joe, [click here](#).

PUBLISHER'S EDITORIAL: A history of 43 years doing the hobby, part 1

Musings from the MRH founder



Wow, I've spent 43 years in the model railroading hobby as of this year ...

I've recently been looking back at my journey through 4 layouts. Like many modelers, I was first introduced to the hobby by my dad with a Lionel trainset at age 8. The roundy-roundy running wore thin quite fast. The trainset only got mileage when other kids came over to play.

I remember seeing some model railroading articles in Boy's Life, the magazine put out by the Boy Scouts. For instance, they showed how you could improve the realism of 3-rail Lionel track by adding wood ties, using gun bluing on the middle rail, and adding ballast – with stunning results to the eyes of this 9 and 10-year old Cub Scout.

But I count my real beginning in the hobby to be age 12 with my first visit to a local hobby shop. It was June 1967 and we had gone to “town” so Mom could visit the county courthouse on family business. I had

earned \$5 and was eager to spend it on something fun.

Right across the street from the courthouse was a model trains-only hobby shop. I was fascinated! I bought my first issue of Model Railroader (June 1967) for 50 cents and also got my first HO box car – a 50-foot Southern Pacific Athearn “Blue Box” for \$1.25! The fineness of the detail blew me away.

That August, the excitement continued when I saw the Umpqua Model Railroaders club layout display at the county fair. I remember studying the couplers between the cars – they had something that looked much better than the horn-hooks on my Athearn kit. The couplers even looked like they had air hoses between the cars! I later learned these were Kadee magnetic couplers.

I built my first cobbled-together layout in our upstairs spare room using scrap lumber. I handlaid the track using balsa ties and brass code 100 rail. I built some scenery using plaster we had on hand, referring to Bill McClanahan's Scenery for Model Railroads (Kalmbach) – the defacto model railroading scenery bible at the time.

This first layout never got very far mainly because young teenagers don't have much cash. After giving up on this layout, I figured it was time to gather some others and to pool our resources. In our tiny town of 800, I managed to find one other kid to join



My third layout was inspired by John Allen's Gorre & Daphetid, and I called it the Morale Falls & Sadgino (pronounced Sad-jeh-no, as in Sad-You-Know). I built this small switching layout in the 1970s using handlaid code 70 nickel silver rail. The layout included a small trestle, a mine on a switchback, and an operating turntable.



I started Layout number 4 first as a module intended to be a section in my larger proto-freelanced Northern Railway. The layout borrowed elements from both the Great Northern and the Northern Pacific such as Rocky the goat. I created my own version of the NP slogan, "Main Street of the North". On this layout, I moved from handlaid to MicroEngineering flex track and lettered some locos and rolling stock using custom decals.

me, so we pooled our resources and started my second layout (and his first layout). Being the daring sort, I handlaid some turnouts on this layout, including a double slip switch that actually worked surprisingly well.

Layout number 2 met an untimely fate – it was on an enclosed porch with some not-so-great electrical wiring. An unfortunate short triggered a fire – and after the fire department put out the fire, there wasn't much left of the layout. Water-drenched and scorched, we tossed it.

My friend Dennis and I turned instead to the Umpqua Model Railroaders club and as our modeling and hobby outlet for the next few years. In those years I consumed every issue of Model Railroader and Railroad Model Craftsman I could get, reading and rereading each issue many times. The most memorable hobby learning in these years (age 14-17) came when I read about the "Wizard of Monterey", John Allen. His amazing modeling really captured my fancy.

Once I turned 18 and graduated, my first real summer job gave me enough

Have us add sound to your favorite loco!



cash to do the hobby more seriously than before, so I started layout number 3 – an L-shaped switching layout I called the Morale Falls & Sadgino (pronounced Sad-jyeh-no, as in Sad-You-Know). It's a cutesy name in the spirit of John Allen's Gorre & Daphetid (Gory and Defeated).

This layout included a turntable, a switchback to a mine, and a small trestle. I continued handlaying track and turnouts, only now I had graduated to code 70 nickel silver rail. I used Lin Westcott's hard shell and zip texturing scenery techniques with great success.

I worked on this layout off-and-on while in college. Once out of college and married, it was now the late 1970s and Allen McClelland's "prototype freelanced" V&O series debuted, setting the hobby on its ear. Gone was the fanciful cutesy paradigm of modeling ala John Allen. Enter model railroading based more on the real railroads and how they function.

By this time my skills and interests had shifted enough that I rethought my approach to the hobby. I sold my (partially finished) Morale Falls & Sadgino to another modeler and I started layout number 4 – a module of my proto-freelanced Northern Railway. I envisioned the NR to be a cross between the Northern Pacific and the Great Northern, and I borrowed the best from each.

I used Rocky the goat in the logo, and I adopted an altered NP slogan: "Main street of the North". While planning various layout incarnations

of the Northern Railway, I devised the "double opposing deck" concept (which John Armstrong later coined the "mushroom"). By this time, it's the mid 1980s and was deep into planning mushroom versions of my protolanced Northern Railway.

One day I opened Model Railroader and discovered John Armstrong had published a track plan using my opposing deck idea and dubbed it a "mushroom". Now I knew what to call this type of layout configuration! Clearly, I wasn't the only one toying with this idea for doing multi-deck layout designs. In fact, John credited Richard Benjamin with the original idea – and rightly so. Richard actually built a mushroom in the late 1970s!

One thing that's clear to me in looking back at my pursuit of the hobby is that I kept putting effort into actually doing the hobby and building layouts. Even though I never finished any of layouts 1-4, they each allowed me to hone my skills and each provides fond memories of doing the hobby, not just dreaming about doing it.

There were also years when I didn't do the hobby very much, especially in the early years of my career and raising young children from about 1979-1989. But even in those "off years", I still dabbled in the hobby off and on, never dropping it completely.

What lay ahead for me in the hobby as the 1980s closed out? We'll discuss that journey in the next issue.

New York Railway Supply



FLAWLESS Turntable Operation.



**Click to
learn more**

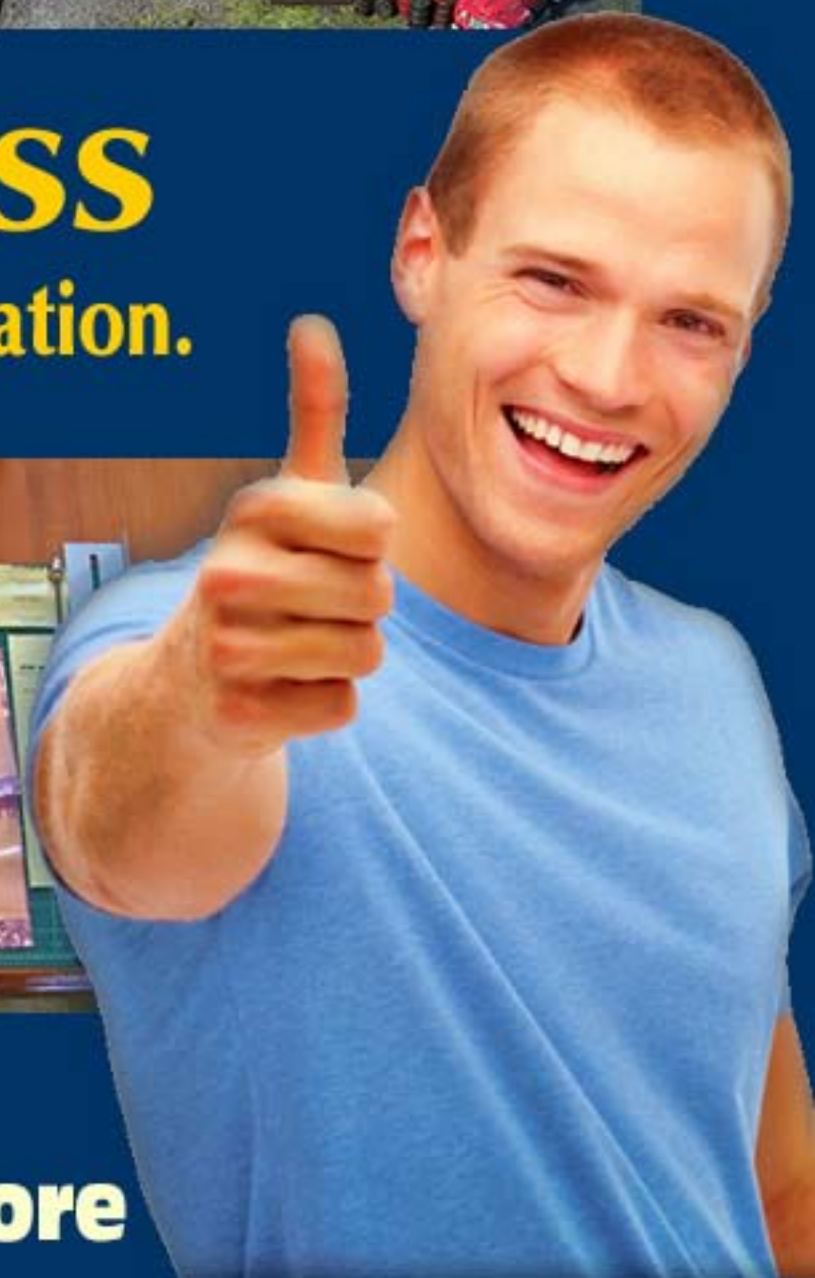

Model Railroad Hobbyist - HOBBY MARKETPLACE

GP Jack Pads - DP 6190

Injection Moulded Styrene 3D Replica



Railflyer Model Prototypes

www.railflyermodelprototypes.com

TWO & FOUR TRACK SIGNAL BRIDGES

AT YOUR DEALER NOW!

HO SCALE
—
FITS ALL ERAS



www.oregonrail.com



PO Box 490
Scappoose, OR 97056
503-543-6466
oregonrailsupply@gmail.com

Your ad could be reaching tens of thousands of MRH readers from our Hobby Marketplace pages for a very reasonable cost. Learn the details [HERE](#) . . .



Want scenery this good on your layout?
RIGHT OUT OF THE BOX!

HAND MADE PRODUCT
NO TWO PIECES ARE IDENTICAL!

Modeller's Warehouse
www.modellers-warehouse.com.au

Proto:87 Stores!

WELCOME TO THE PROTO:87 STORES NEWS AND LATEST PRODUCTS PAGE -

INTRODUCING OUR NEW, FIRST MID-EAST, HO SCALE (HO) HOBI (OR HO) "ROLLING HOBI" PROTO:87 LOCOMOTIVE STATIONARY RUNNING 1841 848

A FULLY ADJUSTABLE BI-AXLE SYSTEM FOR DIESEL OR STEAM AT AN INTRODUCTORY PRICE OF ONLY \$89.99 (A \$149.99 UNIT)

EXPANSION UNITS ARE ALSO AVAILABLE TO SUPPORT ANY NUMBER OF EXTRA AXLES. POWERED OR NOT, TO COVER EVERY POSSIBLE PROTOTYPE LOCO

Awesome HO, N, and Z
click here to
Visit our web site!

Model Railroad Hobbyist - HOBBY MARKETPLACE

Proud supporters of "MODEL RAILROAD HOBBYIST"



Timesaver Layouts
AUSTRALASIAN DISTRIBUTOR
www.timesaverlayouts.com
timesaverlayouts1@bigpond.com

- * Cost effective Turnout - Semaphore & Crossing control
- * Frog and Lighting control at your fingertips
- * Compatible with all DCC systems
- * Useable on DC or DCC layouts
- * **Dealer Applications WELCOME**



Click for more ...

Have an article you just can't seem to get published? Submit it to ModelRailroadTips.com today!



Home to 100% free online, and PDF articles. Upload an article online, and we'll take care of the PDF file for you.

If you are looking for a great way to display your N, HO and O trains, try grooved ShelfTrax.

Attaches to the wall without brackets.



Learn more at www.shelftrax.com



Berrett Hill Trains

Custom Layouts and Modules

www.berretthill.com

- Shop built sections delivered and set up. Move your layout whenever you want to.
- Built to any level of completion: bench-work, rails, wiring, or scenery.
- Design for dramatic scenery is our specialty.
- CAD design for precise track placement and grades.
- Wiring for AC, DC, or DCC. All sections mate with universal harness plugs.
- Serving the eastern US.

See us at the Great Scale Model Train Shows.



Reach well over 20,000 modelers with your text-only ad on this page for as little as \$15 per issue.

[Learn the details here.](#)



LBH Custom Model Railroads

Layout Design and Construction Services

For more information visit our website:

www.lbhmodelrailroads.com



LISTEN UP!

SPONSORED BY:
THE MODEL RAILROAD
HOBBYIST MAGAZINE

The Scotty Mason Show

THE FIRST INTERNET MODEL RAILROADING PODCAST

Get the Latest Model Railroading
News, Tips, Reviews & Opinions
From These Knuckleheads.

Scotty Mason

Jimmy Deignan

Dave Frary

Doug Foscale

Available here or on iTunes

www.modelrailroadpodcast.com

Notes from the MRH Staff

**New stuff, in this issue,
layout lookout, bonus
downloads, and more ...**



May/June 2010 is our second issue on a bi-monthly production schedule. Computer nerds use the word 'threading' to describe the situation where a computer works on two instructions at the same time, and that's what we're doing - going forward there will be two editors working on two issues at once. By doing this, each editor only needs to produce an issue every four months - we're hoping this will avoid burnout and allow us to keep producing MRH in a timely manner.

New stuff

We've received such positive response to Les Halmos' articles on installing a turntable and building a roundhouse that Les has agreed to write a column starting next issue: *My Modular Adventure*. Les has a long association with modular layout design and construction which should make his column fascinating.

You can expect to hear a lot more from Les in the future.

We've also added a new section, Derailments, containing funny stuff (we hope so anyway) such as cartoons and train-related jokes. By the way, if you have a good (and clean!) train related joke it could be worth \$10 to you if/when it appears (and you were the first to submit it). Click [here to submit a humor item to MRH](#)

Another new thing - although we strive for perfection, every once in a while we goof and errors get into 'print'. [The Department of Corrections](#) section of MRH addresses errors and presents fixes (we'll also post fixes/corrections on the MRH Forum for the fastest notification).

In this issue

The lead story in this issue is [Modeling the Modern Era](#) by Lance Mindheim. Lance is well known for his outstanding modeling. He presents some good arguments for choosing to model modern times (as opposed to transition era).

If you've had a secret yearning to super-detail your locomotive fleet but were too intimidated by this task to begin, then [Basic Diesel Detailing for Beginners](#) by Matt Snell should be just the ticket. Matt, another well known

writer, shows you that super-detailing isn't as tricky as you might think.

Also, starting with this issue, we're looking to include at least two one-night-projects. In this issue, Rick Wade shows a [unique way to model retaining walls using pink foam insulation](#). There's also a discussion of detailing your loading docks with cardboard cartons, pallets, and drums, etc.

Know a good layout?

Do you know of a nicely executed layout just waiting for a magazine spread? Let us know, we're on the lookout for article-worthy layouts.

The following attributes will improve a layout's chances of appearing in MRH:

- It should have enough good looking scenery for nice close up photos.
- A well thought out trackplan is a definite plus.
- Unusual features - like unique scratch-built or kit bashed buildings help make a layout more interesting than one populated with out-of-the-box building kits. Realistic, situation and era appropriate weathering is a plus.
- A friendly environment - good lighting and nicely finished fascia.
- A scale besides HO also improves a layout's chances.

- Not having been in the hobby press already is a bonus.

Know of such a layout? Click [here to suggest a layout for an article](#).

Bonus downloads

Make sure you check out the bonus downloads for this issue. The goodies include:

- Printable scale rulers. This is a .pdf file containing Z, N, HO, S, and O rulers (courtesy of RS laser kits).
- DVD quality video of the videos in this issue.
- DVD quality bonus video of the grade crossing in this month's [Up the Creek](#).
- You can also download the bonus items from previous issues.

Note that the bonus downloads are only good for the first 30 days after an issue release. We provide the bonus materials to encourage early downloading of each issue. If you wait too long to download an issue, you'll miss out – so don't procrastinate!

Write for us

A bimonthly magazine needs 50% more articles than a quarterly. We can use more article submissions than ever!

Continued on page 20

Issue 7 Premium Extras!

Free for the first 30 days after issue release
(After June 2, 2010, these extras will no longer be available)

- **Printable scale rulers**
- **DVD-quality versions of this issue's videos**
- **Special money-saving advertiser coupon codes**



Click here to access



When you see this symbol, it means:

“Click here to learn more!”

- *Every click tells advertisers an ad in MRH is a wise investment ...*

Tips for reading MRH:

- *Clicking an article on the cover will take you directly to that article.*
- *If you're using Adobe Reader to read MRH, holding down ALT and hitting the left-arrow-key will take you back to the previously viewed page (like a browser 'back' button).*
- *Looking for a particular advertiser? Click [Index](#) (at the bottom of each page). In addition to our article index, you'll find an alphabetized List of Advertisers on that page.*



ACCU-LITES, inc

We are an Authorized Walthers and Digitrax Dealer
We offer 20% off the MSRP on ALL Walthers
Catalog Items!

- DCC Specialists
- Digitrax-NCE-LENZ-Soundtraxx
- TCS-QSI Solutions-RR CirKits

Watch our website for our monthly specials!

CLICK TO LEARN MORE: <http://www.acculites.com>



RailroadKITS

DANNEN FEEDS

Only \$ **9**



MRR Television's Boz Collins says "These Little Kits Are Cool!"

Railroad Kits Structures:

- Great Designs in HO Scale
- Laser Cut Basswood Walls
- Northeastern Scale Lumber™
- Tichy™ Doors and Windows
- Metal and/or Resin Detail Castings
- Online, Printable Instructions



Visit us at www.RailroadKits.com

Continued from page 18

However, acceptance is not guaranteed. The most common reasons for rejecting a submission are poor photography or the article isn't a topic we want to cover in the manner the author has approached it.

If you want to increase your odds that we'll accept your article, first send us a proposal [via this link on our web site](#).

We will respond within a two or three weeks and let you know if your idea is something of interest to MRH. We'll often also provide some guidelines as to approaching an article.

You've an article written? The following is a checklist of things to keep in mind when creating submitting it:

- Include your full name and email address in the article text. You would be surprised how many submissions we get *without* this information!
- Include captions for all photos, diagrams, drawings, tables, and videos as a separate document.
- Include a version of your document that has the images and diagrams inline in the text if you like, but also give us a text-only version of your article.
- Write us a short bio about yourself and your hobby interests. Include a recent photo of yourself.

We prefer Microsoft Word format for documents. For images, send us 2-3 megapixel jpgs at least 1800 x 1200 pixels.

If you don't have a copy of Microsoft Word or Office, you can [download a free copy of Open Office here](#). Open Office reads and writes Microsoft Office formatted files.

For drawings or diagrams, contact us and we'll give you some guidance of how to produce them for publication with us.

One Evening Projects

Never written before? Don't have time to create a War and Peace length article? No problem! Try writing for our series of *One Evening Project* articles. Currently, we have *The Scenery Scene* - projects that make a visible difference in the layout. In the next issue we'll start a new series - *The Tool Shed*. We're looking to expand into other areas too, such as track work, electronics, or any other project that takes an evening or afternoon to complete.

Meet the MRH Staff

MRH staff will be attending the following shows in force in 2010:

- [NMRA National Convention](#)
(Milwaukee,WI) - July 11-18, 2010
- [National Narrow Gauge Convention](#)
(St. Louis, MO) - Sept. 1-4, 2010
- [Craftsman Structure Show](#)
(Mansfield, MA) - Nov. 10-13, 2010

If you'll be attending any of these shows be sure to drop by our booth and say "Hello!"



What's On Your Work Bench?



KIT PHOTO BY DAVE FRARY

**Over 40 Unique Structure Kits
You Won't Find Anywhere Else.**

www.foslimited.com

**Click to
see more**



We're looking for local volunteers to help us at the St. Louis Narrow Gauge Convention.

Promoting MRH

There are too many shows for the MRH staff to attend them all in force! We're looking for volunteers to help promote MRH at these shows.

If you'd be willing to do any (or all) of the following:

- Put flyers and CDs out on the free handouts table.
- Help staff a table.

- Help us get flyers and CDs in the registrant bags (if the event has such things)

If you're willing to help staff a table, we'll pay for the table and pay the entry fee for you and any other reliable volunteers you can get to help you at the table.

We'll also give you an official MRH shirt to wear at the event (yours to keep), and send you promotional materials with guidelines on how to best use them.

Just click here if you're [interested in helping out at a show!](#)

Model Railroad Hobbyist magazine™

Your first choice for **FREE** on-line model train information!



Everything you need to know about model building in one great How-To resource...the Micro-Mark catalog!

More than 2,750 name-brand and hard-to-find tools, trains and supplies, plus tips, techniques and more...all designed to help you complete your hobby projects in less time with more satisfying, professional results!

Micro-Mark®

Berkeley Heights, New Jersey 07922
1-800-225-1066



Free Catalog!

Click [here](#) and enter code BA5

1-800-225-1066
Shop On-Line: www.micromark.com



The Department of Corrections

Oops! Sometimes goofs do slip through ...

Issue 6 - Mar/Apr 2010

Static Grass Applicator x 3

I took a look at the Mouser parts today or the 12VDC version, and noticed a small error. the parts list on page 94 says the hassis mount co-ax power jack is #163-5006. According to the on-line catalogue, it should be 163-5006-E.

- Philip H.

Oops! 163-5006 is wrong. The correct part number is **63-4302-E**. Part Number 163-5006-E is a rectangular, molded chassis mount, jack. While workable it might be more of a chore to mount than a through-hole, panel type.

Here's a link to the correct part's datasheet:

www.mouser.com/catalog/specsheets/KC-301339.pdf - DC Power Jack 163-4302-E Datasheet

I hope this error does not cause anyone grief, sorry guys!,

- Kevin (Blue Hills)

Issue 5 - Jan/Feb 2010

Building an Operating Turntable and Roundhouse - part 2

In issue #5 Jan/Feb 2010, page 112, Fig 89, on the drawing showing the APR (Automatic Power Routing) Terminal Block wiring, the position of the track numbers were wrong, please refer to the Revision #1 drawing (below) for the correct wiring. I misinterpreted the way the APR worked!

Sorry for the inconvenience.

- Les Halmos

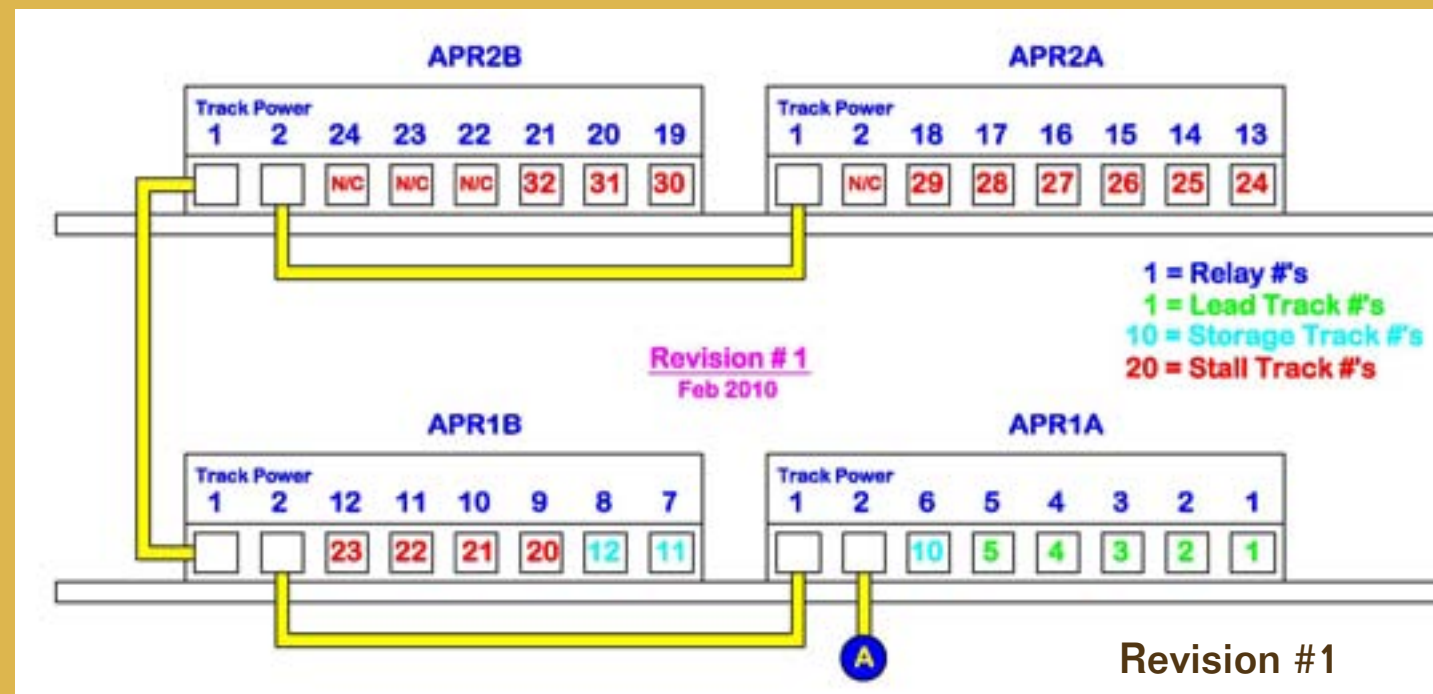

DCC Systems - DCC Decoders DCC + Sound Installations

Also offering quality
model trains and model
railroading accessories in
HO & N Scale!



CLICK HERE
TO VISIT OUR WEBSITE!

DCCinstalled.com

Model Railroad Hobbyist newsletter™

May 2010

▶ **Reader Feedback**
(click here)



The Old Yardmaster



News and views from up and down the line...

There is an abundance of new products to tell you about this month, so let's get started with the smallest commercial gauge: Z scale.

American Z Lines has a 23,000-gallon Funnel-Flow tank car decorated for Union Tank Car with four different numbers. Also a Pullman-Standard 2CD covered hopper decorated for various Union Pacific merged lines including Missouri Pacific, Chicago & North Western and Missouri-Kansas-Texas. The Z-scale cars feature metal wheelsets and magnetic knuckle couplers. See www.ztrack.com for full details.

Atlas O has re-issued its popular 40-foot and 45-foot O scale containers decorated for a variety of shippers including CCMA-CGM, COSCO, Matson, ZIM, Hanjin, NOL, NYK Logistics and P&O NEDLLOYD. Multiple numbers are available for each company name. Visit www.atlaso.com for details.

Wayne Weiss of Salida Roundhouse is developing an "anti-flicker" lighting kit for Blackstone's HO_{n3} scale D&RGW long caboose. The circuitry, developed by Richmond Controls, requires just 25 seconds of track power (either DC or DCC) to charge a small capacitor that will



FIGURE 1: Athearn (www.athearn.com) is scheduled to release its newly-tooled HO scale Genesis series F45/FP45 locomotives in August. The cowl-style diesel with a front platform ahead of the nose was initially produced by EMD for Santa Fe in 1967 with the FP version providing space at the rear of the locomotive for a steam generator to produce heat for passenger cars. Athearn's FP45 will be decorated in Santa Fe's classic Super Chief war-bonnet scheme with small lettering and Santa Fe's late yellow-bonnet freight scheme (above). The F45 units will be painted for BNSF (black over green) and Santa Fe's Kodachrome merger scheme (above). A DCC version with SoundTraxx Tsunami Command Control and full sound will be available at \$250. The basic DC unit will be priced at \$150.

operate the LED interior lights and exterior markers for up to three minutes without additional track power. The system requires no batteries and the caboose can be lifted off the track and all the lights will remain on for several minutes. Wayne is shooting for availability early this summer with pricing targeted at under \$50. For additional information visit www.locodoc.com.

Look for BLMA to add as-built TTX brown paint schemes to its lineup of HO and N scale ACF-built 89-foot F89-J flatcars. The late 1960s cars will include details appropriate to the original prototypes. Meanwhile, BLMA is booking orders for the 1990s-era yellow RTTX models that feature a die-cast metal frame, positionable center hitch, cut levers, 70-ton trucks and Kadee #58 couplers. Pre-production test samples are expected this month with initial delivery scheduled for the 4th quarter of 2010. Visit www.BLMamodels.com for additional details.

Brass Car Sides is working on two new N scale brass car sides with a release date targeted for early summer. First up are sides for a 56-seat chair car for the UP and C&NW 1937 Challenger. The sides include the car skirting and equipment access doors. HO scale versions will follow if owner Dennis Henry receives reservations totaling eight or more sets. Also coming are sides for a Pullman-Standard lightweight 14 roomette, 4 double-bedroom sleeper. The sides

are based on plan 4153 as used by Amtrak, B&O, Long Island, Mexican National, MP, T&P and Kansas City Southern. These photo-etched brass sides are designed for use with American Limited Models core kits. For full information visit www.brasscarsides.com or contact Dennis Henry at dchenry@gac.edu.

Digitrax (www.digitrax.com) has a new DCC decoder intended for use in multi-motor **HO** and **O scale** locomotives or hard wired multiple locomotive consists. Rated at 4 amps, the decoder features six 500mA FX3 function outputs, is Soundbug® plug-in compatible, scaleable speed stabilization (adjustable BEMF), transponding, and SuperSonic motor drive. Model DH465 measures 0.67 wide by 2.04-inches long and is priced at \$59 each.

Fast Tracks (www.handlaidtrack.com) has a wide selection of PC board ties for both standard and narrow gauge applications in **Z**, **N**, **HO**, **S** and **O scale**. The copper-clad fiberglass ties are used at strategic points in hand-laid trackwork to permanently hold the rails in gauge. The PC ties are soldered into place with wood ties added to complete the trackwork. When painted and ballasted PC ties blend fully with conventional wood ties.

Dan Kohlberg has new **HO** and **N scale** decal sets for three Pennsylvania H40 class 2600 Airslide covered hoppers including PRR/GACX Leased GATC 1959+ (3 cars), PRR shadow keystone GATC 1961+ (2 cars) and PRR plain keystone 1964+ (2 cars). To order visit www.mindspring.com/~paducah.

Microscale Industries has released new decal sets in both **HO** and **N scale** for Union Pacific two-tone gray (Greyhound) steam locomotives. The lettering set includes both the Armour yellow and the striped gray schemes as used by UP



FIGURE 2: Also coming in August are new paint schemes for Athearn's **HO scale** EMD SD40 diesel including CB&Q/C&S (gray over red), CSX, CSX with Operation Redblock logo, SP (bloody nose) and as shown above, Southern Pacific locomotive number 7342 in the 1980s one-time-only experimental orange paint scheme. Features of the model, which is based on reworked RPP tooling, include wire grab irons and prototype-specific hand brakes and truck sideframes.



FIGURE 3: Aztec has introduced a self-contained **HOn3 scale** track cleaning system that is housed inside a Micro-Trains 30-foot refrigerator car. The mechanism consists of a hard black anodized aluminum chassis with a Cratex® (rubberized abrasive) roller inside mounted at a slight angle to the track. This causes a scrubbing action at the railhead when the car is moved. Some assembly and painting is required. Item TS1158 sells for \$99.95 and includes a standard M-T car with trucks and couplers. For ordering information and details about track cleaners for other scales visit www.aztectrains.com.

Scale Color Key:

Z scale news

N scale news

HO scale news

S scale news

O scale news

G scale news



We try to make it really easy for you to leave us feedback. Please click the button above to tell us how we're doing: good, bad, or otherwise.

on most of their passenger train steam locos. Decals for CSX ACF Hoppers, GATX Rail locomotive group, Marquette lease diesels and Marquette cabooses are also available along with revised lettering sets for DT&I diesels, GTW diesels with small logos (replaces MC-4302, MC-4303, MC-4304 and MC-4305) and Norfolk & Western 40-foot and 50-foot boxcars (replaces 87-81, 87-307& 87-353). Future decals under development include sets for MNS 50-foot double-door boxcars, Milwaukee steel cabooses and covered hoppers. For details see a dealer or go to www.microscale.com.

NJ International has a new **HO scale** ready-to-install overhead road crossing signal with a pair of flashing LEDs mounted on the vertical support as well as on the bridge projecting over the road. The LEDs display in both directions. A conventional crossbuck is also mounted on the vertical support. The all-brass structure is painted silver and features an etched walkway. Item #1193 has an MSRP of \$54.99. Visit www.njinternational.com to view the firms large selection of signals and accessories.



FIGURE 4: BTS continues to expand its Rail Facility project with the release of the McCabe Sand House. The **HO scale** craftsman kit is composed of laser-cut wood and card stock with brass and white metal details. The finished model has a foot print of 17 x 37-scale feet. Visit www.btsrr.com for ordering information.

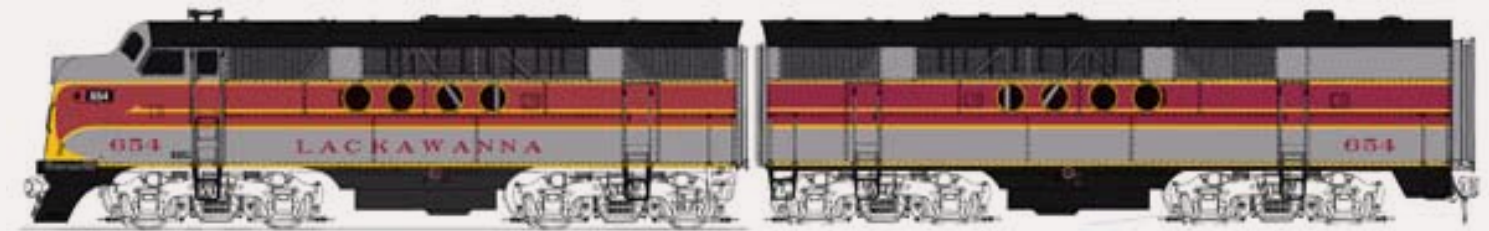

FIGURE 5: This DL&W FT A&B lashup is just one of a series of diesel coming this fall from Bowser (www.bowser-trains.com). Other roads include Baltimore & Ohio, Electro Motive demonstrator, and Santa Fe in the blue and yellow catwisker scheme. The **HO scale** ready-to-run "Executive Line" DCC-ready diesels come with handrails installed and feature MU hoses, air hoses, brass windshield wipers, operating headlight, window glass, can motor, flywheels, nickel silver wheels with RP25 flanges and knuckle couplers. DC versions are available at about \$ 295.95. Units equipped with Soundtraxx have an MSRP of \$459.95. A Western Pacific version is also being produced for distribution exclusively by Hobbytyme. Dealers can contact Hobbytyme direct at 800- 441-3302.

In mid-April Bowser announced a limited run of new paint schemes for its HO scale 100-ton 3-bay hoppers including BNSF, Wheeling & Lake Erie (orange speed lettering), PPLX (black body with yellow ends), NS, WM-Chessie and NW in a special red white and blue 1776 scheme. With the exception of the NW unit, an un-numbered car with numbering decals will be available for each of the other railroads named.

ProtoWest Models (www.protowestmodels.com) has an **HO scale** kit for a Colorado Midland Hanrahan refrigerator car. Kit components include a cast resin body, brass wire, Tichy detail castings and special decals printed by Rail Graphics. Step-by-step instructions are supported by photographs. Trucks and couplers are not included.

The newest products from **Westerfield** are Fort Worth and Denver City class XM-18 truss-rod, double-sheathed boxcars. The models are identical to the parent road CB&Q's cars that Westerfield offered several years ago. The prototypes were built in 1915 with double-sheathed ends and were rebuilt with inverse corrugated ends beginning in 1925 and with Dreadnaught ends beginning in 1928. Many of these sturdy wood cars operated into the 1950s. The **HO scale** kits are composed of resin castings with added details plus decals that cover the life of the car. The kits are available as original (#8904), with corrugated ends (#8955) and with Dreadnaught ends (#8956) at \$33 each. The kits do not include trucks or couplers. To order visit Westerfields new web site at www.westerfieldmodels.com.



FIGURE 6: Eleanor's Quick Lunch is one of the newest craftsman kits from FOS Scale Limited (www.foslimited.com). The kit features double-layered laser-cut walls, laser-cut window glazing, color signage, laser-cut and scored roof, printed brick paper to wrap a laser-cut foundation and laser-cut steps. Interior details include a color printed wall backdrop, various metal and plastic details and a wrap-around counter top that also functions as interior bracing. The O/On30 scale kit has a footprint of 2.25 x 5.5-inches.



FIGURE 7: InterMountain Railway (www.imrcmodels.com) is scheduled to release this N scale Koppel Cylindrical Covered Hopper in July. Other decorating schemes in the production run include CNWX-Canada, CPWX-Canada, Pillsbury, CN, Trona Chemicals, GACX, ATSF, and AAMX-Logimex. The fully-assembled cars include Micro-Trains trucks and couplers. In news for HO scale modelers, InterMountain is taking dealer orders now for fall/winter delivery of two Red Caboose ready-to run-models including a Type 103W 10,000 gallon welded tank car decorated for Anchor, Sinclair, Gulf Oil, DuPont and Standard Oil and two versions of a Southern Pacific 56-foot 3-inch flat cars with laser-cut wood decking, metal wheelsets and Kadee couplers. A Chicago & Eastern Illinois flat will be included in the run.



FIGURE 8: Fox Valley Models of Des Plaines, Illinois (www.foxvalleymodels.com), has released an N scale General Electric ES44AC 4,400 horsepower Evolution series diesel locomotive. In addition to the BNSF version shown above, other road names include Canadian Pacific, CSX, Ferromex, Iowa Interstate, Kansas City Southern and Union Pacific. Road specific options include two, three or four-window cabs, high or low mounted number boards and General Electric steerable or Hi-Ad (high-adhesion) trucks. Several items including grab irons, window sunshades and windshield wipers are supplied but not installed. Small dimples molded into the shell guide the modeler on where to drill holes for mounting these details. Converting the DC locomotive to DCC operation is easy. Removing the top of the radiator section at the rear of the model gives access to the socket for plugging in a decoder without the hassle of removing the body shell from the chassis. This is a clever idea from Fox Valley that we predict will soon be copied by other model manufacturers. Although this is the first locomotive produced by Fox Valley, it is quickly earning high praise from those who have previewed the model.

FIGURE 9: Hunterline has added piers to its extensive line of wood bridges and trestle structures. The Timber Framed Pier (left) uses square posts that sit on a wooden sill that rests on a foundation of rock or concrete. The Timber Pile Pier (right) utilizes round posts that are driven into the ground. Available in most popular scales, the heights of the piers are: N scale 3-3/16-inches, HO scale 5-13/16-inches, S scale 7-13/16-inches and O scale 10-7/16-inches. For full dimensional details and ordering information visit www.hunterline.com.

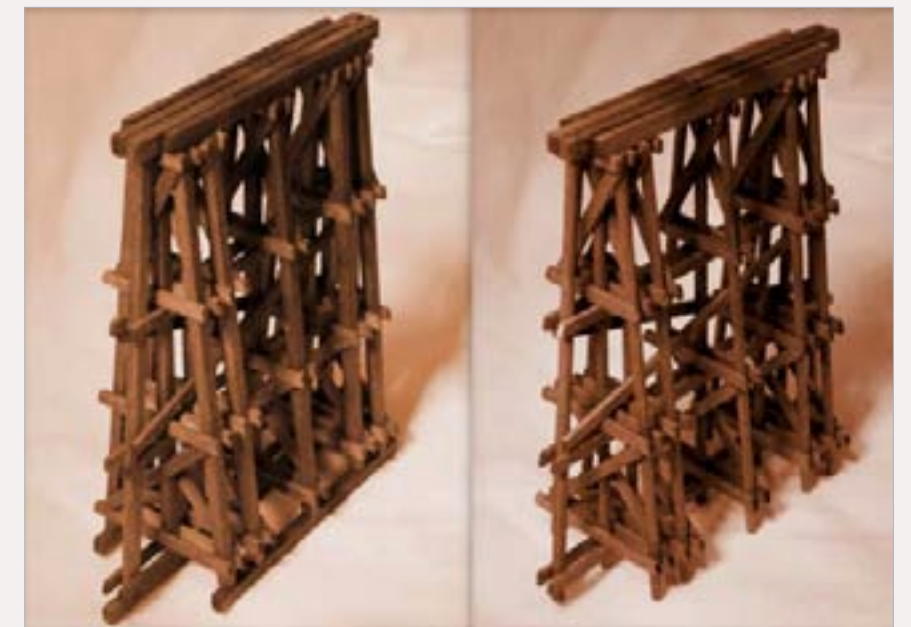

FIGURE 10: Kalmbach Publishing has released the second edition of “*N Scale Railroading: Getting Started in the Hobby.*” Author Marty McGuirk walks beginners through step-by-step chapters that show how to build and operate a complete **N scale** 4 x 8-foot railroad based on his own Androscoggin Central. The 96-page, soft-cover book has an MSRP of \$19.95 and is available from hobby stores or direct from the author at www.martymcguirk.com.

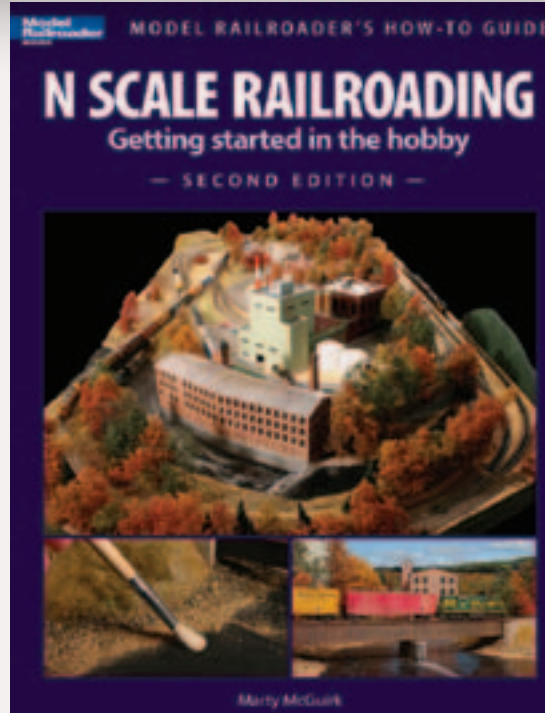

FIGURE 12: Here’s an early look at one of three heavyweight steel passenger cars coming from Micro-Trains (www.micro-trains.com) later this summer. In addition to the 12-1 Pullman sleeper shown here, M-T will also release a 10-1-2 Pullman sleeper and a 28-1 Parlor car. The **N scale** models will have interior seating, underframe details unique for each car type, operating diaphragms and roofs modified with air conditioning features. The classic heavies will ride on appropriate 6-wheel trucks and have body-mounted Magne-Matic® couplers.



FIGURE 11: ExactRail introduced two new Signature Series **HO scale** freight cars in mid-April. The new products include a Pullman-Standard 50-foot 5277 cubic foot waffle boxcar that was initially ordered in 1974 by the Southern Railway. ExactRail’s HO scale version features Kadee #58 couplers, wire coupler cut-levers and Barber 70-ton S-2 trucks with 33-inch wheels. Road names on the initial release include SIND, DME, BR, CSXT and NS plus an undecorated version.

The second new HO scale car from ExactRail -- also in the Signature Series -- is a CP Rail 65-foot mill gondola as built by the Canadian firm of Hawker-Siddeley. The ready to operate model has Kadee #58 couplers and ASF 100-ton Ride Control trucks with 36-inch wheels. The initial sales run by both dealers and individuals quickly emptied the factory stock, however, some hobby stores may still have product available. Go to www.exactrail.com/index.php/dealer-locator for information on ExactRail dealers.



FIGURE 13: PBL (www.p-b-l.com) has a selection of beautifully-detailed **Sn3 scale** D&RGW 3000-series boxcars featuring both Camel doors and so-called “economy” doors. Eleven different road numbers are available in four different shades of paint. Two of the cars, 3455 and 3000 (shown above), display the circular “Royal Gorge” herald. The other nine cars, S-3038 (sand service), 3044, 3128, 3206, 3297, 3409, 3456, 4361 and 3463 are decorated with the speed-writing or “Flying Grande” herald. The ready to operate cars come with Kadee couplers and coined, nickel plated brass wheelsets. They require a minimum 28-inch radius for reliable operation

INDUSTRY NEWS

Ramsey, New Jersey: After a successful run of nearly six decades, Hi-Way Hobby House and its mail order operation known as Standard Hobby Supply, are calling it quits. The move is prompted by the retirement of co-owners Frank and John Mangano. The retail storefront operation in Ramsey is scheduled to close in mid-May with the mail order operation continuing to liquidate inventory for an additional four to six weeks.

Philadelphia: International Hobby Corporation (IHC), an importer of model railroad products primarily from European sources, is downsizing its operation and has listed its Philadelphia warehouse on East Allegheny for sale. IHC president Bernie Paul was not available for comment, but, an unnamed company official denied that the business itself was also for sale. The spokesperson said that current plans call for IHC to continue supplying hobby dealers from a smaller facility. IHC was established by Paul in the mid-1980s following the bankruptcy of Associated Hobby Manufacturing (AHM), a similar operation also founded Paul. Both Associated Hobby Manufacturer and International Hobby Corporation specialized in importing AHM and IHC branded product from various overseas sources including Rivarossi, Mehano and Roco.

Concord, Ontario: Rapido Trains Inc., has moved. Effective 1 May 2010, the new address is 445 Edgeley Boulevard, Unit 1, Concord, Ontario, L4K 4G1, Canada. The telephone number (1-905-738-6445) is unchanged.

Orem, Utah: Blaine Hadfield has been appointed vice president of operations at ExactRail LLC. Mr. Hadfield has been responsible for marketing and production since shortly after the firm opened in March 2009. ■



FIGURE 14: Here's a look at the hand-crafted pilot model of a Duluth Missabe & Northern and Duluth Missabe & Iron Range 0-10-0 steam locomotive scheduled to be imported by Precision Scale Models (www.precisionscaleco.com) early this summer. The all-brass HO scale model comes with the big 10,000 gallon 14-ton clear-vision tender and will be available in paint schemes from several different operating eras representing the life of the locomotives.



FIGURE 15: The latest release of N scale Panorama series lightweight passenger equipment from Rapido Trains Incorporated (www.rapidotrains.com) includes the Union Pacific coach and C&NW duplex sleeper shown above. Cars in the Panorama Line have battery-powered interior LED lighting that can be turned on/off by a Lighter wand (magnet on a stick) Wave the Lighter over the roof and the lights turn on. Wave it again and the lights turn off. A Rapido Lighter and two batteries are supplied with each car.



FIGURE 16: Seaport Model Works (www.seaportmodelworks.com) has a solid resin kit for an HO scale 57-foot flat barge. Components for the waterline model include a solid resin hull, photo-etched brass cabin and ladder, a cast resin cabin roof plus an assortment of special metal castings for the mast and boom assembly. The finished barge measures 8-inches long by 3.75-inches wide.



FIGURE 17: Old Colony Model Railroad Club has commissioned Accurail to produce two versions of a 40-foot single-sheathed outside-braced 6-panel wood boxcar decorated for the International Cooperage Barrel Manufacturing Co. The HO scale cars will be available with either a wood door (above) or steel doors and ends. They are priced at \$24.95 plus \$5 shipping and handling and may be ordered by contacting Dennis Ingallsdingalls@comcast.net.



FIGURE 18: Tamiya America will soon introduce this beautifully detailed O scale Japanese military bulldozer that seems to be crying out to be Americanized with some funky weathering. The model features nice details in the mechanism, 3D hydraulic lines, and a positionable blade. My friend Lew Matt brought this little gem to my attention and suggested that it could easily be adapted to a logging operation or rebuilt with a taller blade for pushing coal at a mine site. So far, Lew is undecided on whether to use the whole bulldozer or adapt the tracks for some other application or use the body for an On30 “critter” project. With an MSRP of around \$21, I’m guessing Lew will buy more than one. For more details visit www.tamiyausa.com and type 32565 in the upper left-hand box of the web site.



FIGURE 19: Among Walthers newest HO scale releases is this Greenville 7000 cubic foot Southern wood chip car. Other railroad names available include CSX, NS, UP and Seaboard System. The assembled model features a heavy die-cast underframe, interior bracing and nicely detailed hopper latches. Also new from Walthers HO scale ready-to-run Gold Line series is a Flexi-Van Mark IV flat car with two trailers. Road names include New York Central, CB&Q, MDT, Illinois Central, PRR/MDT, ATSF and undecorated. Visit www.walthers.com for additional information.



FIGURE 20: Wild West Models (www.wildwestmodels.com) has released kits for this Miners Supply building in Z, N, HO and S scale. Based on drawings by Joel Crea of a structure in South Park City, Colorado, the craftsman-style kit features laser-cut wood components, self-squaring walls, positionable doors and windows with laser-cut glazing, etched floor boards, removable roofs, a brick chimney, signage, and laser-cut tar paper roofing. The HO scale version of the kit includes extra interior window and door frames.



When you see this symbol, it means:

“Click here to learn more!”

Every click tells advertisers an ad in MRH is a wise investment ...

DISCLAIMER

The opinions expressed in this column are those of the writer and do not necessarily reflect the opinion of Model Railroad Hobbyist or its sponsors. Every effort is made to provide our readers with accurate and responsible news and information, however, neither Model Railroad Hobbyist or the writer of this column can be held responsible for any inaccuracies or typographical errors that may inadvertently appear in this publication.

Briefly noted at press time...

... Month after month, Athearn continues to generate new products at a prodigious rate. The most recent announcement listed a combination of more than 200 different decorating and numbering schemes on 23 upgraded or newly tooled HO and N scale models. We'll provide more details next month, meanwhile, here's a quick look at four new HO scale items:

Genesis-series FP7-F7B A&B diesels will arrive in August decorated for Pennsylvania Railroad, with Union Pacific F units following 30 days later. In October, Southern Pacific FP7-F7Bs in the classic Black Widow scheme will be released with a choice of either road pilots or snow plows. The locomotives are equipped with DCC and will be available without sound or with Tsunami Sound by Soundtraxx.

Athearn is modifying the tooling of its 50-foot PC&F boxcar to create a welded-side car with a 10-foot door. The new Genesis Series car is scheduled to be ready for dealers in September decorated for BN, GN, RBBN-Western Fruit Express, and RBWX-Western Fruit Express. Features include a photo-etched end platform, coupler lift bars, separately-applied door hardware, and wheelsets with .110-inch treads and operating bearing caps. An undecorated car will be available as an unassembled kit -- an unusual option for a Genesis-series car, but one thought necessary by Athearn in view of the challenge of painting this complex car.

Utilizing reworked tooling originated by Rail Power Products, Athearn will deliver standard DCC-ready SD35 diesel locomotives in September decorated for Santa Fe (blue freight), Baltimore & Ohio, Canadian Pacific, and D&RGW (Rio Grande speed-writing).

Athearn designers continue to add new payload configurations to its Ford F-850 truck. The latest, a Flat Bed, is coming in August. With homage to the Eagles, I'm personally looking forward to adding to my layout..."A girl, my Lord, in a flat bed Ford, slowing down to take a look at me." ■

About our news and events editor



Richard Bale writes our news column under the byline of The Old Yardmaster. He has been writing about the model railroad trade for various hobby publications since the 1960s.

Deluxe Track-Cleaning Slider Car. Homemade car that helps you keep the rails clean. - Mike Ruby. Photos by the author. Includes text and images of the slider car.

Did you see this article in MRH? Model Railroad Hobbyist is loaded with articles like this in our back issue archives!



Click to download some back issues today!

(Psst! Back issues are FREE too!)



Send us your product announcements!

If you are a hobby manufacturer with a product you want to announce, just click here and submit your announcement to us!



Selected Events

May 2010

ILLINOIS, HOMEWOOD, May 16-17, Annual Rail Heritage Day, Municipal Center Park District Auditorium. Info at 708-957-7944.

OHIO, HILLIARD (COLUMBUS), May 1-2, N Scale Weekend, Franklin County Fairgrounds. Info at www.centralohiontrak.org.

WASHINGTON, AUBURN, May 8, 11th Annual Northwest Santa Fe Mini-Meet, Messiah Lutheran Church, 410 H Street NE. Details from John Thompson at jthomp1945@aol.com.

WEST VIRGINIA, CASS, May 21-23, Cass Railfan Weekend. Multiple events, some requiring advance reservations. Details at www.msrlha.org/rfw/index.html.

WEST VIRGINIA, CHARLESTON, May 13-16, Coalfield Express, NMRA Mid-Central Region Convention, Embassy Suites Hotel. Info at www.coaldivision.org/coalfield_express.

CANADA, ONTARIO, TORONTO, May 20-23, Annual Fest of Canadian Association of Railway Modelers (CAORM), Lakeshore Campus Humber College. Details at www.caorm.org.

CANADA, WINNIPEG, MANITOBA, May 28-30, Steam on the Prairies, NMRA Thousand Lakes Region Convention, Canadian Mennonite University. Info at www.thousandlakesregion.org.

June 2010

CALIFORNIA, RICHMOND, June 26, Bay Area Prototype Modelers meet, St. David's School Hall, 871 Sonoma Street.

CALIFORNIA, SANTA CLARA, June 30-July 3, O scale National Convention, Details from chairman Rod Miller at www.2010oscalenational.com.

COLORADO, ALAMOSA, June 3-6, NMRA Rocky Mountain Region Convention, Inn of the Rio Grande, 333 Santa Fe Avenue. Details at www.trackstoalamosa.org.

COLORADO, LITTLETON, June 11-12, 4th Annual Rocky Mountain Prototype Modelers Meet, Littleton Baptist Church, 1400 W. Caley Avenue. Details at www.rockymountainprototypemodelers.org.

CONN., COLLINSVILLE, June 4-5, New England Prototype Modelers Meet, Canton Community Center, 40 Dyer Avenue. Details at www.neprototypemeet.com.

KANSAS, MERRIAM, June 26, 8th Annual Narrow Gauge Meet hosted by Kansas City Area Narrow Gaugers, Johnson County Library, Antioch Branch, 8700 Shawnee Mission Parkway. Contact Larry Alfred at captlalfred@gmail.com for details.

Future 2010

ILLINOIS, NAPERVILLE, October 21-24, Naperville RPM Meet, Naperville Holiday Inn. www.railroadprototypemodelers.com/rpm-2010-eventsmeets/rpm-naperville-il-oct-21-24

KANSAS, BENTON, November 6-7, Mid-Continent Prototype Modelers Meet, Benton Lions Community Center, 150 S. Main Street. Details at www.midcontinentprototypemodelers.org.

MASS., MANSFIELD, Nov 10-14, Craftsman Structure Show, Mansfield Holiday Inn. Details at www.css2010.com.

MISSOURI, ST LOUIS, September 1-4, 30th National Narrow Gauge Convention, St Charles Convention Center. Details at www.30ngconvention.org.

NORTH CAROLINA, PISGAH FOREST (NEAR BREVARD), October 8-9, Narrow Trak 2010, Transylvania County Recreation Center, hosted by Frank Pearsall.

WISCONSIN, MILWAUKEE, July 11-18, NMRA 75th Anniversary National Convention, details at www.nmra75.org.

WISCONSIN, MILWAUKEE, November 13-14, Trainfest, Wisconsin Exposition Center at State Fair Park. Details at www.trainfest.com.

Future 2011

MASSACHUSETTS, AMHERST, January 29-30, 2011, Amherst Railroad Society Annual Hobby Show, Eastern States Exposition Fairgrounds, West Springfield.

NORTH CAROLINA, HICKORY, September 7-10, National Narrow Gauge Convention. ■

MRH

Questions, Answers and Tips

Reader Feedback
(click here)

QUESTIONS AND ANSWERS

Q: I've decided I want to use DCC on my layout because it simplifies the track wiring. But I've heard that I should divide my layout into blocks. What's going on with that? I thought DCC got rid of blocks?

A: It's true that DCC allows independent control of multiple locomotives on the same track(s). This relieves a layout builder of the need to have a separate block for each train, with each block having a selector switch that connects one of two or more cabs to the block.

However, there are still a number of very good reasons for separating a layout into blocks.

The first is to make it easier to find short circuits. If each block can be turned 'off' (disconnected from its DCC booster) you can isolate a short circuit to a single block. This is a big improvement over facing several hundred (or thousand!) feet of track, an part of which could have the problem.

A second is to prevent a temporary short circuit in one area (often caused by a derailment at a turnout) from stopping all the other trains on the layout, too. By using current limiting devices in series with each block, the DCC booster doesn't see the short circuit and shut down leaving power for the other blocks.

A third reason is signalling. For signals to detect the presence of a train in a

Figure 1: A portion of a layout divided into 3 blocks using common rail wiring.

The DCC booster drives a main bus. Short prevention/detection circuits connect each block sub-bus to the main bus. Good wiring practice is to add a feeder from every piece of track to the sub-bus for its block.

Using a toggle switch to connect the blocks to the main bus makes it easy to determine which block has a short circuit.

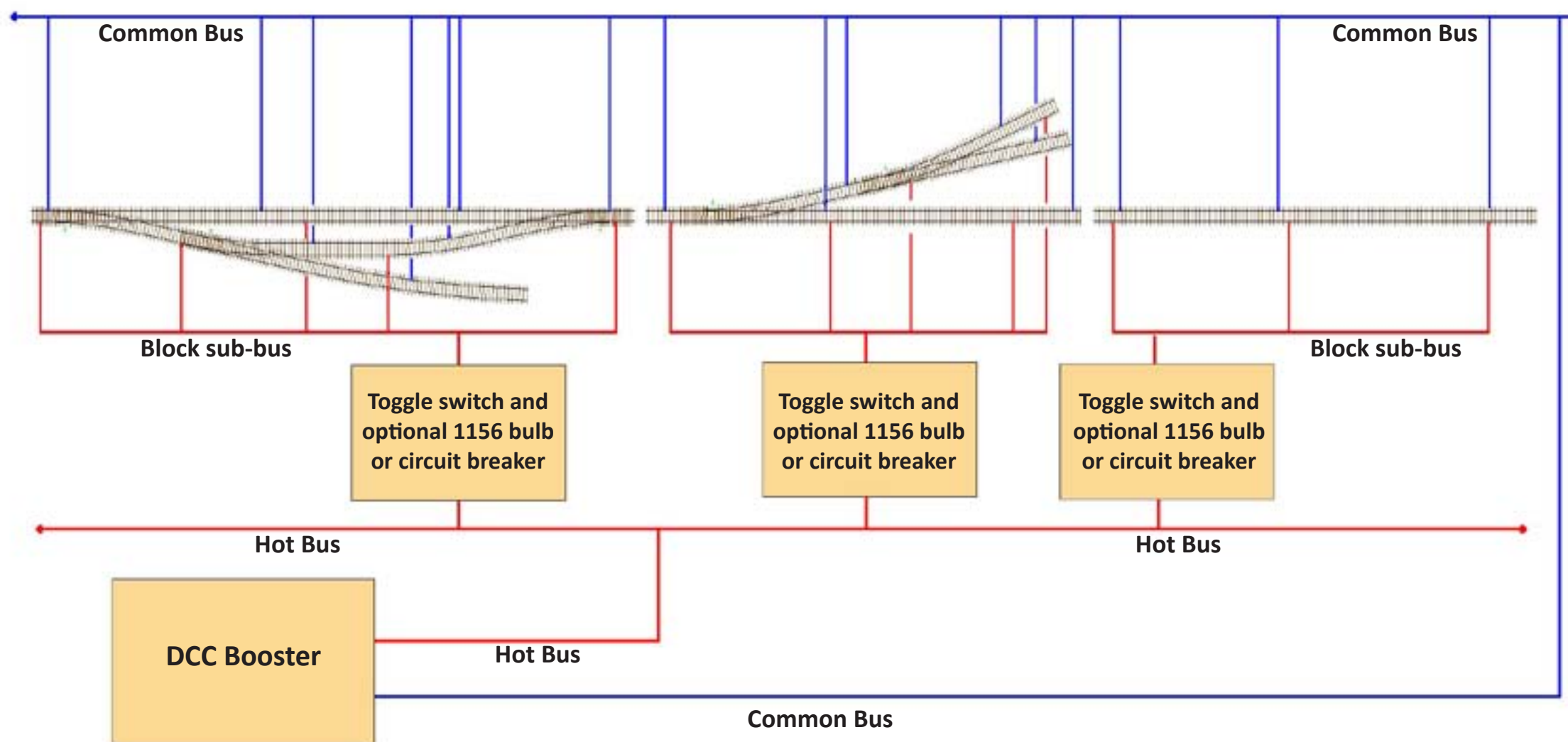

block, you need to divide the track into electrically isolated blocks.

Figure 1 shows a portion of a layout separated into blocks and using short circuit isolation for each block.

— **Charlie Comstock**

Q: My friend says I should cut off the ‘dangler’ thingees on Kadee couplers because they don’t look realistic. Is this a good idea?

A: The “dangler” thing on Kadee and other magnetic knuckle couplers is known as the Coupler Trip Pin and is required if you use magnets under or on the track to uncouple cars. If

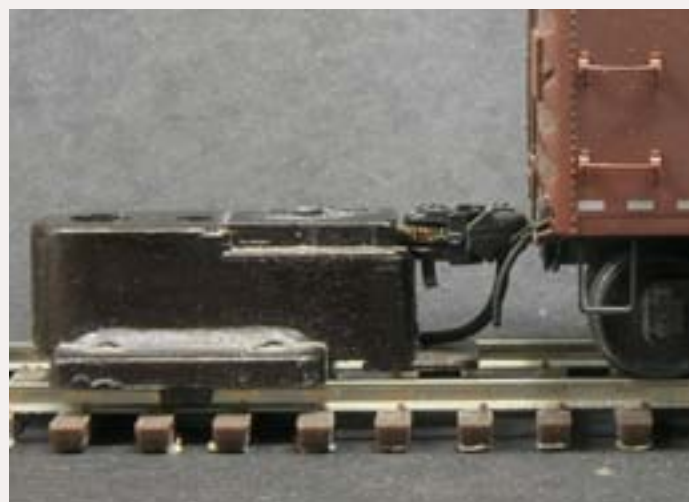

Figure 2: A Kadee 205 height gauge. Both the coupler and the trip pin are at correct height in this illustration.

you aren’t using the magnetic uncoupling feature of the Kadee couplers, go ahead and cut them off, since they have no effect on coupling cars together. I recommend using a good pair of wire cutters - not your track

cutters - to cut with. Wear eye protection - the pins tend to go flying.

That said, it’s your railroad, so if you want to keep them, there is no harm in doing so, as long as you make sure to use a [Kadee #205](#) or a [Kadee #206](#) Coupler Height Gauge to insure that the trip pins aren’t going to drag or catch on anything between the tracks, such as a grade crossing.

They can be bent as needed either by very careful use of a pair of pliers or by using the [Kadee #207 Coupler Trip Pin Pliers](#) which are designed for this task.

— **Jeff Shultz**

Q: Why do some cabooses have windows in different places - cupola, bay window, wide vision?

A: The answer seems to be that freight cars got taller. The American Association of Railroads (AAR) has created a set of standardized heights and widths known as Plates. They are identified by letter starting with Plate B for the smallest and going up to Plate J for autorack cars. A complete set of AAR Plate diagrams, as well as some international ones, can be found at www.emdx.org/rail/Gabarit/ComparaisonGabaritsEuropeEtAAR.pdf (PDF File).

When cabooses were common, the trainmen riding in them looked out the cupola (or bay) windows for signs

of derailments or ‘hotboxes’ (an axle bearing that was failing could get hot enough to start a fire, cause the bearing to seize, or a truck could fail catastrophically). As long as railroad cars were within Plate B sizes, a conductor in a standard cupola caboose had no problems looking over the top of a train to see if there were any problems.

Once larger cars such as Plate E, Plate F, or even larger came into service it was no longer possible to see over those cars all the way to the front of the train - so instead they changed to seeing around the cars instead of above them - Bay Window and Wide Vision Caboose helped them to do this.

Nowadays of course there is a FRED (Flashing Rear End Device) to report the brake air pressure to the engineer via radio. Problems like hotboxes or dragging equipment are detected by automatic equipment mounted along the track in various locations, (also reporting problems via radio) - if you’ve ever heard a voice on the radio announce that it is “*Detector such-and-such, 100 axles, no defects*” you’ve heard a detector reporting back to a train that just passed it.

To model these detectors in HO Scale, you could use the Details West kits for the [Hotbox Detector](#) and [Dragging Equipment Detector](#).

— **Jeff Shultz**

Q: I want to build a grade crossing for a highway on my layout. I’ve noticed that some grade crossings are just pavement across the rails, some use old railroad ties, and some use some kind of rubbery looking material. Which should I use?

A: This is one of those questions for which the answer is “it depends.” What it depends on is what type of road it is, what type of track it is and what your prototype (if any) does.

With the variety of durable grade crossing materials out there now, I doubt you’ll find ties being installed on any mainline trackage, and probably not on many short or branchlines either, aside perhaps for private crossings. Fortunately, it’s easy to model all of the different types of grade crossings.

For ordinary pavement crossings you simply need to put whatever your pavement material is between the rails, leaving enough room on each side for the flanges. Modular concrete & rubber grade crossings are made in HO, N and Z scales by MRH Sponsoring advertiser BLMA (blma-models.com) as well as in HO scale by Walthers, our latest Sponsoring advertiser, (www.walthers.com) in their Cornerstone line.

Straight and curved wood grade crossings are available from Blair Line (www.blairline.com/miscsce) and GCLaser (www.gclaser.com) in scales from Z to S, including narrow gauges.

Of historical note, I found a photo online claiming to be of the first railroad crossing using rubber paving in Racine, Wisconsin in 1925 - www.wisconsinhistory.org/whi/fullimage.asp?id=40035

— Jeff Shultz

TIPS



“FREE” tools source with your next annual dental checkup:

A friend of mine is a dental hygienist.

I asked her if the

scraping and picking tools ever dull, and if so, and what do they do with their old instruments? To my surprise, she told me that the tips do break, and if that happens on either end of the tool, they are just sterilized and retired for disposal.



Figure 3: Assorted dental picks - useful for carving rocks or other scraping duties.

I told her the picks make great tools for model railroading and would it be possible to get some of the rejects? The next day I received over a dozen sterile dental tools, albeit minus one point or a chipped edge. (The key word is sterile. These instruments are considered “sharps” and are a “bio-hazard” unless sterilized).

It wouldn’t hurt to ask your dentist about what he or she does with their damaged tools. You might just recoup a little on your bill.

But visualizing one of these tools of the devil actually breaking in one’s mouth made me kind of wonder... just where do those tiny broken parts end up? Maybe this is why your dentist asks to “spit” so often.

— Ken Ferguson

Narrow masking tape:

When masking for painting on my models, I often cut down regular 1/2” or 1” masking tape into narrow strips 1/8” or 1/16” wide - by taping a strip to a piece of glass and use a fresh single-edged razor blade.



Figure 4: K-Tape, narrow masking tape (from amazon.com)

I recently found auto supply stores provide very narrow masking tape for use in automotive painting. K-Tape is a good brand. You can also find K-Tape on the internet at Amazon if you Google ‘k tape masking fine amazon’.

I now try to keep rolls of the 1/4”, 1/8” and 1/16” widths on hand.

— Joe Fugate

Cats and trains and screen doors:

I live with two cats in a part of the country where below-zero temperatures are normal in the winter. Keeping the train room door closed is not a good idea - we have a furnace, but closed rooms don’t get much air and heat flow, not a comfortable environment for railroads (I don’t want my paint, or other important things, freezing in there!).

My solution was to hang a screen door on the outside of the bedroom door frame. This lets me leave the normal door open, so the room stays warmer in the winter, but keeps cats and occasional young grandkids out when I am not present. I used the least expensive wooden screen door from a local big box store. I had to trim the door edges to fit properly on the interior door frame - it was a bit too wide. I put a pull handle on the door and mounted a latch at shoulder height.

The layout across the door is a liftout section which I remove to convert the train room to a guest bedroom. I leave the liftout in place and use the screen door to control access at other times. I pull the regular door off and store it under the layout - removing



Figure 5: The cat containment screen door on Terry’s train room.

it gives me an additional 6 inches of layout width in that area. The screen door stays on all of the time.

— Terry Roberts

GET \$25 PER TIP



We pay \$25 USD per tip if we publish it. [So send in your modeling tips to Model Railroad Hobbyist](#) and we’ll get your payment to you upon acceptance.

Just think, for only a few minutes effort, you could fund your next piece of rolling stock – or even pay for an entire train if you send in several tips and we publish them!

If you include any photos with your tip, we pay a bonus of \$10 per photo we use with the tip. ■

We didn't join
to showoff or boast.
We joined for one
reason. To learn.



prototype weathering
really isn't anything
new. Mother nature
has been doing it
for years!

Along with world class
modeling we offer some
unique insite into
what it takes to take
your modeling to the
next level!



visit Weathering Solutions, proud sponser of
The Proto Weathering Forum.

A.I.M. Weathering Powders are always discounted

Coming Soon



This Beautiful PRR H30b in HO Scale.

weatheringsolutions.net



click to visit us today!

There are no better Rail History Books for your Library



Click here to
learn more!

SIGNATURE PRESS

Order securely at: www.signaturepress.com
or order direct: 11508 Green Rd, Wilton, CA 95693

TELEPHONE ORDERS OR DEALER INQUIRIES TO:
1-800-305-7942



see our web site for information on all our books

Still looking for the key to easier Decoder installs?



Look no further than
www.traintekllc.com



CLICK TO LEARN MORE



Proto-freelancing a Canadian Prairie Crossing

This mid-sized HO layout showcases
elevators and two railways...

— by **Byron Henderson**
www.layoutvision.com



The high plains of Alberta are the subject for this HO layout set in 1957. My client wanted to reflect a typical rural small-town atmosphere and feature branchlines of two of his favorite prototypes, the Canadian National (CN) and Northern Alberta Railways (NAR).

Figure 1: This scene on the [Alberta Prairie Railway](#) in Big Valley, Alberta, might have come from the 1957 era of the layout (only the high-cube boxcars give it away). Peter Bowler caught the tourist line's immaculate 2-8-0 and the restored elevator in May 2003.



Figure 3: Although the SD40-2Fs and cylindrical grain hoppers are from a later era, the “prairie skyscraper” at Tempest, Alberta, still stood proudly in July, 2008. Tim Stevens photo.

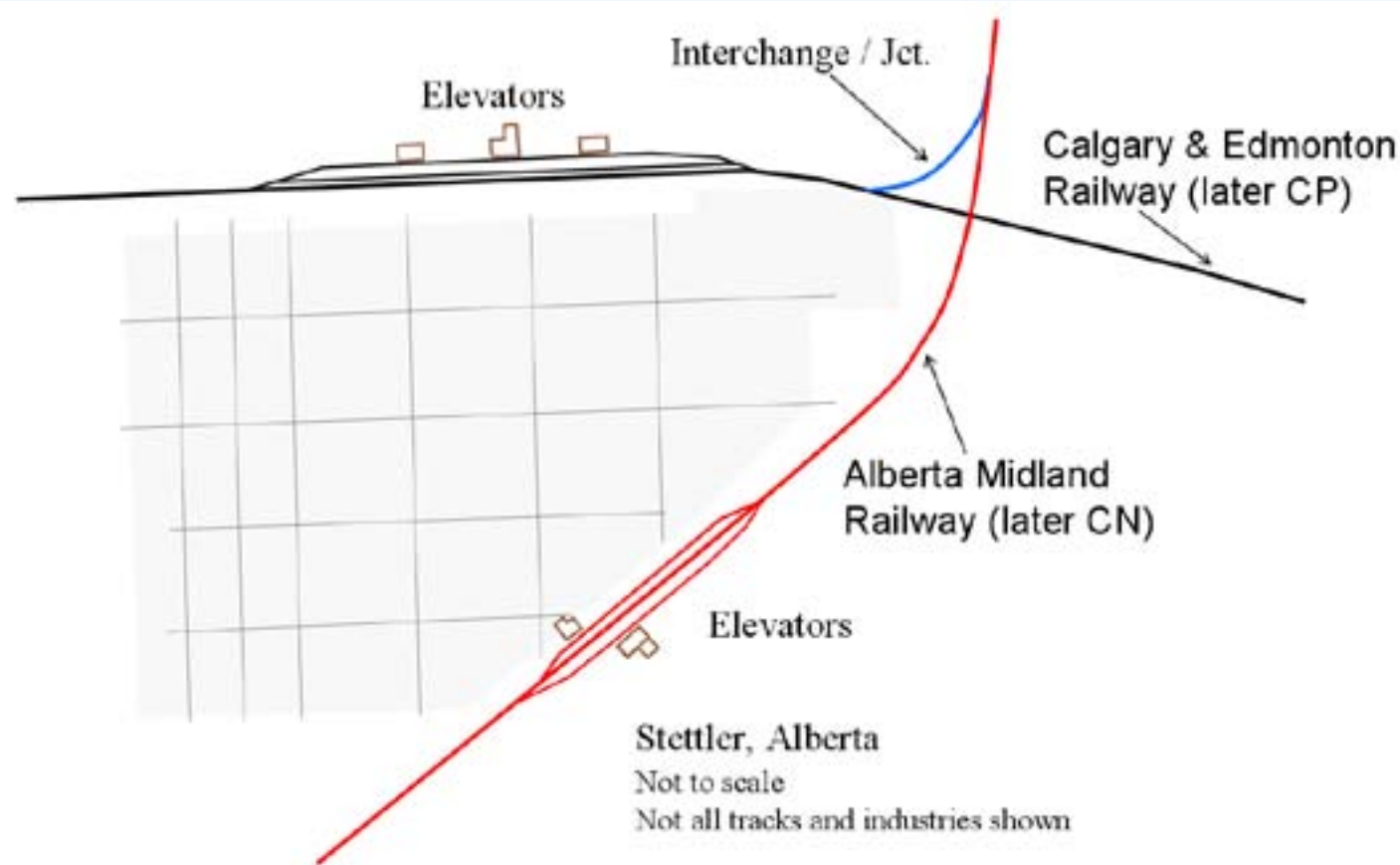

Figure 2: Stettler, Alberta inspired the crossing and interchange scene on the layout. Double-ended sidings on each of the crossing lines served a number of elevators.

Prairie town priorities

In real life, the CN and NAR intersected only in Edmonton, so we proto-freelanced a crossing out on the rural prairie. My client suggested that we consider Stettler, Alberta as an inspiration for the layout, although no effort was made to duplicate the real location.

Stettler (see map, Figure 2) had a couple of interesting features we wanted to capture in the layout. There are grain elevators on both of the crossing lines. And as is typical of many small Canadian prairie towns,

these elevators are situated on double-ended sidings. A short interchange and/or junction track joins the two main tracks in one quadrant of the crossing.

My client felt that he didn't need a lot of railroad “infrastructure” such as a large classification yard, so the focus was on capturing as much of the feeling as we could of the small towns themselves, using staging to represent distant division points and classification yards.

The goal for the layout became incorporating one or two small towns and one or two larger towns that could be

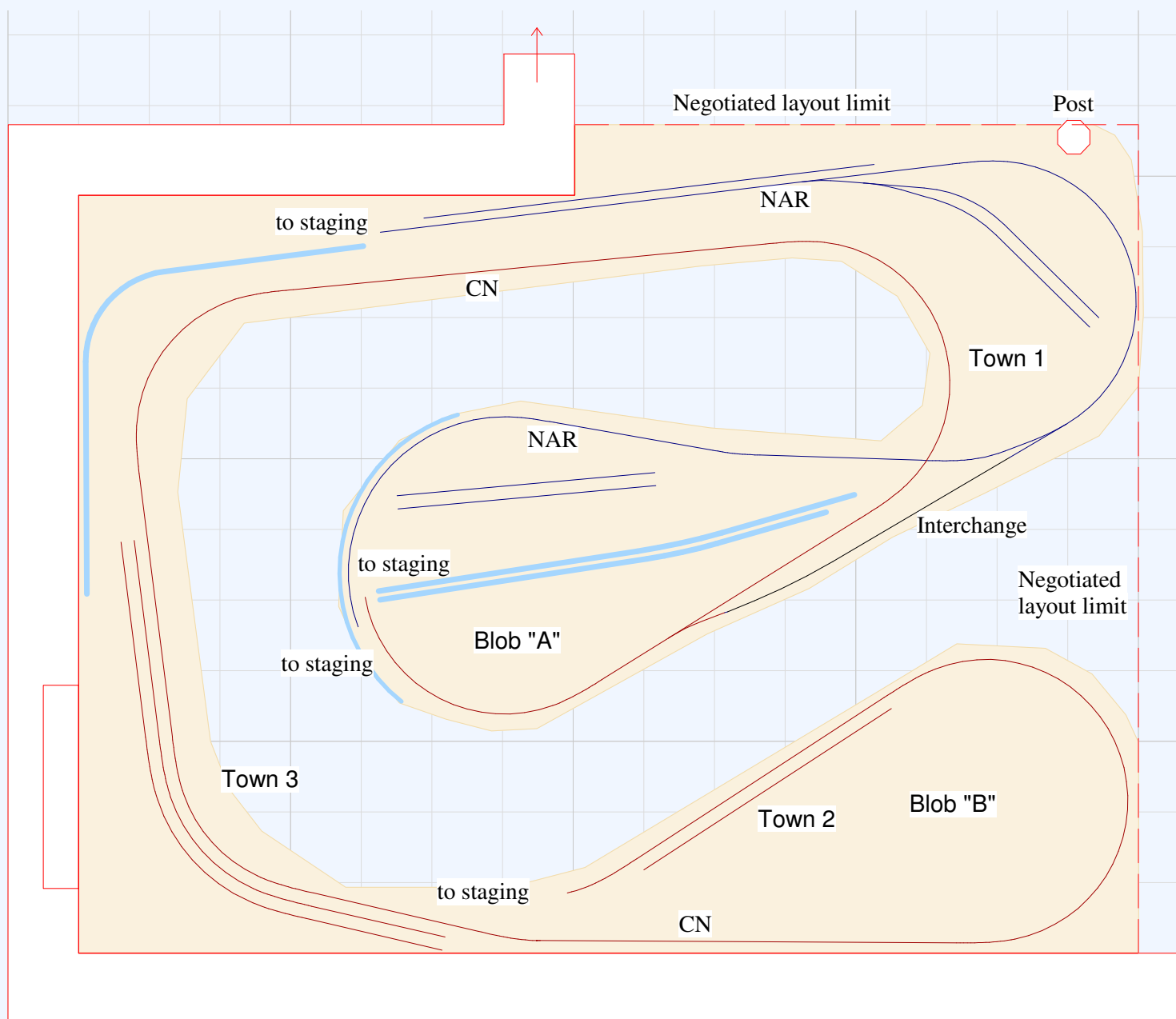

Figure 4: A long spiral footprint offered a number of good features (including easy walk-in), but it would have been a challenge to scenic the staging connections.

Byron Henderson is a custom model railroad layout designer from San Jose, CA. Byron is a member of the [Layout Design SIG](#) and [Operations SIG](#), and is a past editor of the LDSIG's *Layout Design Journal*.



the basis for modest branchline operations of freight and mixed trains.

Finding a footprint

With a proto-freelanced town in mind, we began looking at footprints. The space available was the roughly 170 square foot corner of a nicely-finished basement. A support column stands near one corner of the negotiated space, but otherwise, there were no major issues. Besides the branchline-style operation, a provision for continuous running on one or both lines was also a requirement.

... the tricky arrangement needed to accommodate staging connections created some potential appearance issues.

Although my client indicated that he had no concern about building some sort of moveable benchwork, I often try to at least explore a walk-in footprint for the available space, such as a spiral peninsula.

The first effort (Figure 4) had some good points, but the desired crossing and the tricky arrangement needed to accommodate staging connections created some potential appearance issues. With a little more space, this tack might have warranted more effort, but we elected to look instead at an around-the-room oval

approach, with most of the operation from the center of the “doughnut” (Tim Hortons, no doubt).

Working the room

Because of the way the layout was situated in the larger basement area, there was the potential for some operation and viewing from outside. Because I felt the layout benchwork might become a bit deep in the area of the crossing, I placed this feature near the outside aisle.

Building from the crossing and interchange, the resulting plan (Figures 5 a&b) offers two small towns, Millet and Hastings, along with the slightly larger town of St. Albert. (All the names are placeholders only; the client has yet to choose the final appellations.)

Building from the crossing and interchange, the resulting plan offers two small towns...

The CN has the major role here. Besides the elevators, oil distributor, and feed-and-seed in Millet, Hastings boasts multiple elevators and a larger industry (packing house or similar) placed against the backdrop of a narrow peninsula. This peninsula helps separate the layout into scenes and also makes better use of the large area in the center.

Canadian Prairie Crossing

Scale: HO
 Size: 15'x 11'8" overall
 Era: 1957
 Locale: Alberta, Canada
 Min radius: 24" on main

Turnouts: Atlas C83
 Max. grade: 3%
 Style: Nested loops with crossing.
 Size: 15'x 11'8" overall

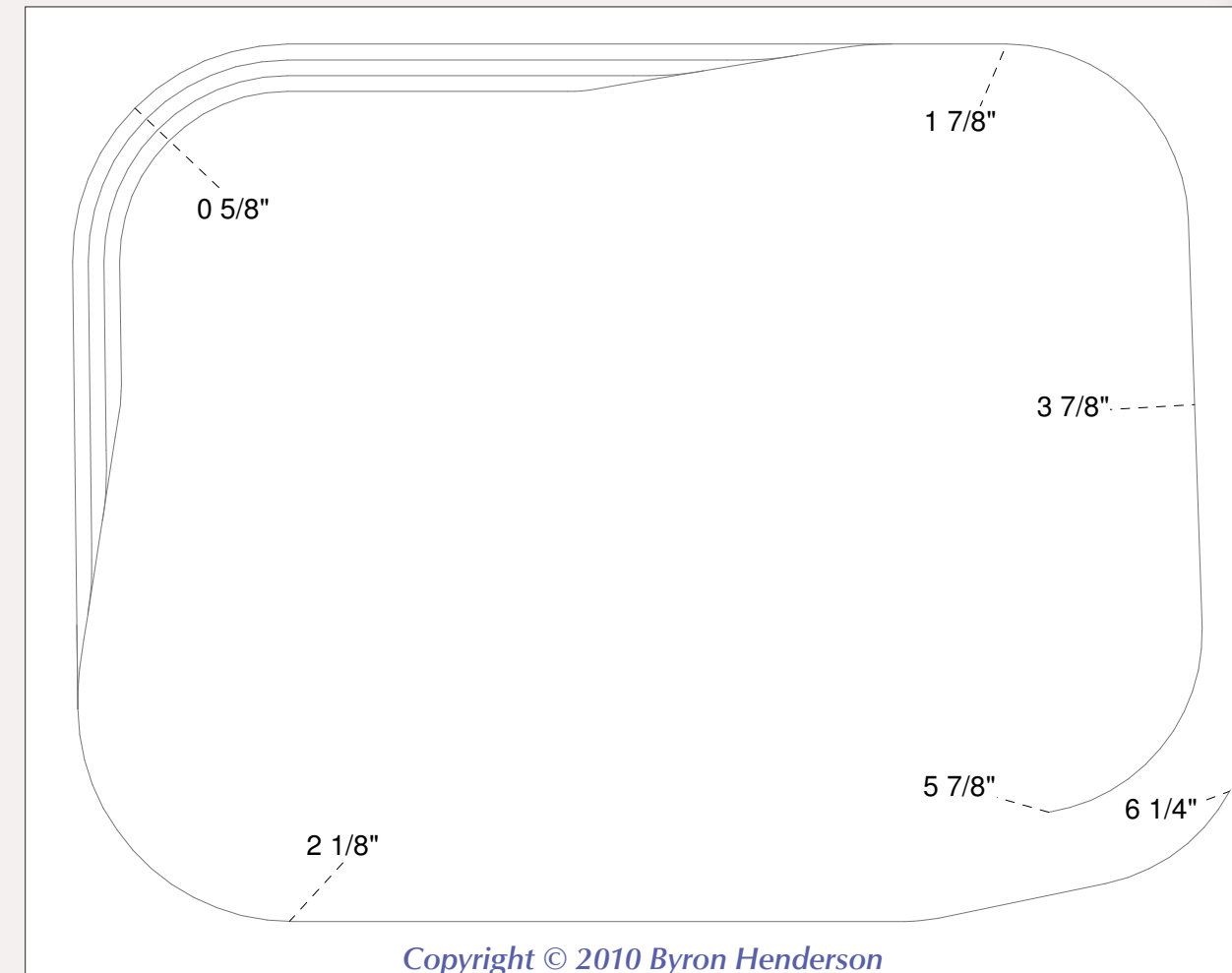
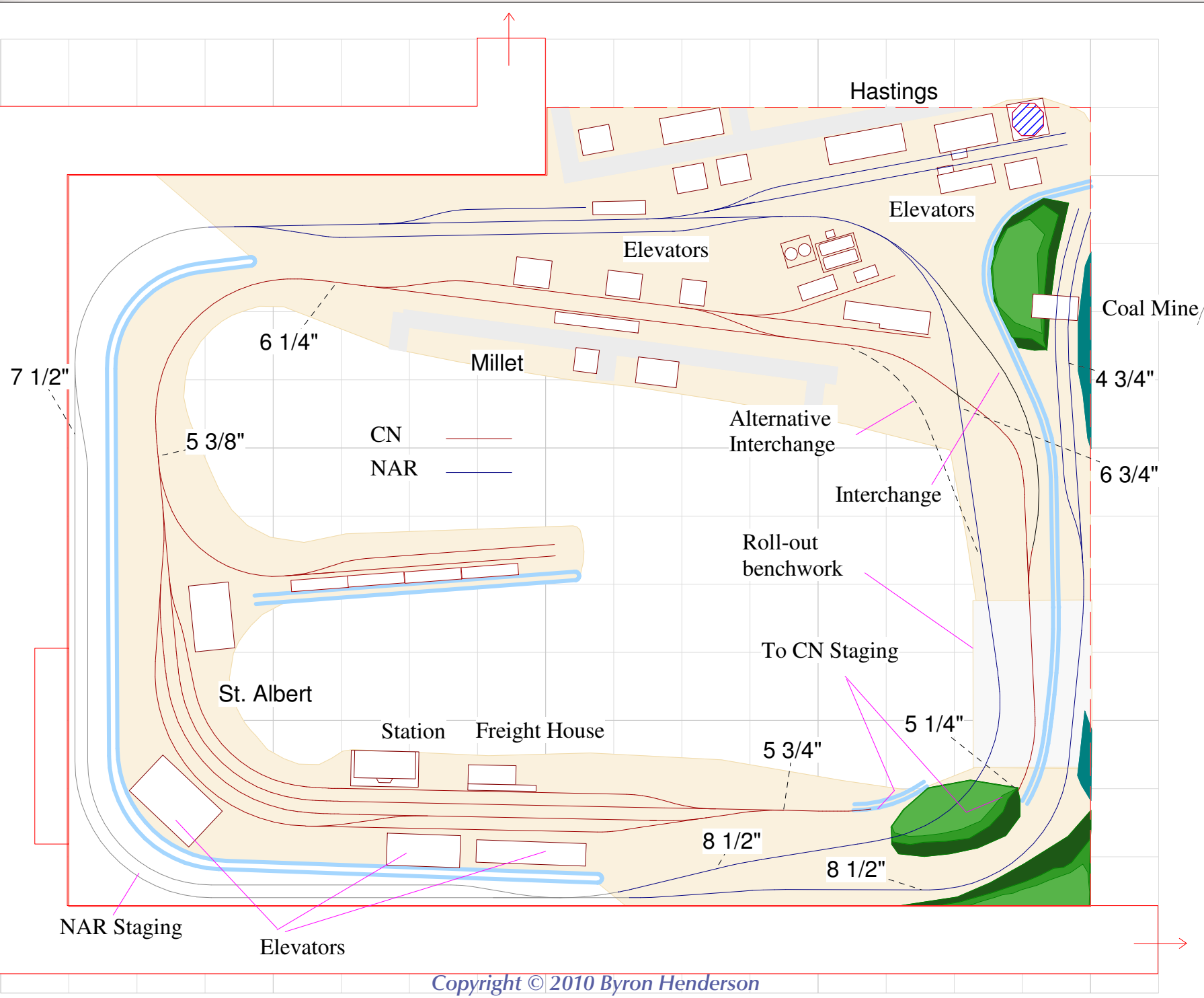

Figure 5a: main deck (12" grid) - the final "doughnut" style plan offers room to work inside and outside the benchwork, at the cost of some fairly complex elevations at the lower right. You can 'zoom' into this track plan for more detail.

Figure 5b: lower staging - the staging below the final "doughnut" plan offers 4 storage tracks.

A somewhat tricky criss-crossing configuration in the lower right corner of the plan leads to the CN staging below St. Albert.

The NAR serves the small town of Hastings, where I added a slightly out-of-character elevator "alley". This

allowed me to propose partially concealing the support column inside a grain elevator.

My client also suggested that we set aside some part of the outside edge for a riverside coal mine scene, since the NAR had a heavy coal focus

in real life. NAR staging is tucked behind the backdrop at St. Albert.

Concept to construction

Construction is underway, with my client beginning with a 1:1 printout of his final plan derived from my design (Figure 6).

Sharp-eyed readers will notice the plan is simplified in the area of Hastings, creating a configuration a bit more like Stettler: Both the CN and the NAR will serve a single smaller town with elevators on both lines. He also selected the alternative interchange location.



Figure 6



Figure 8



Figure 7

Figure 6: Laying out the plan in 1:1 from printouts was the first step in benchwork construction. Note that some changes have been made from the original track plan. Dwayne Aasberg photo.

Figure 7: Construction of the benchwork is well under way in this view, with the roll-out movable section in place. Dwayne Aasberg photo.

Figure 8: A bit later in construction, we can see the arrangement of the subroadbed for staging and visible tracks crossing the movable section with the roll-out. Dwayne Aasberg photo.

The overall view of the benchwork (Figure 7) shows the roll-away section my client chose to allow easy entrance to the inner operating and viewing aisle. A later view of this area (Figure 8) from the inside aisle shows the complexity of the crossing tracks in this area.

Ops on the prairie

Sessions are intended to be a purposeful but relaxed exercise for a couple of operators. Branch freights and mixed trains may operate as turns (out-and-back) from staging, or a local may work in each direction, beginning and ending its run in staging. (With no turning

facilities, steam-powered turns would run in reverse on the return trip).

More interest - Less space

By forgoing some layout elements, such as a large classification yard, more

space is left to capture the atmosphere of rural Canadian railroading. Proto-freelancing lent itself well to distilling the essence of a favorite style of railroading in a modest amount of space -- while still leaving room to suggest the wide-open prairie.



Figure 9

Figure 9: June 2008 finds wide-cab Canadian National GP40-2(W) making a lift of grain cars from the elevator at Hawk Hills, Alberta. Sometimes even prairie modelers need a few trees. Tim Stevens photo.

Ah Ha! The Search is over!



Click to learn more

- DCC circuit breakers
 - Blast-mode programming booster
 - Wabbit turnout control
- ... and other *hard-to-find* DCC goodies





Retaining Walls from Pink Foam

by Rick Wade

Rigid extruded foam is common on model railroads. However, carving details into it, such as the stonework on this retaining wall into it, is something I just discovered.

I needed a curved retaining wall for my HO layout and didn't want to pay premium prices for commercial castings. I also didn't like the idea of making my terrain fit the wall – I wanted the wall

to fit the terrain. I like having something that is one of a kind, so making the wall out of pink foam was appealing, inexpensive and easy!

First, I used my hot-wire cutter cut a piece of 2" thick foam approximately 4" by 13" long (figure 2). I sanded the piece to the desired curve and height with a drywall sanding block. I finished sanding using the rougher side of the block, giving a gritty texture. I wanted a wall with columns, so I cut some 1/2" foam into 3/8" x 3/8" x 4" pieces using my fine tooth saw.

The next step was making the mortar lines. I "eyeballed" these, using a pizza cutter to 'roll' the horizontal lines first. I pressed a small screwdriver into the foam for the vertical mortar lines. I

offset them in adjacent rows to get a random stone look.

After the mortar lines were complete, I hot glued the vertical columns on the wall using foam-safe glue and then scored lines on them with the back side of a hobby knife to match the wall (figures 3 and 4).

I brushed *Apple Barrel* #2620 Pewter Gray over the entire wall (*Apple Barrel* is a brand of water based paints available at Michael's or the Hobby Lobby, but any water based paint will work). I thinned the paint - 1 part water to 3 parts paint. It's very important to make sure that you use foam-safe paint, NOT SOLVENT BASED, and that there is

Figure 1: The finished retaining wall installed on the author's layout.



Figure 2



Figure 3



Figure 4

Figures 2, 3, 4, 5: The stages of wall construction: raw bits and pieces, carved and assembled, and after initial coats of paint. Note the lip at the top, most of the wall is thick for strength, only the top is 'wall-thickness'.

 **Reader Feedback**
(click here) 



Figure 1



Figure 5

complete coverage. Any pink showing through will not look natural!

I randomly dabbed *Apple Barrel* #20526 Country Gray (a lighter gray)

on the surface to create subtle differences in shading. After the paint was completely dry, I used

Warning! Never use solvent based paints or glues when working with rigid pink foam!

a wash of black thinned with alcohol on the entire wall to bring out the details of the stones. Finally I mixed a small amount of Country Gray with white to create a very light (almost white) gray. I used this very light gray to highlight the stones by dry brushing it across the surface of the

stones, paying special attention to cover the edges of the columns.

I added extra interest with a top cap cut from a piece from $\frac{3}{16}$ " thick hobby

foam. I scored and dinged the cap before painting it concrete gray and hitting it with the black wash before I

hot glued it atop the wall (figure 6).

Something was still missing – dirt! I used *Apple Barrel* #20432 Nutmeg Brown and dry brushed it on the wall, being sure to apply more of it along the cap and base where it would naturally accumulate (figure 7).

Figures 6 and 7: The retaining wall ready for the top cap and after top cap installation with dry-brushed highlights.



Figure 6



Figure 7



The largest selection of scale Model Railroad Scenery Supplies on the web!

Click to visit!



Scenic EXPRESS Model Landscaping Supplies, Inc.

FINALLY!



"Somebody's
doing
laser kits
in more
than just
HO!"

Rslaserkits

Quality laser cut kits
structures to rolling stock in Z to O scales



rslaserkits.com

click to visit our web site ...



NEW!

VOL. 1

\$20*

Fillmore Yard on
GEORGE SELLIOS'

HO FRANKLIN & SOUTH MANCHESTER R.R.

Only 36
cents per
photo

Photos of George Sellios' Franklin & South Manchester

- Never-before photographed
Fillmore Yard
- Over 50 large high-quality digital
photographs

click this button to ...

Download Photos

Instant download!

**NOTE: George is generously donating a portion of the proceeds from each collection sold to help keep MRH forever free! Thanks, George!*



Jim Dias'

3rd sub-division layout

by Charlie Comstock



For the past 22 years, a beautiful model of the Western Pacific's 3rd Sub has been under construction in a San Francisco Bay Area garage. Drawing on the talents of many of his friends, Jim

Dias' layout includes a breathtakingly intricate model of the Keddie wye. This layout seems much larger than its size, because of its scenic vistas, realistic coloring and Jim's attention to detail.



**Reader
Feedback**
(click here)



I had the opportunity to visit Jim Dias' fantastic Western Pacific layout in May, 2009. Upon walking into what used to be a two-car garage, I was greeted by the sight of the high line and a detailed model of the Keddie Wye. A short duck-under took me into the inner sanctum where super-realistic scenery, structures, trains, and backdrop painting greeted me everywhere I looked.

Why the Western Pacific?

MRH: Jim how did you come to select the Western Pacific as a prototype?

Jim: To be quite honest with you it was kind of an accidental pick.

MRH: Accidental?

Jim: My love in railroading was logging with Shays and geared engines. Well, **Jack Burgess** [who lives 3 blocks from Jim], who was very influential in my modeling, said why don't you pick the Western Pacific to model?

So I forgot about logging railroads and started doing research on the Western Pacific and that's the direction my modeling went.

MRH: So you became a prototype modeler because of Jack?

Jim: Yes, Jack was a big influence! I had very little knowledge of the West-

ern Pacific when I started. I'm glad I picked it though, it's a mainline railroad, but it's like the Ma & Pa – what I call a real small one. I had a good time modeling it, doing the research, meeting people who worked on the railroad, and gathering things I'd need.

MRH: Is there a particular year you're modeling?

Jim: Yes, Jack got me down to a season of a single year - I'm modeling the spring of 1938.

MRH: Is there a reason you picked 1938?

Jim: Well, originally I was all over the map – 1930 to 1937. But there was a 40' box car on the WP had I really liked. It was rebuilt in 1938 so I stretched my time frame to 1938 and finally ended up doing only that year.

MRH: This isn't your first layout; how many have you had?

Jim: To be honest with you, there were two layouts prior to this. The first was in a 10' x 10' bedroom in my house in San Ramon. The second layout was built in this garage but it was unprototypical - it had tight radii, a dog-bone track plan and steep grades.

Figure 1 (previous page): WP #324 about to depart from Portola yard heading toward Blairsden.

Figure 2: Coming off the Keddie wye onto the high line. Following this track back through the tunnel would eventually take you to the Bay Area.



Figure 2



Figure 3

Like I said earlier, after I met Jack I came home and tore what I had down and started building this one.

MRH: How long have you been in the model railroad hobby?

Jim: 30 years.

MRH: Well you've accomplished an awful lot on this layout!

Jim: We've been in this house 24 years and I've been working on this layout probably 22 years: the design, insulating [the garage], updating the electrical [system], and the layout itself, but I'm still not done.

MRH: When you built this railroad, what style of benchwork did you use?

Jim: It was typical L-girder that Lynn Westcott recommended.

MRH: After you got the benchwork up, what did you use for roadbed?

Jim: 5/8" plywood with homasote on top of that.

MRH: Did you do the track plan yourself?

Figure 3: Running toward the Keddie wye beside the Feather River at Merlin

Jim: No, **Dave Clemens** did the track plan for me. He gave me the basis. It's changed a bit, but he gave me the initial track plan and I worked from

there. A round-robin group I belonged to helped me make a few changes.

MRH: Did the plan change a lot since the original, or did it slowly evolve?

Jim: Well, originally the track plan had a grade on it like the WP, which had a 1% grade in the [Feather River] canyon. The original track plan had a feature called William's Loop which goes over itself. I did away with that which allowed me to 'flatten' things (literally).

MRH: So there's no grade here? It looks like there's a grade!

Jim: There's no grade at all. I know, a lot of people are fooled.

MRH: It's an illusion?

Jim: Yes, I don't know if it's because of the way the backdrops are done or an effect of the hills and mountains but all the bench work is the same height.

MRH: Huh...

Jim: In some spots the fascias are higher than others but the bench work is the same height. There are no grades.

MRH: What are you using for a minimum radius?

Jim: The #3 track in Keddie yard is 24" radius but all the others except the curved leg of the wye are 30".

MRH: How about minimum turnout?

Jim: The minimum turnout is a #4 in the logging area, but most turnouts on the WP layout are #6.

MRH: I see you've got an articulated [locomotive] on the layout. How does that go through the 24" curve?



Figure 4

Figures 4, 5: Jim's love of logging led him to build a logging area on an upper deck (75.5" above the floor!). It's self-contained, there's no connection between it and the WP on the lower deck.

Jim: Well, it'll go through the 24" curve because **Al Massie** worked on most of my steam engines and got them to run pretty much like Swiss watches. It will go through that 24" curve but I generally run the big mallet out on the main which is a 30" radius except for the curved leg of the bridge [the Keddie Wye]. That's 28".



Figure 5



Figure 6

Figure 6: Engine 324 pulls into the yard at Portola from Merlin. This view can not be seen from an aisle. Note the realism of the ballast and weeds.

The Keddie Wye

MRH: You're modeling the famous wye at Keddie, built on steel trestles over Spanish Creek. Where on the Western Pacific, was this?

Jim: Well it was located on the 3rd sub-division between Oroville and Portola. The high line portion of the bridge went to Oregon. A lot of pictures have been taken of trains on this bridge! It is a very well-known railfan spot.

MRH: The California Zephyr was a famous passenger train that ran on the Western Pacific. Would it have traveled over the Keddie Wye?

Jim: Yes it would have.

Editor: Refer to Figure 8. The California Zephyr would have traveled over the right hand leg of the wye. The left hand leg is the high line leading to Oregon.

Jim: The high line bridge should be curved too, but on my layout it's straight because I had to make do with the room I had.

MRH: It's sure a great looking model! How much time did it take for you to build this bridge?

Jim: It was one of my first projects on this railroad. It took me about 8 years. I know it seems like a long time. I got some help from **Rick Fortin**.

MRH: It's very intricate.

Jim: It took me several years to get up enough nerve to start on it!

MRH: What did you use to build it?

Jim: I kit-bashed it out of Micro Engineering components.

MRH: If you built this bridge to scale, how much space would you have needed for it in HO?

Jim: Well on the main line I would have needed 7 feet and probably 7 feet on the high line side too, to do it proto-

typically. Because of the size of the layout room, I had to scale it down. I built the towers spindly so it would have the flavor of the Keddie wye.

Scenery

MRH: There is some very rugged country, lots of mountains, around there in the Sierras. How did you model it?

Jim: Most of the mountains and the hills were made with cardboard strips hot glued in a checkerboard fashion and covered with paper towels dipped in Hydrocal. I added two layers of towels, then I would shine a light up through it to see if I had any thin spots. If there were I'd mix more Hydrocal and brush it on until I got to where the light wouldn't shine through.

After the Hydrocal dried I painted it over with a color similar to the dirt. All the dirt you see on the layout is real dirt.

MRH: Where did you collect your dirt?

Jim: I went up to the areas that I'm modeling like Portola, Merlin, Keddie, and some other places. I collected the dirt and brought it back home in 5-gallon buckets and sifted it to get five or six different textures: fine dirt all up to rocks and boulders.

MRH: So you actually have the right colors because you went to where you're modeling to get those colors?

Jim: Exactly! It's the actual dirt from the places I'm modeling - so you're right, the colors are exact.

MRH: That's really cool. I notice your boulders are very real looking. Those came with the dirt?



Figure 7



Adrian Studer photo

Figure 8

Figure 7 (prev page): Mallet 252 leaving Keddie onto the wye headed toward the Bay Area (west) on Jim Dias' layout. The track in the foreground is the high line (to the left).

Figure 8: The Keddie Wye near Quincy, CA. Shot from highway 70 in October 2003.

The upper left track is the high line leading north to Oregon. To the right, tracks go to Keddie yard and eventually to Utah. The lower left tracks drop down out of the California Sierras heading for Oakland.

Photo by Adrian Studer, used under the GNU free documentation license.

Figure 9: An example of the beautiful backdrop painting (by Dave Biondi) behind the East Keddie turntable.



Figure 9

Jim: Yeah, the rocks came along with the buckets of dirt. It's like I said, I sifted it into various sizes...

MRH: So those are from the extra coarse grade of dirt...

Jim: Exactly, I used the rocks throughout the layout as boulders. They're not plaster that's been dyed.

MRH: Some of the rock outcroppings look like they were built in place (Figure 7)? Are those cast or carved plaster?

Jim: Yes, they're plaster, I did some rock carving and casting in different places.

MRH: Did you do much scenery on your previous layouts?

Jim: No this is my first layout that's actually had scenery on it.

MRH: Really? Did you have a scenery mentor or are you just a supremely talented fellow?

Jim: No, I'm not supremely talented. I was in a round-robin group with 3 others: **Steve Cavanaugh**, **Dave Biondi**, and **Dick Roberts**. They were pretty good modelers and I learned from them. Dave and all of us did scenery together and I learned [scenery] from there.

MRH: **Jack Burgess** is a fairly close neighbor of yours, did you learn stuff from him too?

Jim: Oh yeah. Like I said earlier, Jack was a big influence. As a matter of fact, even though I learned a lot from the

[Text continues on page 54](#)

Layout Summary

Name: The Western Pacific - 3rd Sub

Locale/Era: California Sierras, 1938

Scale: HO standard gauge

Room Size: About 20' x 16' + 3' x 11'

Track style: Loop with branchline

Mainline length: aprox 87'

Min. turnout: #4 (logging) #6 (main)

Min. radius: 28" mainline, 18" spur

Max grade: flat (main deck), 8% (logging)

Rail Sizes: Code 83, 70 & 55 (main deck), code 70 & 55 (logging)

Track elevation: 51" (main deck) 76" (logging)

Benchwork: L-girder

Scenery: Cardboard webbing covered with Hydrocal-dipped paper towels.

Number of Trees: about 500 on main deck

Rocks: Cast and hand carved plaster with hand tinting

Backdrop: 1/8" masonite, painting by *Dave Biondi*

Loco control: DCC

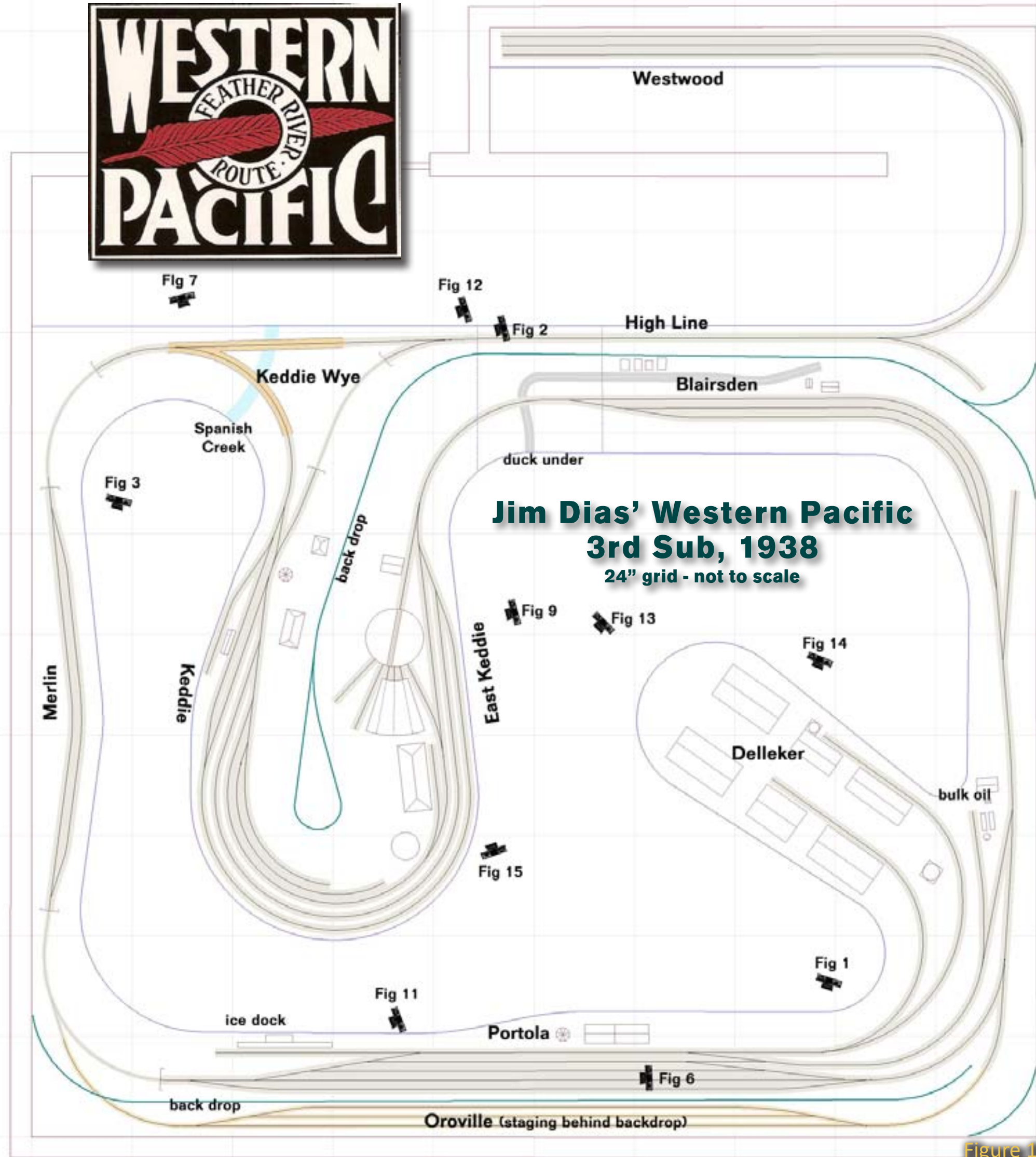

Figure 10

Want to see Jim Dias' layout in person? It's one of the layout tours for the 2011 NMRA national convention in Sacramento, CA.





Figure 11

Figure 11: The icing platform in Portola yard.

Figure 12: A train from Oroville crossing the wye on to the high line.

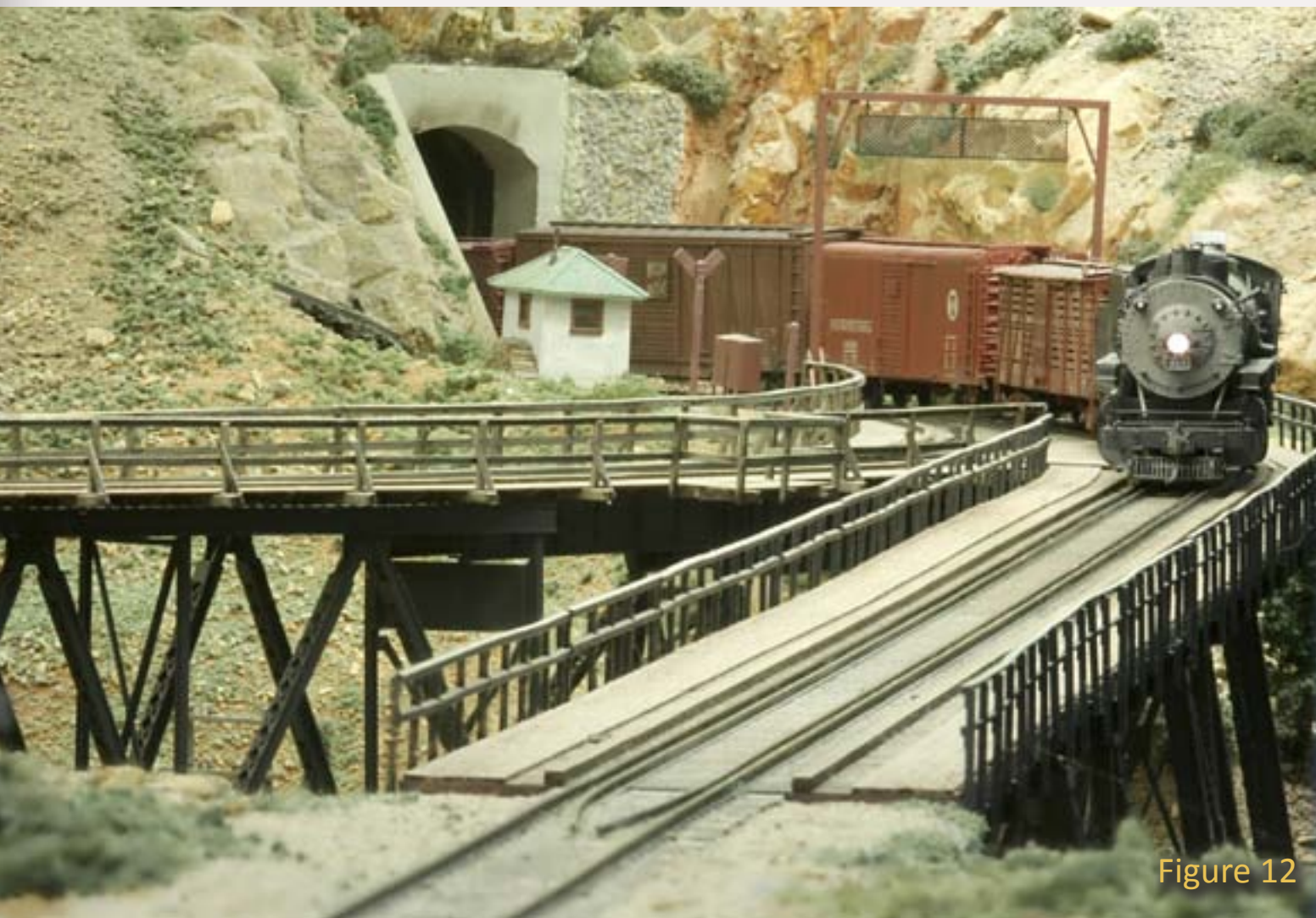

Figure 12

round-robin group, I was over at Jack's house a lot - looking at his layout and I learned a lot of stuff from him: how to cast rocks in molds and paint them, do scenery, apply dirt, make bushes – a lot of my bush-making I learned from Jack.

MRH: I see some water on the layout. Is that Envirotex or is it casting resin?

Jim: No, it's Envirotex. The reason I used that is because it's odorless!

MRH: I hear the casting resins get kind of stinky?

Jim: Yes they do, and I didn't want to smell up the house or the garage by using the resins.

... because of doing a layout modeled on this prototype, the buildings had to be scratch built - there are no commercial models for any of them...

Structures

MRH: What is your favorite part of building your railroad?

Jim: Well, I'm right now getting to that phase - building structures and doing the details – figures, automobiles, trucks....

MRH: Where do you get your structures? Are they scratch-built, kits, kit-bashed?

Jim: Well because of doing a layout modeled on this prototype, the buildings had to be scratch built - there are no commercial models for any of them. So everything is scratch built except for buildings that are serving as stand-ins until I can get around to building the real ones.

MRH: What's your favorite material for buildings? Are you a wood guy?

Jim: Basically I use styrene. 90% of the buildings that you see are made of styrene.

MRH: Is there a reason for that?

Jim: It's easier to work with and it's very durable.

MRH: Is it faster?

Jim: I think it is faster, at least for me.

MRH: There are quite a few structures here. Did you have help with them?

Figure 13: The scratch build East Keddie roundhouse.

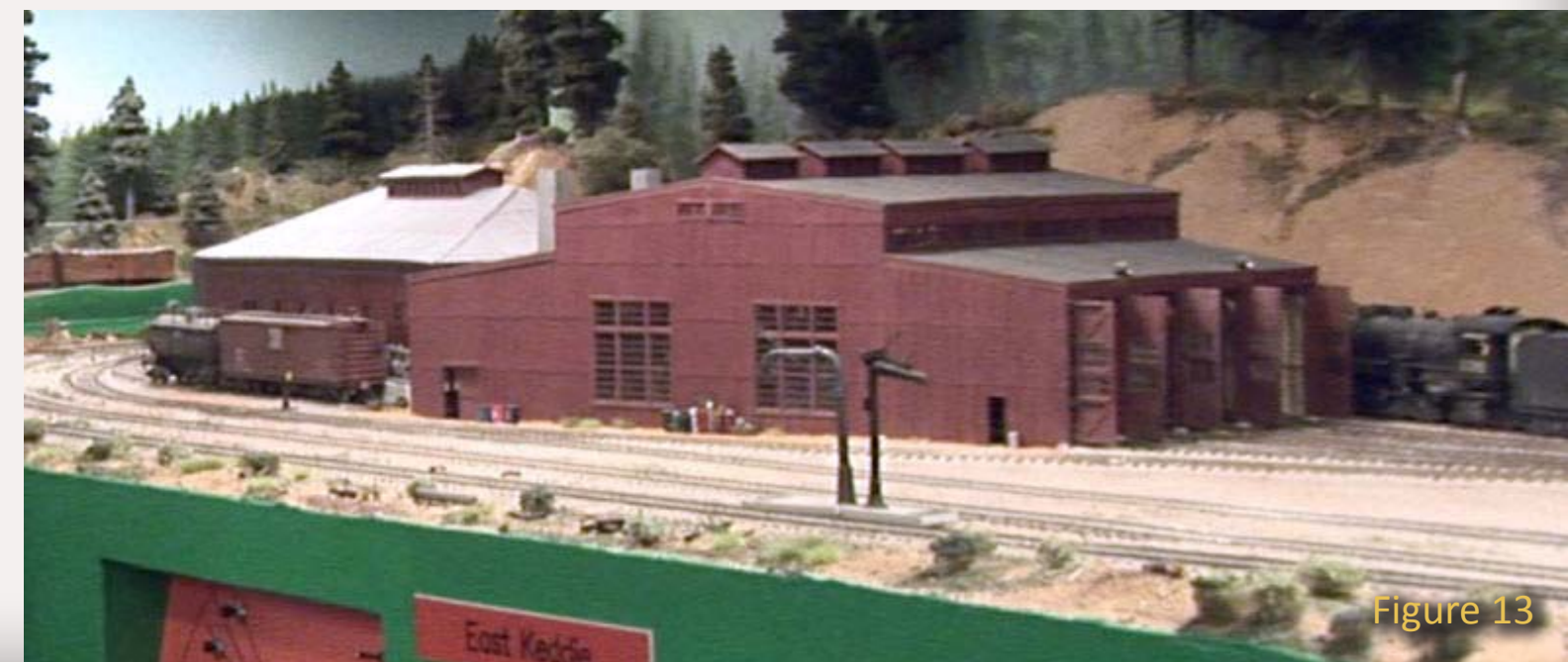
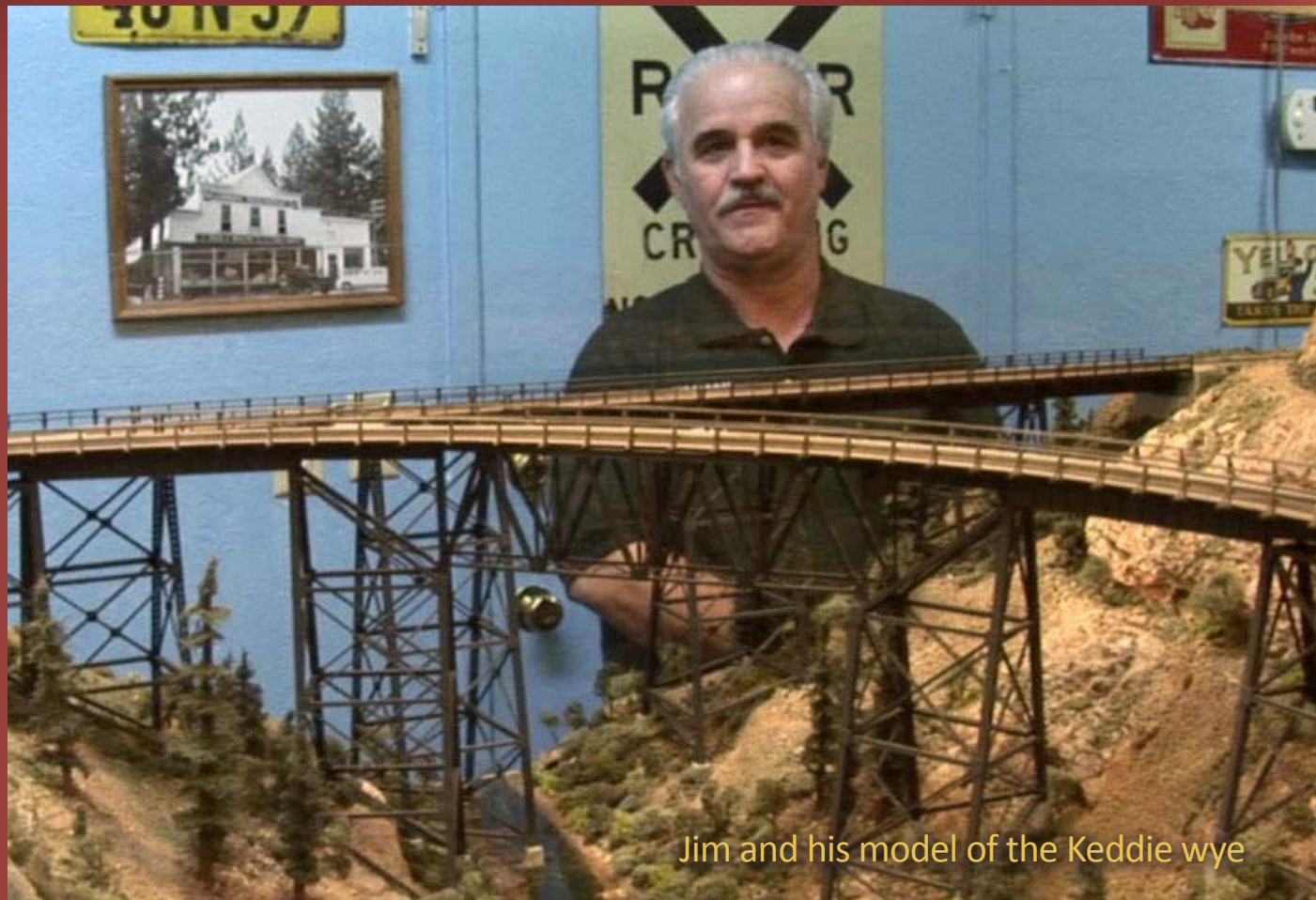

Figure 13



Jim and his model of the Keddie wye

Jim Dias is a California native. He got started on trains with a Lionel set when he was age 11. Since then, he's been married, raised a family, and built three layouts managing to do it all in the San

Francisco Bay Area. Jim lives near Jack Burgess where he learned a great deal about prototype modeling. His layout has been featured several times in national model train magazines.



Jim: Yes I did, for example the roundhouse in East Keddie (Figure 13). A good friend of mine, **Tom Lawler**, built the cement pits and made the lumber framing for it. Then I added the corrugated metal sides, the roof, and painted the building.

MRH: You said corrugated metal?

Jim: Yes, *Campbell Scale Models* has a product you can buy that looks just like corrugated metal. It comes in strips and you have to cut it to size. I believe 2 ½ feet was the standard size I used.

Editor: It's heavy duty aluminum foil, that's been embossed to look like corrugated steel. It looks very realistic.

MRH: Well it looks very real. Since it's so thin, it avoids the chunky look of too-thick plastic simulating corrugated steel.

Jim: That's why I use the corrugated metal sheets from Campbells – because they look so nice.

MRH: Were there any other things you had help with?

Jim: Yes, **Les Dalstead** and I cooperated on the large buildings in Delleker. They are all corrugated steel (Figure 14). I built all the shells and he put the corrugated metal on the buildings themselves.

Also, the machine shop [next to the Keddie roundhouse] was built by Dave Biondi, Les and me.

MRH: Were there other aspects of the layout where you had helping hands?

Jim: Yeah, making trees, both deciduous and conifer trees, bushes. Dick Roberts

did the barbed wire fence in Blairsden and all the power pole wiring. Dick also did the sound effects on the layout.

MRH: You've had this railroad for quite a while, is it meeting your objectives?

Jim: As a matter of fact it's gone well beyond what I had expected the layout to look like!

MRH: While building the layout, you've had existing friends help and made new friends too. It must have been a real camaraderie builder?

Jim: Yes it has. 22 years ago it started with 4 of us, then at one time we actually had 10 people in the group. I've met a lot of great people because of the hobby, because of having this layout.

Operation

MRH: Your equipment runs really well. Would you call yourself a railfan railroad owner or a prototype operator owner, or someplace in the middle?

Jim: Well, probably some place in the middle. Originally I built this as a railfan railroad, I had no intention of ever operating – it was to build and enjoy. But then I got involved in operating. Other friends, **Rick Fortin** and **Byron Henderson**, came over and Byron put together an operating session plan, and now I do operate.

I prefer modeling, but when four or five people want to operate here, we just set a date and do it.



Figure 14

Conclusions

MRH: Looking back over the years, if you had a chance to go back and do things differently, is there anything you would change?

Jim: If I had the same size room probably not. If I had a larger room I don't think I would change anything other than have longer distances between towns and a little longer sidings.

MRH: Thank you very much Jim, it's been wonderful seeing your layout.

Jim: You're quite welcome. I hope what I've done here helps other people get interested in the hobby.

MRH: I'm sure it will.

Figure 14: The lumber company at Delleker is the newest part of Jim's layout.

Figure 15: The East Keddie engine service area.



Figure 15

Some of the finest trees in the hobby ...

... available in any scale!

CANYON CREEK
SCENICS
canyoncreekscenics.com



click to visit our web site

The **Model Railcast Show**

**Keeping
you
on the
RIGHT
TRACK!**



**Click here to
learn more ...**



Ryan & Tim at Hartford 2009

(Show hosts)

advertisement

Your 1/2 page ad in this space could cost as little as \$245 and be reaching over **20,000** model railroaders.

And remember, your web site is always just a single click away from our ads! No more dog-eared pages where a reader intended to check out your site but never quite got around to it . . .

Make it easy for your customers to reach you!

Click to learn more ...



Modeling the Modern Era

— by Lance Mindheim



While steam-to-diesel transition era modeling is popular, don't overlook the rewards of modeling the modern non-roofwalk era ...

Choosing the era we will model is one of the most critical modeling decisions we will make. Far too often though, the decision is made without a full understanding of all the choices available to us. Failing to dig as deeply as we should into those options may cause us to miss out on something that can provide a tremendous amount of enjoyment and satisfaction.

 **Reader Feedback** 
(click here)

When it comes to selecting an era, you have a few camps. You have those that are passionate about a specific time period, understand its pros and cons, and forge ahead full-throttle blissfully content.

Then you have those that are somewhat ambivalent and settle into the steam-to-diesel transition era by default, knowing that is the most popular time period and there are many modeling products available to fill our needs.

Finally, you have those that have not decided what era to model, realize

it's a crucial planning decision, and want to make an informed decision. This article is not meant to sway those who are happy with their era selection (probably the steam-to-diesel transition era). Rather it is geared to those who are actively looking for an era to model or are ambivalent.

For those groups I'd like to make a case for strongly considering modeling modern times, in particular the present. I'd also like to reach out to those modelers that have been building their layouts for some time, taken their theme as far as they can and are

looking for a fresh start to re-energize their interest in the hobby. This was my situation.

For over a decade I was a dyed-in-the-wool 1950s-era Monon Railroad modeler. During the time I had my Monon layout I viewed the modern era as the absolute *least* attractive option when it came to themes. This view was held solely out of ignorance as to what the era was all about.

I thrashed the Monon theme for all it was worth and it provided many years of enjoyment. As it neared completion though, a sense of malaise and boredom set in. The 1950's just seemed to be an era that was increasingly beaten to death.

In addition, research became increasingly time consuming and frustrating as I spent hours looking for critical information often coming to the realization that it simply did not exist.

I found myself building and operating the layout less and less until things ground to a total halt. Deep down I knew that it was time to start over with a new theme but really didn't know where to start.

As passionate as I had been about the 1950s era, I knew if I didn't move onto something else I'd quickly be back in the same boat. I really needed something new to re-energize my interest in the hobby.

The solution to my problem came from a rather unexpected source, senior

railroad employees either recently retired or close to retirement. Given the depth of their experience and knowledge I particularly valued their advice. Their suggestion was to model the modern era.

These were guys with broad first-hand knowledge of a variety of eras. In their opinion, the modern era offered just as many interesting modeling subjects as previous time periods but had the huge added benefit of being able to experience it first hand. Five years down the road, it was some of the best modeling advice I've ever received.

It's an era that, surprisingly, many don't have an accurate understanding of, and dismiss far too quickly. My intent here is not to try to change the mind of anybody who is happy with their current theme. Instead my goal is to provide some food for thought for those searching for an era so they can make an informed decision

The Modern Era, The Myth

If most modelers were asked to sum up modern era railroading they'd describe double-track mains, very few small industries, and no local switching operations.

Many would think that the few industries that are still rail-served are massive characterless structures that would be difficult to fit on a model railroad. Rolling stock would be thought to consist of forgettable gray hoppers, containers, and auto racks. In other



Figure 1

Figure 1: With just a few inches to spare on each side, the switcher squeezes between the concrete canyon formed by Florida Bottling and Proveedora Jiron. Both shippers, although small, still take incoming rail shipments.

words, when asked to visualize the modern era, most model railroaders have an image of a barren wasteland, devoid of character and modeling interest. Yawn . . .

The Modern Era, The Reality

As so many others likely do, my initial view of the modern era was personified by the myth above. What could be more boring than ribbon straight double-track mains, totally devoid of spurs and sidings, carrying an endless parade of plain vanilla unit trains. Answer, nothing could be less appealing. Why would anybody in their right mind chose to model the present day?

Here's why. The commonly-held, modern era myth, while having some basis in fact, is not the total picture of present-day railroading.

Regional and local situations vary greatly, and in many metro areas railroading is still very similar to what it was in the 1950s the difference being that you can put yourself trackside and still watch the action unfold.

I haven't done a nationwide survey of the various metro areas, so can't give a breakdown of those who hold interest versus those who don't.

The region where I live, Metro Washington/Baltimore, is pretty short on appealing modeling subjects and those that do remain are becoming fewer and fewer.

I live in a county with a population of almost 750,000. The CSX double-track main slices through end-to-end passing a mere half-dozen rail-served industries. Pretty bleak from a modeling standpoint.

In other cities however, the opportunities are much brighter. Miami, Orlando, Seattle, and many areas in California, to name a few, are packed with secondary industrial tracks serving interesting and

easy-to-model industries, short lines mixing with class ones, passenger and commuter traffic etc.

Don't let a snapshot of one region of the country color your view of the entire modern era.

In simple terms, modeling the present day offers:

- Unlimited, easy to obtain, accurate research data
- Operational interest equal to that of other eras plus the ability to watch those operations first-hand.
- Structures as interesting as that of previous eras.



Figure 2a



Figure 2b

Figures 2a, 2b: A photograph represents only the situation as it exists at a moment in time and often does not give the degree of accuracy that you would get if you studied the situation over longer time periods. This harsh reality hampers the ability of the prototype modeler to be accurate when earlier eras are being modeled. If you were to have visited the overgrown

spur in the left photo the day before the shot was taken, you could logically assume that the spur had been abandoned years ago. What a difference a day makes. A few moments later a switcher appeared around the corner and began working the spur (right photo).

- As much, if not more, variety in terms of motive power and rolling stock.
- Ability to incorporate digital photos of actual structures and their components onto and into our models.

The Research Dilemma

What is perfect research? It's being able to have access to every piece of information needed to accurately model a railroad. This includes photos of all structure faces, knowledge of

operational practices, details on vehicles, signs, rolling stock, etc.

If having very accurate information is important to you, and you model an earlier era, you have a few problems. One is that the information may no longer exist or, if it does, it often takes an enormous amount of time to track down. The problem gets worse with the passage of time as structures are demolished, memories fade, people pass away, documents are lost, etc.

Another issue that many don't think about is that photographs are just a snapshot representing a moment in time. Older photos often show the unusual rather than the typical. They don't necessarily represent what the typical situation is over long time periods.

A photo packed with freight cars tells you a lot. A photo of an empty siding tells you nothing. Is the industry abandoned? Don't make that assumption. Maybe there were three cars spotted there last week. Maybe it takes cars, but how often? Weekly, monthly, semi-annually?

Industries change. A factory may change owners and products over time. Structures may be repainted every several years. The one constant is change and all a snapshot captures is that one instant.

Access to an endless supply of research material is where the modern

era shines. It is possible to have almost every piece of information you need.

With the advent of the internet we now have access to aerial photos of such quality that would have been impossible just a few years ago. These photos are of such resolution you can literally read the print on the side of a freight car. Modern aerial photos routinely capture trains going about their switching moves.

Google street view allows you to literally be at the site at street level and virtually walk around the area. Aerials are so good you can get 'good enough' dimensions to model any structure.

Modern industries have websites providing information about their services. Modeling organizations routinely contain current railroad employees who are very generous in terms of putting on seminars and answering questions about modern operating practices.

Most importantly, modeling the modern era gives you the luxury of observing longer time periods to get a more accurate sense of what is going on operationally.

A photo of the area I model would lead one to believe that the branch is essentially abandoned and serving only a customer or two.

Observation over long time periods has shown that the number of rail-served industries is probably ten times what I originally thought. Freight cars



Figure 3

Figure 3: The sign on the side of this structure reads "Miami Waste Paper". Standing in front of the structure you see trailers of waste paper. This would lead one to reasonably expect that the boxcars spotted at the back of the building handle waste paper. Wrong! A walk around the back of the building reveals that the portion of the structure being served by rails contains stacks of rice and drink concentrate. This means Miami Waste Paper has sublet the rail served portion of the warehouse to another tenant that takes incoming rail shipments of food products and does not ship outgoing paper loads as would likely be assumed. The ability to make these types of distinctions is another advantage of modeling the modern era.



Figure 4a

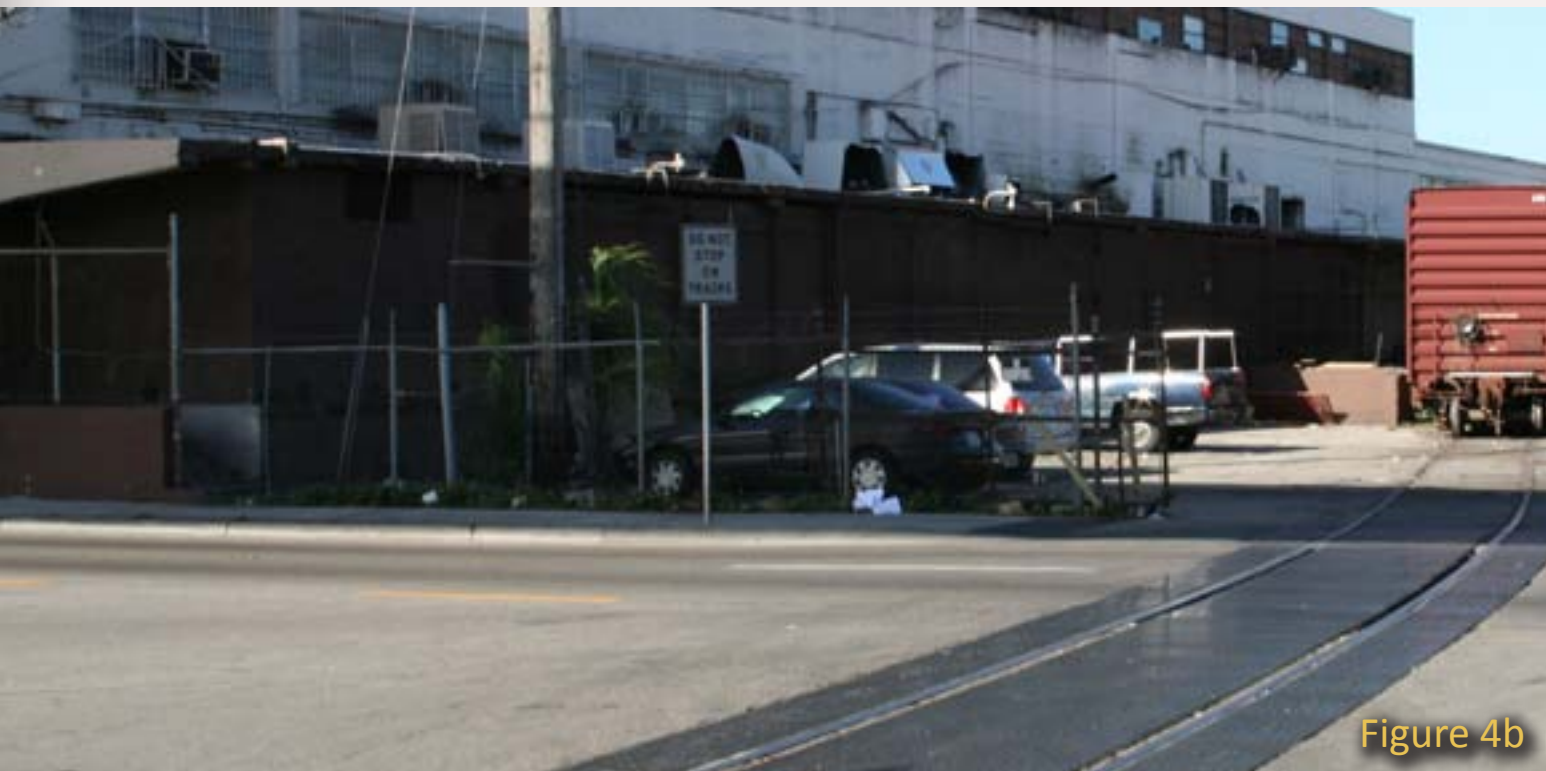

Figure 4b

Figures 4a, 4b: Snapshots can be misleading. The photo on the top is of a section of the 12th Avenue switchback in Miami. Upon looking at the weed choked right-of-way I erroneously assumed the track was abandoned. A few months afterwards I learned that not only was the white structure in the background still receiving rail cars but just beyond was a fascinating open-air courtyard (lower photo). Aerial photos and a second visit to the site allowed me to correct my original snap-judgment regarding abandoned rail.

don't stay on location long. They are spotted, unloaded, and pulled. Unless you happen to catch them the day they are spotted, you could easily assume the industry is not rail-served (Figure 2 on page 60 and Figure 3 on page 61).

Modern Era Research Tools

- Bing Maps: Birdseye View
- Google Maps: Street View.
- Site photos and observation.
- Interviews and seminars with modern era railroad employees.

Operations

Mainline operations have changed from what existed in the 1950s becoming more streamlined, efficient, and admittedly more boring. However, local switching operations, the most sought-after crew assignment in most operating sessions, remains remarkably unchanged from previous eras.

In most cases there is only one way to pull an empty boxcar from a siding and replace it with a load whether you are looking at 1955 or 2010.



Figure 5

Figure 5: There really aren't too many different ways to swap a loaded boxcar for an empty, whether you are looking at 1955 or the present day. In this photo the local switcher works a food-processing facility pulling the loaded cars and dropping off a load.

Likewise, a local entering an industrial park with a string of fifteen cars will likely perform the moves in the same manner they did fifty years ago. So, what many consider to be the most appealing operational aspect of model railroading, local switching, still exists in pretty much the same form as older time periods (Figure 5 on page 62 and Figure 6 on page 63).

Structures

We've all heard the statement that modern railroading is trending

towards only serving customers that can provide hundreds or thousands of car loads per year. The conventional wisdom is that the railroads are perfectly content to, and would actually prefer to, let smaller industries haul by truck. In some regions I'm sure this is true. On a national basis however, this is just not reality even among class ones.

In many locales sales departments actively and aggressively seek new customers, even small ones that ship just a handful of cars per year. The result is



Figure 6

Figure 6: The equipment is newer but otherwise this timeless scene plays out the same now as it did decades ago.



Figure 7

Figure 7: Westway Terminals, Baltimore, MD.

an unlimited supply of industries that are small enough to be included on a model railroad without stretching the bounds of plausibility.

These smaller industries handle a broad variety of car types and have enough architectural variety to pique anybody's interest. Certainly mega-box, white sheet-metal warehouses are a big part of the modern structure landscape, but there is much more out there beyond that.

Shown on the next two pages are just a small sample of some diverse, architectural-interesting, modern-day industries (Figures 8-12).

Rolling Stock

In terms of variety and interest, rolling stock is one area where the modern

era has lost no ground to previous time periods being as varied, colorful, and interesting as any time in the past.

Most of the car types of previous eras still exist in a more modern form. In addition, new car types have come on the scene. The argument could be made that modern cars are more colorful and diverse than ever before.

For example, the long trains of oxidized boxcars that personified the '50's have been replaced with multi-hue, faded, and re-stenciled cars from the incentive per-diem craze (Figure 13 page 65 and Figures 14a and 14b page 66).

New Construction Techniques

There have been some changes in technology over the past decade

that add exciting new possibilities to how we build our models, specifically structures (or to be more accurate make old ideas much easier to implement). Advances in digital photography and printing now make it much easier and more practical to use photos or portions of photos as components of our models.

It is now possible to photograph a structure, or part of a structure such as a door, edit the photo and literally wallpaper it onto styrene yielding perfect colors and weathering patterns. Such digital techniques work well when modeling modern structures since it's just a matter of going to the site and taking the shot. Doing the same thing with earlier eras, while

still possible, is more difficult because the structures often no longer exist (Figures 15a and 15b on page 66 and figures 16a and 16b on page 67).

The Craftmanship Mindset

For reasons that are well-deserved, certain eras and themes are associated with a craftmanship mindset. This is a culture characterized by quality results from top to bottom and where doing whatever is necessary in terms of scratch building to bring the point home is the norm. Narrow gauge modelers are one such group.

There is really no reason why this same mindset can not be applied to any

era, including the present day. When it comes to modern structures, many probably conjure up images of a shiny blue unpainted Rix warehouse kit hastily assembled and plopped into place. However, that same structure can be broken down, kitbashed, painted, detailed and weathered into something of quality equal to the craftsman structures we are used to seeing from earlier time periods (Figure 17a and 17b on page 68).

A Word About Passenger Traffic

Who could not be captivated by glamour trains of the past such as the Twentieth Century Limited. Not only was the equipment magnificent but the rolling stock variety and head



Figure 8

Figure 8: PanAm Frozen Foods, Miami, FL.



Figure 9

Figure 9: Vulcan Materials, Annapolis Jct., MD.



Figure 10

Figure 10: Lehigh Cement, Baltimore, MD.



Figure 11a



Figure 11b

Figures 11a, 11b: Modern times have brought us new, interesting, and easily modeled industrial structures that didn't exist in earlier time periods. The model in figure 11a shows a plastic pellet hopper being unloaded at a team track. Figure 11b is of a larger plastic facility.

operations were fascinating. Some of that lives on with Amtrak but it really isn't the same.

When it comes to modeling, changes in passenger traffic aren't necessarily so bad. We've lost some treasures of the past but, if you step back a second, we've also gained something that is easier to model. As wonderful as the passenger operations of the past were,

they aren't always that easy to model, especially if you have a smaller layout.

Enter the modern-day commuter train. Drab gray and Pullman green commuter trains of the past have given way to stunning bi-level cars with dazzling murals on the side. Better yet, commuters with their shorter lengths, frequent stops, and smaller stations are easier to model on small to



Figure 12

Figure 12: Potomac Valley Brick, Derwood, MD.



Figure 13

Figure 13: Then and now. Locomotive styles have understandably changed with the times, but not necessarily for the worse. To this modeler's eye, the two switchers above, while from totally different eras, are equally interesting for their own separate reasons.

mid-sized layout. Passenger traffic has changed. It is different but not necessarily worse (Figure 18 page 69).

Summary

Many of the most appealing aspects of 1950's railroading still exist today. In fact, today's railroading even offers a few interesting elements that didn't

exist in the past. In addition, the modern era offers the additional advantages of limitless and accurate research information and the ability to observe our modeling subject first hand. For those searching for an era, you owe it to yourself to at least explore the modern era. (See the following pages for more photos and Comparison Table.)



Figure 14a



Figure 14b

Figure 14 a, b: The chemical tank car (left) and reefer (figure 15a) aren't much different than what you would have seen fifty years ago. The modern era has lost little in terms of rolling stock variety and even added new car types such as the lumber flat (above).



Figure 15a

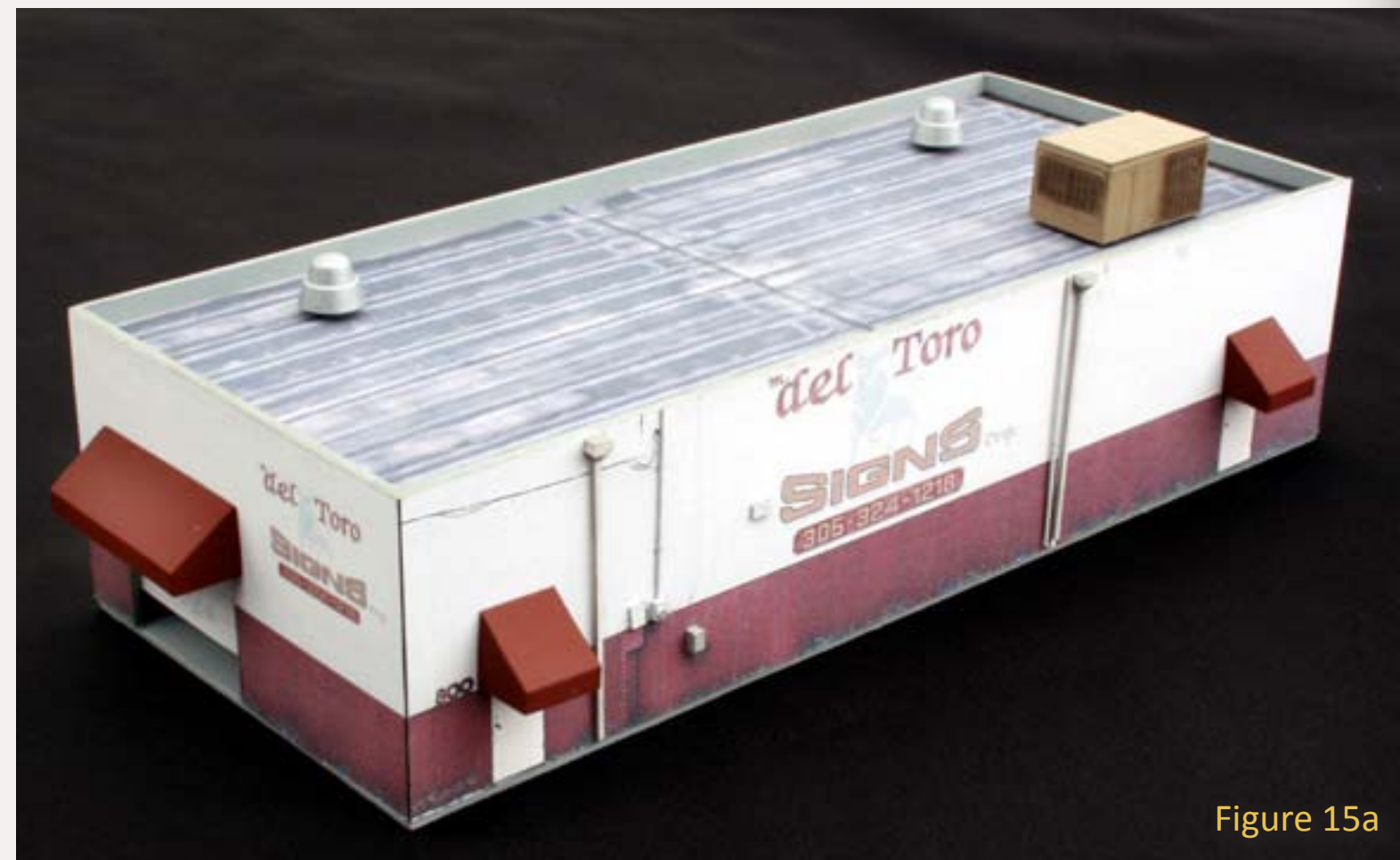

Figure 15a

Figures 15a, 15b: The complex weathering patterns and intricate signs on the sides of International Freight Consolidators and del Toro Signs would make the structures extremely difficult to model using conventional methods. Technology advances make it possible to

lamine digital photos of the actual structures onto styrene and then create 3D depth by adding stand-off details. The ability to go to the site and photograph the structures make this possible, whereas this might be more difficult with structures from earlier eras.



Figure 16a

Figure 16a: The complex graffiti on this masonry wall would be very difficult to do by hand. To capture the effect, a photograph of the actual wall was taken, edited, and affixed to styrene.



Figure 16b

Figure 16b: In a similar vein, the complex weathering patterns on the walls of the 12th Avenue Courtyard structure are more easily captured using the photo wallpaper technique.

MODEL TRAINS WEATHERED

.COM

THE WORLD'S ONLY WEATHERER'S NETWORK FORUM

STOP BY TODAY AND INQUIRE ABOUT MEMBERSHIP



Figure 17a



Figure 17b

Figure 17a, 17b: Craftsman structures need not be the sole domain of narrow gaugers and those modeling earlier eras. There is no reason the techniques and mindset taught by master modelers modeling those eras can not be applied to structures of the modern era. The top photos is of D&E Argentinas in Miami. The bottom is of the Miami Produce Market. Both models were entirely scratchbuilt.

ERA COMPARISON

Item	Present Day	1955
Availability of Accurate Research Material	✓	
Ease of Obtaining Accurate Research Material	✓	
Access to Railroad Employees	✓	
Ability to Observe First-hand	✓	
Interest of Switching Operations	✓	✓
Street Running	✓	✓
Rail Marine Operations	✓	✓
Small Towns with Depots and Freight Houses		✓
Industrial Parks	✓	
Interest of Main Line Operations (Mainline Timetable and Trainorder Operations)		✓
Freight Car Variety and Interest	✓	✓
Caboose		✓
Passenger Car Variety and Interest		✓
Commuter Train Variety and Interest	✓	
Structure Variety and Interest	✓	✓
Availability of Needed Modeling Materials		
Locomotive Availability	✓	✓
Freight Car Rolling Stock Availability	✓	✓
Vehicles	✓	
Structure Kits		✓
Miscellaneous Details (street Lights, fences, etc.)		✓



Figure 18: Commuter trains with their short lengths, dazzling paint schemes and frequent stops at small stations make passenger operations much more viable for those with smaller layouts.



Lance Mindheim, is the owner of *Shelf Layouts Company, Inc.* a custom layout building and design firm.

www.shelflayouts.com

He is currently building a layout of Miami's Downtown Spur set in modern times.

Deraillments

humor (allegedly)



“Big Boy meets Little Boy”

If railroad workers formed a football team and made it to the playoffs, where would they play? The steam dome or the sand dome?

Which part of a freight car can't be trusted around the cops? That's easy! It's the brakes - they're always squealing!

What's with the new lady track worker? You mean the one who only wants to work on crossings? Yeah! Well, she knows diamonds are a girl's best friend!

Got a good bit of humor? If you're the first to [submit it](#) and we use it, it's worth \$10!

Basic Diesel Detailing for Beginners

– by M.R. Snell
Photos by the author



 **Reader Feedback**
(click here) 

It has been said that details can make the difference between a good model and a great model. Even manufacturers are now following this mantra and newer model releases are becoming more detailed right out of the box. However even these are often only partially-detailed leaving the modeler to complete the job at the workbench.

It has also been stated that detailing models is becoming a lost art, in part due to a lack of understanding of the hows and whys of detailing. Indeed, the myriad of parts available coupled with their unfamiliar names can certainly become confusing, especially for a novice modeler.

In the following pages we'll attempt to demystify detailing, adding the basics to an Athearn 'blue-box' CSX GP40-2 model and transforming the basic 'starter' model into one that will look good alongside its higher-end counterparts.

Accurate Detailing Begins with Research

The first step in understanding detailing doesn't involve tools or even a model itself – accurate detailing

begins with simple research. While we may look at a locomotive and think we may know everything about a particular road's fleet, there are often things we may be unaware of, such as the history of a particular locomotive:

- Was it obtained from a predecessor road?
- Was it purchased used?
- Are there options the road may have specified such as horns, antennas, snowplows, etc?
- What modifications may have been made by the road's locomotive shops?

Even though locomotives may share model designations and paint schemes, by using photos as a

guide you can determine variations between specific units as well as changes in both detail and paint that have taken place over time.

For those modeling specific dates this is a necessity and this can also be used as a guide when modeling looser time frames. Fortunately in the digital era research is as close as our fingertips via the internet. High quality photo galleries of both locomotives and rolling stock can be found at several websites including:

www.rrpicturearchives.net

www.rr-fallenflags.org

For example - while researching the locomotive for this article, CSX GP40-2 #6144, I learned that it was originally built as B & O (Chessie System) 4245

in June of 1975. Over its lifetime it wore the colors of the CSX predecessor, Chessie System, as well as CSX itself.

As delivered, the locomotive featured several options favored by the Chessie including a hood-mounted bell, whip-style radio antenna, and the hardened 'rock' pilot typically found on locomotives of that railroad.

Moving forward into the CSX years, changes made to the locomotive included the addition of ditch lights and the removal of the 'rock' pilot in favor of a flat pilot.

As I model a loose time frame – 'the 1990s' – this information provided the basics for the details I would need to create a credible model.



Figure 1: Simple research revealed that the CSX locomotive I was modeling had a Chessie System heritage.

The Right Tools for the Job

As with many tasks in life, achieving good results begins with having the correct tools for the job. While the tools required for detailing are not unusual or exotic, they are tools we may not have if we are only 'casual' or novice modelers. When assembling a detailing toolbox several tools to include are:

- **Small Hobby Screwdrivers:** This can prove useful when disassembling a model.
- **Sharp Tweezers (both straight and angled):** These are a necessity when handling small parts such as the detail castings we will be using.
- **Needlenose Pliers:** These can hold parts during installation as well as make adjustments to metal castings after they have been applied on a model.
- **Sharp Wire Cutters:** Many of the parts used for detailing are formed-wire or metal castings. Sharp wire cutters will reduce the size of mounting stems or mounting legs when necessary.
- **Cyanoacrylate Cement:** "CA" allows us to bond metal to plastic, metal to metal, or plastic to plastic – a necessity when adding metal castings to a plastic model.

- **Gluing Tips:** These small tips, often with thin tubing, allow us to control the flow of cement from a bottle, preventing an excess of cement from marring the model's painted surfaces.
- **Toothpicks or Small Brass Wire:** These are useful for cement applications in which even a gluing tip will not allow an accurate application of cement. Applying a small amount of cement to a toothpick or thin brass wire allows us to position the cement precisely where we want it.
- **X-Acto Knife with #11 Blade:** The #11 angled blade is the most common blade used in hobby applications.
- **X-Acto Knives with #17 and #18 Chisel Blades:** The chisel blade is a flat blade and is a necessity for carving off factory details cleanly.
- **A Pin Vise:** This holds small drill bits. Due to the small nature of the bits drilling must be done by hand with the bit held in the vise.
- **Drill Bits (#61-80):** Detailing requires the use of drill bits so small that they are in the numbered range and are also very breakable. One of the most useful sizes is the #80 bit and it's a good idea to have spares on hand as these tiny bits can break easily.



■ A Drill Gauge: This is used to measure the size of drill bit required to make a specific hole. Inserting the mounting stem of a casting will easily tell us what size drill bit to use and is also useful for sorting the bits themselves as they are not marked with their respective sizes.

Now that we've done a little research and have assembled the proper tools we can get started with building the model!

STEP 1: Getting Started

The Athearn 'blue box' line provides an excellent starting point for those learning to detail. The model itself features no detailing other than a plastic horn, allowing an opportunity to 'detail from the ground up' so to speak.

To begin, we'll remove the shell from the frame, allowing us access to the interior of the shell. This makes it easier to handle and allows us to apply cement from the interior to prevent marring the model's painted finish.

The Athearn design uses tabs extending from the shell into the fuel tank to secure the shell to the frame. To remove the shell, hold the locomotive upside-down and place a small flathead screwdriver along the tabs. Press inward while pushing upward, popping the mounting tabs free from the fuel tank. The cab can now be removed by pressing inward on the tabs (blue tabs in photo #6) located on the underside of the cab roof.

Now disassembled, the locomotive can be detailed using a two step approach – adding standard manufacturer details then adding railroad specific details. We'll begin by adding the details standard to most EMD locomotives.



Figure 2: Athearn's blue box GP38, GP40-2, and GP50 models have tabs securing the shell to the frame. Removing the shell is as simple as pressing inward on the tabs while pulling the shell upward from the frame.

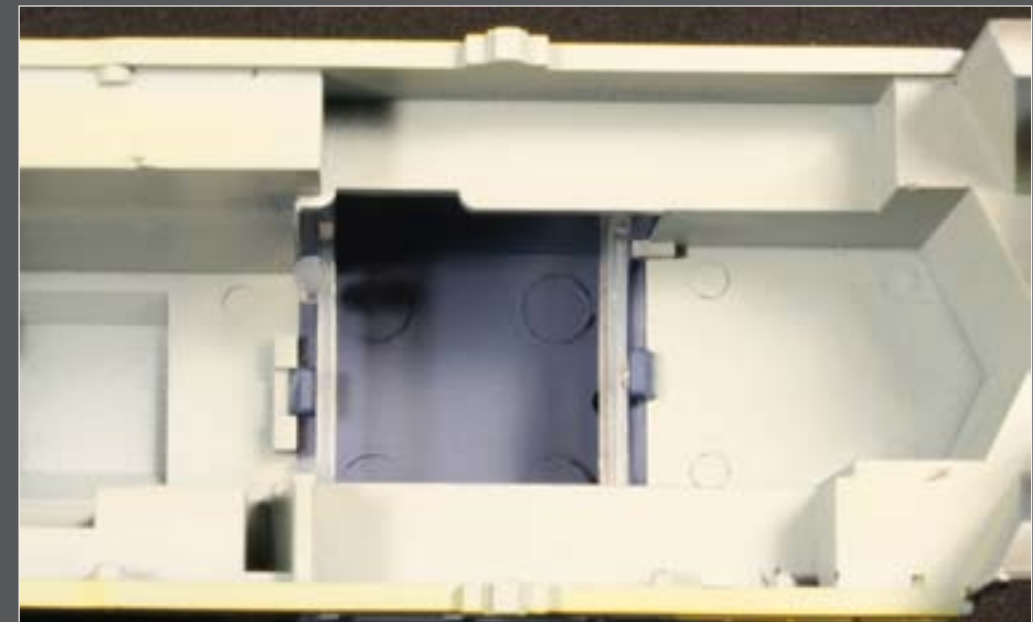

Figure 3: The Athearn body consists of two pieces: a one-piece shell and a separate cab. The cab can be removed from the shell by pressing inward on the two tabs at the front and rear of the cab while pulling it upward, away from the shell.

STEP 2: Adding Grabirons



Figure 4: The photos of this CSX locomotive illustrate the placement of the grabirons at the front and rear of the locomotive. Using photos we can determine the accurate placement of these details.



EMD standard cab locomotives such as the GP40-2 feature GRABIRONS on the rear of the long hood and the front, side, and top of the short hood, used by maintenance personnel to reach the top of the long and short hoods. (The long hood is the engine compartment, and the short hood is in front of the cab.)

In addition to the hood-mounted grabirons, EMD locomotives also feature a grabiron located along the engineers side walkway, forming a step alongside the short hood.

STEP 2: Adding Grabirons *continued...*



Figure 5: Many models feature a nut/bolt/washer cast into the shell plus a dimple where a hole should be drilled.

The Athearn model is not equipped with grabirons, but a dimple and bolt are cast into the shell at each grabiron location. Adding grabirons is fairly simple using Detail Associates #2202 wire grabirons inserted into #80 holes drilled into the shell at each dimple. Begin by using a #80 bit in a pin vise then drill out each of the round dimples (located above the bolt casting).



Figure 6: Cut one leg of a grabiron shorter to make it easier to mount.

One trick to make installing grabirons easier is to cut one mounting leg shorter than the other, enabling you to insert one leg at a time into the holes rather than trying to do both simultaneously. After cutting one leg hold the grabiron with angled tweezers and insert the legs into the holes, pushing inward until the tweezers contact the shell. Once each grab is in place, check the spacing between the shell and the outer edge of the grabs to insure they are all uniform. An easy way to do this is to use the tip of the tweezers for spacing between the shell and the edge of the grabs.

STEP 2: Adding Grabirons *continued...*

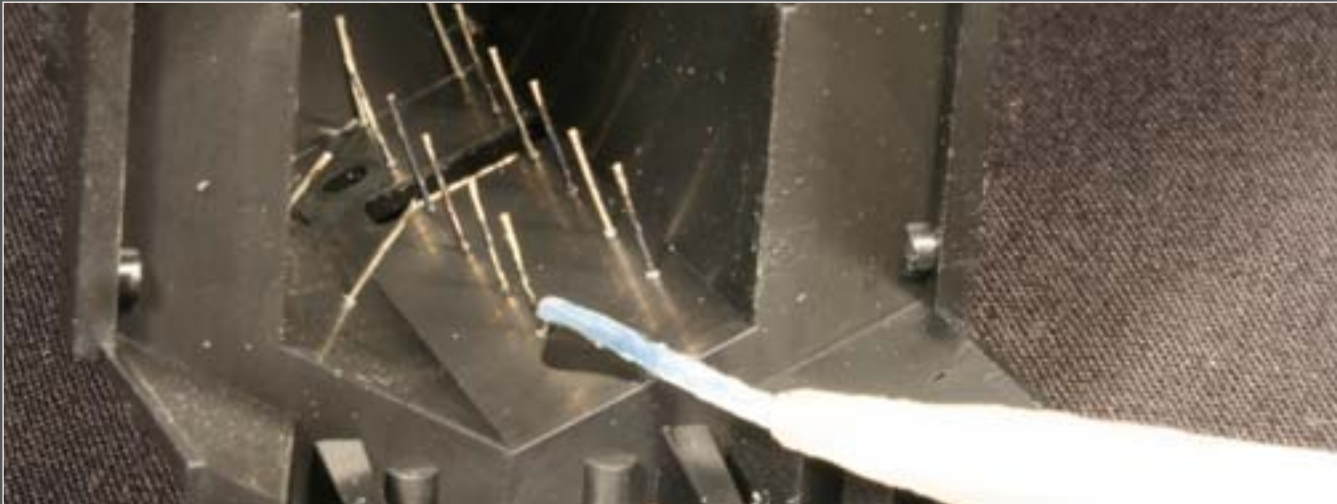

Figure 7: Once the grabirons are in place they can be secured with cement applied from the interior of the shell. The excess mounting legs can be cut off or simply bent against each other.

Once you are satisfied with the grabiron spacing, apply a drop of cement to one of the grabiron legs from the interior of the shell. When the cement has dried, recheck the spacing, and make any adjustments you see necessary. Then apply cement to the opposite leg in the same manner.

Now that the grabirons have been installed, the legs protruding into the shell will almost certainly interfere with the drive mechanism or shell mounting. There are two ways to correct this problem: cut the legs off or bend them over.



Figure 8: Once in place minor adjustments can be made to grabirons that are not level, gently bending them until they are properly aligned.

Once the grabirons are in place, several may be slightly askew, leaning at unrealistic angles. While this may seem like an incurable problem because they are glued in place, there is a simple fix. Carefully place the pliers over the grabiron then very gently twist it left or right until it lines up correctly, providing a uniform row of grabirons on the hood.

Now that the grabs have been installed we can move to the area most viewed on many of our models – the roof.

STEP 3: Basic Roof Detailing



Figure 9: Visible in this photo are the lift rings and fan grab on the roof of this CSX locomotive.

EMD cab locomotives have two standard details on the roof – LIFT RINGS used to lift roof components, and a FAN GRAB used when climbing onto the roof from the end of the long hood. Adding each of these is similar to adding grabirions and will utilize Detail Associates #2006 eye bolts to represent the lift rings. A #6503 curved grab or #2218 angled fan grab will be added at the end of the roof.

Begin the roof detailing by drilling out each dimple on the roof, then inserting an eye bolt in the 4 holes located beside the fans at the rear of the roof. Follow this by adding the fan grab located at the rear of the fans. Moving toward the front of the locomotive insert an eye bolt into each of the 3 holes located atop the inertial filter hatch (adjacent to the cab).

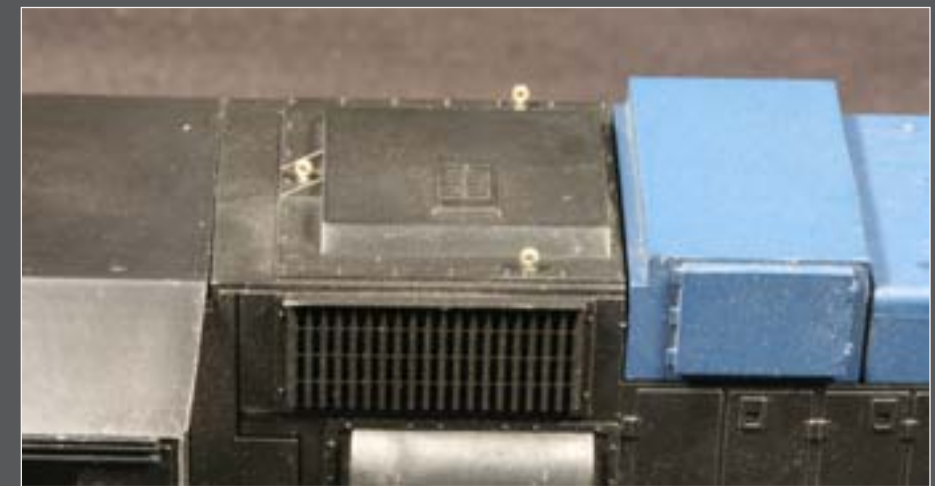

Figure 10: Lift rings can be added to a model using eye bolts. Fan grabs are available in both curved and angled versions, the latter applied to later production locomotives such as GP/SD50 and 60.

EMD locomotives were available in both DYNAMIC and NON-DYNAMIC brake versions that can easily be identified by looking at the center of the roof. Dynamic brakes form a ‘blister’ with screening along the sides as well as a fan and exhaust stack located atop the blister.

STEP 3: Basic Roof Detailing *continued...*



Figure 11: Some locomotive models were available in either dynamic or non-dynamic brake versions and can be easily identified by the large “blister” of the dynamic brake fan.

Non dynamic models featured a panel that was flush with the sides of the long hood, and often had the exhaust stacks mounted in the center roof of the panel. Both versions had lift rings however they were located in different locations. (Four photos above). After determining the model you are working with, drill out the appropriate dimples and then insert eye bolts into each hole.

STEP 3: Basic Roof Detailing *continued...*

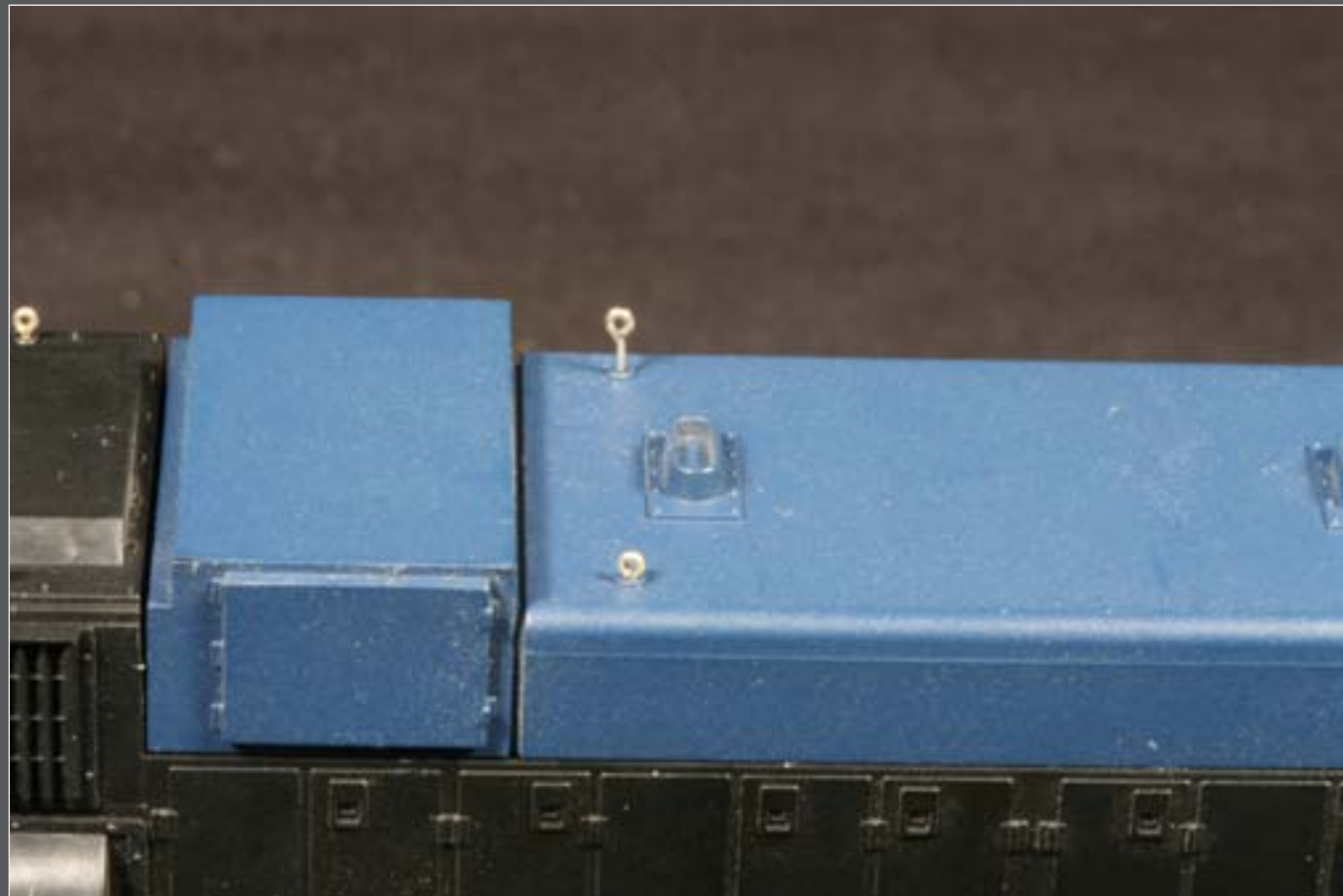

Figure 12: Prior to applying cement test fit each eyebolt to insure it is not too long. If it is, shorten it with wire cutters.

One problem posed when working on the roof is, you may not be able to drill deep enough to allow the eye bolt to seat fully due to metal weights housed within the dynamic brake insert. Fortunately, correcting this is simple: cut one leg shorter until it seats properly.



Figure 13: A good way to keep excess cement from marring the surface of your model is to apply the cement to a piece of scrap styrene, then dip the mounting stem into the cement rather than applying cement directly to the model.

A second problem posed by the design of many models is that applying cement from the interior of the shell may not be possible as some of the mounting legs may seat within the molded sides of the shell. To keep excess cement off your model, place a drop of cement onto a piece of scrap plastic then dip the leg of the eye bolt into the cement prior to placing it into the hole on the model. This will help prevent cement from marring the surface of the model while still allowing enough cement to remain on the eye bolt leg to hold it securely in place.

Locomotive roofs feature many other details such as horns and antennas which are often road-specific so we will look at these later after the standard manufacturer details have been completed.

STEP 4: Pilot Detailing

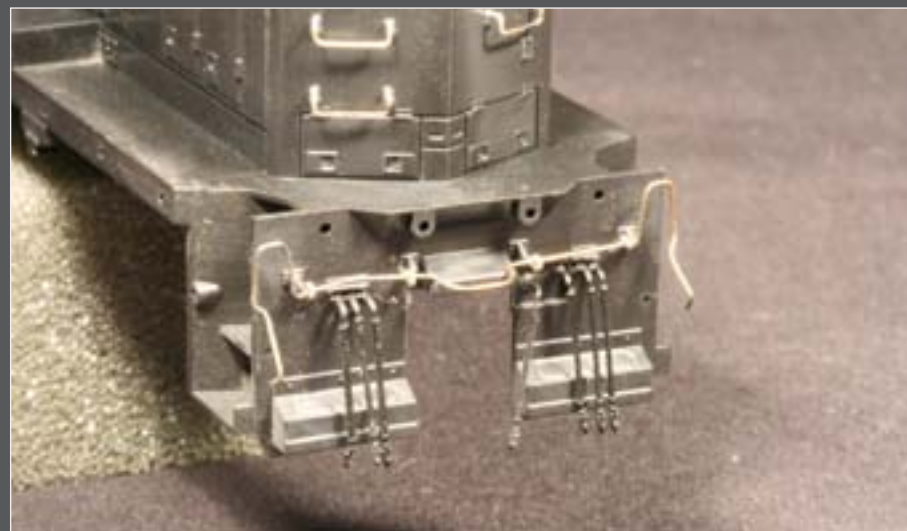

Figure 14: Several common details are MU hoses and a cut bar, both easily added using detail parts available from several manufacturers.

The word PILOT has several uses in the railroad vernacular but in this case it refers to the ends of the locomotive – specifically the vertical flat surface located below the end walkways. In addition to housing the coupler, the pilot also has appliances for multiple unit (commonly known as MU) connections including hoses and electrical plugs, a brake hose (also known as a trainline connection), and a cut bar for uncoupling the locomotive.

Figure 15: Snowplow style varies by railroad and detail castings are available for almost every variety.

In addition to the standard factory details the pilot often holds a SNOWPLOW. Prior to installing the pilot, determine whether a plow will be mounted on the front or rear, as these pilots will need to be adapted to hold it.

Snowplows are generally railroad-specific and a variety of styles are available from Details West, Holgate and Reynolds, Custom Finishing and several other manufacturers. The locomotive being modeled here is equipped with a Chessie-style hardened pilot rather than a snowplow, but still requires removal of the footboard area, the same as a plow mounting would require.

STEP 4: Pilot Detailing – Mounting *continued...*

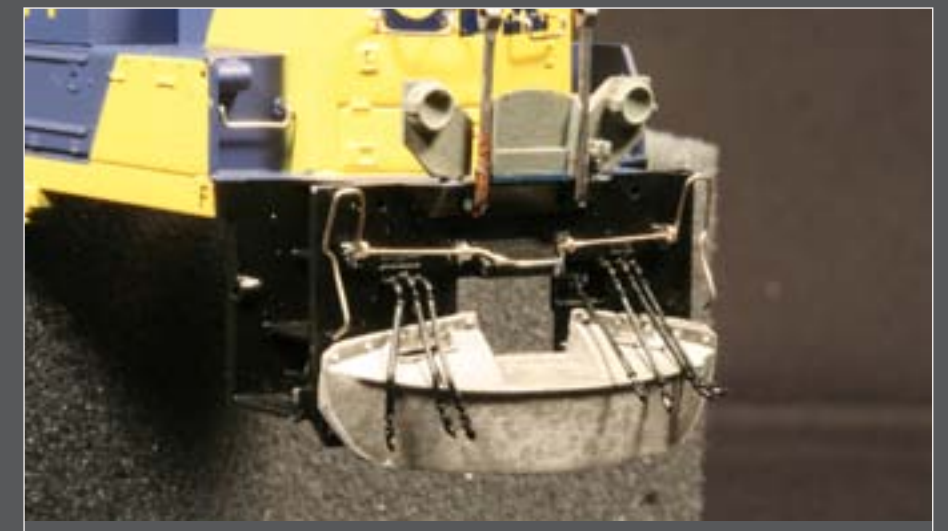

Figure 16: To properly mount a snowplow, the pilot face must be flush, requiring removal of footboards of any other protrusions.

Begin by removing the footboards, placing the shell upright on a solid surface and slicing downward through the footboard area with a #17 X-Acto blade. This will make the pilot face flush, allowing the plow to mount onto the pilot without any gapping (Figure 16).

Once the footboard extensions have been removed, mounting a snowplow is fairly easy using a template often provided with the snowplow casting. If a template is not included, simply cut a piece of index card to the size of the pilot and mark the holes for the mounting pins. Attach the template to the model with tape, then mark the holes for mounting the snowplow by drilling through the template.

Figure 17: Mounting a snowplow requires drilling holes for the mounting pins and included with many snowplow castings is a template that can be taped to the model.

Once the mounting holes have been marked, remove the template and drill the holes for the mounting pins. Next test-fit the snowplow for centered alignment and clearance to the top of the rails. After making any adjustments, remove the snowplow until the model has been completed – it will be the last thing added to insure there is no interference with handrail, coupler, or detail mounting, all of which must be completed first.

STEP 4: Pilot Detailing – Cut Bar *continued...*

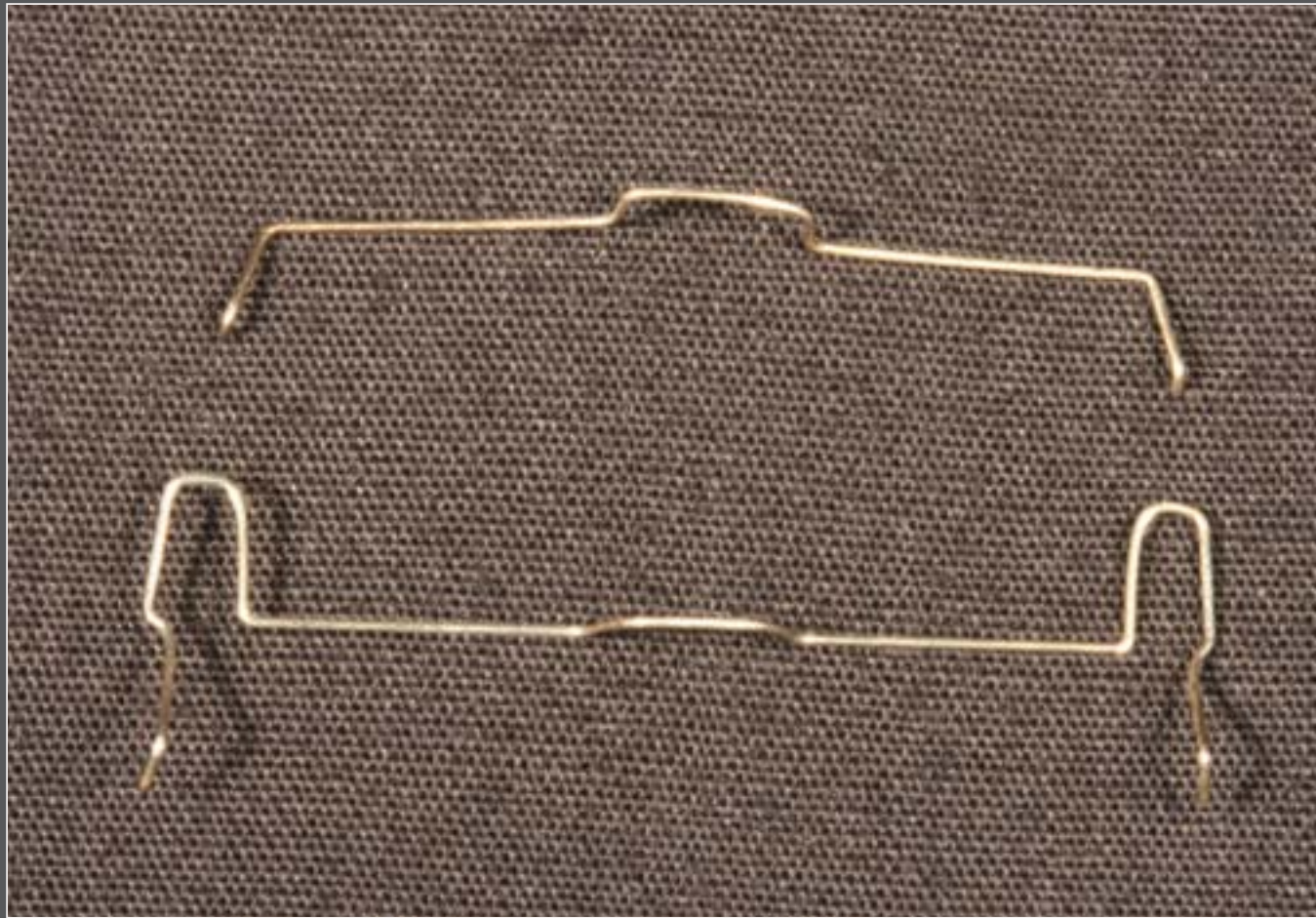

Figure 18: Cut bars are available in several styles. The standard cut bar is suitable for older GP/SD locomotives and the AAR Type 1 is suitable for newer or rebuilt locomotives.

Once the snowplow has been accounted for detailing, the remainder of the pilot can commence beginning with the addition of the CUT BAR. Two styles of cut bars appropriate for EMD locomotives are available from Detail Associates. The first style is an older style known as a STANDARD CUT BAR (#2204) and second is a newer style known as an AAR TYPE 1 CUT BAR (#2211).

Figure 19: Prior to mounting the cut bars, remove the cast-on brackets. With the brackets removed, the cut bars can be mounted using eye bolts to hold them in place.

The cut bars can be mounted using the brackets supplied with them, or by using #2206 eye bolts inserted into holes drilled into the pilot. Either method requires removing the cast-on brackets with a #17 X-Acto chisel blade, then drilling four holes in the pilot, using the removed bracket locations as a guide. When using eye bolts to mount the cut bar, you will find that the 2 outer eye bolts will mount into the step areas. An easy way to conceal these is to drill the 2 outer holes at a downward angle, allowing the leg of the eye bolt to extend underneath a step where it can be bent out of view.

STEP 4: Pilot Detailing – Cut Bar *continued...*

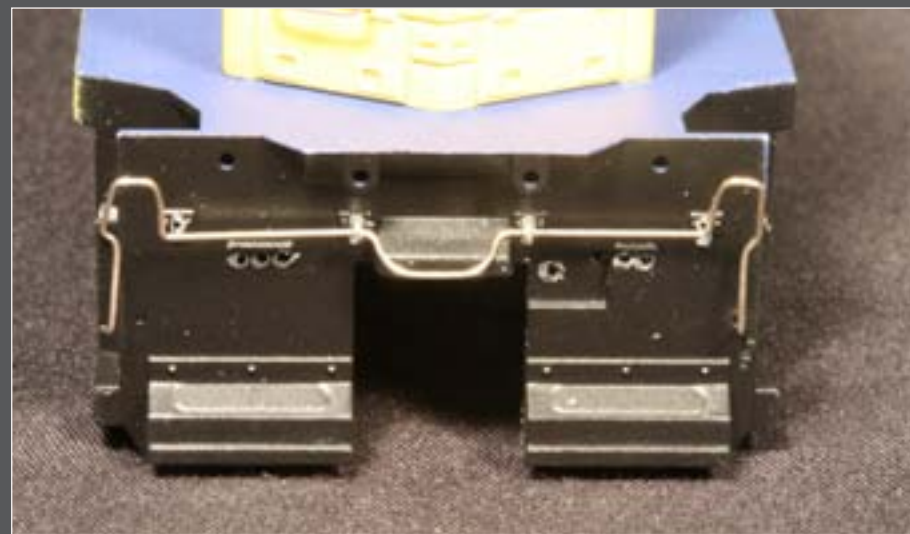
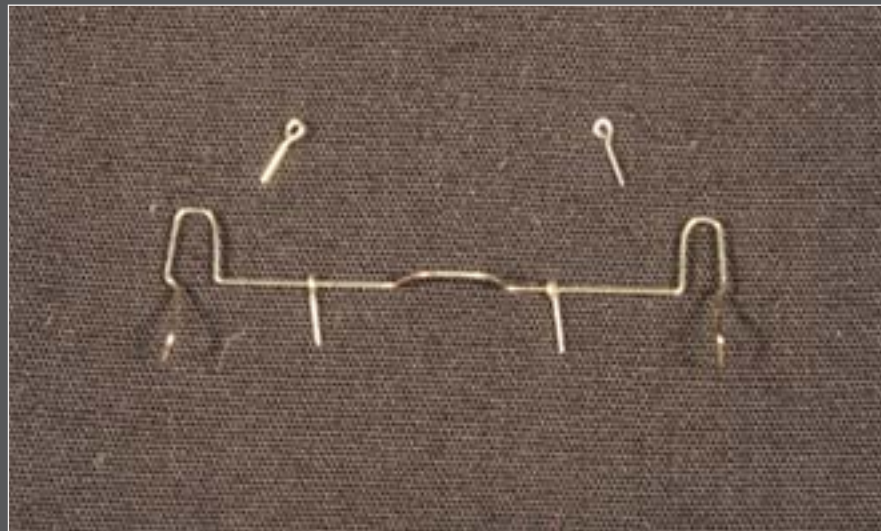

Figure 20: When mounting a cut bar, begin with the two center mounts. Once these have been cemented in place, the two outer mounts can be added.

Once the holes have been drilled the cut bars can be easily mounted by placing one eye bolt over each end of the cut bar, then holding the cut bar over the pilot and placing the legs of the eye bolts into the 2 center holes with tweezers. Next, hold the cut bar in place with one finger and place an eye bolt over each end, and insert these into the outer holes. When the cut bar is fully in place, cement can be applied from the rear of the pilot.

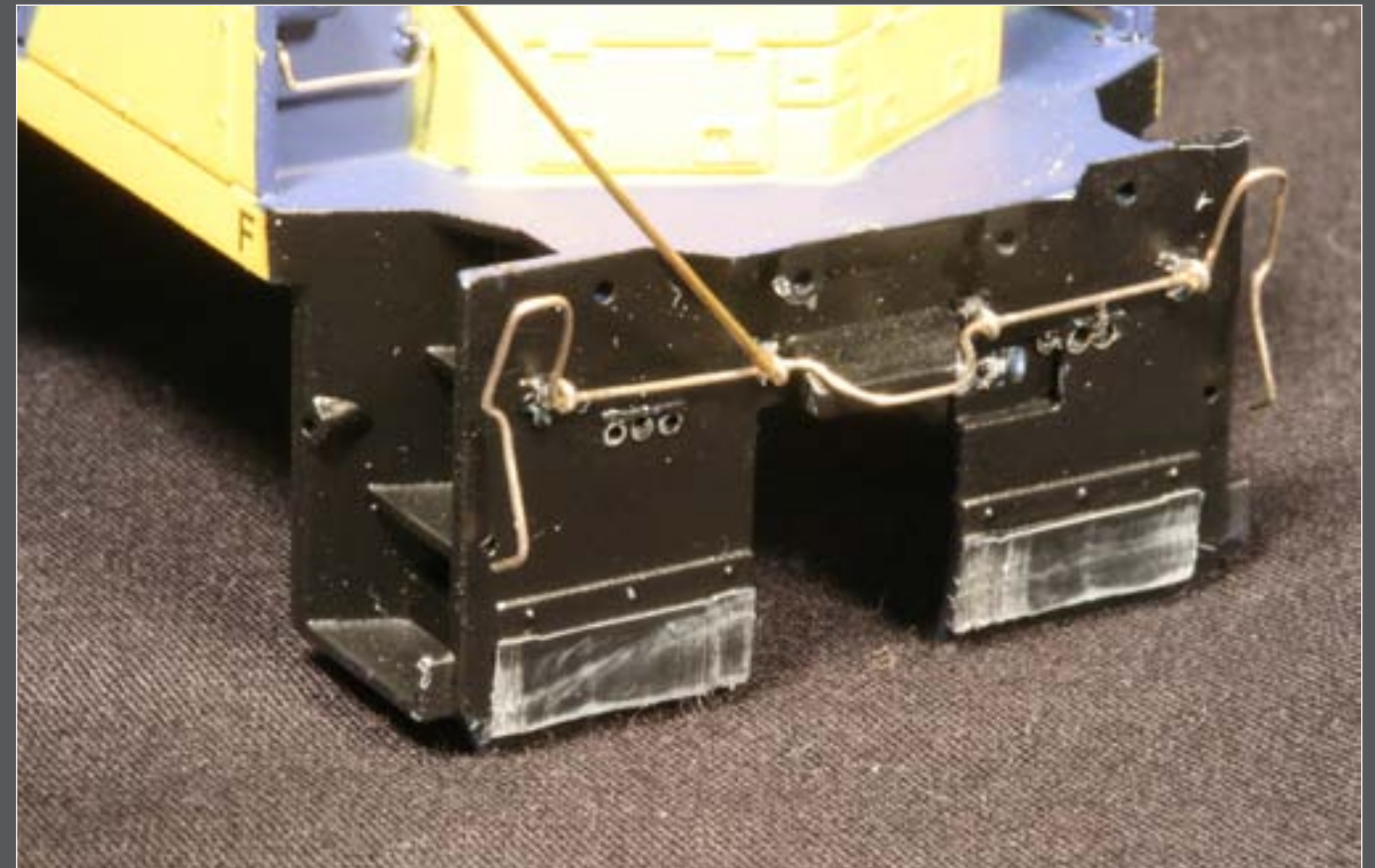

Figure 21: Once the cut bar is mounted, a tiny amount of cement applied between each mount and the bar itself will keep the bar from moving.

Sometimes a cut bar may lean upward due to stress between the mounts and the bar itself. To correct this, place a small weight (such as a screwdriver) in the center of the bar causing it to lean downward. Apply a small amount of cement between the mounts and the cut bar to hold it at the correct angle.

STEP 4: Pilot Detailing – MU Hoses *continued...*

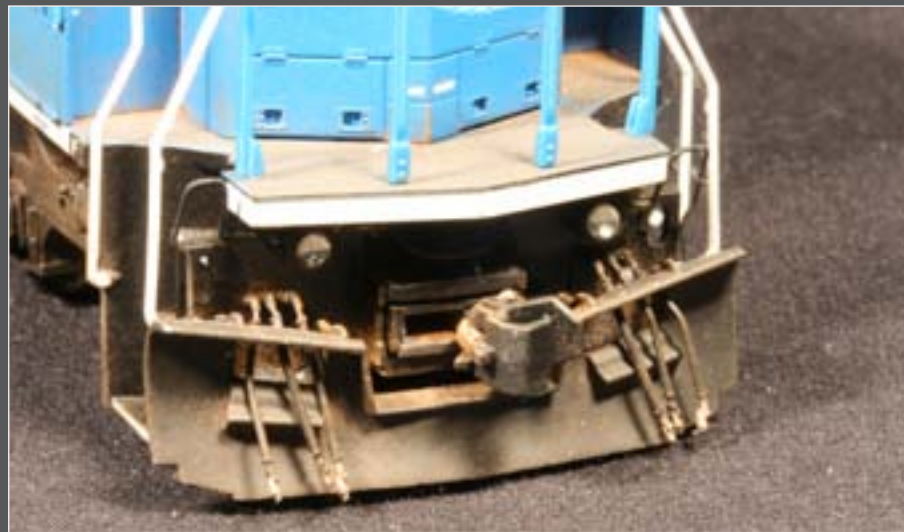
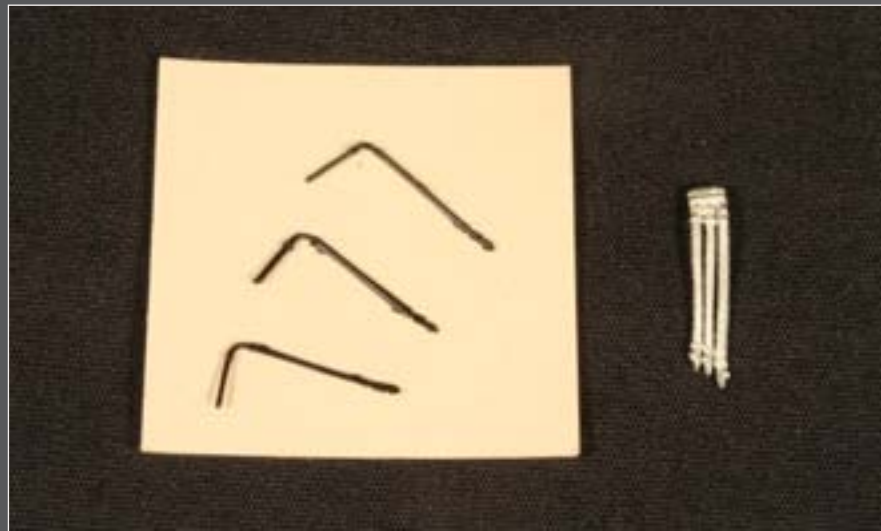

Figure 22: MU hoses are available in ‘clusters’ or as individual hoses, allowing the modeler to recreate any combination.

Figure 23: Adding MU hoses requires removing the ‘blanks’ cast on at the factory then mounting the hose castings into holes drilled through the blanks.

The next standard item is MU HOSES, allowing multiple locomotives to be run in a single consist controlled by one locomotive. MU hoses are available in “clusters” which are one piece castings with multiple hoses as well as individual hoses to match the locomotive being modeled. This is especially useful if it did not have the common 3-hose application. While the one-piece clusters require less drilling, the individual hoses can be much easier to work with, as they are flexible. This is especially helpful where the hoses thread through cutouts in a snowplow (Figure 22).

Whichever style you choose, the first step in mounting the MU hoses is to remove the cast-on dimples from the pilot using a #17 X-Acto chisel blade. Then drill the holes for the cluster or individual hoses. For this locomotive Detail Associates #1508 MU hoses were used, each inserted into a #74 hole drilled in the pilot using the dimple locations as a guide (Figure 23).

STEP 4: Pilot Detailing – MU Hoses *continued...*

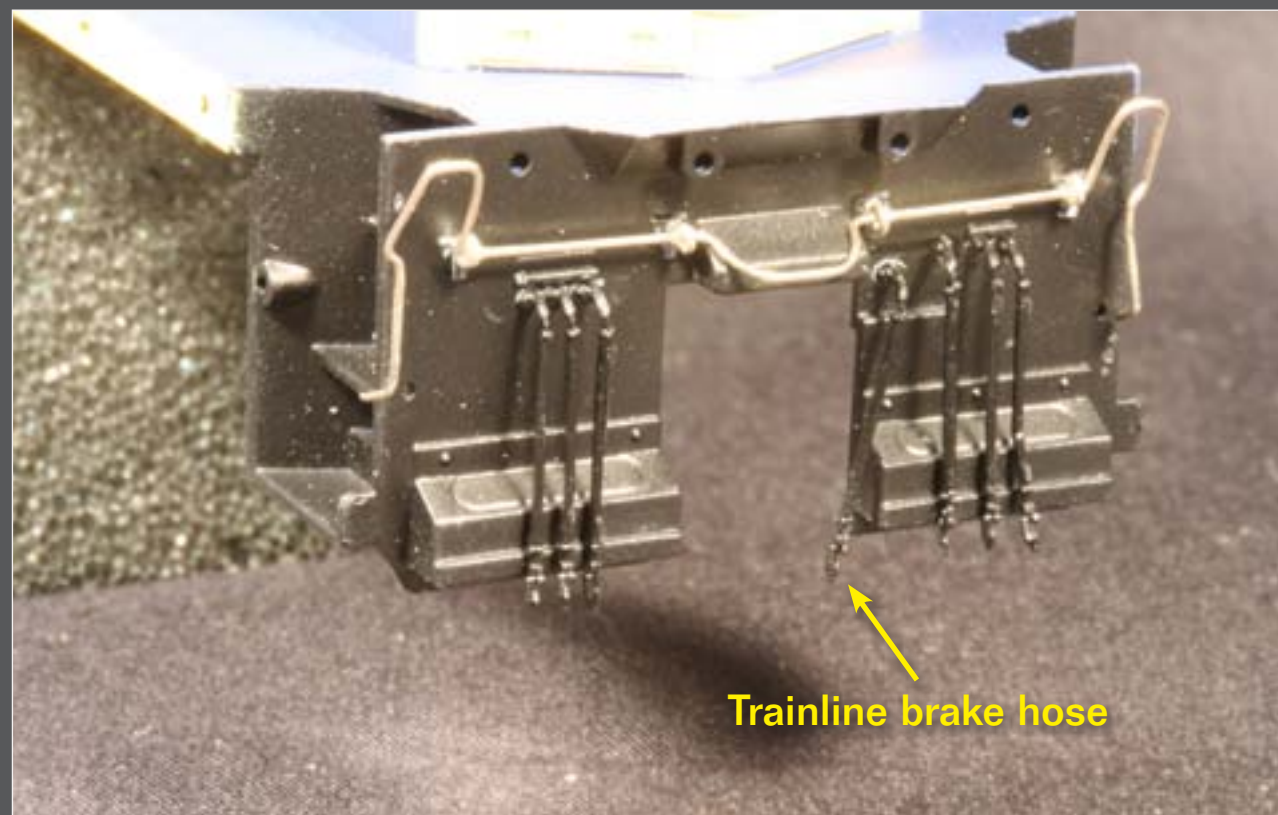

Figure 24: The final ‘standard’ detail is a trainline hose for the trains braking system.

The final standard detail is the addition of a TRAINLINE BRAKE HOSE to provide air for the braking system of the train. Slightly larger than an MU hose, a single hose is mounted on each pilot to the right of the coupler, and slightly lower than the MU hoses, often extending from a small length of pipe.

STEP 5: Railroad Specific Details – Bell

2



Figure 25: When purchasing a locomotive, each railroad had specific options that often were a ‘signature’ of the railroad. This hood-mounted bell was one option applied to Chessie System locomotives.

Now that the standard EMD factory details have been applied, we can look at railroad-specific details. This is one area where simple research becomes a necessity. Each railroad had its own specifications for locomotive options, often suited to the service the locomotives were purchased for. Some options even considered standard within the railroad’s fleet may have been added or removed if the locomotive was assigned to a specific region or type of service.

The first railroad specific detail we’ll add to the CSX GP40-2 is a hood-mounted BELL.

STEP 5: Railroad-Specific Details – Bell *continued...*



Figure 26: Using detail castings to add railroad specific details can really make a locomotive stand out, telling the heritage of the locomotive.

This locomotive has a heritage dating back to the Chessie System. Rather than using the standard underframe bell, the Chessie opted for one mounted on the side of the long hood, making it a highly visible detail. Using photos as a guide, the mounting location of the bell was determined to be on the fireman's side behind the dynamic brake blister. A Details West #176 hood mounted bell was inserted into a hole drilled into the side of the shell.

STEP 5: Railroad-Specific Details – Horn/Antennae *continued...*



Figure 27: Roof details are often a mystery, as we often view the prototype at ground level. Several common details applied to cab roofs are a horn, radio antenna, and end-of-train antenna.

Several other details which are noticeable on all modern locomotives are a HORN and an ANTENNA.

Horns are very railroad-specific and often differ greatly from the 3-chime generic horn that the Athearn model provides. Replacement horns are available from a variety of manufacturers including Details West, Cal Scale, Precision Scale, and Custom Finishing.

STEP 5: Railroad-Specific Details – Horn/Antennae *continued...*



Figure 28: When replacing a horn, rather than attempt to fill the hole left by a manufacturer horn simply cement it in place then cut it off flush with the cab or hood roof. This gives a solid surface to mount a replacement horn.

One of the problems posed when replacing or relocating a horn is the large mounting hole left from the Athearn horn. Rather than try to fill the hole with putty it is much neater and easier to cement the horn in place from the interior of the cab then cut the horn off flush with the top of the cab using a #17 X-Acto chisel blade. Now you can drill a hole for the new horn directly into the mounting tab.

Figure 29: Locomotive horns are often railroad-specific. Castings for a variety of horns are available and adding one only requires drilling a new mounting hole, painting the casting, then cementing it in place.

Also atop the cab is a small defect common among most Athearn locomotives – the round dimple left from the molding process. One way to hide this is by placing a portion of the antenna over the dimple. Prior to mounting the antenna, carve off the raised dimple with a #17 blade.

STEP 5: Railroad-Specific Details – Horn/Antennae *continued...*



Figure 30: Radio antennas are available in several styles including two of the most common – the SINCLAIR, resembling a long handle and the FIRECRACKER, resembling a firecracker. When adding antennas, it's best to consult photos for style, number of antennas, and proper placement.

Radio antennas are another railroad-specific application, as multiple styles of antennas are in use. The most common are the Sinclair and Firecracker styles. In addition to antenna style, almost as many variations exist in placement. Because radio equipment is now used for helper locomotives, end-of-train devices, and Global Positioning Systems, this often results in having multiple radio antennas.



Figure 31: While castings for a 'whip style antenna' are available most only include the base. The actual whip can be added using fine wire or even one leg of a grabiron.

Photos of the CSX model show evidence of only a single 'whip-style' antenna. This was the antenna style that was chosen by the Chessie System when the locomotive was originally purchased. While a Detail Associates #1802 casting will provide the base for the antenna it does not include the whip, which can be easily fabricated from a length of wire.

To fabricate the complete antenna, drill a #80 hole through the center of the antenna base then insert a wire or grabiron leg into the hole.

STEP 5: Railroad-Specific Details – Horn/Antennae *continued...*



Figure 32: After the whip antenna has been added to the roof it can be trimmed to the proper height. This method is useful on locomotives as well as any rolling stock or vehicles equipped with whip-style antennas.

Once the grabiron leg has been inserted through the casting, drill a #80 hole in the roof, then place the grabiron leg into the hole, allowing the antenna base to float freely above the roof. Apply cement along the grabiron leg between the antenna base and cab roof. Then slide the base down to the roof surface. The cement that is picked up by the base will be enough to secure it to the roof, then the upper portion of the grabiron can be trimmed leaving only a single straight whip.

STEP 5: Railroad-Specific Details – Ditch Lights *continued...*



Figure 33: Illustrated in this photo are the ditch lights and drop step (visible above the locomotive walkway), and MU cable (the large cable looping across the top of the pilot).

Two retrofits made by railroad shop forces are evident in photographs and both have the telltale signs of non-standard paint common among railroad shop modification. These include the replacement of the DROP STEPS (allowing crews to travel between locomotives) and the addition of DITCH LIGHTS to the front walkway of the locomotive.

STEP 5: Railroad-Specific Details – Drop Steps *continued...*

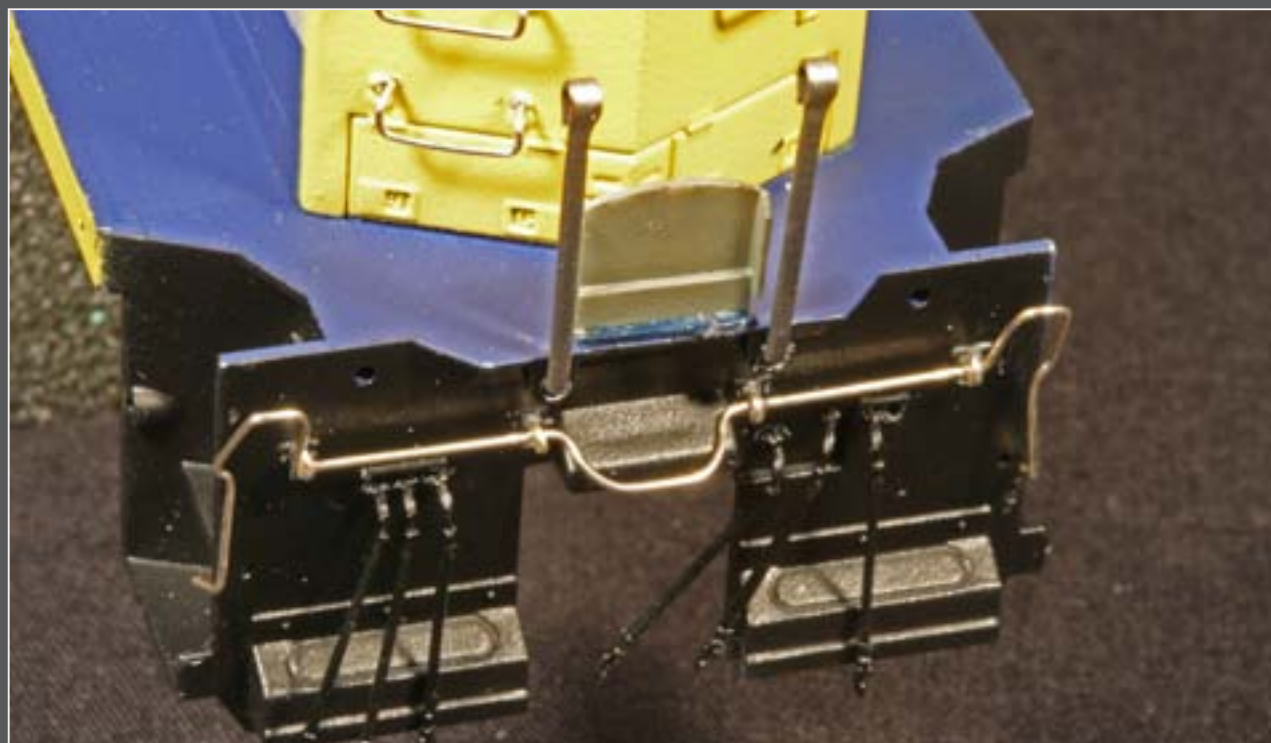

Figure 34: When adding detail parts it is sometimes better to paint them off the model to prevent marring the factory finish. The drop steps added to this model were painted prior to installation.

Drop steps were added using Detail Associates #1404 EMD Late Style Drop Steps which consist of two-piece castings comprising a mount and a step, allowing the modeler to use these in either the up or down position. One discrepancy between the step casting and locomotive model is the lack of safety tread on the locomotive shell. Modeling both drop steps in the 'up' position will help to make this less obvious.

Almost as important as keeping excess cement from marring the shell is keeping excess paint from doing the same thing. It is important to decide whether to paint the detail parts before or after installation. Some parts require painting prior to installation. A simple way to hold parts during painting is to double-over a piece of masking tape and apply it onto a piece of scrap paper. Stick the parts to the tape while they are painted.

In the case of the drop steps and antenna, the bases were painted using blue paint close to the factory CSX blue paint. While not a perfect match, once the locomotive is weathered, these colors can be blended with the factory finish using grimy colors.

Once the step mount was painted to match the walkway surfaces, the handrail stanchions to the left and right of the drop step were placed into their mounting holes and used as a guide for the location of the drop step base. The base was dipped into a small puddle of cement then placed onto the model using tweezers.



Figure 35: Many older locomotives have been retrofitted with ditch lights. Castings are available in several different styles, many with the capability of lighting.

The second detail added by shop forces are the ditch lights applied to the walkway at the front of the locomotive. Several styles of ditch light castings are available from Details West, Detail Associates and Custom Finishing. The angled-mount ditch lights for the CSX locomotive used a Custom Finishing #294 casting. Holes were drilled into the walkway taking care not to drill through the bottom of the lip that extends below the walkway (above the coupler), and after painting, the castings were cemented in place.

Another detail that can vary from locomotive to locomotive is the placement of MU (Multiple Unit) PLUGS and the addition of a thick MU CABLE, providing electrical connections between locomotives. MU plugs can be found on the pilot or above the pilot on the walkway. Multiple styles to

Figure 36: Metal MU cable castings will allow bending, giving the look of a cable tethered to the pilot of the locomotive.

suit almost any locomotive are available from Detail Associates and Details West.

The locomotive being modeled had an MU cable extending between the MU plugs and adding this is as simple as drilling the corresponding holes in the pilot and adding a Details West #236 double-ended MU cable casting. MU cables are generally tethered to the pilot with a small chain, and one feature of the Details West white metal casting is that is already cast with the proper curvature, requiring only minor bending to achieve the right appearance.

STEP 6: Completing the Locomotive – Handrails/Number Boards

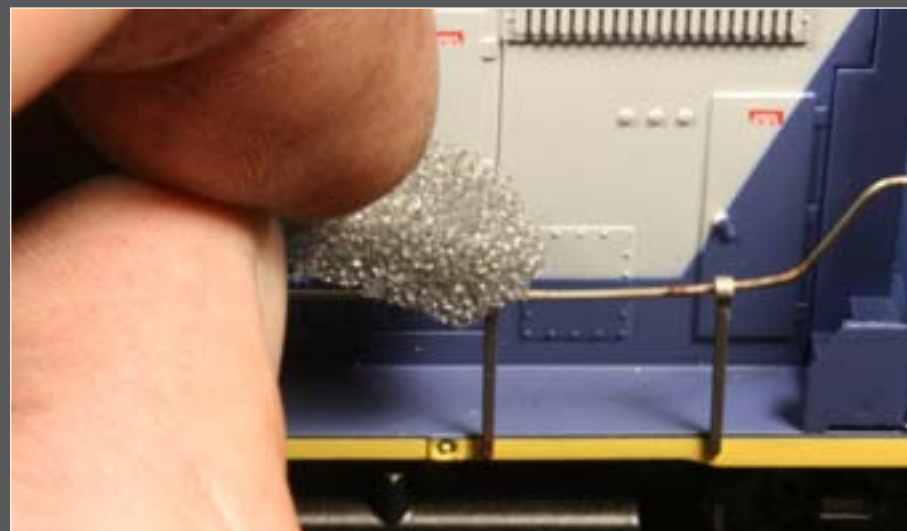

Figure 37: Applying cement to the handrails of a locomotive can be done neatly using the tube/tip applicator of a CA bottle then the excess can be quickly blotted off with a piece of scrap foam.

Prior to reassembling the locomotive, the HANDRAILS were added and secured in place by placing a drop of cement at each joint between handrail and upright stanchion. Once dry, the center section of the handrails at the front and rear of the locomotives were cut with wire cutters. This forms the opening allowing crew members to travel between locomotives using the drop step. If desired a small length of A-Line CHAIN may be installed between the handrail openings.



Figure 38: One detail modelers often overlook is the numberboards. The numberboard background can be either painted or decal'd white or black, then number decals can be applied.

The NUMBER BOARDS were cemented in place, then decal'd using Shellscale decals which provide both the colored number board backing as well as the numbers. Available in multiple colors and fonts, Shellscale number board decals also feature an ingenious 'number jungle' which allows any combination of numbers splicing only two decal parts together. This eliminates applying 3 or 4 individual numbers while trying to keep them all properly aligned, a difficult task even for veteran modelers.

STEP 6: Completing the Locomotive – Other Miscellaneous Parts



Figure 39: Athearn's locomotives come with basic truck details, but more can be added for a super-detailed model.

Now that the locomotive body was complete, the basic details of BRAKE CYLINDERS, SWING HANGERS, and SHOCK ABSORBERS provided with the model were added to the trucks, then couplers were installed on the frame. As this is a locomotive destined for operation and we're only covering basic detailing no additional details were added to the underframe. However for a truly super-detailed model several castings can be added including fuel fillers, speed recorder cables, sanding lines, and fuel tank details.

The body shell was then remounted onto the frame, the hardened pilot casting was installed and the couplers were checked for proper operation. Several coupler issues can arise when adding details such as snowplows or the hardened pilot used on this locomotive. These include restricted



Figure 40: Adding a snowplow can interfere with factory couplers. Extended-shank couplers will project beyond the snowplow, easily correcting interference issues.



coupler swing, the coupler knuckle hitting the plow, and interference with the 'trip pin' that extends below the knuckle. If the couplers will not operate properly installation of a Kadee extended-shank coupler may be necessary.

STEP 6: Completing the Locomotive – Painting



Figure 41: Modelers who do not wish to light their locomotives can opt for 'jewels' placed in the ditch light and headlight openings.

To complete the locomotive, the parts which weren't painted prior to installation were painted in colors to match their placement on the locomotive. MV Lenses LS25 clear LENSES were installed on the ditch lights and the yellow safety striping along the step edges was added using Microscale 2" Yellow Striping, settled in place with an application of Microsol. The model was then weathered using a mixture of airbrushing and chinks which allowed blending the various shades of paint used on the detail parts with the factory-painted locomotive, creating a realistic effect.

Once demystified, detailing can be a rewarding and relaxing model railroading experience. While the level of detail you choose is strictly up to you, even adding these basic details will increase the realism of your locomotive fleet and you'll sharpen your observation skills as you begin to look for differences among equipment. As an added bonus you'll begin to learn what all those parts are there for!

STEP 6: Completing the Locomotive – Painting



Figure 42: One thing that can really transform the appearance of a locomotive is coloring the step edges. Step edges are generally painted bright colors for visibility and can be easily decaled using 2" striping.

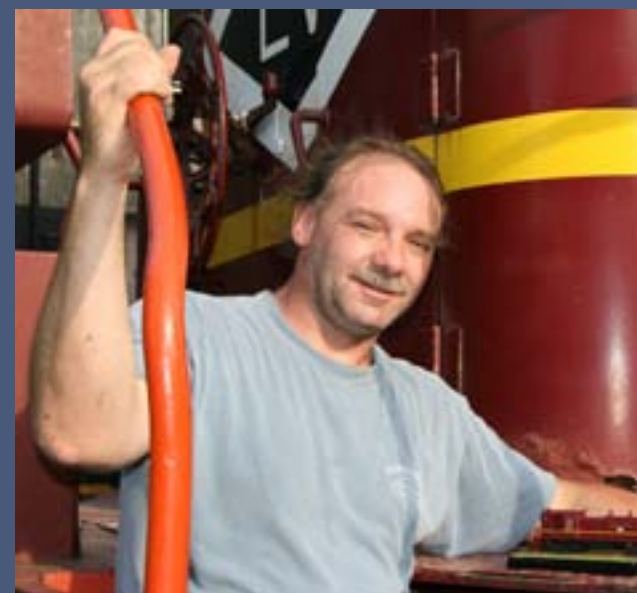

M.R. (Matt) Snell has been a model railroader and railfan for 30 years. His interest in railroading grew while growing up in New

Jersey surrounded by freight and passenger rail lines.

Presently residing in Ohio, Matt and his wife Debie share the hobby, modeling the area he grew up in: north-central Jersey.

Their "Conrail New Jersey Division" layout has been featured in *Great Model Railroads*, *Rail Model Journal*, and in the Allen Keller *Great Model Railroads* DVD series. Matt has had articles in *Railroad Model Craftsman*, *RailModel Journal*, *Scale Rails* and *Model Railroader*, as well as online at railroad.net.



model-railroad-hobbyist.com



The Scenery Scene

Detailing Your Loading Docks

Boxes and Drums and Pallets Oh My!

by Charlie Comstock

 **Reader Feedback**
(click here) 

Spruce up your loading docks with some easy to create clutter. I mix boxes I make from bits of styrene with purchased 55 gallon drums, pallets, and other items for my HO scale BC&SJ. With a bit of weathering they look pretty decent.

Boxes

I simulate corrugated boxes by cutting pieces of styrene stock to length using a razor saw (figure 2).

After cutting the pieces to length I file off the burrs, trying to leave the pieces fuzz-free and with squared up ends (figure 3).

I press an X-acto blade across the top of the boxes to simulate the seam where the two flaps meet (figure 4).

I prepared the boxes for painting by using masking tape to stick them on a

Figure 1: Pallets, boxes, and 55 gallon drums on a loading dock.



Figure 2



Figure 3

Figure 2: Cutting styrene stock into appropriate sizes.

Figure 3: A selection of raw boxes.

Figure 4: Making the seam where the flaps meet on top of a box.

Figure 5: Boxes taped to a piece of scrap and ready for painting.



Figure 1



Figure 4



Figure 5



Figure 6

Figure 6: Preiser pallets are inexpensive and look good.

Figure 7: Grandt Line makes nice 55 gallon drums. I painted some green, grimy black, and roof brown (for rusty drums).



Figure 7

Figure 8: I prepared this collection of 'stuff' in a couple of hours.

scrap of wood (figure 5) Double-sided scotch tape would also work.

I brush painted the boxes using two coats of Polly Scale 'Earth'. An airbrush would result in a more even paint job.

Once the paint dries you can optionally simulate markings on the boxes with a fine-point, felt-tip pen.

Styrene sizes	HO Box sizes
19" x .19"	16.5" square
.125" x .125"	11" square
.19" x .10"	16.5" w x 9" d
.25" x .10"	22" w x 9" h

55 Gallon Drums

I chose to use Grandt line drums. The detail is crisp and they won't break the bank. I paint them in different colors.

Pallets

I used pallets from Preiser (the company that makes the huge assortment of scale people). I broke a few slats to make some look old and abused. Then I painted them with Poly Scale Dust. After that dried, I drybrushed them with Poly Scale Earth, and again with just a touch of Polly Scale Grimy Black.



Figure 8



**FIND OUT
ABOUT OUR
SUMMER
LAYOUT TOUR**

IMPROVE YOUR STRUCTURE MODELING

Learn from the best, well known modelers in the country.
**DAVE REVELIA-DAVE FRARY-BRIAN NOLAN.
SCOTT MASON-BRETT GALANT-DOUG FOSCALE.**

BOB MITCHELL-MIKE ROSE & MORE

DON'T MISS OUT

**SIGN UP NOW FOR PREMIUM CLINICS
DOZENS OF VENDORS - CONTESTS**

css2010.com

Building an Operating Turntable and Roundhouse

My Modular Adventure - Part 3

Runaround track and turnout control – installation and wiring



Les Halmos has been a model railroader since 1979. He's been involved with setting modular standards for the NMRA since 1981. In 2001, he founded the Free-Modu-Rail Group and has been active in promoting Free-mo module standards.

[Click here](#) to learn more about Les.



Editor's note: Les Halmos' articles on building a roundhouse and installing a turntable on his Free-mo module-based layout have been so popular, we asked Les if he'd like to have a regular column. Les said "Yes!" So starting with the next issue of MRH *My Modular Adventure* will become a regular column!

I hope you enjoyed Part 2. Did you see the video? Boy, who was that guy... he sure sounded like he had his knickers in a knot. I better have a chat with him and get him to relax a little. Who knows, maybe in his next video he will be a little more at ease!

OK, you thought that all the wiring was completed. Well there is still a little more. In this segment, I complete the construction and installation of the runaround track and the three turnouts.

So let's go see the progress step by step. First, I made sure I had all the parts I needed for the job. For the track and the #8 Turnouts, I used Central Valley tie strips and Micro engineering Code 83 and 70 rail. The installation method was the same as what I used on our Free-Modu-Rail layout, and as described previously in Part 2 of this article (MRH Issue # 4 Oct 2009).

I modified the Central Valley turnout tie strips by removing some ties and replacing them with Fast Tracks PC board ties in several crucial places.

To operate the turnouts, I used Tortoise (Circuitron) switch machines. The three Tortoises are controlled by a Digitrax DS64 Stationary Decoder; this gives me the option for either local, throttle, or computer control of each turnout. Prior to starting this segment I had already installed the ties for the mainline, sidings, and turnout strips. ☑

Correction

In issue #5 Jan/Feb 2010, page 112, Fig 89, on the drawing showing the APR (Automatic Power Routing) Terminal Block wiring, the position of the track numbers were wrong.

The correction appears in the [Department of Corrections](#) and on the MRH Forum [Reader Feedback Page](#) for *My Modular Adventure - part 2*.

STEP 1: Preparing and Installing PC Board Ties



Figure 1: I use rubber gloves when sanding PC board ties to prevent glass shards from penetrating the pores in my fingers. I don't know if you have ever experienced tiny glass shards in your pores, but let me tell you, they are extremely annoying and practically impossible to remove.

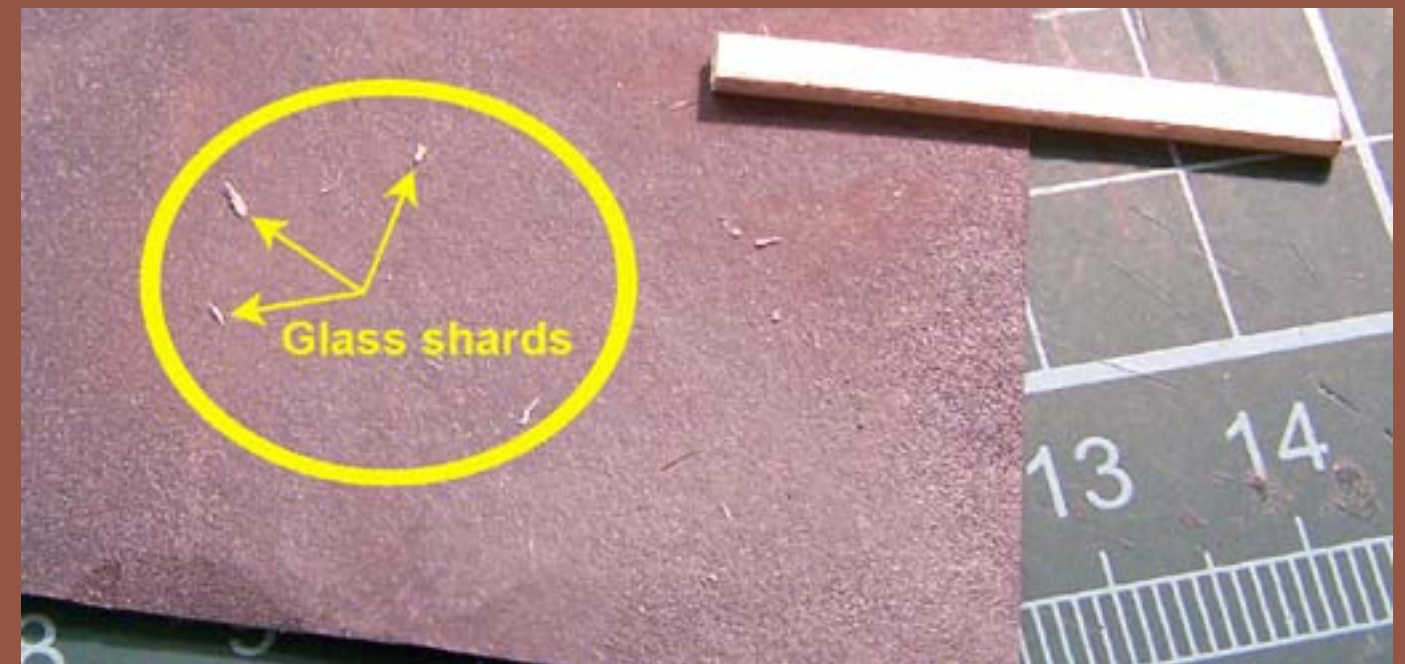

Figure 2: I don't want any of these little guys under my skin!



Figure 3: I prepared each tie by filing and adding two thicknesses of masking tape. This brings them to the proper thickness as I demonstrated previously in Part 2 of this article.

STEP 1: Preparing and Installing PC Board Ties *continued*

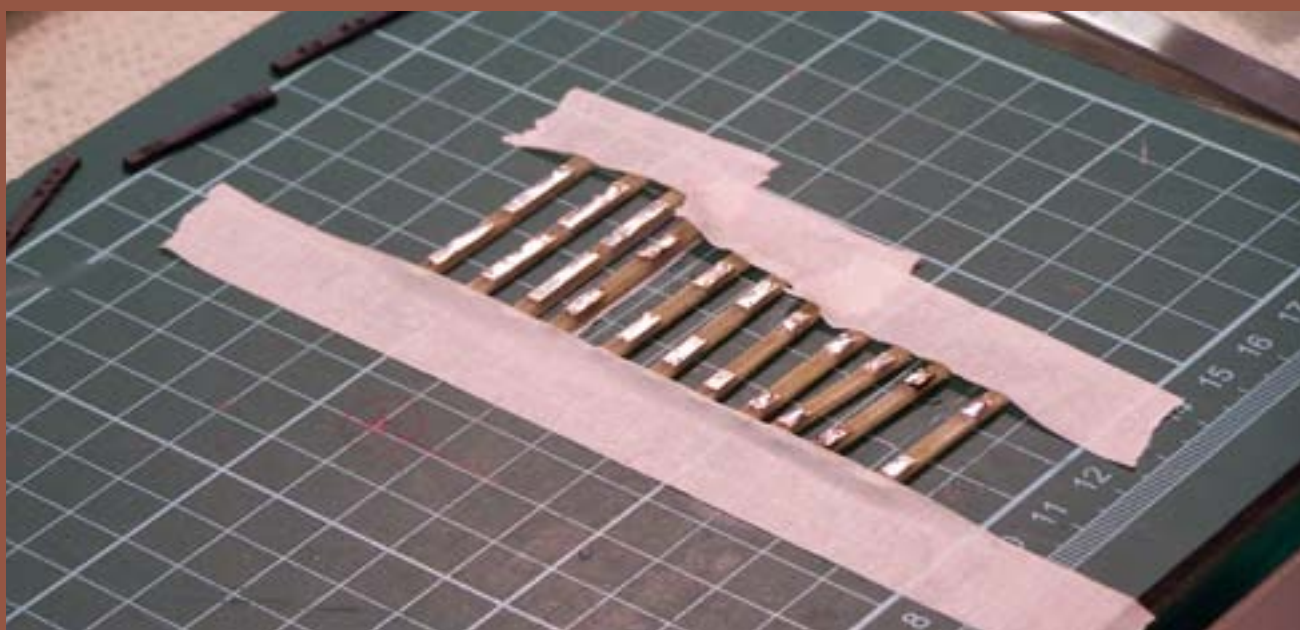

Figure 4: I fluxed and tinned the ties. Be careful not to overheat the pads because the foil will delaminate from the PC board substrate.

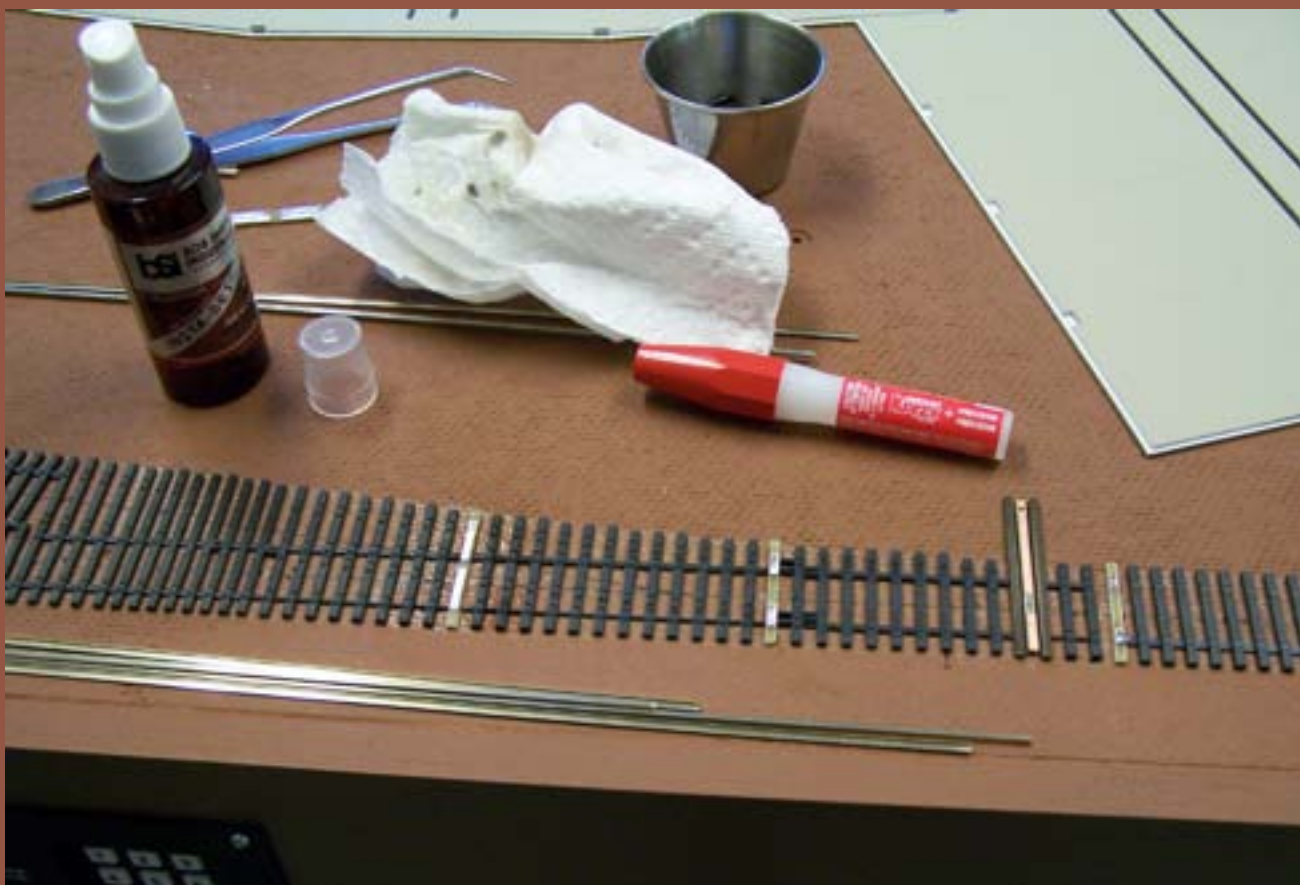

Figure 5: I ACC'd the strips in their respective places (all but the throw bar).

STEP 2: Laying Rail



Figure 6: I measured and cut the stock rails. I like to use full-length stock rails as much as possible.

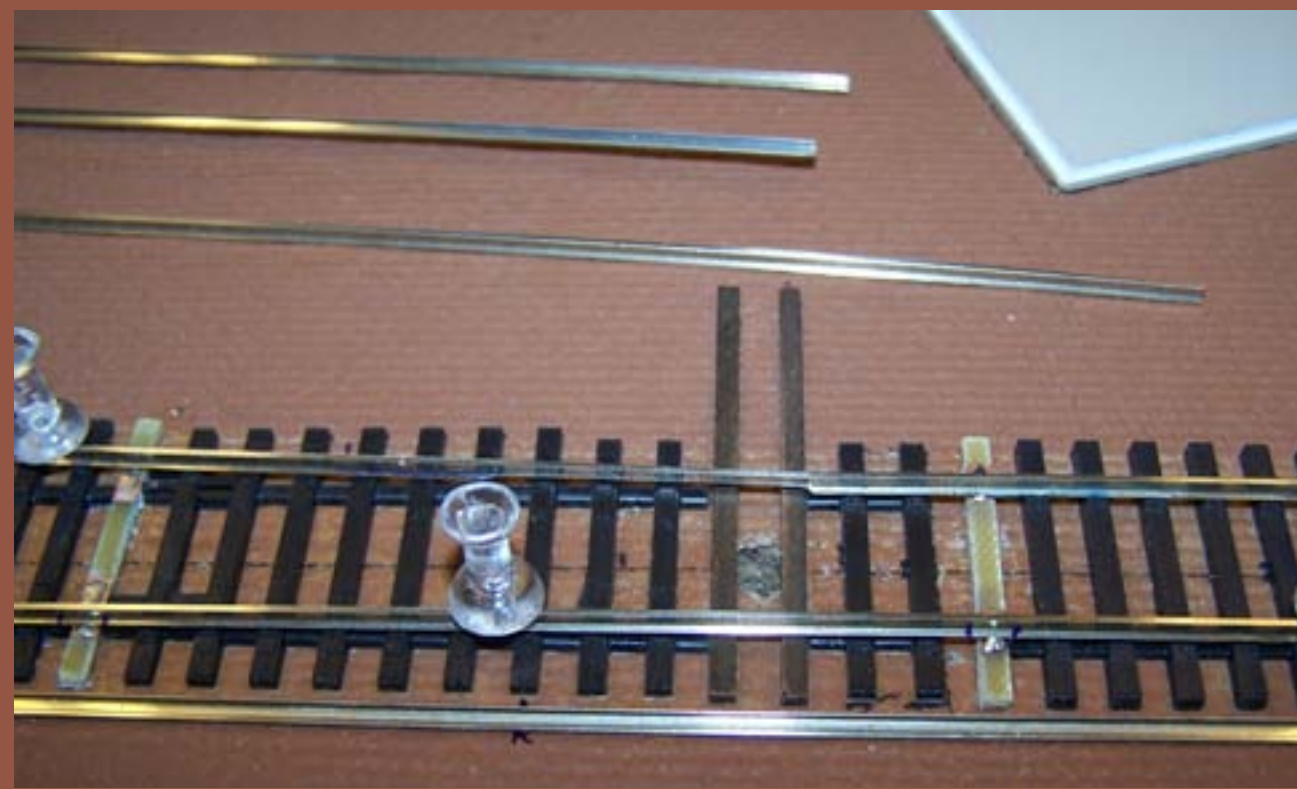

Figure 7: I filed the stock rails to clear the points. I also marked the places where the rails will be soldered to the PC board ties.

STEP 3: Preparing the Frog and Point Rails



Figure 8: I filed the frogs and the points using the Fast Tracks point forming tool.

Figure 10: The jig consists of a base plate with 3 UHMW (plastic) pieces, 2 of which are screwed to it. You cannot glue UHMW, so Reynald tapped and screwed them to the base. The third piece is left floating, and holds the point-forming tool snug when tightening the two bolts. I used this tool to build over 70 sets of frogs and points and it's still going strong. One of the characteristics of UHMW is its "slipperiness" which, while I was filing, kept the wear on the Fast Tracks Point Filing tool even.

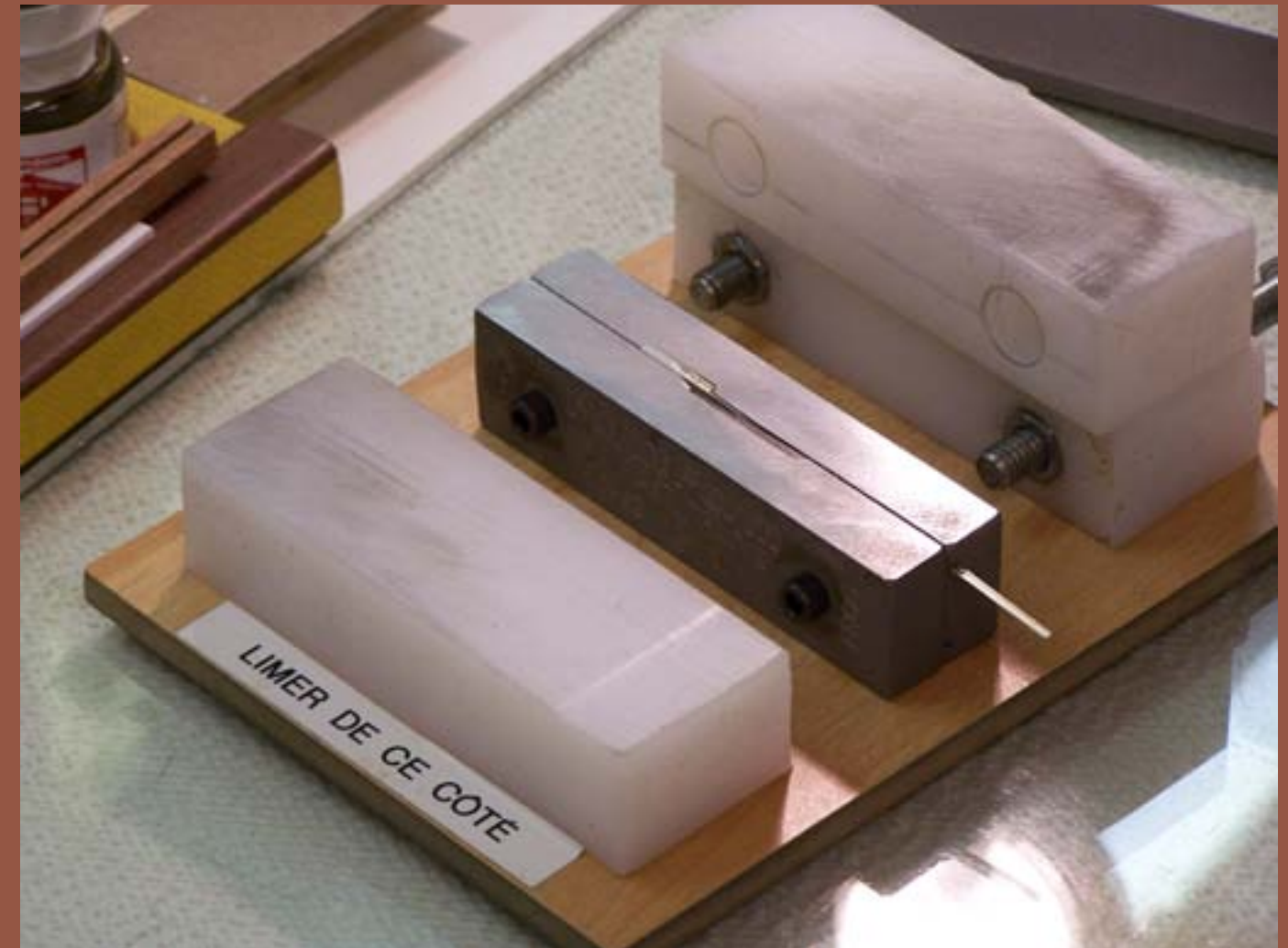
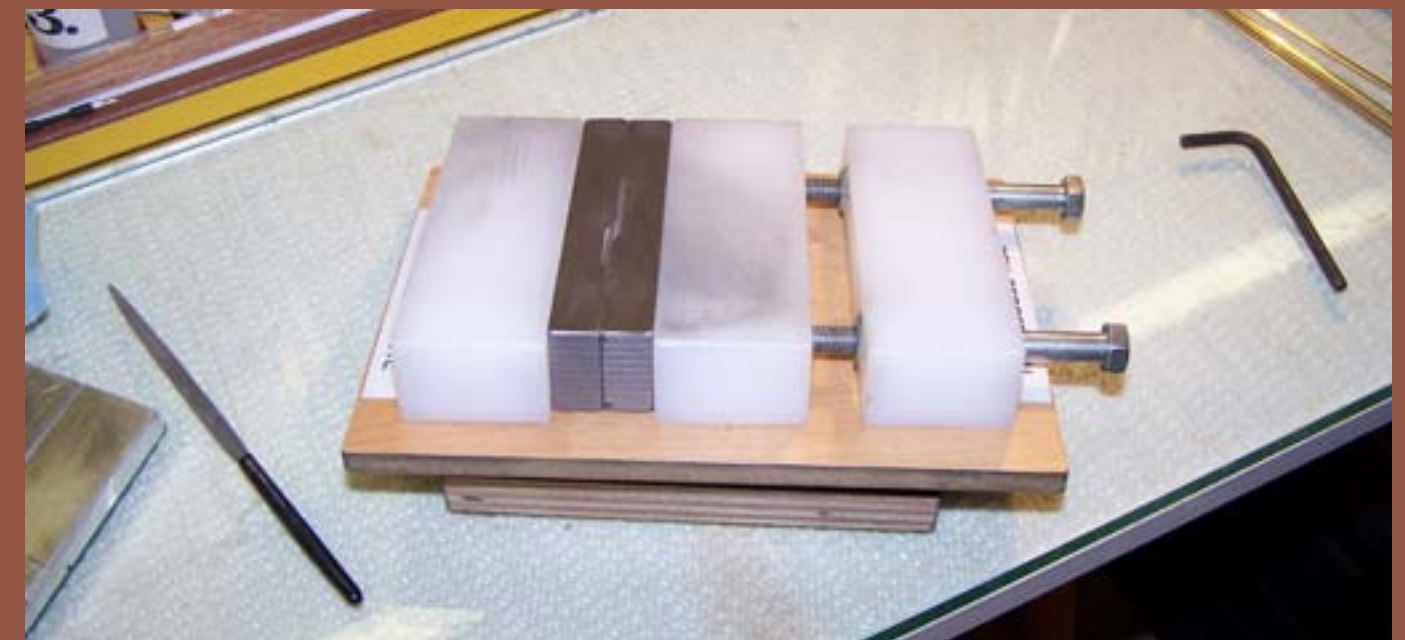

Figure 9: This ingenious jig was the idea of my friend Reynald Lepage, member of our Free-Modu-Rail Group.



STEP 3: Preparing the Frog and Point Rails *continued*



Figure 11: Then I installed the stock rails and added the frog and point rails.



Figure 12: A few gentle taps seats the frog rails in the Central Valley frog casting. I prefer using this casting as well as Central Valley guard rails because they remain dark even after cleaning the track. Since they're plastic they won't shine like metal ones, for a more prototypical appearance.

STEP 4: Finishing the Runaround Track



Figure 13: The main line track (in front) is Code 83, but the siding (in back) is Code 70. Transition rails are required to connect them.

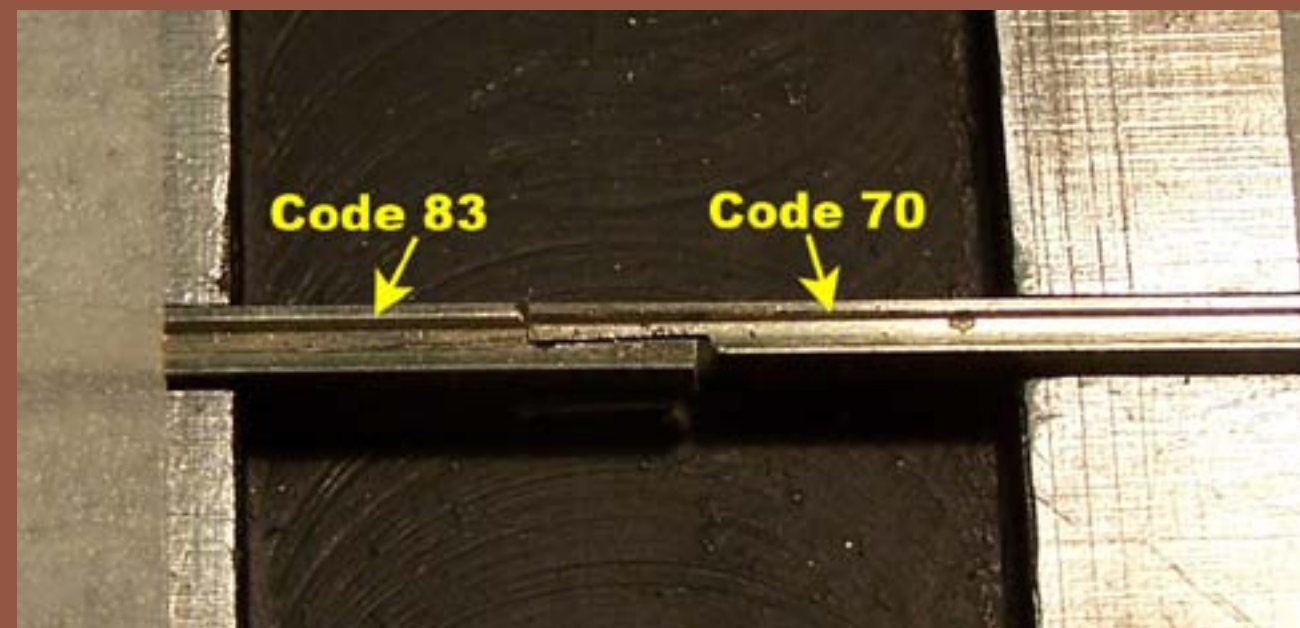

Figure 14: I file my transition rails so that they're half-height. When mated, they're full-height and I solder them together.

STEP 4: Finishing the Runaround Track *continued*

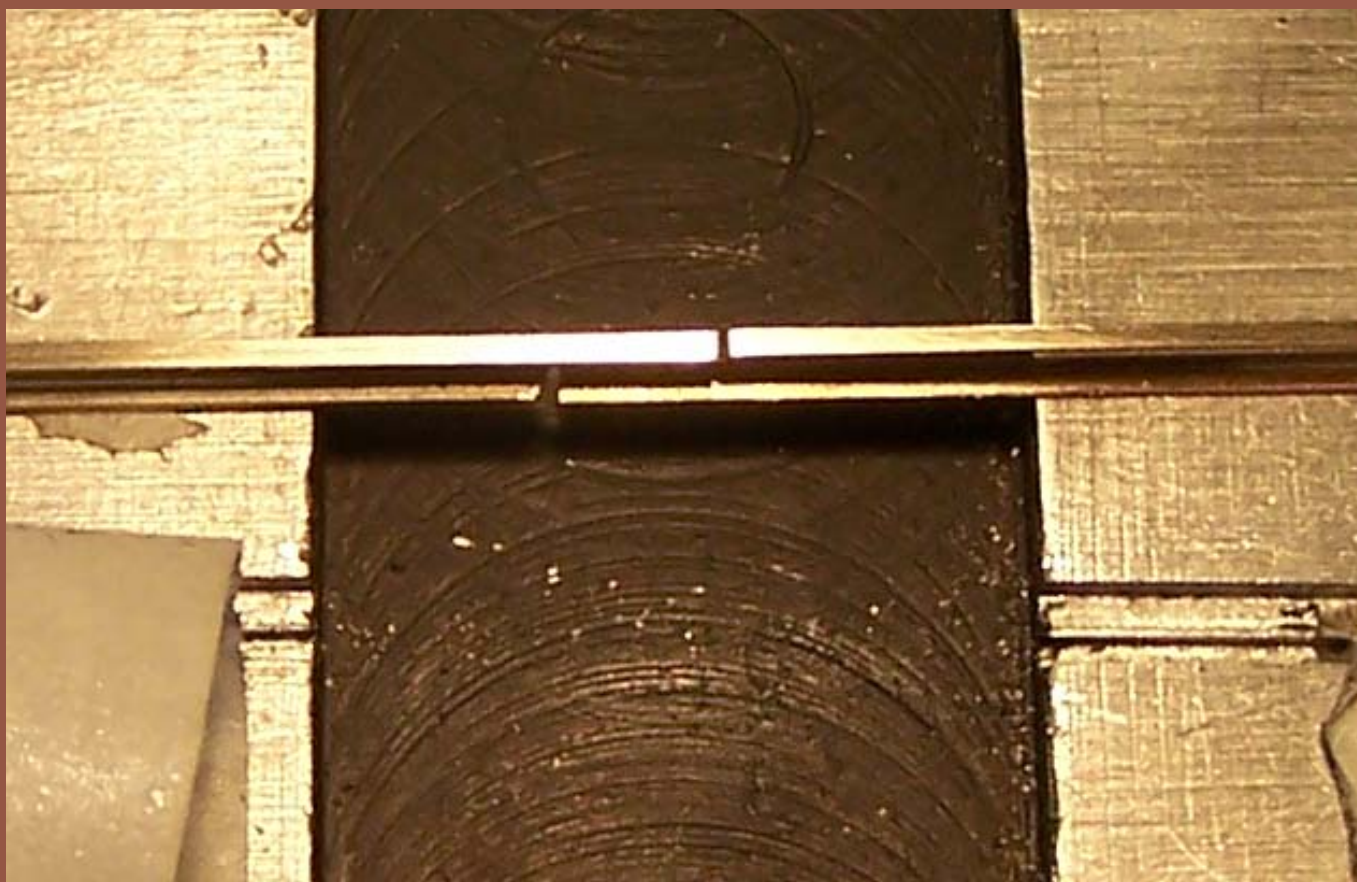

Figure 15: I made one for each side with the inside of both rails flush.

If you don't have access to a milling machine to make a custom fixture out of aluminum, there are some other ways of making transition rails:

1. Slide a rail joiner on the larger rail (code 83 in this case). Then use a pair of pliers to squash the free end flat. Solder the smaller rail (code 70 in this case) on top of the squashed rail joiner end.
2. Use a special code transition railjoiner.
3. Make a jig out of wood using a table saw instead of a milling machine to 'mill' the slot.

Take care when joining unequal height rails. There is a .013" height difference in the rails, but if the ties beneath the rails are the same size, you'll need to shim them to make the roadbed of the code 70 track .013" higher than the code 83 track's roadbed.



Figure 16: End view of jig. Groove on one side is for Code 83 and Code 70 on the other. The jig was built using a 3/8" piece of aluminum. I left a wide space in the middle for soldering. It really does a great job and also acts as a heat sink.

STEP 4: Finishing the Runaround Track *continued*

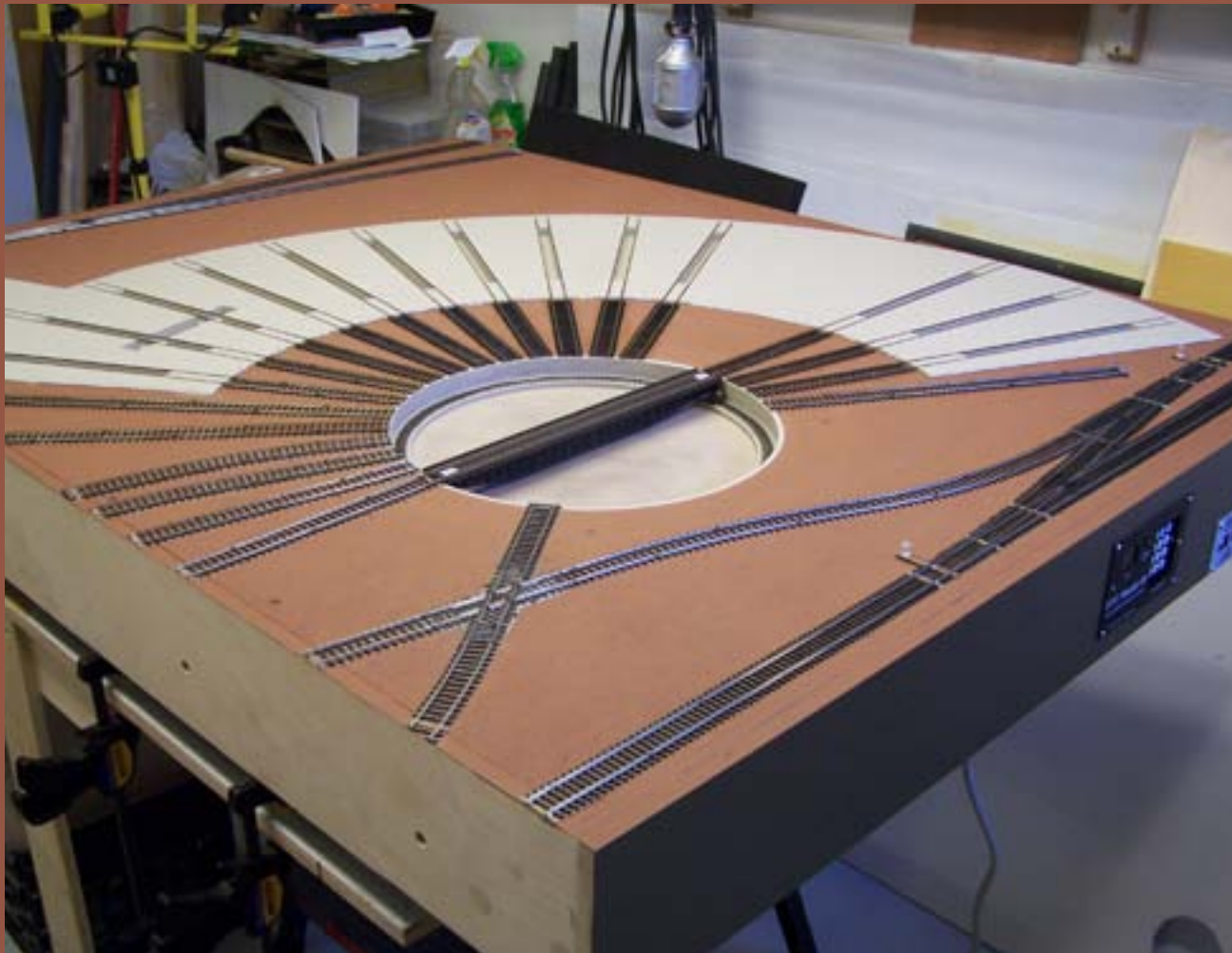

Figure 17: All done! Look out Tortoise, here I come!

STEP 5: Installation and Wiring of Turnout Control (Tortoise)

Now that the trackwork on the module is complete I'm ready to start installation of the turnout control system. The first thing that I did was to prepare three Tortoises for installation by constructing mounting plates for them.

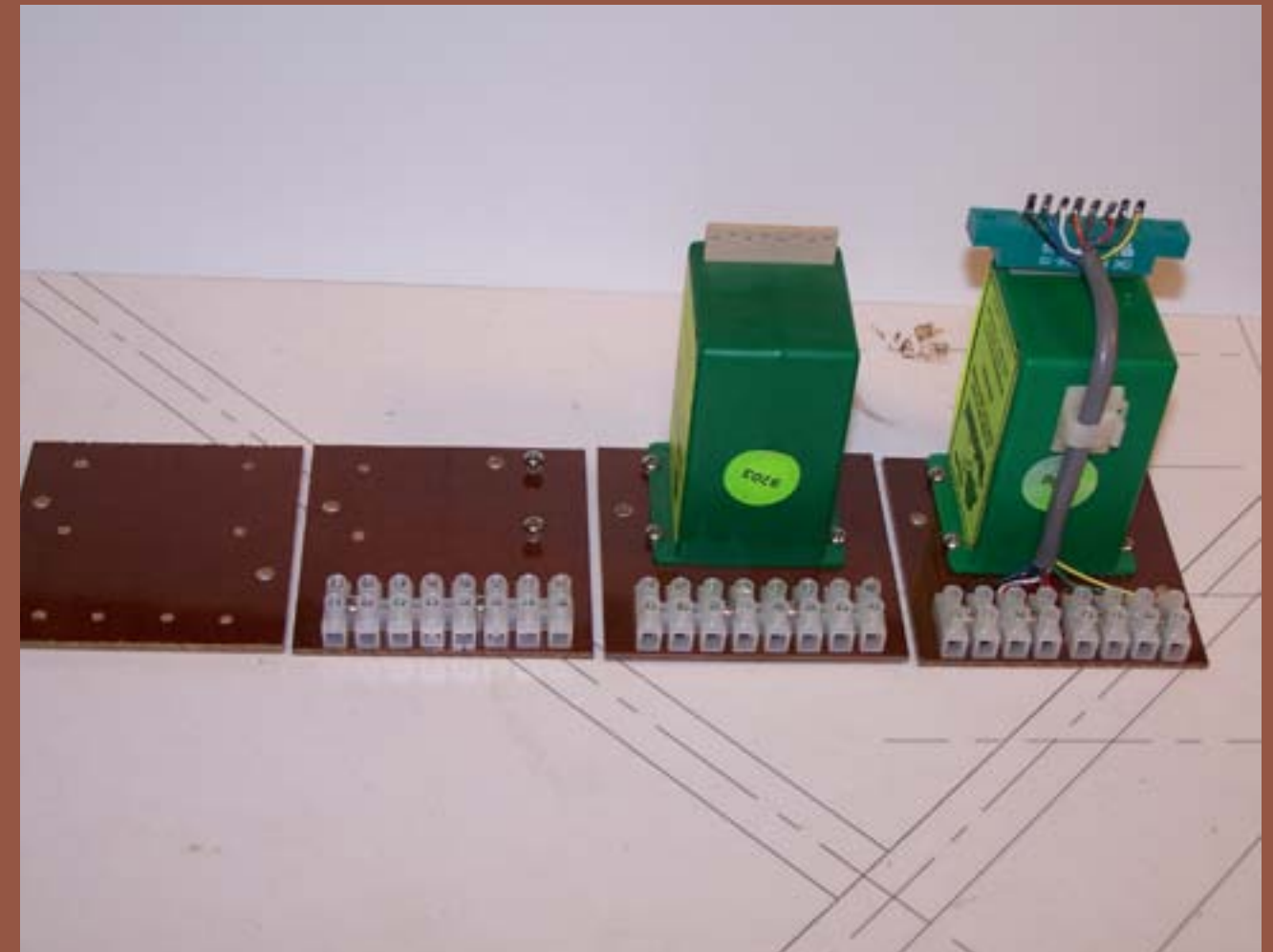
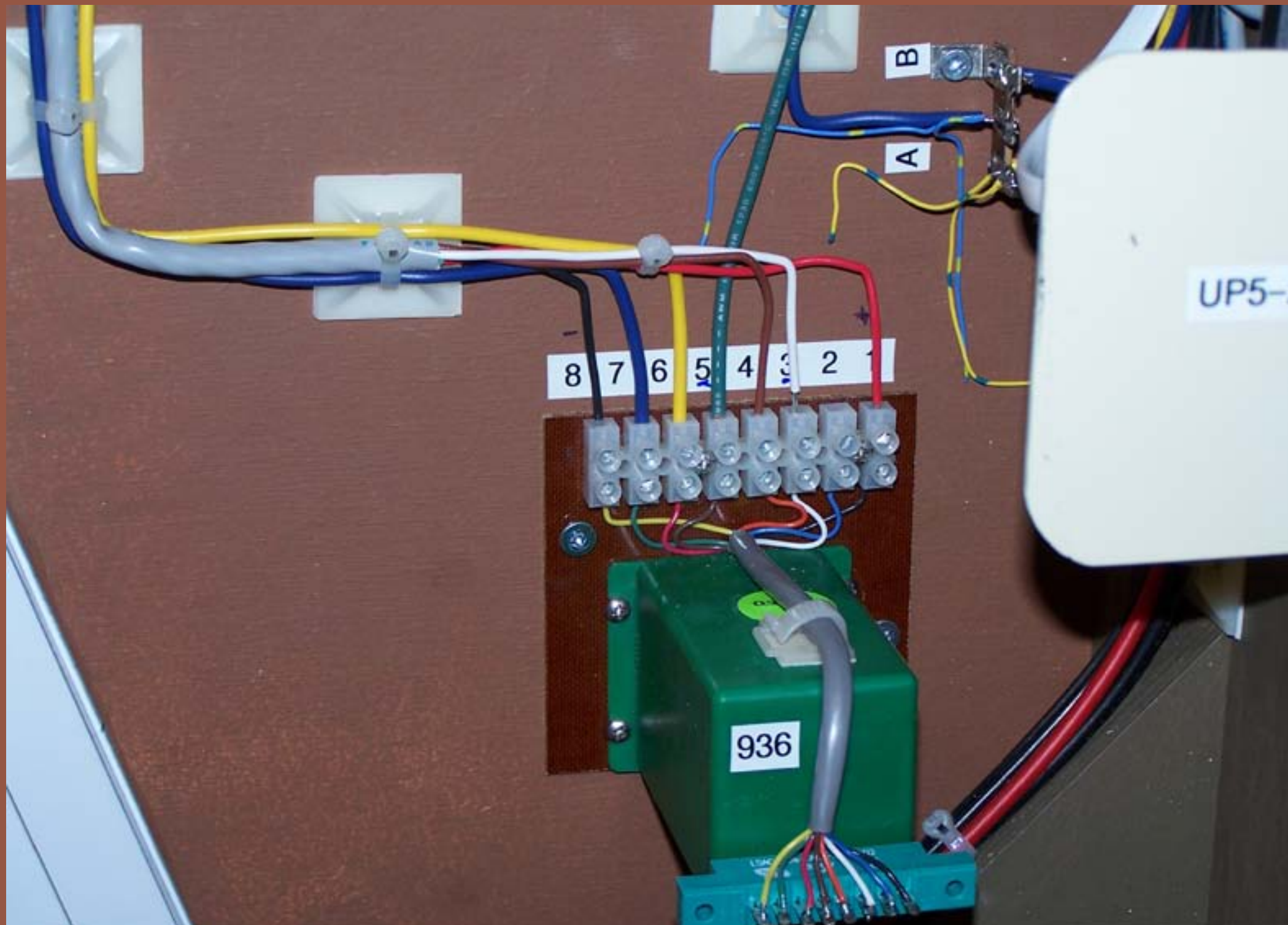

Figure 18: My standard Tortoise mounting showing the base plate, connectors, Tortoise installation, and wiring. We drilled and tapped 100 phenolic base plates! The 'extras' will be used on the Free-Modu-Rail Layout!

In this step I cut, drilled, and with the help of my friend Reynald, tapped 8 holes in each 1/8" [phenolic C plate](#). I assembled and Reynald wired the Tortoises!

STEP 5: Installation and Wiring of Turnout Control (Tortoise) *continued*



The three turnouts on the module are connected to a Digitrax DS64 Stationary Decoder. This allows each turnout to be controlled via push buttons from either side of the module (a Free-mo requirement). The turnouts can also be controlled via the throttle or a computer hooked up to the Digitrax (peer to peer) LocoNet. There is lots more information on this system at the [Digitrax website](#).

The Tortoise wiring was pretty straightforward – see Figure 20 (next page) for details.

Figure 19: Tortoise installed with power, track, frog and aux contacts connected.

STEP 5: Installation and Wiring of Turnout Control (Tortoise) *continued*

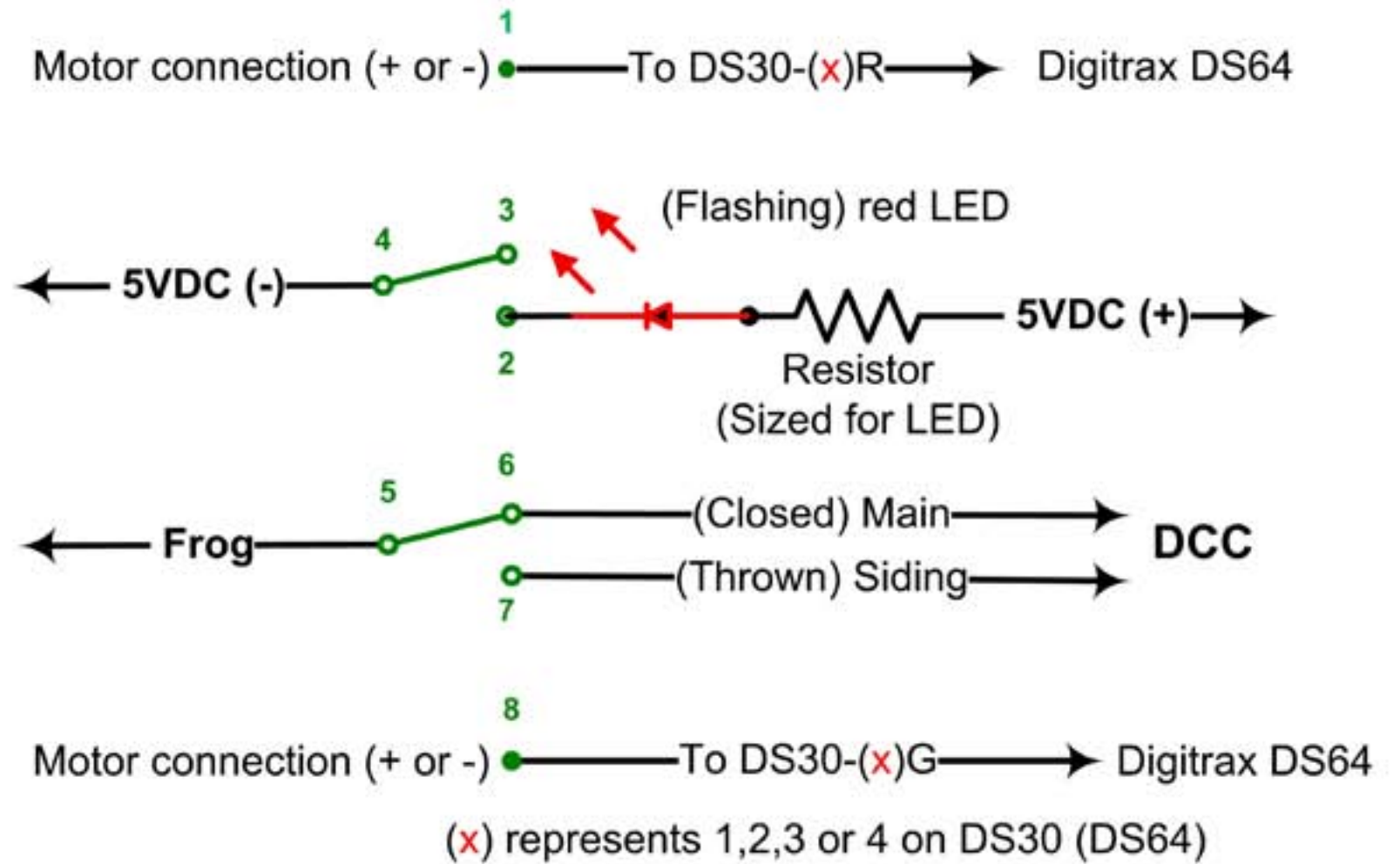
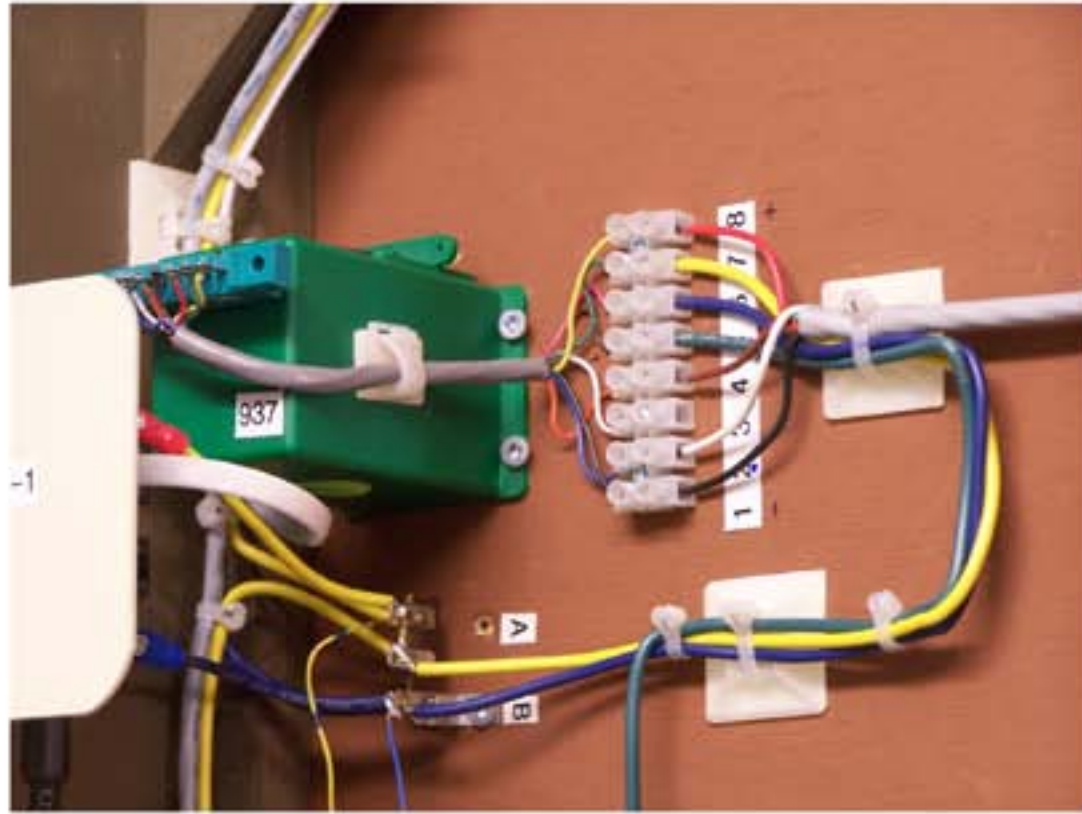

Typical Tortoise wiring

Figure 20: Typical Tortoise wiring. I picked up 100 5mm red flashing LEDs with resistors, on eBay for \$8.50 USD. Shipping was included. myworld.ebay.ca/cwithk/. They also carry a lot of different LEDs for ridiculously low prices!

STEP 5: Installation and Wiring of Turnout Control (Tortoise) *continued*

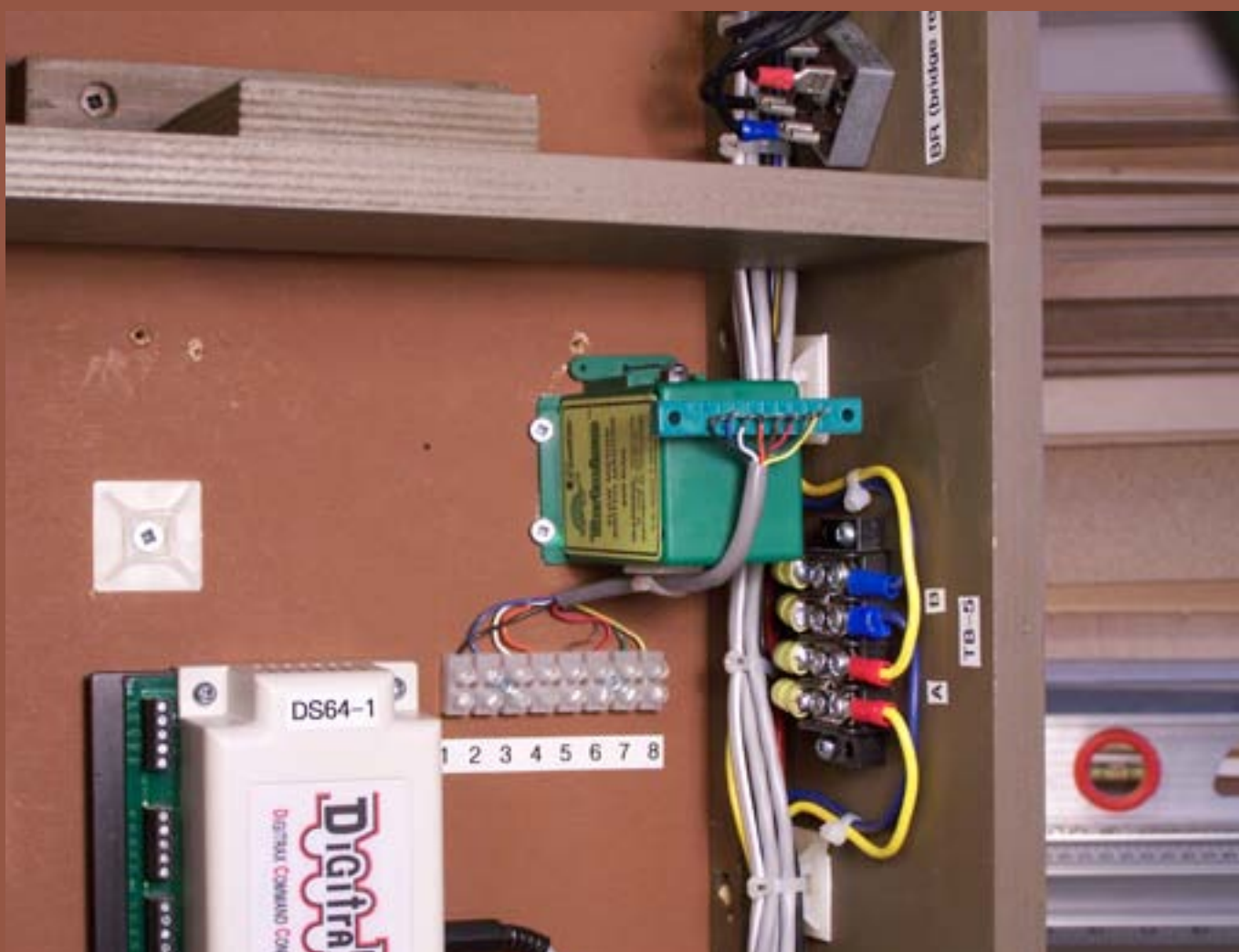

Figure 21: I had to remove the phenolic base to be able to fit this Tortoise into a tight corner! I could have used a bunch of linkages, but I had just enough room to avoid them. When I built the module and installed the plywood subroadbed, I neglected to notch the $\frac{3}{4}$ " pine strip to allow room for my standard Tortoise mounting.



Figure 22: All three Tortoises hooked up to the DS64. I'm not particularly proud of the routing of the wires here. I'll do better next time!

Once I finished the installation, I double-checked my wiring and tested the Tortoises (and turnouts) to see if all was according to plan. Lo and behold it was! I moved on to the installation and wiring of the Push Button Stations.

STEP 6: Building and Wiring the Two Push Button Stations



Figure 23: This is the final product. One push button and one Red Flashing LED with the Turnout numbers on the schematic diagram. Ok, so how did I get there?

It took me a while to figure out how I would handle the Free-mo requirements for control of the Turnouts from both sides of the module.

Then suddenly in the middle of a wintery night, it came to me... this happens to me often... at my age, the hardest part is to remember it in the morning. I said to myself, "Self, why not use a common item like a 1- 1/2" ABS pipe end cover?" I could install a Push Button and an LED, then drill a hole in the module and insert it. So I got up, took out my notebook, and designed the whole thing. Aren't we retired guys lucky? Being my own boss, with the exception of TOWMBO (the one who must be obeyed), next morning I slept-in.

The bright ideas I get usually sound quite simple on the outset, but as the design evolves, things get a little more complicated. I figured that I would draw a label on the computer and also use it as a template to drill the holes for the Push Button and LED.

So the next afternoon, I gathered all my components, 4 ABS end caps, two for each side of the module, 4 momentary Push Buttons, 4 Red Flashing LEDs including resistors and a Forstner bit to drill the holes in the modules.

I needed 4 of these because there are 3 Turnouts (2 of which form a single crossover controlled by one push button), and they need to be controlled from either side of the module.

STEP 6: Building and Wiring the Two Push Button Stations *continued*

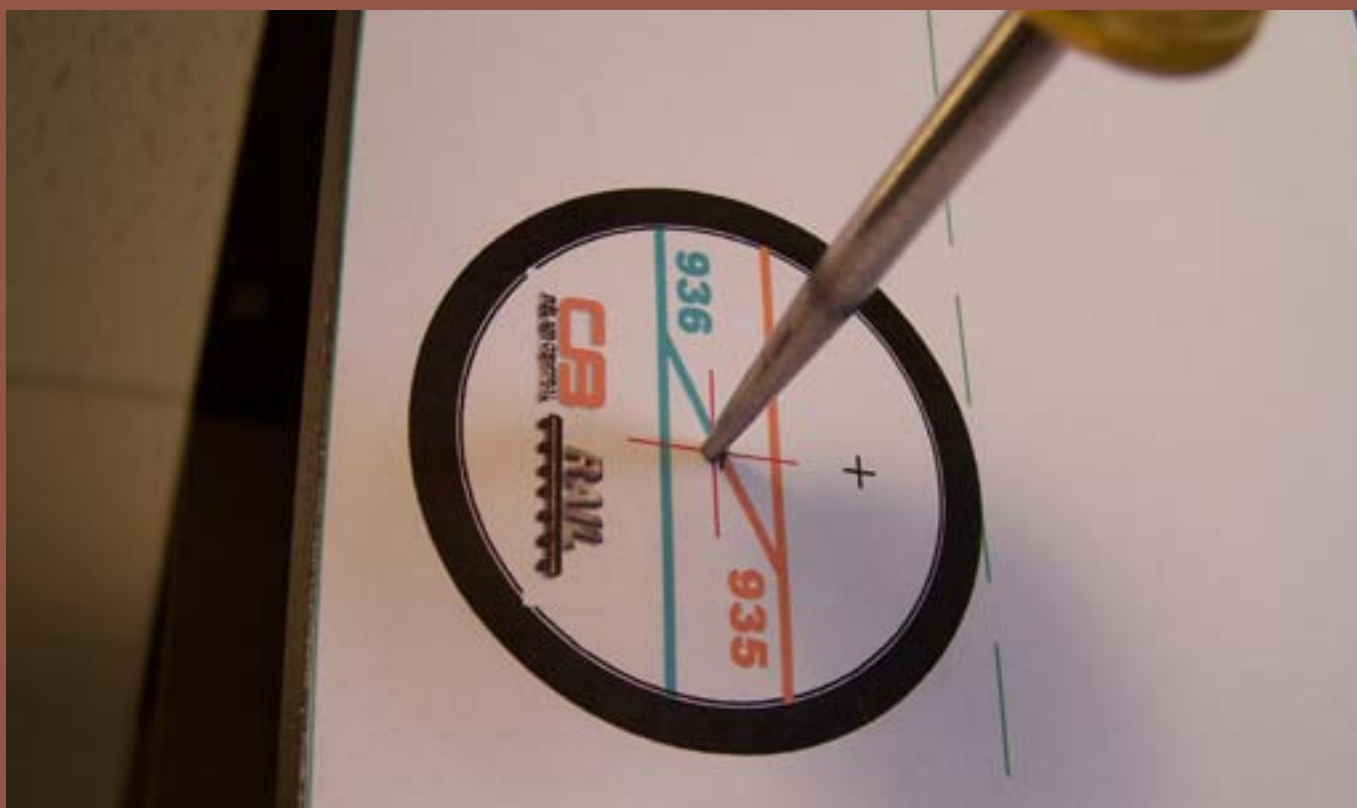

Figure 24: I drew and printed out labels, using them as templates to punch a location hole in the module.



Figure 25: I Used a Forstner bit to drill the holes in the module sides.



Naturally Murphy showed up at this point, and when I tried to fit the cap in the hole, its diameter was ever so slightly larger than the hole. What to do! I could either try to make the caps smaller or the hole larger. I went on a trek to find a larger Forstner bit. Of course the next size larger was too large, but an experienced clerk at the tool shop showed me another way. His recommendation only set me back about \$17 CDN instead of a hundred or more for a custom bit!

Figure 26: A simple drum sanding kit which made enlarging the holes go smoothly. Now why didn't I think of that? I have so many tools in my arsenal, but (until now) not this one!

STEP 6: Building and Wiring the Two Push Button Stations *continued*



Figure 27: After careful sanding, I wound up with two perfectly sized holes.

Now that the holes were drilled and the end caps fitted, I moved on to the preparation of the “Local Push Button Controls.”

On my track plan, one side of the module has a simple siding and the other side has a crossover. I need to control these from both sides of the module. That is the reason for two separate end caps on each side of the module. On each side, one Push Button controls the turnout for the siding and another Push Button controls both turnouts of the crossover. I used momentary push buttons instead of DPDT toggle switches because the DS64 Stationary Decoder allows me to have a push-push control - each push changes the position of the turnout(s). I used the auxiliary contacts of the Tortoises for switching the frog polarity and to turn on the Flashing Red LED.



Figure 28: The ABS end caps, one with the lettering sanded off. I did this on both sides to get rid of the raised lettering.

My strategy is: When the turnouts are set for the through route (closed) the LEDs are off, and when they are set for the siding or the crossover (thrown) the LED flashes. This allows me, at a single glance, to see the position of the turnout, and reminds me to return the turnout to the closed position after I am finished.

This will become quite illuminating (no pun intended) as we will see later.

Here’s how I built the four Push Button Controls.

Job # 1 was to make sure I had a smooth surface to work with when drilling the end caps (Figure 28)!

STEP 6: Building and Wiring the Two Push Button Stations *continued*



Figure 29: Using the label as the template, I marked the hole locations with a center punch.



Figure 30: Using the punch marks as references, I drilled two 1/16" diameter pilot holes for the next step.



Figure 31: I countersunk the rear of each hole, using the pilot holes as references, removing just enough thickness so that I could install the hardware. Then I drilled a hole for each component.



Figure 32: The holes countersunk and drilled, ready for the installation of the push button and LED.

STEP 6: Building and Wiring the Two Push Button Stations *continued*



Figure 33: I laminated double-sided tape on the back of the labels and trimmed them to fit inside the end cap.

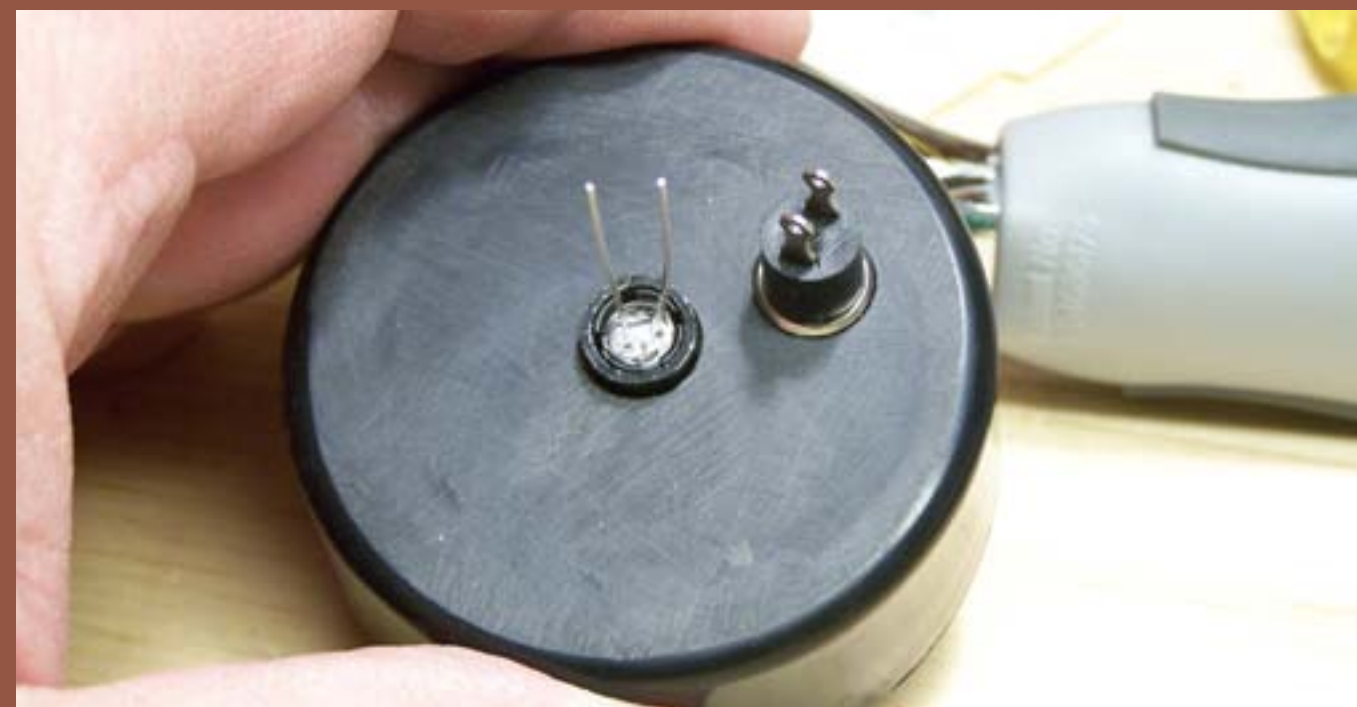

Figure 34: I carefully centered the labels in the end caps, then I perforated the label at the hole locations (removing any excess label) and installed the push button and LED on each cap.

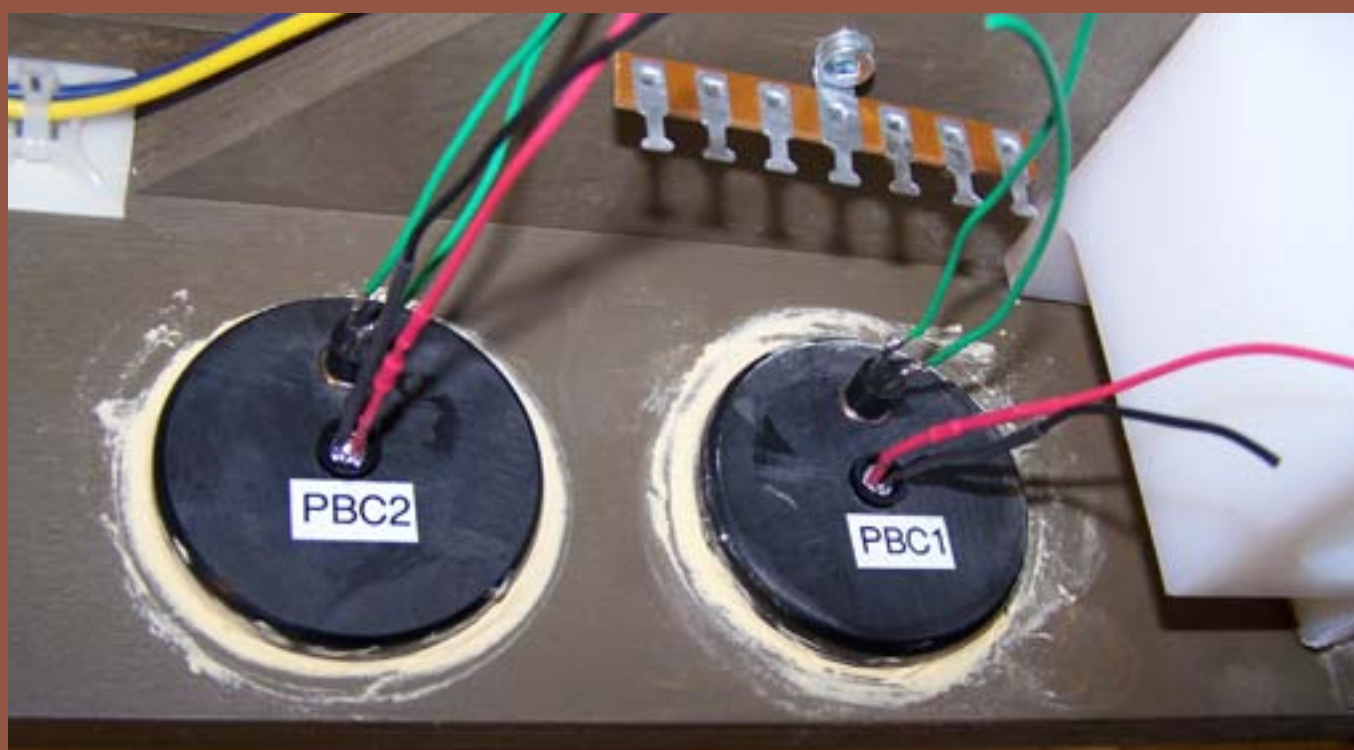

Figure 35: I had pre-wired the end caps before securing the caps in place with caulking compound.



Figure 36: I test fit the push button/LED assemblies on the module.

STEP 6: Building and Wiring the Two Push Button Stations *continued*

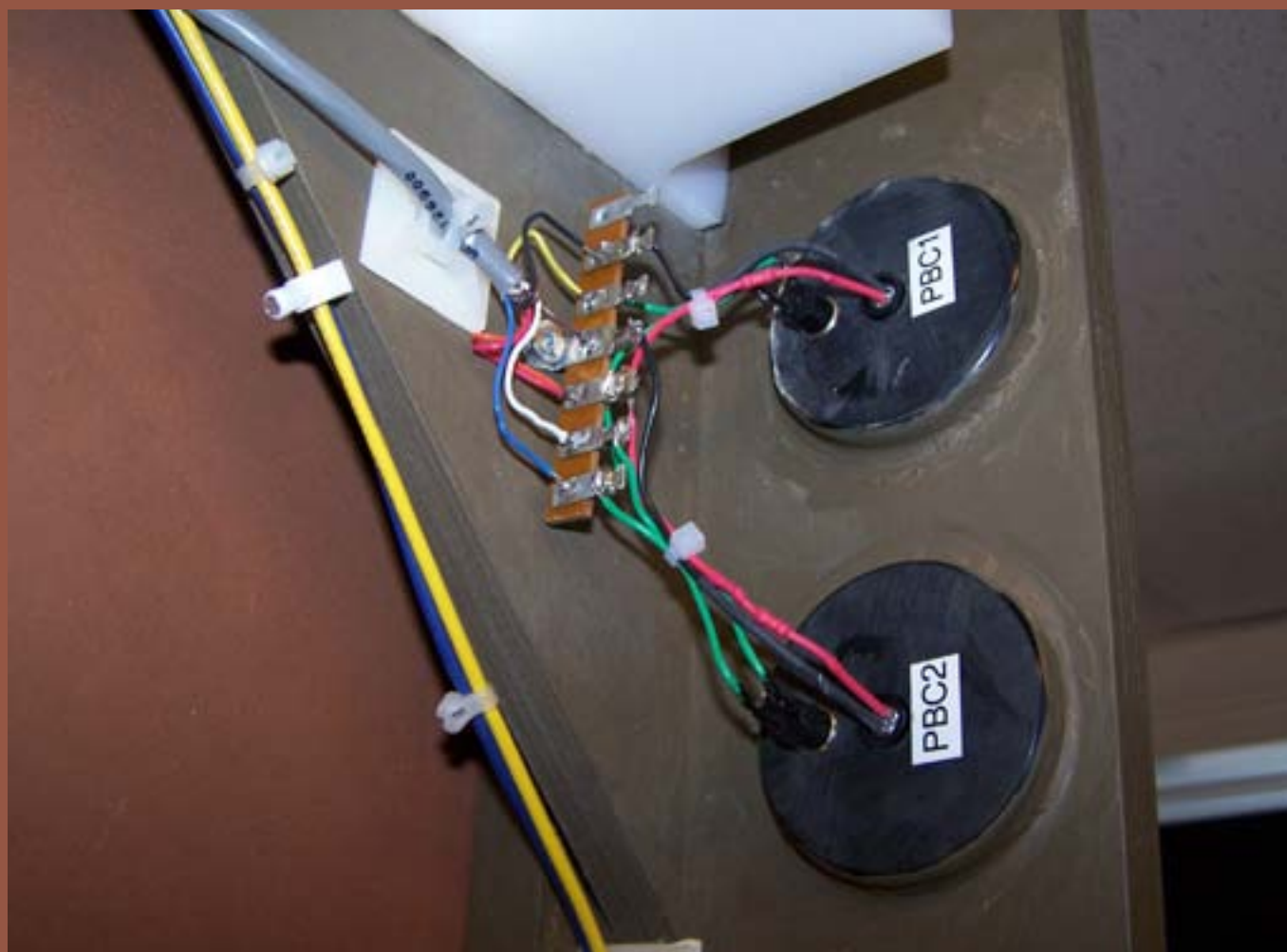

Figure 37: I used a solder terminal to provide a solid place to attach the wiring. Once the caulk dried, I painted it. It looks much better that way. If you look closely you will notice that I used heat-shrinkable tubing on the LED leads and resistor. This adds strength, prevents breakage of the more fragile leads, and eliminates shorts.

Before I got too deeply into the wiring, I took some time to do a little pre-planning. Each of the push button control stations has to be wired in parallel, then the push button leads have to be routed to the DS64 identified as (DS30). The LEDs, on the other hand, are routed to the auxiliary contacts on the Tortoises and the 5VDC power supply.

This is an example of how the Push Button Controllers are wired.

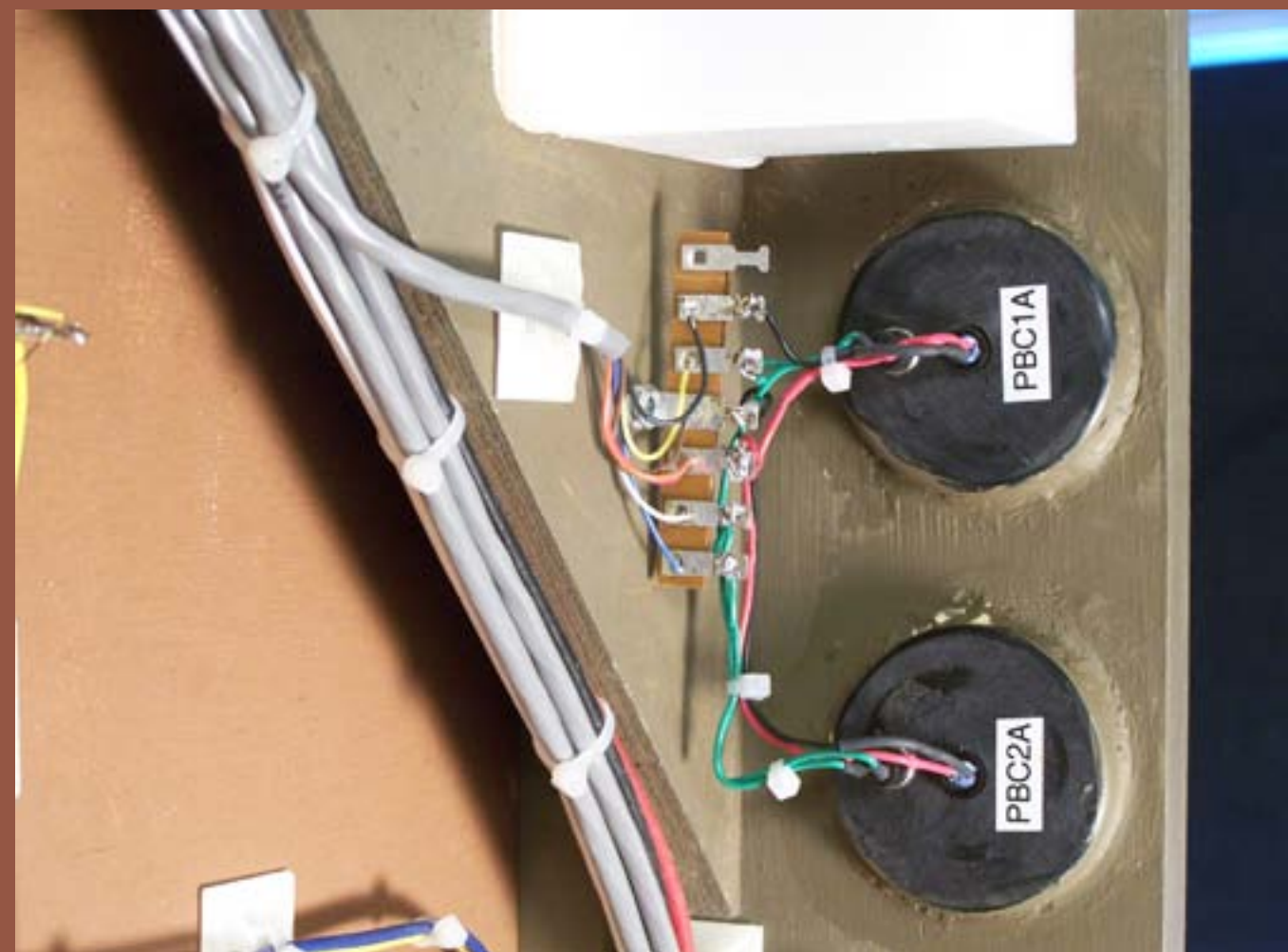
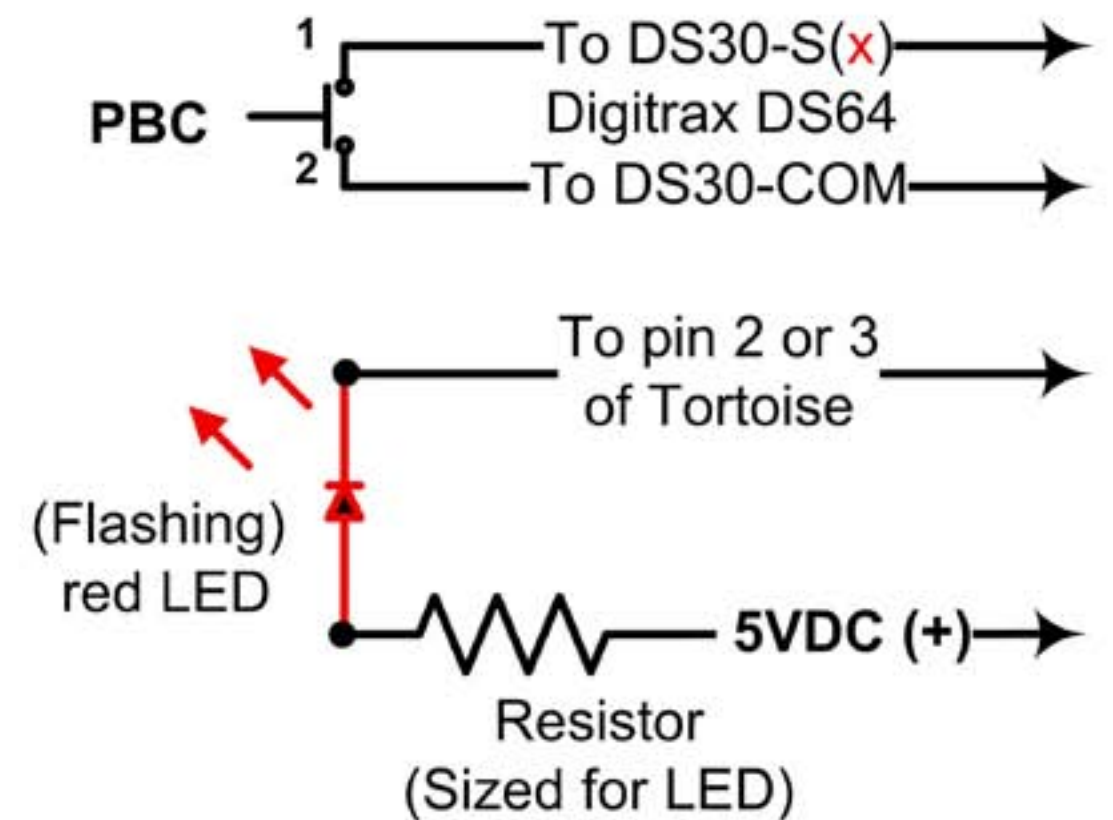
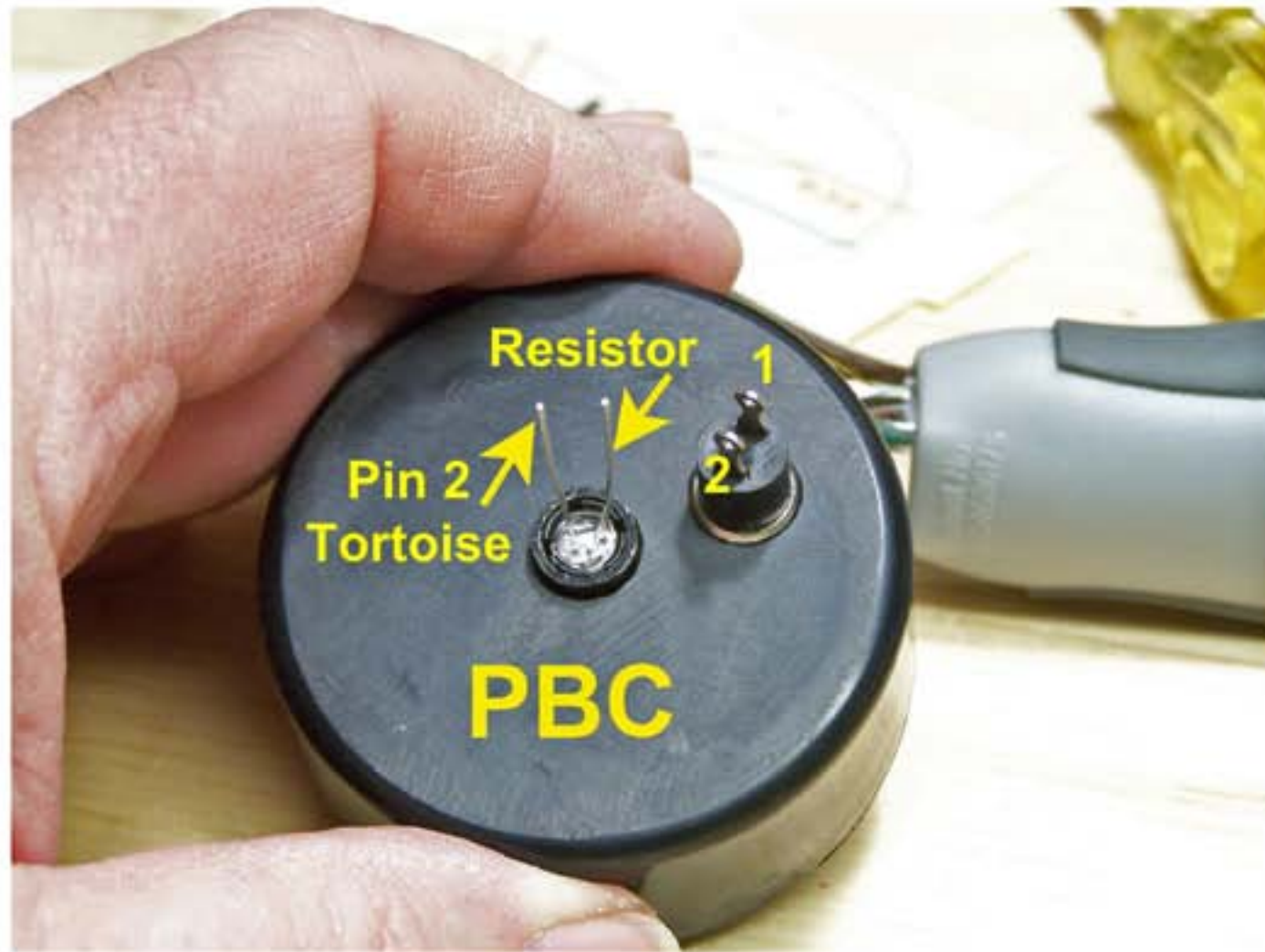

Figure 38: Both sides of the modules now have the controls installed. All that is left now is the interconnecting wiring.



(x) represents 1,2,3 or 4 on DS30

Typical Push Button control wiring

Figure 39: The end caps set me back \$0.60 CDN each for 100, (the 96 others will be used on the Free-Modu-Rail layout). The momentary push buttons came out to approximately \$0.99 CDN each, and the LED mounting hardware was approximately \$0.10 CDN each.

STEP 6: Building and Wiring the Two Push Button Stations *continued*

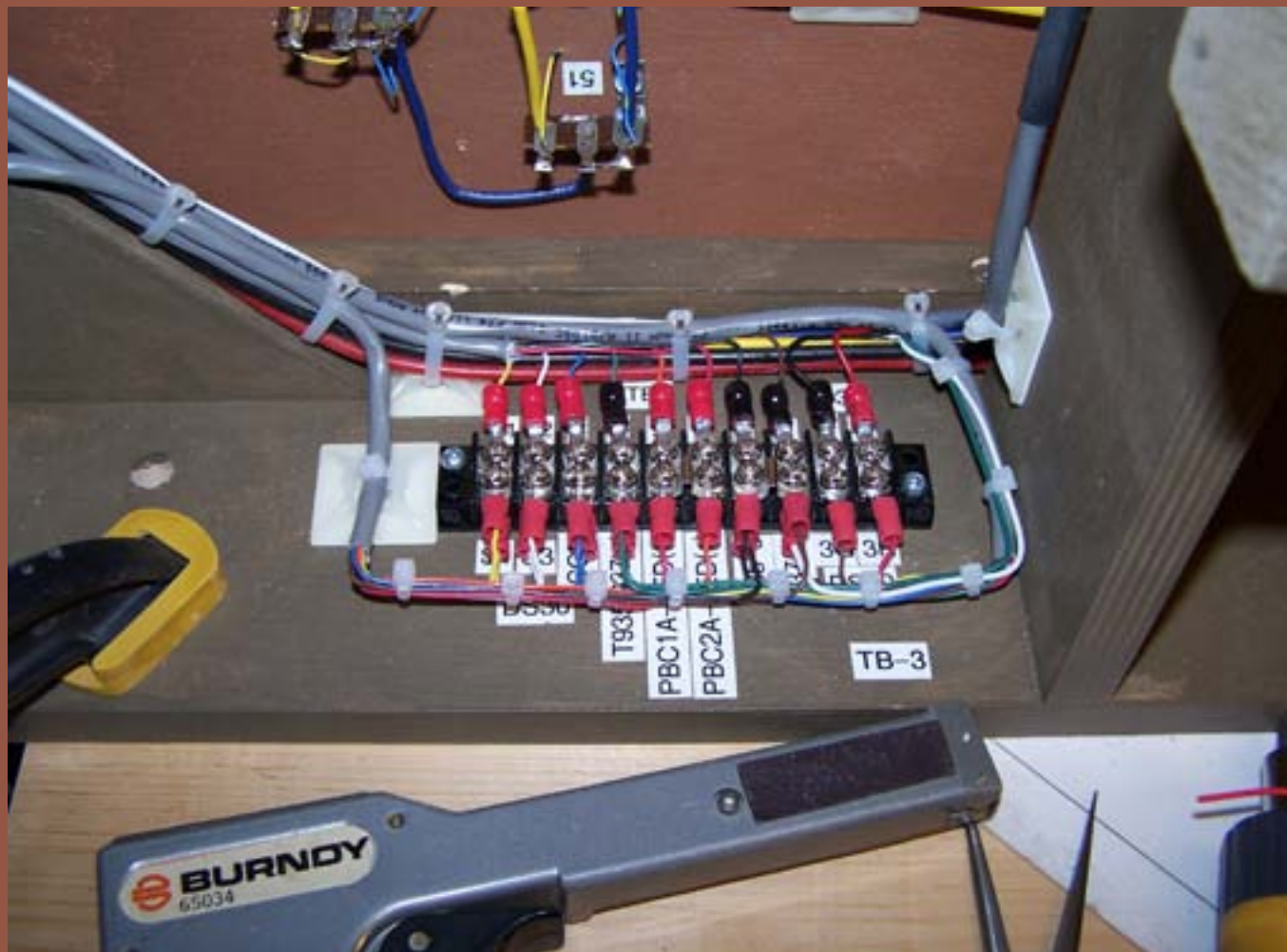

Figure 40: TB3 wires come in from push button controls PBC1 and PBC2 and go out to TB9 on one end.

The two pictures Fig. (40 – 41) show the wiring on this module for the push button controls, each of these wires and its respective terminal block or component is clearly detailed on the wiring list see Fig (43). TB3 and 9 are used as transfer blocks allowing me to bring the wires from one side to the other side of the module. This way both sides have access to each other's Push Button Controls and thus meet the Free-mo requirements of control from both sides.

It would be pointless to show all of the wires on the module. Your installation would most likely vary and you might not be using Digitrax. My point is, that when doing control wiring, make a plan and follow it. Figure out where each wire has to go and note it on a sheet. Mark the location of

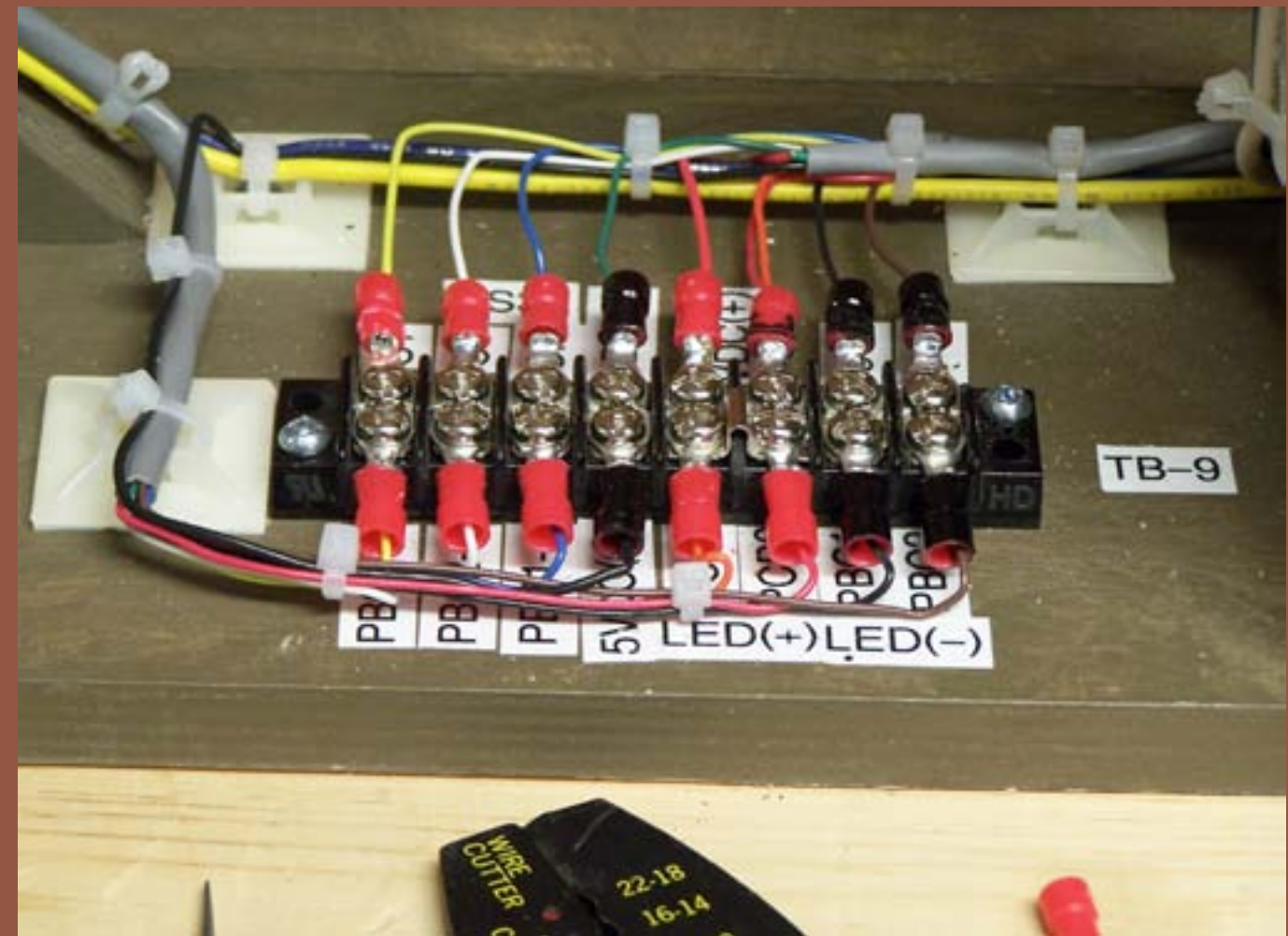

Figure 41: TB9 wires come in from push button controls PBC1A and PBC2A and go out to TB3 on the other end.

your components on a plan of your module, and make a rough wiring diagram showing each component and its inputs and outputs.

Each Terminal Block or component has incoming (inputs) and outgoing (outputs) wires. Some have both, some only one. Number each wire and identify where it goes. After a while you will notice that all your wiring has been identified, and you will know how many you need and where they all go. Plus, once it's built, you'll have a written record of everything. This is an invaluable resource if you ever need to make repairs or enhancements!

Do this one wire at a time. A wise man once said, "A journey of a thousand wires begins with only one!" Now where have I heard that one before?

STEP 6: Building and Wiring the Two Push Button Stations *continued*

Figure 42: This drawing can be used as an example for locating your components on your module, it was sure helpful to me.

(click on image for a hi-res version)

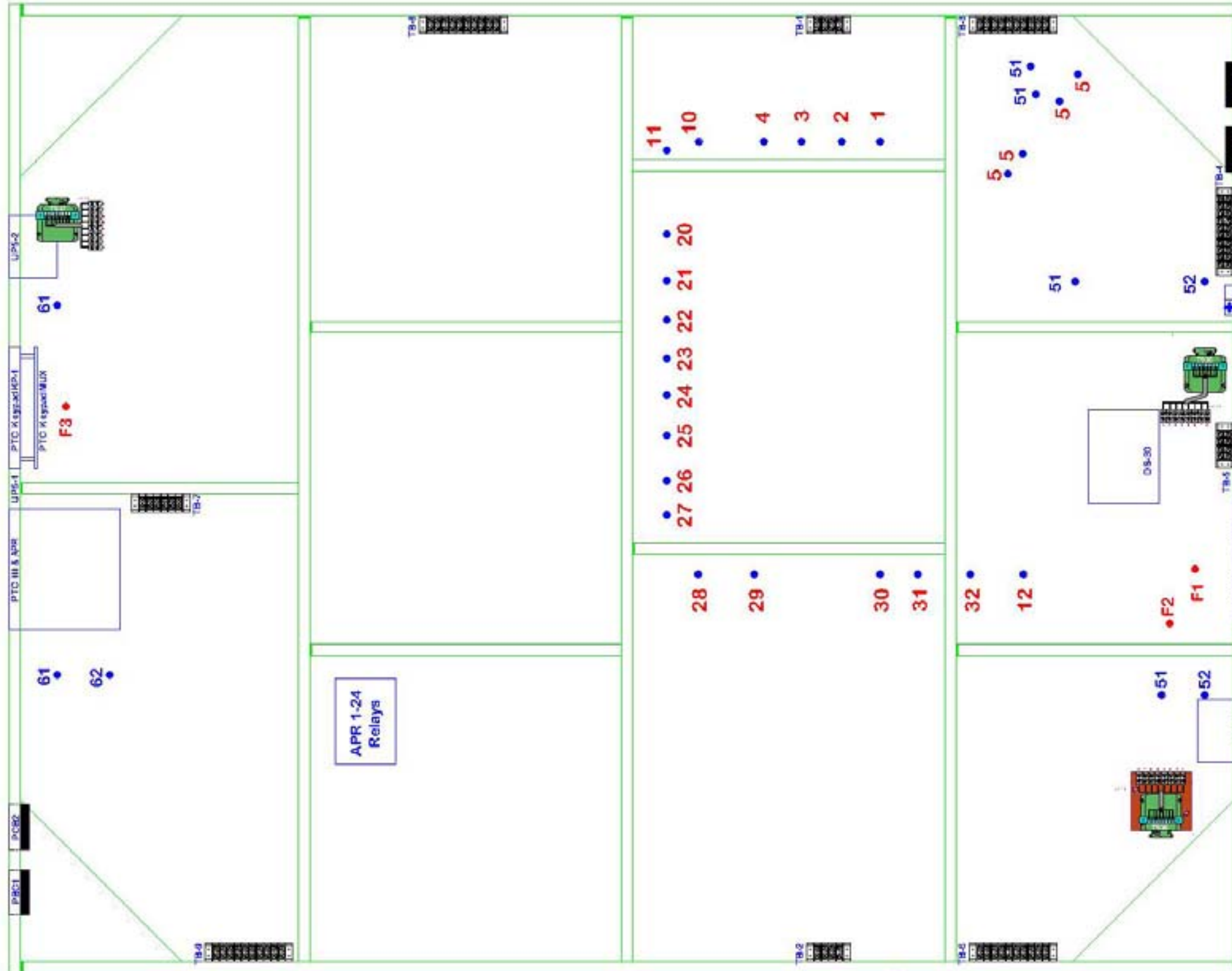

Components & Terminal Blocks
View from the bottom

STEP 6: Building and Wiring the Two Push Button Stations *continued*



26-Feb-10

Liste de filage - TT (Module M3) - Wiring list

Entrées / Inputs				Alimentation / Supply				Sorties / Outputs			
Couleur/Color	Fil / Wire	Tension / Voltage	Bornier / TB	Amps	AWG #	Amps	AWG #	Bornier / TB	Tension / Voltage	Fil / Wire	Couleur/Color
PTCIII New York Railway System TT Control											
Yellow	DCCA	DCCA	✓ A	4.5	18						
Blue	DCCB	DCCB	✓ B	4.5	18						
						4.5	18	C	✓ DCCA	TT-A	Yellow
						4.5	18	D	✓ DCCB	TT-B	Blue
						2.1	Plug	Motor	✓ 12VDC	6 Pin Molex	Grey
								Brake1		n/c	
								Brake2		n/c	
								Brake3		n/c	
								Brake4		n/c	
Red	TB7-1	12VDC (+)	✓ Power	2.1	Plug						
Black	TB7-2	12VDC (-)	✓ Power	2.1	Plug						
APR1A Automatic Power Routing Relay Board - 1A											
						4.5	18	1	✓ DCCA	LT-1A	Yellow
						4.5	18	2	✓ DCCA	LT-2A	Yellow
						4.5	18	3	✓ DCCA	LT-3A	Yellow
						4.5	18	4	✓ DCCA	LT-4A	Yellow
						4.5	18	5	✓ DCCA	ST-5A	Yellow
						4.5	18	6	✓ DCCA	ST-10A	Yellow
Yellow	DCCA	DCCA	✓ TP2	4.5	18						
						4.5	18	TP1	✓ DCCA	APR1B-TP2	Yellow
APR1B Automatic Power Routing Relay Board - 1B											
						4.5	18	1	✓ DCCA	ST-11A	Yellow
						4.5	18	2	✓ DCCA	ST-12A	Yellow
						4.5	18	3	✓ DCCA	RST-20A	Yellow
						4.5	18	4	✓ DCCA	RST-21A	Yellow
						4.5	18	5	✓ DCCA	RST-22A	Yellow
						4.5	18	6	✓ DCCA	RST-23A	Yellow
Yellow	APR1A-TP2	DCCA	✓ TP2	4.5	18						
						4.5	18	TP1	✓ DCCA	APR2B-TP1	Yellow
APR2A Automatic Power Routing Relay Board - 2A											
						4.5	18	1	✓ DCCA	RST-24A	Yellow
						4.5	18	2	✓ DCCA	RST-25A	Yellow
						4.5	18	3	✓ DCCA	RST-26A	Yellow
						4.5	18	4	✓ DCCA	RST-27A	Yellow
						4.5	18	5	✓ DCCA	RST-28A	Yellow
						4.5	18	6	✓ DCCA	RST-29A	Yellow
Yellow	APR2B-TP2	DCCA	✓ TP1	4.5	18					n/c	
APR2B Automatic Power Routing Relay Board - 2B											
						4.5	18	1	✓ DCCA	RST-30A	Yellow
						4.5	18	2	✓ DCCA	RST-31A	Yellow
						4.5	18	3	✓ DCCA	RST-32A	Yellow
								4		n/c	
								5		n/c	
								6		n/c	
Yellow	APR1B-TP1	DCCA	✓ TP1	4.5	18			TP2	✓ DCCA	APR2A-TP1	Yellow
UP5-1 Digitrax Universal Panel - 1											
Yellow		DCCA	✓ A	4.5	18						
Blue		DCCB	✓ B	4.5	18						
Grey	TB4-(1,4)	14VDC	✓ Power	10	Plug						
	n/c		Loconet A								
						Data	30	Loconet B	✓	Data	DS30-LB
											Flat Cable
UP5-2 Digitrax Universal Panel - 2											
Yellow		DCCA	✓ A	4.5	18						
Blue		DCCB	✓ B	4.5	18						
Grey	TB4-(2,5)	14VDC	✓ Power	10	Plug						
Flat Cable	DS30-LA	Data	Loconet A	Data	30						
								Loconet B			n/c

Figure 43: Every wire on my module is identified here, Inputs on the left and Outputs on the right. You can use this as an example of how to identify each component, and to figure out how many terminal blocks you will need. Of course this list is complex because of the Turntable and controls, but yours could be much simpler.

(zoom-in to see this table with more detail or click for a printer friendly table)

I hope you have enjoyed the series so far! To conclude this part, I prepared these 2 short videos showing the LED flashing effect of the Push Button control stations clearly, and the flawless operation of the Tortoise. With that flashing LED there is no way I can forget to reset the turnout to the closed position!

WHOOPEE, NO MORE WIRING.....!
Well at least not until I install lighting and other details, but that's another article!



Figure 44: Flashing LED Video.



Figure 45: Tortoise Video.

Model Railroad Hobbyist magazine™

Jul/Aug 2010 issue sneak peek ...

The Return of the PENNSYLVANIA Middle Division



Model Railroad Hobbyist magazine

The planet's most popular model railroading mediaZine!

Release date:
July 5, 2010

Subscribe to **Model Railroad Hobbyist magazine™**
click here

Lighting Structures

with **L****E****D**s

Lighting up the night!



**Reader
Feedback**
(click here)



by Ken Ferguson

Figure 1: Even with a significant amount of ambient light present, the LED lighting in 'Spud's Bar' is bright enough to illuminate the sidewalk.

LEDs are bright, run cool, have great energy efficiency, and last nearly forever.

I believe I have found the ultimate lighting device for model structures – the LED or Light Emitting Diode. Until a few years ago, LEDs were limited to the utilitarian task of indicating that your TV, stereo, or throttle was powered on. Early LEDs were limited to red, yellow or green. Today LEDs are available in virtually every color of the spectrum (including white and a warm white), plus you can easily control where and how much illumination is delivered.

By definition, an LED is a solid state device, a special diode that emits light when energized with a low

voltage electric current. The heart of the device is a semiconductor that is encased in a clear epoxy cover with two power leads. When LEDs are on they produce virtually no heat and draw very little current. This means you can use very small gauge wire inside your buildings.

The Project

As a demonstration project for myself, I chose to build a turn-of-the-century structure dubbed - SPUD's Pool Hall & Bar. It's an off-the-shelf kit similar to DPM's "Skip's Chicken & Ribs" (figure 2).

My challenge was to provide controlled lighting in a gentlemen's bar decorated with several paintings and a mirrored wall. Showcasing the seamier side of the establishment, there is a long corridor leading to the pool hall in the back, where a green glow reflects off the felted tables. The second floor was to be a group of rooms for boarders, some of which were rented for as little as an hour at a time. The shadow on the window shade would tell only part of the story.

Construction

I used bright LEDs in this project - I mean really bright. You will be surprised at output of an LED versus a grain-of-wheat or other incandescent lamp. Before assembling the building, I gave the interior walls a paint job. The

Figure 2: The future Spud's bar.



Figure 2



Figure 3

Figure 3: Matte board floor, cutting template, and interior paint

paint becomes a light block, preventing a "translucent glow" through the walls.

Two methods can be used to create this light block (figure 3):

- Craft-acrylic, black paint applied with a brush works just fine. Two or three coats will be necessary. I use this technique when there are a lot of windows and doors because it gives me better control of where the paint goes.
- Generic black automotive primer (in a spray can) works too. I use this method when there are a lot of surfaces with few doors or windows that might get an unintentional coat

of paint from over spray. Again, I apply multiple coats to insure complete opaqueness.

At this point, I assembled and painted the exterior walls, sashes, and window sills before adding the window glazing on the interior.

Next, I traced the interior of the building on a scrap piece of matte board. This makes a mechanically solid floor for the building. When cutting the matte board floor, I intentionally left a void in the rear of the building. It occupies the space that will be the pool room and serves as a place for the

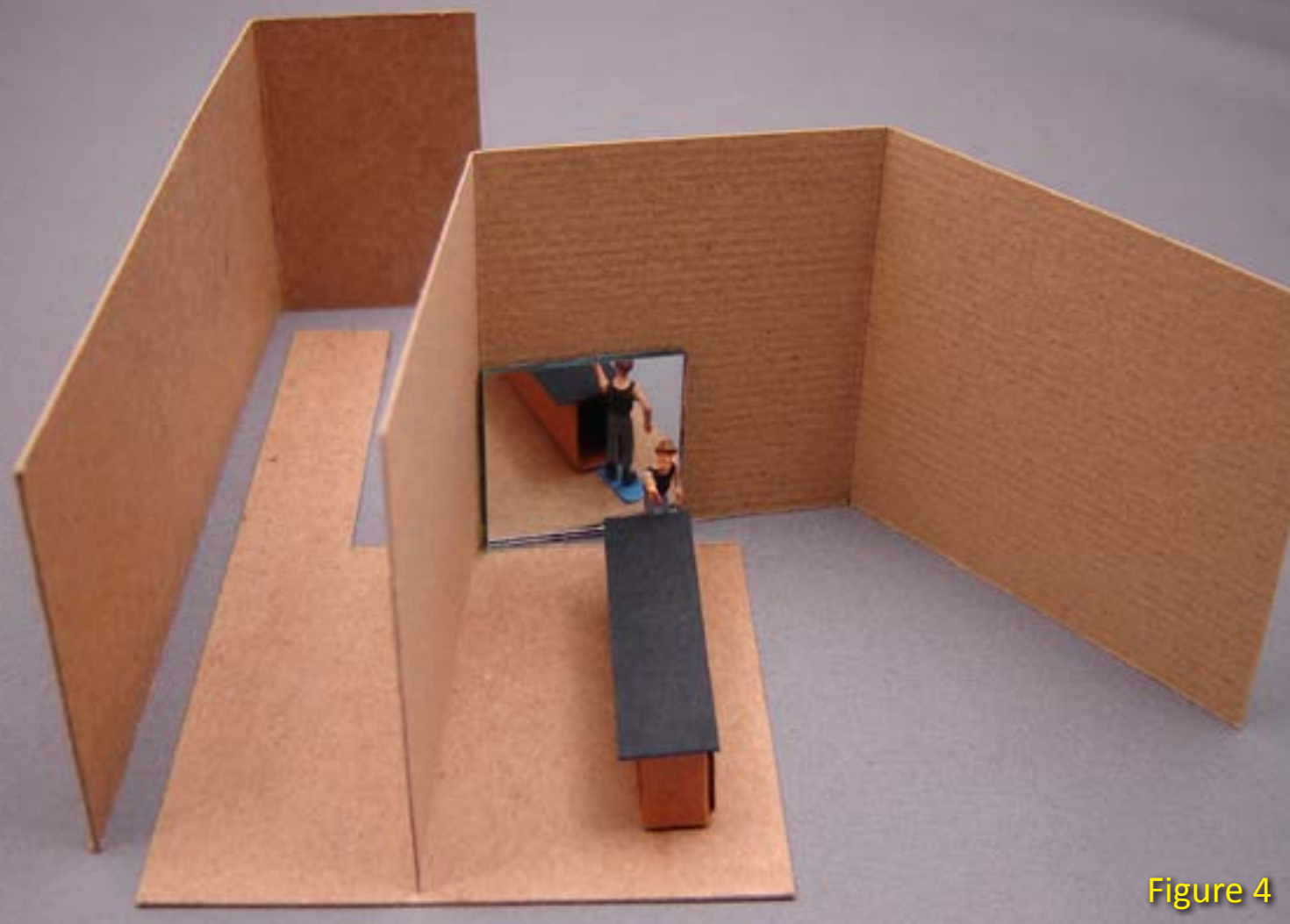

Figure 4

Figure 4: Textured paper floor, walls and bar.

Figure 5: Cut-away view of the matte-board upper floor with the LEDs installed.

Figure 6: The 'set' with patrons, paintings, mirror, and door installed.

wiring to enter the building. I saved a template of the floor as a pattern for when I'm cutting out the second floor and roof. Then I glued the first floor into the building. The seam between the walls and the floor needs a liberal coat of paint to prevent light leaks under the sides of the structure. Think of this as a form of caulking.

With those steps complete, I got to work on the "scene." When I was in

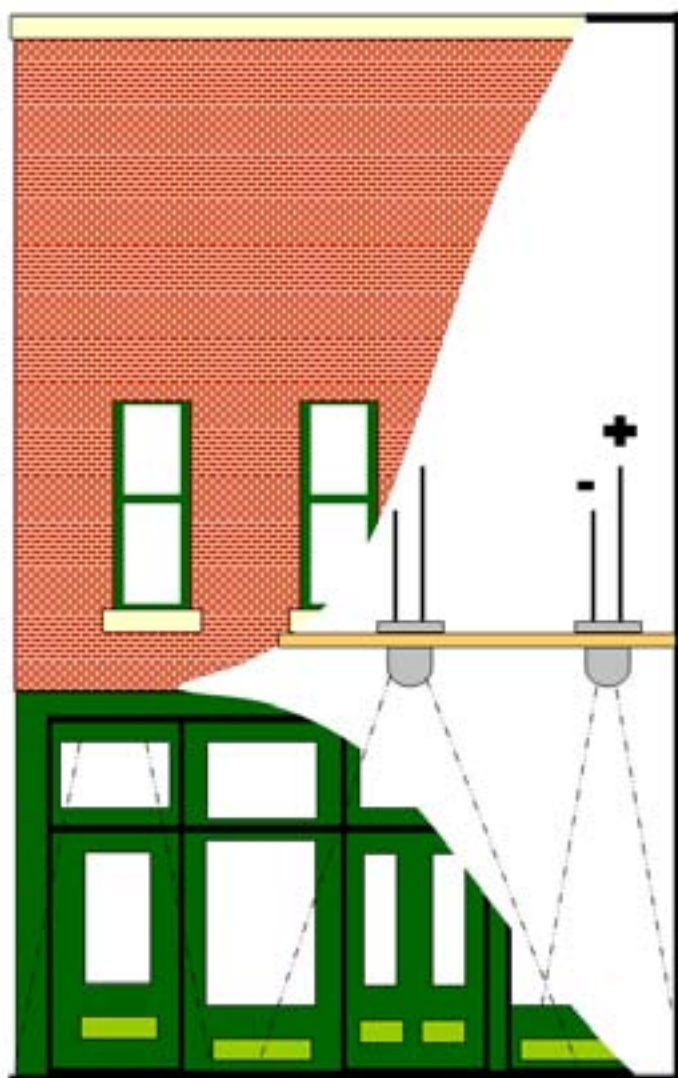

Figure 5



Figure 6

college, I spent time in the theater group, so it was natural for me to construct the interior of the model as a miniature set.

I used the template to cut a piece of textured paper to size for the floor covering. I used heavy textured paper for the walls too. The wall height is critical for a couple of reasons.

- I didn't want the observer to see the lighting "instruments," so I made the ceiling as high as possible.
- To take full advantage of the characteristics of LEDs, I needed to have

some distance between them and the objects below.

I chose an interior wall height that aligns with the bottom of the second floor window frames. The front wall of the building hides the LEDs.

Then, I positioned the bar, the paintings, and the people in the main room (figure 6). When I was satisfied with the arrangement, I glued the whole assembly together as a single unit, and glued it to the sub-floor.

Now the real fun began as I became the Lighting Director! I visualized the scene with both entrances having

fairly strong warm light, to attract patrons. On the bar side, I wanted to highlight the “Ingres Odalisque” canvas (a painting that is so bad that art students actually study it for what NOT to do when painting the human form) behind the bar, and let the light get dimmer farther away from the bar for some privacy. The hall leading to the pool room would get progressively darker moving toward the back, with a very soft green glow at the end. The shades on the second floor would have a yellow incandescent blush.

The question now is, what LEDs would produce this mix of lighting effects?

Types of LEDs

Search the web and you’ll find numerous LEDs available from a variety of vendors. I purchased mine from Super Bright LEDs www.superbrightleds.com. Their website has all of the information any modeler will need to select appropriate devices, plus a lot more information about LEDs in general.

There are five attributes that need consideration before placing an order: Size, color, lens color, luminous intensity, and viewing angle.

- **SIZE** - LEDs are manufactured in a variety of sizes and shapes for many different applications. For this project, I limited my choices to the 5mm (diameter) devices. A modeler in N scale might want to consider the smaller 3mm LED, but the selection is not as extensive.

- **COLOR** - Rather than go into a detailed technical explanation on color temperature and wave lengths, simply put, a white LED emits a brilliant white light that has a very slight violet overtone. A warm white LED emits a light that leans toward a very pale peach color. The rest of the color spectrum available includes a vivid blue, green, aqua, red, yellow, orange, and violet. On this project, I went with warm whites for the entrances, white for the painting, green for the pool hall, and yellow for the second floor.

- **LENS** - There are two options here - clear or diffused. The effect on the light output is analogous to a table lamp with a bare bulb, and the same lamp with a lamp shade on it. The diffused lens puts out soft omnidirectional light. With the exception of the green light in the pool hall, all of the other LEDs I used for this project have clear lenses and project beams.

- **LUMINOUS INTENSITY** - This is equivalent to the “wattage” of an ordinary bulb. Intensity is measured in millicandela (1/1000th of a candela, abbreviated mcd). The definition according to the Super Bright LEDs web site is, “Candelas are used to measure how much light is produced at the light source. The candela is the Luminous Intensity, in a given direction, of a source of monochromatic radiation of

frequency 540×10^{12} hertz, that has a radiant intensity in that direction of 1/683 watt per steradian.” More simply put, the more mcDs, the brighter the light. But before making a decision based solely on output, the viewing angle must be considered. The desired lighting effect will be a combination of these two specifications.

- **VIEWING ANGLE** - Choices here range from 15° to 120°. A 360° viewing angle LED is also offered in another section of the web site, but all of the lenses are diffused, and color selection is limited to white, blue, green and red. How the viewing angle affects the light intensity is straightforward. In the LED manufacturing process, tiny reflectors are mounted behind the solid state junction that produces the light. Variations here determine how wide the emitted light beam will be. If you have a Maglite® flash light, you know that you can adjust the beam

width by turning the barrel. The narrower the beam, the brighter the light looks. But, that is not really the case. The output of the bulb is the same regardless of the beam width - the perceived brightness is a function of how much area the light beam is covering. More area with the same light will appear dimmer.

In figure 7, the LED on the left is a white, 1500 mcd, 120° device. The one in the middle is a white, 2500 mcd, 45°, and the one on the right is a white, 6000 mcd, 18°. This demonstration shows the variations in intensity and beam spread. At a distance of 2”, the narrow 18° device casts a beam that is about 3/4” in diameter. The medium 45° unit spreads out to about 1 1/2”, and the 120° device casts a soft glow over 3” in diameter.

There were no options for intensity or angle with the warm white LEDs on my project. I did have several possibilities

Figure 7: LED comparison.

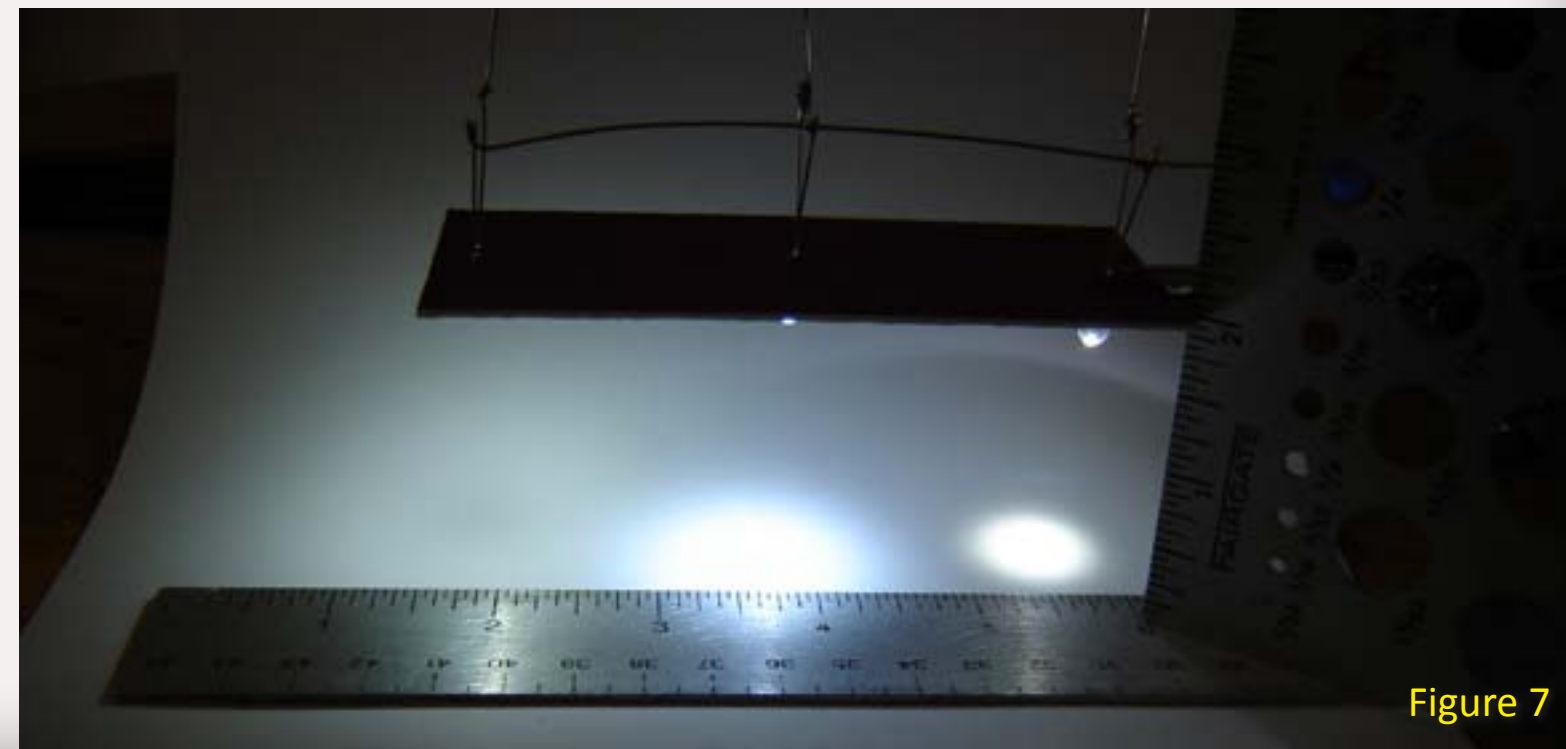

Figure 7

for the focused light on the painting behind the bar and I went with the 6000/18° device. The pool hall light is a diffused 2000/360° green. The lights on the second floor needed to be strong enough and tight enough to cast a hard shadow on the shade, but not so intense that they overpowered the ambiance on the ground floor. That selection was two yellow 3500/45° units.

So with shopping list in hand, I went online and placed an order. Super Bright LEDs shipped my order promptly. I liked that there was no minimum purchase. If an item is out of stock, it's not listed on their web site.

While waiting for the mail to arrive, it was time for me to return to construction mode. Using the template from the ground floor, I cut a full sheet of matte board without the wiring void in the ceiling. The piece should be tight enough that friction will hold it in place. Do not glue this in place as you WILL be taking this part in and out of the model several more times as the project progresses.

Next, I used a pencil to mark the LED location, on the underside of first floor's ceiling. I used a 4mm bit to drill the LED mounting holes. With a 5mm unit and a 4mm hole, the LEDs will fit snugly into place without gluing.

I took a trip to Radio Shack to purchase a power supply and current limiting resistors. I opted to power my LEDs with a 12vdc source. LEDs will light with as little as 3.3 volts, but I chose a

higher voltage supply to avoid issues of voltage drop in the wiring around the layout, as I planned to use the power supply for multiple buildings. I picked out a 1000ma, 1.5-12 VDC Universal AC Adapter (p/n 273-316) for about \$19 from Radio Shack. This single unit will light a lot of LEDs, considering that each LED will typically draw about 20ma @ 12vdc.

My second purchase was a bulk pack of resistors. Generally, a 470 ohm resistor will work with most LEDs. But since this project entailed some experimentation, I selected the 100 piece, 1/4 watt fixed resistor assortment (p/n 271-308) for about \$7.

Resistors have colored bands. Three indicate their resistance in ohms. A fourth band specifies tolerance (how close the component guaranteed to be to the specified resistance). The color code cipher is on the back of the pack.

For example, the color codes yellow, violet, brown, silver, means a resistance value of 470 ohms plus or minus 10% (423 ohms to 517 ohms).

Back at home, I cut the plug off the output side of the power adapter and attached alligator clips to the wires. This makes testing the LEDs much easier.

Since we are working with DC, we'll need to determine which wire is positive and which is negative. This can be done with a voltmeter. If you don't have one, there is a simple work-around (figure 8). Take a 470 ohm or and clip it to one lead of the power source, and connect the

Resistor Color Codes

0 - black	5 - green
1 - brown	6 - blue
2 - red	7 - violet
3 - orange	8 - gray
4 - yellow	9 - white
10% - silver	2% - red
5% - gold	1% - brown

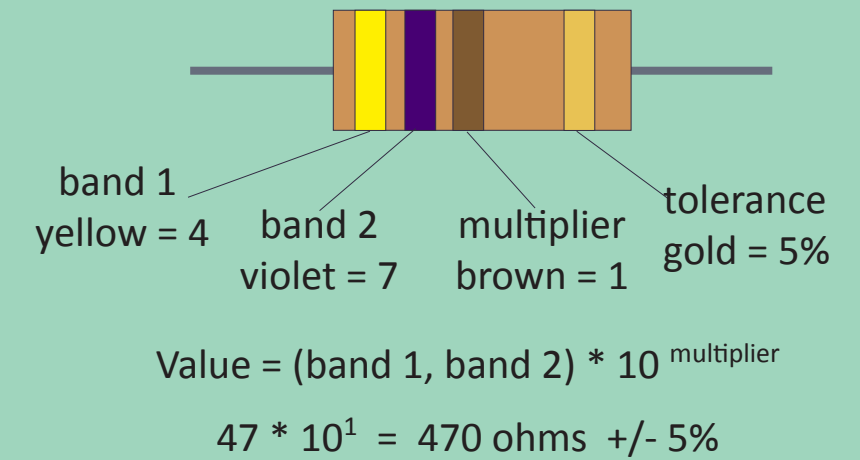

remaining clip to either of the leads on the LED. Plug the adapter into an outlet. Touch the lead from the resistor to the unused lead on the LED. If it lights, you know that you have the correct polarity. Mark the alligator clip that ultimately connects to the LED's long lead as positive. Mark the alligator clip connected to the LED's short lead as negative.

My order finally arrived with my LEDs. I was pleasantly surprised that the

variety of LEDs I purchased were individually packaged and labeled with the color, mcd, and viewing angle. This is a good thing because most LEDs look identical with no external markings.

NEVER connect a LED directly to a power supply without a dropping resistor - it will instantly burn out . . .

Figure 8: LED testing setup.

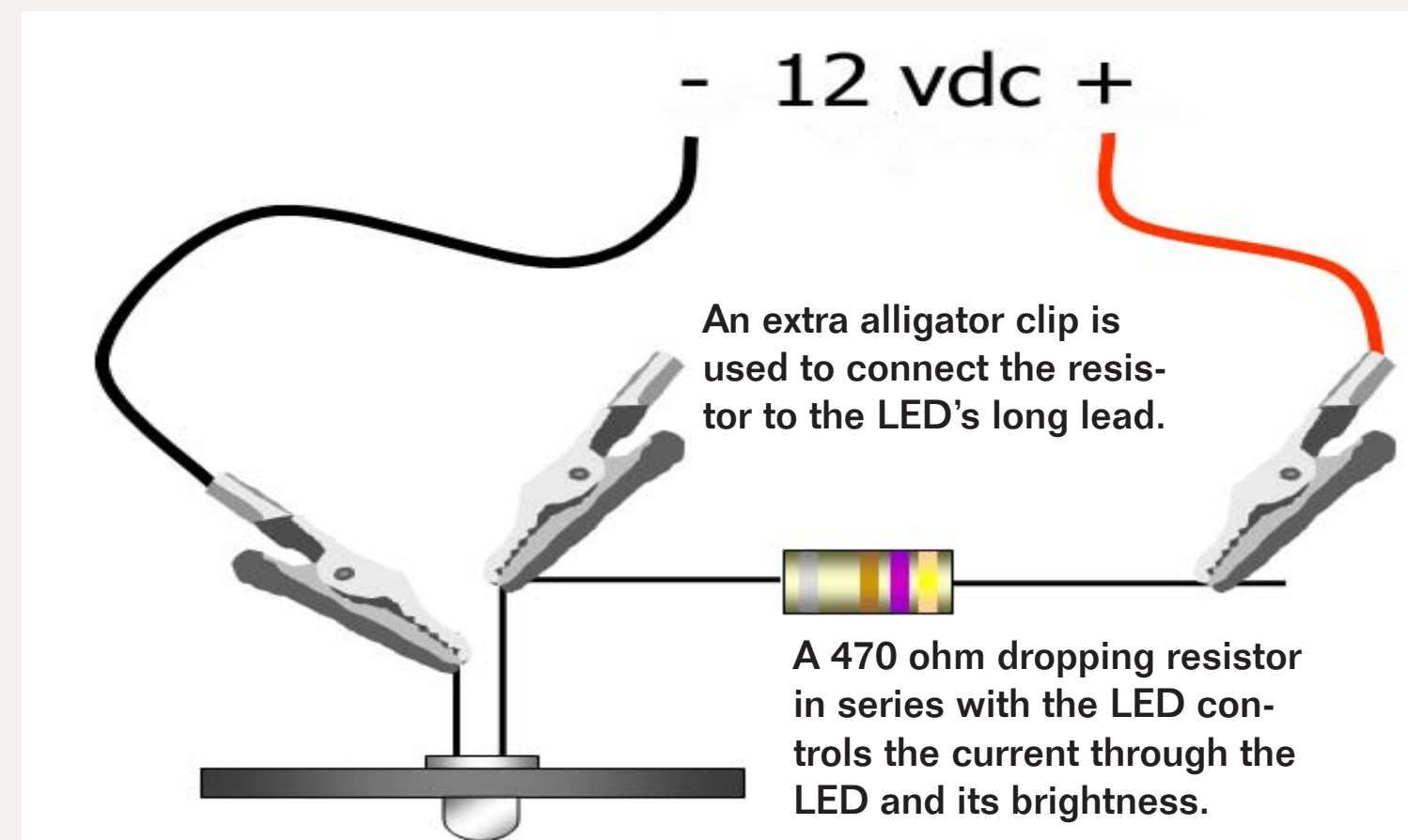

Figure 8

LED Handling Precautions

- **LEDs are static sensitive devices.** The static electricity shock you get when walking across a carpet and touching a door knob has a potential of several thousand volts. A mishandled LED may get fried. Pick up an LED by its shell, not by its leads, if you're not grounded.
- **LEDs are heat sensitive.** When wiring the devices, solder for no longer than 3 seconds with 700° iron. Ignore this and your device becomes a burned out fuse.
- **LEDs are current and voltage sensitive.** ALWAYS use a resistor in series with an LED or LED array (more on this later.) Failure to do this can lead to the unintentional construction of a mini smoke generator on your pike.
- **LEDs are polarized devices.** Positive power to the positive lead, and negative to negative (through a resistor) produces light. With the power source leads reversed, the device remains very dark. The ANODE or positive contact is the longer of the two leads. The resistor in the circuit is not polarized so its orientation is not a concern.
- **LEDs can be mechanically abused.** If you need to form the leads, make the bend at least 3mm from the bottom of the LED.

I strongly suggest working with one color or beam width at a time.

Curb your desire to open any of the diode packs until you read and understand **LED Handling Precautions**.

I started LED installation by removing the second floor from the building. I gently pressed the LEDs into the pre-drilled holes from the upper side of the floor/ceiling. LEDs have lips around their bases that will keep them from going completely through the hole. I oriented all of the negative leads (the shorter leg) toward

Figure 9: Wiring diagram. Red is positive, black is negative.

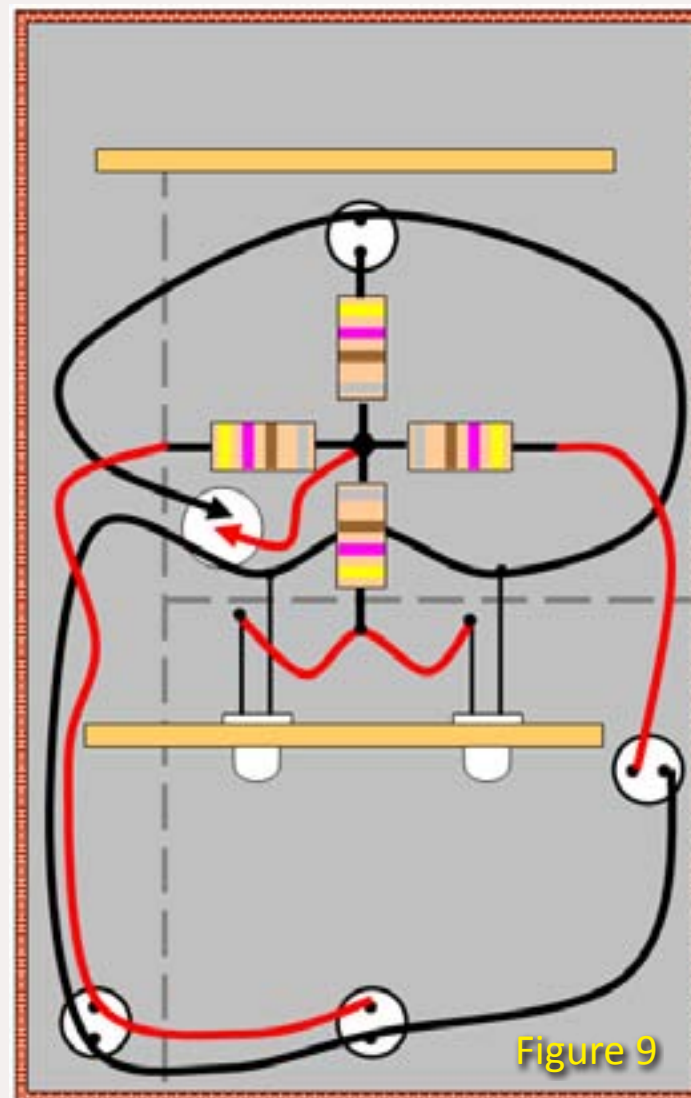

Figure 10: The figure that casts the 2nd floor shadow. The yellow LED is right in front of his face.

the exterior of the building. This will make wiring a bit easier (figure 9).

I began wiring by connecting LED's negative leads (short lead) together with #24 gauge black (for negative) wire. You could use wire as small as #30 gauge since the amount of current here is so low. I added one long black wire leading through the hole above the void on the ground floor for connection to the power supply.

Two or more LEDs can be connected in series (positive to positive) with a single resistor at the beginning of the chain. The Super Bright LEDs web site has a resistance calculator to help determine the resistor value for more than one LED in a circuit.

I used clip leads to connect a resistor between a LED (or set) and the positive

power supply lead. Then I replaced the second floor and turned on the power.

If the light from those LEDs was too bright I increased the resistance and tried again until it seemed about right. When I'd picked appropriate resistors for each LED I soldered the resistors to the LED's positive (long leads) and connected the other ends of the resistors together and added a long red wire to connect to the positive power supply wire.

As you can see from figure 10, I glued two pre-drilled upright panels to the floor to hold the LEDs for the second floor windows. These panels also support the roof, so trim their heights accordingly.

The final step is to carefully cut a matte board roof and gently force fit it into place.



Figure 11

Figure 11 - Spud's in dimmed room lights. Note the different colors of light: green from the pool room, yellow upstairs, and white in the bar area.

Adjusting LED Brightness

Rather than having to substitute resistors for each LED in order to find the correct resistance for each LED's brightness, I'm building a 5 channel dimmer board (figure 12).

With this variable resistor bank, I can adjust each LED circuit independently by twisting the potentiometer (variable resistors) knobs. Once all the LEDs are brightness-balanced, I'll use a multi-meter (a device that measures voltage, current, and resistance)

to measure the resistance across each potentiometer (and the common resistor!). Then I'll pick an appropriate fixed resistor to install permanently.

WARNING: The common resistor (shown in the lower left of figure 12) MUST be included. Otherwise if the resistors are twisted full off, that resistor will be connected directly across the power supply with no dropping resistor. Flash! Dead LED.

Wrap Up

Using LEDs for lighting really does offer an inexpensive way to make the interiors of all of your buildings "POP." The exciting part is that every modeler can become a budding Lighting Director, because now you can choose the colors and intensities of lighting to match the mood and themes of your layout.

Most buildings on a layout will not use as many colors, intensities, and beam widths as Spud's Bar. However, I have under construction I plan to light with LEDs. That will present some real challenges...flashing lights and more!

Figure 12 - Dimmer board example with five trim potentiometers used to set LED brightness.



By day Ken Feruson is an award-winning producer and director of TV commercials. He got started model railroading in 1954 when his dad brought home an HO Gilbert PRR switcher freight. He lives in northeast North Carolina with his wife Susan and has two grandkids who love his trains. His current layout is his third (and he claims his last).

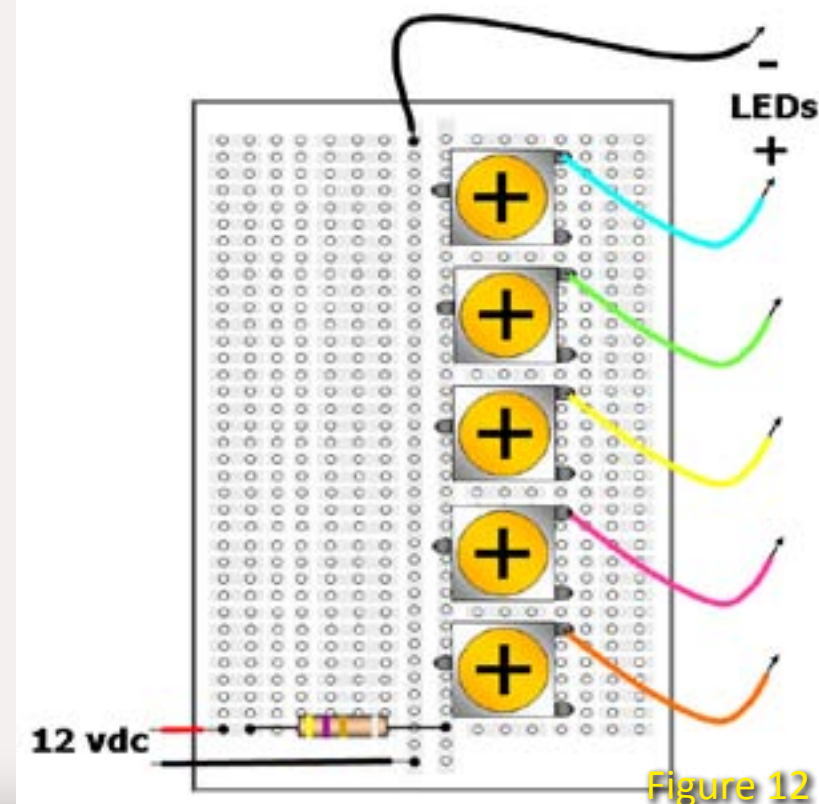

Figure 12



About our layouts columnist



Charlie Comstock is our layouts editor and columnist.

[Click here](#) to learn more about Charlie.

Charlie Comstock is ...

UP THE CREEK: Roadwork

A regular report on the construction of a 1950s-something layout

▶ **Reader Feedback**
([click here](#))

My road paving crew tackles a concrete road on the Bear Creek and South Jackson.

For about a year the dividing line between South Jackson and Mill Bend on my BC&SJ has shown promise of future scenery. But until recently nothing much was happening. A key part of this scene is a road from aisle to backdrop. Joe Fugate has had success paving roads with styrene and I elected to try this method. I have

memories from my youth of roads paved with concrete. The lanes were narrow, and by the time I was old enough to remember anything these roads were getting a bit long in the tooth and showed their age with a number of cracks that were patched with tar to keep them from getting worse. I figured a road like this would look rather cool...

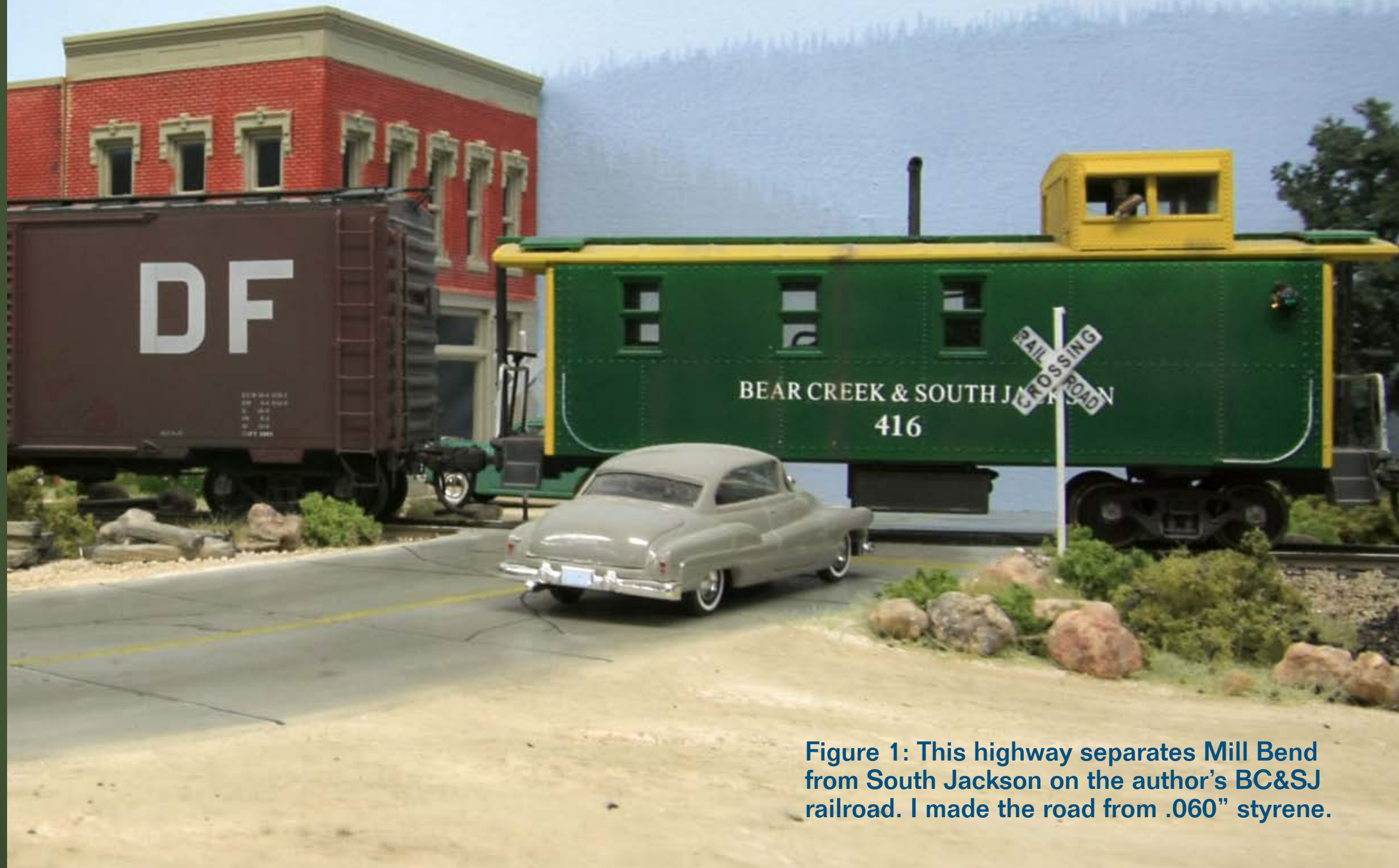

Figure 1: This highway separates Mill Bend from South Jackson on the author's BC&SJ railroad. I made the road from .060" styrene.



Figure 2

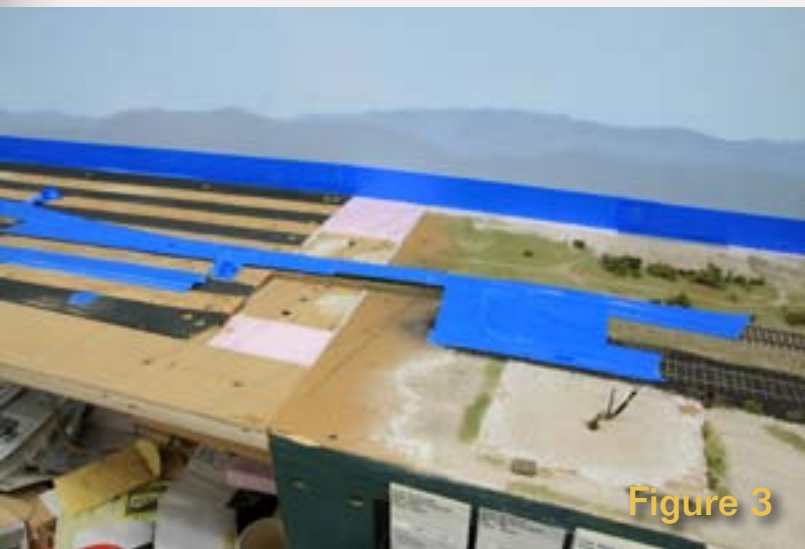

Figure 3

Figure 2 BEFORE: I cut the highway segments from .060" styrene and painted them with some cheap gray primer. I also installed the grade crossing timbers (Micro Engineering wood ties ACCed in place). This scene looked like this for about a year.

Figure 3: I moved all the buildings out of the way, then started to mask off the backdrop. DON'T use masking tape (which can pull paint off when it's removed) on backdrops, use blue painter's tape or drafting tape instead. Then I masked off the tracks.

Figure 4: I used some brown paper (I got a roll of this stuff from a local big-box store) to finish covering up the backdrop. I didn't want splotches of spackle up there!

Figure 5: I used spackle (dry wall mud) to 'level' the ground and to provide a bedding to hold the styrene highway segments in place. If you look carefully you can see that not all of the plywood is at the same height.

Figure 6: I made a 'lip' on the trackside edge of each highway segment. The 'lips' rest on the RR ties and are thick enough so the top of the road matches the top of the rails.

Figure 7: I've installed the rear highway segment and made a bed of spackle for the front highway segment. Before installing the second segment, I batter its backside with spackle. It's a little tricky guessing how much to use - too much and there's lots of cleanup, too little and there may be voids under the road making it a bit unstable.



Figure 4



Figure 5



Figure 6



Figure 7

Concrete Highways

During the 1930s Depression the government put people to work on public works projects. One of these involved paving lots of highways. For durability these were often paved with concrete. These concrete roads often lasted into the late 1960s (or even later).

While overall, concrete is a very durable material for road construction, over time it does tend to crack. When this happens, the cracks are filled with tar to make them watertight. Concrete roads also have expansion joints between the concrete slabs, also sealed with tar. Any water under the roads will produce a hydraulic mining action when heavy vehicles roll overhead, eroding the sub-roadbed and leading to rapid wear.



Figure 8

Figure 8: I carefully set the styrene highway segment in place, bedding it down in the spackle on the benchwork beneath the highway and spread on the bottom of the highway segment (figure 7).



Figure 9

Figure 9: I press the segment down firmly until it's the right height, embedding it in the spackle. Note the spackle mushing out from the sides of the highway.

Figure 10: I use an artist's palette knife to shape the shoulders of the highway embankment, trying hard to keep the spackle off the adjoining terrain.



Figure 10



Figure 11

Figure 11: Then I use a 3" putty knife to ensure that the embankments don't rise higher than the road. I also scrape any excess spackle off the road with this knife.

Figure 12: I let the spackle dry (I encourage this by having a fan - set on low - blowing on it). I'll sand the worst of the lumps off the spackle with a coarse sanding sponge. The flexibility of the sponge lets it conform to the terrain and its block shape makes it easy to grip.

Figure 13: Sanding spackle makes lots of really dusty mess. To avoid having the rest of my layout look like a snow storm hit it I use a vacuum to suck up the dust (hopefully as fast as I make it!).

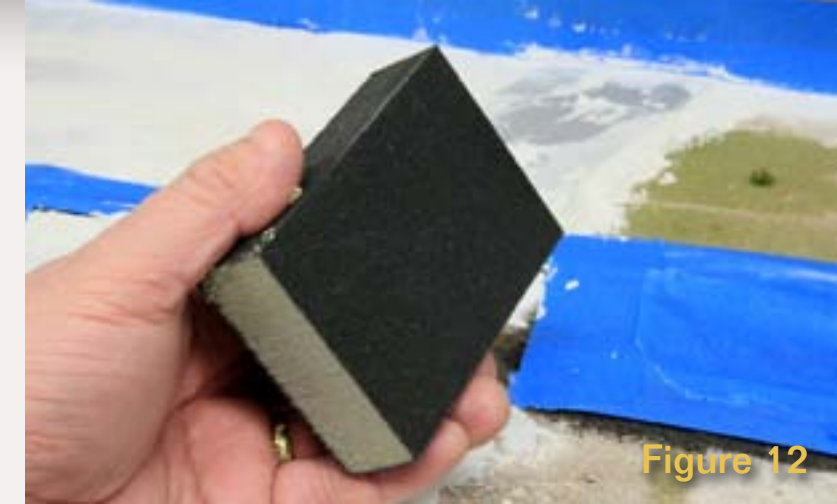

Figure 12



Figure 13

Road Construction

Prior to starting on the road I ACCed Micro Engineering ties between and outside the rails to make a timbered grade crossing. I stained the wood with India ink diluted with alcohol for a well-weathered look.

I cut out the two segments of the highway from .060" styrene, carefully fitting them in place between the wall and the grade crossing, and the aisle and the grade crossing.

After being sure the highway segments fit well, I spray painted them with some primer gray I had on hand.

I installed the highway by bedding it down in spackle paste (drywall mud) (figures 4 to 11). I spread the spackle around to smooth out surface irregularities and make smooth contours in

Text continues on page 131



Figure 14

Figure 14: I use a strong light (off to the side) to reveal the nooks and crannies left by the spackling process.

Figure 15: Did I mention that sanding spackle is dusty? Note the edges of the styrene highway segments where the gray primer got sanded away, revealing the white styrene underneath.

Figure 16: I applied a second layer of spackle to fill in the remaining holes. The lumps disappeared after re-sanding and vacuuming, but there are still small surface imperfections.

Figures 17 a,b: After sanding I rub the spackle with a wet sponge. This moistens the spackle enough to move it around and smooth it out. All the tool marks and sand paper scratches disappear. Sponging produces a smooth but not entirely even surface that has good visual appeal.

Figures 18 a,b: I temporarily replaced the buildings to see how the scene was looking. I try to model with a bit of 3-D even in flat scenery.



Figure 15



Figure 16



Figure 17a



Figure 17b



Figure 18a



Figure 18b



Figure 19a



Figure 19b

Figures 19 a,b: Perhaps I'm doing this out of order? It might have been a good idea to scribe the expansion joints and cracks BEFORE installing the styrene highway segments. However, I forgot, so I'm doing it after the highway's installation. It did keep them from being filled with spackle though!

Figure 20 a,b: I painted over the stark white spackle with dirt-paint (actually brownish, latex interior house paint). I masked off the road to keep it from becoming brown also. Note I added extra masking for building foundations...

Figure 21: I use a small paint brush to apply water to surfaces I want covered with zip textured dirt.

Figure 22: Quickly, before the water soaks in or runs off, I sprinkle a mix of plaster and powdered tempera paint on the scenery (zip texturing). I work in small areas at a time for better water control.



Figure 20a

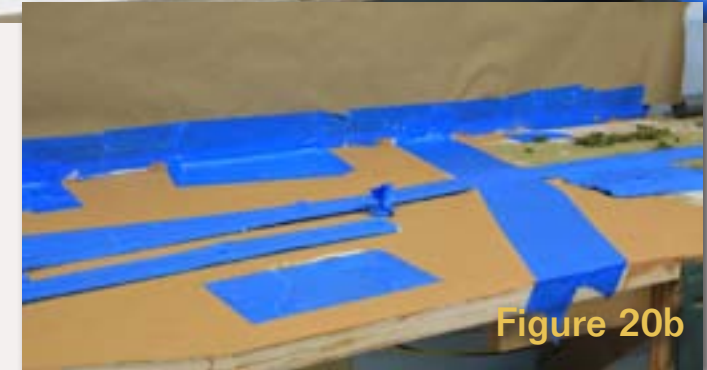

Figure 20b

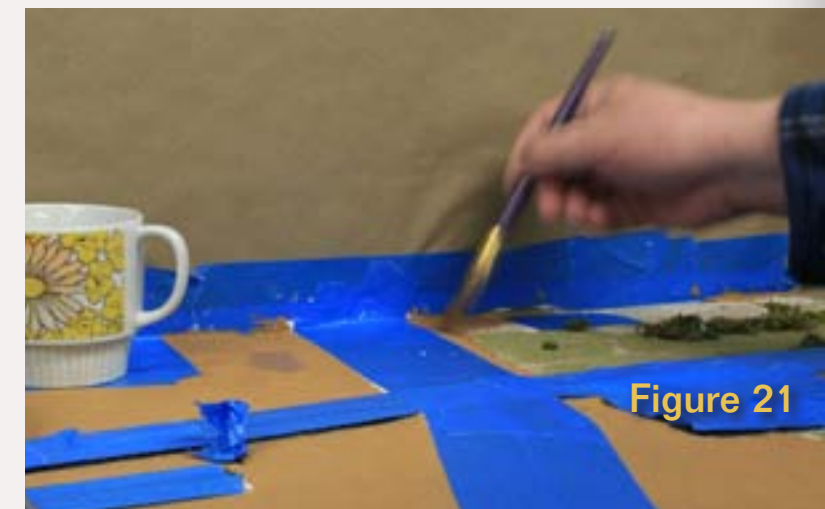

Figure 21



Figure 22



Figure 23

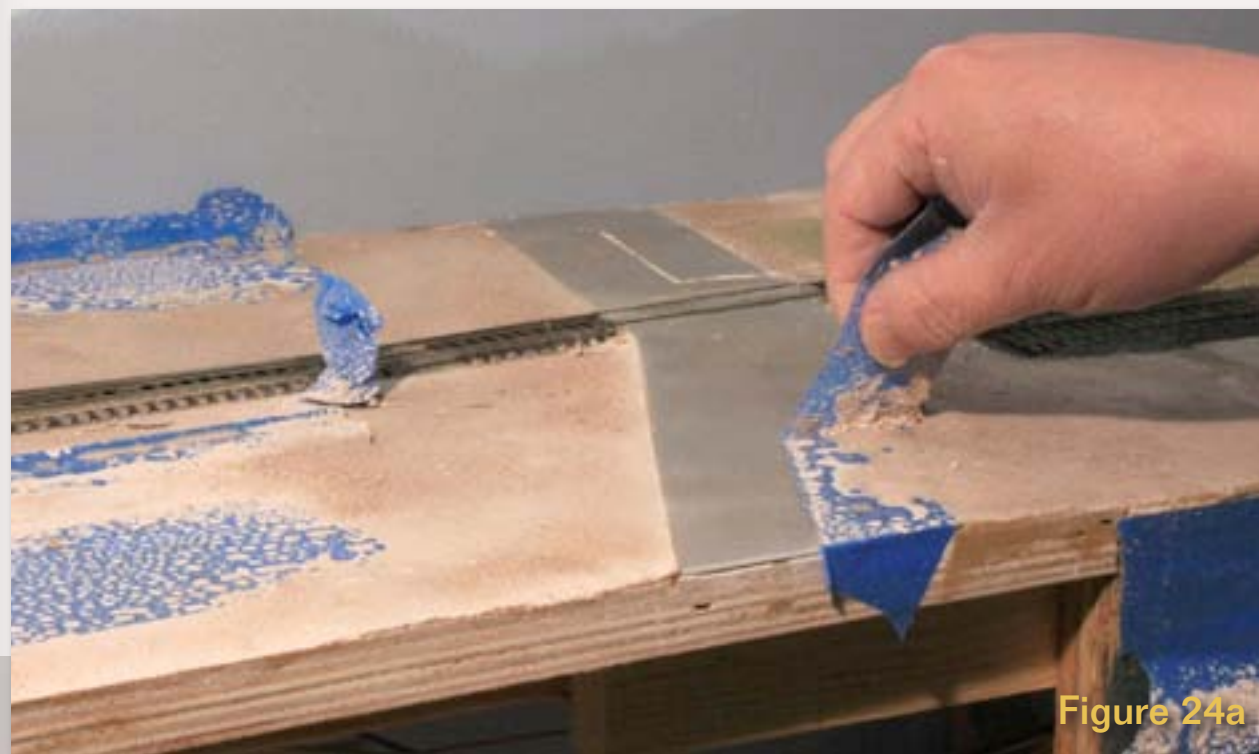

Figure 24a

Figure 23: I used a spray bottle to add extra water where there wasn't enough. This is the result Masking is important!

Figure 24 a,b: The scene after I remove the masking. Note I masked where the buildings will sit. This results in micro-foundation holes making the buildings look a bit more permanently installed.

Figure 25: I moved the buildings back into place to see how everything looks.

places where the plywood sub-road-bed wasn't even.

Once the spackle dried I sanded it and applied a second coat to fill in the holes in the first coat and smoothed the result with a wet sponge (figures 14 to 17).

I used an X-acto knife to carve the expansion joints and some cracks into the pavement, but I probably made too many cracks (figures 19 a and b).

Text continues on page 133



Figure 24b



Figure 25

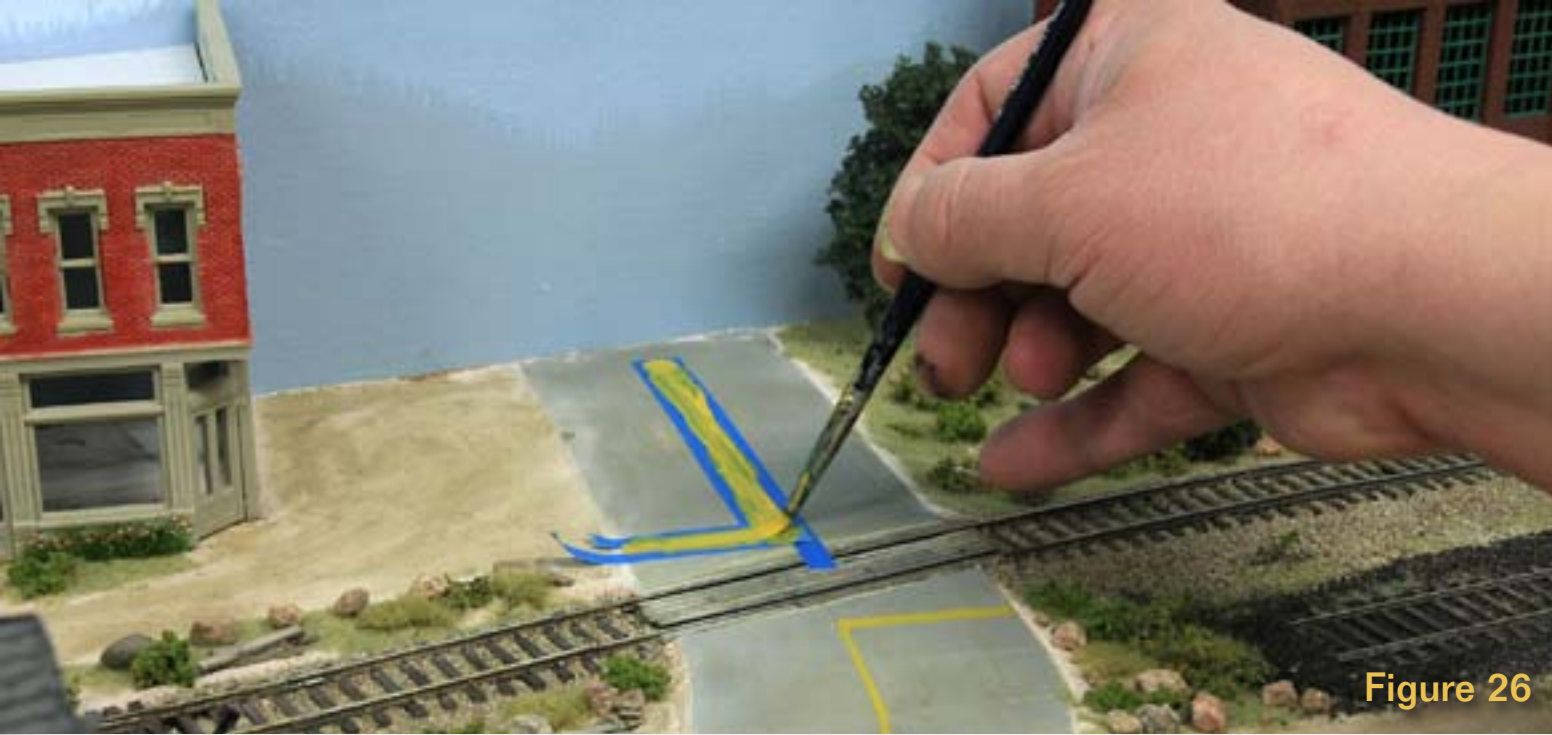

Figure 26



Figure 27

I brush-painted the road with Polly Scale Concrete using a 1/2" flat brush and being careful to keep 'concrete off the dirt'. Then I added a bunch of other scenery elements - old ties, rocks, static grass, bits of Silflor, some Fine Leaf Foliage, a few Scenic Express Super Trees, and a couple of larger conifer trees. Then I remembered what I should've done before... I keep getting in a too much of a hurry - road stripes and expansion joints!

Figure 26: I used some blue painters tape to mask the road. Then I brush painted the stripes with Polly Scale Reefer Yellow.

Figure 27: I used a fine-point black felt tip marker to add tar to the road's expansion joints and cracks. I also added a small area where the concrete had broken enough that it was repaired with an asphalt patch.

A clipping from the *South Jackson Gazette* ...

Citizens Complain About Lousy Local Roads!

Citizens living near South Jackson have long been unhappy with the state of the local highway system.

Said Mac White, a local truck driver, "Hillmovers Construction Co. spent bunches of time making mountains and hills up around Oakhill, and some nice roads up there too. Then they made some nice roads over by Mill Bend and Baynes Valley. Tell the truth we're getting kinda tired driving around on plywood. I heard just the other day that Abe Euhnett fellow got another flat from running over a sharp splinter. When they gonna get us some real highways, here?"

When contacted at his office the President of Hillmovers Construction claimed they were already working on this problem and that a new highway had just been finished and was now available for Sunday drives.

It wasn't clear whether the new roads will actually go anywhere. An ugly rumor has been circulating at the South Jackson Tavern that you gotta to 'be on your toes' when out driving because some roads seem to either lead straight into a cliff face or over the edge of the world!

Furthermore, a scandal regarding the brand new highway is brewing. Investigators are claiming that Hillmovers Construction has been



A new highway?

building roads with used materials, yet they've been charging the local county for all new material! Indeed it does appear that the new highway between South Jackson and Mill Bend has been around for a while what with all the cracks and patches on it! Company officials have responded that certain locals (including some RR officials) demanded that the highway should appear to be old so it would fit in better with the 'natural environment'! "Heck, we should charge 'em extra", the Hillmovers spokesperson responded!

This reporter certainly hopes that Hillmovers will quickly find a resolution to these issues before more roads are built! ✕

* If you like the South Jackson Gazette, you can read more at bcsjrr.com.



Figure 28



Figure 29



Figure 30

Figure 28: Once the expansion joint 'tar' and the yellow road striping paint dried it was time for some weathering. I brushed on some dark gray chalk powder for this.

Figure 29: Then I smeared the chalk around with my finger.

Figure 30: Finally I went over the road THOROUGHLY with a vacuum to remove all excess chalk. I don't want this stuff getting into wheel journals or locomotive mechanisms!

I painted the spackled areas with my standard dirt-colored paint (figures 20 a and b) to kill the whiteness.

Next I applied some zip-texturing (a mixture of 1 tsp. each of brown and black tempera powder to a 16 oz. cup of plaster). I masked off places I absolutely didn't want the zip mixture to reach (like the new road!). I found I needed extra water to get all the zip mix to turn to slurry (figures 21 to 24) so I misted the area with a spray bottle.

After removing the masking and vacuuming I added scenery elements around the road (vegetation, rocks, etc.).

I masked for road striping and brush painted them with Polly Scale Reefer Yellow. I used a sharp #11 X-acto blade to cut the blue tape into 1/4" wide strips so it would bend around curves better. This also gave it a clean edge that masks better than the factory edge. I let the stripes dry and removed the masking tape. Then I used a fine-point felt tip marker to simulate the tar in the expansion joints (figures 26 to 27).

Finally I weathered the road surface with dark gray chalk, making the middle of the lanes darker (where oil dripping would accumulate (figures 28 to 30).

Conclusion

Using sheet styrene to make a road was pretty easy and the results look fairly realistic. Thanks for the idea Joe!

The only problem I have is the chalk weathering powders burnished the road surface, making it too shiny when viewed from a low angle. Sigh...



Figure 31

Figure 32: The area BEFORE showing promise of what's to come.

Figure 33: The area AFTER. What a difference! The styrene 'concrete' can be seen at the edge of the world.



Figure 32

About our prototype modeling columnist



Marty McGuirk is an avid Central Vermont fan, modeling the “Southern New England” – an HO scale proto-freelanced railroad set in the 1950s and based in part on the real Central Vermont Ry.

[Click here](#) to learn more about Marty.

Photos by Norm Wolf unless otherwise credited.

GETTING REAL: Sea Trials for the SNE

Adventures in Prototype Modeling



Taking the SNE through its paces...

After 14 months of design, construction, a little re-design (and the corresponding reconstruction), I felt it was time to put my HO scale home layout, the *Southern New England Railway*, through its paces. While I knew the railroad and I weren't ready for a full-fledged “operating session,” I felt things were far enough along to try and uncover any issues at this early stage and to allow potential members of my future operating crew to get to know the railroad.

Since it wasn't an operating session I opted to call it a “sea trial,” a salute to my Navy background. (Without getting into an overly complicated explanation, sea trials are a series of tests a new ship undergoes before it's accepted into the fleet).

So, back in early January I looked at the calendar, and thinking “six weeks would be more than enough time to get ready,” I tentatively set a date “sometime in mid-February. Was I ready? Well, read on and you'll see.



Figure 1: I held a test session on my HO scale Southern New England Railway on February 19, 2010. Eight fellow modelers participated. Their help is much appreciated and they've already made the layout better. From left to right they are: Mat, Pete, Don, MRH N scale columnist John Drye, former MRH N scale columnist Bernie Kempinski, yours truly, Rich, and Fred. Norm Wolf was also present but he's behind the camera!

Meet the SNE

My *Southern New England*, (which everybody, including me, calls the “Snee”) is an HO scale prototype-freelanced railroad with its roots firmly planted in the prototype Central Vermont in southeastern Connecticut and central Massachusetts. The layout is set in October, 1952. At that time the CV was a subsidiary of the

Canadian National Railway, a fact that significantly impacts the traffic patterns and motive power. With the exception of a few Alco yard switchers, the CV was an all-steam railroad with the largest engines on the modeled portion 2-8-0s. The major through freights, trains 490 and 491 between Chicago (via the Grand Trunk Western and CN) and the main terminal in New London have been

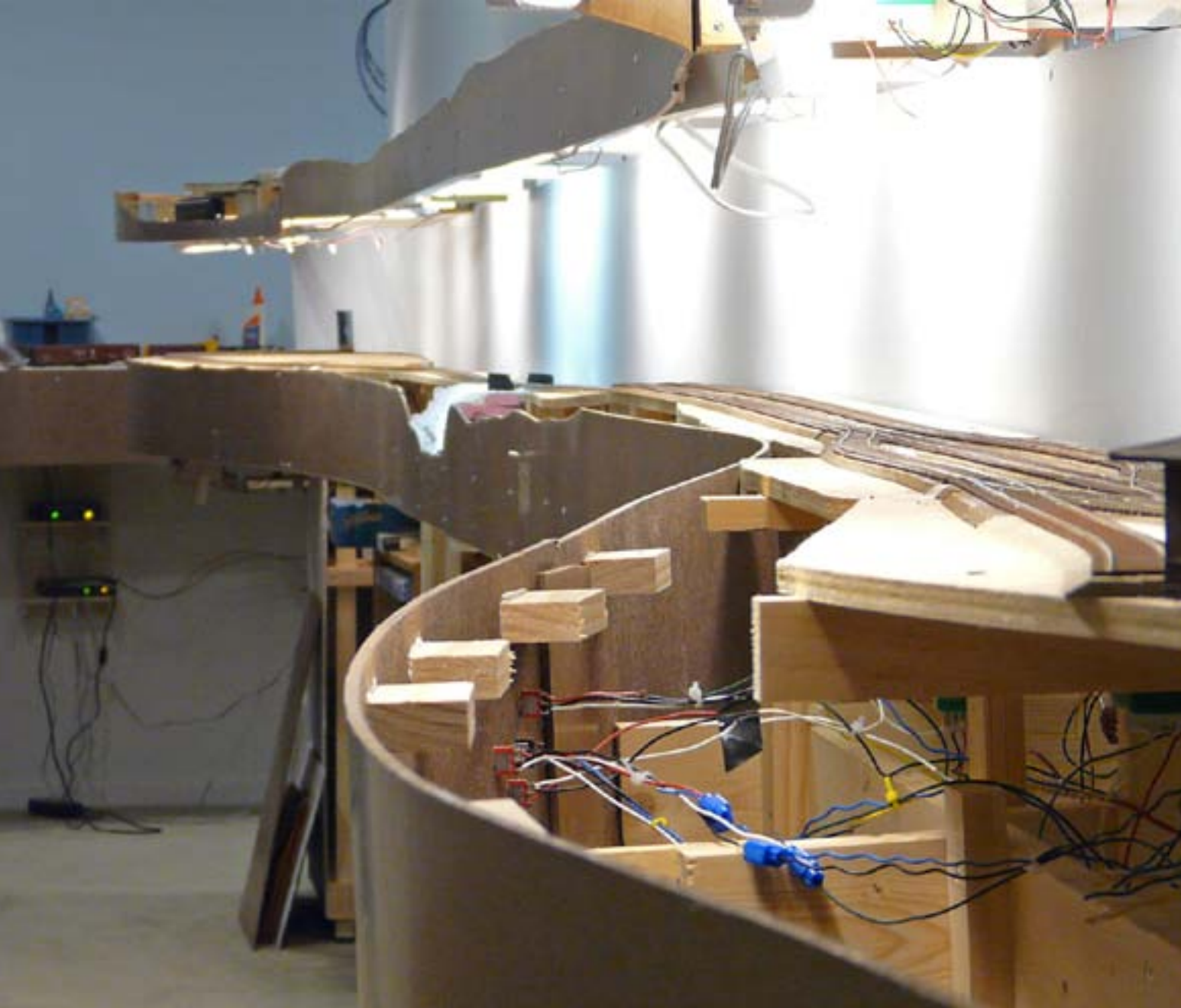

Figure 2: The SNE is single-level around the outer walls of the room with a double-deck, two-sided peninsula. Although the scenes on the peninsula are fairly shallow, the use of the peninsula (and the associated helix) adds an additional two scale miles of mainline. This view, taken from the helix end, shows Windham on the lower deck with Stafford Springs on the upper level.

dieselized for several months with CN road diesels – primarily CLC C Liners although you can also see an assortment of products from Alco, EMD, and F-M – all painted in CN’s handsome green and yellow colors.

In manipulating the prototype to fit my space, budget (both time and

money) and interests I’ve felt free to change the order of towns, eliminate some towns, and lift structures and industries from one spot and drop them in another. I’ve also felt free to use readily available plastic steam locomotives, some of them modified, others to be modified as time and interest permits. CV brass is extremely

rare and, therefore, quite expensive. I’d rather see a \$200 Bachmann engine fall to the floor than a \$1900 brass model. Besides, the Bachmann engines tend to run better, which itself is a subject for another day.

The Model Railroad

The layout occupies an 18 x 40-foot area in the basement of our home. That is really not as big as it sounds because there’s a section along that 40-foot length that narrows to about nine feet. Most of the section around the walls is single-deck, but the peninsula is double deck with a helix at one end (Figure 2).

The total is about 4 scale miles of running in the space – a respectable distance for timetable and train order operation considering the prototype’s 30 mph speed limits and relatively short trains.

The schematic is very simple. At New London there are a pair of small piers and a connection with the New Haven Railroad mainline between New York City and Boston. The SNE single-track mainline works its way north through the New England countryside, passing through several small mill towns before reaching Palmer, Massachusetts. At Palmer the Boston & Albany, a subsidiary of the New York Central System, crosses the mainline at grade. North of Palmer trains proceed into a seven track stub-ended staging yard.

Planning

I somewhat arbitrarily chose February 19 for the test session. That weekend had no family conflicts and didn’t conflict with any previously scheduled operating sessions in our area. About three weeks before that date, I sent the following notice to some members of our local round-robin operating group and posted it to my SNE Yahoo! Group (which you’re welcome to join at SNE_RY@yahoogroups.com):

As Captain Ron said, "... If anything's gonna happen, it's going to happen out there!"

So, in keeping with that spirit it's getting close to the time to "kick the tires" on the Southern New England.

Description: SNE Sea Trial #1

Date: Friday, 19 February 2010

Time: 1900-2200

Location: SNE Headquarters

PURPOSE:

To test control system, track-work, and basic operating scheme in an operational environment.

Familiarize operating crew members with the railroad and its operations.

DISCLAIMER: What this is NOT -

It is not an "operating session" in the true sense of the term. We'll have trains to run, industries to switch, etc..., but all operators should be

prepared for delays, service interruptions and the like if and/or when issues are uncovered.

I need to limit the number of attendees to six:

I will, of course, play the role of Alert One . . . (that's another Navy reference for all you landlubbers).

Positions will be assigned on a first-come, first-serve basis. Several individuals have seniority - I will hold their slots until I receive confirmation from them.

Please reply by return e-mail with your interest and availability.

We typically have our local operating sessions on Saturday mornings, a necessity considering the fairly hideous traffic in the DC area. Frankly, I thought Friday night would be a non-starter for most of my potential operators and was concerned I wouldn't get six people. I was pleased, and not just a little concerned, when 14 people expressed an interest in attending – well over my self-imposed six-person limit. I invited the first nine to answer my invite, and, realizing things would quickly get out of control if I didn't make a firm cut-off at that point, I sent “sorry we're full, maybe next time” notes to a few folks.

I was still very concerned about the total number, but; if nothing else, I figured it would be offer a good test of the “people flow” in the space.

Make All Preparations for Getting Underway ...

Two weeks before the sea trials we had a record snowfall in the DC area. The extra unplanned time this gave me to work on the railroad almost proved to be my undoing. I overreached – thinking I had time to complete the entire mainline and the north end staging yard. One day was spent laying track in the staging yard – which was still not connected to the rest of the railroad. A second, and some of a third day, was spent playing around with track arrangements for Palmer yard (Figure 3).

Three days into my four day “vacation” the portion of the layout I was planning to test still wasn't completely functional.

So, I decided to focus “Thames Street Yard.” Something had been bugging me about the yard arrangement – specifically the approach to the yard – since I installed it. I'd glued down the ties for a couple of turnouts and never laid them – a sure sign something was wrong. After playing around with some different arrangements (there went another day . . .) I figured out the problem (that alone could occupy another column), scraped up the ties and by the time I was done had taken up most of the track to get things to “flow” better.

Great, I had about ten days before my test session and I'd basically scrapped



Figure 3: I overreached a little by trying to get too much done prior to the session. One project that burned up a lot of time, and didn't get finished in time for the sea trials, was the Palmer area. I did manage to get the track arrangements figured out. Oh well, at least I'm ahead in this area for the next time! Marty McGuirk photo.

the most complex part of the railroad in less than an afternoon!

A few days before the sea trials it sank in. It was obvious I'd underestimated how much time all the little tasks necessary to prepare for even a test session can take. I was going nuts trying to prepare a layout, fill out waybills and car cards, get the rest of the yard

track installed, lay the track in Palmer yard, and a dozen other tasks.

My initial thought was to postpone the session. Instead I stepped back, realized I was never going to make that schedule, and reminded myself this was not supposed to be an “operating” session.

The “operating sessions” will come in good time. Instead, this was a chance to share my progress to date with some friends, see how a number of people can move around in the layout room, and discover any bugs or mechanical issues of the portion of the layout that’s already complete.

With that in mind, a few days before the event I sent the following to the invitees.

TO: ALL SOUTHERN NEW ENGLAND EMPLOYEES

FROM: OFFICE OF THE GENERAL MANAGER AND SUPERINTENDENT

WHAT: SNE Sea Trial #1

WHEN: FRIDAY, FEB 19.

Considering the traffic issues, etc., remaining from the snow storms . . . we’ll push the “official” start time back to 1930 (7:30 pm). However, I’ll “open the doors” at 1900 (7:00 p.m.).

We’ll run some trains, then kill the power after a couple of hours and have a quick “out brief” with light snacks. We should wrap up no later than 2230 (1030 p.m.).

SUBJ: SEA TRIAL #1 OP ORDER

The only hard and fast rules are enjoy yourself, not mishandle the models, run at appropriate speeds, and get into the spirit of the railroad and the time period. Oh, and greet the two mascots ...because they’re going to greet you... They are lively and quite loveable and

pose absolutely no threat. (In all seriousness, if you have dogphobia please let me know and I’ll be sure they’re boxed up before you arrive).

We will have more people here than I originally planned so the back aisle may get a little overcrowded at times. We will use smoke orders to prevent collisions. This is not the way I plan to run during formal sessions - but seems to be the easiest and quickest way to test the layout at this stage.

Special operating notes, instructions and bulletin notices for this session are:

1. Priorities for this session are:

a. Test all installed track including switch motors

b. Ensure the radio throttles operate from all areas of the layout.

c. Locate and identify any issues with rolling stock - some of these cars have been stored for more than five years. Habitual derailleurs, cars with low hanging couplers etc . . . should be removed from the layout for corrective action. Please identify any problems with a bad order note.

2. Post-It notes are placed around the railroad. Please fill these out with any issues you discover. The goal is to uncover as many bugs as possible. I also welcome any comments on the layout, room environment, etc...



Figure 4: Upon learning the classification yard was out of service because some feeders hadn’t been installed Don (foreground), Pete (behind), and Mat (right) got to work installing them. The yard was working by the end of the evening.

Part of me was secretly hoping everyone would answer back with “sorry, something suddenly came up.” No such luck. One person had an out-of-town meeting so he had to cancel – all the rest said “see you then – looking forward to it . . .”

After Action

If you’re still reading this, I’m sure you’re wondering “How did it go?”

All in all, it was a blast. Thanks to the entire gang (see Figure 1) for showing up and, most of all, to Christine for putting up with all this! I know I had fun, although I would have liked to be a little more prepared.

Lesson learned for all you layout builders - before your first test session set very small, but achievable goals and don’t get distracted thinking you

can get “just a little more done” beforehand. Determine what you want to test, work towards that, and ignore the rest of the railroad until all those elements are in place and working.

As expected we uncovered some issues with the layout – one or two falling into the category of “Significant.” The vast majority of issues were minor.

For those who are interested, here’s a run-down:

- **Significant Item #1** - The yard tracks weren’t working when the gang arrived – frankly I’d had a brain freeze while installing the feeders the night before and had missed about a half dozen of them. My reaction was to declare the yard “out of service.” Pete, Mat, and Don, who were among the first to arrive, would



Figure 5: One of the crew noted a “bumpy frog” in Montville. I was fully prepared to tear up the turnout and rebuild it when I realized the frog was approximately – make that exactly – .015” lower than the other rails . . . someone (me!) had put a Details West code 55 frog in an otherwise code 70 turnout... Swapping it with a code 70 frog took all of two minutes. Marty McGuirk photo.

hear none of that. They immediately went to work installing the necessary feeders. Within an hour, the class tracks in the yard were up and running. So one “significant” issue was corrected on the spot (Figure 4).

- Item #2 - I know from previous layouts DCC installations always need some debugging and this one is proving to be no exception. Over the course of the evening, several engines seemed to lose touch with the DCC system. We had a couple of “runaways” but no disasters. Some

of these glitches were likely directly attributable to running trains on one part of the railroad while the “feeder gang” was connecting to the buss wires. I noticed once that connecting stopped, things calmed down considerably. Another possibility was running so many engines over a relatively large layout on a single booster. Separating the layout into independent power districts is high on the list before the next session.

- Significant Item #3: Two of my five Easy DCC throttles simply did not work. One was an easy fix. I had pulled it out of the box just before everyone arrived, got distracted, and forgot to set a dedicated frequency for the throttle! The fifth throttle has issues – it won’t “take” a throttle I.D. number and the command station doesn’t recognize it. After a quick phone consultation with CVP that throttle has gone back for diagnosis. (I should add here that Al at CVP is extremely knowledgeable and very helpful, so my throttle issue in no way reflects dissatisfaction with the product or service).

- Three turnouts needed minor adjustments, and one needed what I would call a major rework. I was able to make the needed adjustments to two of the turnouts during the session. The third was a bigger problem. Cars and engines tracked through it, but they shimmied and clicked pretty badly. Over the next few days and evenings I replaced the frog and wing rails. It now works fine.



Figure 6: Rich gave a complete workout to the paper mill at Montville, Conn. Some rather strange “chemical tanks” appear in the distance.

- One of the turnout “issues” was almost laughable. One of the crew noted “Bumpy Frog” (Figure 5) at the mill yard lead in Montville.

With the most pressing problems handled, the crew ran trains for a couple of hours. Instead of worrying about car cards and waybills, I simply instructed everyone to “couple onto a few cars and switch each town as you reach it.”

Rich gave the mill complex track-age a lot of exercise. Some wise acre couldn’t resist adding several “tanks” to chemical spur (Figures 6 and 7).

Other minor issues included several misaligned rail joints, a few cars that had plastic wheelsets or one of the “non-Kadee” knuckle couplers, such as the early McHenry, Intermountain, and Proto 2000 couplers (Figure 7).

These and other similar minor items were taken care of during the session. One unexpected issue was the way the wire harnesses between the engine and tender on some of my Bachmann steamers grabbed the frog or point rails – causing them to snag the turnouts and sit there spinning their wheels. This is easy to fix but



Figure 7: I added folded index card “tents”, indicating industry type, on various tracks. Someone felt we needed some “structures” and so added a stack of soda cans to the chemical track in the paper mill. Not sure why a hopper got spotted there... Marty McGuirk photo

something I couldn't easily address during the session.

When the smoke cleared, 12 items made my list of things needing to be addressed before the next test session. Table 1 shows the status of that list as of press time.

The “out brief” was anticlimatic, very complimentary, and other than the group picture I'm not sure it accomplished much. I certainly didn't learn anything from it! One follow-up comment I got from one member of the crew was the need for some additional signage on the layout - just

#	Category	Location	Description	Planned Action	Status
1	Track	Montville	North mill lead “Bumpy frog”	Replace w/ code 70 frog	Closed
2	Track	Montville	Freight house lead – wing rail slides	Respike wing rail. Fill gap in frog with plastic to prevent shorts	Closed
3	Track	Thames Street	Yard lead south turnout does not throw all the way w/Tortoise	Wire Tortoise – check throwrod for obstructions.	Open
4	Track	Thames Street	Spring missing from track 3, south ladder turnout	Replace turnout	Closed
5	Track	Norwich	Rough operation - South siding turnout	Replaced frog and wing rails. Enlarged distance between point and stock rails	Closed
6	Wiring	Various	Feeders in sidings not connected to buss wires. Locations marked on layout	Connect to buss wires	Closed
7	Locomotive	Various	702 and 706 lose comms with DCC	Disable DC operation, reprogram decoder	Closed
8	DCC	Throttle 2	Does not operate	Check frequency and mode	Closed
9	DCC	Throttle 5	Does not operate. CS does not recognize	20 Feb: verified frequency and mode. CS still not finding it. 23 Feb: Contacted CVP 25 Feb: Returned to CVP for diagnostic	Open
10	Locomotive	Various	702, 706, 489 snag turnouts	Shorten wires between tender and engine	Open
11	Layout	Various	Insufficient Signage	Add additional signage to fascia	Open
12	DCC	Various	Power levels varied	Set up power districts	Open

Table 1: Southern New England – Sea Trials #1 19 Feb 2010 – Punch List

because I know where Montville, Berkman Feed and Coal, and Thamesville, etc., are doesn't mean my crew does!

A few of the gang had to leave at 10:00 pm (they were going to an operating session the next morning!) and Bernie Kempinski treated those remaining to a live backdrop painting clinic. Bernie did a wonderful job painting about six feet of backdrop

in an hour or so. We'll cover the techniques in a future column, but I couldn't resist including pictures of Bernie at work (Figures 10 and 11).

Next Step - OPEVAL

As noted above, most of the issues were easily corrected. With one test session under our belt I'd like to get the entire mainline in and operational,

and the remaining yard tracks in place, before trying the next Sea Trials session.

But before doing that, I'm going to divide the railroad into power districts and make sure the control system is working properly.

All in all, I was very pleased with how things went and how well the railroad performed. For the next sea trials session I'll focus on verifying things were

indeed fixed (wireless throttles are best tested with a number of people in the room, for example) and try out version 1.0 of the planned operating scheme. We may well find new problems next time, but nothing we found indicates it's necessary to tear out wholesale chunks of the railroad and start over. I plan to invite back the same crew, or at least give them first shot. After all, they suffered through the little gremlins and glitches so they should get the reward of trying things out on a functioning layout. ✓



Figure 9: This test session gave me a chance to see how many people could fit into the aisles at once. The narrowest portion of the aisle may be an issue, although there should never been more than three people in the aisle at one time. Lesson learned – keep operating positions turnout toggles and the like, offset across the aisle.



Figure 10: Once we finished running, Bernie conducted an impromptu backdrop painting clinic. He started by taking a few trees for color samples and sketching a horizon line, then painting several shades of brown to create the basic landforms.



Figure 8: Some of the cars had been in storage for 5 years and I knew they might need some tweaking. I asked the crew to be relentless about issues with couplers and wheelsets, and they were. Any car that derailed more than once was placed to the side for further investigation.



Figures 11 a and b: We'll cover Bernie's backdrop painting techniques in a future column. In the meantime, here he is hard at work. It took him about an hour to paint six feet of backdrop.



About our N-scale columnist



John Drye is our N scale editor and columnist.

[Click here](#) to learn more about John.

COMME-N-TARY: Progress Report on my N Scale PRR Layout

Modeling in the hobby's most eNgaging scale



Building PRR's Horseshoe Curve in N scale ...

Last year, I related the thought process that led up to the construction of an N Scale version of Horseshoe Curve in my basement. A year later, considerable progress has been made, with a lot of help from some pretty good model railroaders.

Introduction

The layout represents a mid-1950s version of the Pennsylvania Railroad. The main line trackage begins in downtown Altoona at the base of the hill, runs out of town and up to Horseshoe Curve, past MG tower (at "mid-grade"), to the three tunnels at the top of the hill

Figure 1: Horseshoe Curve on Oct. 12, 1934. Used under the GNU free documentation licence.

(where helpers, called snappers on the PRR, are removed), on to Cresson where several coal branches radiate from the main line, and finally down the West Slope towards Pittsburgh and points west.

The layout fits in a 15 x 21 finished basement, plus ten, 12' to 15' staging tracks in an adjacent 8' x 15' utility



Figure 2: The Horseshoe Curve on the author's under-construction N Scale layout.

room. One of the key lessons gleaned from the model railroading operations community is that you can never have too much room for staging. So, the staging yard will accomodate at least 16 trains.

About three-fourths of the track is laid and work is beginning on scenery in some locations. Some "testing" has already taken place; also known as running trains back and forth.

Construction

The benchwork is open L-girder with plywood sub-roadbed for most of the main line. This construction was pretty straightforward. An interesting aspect was building several spiral curves, including Horseshoe Curve. Using several carpenter's levels and measuring carefully created a smooth grade up the mountain.

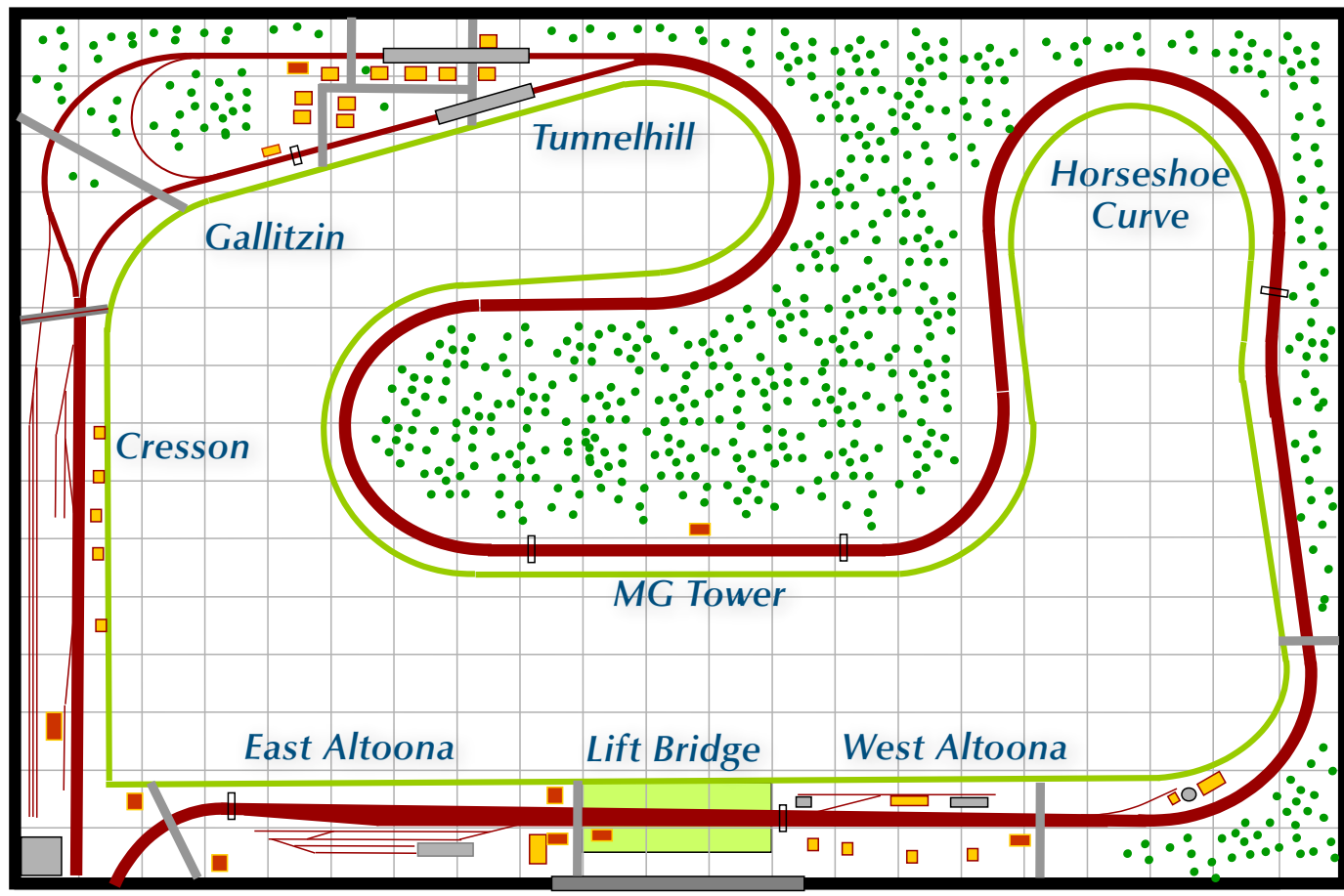

to staging
Figure 3: Trackplan (12" grid). The wide red line represents the four-track main. Thin lines represent one or two tracks. Horseshoe Curve is in the upper right.



Figures 4a,b: Construction with L-girders. Note L-girders in 4a face down (flange below), while those in 4b face up (flange on top).

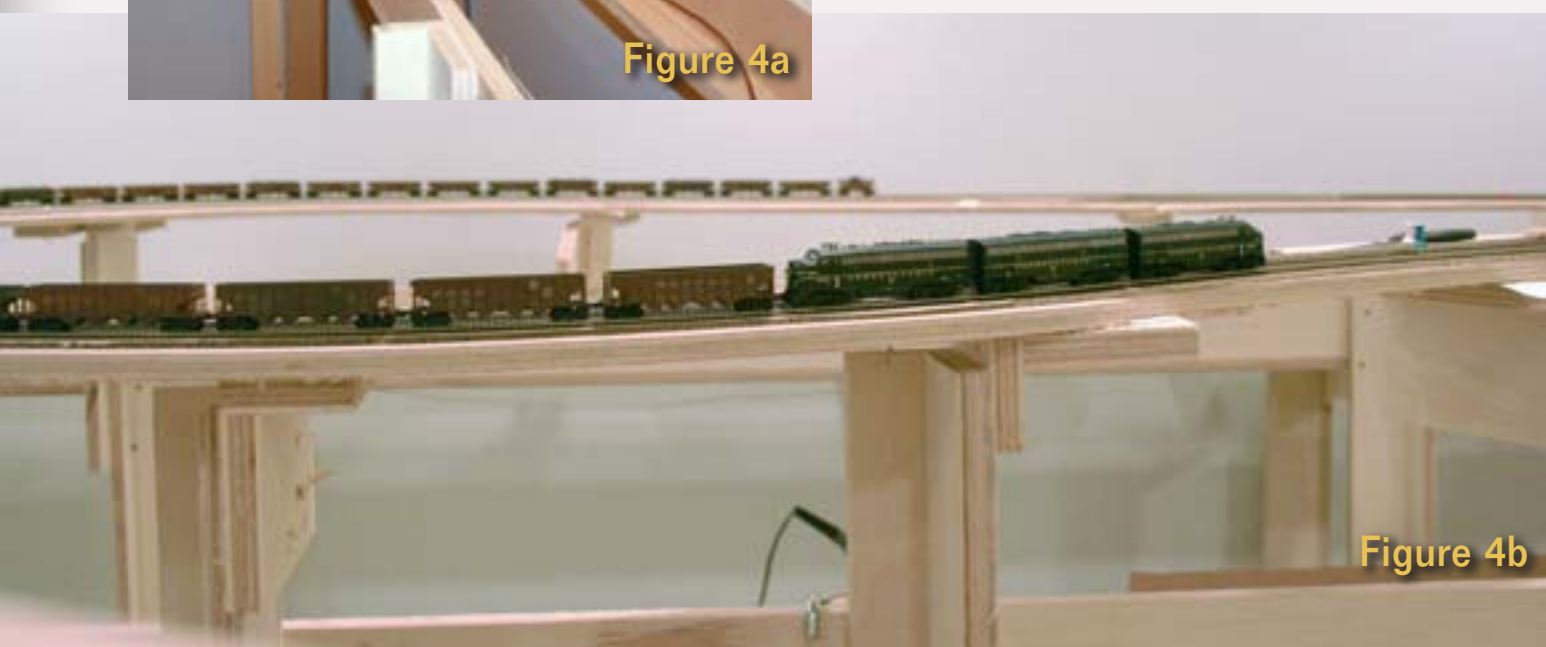

Layout Facts

Scale: N
 Locale: Pennsylvania
 Prototype: Pennsylvania RR
 Era: mid 1950s
 Radius: 24" main, 18" elsewhere
 Height: 50" to 59"
 Grade: 1.75% max
 Track: Atlas code 55 main, Peco code 80 staging
 Turnouts: #10 main, #7 sidings
 Mainline length: 130' (four tracks)
 Control system: Digitrax DCC

The four-track mainline was laid on conventional cork roadbed yellow-glued to the plywood sub-roadbed. After several experiments we settled on clear caulk to hold the track in place. The caulk is spread in a thin layer across the cork, then the track is pressed into place and secured with pins. The caulk allows several minutes of time for minor adjustments before it sets.

The caulk holds the track solidly in place but it can easily be lifted with a spatula in case adjustments need to be made later. That came in handy when seasonal changes in heat and humidity kinked some of the trackage.

One of the crew came up with a clever tool made from plywood to ensure consistent between-track spacing on the curves. This tool was



Figure 5: The four-track main at McGinley's Curve.

made by carving two notches in a piece of scrap plywood. It's placed against the outside rail of Track #1 (closest to the aisle) which was laid first. The inside rail of the next track #2 is forced into the notch in the tool, holding it a fixed distance from the previous track. The tool is moved around the curve as new track is laid. This process was repeated for tracks #3 and #4. The result is trackwork the PRR would have been proud of.

Once final adjustments and testing have been completed, ballast is applied and glued to hold the track securely in place.



Figure 6: The Tunnelhill Module

The crew's modular railroading experience led to trying a different approach for the complex areas of trackage -- those areas with a lot of switches and Tortoise machines. With a four-track mainline, interlockings can get pretty interesting.

We built the complex sections as modules, similar to the domino approach espoused by David Barrow

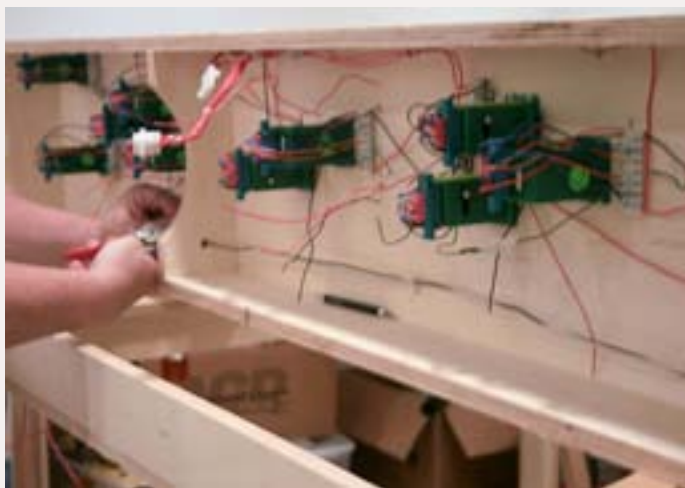

Figure 7: Wiring underneath the MG Tower module

on his Cat Mountain and Santa Fe. However, the sections are not all the same size or shape. There are six modules: MG Tower, Tunnelhill, Gallitzin, Cresson, West Altoona, and East Altoona. Four of these are rectangles, varying in width from 18" to 24" and in length from 6 to 7 feet. Tunnelhill and Gallitzin fit in a corner of the layout room and are irregularly-shaped to fit the trackage around the curve.

In some cases, the tops of the modules were cookie-cuttered to accommodate track grade and scenic



Figure 8: Connecting track on the MG Tower Module

elements. Tunnelhill, for example, includes the crest of the eastbound main and incorporates the elevation difference between the eastbound and westbound tracks (Figure 6).

The biggest advantage to constructing the complex trackage elements this way is that most wiring can be completed at the workbench, instead of working under the tracks, where solder drips on your nose and lighting is a challenge. One of the crew took several of the modules home to work on the wiring! That can be hard to do with conventional construction.

When the wiring was finished and tested, the module was dropped into place on the layout (this is a very important place to measure twice!) The cork roadbed was laid all the way to the edge of both the modules and standard roadbed as part of the measure twice process. However, a 12-18" gap was left in the track so that the connecting track could be added in a smooth curve (Figure 8).



Figure 9: Plywood scenery contours.

Scenery

One attractive scenic features of this part of the PRR is the mountains towering over the trains. On the layout, the mountains rise as much as 24" above and 12" below the tracks. N Scale is great for creating this scenery-to-trains ratio.

Here, however, was a place where modular railroading techniques did not seem like the best way to go. NTRAK modules often use stacked styrofoam because of its light weight and reasonable durability. Stacking foam on a module allows the terrain to be easily contoured with knives, Sur-Form® tools and sandpaper. Stacking and shaping styrofoam up to 36" high for 20+ feet of mountain terrain seemed a somewhat daunting task.

After some head scratching, we came up with a different approach. First, we cut several pieces of ½" plywood to match the vertical contour of the mountain. Kind of like setting half a pizza on its side, the plywood was

attached to the benchwork, creating a base for further construction.

Next, the plywood contours were connected with a 2 x 4 lumber ridge-pole. The ridgepole, benchwork and plywood were used as a frame for cardboard strips attached in a grid to fill in the contours. The cardboard was hot-glued and stapled, then crumpled construction paper was glued over the grid to form the final contour of the hill (Figures 9, 10, and 11)

The open space below the hollow hill construction allows the dispatcher / tower operator to sit underneath, out of the way of the engineers. There is room for a desk, chair and dispatcher's screen right below MG Tower.

Backdrop

A scenic backdrop goes a long way toward establishing an attractive environment for operating the railroad. There are many approaches to



Figure 10: Cardboard grid over plywood contours.

installing a backdrop, from painting directly on the walls or on aluminum or plastic sheet, to commercial custom photographs.

For this part of the PRR, we decided to use 0.060 styrene sheet. This material is easy to cove into corners, sturdy enough to stand on its own, relatively inexpensive, light and manageable. We installed the 2 x 10 foot sheets with drywall screws and glued them together with a 4" wide splice cut from the same sheet (Figure 11).

Operations Planning

While all this construction was going on, the superintendent of motive power, trainmaster and dispatcher were coming up with an operating scheme for the railroad. The overall objective is to operate a set of trains that provides a realistic snapshot of the Pennsy in the mid-50s (Figure 12).

Fortunately, there is a wealth of information available documenting this snapshot. Railroad Books and

Websites provide lists of the passenger and scheduled freight trains operating over this part of the railroad, and photographic, video and prototype records show the typical consists. The source material also describes locals and mineral extras.

A great source for this type of information is the [Pennsylvania Railroad Technical and Historical Society](#) which does a magnificent job of preserving the history of a railroad that has been gone more than 40 years. Most fallen flags have similar organizations and they are a great place to start researching.

The information we obtained was used to identify a representative sample of the trains that traveled the mountain on a typical 1950s day. That sample is the first step to a manageable operating scheme.

Although most of the Blue Ribbon Fleet (Pennsy's first class passenger trains, including the Broadway Limited), traveled over the curve in the middle of the night, a little modeler's license will allow some to pass during daylight hours. These trains included sleepers from foreign roads dressed in attractive paint schemes, and such an eastbound and westbound train will head up the fleet. The rest of the passenger fleet will include several all-coach trains, at least one mail and express and the PRR Aero Train, because a great-looking model is available.

Some of these will have head-end cars shuffled in Altoona

The Pennsy handled a considerable amount of high-priority freight in the 1950s. This included blocks of perishables in orange and yellow reefers, some of the first intermodal traffic on TTX flatcars, auto parts to be delivered on a "just in time" basis to east coast assembly plants, livestock traffic and a still-robust LCL business. This priority traffic will be represented by a solid reefer block, a consist of trailers on flatcars, and a couple of priority merchandise freights including livestock, auto parts and LCL shipments.

The PRR will always be known as a mineral hauler; primarily coal, but also including both domestic and imported iron ore. The coal branches radiating from Cresson are represented by a marshaling yard to stage loads for a trip over the mountain. Additional traffic will originate from coal fields west of Cresson, and of course, the empties need to be carried back to the mines. Some of the empties will haul imported iron ore to the mills in Pittsburgh.

Finally, there is room on the railroad for a few locals. One will handle industries on the Hollidaysburg Branch and another will make a turn from the Altoona staging yard to Cresson, servicing the helper facility and a couple of local industries. Another crew will cover duties at the Altoona freight station and handle the passenger switching.



Figure 11: The painted backdrop behind Horseshoe Curve on the author's layout.

Altoona Layout Trains													
Passenger													
		Description	Power		X Box	Bagg	Mail	Old Coach	Mod Coach	Diner	Sleeper	Cabin	Total
1	WB	1st Class: Penn Texas	2	E8/9			1			2	5		8
2	EB	1st Class: St Louisian	2	E8/9			1			2	5		8
3	WB	Day/Night	2	E8/9	1	1			3	1	2		8
4	EB	Day/Night	2	E8/9	1	1			3	1	2		8
5	WB	Day: Duquesne	2	E8/9	3	2			4				9
6	EB	Day: AeroTrain	2	Aero					6				6
7	WB	Mail	2	FP7	6	4		1				1	12
8	EB	Mail	2	FP7	5	3		1				1	10
					16	11	2	2	16	6	14		
Thru Freight													
		Description	Power		Box	Hop	Gon	Flat	Reef	Tank	Stock	C hop	Total
1	WB	TrucTrain	2	GP9				12					12
2	EB	TrucTrain	2	F7A/B				12					12
3	EB	Reefers	3	F7A/B					22				22
4	WB	Empty Steel Gons	2	I1			18						18
5	WB	Gen mdse	3	F7A/B	14	2	4	2	2	2		1	27
6	EB	Gen mdse	3	F7A/B	16	2	3	0	1	1		1	24
7	WB	Gen mdse	1	M1	18	1	2	1	2	1	2	0	27
8	EB	Gen mdse	1	M1	12	1	2	0	1	0	8	1	25
9	WB	Gen mdse	3	F7	14	2	3	1	2	2		2	26
10	EB	Coal loads	3	Shark		24							24
11	EB	Coal loads	3	FA/B		24							24
12	WB	Coal empties	3	TM		24							24
13	WB	Coal empties	2	I1		24							24
14	EB	Ore loads	3	Shark		18							18
Local													
X1	Altoona	Gen mdse	1	GP7	6			1					7
X2	Cresson	Gen mdse	1	GP7	4	2				1			7
				Totals	84	124	32	29	30	7	10	5	321

Figure 12: The operating scheme will be representative of traffic on the PRR around Altoona in the 1950s..



Figure 13: Multiple trains passing on Horseshoe Curve.

Some of the trains; in particular general merchandise and coal hoppers, will use the same consist and only have power changed out in staging. This saves on both staging space and the freight car roster. Since such trains were all pretty similar (mostly boxcar red boxcars, or black and red hoppers), avoiding distinctive cars will help disguise the recycled consist.

The next step is to identify actual train names for the mainline traffic. These may include the Penn Texas or Duquesne for the passenger trains and LCL-1, CIN-2 or Extra 1445 for the freights. Prototype designations and consists clearly provide a purpose and context for operators and helps maintain the impression of the real rail-

road. Figure 12 shows the beginning of this process.

There is a lot more to do, but at this point the layout is beginning to look a little bit like the railroad. The hope is to have all the track in and operating by summer. Ballasting and detailing of the main line will begin soon and scenery (lots and lots of trees) will follow.

Later tasks include installing signals (nothing says "PRR" like position light signals), testing and refining the operating system, weathering the rest of the rolling stock and installing buildings. Enough to keep the crew busy for a while yet.

REVERSE RUNNING: Now You See It, Now You Don't!

Stepping outside the box with a contrary view



— by *Charlie Comstock*

Model railroaders are asking for more and more detail on their models. The goal seems to be making everything scale size! While wonderful for shooting ultra close-up photographs, is this always a good thing?

In HO, a scale-size ladder rung is less than .010" thick. So are the grabs and stirrups on a box car. In N scale these detail parts are positively microscopic. O scale fares a little better – a 3/4" ladder rung scales out to .015". Even in Fn3 (20.3:1) ladder rungs are only .037".

When all those tiny detail parts are styrene, a good rule of thumb is

"Don't even look at 'em closely or they'll break off!"

OK, that's an exaggeration, looking at a stirrup on an HO scale freight car isn't really going to cause it to break off (though I know folks who would swear otherwise . . .).

Detail and Operation Don't Mix

What happens when super detailed cars are put into regular service on a model railroad layout?

It depends:

- How much are the cars handled?
- What are the details made from?

If your idea of operation is to select a train waiting somewhere, set it orbiting the layout, go to the fridge for a soda or brewsky, then watch it chuffing through your scenery, you won't have many problems. You're not touching your rolling stock that much.

But if you have op sessions where cars get picked up and dropped off at industries, classified in yards, and hauled back and forth around the railroad, your cars are going to see some handling-related wear and tear.

If you have an active staging area, where a *mole* operator moves cars around with the good old 0-5-0 switch engine, those cars will get handled a LOT. Even when I'm restaging my

layout before the next op session, I end up handling the rolling stock more than I'd like.

The more cars are handled, the more likely they are to sport busted details. Missing stirrups, grabs, broken ladder rungs, and boxcar doors that no longer close perfectly become standard. It matters not how careful you are. Eventually stuff gets broken.

If details were made of titanium and chrome moly steel, they would stand up to use pretty well. But all too frequently they're made of styrene.

While great stuff for quickly building models, thin styrene parts just aren't strong enough to stand up to handling.

Engineering plastic, such as is used by Kadee on their great looking HO box and hopper cars, is much more robust, but can still get broken off.

Some modelers routinely replace all the details on their cars with brass wire or metal parts. This resists breakage, but .010" brass wire does bend rather easily.

What's a poor modeler to do, especially if they want to operate?

Either we live with broken details or we use rolling stock without the scale size components.

Weathering IS Pseudo Detail

If you can't deal with broken details, don't put your most highly detailed cars into revenue service. Instead use Athearn Blue Box, Accurail, or Branchline Yardmaster cars on operating layouts. Sure, they have less detail, but from 3 feet away you'll have a hard time seeing that the roof-walk isn't scale thickness with a see-through tread.

You can further increase your ability to NOT notice a lack of detail by weathering. Some heretics claim that a really nice weathering job on a less detailed model looks better than an unweathered, super-detailed model!

A Confession...

I still have a number of high-detail models on my layout, even during op sessions. I try to be careful around them and I discourage the crew from handling cars. Stuff does get broken, but I no longer have a coronary when it happens. It's just part of life. But the majority of my freight cars are Accurail, which are pretty robust.

I no longer feel that every car has to have perfect, scale-size detail all over, because with details, it's a matter of *now you see it, now you don't!* 

Clickable Advertiser Index	Page
Accu-Lites	19
Berrett Hill Trains	16
BLMA	3
BPL Brassworks	11
Canyon Creek Scenics	56
Canadian Model Trains - CMT	7
Craftsman Structure Show - 2010	97
Dallas Model Works	4
DCC Installed	22
Digitrax	10
Fast Tracks	5
FOS Scale Limited	20
LBH Custom Model Railroads	16
Litchfield Station	13
Micro-Mark	21
Model Railcast Show	57
Model Railroad Hobbyist	57
Model Railroad Tips	16
Model Trains Video	6
Model Trains Video (F&SM)	45
Model Trains Weathered	67
Modeler's Warehouse	15
New York Railway Supply	14
Oregon Rail Supply	15
Proto:87 Stores	15
Railflyer Model Prototypes	15
Railroad Kits	19
Rapido Trains	9
RS Laser Kits	45
Scenic Express	44
Scotty Mason Show audio podcast	17
ShelfTrax	16
Signature Press	35
Timesaver Layouts	16
Tony's Train Exchange	42
Trains, Videos, and Parts	15
Traintek	36
Weathering Solutions	35

Clickable Topic Index	Page
Editorial – Publisher’s Editorial	12
Editorial – Notes from the MRH staff	17
Editorial – Reverse Running	146
Layouts – Jim Dias's Western Pacific	46
Locos – Basic Diesel Detailing	70
Modules – My Modular Adventure	98
News – Coming Events	31
News – May Newsletter	23
Operation – Getting Real	134
Operation – Comme-N-tary	141
Prototype – Modeling the Modern Era	58
Prototype – Comme-N-tary	141
Q and A – MRH Questions, Answers, and Tips ...	32
Scenery – Up the Creek - Roadwork	126
Scenery – Pink Foam Retaining Walls	43
Structures – LED Structure Lighting	119
Structures – Detailing Loading Docks	96
Track plan – Canadian Prarie Crossing	37

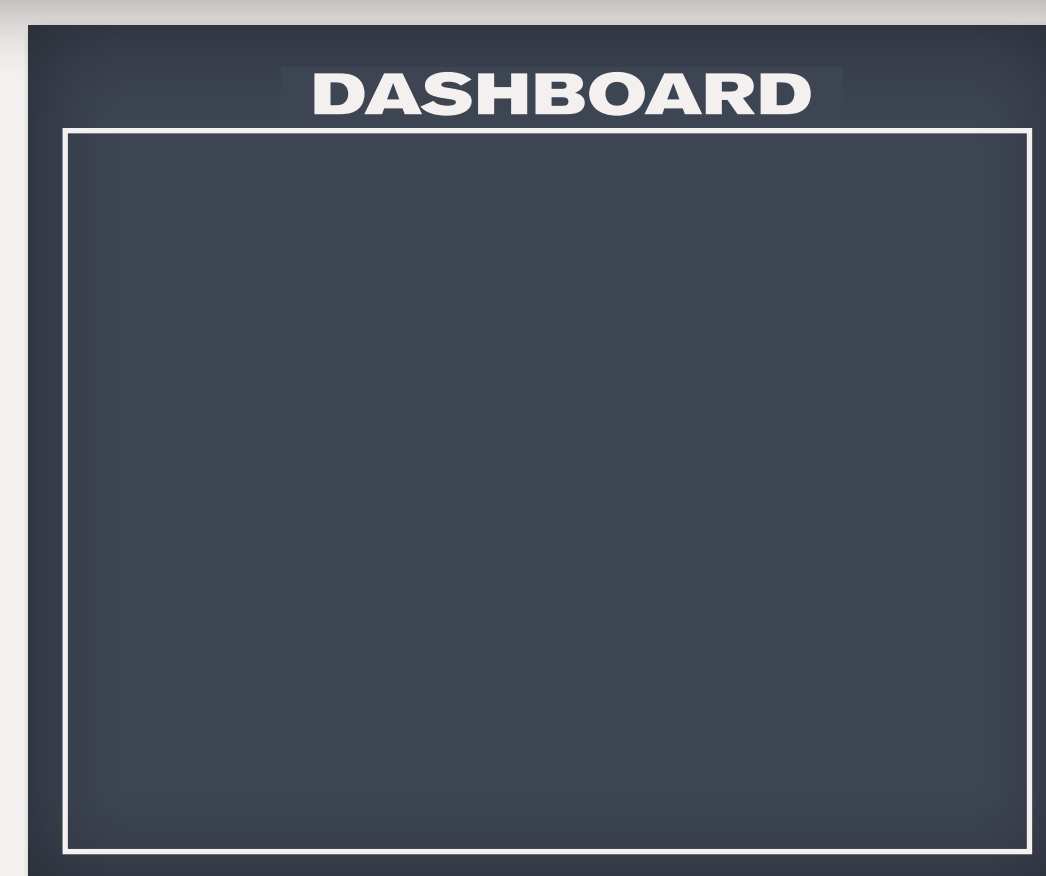

Other – Cover	1
Other – MRH Sponsors	2
Other – Table of Contents	8
Other – Bonus Downloads	18
Other – Department of Corrections	22
Other – Derailments (humor)	69

For the love of model trains

Coming in the Jul/Aug 2010 issue

- Kitbashing a U18B, part 1 - Mike Rose
- Build a reusable modular cradle
- Using sound to enhance your layout
- New one-evening projects
- Jimmy Deignan's Pennsy Layout
- Modeling decrepit spur tracks
- More MRH Questions, Answers and Tips

... and lots more!

