

# Model Railroad Hobbyist magazine™

Price:  
Forever Free

STANDARD  
Edition

The model-trains-video.com mediaZine

Jul/Aug 2010

## Mike Rose Kitbashes a U18B

Learn the keys to a  
successful loco kitbash

**Modeling decrepit spurs**

**IN DEPTH: Enhancing a layout with sound**

**Modeling Amtrak in N scale**

**And much more ... *inside!***





**Front Cover:** Mike Rose needed a U18B but at the time, there were no commercial models to be found. So he decided to kit-bash his own! Read along and see what he did to create this beautiful model.

ISSN 2152-7423

#### Editorial Staff

Joe D. Fugate, Publisher  
Charlie Comstock, Layouts and media editor

#### Columnists

Ryan Andersen, New media  
Richard Bale, News and events  
John Drye, N scale  
Lew Matt, Narrow gauge and shortlines  
Marty McGuirk, Prototype modeling  
Les Halmos, Modular railroading  
Tim Warris, Trackwork

#### Special Correspondents

Jim Duncan, Layouts and operations  
Byron Henderson, Layouts and track planning

#### Production

Patty Fugate, pasteup and layout  
Joe Brugger, copy editing  
Mike Dodd, copy editing

#### Technical Assistant

Jeff Shultz

#### Advertising Account Manager

Les Halmos



Click to learn more about this sponsor



Click to learn more about this sponsor



Click to learn more about this sponsor



Click to learn more about this sponsor



Click to learn more about this sponsor



Click to learn more about this sponsor



Click to learn more about this sponsor



Click to learn more about this sponsor



Click to learn more about this sponsor



Click to learn more about this sponsor



Click to learn more about this sponsor



Click to learn more about this sponsor



Click to learn more about this sponsor



Click to learn more about this sponsor



Click to learn more about this sponsor



Click to learn more about this sponsor



Click to learn more about this sponsor



Click to learn more about this sponsor



Click to learn more about this sponsor



Click to learn more about this sponsor



Click to learn more about this sponsor



Click to learn more about this sponsor



Click to learn more about this sponsor



Click to learn more about this sponsor



Click to learn more about this sponsor



Click to learn more about this sponsor



Click to learn more about this sponsor

**Sponsoring Advertisers - Visit them and say: "Thanks for bringing me MRH completely free."**

**Your logo could be on this page, putting your web site just one click away from tens of thousands\* of readers!**

Our click tracking indicates sponsoring advertisers get up to *double* the clicks ...



[Click here](#) to learn how to become a *sponsoring advertiser*.

\* Our oldest issue, released in January 2009, has now had nearly 50,000 downloads – and continues to get hundreds of new downloads per month even now. Sponsoring advertisers who've been with us since issue 1 are still getting clicks from all our back issues, from their logo on our web site, *as well from as our current issue*. A sponsoring ad with MRH is truly an *investment* in growing your business.

HO & N

LIKE YOU'VE NEVER SEEN



6 Unique Numbers!

TRINITY 3-UNIT SPINE CAR **NEW!**

N Scale



7 Road Names!

**NEW!** PS-2CD 4000 COVERED HOPPER

**NEW!** ACF F89-J 89' FLAT CAR **6 Unique Numbers!**



HO & N Scale Brown "As Delivered" TTX

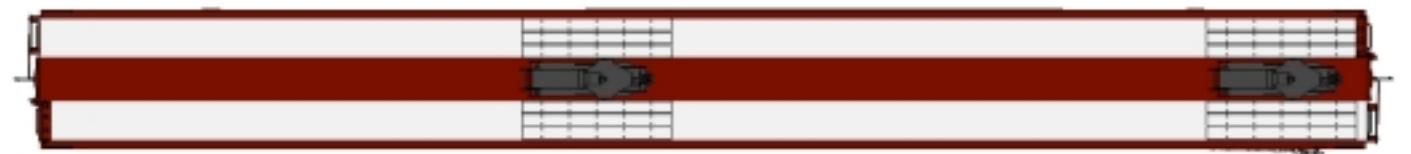

**BLMAmodels.com**

Catch us online!

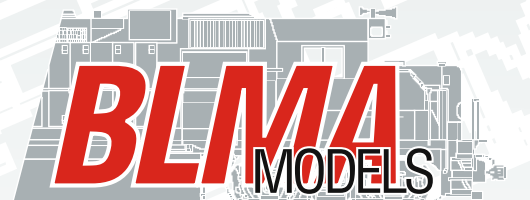

ORDER NOW THROUGH YOUR FAVORITE DEALER

Phone: 562-712-7085 sales@BLMAmodels.com

[Visit the BLMA web site](#)

[Tell a friend ...](#)

[Contents](#)

[Index](#)



*My Railroad*

# Defect Detector

*Is Here!*



Simulates real-world trackside detectors

Adds realism to your operations

Accessible over the Internet

Free to Use

Works on iPhone + other mobile devices

Simulated radio messages

Complete instructions

Are you a Member?



 Click to Visit



**THE**

# **BULLFROG**

## **MANUAL THURNOUT CONTROL**

**NEW**



- ✦ Inexpensive
- ✦ Integrated Control Rod Mount
- ✦ Automatic Power Routing
- ✦ Full Selection Of Supporting Products



**\$9**

**Ready  
To Install**

**You Assemble It**



**\$6**



Order online now at:  
[www.fast-tracks.net/bullfrog](http://www.fast-tracks.net/bullfrog)



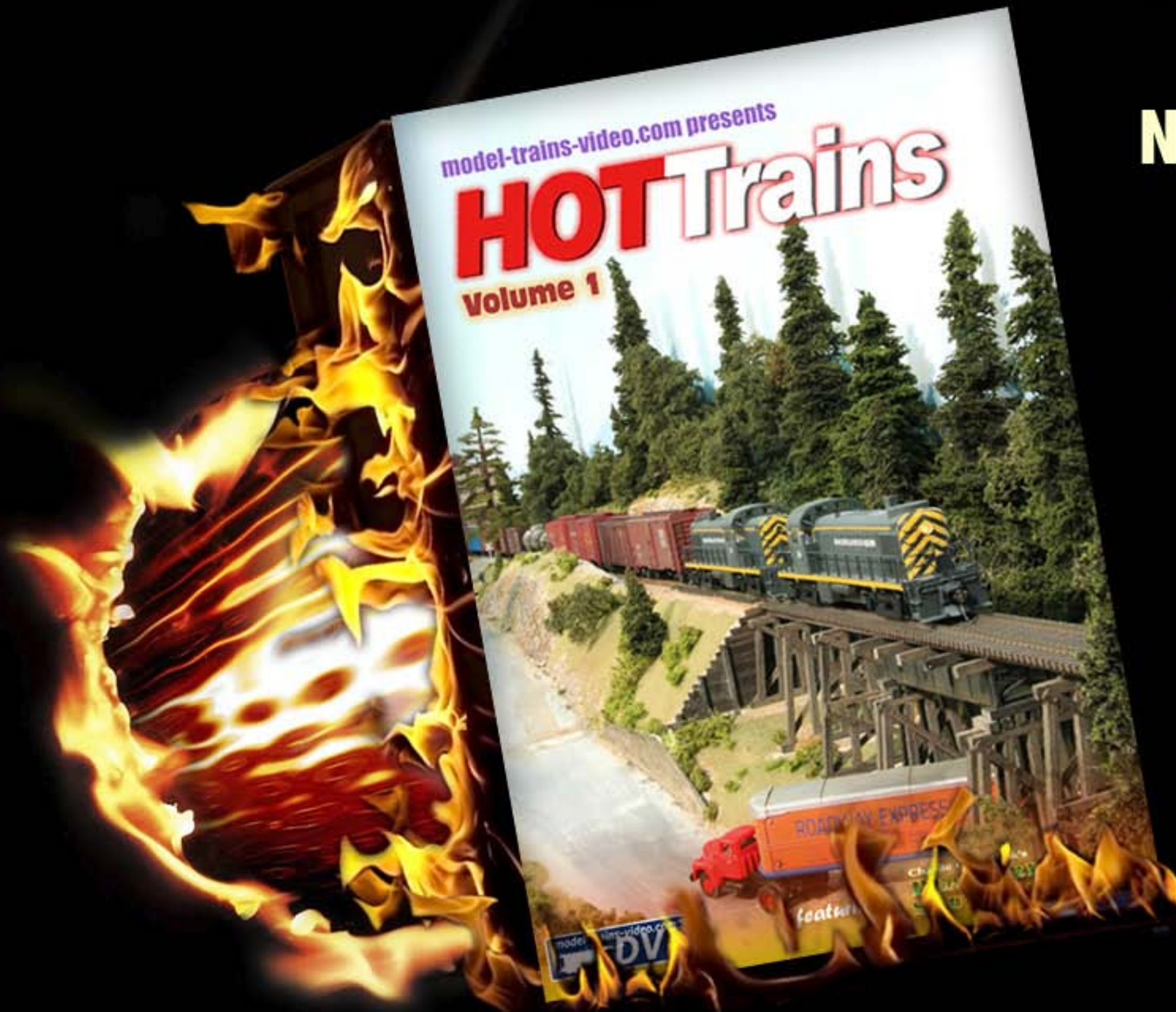

**NEW VIDEO SERIES!**

# Coming this August

## VOLUME 1

### \$29.95

Discounts available to  
MRH subscribers

**A delightful mix of trains  
running through awesome  
scenery and how-to's**



**Do more. Spend less.**

**[model-trains-video.com](http://model-trains-video.com)**



**It's a  
real crime  
when  
you miss  
out on a  
limited  
run  
model ...**



***to the  
rescue!***



**Click here to learn  
how to prevent  
this crime!**

# Main Features

# Table of contents

# Columns



**40** **Return of the Pennsy**  
The Pennsylvania Middle Division,  
restored and expanded  
*by Charlie Comstock and Joe Fugate*



**102** **Modeling Decrepit Spur Tracks**  
Making track look poorly maintained  
*by Charle Comstock*



**50** **Ties and Tie Plates**  
Scenery Scene: one evening project  
*by Charlie Comstock*

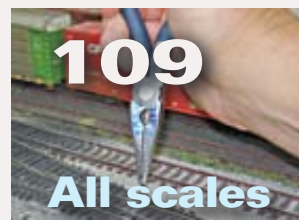

**109** **Custom Spiking Pliers**  
Tool Shed: one evening project  
*by Steve Pirosko*



**54** **Kit Bashing a U18B**  
When the loco you want doesn't  
exist, kit bash it!  
*by Mike Rose*

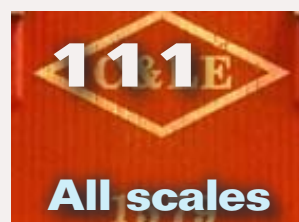

**111** **Rolling Stock Numbering**  
Setting up a prototype based  
scheme for a protolanced railroad  
*by Lew Matt*

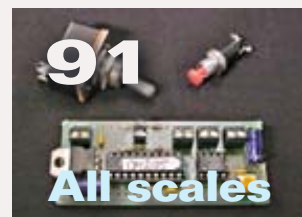

**91** **Layout Sound**  
Using sound to enhance your layout  
*by Matt Snell*



**116** **Product FIRST LOOK**  
New cars from ExactRail  
*by Jeff Shultz*

# Other Features

**12** **A history of 43 years doing the hobby, part 2**

Publisher's Editorial *by Joe Fugate*

**15** **MRH Staff Notes**

Building issues on a bimonthly schedule,  
and more ...

**34** **MRH Q - A - T**

Questions, Answers and Tips

**115** **Derailments**

Humor (perhaps)

**22** **July Model Railroading News**  
MRH News and Events  
*by Richard Bale*

**120** **The Roundhouse**  
My Modular Adventure  
*by Les Halmos*

**135** **Modeling a Creek**  
Up the Creek  
*by Charlie Comstock*

**143** **Eating an Elephant**  
Getting Real  
*by Marty McGuirk*

**148** **Today's Amtrak**  
Comme-N-tary  
*by John Drye*

**154** **Get off the computer**  
Reverse Running  
*by Joe Fugate*

**16** **Bonus downloads this issue!**



# CSX MADE THIS.



# AND SO CAN YOU. [CLICK HERE.](#)



## Digitrax UT4D Duplex Equipped Utility Throttles

### Select, Run and Dispatch

### Without Plugging In!

Shipping Now! The UT4D is the latest in the UT4 series of Digitrax Utility Throttles. Operators from around the world asked for a simple to use, affordable throttle with intuitive operation & rock solid design. Based on operator input, Digitrax created the UT4 throttles.

UT4D is Duplex Equipped to work with the UR92 Duplex Transceiver. It can also be used as a walk around throttle with UP5 or as InfraRed with any Digitrax InfraRed Receiver.

For UT4 & UT4R upgrade information visit [www.digitrax.com/ut4upgrades](http://www.digitrax.com/ut4upgrades)

Digitrax, Inc. 2443 Transmitter Road, Panama City, FL 32404  
Phone 850 872-9890 / Fax 850 872-9557 [www.digitrax.com](http://www.digitrax.com)

**UT4D \$135.00 msrp**



# TELL US WHAT YOU WANT. WE'LL HELP YOU FIND IT.

SPECIALISTS IN HO, O AND N SCALE HARD-TO-FIND ITEMS

BPL Brassworks' sophisticated Want List system "sends up a flare" when a new collection comes in with just what you're looking for, and we send you a "heads up." You won't miss out on the opportunity to add that sought-after item to your own collection. You know what to look for, and we provide crisp, detailed photos to give you confidence in the quality and value of our offerings.

FINE DOMESTIC AND IMPORTED BRASS MODELS FOR  
DISCRIMINATING COLLECTORS AND OPERATORS.

- All major importers and domestic manufacturers
- Newest manufacturer offerings
- Want List system for special requests and hard-to-find items
- One-to-one personal service
- More than 15 years of railroading study and experience
- A boss who's as passionate about brass and trains as you are
- Order confirmations, layaway and prepayment options available

*Make our web site your first stop for the newest offerings.*



2 6 2 - 3 7 5 - 1 1 0 7

CLICK FOR MORE INFO



## About the Publisher



**Joe Fugate** is the featured expert in many [Model-Trains-Video.com](http://Model-Trains-Video.com) videos, and he's also the founder and publisher of **Model Railroad Hobbyist Magazine**.

To learn more about Joe, [click here](#).

## PUBLISHER'S EDITORIAL: A history of 43 years doing the hobby, part 2

Musings from the MRH founder



**Wow, I've spent 43 years in the model railroading hobby as of this year ...**

In 1987 I attended my very first NMRA National Convention, which happened to be in Eugene, Oregon, my "home stomping grounds" since I grew up in southern Oregon. At this convention, I discovered the Layout Design Special Interest Group (LDSIG) and elected to become a member.

I didn't know it then, but joining the LDSIG has turned out to be one of the smartest things I've ever done. The LDSIG's publications gave me

many new insights on how to think about layout design. For instance, the LDSIG published a discussion they had among the members on layout height. As part of the discussion, the SIG interviewed existing layout owners about the heights of their layouts.

Many of the layout owners had built their layouts between 40" - 48" from the floor – but when asked what they would do if starting over, most said they would build higher the next time!



Thanks to the LDSIG discussion in the late 1980s about what makes the most satisfying layout, I went back to my railroading roots and elected to model the Southern Pacific's Siskiyou Line in southern Oregon where I grew up. In hindsight, that was excellent advice because modeling this SP line has made for a deeply satisfying layout.

It's insights like this that lead to the design recommendations I make today – build high and narrow. Aim for benchwork in the elbow to armpit range, to express it ergonomically.

If you drop much below elbow level, you start to get too much of a helicopter view of the trains, and if you go above armpit height, it becomes difficult to reach into the scene to uncouple cars or to do maintenance on the track.

While designing one of my freelanced Northern Railway layout plans, I kept thinking about how to add interchanges to the Tacoma, Washington yard on my plan. I got the idea to add an interchange with the Southern Pacific – even though the SP never made it that far north. I was freelancing, so why not?

The idea of having the SP on my layout got me really excited. And that's when it hit me – if the SP got me that excited by just having it make an "appearance" on my layout, why not just model the SP?

The Layout Design SIG recommends you look back to what first got you

interested in trains, then try to make that your basis for modeling. By doing this, you'll probably have the most passion for the hobby, and you will get the most satisfying and fulfilling layout as a result.

The Southern Pacific's Siskiyou Line ran right by my house when I was growing up in southern Oregon. It captured my attention as a young boy and instilled in me a passion for railroading, mountain style. By going back to these roots and modeling the SP Siskiyou Line, I could rekindle my original passion for railroading every

time I entered the basement!

That turned out to be great wisdom indeed! I am thoroughly satisfied with my choice of prototype, and if starting over would build essentially the same layout modeling the SP in southern Oregon.

I also knew there is a part of me that loves freelancing – in my research of the prototype SP Siskiyou Line, I learned about the Coos Bay, Roseburg, and Eastern that built east out of Coos Bay in the late 1800s. While this line was never completed, it did make it as far as

**Growing up in southern Oregon next to the Southern Pacific Siskiyou Line, captured my attention as a young boy and instilled a passion in me for railroading, mountain style ...**

# Have us add sound to your favorite loco!



the foot of the Oregon Coast mountains before running out of funds.

The SP purchased the line in the early 1900s and then connected it with Eugene by running the line north up the Oregon coast and then over the Coast Range west of Eugene.

I knew Roseburg would be the focal point of my Siskiyou Line, so why not assume the Coos Bay, Roseburg and Eastern actually was built as originally planned? This would give me a way to scratch the freelancing itch, yet keep it entirely plausible!

Later, a good model railroading buddy of mine from Roseburg, Nick Lehrbach, found a 20-some foot long surveyor's linen with the complete route of the Coos Bay, Roseburg, and Eastern laid out on it! Talk about tangible evidence – this is the route that almost was!

I officially started construction of my HO Siskiyou Line on May 1, 1991. We had moved into a new house with a large basement a few months earlier, and because I kept active in the hobby and doodled a lot of track plans in the 1980s, by the time I actually had space for a layout, the track plan came together in just a few months time.

It's hard to believe this layout is now almost 20 years old! I showed the then under-construction Siskiyou Line at the 1994 NMRA National in Portland, Oregon, and I drove the golden spike in 1997, completing the mainline. Shortly thereafter, I started formal monthly operating sessions on the layout.

All in all, it's been a really fun ride, and I have to thank the LDSIG for their

insight and advice – it's helped make the hobby and my layout extremely satisfying for me. For me, it's connecting with other modelers and learning from them that makes the hobby more satisfying – none of this lone-wolf stuff for me.

No longer do my fellow model railroaders need to share my zip code – through the Internet I can count among my circle of the hobby friends anyone on the planet who is online and shares my interests.

That new reality for the hobby, more than anything else that's happened in the last 43 years, has me more pumped than ever about being a model railroading hobbyist! 📧

**... Roseburg would be the focal point of my Siskiyou Line, so why not assume the Coos Bay, Roseburg and Eastern actually was built as originally planned?**

# Serious models for serious modelers



**Detailed  
Z, N, & HO  
Structures**

[www.pawofabear.com](http://www.pawofabear.com)



# LISTEN UP!

SPONSORED BY:  
THE MODEL RAILROAD  
HOBBYIST MAGAZINE

## The Scotty Mason Show

### THE FIRST INTERNET MODEL RAILROADING PODCAST

Get the Latest Model Railroading  
News, Tips, Reviews & Opinions  
From These Knuckleheads.

Scotty Mason

Jimmy Deignan

Dave Frary

Doug Foscale

Available here or on iTunes

[www.modelrailroadpodcast.com](http://www.modelrailroadpodcast.com)

## Notes from the MRH Staff

New stuff, in this issue,  
layout lookout, bonus  
downloads, and more ...



Jul/Aug 2010 continues our bimonthly magazine schedule. Wondering when each new issue is due out? The answer is, the first Monday of each odd numbered month. Our 'threaded' approach to magazine production continues to work for us - editor burnout is being held at bay and we're looking forward to producing many more issues.

### New stuff

This issue marks the debut of Les Halmos' column *My Modular Adventure*. He plans to continue documenting the installation of a turntable and construction of a roundhouse on one of his Free-mo modules. Les builds his modules to high standards of engineering. Modules do get more abuse than a built-in layout so bullet-proof, well-documented construction is a good thing. We're looking forward to lots more great stuff in *My Modular Adventure*.

This issue also debuts a new series of one evening projects - *The Tool Shed*. These quick projects will document custom tooling or jigs for making modeling tasks easier.

### In this issue

The lead story in this issue is [Kitbashing a U18-B](#) by Mike Rose. Mike is well known to those of you who either listen to the Scotty Mason Show podcast or are prototype modelers. This is part one of this article and is packed full of what you need to know to build that unique prototype you've been yearning for.

Matt Snell, author of the Basic Diesel Detailing for Beginners article in Issue 7, presents how he uses [sound to enhance the realism of his layout](#).

### MRH podcasts are here!

Starting with Issue 7, MRH is partnering with Paul Gillette and Ryan Anderson to produce MRH podcasts. These podcasts will feature authors in an issue or other persons of interest. The first set of podcasts feature Paul talking with Lance Mindheim (Modeling the Modern Era), Tim Warris (of Fast Tracks) and Charlie Comstock (of MRH).

The podcasts are available online through iTunes or as separate mp3 files.

MRH has a new presence on these well known web sites:

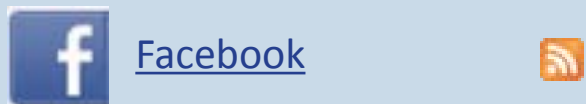

[Facebook](#)



[Twitter](#)



[iTunes \(podcast\)](#)

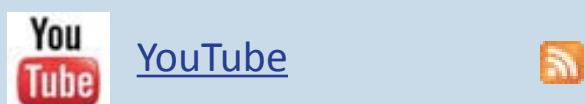

[YouTube](#)

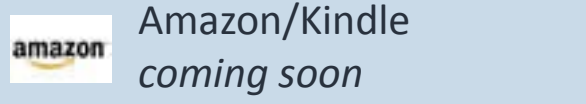

Amazon/Kindle  
*coming soon*

mention of our favorite electronic trains magazine (that would be MRH!) giving our URL and a few words about who and what we are.

We'll collect the entries and do a popular vote. Then the MRH staff will take the top entrants and decide who gets the prizes.

Did I say prizes? How about a \$500 first prize, \$250 second prize, and \$100 third prize.

There will also be honorable mentions for the funniest, the most professional, and what ever other categories we come up with. Honorable mention winners will receive free videos and an official MRH T-shirt.

We'll conduct the contest over the next four months – winners will be announced in the January 2011 issue. Watch for more details on the MRH web site (rules, exact end date, etc.).

### **Know a great layout?**

Do you know of a well executed layout just waiting for a magazine spread? Let us know, we're on the lookout for article-worthy layouts.

The following attributes will improve a layout's chances of appearing in MRH:

- It should have enough good looking scenery for nice close up photos.
- A well thought out trackplan is a definite plus.

### **MRH online expansion**

MRH has been building additional presence in several popular areas of the internet – our goal is to become your *One Stop Source* for online train information! Now you can check us out on Facebook, Twitter, iTunes, and YouTube.

### **YouTube Video Contest**

Attention all you video phreaks out there! Here's a chance to win some bucks to spend on your favorite hobby.

We're still thinking about the exact details but basically, shoot and produce a YouTube video that's pro-model railroading and includes a

## **Issue 8 Premium Extras!**

Free for the first 30 days after issue release  
(After Aug 4, 2010, these extras will no longer be available)

- **model-trains-video Hot Trains series preview**
- **DVD-quality versions of this issue's videos**
- **Special money-saving advertiser coupon codes**



**Click here to access**

- Unusual features - like unique scratch built or kit bashed buildings help make a layout more interesting than one populated with out-of-the-box building kits. Realistic, situation and era appropriate weathering is a plus.
- A friendly environment - good lighting and nicely finished fascia.
- A scale besides HO also improves a layout's chances.
- Not having been in the hobby press already is a bonus.

Know of such a layout? Click [here to suggest a layout for an article](#).

### **Bonus downloads**

Make sure you check out the bonus downloads for this issue. The goodies include:

- DVD quality video of the videos in this issue.
- You can also download the bonus items from previous issues.

Note that the bonus downloads are only good for the first 30 days after an issue release. We provide the bonus materials to encourage early downloading of each issue. If you wait too





Watch our website  
for our monthly  
specials!



**ACCU-LITES, inc**

Your DCC Center!

CLICK TO LEARN MORE:



<http://www.acculites.com>

long to download an issue, you'll miss out – so don't procrastinate!

### Write for us

Now that we're bimonthly, the magazine prints 50% more articles than a quarterly. Those articles need to come from somewhere (we're not going to write all of them ourselves!). We can use more article submissions than ever!

However, acceptance is not guaranteed. The most common reasons for rejecting a submission are poor photography or the article isn't a topic we want to cover in the manner the author has approached it.

If you want to increase your odds that we'll accept your article, first send us a proposal [via this link on our web site](#).

We will respond within a two or three weeks and let you know if your idea is something of interest to MRH. We'll often also provide some guidelines as to approaching an article.

You've already written an article? The following is a checklist to keep in mind when submitting it:

- Include your full name and e-mail address in the article text. You would be surprised how many submissions we get *without* this information!
- Include captions for all photos, diagrams, drawings, tables, and videos as a separate document.

- Include a version of your document that has the images and diagrams in-line in the text if you like, but also give us a text-only version of your article.

- Write a short bio about yourself and your hobby interests. Include a recent photo of yourself.

We prefer Microsoft Word format for documents, we also accept Open Office format. For images, send 2-3 megapixel jpgs around 1800 x 1200 pixels.

If you don't have a copy of Microsoft Word or Office, you can [download a free copy of Open Office here](#). Open Office reads and writes Microsoft Office formatted files.

For drawings or diagrams, contact us and we'll give you some guidance of how to produce them for publication with us.

### One Evening Projects

Never written before? Don't have time to create a War and Peace length article? No problem! Try writing for our series of *One Evening Project* articles. Currently, we have *The Scenery Scene* and *The Tool Shed*. However, we're looking to expand into other areas too, such as track work, electronics, or any other project that takes an evening or afternoon to complete.



## First Looks

Issue 8 resumes our [First Look](#) product presentations, with a trio of Exact Rail models.

First Looks are not reviews – we’re not trying to tell you the good, bad, or ugly about a model. Face it, why would you trust a review of an advertiser’s product in a completely advertising-supported magazine?

Instead *First Looks* are a show and tell about something nifty and new often with some prototype background.

If you’re a vendor and have some new stuff you’d like featured in a MRH First Look article, [contact MRH with what you have in mind](#).

## Meet the MRH Staff

We’re getting ready for the trek to the [NMRA 75th National Convention](#) in Milwaukee, Wisconsin – July 11-18. ] Joe is signed up to give a few clinics and we’ll be looking for news.

MRH parent [Model-Trains-Video](#) will have a booth at the National Train Show in Milwaukee, so stop by and say “Hello!” if you’re in attendance. You might also see our roaming video crew on the show floor doing interviews.

MRH staff will be attending these other shows in force in 2010:

- [NMRA National Convention](#)  
(Milwaukee,WI) - July 11-18, 2010
- [National Narrow Gauge Convention](#)  
(St. Louis, MO) - Sept. 1-4, 2010

- [Craftsman Structure Show](#)  
(Mansfield, MA) - Nov. 10-13, 2010

We’re still looking for local volunteers to help us at the St. Louis Narrow Gauge Convention.

## Promoting MRH

There are too many shows for MRH staff to attend them all in force! We’re looking for volunteers to help promote MRH at these shows.

If you’d be willing to do any (or all) of the following:

- Put flyers and CDs out on the free handouts table.
- Help staff a table.
- Help us get flyers and CDs in the registrant bags (if the event has such things)

If you’re willing to help staff a table, we’ll pay for the table and pay the entry fee for you and any other reliable volunteers you can get to help you at the table.

We’ll also give you an official MRH shirt to wear at the event (yours to keep), and send you promotional materials with guidelines on how to best use them.

Just click here if you’re [interested in helping out at a show!](#)

# Tear Up Our Kit Instructions. Build It Your Way.

You already know a Fos structure kit doesn’t look like anyone else’s. Go one step further and make it your own. Change it. Add to it. Have fun with it.



**FOS** **SCALE MODELS**

Structure Kits  
For Your Model Railroad

Click to  
see more

[www.fosscalemodels.com](http://www.fosscalemodels.com)



# The Model Railcast Show

Keeping you on the **RIGHT TRACK!**



Click here to learn more ...



Ryan & Tim at Hartford 2009

(Show hosts)

# Model Railroad Hobbyist magazine™

Your first choice for

**FREE** on-line model train information!



Do you remember this article?

- by V.S. Roseman  
Photos by the author

### More Realistic Model Windows: Enhancing Model Structures with Photo Windows

**B**uilding a model railroad is much easier today than it was years back. There are more structures than ever before, and while the latest releases include a lot of excellent models, some still have thick heavy window muntins that make the model look toy-like. (Muntins are the supporting strips between panes of glass.)

While wooden window muntins are somewhat thicker than metal ones, generally, some model window muntins are not only overly wide but are also thick. Models for injection molding plastic, or soft metal superlines have to be cut this way to prevent the material to flow or be injected properly.

It is possible to upgrade kits that have oversized window muntins by using photographs of prototype windows to produce a very realistic effect. Using either a color copier or computer it is possible to size the printed windows to fit specific models, and the proportions can even be adjusted.

Generally the best subject windows to be photographed for model use should have high contrast with a dark interior and light window frames or light colored shades with dark window frames. An especially good effect is created when shadows of the window frame grid fall on objects just inside the window, such as light colored window shades, packing crates, machinery

Figure 1: The Williams Redwing feed mill happens to have fine window muntins, but this was the only structure I had for demonstration purposes when I began this project. I liked these windows because they have light shadows on the window shades which create a very three dimensional effect.



No? No problem! [Download Issue 4](#) from our website now!  
Remember, all back-issues of MRH are **FREE!**





# Looking for the key to DCC sound design?

Your Sound Solutions™ are at  
[www.traintekllc.com](http://www.traintekllc.com)



# FINALLY!



"Somebody's  
doing  
laser kits  
in more  
than just  
HO!"

## Rslaserkits

Quality laser cut kits  
structures to rolling stock in Z to O scales



[rslaserkits.com](http://rslaserkits.com)

click to visit our web site ...



**DCC Systems - DCC Decoders  
DCC + Sound Installations**

**Also offering quality  
model trains and model  
railroading accessories in  
HO & N Scale!**



**CLICK HERE  
TO VISIT OUR WEBSITE!**

**[DCCinstalled.com](http://DCCinstalled.com)**

# Model Railroad Hobbyist newsletter™

July 2010



**Reader Feedback**  
(click here)



*The Old Yardmaster*



## The latest model railroad products news and events

Warm weather, family vacations and outdoor chores have a way of pushing model railroading aside this time of the year, but summer evenings are still a good time to plan for the future and see what new products are on the horizon for the coming fall. We begin this mid-summer report with a look at a beautifully handcrafted pilot model of a Northern Pacific W-5 class 2-8-2 Super Mikado to be imported by **3rd Rail Division of Sunset Models** ([www.3rdrail.com](http://www.3rdrail.com)). There were five classes of Mikados on the NP and the W-5s were the biggest, heaviest and baddest of the lot. A scowling front-end was the most notable spotting feature of the class, with a pair of pumps hanging on the smoke box door and an imposing Elesco feedwater heater perched on her brow. Reservations are being taken now for the **O scale** model that will be available for either 2-rail or 3-rail operation.



**A**MS Division of Accucraft ([www.accucraft.com](http://www.accucraft.com)) is taking reservations for both **On3** and **On30 scale** versions of a D&RGW class C-16 2-8-0 locomotive. Although this pilot model is handcrafted in brass, the production version of the popular narrow gauge Consolidation will be a hybrid that combines both metal and plastic components. Available models will include the RGS No. 9 pictured above plus D&RGW numbers 42, 268 and 278 in black, flying Rio Grande as well as bumble bee decorating schemes.



**A**Ikem ([www.geocities.com/bkempins/ASMMain/Main.html](http://www.geocities.com/bkempins/ASMMain/Main.html)) has introduced two laser-cut multimedia kits for specialized valves for super detailing Walthers **HO scale** blast furnace kit. The Gate Valve kit (left at \$29.95) makes seven valves for the cold blast main plus four smaller gate valves that will fit the gas burner pipes. The three larger valves are sized to fit 1/2-inch tube (not included in Walthers kit). The kit for the 72-inch diameter Google Valve (right at \$9.95) fits the stock pipes of the Walthers blast furnace.



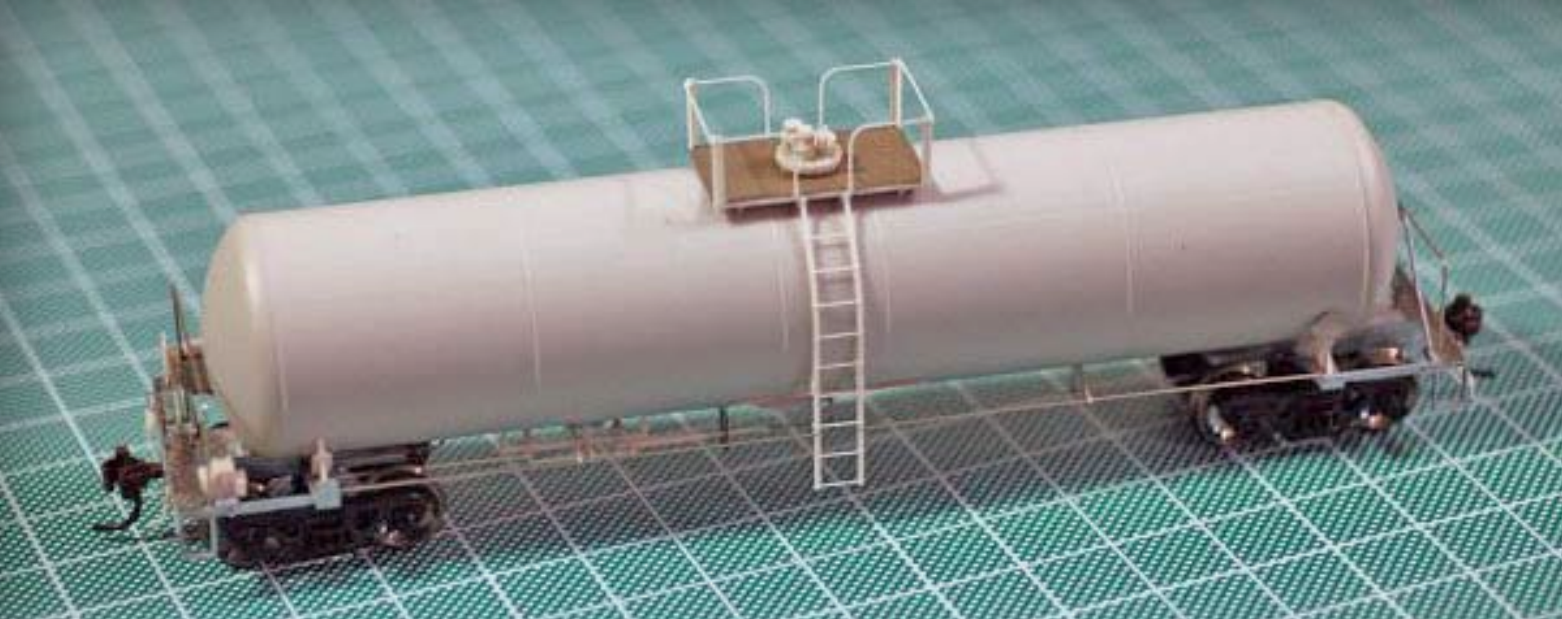

Here's an early look at **Athearn's** ([www.athearn.com](http://www.athearn.com)) forthcoming **HO scale** 50-foot GATC 20,000 gallon type-40 tank car. The prototype was built by General American from the late 1960s through the 70s. Although the version shown here is equipped for acid service, the prototype was adaptable to hauling a variety of liquids including edible oils. Athearn's production schedule has these ready-to-operate models available at dealers in October.

After Athearn shipped its new DCC sound-equipped Norfolk Southern GP15-1 models in early June, it was discovered that the front ditch lights were not functioning properly. The fix is relatively easy and can be found on this [Athearn facebook page](#).

Athearn has scheduled a third release of its **N scale** GATC 2600 34-foot Airslide hopper car for November. The new road names are Chessie/C&O, Delaware & Hudson, GACX-Jack Frost and Southern, plus an undecorated version. The N scale ready to run cars are from tooling completed in early 2009. **N scale** modelers can also look forward to another release of the popular SFRD 50-foot ice reefers decorated with Chief, Super Chief, Grand Canyon Line, and Santa Fe All The Way schemes. The 2006 and 2008 weathered run of these popular cars sold out quickly.

**HO scale** equipment coming from Athearn late this fall include a DCC-ready SW1500 diesel decorated for Burlington Northern (green), Montana Rail Line (blue with white diagonal), Wisconsin Central (orange and vermillion) and Sandersville (white body with red letters and deck belt). Also a DCC-ready SD40-2 for Milwaukee Hiawatha (81-inch nose), C&NW (Zito yellow with 81-inch nose), Conrail Q (88-inch nose) and a CP Rail B-unit with a high 81-inch nose.

**Atlas Model Railroad Company** ([www.atlasrr.com](http://www.atlasrr.com)) will begin distributing Welly brand **HO scale** vehicles late this summer. The introductory lineup will include a 2005 Mustang, a 1972 VW bus and the Mini Cooper seen here. The models are priced at \$5.95 each and come with a pedestal stand and display case.



**Atlas's** new **HO scale** U30C replicates the six-axle, 3000 hp diesel built by General Electric between 1966 and 1976 primarily for assignment on heavy freight and unit train service. Features of the Atlas model, which represents the common "Phase III" post-1970 body style, include Adirondack floating-bolster trucks, directional lighting, golden-white LEDs, marker lights with separate lenses, an optional snowplow, crew figures, and individually-applied windshield wipers, drop steps, handrails, and metal grabs.



Additional details appropriate to the road being modeled include truck bearing caps, nose headlight and non-operating roof-top beacon. Atlas will offer the U30C as a Silver series model with a Dual-Mode® decoder (e-DMD) that allows the locomotive to run on DCC or traditional DC, and in its Gold series with a full-featured QSI® Quantum System. A minimum 22-inch track radius is recommended. Visit Atlas' website for more information.

### Scale Color Key:

Z scale news

N scale news

HO scale news

S scale news

O scale news

G scale news



**B**achmann ([www.bachmanntrains.com](http://www.bachmanntrains.com)) is selling a basic **HO scale** EMD GP30 diesel locomotive at a suggested retail price of \$50. Among the features of this economy-priced ready-to-run locomotive are all-wheel drive, helical-cut gears, dual flywheels, metal grab irons and directional headlights. In addition to the Santa Fe scheme pictured, the model is also available decorated for Union Pacific, Canadian Pacific, Nickel Plate, Great Northern and EMD Demonstrator #1962.

Bachmann has upgraded the latest version of its **On30 scale** DCC equipped Baldwin 4-6-0 steam locomotive with Soundtraxx® Tsunami® technology that generates more than a dozen prototypical steam sound effects including exhaust chuff, bell, dynamo, snifter valve, pop valve, blower sound, Johnson bar, and three different selectable whistles.

**B**anta Modelworks ([www.bantamodelworks.com](http://www.bantamodelworks.com)) is selling craftsman-type kits for Up The Creek Paddle Company in both **HO scale** at \$70 and **O scale** at \$120. Laser-cut components include the signs and paddles. The model has a scale footprint of 30-feet deep by 32-feet wide.



**B**ar Mills has developed a rough-cut look to the lumber for its latest **HO scale**

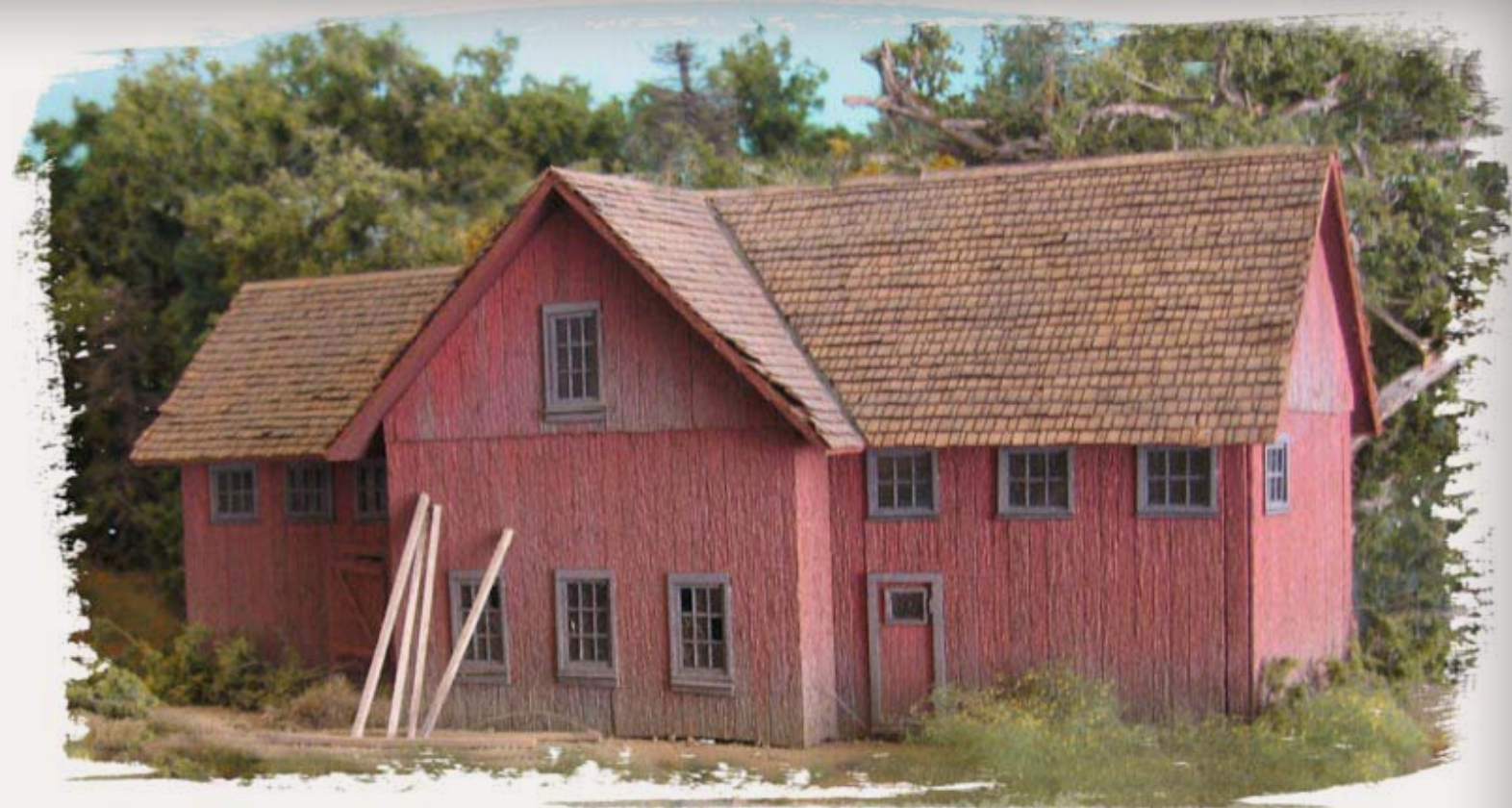

laser-cut structure kit. Identified as “The Barn on Rt.20,” the new craftsman style kit features specially-milled wood with one side unsanded. The board-on-board construction gives the modeler the option to randomly omit or heavily distress individual boards. Additional laser-cut components include windows, doors, shingle strips and interior framing. The finished structure is 9-inches wide by 3.5-inches deep. The kit is available direct from Bar Mills at [www.barmillsmodels.com](http://www.barmillsmodels.com).

**C**raig Martyn of **BLMA** ([www.blmamodels.com](http://www.blmamodels.com)) shows a pilot model of an **HO scale** 200-foot bridge scheduled for release late this year. The brass model replicates a prototype steel thru-truss with a curved upper chord. In other product news, Craig reports that BLMA will be expanding its selection of HO scale signals with the addition of right-hand versions of its modern dual-head signal.

**H**ere’s a preview of a Southern Pacific version of **Bowser’s** ([www.bowser-trains.com](http://www.bowser-trains.com)) new **HO scale** Baldwin VO-1000 diesel switching locomotive equipped with non-working trolley poles (next page).







SP and Pacific Electric prototypes needed the poles to activate signals while operating on PE tracks. Additional road names on the initial release are US Steel/USS, P&BR/ Bethlehem Steel, Western Pacific, Lehigh Valley, and Great Northern. The model represents the post-1941 prototype with a rectangular radiator front. Other details on Bowser's Executive Line model include MU and air hoses, brass windshield wipers, separate grab irons, coupler lift bars, operating headlight, window glass, can-motor, flywheel, nickel-silver RP25 wheels and knuckle couplers. The ready-to-run locomotive will be available DCC-ready with the standard NMRA 8-pin plug at \$150 or with DCC and SoundTraxx (Tsunami) sound at \$260. The SP and PE trolley pole models are priced at \$170 and \$280.

**Broadway Limited Imports** ([www.broadway-limited.com](http://www.broadway-limited.com)) is scheduled to release the production version of this New York Central J3 class 4-6-4 Hudson before the end of July. The **HO scale** model replicates the famous steam locomotive industrial stylist Henry Dryfuss designed to head NYC's 1938 edition of the prestigious 20th Century Limited. The brass-hybrid model will feature BLI's Paragon2 sound and control system that includes a factory installed DCC decoder for dual mode DC and DCC operation. Construction of the hybrid model includes brass locomotive and tender bodies mounted on die-cast metal chassis.



**Digital Fox** ([www.digitalfox.com](http://www.digitalfox.com)) has this Ontario & Western 55-ton twin-bay hopper available in six road numbers and six different OW lettering styles covering the 1920 to 1945 life of the cars. The limited edition **HO scale** model is based on an Accurail injection molded model.



**New HO scale** items from **Custom Traxx** ([www.customtraxx.com](http://www.customtraxx.com)) include a decal set for Illinois Terminal orange interurban cars. The set contains black letterboard lettering, four different styles of ITS and ITC heralds, and several individual car names such as Lincoln, Cerro, Gordo and Urbana.

**This** imported brass Norfolk & Western class BEj baggage/express car is available in **HO scale** now from **Division Point**. Future cars in the N&W heavyweight series include class Bpd combination baggage/coach with clearstory roof, class PG coach in both clearstory and round roof versions, class De diner, and three versions of class XO business cars. Visit [www.divisionpoint.com](http://www.divisionpoint.com) for complete details including ordering information.



Reservations are being taken for a limited re-run of this massive Australian New South Wales Railroad AD60 class 4-8-4+4-8-4 Beyer-Garratt steam locomotive. The ready-to-run **HO scale** model has NMRA profile wheels and knuckle couplers and is available in standard livery or factory weathered as



pictured here. The model is crafted from a combination of brass, plastic, and die-cast metal components. It has dual motors and can be ordered DCC-ready or with DCC installed and QSI sound. The model is available in North America from **International Hobbies** ([www.interhobmodels.com](http://www.interhobmodels.com)) located in Auburn, CA. Overseas customers can order the model direct from the importer, **Eureka Models of Australia** ([www.eurekamodels.com.au](http://www.eurekamodels.com.au)).

Late last month **ExactRail** announced the immediate availability of reruns for two cars, including the second run of road names for its **HO scale** Evans 4780 3-bay covered hopper cars. In addition to the Daykin Farmers Coop car shown



above, other new road names include USLX, Juniata, ADM (yellow), ADM (gray), Armstrong/USLX and Peninsula Terminal.

The second car released was the Trinity 50-foot HyCube in three new road numbers in the brilliant red Southern Railway of British Columbia scheme with

Catalyst logo. Both of the rerun cars are in ExactRail's Evolution series. Although the factory may already be sold out, visit ExactRail's web site at [www.exactrail.com](http://www.exactrail.com) for a list of participating dealers who may still have stock available.



In other news from **ExactRail**, assembly instructions are now available for the undecorated **HO scale** Evans 4780 covered hopper kit. Even if you don't have a kit to assemble, a look at the instructions and close-up photos of the individual components that go into the ExactRail kit will give you a new appreciation for the engineering skill required to develop such state-of-the-art models. The free 36-page guide can be downloaded by visiting [www.exactrail.com](http://www.exactrail.com).

**Funaro & Camerlengo** ([www.fandckits.com](http://www.fandckits.com)) has an **HO scale** resin kit for a Pennsylvania Railroad class FM flat car with type DD1A containers. The kit (less trucks and couplers) includes the car body, containers, and appropriate decals. It is sold direct only at \$50.





**Kato USA** ([www.katousa.com](http://www.katousa.com)) is planning to deliver **N scale** versions of EMDs F40PH Amtrak Phase III locomotives in October. The models will feature directional golden-white LED headlights, illuminated preprinted number boards, a five-pole motor, all-wheel electrical pickup, blackened wheels, and Kato body-mounted magnetic couplers. An optional snowplow pilot will be included, which can ease operation on layouts with tight-radius curves. The locomotives will be DCC-ready for either Train Control Systems KOD8-C or Digitrax DN163K0D. Available road numbers are 376, 379 and 346. Engine 375 shown above is from a previous run.

**A**fter nearly a year of frustration, **Frenchman River Model Works** has cancelled plans to develop an **HO scale** kit for a 169-foot steel barge and two-track station float. Although a number of masters were built and various production methods tested, it was determined that a suitable product with consistent quality was not possible, and all further efforts to develop the kit have been dropped. Meanwhile, work continues on developing masters for a series of GMA steel and wood barges. The Nebraska-based company has restructured its sales policy and will no longer market through distributors. All sales are now direct at [www.Frenchmanriver.com](http://www.Frenchmanriver.com).

**I**nterMountain Railway Company ([www.imrcmodels.com](http://www.imrcmodels.com)) is quoting an August delivery date for a series of **HO scale** cylindrical covered hoppers. Decorating schemes scheduled for this run are Canada-CNWX, Pillsbury, Canadian National, Koppel, GACX, ATSF, Logimex-AAMX, and Trona Chemicals. Also coming late this summer are HO scale Santa Fe stock cars decorated for four different ATSF classes including SK-R (1938-43), SK-U and SK-S (1945-55) and SK-T (post 1962). IMRC locomotive projects due to arrive around the end of the year include both **N scale** and **HO scale** FP7A and F7B diesel units decorated for Canadian Pacific (grey/maroon with script), Frisco (black body), SOO Line (maroon body) and C&NW.

**T**hree new **HO scale** freight cars due from **Kadee** ([www.kadee.com](http://www.kadee.com)) next month include a 1959-era SOO Line 40-foot boxcar with an 8-foot door and a similar 40-foot Frisco-SLSF boxcar featuring the bold *Ship on the Frisco* slogan. Both cars come with Kadee's new two-piece self-centering trucks. Also due in August is a Great Northern 50-foot boxcar with a functioning cushion underframe. The GN car will have a glacier-green paint scheme with a red 10-foot door.



**N**ew **HO** and **N scale** decal sets under development by **Microscale** ([www.microscale.com](http://www.microscale.com)) include Milwaukee covered hoppers and steel cabooses, New Haven flat cars and trailers, and PFE mechanical reefers (a replacement for set 87-17). The company will soon release an online PDF catalog that displays all new decal sets issued throughout 2009. A convenient option allows users to download individual sheets or the entire catalog. New releases made during 2010 are being compiled for release at the end of the year.

Although not a new product, we'd like to point out that in addition to decals, Microscale sells a colorful selection of metal signs displaying authentic railroad heralds. Sizes vary by road name but they are roughly in the 8x8-inch range. The above web site shows the full selection.

**M**icro-Trains Line ([www.micro-trains.com](http://www.micro-trains.com)) is cutting tooling and finalizing road names for an **N scale** PS2 high-side 3-bay covered hopper. Features will include separate bay hatches and a photo-etched metal roof walk. No specifics yet on a release date, but they should arrive before the end of the year.

**N. J. International** ([www.njinternational.com](http://www.njinternational.com)) has a new **N scale** fuel tank facility. The plastic injection molded kit features a loading platform, a small office, and a pair of vertically mounted fuel tanks positioned within a spill containment area. The kit is priced at \$25 and when completed occupies a foot print of 3.5 x 9-inches.

This familiar DPM HO scale structure has been given a different look using a laser-cut façade modification kit from Paw Of A Bear ([www.pawofabear.com](http://www.pawofabear.com)). The upgrade kit includes a replacement cornice, new storefront window, and front door arrangement and new upper windows as well as scale doorknobs, window glazing, curtains, window blinds, and instructions.



PBL ([www.p-b-l.com](http://www.p-b-l.com)) has released this Sn3 scale D&RGW class 5500 stock car in eleven different versions, each with twelve different road numbers and in three different shades of paint. Each version of the car replicates a specific prototype or a prototype photo. The injection-molded, ready-to-run cars have complete underbody detail, Kadee couplers, and PBL's own coined nickel-plated, ribbed-back "Griffin Denver" wheelsets. The cars require a minimum 26-inch radius for reliable operation.



Regarding another PBL project, we've learned that delivery of the class C-60-3 three-truck Shays including the narrow gauge New Mexico Lumber Co. #7, Swayne Lumber #2 and #6, and West Side Lumber Co #12 grinders has been rescheduled to spring 2011. Also delayed are the standard gauge Shays of the Eagle Lake

Spruce Mills Company and Klickatat Log & Lumber Company. See Model Railroad Hobbyist, May 2009, page 5 for details on this Shay project.



Precision Scale Company expects delivery this summer on a series of HO scale Rock Island class K-67b/K-68B 2-8-2 steam locomotives. Pictured here is the handcrafted brass pilot model of Rock Island No. 2693 class 68b with Worthington feedwater heater, front-end throttle, Mars light, booster engine, and 14,000 gallon rebuilt oil-tender. You can reserve through your favorite dealer or visit [www.precisionscaleco.com](http://www.precisionscaleco.com).



Rapido Trains' ([www.rapidotrains.com](http://www.rapidotrains.com)) overseas factory is scheduled to begin production this month on the first run of HO scale LRC Amtrak and VIA Rail Canada coaches and club cars. Delivery to dealers is expected in late fall or early winter. Built by Bombardier, the LRC (Light, Rapid, Comfortable) cars were operated by Amtrak in the Northeast and Midwest between 1980 and 1982. Today, LRCs comprise the backbone of VIA's fast services in central Canada. With reference to the striking appearance of the VIA cars, Rapido's Bill Schneider said, "Wait until you see the Star Trek shuttlecraft, that is, the LRC locomotive!" I'm sure Bill meant it in a good way when he added, "It sounds like an Alco, even if it looks like it was smacked with a shovel."

Railroad Model Craftsman's book department has released RSCRATCHBUILDING FOR MODEL RAILROADERS by Bob Walker, one of the magazines most popular columnists. Walker is a thoroughly experienced model

builder and offers helpful advice and techniques in a comfortable, easy to follow manner. The book is priced at \$19.95 and may be ordered on line at [www.carstens-publications.com](http://www.carstens-publications.com).

**S**an Juan Car Company ([www.sanjuancarco.com](http://www.sanjuancarco.com)) says it intends to meet its promise of a September intro date for its highly-anticipated **HOn3 scale** passenger cars. Tooling has been completed in-house for the draft gear, steps, roof vents, platform, end railings, exterior fascia, chimney, two different needle beams, several small detail parts, and four different styles of clearstory windows. Next on the tool maker's agenda is the brake rigging which will be a combination of molded Celcon and formed wire. Meanwhile, tooling for the one-piece interior that includes the walls, stove, and seats, is being prepared at the factory in China.

**R**usty Stumps Scale Models ([www.rustystumps.com](http://www.rustystumps.com)) has released M. Chambers – Merchantile Store, the sixth and final model in the Kelley's Landing series of **HO scale** craftsman kits. The main brick structure is composed of four resin castings plus a wood lean-to on one side. Roofing material includes raised-seam metal for the large building and tarpaper on the lean-to. The completed model has a footprint of 6.25-inches x 8-inches wide by 3.75 tall. The kit is priced at \$94.95 plus shipping and handling.



**A**fter a series of delays, it looks like the **O scale** SDP45s from **Union Terminal Imports** ([www.union-terminal-imports.com](http://www.union-terminal-imports.com)) will be ready late this month. The delays are the result of UTI officials keeping the pressure on the Korean builder, Boo Rim Precision, to fine-tune the O scale models until they are

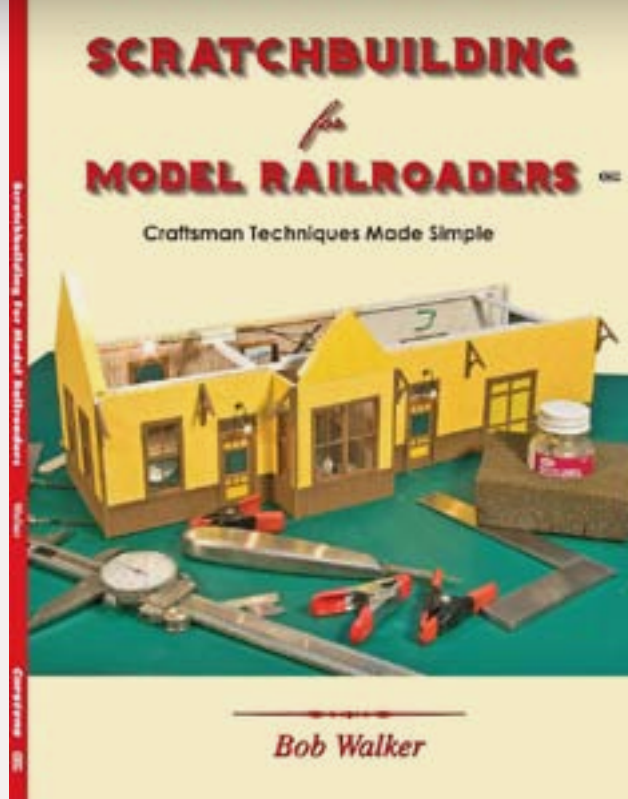

nothing less than perfect. The pre-production sample shown here looked pretty good to us, and the dealers we've talked to say the final results will be well worth the wait.



**H**ere are before and after photos of a basic **HO scale** Atlas signal tower that has been significantly modified using an upgrade kit available from **Vector Cut** ([www.vectorcut.com](http://www.vectorcut.com)). Laser-cut components in the kit include a new roof, shingles, staircase, door, windows and glazing, window trim and an interior switch lever rack. The upgrade kit is priced at under \$40 and does not include the basic Atlas structure.

**W**althers ([www.walthers.com](http://www.walthers.com)) is working on both **N** and **HO scale** versions of the Sieco-built (Southern Iron & Equipment Company) 50-foot pulpwood bulkhead flatcar shown on the next page. It will be decorated for CSX, NS, MEC and Southern, as seen here. The N scale model, which should be ready by August, will have Accumate knuckle-type couplers, and be priced at \$15. The



HO edition is from Walthers upscale Platinum Line and will feature separate factory-installed grab irons, correctly sloped deck, Proto MAX™ metal knuckle couplers and metal RP-25 wheels. The HO edition is expected this fall. Arriving at about the same time is an HO scale 53-foot 3-unit well-car based on a popular prototype built in Hamilton, Ontario, by National Steel Car. The Walthers ready-to-run model will combine a die-cast metal body with appropriate plastic details.

**Smokey Mountain Model Works** has a new resin kit for Southern Railway “Silverside” gondolas. The **HO scale** kit features a one-piece urethane body with separate underframe and detail parts including interior bracing, Tichy truck side frames, ladders, grabs and steps, Kadee 36-inch wheelsets, and #148 whisker couplers. Stock number #87-G1 comes with vermilion decals while #87-G2 has green decals. The kits are priced at \$42 each plus \$7 shipping. For ordering details go to <http://smokymountainmodelworks.com>.

**SoundTraxx** ([www.soundtraxx.com](http://www.soundtraxx.com)) has three new Baldwin sounds for their Tsunami® TSU-1000 DCC Sound Decoder: the Baldwin VO, 608NA (non-turbo) and 608A (turbo) prime movers. The Baldwin VO diesel sound decoder is recommended for installation in models representing Baldwin prototypes such as the VO1000, VO660, and DR-6-4-2000. The Baldwin 608NA diesel sound decoder is recommended for installation in models representing Baldwin prototypes such as the D4-4-1000, DTS6-6-2000, and DR-6-4-2000. The Baldwin 608A diesel sound decoder is recommended for installation in models representing Baldwin Prototypes such as the AS-16, AS-416, AS-616, DR-4-4-1500 “Sharknose”, DR-4-4-1500 “Babyface”, DR-6-4-1500, RF-16 “Sharknose”, DRS-6-4-1500, DRS-4-4-1500, and DRS-6-6-1500.

Horns included in these decoders: Wabvo A2, E2; Leslie A125, A200, S2M, S3L, S5T; Nathan K3L, M3, M5, P3, P5 (Early); Holden M3H, K5H and Hancock 4700 Air Whistle.

**Blackstone Models** ([www.blackstonemodels.com](http://www.blackstonemodels.com)) has released their ready-to-run **HOn3** D&RGW Economy Door Boxcars. These boxcars represent the cars after they were rebuilt between 1923 and 1926. D&RGW standard specifications and remaining prototypes were used to



create this collection of cars, sometimes also called “Plain Door” box cars. The models feature accurately placed and scaled hardware, brake rigging, underbody detailing, and fine nut and bolt applications. Construction features include high-quality diecast metal and injection-molded plastic, free-rolling arch bar freight trucks and Kadee® no. 714 couplers. The cars are available in either non-weathered versions for \$54.95 and weathered versions for \$59.95.

Blackstone also has their ready to run D&RGW Class 5 Long Cabooses in **HOn3**, factory painted and lettered for multiple road numbers and heralds. This model represents the version rebuilt between 1912 and 1923. The model includes molded detail variations such as ladder dimensions, window moldings, awnings, cupola grab irons, and a detailing kit - giving each caboose road number a unique and prototypical appearance. Each car features accurately placed and scaled hardware, individual wire grab irons, brake rigging and underbody detailing, and fine nut and bolt detail. The model uses high quality diecast metal and injection-molded plastic construction, free-rolling arch bar caboose trucks equipped with electrical rail pickups, and Kadee® no. 714 couplers.

## SoundTraxx Sound Samples (click to play)



## INDUSTRY NEWS

**Belington, West Virginia:** B.T.S., a manufacturer, importer and publisher of model railroad supplies has purchased Babbitt Railway Supply. The acquisition includes the tooling, fixtures, inventory and rights to manufacturer the Babbitt line of six O scale kits for steam locomotives that feature cast bronze boilers, NWSL gearing, cast aluminum or sheet brass tenders, and brass and white metal details. Gordon Varney began the line shortly after WWII with the introduction of an O scale 4-6-0 steam locomotive kit. General Models Corporation purchased the line from Varney and added more locomotives before selling it to All Nation. The steam locomotive portion of the line was later sold to George Sennhauser of Babbitt, Minnesota, who renamed the brand and added a 4-8-2 to the catalog. Boyce Yates acquired the company in 1993 and expanded it to the present selection of six locomotives. B.T.S. owner Bill Wade plans to rejuvenate the Babbitt line and add the full assortment of products to the B.T.S. on-line catalog.

**Dummerston, Vermont:** Banta Modelworks has put the S scale portion of its extensive line of structure kits up for sale. Interested parties (serious inquires only please) should contact Bill Banta at 802-258-3869.

**Montoursville, Pennsylvania:** Friends and family celebrated the 90th birthday of Shirlee English who, with her 92 year old husband Lew (left), own Bowser Manufacturing. Known originally as English's Model Railroad Supply, the business name was changed following the 1961



purchase of Bowser of Riverside. Other model railroad businesses the English family has acquired over the years include Penn Line Company, Pittman Motors, Pennsylvania Scale Models, Selley Finishing Touches, Cal Scale, Cary Locomotive Works, Arbour Models, Stewart Hobbies and tooling for Varney HO locomotives. Although their son Lee, now manages the business, the two elders still report for work daily at the family enterprise.

**Provo, Utah:** Actor and long-time model railroader Gary Coleman passed away May 28 from a brain hemorrhage following an accidental fall. He was 42 years old. Coleman was best known for his work during the 1970s and 1980s on the hit TV

show Diff'rent Strokes in which he starred, eventually earning up to \$100,000 per episode. He was an avid model train enthusiast and was a regular at many west coast train meets and conventions. Several years ago he was featured on the cover of Railroad Model Craftsman magazine. Coleman enjoyed hanging out at hobby stores and for a time worked at Caboose Hobbies in Denver. Born in Zion, Illinois, Coleman's diminutive size was the result of congenital kidney disease.

**Philadelphia, Pennsylvania:** Bernie Paul, a pioneer in the model railroad hobby industry, passed away here on June 19. He had been suffering from poor health for the past year. Mr. Paul was best known for establishing Associated Hobby Manufacturing (AHM) and International Hobby Corporation (IHC). Both firms specialized in importing AHM and IHC branded products from various overseas sources including Rivarossi, Mehano and Roco. IHC, established in the mid-1980s following the bankruptcy of AHM, has been inactive in recent months.

**Victor, Montana:** Precision Scale Company (PSC) Inc., an importer of brass locomotives and rolling stock and a major supplier of detail parts to hobbyists and overseas manufacturers of brass models, has expanded its selection of superdetailing parts with the purchase of the tools, masters and inventory of PIA/PFM (Precision Investment Associates/Pacific Fast Mail). PSC owner Mark Mogensen said the new items have been identified and blended into PSC's existing line of parts, however, customers may also order under the old PIA numbering system. For more information visit [www.precisionscaleco.com](http://www.precisionscaleco.com).

**Long Beach, California:** Recording star and train enthusiast Stevie Wonder visited the Woodland Scenics exhibit booth during the Worlds Greatest Hobby Show. Happily posing with Stevie are Woodland Scenics factory representatives Lenzie and Jackie who demonstrated products during the show held recently at the Long Beach Convention Center.



**Milwaukee, Wisconsin:** Michael Stephens has been named vice president of proprietary products at Wm. K. Walthers, Inc. Stephens has a long history in the model railroad business, beginning at the age of 14 while working for a family-owned model train importing business. He later served as vice president of marketing with Kalmbach Publishing before moving to the west coast as president of Athearn Trains. He was most recently with Silvergate Distributors located in San Diego. Walthers president Phil Walthers said that Michael will provide strategic direction for Walthers marketing and brand managers in product selection and development. ■



## About our news and events editor



**Richard Bale** writes our news column under the byline of *The Old Yardmaster*. He has been writing about the model railroad trade for various hobby publications since the 1960s.

He enjoys building models, particularly structures, some of which appeared in the June 2006 issue of *Model Railroader* magazine



### Send us your product announcements!

If you are a hobby manufacturer with a product you want to announce, just [click here](#) and submit your announcement to us

## Briefly noted at press time...

... A change in policy by one of China's largest contract manufacturers of branded model railroad equipment has consumers in America worried about the future availability of new products. The concern was triggered in late June when Sanda Kan Industries sent letters to all but its largest customers stating that it would complete all current commitments but no new orders would be accepted. The new policy of focusing on a handful of high-volume customers is seen as an attempt by Sanda Kan to end the company's history of production delays.

The termination letter was apparently sent to more than 50 companies worldwide including such American firms as BLMA, Bowser, American Models, S-Helper, Des Plaines Hobbies/Centralia Shops, Micro-Trains and Weaver.

Frustrated by Sanda Kan's chronic delivery problems, some American companies have already turned to other companies including Affa Industries, Regal Way, Creative Master, the newly-established Maytex-Rapido, and other Chinese sources for tooling, branded products, and finishing services.

Sanda Kan is owned by Kader Industries which also controls Bachmann. In addition to supplying products branded for Bachmann and Williams, Kader's customer list includes Aristo-Craft, Branchline, Lilliput, Tenshodo and Woodland Scenics.

The Chinese government's recent decision to allow the yuan to rise in value, particularly against the US

dollar, will likely cause prices to climb, but for model railroaders, some of that increase may be offset as new manufacturers compete for a share of Sanda Kan's former business. ■

### DISCLAIMER

The opinions expressed in this column are those of the writer and do not necessarily reflect the opinion of Model Railroad Hobbyist or its sponsors. Every effort is made to provide our readers with accurate and responsible news and information, however, neither Model Railroad Hobbyist or the writer of this column can be held responsible for any inaccuracies or typographical errors that may inadvertently appear in this publication.



We try to make it easy for you to leave us feedback. Please click the button above and tell us how we're doing: good, bad, or otherwise.



When you see this symbol, it means:

**"Click here to learn more!"**

Every click tells advertisers an ad in MRH is a wise investment ...

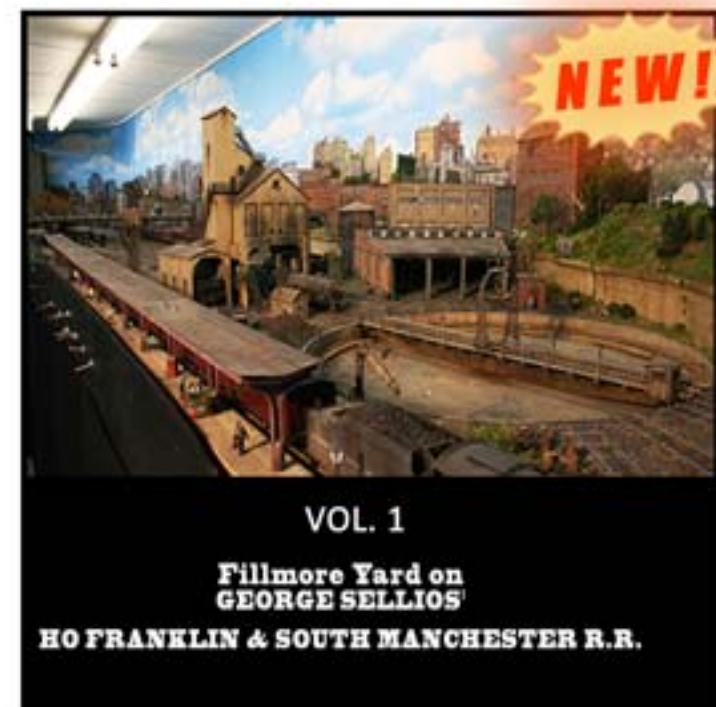

**\$20\*** Only 36 cents per photo!

## Photos of George Sellios' Franklin & South Manchester

- Never-before photographed Fillmore Yard
- Over 50 large high-quality digital photographs

click this button to ...

**Download Photos**

**Instant download!**

*\*NOTE: George is generously donating a portion of the proceeds from each collection sold to help keep MRH forever free! Thanks, George!*





## Selected Events

### July 2010

MINNESOTA, DULUTH, July 21-24, Annual Convention of National Association of S Gaugers, Duluth Entertainment and Convention Center, 350 Harbor Drive. Info at [www.nasg2010.com](http://www.nasg2010.com).

WISCONSIN, MILWAUKEE, July 11-18, NMRA 75th Anniversary National Convention, Hilton Milwaukee City Center. Info at [www.nmra75.org](http://www.nmra75.org).

WISCONSIN, MILWAUKEE, July 16-18, National Train Show, Midwest Airlines Center, 400 W. Wisconsin Avenue. [www.nationaltrainshow.org](http://www.nationaltrainshow.org).

### August 2010

CALIFORNIA, BUENA PARK, August 1, California Express Railroad & Transportation Show (RR memorabilia swap meet), UFCW Hall, 8550 Stanton.

GEORGIA, MARIETTA, August 10, NMRA Piedmont Division Meet at Elks Lodge, 1775 Montreal Road. Info at [www.piedmont-div.org](http://www.piedmont-div.org).

KANSAS, LENEXA, August 7, NMRA-MCoR Turkey Creek Division Annual Train Meet, Lenexa Community Center.

OREGON, SALEM, August 20-21, Rails by the River RPM meet. For more info, see: [railsbytheriver.com](http://railsbytheriver.com).

PENNSYLVANIA, ROBESONIA (Reading), August 13-14, Greater Reading Narrow Gauge Meet, Trinity Lutheran Church, 108 S Robeson Street. Info at [www.nateslightironhobbies.com/narrowgaugemeet.htm](http://www.nateslightironhobbies.com/narrowgaugemeet.htm).

### Future 2010

CALIFORNIA, SAN DIEGO, September 15-19, NMRA-PSR Convention, Handlery Hotel, Hotel Circle North. Info at [www.sandiegodivision.org](http://www.sandiegodivision.org).

CALIFORNIA, SAN LUIS OBISPO, Oct 7-11, Central Coast Railroad Festival includes self-guided tour of various layouts. Info at <http://ccrrf.com/> or contact Bob Chaparro at [thecitrusbelt@yahoo.com](mailto:thecitrusbelt@yahoo.com).

CONNECTICUT, ORANGE (New Haven), Oct 10, Annual Model Train Show (includes N, HO and G operating layouts), New Haven & Derby Model Railroad Club in affiliation with the Orange Historical Society, High Plains Community Center. Details at [www.newhaven-derbymodelrailroadclub.org](http://www.newhaven-derbymodelrailroadclub.org).

ILLINOIS, NAPERVILLE, October 21-24, Naperville RPM Meet, Holiday Inn Select, 1801 North Naper Blvd. Info at [www.ppw-aline.com/rpm-naperville.htm](http://www.ppw-aline.com/rpm-naperville.htm).

KANSAS, BENTON, November 6-7, Mid-Continent Prototype Modelers Meet at Benton Lions Community Center, 150 S. Main Street. Info at [www.midcontinentprototypemodelers.org](http://www.midcontinentprototypemodelers.org).

MARYLAND, ELLICOTT CITY, Sept 2-5, 2010 Steel Mill Modelers Meet, Turf Valley Hotel. Info at [www.peachcreekshops.com](http://www.peachcreekshops.com).

MASS., MANSFIELD, Nov 10-14, Craftsman Structure Show, Mansfield Holiday Inn. Info at [www.css2010.com](http://www.css2010.com).

MISSOURI, ST LOUIS, September 1-4, 30th National Narrow Gauge Convention, St Charles Convention Center. Details at [www.30ngconvention.org](http://www.30ngconvention.org).

NORTH CAROLINA, PISGAH Forest (near Brevard), October 8-9, Narrow Trak 2010, Transylvania County Recreation Center, hosted by Frank Pearsall.

VERMONT, BURLINGTON, September 9-12, NMRA Northeastern Region Convention, Sheraton Burlington Hotel & Conference Center.

WISCONSIN, MILWAUKEE, November 13-14, Trainfest, Wisconsin Exposition Center at State Fair Park. Details at [www.trainfest.com](http://www.trainfest.com).

### Future 2011

CALIFORNIA, MONROVIA, February 17-19, Sn3 Symposium, Double Tree Hotel, 924 W. Huntington Drive. Info at [www.sn3-2011.com](http://www.sn3-2011.com).

CALIFORNIA, SACRAMENTO, July 3-9, Combined conventions of NMRA National and National Association of S Gaugers, Sheraton Grand Hotel. Info at [www.x2011west.org](http://www.x2011west.org).

CALIFORNIA, SACRAMENTO, July 7-9, National Train Show, Sacramento Convention Center.

MASSACHUSETTS, AMHERST, January 29-30, 2011, Amherst Railroad Society Annual Hobby Show, Eastern States Exposition Fairgrounds, West Springfield.

NORTH CAROLINA, HICKORY, September 7-10, 2011, National Narrow Gauge Convention. ■



# MRH

## Questions, Answers and Tips



### QUESTIONS AND ANSWERS

**Q: I've started using an electrostatic grass applicator. The grass looks really good, but I need to apply grass in an area much smaller than the applicator. Are there applicators available with a 1" diameter head?**

**Figure 1: A Noch GrassMaster with a paper aperture reducer installed in the business end.**



**A:** I agree that static grass looks great! Instead of buying or making another static grass applicator (see [MRH Issue 6 - Static Grass Applicators](#)), try cutting a disc of paper to fit inside the head of the applicator you have. Cut a hole in the paper the proper size for your needs (figure 1).

— **Charlie Comstock**

**Q: I hear people talking about spur tracks and sidings. I'm a little confused, aren't these just different names for the same kind of track. If not, what's the difference?**

**A:** I don't know that there is any official difference between the two names and they are occasionally used interchangeably, but in common usage a siding has a switch at each

end connecting it to the mainline - for non-industry tracks these are commonly referred to as "passing sidings," as their purpose is to allow one train to pass by another.

Similarly, what is commonly referred to as a spur track only has one switch connecting it to the mainline - it dead ends at the other end.

— **Jeff Shultz**

**Q: I have a 10 year old son. We want to start building a layout but when we went to the hobby store we couldn't decide what size equipment we should use. Is there a best scale for us?**

**A:** Children under 10 often have difficulty handling small objects. Remember the big, thick pencil you first wrote with in kindergarten or first grade?

HO (1:87) and larger (S, O, G) are quite appropriate for a 10 year old. Additionally, as your son grows, those trains and the railroad can grow with him.

Once a child is 12-14, N scale (1:160 – roughly half the size of HO) becomes another option. The most popular scales are HO and N and you will find more equipment and a wider variety in these scales. If you have lots of room don't overlook O scale (1:48 – Lionel is O scale).

Let your son's physical and emotional maturity help guide you in this decision!

— **Jim Duncan**

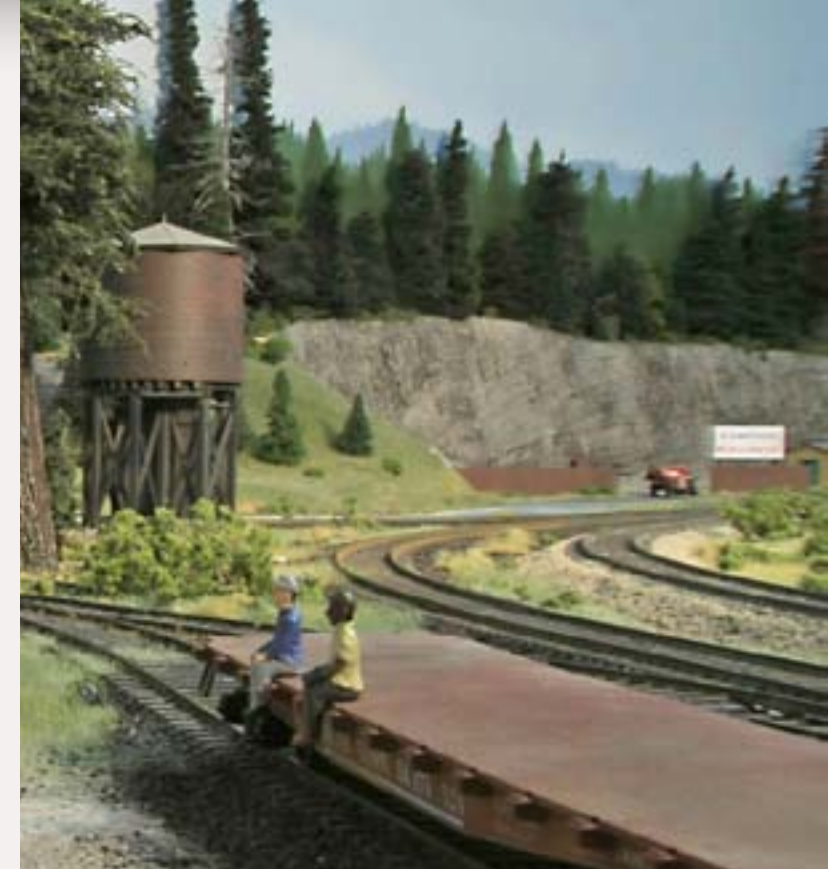

**Figure 2: The difference between mainline on 1/4" cork, a siding on 1/8" cork, and the spur under the flat car, which has no cork beneath it, can be quite striking.**

**Q: I've decided to use cork roadbed under the track on my HO layout. Should I use 1/8" or 1/4" thick cork?**

**A:** Mainline tracks are usually higher than sidings which are higher than spur tracks. I build the town areas on my railroad on plywood. I use the 1/4" cork under my mainline, 1/8" under my sidings, and lay my spur tracks directly on the plywood. The differences in height help identify which track is which (figure 2).

— **Charlie Comstock**

**Q: What does kitbashed mean?**

**A:** Kitbashing is the term used when, instead of assembling a model kit in accordance with the instructions,

combining it with parts from other kits or adding scratch built parts to create an entirely new model.

Kitbashing is frequently used to create a more exact model from a kit that is close to, but not exactly, the prototype being modeled.

It's also used to create a unique structures or group of structures to avoid the "didn't I see that same building on 10 other layouts?" syndrome.

— Jeff Shultz

**Q: I have a bedroom-size layout that I'm planning to convert to DCC. I've noticed that radio throttles are more expensive than tethered**

**throttles. Are there any advantages if I go with the radio throttles?**

**A:** Radio throttles use radio signals to connect them to the Command Station, the brains of a DCC system, rather than wires. If all of your throttles are radio equipped, you can omit what is called a throttle bus. This wiring connects a set of throttle jacks with the Command Station. Tethered (non-radio) throttles, plug into the throttle bus.

If you elect to use radio throttles you will need a radio receiver to communicate with your throttles. If you purchase a radio equipped starter set, an appropriate radio receiver will be

included, otherwise you'll need to buy one separately.

A radio throttle is nice because you don't need to plug and unplug your throttle(s) into the throttle bus jacks. This frees you to wander around your layout, running your train instead of looking ahead for the next throttle jack.

Another benefit is no more throttle wire tangles when multiple operators try to navigate the railroad room and snag each other with throttle wires.

Disadvantages of radio throttles include their insatiable appetite for batteries and their extra cost (plus the extra cost for the radio receiver). In large areas, you might need to install

multiple receivers, but with a bedroom size layout, this is highly unlikely.

Some radios (early Digitrax) are simplex – they can only transmit, but can't receive. These must be plugged into a throttle jack to connect to a loco or change the MU (multiple unit) consisting. I have these throttles and have not found this to be a big deal. Other radio systems are full duplex (NCE and the 'D' series of radios from Digitrax).

Radio isn't required, but it is nice. If you can afford the cost, I recommend it. If you can't, all is not lost – should you desire, you can upgrade a Digitrax or NCE system to radio in the future.

— Charlie Comstock

## Everything you need to know about model building in one great How-To resource...the Micro-Mark catalog!

More than 2,750 name-brand and hard-to-find tools, trains and supplies, plus tips, techniques and more...all designed to help you complete your hobby projects in less time with more satisfying, professional results!



**Free Catalog!**

Click [here](#) and enter code BA5

1-800-225-1066  
Shop On-Line: [www.micromark.com](http://www.micromark.com)

**Micro-Mark**

Berkeley Heights, New Jersey 07922  
1-800-225-1066

# MODEL TRAINS WEATHERED

.COM

THE WORLD'S ONLY  
WEATHERER'S  
NETWORK  
FORUM

STOP BY TODAY AND INQUIRE ABOUT  
MEMBERSHIP

**Q: I have an old brass steam locomotive model I want to paint. I'd like to use acrylic paint because it's less toxic but a friend told me I should use solvent based paint. Which is the best?**

**A:** It's possible to get high quality paint jobs with acrylic or solvent based paint. The key to a good looking and durable paint job is in the model preparation and painting process, rather than paint type. Solvent based paints are much more toxic than acrylics, but you should use breathing protection with either.

For the best paint job on a brass engine, completely disassemble the model. Save the various assemblies in labeled plastic bags so you'll be able to reassemble it after painting.

Put on safety glasses and rubber gloves, then remove any paint with a chemical paint stripper and/or bead blasting.

Thoroughly clean the body and frame of the model in hot water with a good detergent and rinse to remove all of the soap. NEVER touch the brass with your bare hands, always wear clean latex or rubber gloves.

Acid etch the brass to prep the surface and give it more 'tooth' for the paint to grip, resulting in a more durable finish. You can use a commercial product designed for this, but I submerge my brass overnight in white vinegar to prep the metal (do NOT use the vinegar for cooking after soaking the model in it!). Small bubbles will appear on the model after a few hours. That shows

the acid is working. Rinse in distilled water and allow it to dry.

Mask off anything you want to keep looking like brass – bell, builders plate, etc. Give the entire loco a very thin coat of primer and allow to dry overnight. Apply a thin coat of the basic body color with a few drops of gloss added. After an hour or so, give the loco another light coat of paint and allow the paint to dry completely.

I use an old food dehydrator as an oven to "bake" the paint in place. The dehydrator provides a little warmth and circulates air to remove moisture (or solvent). Don't bake a model in the kitchen oven – bad smell!

When all trace of solvent smell has disappeared, mask the boiler and

airbrush the smokebox, firebox, etc., allow it to dry, then bake.

Remove the masking from the smokebox, firebox, etc. Use a small brush to carefully paint details such as contrasting color pipes, headlamps etc.

Remove any masking over the raw brass. Give the loco two light coats of gloss finish and let it cure. Then bake until the smell disappears.

Reassemble the loco, add decals and spray with one light coat of flat finish to seal the decals. Apply any weathering you want with airbrush, paint brush, powder etc. Don't forget to weather the wheels, rods and valve gear. Seal with another light coat of dull finish and allow to dry (or bake) until all solvent smell is gone.



Lubricate the loco lightly and enjoy watching it run!

— Lew Matt

because of the one truck that only swivels. I've done this since my days as a teen in the hobby, and it's simple but quite effective.

— J. Fugate



### TIPS

#### Improve the tracking of your rolling stock:

Here's a rolling stock tracking trick

I learned from a hobby old-timer. When tightening the truck screws on a piece of rolling stock, tighten one down enough that the truck can freely swivel, but not rock. Leave the other truck loose enough that it can rock as well as swivel. This creates a kind of "three point" suspension on the car, allowing it to follow any minor imperfections in the track, yet the car won't rock unrealistically



#### GET \$25 PER TIP

We pay \$25 USD for each tip we publish. [So send in your modeling tips to Model Railroad Hobbyist](#) and we'll get your payment to you upon acceptance.

Just think, for only a few minutes effort, you could fund your next piece of rolling stock – or even pay for an entire train if you send in several tips and we publish them!

If you include any photos with your tip, we pay a bonus of \$10 per photo we use with the tip. ■

We didn't join to showoff or boast. We joined for one reason. To learn.



Prototype weathering really isn't anything new. Mother nature has been doing it for years!

Along with world class modeling we offer some unique insite into what it takes to take your modeling to the next level



visit *Weathering Solutions*, proud sponser of *The Proto Weathering Forum*.  
**A.I.M. Weathering Powders are always discounted**

Coming Soon



This Beautiful PRR H30b in HO Scale.

**weatheringsolutions.net**



click to visit us today!

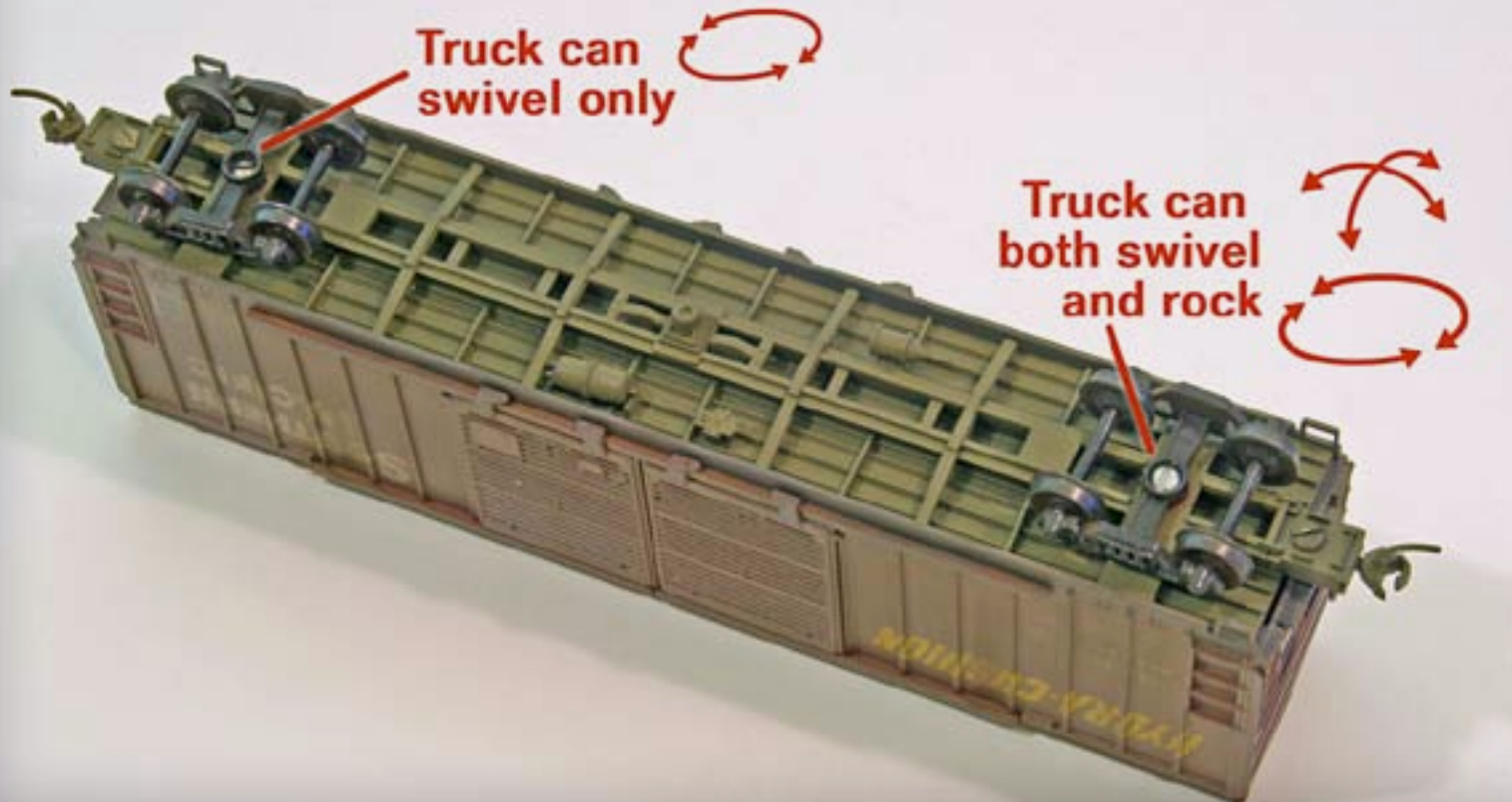

# Model Railroad Hobbyist - HOBBY MARKETPLACE

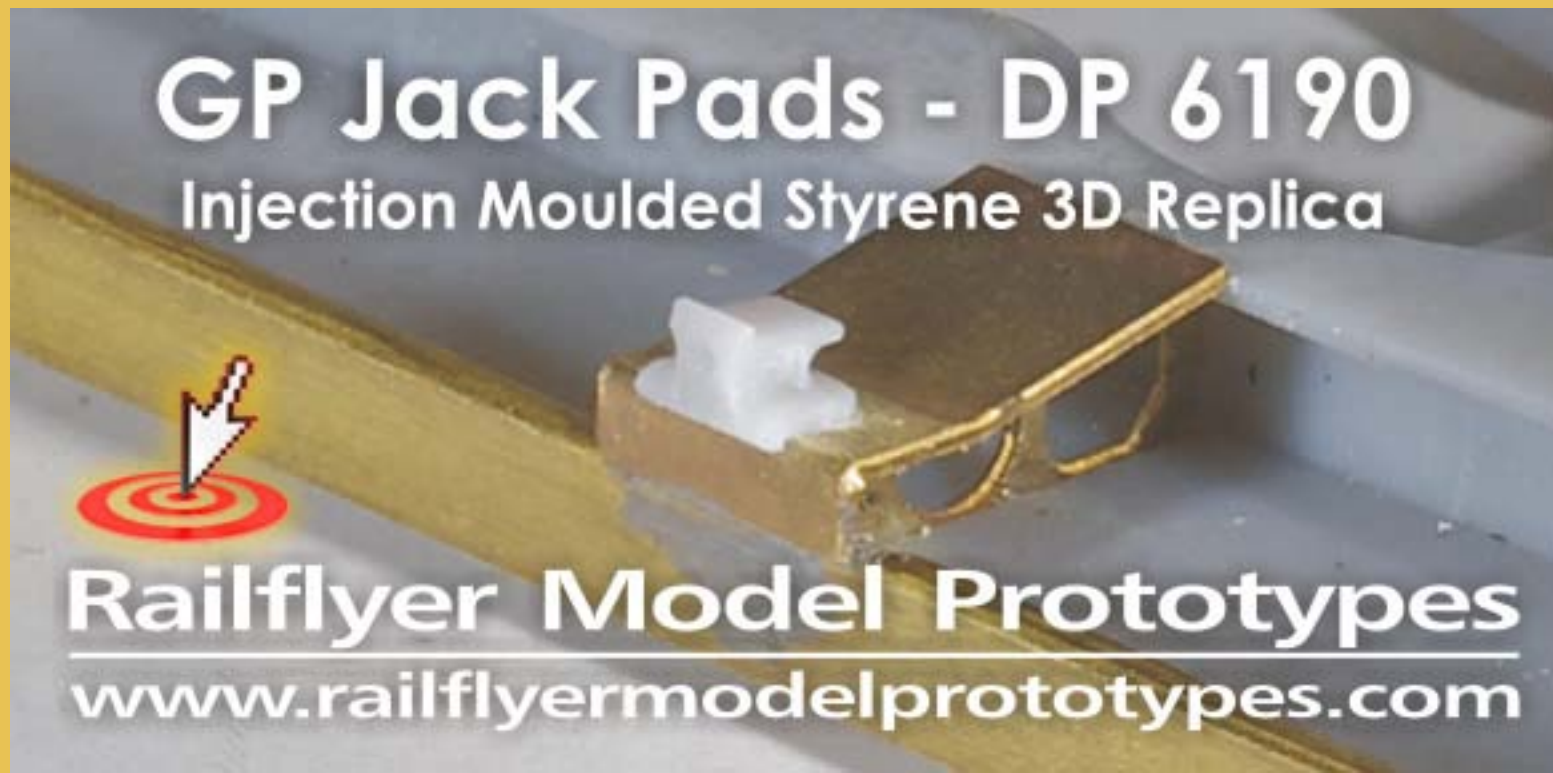

**GP Jack Pads - DP 6190**  
Injection Moulded Styrene 3D Replica

**Railflyer Model Prototypes**  
[www.railflyermodelprototypes.com](http://www.railflyermodelprototypes.com)

Your ad could be reaching tens of thousands of MRH readers from our Hobby Marketplace pages for a very reasonable cost. Learn the details [HERE](#) . . .



**TWO & FOUR TRACK SIGNAL BRIDGES**

**AT YOUR DEALER NOW!**

**HO SCALE - FITS ALL ERAS**

[www.oregonrail.com](http://www.oregonrail.com)

**OREGON RAIL SUPPLY**

PO Box 490  
Scappoose, OR 97056  
503-543-6466  
[oregonrailsupply@gmail.com](mailto:oregonrailsupply@gmail.com)



# Model Railroad Hobbyist - HOBBY MARKETPLACE

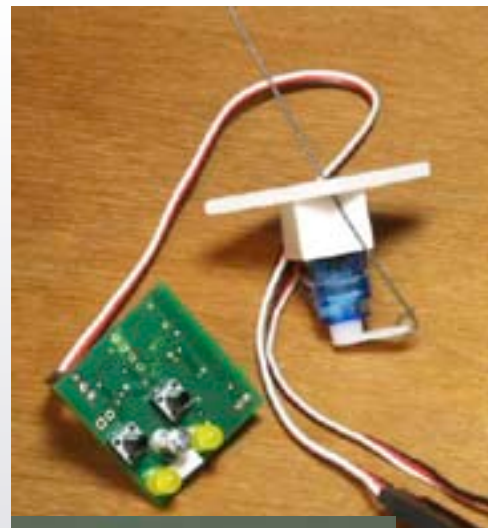

## *Singlet II* Micro Switch Machine

Easy to Hookup...

Plug and Play

Easy to mount...

Senses point pressure to automatically adjust stops

No need for precise mounting

Control with...

Panel buttons

or Built-in DCC Decoder

\$19.95 (\$15.96 for 10+)

Includes Servo

- ◆ Switch Turnouts ◆ Animate Semaphores
- ◆ Lower Crossing Gates ◆ Anything that Moves!

*www.TamValleyDepot.com*

*Great Electronics for Great Model Railroads*



## LBH Custom Model Railroads

Layout Design and Construction Services

For more information visit our website:

[www.lbhmodelrailroads.com](http://www.lbhmodelrailroads.com)



Make Your



# Horn



Memorable

[TrainHornsDelivered.com](http://TrainHornsDelivered.com)

If you are looking for a great way to display your N, HO and O trains, try grooved ShelfTrax.

Attaches to the wall without brackets.



Learn more at [www.shelftrax.com](http://www.shelftrax.com)

Reach well over 20,000 modelers with your text-only ad on this page for as little as \$15 per issue.

[Learn the details here.](#)



Have an article you just can't seem to get published? Submit it to [ModelRailroadTips.com](http://ModelRailroadTips.com) today!



Home to 100% free online, and PDF articles. Upload an article online, and we'll take care of the PDF file for you.



# The Return of the PENNSYLVANIA Middle Division



Jimmy Deignan found Dave Frary's Pennsy Middle Division project layout on eBay, brought it home, restored it, and added on to it.



Jimmy Deignan is fascinated by intricately detailed structures. This passion led him to start [craftsmankits.com](http://craftsmankits.com) and later create his own line of structure kits available at [railroadkits.com](http://railroadkits.com).



Interview: Joe Fugate,  
Photos: Charlie Comstock

Jimmy already owned the *Clinchfield* model railroad when he noticed Dave Frary's *Pennsy Middle Division* project layout on eBay. Like the *Clinchfield*, the *Pennsy's* construction was presented in *Model Railroader* as a series of articles (in 1993) making it well known. He placed a bid on the *Pennsy*.

When the auction winner reneged, the seller contacted Jimmy – the layout was his! He arranged to get it home to Massachusetts and began making plans for its restoration.

**MRH** was in Massachusetts last fall for the 2009 Craftsman Structure Show. Among the layouts open to show attendees was the *Pennsy Middle Division* layout. Jimmy graciously gave **MRH** an impromptu interview from his train room.

Jimmy started in our hobby with a Lionel train set when he was six years old. As time passed he noticed that real trains ran on two rails, not three,



Figure 2

and that HO trains looked more realistic. With building kits and rolling stock readily available in the local hobby shop he made the switch.

Fast forward a number of years and let's pick-up the story ...

## The Middle Division

**Joe:** Tell us the story of how you ended up with the *Pennsy*?

**Jimmy:** The Pennsylvania Middle Division layout was built by Dave Frary for *Model Railroader* magazine in 1993 where its construction was detailed in

**Figure 2: Lock Haven is one of many super-detailed areas Jimmy added on the new peninsula**

nine issues. It traveled with Greenberg Train Shows and when they were done with it, it went through a few different private owners. In 2000, I saw it for sale on eBay – I placed a bid and



Figure 3

### Figure 3: This mine, at Gobblers Knob, is one of the original structures on the Middle Division

won. The Pennsy was in Florida and I'm in Massachusetts but the seller agreed to pack the layout in a U-haul trailer and meet me halfway (in South Carolina) with it. He unhooked the trailer, I hooked it to my truck and I towed it home.

**Joe:** After traveling the show circuit it probably had some wear and tear. What kind of condition was it in when you got it?

**Jimmy:** Ah, it was pretty bad. You could tell that the people who handled it for Greenberg hadn't kept it in the best shape. There were a lot of things broken and a lot of the tracks were dead. It was in need of a lot of repair work and at the time I wasn't ready, so I put it in storage and said "some day I'm going to put that layout together"

**Joe:** How did you get it running again?

**Jimmy:** Well, the plan was to restore it as originally built by Dave Frary, but a motorcycle accident in 2003 put me

in a wheelchair. So I put it away again for quite a while until I met the friends who were able to help me build it into what it is today

### Changes

**Joe:** How close is the layout now, to the Pennsy Middle Division as it was originally built?

**Jimmy:** The original Pennsy is still there but it got divided in two with a peninsula added which makes it more handicap accessible for me [ED: Jimmy was

unable to get his wheelchair through the narrow aisle between the turnback blobs – Gobblers Knob and St. Andrews. As well as adding the peninsula, the aisles were widened]. Now the aisles are wide enough for me to get my wheelchair to go in and turn around.

**Joe:** What kind of help did you get with putting the expanded layout up?

**Jimmy:** Well, luckily, with the Internet, I was able to meet a lot of people who were willing to help me. I asked for help with track planning and **Bob Leonard**, a gentleman from Florida, came up with a plan for the new peninsula I really liked. **Scott Mason** agreed to handle most of the renovation. **Dave Frary**, **Dick Elwell**, **Jim Corcoran**, and **Doug Foscale** all were local to me so they were able to work on it.

**Joe:** So the original builder, **Dave Frary**, actually worked on the expansion?

**Jimmy:** That's why they meld so well. If you stand back it's really hard to tell that in essence they're two different layouts built in two different eras – a separation of almost 15 years! **Dave Frary** made them like they're one.

**Joe:** What guided the changes you made?

**Jimmy:** Well, originally the layout was built as a static display for Greenberg Train Show. The double track mainline was designed to run with two trains in separate directions. It was made to interest the crowd at Greenberg train shows (and get them to subscribe to Model Railroader). I would get bored

awfully quickly watching the trains running endless loops.

When I asked **Bob Leonard** to do the track plan I asked him for some extra operation. He did that by adding additional sidings and industries.

**Joe:** What's the size of this layout?

**Jimmy:** The layout is now 16x28 [feet] vs the original Pennsy which was 11x16, so it's grown considerably.

## Layout Details

**Joe:** What about details on the layout like the structures and so on?

**Jimmy:** The original part of the layout is still the same – we kept the same structures that Dave had originally put on there. Dave built it with donated items such as kits by Atlas or International Hobby – stuff you could buy at your local hobby shop.

Since I'm a craftsman kit guy, the new section incorporates these highly detailed buildings, because that's where my interest in the hobby is now.

**Joe:** OK, and for running trains do you have DCC on the layout?

**Jimmy:** Yup, I have NCE – the North Coast Engineering version because it's easiest for me and my handicap and limited dexterity – the buttons were easiest for me to use and it just turned out to be a swell system.

**Joe:** Are your locomotives equipped with sound decoders?

**Jimmy:** All my locomotives are sound equipped. I love that it adds a little bit of audible animation to the scene with the train noise.

**Joe:** What about having sound on the layout itself?

**Jimmy:** I've dabbled with adding sound to some industries. I have Lok-Sound on my computer where I can program different sounds into a decoder – I'm going to have some industry sounds on the layout soon.

## Handicap Considerations

**Joe:** Jimmy, I'm sure there are some readers who, like yourself, have to work from a wheelchair. What are some special issues that you've dealt with in having this layout?

**Jimmy:** The most important thing is height, being that I'm always sitting down. Most model railroaders build their layouts for when they're standing, but I'm always sitting. At 36" my layout is a lot lower than most people would like, but for me that height is perfect.

**Joe:** What about being able to see over the entire layout, view blocks and that sort of thing?

**Jimmy:** A lot of people want to separate their scenes with view blocks – usually walls. In my case, I have a mountain running down the middle of the new peninsula. Dave [Frery] built that with me in mind. People standing can see right over it, but for me, the other side is a world away. When I'm operating, once a train has gone to another town it's gone and I can't see it.



Figure 4

Figure 4: Dave Frery brought this building in St. Andrews to life.

Figure 5: Rollin Saywer Chemicals in Dixon.



Figure 5

**Figure 6: Sewall's Foundry is typical of the craftsman type structures on the new peninsula.**

## Operation

**Joe:** What about your layout era and the rolling stock you have?

**Jimmy:** When Dave Frary originally built the Pennsy he figured it was set in Pennsylvania around 1955 and I kind of like that era because there are some diesels that I love and there's some steam that I love, so I can get away with that. But that being said, it's my layout so if I want a SD-40 in a consist with a Shay then that's what I'm going to do.

**Joe:** Yup, that's rule #1, right!

**Jimmy:** For visitors I try to keep the era consistent with the 1950's – most of the vehicles are Jordan vehicles which are '30s and I do have some power from the '50s so for the most part I keep the rolling stock, the box cars and the passenger cars with the 1950s.

**Joe:** You're interested in operation, what are your plans in that area?

**Jimmy:** Right now I'm still researching and learning about it. That's a different aspect of the hobby and it's a whole new world I've found. Timetables are probably the way I'm going to go and I hope to have a dispatcher. I think the layout's big enough for four of us to have a good time.

**Joe:** I noticed you're expanding and putting in a wharf area in the new design. Why do that?



Figure 6

**Jimmy:** When looking at the trackplan I realized that the operation needed a little bit more, so by adding five more sidings to the new section it will add one more operator when my operating session is ready.

## Lighting

**Joe:** How's your layout lit?

**Jimmy:** I use halogen, low-voltage spot lights, aimed at places I want highlighted.

**Joe:** Do you have any structure lighting on the layout itself?

**Jimmy:** None of the structures are lit presently, but quite a few of them do have lights and wiring installed. I do plan to get those illuminated at some time in the future.

## [craftsmankits.com](http://craftsmankits.com)

**Joe:** Jimmy, your interest in craftsman structures has become more than just a hobby for you, hasn't it?

**Jimmy:** I went to an auction and bought some kits that I ended up not using so I sold them on eBay. I realized there was a need out there for somebody to find out-of-production craftsman kits and make them available. In 2003 I started [craftsmankits.com](http://craftsmankits.com), to deal in out-of-production craftsman kits.

**Joe:** Do you manufacture your own kits?

**Jimmy:** Yes, a few years back I started [railroadkits.com](http://railroadkits.com), my own line of laser cut structures. I scratch built a structure

for my new peninsula and a few people said “That would make a nice little kit!” So I had another manufacturer make the kit for me and it sold very well. Ever since then I’ve been producing my own line of kits.

**Joe:** How are the craftsman kits different than a plastic, off-the-shelf structure?

**Jimmy:** Well, plastic structure kits are great, but their injection molding limits detail. With a wood structure there's so much more that can be done – you can weather an old building to look like it's run-down after having been lived in for 50 years. It takes a lot more work to do that with styrene or injection molded buildings. I like weathering wood. I

feel you can detail a craftsman kit much further than an injection molded model.

**Joe:** I know there are some manufacturers who make wood kits that I would not call craftsman kits but they're less expensive.

[continued on page 48](#)

**Figure 7:** Jimmy's favorite part of the layout is the service area which features this South River Modelworks brick roundhouse and the AAA Turntables DCC controlled 90' turntable.



Figure 7



Jimmy Deignan lives in Holden, Massachusetts with his wife and two young children. A motorcycle accident in 2003 left him a quadriplegic but didn't diminish his zeal for model trains. He designs web sites specializing in the model railroad hobby.

Jimmy is a founding partner of The Craftsman Structure Show. He welcomes visitors to his layout. If you will be in his area contact him via e-mail at [jamesdeignan@yahoo.com](mailto:jamesdeignan@yahoo.com).

For more information on out-of-production craftsman kits visit [craftsmankits.com](http://craftsmankits.com) or see Jimmy's line of kits at [railroadkits.com](http://railroadkits.com).

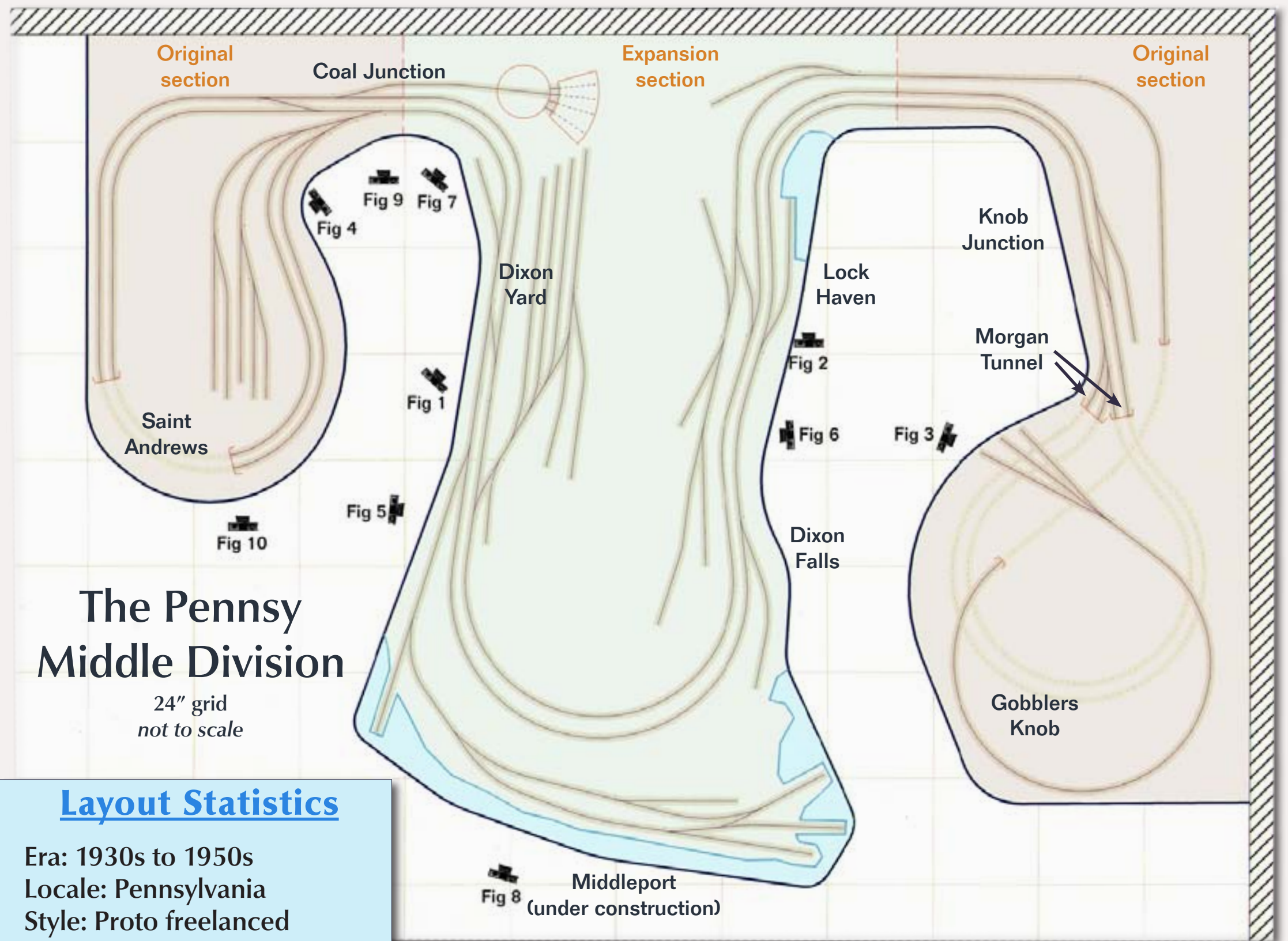

## The Pennsy Middle Division

24" grid  
not to scale

### Layout Statistics

Era: 1930s to 1950s  
 Locale: Pennsylvania  
 Style: Proto freelanced  
 Scale: HO  
 Trackplan: Continuous loop  
 Size: Aprox 22' x 18'  
 Min. Radius: 20"  
 Track: Atlas code 83  
 Turnouts: Walthers, Atlas  
 Control: DCC - NCE Pro Cab  
 Built: 1992  
 Restored/expanded: 2005

Want to know more about how The Pennsy was restored and expanded? Read Scotty Mason's [The Pennsy Diary](#). Scotty documented; in great (and often hilarious detail) how he was enticed into the restoration process (Jimmy gave him the *Clinchfield* in exchange for the restoration), historical layout details, and the pitfalls encountered.





Figure 8

Figure 8 (previous page): This view of the peninsula shows Middleport (under construction) at the near end. Joe Fugate is running a train near Dixon Yard while Les Halmos watches. The ridge running down the peninsula is the right height to act as a view block for Jimmy.

Figure 9: A sort of rogues gallery of buildings named for notorious modelers at Coal Junction.

[continued from page 45](#)

**Jimmy:** The less expensive wood kits are often called laser kits. Craftsman kits are usually a limited run, perhaps 200 to 400 kits, and it includes a lot of details: metal castings, brass etchings, resin castings.

**Joe:** When you say a lot of details, what kinds of things am I going to see?



Figure 9



**Jimmy:** Depending on the structure they could be simple things like crates and wood boxes, gas pumps, roof details and pigeons. It goes on and on – anything you can imagine that would be on a building could be included.

**Joe:** So for example, a machine shop kit might include milling machines?

**Jimmy:** There might be lathes and drill presses and other things like that. Those castings can use lots of metal plus there's the time to make the masters

and do the casting. They're part of what makes a kit a craftsman kit. Often they're only available as part of a kit.

**Joe:** These kits sound like they're tricky to assemble?

**Jimmy:** They're called craftsman kits because you're expected to be a craftsman. However, the instructions are often complete lesson books – if you follow the directions, you'll look back and say "Oh my gosh I just built that!"





Figure 10: The St. Andrews yard

Joe: So building a craftsman kit can be a great learning tool as well as a good looking structure?

easy it is if the instructions are well written, you get hooked.

Jimmy: Definitely and it can become very addicting – when you see how

Joe: Jimmy, thank you for having us!

Jimmy: You're welcome!

# Get the complete HO Pennsy Middle Division Story!

– by Dave Frary

**\$5.95 eBook!**

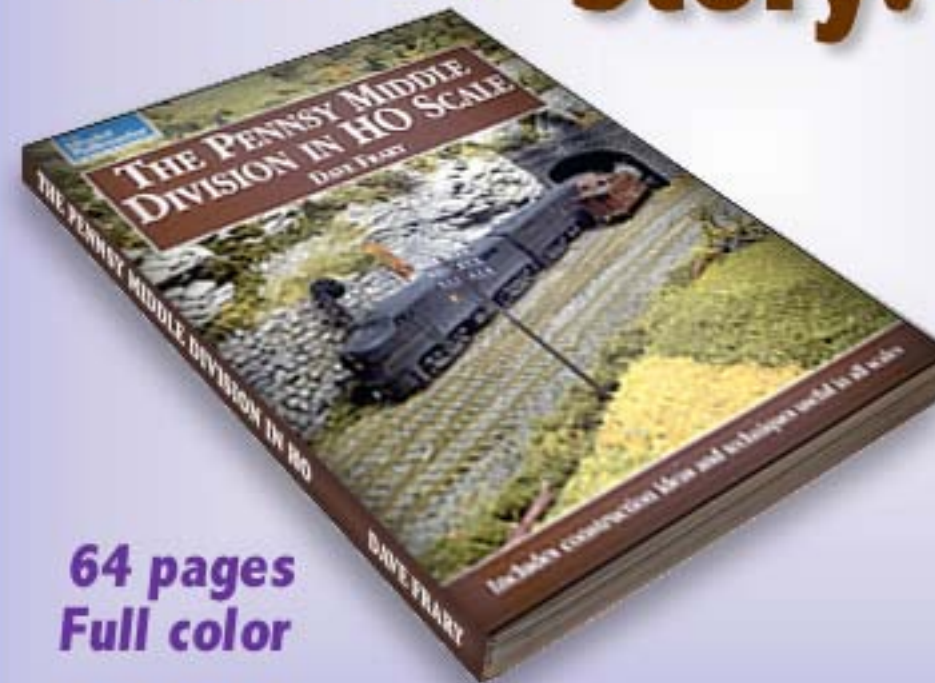

**64 pages Full color**



click here to **Download Immediately**

## Middletown Station \$29



MRR Television's Boz Collins says "These Little Kits Are Cool!"

### Railroad Kits Structures:

- Great Designs in HO Scale
- Laser Cut Basswood Walls
- Northeastern Scale Lumber™
- Tichy™ Doors and Windows
- Metal and/or Resin Detail Castings
- Online, Printable Instructions

**RailroadKITS**



Visit us at [www.RailroadKits.com](http://www.RailroadKits.com)





## Trackside Stuff Ties and Tie Plates!

by Charlie Comstock



I installed a speeder/utility shed in Oakhill on my early 1950s layout. After some weathering it

looked fairly nice, but something was missing. I needed a bit more detail around the shed.

A stack of ties and a heap of tie plates next to the shed looked good and added an extra level of detail to the scene. Here's how I made them.

### Tie Stack

I stained some Micro Engineering wood ties by dunking them in a mixture of India ink and alcohol (about 10 drops of

ink in a mostly full 35mm film container of alcohol) then spread them on some paper towels. While they were drying I made a template by drawing a square on a piece of paper using a tie to set its size. I stuck some double-sticky Scotch Tape on the template to hold the bottom tier of ties in place. I used full length ties only on the outside edges and on the top tiers to conserve my tie supply.

Figure 1: A stack of ties and pile of tie plates.



Figure 1



Figure 2



Figure 3

Figure 2: I laid out the first tier on the template. Note the hollow interior to conserve my tie supply.

Figure 3: Second tier.

Figure 4: Starting the top tier.

Figure 5: Top tier complete with a few extra ties on it.



Figure 4



Figure 5

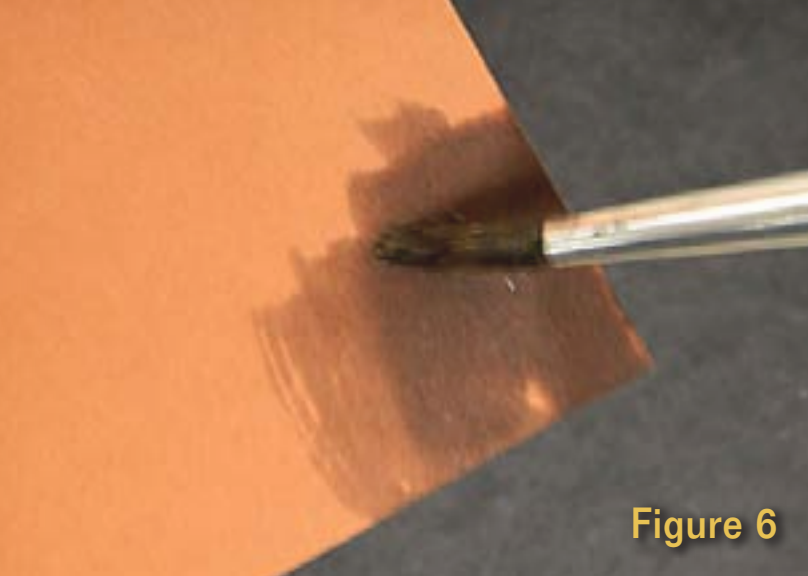

Figure 6

Figure 6: 'weathering' brown construction paper.

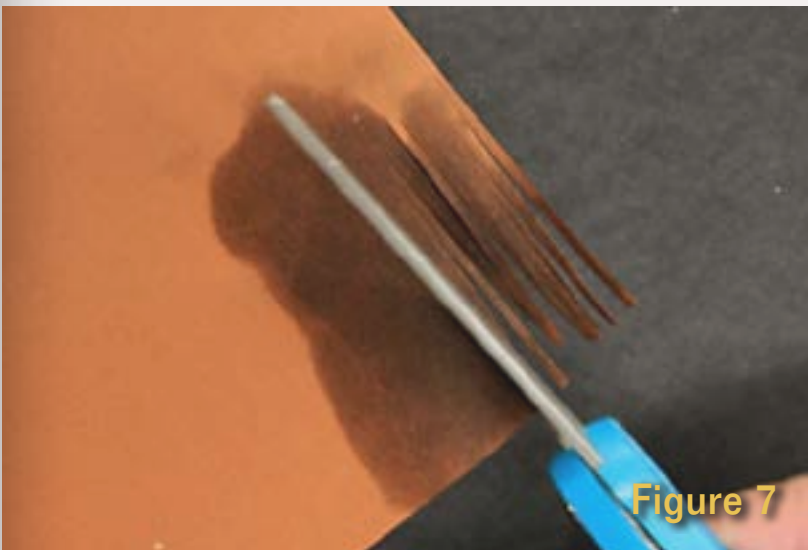

Figure 7

Figure 7: Longitudinal cuts.

Figure 8: Cutting out individual tie plates

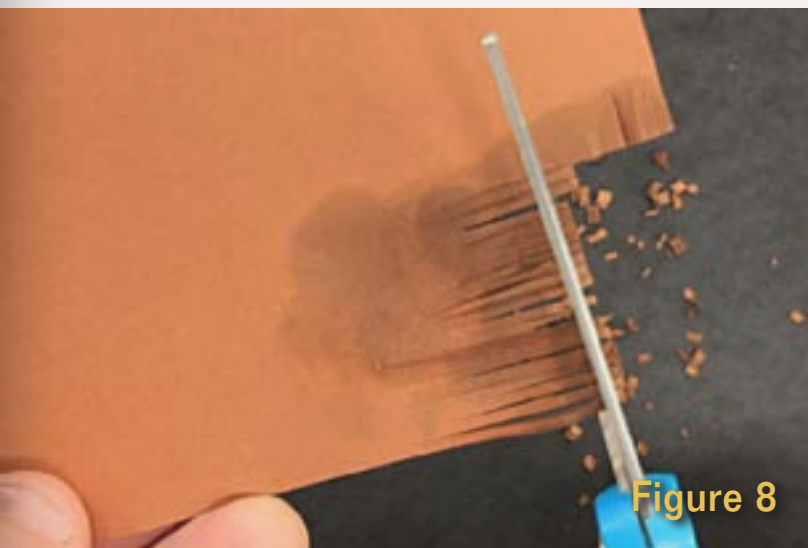

Figure 8

Figure 9: Pile of 'tie plates' ready for installation.



Figure 9

I added a more tiers of ties securing them with yellow glue, then added a tier of full-length ties. I also added a few 'extra' ties on top to make the stack look like it was being used.

After the yellow glue dried, I pried the tie stack off the template and white-glued it in place on the layout.

### Tie Plates

I got this idea for heaps of tie plates from George Selios. I stained brown construction paper with a mix of India ink and alcohol, for a weathered rust color, then made a number of longitudinal cuts about  $\frac{3}{32}$ " apart (around 8" in HO scale - figure 7).

Then I made a series of cross cuts about  $\frac{3}{32}$ " apart making a bunch of square confetti (figure 8). I picked these up and piled them next to my speeder shed. Once the tie plates were in position I used an eye dropper to dribble alcohol on them, then added a few drops of 50/50 white glue and water to hold them in place.

For more detail you could 'print' spike holes with a computer. But that's a lot more work (and needs to be done on both sides!), at a reasonable distance, its hard to see the lack of holes.



# The largest selection of scale Model Railroad Scenery Supplies on the web!

Click to visit!



# There are no better Rail History Books for your Library



Click here to learn more!

**SIGNATURE PRESS**

Order securely at: [www.signaturepress.com](http://www.signaturepress.com)  
or order direct: 11508 Green Rd, Wilton, CA 95693

TELEPHONE ORDERS OR DEALER INQUIRIES TO:  
1-800-305-7942

see our web site for information on all our books



# Some of the finest trees in the hobby ...

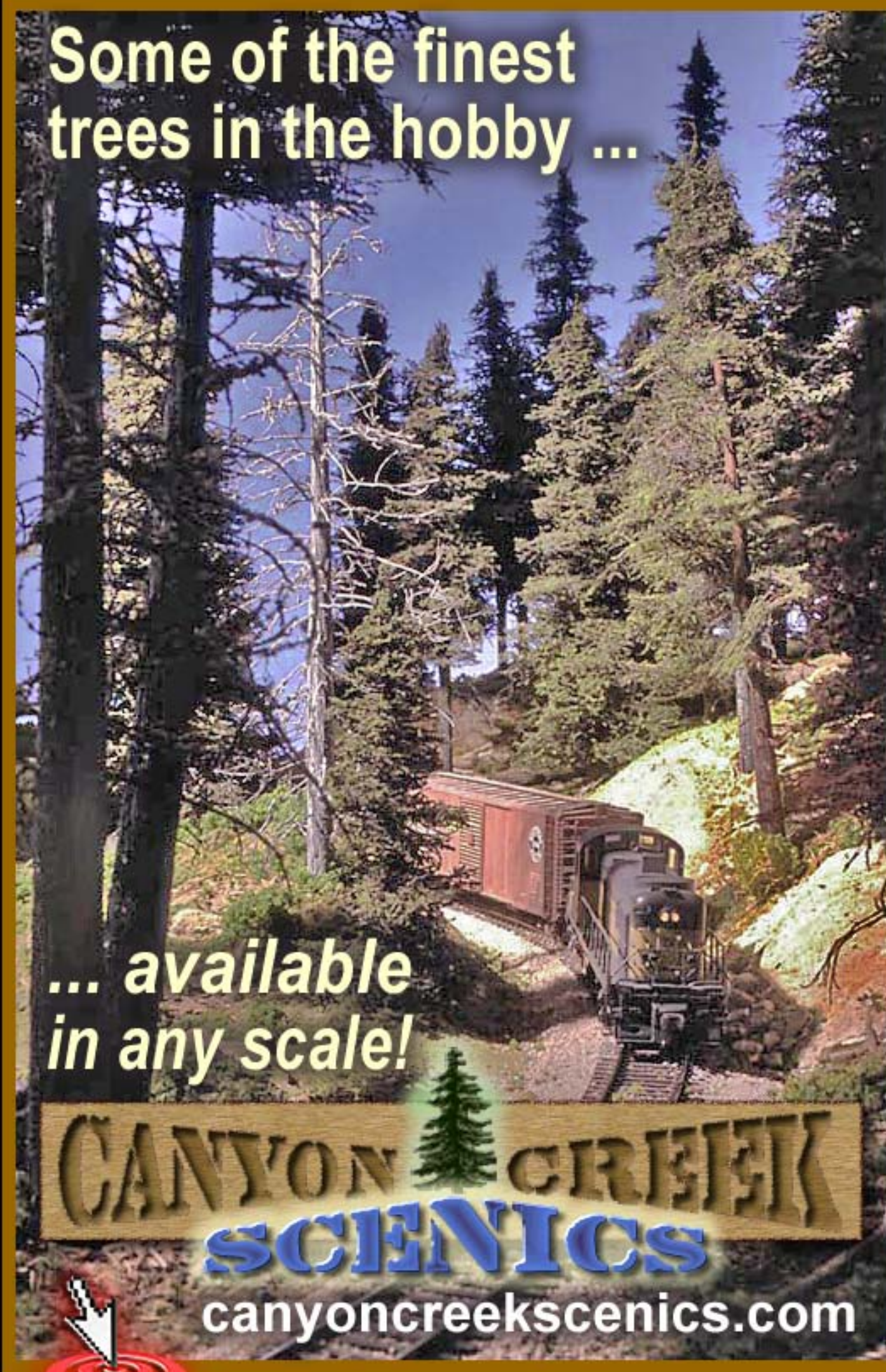

... available in any scale!

**CANYON CREEK SCENICS**

[canyoncreekscenics.com](http://canyoncreekscenics.com)



click to visit our web site



visit us at  
NMRA Show  
booth 133-143

# iwata

Your Hobby Needs Are Covered!  
Visit Us On The Web  
[click here!](#)

## iwata *Revolution*

Quality, Performance and Value



### "HANDS-ON" AIRBRUSH WORKSHOP

Wednesday July 14, 2010

8am to 11am Room 202A

*Midwest Airline Convention Center*

This 3-hour HANDS-ON workshop teaches you basic airbrush techniques for weathering, including air source selection, material and working surface compatibility and preparation, and simple procedures for airbrush maintenance. You will also complete scenery & rolling stock weathering projects.

**INSTRUCTOR:**

Leslie Eaton, Master Model Railroader, expert in airbrush weathering and Nano-Animation electronics.

**CLASS SIZE IS LIMITED TO 20 PARTICIPANTS  
TO PRE-REGISTER...**

**CALL: 719-268-9848 or EMAIL: [tomtag@pcisys.net](mailto:tomtag@pcisys.net)**

iwata  
MEDEA



[www.iwata-medea.com](http://www.iwata-medea.com)



# Kitbashing a U-18B: GTI 404 – Part 1

– by Mike Rose

Photos by the author



Figure 1: For the purposes of my layout and era, the Guilford ex-Maine Central model seemed the way to go. I already owned several Atlas U23Bs in the Guilford scheme, among other models for that railroad, so I thought this would be a neat loco to run with them.



**Reader Feedback**  
*(click here)*

## A seemingly simple locomotive kit-bashing project takes on a life of its own ...

**W**hen my good friend Jim Six approached me about doing various U-boat modeling projects, I immediately saw the attraction and readily agreed. I've always admired the U18B – it's long been on my eventual project list – a list so long that it's difficult to take the whole thing in with one gaze!

Jim sent me the cutting diagrams of his pilot U18B project, and I set out to gather photographs that would

provide me the detail I needed to accurately do this engine.

Warren Calloway was very generous (Figures 2 and 3) in providing me with multiple images and referred me to the Diesel Era article on U18s in the September/October 1990 issue. This article has a wealth of close-up photos that soon proved to be a mixed blessing!

The SCL U18 that Jim did followed most of the details already on the Atlas U23B, with the primary difference being length. But the more I studied the MEC/GTI (as well as the sole Providence & Worcester) units, I realized to my horror that there are significant, visible differences between early and late production U18s.

These late production models had Dash-7 style door latches, different in that they were square instead of



**Figure 2:** This prototype photo shows a standard late production U18, ex-MEC Guilford 406. For those of you who want to make the unit that is the most common, this would be your choice.



**Figure 3:** Because I can't resist a challenge, and like a unique model, the unit I modeled was GTI 404, which has a U25B nose that Guilford shop forces applied to to repair wreck damage. The nose has the distinctive class lights of a U25 located on the corners of the nose rather than squarely on the front of the short hood. Should you chose to do this unit, you'll need an old AHM U25C shell to get the correct class lights. The Stewart U25B shell is not correct for GTI 404. **NOTE:** As part of the kitbash for 404, I show how to recreate the seams that exist on the prototype where they welded the new nose in place!

round, and located as a single latch in the door center instead of top and

### I've always admired the U18B – it's long been on my eventual project list

bottom round latches like the Atlas U-23B had. I also noticed that the equipment boxes on the walkway

behind the cab on the engineer's side were also different, resembling those on the Dash-7 production.

I decided that if I was going to take the trouble to cut up and shorten a locomotive, I might as well make it as accurate as possible, within reason. Careful study of the Atlas C30-7 convinced me that it would be possible to use it in much the same way that Jim used the Atlas U33C body to make his model.

## Comparison of Intermountain U18B Model with My Kitbashed Version



Photo credit: Leonard Ruback (<http://centextrails.blogspot.com>).

At the time of the U18B kit-bash project that I conducted with fellow modeling friend Jim Six, there was no commercial model available. We did take note that one of the members of the Yahoo Group we consulted for this project was an employee of Intermountain at the time.

Eventually it became clear that Intermountain was following the project closely, and we assumed that a product would result eventually. They later offered all three phases of the U18B, and I recently was able to closely examine an undecorated version.

One nice thing about the Intermountain loco: the undecorated version comes with all three types of cabs, in terms of window arrangements. The chassis and shell are the correct length, and the chassis itself is rugged and well made.

It's not easy to engineer a chassis that does everything we expect of a modern model loco, has the ability to have sound, yet fits into such a short package. In fact, the overall length of the U18B is not much greater than an MP-15 EMD loco, so it's essentially a switcher-sized chassis. The Intermountain chassis itself is lighter in weight than the modified chassis we created for the kit-bashing project.

Taking a look at the body and tooling, while the overall dimensions appear correct, I noticed a number of minor differences. There is a general lack of depth to the door latches as compared with the Atlas shells I used.

The battery box covers lacked the representation of bolt heads that are apparent on the prototype as well as the Atlas shell. Additionally, the louver count is incorrect on the battery box covers, at least for the late phase unit I was examining.

Although the model had Blomberg trucks in the version ordered, the air piping was not correct for the prototypes that actually had Blombergs. The supplied air piping is standard EMD as opposed to the SCL version that also appeared on the MEC units, as fabricated for the kit-bash. There are also missing panel lines below the radiator intake grills, and shallow detail overall.

Many modelers have taken exception with the Intermountain cab. It's clear that the cab roof angles as well as how the windows were handled are just not accurate for the prototypes I compared them to.

Either the Hi-Tech or the Atlas U-boat cabs would be a better choice, although I was unable to test fit either on the sample Intermountain loco I was examining.

Overall this is a nice little model and considerably easier than kitbashing one from the Atlas U23B and various shells as described in the article, but a far more accurate model results from the kitbash.

**NOTE: The kitbashed Atlas body could also be fitted to an Intermountain U18B chassis. ■**



## STEP 1: Marking the Loco Shells for Cutting

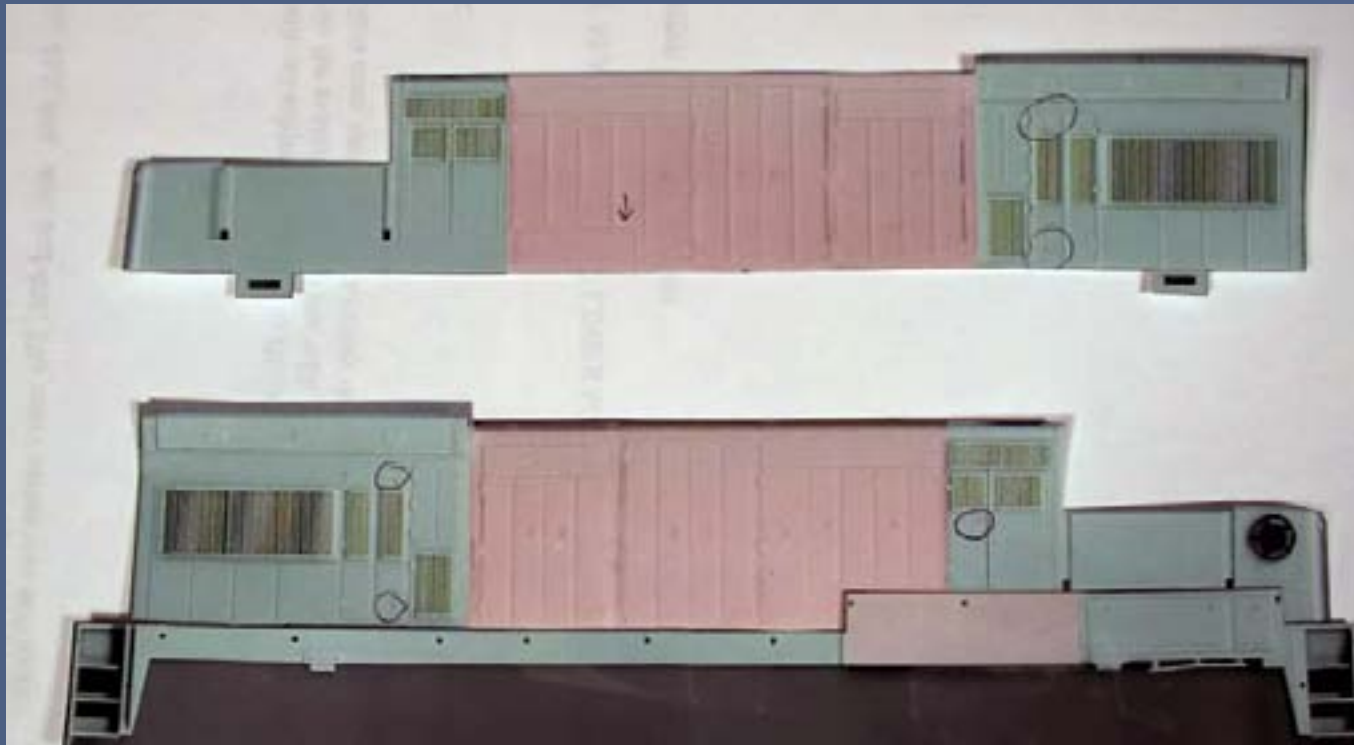

Figure 4.

It became evident that starting with an Atlas C30-7 shell would provide the needed items to bring about this kitbash. When planning these conversions, before I take an X-Acto saw to plastic, I often take the potential shells and put them in my flatbed scanner, in effect, making color copies of them. Then I print the images on my ink-jet printer.

This enables me to take scissors and some Scotch tape and piece things together at will. What you see in Figure 4 convinced me that this was do-able. Note that the circled areas represent round latches on the original U23 shell to be replaced with square ones for consistency. These can be stolen from the leftover pieces of the C30-7 shell. Also see the down arrow on one door – that short door needs to be a long door. This too can be taken from the C30-7 shell, which will be shown in the next step.

Figures 5 and 6 show how I marked up the Atlas C30-7 and U23B bodies (both sides) prior to cutting. I did the marking with a fine point Sharpie. If you make a mistake, some alcohol will easily remove the lines.

Any part marked with an “X” is not needed for the finished product, but should be retained to rob details from.

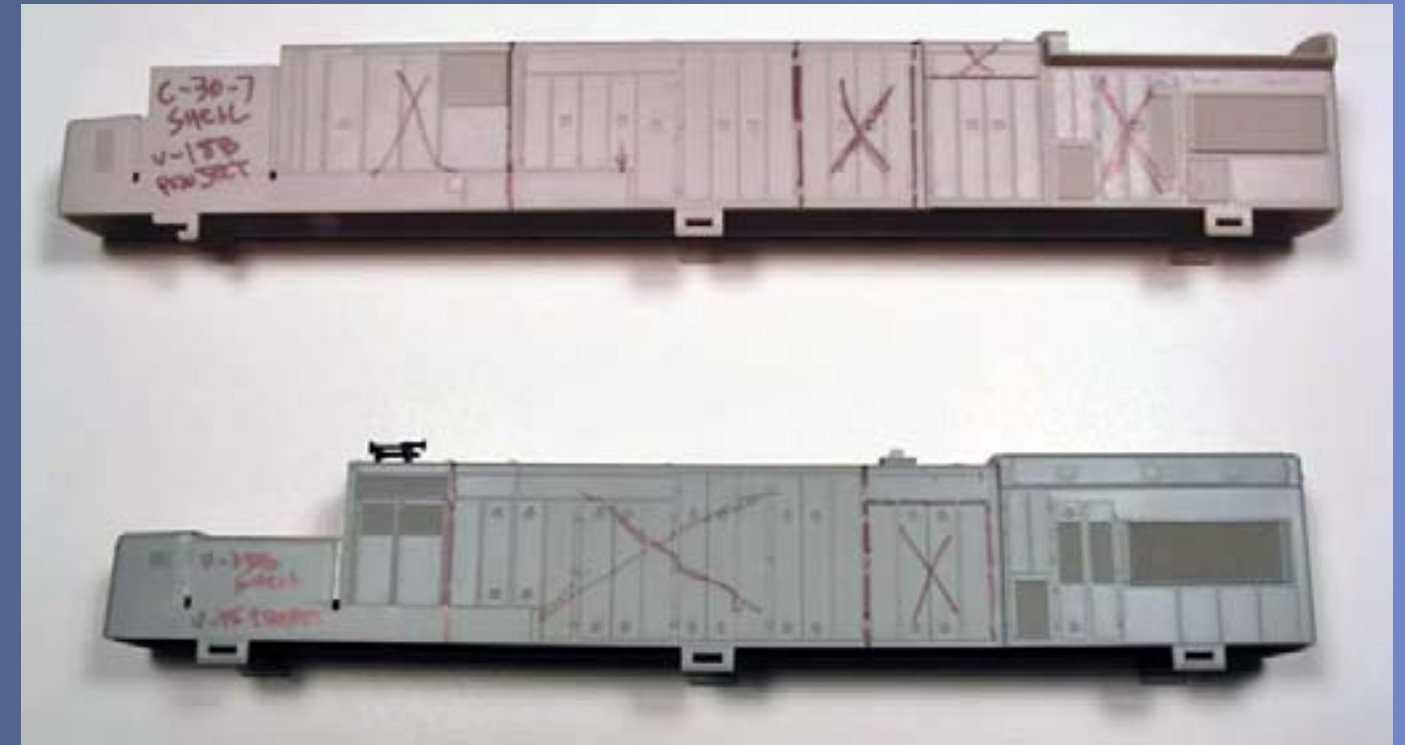

Figure 5.

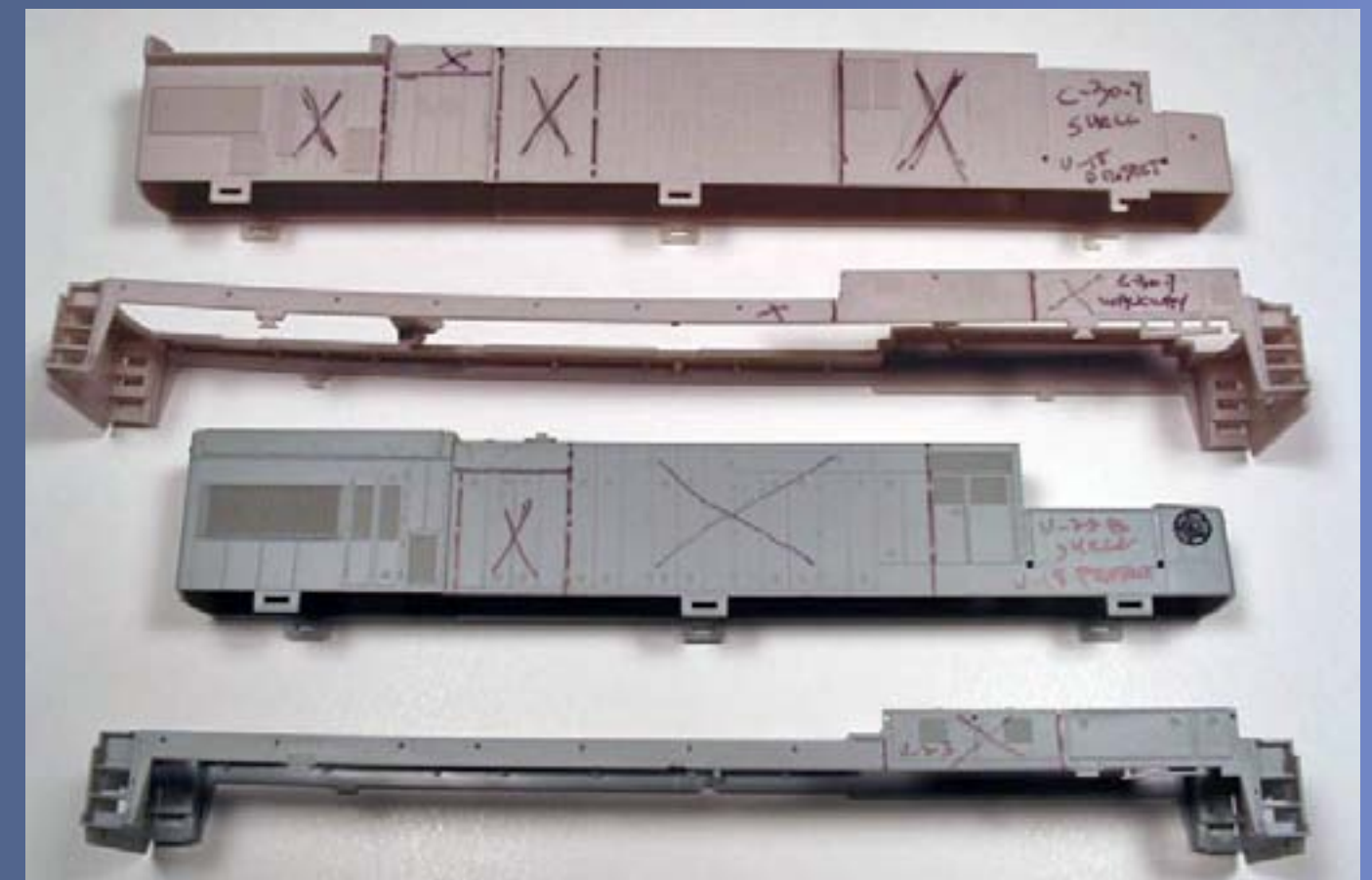

Figure 6.

## STEP 2: Cut and Assemble the Shells

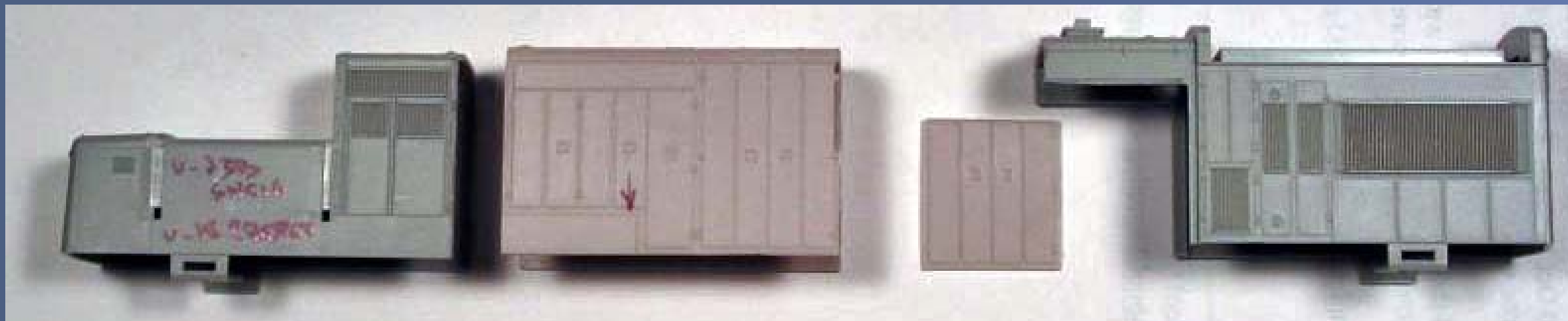

Figure 7.

I made some of the cuts on the Micro Mark table saw, and finished the rest with a razor saw. I deliberately cut outside the line to allow plenty of room for filing and sanding in order to get the proper fit. In most cases you are bringing the cuts back to existing seam lines on the prototype body.

Figure 7 shows the shell before assembly, with the pieces laid apart for clarity. Note how the lower portion of the wide section in front of the C30 radiator section has had its lower door section removed to add to the U23 normal width upper section. Also notice the arrow on the short engine compartment door – it has not yet been removed.

I had noticed this door discrepancy on the conductor's side of the engine room section: where there should have been three short doors and two long, there were four short and one long. The door that needs to be longer is the one indicated by the down arrow.

Fortunately, there is a door that can be stolen from the C-30-7 radiator section as shown in Figure 8. Once this door is removed, I cut and filed a corresponding spot for it in the body section as shown in Figure 9. I found it easier to do this door work before assembling the entire body.

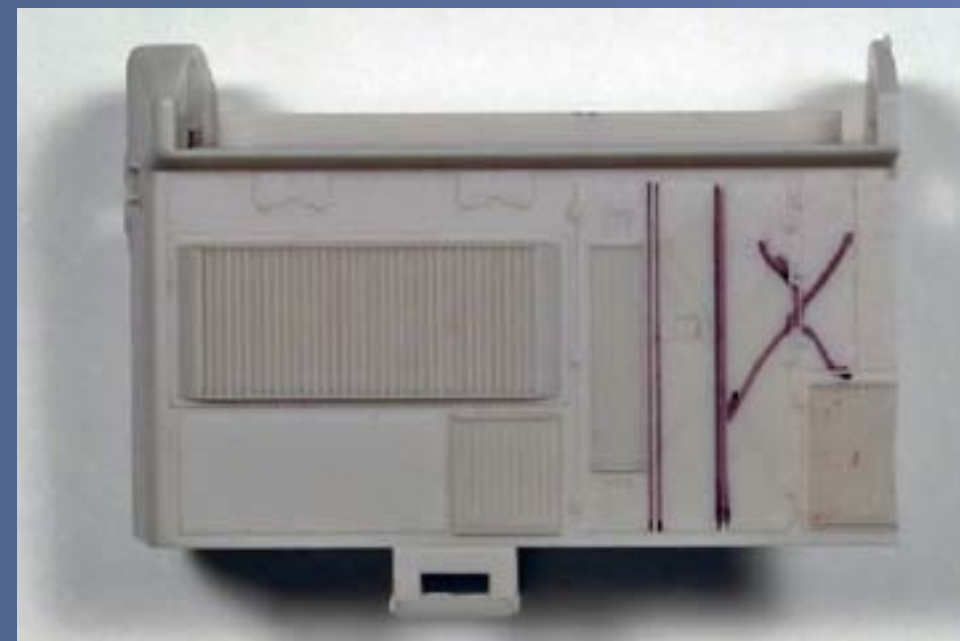

Figure 8.



Figure 9.

## STEP 2: Cut and Assemble the Shells *Continued...*



Figure 10.



Figure 11.

Working carefully, all body parts were built up by cementing with Ambroid Pro Weld plastic liquid cement, starting from the radiator compartment and working towards the cab. The Atlas plastic glues easily and quickly with Pro Weld. The left hand and right hand views (see Figures 10 and 11) show how careful cutting, filing and fitting pay off with virtually zero body putty needed.

You may choose to assemble the body right to the Atlas walkway. However, I felt that I was dealing with too many pieces to consider that option. I preferred to assemble the smaller pieces to the U23 roof section that was left intact, gluing one side at a time and letting it set up, then doing the other axis of the piece, since alignment is critical on this body. Once this had set up, I worked my way towards the cab, one seam at a time, filing and using a machinist's square to check my cuts.

## Bill of Materials

Here is the basic bill of materials for any U18B kitbash, assuming you are not doing a late production model. See the GTI Late Model Changes sidebar for what is needed to do a late production unit. The Details West AT-263 air tank set is a better choice than trying to piecemeal all the parts that are in it. It's a very useful kit!

Details West AT-263 (detailed air tank kit) includes the following items:

- air tank (qty 2)
- curved pipe (qty 2)
- elbow pipe
- fuel line pipe
- moisture evaporator valve (qty 2)
- small diameter pipe
- underframe bell (DW-127 bell)
- air filter set (DW 139 fuel system air filters)

**NOTE:** The last two items above are already in the original bill-of-materials reprinted below. Obviously, how much detail you add to your model is completely up to you!

### BILL OF MATERIALS

**NOTE:** This list identifies the correct parts for CSX, SCL, and MEC versions. Only one cab is needed, depending on which model is built.

#### Atlas

Atlas U23B (prefer undec)

Atlas U36C long hood (prefer undec)

#### Hi-Tech

Hi-Tech 5003 GE cab, standard with 2 windows (late FL thru CSX)

Hi-Tech 5004 GE cab, standard with 4 aux windows glass (as delivered SCL)

Hi-Tech 5005 GE cab, standard with 4 aux windows plated over (FL thru CSX)

#### Details West

DW-191 brass 5-trumpet horn

DW-324 cab sun visors

DW-295 mu-hoses (MEC)

DW-294 mu-hoses (SCL)

DW-268 air hoses

DW-127 bell

DW-149 fuel filler

DW-305 fuel tank detail

DW-157 firecracker radio antenna

DW 139 fuel system air filters

#### Utah Pacific

Utah Pacific 87 handrail stanchions

#### K&S Metals

K&S .010-inch brass rod

K&S .012-inch brass rod

K&S .015-inch brass rod

K&S .022-inch brass rod

#### Detail Associates

DA 2202 formed wire grab irons

DA 1403 GE-type drop steps

DA 2314 windshield wipers

DA 1708 class lights

DA 1009 warning light fixtures

DA 1570 mu receptacles

DA 3001 sand fill hatches

#### Other

Sunrise H-3001 brass cab sun shades

Custom Finishes 195 wheel slip modulators

MV Lenses LS22 headlight lenses

Evergreen .020-inch styrene sheet or strips

Kadee #58 couplers

Microscale 87-896 SCL diesel decals

Microscale 87-62 SOU diesel decals

(for yellow pinstripes)

Cannon BW-1108 brake wheel ■

## Saga of the Missing AHM U25 Shell

I was pretty sure I had an old AHM U25C shell in my scrapbox, but an extensive search failed to turn it up. Temporarily stumped, I put out an appeal on the Railroad Modeler Yahoo Internet group, and soon had one nice fellow who agreed to send me a beat up Stewart shell that he had. I figured that the Stewart had to be better than the old AHM, and eagerly awaited its arrival.

Imagine my surprise when I took it out of the box, and the class lights were basically in the same spot as the U23!! Further research revealed that this was a known error on the Stewart shell, apparently unknown only to me ...

Now it was back to Plan B. I had a very clear memory of that old AHM shell of mine, purchased as a Santa Fe red and silver unit, cut down to begin to make a U25B long before the Stewart model existed, painted (right over the red and silver) and lettered for Penn Central. That was at least 30 years ago! Eventually I realized I'd sold it off as part of a large lot of old shells, locos, and other parts during an upgrade of my fleet several years ago.

I managed to find the e-mail transactions I'd had with the gentleman who had purchased the group, and after a couple of photo exchanges, he found the shell! He was nice enough

to sell the shell back to me for what I sold it for, plus freight. Imagine what I felt when I opened the box and saw my 30-plus-year-old shell and paint job after an absence of several more years. But most importantly, it had exactly the right class lights that I needed for this project. I checked the dimensions of the nose, and they were very close, close enough that I felt I could do what I wanted to do with it.

The first step was a trip to the blasting booth to remove the black PC paint and also the layers of red and silver from the SF paint job.

At last, I had my long-lost AHM U25 shell, ready to use for my U18 kitbashing project! ■

### STEP 3: Battery Boxes and Walkway



Figure 12.

The walkway sections need to be shortened and, for this loco, the equipment boxes on the engineer's side need to be replaced with a pair taken from the C30-7 walkways. First, it's necessary to determine the correct length of the walkway and then where to cut it.

The prototype walkway is 50' 6" long from pilot face to pilot face. The length of the hoods just above the walkway from end to end is 48'6". Figure 12 shows the relationship of the walkway length to the completed body. Remember, there is only one foot of walk space at the peak of each hood where it meets the walkway.

On the prototype and the model walkway, more space is provided by the deck extending out beyond the face of the pilots, and of course the drop steps fill in the rest.

Figures 12 and 13 (next page) show the cut U23B walkway from both sides. Make a cut on the U23B walkway right behind the row of six equipment boxes, just where the walkway joins. Do the same on the opposite side. Next, make a cut just to the left (or rear) of the large, two latch box directly below the cab, vertically, on the engineer's side.

### STEP 3: Battery Boxes and Walkway *Continued...*

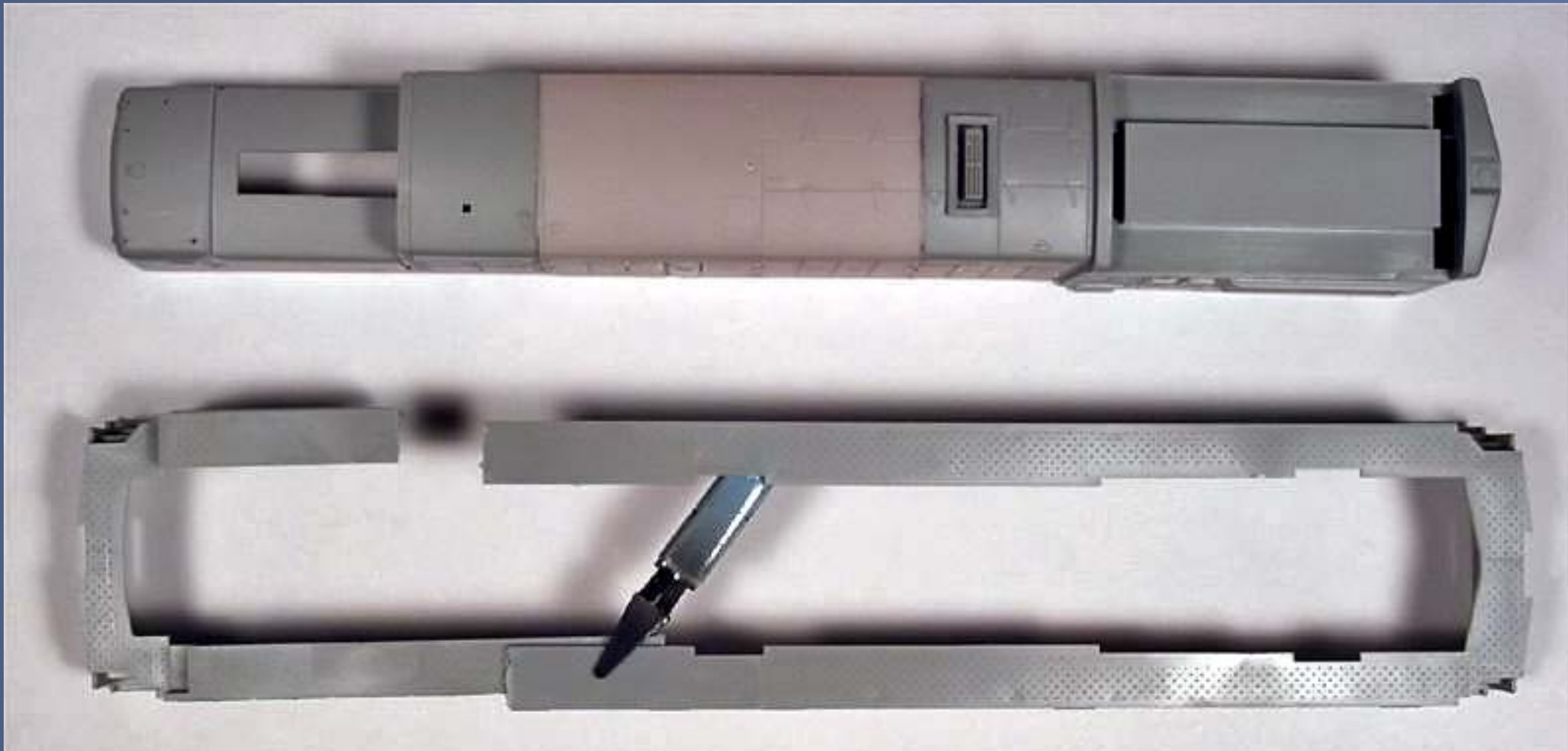

**Figure 13.**

Note that there is a gap on the engineer's side of the walkway visible in figure 13. This is because there is a segment that needs to be added in from the C30-7 walkway. One cut, towards the left, or front of the unit, on the engineer's side, is the starting point of that segment. Once it's partially in place, it's easy to determine where to cut the rear portion of the walkway.

To determine the proper place to cut the walkway on the conductor's side to shorten it up, I clamped one piece over the other and slid it until the length over the pilot face was the proper 50'6" and then clamped temporarily (you can see the clamp in Figures 12 and 13). Placing the assembled body on these clamped together walkways to check allows easily adjusting it to get the proper spacing at each end perfect!

However, when I marked the walkway for the cut, I noticed that the cut would fall right in the middle of an access panel on the walkway edge. This got me into looking into where these should be, and also handrail locations.

## STEP 3: Battery Boxes and Walkway *Continued...*



**Figure 14.**

Using a brand new single edge razor blade, I carefully sliced off, from left to right, the second and third access panels. The second one has to come off because you don't want to cut it in half, and the third one needs to go because one handrail stanchion goes there. I positioned these panels by eye to the left and right of the new stanchion location.

You should find that you remove about 5.5' from the conductor's side walkway, and about 7' from the engineer's side. Don't take those as exact, but rather use them to prove whether or not you're planning your cuts correctly.

Figure 14 shows the piece removed from the C30-7, as noted earlier. Cement it to the U23 walkway.

Remember to fill in the semi-circular cut out that was over the U23 fuel filler location. Not only is it in the wrong place now, but there is no cutout on this U18.

The decision had already been made that I would cement the body to the walkway, using the coupler pockets to hold the assembly to the frame. This would make for much easier shell removal. So I trimmed off any remaining mounting ears on the bottoms of the body sides, and smoothed these spots nice and flush. Despite assembling the body without the walkway, the hood body proved to be completely even and flush at the bottom.

## GTI Late Model Changes

Here are the parts you'll need for a late-model GTI unit:

- Atlas C30-7 long hood, part # 860200, and the "running board" which is the walkway assembly, part # 860207. The latter is needed for some of the equipment doors on the engineer's side behind the cab. The U18 for MEC was late enough that it had a lot of Dash-7 parts.
- Decal sheets would be the Herald King L-1970-1 for earlier lettering, or the Microscale 87-457 for MEC. For Springfield Terminal lettering, use Microscale 87-951.
- The bell for the MEC/GTI is a side mount behind the cab on the conductor's side. I'm using Details West BE-129.
- There is a plow on these units. The proper one seems to be the Details West the PL-120.
- There are ditch lights on the model in my era (1990-1998). I recommend the Details West DL-301.
- I had planned to use DW flag bracket FH-323 on the cab roof, but in the later paint scheme I did I noticed that the bracket had been removed, so bear this in mind depending on what time frame you are modeling. You'll definitely need it for MEC or early Guilford.
- There is a single white strobe on the cab roof as well, I ended up fabricating this part out of clear sprue as detailed in the steps (in the upcoming Part 2 of this article) since there appears to be no commercially available part. ■

### STEP 3: Battery Boxes and Walkway *Continued...*



**Figure 15.**

I ended up being unhappy with the length of the walkways. Translation: I cut off a bit too much! What I should have done, and what you should do, is leave at least 1/16" or more for truing and filing purposes. If you look closely in the photos, you can see that I added a styrene shim to the ends of the walkways to get to the overall correct length of 50' 6".

Figure 15 basically shows it all. You can see how the C30-7 battery boxes were "welded" in place, and how it relates to the rest of the body. The small vertical piece of white styrene at the joint is because I inadvertently cut the walkway too short!

Note that body putty has been used to smooth the seam a bit, and also that the handrail hole closest to the cut has been filled. It's in the wrong place. Also note that the "C" shaped cut-out that was above the U23 fuel filler has been filled in with white styrene, as it does not exist on this U18 and would have been in the wrong place anyway! To the right is the U25 nose, not yet modified or installed, but removed from the AHM shell.

The Hi-Tech cab has been built and is temporarily in place, but will not be used for reasons I'll talk about in Step 4.

## STEP 4: Cab and Latches

Jim mentioned that the Hi-Tech cab is his preferred choice for the SCL prototype, and I agree. Looking at photos of the earlier units, it seems that the left hand window post of the engineer's front window (which forms the cab corner), was simply too thick on the Atlas cab. So I went ahead and built the Hi-Tech cab, as you can see in Figure 15 (previous page).

However, I was not completely satisfied with the headlight/number board casting on the Hi-Tech cab, and I thought, "no problem, I'll just take the one off the Atlas cab", and proceeded to do so. After removing it from the Atlas cab, ruining it in the process, and sanding it flush, I noticed with some dismay that it did not fit in the available space!! So I set out to figure out why. Something was different, or wrong.

There was a big, full cover picture of a MEC U18 dead-on the nose, featured in the Diesel Era with the U18 article which has proved so useful for this project. I found myself staring at the photo, and realized that the Atlas proportions looked just like the ones in the photo! I proved it to my satisfaction by noting that the center post between the two cab front windows appeared to be the same size as the left hand post as described above.

The Hi-Tech now appeared to be too thin! You just can't win. Once I grabbed a spare Atlas cab and compared it to the cover photo, I felt it to be a better representation of this particular prototype. No question that when I look at most of the SCL prototype photos they look more like the Hi-Tech cab, so you always have to watch for such subtle variations on what would appear to be the same model. If you care about this, study the photos and draw your own conclusions. After making the comparison, I *elected* to go with the Atlas cab.

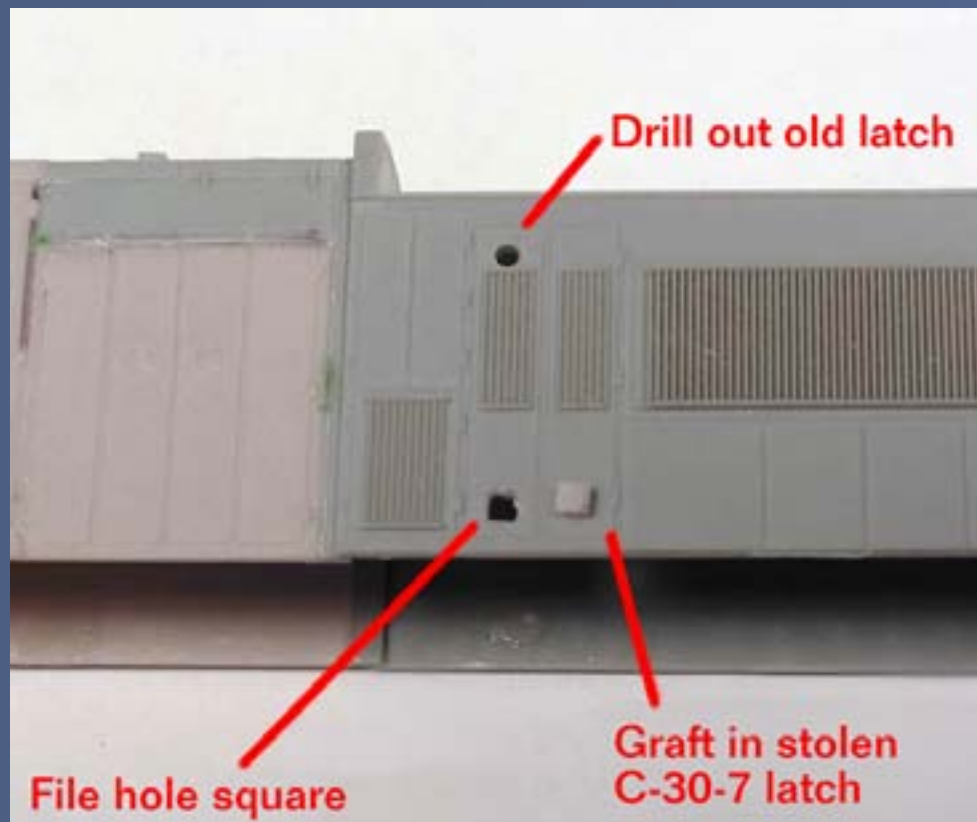

Figure 16.

For those of you doing the MEC/GTI units, there is definitely more "heavy lifting" involved, as compared to doing the SCL versions. One involves making the latches right.

In an earlier step, I painstakingly grafted in sections from the C30-7 in order to have doors with not only the latches in the right place, but also to have the correct shape. Note that the latches on the U23 sections are in the correct place, but are round, not square. (You could ignore this, and I won't say a thing if you do!) But the more I looked at it the more it bothered me, and the next thing you know, I was swapping latches on the spare leftover parts to see if it was feasible. Some things to keep in mind:

1. Replace the latches with latches from the corresponding locations on the C30 body (see Figure 16). Be careful. There are two different latch sizes! On the radiator section you need to use the small latches. Note that on the compartment right behind the cab on the engineer's side (that section is the generator compartment and houses the main traction alternator and the auxiliary generator) the latch needs to be relocated slightly down and to the left, which is why you see more body putty in figure 17 at the top right hand corner of the new latch. The old one was scraped flat and then filled in prior to re-drilling the hole.

2. You can dry fit these to your heart's content, then cement from the rear. Don't use too much cement! It's better to apply small amounts of cement multiple times than to apply too much all at once and then be sorry!

3. The removed latches are tiny and pesky. I lost one in a tweezer "incident" and it was gone forever in my Berber rug!

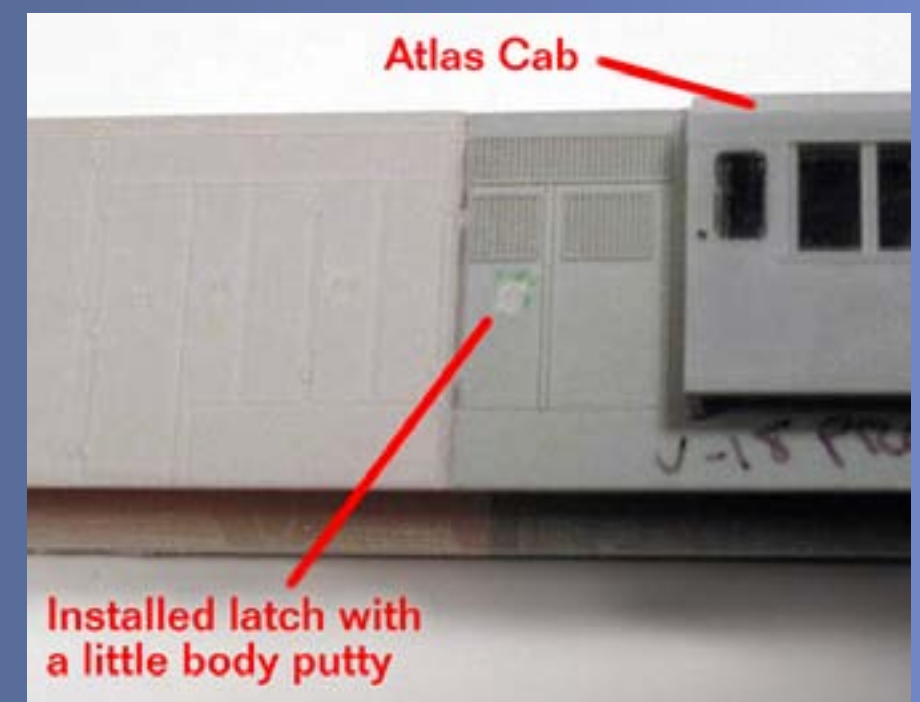

Figure 17.



## STEP 5: Rework Nose (optional)

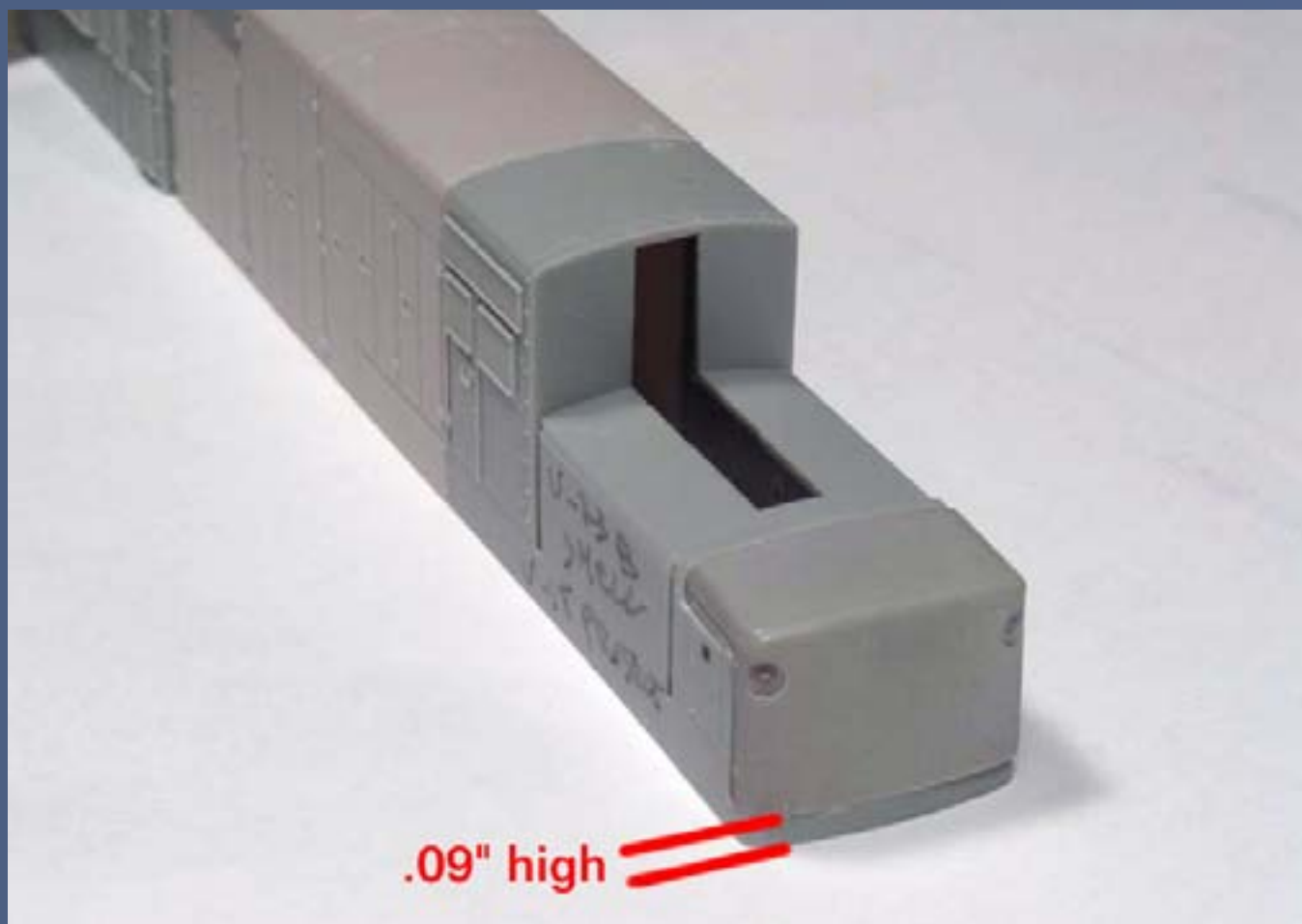

Figure 18.

After poring over the details and text in the Diesel Era article, it figures that unit 404 caught my eye. I happen to have a couple other images of this engine from Warren Calloway. The nose on 404 caught my eye, because it looks like a U25B, with class lights widely set, almost as part of the corners. Apparently because of a wreck repair, the creative shop workers decided to use an old nose from a “parts loco” U25 to fix the U18.

If you look carefully in the photos you can see the weld lines where this was done. As soon as I realized that, I was hooked. I’m always looking for a way to make a particular model distinctive, so I decided to recreate this repair!

Here are the pertinent details for those of you brave (or foolish!) enough to model the unique #404. Remember that a piece of the old Rock Island lives on in this U18 since the U25Bs originally came from the RI.

As shown in Figure 18, make the size of the nose piece you leave .09” high. This seems to jive nicely with the prototype photos. I judged it to be half the height of the equipment boxes and in line with the step.

Figure 19 shows the other two critical dimensions. One is the .55” dimension, that is from the bottom of the shell to the top of the cut. The .40” dimension is marked from the REAR of the cab mounting shown there to the front of the cut. The reason for using the rear is that the front of that groove has a slope and is not a good place to drag the point of the compass from. Do that on both sides.

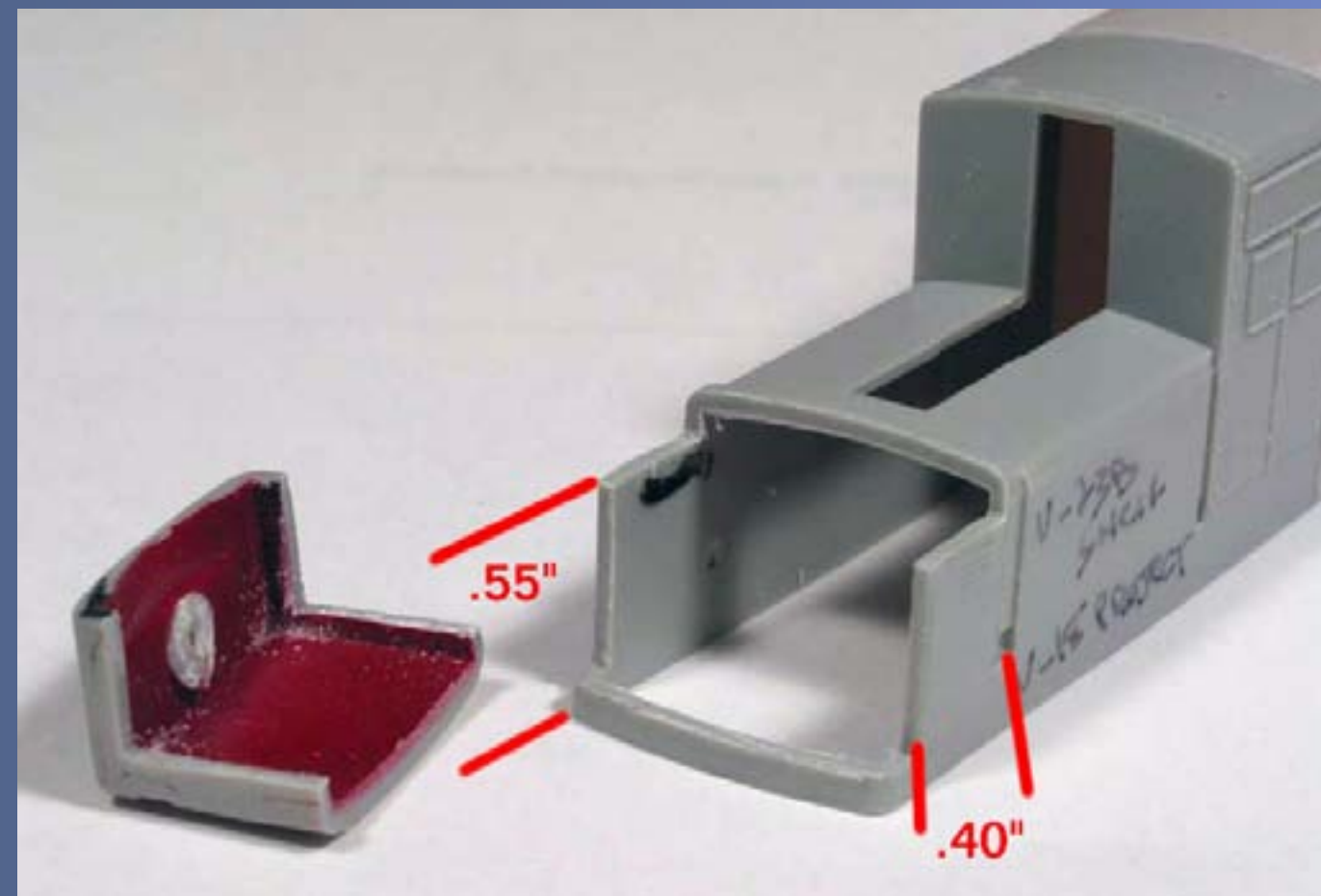

Figure 19.

## STEP 5: Rework Nose (optional) *Continued...*



**Figure 20.**

I used a compass (you can also use dividers) to mark the cut lines on the shell, dragging the point of the compass on the edge of the body, and used the pencil end to mark the cut line.

I made a horizontal cut into the U23 nose with a razor saw along marked lines. Then I did a downward cut to remove the front of the nose piece, followed by another horizontal cut towards the cab, and finally a short cut downwards near the cab windows.

Figure 20 illustrates using the razor saw to remove the AHM U25 nose by cutting right at the walkway level. Figures 21, 22, and 23 (next page) show the new AHM nose's fit after I chopped it along the weld lines I could discern from the various prototype photos I was using.

Once I had a nice clean cut on the body and trued it up with some judicious filing, I took to removing the necessary material from the AHM nose piece.

This is definitely cut and fit time. I used rail nippers to gradually snip away at the bulk of the material, which always works well for me. Don't try to take a big bite all at once or you will deform and crack the plastic!

I used a mill file and razor blade to remove the last of the material from the AHM nose. Work carefully so you don't inadvertently take material off where you don't want to. It can be tricky since you're trying to get two different pairs of surfaces to all align. Work slowly and carefully. I wanted to be confident that when I glued this in place that it would mate properly.

## STEP 5: Rework Nose (optional) *Continued...*



Figure 21.



Figure 22.

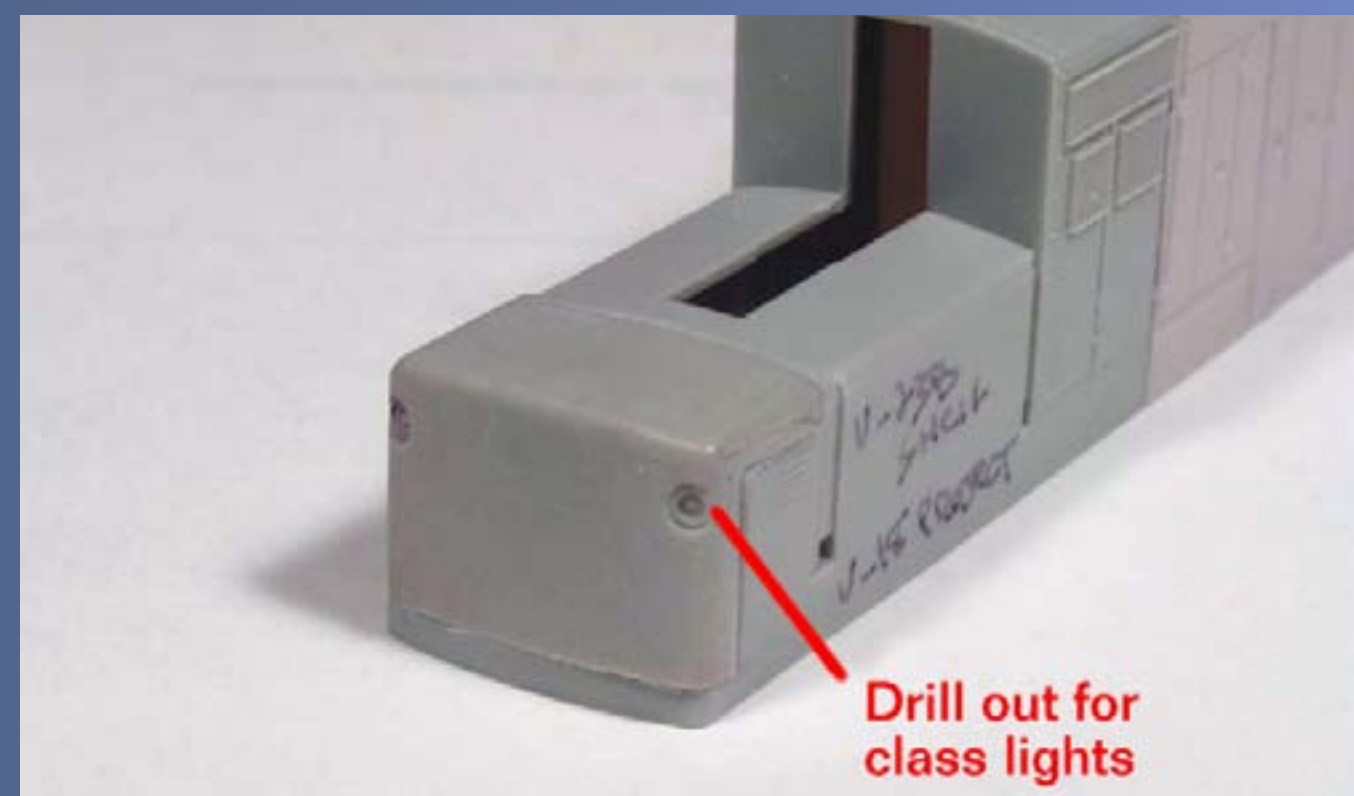

Figure 23.

Although the AHM contours are not quite an exact match, testing revealed that it could be persuaded into place by doing one seam at a time and letting it set in between. I figured that once I saw what those seams looked like, I'd determine if they needed any additional work to look like what the prototype did. The prototype weld seams are pretty neat, so as it turned out, I basically did nothing to the seams except remove a little oozed out plastic melted by the cement, leaving them as-is otherwise.

Figure 23 shows the final nose fit, and also notes that you need to drill out the class light depressions.

## STEP 6: Chassis Modifications



Figure 24.

Most of the chassis text and all the pictures in this step are by Jim Six, who has generously allowed me to use them to avoid simply re-stating a step that was identical on both the early production model that he did, and the late production model that I did.

To do this modification, I need to cut and splice the Atlas U23B frame to shorten it to make the new U18B frame. This is the most difficult part of the project.

While I completed a similar project several years ago using a hack saw and files, this time I used the machine shop at work to make the cuts and milling, which is much easier. If you don't have access to a machine shop, then small machine shops can be found in most communities. I called one and described the work that I did and was told that this could be done for anywhere from ten to twenty dollars at most shops.

Shown in Figure 24 shows the bare Atlas U23B frame. Figure 25 (next page) gives the dimensions of the cut lines that I scribed into the frame at each end of the fuel tank area and Figure 26 (next page) shows the cut-up components that make up the new U18B frame.

## Body Assembly Tips and Techniques

My co-conspirator Jim Six chose to assemble his body sections right to the walkway, and removed the bracing piece inside the cab that connects the long and short hood. He used the Hi-Tech cab.

Since my body was in a few more pieces than Jim's, it was far easier for me to completely remove the body mounting tabs, then cement in the first two short pieces just ahead of the radiator to complete that compartment. The radiator section houses a number of items including the turbocharger, cooling water tank, lube oil filters and oil strainer. In Dash-7 production, this section was "bumped out" (widened) to do away with freeze-up problems from the water tank being too close to the outside of the hood. Since this is a U-boat though, we wanted those doors. We needed them to not be bumped out, which is why we removed just the doors and added them to the existing U-boat top-of-compartment.

I never removed the piece inside the cab that braces the hoods together. This made for a stronger shell, and according to Jim, he decided later it was not necessary to remove this piece (nothing like hindsight).

Once I had that body section together and stable, I simply lined up all the body sections one at a time on a piece of plate glass (actually my work top is a piece of plate glass). I glue the next section in place, lining up the rooflines first, then doing each side at a time. The best way I found was to brush the Pro Weld on the edges of each piece twice, then put them together. Too much cement will give you plastic oozing out. Too little will mean that a slight gap might require body puttying and you'll get a weak joint. Experimenting on scrap is helpful, since the process can vary slightly with each type of plastic and cement used.

With the body completed, I used a mill file and then sandpaper wrapped around a piece of Corian to flatten out all the bottoms of the sections. There was very little material to remove, but the C30 sections were just a tad long. I used styrene to fill in the walkway spaces where the body tabs went through so there would be no gaps showing after I cemented the hood in place. I decided I would not do that until I had finished my nose modifications. ■

## STEP 6: Chassis Modifications *Continued...*

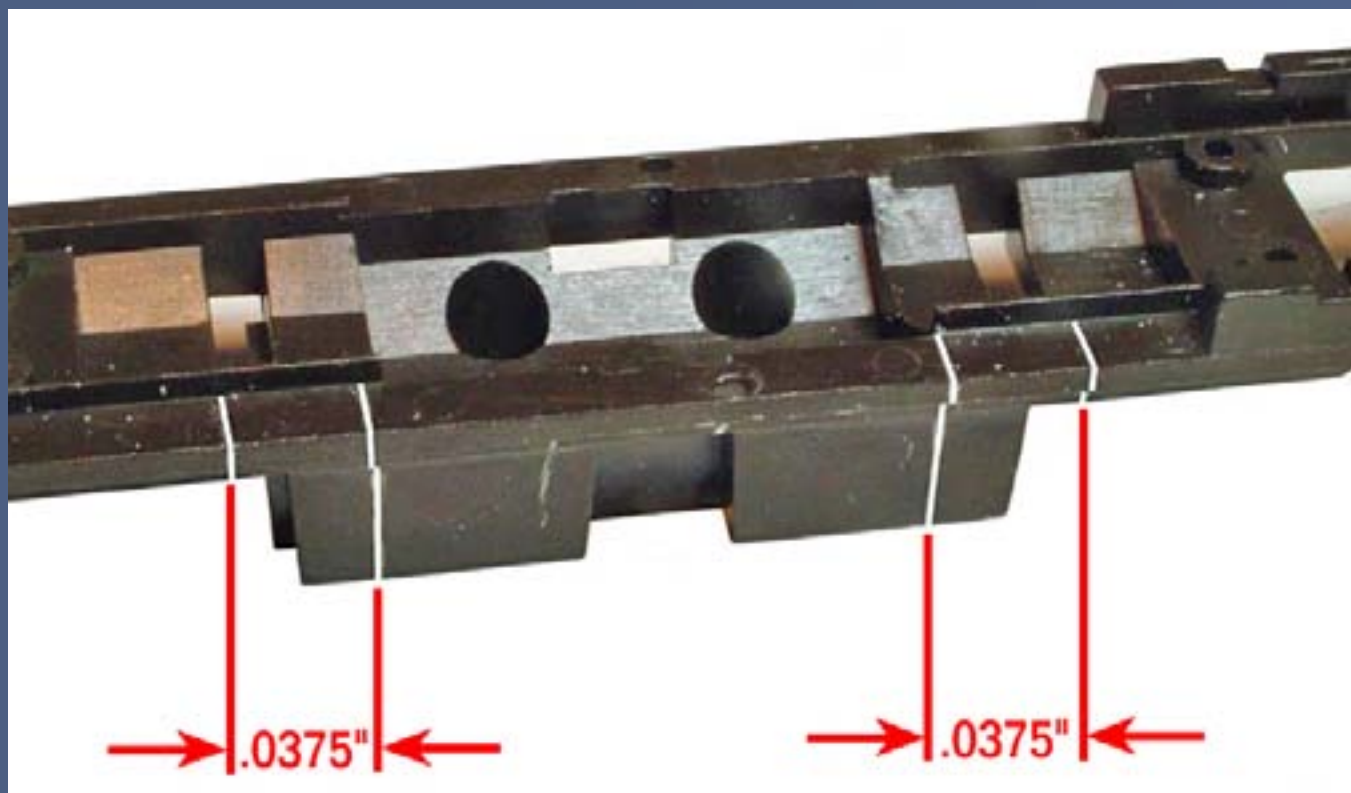

Figure 25.

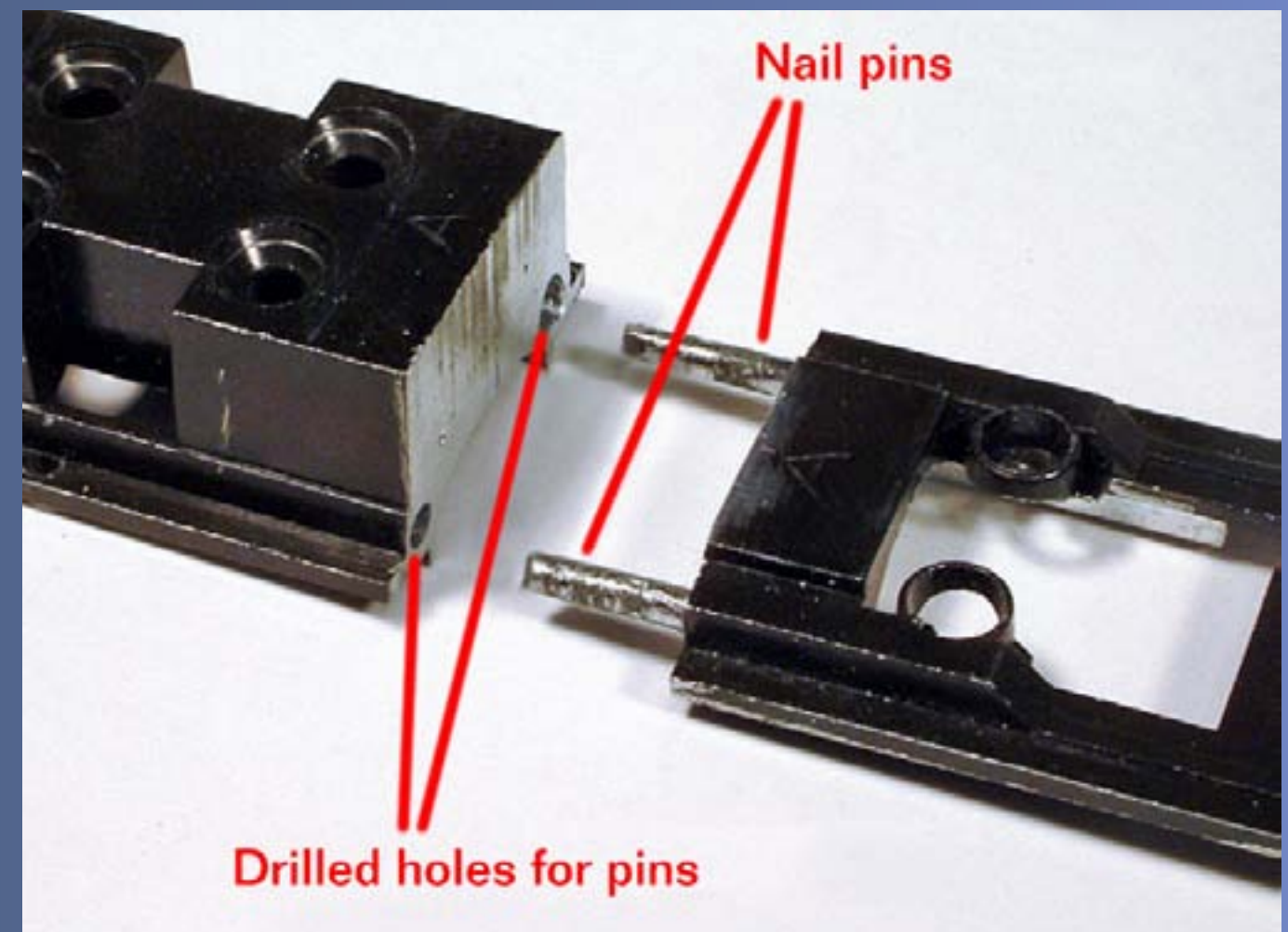

Figure 27.

Once I had cut the frame components, I drilled holes into both end sections and the center (fuel tank) section for the finishing nail pins used to align the frame pieces. You can tell the location of the holes from Figures 26-28 (Figure 28 is on the next page). I drilled the holes to "loosely" to fit a 6D finish nail. I say loosely because I wanted to allow enough play for alignment. Because I took care in locating the holes, I did not need to drill the holes much larger than the 6D nails.

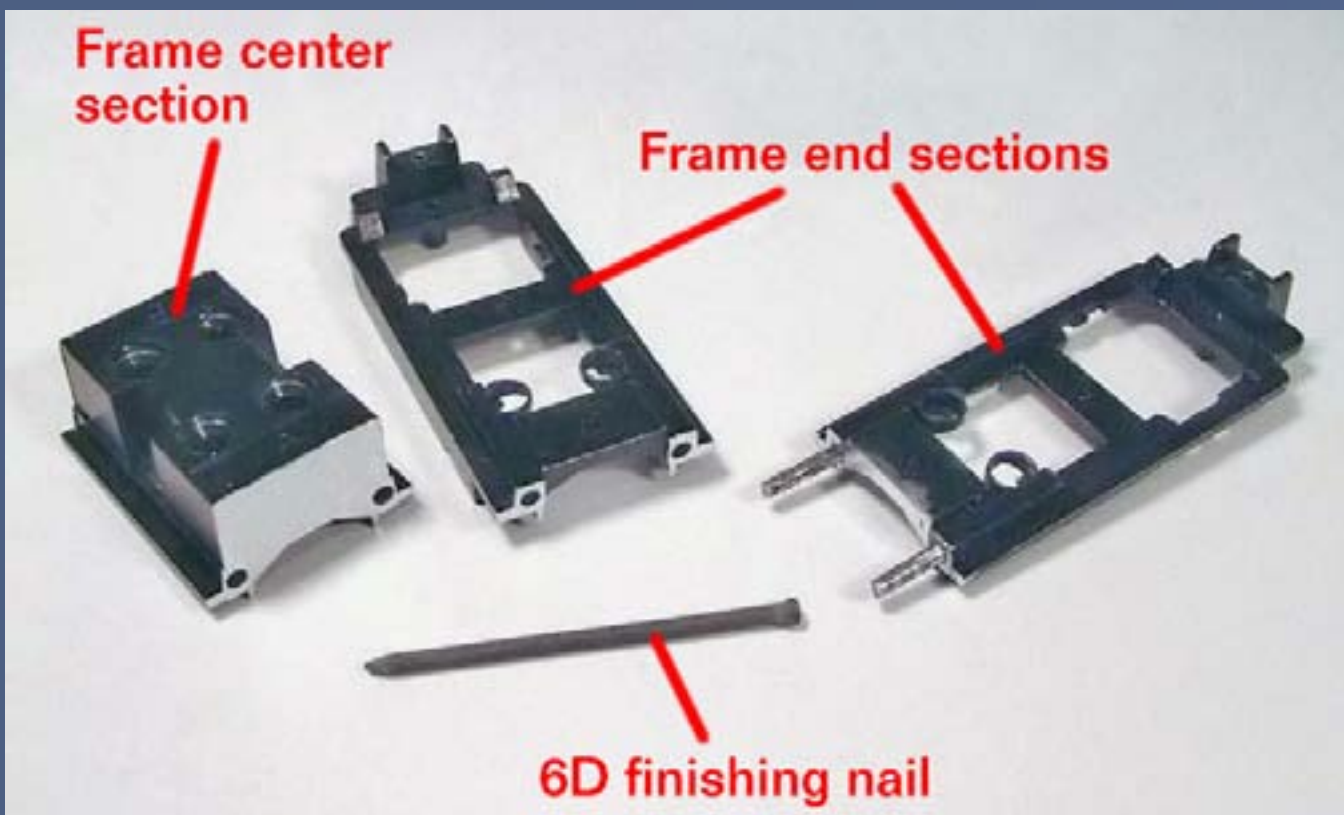

Figure 26.

## STEP 6: Chassis Modifications *Continued...*

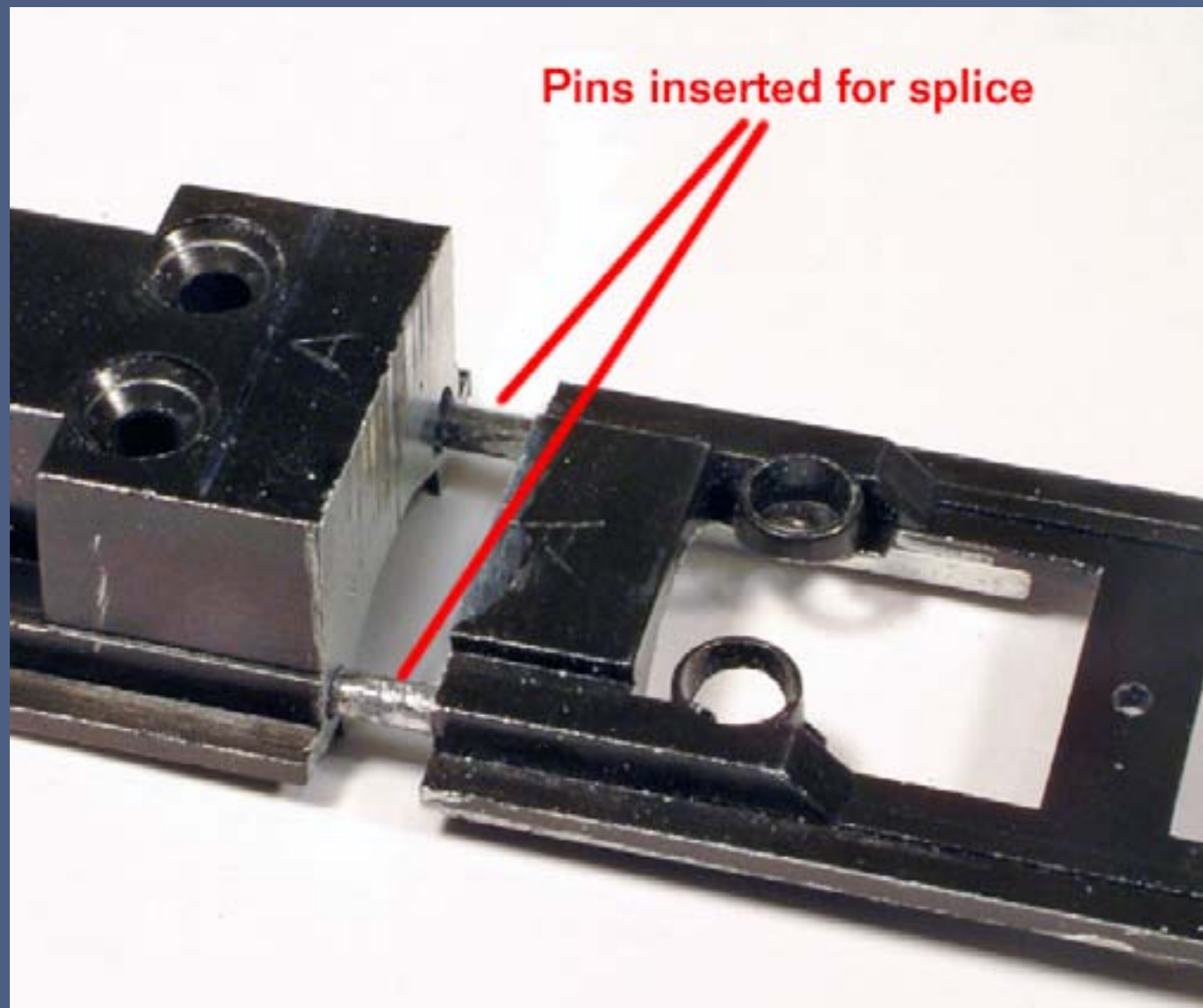

Figure 28.

Figure 28 shows the frame sections partly pressed together for a dry fit. Once I was happy with the dry fit, I filled the frame end with Cypox, misted the pins with Activator, and then quickly inserted them all the way into their holes. I applied Cypox liberally to the entire surface where it would join up to the fuel tank casting. I misted the fuel tank casting with Activator, then quickly pressed the two pieces together, held them for 10 seconds, and crossed my toes, hoping it would work out all right. Well, it did! The pieces were as if they were welded together (Figure 29).

I repeated the process for the other side, then further reinforced the frame by flowing some more Cypox into the offset holes from inside the fuel tank motor cavity area. Once this all set up it was quite rigid.

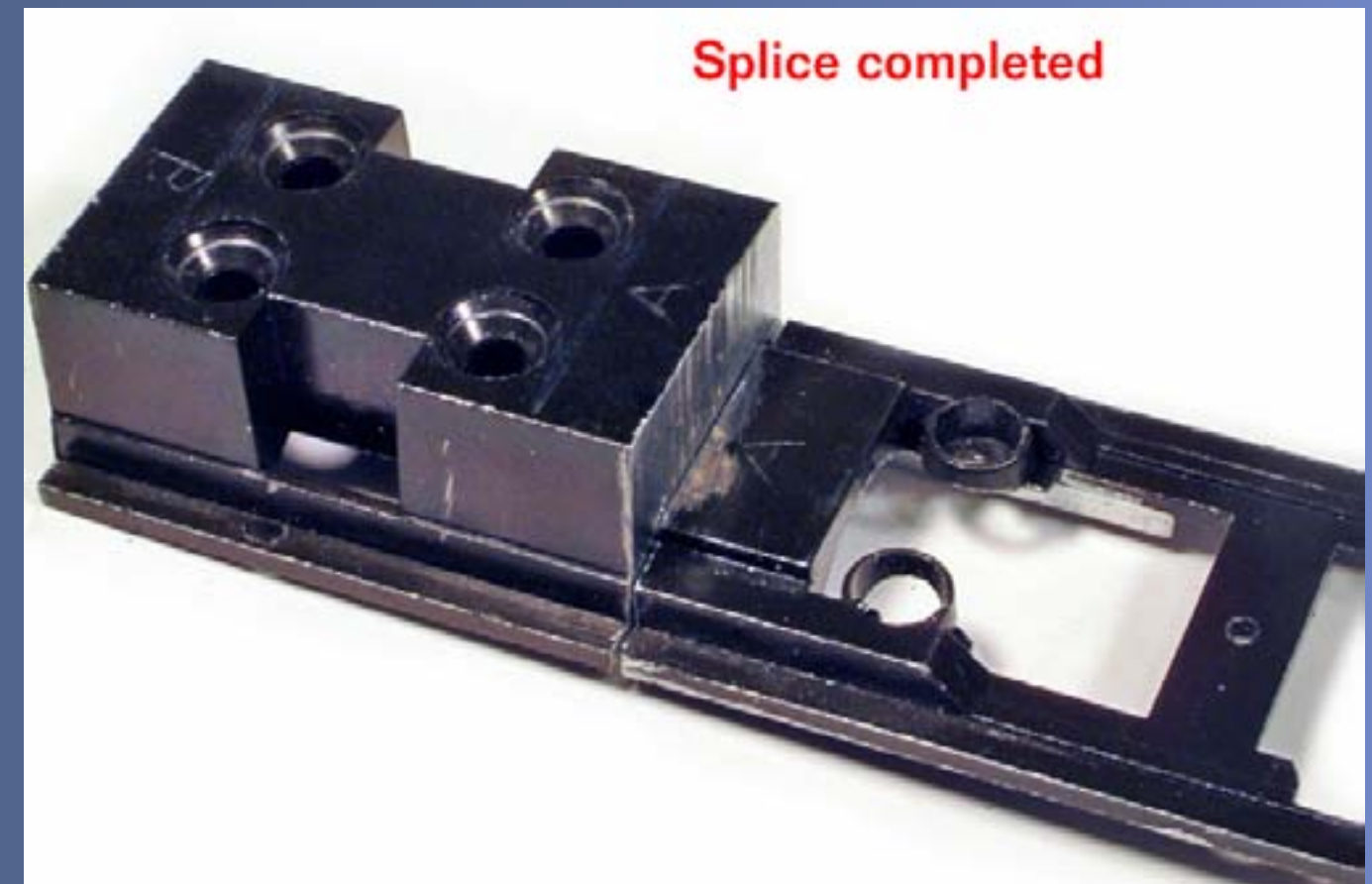
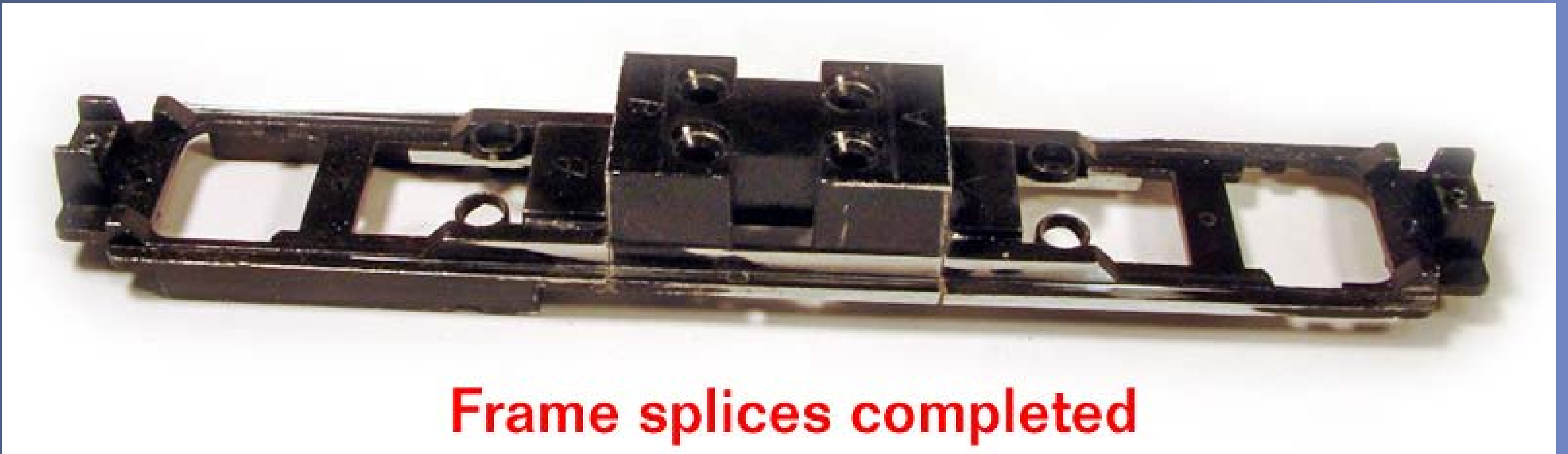

Figure 29.

Should you have questions about Cypox or where to get it please see the following link: <http://mrhobby.com/C-PoxCypoxEquivalent.html> (it should answer most of your questions and enable you to order some online).



## Frame splices completed

**Figure 30.**

Once the frame was glued together, I used a mill file to dress the bonded surfaces and make sure everything on the frame mated smoothly. See figure 30. The chassis test fit into the already shortened walkway nicely.

After cutting the fuel tank (next step) to the proper length, I discovered that it would not fit over the metal frame section that goes inside the fuel tank. Just remember that the tank needs to end up being eleven feet in length, so remove enough of the metal behind the old tank to get it to 11 feet.

A Dremel tool helped me quite a bit with this project. I used it with a cut-off disk (and always with eye protection!) to trim the length of the pins after the Cypox had set but before I put the frame sections together. I also used a Dremel with a straight milling bit to remove the extra fuel tank material and shorten it up to the correct length. A good file finished the job. It's not as fast as using a milling machine, but it works! I found that a larger toothed milling bit worked much better than a finer one, which kept getting clogged up. A medium speed also worked better than a slow or fast speed.

For those of you modeling the MEC/GTI unit who want to replicate sanders, this is a good time to remove about a sixteenth of an inch from each

of the four corners of the frame behind each set of steps. The MEC unit uses a frame mounted sander instead of the more common hose-to-the-truck type. I'll describe in another step how I fabricated these and mounted them to the body behind the steps. The removal of more frame material is needed if you decide to do that, and it's easier to do all this milling and filing all at once and be done with it.

I also discovered I needed to mill out a bit more of the frame to make room for the motor flywheels – see the sidebar “My chassis tale” for the details.

It's true this frame modification means this is not a beginner project, but it is quite doable and one that is definitely worthwhile. Once you get past creating the frame, it gets a lot more fun, trust me!

## My Chassis Tale – Snatching Victory from the Jaws of Defeat

Cutting up a locomotive frame is not a trivial task, and it definitely requires good planning. All of the cuts can be done with a hand hacksaw and plenty of elbow grease while hand filing.

I chose an easier route. Friend and fellow modeler Dan Risdon had access to a milling machine, and a deal was struck for me to do some grit blasting on shells for him in return for milling. Based on his description of the work, I definitely got the better of the deal!

**Cutting up a locomotive frame is not a trivial task, and it definitely requires good planning.**

Apparently it took him about half a day with help, creating fixtures to hold the frame properly, and working carefully. However, as the photos show, he did a great job and saved me a lot of time. I even had him cut the Atlas weights back for me.

Once I got the frame back, test fitting of the motor revealed that I'd need to hollow out part of the frame on each side under the flywheel, since this depression was basically what was removed as per the drawings. I did

this with an end mill held sideways in a Dremel tool, making sure I used eye protection and worked deliberately. I found that a larger cutter, with a slower speed, seemed to work best. The smaller fluted cutter kept getting clogged constantly and was very difficult to clean.

Assembly of the three major frame pieces didn't go as smoothly as I hoped. Despite the excellent cutting job that had been done, the holes I asked to be drilled in the fuel tank and the end frame pieces did not line up well enough. As I tried to rectify this with my drill press, I discovered why. The particular aluminum alloy used for this casting has harder and softer areas, and a drill bit tends to wander in it. I was close to taking another frame and starting from scratch, not something I relished.

Fortunately, I figured that there was nothing to lose from attempting to put this frame together. Choosing some clevis pins as a very rigid, smaller diameter linking device, I drilled new holes in the edge of the bottom of the end pieces and in the fuel tank casting. I then applied some Cypox to the end of one pin, and using pliers pushed it all the way into the end frame pieces. I then applied Cypox to the entire mating surface of the pinned end, and liberally sprayed

the fuel tank side with Activator, then deliberately pushed the entire assembly together. Checking the alignment at this point is critical, you only have a very few seconds to do this.

With pressure applied, the bond cured quickly, and I was once again amazed at how the two mated halves now seemed to be welded together. For good measure, I poured some Cypox into the holes that did not line up, since they were visible in the corners of the fuel tank where the drill bit had wandered. Despite the fact that they did not line up exactly, it proved to be a perfect conduit to flow the bonding agent. After it had cured, it acted like strong pins to help hold everything together. So in effect I was able to snatch victory from the jaws of defeat!

The U18 chassis has very little area to bond it back together via conventional means, so in this case Cypox proved invaluable. I'm told that another option would be to use

**The U18 chassis has very little area to bond it back together, so... Cypox proved invaluable.**

the TIG welding process to literally weld the aluminum frame, I know that other members of the U18B group did just that. So if you have access to the equipment or someone who can weld the chassis for you, it's something to consider. ■



## STEP 7: Trucks, Motor and Driveline



Figure 31.

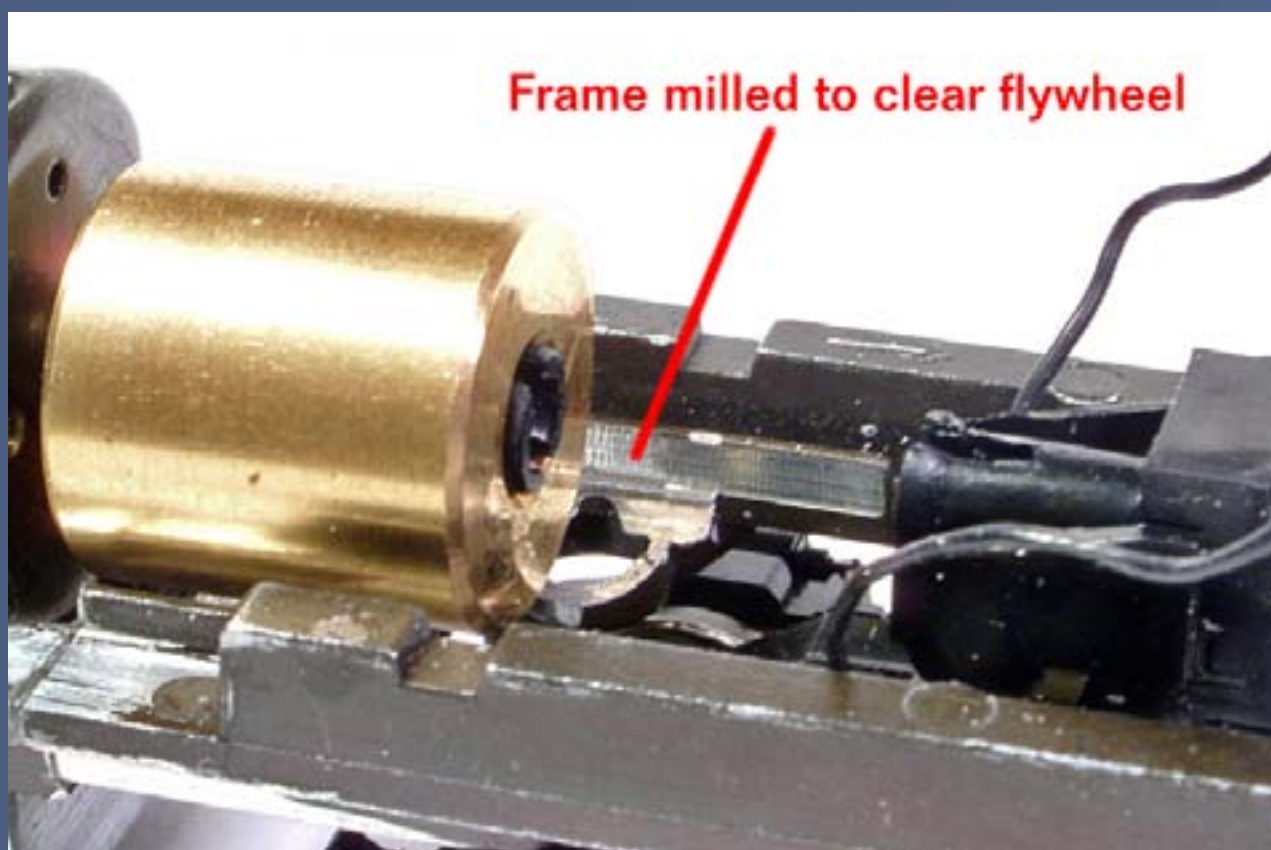

Figure 32.

In this step I test fit the trucks back into the modified chassis, see Figure 31. Note that the areas of the frame where the flywheels will reside have been milled out to clear the flywheels. I also filed the top surfaces of the frame flat at the splice seams using a mill file.

I chose to use the stock Atlas motor mounting method, retaining the plastic clip and lighting board from the U23. Once the frame was milled to allow room for the flywheel, the motor and flywheels dropped beautifully back into the original mounting location, Figure 32.

## STEP 7: Trucks, Motor and Driveline *Continued...*

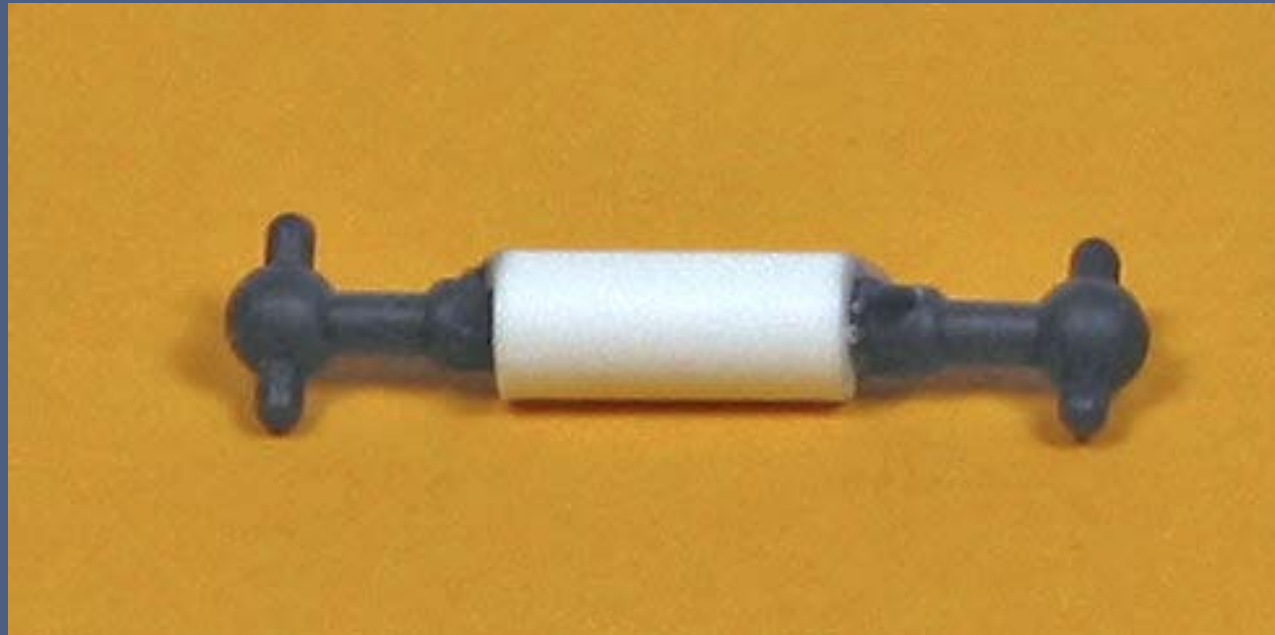

Figure 33.

Going strictly by trial and error, I removed a total of .31" from the middle of the drive shafts on each side. I then used a piece of Plastruct TBFS-4 1/8" plastic tubing as the splice on the driveshafts. See Figure 33. Since the shaft appears to be some sort of Delrin, I used the Cyvox Plastic Primer 302 material to prepare the shafts by applying it and waiting 90 seconds.

Then I put some Cyvox into the tube end, sprayed the drive shaft with Activator, and inserted it into the tube. I did the same thing with the other half of the drive shaft. This was allowed to set up overnight for maximum strength.

Figure 34 shows my completed drive which has been temporarily wired to do test running. Note that at this point the unit still has the FB-2 trucks that the chassis came with. In the next step, I'll show the upgraded Blombergs and how I soldered the connections to them.

I track tested the unit and it ran perfectly – identically to a stock Atlas U23B.

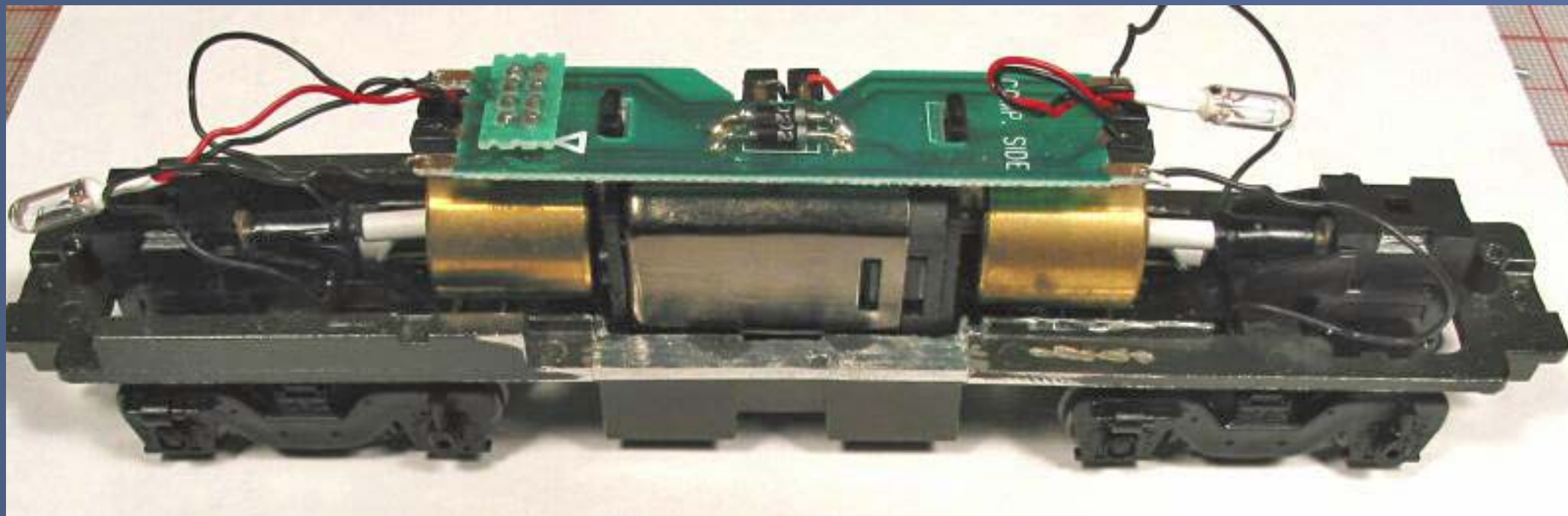

Figure 34.

## STEP 8: Truck Modifications

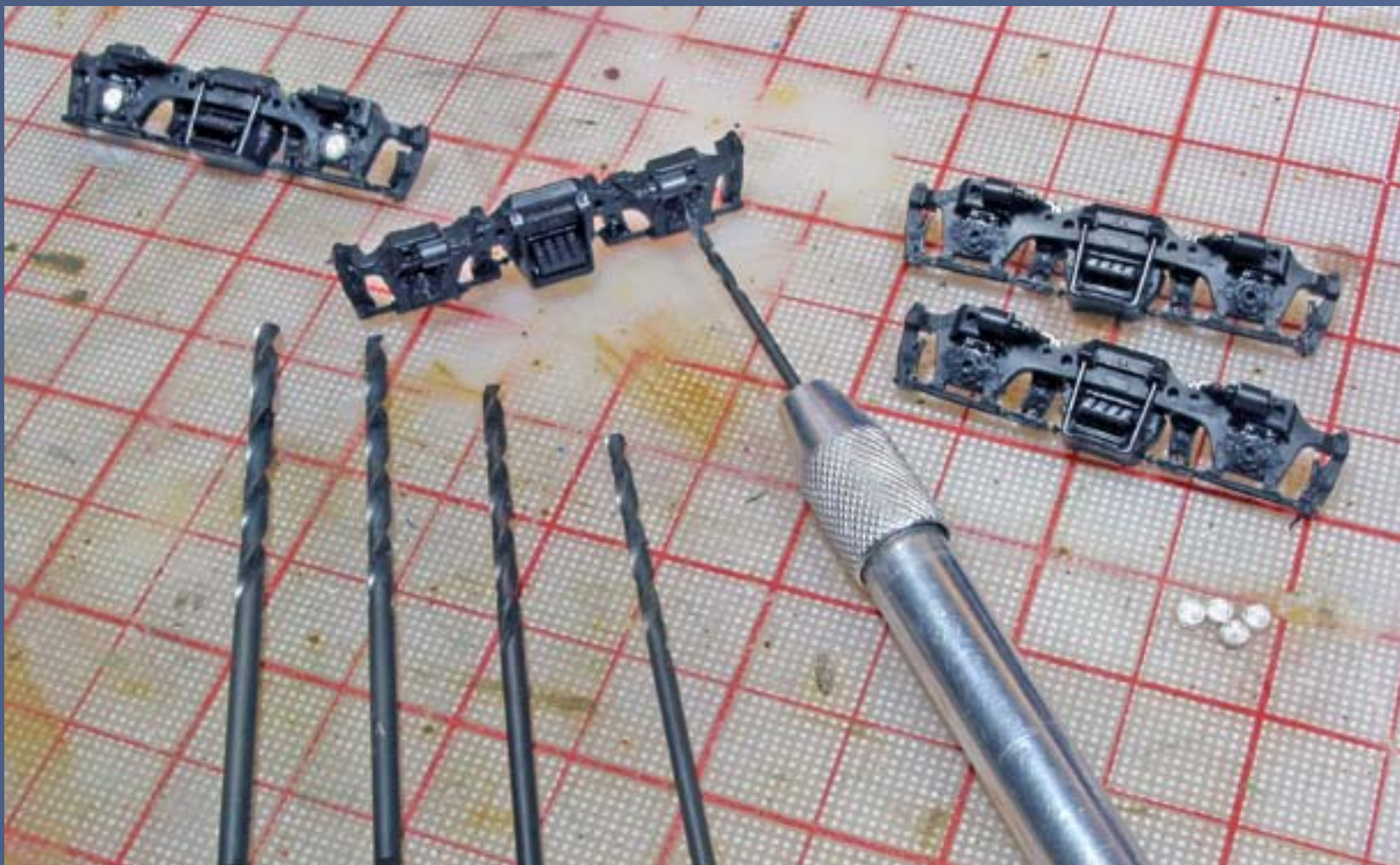

Figure 35.

The trucks used on the ex-MEC Guilford units have Timken bearings instead of the cast on Hyatts on the Atlas Blomberg sideframe. This part is available as Details West BC-244. I drilled out the Hyatt bearing with progressively larger drill bits, ending up with a #31, see Figure 35. Before installing the bearing, I filed down the remaining rim until it was flush. The BC-244 Timken bearing was then press fit into place from the rear, and tacked into place once I was sure of the location using the same Plastic Primer 302 /Cypox/Activator methodology described above: see Figure 36.

This is also used to hold the speed recorder (Custom Finishing S-196) on the right hand journal of the front truck on the engineer's side, and the wheel slip (Custom Finishing W-195) modulator on the right hand journal of the front truck on the conductor's side. The rear trucks just get straight replaced bearings only, both axles, both sides. You also need to trim off the little angled guides that are on each side of the Hyatts. The Timkens do not use these. (My thanks to Dave Carr for sharing his methods with me on this bearing replacement.)

Figure 37 shows all four truck sideframes to this point.



Figure 36.



Figure 37.

## STEP 8: Truck Modifications *Continued...*



Figure 38.

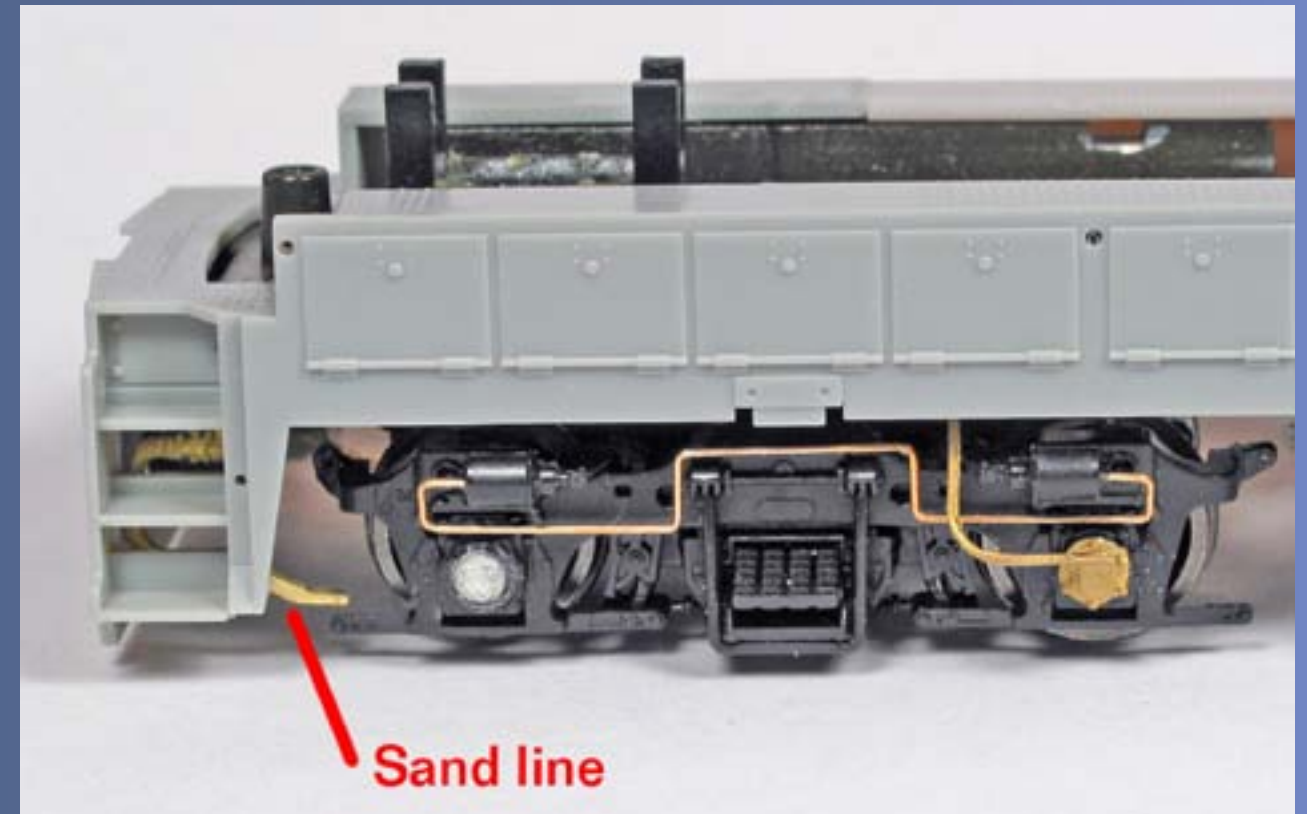

Figure 39.

Careful study of the prototype photos revealed other interesting things about these trucks. There are no outside brake shoes, so these were trimmed off completely. Do this carefully; you want to leave the little mounting hanger at the top. I drilled a #78 hole in each of mine on the dot that's there, and thinned that piece by about half using a single edge sharp razor blade. I also shaped it to resemble what I saw in the photos. Working from the bottom I also trimmed off the bottom bracket to remove the left over flat piece that remains once you remove the brake shoe on each side.

Now it's time to bend the air lines. For some reason, the brake lines on these trucks are particularly convoluted! Following the photos I painstakingly recreated the complex bends that the prototype Blomberg has. Anyone modeling Seaboard Coast Line will recognize these items.

The brake lines were inserted into holes drilled into the ends of the brake cylinders and secured with tiny drops of Cypox, see Figure 38.

Note that there are no truck-mounted sanding lines on these units. They have chassis mounted sanders that are visible behind the steps, which then curve towards the wheels and apply sand on the outside truck wheels only. Since these were clearly visible in the photos I had, and since I hadn't modeled this interesting feature before, I chose to give it a whirl (Figure 39).

## STEP 8: Truck Modifications *Continued...*

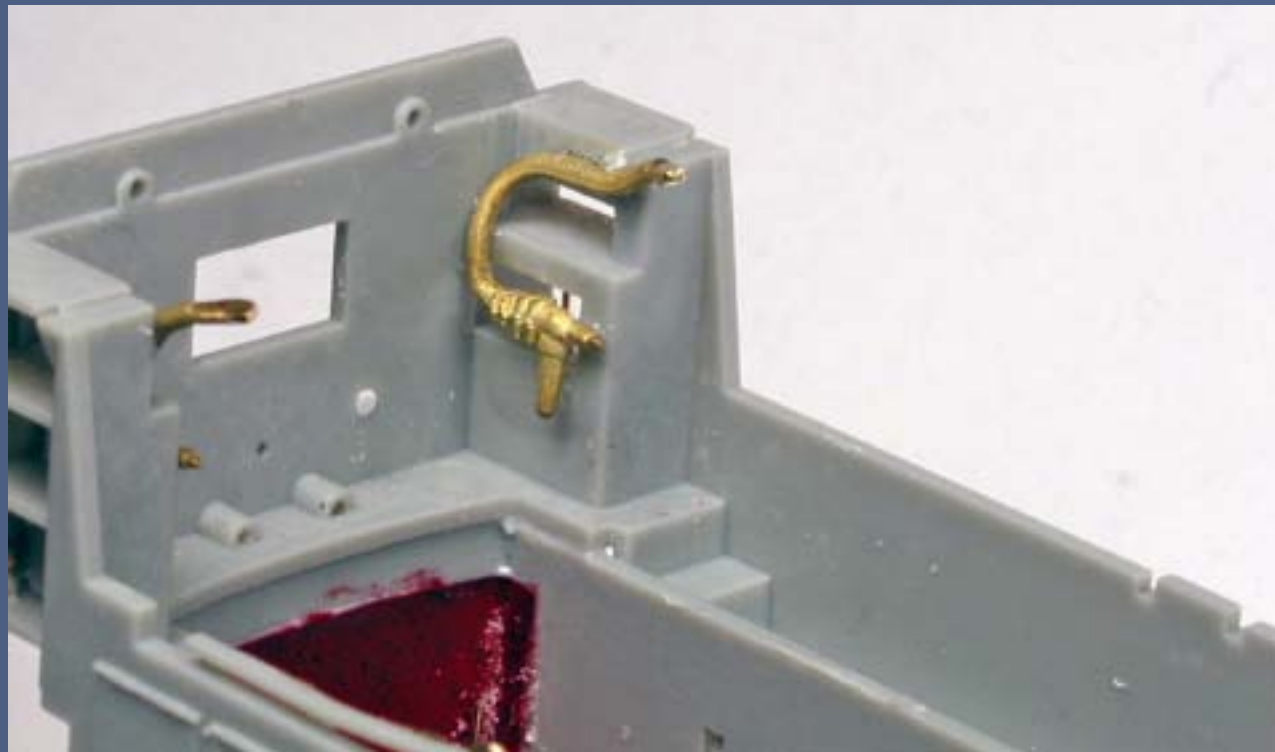

Figure 40.

The sand lines were modeled using some brass fittings I happened to have around from a collection of parts that I'd purchased. The ones I used were Cal Scale CV-265, which is a boiler check valve with a long molded on brass pipe. Two of these were cut, bent, and fit into place for the front sand lines as shown in Figure 40, and then bonded in place with a healthy amount of Cytop.

I took great care to have them positioned such that they would not interfere with truck rotation, yet still have the right appearance in terms of location. Using flat nosed pliers, I made a duck bill on each end going strictly by eye, and then trued it up with a file to make the "sander" nozzle.



Figure 41.

On the rear trucks, I used K&S 1602 1/32 solid brass rod and fashioned the straight and curved sections in a similar fashion. Be sure to angle both nozzles inward so that they are in line with the wheels. See Figure 41.

## STEP 8: Truck Modifications *Continued...*



Figure 42.

Once all four sanders were in place, I had a bad feeling, and test fit the walkway assembly onto the chassis. Sure enough, it did not fit! If you chose to go this route, you will need to mill off some of the ends on the chassis to clear the nozzles sufficiently to mount the body. Bonded to the inside of each stairwell, it's a safe bet that you need to take off a tad more than the 1/32 diameter of the rod. Fortunately this was easy to do with the Dremel and a milling bit, plus some filing. The finished sanders really dress up the loco and add to the "busy" look prototype diesels have under the walkways, as you can see in Figures 39 (previous pages), 42, 43.

On my last review of the details to be added to both the trucks and the underframe, I decide to see if I could capture the real chain effect on the handbrake. So I drilled a #80 hole vertically in the end of the left hand brake cylinder arm, and then fashioned a tiny hook out of .010 brass rod to accept the chain. Using the Cytox Plastic Primer material, I applied it to the brake arm, waited a minute and a half, then used a tiny dot of Cytox and spray of the Activator to hold the hook in place on the Delrin truck sideframe.

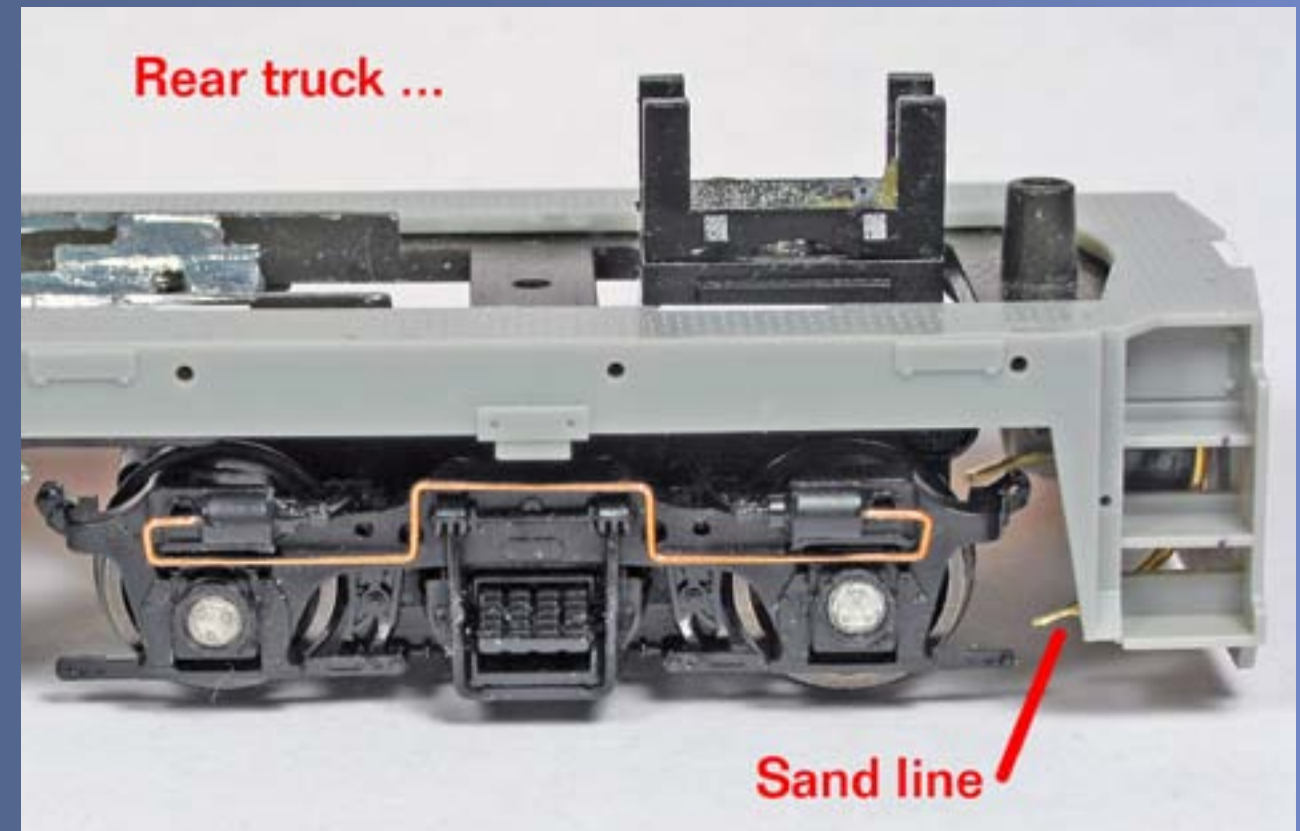

Figure 43.

I also formed a corresponding hook that I mounted in similar fashion but without Activator to the styrene Atlas body, behind the "pipe" that holds and guides the hand brake chain on the prototype. Now I had two tiny hooks that I could use to loop each end of the proper length chain through when finally assembling the model. Be sure you read the entire article before doing this step though, as things ended up changed as they often do! This is now a good time to move on to detailing the undercarriage and fuel tank.

## STEP 9: Fuel Tank and Details

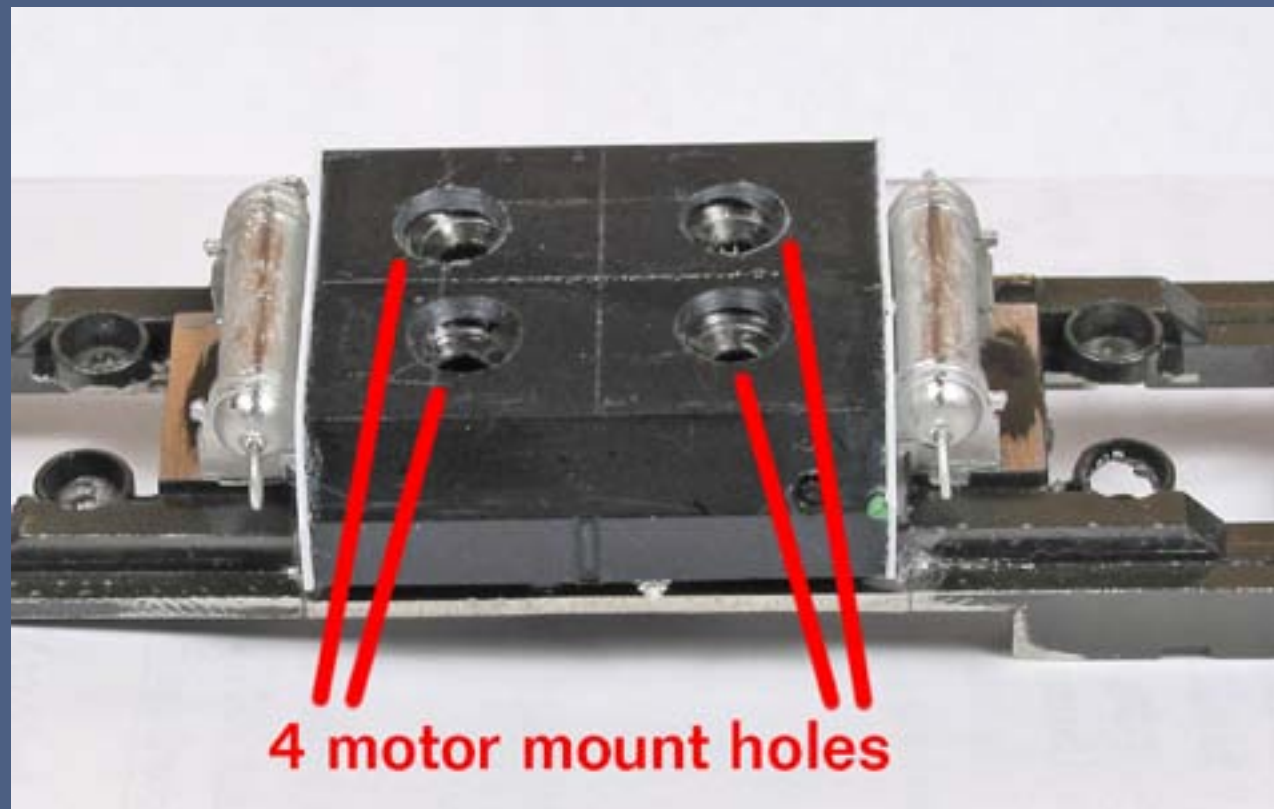

Figure 44.

The first order of business is to get the tank to the right length. I chose to glue the tank halves together, so that I'd be working with one piece. Then I marked a center line on the tank bottom, and measured 5.5' scale feet in either direction, to get my 11' total length. These cuts were made with a razor saw in an X-Acto miter box, and then cleaned up with a mill file to be just under eleven feet to allow for the thickness of the ends.

Next, I cut rectangles of .020 plastic bigger than the end of each fuel tank. I applied a liberal amount of Pro Weld to the edge of the tank, and quickly applied it to the rectangle sitting on my work surface. In order to get a good bond, I eased up on the pressure, applied a small flood of Pro Weld to the inside of the joint, and then pressed down until I got some ooze on both sides of the bond, indicating a good "weld". The process was repeated for the other end and allowed to set up overnight.

Imagine my surprise when, the next day, both end pieces were not firmly attached and began to come off when I started to trim the excess material! Shaking my head, I repeated the process with even more Pro Weld,

and waited again, only to have a similar result. I'm still not sure what the problem was. Apparently the Atlas fuel tank and the standard Evergreen styrene sheet I used were incompatible with one another. I ended up using Cypox to properly bond the tank end sheets to the cut-down tank.

After that had set-up properly, rail nippers were used to trim the end sheets to the shape of the tank, leaving just a tiny lip as on the prototype and as shown in the pictures. Final shaping was done with a file. I then needed to think about how to fasten this tank in place and get on with the detailing. See Figure 44.

Jim had decided to weld his motor in place with Liquid Nails and Cypox! I'm pretty sure that motor is not coming out, ever again. And I'm equally sure that while he'll probably get away with that. Knowing my luck, I'd burn out a motor the first time I tried to use the loco and need to replace it or remove it for servicing. I needed to preserve the Atlas loco mounting method, which meant maintaining access to the four screws that attach to the motor mounts from underneath.

However, at this time there was no way to hold the fuel tank in place! Atlas cleverly does this on the U23 by using the end air tanks, which are part of each fuel tank half, to hold the two fuel tank halves together in a press fit. The fuel tank simply grabs onto the frame, and indeed can be jiggled slightly since it's a bit of a loose fit. What is no problem on the U23 will simply not work on this U18. My intention was to remove the Atlas air tanks anyway, and the underframe was now different enough that the tank would not hold on the same way regardless.

I ended up holding the new tank in place, and using various sized drill bits to progressively drill out the four motor mount holes from inside the chassis, while the motor was still removed. This gave me the exact location of the four holes, which I next enlarged enough to clear the screw heads and allow them to be inserted from underneath into the Atlas motor mounts. The tank could then be glued to the chassis, since there would no longer be a need to remove it. This I did with a dab of Cypox, though silicone sealer could also be used.

## STEP 9: Fuel Tank and Details *Continued...*



Figure 45.



Figure 46.

I used Details West's excellent AT-263 kit for the air tanks and much of the associated piping, as shown in figures 44-48 (previous through next pages). I followed the instructions to get tanks that sloped for "drainage", then mounted all parts with Cypox for a solid bond and fit. Everything went well until I came to the moisture ejectors, which mount to the lower end of the tank.

The MEC/GTI photos that I had all showed a different and more complicated piping arrangement than I could discern from the Details West drawings, yet they were not good enough to clearly show me what to do. I felt that the looped pipe at the tank bottoms was visible enough to deserve reproduction, and that I'd be sorry if I didn't at least try. So the call went out for better photos or some close-ups.

Every photo I got was better than I had, but not quite what these old eyes would call a shot that clearly depicted the area. Still, I think it enabled me to replicate the looped copper tubing that is part of the ejector system. Micro Mark sells a set of wire shaping pliers, and I used one of them in

this set, on the smallest part of the plier, to form the loop in .005 phosphor bronze wire. This is very fine stuff, but I wanted to capture the different diameters of the various piping used in the air system.

I drilled a #80 hole (which was too big but it was the smallest drill bit I had) in the air tank right next to the ejectors, and also into the chassis frame right next to the already mounted equipment, then mounted this fragile detail with Cypox, a tiny dot on each end filling up the too big hole. I also chose to add the overflow tubing from the center fuel filler with .015 brass rod, shaping the bend with Kadee trip pin adjusting pliers. These form a nice radius and I use them a lot for wiring bends in HO. See Figure 46 (without walkway) and Figure 47 (with walkway, next page).



## STEP 9: Fuel Tank and Details *Continued...*



Figure 47.

I noticed that there was another filler of some kind on the conductor's side of the unit, about halfway between the end of the tank and the main, larger fuel filler. Chris Toth came through with a description of what this is and what it is for:

"That is actually the engine oil drain pipe. This is usually a 2 1/4" or 2 1/2" pipe with either a straight nipple or 90 degree fitting and a pipe plug in the end. Somewhere in the pipe is a valve. The plug in the end of the pipe is to prevent the loss of the engine oil in case the valve fails or is accidentally opened." He also informed me that it's on the left side only because the oil piping and filter are on the left side of the engine.

Scrounging around in an assortment of brass fittings I "inherited" when I bought Brian Banna's collection, I found a second use for the Cal Scale part # CV-265 Boiler Check Valve. It was pretty close to what I was looking for, and as described by Chris.

So I trimmed it down with rail nippers, filed it flat on the two spots where it was to be glued (on the bottom to the tank, and on the rear to the frame, and bonded it in place with two tiny dots of Cypox – it's the brass fitting in figure 46 (previous page).

See Figures 45-48 (various pages) of the tank area for final before-painting depictions of these details.



Figure 48.



Figure 49.

## STEP 10: Detailing the Body

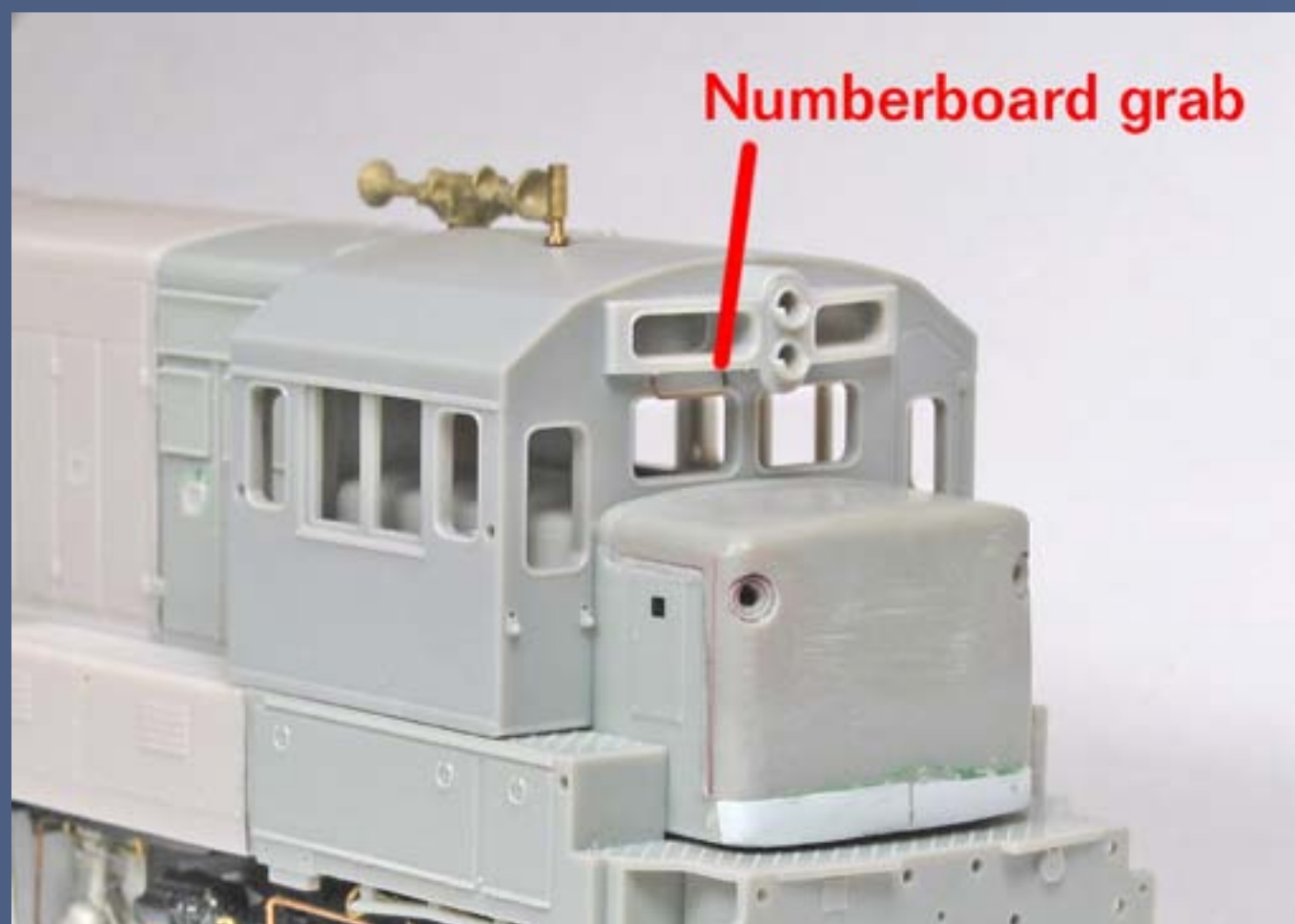

Figure 50.

There are a few metal details that are best added to the body before painting for ease of assembly and bonding. I like my detail parts to be very rugged so as to withstand handling. With that in mind, I try to bond them directly to the plastic whenever possible so as to not depend on a paint bond, which is always weaker.

To get the proper prototype look to the model, placing the parts in the right location is essential. It's not always easy to do this without a whole passel of photos that show everything from every angle, which can be nearly impossible. Fortunately the *Diesel Era* article had enough different views that, when combined with the other photos I had, provided enough insight to deduce where everything mounts.

First, I drilled holes for a grab iron under the engineer's numberboard as you can see in Figure 50. This grab is a straight one that I bent from .015 phosphor bronze wire. I installed it with very tiny dabs of Cypox, and

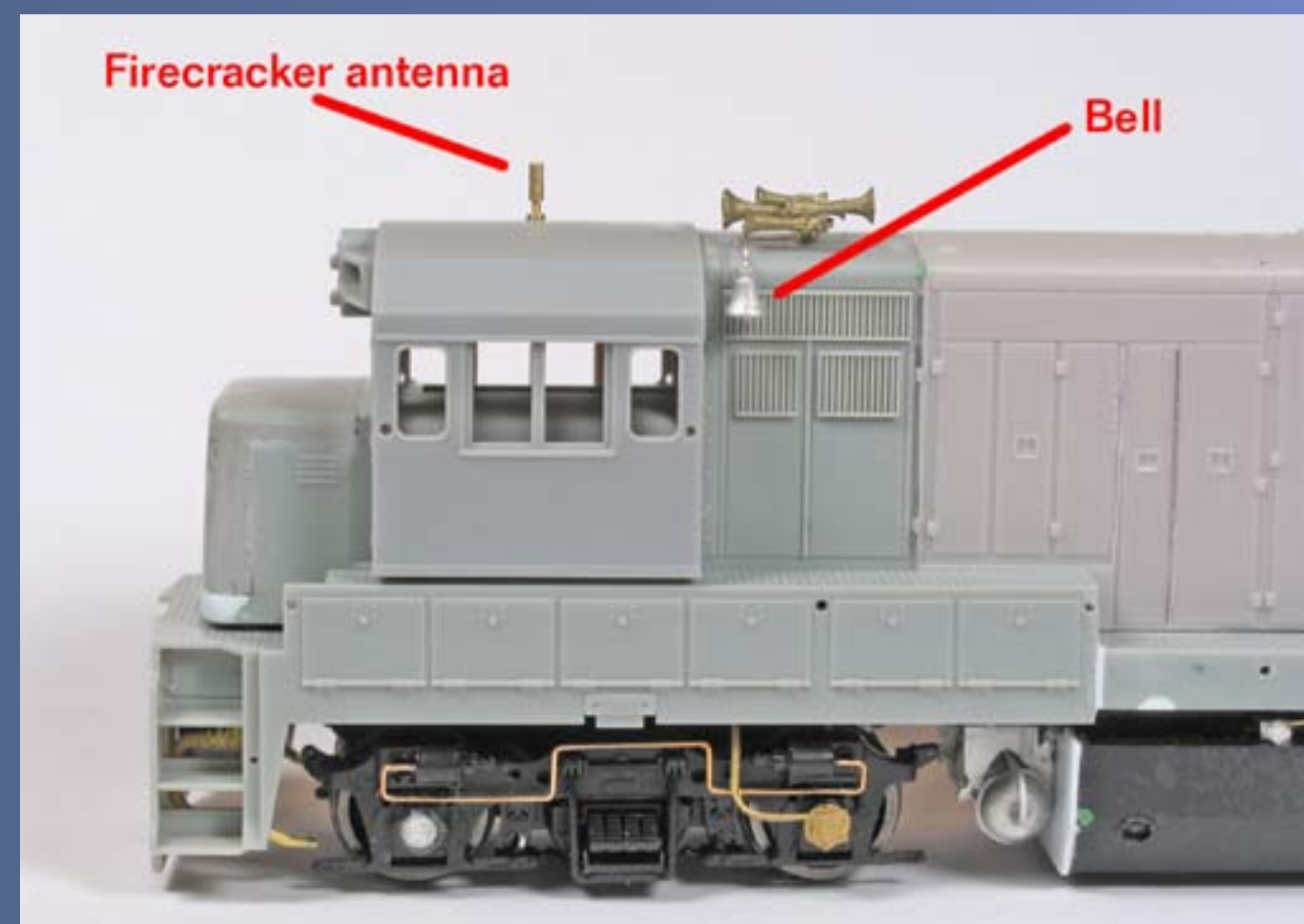

Figure 51.

when it had set-up, used a small file to trim it flush on the inside so the numberboard inserts would fit properly.

Figure 50 also shows my latest progress on the nose. I've drilled out the class lights, and I've laminated some .005 strip styrene to the bottom of the original U23 nose so that I could then file it down to match the contour on the U25 nose – it needs another touch up of putty and sanding. To capture the feel for this loco, I'm working to match the seams that exist on the prototype. They grafted this nose on the real loco, so I've deliberately not made the seams *too* perfect.

I drilled a #66 hole in the cab roof for the Details West RA-157 firecracker antenna. See figures 50 and 51. I located this exactly in line with the center member of the cab window looking from the side, and just to the left of the headlight looking from the front – all deduced from photos.

## STEP 10: Detailing the Body *Continued...*

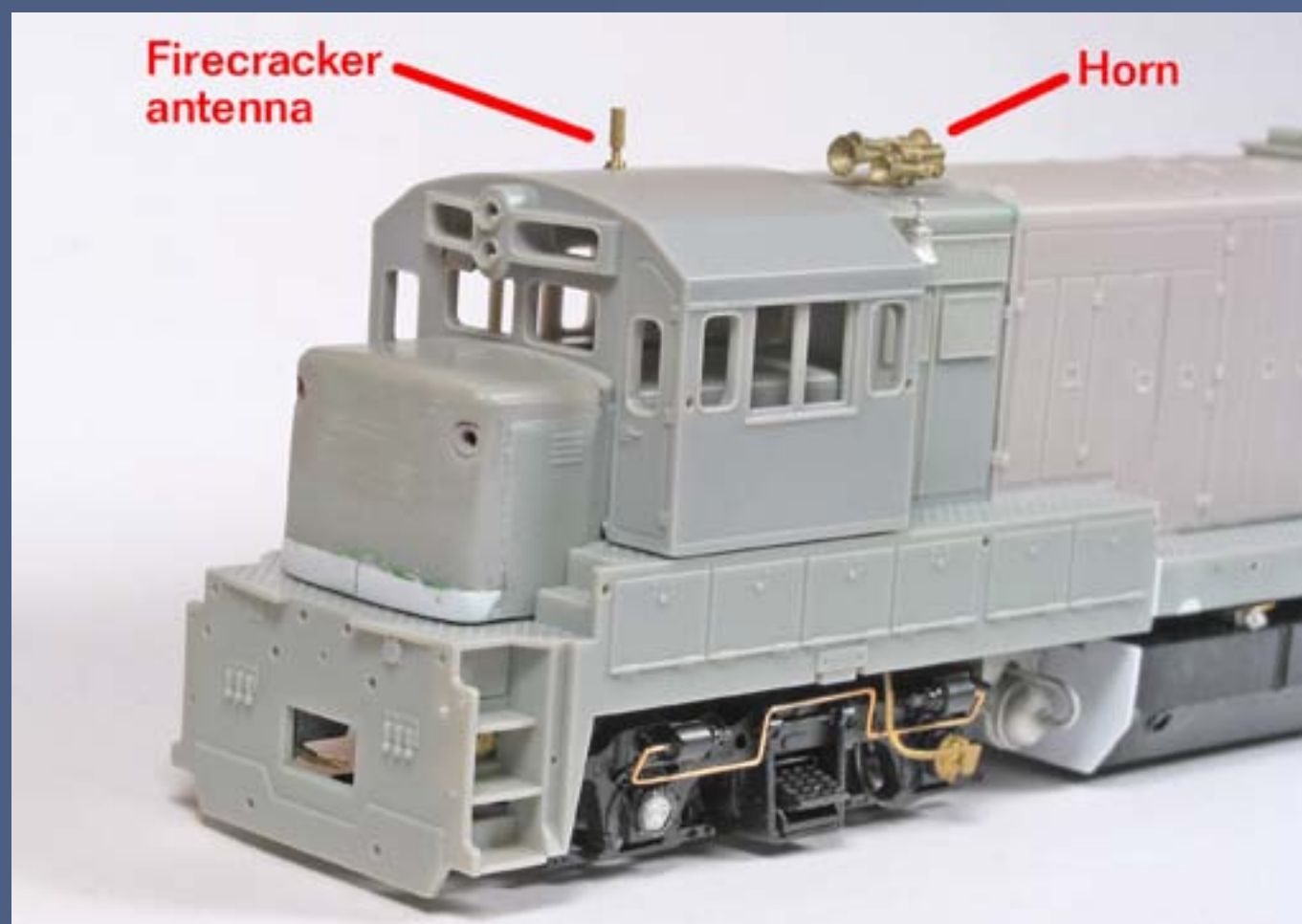

Figure 52.

I drilled a #60 hole just above the top intake grill, right behind the conductor's side of the cab rear window, see figure 50 (previous page). I located it just far enough aft so that the Details West BE-129 side mount bell will fit. I found I needed to file a bit of the mounting bracket on the bottom, as the mounting area is very small. I mounted a Details West AH-191 5-chime horn in the stock Atlas horn location, with the three chime side facing forward, see Figures 51 (previous page) and 52.

I very carefully drilled out the class lights on the cab front and long hood rear with a #56 drill to accept a Details West JW-1708 lens, but I of course did not install them yet – see Figure 53. I wanted to be ready to insert the lenses after painting the body and Dullcoating the decals. As anyone who has messed this up knows all too well, it's essential to get this hole centered in the class light housing.



Figure 53.

I left details such as the engineer's cab front grab, ditch lights, short hood corner grabs, rear grabs, and pilot details until after painting. The Guilford stripe makes certain grabs and the brakewheel, among other things, more sensible to apply after I had painted and decaled the unit.

## STEP 11: Handrails and Stanchions

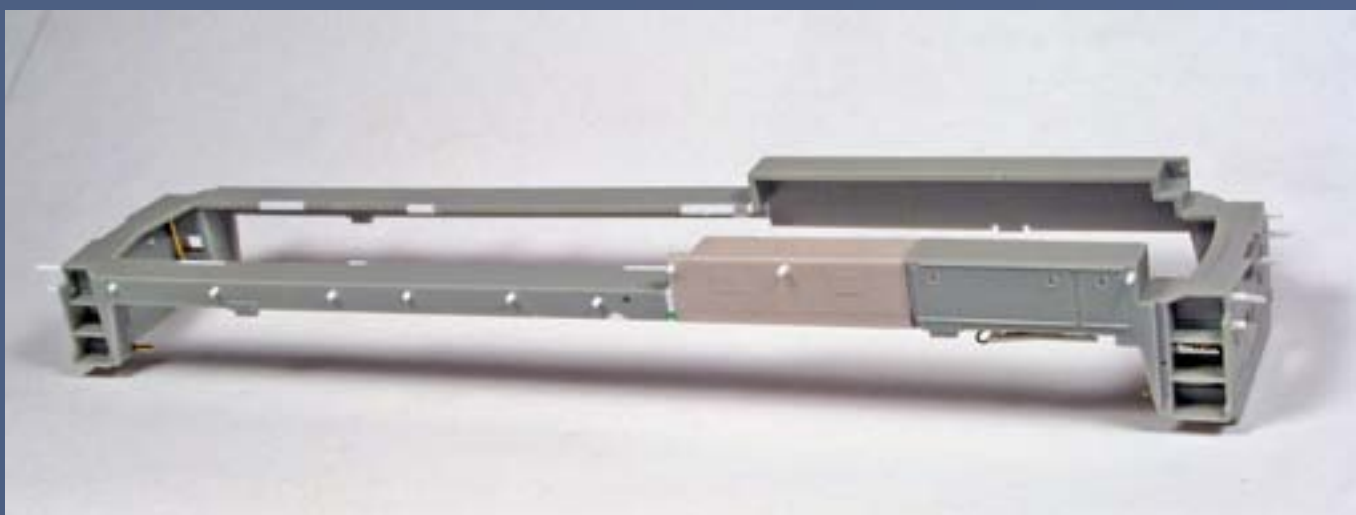

Figure 55.



Figure 56.

For the same reasons as stated in the previous step, I like to bond my handrails to bare plastic for the strongest bond. This means it made sense to begin the handrails next.

When using the Utah Pacific handrail stanchions (which are so good and rugged I wish they could be persuaded to make EMD versions out of this beryllium copper alloy), the first thing you'll notice is that the Atlas handrail stanchion holes are in the wrong place. Using the existing holes puts the stanchions too high, and leaves the support bracket on the inward side of it dangling in mid-air.

Once I realized this, I knew I needed to plug the existing holes and drill my own, everywhere. I got some Evergreen #220 .035 styrene rod, then drilled out all the existing holes for the stanchions with a #64 drill, and plugged the holes with pieces of this rod and plenty of liquid styrene

cement. I left the plugs to set up for a few hours before I trimmed them flush. While I was at it, I plugged the holes on the pilot for the Atlas coupler cut lever, since I'd be using a different one and the holes were big. Figure 55 shows the plugged holes, ready for trimming.

With the new holes to be drilled so close to the old plugged ones, I didn't want to risk any chance of the drill "wandering", so I made a simple jig out of a scrap of .010 sheet brass. To make it easier to line up the jig properly, I drilled a larger hole on the top piece that rides on the walkway surface. That way I could view the pencil line I'd drawn for each hole location. Having the sill/walkway not glued to the body at this point made it easy to clamp the jig in place as I moved along. Figure 56 shows that jig in use – it was quick and easy to build – it ensured accurate alignment of each hole for a nice, even handrail line, with no walking of the bit into the old hole.

## STEP 11: Handrails and Stanchions *Continued...*



Figure 57.

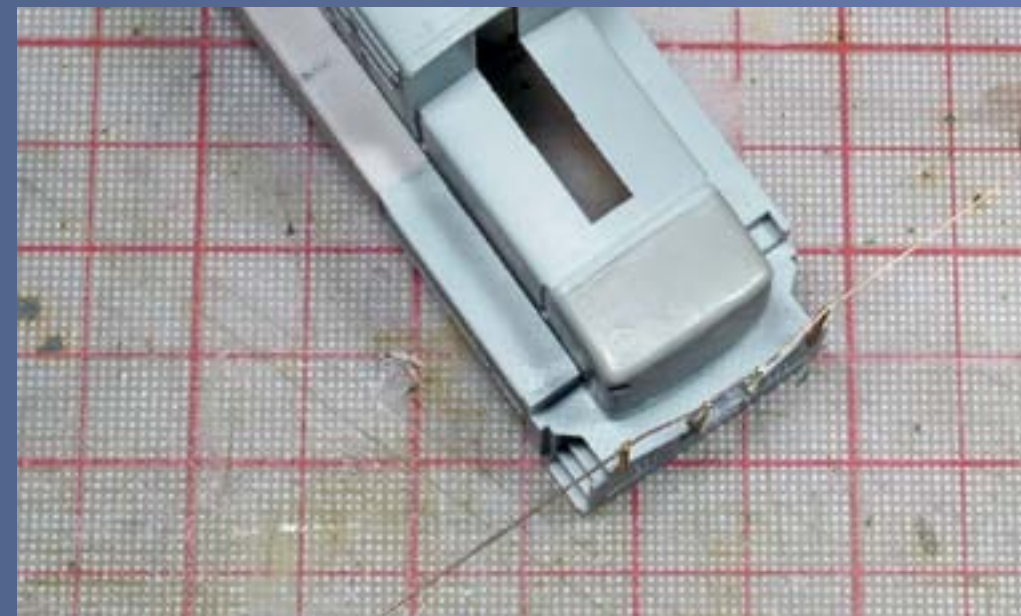

Figure 59.



Figure 58.

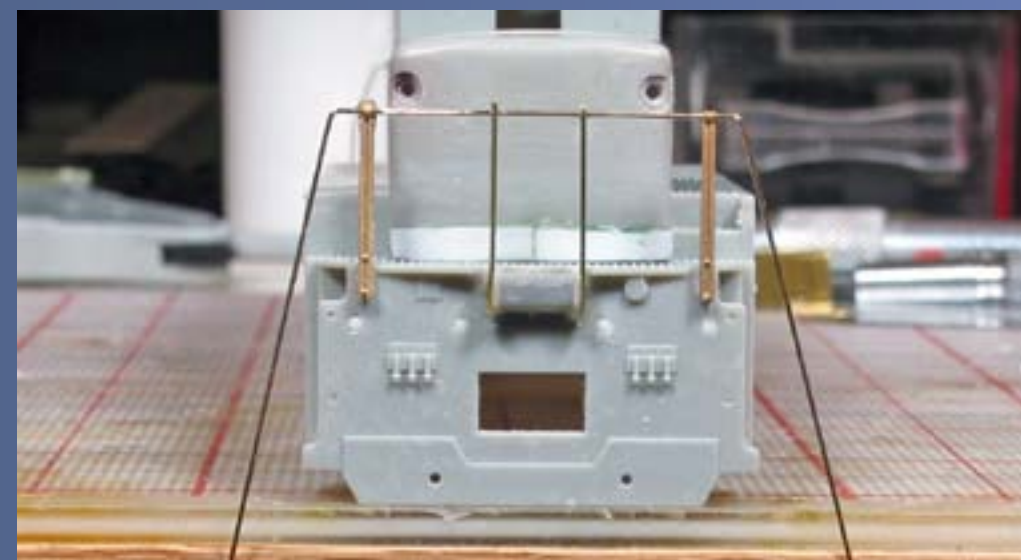

Figure 60.

In figures 57 and 58 you can see how I bonded the two end Utah Pacific handrail stanchions in place. Once set, I took a piece of .015 phosphor bronze rod, and formed it as shown to get the characteristic bump out that GEs have. You can also follow the Atlas handrails to see this. I threaded the rod through the left hand stanchion, then threaded two of the flat stanchions that I fabricated out of brass stock, and finally threaded it through the other stanchion. Using tweezers, I positioned the rod so that the bump out was parallel to the ground, and then used pieces of tape to hold it in that position. See figures 59 and 60. Otherwise, it would have drooped and the walkway flat stanchions would have been too low.

Using tweezers, I flipped the flat stanchions up onto the hood, then

applied a dot of Cytox to each side of the drop step. This step has been spaced out a bit to accomplish the necessary bulge. I did this by simply filing down the original that I'd glued in place. You can do this with a small piece of styrene. The flat stanchions were each then swung down and quickly positioned in place, then I misted the assembly with Activator. It's amazingly strong! When I had to remove them after the first attempt, which had them all in line (incorrect), I literally had to slice the plastic they were bonded to, and then file the plastic and Cytox from the bottom of each, in order to re-apply to the new drop step bracket.

## STEP 11: Handrails and Stanchions *Continued...*



Figure 61.

Once I had the stanchions in place on each end I test fit the assembled body to the walkways, only to realize to my horror that the body was a scale foot too long! Once I calmed myself, I realized that the extra length was at one of the seams, between the engine compartment and the clean air room as shown in figure 62.

Using a razor saw, I cut the seam apart, re-filed everything square and made sure that I removed enough extra material to equal the foot that was too long. I kept test-fitting until I had the proper clearances then re-glued the body back together. The result is shown in figure 63. Mistake recovery is a key skill related to locomotive kit-bashing!



Figure 62.



Figure 63.

## STEP 11: Handrails and Stanchions *Continued...*



Figure 64.



Figure 65.

I press fit each Utah Pacific stanchion in place with a little Cytopx – both on the pin and also on the walkway bracket. If there is too much, I wipe it off quickly. No Activator spray is needed for this, since it's a good mechanical fit. A small jeweler's screwdriver that fits between the grooves of the stanchion is useful to help seat it home tight against the sill. Once bonded in place the stanchions are extremely rugged. See Figures 64 and 65.

## STEP 11: Handrails and Stanchions *Continued...*



Figure 66.

Studying the prototype photos, I could see that the handrails at the step-wells were right along the inside of the step-well, and then attached to the sill with a bolt. I didn't want to simply stick the wire into the Atlas pre-drilled hole, so I elected to take a Tichy NBW and glued it into each Atlas hole with liquid cement and let it firm up. Next, I marked a spot immediately adjacent to the casting, and drilled a #78 hole to accept the new hand-rail. See figures 66, 67, and 68.

Starting with that hole, I took a length of .015 phosphor bronze rod and made a small bend, inserted it into the newly drilled hole, then made a series of bends, following the prototype photos, working my way up the handrail and then across.

On the engineer's rear handrail the bends are a good deal more complex, but to Atlas' credit they captured those same bends fairly accurately, so you can use it as a guide. The same is true for the conductor's side front hand-rail, lots of odd angles, but it looks great when you capture all of them!



Figure 67.

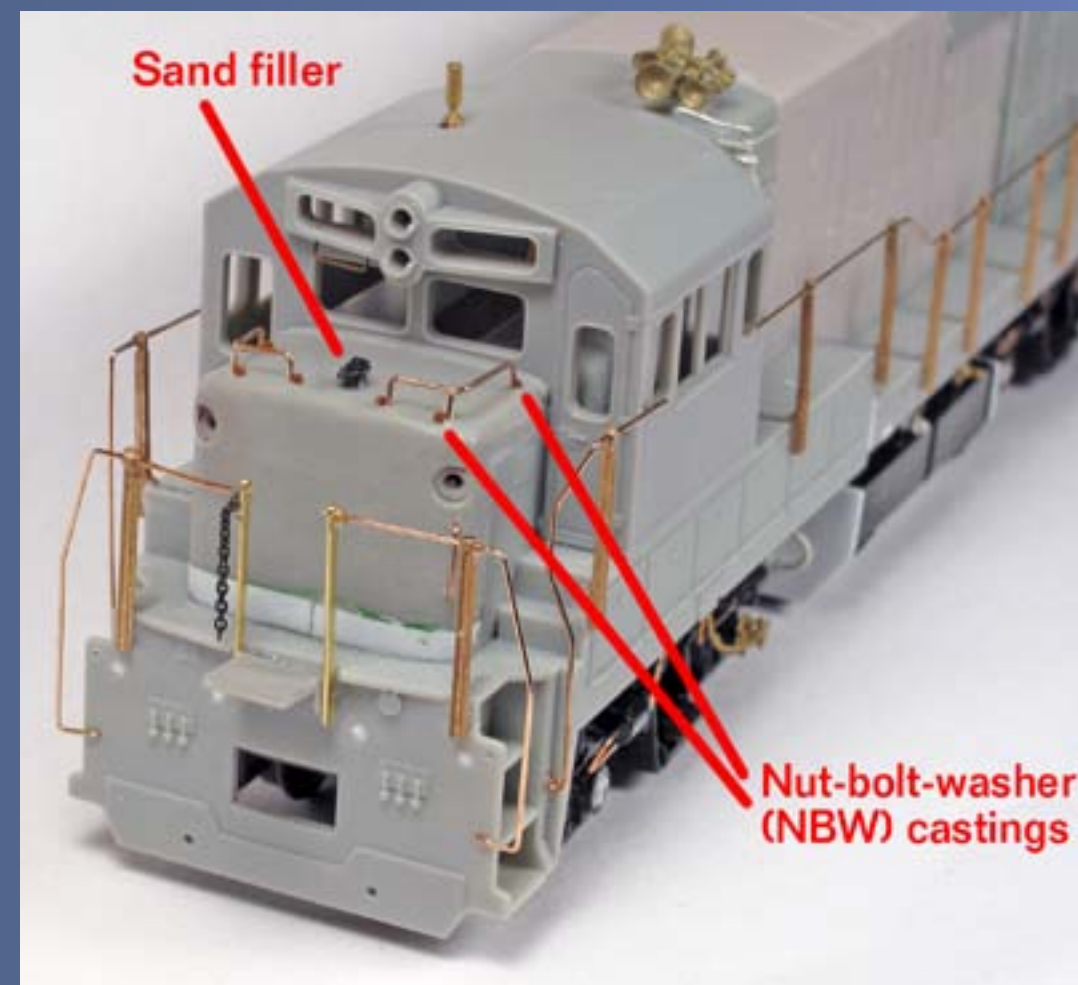

Figure 68.



## STEP 11: Handrails and Stanchions *Continued...*

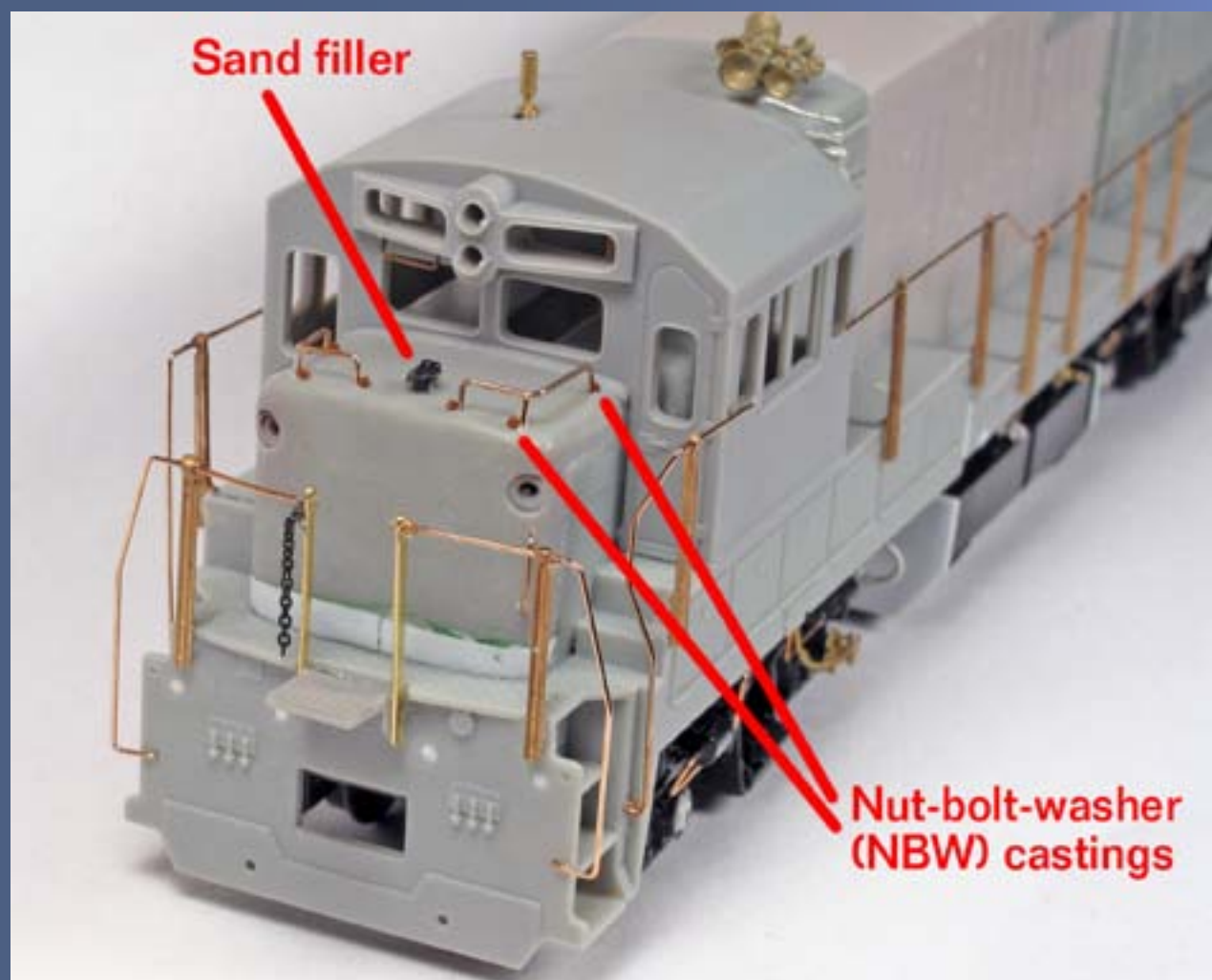

Figure 69.

One note of caution: I found one Utah Pacific stanchion that had its mounting peg in the wrong place! Consequently, I had an uneven hand-rail line on one side when I began. I thought maybe I'd drilled the hole wrong, but a new stanchion quickly cured the problem, and when comparing the bad one with the others, it was clear what the problem was. Needless to say, I recommend finding this out prior to gluing the stanchions in place.

I was having a lot of trouble keeping the nose sand filler attached, despite the fact that I'd melted it in place with Pro Weld. I also Cyanopoxied it, but it still let go in normal handling. I finally resorted to drilling and pinning it, then bonding with Cypox, and it seems to be holding nicely now. See figure 69.

The walkway chain on this loco is being modeled in the dangling position, just for variety (Figure 66 previous page).



Mike Rose has been an active model railroad builder and kit-basher since his early teens. Even back then he was interested in weathering. His first attempt involved blowing shaved chalk dust onto the pilot of a freshly Dull-coted PC GP-35. His first articles appeared in *Railroad Modeler* magazine at the age of 16, and since then Mike has had articles in all the major model railroad magazines.

To date Mike has had over 70 published articles. In addition, Mike has contributed photos and articles to a number of prototype and modeling books. He's also the owner of Mike Rose Hobbies ([www.mrhobby.com](http://www.mrhobby.com)), an Internet hobby shop catering to the needs of Prototype Modelers.

A regular on the Prototype Modeling Meet circuit all over the country, Mike regularly gives clinics on a variety of model railroading topics. This is his first article for *Model Railroad Hobbyist Magazine*.



## STEP 11: Handrails and Stanchions *Continued...*

69



Figure 70.



Figure 71.

Figures 70, 71, and 72 show how the loco looks with the handrails in place. Ditch lights and all pilot details will be added after painting. We'll pick up with that in Part 2 of this article next issue.



Figure 72.

# Using Sound to Enhance Your Layout



— by M.R. Snell  
Photos by author

**Want your layout to do more than just look good – but to sound good too? Then you don't want to miss the techniques we cover here ...**

One of the common goals of model railroaders is to make our layouts as realistic as possible; our trains running through carefully executed scenery often enhanced with visual animation. While visual animation can really add to the look of the railroad environment have you ever considered also employing audio animation to further bring your layout to life?

Several years ago during an operating session on my layout I noticed something seriously amiss. It was the middle of the night in “railroad time” and the only activity on the railroad was in a large classification yard where the next day's local trains were being assembled.

As the yard crew stopped to read their waybills it was quiet – eerily quiet to the point I had wondered if the operators had vaporized, leaving only the sound of the transformer fans filling the room. It was then that I began to notice what a noisy world we really live in – just close your eyes and listen. As I model north-central New Jersey where the air is constantly filled with highway, city, industrial, and other noises, I wasn't happy at all with this situation. This began my quest to enhance my layout by making it *sound* more realistic.

When we think of sound, there are two types of basic sounds we hear every day. Ambient sound is the low “rumbling” we hear everyday, most of which we have learned to tune out over the years. This can be noise from highways, water splashing along a river bank, or the ever present undertones that permeate both city and rural environments. The

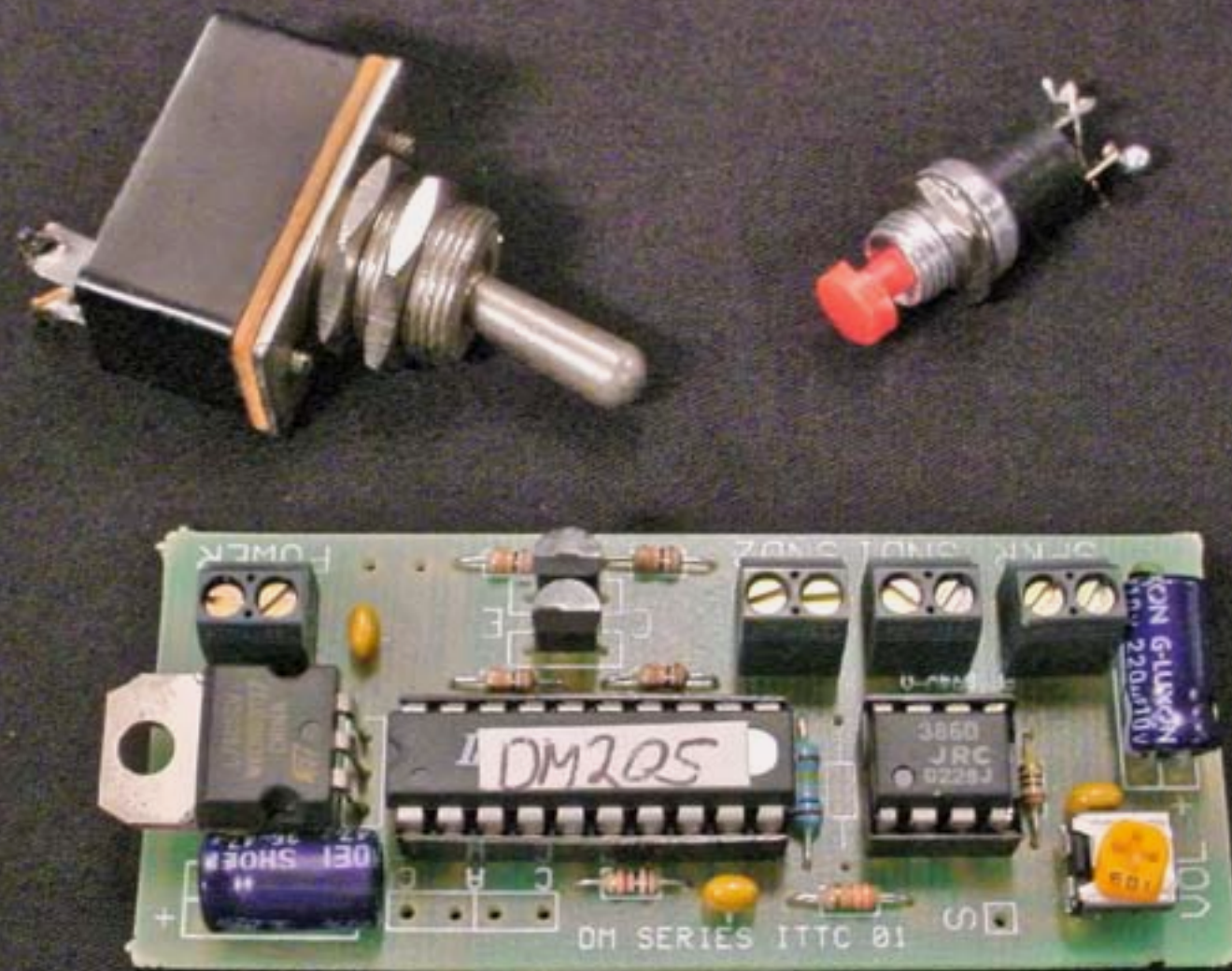

**Figure 1:** Two types of switches can be used to activate each module. The first is a ‘normally open’ (N/O) momentary switch such as a push button which is used for a ‘play once’ application. The second is a toggle which allows continuous play while the toggle is in the on position.

second type is annunciating sound, short punctuating sounds such as the sounds of car or train horns, whistles, and bells at grade crossings. Both types of sound can be added simply and inexpensively to your layout, bringing realism to a new level while also complimenting the new generation of sound equipped locomotives rapidly gaining popularity.

In earlier days modelers added sound to their layouts using continuous loop tapes with speakers mounted around the layout. Fortunately the addition of sound has been made easier in

the digital age in the form of small electronic modules, each featuring a sound chip embedded into the module. These easy to use modules are generally equipped with one sound per module and can be used for either a momentary annunciating sound or made to play continuously for ambient background sound.

Stock sounds suitable for rural, urban, industrial and railroad environments are offered by several manufacturers, but these modules may also be customized to suit your specific needs such as a horn tailored to a specific

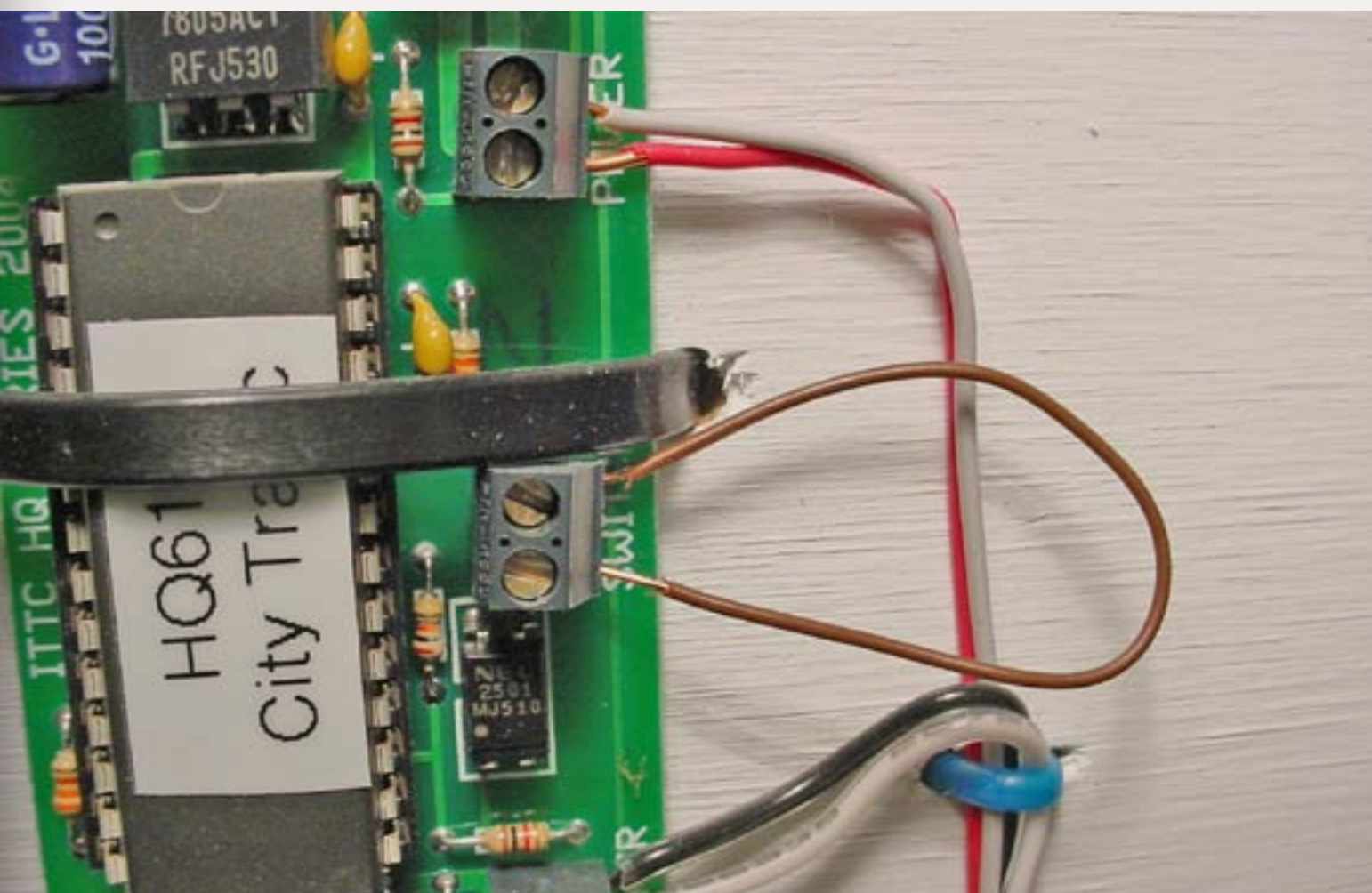

**Figure 2: A jumper wire can be used in place of a toggle switch, the solid wire taking the place of the closed contacts of a toggle switch. While this requires less wiring the downside is the inability to turn the module off.**

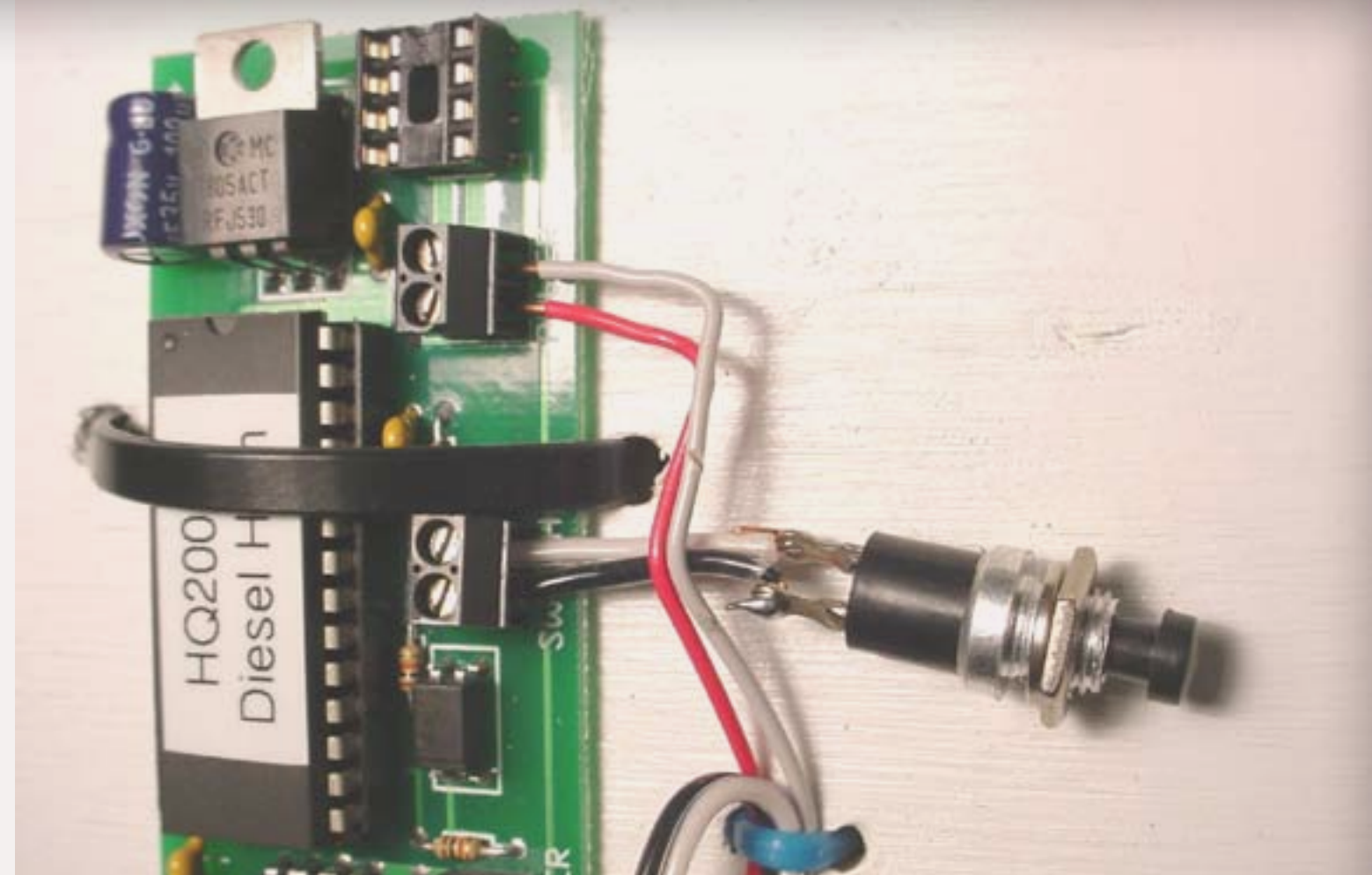

**Figure 3: Connecting a switch is as simple as connecting the wires from the switch to the module using the screw terminals located on the module.**

prototype railroad or ambient background sounds suitable for your modeled environment. A search on the web will reveal thousands of sound effects available from multiple sources and once you have located a sound that will suit your specific situation it may be placed onto a module, bringing audio animation to your layout.

Prior to looking at how the addition of sound has enhanced my own layout lets cover the basics of sound modules, looking specifically the module manufactured by Innovative Train Technologies. Each module consists of a small PC style board equipped with several electronics components including a computer sound chip, a variable

resistor (used to control the volume output from the module), and three pairs of screw terminals for power, a speaker, and a switch.

Aside from the module itself several components are required to complete the module installation including a switch to activate the module.

A momentary push button switch can be used for a 'play once' sound or an SPST toggle style switch can be used for repeated play, as the module will continue cycling the sound over and over until the toggle is turned off.

In installations where continuous play is desired, such as the sound of a river, a jumper wire placed between

the switch terminals may be used to in place of a switch, however there will be no ability to turn the sound off when desired (see Figure 1 first page and Figures 2-3 previous page).

Each module requires 9-18 volts DC or 4-18 volts AC for operation and can be powered from a standard wall transformer or even the accessory terminals of older power packs. Since the modules feature a low current draw multiple module installations can utilize a single power source connected to a terminal strip equipped with a 'bus strip', maximizing the output of the transformer. (A bus strip is a solid piece of metal equipped with "fingers"

which slide under the screw terminals of the terminal strip, making each screw connection powered.) A transformer can be connected to the terminal strip using one half of the strip as the positive side and the other as the negative side. This will enable powering each module from the terminal strip, requiring wiring only between the module and the terminal strip rather than having to make separate connections from each module to the transformer itself (Figure 4).

The final component required in a sound installation is a speaker. Several sizes of compact speakers are available ranging from 1" to 4" and the larger

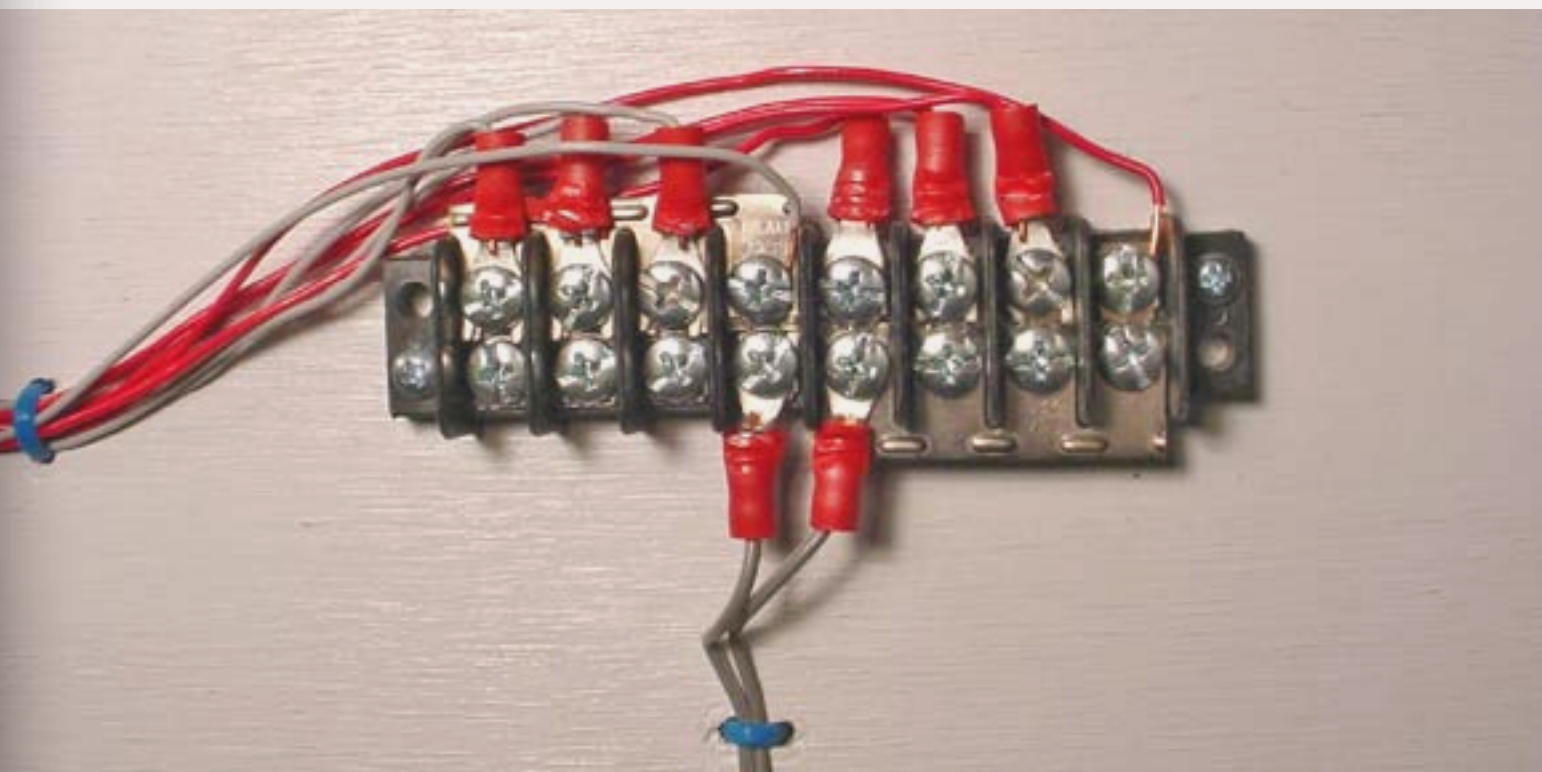

**Figure 4: Use of a terminal strip allows centralizing the power wiring between modules. The transformer is connected to the terminal strip using one half as the positive side & the other half as the negative side then power wires can be run from the strip to each module.**

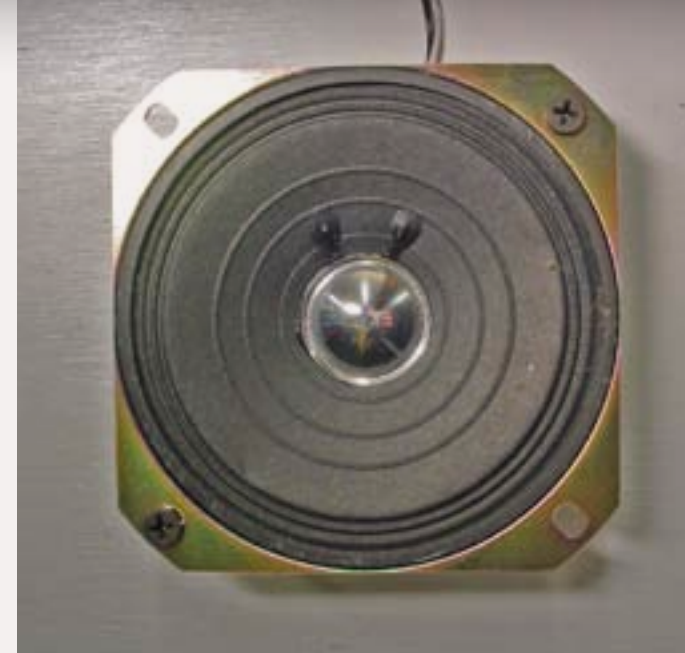
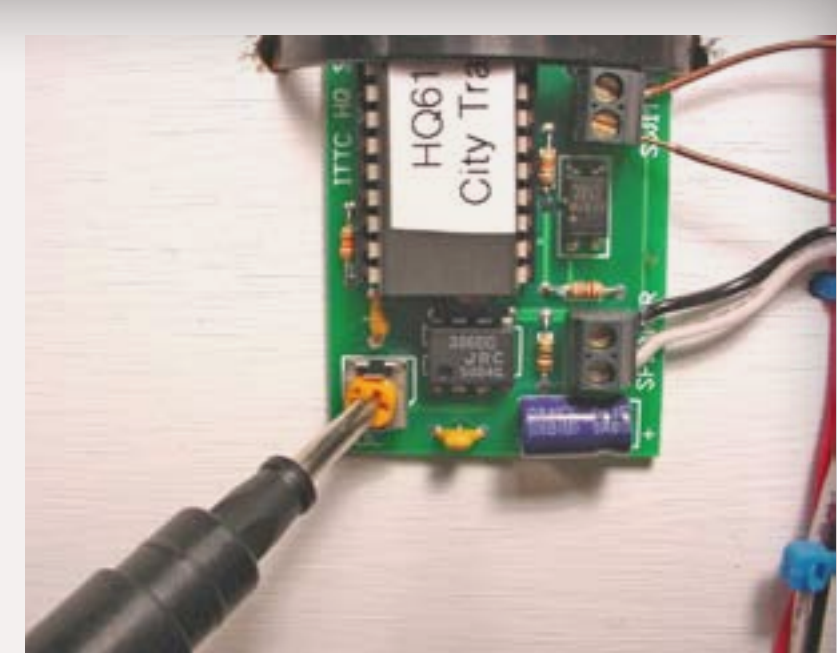

**Figure 5: A speaker mounted under the layout will deliver the sound & controlling the speaker volume is easy using the variable resistor mounted on the module.**

the speaker the better the sound quality. Similar to the principals of a home or car stereo, this is especially true in cases where a deep bass type sound such as the rumble of an idling locomotive is desired.

Speakers may be mounted under the layout and aimed towards the front, allowing the sound to appear to come from the area it's meant to accentuate. The output volume of each speaker can be easily controlled using the variable resistor built into the module. Simply turning the resistor will raise or lower the volume, making the sound more or less pronounced while allowing you to compensate for a noisy location on the layout (Figure 5).

Now that we've covered the basics let's take a look at how I've added sound to my own layout, bringing another degree of realism to my HO scale world.



## Grade Crossings

Almost all railroads have highway-rail crossings, commonly known as grade crossings. Most modern grade crossings are equipped with a combination of crossbucks, flashers, bells, and in many instances gates to stop traffic in the path of an oncoming train. Equipping your layout with the appropriate warning devices and animating them is rather simple, given all the options offered by Walthers, NJ International, Tomar, and others.

Indeed on my layout each mainline grade crossing is equipped with the appropriate highway warning devices however I was never happy with the bell included with the animation package so I looked at what I could add to make each crossing more realistic (Figure 6 next page).

As I have not yet taken the plunge into the sound equipped locomotive market, adding a separate crossing bell

as well as a locomotive horn and bell provided a solution making the crossing animation more realistic. This also enabled me to tailor the sound to my specific prototype, with each module playing back sound recorded on audio tape while trackside.

Given the small size of the modules I was able to hide both the modules and speakers directly under the crossing. A small plate added to the layout fascia was equipped with momentary push-buttons enabling the trains engineer to activate the locomotive horn, blowing it as the train approached the crossing. A toggle switch controlling the locomotive bell was also added, allowing continuous play of the locomotive bell which can prove useful during switching operations.

As the crossing bell was to activate simultaneously with the crossing gates the crossing bell was wired directly into the crossing activation circuit, while an SPST toggle switch installed inline between the module and speaker provided a comfort feature for the engineer allowing the crossing bell to be silenced when making long extended switching moves. Since hearing is believing here are two video clips showing both a prototype crossing and a modeled crossing. As you can hear, the addition of audio really brings the crossing scene to life (Videos 1 and 2)!

## Highway Bridges

While it's hard to describe ambient background sound in text, several places necessitated this type of sound including traffic noise along the highways. Anyone who has ever



**Figure 6:** Each highway-rail grade crossing is equipped with sound for high speed & slow speed locomotive horns, a locomotive bell & a crossing bell. Using the sound features is as simple as pushing a button as you approach the crossing with your train.



**Video 1:** South Plainfield, NJ prototype crossing.



**Video 2:** Model crossing.

spent any time standing near a highway bridge can attest to a low rumble of traffic, punctuated with the sound of tires crossing the expansion joints placed between the pavement and the bridge's roadway.

On my layout I have modeled several heavily trafficked bridges including US 1 and 9, the Garden State Parkway, and the Outerbridge Crossing between New York and New Jersey. The addition of a sound module at each location allowed me to add the feel of moving traffic to each area, even though the scene is a static representation of the bridge and traffic.

To hear the effect of highway sound, join the crew of local train PR-13 as they switch below the Outerbridge Crossing (see Figure 7 and Video 3 video).

## Waterways

Many of us have modeled waterways on our layouts, ranging anywhere in size from a small stream to large rivers or port areas.

While we may have spent hours painstakingly pouring epoxy or applying layers of matte medium to create the perfect scene it remains a quiet static scene. Waterways abound with sound



Video 3: PR-13 switching under Outerbridge – model.



Figure 7: Highways and bridges both feature the constant whooshing sound of passing traffic.



Figure 8: Waterways of all sizes abound with sounds of splashing water, boat traffic, & waterfowl.

including waves lapping along the banks or shore, seagulls, boat traffic and even the occasional foghorn on large waterways (Figure 8).

Once again the addition of a sound module mounted under the layout has allowed me to add the sound of water splashing against the rocks as well as the occasional seagull, bringing a prototypical element to my large Raritan River scene (Videos 4 and 5).

## Locomotives Servicing Facilities and Yards

Those of us familiar with railyards will agree that they can be noisy places, with the low rumble of idling diesels awaiting their next assignment,

locomotive bells as they move throughout the yard complex, the crashing of couplers, and the pop of airhose connections being broken. While simulating all the sounds of a railyard can prove daunting and maybe even annoying adding even a single ambient sound can greatly add to the realism of the scene (Figure 9).

The most common sound found at many railyards both large and small is sound of idling locomotives. Adding this low pitched rumble in several places such as engine facilities or near a yard office will certainly give the feel of an active complex, rather than a collection of scale locomotives sitting within a modeled scene. For those like myself who are fans of prototypical



Figure 9: A railyard is rarely a quiet place, especially around locomotive servicing areas.



Video 4: Video Raritan River – prototype.



Video 5: Raritan River model.



operation, the addition of a toggle controlled locomotive bell will also allow the use of the bell when moving throughout the yard or engine facilities, adding another factor of realism.

To illustrate the additional realism sound can add around a modeled rail-yard the following video clips will show the immediate difference (Videos 6-9).

## City Scenes

Urban modelers will immediately recognize the use for sound. Any city scene bustles with life including the sound of pedestrians, street vendors, traffic and car horns. Even a background city scene will have a quiet noise about it and this can be easily added, bringing the city to life. Careful placement of the speakers

can direct the sound in specific directions, allowing the 'city life' to be heard in specific locations, separating it from other scenes on the layout (Figure 10 next page).

## Specialty Sounds

Each of us has a particular scene we have modeled that would lend itself to a specialty sound of one sort or another. Industry abounds with the sounds of moving equipment and machinery in every sort from large presses to the hammer of an old time blacksmith shop. In some cases a specialty sound doesn't have to be a model on the layout at all, but can be representational (Figure 11 next page).



Video 6: Oak Island prototype - diesels idling on service track.



Video 7: Service tracks without sound - model.



Video 8: Service tracks with sound - model.

My layout, modeled after the north/central New Jersey area, features one yard, Conrail's Portside Yard, located very close to both the New Jersey Turnpike and Newark Liberty Airport. While doing research for the layout I spent some time at this yard and observed the sound of the Turnpike coupled with the roar of a plane overhead every few minutes.

While I was not including either on the layout, a sound module was installed near the modeled yard allowing the

traffic to speed by and planes to roar overhead, just as on the prototype.

In fact the possibilities for sound on a layout are almost endless as we look at our modeled scenes, limited only by our imaginations (Video 9).

## **Portable Installations**

No steam engine is complete without the unique whistle and chugging sound of the locomotive. A portable sound box allowed the operator of this



**Figure 11: Sometimes an area we model is incomplete without a specific sound such as the planes arriving & departing over the Portside Intermodal Yard, located several hundred yards from Newark airport.**



**Figure 10: City scenes both large and small emanate with sound, everything from car horns to this street baseball game can be heard, giving a sense of busyness.**



**Video 9: Portside Intermodal Yard – model.**

otherwise quiet locomotive to carry these unique sounds around the layout.

While the sound installations described so far are stationary, as each module requires only 9-18 volts they also have the flexibility of on board or even portable installation. In 2005 we hosted several tours for the NMRA National Convention and to honor the event a steam excursion reminiscent of an NRHS trip was operated for the visitors (Figure 11).

In this instance the previously installed horns of my diesel powered layout would be inappropriate so rather than replace the existing sound modules a battery powered portable “sound

box” was constructed. This enabled the steam locomotive operator to walk with his engine, while carrying the sounds of the steam engine, including a steam whistle and appropriate bell for use when desired (Video 10).

Construction of the portable sound box began with a small project box from Radio Shack. Speaker holes were cut into each side then covered with perforated PC board which was painted black and switches to activate each module were installed on the top of the box. This enabled easy access for the operator while speakers, sound modules, and 9 volt batteries



Video 10: NKP 765 with Excursion Train - model.

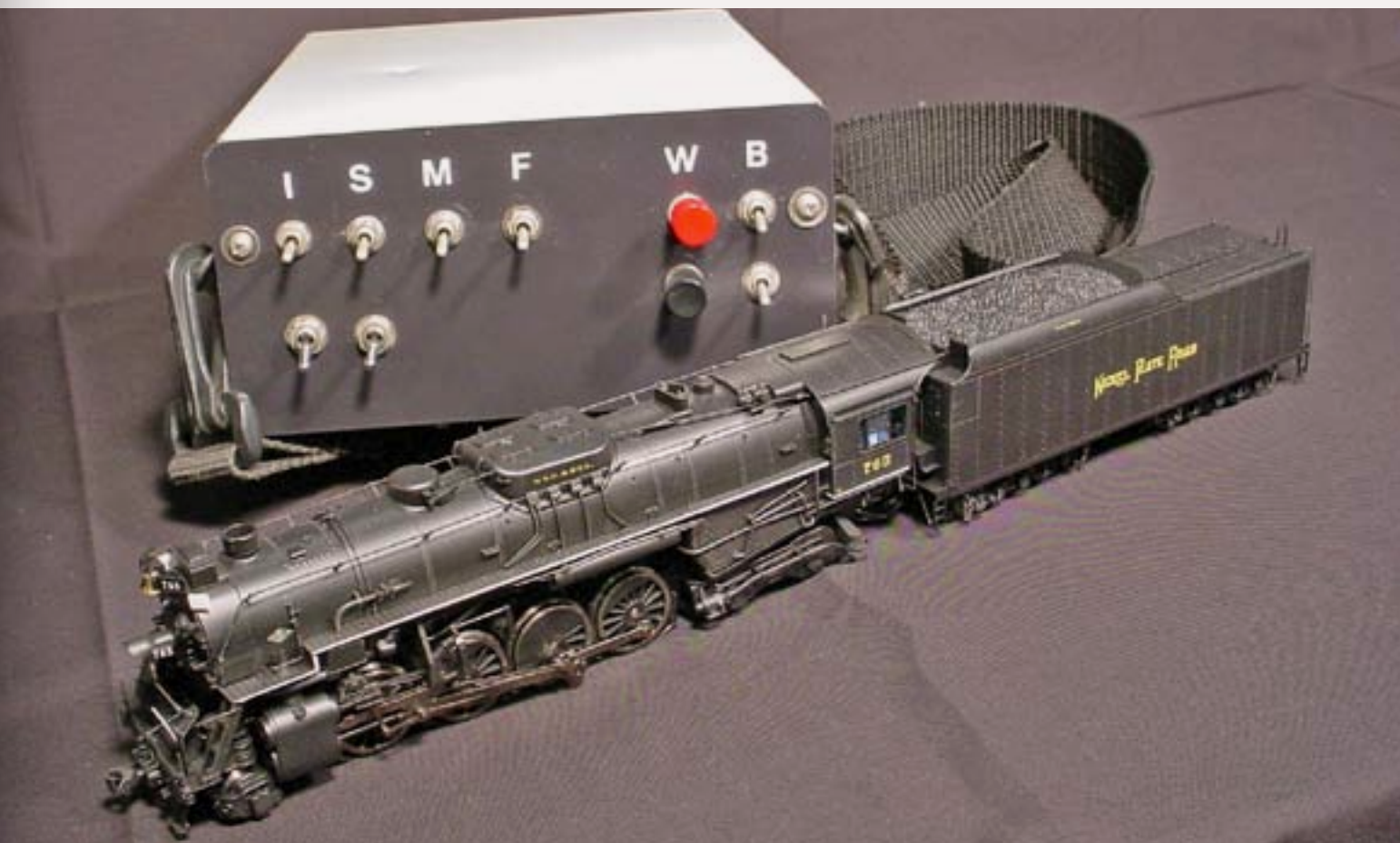

Figures 11 and 12: No steam engine is complete without the unique whistle and chugging sound of the locomotive. A portable sound box allowed the operator of this otherwise quiet locomotive to carry these unique sounds around the layout.

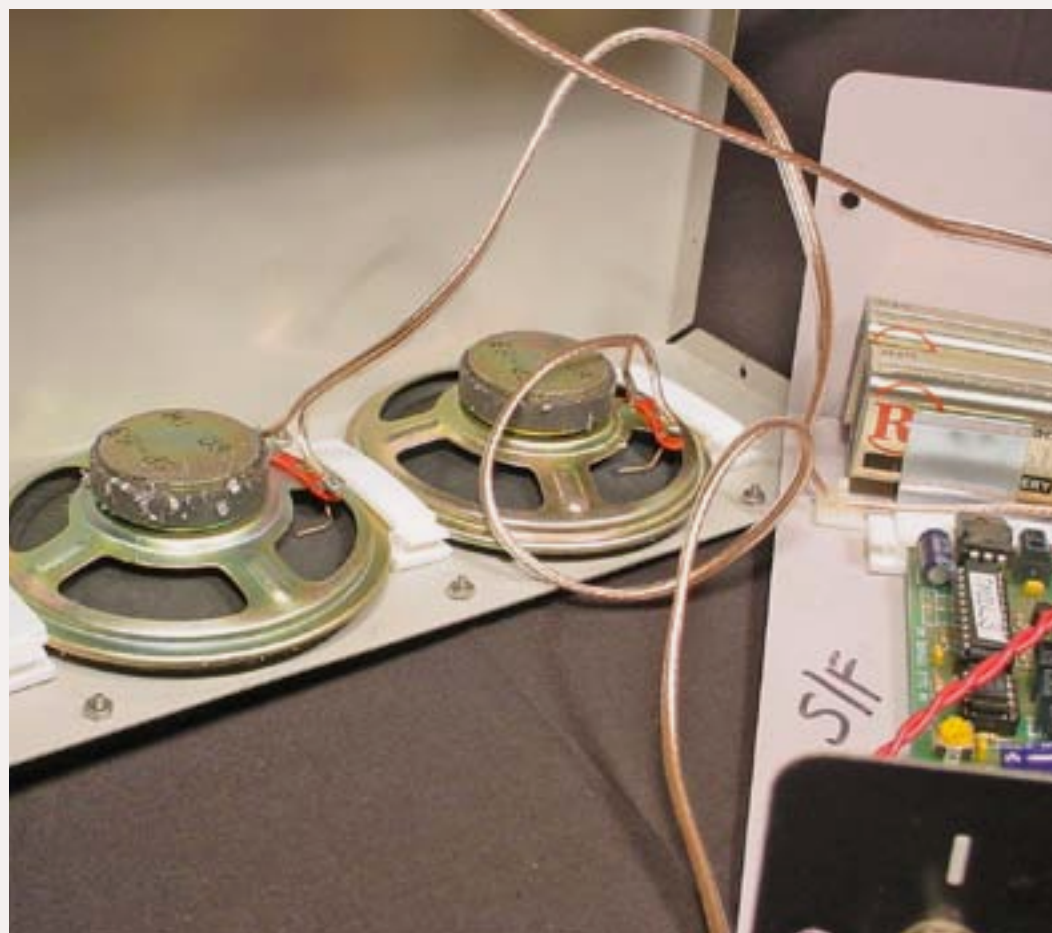
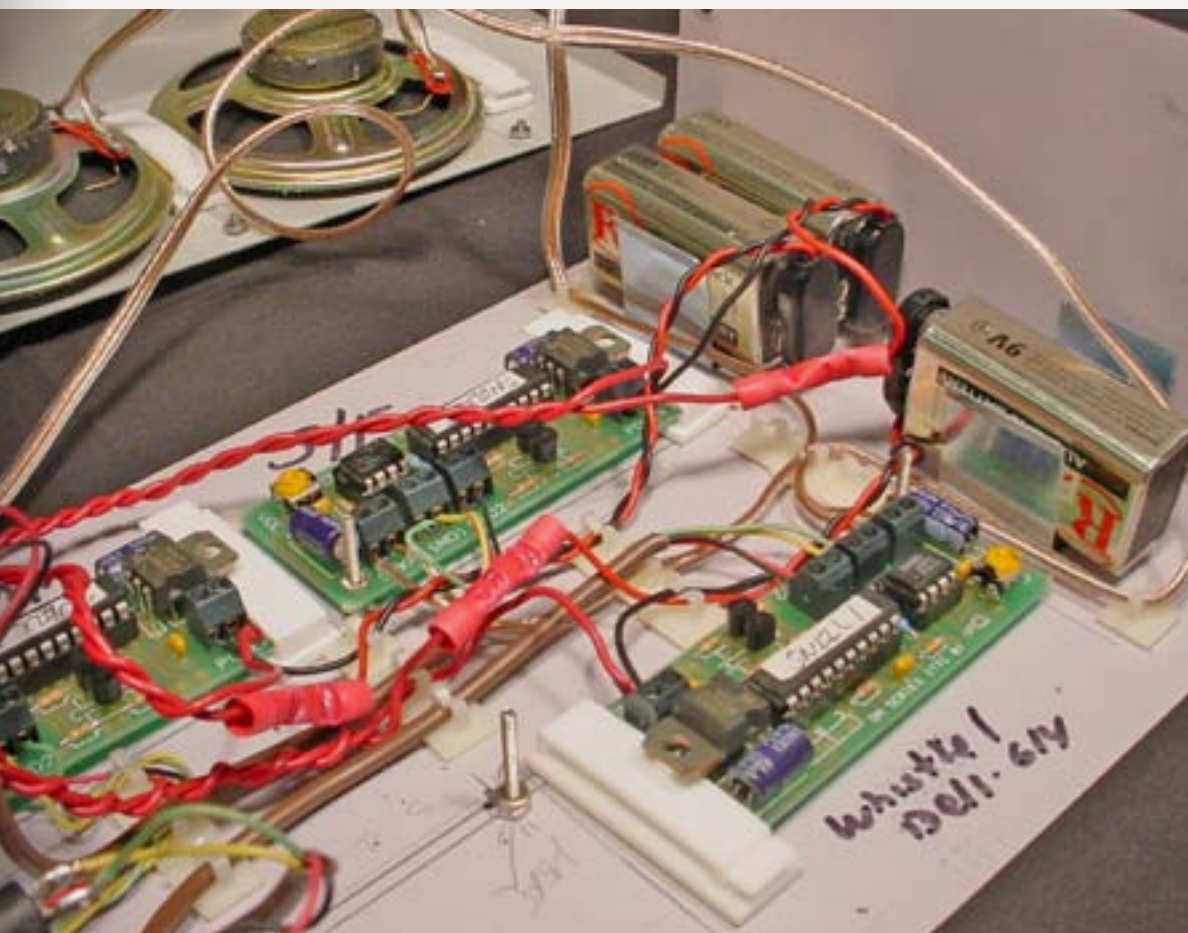

## WEB-BASED SOUND EFFECTS

### RESOURCES

Sounddogs

<http://www.sounddogs.com>

Sound Effects Library

<http://www.sound-effects-library.com>

Absolute Sound Effects Archive

<http://www.grsites.com/sounds/>

### WEB BASED SOUND MODULE COMPANIES

**Innovative Train Technologies**

P.O. Box 5042

West Hills, California 91308

(818) 992-6124

[www.ittsound.com](http://www.ittsound.com)

(Also available through hobby stores with a Walthers affiliation:  
Walthers manufacturer number 349)

**RAM Track Sound Devices**

229 E. Rollins Rd.

Round Lake Beach Illinois 60073

(847) 740-8726

<http://www.ramrcandramtrack.com/rtsound.html>

**Dallee Electronics, Inc.**

246 West Main Street

Leola, Pennsylvania 17540

(717) 661-7041

[http://www.dallee.com/sound\\_systems.htm](http://www.dallee.com/sound_systems.htm)

Figure 13: Construction of a portable sound box took less than an hour and will allow quick a change out of modules, tailoring them to suit the sounds of specific prototype equipment.

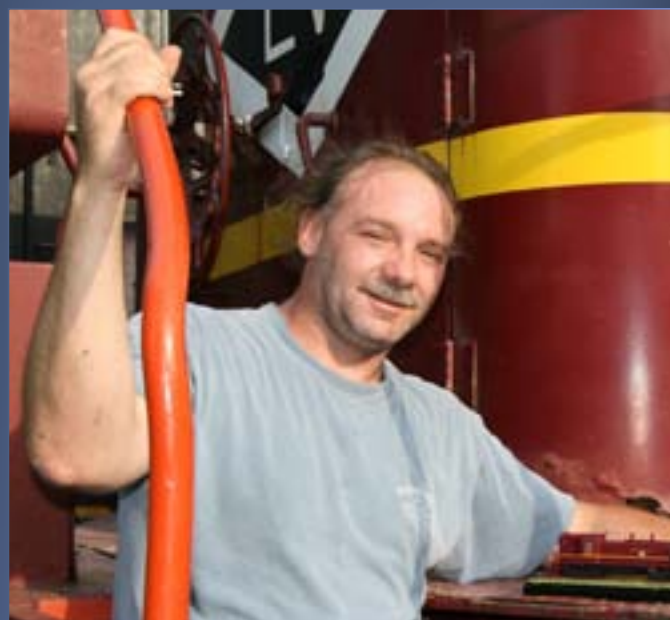

M.R. (Matt) Snell has been a model railroader and railfan for 30 years. His interest began while growing up in New Jersey surrounded by freight and passenger rail lines.

Presently residing in Ohio, Matt and his wife Debie share the hobby, modeling north-central Jersey.

Their "Conrail New Jersey Division" layout has been featured in *Great Model Railroads*, *Rail Model Journal*, and in the Allen Keller *Great Model Railroads* DVD series. Matt has had articles in *Railroad Model Craftsman*, *RailModel Journal*, *Scale Rails* and *Model Railroader*, as well as online at [www.railroad.net](http://www.railroad.net).

to power the modules were added to the interior.

Since the modules use capacitors, a power cut out switch placed in line between each battery and module insured that there would be no power drain while the box was not in use and to finish off the portable sound box a strap was added so the operator could carry the box over his shoulder while operating the train. In the future if we operate other excursions using different equipment featuring unique horns or whistles the modules can be changed out rather simply and the sound box can be placed back in service in a matter of minutes (Figure 13).

### **Industry abounds with the sounds of moving equipment and machinery in every sort from large presses to the hammer of an old time blacksmith shop**

Whether you are modeling heavy industrial areas, rural pastures, or large cities all will have unique sounds and adding sound to your own railroad will indeed bring realism to a new level. Not only will it compliment sound equipped steam and diesel locomotives, it will also put your operating crews in a new frame of mind – that of operating in a miniaturized prototypical world. All that's required is some basic wiring skills and opening up your ears to the possibilities!

# Model Railroad Hobbyist magazine™

## Sep/Oct 2010 Issue Sneak Peek ...

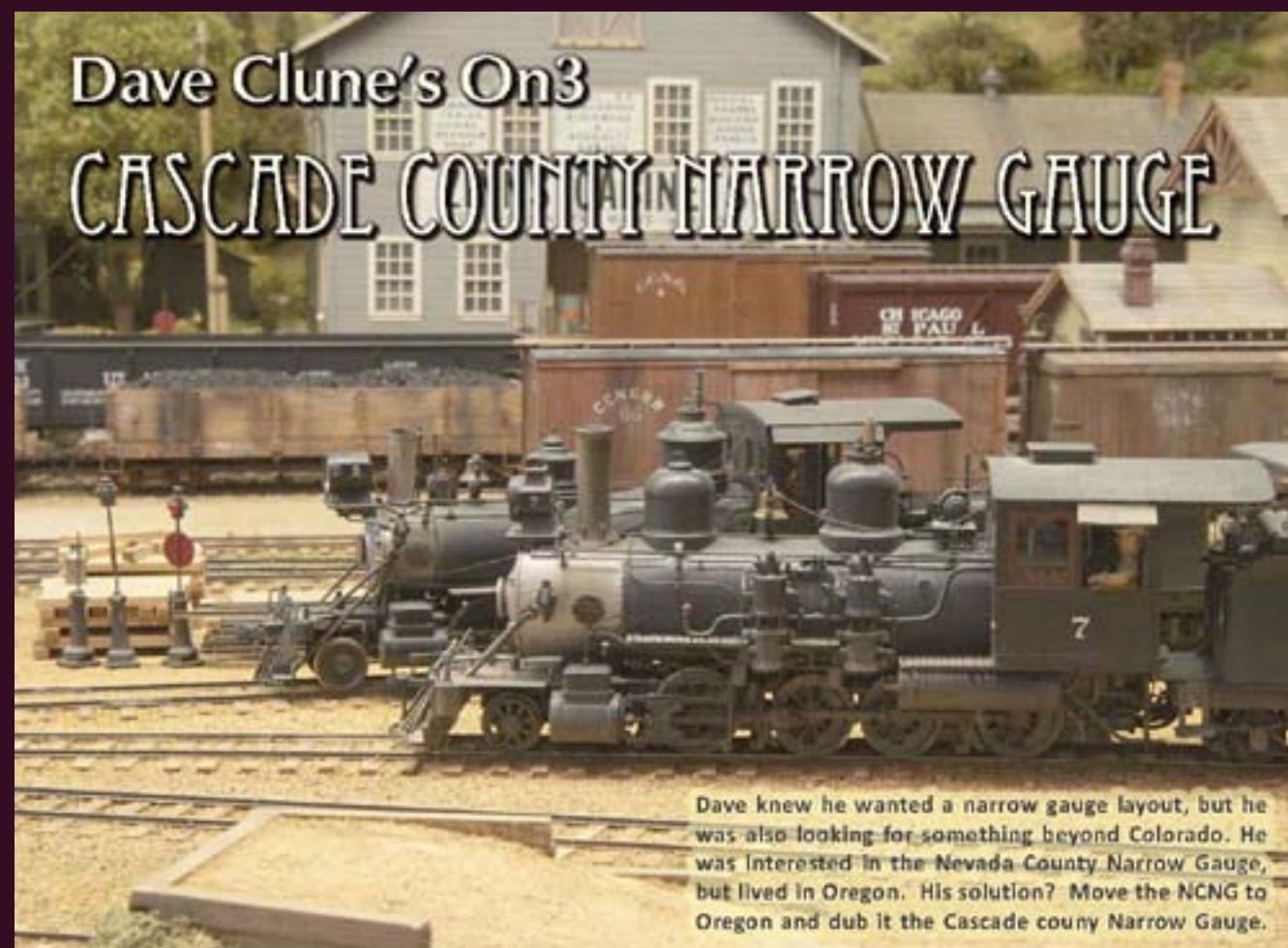

## Model Railroad Hobbyist magazine

The planet's most popular model railroading media-zine!

Release date:  
Sept 6, 2010

Subscribe to **Model Railroad Hobbyist magazine™**  
[click here](#)

# Modeling Decrepit Spur Tracks



Are those sidings or rollercoasters?

by Charlie Comstock

Figure 1: A spur serving the Mill Bend Warehouse and Cold Storage Plant on the author's BC&SJ layout looks like it's seen better days. Note the rail size and elevation differences between the three tracks.

**B**eauty is in the eye of the beholder they say. Sometimes, especially on model railroads, ugly is beautiful. I like to make some of my spurs look like they've not been maintained in ages.

## Decrepitude

When is a spur decrepit? I don't think there is an official prototype definition for this state, so allow me to espouse my own opinion.

- Weed control hasn't.
- Ties are irregularly spaced, random lengths, and varying degrees of rotteness.
- The track ain't exactly smooth and level anymore (if it ever was).
- Poorly ballasted

Spur tracks and other lightly-used tracks are not expected to see high speed traffic from ultra-heavy locomotives and cars. Railroads often built them with light-weight, recycled rail. The rail head may be worn down significantly. Ribbon rail would be unheard of in such locations. You definitely won't be finding 130+lb. rail on many spurs.

Ties for spurs are often on their third life - they started on the mainline, after a while they were removed and placed under secondary trackage such as a low-speed passing siding, finally they were removed again and installed on a spur track. Not all spurs have ties this bad off, but many do.

Ballast costs money and applying it costs money, so if the rails are still mostly visible above ground, railroads often figure that they're good enough. Heavily-used sidings under a major coal flood loader or in an intermodal yard probably are better off than this, but many sidings are not.

Likewise, weed control costs money and may be deferred for a long time before something gets done about it.

## Supplies

I typically use Micro Engineering code 55 flex track for (my HO) spurs. The small sized rail (in comparison to the code 83 and 70 I use elsewhere) really gives the appearance of light-duty track. Refer to figure 2: the track on the right is code 70, the spur track (next to the building) is code 55.

I like ME track because its rail has a close-to-correct railhead width and the spike head detail on it is some of the most realistic available in HO flex track.

I use paintable, latex, caulking compound to hold my flex track in place. Latex means water cleanup, and paintable means ballast cement - diluted white glue in my case - will adhere to it.

Figure 3 shows the basic supplies: flex track, wood ties, caulk and yellow glue.

## Getting started

Once I've picked a location for new spur tracks I mark the center lines and prepare for building a roller coaster. Main track usually has the highest ballast profile, followed by secondary trackage



Figure 2



Figure 3

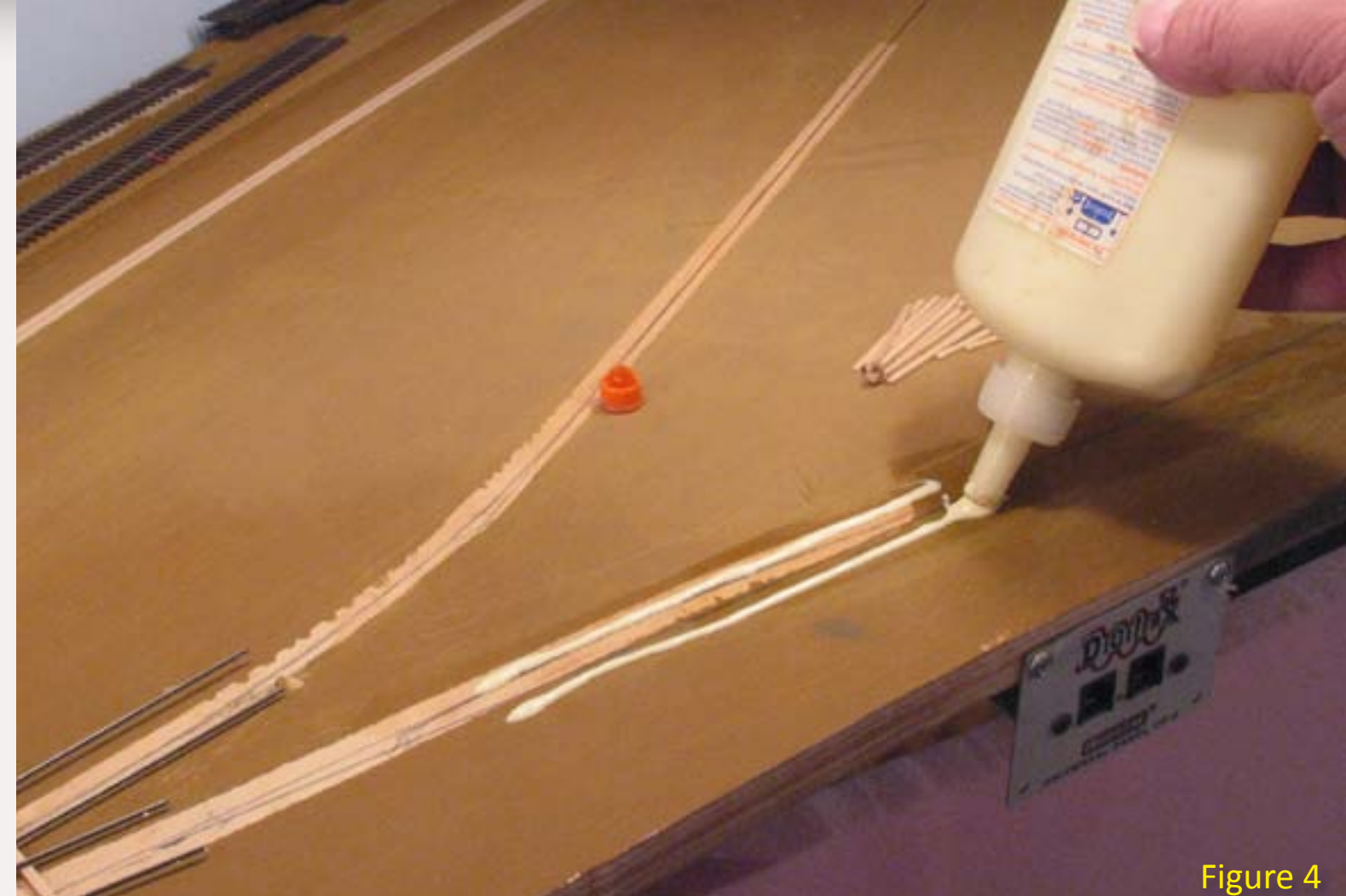

Figure 4

(passing sidings), and spurs are often at the lowest level (figure 1). I usually use 1/4" cork under main tracks, 1/8" cork under secondary tracks, and often lay spurs right on the plywood sub-roadbed.

I get the track to go up and down by gluing shims in place below it. The flex track rides on these. By varying the shim height the track height (above the roadbed also varies).

I make the height shims by gluing full length switch ties in place on either side of the track center line. I make sure the ties will be under the rails (figures 4, 5, and 6). After the yellow glue dries I come back and sand the shims (ties) down at each end to give them a smooth up-and-down contour. This generates a surprising amount of sawdust so I keep a vacuum handy!

**WARNING! Be extremely careful when building roller coaster track on a curve! Locomotives with 'stiff' trucks or long rigid wheel bases may lift an outside wheel off the track enough to clear the flange and derail when cresting a lump! This is especially true when 'lumps' are diagonal (not directly opposite each other). Test your track frequently with your most finicky locos!**

Figure 3: Micro Engineering switch ties, code 55 flex track, paintable latex caulk, and yellow glue.

Figure 4: Beads of yellow glue to hold the track height shims. Each bead will be under a rail.

Figure 5: Putting the ties in place with a pair of tweezers. Neatness isn't very important - they'll be sanded down and covered by flex track.

Figure 6: Ties installed and waiting for the glue to dry.



Figure 5



Figure 6





Figure 6



Figure 7

## Track Preparation

I find that pieces of ME flex track sometimes have casting lumps on the bottom of the ties. I turn each piece over and sand it gently with some 220 grit sandpaper to smooth things out.

Then I use a pair of flush cutting nippers to cut random amounts off the ends of some ties. I vary the angle of these cuts and try hard not to be regular about which ties get nipped. When done, the flex track should look like a batch of random length ties was used to lay the spur.

## Gluing Down the Track

When I had the linoleum replaced in my first house I noticed the notched trowels the installers used to spread the mastic (glue). The notches made little lines of mastic that were just the

[Text continues on page 107...](#)

Figures 6 and 7: The height shim ties glued in place. That's code 55 flex track next to the shims.

Figure 8: I use a long sanding block with 50 grit sandpaper.

Figure 9: I sand the height shims so they form a smooth curve from the roadbed up to the top of each lump and down again - a roller coaster shape.



Figure 8



Figure 9



Figure 10



Figure 11

Figure 10: Sawdust debris after sanding the shims.

Figure 11: You can see, a little anyway, the up and down contour sanded into the height shims (ties).

Figure 12: Sanding the back of the ME flex track gets rid of any casting nubs (sprues?) leaving it flat. It also adds a little extra 'tooth' to the plastic ties so the caulk can grip better.

Figure 13: Snipping random lengths off of random ties to make it look like, random ties were used on this track. I also remove every 8th tie and spread out the others - spur tracks don't have the tie density of mainlines.

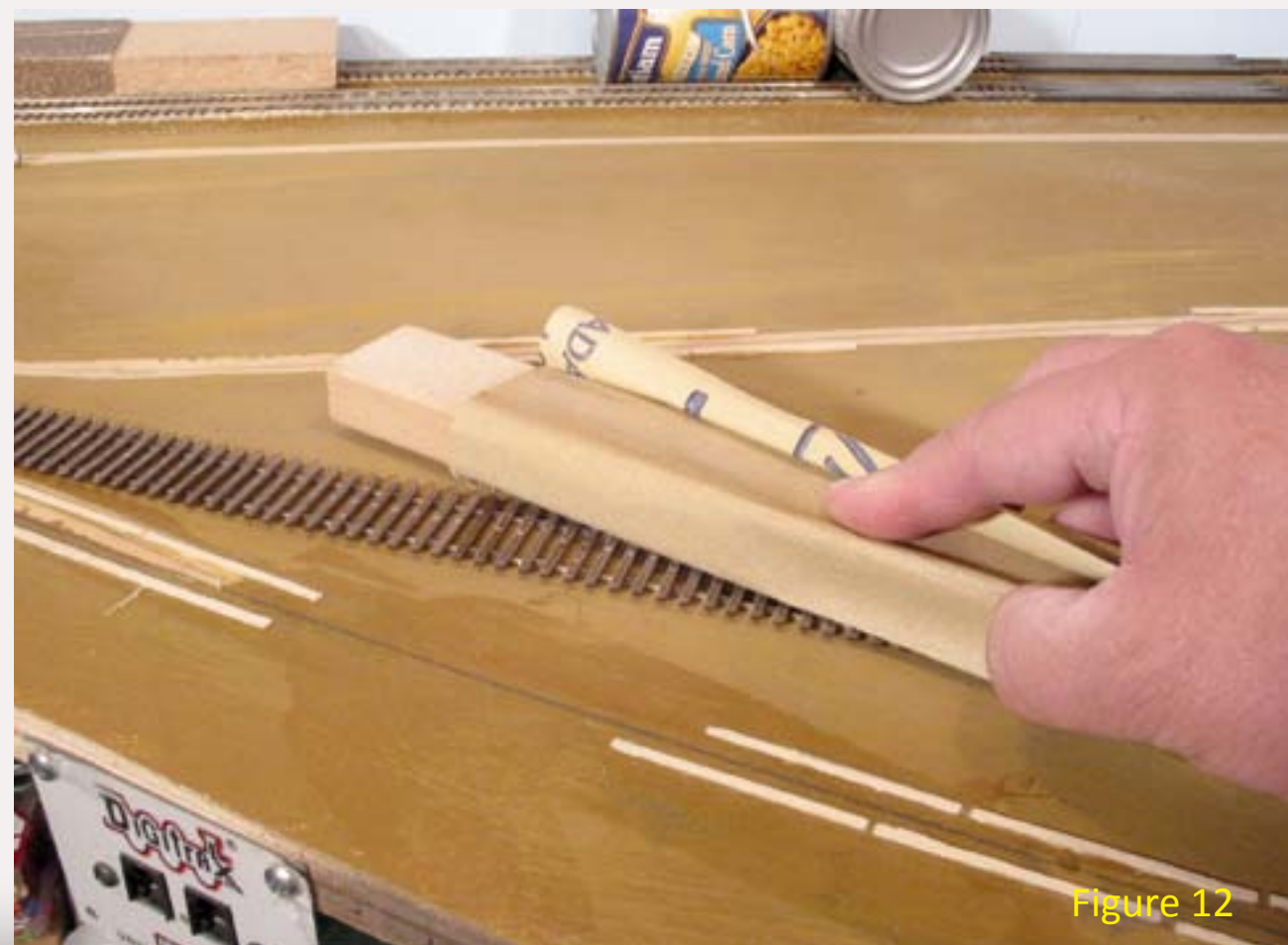

Figure 12

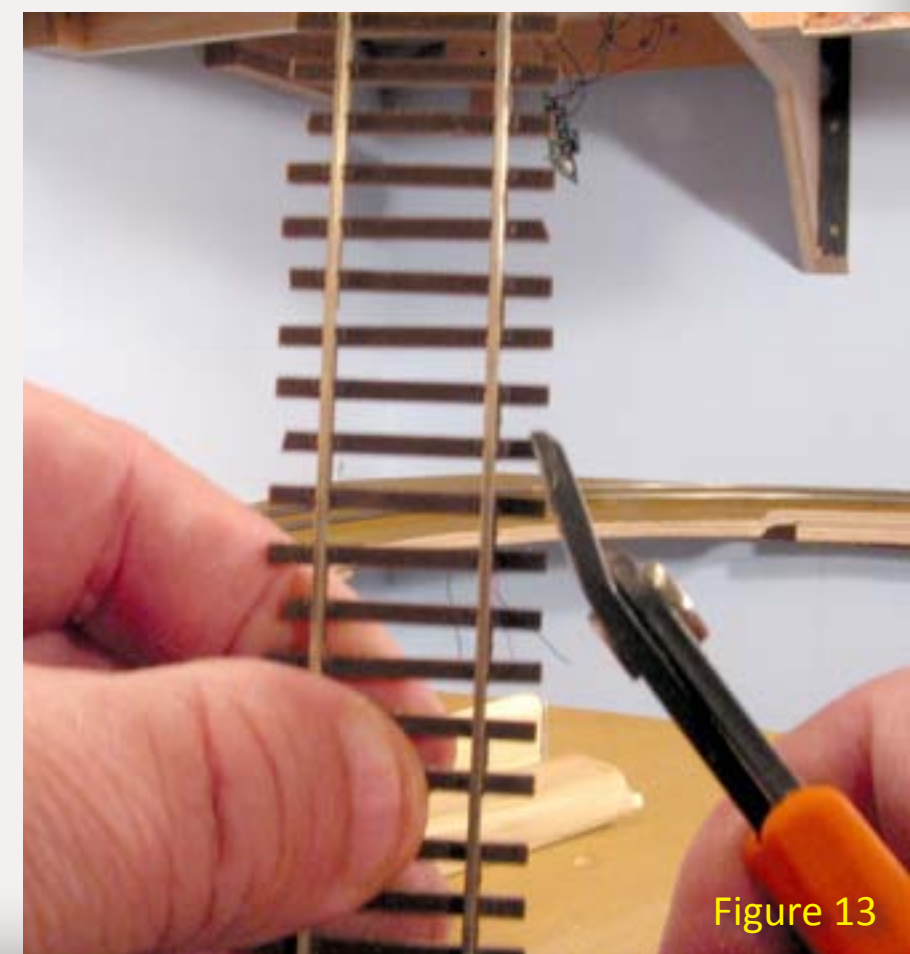

Figure 13



Figure 14



Figure 15



Figure 16

right size - enough mastic to hold the linoleum in place, but not so much the mastic leaked out all over the place.

Remembering this, I made myself a little notched 'trowel' out of a piece of styrene (figure 14). I squirt a bead of caulking out on the track center line, then I spread it with my 'trowel'. Finally I bed the flex track down into the caulk and

use a straight edge to work the kinks out of it (figure 18). Finally I weight the track down with cans of vegetables (thanks to Terry Roberts for this idea!). The weight of the cans conforms the flex track to the height shims until the caulking compound sets up (figure 19).

It's very important to get the track straight before the Canned Goods

**Figure 14:** My miniature notched trowel for spreading caulking compound.

**Figure 15:** Laying a bed of caulk. It's tricky not to use too much or too little.

**Figure 16:** Spreading the caulk out - too thin and the track won't stick, too much and it makes a mess.

**Figure 17:** Flex track bedded down into the caulk.

**Figure 18:** Using a straight edge to line up the flex track.

**Figure 19:** A row of canned vegetables holds the track in place until the caulking compound sets. Use enough weight to conform the track to the height shims.



Figure 17

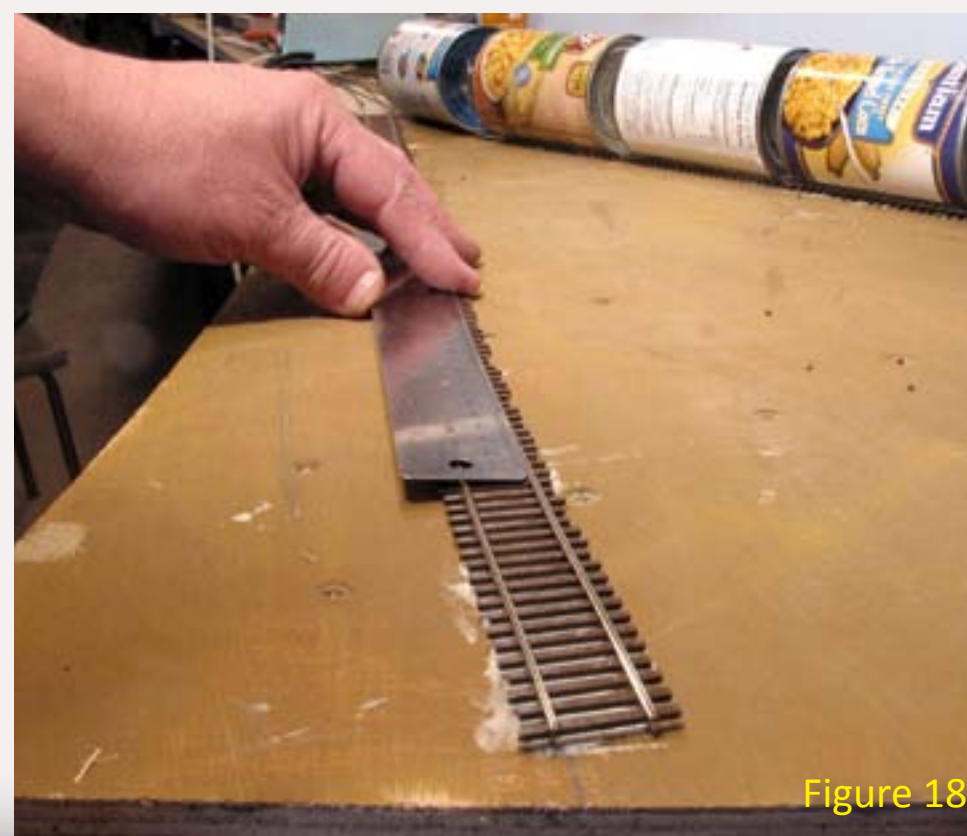

Figure 18



Figure 19



Charlie Comstock is the Layouts and Media editor for Model Railroad Hobbyist. He got started with model trains at age 5 and is currently working on the 3rd version of his HO Bear Creek and South Jackson Railway Co. [www.bcsjrr.com](http://www.bcsjrr.com)

Express runs. Once the caulk sets it's more than slightly difficult to realign the track (soaking with alcohol can get the caulk to release the track).

## Finishing Touches

First a confession - the Redland Lumber Co. spurs that are the subject of this article are still raw spurs - (since Redland is on the lower deck I wanted to get scenery on the upper deck finished first to avoid 'dribbles' so there is still no scenery in the land down under). However, the spurs in Mill Bend

**Figure 19: The newly installed spur track showing 'vertical instability'.**

**Figure 20: Lumpy, weed infested, poorly maintained track in Mill Bend built on track height shims.**

have nice scenery - I used one there for the photos in figures 1, 2, and 20.

Quite often, old spur tracks will be nearly buried in dirt. The ballast if present, usually won't be the neatly maintained fresh gravel on the mainlines. I chose to use different ballast types for my mainline and the spurs.

- Smith & Sons limestone ballast on my mainline.
- Arizona Rock & Mineral's SP Yard Mix on my sidings and spur tracks (it looks like cinders).

As tracks become less used - mainline being the most used, followed by passing sidings, and spur tracks which are the least used - I add increasing amounts of vegetation encroaching on the tracks. Figure 1 shows this well -

there's little doubt as to which of these are the mainline and the spur tracks!

I use quite a bit of static grass applied with a Noch Grassmaster (see the excellent article by Kevin Rowbotham in MRH Issue #6 on economically building your own static grass gun). After that I install Silflor (from Scenic Express) weeds and ground foam bushes.

Finally I add bits of discarded wood and metal strapping and some piles of broken glass or other junk appropriate to the area..

Give roller coaster track a try. It'll add another dimension (a vertical one) to your spurs!



Figure 19



Figure 20

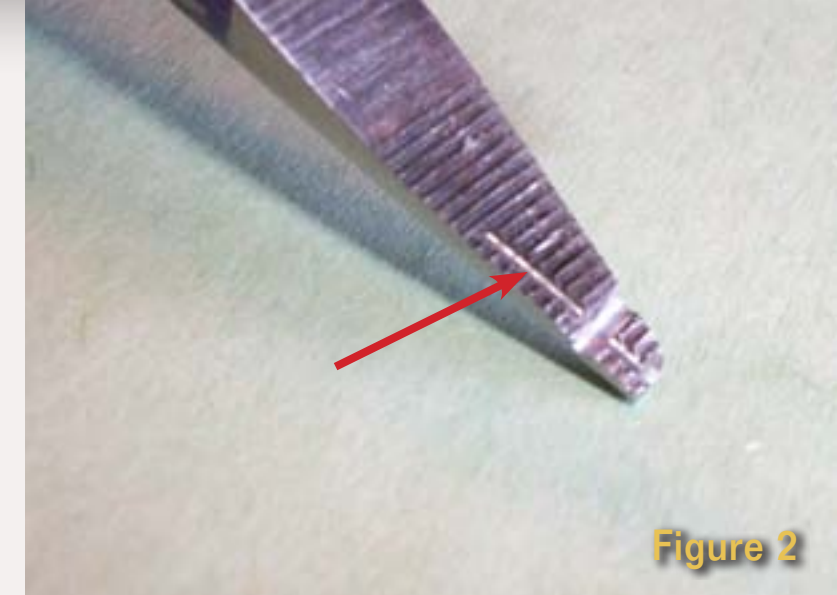

## Make Your Own Spiking Tool

Turn a set of pliers into a custom tool!

by Steve Pirosko

 **Reader Feedback**  
(click here) 

**W**hen I started hand laying track I figured having a special spiking tool would help speed the job considerably. A quick investigation showed commercial tools ranged in price from \$15 to \$45, ouch! Being a frugal sort, before plunking down that much cash I figured I'd try making my own tool. I had an extra pair of 6" needle nose

Figure 1: My spiking tool

pliers on hand so I experimented with them.

First I made the point end a little blunter by swiping a file across it a few times. This gave me enough surface area to drill a .050" diameter hole though the tip to securely hold the shafts of the spikes. Not having a drill press made this operation a little precarious and the result was that the hole is not straight down the center

Figure 2: The .050" hole that will hold the shafts of the spikes. Steve drilled this hole without a drill press and it ended up a bit 'slanted'. However this turned out to be an advantage.

Figure 3: The sideways slot to to securely hold the spike heads. Here the tool is shown with a track nail.

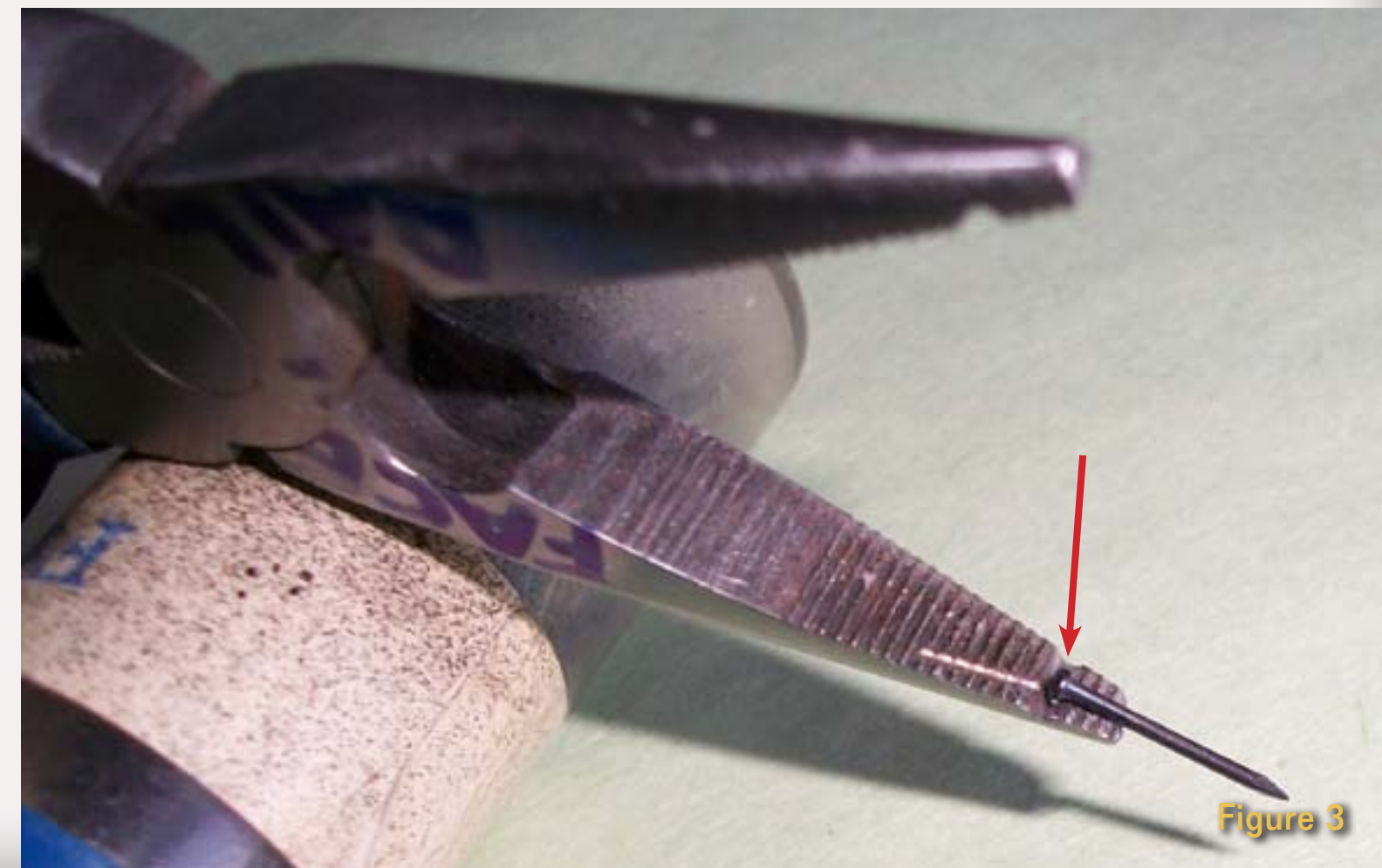

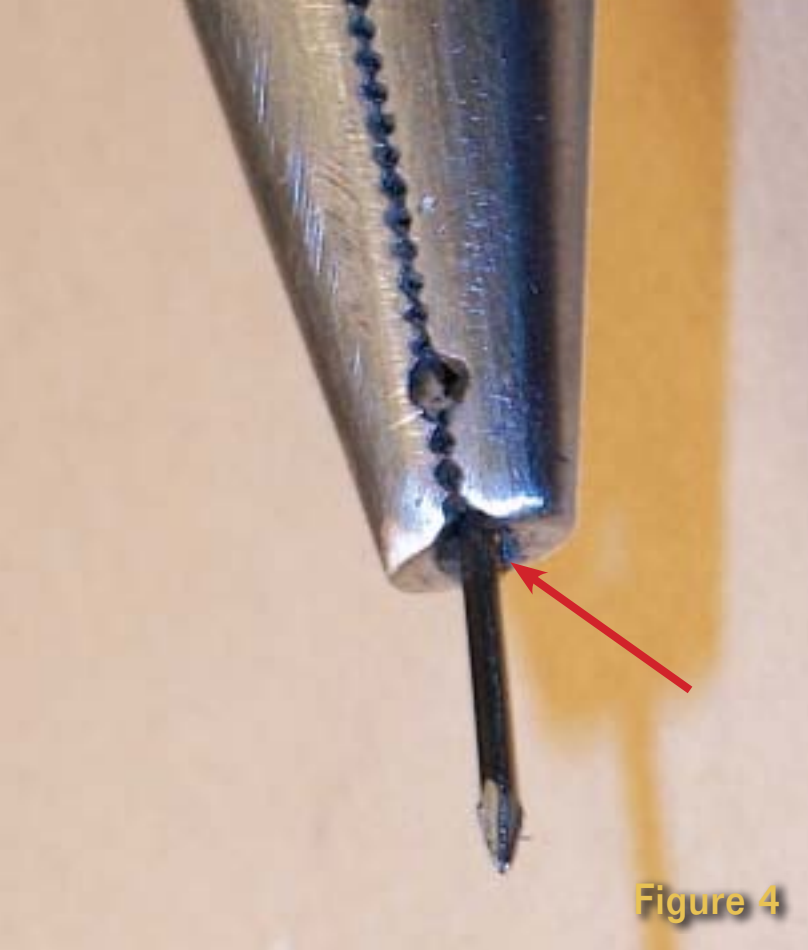

Figure 4

Figure 4: The tips of the tool. Look carefully to see the countersinking giving a secure way to push spikes home.

Figure 5: Steve magnetized the tool making it easier to pickup spikes.



Figure 5

(figure 2). However this proved to be an advantage as it allows the tool to be held at a slight angle making it easier to see what I'm doing.

I used a Dremel tool with an abrasive cut-off disc to grind small slots in each arm to better hold the head of the spike. I positioned this slot about 1/3 of a spike length from the tip. This helps prevent spikes from bending while driving them (figure 3).

I countersank the hole (barely) in the tip of the tool with a .063" drill bit to provide a secure means to push spikes home. The countersinking should only be as deep as a spike head (figure 4).

Finally I magnetized the tool to help with picking up and holding spikes (figure 5). I did this by swiping the tool against a strong industrial magnet I had on hand. This step isn't necessary but is a nice touch.

If I had a drill press and had been able to properly secure and align the work piece and the drill bit I would not have had to file the end so much - having a smaller tip on the pliers would allow working in tighter quarters when spiking.

It's a neat little tool that cost me nothing more than a little time (since I already had the pliers on hand). Now to take the money I saved and look for a drill press.



**FIND OUT ABOUT OUR SUMMER LAYOUT TOUR**

# IMPROVE YOUR STRUCTURE MODELING

Learn from the best, well known modelers in the country.  
**DAVE REVELIA-DAVE FRARY-BRIAN NOLAN.  
SCOTT MASON-BRETT GALANT-DOUG FOSCALE.  
BOB MITCHELL-MIKE ROSE & MORE**

**DON'T MISS OUT  
SIGN UP NOW FOR PREMIUM CLINICS  
DOZENS OF VENDORS - CONTESTS**

# css2010.com



# Developing a Numbering System for a Proto-lanced Model Railroad

Basing a numbering system for rolling stock and locos on a prototype railroad is realistic and saves a lot of guesswork.



by Lew Matt

Railroad equipment that moves on rails, whether locomotives, passenger cars, freight cars, or M.O.W equipment, needs a paint job, lettering and a number for identification. If you're a prototype modeler picking a numbering scheme is simple - you copy your prototype. But what about those of us who have our own railroad?

Freelanced model railroads are often at least loosely based on a prototype – why not borrow that railroad's numbering scheme? Following a prototype railroad's standards means you won't have to reinvent the numbering and lettering scheme, leaving more time for building and operating. The *Cumberland and Lake Erie* Railroad is an example of how

one modeler developed a plausible numbering system (and set of paint schemes) for his *Western Maryland* based, generic short line.

## The C&LE

Last winter I attended an operating session on **Dave Baker's** layout in central Pennsylvania. Dave models a fictitious regional railroad, the *Cumberland and Lake Erie*. He's been interested in *Western Maryland* so it was natural for his model railroad to be influenced by the WM from which he borrowed a lot of style and color to give the C&LE a believable look.

Dave's railroad is set in 1957 and runs from Cumberland in Maryland through Johnstown to Erie in Pennsylvania. He modeled the C&LE as though it was part of the *Alphabet*

*Lines* providing coal, ore and limestone to the steel industry in Johnstown and merchandise service to other towns along the line. The C&LE features a designed-for-operation track plan.

Dave has been a railfan and model railroader since he was a preschool youngster watching the streetcars run in front of his house. He and his crew enjoy operating the C&LE under TT&TO (*TimeTable and Train Order*) rules. Dave hosts at least two op sessions each month and enjoys inviting out of town groups and clubs to run his railroad, too. That's how I got to operate on the C&LE!

Dave did a great job with his available space. His talent and extensive knowledge of the *Western Maryland* let him

selectively compress the area he models – the WM from Cumberland to Rockwood and the B&O Somerset and Cambria Branch to Johnstown – in a very believable manner. The geography on the C&LE is life-like enough that those of us who live in this area thought we knew where each scene may be located.

His desire for realism led him to wanting a plausible lettering and numbering scheme for the rolling stock on the C&LE.

## WM Influence

The C&LE's lettering is based on the *Western Maryland* and is extremely well thought out. Like the WM, cars and locos lettered before April 1954 receive a Fast Freight lettering style

**Figure 1: This class XAR 50' boxcar with dreadnought ends was lettered for the C&LE and given the number 27916. Note the reweigh information just to the right of the LT WT. SS-11-54 represents Somerset as the reweigh station and November, 1954 as the date. All the reweigh years are close to 1957, the era Dave picked to model.**



Figure 1



Figure 2a



Figure 2b

**Figure 2a,2b: Number 1579 is a Cumberland and Lake Erie class NE caboose, made of wood, C&O Style with old paint. Every railroad had older cabooses that remained on the roster until they were no longer serviceable (meaning a rebuild would cost more than a new unit).**

**The diamond logo makes a distinctive impression and is a C&LE trademark. The lettering is a pre-1954 (fast freight) lettering scheme. Note the deterioration of the logo's paint.**

while those lettered after April 1954 receive Speed Lettering. Dave says you can use any prototype railroad's lettering and numbering system as a model to produce your own.

## Decal Sheets

Dave produced a decal master for car numbers (figure 3) using his computer to make it twice as big as the final decal sheet size. He used Miller Advertising to produce the actual decal sheets for him.

Car numbers on the C&LE are 5 digits long. The numbers on the decal sheet lets him pick a 3-digit beginning and a 2-digit ending allowing many car numbers to be formed with only two individual pieces of decal to align.

The three digit numbers on the top of the car decal number sheet match the C&LE's car numbering system: 100 and 130 are for GM class gondolas;

100 130 140 141 203 204 214 220 221 240 300 301 302  
 310 311 312 313 314 315 316 317 318 320 321 322 324  
 335 340 345 348 350 351 355 356 510 520 01 02 03 04  
 05 06 07 08 09 10 11 12 13 14 15 16 17 18 19 20 21 22 23  
 24 25 26 27 28 29 30 31 32 33 34 35 36 37 38 39 40 41  
 42 43 44 45 46 47 48 49 50 51 52 53 54 55 56 57 58 59  
 60 61 62 63 64 65 66 67 68 69 70 71 72 73 74 75 76 77  
 78 79 80 81 82 83 84 85 86 87 88 89 90 91 92 93 94 95  
 96 97 98 99 00

SS-10-56 SS-11-55 SS-12-55 SS-8-56 SS-4-56 SS-1-56 SS-3-56 JTN 3-57 JTN 5-56 JTN 10-56 JTN-11-55 HAG 1-56 CB 10-55 CB 7-56 ER 8-55  
 SS-11-56 SS-12-55 SS-10-55 SS-5-56 SS-6-56 SS-2-56 SS-7-56 JTN 9-55 JTN 6-56 JTN 11-56 JTN-12-56 HAG 2-56 CB 11-55 CB 9-56 ER 9-55  
 C&LE  
 100 130 140 141 203 204 214 220 221 240 300 301 302 310 311 312 313 314 315  
 C&LE  
 316 317 318 320 321 322 324 335 340 345 348 350 351 355 356 358 510 520 820 827  
 01 02 03 04 05 06 07 08 09 10 11 12 13 14 15 16 17 18 19 20 21 22 23 24 25 26 27 28 29 30 31 32 33 34 35 36 37 38 39 40 41 42 43 44 45 46 47 48 49 50  
 51 52 53 54 55 56 57 58 59 60 61 62 63 64 65 66 67 68 69 70 71 72 73 74 75 76 77 78 79 80 81 82 83 84 85 86 87 88 89 90 91 92 93 94 95 96 97 98 99 00  
 HAG 1-56

Figure 3

**Figure 3: Car numbering data sheet for the decal master. Numbers are grouped in specific series to reduce the trimming required.**

140 and 141 are for GB class gondolas; 203 and 204 are for XM class box cars; etc. See figure 6 - "Car and Locomotive Classification and Numbering System" for his car numbering system. Dave got the idea for the decal sheet when he purchased custom lettered cars from [Accurail](#), who supply number decals for their cars using a similar format.

Note that the lettering for the end of car reporting marks contains the C&LE initial and first three digits for the car number. Dave used the Century Schoolbook font for the C&LE initials and numbers. This font is a close ringer for Railroad Roman and is commonly found with word processing programs. The sheet also contains reweigh dates

and locations to add a bit more personalization. All the reweigh years are within two years of 1957.

When making your own decal masters it's easy to create your own initials for whatever locations on your railroad have shops with reweighing facilities.

## Reweight data

After WWII, cars were required to be reweighed every 30 months. Proper weight is important to the railroad because their income is:

$$\text{money} = \text{weight} \times \text{miles}$$

When a car was repaired or modified and the tare (unladen) weight changed, the reweigh location and date were stenciled on the car's side.





Figure 4

**Figure 5: Dave Baker poses with some C&LE rolling stock. The lettering is based on Western Maryland railroad practices. By following this prototype scheme, the fictitious C&LE becomes more believable.**

**The 50' double door, automobile boxcar has speed lettering. This style, introduced in 1954, marks the car as either newer than 1954 or repainted after 1954.**

**The old, wood sided, steel frame caboose has a pre-1954 lettering scheme. Photo by Allen Baker II**

This detail helps to target the modeling era. The reweigh stencil is placed under the reporting marks close to the capacity and light weight.

New cars are stenciled NEW followed by the date. Cars are also restenciled when the journals are repacked. This small stencil is usually placed just above the right truck and may include letters for location and date numbers to indicate where and when the work was done. New car's journals are stenciled to be NEW followed by the date.

After WWII, date stencils for weight, either NEW or reweigh, and journal repacking should not be more than 30 months previous to the date

you are modeling. Before WWII, 24 months was the norm and for the more modern era, after 1965, 36 months would be common. All of these decal details help solidify the illusion of the modeled era.

**The tables on the next two pages show the number series and lettering styles for all classes of C&LE rolling stock and locomotives.**

**Having a table such as this one, makes it easy to track the numbers assigned to each car and loco..**



**Lew Matt** is a published writer, photographer, and illustrator whose work has appeared in many model railroad hobby magazines.

[Click here](#) to learn more about Lew.

# Cumberland and Lake Erie Railroad

## The Laurel Ridge Route

### CAR AND LOCOMOTIVE CLASSIFICATION AND NUMBERING SYSTEM

C&LE - Non-Revenue Equipment			
Class	Series	Model	Notes
Steam Locomotives	100-149	0-4-0, 0-6-0, 0-8-0	
	151-199	2-4-0, 2-6-0, 2-8-0, 2-10-0	
	201-249	2-4-2, 2-6-2, 2-8-2, 2-10-2	
	251-299	2-6-4, 2-8-4, 2-10-4	
	301-349	4-6-2, 4-8-2	
	351-399	4-6-4, 4-8-4	
	501-599	2-6-6-2, 2-8-8-2	
Diesel Switchers	401-425	S-2	
	526-450	S-4	
	451-475	VO-1000	
	476-500	SW-7	
Road Diesels	601-605	FTA	Speed lettering
	606-609	FTB	
	611-624	F-3	Speed or Fireball lettering
	625-649	F-7A	Fireball lettering
	651-669	F-7B	
	671-679	FA-1	
	680-689	FA-2A	
	690-699	FA-2B	

C&LE - Non-Revenue Equipment			
Class	Series	Model	Notes
General Purpose Diesels	701-714	RS-2	Speed lettering (repainted)
	715-730	RS-3	Fast Freight (repainted)
	800-819	GP-7	Fast Freight (old paint)
	820-829	SD-7	
	830-849	GP-9	Speed lettering
	850-870	SD-7	
	870-879	SD-9	
	880-999	other	
Passenger Diesel	1000-1999	all	With steam generators
Work Train cars & equipment	W8111-W8115	Burro Crane	
	W8141-W8143	Crane	
	W8171-W8173	Crane support	
	W8201-W8206	Plows	
	W8301-W8303	Black smith	
	W8401-W8428	Hopper	
	W8601-W8614	Boxcar	
	W8701-W8719	Gondola	
	W8801-W8808	Flatcar	
	W8901-W8918	Crew and kitchen	
Class NE Caboose	9000-9002	Transfer	
	1501-1599	Wood	C&O style, old paint
	1601-1610	Steel	Roundhouse

C&LE - Revenue Equipment			
Class	Series	AAR	Notes
Class G Gondola	10001-13999	GM	Mill Gondola
	14001-14999	GB	



# Derailements

humor (allegedly)

C&LE - Revenue Equipment			
Class	Series	AAR	Notes
Class X Box	20301-20400	XM	Outside Braced Wood Panels
	21401-21499		Steel Riveted, 10 panel
	22001-2299		PS-1
	24001-24999	XAP	50' dreadnought end
	27901-28000	XAR	50' dreadnought end
Class H Hopper	30001-30100	HM	31' fishbelly
	30101-30200		31' ribbed side
	30201-30300		31' U-channel
	30301-30999		USRA-55 ton
	31001-31699		34' offset w/bulkheads
	32001-32499		34' offset w/o bulkheads
	34001-34499		34' ribbed side, wood or metal, war emergency
	34501-34999		34' U-channel
	35001-35499		34' ribbed side, steel, w/o bulkheads
	35501-35999		34' ribbed side, steel, w/ bulkheads
	36001-36299		36' offset side
	37001-37999		40' 70 ton, 3-bay
	38001-38999		40' offset side, 4-bay
Class S Stock	40001-41399		
Class F Flat	51001-51399	FM	40' wood floor
	52001-52040		50' wood floor
Class R Refrigerator	60001-60999		various
Class B Passenger	70001-70999		various
Class T Tank Unlined/Uninsulated	81001-81199	TA	single dome
	81201-81299		two domes
	81301-81399		three domes
Class L Special Purpose	93001-93010	LFA	LFA flatcar, wood
	93101-93199		LFA flatcar, steel
	45001	LO	Covered Hopper
	55001-55100	LP	Pulpwood



C.I. Herrera

Static grass on the cheap

A model railroader reported a burglary to the police. When the officers arrived they asked, "What was taken?"  
 "It's very strange replied the distraught modeler. They left my brass locos, the 12 car California Zephyr passenger train and my set of collectible train books. In fact they only took one thing!"  
 "Let me guess", replied a cop. "It was your model of a steal mill!"

Did you hear about the engineer trainee who thought notch-8 was what he should carve on the throttle after driving his seventh train?

Got a good bit of humor? If you're the first to [submit it](#) and we use it, it's worth \$10!

# ExactRail

## Modern Freight Cars

**First Look**

by Jeff Shultz  
photos Joe Fugate



**Reader Feedback**  
(click here)



In late January 2009 the model railroad community lit up with the announcement of a new, high quality car manufacturer – [ExactRail](#), led by veteran model railroad toolmaker Chris Clune. ExactRail officially launched February 1st, by shipping three new HO Scale models – the Vert-A-Pac Automobile Car, the Gunderson 7466 cu. ft. Wood Chip Gondola, and the PC&F 6033 cu. ft. Hy-Cube Box Car. One month later, Exactrail entered the N Scale market with N Scale versions of the PC&F 6033 cu. ft. Hy-Cube, the Vert-A-Pac Automobile Car, and a new prototype, the Trinity 5161 Covered Hopper. Every couple of months since then, they’ve released both new models and additional runs of previously released models, all of which quickly sell out.

From the beginning, [ExactRail](#) divided their HO models into different “series,” with different levels of detail and pricing. Beginning with the high-end Platinum and mid-range Evolution series initially, [ExactRail](#) has added two more series – the economy Express series and the Signature Series, which features Platinum quality models of what they call “railroad-unique prototypes” such as Southern Railroad’s “Waffle Boxcar” and the Milwaukee Road’s 40’ Rib Side boxcars. ExactRail’s N-Scale products are not differentiated by series.

Recently [ExactRail](#) released new runs of three models – the Platinum Series Thrall 3564 cu. ft. gondola, the Evolution Series PC&F 6033 cu. ft. hy-cube boxcar, and the Express Series Gunderson 2420 cu. ft. gondola.

Many thanks to the contributors and members of the [Modern Freight Car List](#), [The SP Freight Cars Page](#), [the Atlas Forums](#), [Railcar Photos](#), and [TrainOrders](#) for the information I was able to collect from their posts and photos.

### **Thrall 3564 gondola**

The Thrall 3564 was mislabeled as a 3267 cu. ft. gondola in the original release, an error that was quickly

**Thrall 3564 cu. ft. gondola decorated in the GNTX paint scheme.**

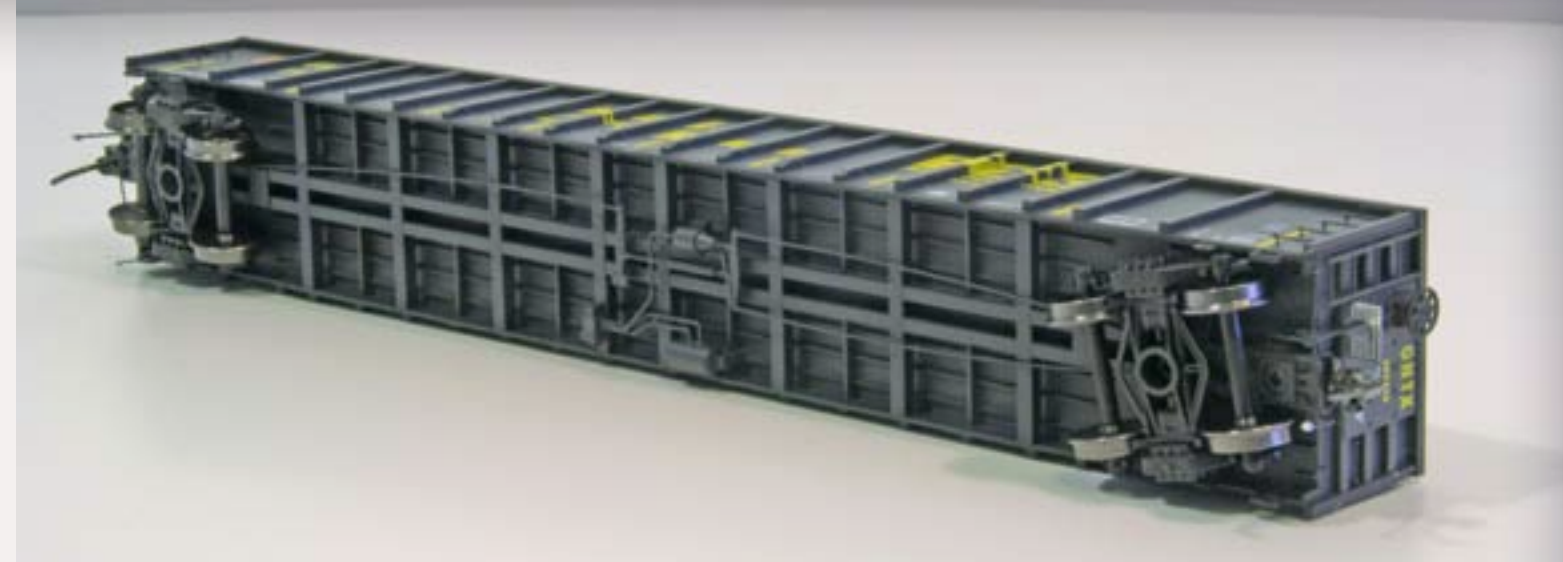

corrected by [ExactRail](#) on online forums and mailing lists. The original release models are still described as 3267's on the [ExactRail web site](#) and several, if not all, of the paint jobs offered in the current release, such as TTX's GNTX, Southern Pacific and others, are found on prototype 3267's and 3242's instead of the 3564. All three prototypes are visually similar, differing in height and length by about 6" between each other.

This release of the gondola includes ExactRail's ASF 100 Ton Ride Control Trucks with machined 36" wheels and Kadee #58 knuckle couplers – a change from the original release's McHenry #41 couplers.

### **PC&F Hy-Cube boxcar**

The PC&F 6033 cu. ft. Hy-Cube boxcar was one of ExactRail's original releases and is based on the Southern Pacific Class B-70-32 boxcar. Originally manufactured in 1966-67, the prototypes are 50'5" long, and feature the Hydra-Cushion underframe. Many of them also included Car Pac Loaders. Originally purchased for appliance service, they were also reportedly used for kraft paper service. Many of these cars were sold to other railroads, such as Alaska and Western Pacific, as well

### **Thrall 3564 cu. ft. gondola (top)**

**PC&F Hy-Cube car based on the Southern Pacific B-70-32 class boxcars. (bottom)**

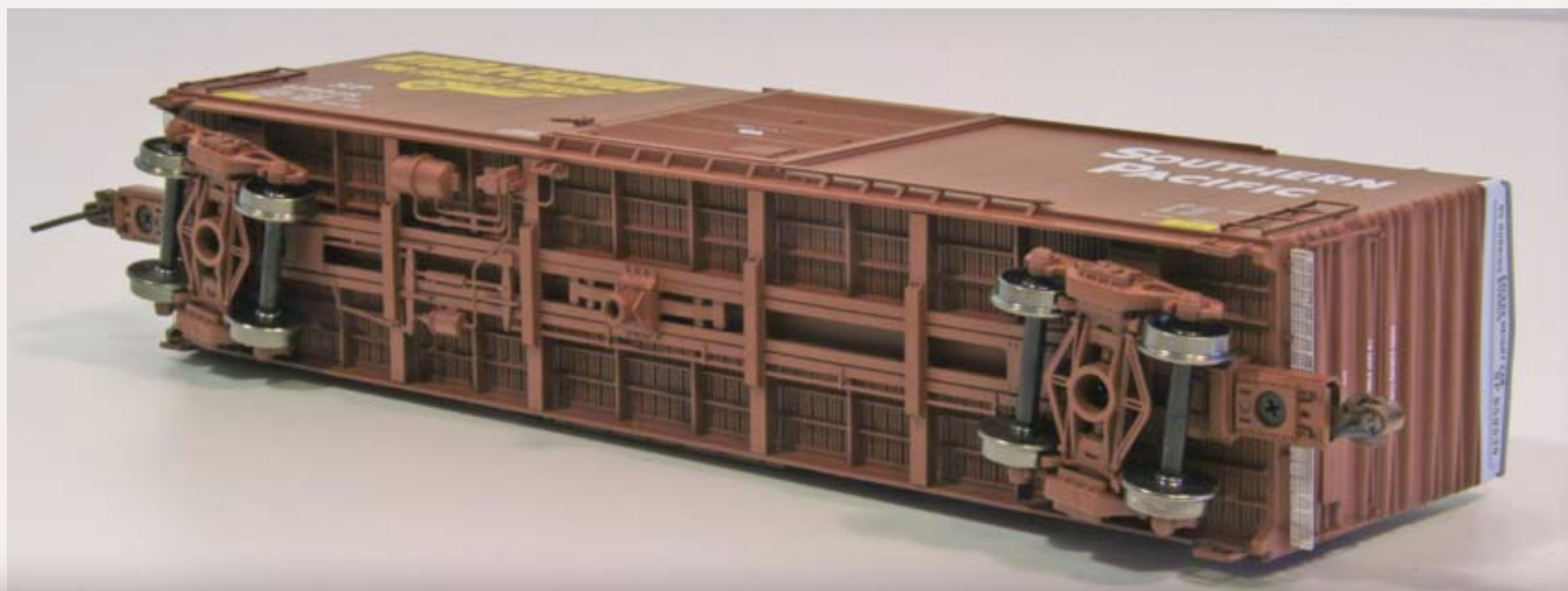

as finding their way into lease and per diem car service. This release of the PC&F 6033 includes the Southern Pacific's "as delivered" paint scheme as well as in ATSF paint as a stand-in for the visually similar BX-82 boxcars that were rebuilt for appliance service in 1967. The models feature McHenry #41 scale knuckle couplers and ExactRail's 70 ton Barber S-2 trucks with machined 33" wheels.

## Gunderson gondola

The Gunderson 2420 cu. ft. gondola is a model of the Southern Pacific's Class G-100-7 gondolas, originally built in 1965. Their length was is 42'6" and they were numbered SP 333500 – 334399, with some being renumbered with SPMW maintenance of way reporting mark and numbers. Many of them were rebuilt and renumbered in 1984 into the G-100-7R class, replacing the corrugated panels with flat panels. Many of the rebuilt units were sold to the Georgetown Railroad, where they were still running in 2009. This second run of [ExactRail's](#) first "Express Series" car includes 3 Southern Pacific Road numbers – 333538, 334176, and 334269. The models include McHenry #41 scale knuckle couplers and ExactRail ASF 100 Ton Ride Control Trucks with machined 36" wheels.

PC&F Hy-Cube boxcar based on Southern Pacific's B-70-32 class.



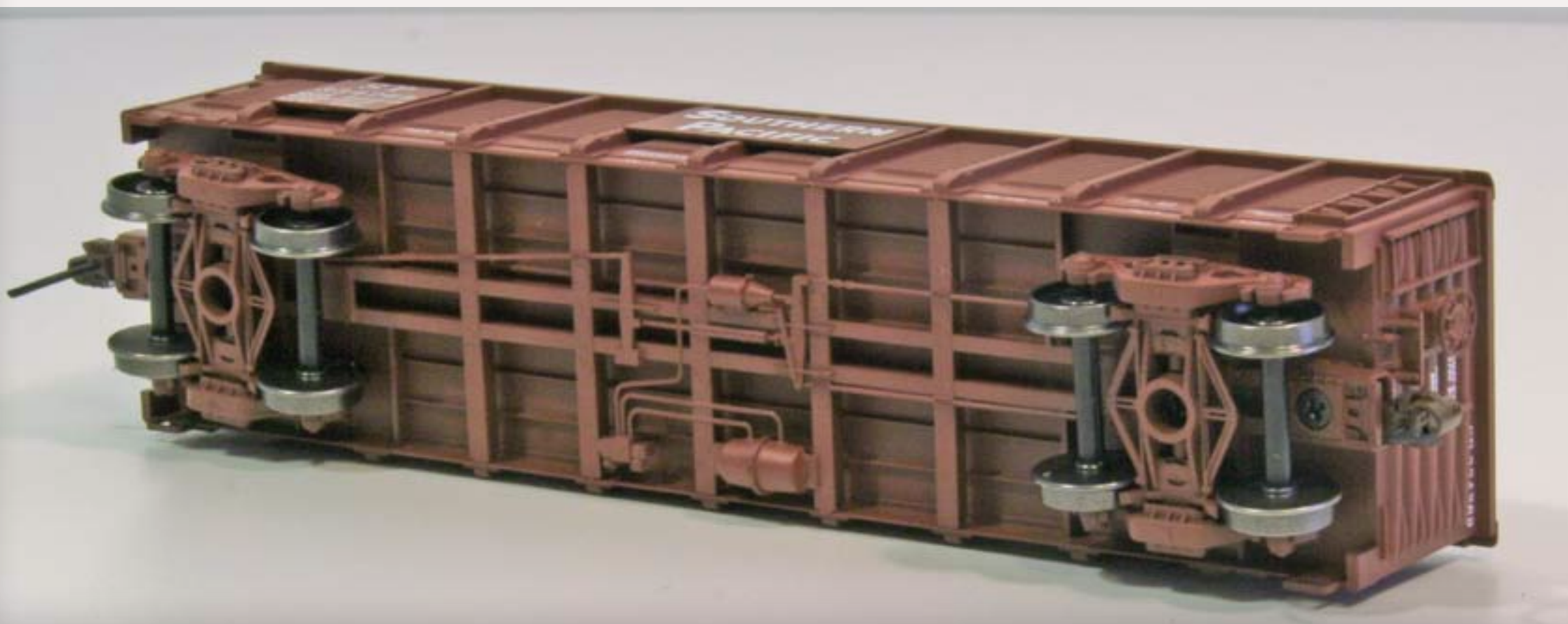

Gunderson 2420 cu. ft. gondola is a model of the Southern Pacific G-100-7 cars.

# MY MODULAR ADVENTURE: Having fun a module at a time.

The ongoing story...



**Les researches a roundhouse then scratchbuilds one from styrene ...**

## Introduction

**W**hen I first planned to build my engine facilities, I did a lot of research. I wanted a big engine facility with a large roundhouse because my main interest centers on the job of hostler! I also wanted spectacular scenery where I could watch trains run.

I drew my layout master plan based on the "Club-size engine terminal" from page 38 in John Armstrong's "Track Planning for realistic operation" Seventh Printing (1976), a Kalmbach publication. John's impressive design met most of my "Givens and Druthers" for an engine terminal.

For many years I planned and revised my future layout with this design in mind. During that time (a good 20 years or more) I drew and redrew the layout several times. I spent most of my model railroading time building,

operating and showing off modules at local and national shows. By the time I finally built my home layout, the decision became well entrenched that it would be in modules. Hence "My Modular Adventure".

I also kept an eye out and bought the kits and products I would need to be able to make this layout a reality.

I first bought a Diamond Scale turntable kit, followed by a transfer table and 4 extensions (Walthers Cornerstone), all the while looking for my roundhouse. I bought (Heljan and Vollmer) badly assembled kits at swap meets, but they did not really meet my requirements.

After more research I discovered a publication by Edward Forbes Bush titled "Engine Houses & Turntables on Canadian Railways 1850-1950", published by The Boston Mills Press in 1990. On page 74, there is a 15-stall Canadian Roundhouse built circa 1911 in Trenton, Ontario (see Figure 1 next page).

I found this to be exactly what I was looking for! After several attempts to find a kit that I could use to build this roundhouse, I gave up searching and decided to scratchbuild it.

But *how* would I go about it?

"Sleep on it," I said to myself, "you usually come up with some interesting schemes during the night". So I did, several times. The result: nothing.

One day I started taking the Heljan kit apart to see how it was put together. Then it dawned on me, why not use the basic parts of the kit as examples to build my own?

The next day I went to the drawing board (I mean my computer) and started planning, "AutoCad is your friend". The rest is history, as they say, or at least you can read all about it in my first three articles in MRH #4, 5 and 7.

The final outcome is the drawing you see in Figure 2 (the following pages), which I hope to call my final track plan – but we all know it won't be!

## My Modular Adventure

In my column, I deal with the construction of my home layout with a twist, because it is built entirely modular, and a portion of it will hopefully be hooked up to a Free-mo layout.

I want to acknowledge Joe Fugate and Charlie Comstock for their confidence in my writing abilities and for offering me the opportunity to write

[Continued on page 123](#)

## About our Modular columnist



**Les Halmos** has been a model railroader since 1979. He's been involved with setting modular standards for the NMRA since 1981. In 2001, he founded the Free-Modu-Rail Group and has been active in promoting Free-mo module standards.

[Click here](#) to learn more about Les.

Photos and illustrations by the author unless otherwise credited.





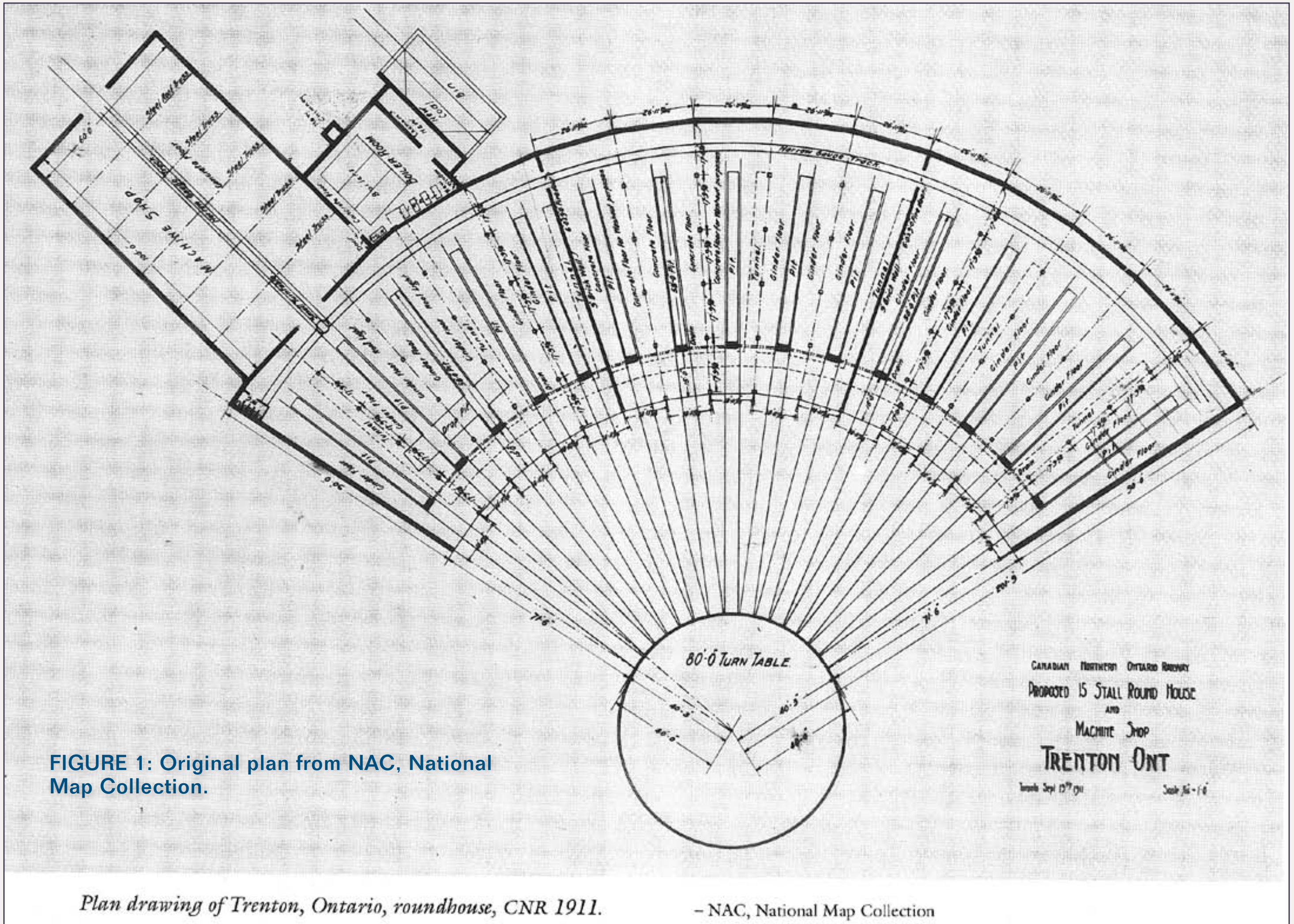

**FIGURE 1:** Original plan from NAC, National Map Collection.

*Plan drawing of Trenton, Ontario, roundhouse, CNR 1911.*

- NAC, National Map Collection

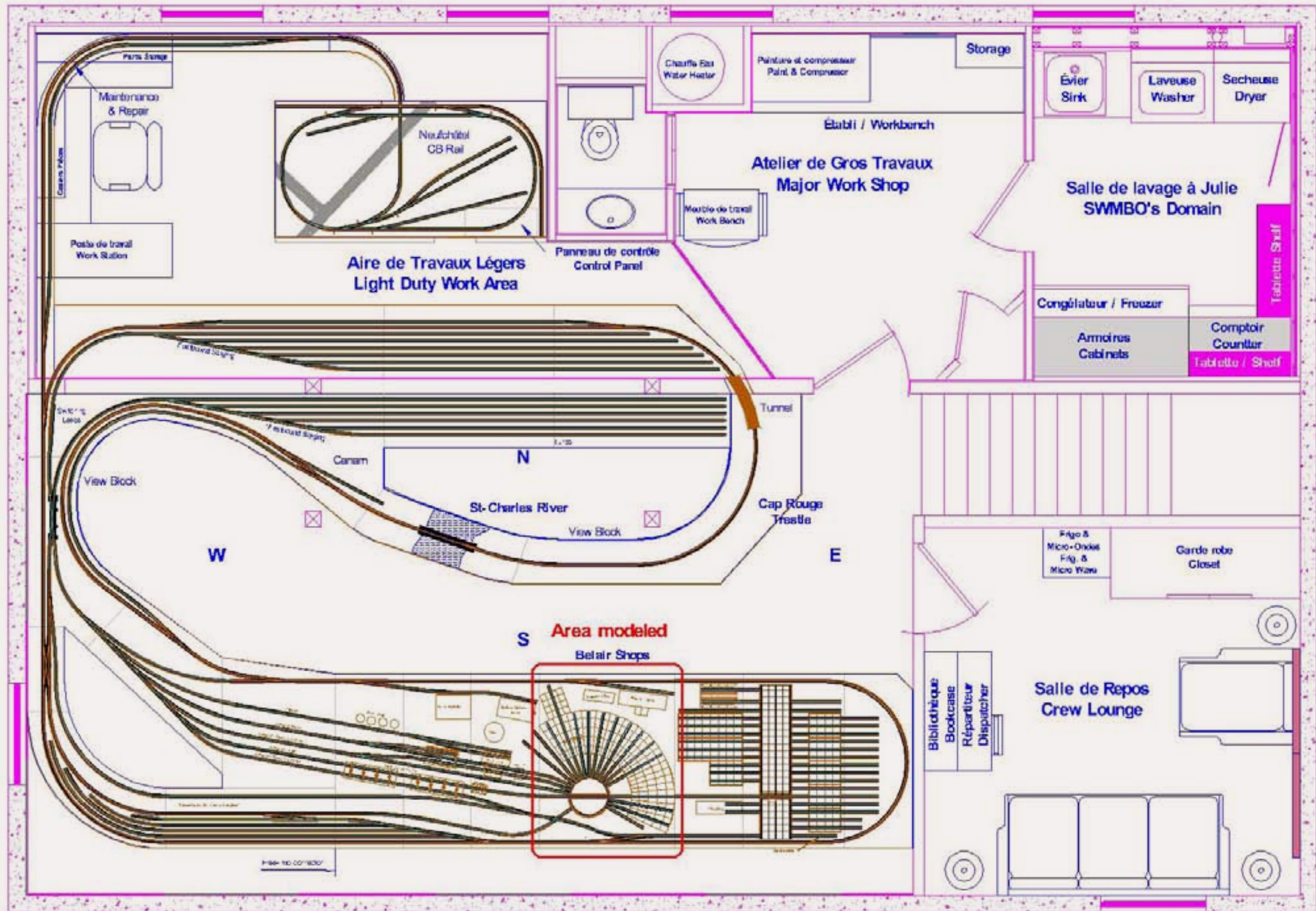

FIGURE 2: [Click here](#) for a full-res version of this image. Final and last revision of my home modular layout – I hope! The room has been prepared, and the walls are painted blue. I still need to finish the shop area and get rid of all the clutter and stuff I have been saving, but will never use. In the meantime, I am building my module in the shop area at our Free-Modu-Rail facility!

[Continued from page 120](#)

a regular column. Although I hold an “Authors Certificate” in the NMRA Achievement program, my writing talents were mainly limited to technical specifications and the like. This is new territory for me, so I hope not to disappoint. I am also humbled by the regular columnists and all the other very talented writers being published in MRH. In the past year I have learned a lot from Joe and Charlie, for which I am very grateful.

You may already know (if you read my other articles) that I worked for a plastics supplier after my retirement, and thanks to them I was able to turn my drawing into real parts. (MRH #4).

Some lucky modelers have access to a laser cutter, for me it was an XYZ Router. Either way it does not diminish the amount of work it takes to plan, draw, then detail and assemble a roundhouse like this one. If you follow this series the amount of work it entails will become very evident.

First of all, I grouped all the individual parts drawings onto one sheet to be able to identify which part goes where. I use this something like an “Instruction Sheet”. The only thing is, I am the only one that can figure it out. Follow my step-by-step instructions and you might be able to do the same.

## STEP 1: Gathering the Parts

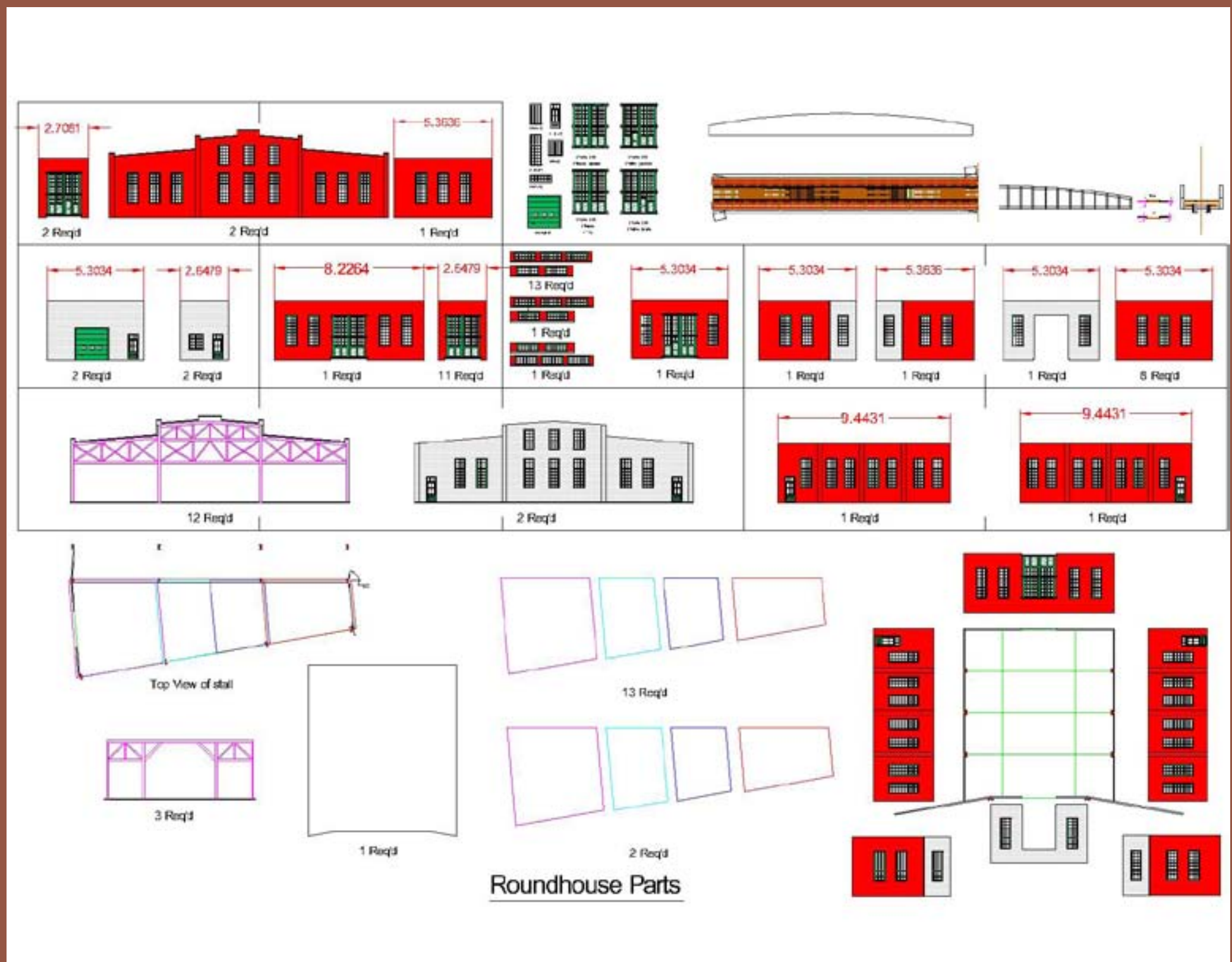

Figure 3: Roundhouse Instruction Sheet - click [here](#) to see a hi-res version of this figure.

I checked all my pieces of styrene against my “Instruction Sheet” to see if any were missing; luckily, when cutting the styrene, I made some duplicate pieces just in case Murphy shows up during assembly!

## STEP 1: Gathering the Parts *Continued ...*



Figure 4: Parts for the roundhouse (that's a lot of parts). What you see here are the parts that were cut on the XYZ Router sometime back in 2006, if I remember correctly. These parts have been lying around ever since, waiting for me to start my home layout. I shrink wrapped the whole thing to prevent them from gathering dust. When I unpacked them they were pristine.



Figure 5: Next I bought all the Evergreen and Plastruct shapes used for detailing the Roundhouse walls. See details on the next page in Figure 7. Quantities will vary according to the number of stalls you build. I used quite a lot.

## STEP 1: Gathering the Parts *Continued ...*

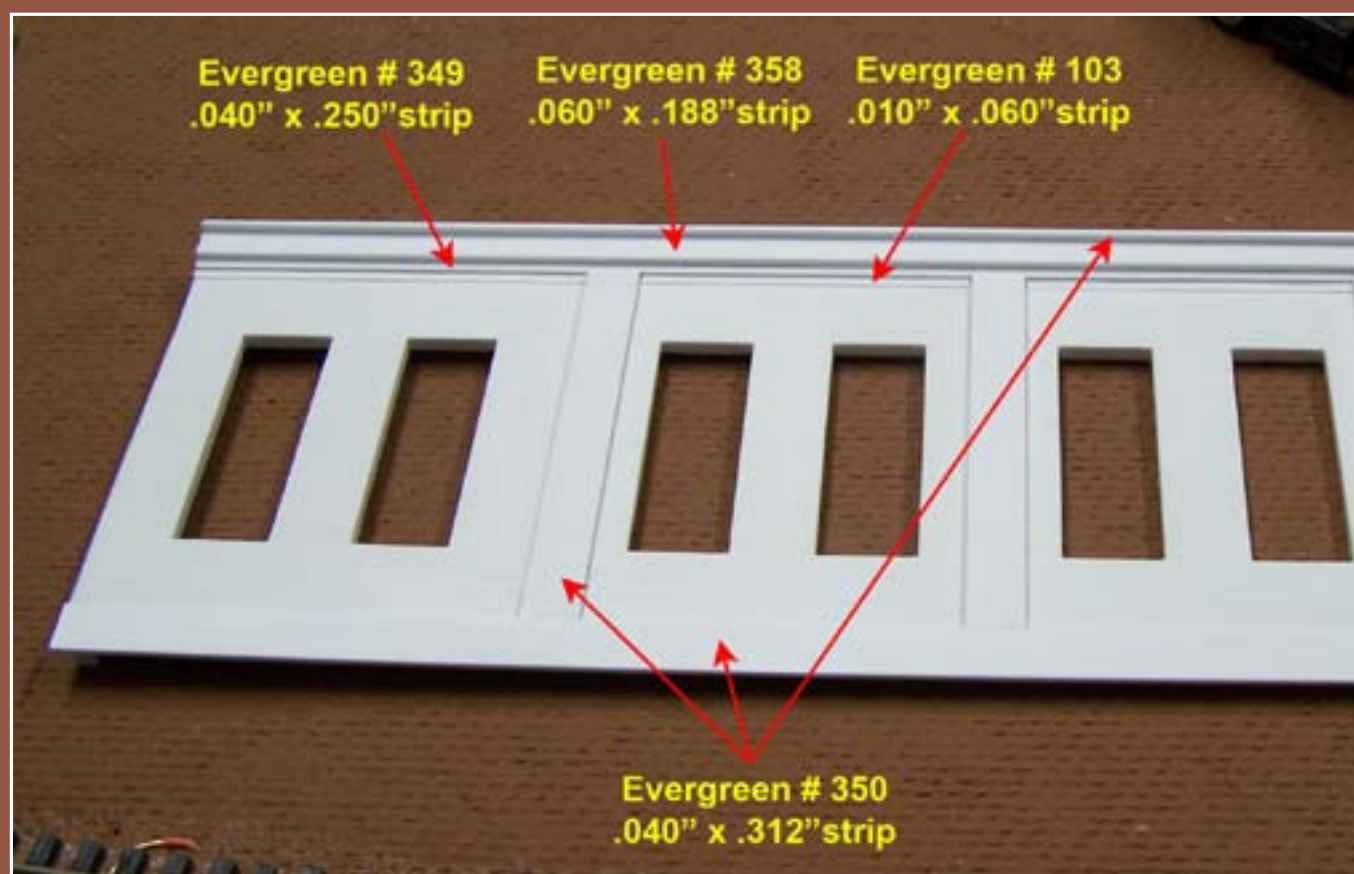

Figure 6: Evergreen strips for walls.



Figure 8: I also pre-purchased all Tichy doors and windows, Central Valley Large Shop doors and Pikestuff freight doors.

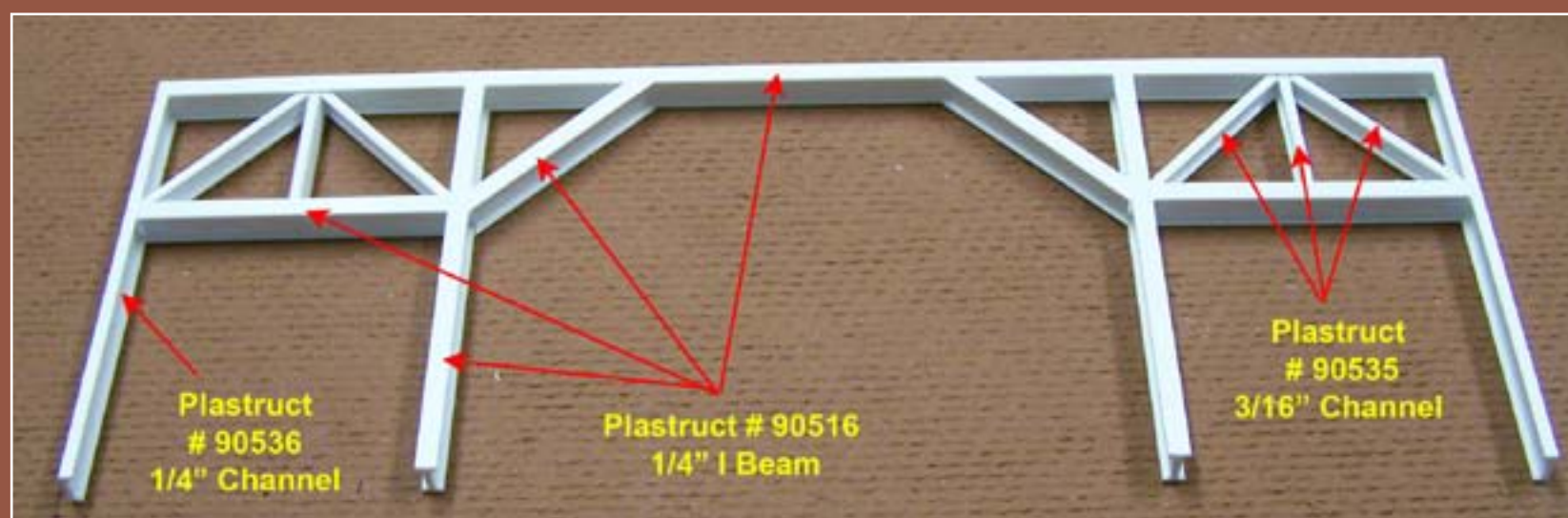

Figure 7: Plastruct shapes for trusses.

When I had everything on hand, I stored all that stuff and waited for the opportunity to start on my layout. A lot happened during those years especially my involvement in the Free-Modu-Rail layout. But one day, our Publisher Joe Fugate came looking for an article on modules, and that was just what I needed to build this module and officially begin construction of my home layout. Now I am ready to go to the next step which is more fun than all that necessary wiring and electronics in the previous segments of this Modular Adventure.

### Tichy #'s:

- 10 x 1102 – .015" dia. Phosphor Bronze wire
- 12 x 8054 – 9 x 9 Double Hung Window
- 75 x 8057 – 6 x 6 Double Hung Window
- 2 x 8064 – 4 x 4 Double Hung two unit Window
- 92 x 8100 – 27 Pane Window
- 6 x 8119 – Factory Door

### Central Valley #:

- 15 x 1605 – Large Shop Doors (Left & Right)

### Pikestuff #:

- 2 x 1112 – 12' x 12' Freight Door

## STEP 2: Begin Construction

I got down and dirty and started building this thing! In the first part (MRH#4), I assembled the pits and installed the floor on the module. I am now putting up the structure. What better place to start than the machine shop. Just the right size to get my feet wet, so to speak!



Figure 9: I temporarily attached full size prints from the Instruction Sheet to the pre-cut machine shop walls. Hmm...it looks promising.

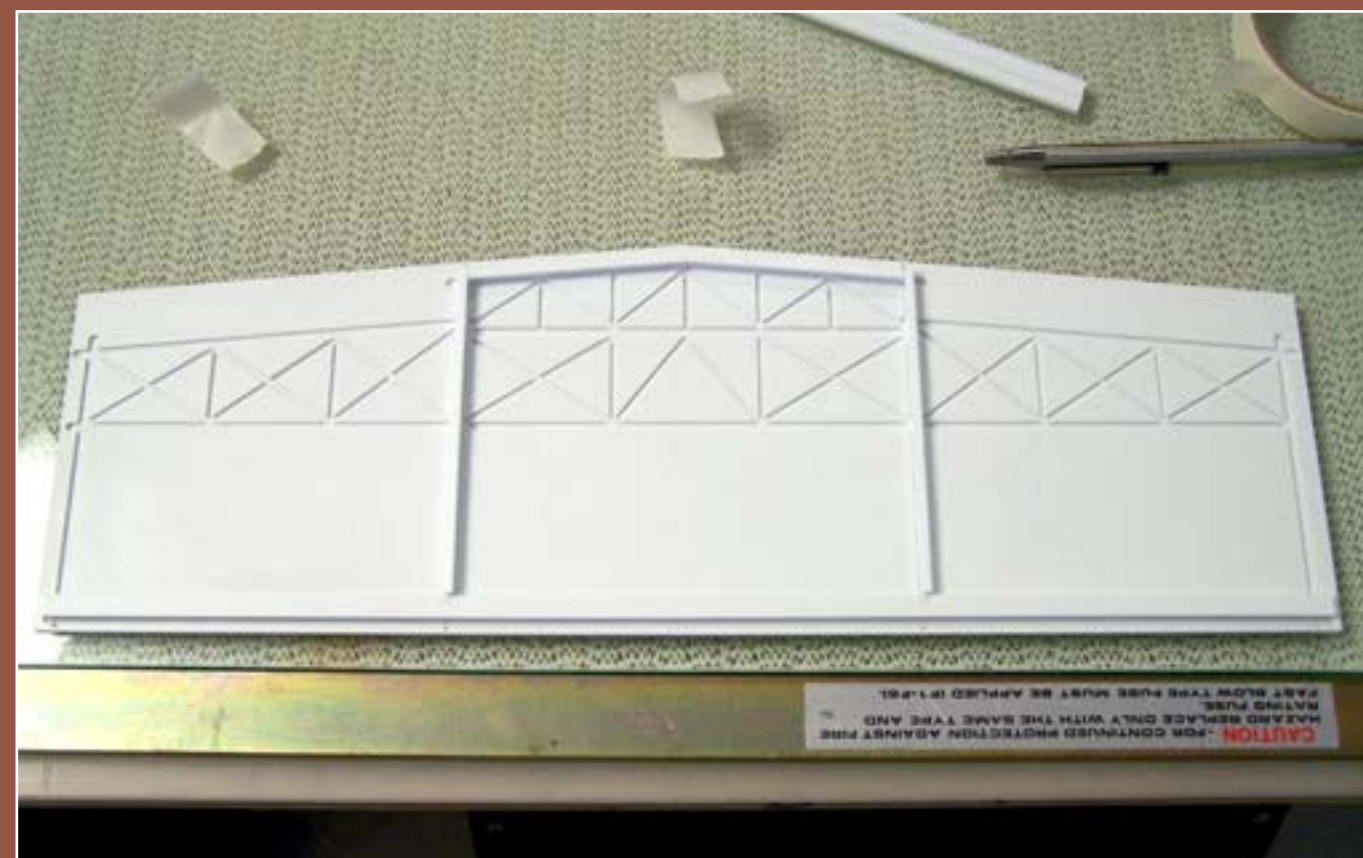

Figure 10: When I had the parts made, I thought of making a jig for the structural parts of the roundhouse. If I had a laser cutter I would have made it out of plywood. It is styrene so I will be very careful when gluing parts not to bond them to it permanently. The construction of main roundhouse trusses will be discussed in the next instalment; I only need to make a dozen!

## STEP 2: Begin Construction *Continued ...*

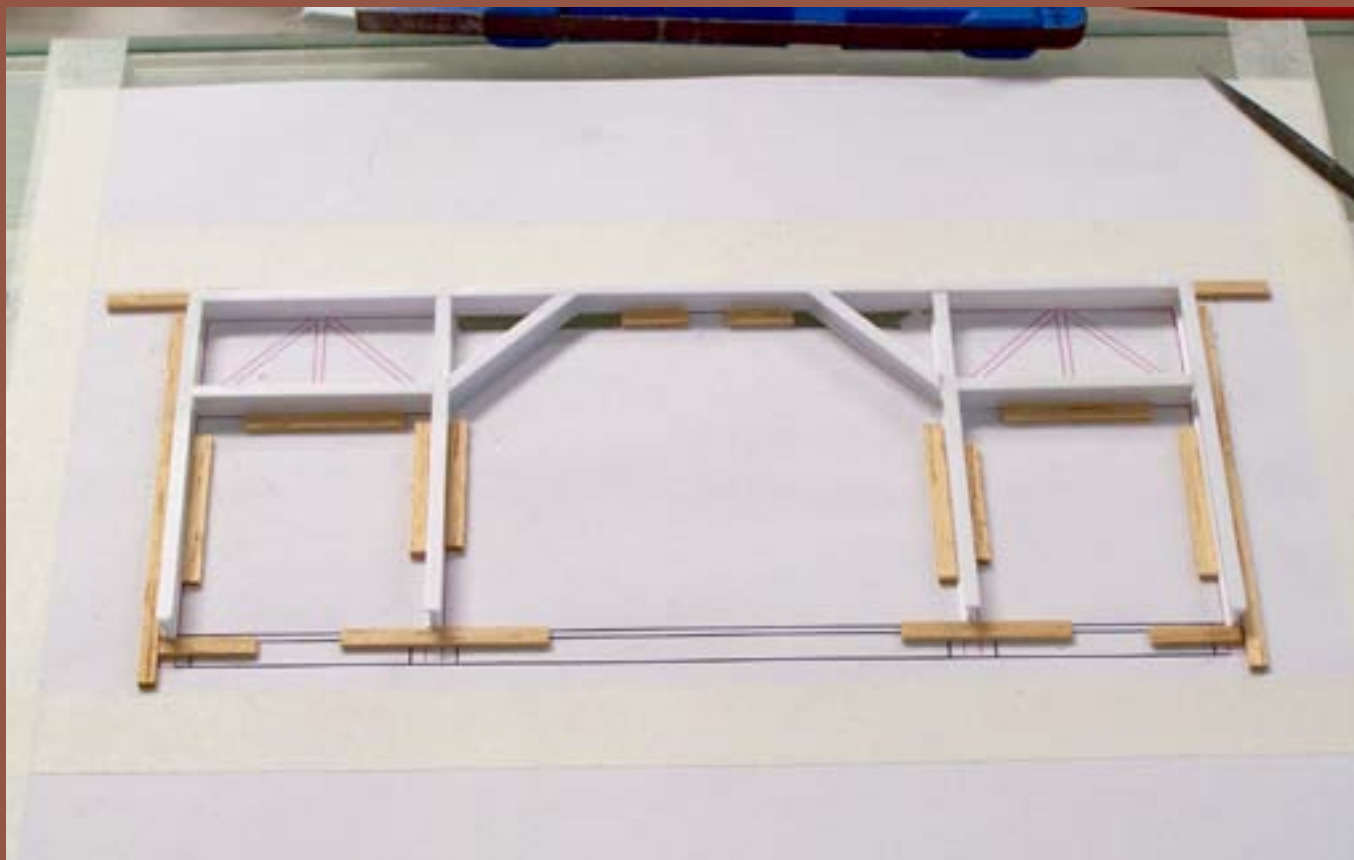

Figure 11: I wasn't so lucky with the truss jig for the machine shop extension, because I simply forgot to plan for one. I used the old tried and true method – a scale drawing with some basswood strips.



Figure 12: I built three trusses for the machine shop, using “I” beam and “C” channel strips from Plastruct.

It's a little fiddly to cut each part and get them to fit. I cut the pieces on my North West Short Line [Chopper III](#) then sanded them square or angled to the proper dimension with the [True Sander](#) from the same company. I'll cover these steps in more detail in my next column.

### STEP 3: Clean Up (More precisely filing)

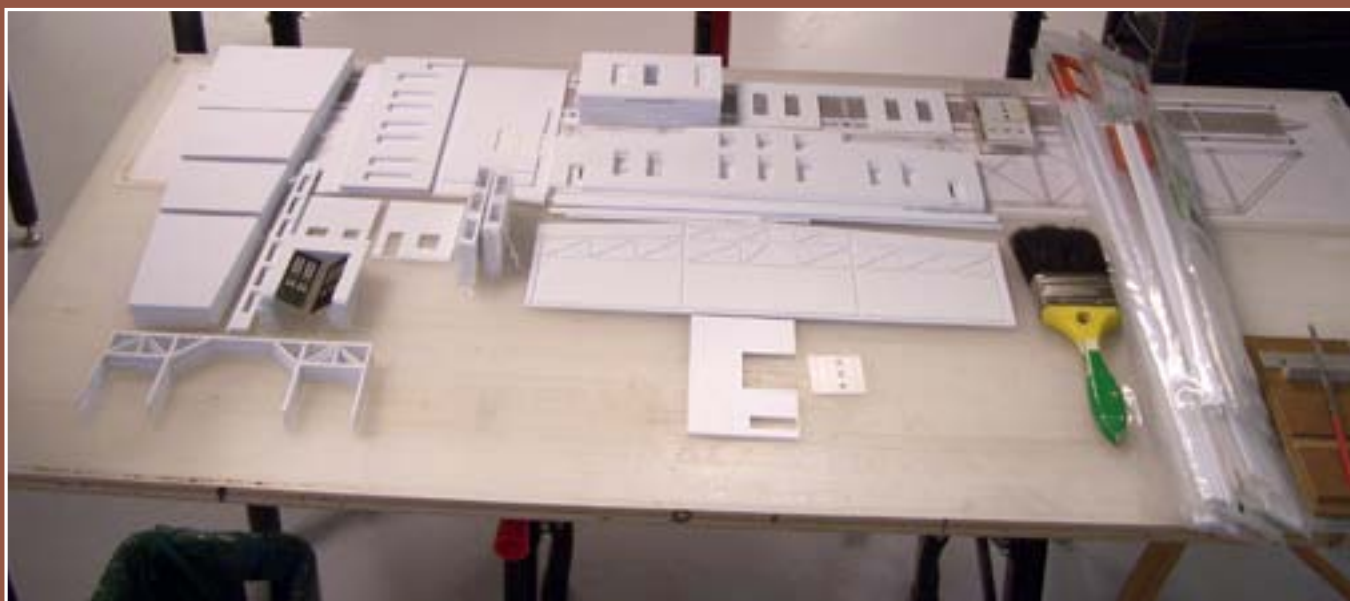

Figure 13: Once the three trusses were completed, then came the part of the project I love the most...NOT! Sanding and filing the parts to square off all the openings.

I designed the roundhouse for Tichy windows and personnel doors, and the new Central Valley Large Shop doors. There are also 2 Pikestuff Freight doors. I used a 1/16" drill bit in the XYZ Router that left a 1/32" radius fillet on each corner of the openings.

I had the cut-outs made to the exact size for each part. When I test fitted the parts I came upon a shocking reality. I needed to have square corners on all my openings in order for the parts to fit. Also upon closer examination of the windows and all other parts, I noticed flash preventing them from fitting properly. It had to be sanded.

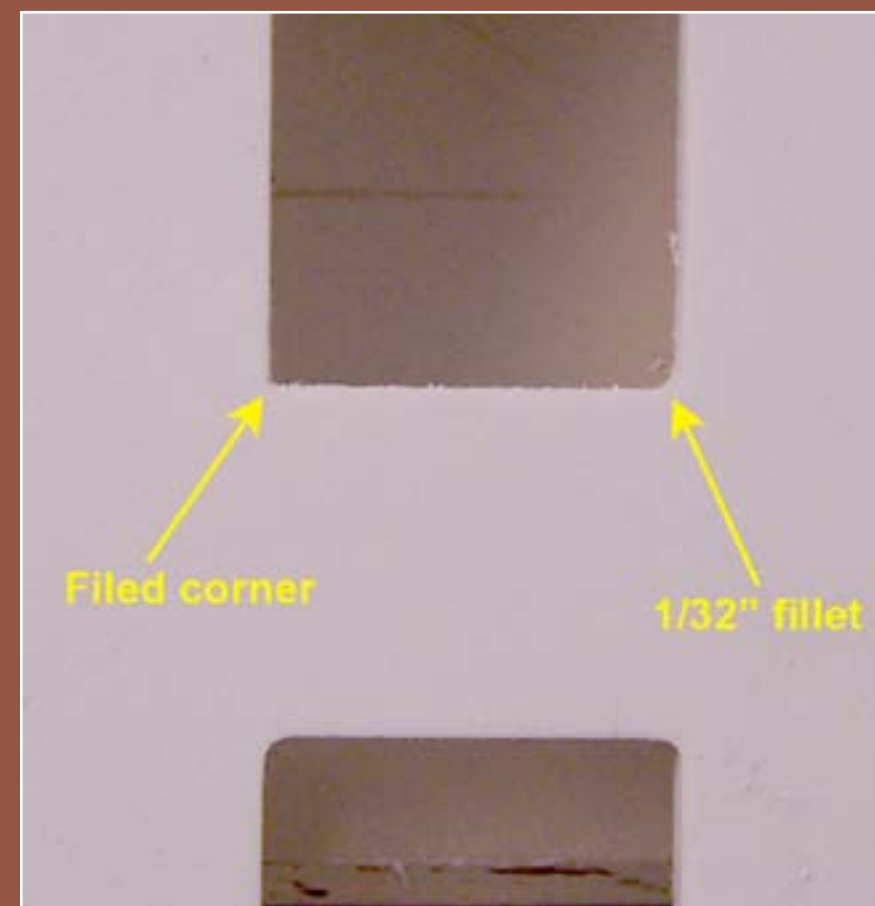

Figure 14: Before and after filing.

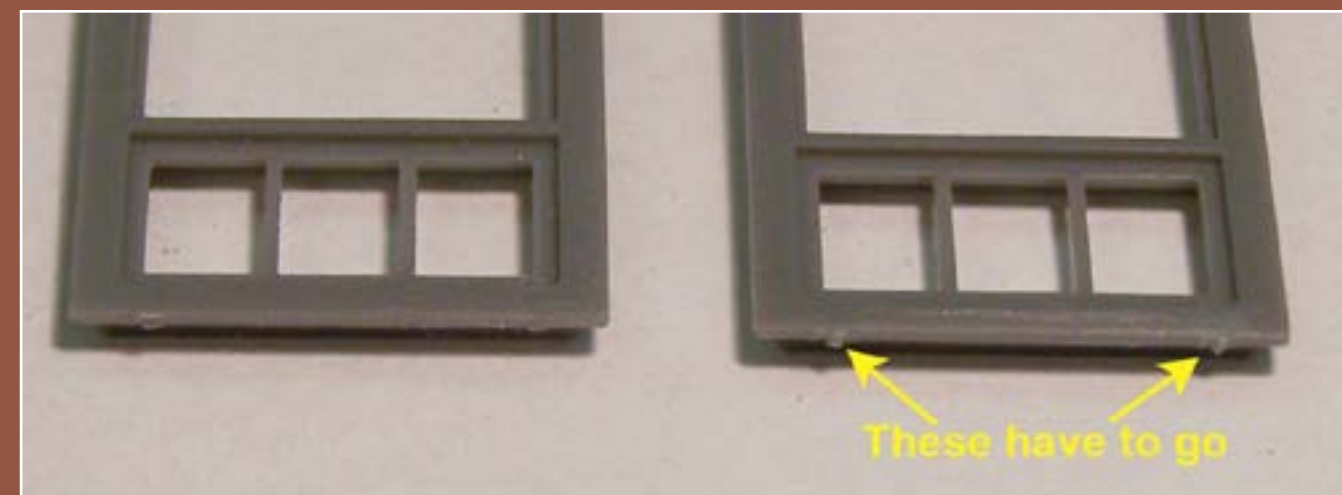

Figure 15: Every part has these parting line bosses that have to be sanded flush.



### STEP 3: Clean Up (More precisely filing) *Continued ...*

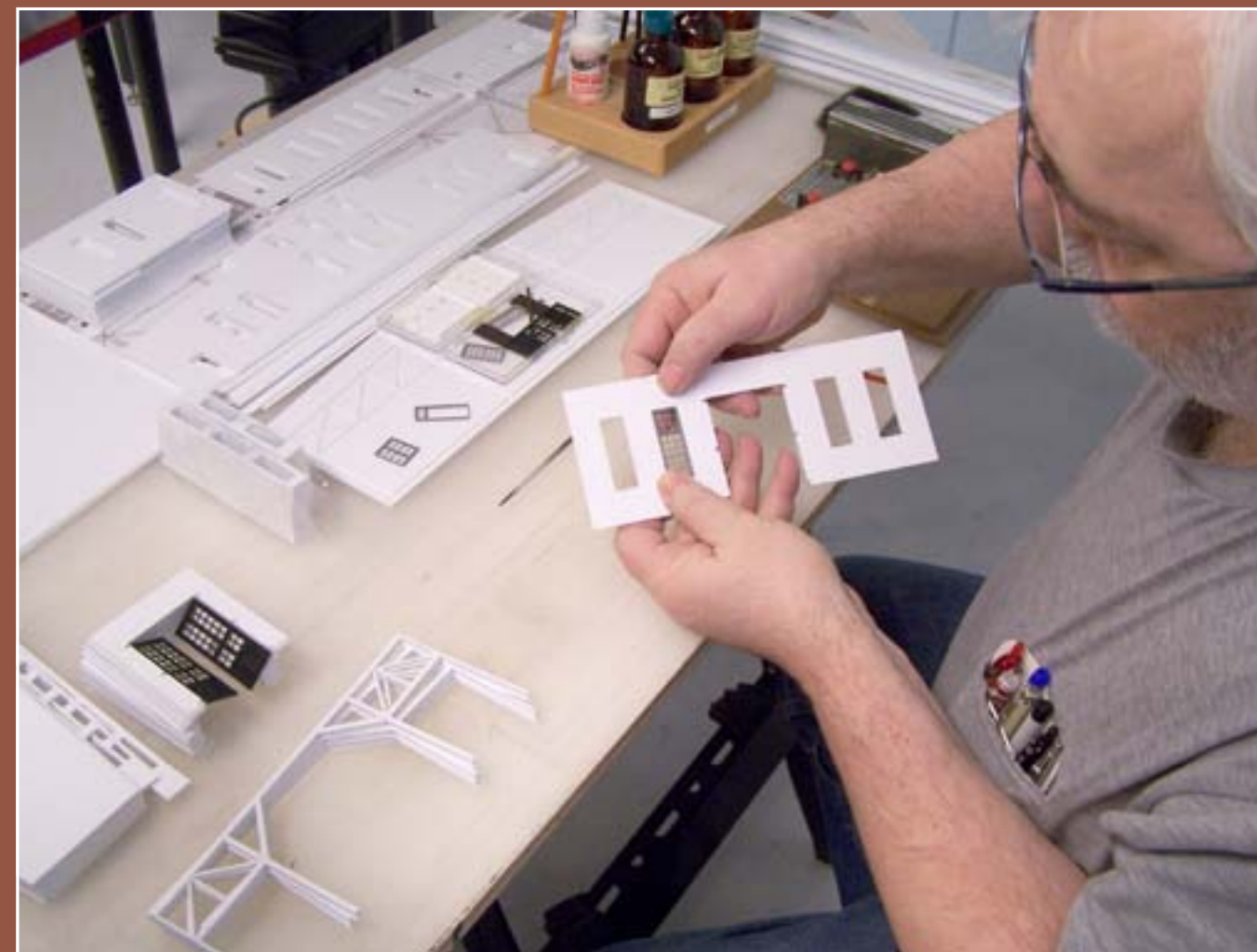
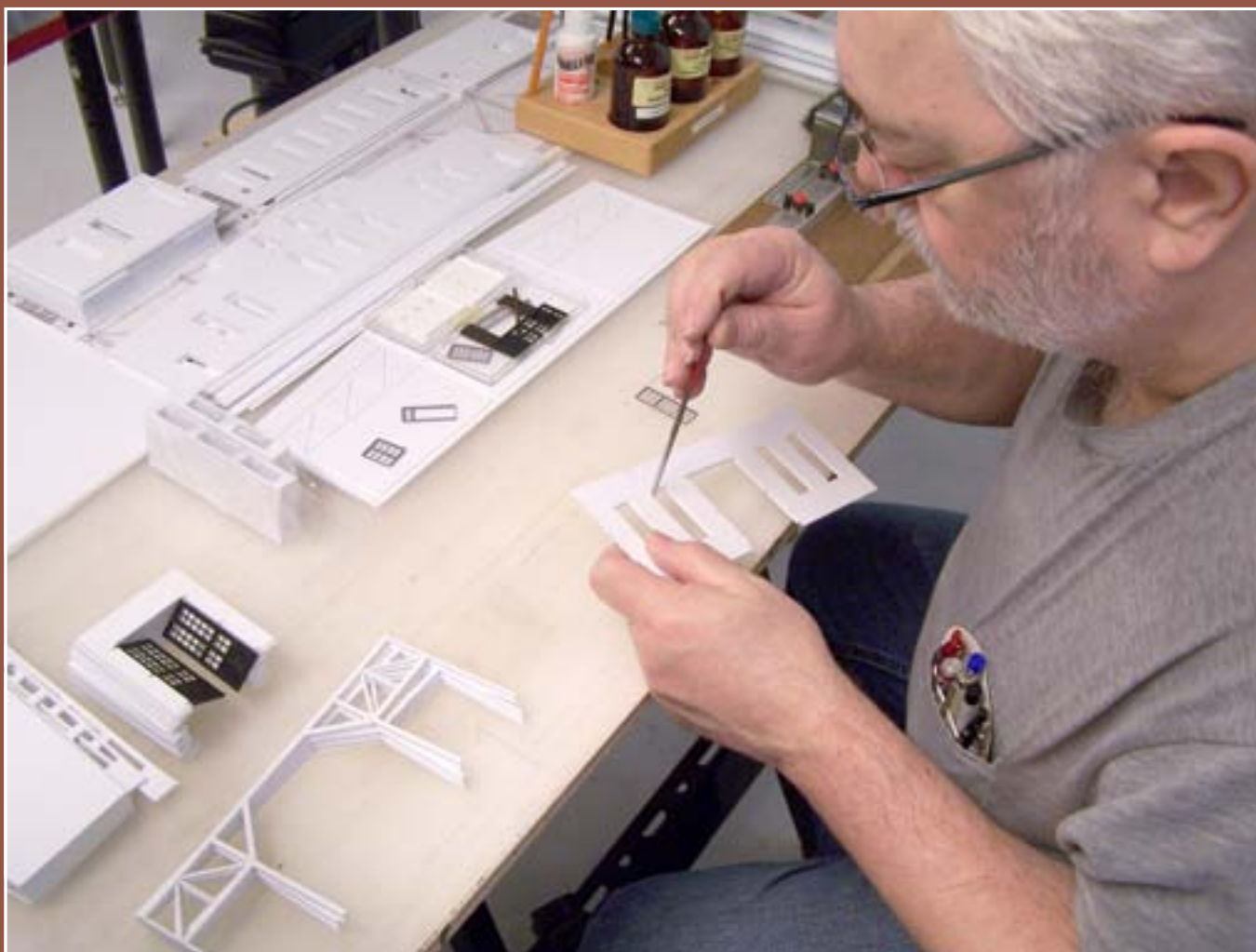

Figure 16: I took a square file to all the 782 corners. This effort gave me days of pure unadulterated pleasure. Not to mention the time spent sanding all the edges of the windows and doors and other parts.

I think I'm on number 116, top left hand corner. All the while I was listening to classical music to sooth my nerves. Wow! Only 666 more corners to go. Hmm ... then, when I am finished with all the openings, I can start sanding the parts!

Figure 17: This is a test fitting of Tichy window, which I did for every opening as I went along. I didn't want any surprise later when it came to the final assembly.

## STEP 4: Preparing and Assembling the CV Large Shop Doors



Figure 17: I prepared the 13 sets of CV Large Shop doors by installing three small hinges on each.

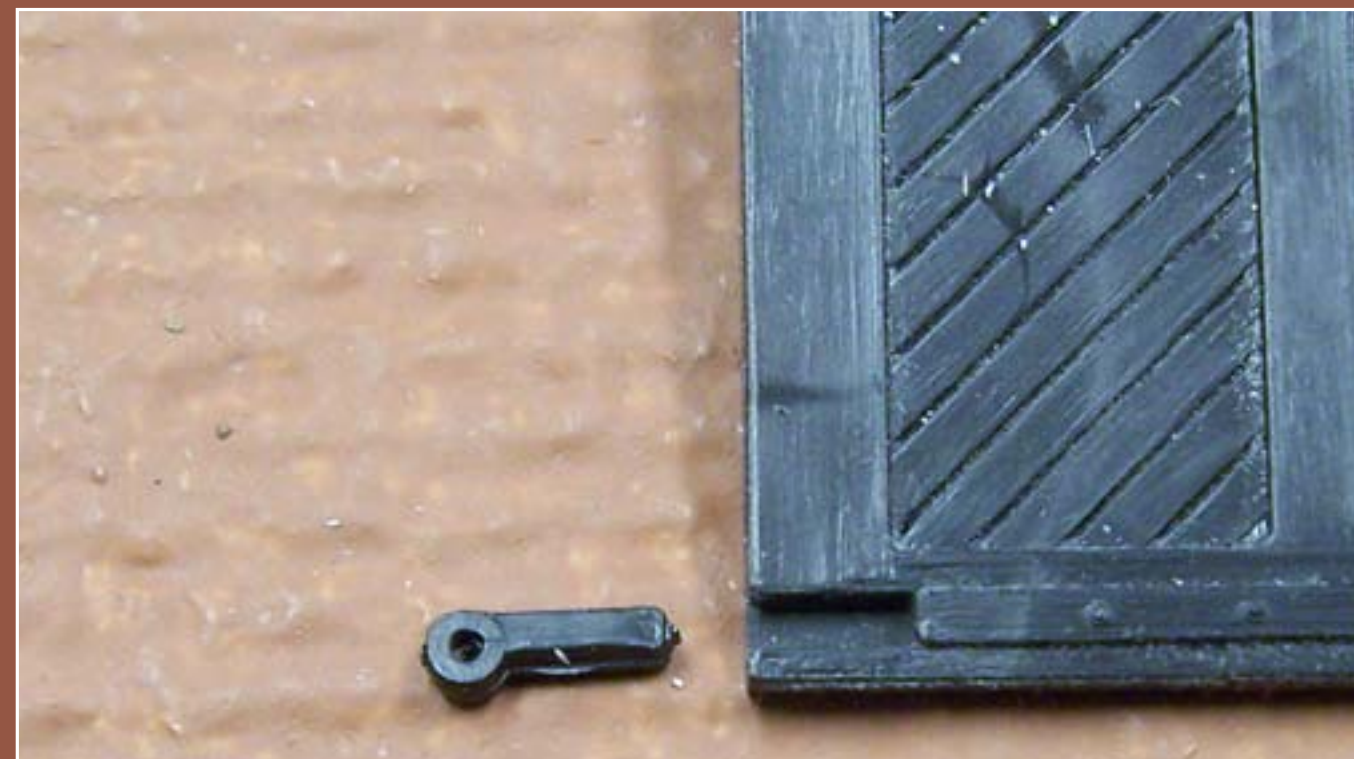

Figure 18: Close up of hinge. It needs a bit of filing.

Figure 19: I trimmed .010" off each door to allow clearance for the track. When I designed the openings I forgot to allow clearance for the track, the top of which happens to be that much higher than the roundhouse floor. (Code 70, .070" track in a .060" deep groove that should have been a sign). No matter how hard you try and how detailed your planning is, you can't think of everything. That's why the note on many construction drawings "Adjust to suit on assembly"! This little omission is not the last you will see as we progress.



## STEP 4: Preparing and Assembling the CV Large Shop Doors *Continued ...*



Figure 20: I cut a groove .010" deep on each side of the wall, cleaned out the slots, and then I inserted the door assemblies. The doors now open freely and clear the track. (The three slots for the hinges were cut by the XYZ router, lucky for me). Sometimes you do get it right.



This is how I cut a precise groove. Using my table saw (Figure 19 previous page) and my digital calliper set to .010", I adjusted the height of the blade (.020 kerf) to .010". Then I adjusted the fence to .030" from the door opening and cut a groove on both sides of the opening to make room for the wire.



Figure 21: Close-up of the hinge inside the groove. I used some masking tape to temporarily hold the assembly in place. I only glue the wire with a spot of ACC at the top and between the three hinges (3 spots). The rest will be covered up by Micro Mark's brick paper ([red brick paper](#)), but that's another story which I will cover in an upcoming column.

Finally all done. All the parts are now ready for assembly, but I'm not ready yet! A lot more has to be done before I get to that stage.



## STEP 5: Making the Walls Look Realistic



Figure 22: I took some pictures of the Joffre Roundhouse in Charny Quebec. The (full circle) roundhouse still standing today gave me the information I needed, even though it has been modified and new windows added. I am modeling it as it must have looked back in the 1970's.

Although I have no pictures of the Trenton Roundhouse, I figured it was built with a concrete floor and a brick facade same as the Joffre Roundhouse. Either way, it did serve my purpose, and I feel comfortable in using this design on mine.

Figure 23: Here is an aerial view of the structure. it's one of the very few full circle roundhouses still being used today.



## STEP 5: Making the Walls Look Realistic *Continued ...*

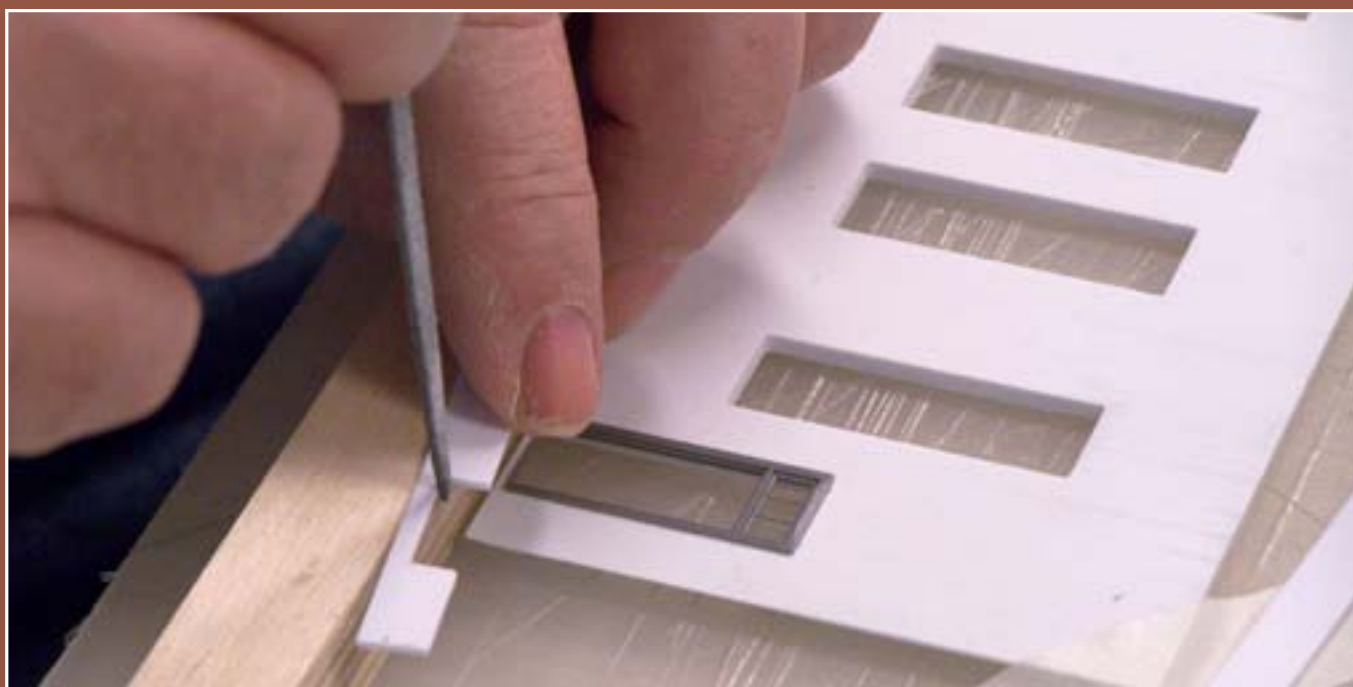

Figure 24: I added a .312" styrene strip to simulate the concrete foundation and made sure to leave a clearance for the door. The styrene I am using is a dimensional strip made by Evergreen.



Figure 25: I use a syringe (available in pharmacies), with MEK (observe all cautions when using MEK) to weld my styrene pieces together. I prefer this method because it gives me more control over where the MEK ends up and it creates a very strong bond.



Figure 26: One trick I learned from the pros while I was working at my plastics supplier, was to bend the needle at an angle. This gives me much better control. With a little experience I can slide the needle along the joint and apply just the right amount of MEK without making an undue mess.



Figure 27: The vertical and horizontal strips gave me the look of the prototype I wanted.

## STEP 5: Making the Walls Look Realistic *Continued ...*



Figure 28: After adding a roof ledge to the completed Machine Shop Walls and completing three of the adjacent roundhouse walls, I temporarily assembled it to see how it looked. It's starting to look pretty good, even if I do say so myself. I am quite satisfied with the results so far.

### Conclusion:

Now that the Machine Shop walls and interior framing are complete, the only thing missing is the roof, which I will take care of later.

In the next instalment, I will discuss the construction of the trusses for the stalls, the fire barrier walls and the remaining walls and doors. I will also cover what weathering and detailing needs to be done to the roundhouse floor before I can begin the final assembly. There is still a lot to do, but at least I'm starting to see the progress on top of the module.

Thank you for reading this far. I hope you enjoyed it. If you have any questions or comments please click on the "Reader Feedback" button and let me know what you think. I frequent the MRH web site, and I'll try to respond in a timely manner.

Charlie Comstock is ...

## UP THE CREEK: Modeling a Small Creek - part 1

A regular report on the construction of a 1950s-something layout

### About our layouts columnist



Charlie Comstock is our layouts editor and columnist.

[Click here](#) to learn more about Charlie.



Reader Feedback  
*(click here)*



Hillmovers Construction starts work on the Sheffield Creek area of Oakhill by installing a grade crossing and building a king-post highway bridge ...

Figure 1: Sheffield Creek runs through the middle of the wye at Oakhill in the Oregon Cascades.

For about a year the scenery in Oakhill has been mostly complete. However, I kept putting off working on the area around the wye. The reason was simple – it's 63" off the ground and is almost 4' deep. Access to the rear of it is by lift up hatch (see my column in MRH Issue 2) and frankly the access wasn't all that great. Finally however, my desire for finished scenery overcame my trepidation and I got started.



Oakhill is at the summit of the BC&SJ. I knew I wanted a wye there for turning helper locomotives. I also wanted a small town and community supporting the logging going on in the nearby hills (in the Oregon Cascades) and the railroad.

I planned a road, highway 58, winding through the area before going up a grade and into the hills. A creek, recently dubbed Sheffield Creek after the BC&SJ operator who for a while seemed to be crewing every Oakhill Turn, runs from the backdrop to the edge of the layout where, in theory, it becomes a tributary of Roberts Creek which, with a few liberties, eventually flows into the Deschutes River.

This area is filled with conifer trees, mostly douglas firs. Doug firs attract



Figure 2

**Figure 2: AFTER** - the highway crosses Sheffield Creek on a narrow king post bridge. It won't be long before this bridge is replaced, but in 1952 the highways in the Cascades aren't entirely modern.

This view shows tracks crossing the creek on fills pierced by culverts. The wye is used to turn helpers and by the Oakhill Turn.

**Figure 3: BEFORE** - plywood, subroadbed cookie-cuttered to make the creek bed with pink foam added for a smoother slope down to the water.



Figure 3



loggers the way honey attracts flies and there are stumps all over to prove it, plus a log loading area in east Oakhill ships several carloads of logs a day to the lumber mills in Mill Bend and sometimes Redland. Oakhill is also the home of B. Josef Gravel, a primary source of ballast for the BC&SJ railroad. Old man Josef says they'll really rock you.

## The Grade Crossing

The grade crossing on the right leg of the wye (hidden behind the water tank in figure 2) has been in place for a few years. I started the new scenery by installing the grade crossing on the left leg (figures 1 and 2).

This crossing is timbered and on a (40" radius) curve. While not a sharp curve, this meant I would need to use short guard timbers to get them to fit well on the curve. The track is Micro Engineering code 55. I dribbled a little gap-filling ACC on the track, then speared wooden ties with an X-acto knife, setting them carefully in place. I needed to be very careful not to jostle the previously-installed ties until the ACC set (figure 6). I was also careful not to get ACC on my fingers and glue them together or to anything else.

After the ACC set, I used a small block of wood (about 8" x 1 1/2" x 3/4") wrapped with 80-grit sand paper to sand the ties even with the tops of the track, being careful not to remove metal from the rails.

**Figure 4: Oakhill's trackage showing the wye, spur track, highways, and Sheffield Creek.**

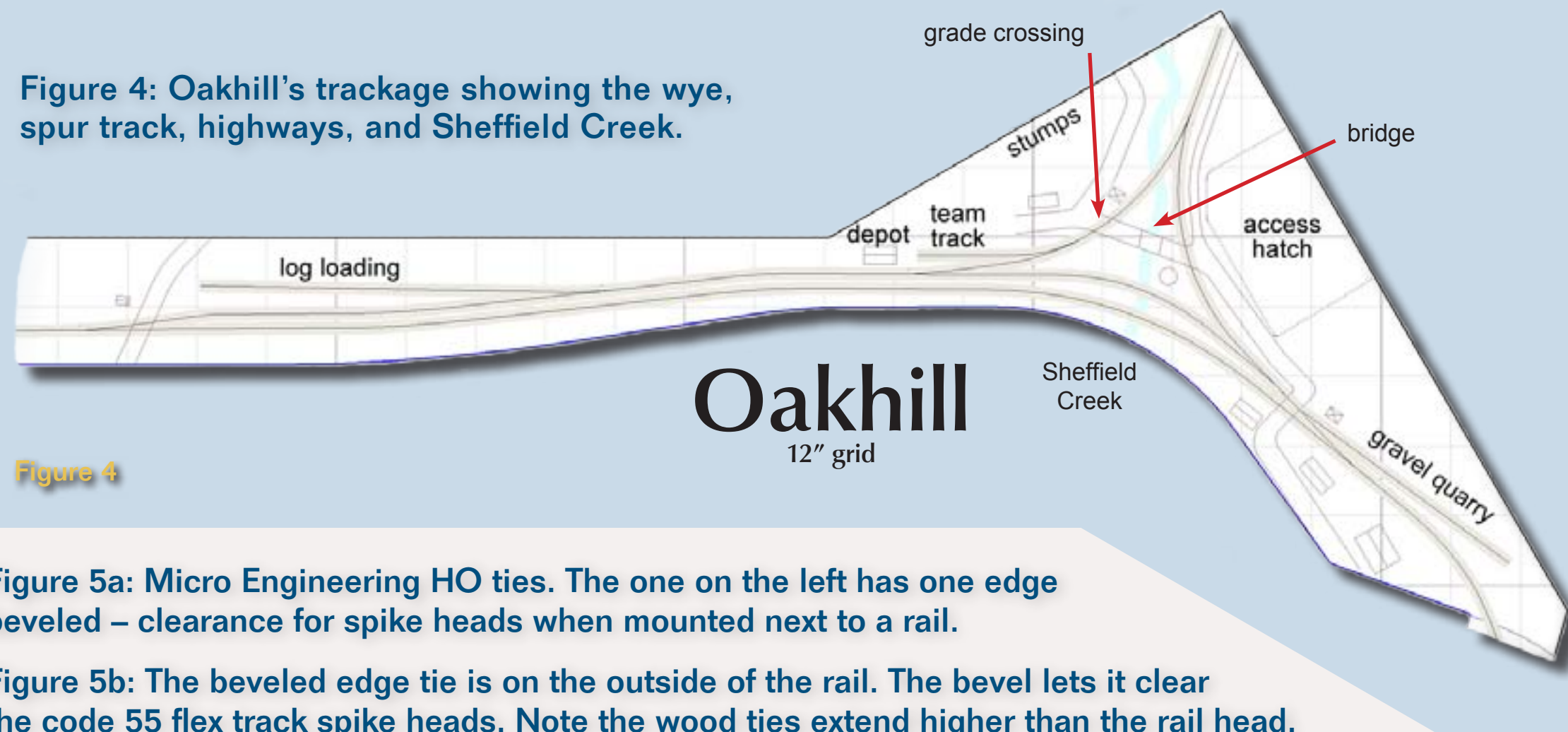

**Figure 4**

**Figure 5a: Micro Engineering HO ties. The one on the left has one edge beveled – clearance for spike heads when mounted next to a rail.**

**Figure 5b: The beveled edge tie is on the outside of the rail. The bevel lets it clear the code 55 flex track spike heads. Note the wood ties extend higher than the rail head.**

**Figure 6: Guard timbers ACCed to the ties ready for sanding. The arrows point at the highway edges penciled on the plywood.**

**Figure 7: The guard timbers, sanded and stained (but still damp).**

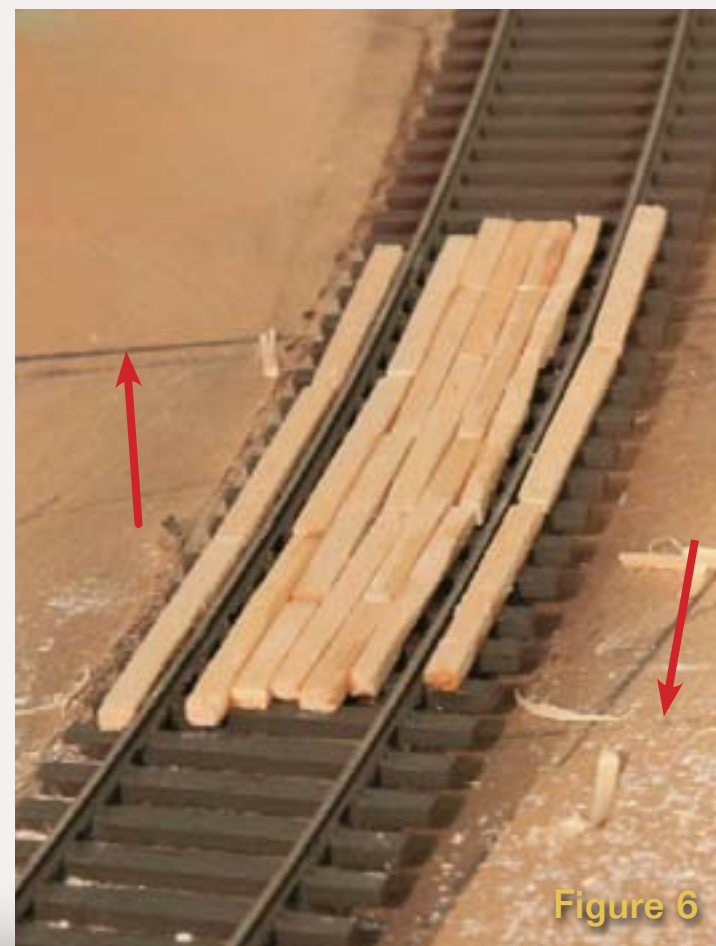
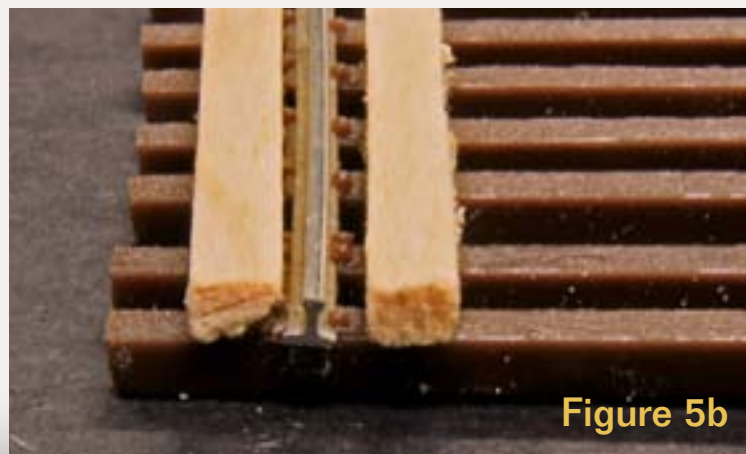

Once the timbers were level, I smoothed them with some 220-grit sand paper and vacuumed up the sawdust. Then I pushed a freight car through the crossing to ensure the flangeway clearances were OK and finally ran a loco through to ensure the grade crossing timbers weren't too high.

After a couple of small adjustments everything checked out, so I stained the timbers with an mixture of India ink and alcohol – about 10 drops of ink in a 35 mm film canister of alcohol (figure 7). You may want to experiment with the ratio until you find one that gives good results for you.

## King Post Bridge

Next I built the highway bridge over the creek. I had considered adding a third fill for the highway to cross the creek, but decided on a bridge instead as it would reveal more of the creek's scenic beauty.

Sheffield Creek isn't very wide at this point, requiring only about a 30' span, but there wasn't much room underneath the bridge. This suggested a deck or through girder bridge would be inappropriate. So I elected to use a King Post bridge.

I referred to Paul Mallery's *Bridge and Trestle Handbook* and used 3rd Planit to create a full-size construction template for the bridge (figure 8). I printed it on a piece of card stock which I trimmed to full size. I laid this over the creek where the bridge would go before starting to build. This turned

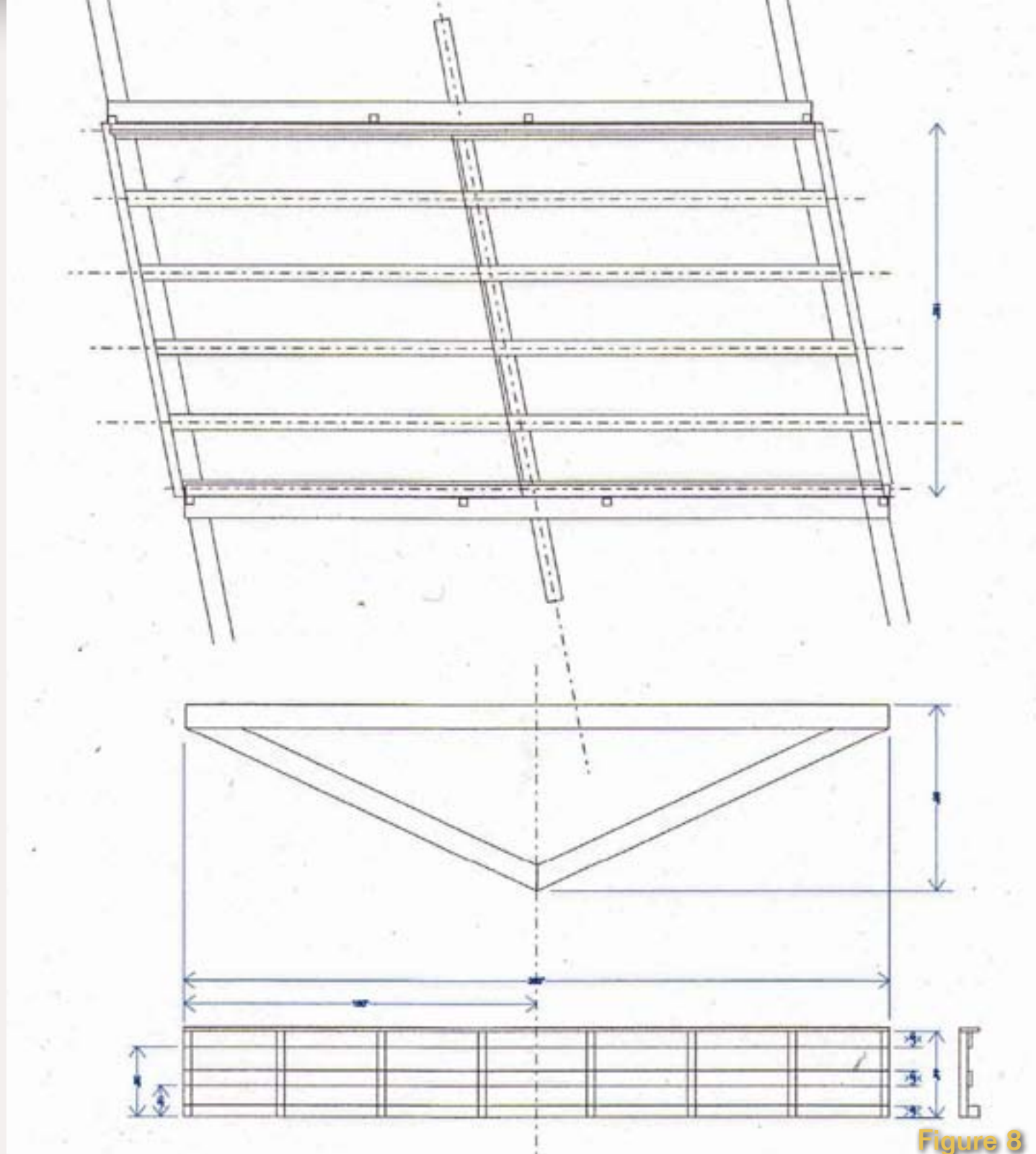

Figure 8

**Figure 8:** I used 3rd Planit to make a full size template for the bridge floor, trusses, and railing assemblies.

[Download my .3pi file.](#)

[Hi-res HO scale bridge template.](#)

**Figure 9a-d:** I taped the template to a smooth, flat work surface. I put down a piece of double-sided Scotch Tape then placed the

guard rail assembly risers on top of the template where the tape held them in place.

Once the risers were positioned, I used a toothpick to apply tiny drops of yellow glue before pressing the railings in place. Finally I added the top cap, using the end of a tweezers to push it firmly in position.



Figure 9a



Figure 9b



Figure 9c

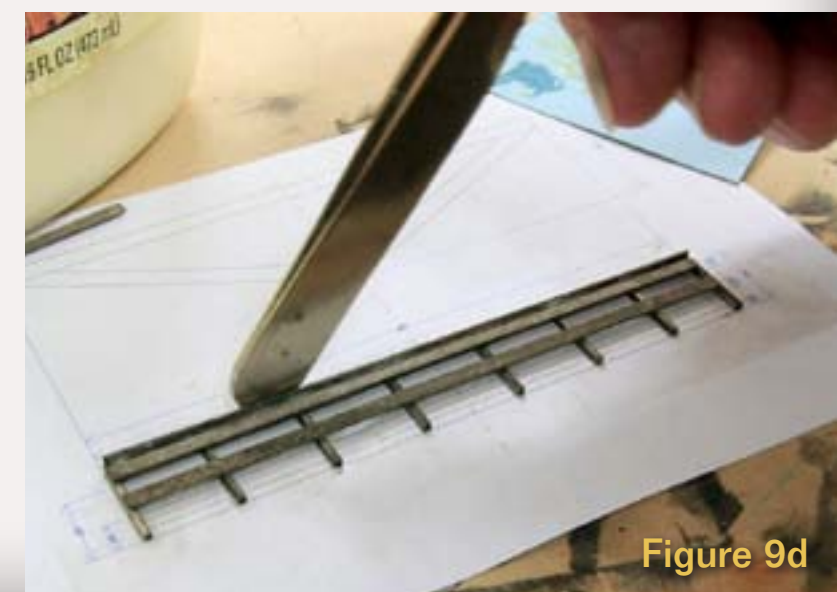

Figure 9d



Figure 10

gentle sanding to remove excess wood 'fuzz' I stained all the wooden pieces with my India ink and alcohol mixture giving them a weathered color.

I tackled the guard railings first (figures 9 a-d). Assembly on top of the template made this a snap.

I needed one more piece for the truss assemblies – the truss rod. This is steel and between 1 1/2" and 2" in diameter. I had some .032 steel wire on hand and decided this was close enough.

I drilled holes for the truss rod in each base beam and carved out a little space in the truss beams where they meet at the top (figure 10a - red arrows).

Then I stuck some double sided Scotch Tape to the template and laid the joists and beams in position. I used my 'toothpick' to apply yellow glue for the joints and pressed the trusses

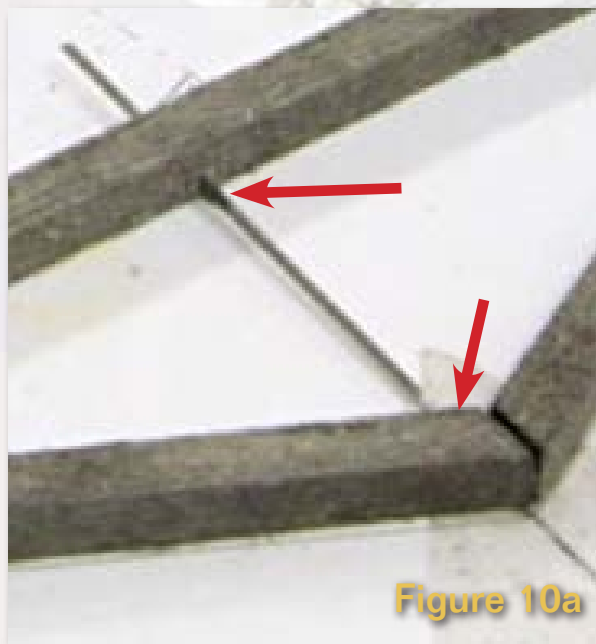

Figure 10a

out to be a very good idea. The ends of the bridge aren't square, and my first template got the angles backward, arggh! Test-fitting the template revealed the problem – which I quickly corrected on the computer before building a wrong-way bridge!

A trip to the hobby shop netted me the wood I'd need for the railings, beams, joists, and decking and I was ready to begin.

I started by drawing a razor saw along the grain of the stripwood to bring out its grain, then I cut the guard railing pieces, beams and decking to length using the template as a guide. After a



Figure 11

**Figure 10: The bridge deck assembly after prying it from the grip of the double sided tape on the template.**

**Figure 10a: It's easy to see the places where I drilled holes for the support rod (red arrows).**

**Figure 11: The bridge deck supported by styrene abutments. I made the abutments from two pieces of .060" styrene laminated together. I added a piece of .040" styrene to retain the paving materials next to the bridge from falling down underneath.**



Figure 12

**Figure 12: I made the abutments the right height to sit on the plywood creek floor with the deck slightly higher than the rails. This was difficult. It took me several attempts to get the abutments cut down to the right height (it helps to start with them taller).**

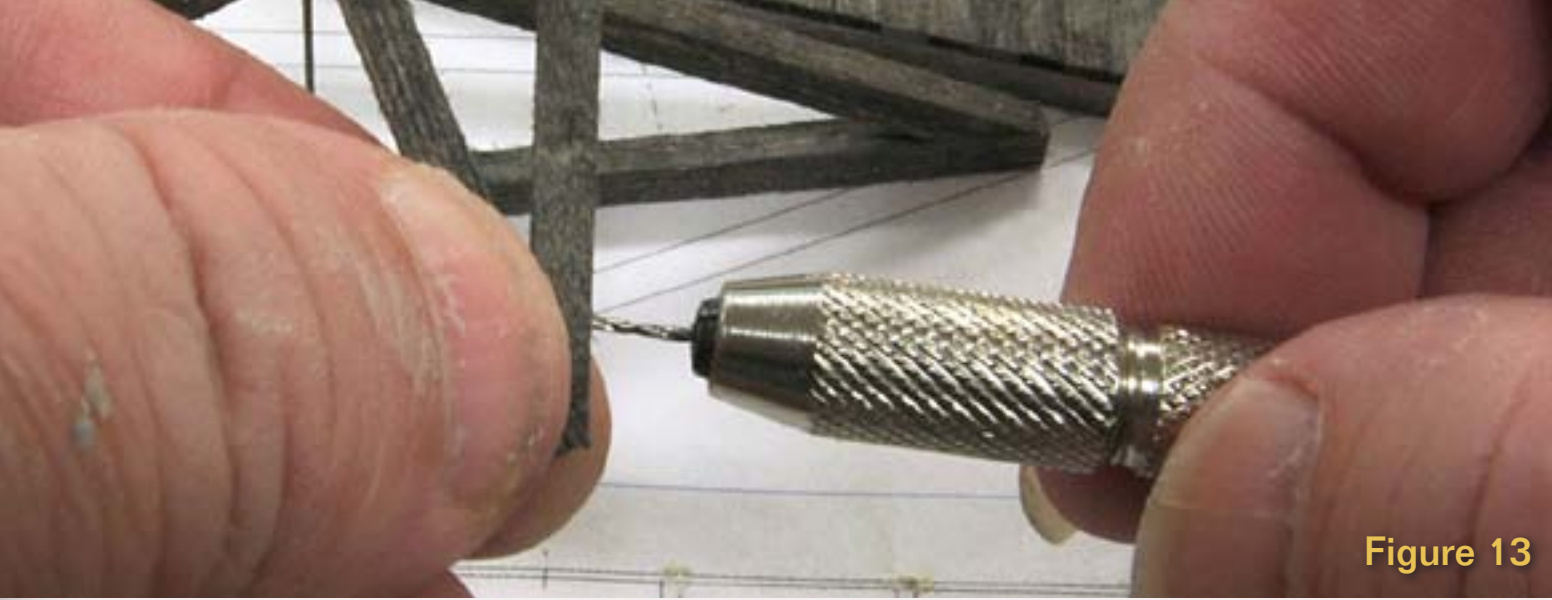

Figure 13



Figure 14



Figure 15



Figure 16

**Figure 13:** I used a small bit in a pin vise to drill holes to receive the shanks of the NBW (nut-bolt-washer) castings.

**Figure 14:** The tiny NBWs add a lot to the appearance of a model, but they tend to go flying across the room if gripped by the heads. These NBWs are from Grandt, I pre-painted them with Polly Scale Boxcar Red.

**Figure 15:** I cut the NBWs from their sprue leaving not quite 1/8" of shank for gripping with tweezers.

**Figure 16:** The bridge trusses with NBWs inserted in their holes. I dip the end of the NBW in a tiny puddle of ACC before inserting them.

together. I added more yellow glue on top of the deck joists and added the planks for the decking.

Once the glue dried, I pried the deck assembly and the two trusses off the template (figure 10).

The trusses still needed a few more details. I made a 'steel' reinforcing plate for the tops of the truss beams out of a bit of .010" styrene and ACCed it in place.

Then I drilled holes where I'd be installing NBW castings. These castings are models of nut-bolt-washer sets and can look remarkably realistic. It's nearly impossible to pick up a NBW by its head with tweezers and not have the little bugger go flying. So I leave about 1/8" of shank (figure 15 - NEVER clip them as shown here – always put a finger on the NBW to keep it from flying away) as a place to grip it.



Figure 17



Figure 18

I dipped the NBW shanks in ACC before pressing them home in their pre-drilled holes.

Figure 16 shows the trusses after NBW mounting but prior to painting the

steel reinforcing plate (which I probably should have painted before mounting). I painted the reinforcing plate with Polly Scale Roof Brown. While I had that jar open I hit the truss rod and added some rust stains below the truss rod, too.

I airbrushed the guard rails white then glued the trusses to the deck assembly

Figure 17: The bridge and abutments test fitted in place.

Figure 18: The bridge with detail inset.

with yellow glue. When the glue dried I glued the guard rails in place. When that glue dried I added the main support beam, crosswise under the deck.

I installed the bridge by carving away pink foam along the edges of the creek bed where the bridge would go (figure 17). The foam had been hot-glued in place – I used a chisel to scrape the hot glue off the plywood. After test-fitting and test-fitting again, I glued the abutments in place by squirting latex caulk into the gaps between the abutments and the edge of the creek.

## What's Next?

In part 2 of the Modeling a Creek series I'll show how I made some quick and easy culverts, cast some rocks, and filled in the contours of the creek bottom. 

## A clipping from the *South Jackson Gazette* ...

### Locals Demand Seafood!

Citizens living near the BC&SJ railroad have long desired something in their waterways besides plaster, paint, and plywood.

Said Horace Fithers, a very vocal local, "Well, it's like this. We've been livin' here for what seems like a good long while. Now them fellers at Hillmovers Construction have been makin' some progress with the Terra Forming<sup>®</sup> along the railroad's right-of-way, but up to now we just haven't had much of anywhere to go fishin' or swimming! Without fishing, it's a real problem gettin' seafood to fill out our menu. I've been wanting salmon or trout almondine for ages, but without no water in them dadgum creeks, fish have been pretty hard to come by!"

Some diehard fishermen have reportedly tried their best, but say it's really discouraging when their hooks keep getting snagged on plywood creekbeds. One fisherman, claimed to have caught a Rainbow Trout 'this big', but it was covered with some kind of greenish blue goo and looked so unappetizing he felt obliged to throw it back.

Honey Dwords, spokesmodel for Hillmovers Construction, stated in a recent press conference that real-soon-now, the Oakhill citizenry can expect to find water (or at least something closely resembling it) in their



Sheffield Creek in Oakhill

creeks, steams and waterways.

A source within Hillmovers, unnamed because he was not authorized to speak on the subject, claimed that while the stuff does look an awful lot like water, it still wasn't going to be anything fish (or people) would find suitable for swimming. In fact, "This stuff is hard as rocks. The company researchers think they may have discovered high freezing point water – the creeks are filled with the stuff!"

Undeterred, fishermen are buying ice saws they hope will allow them to finally catch something besides a nap or sunburn!

This reporter certainly hopes that seafood will soon be on the menu at the South Jackson Grill 

\* Enjoy the Gazette? Read more at [bcsjrr.com](http://bcsjrr.com).



Figure 19

Figure 19: This view of the bridge lets you see the cross section of the guard rail assemblies.

Figure 20: The bridge with water running beneath it. I like the way this scene turned out!



Play Grade Xing video clip



I cheated at the ends of my trusses. Real King Post bridges don't rely merely on a few bolts to join the truss ends to the main beam as these joints receive all the stress from the weight of the bridge plus the cars and trucks on it.

Instead, the truss beams are embedded in the main beam for a much stronger joint (methods **B** and **C**) and the bolts merely keep the beams from separating.

I chose **A**, figuring it would be hard to see the difference from a few feet away, especially with some strategically-placed vegetation. But for a more realistic bridge you might consider using method **B** or **C**.

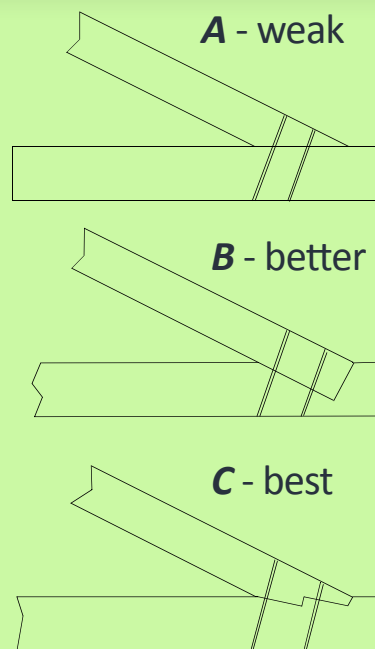

Figure 20

## About our prototype modeling columnist



**Marty McGuirk** is an avid Central Vermont fan, modeling the “Southern New England” – an HO scale proto-freelanced railroad set in the 1950s and based in part on the real Central Vermont Ry.

[Click here](#) to learn more about Marty.

Photos and illustrations by the author unless otherwise credited.

# GETTING REAL: How to Eat an Elephant

## Adventures in Prototype Modeling



**Learn how successful layout builders actually make real progress and get that layout built ...**

**W**hen model railroading steps beyond building a few models on the workbench, or building a beginner’s oval layout, to building a “large” or “life-time” layout, then having a sense of the amount of work, time, and effort in front of you to get from “here” to “there” (wherever “there” is) can be a big help.

I’m reluctant to preach work-type stuff like goals, objectives, action plans, and milestones, but without a certain sense of scope, you risk never really accomplishing the goal of a “finished,” or at least, operable, model railroad.

The other side of the coin is looking at a beautiful, almost complete model railroad (or one that at least looks complete) and say to yourself, “That’s great, but I’ll never have the time to build something like that . . .”



**FIGURE 1:** This issue, we’ll look at how successful layout builders tackle the somewhat overwhelming task of planning and building a large model railroad. Although the long weekend work sessions are great, the warm weather makes it harder to dedicate a long sunny Saturday to the layout. Another approach is spending a few minutes every day doing something, no matter how small. I tried this approach for a week to see if I made any progress. On this night I programmed a few decoders and even read portions of the EasyDCC manual!

Staring at your empty basement with some wood stacked in the corner is a thrill for any model railroader. It’s also a little overwhelming if you spend too much time thinking about the amount of time, effort, and resources you

need to convert that open space into a scenicked, operating model railroad.

Before embarking on construction of my HO scale Southern New England Railway, I seriously considered

if I had the time, money, and frankly, the energy to tackle such an involved project. I asked a number of fellow modelers who owned “finished” or almost-finished layouts how they managed to accomplish that feat.

You might think they were: (1) retired; (2) single; (3) obsessed, with few or no other interests; or (4) some other combination of factors that allowed them to spend every waking minute in the basement. Perhaps, I thought, they simply lived under the house like some sort of model-railroading troll, only emerging to see if they cast a shadow before raiding the refrigerator and returning to their subterranean lair to spike down yet another turnout.

I found that wasn't the case at all. I've noticed over the years truly spectacular layouts tend to be built by people who, although dedicated modelers with a strong vision, were quite busy with their “real” lives. So, how do they do it?

I got as many answers as people I asked. But the following emerged as common themes:

## **1. Drive a Stake into the Ground**

This would not look like basing plans for a present or future railroad merely on what Athearn, Walthers, Atlas, or others might be making available. Nor would it be holding off on that perfect theme because, “No one makes a such-and-such.” Driving a stake means choosing what you're modeling, being

content with that choice, and then sticking with that theme and seeing it through. Decisiveness, not dithering.

## **2. Have a Plan – But Don't Waste Time Planning**

Don't spend years drawing track plans without actually trying the tools, techniques, and materials.

I must admit, as badly as I feel for would-be model railroaders who just can't get it together, I experience sudden aggravation when I hear, “My track is going to be perfect; all my cars and engines will be prototype-perfect models; each town will reflect exactly how the prototype location looked at a time-certain; the scenery is going to be picture perfect too; every stone of ballast will sit at the correct angle of repose; and the operating scheme will be supported by accurate prototype paperwork and a working interlocking signal system,” usually accompanied by a wisp of a sneer at the sight of many imperfections on my layout.

But these lofty goals always seem to be accompanied by a raft of artificial barriers: need to find out what color overalls the engineer was wearing on that date; gotta research the very best type of room lighting; whether or not to carpet the layout room – and if so, form a panel of hobbyists to determine which color might best communicate the pike's placement in time.

With that figured out stand back, because they'll move smartly ahead to start thinking about writing a

statement of work, getting bids, and hiring a contractor to finish the layout room – or maybe finish it themselves. So the merry-go-round spins around again.

I apologize for seemingly making light of a serious model railroading tragedy that's all too common. But it's a trap that's all too easy for almost anyone to fall into, and once you're in this place, you'll be the only one who can't see it for what it is: death by trivia. To avoid getting caught in this cycle:

(1) make your dreams be informed by your reality and then

(2) act on them, not waiting for every last fantasy to be thought out and every conceivable problem to be solved.

## **3. Focus on a Prototype, Theme, or Era**

This is another common thread among the successful layout builders I know. Such a focused approach doesn't have to be prototype-specific. However, limiting yourself to a prototype, or a freelance-prototype, and an era is one way to stay on the straight-and-narrow and avoid temptations at the hobby shop, and save yourself from roomfuls of extraneous stuff.

One of my friends, an extremely accomplished modeler with a world-class layout to his credit, doesn't have a clue what new modern diesel is coming out, or if anyone makes

Amtrak passenger cars – neither of those fit his interest or era. On the other hand, a new sound decoder, particularly an F-M- specific one, would certainly get his interest.

## **4. Keep the Layout Room and Work Area Neat and Organized**

To some extent, this guidance nests neatly with focused themes. A lot of these guys don't have a bunch of extraneous model railroad “stuff” cluttering the underside of their layouts, aisles, work areas, shelves, and everywhere else. Keeping the layout free of construction debris, tools and the like can be tough and it's something I personally struggle with. This isn't operating room cleanliness, but rather, a discipline to clean up the work area after each session so you can find the tools and materials you need before you start work again.

A bright, clean room gives the layout a come-hither look instead of looking like a repulsive place to go. That's especially important when you're working on something particularly difficult. By the way, one of my friends maintains that the one tool all model railroaders really, really need is a good shop vac (Figure 2 next page).

I used to think a cordless drill was the most important tool, but the drill is only good for benchwork. In contrast, the shop vac is something you need to use throughout the life of a railroad. Get one, and don't be afraid to use it.





## 5. Organize

This word ran through everyone's lips so I'll continue the discussion from item number 4 above. One modeler suggested grouping all the materials and tools needed for a specific task – track laying, for example – together in one of those small plastic storage tubs. Affix a label to one end. Don't be afraid to have duplicate tools – if you have three pairs of needlenose pliers like I do, go ahead and put your favorite spiking pliers in the “track laying” box along with the rail joiners and track gauges.

## 6. Avoid Active Participation in Online Forums and Chat Lists

Sure, successful layout builders are on some of those lists. Occasionally, they even post something. But the few among them who are active on the net are conspicuous but not representative.

Ask yourself this – if you're not finding enough time to build a model railroad, how can you find time to spend posting, and reading other posts, on model railroad forums? If you don't care what

FIGURE 3: Over the course of a couple of weeks I put all the loose tools, materials, etc into bins labeled by task (“Layout Wiring,” “Track Laying,” etc . . . or by the items in the bin, in this case “Wheelsets.” This is handy to determine when you're running out of certain items like couplers or wheelsets. This lets me know when I need to restock these items. The bigger the layout, the bigger the risk of getting buried in inventory.

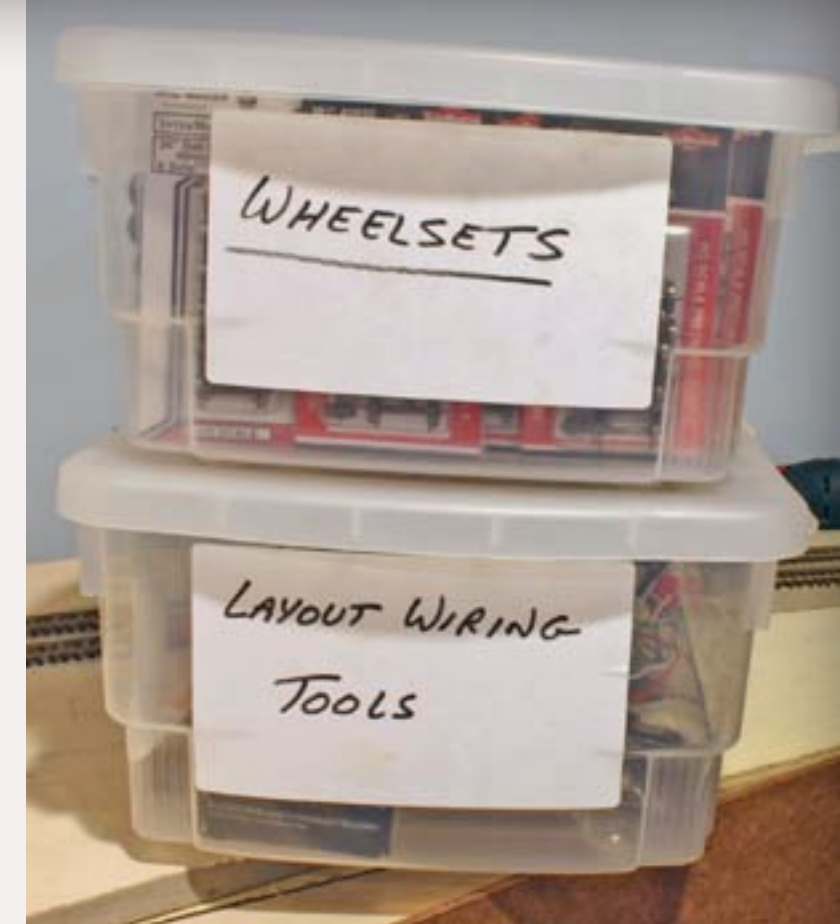

FIGURE 2: Ever wonder what tool every layout-building model railroader needs? It may very well be a good shop vac. Get one, and make a commitment to use it regularly. It will make the layout room a more pleasant place to be.



FIGURE 4: When you do as much modeling as I do you end up with lots of detail parts, structure components (windows, doors, and the like). Before these were squirreled away throughout the layout area. A five drawer rolling cart like this one, and a couple of evenings of spare time in front of the television, allowed me to get all these parts sorted into the drawers. This has already paid big dividends in being able to find things when I need them.

new diesel is coming out next month since it doesn't fit your theme, why would you want to spend one minute of modeling time reading other people's opinions about it?

## 7. Make Sure the Foundation is Solid Enough, but Get Enough Done Up Front to Get the Railroad Running NOW

Go back later to upgrade things as time, budget, and interest permits. More than three decades ago, Allen McClelland sagely referred to this as "good enough."

Although today's "good enough" is a lot better than it was back in the 1970's, the concept is as solid now as it was then. As a "by the way," in general terms, rolling stock is the easiest stuff to upgrade followed closely by structures. Scenery, track, wiring, and benchwork are a bit more involved to revisit, but successful layout builders "take a minute and get over it" and routinely make improvements.

When I started construction of the present edition of my Southern New England Railway, I had every intention of getting one town completed to the point of finished scenery. Seemed like a good idea. I love doing scenery and I could enjoy switching in that one finished setting while I built the remainder of the railroad.

However, as I completed the track and wiring in that town, I realized that switching one town was hardly

a primary reason for building a big layout and not even an appealing milestone, as it would keep me from making progress on my highest priority, namely, to recreate timetable and train order operation on an entire secondary line in the late steam era.

To get things rolling (pardon the pun) toward that objective as soon as possible, I decided the mainline, passing sidings, and staging yards were the most critical elements. Industrial sidings could be filled in later.

I abandoned the town-by-town approach, built the remaining benchwork, and now, I'm well into the track work. And, I feel much better about how and where things are going.

Finally, I want to share my friend Paul Dolkos's response when I asked how he manages to get so much done on his railroad. I thought his answer applied not just to me, but also most model railroaders. I figured he would tell me he spent every minute of the weekend working on his layout. And, although he admitted there have been "full day" modeling sessions, those are quite rare.

Although he's retired now, he knows I'm not, so he put his answer into a context I could use. "When I was still working," he said, "I tried to get downstairs and do something – anything – on the railroad every night. Sometimes those sessions were 10 minutes, sometimes an hour. It doesn't seem like much, but when

you spend 15-30 minutes a night, and add it up over several weeks, you can accomplish something."

I put Paul's guidance to the test. Over the course of an otherwise ordinary work week (5 nights) I managed to get downstairs to the layout room each evening. The following is an account of the progress I made.

About three months previously I'd installed the track and the Tortoise switch motors in the small town of Smithfield, but I'd never wired the Tortoises since I had been waiting for one of those "long Saturday afternoon" work sessions. That long day had not materialized, so I spent about 40 minutes on the first night wiring

up the Tortoises and the toggles. (As an aside, having the toggles, wire, and IDCs in one of my plastic tubs meant I was ready to start once I'd turned on the lights!

The following evening I spent about 10 minutes and made up a track diagram (Figure 5).

I still had 10 minutes left at that point, so I went ahead and repaired a few couplers that had not passed muster during the SNE Sea Trials (see MRH 7).

The third night was spent dealing with what has become a long-running project - the New London turntable. This is hardly the type of project that lends itself to a long Saturday work session.

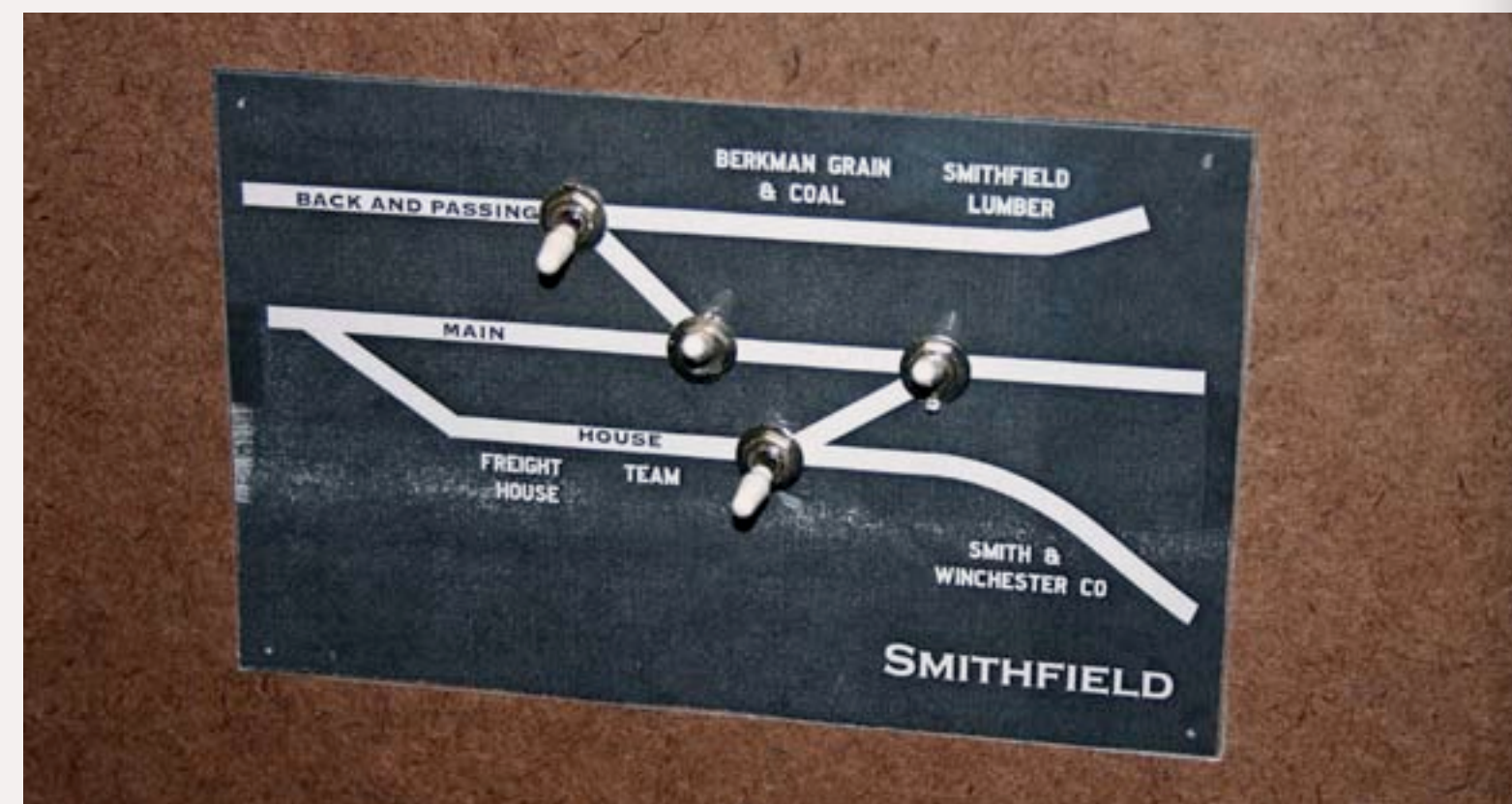

**FIGURE 5:** A few minutes at the computer was all it took to create this control panel for Smithfield. I used Adobe InDesign, since I'm familiar with the program, but any simple line drawing program will work.

I used lightweight joint compound to blend the pit base into the raised area where the pit rail sits, and add some additional sheathing to the bridge deck. I also installed the turntable into the layout (Figure 6).

Another project that had been waiting for a “long session” was lengthening the passing siding at the town I’m tentatively calling Milton. I spent close to an hour (maybe a little more) taking up the turnout, extending the subroadbed and roadbed, and replacing the track.

By the time I turned out the lights, I’d managed to scratch another item off my “to-do” list.

I was feeling really good about my progress. But evening number 5 was one of those short “15 minute” sessions. But I did manage to get some CV’s programmed on a few Soundtraxx decoders.

Suffice to say, the pre-set volume on the sound is way too loud. A few minutes with the manual and I



**FIGURE 6:** Another “one evening” project was blending the pit base into the pit rail base on this Diamond Scale turntable. This is a simple, but somewhat tedious task, which is ideal for a short “work night” modeling session.



**FIGURE 7:** The siding at Milton was really not long enough. One evening session of about an hour was all it took to remove the track, add new subroadbed and roadbed, and replace the track. The last five minutes were spent putting the shop vac to use!

reprogrammed several decoders (see Figure 1 first page).

I admit, after reviewing the previous list, I need to focus on one project at a time. Call it model railroad ADD, but I find I prefer to have a bunch of different projects going on at any one time. But the proof is in the pudding.

The old business seminar question of “How do you eat an elephant” applies to building a large model railroad – “one bite at a time.” A few minutes a night (or morning, if you’re a morning person) seems to be an ideal way to maintain enthusiasm and momentum, all at the cost of a few sitcoms. I think I can handle that.



## About our N-scale columnist



**John Drye** is our N scale editor and columnist.

[Click here](#) to learn more about John.

# COMME-N-TARY: Today's Amtrak – How to Add Passenger Service to a Modern Era N Scale Railroad

Modeling in the hobby's most eNgaging scale



**Today's Amtrak operates a variety of service types, from short "locals" to long-distance sleeping car service. You can create prototypical passenger consists for your own railroad using readily-available models from a variety of manufacturers.**

**A**mtrak was formed in 1971 to replace the individual railroad's intercity passenger service. Today, it operates on over 21,000 miles of track in 46 states and three Canadian provinces while carrying almost 30 million passengers a year.

Most of Amtrak operates with diesel locomotives on trackage owned by freight railroads. Service ranges from short trains with 3-6 coaches plus a single locomotive to long distance trains with two or more locomotives and a variety of coaches plus food service cars and sleepers; all the way to the world's longest passenger train – the



**FIGURE 1: Amtrak #195 arrives at the Amtrak station in Quantico, VA, home of the US Marine Corps.**

Virginia-to-Florida Auto Train that can include more than 30 passenger and automobile-carrying cars.

The US's national rail service has recently received an economic boost as part of the program to reinvigorate the economy. We'll take a look at Amtrak equipment, some examples of Amtrak consists and modeling options for representing Amtrak on your own freight railroad.

### **Amtrak Equipment**

A number of N Scale manufacturers provide a selection of motive power and passenger equipment to allow those who model the modern era to include Amtrak service.

### **Diesel Locomotives**

Most of Amtrak's trains outside the electrified Northeast Corridor are led by General Electric "Genesis"

locomotives, either the P40 or P42. GE built more than 300 of these 4000+ hp locomotives between 1992 and 2001 to replace EMD's F40PH. The unique design allows the locomotive to meet all of Amtrak's clearance requirements in the Northeast and elsewhere.

This locomotive has been offered in brass and Kato USA offers a great-running DCC-ready unit in a variety of road numbers and Amtrak paint schemes. The Genesis will be a key to assembling our passenger consists as most trains are pulled by one, two or three of these locomotives.

EMD GP-40 series locomotives are also occasionally seen as a replacement for a Genesis. These units were mostly acquired second-hand, originally for work train and switching service. Atlas has recently offered DCC-equipped and DCC-ready Amtrak GP-40s in an attractive silver, red, white blue and black scheme affectionately known as the "Pepsi Can". These great-running models can still occasionally be found and provide a bit of variety to the fleet of Genesis locomotives.



**FIGURE 2: Amtrak #73, a P42 Genesis locomotive, heads south with the Auto Train and 33 cars.**



**FIGURE 3: Looking its age, a heritage baggage car heads north across Quantico Creek towards the nation's Capital.**

### **Heritage Fleet**

Amtrak's Heritage Fleet was a program conducted by Amtrak from 1977 to 1985 to convert older cars from traditional steam heating to head-end power supplied by modern locomotives. Many of these conversions have been retired, but some baggage cars and diners remain.

The baggage cars come from a variety of sources and can be found system-wide on Superliner as well as conventional trains. Both Walthers and Con-Cor produce a conventional baggage car in a variety of schemes. The Con-Cor version will need new trucks to replace the standard rapido couplers. Micro-Trains offers a four-wheel passenger truck that fits. Walther's car comes with AccuMate couplers installed. Either version does a good job of representing the single baggage car right behind the locomotives in most Amtrak consists.

More than a dozen Heritage Fleet diners are in use on long-haul trains in the east where height restrictions prevent the use of Superliners. As with the baggage cars, these came from a variety of sources, including NYC, SP and CB&Q and include both corrugated and smooth-side cars. A number of manufacturers offer a diner painted in various Amtrak paint schemes.

### **Viewliners**

The Viewliner cars were originally intended to replace older coaches, sleepers and diners where clearances would not permit high-level trains. Their modular design allowed interior components (electrical, plumbing) to be assembled separately from the exterior. This allowed easier maintenance and car reconfiguration.

However, only 50 sleepers were built by Morrison-Knudsen in 1995-96. They operate on eastern trains in conjunction with other "low-level" equipment. With increased funding, Amtrak

plans to order 130 new Viewliner diners, sleepers and baggage cars. These will replace the Heritage baggage and dining cars when they arrive.

Con-Cor produced a model of a Viewliner sleeper some years ago and they can still be found occasionally. Like with their baggage car, the rapido couplers will need to be replaced. It will be interesting to see whether Amtrak's purchase of additional cars results in a new model of this distinctive car becoming available.

## Amfleet

The Budd Company built more than 500 Amfleet cars in the 1970s and 1980s to replace the variegated fleet Amtrak inherited from predecessor

passenger railroads. The design is based on the Amtrak Metroliner and this rounded appearance suggested the popular nickname of Amtubes. These cars are used extensively on trains in the east.

Bachman has released both the coach and café versions of these cars complete with interior lighting and illuminated rear-end lights. They come equipped with rapido couplers that cannot be replaced with a new truck / coupler because of the cars distinctive truck design. However, the couplers are difficult to see under the car's diaphragms. They can be included in a consist by installing a rapido truck / coupler on the adjacent cars.



**FIGURE 4: Showing off the unique paired windows that allow both occupants a view from their berths, two Viewliner Sleepers bring up the rear of the Silver Star.**



**FIGURE 5: An Amfleet coach trails P42 #139 across Occoquan Bay.**

## Superliners

The double-decker Superliner cars are among the most recognizable on the system and include the last cars built by the Pullman Corporation. These cars are most often found on long-distance trains bearing the names of famous passenger train predecessors. They were built in two orders; the first for 235 cars in the 1970s and a second for 140 in the 1990s. The design is based on Santa Fe's El Capitan high-level cars built in 1956 by the Budd Corporation and includes coach, sleeper, diner and lounge variants.

Superliner models are available from a number of sources. They have been offered in brass and Con-Cor produced a series of cars in the 1990s. They are also currently in production by Kato who offers sets of cars in several paint schemes.

## Other Services

Amtrak also offers electrified service in the Northeast and service to California in conjunction with the California Department of Transportation.

## Northeast Corridor

The Northeast Corridor, originally operated by the Pennsylvania, New Haven and other railroads, operates more than 300 track miles between Boston and Washington, DC under wire and using electric locomotives, with several extensions incorporating additional mileage.

There are two basic categories of service on the corridor itself; the high-speed Acela and Northeast Regional Trains. Of course, modeling these trains assumes that the corridor is already part of your layout.

## Acela

The Acela is available as a complete train set or individual cars from Bachman. Interestingly, the power is provided by the café car in the middle of the train. The set includes two unpowered locomotives, two coaches and the café car. Additional cars can be purchased separately to make up a typical consist of one locomotive at each end, 1 cafe, and up to 7 business class cars.

## Northeast Regional Trains

Northeast Regional trains utilize one of two locomotives while under wire.

The AEM-7 is a B-B electric locomotive built by Electro-Motive Division from 1978 to 1988. They are known as Meatballs since some of their major parts and components were designed in Sweden. While currently unavailable in N Scale, this locomotive is manufactured by Atlas in O Scale, so there may be some hope of someday seeing it in N.

The double-ended HHP-8 is manufactured by Bombardier and Alstom and began supplementing Meatballs on the Corridor in 2002. A model of this locomotive is available from Bachman as are Amfleet cars (described above) painted in a matching scheme.



**FIGURE 6: Amtrak Train #80, The Carolinian, is an example of Regional Service, including checked baggage in a Heritage Fleet car, Budd coaches and food service provided by a Budd Café.**



**FIGURE 7: Our N-scale Carolinian includes a Kato P42, Con-Cor baggage and Bachman Budd coach and cafe cars.**

## Amtrak California

The state of California operates a number of routes within the state in cooperation with Amtrak. These trains use unique equipment and some are painted in a distinctive blue and yellow livery. Consists on these routes usually include between four and six cars, with one locomotive and a cab control car on the rear end.

The most common motive power on these trains is the EMD F59PHI. Most cars are modified Superliners with two lower level doors for rapid passenger loading and unloading. The F59PHI is available from Athearn in a proper paint scheme, but the cars will take some kitbashing and a custom paint job.

## Some Sample Consists

Now that we have an idea of what is available to model Amtrak in N Scale, we'll take a look at some typical train consists. Very roughly, these can be broken into three groups:

Regional Service: these trains could be described as long-distance commuter runs.

East Coast overnight trains: all long-distance service restricted by northeast height restrictions

Superliner Trains: the rest of the long-distance trains, many headed to the West Coast.

## Regional Services

Amtrak operates Regional Service in a number of areas, including New England, Pennsylvania, the Atlantic

Coast and the Midwest. Examples include the New York to Pittsburgh “Keystone”, Boston to Virginia “Northeast Regional” and Chicago to Indianapolis “Hoosier State”. These are usually short trains, with a single locomotive, sometimes with a baggage car and up to six Budd coach and Café cars.

The Carolinian can be modeled using a Kato P42, Con-Cor baggage and Bachman Budd Coach and Café cars/

### **East Coast Overnight**

These trains are all restricted by height clearances in New York or Philadelphia. They are among the most interesting of Amtrak’s trains because of the variety of cars included.

An example is the former Seaboard Air Line “Silver Star” from New York to Miami. The train was inaugurated in 1947 and is now part of Amtrak’s

**FIGURE 8: The Silver Star passes the signals at Widewater, Virginia, on its way to New York, with stops in Washington, Philadelphia and intermediate points.**

**FIGURE 9: The N Scale Silver Star swings through reverse curves somewhere in Virginia. Visible behind the P42s are a Con-Cor baggage, three Bachman Budd Coaches, a Con-Cor Heritage Diner and two Con-Cor Viewliner Sleepers.**







Silver Service brand that serves many of the Atlantic Coast States.

The Silver Star can be modeled with 2 Bachman AEM-7 engines (New York-Washington D.C.) or 2 Kato P42s (Washington D.C.-Miami), 1 Con-Cor / Walthers Baggage car, 3-6 Bachman Budd Coach, 1 Bachman Budd Café, 1 Con-Cor / Walthers Heritage Fleet diner and 2 Con-Cor Viewliner sleepers.

### Superliner Trains

Amtrak operates long-distance trains entirely with Superliner equipment west of the Mississippi. Some of the

most famous names in American Passenger railroading history survive on these routes. The scenery is as beautiful as it ever was, and the equipment is the best Amtrak has to offer.

The original California Zephyr was a passenger train operated jointly by the Chicago, Burlington and Quincy Railroad (CB&Q), Denver and Rio Grande Western Railroad (D&RGW) and Western Pacific Railroad (WP). The route was designed to pass through the most spectacular of the scenery during daylight hours. Amtrak still operates over much of this route through the Rocky and Sierra Nevada mountains.

**FIGURE 10: The N Scale Zephyr descends the Rockies towards Denver behind two Kato P42s with a consist of Kato Superliners.**

The Zephyr can be modeled with Kato P42s and Superliners along with a Con-Cor baggage. A typical consist would be:

- 2 Engines
- Baggage Car
- Transition Sleeper(crew)
- 2 Upgraded Sleepers
- Diner
- Cafe
- Coach
- Coach/Baggage

### Summary

Great models exist to add Amtrak passenger service to your modern, N-scale, freight railroad. You can write your local member of congress to subsidize anything from a short regional train to a long-distance Superliner train. Just remember to keep them on time to avoid paying late-arrival penalties.

# REVERSE RUNNING: Get off the computer and do some modeling!

Stepping outside the box with a contrary view



– by Joe Fugate

**T**he modern Internet makes it easier than ever to connect with other model railroaders and to find useful modeling information online – often for free! Model Railroad Hobbyist is no exception in this regard.

However, like anything fun, surfing the web and hanging

out on model railroading forums can become something of an addiction.

It's easy to start thinking of yourself as an active model railroader just because you frequently talk about model railroading on the Internet modeling forums. Talking about modeling and doing modeling are NOT the same thing, so watch out!

In the early days of the hobby, before there were even magazines about the hobby, anyone who called themselves a model

railroader actually built stuff and did the hobby.

As publications like Model Railroader and Railroad Model Craftsman appeared on the scene, ever more interesting model railroading content began to fill their pages and the so-called “armchair” modeler was born.

Now you could read about the hobby, look at pictures of great modeling, and literally immerse yourself in reading and thinking about model railroading – but never actually DO any modeling or even hold a model train at all.

With today's Internet, it's even easier to get addicted to this sort of armchair behavior. Through emails, forums, podcasts, and places like Facebook and Twitter, you can literally burn up hours reading about and discussing model railroading.

That's all well and good, and if anyone, anywhere, appreciates having a good, online audience, it would be us at Model Railroad Hobbyist. Having readers who are passionate about discussing

the hobby is great. However, we still believe the most hobby satisfaction comes when you DO the hobby, not just talk about doing it.

Go build some models, and then take some digital photos of your work, or shoot a short video of your new pride and joy running through a nicely modeled scene. Then come on the MRH site and do a show and tell of this latest project!

Tell us what you've learned, how you maybe made a mistake or two and then fixed things.

Those are the posts we all love to see and hear about the most!

By the way, thanks to emerging devices like the new iPad, it's going to become easier to take MRH to the workbench or layout as a reference as you work – so MRH can become leverage to help get you off your laurels and do some modeling ...

So resolve that it's time to get off the computer and go do some modeling!



Clickable Advertiser Index	Page
Accu-Lites .....	17
BLMA .....	3
Blue Ribbon Models .....	49
BPL Brassworks .....	11
Canyon Creek Scenics .....	52
Canadian Model Trains - CMT .....	7
Craftsman Structure Show - 2010 .....	110
Dallas Model Works .....	4
DCC Installed .....	21
Digitrax .....	10
Fast Tracks .....	5
FOS Scale Limited .....	18
iWata-Medea .....	53
LBH Custom Model Railroads .....	39
Litchfield Station .....	13
Micro-Mark .....	35
Model Railcast Show .....	19
Model Railroad Hobbyist .....	19
Model Railroad Hobbyist .....	101
Model Railroad Tips .....	39
Model Trains Video .....	6
Model Trains Video (F&SM) .....	32
Model Trains Weathered .....	36
Oregon Rail Supply .....	38
Paw of a Bear .....	14
Railflyer Model Prototypes.....	38
Railroad Kits .....	49
Rapido Trains .....	9
RS Laser Kits .....	21
Scenic Express .....	51
Scotty Mason Show audio podcast .....	15
ShelfTrax .....	39
Signature Press .....	52
Tam Valley Depot .....	39
Train Horns Delivered .....	39
Traintek .....	20
Weathering Solutions .....	37

Clickable Topic Index	Page
Construction – Getting Real, Task Management .....	143
Editorial – Publisher’s Editorial .....	12
Editorial – Notes from the MRH staff .....	15
Editorial – Reverse Running .....	154
First Look – A trio of ExactRail freight cars .....	116
Layouts – The Return of the Pennsy .....	40
Locos – Kitbashing a U18-B .....	54
Modules – My Modular Adventure .....	120
News – Coming Events .....	33
News – July Newsletter .....	22
Prototype – Comme-N-tary, Amtrak in N scale ..	148
Prototype – Numbering Your Rolling Stock ..	111
Q and A – MRH Questions, Answers, and Tips ...	34
Scenery – Modeling Decrepit Spur Tracks .....	102
Scenery – Ties and Tie Plates .....	50
Scenery – Up the Creek, Modeling a Creek ...	135
Sound – Adding Sound to your Layout .....	91
Tools – Custom Spiking Pliers .....	109

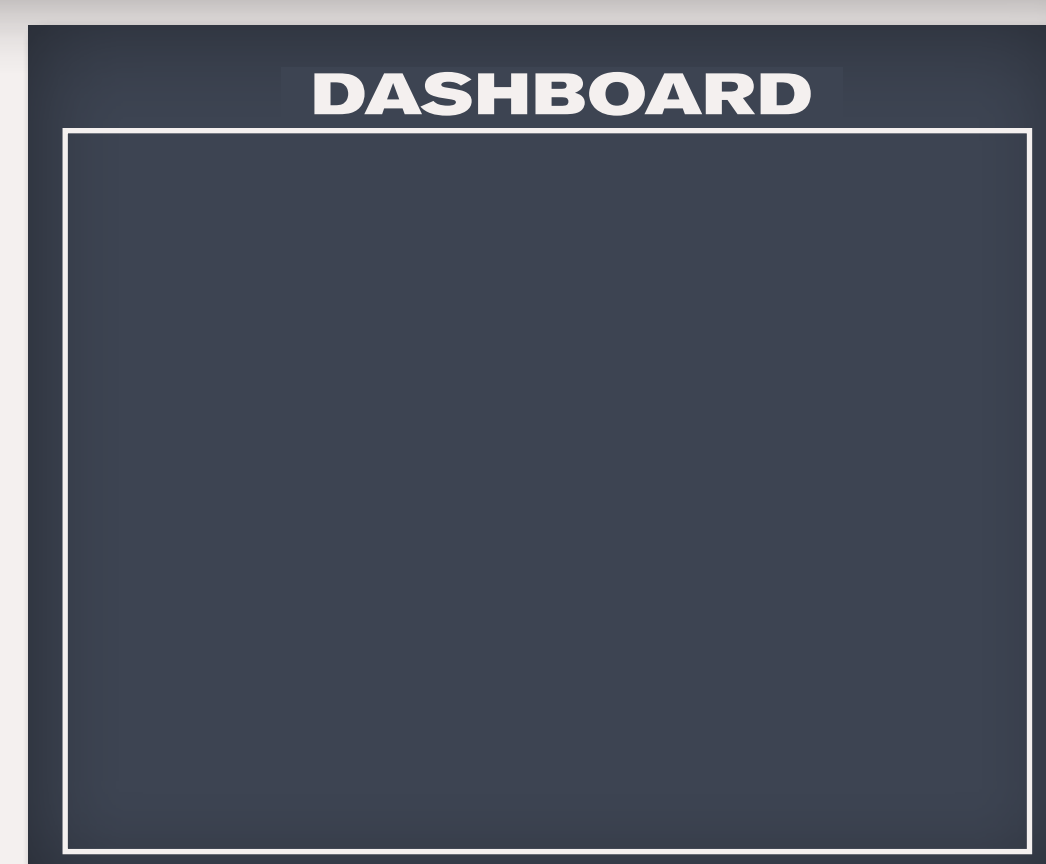

Other – Cover .....	1
Other – MRH Sponsors .....	2
Other – Table of Contents .....	8
Other – Bonus Downloads .....	16
Other – Derailments (humor) .....	115

## For the love of model trains

### Coming in the Sep/Oct 2010 issue

- Lessons in Passenger Car Modeling
- Kitbashing a U18B - part 2
- N scale multideck track plan
- Zip Texturing resurrected - Joe Fugate
- Dave Clune's On3 Cascade County Narrow Gauge
- New one-evening projects
- More MRH Questions, Answers and Tips

*... and lots more!*

