

# Model Railroad Hobbyist magazine™

Price:  
Forever Free

STANDARD  
Edition

Realize your model railroading dreams

Nov/Dec 2010

## Scenery Techniques:

- Airbrushing highway stripes
- Rock molds with Kitchen Caulk
- Planting a giant cedar tree

Modeling a Spanish Revival Bungalow

Tour the Washington Northern!

And much more ... *inside!*

Vic Roseman on

# Switching the 1955 Daylight

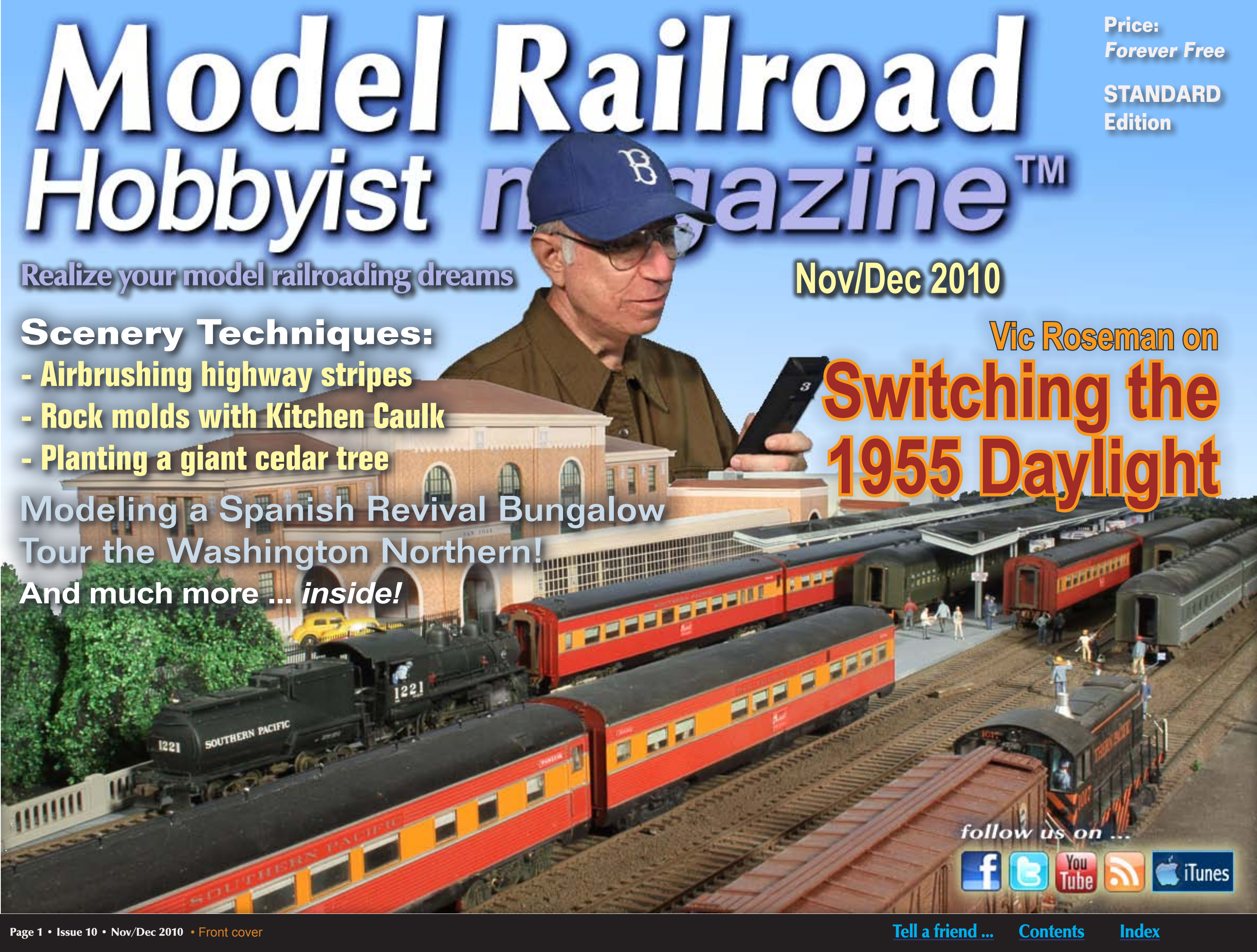

follow us on ...







**Front Cover:** Vic Roseman may be a New York native, but a trip to San Jose in the mid '50s planted the Southern Pacific seed. Vic writes about the switching intricacies of building the Coast Daylight at San Jose – in only 12 minutes!

ISSN 2152-7423

**Editorial Staff**

Joe D. Fugate, Publisher  
Charlie Comstock, Layouts and media editor

**Columnists**

Ryan Andersen, New media  
Richard Bale, News and events  
John Drye, N scale  
Lew Matt, Narrow gauge and shortlines  
Marty McGuirk, Prototype modeling  
Les Halmos, Modular railroading  
Tim Warris, Trackwork

**Special Correspondents**

Jim Duncan, Layouts and operations  
Byron Henderson, Layouts and track planning

**Production**

Patty Fugate, pasteup and layout  
Joe Brugger, copy editing  
Mike Dodd, copy editing

**Technical Assistant**

Jeff Shultz

**Advertising Account Manager**

Les Halmos



Click to learn more about this sponsor



**NEW SPONSOR!**



**NEW SPONSOR!**



Click to learn more about this sponsor



Click to learn more about this sponsor



Click to learn more about this sponsor



Click to learn more about this sponsor



Click to learn more about this sponsor



Click to learn more about this sponsor



Click to learn more about this sponsor



Click to learn more about this sponsor



**NEW SPONSOR!**



**NEW SPONSOR!**



Click to learn more about this sponsor



**NEW SPONSOR!**



Click to learn more about this sponsor



Click to learn more about this sponsor



Click to learn more about this sponsor



Click to learn more about this sponsor



Click to learn more about this sponsor



**NEW SPONSOR!**



**NEW SPONSOR!**



Click to learn more about this sponsor



Click to learn more about this sponsor



**NEW SPONSOR!**



Click to learn more about this sponsor



Click to learn more about this sponsor



Click to learn more about this sponsor



Click to learn more about this sponsor



Click to learn more about this sponsor



**NEW SPONSOR!**



Click to learn more about this sponsor



**NEW SPONSOR!**

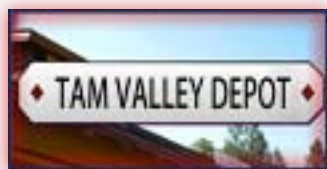

**NEW SPONSOR!**



Click to learn more about this sponsor



**NEW SPONSOR!**

**Sponsoring Advertisers - Visit them and say: "Thanks for bringing me MRH completely free."**

**Your logo could be on this page, putting your web site just one click away from tens of thousands of readers!**



Our click tracking indicates sponsoring advertisers get up to *double* the clicks ...

[Click here](#) to learn how to become a *sponsoring advertiser*.

Our back issues continue to get hundreds of new downloads per month. Sponsoring advertisers keep getting clicks from their older ads, from their logo on our web site, *as well from as our current issue*. A sponsoring ad with MRH is an *investment* in growing your business.



# The Original



N SCALE

# LOW RIDER

NEW!

## ACF 70-Ton 52' Gondola

First produced in 1948 for Pennsylvania Railroad as class G31, PRR purchased 11,600 welded cars of this body style in the G31/G31A/G31B/G35. Besides PRR, several other railroads also purchased these gondolas from ACF. Most of these gondolas were phased from revenue service during the 1990's. This N Scale model features fine-scale detail, body-mounted couplers and BLMA 70-Ton Friction Bearing Trucks and metal wheels.

Reserve By: November 1, 2010

*Coming in early 2011*



Nscale \$21.95

- PENNSYLVANIA** ★ **PENN CENTRAL**  
#14001-14006 #14019-14024
- SOUTHERN PACIFIC** ★ **WABASH**  
#14007-14012 #14013-14018

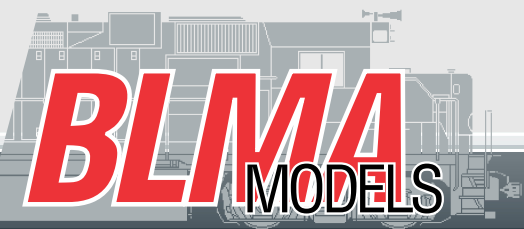

# BLMAmodels.com

ONLINE AT:



Detroit, Toledo & Ironton  
DTI 9676

GD

MTY  
Return To  
**Detroit**



Soo Line  
Soo 62546

HT

MTY  
Return To  
**Sault Ste. Marie**



Procor  
PROX 15136

TA

MTY  
Return To  
**Brantford**

**Advanced**

# Car Card Generator

**for My Railroad!**

Easily create Car Cards online for car card and waybill operations · Easily reprint torn and worn cards · Complete instructions · Works with My Rolling Stock · For Dallas Model Works Members only · Free to use!



 [Click to Visit](#)

Walthers models 932-40257, 932-7853 and 932-7224 shown



**THE**

# **BULLFROG**

## **MANUAL THURNOUT CONTROL**



-  **Inexpensive**
-  **Integrated Control Rod Mount**
-  **Automatic Power Routing**
-  **Full Selection Of Supporting Products**



**\$9**

**Ready  
To Install**

**You Assemble It**



**\$6**



Order online now at:  
[www.fast-tracks.net/bullfrog](http://www.fast-tracks.net/bullfrog)



Volume 1

# HOT Trains

**Trains and awesome scenery, operation and how-to's - see Charlie Comstock's Bear Creek and South Jackson as he dreamed it...**

*I was most impressed by the most professional model railroad video production I have ever seen - John D.*

*... a great job ... I think Charlie really hit it out of the park when it came to the sound - Steve*

*... the video was great. Fantastic scenery too - Jim*

*the best overall lighting that I have seen in a model video ever - Tom W.*

*... played it during our operating group work night and it was a hit! - Rick W.*

Christmas special price only

List price  
~~\$29.95~~

**\$14.95**

plus shipping+handling

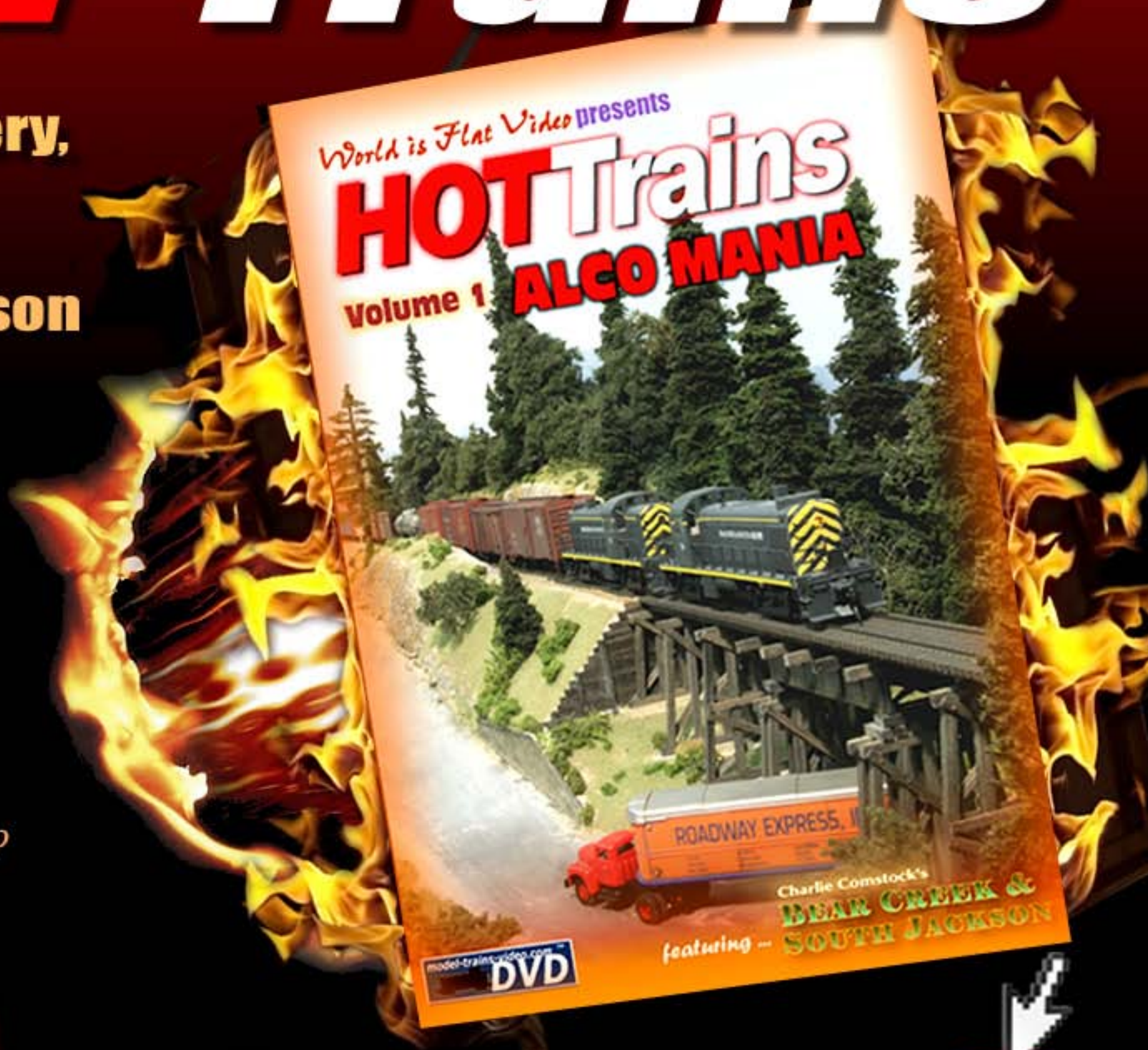

Do more. Spend less.

[model-trains-video.com](http://model-trains-video.com)





**It's a  
real crime  
when  
you miss  
out on a  
limited  
run  
model ...**



***to the  
rescue!***



**Click here to learn  
how to prevent  
this crime!**



# Main Features

# Table of contents

# Columns



**Lessons in passenger car modeling**  
Part 2 - Modeling Conrail 21  
*by Matt Snell*



**Silicone Caulk Rock Molds**  
Rock molds on the cheap  
*by Roy Buchanan*



**Washington Northern**  
Visiting a bedroom sized HO layout  
*by Charlie Comstock*



**Weathering Powders**  
Scenery weathering the easy way  
*by Joe Fugate*



**Easy Highway Striping**  
Scenery Scene: one evening project!  
*by Charlie Comstock*



**Toolless benchwork - 22 floors up!**  
Apartment modeling in Abu Dhabi  
*by Thomas Garbelotti*



**Switching the Daylight**  
Building the Coast Daylight - in just 12 minutes!  
*by Vic Roseman*



**A Spanish Revival Bungalow**  
Modeling an interesting structure - with cardstock!  
*by Isaac Herrera*

# Other Features

**12 The Silence is Deafening ...**  
Publisher's Editorial *by Joe Fugate*

**15 MRH Staff Notes**  
MRH is going monthly next year!

**27 MRH Q - A - T**  
Questions, Answers and Tips

**89 Derailments**  
Humor (perhaps)

**121 First Look**  
ComArt - Real Deal Weathering kit  
Walthers - 2011 HO Reference Book

**20** September Model Railroading News  
MRH News and Events  
*by Richard Bale*

**125** Building a Speeder  
The Lite and Narrow  
*by Lew Matt*

**130** Planting a Cedar  
Up the Creek  
*by Charlie Comstock*

**137** Layout Design?  
Getting Real  
*by Marty McGuirk*

**142** Making Mountains  
Comme-N-tary  
*by John Drye*

**147** But we've always done it  
that way...  
Reverse Running  
*by Dave Kilborn*

**16** Bonus downloads this  
issue!





*That looks suspiciously like a*  
**Fairbanks Morse 5-Axle C-Liner**  
*Click for more info.*





# Digitrax UT4D Duplex Equipped Utility Throttles

## Select, Run and Dispatch

## Without Plugging In!

Shipping Now! The UT4D is the latest in the UT4 series of Digitrax Utility Throttles. Operators from around the world asked for a simple to use, affordable throttle with intuitive operation & rock solid design. Based on operator input, Digitrax created the UT4 throttles.

UT4D is Duplex Equipped to work with the UR92 Duplex Transceiver. It can also be used as a walk around throttle with UP5 or as InfraRed with any Digitrax InfraRed Receiver.

For UT4 & UT4R upgrade information visit [www.digitrax.com/ut4upgrades](http://www.digitrax.com/ut4upgrades)

Digitrax, Inc. 2443 Transmitter Road, Panama City, FL 32404  
Phone 850 872-9890 / Fax 850 872-9557 [www.digitrax.com](http://www.digitrax.com)

**UT4D \$135.00 msrp**





# TELL US WHAT YOU WANT. WE'LL HELP YOU FIND IT.

SPECIALISTS IN HO, O AND N SCALE HARD-TO-FIND ITEMS

BPL Brassworks' sophisticated Want List system "sends up a flare" when a new collection comes in with just what you're looking for, and we send you a "heads up." You won't miss out on the opportunity to add that sought-after item to your own collection. You know what to look for, and we provide crisp, detailed photos to give you confidence in the quality and value of our offerings.

FINE DOMESTIC AND IMPORTED BRASS MODELS FOR  
DISCRIMINATING COLLECTORS AND OPERATORS.

- All major importers and domestic manufacturers
- Newest manufacturer offerings
- Want List system for special requests and hard-to-find items
- One-to-one personal service
- More than 15 years of railroading study and experience
- A boss who's as passionate about brass and trains as you are
- Order confirmations, layaway and prepayment options available

*Make our web site your first stop for the newest offerings.*



2 6 2 - 3 7 5 - 1 1 0 7

CLICK FOR MORE INFO







## About the Publisher



Joe Fugate is the featured expert in many [Model-Trains-Video.com](http://Model-Trains-Video.com) videos, and he's also the founder and publisher of **Model Railroad Hobbyist Magazine**.

To learn more about Joe, [click here](#).

# PUBLISHER'S EDITORIAL: The silence can be deafening

## Musings from the MRH founder



### At Model Railroad Hobbyist, we depend on your feedback to tell us how we're doing ...

To help that process out, we work very hard to make it easy for you to give us feedback – for instance, you may have noticed the feedback button we place on each and every article in the magazine (see figure to the right).

Have you ever clicked that button on an article? We hope every one of our readers will answer yes!

We rely on the feedback posted for the articles to tell us how you feel about an article. When we post what we feel is some of our best work and we don't get any feedback posts, we take that to mean you were not impressed. When that happens, we're much less likely to do another article of that type very soon.

So if you like an article, press the feedback button and tell us so! If you don't take the time to let us know, we

can only make assumptions, and we'll probably assume the worst.

To this end, we're adding a new feature to the feedback section as of this issue: the ability to give each article a rating on a 5-star scale. Please click the feedback link on all articles you read and leave a rating. That way we can tell how we're doing and when we get articles that rate well, we'll work hard to publish more of them.

Of course, we'd like it even more if you take the time to post some actual feedback. Believe it or not, we actually like getting critical feedback.

Sure, atta-boys are nice, but it's the critical feedback that helps us improve the magazine. We consider MRH to be your magazine – that's one reason why we call ourselves Model Railroad Hobbyist – you, our audience, matter to us greatly. The truth is, if you're not happy with MRH, then no one is happy.

Dave Clune knew he wanted a narrow gauge layout, but he was also looking for something beyond Colorado. He was interested in the Nevada County Narrow Gauge, but lived in Oregon. His solution? Move the NCNG to Oregon and dub it the Cascade County Narrow Gauge.

By Josef Bruggen and Christine Comstock

Model Railroad Hobbyist had the opportunity to visit the On3 Cascade County Narrow Gauge in May 2010 and interview Dave Clune. Dave got his first issue of Model Railroader in 1949 and has been modeling ever since.

Charlie: Dave, thank you very much for having us. You've got a wonderful layout here.

**Why the NCNG?**

Charlie: The Nevada County Narrow Gauge is not modeled very often. What led you to model this railroad?

Dave: Charlie Best had a book out called the "Nevada County Narrow Gauge." It contained everything I wanted in the concept and execution of the layout, so I used the book as a basis for my modeling. It had mining,

it had common carrier status, it was short – 21 miles – and it contained some nice-looking locomotives.

Charlie: Was there something that attracted you to a narrow gauge layout over a standard gauge layout?

Dave: Yes, narrow gauge is the most personable of all the railroads. I think it's small, intimate and fits well in a model railroad.

Charlie: Some people don't know what a narrow gauge is.

Dave: Narrow gauge is anything less than 4 feet, 8 1/2 inches (standard gauge), in my case it's three feet between the rails. It's a gauge that was adopted in the 1870s to penetrate rough country cheaply. You get the rough country cheaply. The cost of building the railroad was considerably cheaper.

**Layout Concept**

Dave: I was moving a railroad from the California Sierras to the Cascades in Oregon.

Charlie: Some people don't know what a narrow gauge is.

Dave: Narrow gauge is anything less than 4 feet, 8 1/2 inches (standard gauge), in my case it's three feet between the rails. It's a gauge that was adopted in the 1870s to penetrate rough country cheaply. You get the rough country cheaply. The cost of building the railroad was considerably cheaper.

Figure 2: The appeal of small narrow gauge locomotives and detailed west coast mountain scenery. Dave Clune's narrow gauge layout has a twist. Instead of being based in Colfax, California, the model railroad is based in Cascade County, Oregon. Number 60000 near the turntable. Dave Clune's model railroad is based in Cascade County, Oregon. Dave Clune's model railroad is based in Cascade County, Oregon.

**Make sure you click the feedback button and let us know what you think!**

**The lack of feedback on an article says to us "nobody cares" ...**



If there's something we did in an article that you don't like, then tell us. If there's something we didn't do that you wish we would do, then tell us. If you like what we did in an article and want more, then tell us. Be specific: Was the step-by-step clear? Do we need more pictures? Is the process understandable?

While I'm on the topic of feedback, there's another good reason for clicking the feedback button on an article – if you have a question or something is not clear in an article, then you can post a question on the feedback thread.

Often, the authors themselves will drop by and answer your question. Sometimes the author will post additional material, in effect extending the article and making it even more useful.

If you have a question, you're probably not the only one. By being brave enough to post your question on the article feedback thread, you increase the value of the article thread for everyone. Don't be embarrassed to

admit you didn't understand something – go ahead and ask! Authors can't think of everything and your question will also help the next author who writes on that topic do a better job with their article.

Others may also post more information relevant to the article. If you don't click the feedback button, you could be missing out on a lot of extra information. And we provide this extra content to you completely free – not behind a paid login. You do have to be a subscriber to post feedback on the web site – but subscribing is free. We limit posting to subscribers so we can keep the anonymous spam under control.

Remember, if an article doesn't get any feedback, we may find your silence to be deafening!

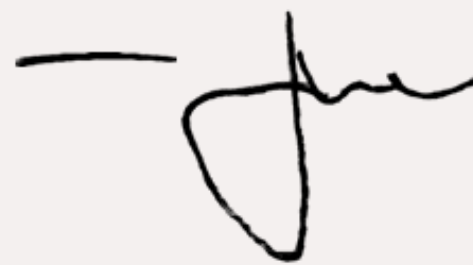

# RS Laser Kits



New in HO  
Tom's \$19.99  
soon in N & Z



Keystone Mill  
Coming soon in HO and N scales  
(test build shown will come with a cast foundation)

Breaking News: We now carry a new line of Scenic products  
Trees, Flocking and Plaster Cloth. Watch our web site for details

## Laser Kits in most Scales Custom Laser Cutting

Scratch Builders Supplies  
Over 30 structures and counting  
4 rolling stock kits more coming  
5 styles of roofing in 10 colors

### Dealers For:

Timber Times Books  
KMP Kits  
Northeastern Strip Wood  
Bragdon's Weathering Powders  
Aspen model N, Nn3 and Z scale

For Price List Send Large SASE  
Dealers welcome

[www.RSLaserkits.com](http://www.RSLaserkits.com)

5145 Gaffin Rd. SE  
Salem, OR 97317

PH: 503 371-4290 Fax 503 585-0850



click here





This laser cut, highly-detailed, craftsman kit is an exact replica of the feed and seed distributor built in the early part of the 20th century and is still in existence in Lakeville, NY.

### KIT HIGHLIGHTS

- Precut textured timbers
- Fully detailed interior
- Northeastern Scale Lumber
- Many original and S.S.L. metal castings
- L.E.D./Fiber optic lighting
- Tichy windows and doors
- Hydrocal base casting
- Full-color detailed instruction manual
- Vehicles and figures not included

PRICE  
**\$125.00**  
(plus S&H)

Order Online Today!  
[www.lasermodeling3.com](http://www.lasermodeling3.com)



[www.lasermodeling3.com](http://www.lasermodeling3.com) • 1 University Drive, Geneseo, NY 14454 • Phone: (585) 243-3480 • Fax: (585) 243-1513 • [lm3llc@gmail.com](mailto:lm3llc@gmail.com)



## Notes from the

# MRH STAFF



Nov/Dec 2010 marks the last of the bimonthly MRH magazine schedule. Starting with the January 2011 issue, MRH will be coming your way each and every month. Wondering when each new issue is due out next year? The answer is still, the first Monday of each month. We're looking forward eagerly (but with a bit of trepidation) to the monthly schedule ahead. The added continuity from going monthly will be great, but producing twice the number of magazines will take a bit of work!

### In this issue

The featured story of Issue 10 is Vic Roseman's *Switching the Daylight*. Whether you're a SP fan or not, this article tells the story of two kids who rode their bikes down to the San Jose, CA depot in 1955 to watch the yard crews working with the road crews to make up the Coast Daylight from three other trains – and they

only had 12 minutes to get all that switching done! Woe to the man who delayed the Daylight! Vic modeled the San Jose depot and all the passenger cars used to demonstrate this process. His first-rate photography will really draw you into the story. Then Vic talks about modeling the Daylight yourself.

Also in this issue are directions for making your own rock molds using kitchen caulk, part 2 of Matt Snell's passenger car modeling, and an interview (and layout tour) with Kevin Klettke and his bedroom size Washington Northern. Kevin is a frequent poster on the MRH forum and when we saw some photos of his layout, we knew we wanted to feature it in MRH. We also have another installment of Thomas Garbelotti's attempt to build a model railroad in a 22nd floor apartment in Abu Dhabi. Our illustrious publisher, Joe Fugate, writes about extending zip texturing to weathering powders. Plus a goodly selection of columns and another First Look!

### MRH podcasts continue

Starting with Issue 7, MRH has been partnering with Paul Gillette and Ryan Anderson to produce MRH podcasts. These podcasts feature authors in the corresponding issue or other persons of interest. So far we have two podcasts and are looking forward

# Can it be???

Come check us out and discover a new world of resin kits allowing you "scratchbuilt" results in just a few evenings time! After all... you really don't want to be a model ship builder... do you?

Easy  
&  
Resin?

Parts straight out of the box... seriously!



# Frenchman River Model Works

[www.frenchmanriver.com](http://www.frenchmanriver.com)

1-308-276-2174

[Visit Frenchman River Model Works web site](http://www.frenchmanriver.com)

[Tell a friend ...](#)

[Contents](#)

[Index](#)



## MRH has a new presence on these well known web sites:

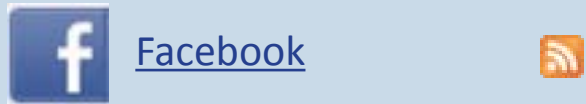

[Facebook](#)

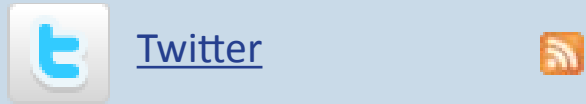

[Twitter](#)



[iTunes \(podcast\)](#)

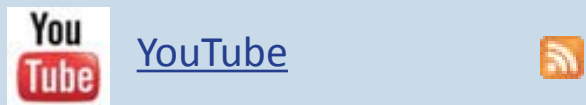

[YouTube](#)

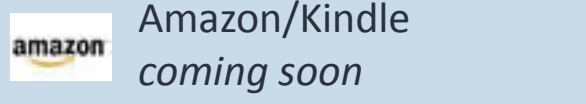

Amazon/Kindle  
*coming soon*

to more. The podcasts are available online through iTunes or as separate mp3 files.

## MRH online expansion

MRH has been building additional presence in several popular areas of the internet. Our goal is to become your One Stop Source for online train information in all areas and forms!

Have you checked us out on Facebook, Twitter, and YouTube yet?

## Know a good layout?

Do you know of a nicely executed layout just waiting for a magazine spread? Let us know; we're on the lookout for article-worthy layouts

even more so now that we're going monthly.

The following attributes will improve a layout's chances of appearing in MRH:

- It should have enough good-looking scenery for nice close-up photos.
- A well-thought-out trackplan is a definite plus.
- Unusual features like unique scratch-built or kitbashed buildings help make a layout more interesting than one populated with out-of-the-box building kits. Realistic, era-appropriate weathering is a plus.
- A friendly environment - good lighting and nicely-finished fascia.
- A scale other than HO also improves a layout's chances.
- Not having been in the hobby press already is a bonus.

Know of such a layout? Click [here to suggest a layout for an article](#).

## Bonus downloads

Make sure you check out the bonus downloads for this issue. The goodies include:

- DVD-quality video of the videos in this issue.
- You can also download bonus items from previous issues.

Note that the bonus downloads are good only for the first 30 days after an

# Issue 10 Premium Extras!

Free for the first 30 days after issue release  
*(After Dec 1, 2010, these extras will no longer be available)*

## ■ DVD-quality versions of this issue's videos



**Click here to access**



**When you see this symbol, it means:**

**"Click here to learn more!"**

- *Every click tells advertisers an ad in MRH is a wise investment ...*

## Tips for reading MRH:

- *Clicking an article on the cover will take you directly to that article.*
- *If you're using Adobe Reader to read MRH, holding down ALT and hitting the left-arrow-key will take you back to the previously viewed page (like a browser 'back' button).*
- *Looking for a particular advertiser? Click [Index](#) (at the bottom of each page). In addition to our article index, you'll find an alphabetized List of Advertisers on that page.*



Watch our website  
for our monthly  
specials!



**ACCU-LITES, inc**

Your DCC Center!

CLICK TO LEARN MORE:

<http://www.acculites.com>

See us at Trainfest - November  
13th and 14th in Milwaukee!

Mention this ad and get \$5 off your purchase!



issue release. We provide the bonus materials to encourage early downloading of each issue. If you wait too long to download an issue, you'll miss out – so don't procrastinate!

### Write for us

Once MRH is a monthly magazine, we'll be reducing content to about 60% or 70% of what it is now. When we say content we don't mean ads, Table of Contents, or the Index. We mean pages of articles. It may seem as though we're shorting you on content, what it really means is we'll be needing 20% to 40% *more* content for two monthly issues than for one bimonthly issue.

Basically, our appetite for articles will become even more voracious than

ever. If you ever considered writing for MRH, now's the time!

Remember though, acceptance is not guaranteed. The most common reasons for rejection is poor photography. The next most common is content selection.

If you want to increase the odds that we'll accept your article, first send us a proposal [via this link on our web site](#).

We will respond within two or three weeks and let you know if your idea is something of interest to MRH. We'll often provide some guidelines as to approaching an article. Also, if your photographs look blurry, with funny colors to them, or are taken with an on-camera flash you may want to re-shoot them.

Got an article ready to submit? Here's a checklist for you:

- Include your full name and e-mail address in the article text. You would be surprised how many submissions we get *without* this information!
- Include captions for all photos, diagrams, drawings, tables, and videos as a separate document.
- Include a version of your document that has the images and diagrams inline in the text; for example in a .doc or .pdf file. Be sure to also give us a text-only version of your article, too.
- Write a short bio about yourself and your hobby interests. Include a recent photo of yourself.

We prefer Microsoft Word format for documents. For images, send us 2-3 megapixel jpgs at least 1800 x 1200 pixels.

If you don't have a copy of Microsoft Word or Office, you can [download a free copy of Open Office here](#). Open Office reads and writes Microsoft Office-formatted files.

For drawings or diagrams, contact us and we'll give you some guidance of how to produce them for publication with us.

### One Evening Projects

Never written before? Don't have time to create a War and Peace length article? No problem! Try writing for our



series of *One Evening Project* articles. Currently, we have *The Scenery Scene* and *The Tool Shed*. However, we're looking to expand into other areas too, such as track work, electronics, or any other project that takes an evening or afternoon to complete.

## First Looks

First Looks are not reviews – we're not trying to tell you what's good or bad about a model. Let's face it, why would you believe a review of an advertiser's product in a completely advertising-supported magazine?

Instead First Looks are a show-and-tell about something nifty and new – often with some prototype background.

If you're a vendor and have a cool new product you'd like featured in a MRH First Look, [contact MRH with what you have in mind](#).

## Promoting MRH

There are too many shows for the MRH staff to attend in force! We're

looking for volunteers to help promote MRH at regional or divisional shows or swap meets. If you'd be willing to do any (or all) of the following:

- Put flyers and CDs out on the free handouts table.
- Help staff a table.
- Help us get flyers and CDs in the registrant bags (if the event has such things)

If you're willing to help staff a table, we'll pay for the table and pay the entry fee for you and any other reliable volunteers you can get to help you at the table.

We'll also give you an official MRH shirt to wear at the event (yours to keep), and send you promotional materials with guidelines on how to best use them.

Just click here if you're [interested in helping out at a show!](#)

**Model Railroad Hobbyist magazine™** Your first choice for **FREE** on-line model train information!



# THE GARMENT DISTRICT



**THIS IS ONLY ONE OF 4 STRUCTURES INCLUDED IN THE KIT, CHECK OUT THE OTHER 3 ON OUR SITE**

**NEW LIMITED RUN KIT - ONLY 150 WILL BE MADE**



\*HALF OF THE RUN IS ALREADY SPOKEN FOR AS OF THIS AD



**OVER 50 UNIQUE KITS**  
**6 DVD'S & MORE ON THE WAY**  
 CHECK OUT OUR INSTRUCTIONAL & LAYOUT TOUR DVD'S

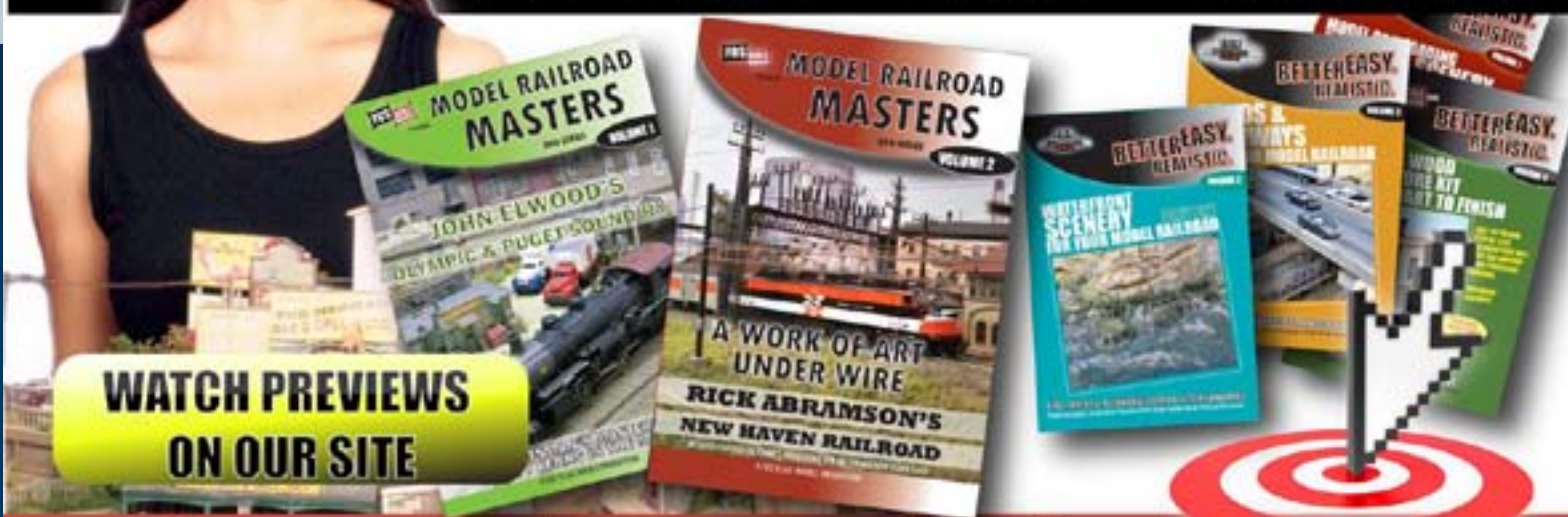

**WATCH PREVIEWS ON OUR SITE**

**fosscalemodels.com**



**Micro-Mark** Unique products make building your model railroad layout easier  
 Berkeley Heights, New Jersey 07922



Reads in %  
 #84519  
**\$34.95**

2-in-1 Miniature Digital Level measures grades with ultra precision.



Easy to install  
 #83201  
 as low as **\$11.95 ea.**

SWITCHTENDER™ switch machine is quiet, dependable and easy to install.



Scenery "guru" Dave Frary  
 #84780  
**\$29.95**  
 103 minutes

Learn how to make detailed scenery... from start to finish...with this DVD.



#83876  
**\$239.95**

Folds to a compact 24" x 31" x 56" for easy storage!  
 The Topside Creeper™ safely extends your reach...reduces back and leg stress.



Covers 72 sq. feet!  
 #83081  
**\$9.95**

Scenery Strips eliminate the hassle of hand-cutting corrugated board.

**Order online at [www.MicroMark.com](http://www.MicroMark.com) or call 1-800-225-1066!**  
 Mention/enter code BA6 when placing your order.  
 Prices good through December 31, 2010. S/H extra.

**FREE** Catalog with any order!

# Model Railroad Hobbyist magazine™

January 2011 Issue Sneak Peek ...

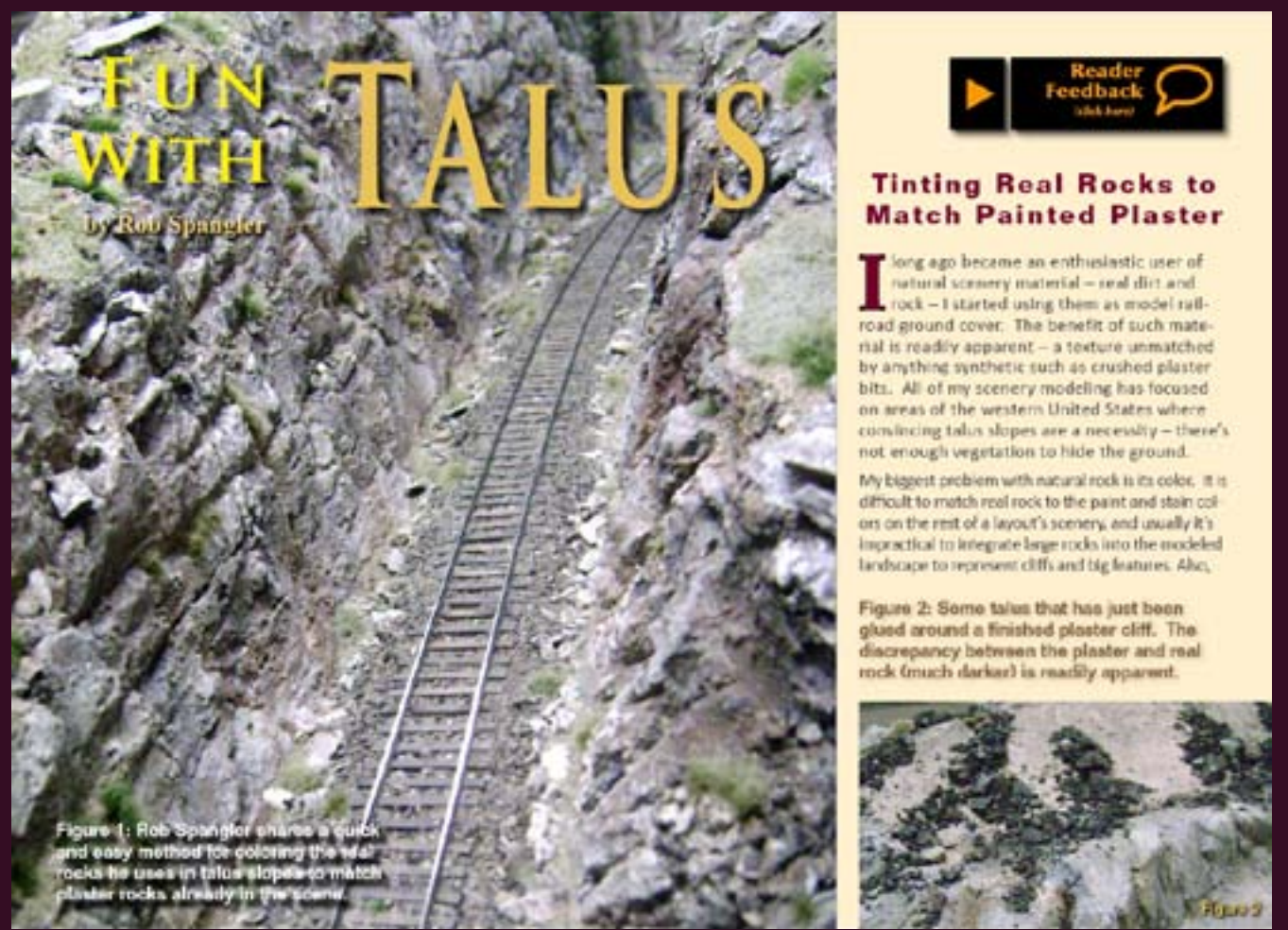

**Reader Feedback** click here

**Tinting Real Rocks to Match Painted Plaster**

by Rob Spangler

Long ago became an enthusiastic user of natural scenery material — real dirt and rock — I started using them as model railroad ground cover. The benefit of such material is readily apparent — a texture unmatched by anything synthetic such as crushed plaster bits. All of my scenery modeling has focused on areas of the western United States where convincing talus slopes are a necessity — there's not enough vegetation to hide the ground. My biggest problem with natural rock is its color. It is difficult to match real rock to the paint and stain colors on the rest of a layout's scenery, and usually it's impractical to integrate large rocks into the modeled landscape to represent cliffs and big features. Also,

Figure 1: Rob Spangler shares a quick and easy method for coloring the real rocks he uses in talus slopes to match plaster rocks already in the scenery.

Figure 2: Some talus that has just been glued around a finished plaster cliff. The discrepancy between the plaster and real rock (much darker) is readily apparent.

**Model Railroad Hobbyist magazine**  
 The planet's most popular model railroading media-zine!

Release date:  
 Jan 3, 2010

Subscribe to **Model Railroad Hobbyist magazine™**  
 click here



# Model Railroad Hobbyist newsletter™

November 2010



**Reader Feedback**  
(click here)



*The Old Yardmaster*



## The latest model railroad products news and events

**A**ccurail ([www accurail.com](http://www accurail.com)) has a 50-foot exterior post modern steel boxcar decorated for Montana Rail Link. The **HO scale** kit is available now. In December Accurail will release a 3-bay ACF covered hopper in three number sets decorated for ACFX Lease.

**L**aserKit, a division of American Model Builders ([www.laserkit.com](http://www.laserkit.com)) has flush fitting replacement windows for Walthers Proto 2000 series **HO**



**scale** General Electric U28/U30 diesel locomotives. The glazing is precision laser-cut from pre-masked clear acrylic. AMB item #349 is available from hobby dealers.

**A**thearn ([www.athearn.com](http://www.athearn.com)) has announced several items including both reruns with new road names and new items from new tooling. Leading off the brand new category is an **HO scale** 65-foot 6-inch mill gondola that will be initially released for Santa Fe, Bessemer & Lake Erie, Pennsylvania, Erie, Rock Island and Southern Pacific. Among the features of the newly tooled ready-to-run car are positionable ends, a side-mounted brake wheel and factory installed wire grab irons. The model is scheduled for delivery in April 2011 at \$25.98 each or \$35.98 with a cast resin pipe load and different car number. New tooling is also being prepared for a Genesis series **HO scale** 50-foot GATC 20,000 gallon type 30 acid tank car with an SHN designation.

The Athearn team is working toward a September 2011 delivery date for UP and SP versions of General Electric's giant 5000 horsepower U50 diesel locomotive. Serving as GE's answer to the 1960s horsepower race, the U50B was essentially two U25B power plants on a single 83-foot chassis. The powerful locomotive used four sets of two-axle AAR-B trucks salvaged from GE's earlier turbine project. The HO scale DCC-ready model will be released in Athearn's standard (non-Genesis) ready-to-run line.

New tooling is being prepared for **N scale** models of GATC 2600 Airslide two-car sets. The 34-foot cars are permanently connected by a drawbar. Joining the new N scale models in an April debut are **HO scale** cars from existing tooling. Burlington Northern, GATX (pale blue), Missouri Pacific and Soo Line will be released in both scales.

Athearn will begin delivery next July of a Genesis series SD70M-2 painted and lettered for CN, Norfolk Southern and Florida East Coast along with the visually identical SD70ACe decorated in Union Pacific's stylized Western Pacific Heritage scheme. Identifying features of the diesels include a full-height nose door, rectangular windshields, dynamic brake equipment mounted at the rear of the long hood and the familiar, large flared radiators with twin fans. The **HO scale** models will be available with and without Tsunami® Sound.

Reruns and new names include Athearn's tried and true standard-line F7A diesel decorated for Baltimore & Ohio, Great Northern (passenger scheme), ATSF (warbonnet), Southern Pacific (bloody nose freight) and SP (Daylight), plus a new scheme: Amtrak's 10th Anniversary Surfliner.





Three 5-packs of **N scale** Coalporters are coming from Athearn in April for BNSF(new logo), BNSF(green), CSX (silver), and UP/CMO. The packs of five cars will have a suggested retail price of \$84.98.

**Anvil Mountain Models** ([www.anvilmountainmodels.com](http://www.anvilmountainmodels.com)), a new company founded by Lowell Ross, has introduced a laser-cut slot-and-tab construction kit for an **HO scale** model of the famous Walsh/Duncan house (above) located in Animas Forks, Colorado. Features include bay windows with positionable sash, detailed interior walls, interior stairs, four-panel doors and architecturally correct trim details. A detailed outhouse, custom assembly jigs and a photo CD with prototype detail images are also included in the HO scale kit that sells for \$74.95. An **O scale** version is expected to follow soon.

**N**ew road names coming in late December for **Bachmann's** Spectrum series 2-truck **G scale** Climax include Clear Lake Lumber, Elk River Coal & Lumber, Climax Demonstrator #3, Bayside Lumber Co. #4 and two versions of a painted but unlettered locomotive. All will be equipped with DCC and sound. A 2-6-0 with standard DC is also scheduled for arrival before the end of the year. In addition to a painted unlettered version, the **G scale** Mogul will be decorated for Midwest Quarry & Mining Co., Colorado Mining Company and Yellow Pine Lumber Co. ([www.bachmanntrains.com](http://www.bachmanntrains.com)).

**W**e haven't seen any photos yet but Art Fahie and Jim Mooney of **Bar Mills Scale Models** report they are hard at work on a special structure kit for release just before Christmas. Called Nemchik's Scrap & Salvage, the **HO scale** craftsman kit will feature five buildings that can be positioned in a variety of ways to meet available space. Included is a small brick factory that will be Bar Mills' first resin building. Visit [www.barmillmodels.com](http://www.barmillmodels.com).

**BLMA** ([www.blmamodels.com](http://www.blmamodels.com)) has introduced precision **N scale** trucks with 33-inch machined metal wheelsets for both 70-ton and 100-ton versions of American Steel Foundry (ASF) Ride Control freight car trucks. Scaled from prototype blueprints, the new trucks have the correct profile on both the front and back of the injection molded plastic sideframe. BLMA's trucks have an MSRP of \$5.95 a pair and are also available in bulk pricing to qualified OEM customers.



#### SCALE COLOR KEY:

**Z scale news**

**S scale news**

**N scale news**

**O scale news**

**HO scale news**

**G scale news**



**We try to make it really easy for you to leave us feedback. Please click the button above and tell us how we're doing: good, bad, or otherwise.**



**Classic Metal Works** ([www.classicmetalworks.com](http://www.classicmetalworks.com)) will begin delivery later this month on **HO** and **N scale** models of a 1953 Ford Country Squire station wagon.

The next production run of **N scale** Maxi-Stack IV cars from **Deluxe Innovations** ([www.deluxeinnovations.com](http://www.deluxeinnovations.com)) will be released with four road numbers for each road name. The 3-unit articulated car sets have die-cast metal wells and come ready-to-run with BLMA trucks with metal wheels and body-mounted knuckle couplers. The end trucks will be the 70-ton version with 100-ton trucks used in the intermediate positions. The car sets will be priced at \$74.95 – five dollars more than the originally announced price due to the upgraded BLMA trucks. Road names will include the early yellow version of TTX with white conspicuity stripes, and BNSF in the brown circle-cross scheme. Delivery is anticipated early next summer.

In other product developments, DeLuxe Innovations has moved production of its deep-rib woodchip gondolas to a new overseas factory. The initial release from the new source will be for single, double and triple packs decorated for Union Pacific and Milwaukee Road.

**ExactRail** ([www.exactrail.com](http://www.exactrail.com)) has released its Signature Series **HO scale** Pullman Standard 50-foot Southern waffle boxcar with Hennessy door openers. The Signature Series HO scale ready-to-run model features Kadee #58 couplers and Barber 70-ton S-2 trucks with 33-inch machined wheels.

Also new from ExactRail are five new road names for its **HO scale** PS-2CD 4427 covered hopper including TLDX-Bartlett & Company Grain, CNW, GELX-Garvey Elevators and B&M, plus an ATSF version equipped with a Morton running board. The Platinum series car comes with ASF 100-ton Ride Control trucks with 33-inch machined wheels.

**InterMountain Railway Company** ([www.intermountain-railway.com](http://www.intermountain-railway.com)) is taking reservations for early summer delivery for AB sets of EMD FT diesel locomotives. The ready-to-run models will be available in both **HO** and **N scales** decorated for CB&Q, Erie, Southern (black scheme), Western Pacific (silver & orange), Seaboard (green & yellow) and Rock Island. The N scale versions will be DCC-ready while the HO scale models will be available for standard DC operation or DCC with optional Soundtraxx Tsunami® Sound.

**Kadee Quality Products** ([www.kadee.com](http://www.kadee.com)) has introduced a redesigned AAR type E coupler for **G scale** modelers. The new design features a hidden



knuckle spring and is said to be stronger yet fully compatible with earlier Kadee large scale couplers.

For **HO** modelers, **Kadee** is preparing two cars delivery in December including an MKT 40-foot boxcar with 6-foot door painted in the 1954 as-delivered oxide red, and a DTI 50-foot boxcar with a 9-foot door and functioning cushion underframe. Both of the ready-to-run cars will have Kadee's new two-piece self-centering trucks.

**KatoUSA** ([www.katousa.com](http://www.katousa.com)) reports that its GG1 Electric locomotives will be available in late December. The ready to operate **N scale** models will be painted black and lettered for Amtrak and Penn Central. The standard DC models have a suggested price of \$145 each.

**Microscale** ([www.microscale.com](http://www.microscale.com)) has issued revised **HO scale** decal sets for Union Pacific turbine and freight cab unit locomotives in common usage from 1950 to 1970. Also new are **HO** and **N scale** indicator numbers for UP steam locomotives in both black-on-white and white-on-black sets.

**Micro-Trains** ([www.micro-trains.com](http://www.micro-trains.com)) is working on an **N scale** 3-car runner pack decorated for Ringling Bros and Barnum & Bailey. The circus cars are scheduled for delivery in April 2011.



**P**recision Scale Company ([www.precisionscaleco.com](http://www.precisionscaleco.com)) plans to import an **HO scale** brass C&NW 4-6-2 streamlined class ES Pacific decorated in the famous yellow and green livery with Chicago & North Western on the tender. Information about reserving this limited edition model is available at Precision's web site.

**J**immy Deignan, who launched **Railroad Kits** ([www.railroadkits.com](http://www.railroadkits.com)) with an easy-to-build **HO scale** laser kit called Dannen Feeds, continues to increase his selection of detailed structure kits through expansion and acquisition. In 2008 Jimmy purchased Country Road Kits from Paul Turner and acquired White River Structures and Southcoast Scale Models in 2009. Earlier this year Jimmy, who is a founding partner in the Craftsman Structure Show, bought the manufacturing rights, molds and masters to several Downtown Deco kits. Jimmy's most recent acquisition is the impressive line of twenty Hydrocal structure kits created by Ed Fulasz. The kits will be marketed as the Ed Fulasz Series by Railroad Kits. For a look at what is currently available visit the address above.

**U**ndecorated **HO scale** car kits currently available direct from Red Caboose include 42-foot flat car with fish belly side sills, type 103W 10,000 gallon welded tank car, three versions of a PFE class R-30-12 wood refrigerator car and several versions of a 1937 AAR boxcar. Visit [www.red-caboose.com](http://www.red-caboose.com) for ordering details.

**S**idetrack Laser ([www.sidetracklaser.com](http://www.sidetracklaser.com)) has released a kit for a Coal Platform/Ramp, the first in a group of seven **On30/On3** lineside structures named the Desperation Pass series. A preproduction sample of the model was previewed at the recent National Narrow Gauge Convention in St. Louis. Future structures in the series scheduled for release over the next several months include a Depot, Outhouse, Water Tower, Engine House, a Yard Structure and Foreman's Cabin.

**I**n February 2011, **Trainworx** ([www.train-worx.com](http://www.train-worx.com)) will begin delivering **N scale** ready-to-run models for all-steel drop-bottom general purpose gondolas decorated for Illinois Central Gulf, Missouri Pacific, Utah Coal Route and Minneapolis & St. Louis.

**E**arly reservations are suggested for a special limited run of EMD low-nose GP20 diesels **Walthers** ([www.walthers.com](http://www.walthers.com)) with delivery in March. The **HO scale** Proto series ready to operate models will be released in four road names with road specific details for each including Santa Fe (with ATSF-style automatic train control box), New York Central (side mounted bell, Sinclair

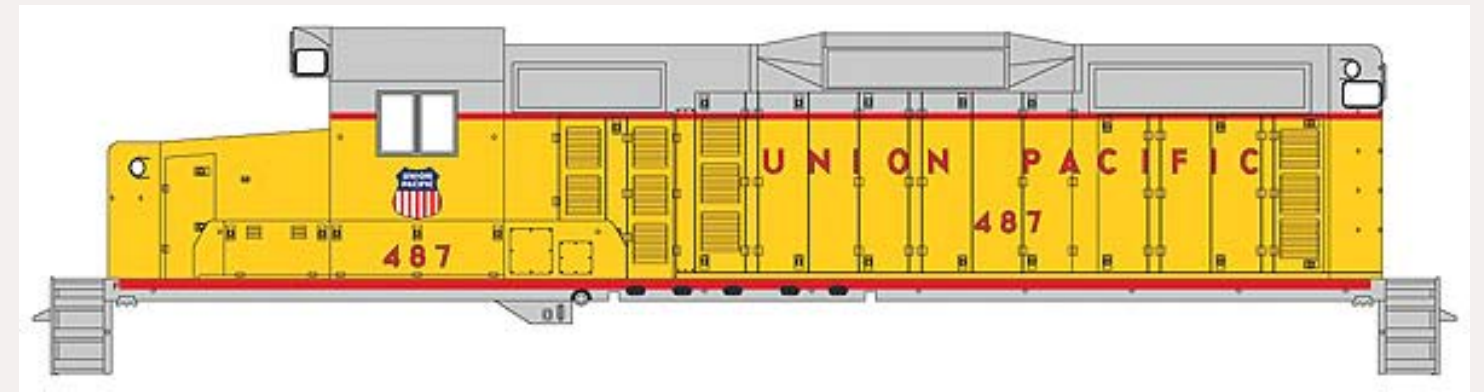

radio antenna, ATS motor generator, ATS shoe on journal bearing, Leslie S-2M airhorn), Conrail (side mounted bell, paper air filter box, Sinclair radio antenna, twin exhaust stack manifold, Leslie S-3L airhorn, no dynamic brakes) and Union Pacific, as seen above with dynamic brakes, winterization hatch, small non-operating beacon, air filter on left cab side, and a raised Leslie S-3L airhorn. An undecorated model will also be offered and will hopefully include all of the detail options listed above. Two numbers will be available for each of the decorated locomotives in both standard DC and with sound and DCC.

Maintenance of Way fans can look forward to a series of specially decorated AAR 53-foot flat cars coming from Walthers in April. Road names for the Platinum series flats will include ATSF, CP, PRR, BN and UP plus an unlettered car in MOW gray.

**W**estern Scale Models ([www.westernscalemodels.com](http://www.westernscalemodels.com)) has a new 1:20.3 scale kit for a Four Block Log Carriage modeled after a prototype carriage built in 1926 at the McLean Sawmill in Port Alberni, Vancouver Island, British Columbia. The kit includes more than 150 white-metal castings. The finished model is a worthy partner to WSM's previously released Double Circular Saw (see Old Yardmaster, December 2009). In order to more fully enjoy his retirement, Bill Gustafson, owner of Western Scale Models, will discontinue the production of **O scale** kits after January 31, 2011. Bill plans to continue developing and producing 1:20.3 scale kits as well as his line of books.

**W**oodland Scenics ([www.woodlandscenics.com](http://www.woodlandscenics.com)) continues to expand its popular AutoScenes® series of **HO** and **N scale** vehicle vignettes. Intro dates have not been announced yet but we understand a nicely detailed bulldozer with an operator will be available





soon along with a couple of farmers loading produce into a vintage 1950s pickup.

**W**ith technical assistance from members of the Pennsylvania Railroad Historical & Technical Society, **WrightTRAK** has developed a new cast resin kit for an HO scale PRR X29D boxcar. The kit includes a one-piece body and a separate underframe. Other components include Tichy ladders and brake equipment, Kadee brake wheel and running board and Bowser PRR trucks.

Coming next from WrightTrak is a Seaboard Air Line V9 ventilated boxcar with Andrew trucks. Also on the horizon for WrightTRAK is an **HO scale** resin kit for an MP/KO&G/Texas & Pacific cupola-style steel caboose as built by International Car Company. If 100 pre-orders are booked work will begin on developing the masters for the HO scale resin kit which will be priced at \$58.95 plus \$7.50 shipping and handling per order. If sufficient orders are not received, the project will be cancelled. To make a reservation visit [www.wrighttrak.com](http://www.wrighttrak.com).

#### INDUSTRY NEWS

**Hillside, New Jersey:** Atlas Model Railroad Company has issued a consumer report that indicates an incompatibility between the new Atlas HO Genset Locomotive and the MRC (Model Rectifier Corp) Tech 6 Power Pack could result in circuit board burn out. Atlas strongly recommends that customers who have purchased this locomotive to not operate it with this specific MRC power pack. Atlas said it would inform customers of more complete findings as soon as possible.

#### DISCLAIMER

The opinions expressed in this column are those of the writer and do not necessarily reflect the opinion of Model Railroad Hobbyist or its sponsors. Every effort is made to provide our readers with accurate and responsible news and information, however, neither Model Railroad Hobbyist or the writer of this column can be held responsible for any inaccuracies or typographical errors that may inadvertently appear in this publication.

#### Briefly noted at press time...

Kato ([www.katousa.com](http://www.katousa.com)) also announced their upcoming **N scale** Union Pacific "City of Los Angeles" passenger train. Modeling the mid-1950s version of this luxury streamliner, Kato is releasing two E9A's and two E9B's as well as a set of 11 different passenger cars from this train, including Storage Mail, Baggage-Dormitory, two 44 Seat Coaches, a Dome Chair, Lounge, 10-6 Sleeper, Dome Diner, 5 Double Bedroom-Lounge-Sleeper, 11 Double Bedroom, and the Dome-Lounge Observation, complete with its illuminated tail signboard. Locomotives will be \$95 each, with the 11 car set retailing for \$270. Delivery is expected in Mid-2011.

#### About our news and events editor



**Richard Bale** writes our news column under the byline of *The Old Yardmaster*. He has been writing about the model railroad trade for various hobby publications since the 1960s.

He enjoys building models, particularly structures, some of which appeared in the June 2006 issue of *Model Railroader* magazine.



When you see this symbol, it means:

**"Click here to learn more!"**

Every click tells advertisers an ad in MRH is a wise investment ...



**Send us your product announcements!**

If you are a hobby manufacturer with a product you want to announce, just [click here](#) and submit your announcement to us!





## Selected Events

### November 2010

CANADA, BRITISH COLUMBIA, BURNABY, Nov 13-14, British Columbia RPM Meet in association with TRAINS 2010, Cameron Centre (across from Lougheed Mall), 9523 Cameron Street. For information send e-mail to [ahutchinson.mudbay@gmail.com](mailto:ahutchinson.mudbay@gmail.com). For information about TRAINS 2010 visit [www.bctrains.org](http://www.bctrains.org).

CALIFORNIA, LOS ANGELES, Nov 6-14, Pasadena Model Railroad Club Fall Event, 5458 Alhambra Avenue. Info at [www.pmrrc.org](http://www.pmrrc.org).

CALIFORNIA, POMONA, Nov 6-7, Southwest Garden Railroad Show, Fairplex, 1101 West McKinley Avenue. Info at [www.swgrs.com](http://www.swgrs.com).

KANSAS, BENTON, Nov 6-7, Mid-Continent Prototype Modelers Meet at Benton Lions Community Center, 150 S. Main Street. Info at [www.midcontinentprototypemodelers.org](http://www.midcontinentprototypemodelers.org).

MASSACHUSETTS, MANSFIELD, Nov 10-14, Craftsman Structure Show, Mansfield Holiday Inn. Info at [www.css2010.com](http://www.css2010.com).

NEW YORK, SYRACUSE, Nov 6-7, Great New York State Model Train Fair sponsored by Central New York Chapter, National Railway Historical Society, New York State Fairgrounds. Info at [www.modeltrainfair.com](http://www.modeltrainfair.com).

OHIO, DAYTON, Nov 6-7, NMRA Division 3 Train Show, Hara Arena. Visit [www.daytontrainshow.com](http://www.daytontrainshow.com) for information including map to arena.

OREGON, HILLSBORO, Nov 6, NMRA Pacific Northwest Region, Fall Meet, Laurel Community Church, 30640 SW Laurel Road. Info at [www.2dpnr.org](http://www.2dpnr.org).

PENNSYLVANIA, ALLENTOWN, Nov 13-14, Annual First Frost Train Show, Fairgrounds Agricultural Hall, 302 North 17th St. Info at [www.allentowntrainmeet.com](http://www.allentowntrainmeet.com).

PENNSYLVANIA, MONACA, Nov 21, Beaver County Fall Model Train Show, Center Stage, 1495 Brodhead Road. Info at [www.bcmrr.railfan.net](http://www.bcmrr.railfan.net).

WISCONSIN, MILWAUKEE, Nov 13-14, Trainfest, Wisconsin Exposition Center at State Fair Park. Info at [www.trainfest.com](http://www.trainfest.com).

### December 2010

OKLAHOMA, OKLAHOMA CITY, December 4-5, Annual Oklahoma City Train Show, OK State Fairgrounds, Travel and Transportation Building, 1313 W. Britton Road. Info at [www.okctrainshow.com](http://www.okctrainshow.com).

### Future 2011

CALIFORNIA, MONROVIA, Feb 17-19, Sn3 Symposium, Double Tree Hotel, 924 W. Huntington Drive. Info at [www.sn3-2011.com](http://www.sn3-2011.com).

CALIFORNIA, SACRAMENTO, July 3-9, combined conventions of NMRA National and National Association of S Gaugers, Sheraton Grand Hotel. Info at [www.x2011west.org](http://www.x2011west.org).

CALIFORNIA, SACRAMENTO, July 7-9, National Train Show, Sacramento Convention Center. Info at [www.x2011west.org/trainshow.html](http://www.x2011west.org/trainshow.html).

FLORIDA, COCOA BEACH, Jan 6-8, Prototype Rails.

FLORIDA, DELAND, Jan 8-9, 34th Florida Rail Fair, Volusia County Fairgrounds. Info at [www.gserr.com](http://www.gserr.com).

MASSACHUSETTS, WEST SPRINGFIELD, Jan 29-30, Amherst Railroad Society Annual Hobby Show, Eastern States Exposition Fairgrounds. Info at [www.railroadhobbyshow.com](http://www.railroadhobbyshow.com).

NORTH CAROLINA, HICKORY, Sep 7-10, National Narrow Gauge Convention.

OHIO, MARION, May 5-8, 2011, 2nd Annual Central Ohio Prototype Modelers Meet, Marion Union Station, Info at [www.facebook.com/pages/manage/#!/pages/Central-Ohio-Prototype-Modelers-Meet/326645470797](http://www.facebook.com/pages/manage/#!/pages/Central-Ohio-Prototype-Modelers-Meet/326645470797).

TEXAS, PLANO, Jan 15-16, Dallas Area Train Show. ■





HO SCALE

**NEW FROM "BAR MILLS"!**



A COMPLETE DIORAMA  
WITH 4+ STRUCTURES,  
CASTINGS, SIGNS, & MORE!  
LIMITED TO 375 KITS!

**NEMCHIK**

**SCRAP &  
SALVAGE**  
\$225.00

+ \$10 DELIVERY WITHIN THE U.S.

SHIPPING DEC. 10TH FOR CHRISTMAS DELIVERY!

[www.barmillsmodels.com](http://www.barmillsmodels.com)

## Get Better Sound from your Locomotives

Can't get good sound from your sound decoder? Give our speakers a test drive with your ears.

We offer high  
quality  
speakers to  
enhance your  
model railroad  
experience



**RAILMASTER HOBBIES**  
**LAKEWOOD, CA 90713**  
**562-461-8825**

[WWW.RAILMASTERHOBBIES.COM](http://WWW.RAILMASTERHOBBIES.COM)

Bass Reflex  
Speakers



High Bass  
Speakers



Our newest speaker only 14 x 36 x 10 mm  
Self-contained ported speaker



Dealer inquiries welcomed



# MRH

## Questions, Answers and Tips



### QUESTIONS AND ANSWERS

**Q: Some of my freight cars have a small black square with a yellow dot in the middle. I don't see those on freight cars now. What does it mean?**

**A:** The stencils were used in the late 1970s. The Southern Wheel Company had produced a run of wheels suspected of failing in service and causing serious derailments. Starting on March 31, 1978, the FRA required railroads to inspect all cars of 70 tons or less which used 33" wheels. Cars that had the suspect wheels were stenciled with a 12" square black panel with a 6" centered white dot. Cars with approved wheels had a yellow dot in the same size panel.

Cars carrying white dots could not be used in trains carrying hazardous materials and after Dec. 31, 1978, the wheel sets had to be removed and replaced with a safe set. Cars built between March and December of 1978 had the dots applied by the makers. The inspection routine wasn't perfect and it wasn't unusual to see yellow dots on all sorts of cars. The yellow dots could still be seen on equipment through the 1980s and later. See figure 1.

— Joe Brugger

**Q: My hobby dealer wants to sell me a DCC decoder he says will simulate Rule 17 operations. What is Rule 17 and why should I care?**

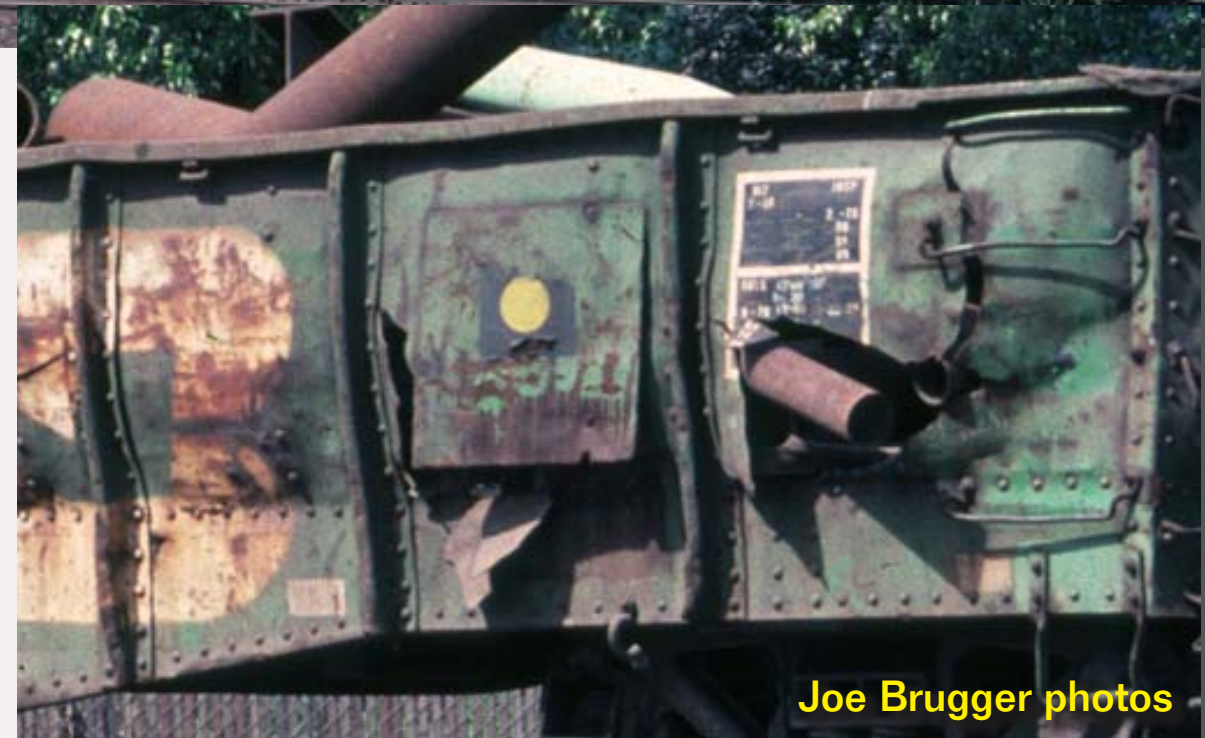

Joe Brugger photos

**A:** The MRH research staff looked in three rule books -- Union Pacific's 1954 and 1972 editions, and the Uniform Code of Operating Rules from June 2, 1968, and Rule 17 governs when and how locomotive headlights are to be used.

There are a couple exceptions and much explanation, but in a nutshell, the rule requires leading engines to display a bright headlight both day and night. It must be extinguished when a train has stopped clear of a main track to meet a train or is standing to meet a train at the end of double track or a junction.

Rule S-17 (which the UP doesn't apply in ABS or CTC territory) says when the

**Figure 1: The yellow dot on the 12" black square signifies this gondola has approved wheels.**

headlight on a train in a siding is burning, an opposing train must approach prepared to stop before passing headlight, and if the head end of train is clear of main track, may proceed at restricted speed to the point where main track may be obstructed.

Rule 17-B, in part, requires dimming headlights in yards where yard engines are being used or in stations where switching is being done; when standing on the main track close behind another train; when standing on the main track awaiting the arrival of



another train assigned to take the siding, but not until the approaching train dims its own headlight; and approaching locations where train orders or messages are to be handed up.

Railroad rule books can be found online or at swap meets and usually cost \$5 to \$10, depending on age and condition.

— Joe Brugger

**Q: A guy at work gave me a box of HO scale track. But the rails are a golden color instead of silver. Is this OK to use?**

**A:** It sounds like you have brass rail in your track. Brass, while a good

conductor oxidizes quickly and brass oxide is an insulator. This is one of the main reasons for the shift from brass rail to nickel-silver. In the days of brass rail, an op session was usually preceded by a very thorough cleaning of the rails to remove the oxide built up since the last session. I'd recommend not using this for running track. However, you might consider using it for scenery – that is, non-operational track.

Some older flex-track with brass rail used fiber ties. If this is what you have pull the brass rails out of the ties. Those fiber ties are bad news!

— Charlie Comstock

**Q: I've heard a lot about timetable and train order operations lately. Does this type of operation really have advantages and what do I need to do to get started?**

**A:** In many styles of prototypical operation, the authority to move trains comes from the dispatcher. Crews obey the dispatcher's dictates. Under CTC crews merely follow signals. Green means go, red means stop (well it's a bit more complex than that). The Dispatcher controls the main line turn-outs so crews don't need to know where they're going.

With a system such as track warrants the dispatcher dictates a warrant to the

crews telling them how far they can go and which track they're authorized to be on. Signal systems are not required and crews need to think a bit more.

With TT&TO crews need to carefully examine the timetable and any train orders they have. Then the crew decides if it's safe for them to proceed to the next station – without encountering another, higher priority train en route.

TT&TO is one of the older train control systems. It was developed long before there was reliable radio communications or telephones! It depends on a complex set of rules that dictate when trains may move. For a real life crew operating under TT&TO knowing and



**DESPERATION PASS**  
Coming in 2010...2011.

A series of 7 On30 Kits:

Available Now: Depot, Outhouse & Coal Platform/Ramp.

Available Soon: Engine House, Water Tower, Foreman's Shack & Utility/Yard Building



**Grass Valley Feed & Seed**

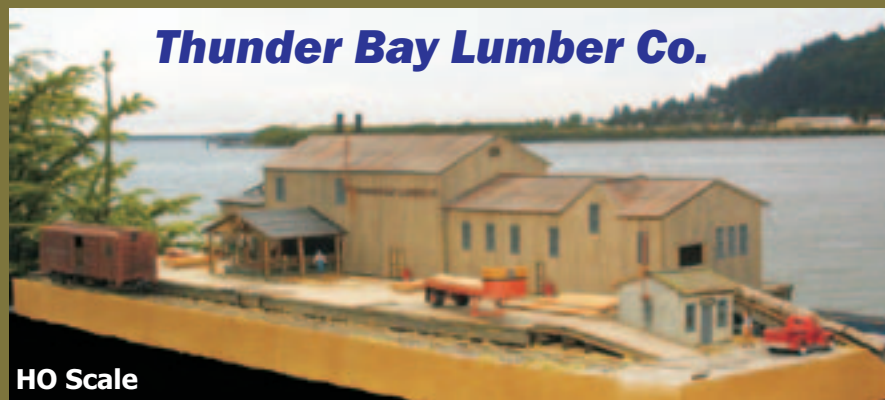

**Thunder Bay Lumber Co.**



**EMD Diesel Shop**



**Armstrong Industries**



**Camp12 Engine House**



**503-449-5361**  
**Newberg, Oregon 97132**

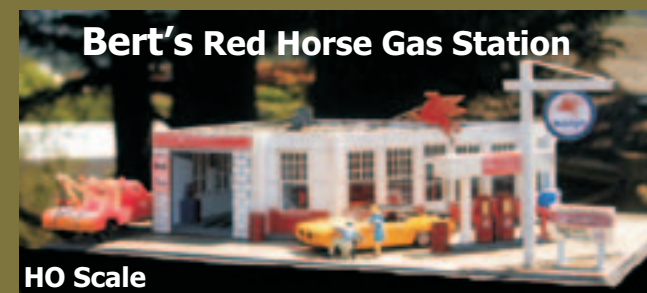

**Bert's Red Horse Gas Station**





# MODEL TRAINS WEATHERED

.COM

THE WORLD'S ONLY WEATHERER'S NETWORK FORUM

STOP BY TODAY AND INQUIRE ABOUT MEMBERSHIP

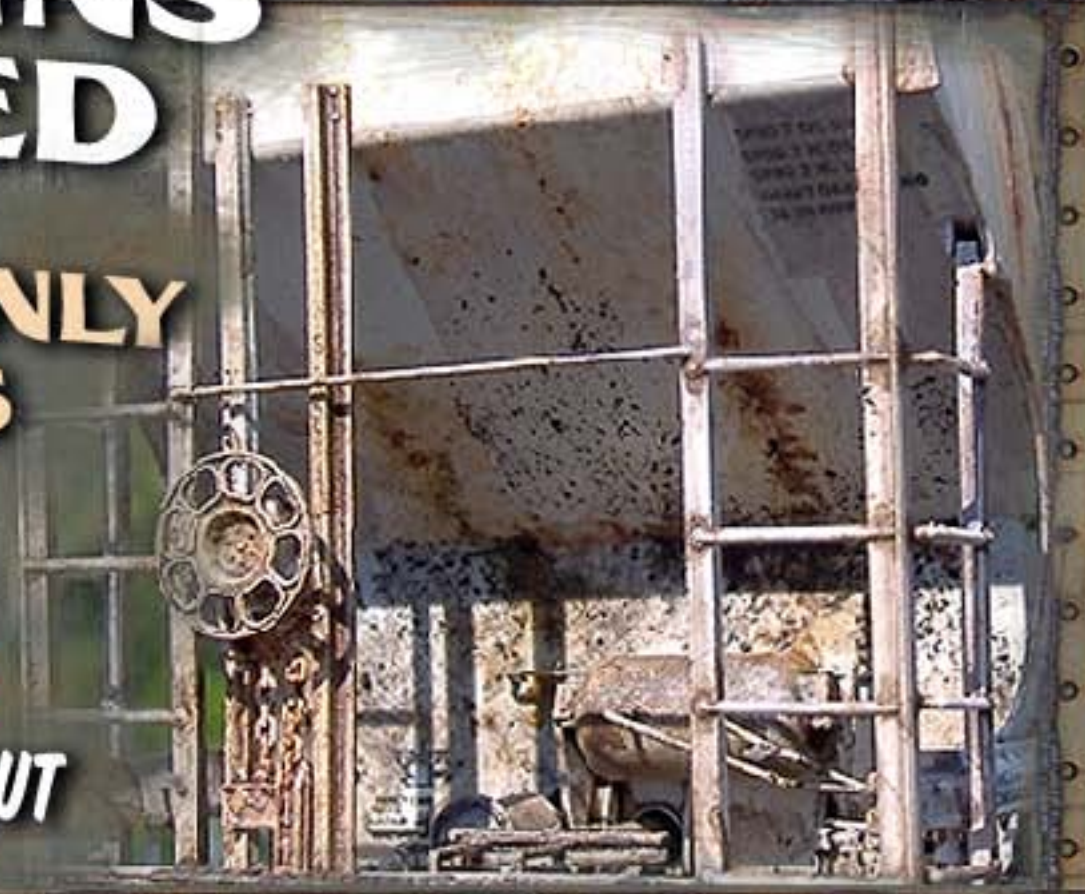

understanding the rulebook was a matter of life and death.

So why would anyone think something this intense is fun? First, TT&TO will tend to slow down operation. It greatly reduces the tendency of crews to want to rush pell-mell around a layout. The slower pace is more relaxing. And the crews having to make decisions helps them become invested in the ops game. Finally, you'll never discover that you needed to bring a certain type of radio!

The best way to get started with TT&TO operation is to look for layouts that host TT&TO op sessions and attend such a session. If you join the *Operations Special Interest group* – [www.opsig.org](http://www.opsig.org) you'll have access to lists of op sessions.

Before attending it would be a good idea to familiarize yourself with the basic rules used by the TT&TO system. Rules varied from railroad to railroad, but the core set was relatively constant across all railroads. Here are some suggestions for TT&TO information:

**The Gateway Division** of the NMRA - [www.gatewaynmra.org/library.htm](http://www.gatewaynmra.org/library.htm)

**The Ops Roadshow** - this modular layout travels the country providing opportunities for us all to get started in TT&TO operation - [www.railsonwheels.com/ors/opershow.shtml](http://www.railsonwheels.com/ors/opershow.shtml)

**The Operations Special Interest Group** - [www.opsig.org](http://www.opsig.org). Look for opportunities to attend an OpSIG Operations

Weekend in your area, many layouts that participate in these events run with TT&TO.

If you're serious about TT&TO operations then you'll probably want to get a copy of *Rights of Trains* by Peter Josserand. A copy will set you back about \$35 at amazon.com. This is THE authoritative text on operating under timetable/train order authority.

TT&TO can seem complex enough to be scary, but with some patience it can be a lot of fun! Don't worry: There are a LOT of folks out there who are ready and willing to help you get started and answer your questions!

— Jim Duncan

**Q: My friend says it's more expensive to model in N scale than in HO. Is this true? What about other scales?**

**A:** Your friend may be referring to the cost per square foot of a layout. A square foot of N scale layout will contain roughly four times the number of items as a square foot of HO layout. This isn't very important when you're modeling open countryside – fields and weeds are cheap. But in cities, you'll need four times more buildings per square foot in N scale than in HO, and N scale buildings, streets, autos, and people, cost more than 1/4 as much as in HO. So from that point of view your friend is correct.

As far as other scales go, a square foot on O scale layout will need about 1/4



the number of items as in HO. They'll be more expensive but they usually don't cost four times as much.

Keep in mind though, that usually the largest expense with a layout is the space it occupies.

— *Charlie Comstock*



## TIPS

### Get Organized - Cheaply!

I use several "Pill Organizers" to store and organize small items such as, screws, washers, nuts, chains, springs, and detail parts. These boxes have an individual locking lid for each compartment so you can simply open the compartment you want, and tip



out the contents. This works better for me than a tackle box with one lid for all containers, since I don't have to fight gravity to retrieve the small parts with my finger.

These boxes are available in a variety of sizes and configurations new and used at your local Good Will or Salvation Army thrift store. I often pay as little as 10 cents and never more than \$1.00 each. The graphics on the lids never bothered me, but you can remove the printing with steel wool or a plastic compatible stripper.

— *Daniel Kleine*



### GET \$25 PER TIP

We pay \$25 USD for each tip we publish. [So send in your modeling tips to \*Model Railroad Hobbyist\*](#) and we'll get your payment to you upon acceptance.

Just think, for only a few minutes effort, you could fund your next piece of rolling stock – or even pay for an entire train if you send in several tips and we publish them!

If you include any photos with your tip, we pay a bonus of \$10 per photo we use with the tip. ■

# ALPINE — DIVISION — SCALE — MODELS



## Simply the finest in structure kits ...

Made in  
the USA



Click to  
Learn  
more...

[alpinemodels.com](http://alpinemodels.com)



# Model Railroad Hobbyist - HOBBY MARKETPLACE



**Berrett Hill Trains**  
*Custom Layouts and Modules*  
[www.berretthill.com](http://www.berretthill.com)

- Shop built sections delivered and set up. Move your layout whenever you want to.
- Built to any level of completion: bench-work, rails, wiring, or scenery.
- Design for dramatic scenery is our specialty.
- CAD design for precise track placement and grades.
- Wiring for AC, DC, or DCC. All sections mate with universal harness plugs.
- Serving the eastern US.



*See us at the Great Scale Model Train Shows.*



Your ad could be reaching tens of thousands of MRH readers from our Hobby Marketplace pages for a very reasonable cost. Learn the details [HERE](#) . . .



**Want scenery this good on your layout?**

**HAND MADE PRODUCT**  
NO TWO PIECES ARE IDENTICAL!

**RIGHT OUT OF THE BOX!**



**Modeller's Warehouse**  
[www.modellers-warehouse.com.au](http://www.modellers-warehouse.com.au)

## Need help with DCC?

We tailor DCC to your Givens & Druthers

### **DCC** by *Design*

offers service to help you enjoy your layout

Learn more at [www.dccbydesign.com](http://www.dccbydesign.com)

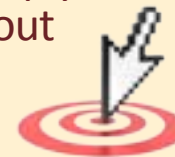

If you are looking for a great way to display your N, HO and O trains, try grooved

### **ShelfTrax**

Attaches to the wall without brackets!

Learn more at [www.shelftrax.com](http://www.shelftrax.com)





# Lessons in Passenger Car Modeling - Part 2

## Modeling Conrail 21

- by M. R. Snell

Photos by the author

**W**e've looked at how an accurate model can be constructed using a ready-to-run car and laser-cut sides, but what can we do when the entire side cannot be replaced? We can once again turn to laser-cut parts, using them to modify only specific areas of an existing model. Such was the case in modeling Conrail 21, a Track Geometry Car.

Figure 34.





Conrail 21 is an ex-Santa Fe open platform heavyweight observation car constructed by Pullman in 1924. Acquired by Conrail in 1983 this car is still in service today as Norfolk Southern 36, assigned to the NS Research Dept. (Figures 34-36).

Due to its riveted-side design, modeling this car creates a unique problem when using laser-cut replacement parts. Certainly detail can be 'etched' into the styrene during the laser process, but detail located above the styrene surface such as rivets cannot be added. Rather than replace the sides wholesale, we'll look at how the sides of an existing heavyweight car can be modified, replacing the non-riveted window section while leaving the riveted portions above and below intact. Once again, a Walthers ready-to-run passenger car, this time a heavyweight observation car, came to the rescue. This car provided not only the uniquely-shaped front (vestibule end) wall and a roof suitable for kitbashing, but it also has the correct carbody – that of an open-ended observation car. To model the second car, Conrail 21, I used a variation of the laser-cut sides. To begin the project, we'll first remove and modify the roof, adding ductwork to form the solid 'bubble-like' rounded roof.



Figure 35: Photo by Chip Syme – M. Snell collection.



Figure 36: Photo by Chip Syme – M. Snell collection.



## STEP 1: Modeling the Roof



Figure 37.

Unlike the prototype which features a roof fully rounded by ductwork on both sides, the Walthers roof is clerestory on one side and only partially rounded by ductwork on the opposite side. Creating the fully rounded roof requires retrofitting additional ductwork onto the Walthers roof. Unfortunately at this time there is no 'drop on' ductwork addition for the Walthers model but with a little cutting and filling, a New England Rail Service Pullman Air Conditioning Duct Kit (#250) can be added, creating the fully rounded roof (Figure 37).



Figure 38.

Prior to installing the New England Rail kit, I found it necessary to remove several obstructions, including the roof vents on the clerestory side and the sloped ends of the molded on ductwork. Using an X-Acto #18 chisel blade, I made cuts vertically in the ductwork slopes. I then joined the vertical cuts with cuts made horizontally along the roof contour to allow removal of the sections which interfere with the ductwork kit.

Once I had removed these sections of the roof, adding the New England Rail ductwork can commence, beginning with the end caps. When I had determined the placement of the end caps, I simply cut the long ductwork casting to fit between the end cap and existing ductwork (between the two end caps installed on the clerestory side), then I cemented it in place (Figure 38).



Figure 39.

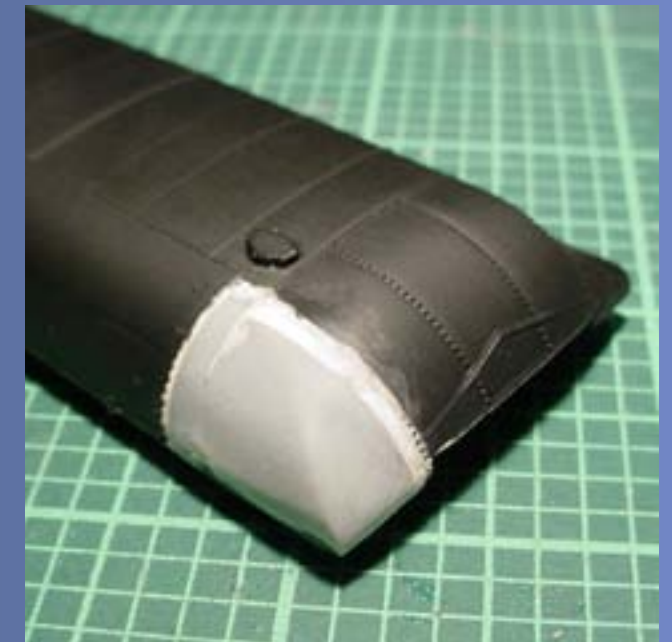

Figure 40.

A problem I encountered when using the New England Rail kits are some large gaps in certain areas, as these kits were designed for use on older Rivarossi models rather than the newer Walthers cars.

While it's possible to fill these gaps with putty, I found a better joint can be created by inserting strip styrene into the gaps, cutting it off even with the contour of the roof and sanding it down until it is even with the roof and end caps. Next I filled joints with putty, sanded them smooth, then primed the roof to see the final result. I filled any remaining gaps and sanded again until I got smooth unnoticeable joints between the original roof and the newly-added ductwork (Figures 39-40).



## STEP 2: Modeling the Sides



Figure 41.

The second major modification to the Walthers model is the car sides which I modified using replacement window strips on both sides. I also added an additional new door and styrene filler panel on the left side of the car.

Unlike Conrail 22, I did not replace the entire side, but only the window strip. This required removing the the car sides and then repeatedly scribing along the top and bottom recesses of the window strip with a #11 blade, cutting deeper with each pass.

Once the top and bottom were cut through, I placed a #17 chisel blade along the door edge and cut through the side by applying gentle downward pressure. I cleaned up any jagged edges with gentle filing, working in lengthwise passes along the car side to prevent gouging or making depressions in the sides (Figure 41).



Figure 42.



Figure 43.

Conrail 21 is a prime example of an older car that has been modified to fit the service it was used in. It has the left side door moved from the vestibule end inward several feet toward the center of the car, leaving the original doorway plated over. Modeling this requires the same changes made by the prototype, cutting in a new door and plating over the existing door with styrene sheet.

To ensure the multiple pieces will line up correctly when completed, I began by laying the new window strip and the car side on a flat surface so the rear edges of both lined up. I drew the new door location onto the side with a sharp pencil then cut it out using both #17 and #18 chisel blades. Once I had cut the new doorway into the car side, I cut out the original door, then reassembled both sides of the car using the laser-cut parts.

I found the most challenging step in reassembling the car to be adding the replacement window strip to the top and bottom of the existing sides and keeping it even with both. I applied a superglue-type cement (equipped with a thin tube-type applicator) from the rear of the sides. I worked to keep the joints clean, and I used the cement with a filling agent to assist in filling minute gaps, saving on puttying later. I tacked the new strip in place in several locations. Once I was satisfied with the fit, I applied a bead of cement along the length of the joints, allowing the cement to flow into the joints and to fill the gaps (Figure 42-43).



### STEP 3: Rebuilding the Side With the Door

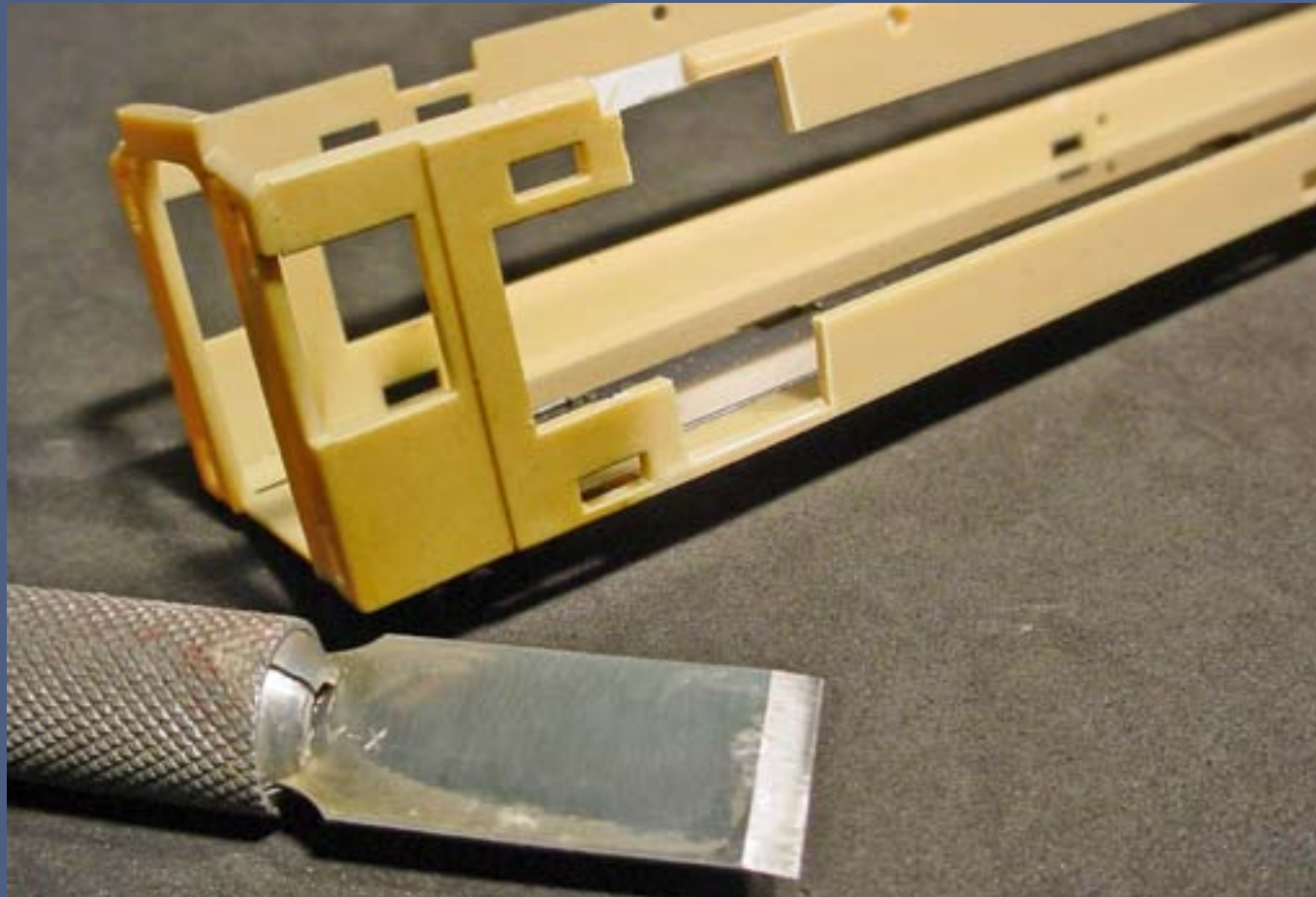

Figure 44.

Rebuilding the side with the new door also presents an additional step – modifying the cage frame of the Walthers car to accept the new door.

Once I had reassembled the side (without the door in place), I temporarily placed it onto the cage frame and traced the new door location onto the cage. I next removed the side and cut the new doorway making it slightly larger than what I traced (Figure 44).

Once I'd cut the new doorway, I completed the installation of the new door by placing it in its correct location cementing two small styrene strips along the inner vertical edges of the door. These act as a guide in placing the door hiding any gap evident from styrene thickness differences between the original sides and new window strip. To complete the modification of the sides, I simply cemented the door in place, applying cement to the joints from the rear of the walls (Figures 45-46).

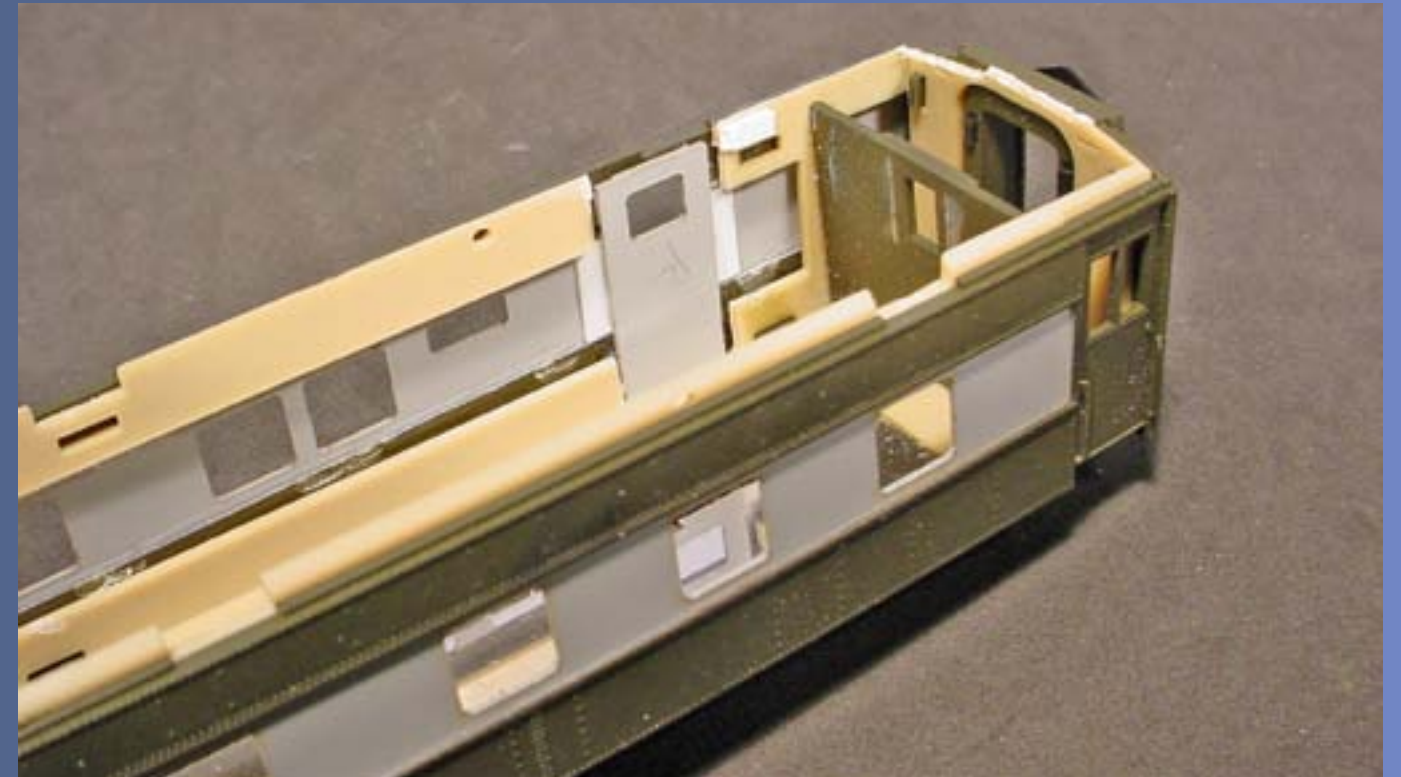

Figure 45.



Figure 46.



## STEP 4: Modeling the Observation Window

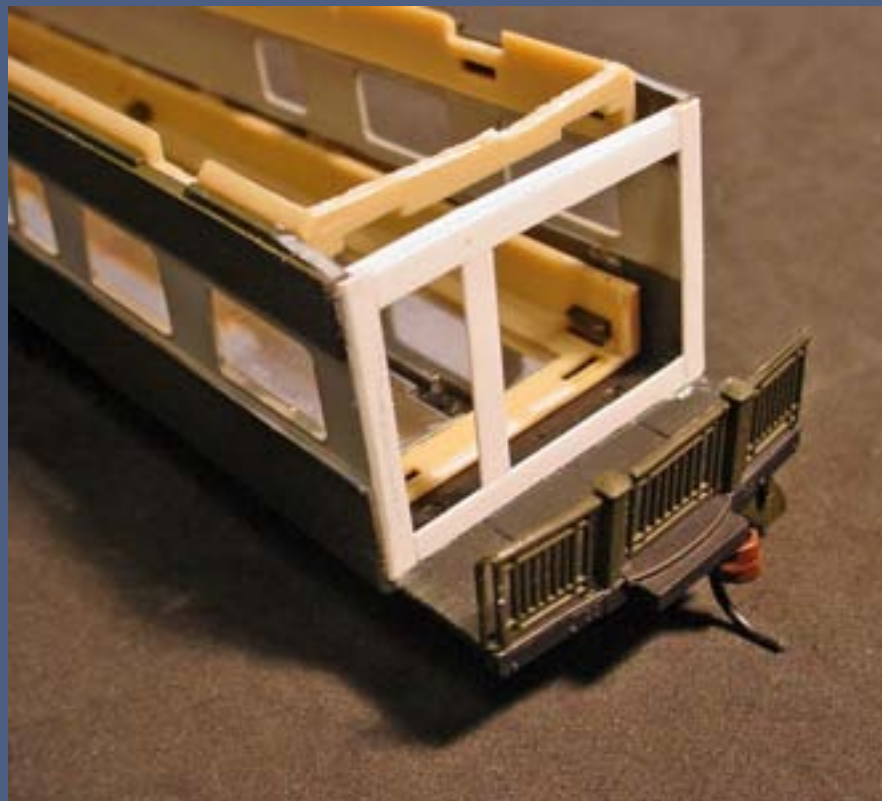

Figure 47.

Looking at the observation end of the car, one noticeable difference between the prototype and model is that the observation window on the prototype is a large unrecessed single pane with a door on the left side. Constructing a new observation window is simple using styrene strip – but once again the cage requires modification to accommodate the changes.

I found three problems with the cage and the new windows. First, there's now an obstruction in the last window. Second, the mounts for the Walthers observation end casting are located right in the middle of the new observation window. And third, the lower lip of the cage end interferes with installing the new longer floor (the floor extends to fit the new interior length).

I cured all 3 problems with a #18 blade. I carved off the lip and cut the center dividers from the end, and cut away the corners of the cage to alleviate any

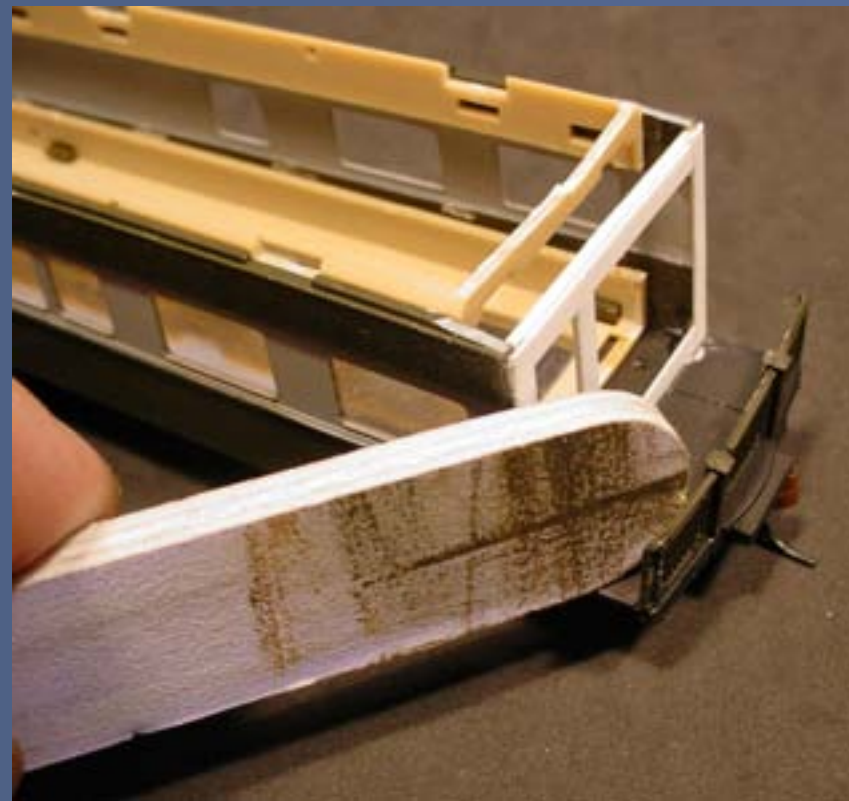

Figure 48.

interference with the side windows. Once these cuts were made, the cage became rather flimsy. However, mounting the sides onto the cage made the assembly sturdy again.

Once I had glued the sides in place, I constructed a new window using 4 lengths of strip styrene, forming a rectangular frame across the rear of the car. I placed another length of strip styrene vertically within the frame, forming a door. To complete the new observation end, I beveled the outer edges slightly with a sanding strip, hiding the thickness of the strip styrene I used to form the new window (Figures 47-49).

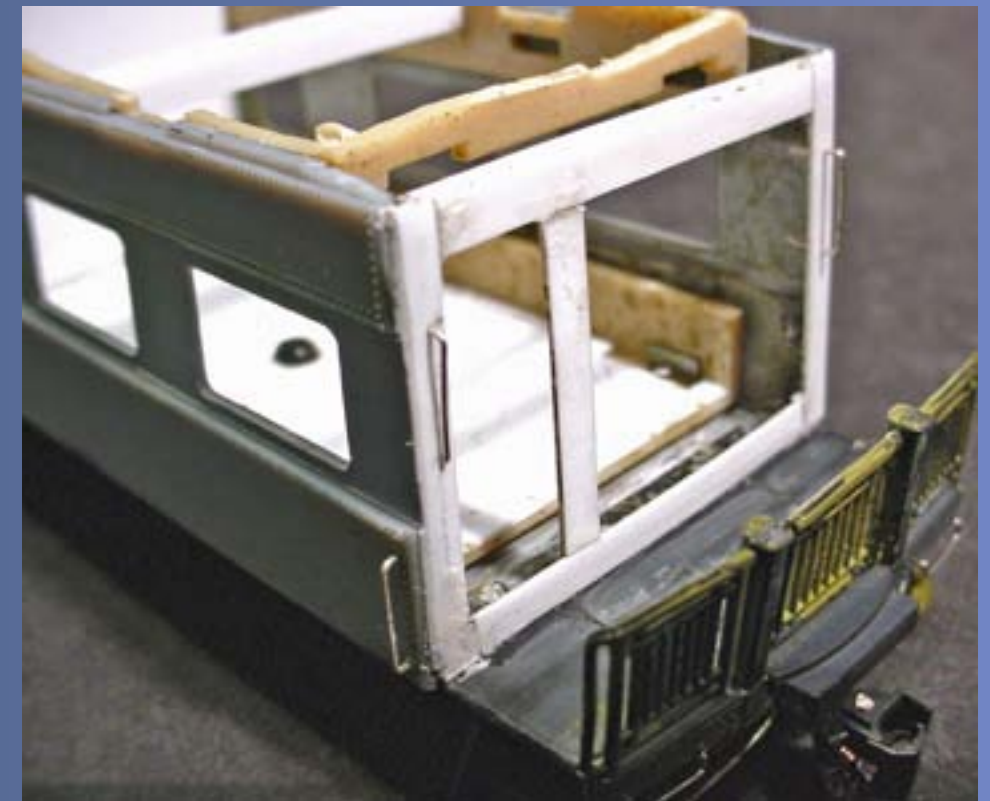

Figure 49.



## STEP 5: Modeling the Underframe

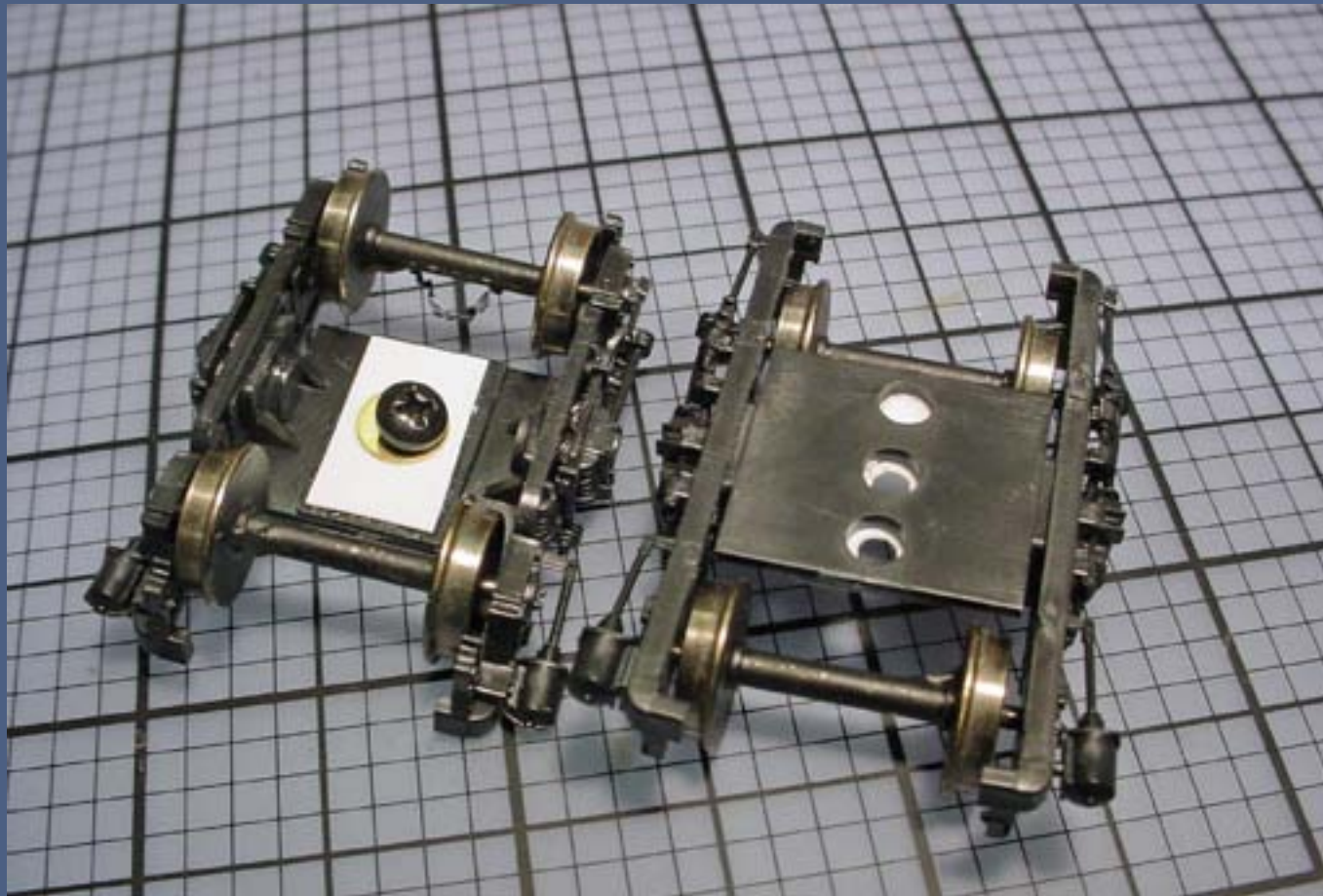

Figure 50.

Similar to Conrail 22, the modernization of this car leaves the underframe quite different from the car's "as-delivered" look. Not only has the railroad replaced appliances, they have also replaced the trucks to meet newer AAR (Association of American Railroads) standards.

I retrofitted this model with Train Station Products #419 Outside Swing Hanger Passenger Trucks. Unlike the Walthers trucks which have a depression in the truck center, the TSP trucks have a flat top mounting which causes the car to ride ridiculously high. In addition to the flat top mounting, they also feature oversized holes which causes the carbody to float when standard screws are used. I easily corrected both problems with a little modification to both the underframe and the TSP trucks.

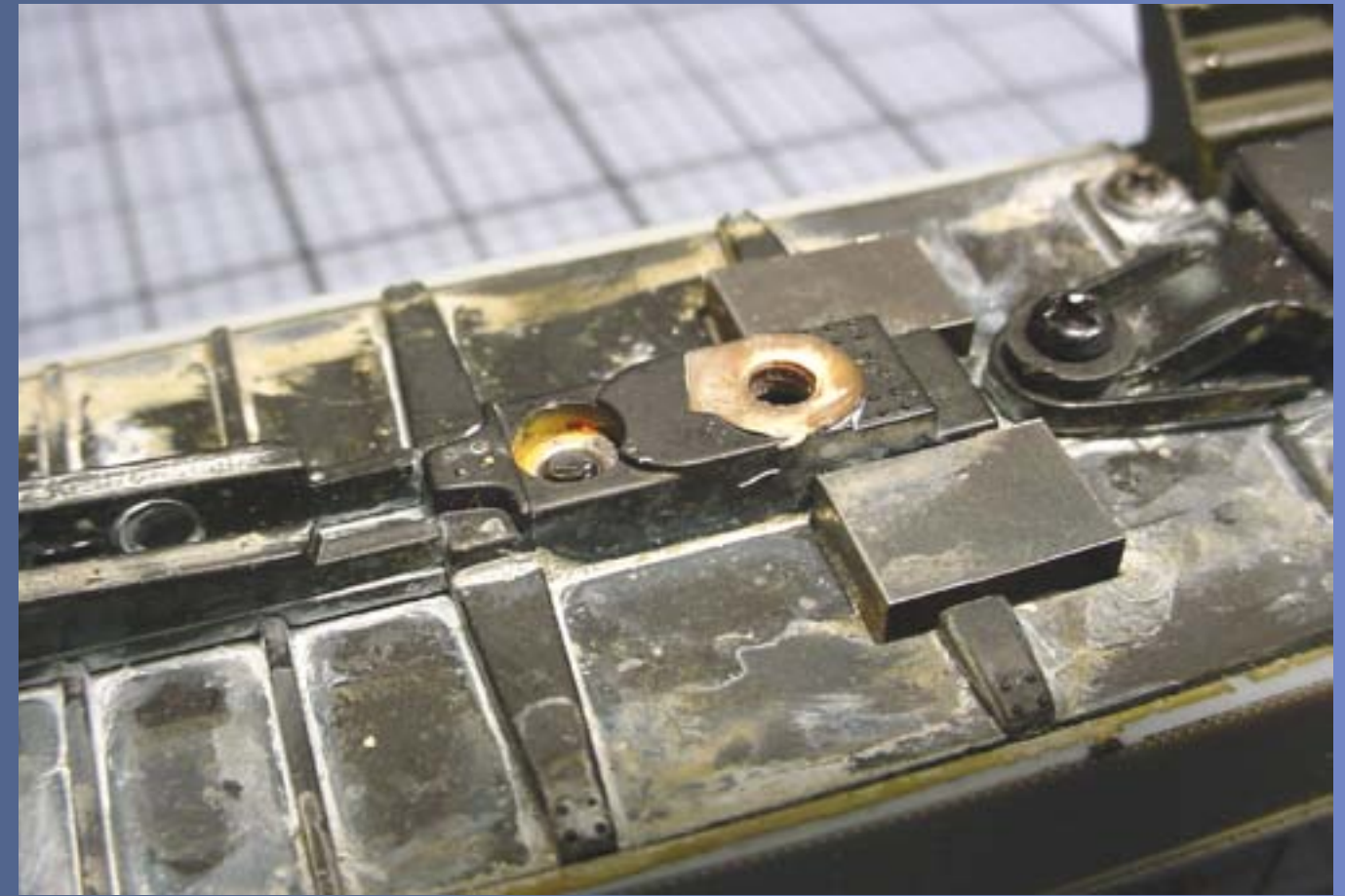

Figure 51.

To correct the float, I cemented a square of thick styrene sheet to the underside of the truck mounting plate and drilled the proper size hole for the screws included with the Walthers model. I found correcting the height issue to be slightly more complex – but I rectified it by cutting off the underframe bolster with a #18 blade then filed it down slightly so the car will sit at a lower height (Figures 50-51).



## STEP 6: Correcting the Coupler Height



Figure 52.

Although the car has been lowered, the coupler mounting will still be higher than normal. I compensated for this using a Kadee overset shank coupler at both ends.

While many may be familiar with Kadee #5 couplers, using overset and underset shanks may be something some have no experience with. The shank is the mount of the coupler – the bar extending from the coupler knuckle to the mounting pin of the coupler box. A Kadee #5 coupler has a medium-length centerset shank – the shank being a medium length located in the center of the coupler knuckle. An overset shank coupler has the shank located at the top of the knuckle and an underset shank has the shank located at the bottom of the knuckle.

In addition to both underset and overset couplers, Kadee also offers coupler shanks in different lengths – short, medium, and long – allowing compensation for mountings where there may be obstructions that interfere with proper operation of the coupler (Figure 52).

## STEP 7: Modeling the Stirrup Steps



Figure 52.

Modification to the visible underframe appliances on this car is similar to what I did when modeling Conrail 22 using a combination of kitbashing and commercial detail parts. One feature of the modernization of this car is the removal of the standard steps at the front of the car, which the prototype replaced with stirrup steps. Adding these stirrup steps requires two different parts, Train Station Products #436 stirrup steps added under both the new and plated-over door location, and a #487 three-section stirrup cut down to form the single long section found under the door on the opposite side (Figure 53).



## STEP 8: Adding a Battery to Power the Rear Marker Lights

54



Figure 54.

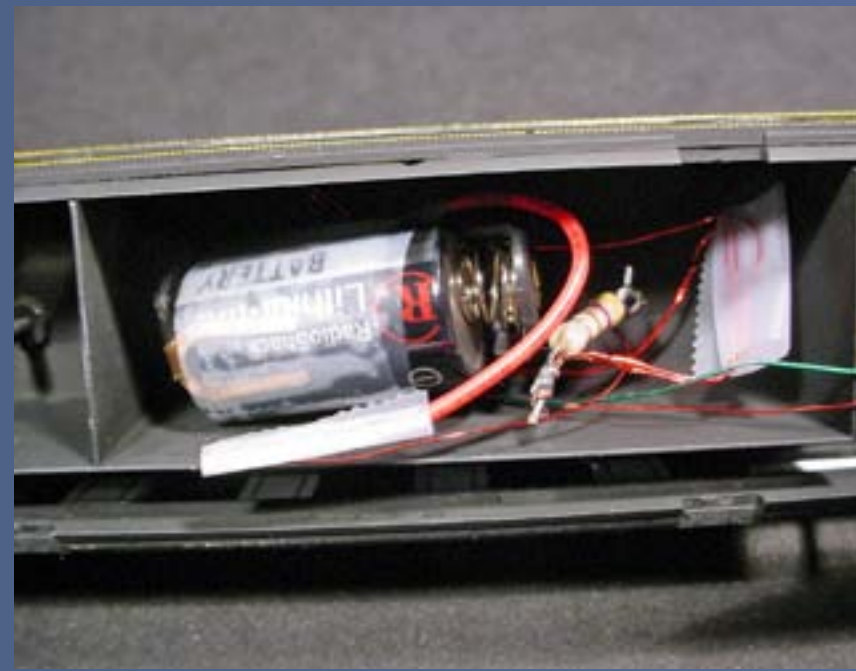

Figure 55.

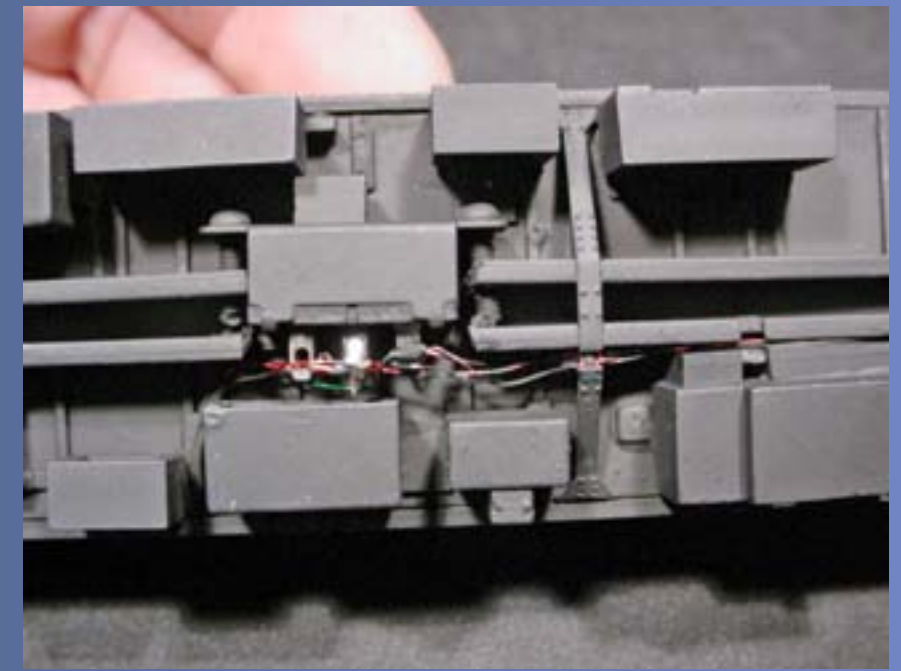

Figure 56

Since I've covered the underbody detailing and interior construction already for the previous car, I won't look in depth at the similar details – rather I'll focus on a special situation that applies to observation or tail cars. Why discuss this now? The interior is a perfect place to conceal a battery to power the rear markers or spotlights mounted under the car.

To conserve power when the car would not be in use, I found a Miniatronics sub-mini slide switch can be hidden in the center-sill, with holes drilled through the new floor to allow wiring the lighting assembly once I had painted the car. With this in mind the underbody detailing helped ensure the switch would be accessible. I left several partitions open when constructing the interior, leaving a compartment long enough to hold a battery and wiring (Figures 54-56).



## STEP 9: Modeling the Observation End Overhang



Figure 57.

The final construction step prior to painting is completing the roof. This involves constructing a new observation end overhang. Doing this now works well because it really could not be done until the sides had been installed onto the car.

I removed the Walthers end insert from the roof and temporarily placed the roof on the car. I cemented two lengths of strip styrene to the underside of the roof, extending from the rear of the walls to the end of the roof. I added two additional strips between the side strips to create an open box. I rounded

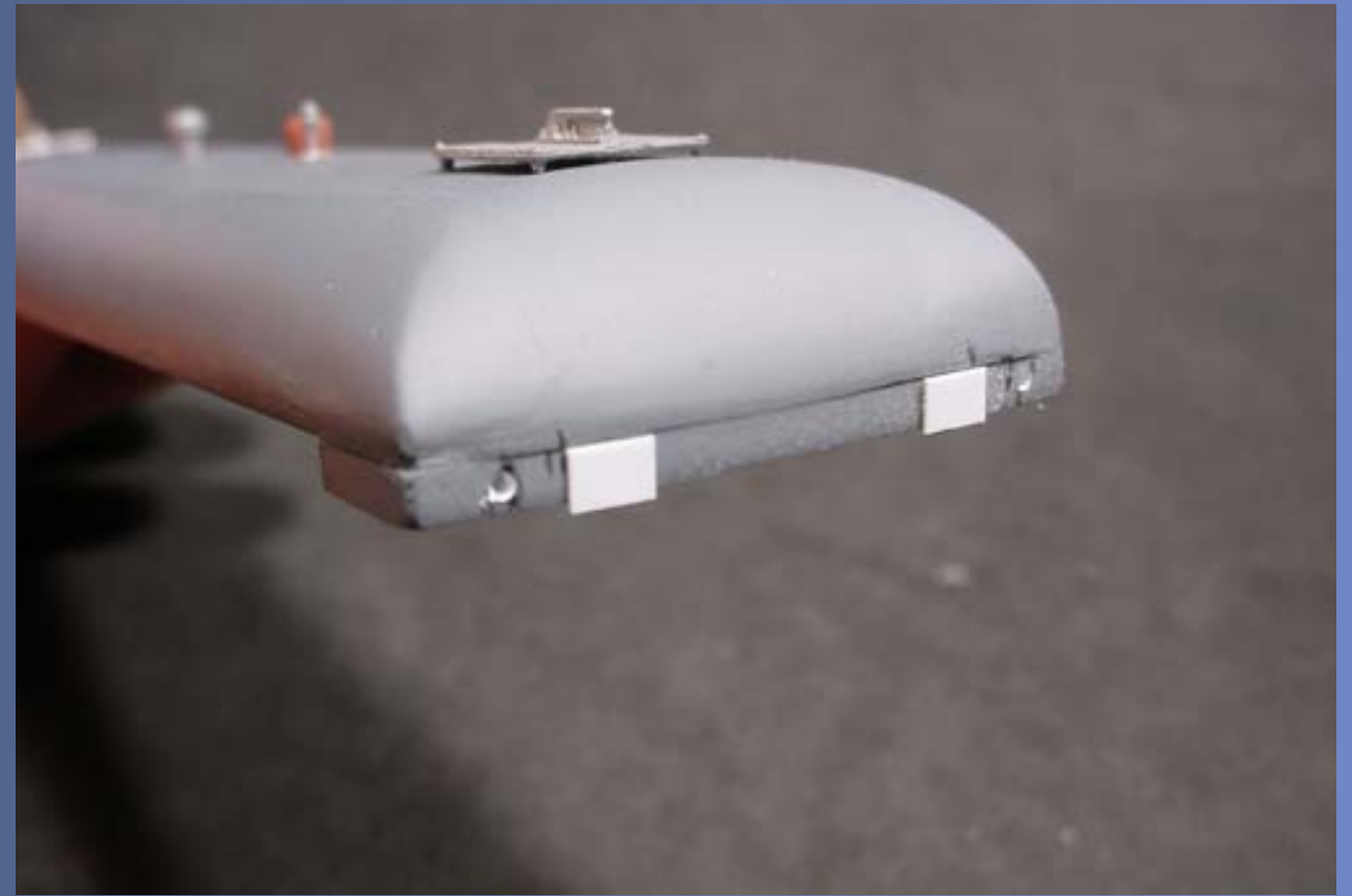

Figure 58.

the end strip to match the roof edge and I left the inner strip straight to match the observation window. Once complete, I drilled holes for the rear markers and added two 4mm long .010 thick rectangular styrene plates, completing the observation overhang (Figures 57-58).



## STEP 10: Adding the Roof Detail



Figure 59.

Detailing on the roof consists of a series of antennas, several vents, and grab irons. I installed three Details West Sinclair antennas (#274) mounted onto Antenna Stands (#233) in the front, center, and rear of the roof, with a 'lollipop' style GPS antenna (#280) completing the antenna array. The ventwork requires two styles of vents, three Bethlehem Car Works Lavatory (#35) vents mounted atop the roof, complemented by two modified Train Station Products vents on the sides of the roof. To complete the roof I added Detail Associates roof grabs (#6602) and ladder grabs (#6603), and fashioned a drip strip made from .010 x.030 styrene strip, which I mounted above the vestibule door (Figures 59-61).

Now that the body detailing is complete, it's off to the paint shop!



Figure 60.



Figure 61.





**Serious models  
for serious modelers**



**KOWALSKI & SMITH WELDING**

A new HO scale multi media kit  
available at  
[www.pawofabear.com](http://www.pawofabear.com)



**Litchfield  
STATION**

**How  
About  
a Gift  
for  
You?**

**[www.Mr-DCC.com](http://www.Mr-DCC.com)  
623-298-7355**



# ELEVATE YOUR THINKING

O,S,H0,N  
SCALE

BRIDGE & SECOND TIER TOWERS  
COMING SOON!

STAIRS

SUPER ELEVATED  
KIT

DISPATCH  
OFFICES

STARTER  
EXTENSION  
KITS

WALKWAYS

PLATFORMS

CHICAGO  
NEW YORK



519-737-0275 [www.imaginethatlaserart.com](http://www.imaginethatlaserart.com)





Kevin Klettke's

# Washington Northern

Big switching in a small space.



Washington Northern 325 leads a short freight into Union yard.



Kevin Klettke knew he didn't have space for long mainline runs on his bedroom-sized pike. So he created a small layout with big-time switching potential and great scenery.



By Charlie Comstock, photos by Joe Brugger

**M**odel Railroad Hobbyist got to visit the Washington Northern in Tacoma, Washington and interview Kevin Klettke. Kevin has been in the hobby for well over 30 years and this is his sixth layout.

**MRH:** Hello, I'm here with Kevin Klettke in his Washington Northern railroad empire. Kevin, this is quite the layout you've got here. It's a little bit small – it fits in a bedroom, but it's very high quality. How long have you been modeling anyway?

**Kevin:** Well, for about 38 years now. I started when I was 12 years old and I'm approaching the big 50 so that's 38 years.

**MRH:** Oh, so this isn't your first layout?

**Kevin:** No, no. I've had layouts since I was 12, three smaller ones as a child, then three as an adult.

**MRH:** How does this compare with the previous layout. Was that in this house also?



**Kevin:** No, it was not. It was in a room I specially built above my garage just for the layout. It was a 23 by 35 and was double decked. Much larger! This is what fits in my spare bedroom, but it has to share the space with an exercise machine.

**MRH:** How big is this layout?

**Kevin:** It's 12' x 8' which doesn't fill the whole room. It's a sort of lopsided T shape.

**MRH:** You said that your previous layout was a double deck; did you have any thoughts about double decking this layout?

**Kevin:** Without coming up with some kind of an elevator idea, there was really no way to get track between the

decks. Plus I'm not really fond of double deck layouts.

**MRH:** Why is that?

**Kevin:** Well for me, I didn't enjoy the sight levels [of the decks] and I found it was harder to work on. It was especially hard for me to work on the wiring underneath the second level - that type of thing. With the current layout, I like the height – not too low or too high.

**MRH:** Did you consider a mushroom plan?

**Kevin:** For this layout no, but in the future if I had that [large] size of room I'd consider it just because it eliminates a lot of the double deck problems.

**Figure 2: Clever use of photo backdrops makes the main road through Port Andrews seem much longer than it really is. Attention to detail and color makes the scene come alive.**

**MRH:** A lot of the stuff I'm seeing here came off your previous layout?

**Kevin:** That's correct.

**MRH:** How much is that here?

**Kevin:** Pretty much everything you see here is taken from a previous layout. I've made very few financial investments in this layout – I didn't need to, I had all the stuff I needed and more to build this size of layout.





Figure 3

**Figure 3:** When naming boats, Kevin says it's wise to not use names of women other than your wife or daughters. The Carol is tied up at the wharf in Port Andrews, a very busy place.

**MRH:** So most of the buildings, most of the track - anything else? Wire or lumber?

**Kevin:** Wire, I was fortunate that my father at one time gave me this huge spool of wire. It's not always the best gauge but I have tons of it. And it works!

**MRH:** Basically you built this layout for very little cash outlay ...

**Kevin:** Yeah, outside of the initial investments, there's probably less than \$500 in new purchases here.

**MRH:** This layout is a 1995 era?

**Kevin:** Currently, yes.

**MRH:** Did you change eras when you went to a new layout?

**Kevin:** Well the last layout I considered a current layout - it was about 1995 when I started that layout. So when I started this layout I kept the era. Once again it was the cost thing. I didn't want to have to invest in a bunch of new equipment.

**MRH:** So you haven't been buying a bunch of new cars and engines...

**Kevin:** No, I have not. Actually I've been selling quite a bit of my older stuff.

**MRH:** You said the previous layout was a current layout. Does that mean you picked 1995 - the current time when



you started and just stayed there, or were you trying to keep current with the present (like Eric Brooman – Utah Belt does)?

**Kevin:** No, I didn't want to be that committed to change. I just like the 1995 era. Everything that I needed to see was right in front of me. I didn't have to do a bunch of prototype research other than go out my front door and see what was running on the rails. I had no intention of upgrading and like I said, with this layout, I already had the equipment for 1995 so I just stuck with the era.

**MRH:** What made you pick 1995, other than going out the front door? Was there anything special about that time that appealed to you?

**Kevin:** No, not particularly. I did like some of the new locomotives that were coming out at the time. SD70s were fairly new then and I liked that type of power. Unfortunately with this layout I can't run a lot of that 6-axle stuff, it's all in boxes right now...

**MRH:** Too-tight curves?

**Kevin:** Yeah, and for switching industrial tracks, SD70s just wouldn't work

**MRH:** The Washington Northern, there's no such real railroad, no prototype for that?

**Kevin:** No, there's no prototype, this is a fictitious line.

**MRH:** Where did you come up with that name?

**Kevin:** I don't really know exactly if I had any particular motivation. I want-

ed to model Washington state – I've grown up here, lived here all my life. The previous layout is where the name started and it was larger, before, with a lot of mountain scenery. I wanted to pick a locale that would fit in with the real railroad map and the Olympic Peninsula was an area that was shy of a major railroad operation so I invented the city of Port Andrews – named after my son – which is sort of like Port Angeles is now, only it's a much bigger metropolitan area. It was the northern part of Washington state and so I just settled on Washington Northern.

**MRH:** Port Angeles, that's at the northern part of the Olympic peninsula?

**Kevin:** Correct, on the Strait of Juan de Fuca.

**MRH:** So the new layout features a lot of waterfront?

**Kevin:** Well yeah, as much as I could fit into this space. The marine aspect has always been an interest of mine and I wanted to incorporate it into this layout.

**MRH:** You weren't able to do that in the previous layout, so this is new?

**Kevin:** Yes, it is new here.

**MRH:** Since the previous layout didn't have a waterfront you wound up having to build some new structures.

**Kevin:** Yes

**MRH:** Was there one of them in particular you found especially interesting, that you scratch built?

**Kevin:** Correct, yes. The Sea Dog Boats and Marine Supply. It's a scratch-built



**Figure 4:** A distinctive Washington state highway bridge.

**Figure 5:** The scratch-built Sea Dog Boats and Marine Supply.







Figure 6

Figure 6: This part of Port Andrews is the most unfinished area on the layout. Kevin has been spending the last two weeks arranging and rearranging the buildings here looking for the one that works the best.

Figure 7. An example of Kevin's structure craftsmanship.



Figure 7

building - originally a warehouse. Then I put it on some pilings that were left over from the Walther's pier and crane kit that everybody is probably familiar with. I made it into a waterfront boat dealer marine supply store.

**MRH:** What materials did you make it out of, styrene?

**Kevin:** No, it's mostly made of wood and card stock.

**MRH:** You had fun building it I bet.

**Kevin:** Ah... yeah, it was interesting.

**MRH:** Did you make up the plans yourself?

**Kevin:** No, I got the plans from a gentlemen that had built other scratch structures. **Jerald Kinney** is his name.

**MRH:** Are you planning to do more scratch building if you can find the space?

**Kevin:** That's the big issue right now, the space - it was fun to do. I've recently started dabbling with craftsman style kits. Because of the era I model, a lot of those kits aren't era appropriate but it's interesting and fun and I'd like to try some more of that but I don't know where I'd put them on this layout at this time. Maybe sometime in the future when I have my basement empire.

**MRH:** There is one place on the layout that isn't really finished yet ...

**Kevin:** Yeah that's correct. That's kind of the city streets of Port Andrews.

I wanted to have a downtown, city street area - inspired by some layouts that I've seen recently in some

magazines and articles. As you can tell it's been a good two weeks rearranging these buildings (figure 6) trying to figure out what would be the best arrangement. It was kind of the last thing to be planned and I didn't have any specific arrangement of the buildings in mind when I started the layout. I'm experimenting right now and this area has been used as a workbench because it's the only free space I have in here right now!

**MRH:** What are you looking for in building arrangements?

**Kevin:** I'm just trying to come up with an interesting city street composition that I can detail fairly well and highlight some of the buildings I'm putting interiors into and that sort of thing.

**MRH:** How much rolling stock is on this layout, Kevin?

**Kevin:** I currently have about 60 cars in my fleet, down from probably close to 200 on my larger layout.

**MRH:** Is there anything special you're doing to the cars weathering-wise to make them look a more realistic?

**Kevin:** Well I've dabbled in weathering a bit. I've really been inspired by some of the examples I've seen on [modeltrainsweathered.com](http://modeltrainsweathered.com) and some of other sites. Some people are doing fantastic work and I'm learning a lot from them. I'm going to be diving into the weathering heavily when the layout itself is more complete and I have more time.

**MRH:** Are there any techniques you have in mind to give a try?

Text continues on [page 51](#)





Kevin Klettke photo

Kevin Klettke lives just south of Seattle, Washington with his wife and dog Bentley. Kevin can't remember a time he wasn't interested in trains. He grew up in Eastern Washington watching trains on the GN and later BN roaring through town. After visiting a layout in San Francisco in 1972 with his father, he became a complete train nut. His modeling exposure started that year with an HO at Christmas. 37 years later he's still at it. His first layout was a 4' x 8' hinged to a wall in his parents garage. The last two of his six layouts have been the fictitious Washington Northern.

His other interests include the Seattle Seahawks, Mariners, and salt water aquariums.

His train website is [wnrr.net](http://wnrr.net).

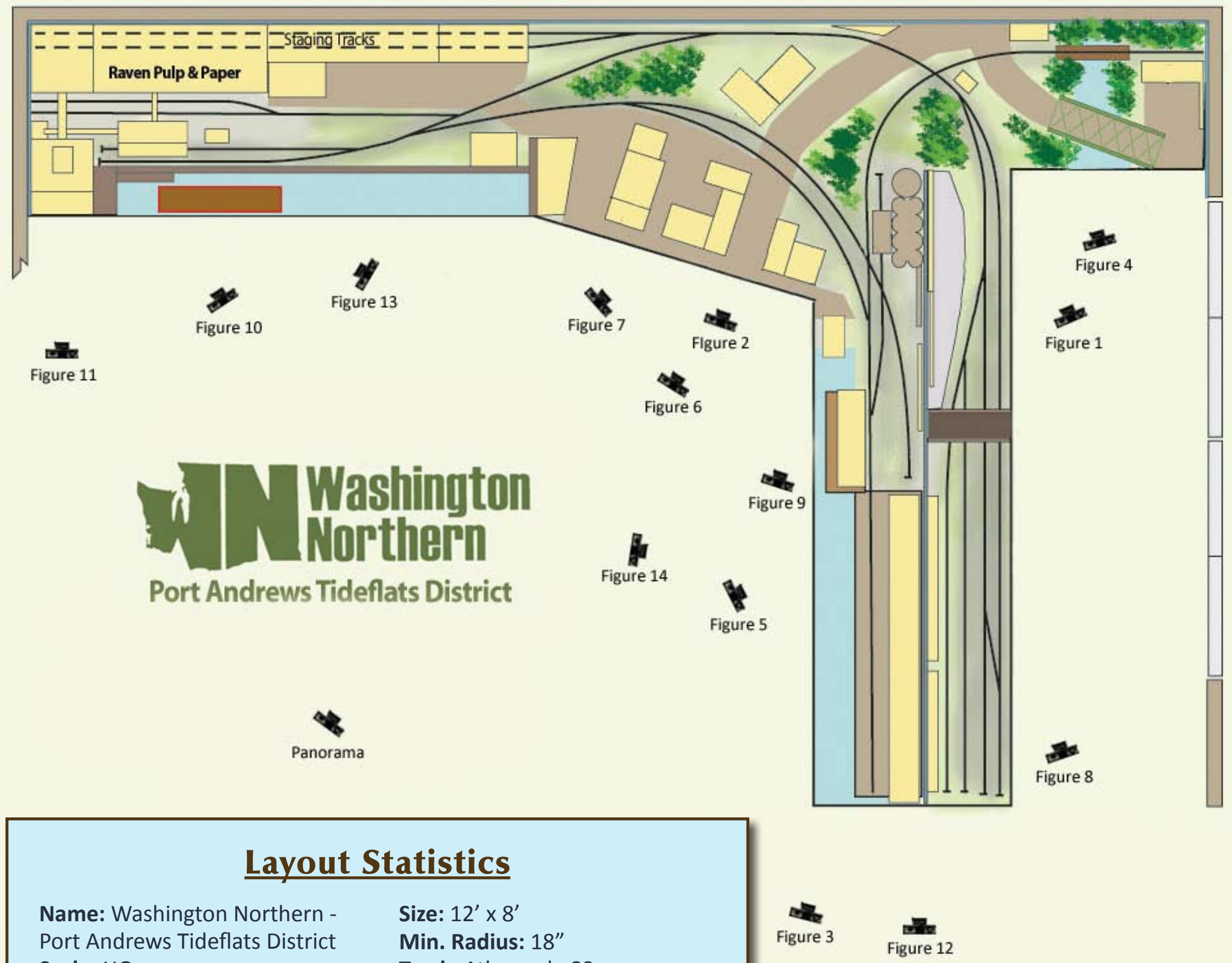

### Layout Statistics

**Name:** Washington Northern - Port Andrews Tideflats District  
**Scale:** HO  
**Era:** 1995  
**Locale:** Olympic Peninsula, Washington State  
**Style:** Proto-freelanced  
**Trackplan:** Switching with staging connection

**Size:** 12' x 8'  
**Min. Radius:** 18"  
**Track:** Atlas code 83  
**Turnouts:** Peco with Tortoise  
**Turnout control:** Hare & Lenz stationary decoders  
**Control:** DCC - Lenz  
**Construction started:** 2009



Text continues from [page 49](#)

**Kevin:** Yes, there are a lot with washes and oil paints, along with some of the weathering powders that are out now. I used to use pastel chalks and there's big improvement on some weathering powders with self adhesive in them. There are some different things being done with cosmetics sponges too.

**MRH:** Have you tried anything with powdered chalk mixed with alcohol?

**Kevin:** No, I have not. I've seen that done and with good results - airbrushing as well. I have an airbrush but it's a cheapo so I might need to invest in something that's a little bit better if I'm going to use the airbrush for weathering.

**MRH:** What kind of techniques are you using for scenery on this layout? I see a rocky beach with dirt and sand and some weeds (figure 9) that looks really good.

**Kevin:** Umm, I've gleaned a lot of things from different web sites and some from Joe Fugate's tutorials that he's had using tempera paints mixed in with sand. I also use real dirt I collected. But I don't have a lot of land forms here, being that it's a flat industrial layout. I plan to make a static grass applicator soon because I want to dabble with that. I've never done that before, but I've seen some great scenery made with static grass.

**MRH:** Static grass applicators work great. When you start, you'll feel like a scenery hero.



Figure 8

**Kevin:** Yes, I'm looking forward to adding that to the scene because, if you're modeling this part of the country there's greenery everywhere.

**MRH:** So you're saying Washington's just filled with greenery?

**Kevin:** It is, except for eastern Washington.

**MRH:** What about your trees?

**Kevin:** The deciduous are mostly sagebrush armatures that I collected myself

over in eastern Washington. I made the canopies with ground foam. The conifers have carved trunks. I used some [furnace] filter material to make the branches and added flocking to that.

**MRH:** How do you plant your trees, spikes in the bottom?

**Kevin:** What I did on the conifers, I drilled holes and put some finishing nails in the bottom to give them a little spike. Then I drill or punch a hole in

**Figure 8: Washington Northern 102 pulling into Union yard next to an AD&N box car.**

**Figure 9: (next page) Blue Star Ready Mix in Port Andrews is near the beach. Caboose 52 shows signs of heavy use or maybe it's just all the salt air near the sea front in Port Andrews.**

Text continues on [page 53](#)





Figure 9





Text continues from [page 51](#)

the ground where I need it and plant them that way. Being that this layout has a plywood surface I needed to drill the holes instead of punching into nice pink foam that many people are using.

**MRH:** What about the sagebrush trees, did you put spikes in them too?

**Kevin:** No, I drill large enough holes in the plywood to hold the trunks. I tried doing drilling a hole in the trunk for a spike and found that sagebrush trunks are pretty delicate – by drilling them I kind of was destroying the trunks. So I’ve just been drilling holes [in the plywood] about the size of the trunk, add a dab of white glue, and plop in the trees.

**MRH:** You’re getting into operations phase now that you’ve got the track in and have rolling stock. What are you trying to do with operations?

**Kevin:** Well I’ve always enjoyed an industrial switching layout. I do miss

the long mainline runs, but since there wasn’t room for that, switching was the next best thing. I’ve developed a car card and waybill system. It’s a two-step waybill - basically one step is onto the layout from staging and the second step is off. That keeps it easy. I’ve got a two track staging yard that’s hidden behind the paper mill. I pre-stage my trains and I run two trains in an operating session.

**MRH:** When you run a train you come out of staging, then what?

**Kevin:** Trains come out of staging and they go to the small yard at Union. If sorting needs to be done, it can be done there. There’s also a couple of industries along the backdrop (figure 12).

It will usually run around the train and take it over towards the paper mill and the Tideflats area where the scrap dealer, Olympic Copper and Pipe, and the concrete plant are located. It col-



Figure 10

Figure 10: Raven Paper Co. in Port Andrews is a major shipper on the Washington Northern.

Figure 11: Some of Kevin’s well-labeled car card boxes.



Figure 11



lects the outbound cars and brings the inbound cars in and heads back to staging when its done.

**MRH:** I see the concrete spur faces the opposite direction from the Tideflats spurs.

**Kevin:** Exactly, when I stage the trains, I have to figure which cars are going to facing and trailing spurs and make sure the cars are blocked properly in the train.

**MRH:** Right now, you're running just by yourself. Does the layout allow running with another operator?

**Kevin:** I think so, I kept that in mind when I adapted the track plan - that

two people could run simultaneously. That has yet to be tried

**MRH:** You're using DCC?

**Kevin:** Right, I'm using Lenz.

**MRH:** How did you pick Lenz?

**Kevin:** Actually I picked Lenz because my local hobby shop – the man I was getting most of my stuff from back on my old layout, recommended it. He knew it thoroughly and could answer all my questions so it seemed like a logical choice. I'm satisfied with it.

**MRH:** You've got a few sound locomotives too...

**Kevin:** Yes.

**Figure 12:** The peninsula backdrop. Union yard is on the right, Tideflat area is on the left. Kevin emphasized marine operations on this version of the Washington Northern.



Figure 12

# iwata

## iwata Revolution

Quality, Performance and Value



### Your Hobby Needs Are Covered!

visit us on the web at  
[www.iwata-medea.com](http://www.iwata-medea.com)

iwata  
MEDEA





# Your source for the modeling information you need.

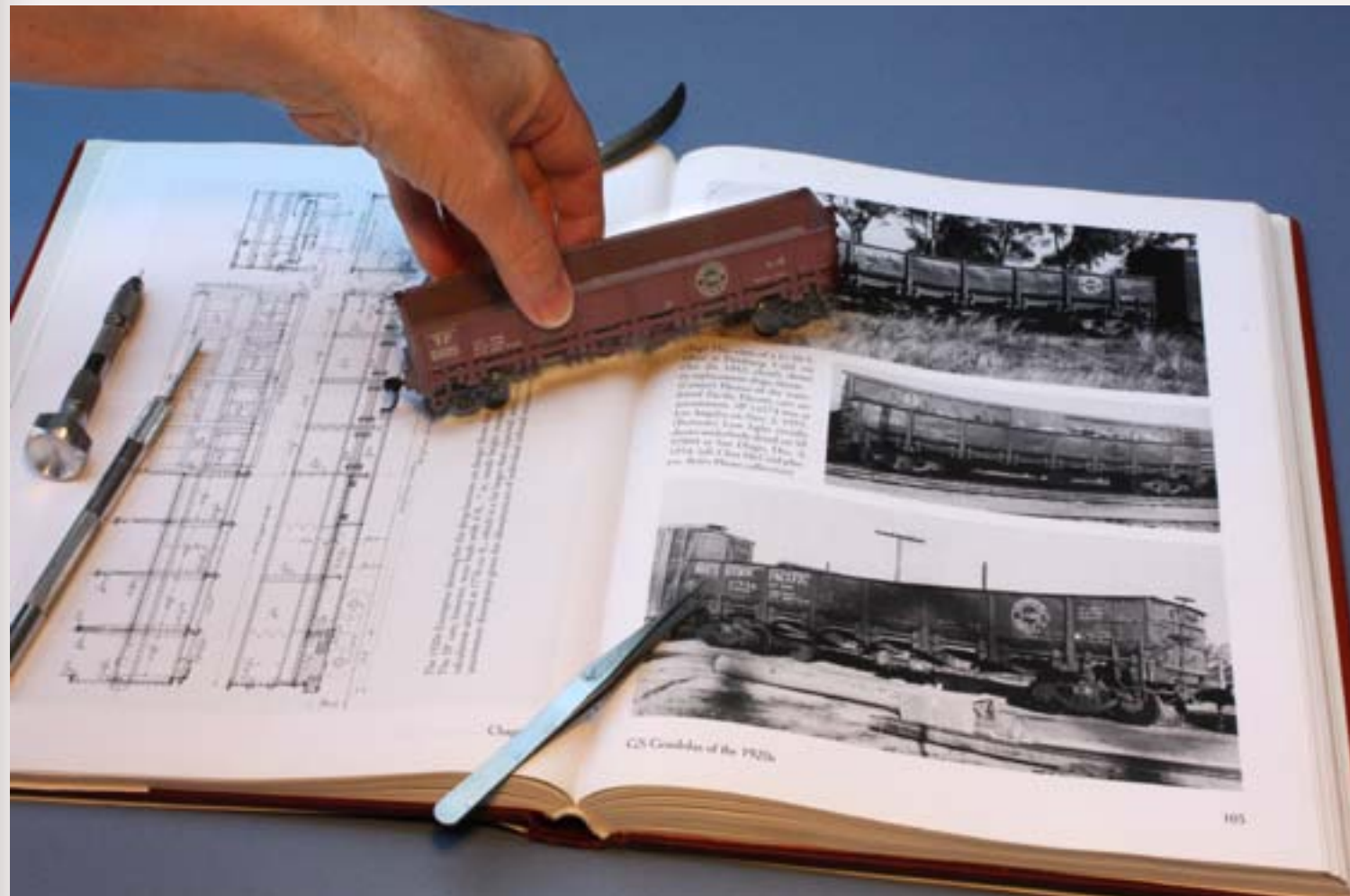

Figure 13: Another view of the Raven Paper Company, the biggest industry served by the Washington Northern.

Click here to learn more!



## SIGNATURE PRESS

Order securely at: [www.signaturepress.com](http://www.signaturepress.com)  
or order direct: 11508 Green Rd, Wilton, CA 95693  
TELEPHONE ORDERS OR DEALER INQUIRIES TO:  
**1-800-305-7942**

see our web site for information on all our books

**MRH:** Do all the locomotives on the layout have sound?

**Kevin:** All the ones that I run have sound. There's a number of DCC equipped locomotives that are awaiting sound to be installed. That will come as I deem necessary. I have three or four locos now with sound and that's all I need to operate.

**MRH:** That's an expense, going to sound decoders.

**Kevin:** Yes it is, it is and with two kids in college we're trying to cut expenses.

**MRH:** Did your kids show any interest in the railroad?

**Kevin:** My daughter Tara did. On the last railroad she actually did help a

bit. She liked getting her hands messy when we did the plaster over wire screen. She liked doing the scenery. She's out of the house now so she had nothing to do with this one.

**MRH:** How long have you been working on this layout?

**Kevin:** I started in 2009.

**MRH:** Geez, you're a fast worker Kevin! You're doing a great job in here. Thank you for having us. This layout is really nice now and when you get the town area behind you finished it's going to be even nicer, I think.

**Kevin:** Thank you for coming!





Figure 14

Figure 14: Switching the wharf at Tideflats.





# *Innovative Electronics for Model Railroads*

Frog Juicers - Automatic Frog Polarity  
Servo Drivers for Turnouts and Semaphores

## TAM VALLEY DEPOT

Great Electronics for Great Model Railroads

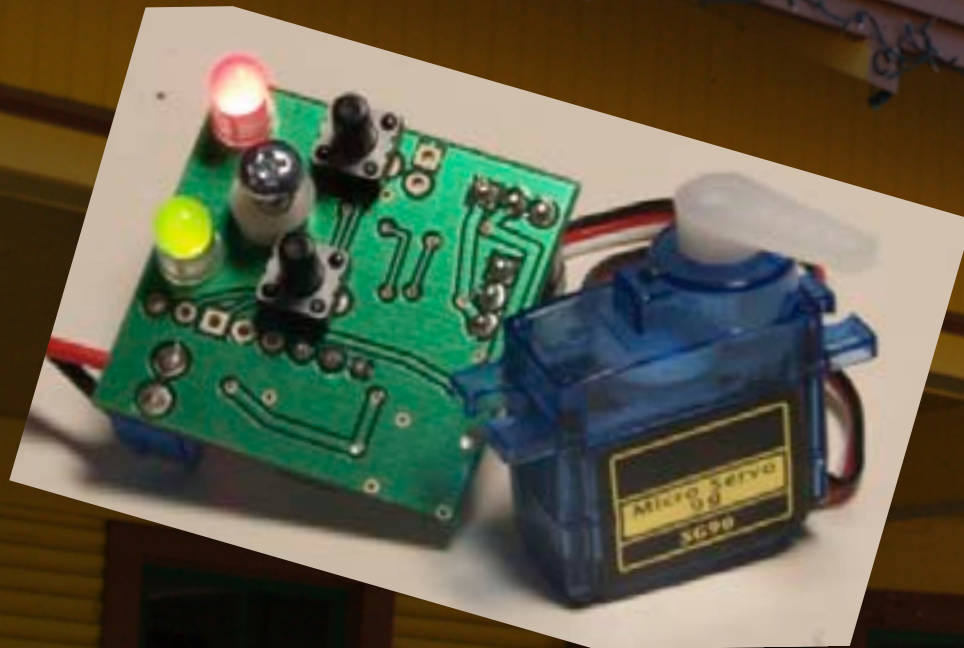

**Featured Product - Singlet**  
built-in panel controls, a DCC decoder, and a servo driver to control your turnouts or animate your layout. Now features bi-color LEDs!

*[www.TamValleyDepot.com](http://www.TamValleyDepot.com)*

[Click here to contact us by email](#)





# Easy Highway Striping ... with an airbrush

by Charlie Comstock

**Reader Feedback**  
*(click here)*

If you are modeling a paved road chances are you'll need to be painting stripes on it. I model the early '50s in the Oregon Cascades where many roads weren't paved (except with gravel). Here's how I painted the center stripe on a road in Oakhill that is paved.

## Stripes

In modern times roads are striped down the middle, along the edges, or even to create a left turn lane in the center of a highway. Paint colors are white and yellow. Reflectors are used to make the striping more visible at night.

In older times stripes were often yellow and were much simpler. I elected to

paint the road in Oakhill with a single, solid, center stripe. Five scale inches is a good width for my stripes – in HO scale that works out to .057". I set a pair of dial calipers to this distance.

I use an Iwata Eclipse double-action gravity feed airbrush to paint stripes but a paint brush can be used in a pinch. To get my stripes to have clean edges I cut blue painters tape into strips about 1/4" wide (figure 2). I carefully stuck the tape to the road surface using a dial-caliper to



Figure 1

Figure 1: The finished road with stripe and weathering.

Figure 2: Using a NEW blade and straight-edge to make 1/4" masking tape.

Figure 3: Masking the stripe.

Figure 4: Double checking the stripe width.

Figure 5: My paint color.

Figure 6: Using my double-action airbrush to paint the stripes.



Figure 2



Figure 3



Figure 4



Figure 5



Figure 6





Figure 7



Figure 8

Figure 7: Removing the masking.

Figure 8: The stripe – a problem with masking is the ‘clean’ area revealed when it’s removed. I weathered to road with grimy black to help cover this up.

Figure 9: An alternative to masking tape – I made some templates out of styrene.

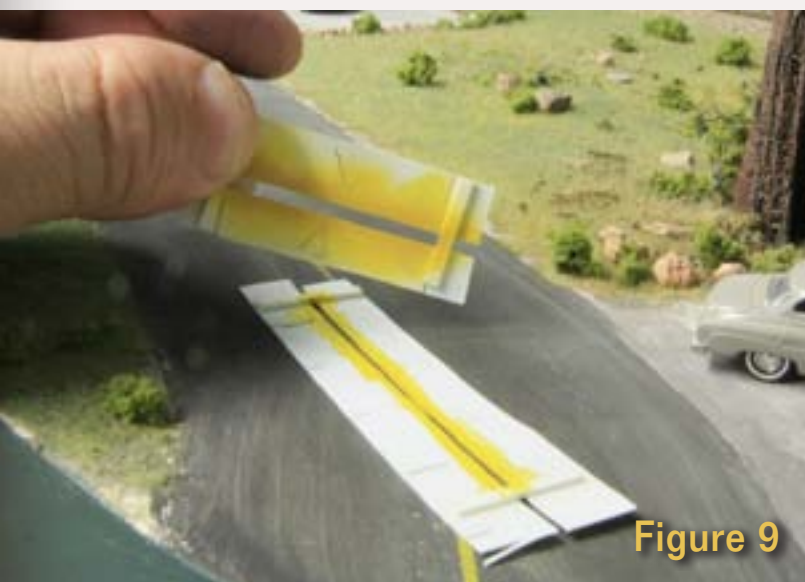

Figure 9

make sure I was correctly approximating the stripe width (figures 3 and 4). A scale five inch stripe will appear very narrow when applying the masking tape, but the width will look correct when the masking is removed.

I chose PolyScale CSX Yellow for my stripes (figure 5). I used this full strength to maximize coverage. I added several drops of yellow to the gravity feed cup on my airbrush, and started spraying. Because I use a double action airbrush, I was able to closely control the amount of paint being sprayed, painting a narrow line so that I could get away with the 1/4" masking widths. Oh yeah, I was spraying at around 15 psi (figure 6). I needed to go over the stripe several times to get coverage.

I removed the masking and checked the stripe (figures 7 and 8). I loaded up the airbrush with diluted PolyScale Grimy Black – about 1 part paint to 8 parts isopropyl alcohol – and gently over-sprayed the stripe and road to weather it (figure 8 is unweathered).

Then I added a few drops of black to the paint mix and carefully paint the oily/grimy streaks in the center of the lanes. Presto, that road looks much better!

I made some templates as an alternative to masking tape. These work well on straight roads but obviously have problems with curves. I hold them down with a couple of fingers, spray the stripe(s) and remove them. I clean them with a Q-tip in between stripes to avoid smudges. I made the templates from .010" styrene.



The largest selection of scale Model Railroad Scenery Supplies on the web!

Click to visit!





# Just like you've always wanted.

Finally, you can turn anything on/off with your DCC throttle!



## AUX-BOX

CLICK TO LEARN MORE ABOUT AUX-BOX ...



## AUX-BOX.com



# RailroadKITS

A typical reaction to our low prices, wide selection, & great service!



**Ed Fulasz Designs.**  
Available Exclusively from  
Railroad Kits.

**20 models to choose from.**

**These kits contain the finest Hydrocal® castings.**

**Fun, and Easy-To-Build!**

***Fine HO Scale  
Structure Kits of  
Heirloom Quality.***

**“Models by Ed Fulasz”  
is now a part of the  
Railroad Kits  
line of structures.  
Prices begin at just  
**\$29!****

- Illustrated instructions
- Full Color Pictures
- Tichy® doors and windows
- Northeastern Scale Lumber® stripwood
- Roofing
- Signs
- More...



**HO Scale Structures Resin Details**



**www.RailroadKits.com 785-JIM-0001 Box 461 Holden, MA. 01520**



# Switching the Coast Daylight

## Train 98 at San Jose circa 1955

– by *V.S. Roseman*

Model photos by the author



**T**he Coast Line of the Southern Pacific Railroad connected San Francisco with Los Angeles, while across the bay on the mainland, Oakland, a large city in its own right, was the terminal for SP transcontinental services and for several East Bay lines, at one time including electrified commuter lines. Oakland was also the terminal for the SP San Joaquin Valley Line to Los Angeles, which served important cities but was several hours slower than the Coast Line.

Figure 1: At 8:40 AM, local train #110 out of San Francisco, carrying a through car for the Daylight, rolls in the ladder tracks and slows to a stop on platform track 3. To the right of the center of the photo, you can see the 8:40 local to San Francisco leaving from 2 track, marking the end of rush hour.



SWITCHING THE  
SOUTHERN PACIFIC'S  
COAST DAYLIGHT  
AT SAN JOSE, CALIF.  
CIRCA 1955



COAST DAYLIGHT  
TRAINS #98/110/250

**My friend and I watched in San Jose as the SP switched the three sections of the Daylight for its sprint down the California coast to Los Angeles. Grab your bike and ride with us!**

My family spent a couple of Christmas and summer vacations with my aunt and uncle and my cousins on the San Francisco peninsula when I was a teenager, over fifty years ago. My cousin introduced me to one of his friends who was as interested in trains as I was. We saw the long freights that ran up to Oakland and the commutes (Southern Pacific jargon for commuter trains) on the line into San Francisco. Near the end of summer in the mid-50's we were sitting on a fence and the Daylight came through from Los Angeles.

Back home in the east, long distance trains usually had mixtures of equipment in the colors of several railroads, and the steam engines I saw were sad looking machines running off their last miles.

But this train was a streamliner and had a scarlet and orange 4-8-4 with twenty shiny cars, just like the railroad



publicity photos. I wanted to see that train up close, and finally that winter I did. I even took a couple of photos with the family Brownie camera, but they haven't survived the years.

Modeling the San Jose station and facilities brought back the memories of a day when I was awakened out of a sound sleep way before sunrise.

A loud tapping noise at the window woke me. I slid the window open, and down on the lawn my friend Paco was tossing pebbles up at the window.

He whispered: "Wanna see the Daylight?- get down here right now!"

I jumped into some clothes, grabbed my camera and took the stairs two at a time.

When I got outside, he whispered,

"We can just beat the rush hour traffic to see the southbound Daylight if we leave right now."

We got on our bikes and took off down the street. We rode for a while and it was getting light when we passed the first cars of the coming torrent of morning rush hour traffic. Then the street ducked under the train tracks. We had arrived at San Jose station.

This was the terminal for the Southern Pacific commute line to San Francisco, and there were trains moving everywhere. We blended into the crowd of commuters moving towards the trains. The crowd was a good thing, for two youngsters alone would sometimes get attention from what I used to call "railroad employees

**Figure 2: Engine 4350 at the head of train 110 was slowing for the stop while on the right a diesel switcher spotted an express car for unloading. Track 1 was often used for mail and express in off hours. The station is in the background.**

with a sense of duty" who might chase us out of the station. We kept our cameras under our windbreakers except when clicking off a shot so we wouldn't get any unwanted attention.

As the platforms filled up with commuters, trains would roll in from the coach yards, load up and quickly depart. With the last train of the rush hour into San Francisco the sections of the Daylight were about to arrive, and the two of us were ready...





Figure 3: The 4-8-2 (Class Mt4) came to a stop across from the switchmen's quarters (yellow building on the right, and it is still there in 2010!) The engineer was inviting us for a cab ride to the roundhouse. Tough decision but we opted to stay to take photos of the Daylight.

Figure 4: At the other end of the platform we heard an engine working and we ran up to see the action. Engine 1221, an 0-6-0, was moving down on the back end of train #110 ready to remove the Daylight chair car. The man on the ground by the passenger car has just pulled the pin on the coupler to be sure the knuckle is open.





# INTRODUCING THE DAYLIGHT

The Coast Line was very popular and was heavily patronized from its inception. Over the years, well-appointed trains had been put into service, establishing the Daylight name. By the 1930s, passenger loadings fell drastically due to the Great Depression. To attract new passengers, Southern Pacific began operation of a stunning new train to run on the fastest possible schedule between Los Angeles and San Francisco.

Route of the Coast Daylight and San Joaquin Valley Line, San Francisco to Los Angeles



In 1937 the all new streamlined Daylight began operation as a luxury train carrying mail and parlor car formation. Many railroads introduced streamliners to attract riders, but few were as innovative as the Daylight. Ultramodern lightweight passenger car sets were ordered from Pullman Standard. The cars rode on newly developed triple bolster trucks, had wide sealed panoramic windows, and were fully air conditioned. The train was an upgrade

panoramic windows, and were fully air conditioned. The train was an upgrade



Figure 5: I was so busy studying the steam switcher that I almost missed this shot of the mail and express train, #250 arriving. This train is carrying the Oakland connecting car for the Daylight at the back end. There was also a rider coach for local passengers behind a string of express cars.

Figure 6: Back again at the south end of the platform I got #250 with its diesel next to #110's 4-8-2.





of earlier fully articulated units on other railroads and had single stand-alone cars, two-car pairs and a triple-articulated food service unit, all employing standard couplers so the consist of the train could be changed at any time. From Lima Locomotive Works came streamlined GS-2 type 4-8-4 locomotives styled to harmonize with the new consists.

Seats were reserved on the Daylights. For most of the train's early history, it ran at or close to capacity. In high demand periods a second section was sometimes run using whatever equipment was available. Other times last-minute passengers were out of luck.

## SUCCESS BRINGS NEW EQUIPMENT

New equipment was added over the years and the Daylight reached 20 cars during summer demand periods. More powerful 4-8-4 engines, classed GS-3 and within a few years, the still more powerful GS-4 were built. GS-5 engines were identical to the GS-4s but had roller bearings. During World War II GS-6 engines were built, but the War Production board would not approve construction of passenger engines, so the SP ordered the class with the slightly smaller drivers of the GS-2s, but tractive effort close to the GS-4, to handle both freight and passenger traffic. A Noon Daylight train was added to the schedule, and the original trains #98-99 with their early departures were now called "Morning Daylights". Unfortunately the Noon



Figure 7: Yard switcher #1221 picks up train #110's Daylight chair car on track 3.

Figure 8: We had to move fast because the signal bridge near the gasworks lit up like a Christmas tree! It was the Daylight, train 98, entering the station pulled by an A-B formation of EMD E-7 diesels.





Daylight did not prove popular and eventually the railroad shifted the equipment to an evening departure named the Starlight. This was a coach formation that ran overnight along with famous first class Pullman train, the Lark. Later on Daylight train 98-99 became known as the Coast Daylight.

As equipment became available, a San Joaquin Daylight train was added on the slower line to Los Angeles out of Oakland via the San Joaquin Valley.

Diesels began to operate on the Coast Daylight in the early 1950s, and on January 7, 1955, steam engines were last used on this train.

## **PASSENGER DECLINE IN THE 1950s**

After the record traffic of World War II, ridership began to slack off due to the increased popularity of automobiles and local airline flights.

To attract passengers, an Oakland section of the Coast Daylight was added on March 7, 1953. This service was operated by adding Daylight coaches to local train #250 which ran from Oakland, south (east by SP terms) on the Mulford line via the east shore of San Francisco Bay to San Jose. The through coach was cut into the Daylight here, providing direct service between Oakland and L.A. via the Coast Line, about two hours faster than the San Joaquin Daylight from Oakland via the inland route.



Figure 9: The Daylight rolls along the platform as railroad personnel keep passengers behind the white line.

Figure 10: As the train gradually brakes to a stop, the scarlet and orange diesel engines rolled by us displaying huge silver billboard letters proudly proclaiming "SOUTHERN PACIFIC."





In a similar operation, the overnight Lark between San Francisco and Los Angeles had already been switching out sleeping cars with the “Oakland Lark” at San Jose. The Oakland through car operations made the SP much more convenient for anyone living in the densely populated suburbs on the east shore of San Francisco Bay.

Suburbs on the San Francisco Peninsula, such as Burlingame and Palo Alto, grew quickly after World War II. Adding stops to the Daylight to serve these communities would have slowed the train’s schedule, so in 1955 Daylight coaches were added to local Commute train #110 out of San Francisco each morning. The train made all stops into San Jose where the through cars were cut into the Daylight along with cars from the Oakland section. This service lasted though September 22, 1960, after which the Coast Daylights began making a stop at Palo Alto to serve the surrounding suburbs. This saved the railroad the cost of switching the local cars.

The northbound Coast Daylight (#99) dropped through cars at San Jose in the evening, with some continuing to Oakland on train #255, the others on a commute local making suburban stops into San Francisco.

In the mid 1950s, The Daylight consist varied – a shorter train operated in the winter months, from 13 cars or less

[Text continues on page 75](#)



**Figure 11: All three trains have arrived in this view from White Street, next to the coach yard.**

**Figure 12: The Daylight and its connecting trains were all nicely arrayed before my camera, but I held off for a second and caught the three, with #4460, a GS-6 4-8-4, backing through the station on its way to the roundhouse after a commuter run.**







Figure 13: As soon the Daylight stops, the doors and passenger steps clank open and the conductors, trainmen and car attendants on the ground move like a military drill team because there are only twelve minutes to take care of passenger business, shuffle in the chair cars and get under way. Passengers are starting to board the train – the clock has started!



Figure 14: 0-6-0 #1221 with a chair car waits for the switchman to throw the points so it can back down the ladder track. Ten minutes left ...





Figure 15: C-8 Consolidation #2724 in yard service is waved to stop behind the observation car without coupling – something is wrong. The engineer (getting off the engine) asks in a gruff voice what happened. A crewman tells him that the air hose must have fallen off and they'd sent a guy to the roundhouse for another.

I hear several new words as the engineer tells the crew to pull an air hose off the back of his tender and use that – no one delays the Daylight! Soon the engine inches forward and couples to the tavern car, parlor car and parlor/observation car. Seven minutes left ...

Figure 16: While this was going on, #1221 had moved onto 4 track, coupled to train #250 and removed the second Daylight chair car – this one out of Oakland. He was now pulling both chair cars to 5 track to be coupled to the Daylight. Five minutes left ...







Figure 17: Engine #2724 (out of the photo on the left) is backing the tavern and two parlor cars from the Daylight.



Figure 18: #2724 backs beyond the signal bridge near the gasworks across Santa Clara Street, making room for engine 1221 to add its two chair cars.





Figure 19: #1221 with its two chair cars backs onto 5 track, clearing the switch. The switch will be lined for the platform 5 track and the cars will be pushed into place on the Daylight. Next, 1221 uncouples and reverses, moving to track 4 where it can back to the roundhouse.



Figure 20: Now #2724 pushes the final three cars of the Daylight into place, coupling gently behind the chair cars so as not to spill any of the breakfast coffee. The hoses are hooked up with billowing clouds of vapor as the steam line is connected.





Figure 21: A wave of the lantern signals that the cars are properly coupled with all hoses secure. The crewman lifts the uncoupling lever for the last time and #2724 backs over to 4 track, then backs up to the roundhouse. Twelve minutes has elapsed, and Daylight is ready to roll!

Figure 22: There were some lanterns waved, more clouds of steam and the Daylight began to move down the platform looking as sleek as Flash Gordon's rocket ship. In the shade of the canopy we could make out the faces of passengers getting settled in the chair cars, having breakfast in the diner and coffee shop car, then the train picks up speed – too fast to see much more than a blur of brilliant color.







Figure 23: As it sped from the station I could make out the red neon “Daylight” sign on the tail car receding in the hazy distance as the streamliner raced to make its evening appointment over 400 miles away in Los Angeles.

Figure 24: As we walked along the platform towards the pedestrian exit, there was the sound of diesel engines coming and a headlight. I pulled out my camera, focused, composed, shot. My friend laughed and told me I got a pig train!

The black diesels in full dress uniform of black red orange and silver with silver herald on the front passed with a trailer train – I realized he meant it was a “piggyback” train, maybe one of the Overnights that ran direct into San Francisco. The brick building is a Del Monte canning plant. What a morning!





Text continues from [page 68](#)

to full consists of 20 cars in summer time. Unfortunately, public timetables showing equipment do not correspond exactly with consist books, but generally there was one car switched from the commute train and one to the East Bay train in winter, with articulated pairs of cars switched during the summer.

With the issuing of new timetables, the departure and arrival times for the Daylight often changed slightly. I chose to represent winter of 1955 because this permitted using a short consist, (to fit better on a model train layout) and used both steam and diesel power and had both the commute train and East Bay cars being switched. Times shown are based on the November, 1955 Official Guide to the Railroads. (The Daylight only had steam power for one week into 1955 – the last run behind steam was made on January 7- but steam engines ran on most of the other trains for another year or two.)

In 1958 the Southern Pacific began simplifying the custom color schemes used on each of their trains, standardizing on stainless steel or painted steel car sides with a scarlet letter board and pale grey lettering, totally changing the appearance of the Daylight. When home-built full length dome cars became available in the 1960s, they replaced the tavern car on the Daylight, operating to the end of Daylight service. 

SOUTHBOUND COAST DAYLIGHT (MORNING) <small>Based on November 1955 time tables</small>										NORTHBOUND COAST DAYLIGHT (AFTERNOON)										
SOUTHBOUND					NORTHBOUND					SOUTHBOUND					NORTHBOUND					
Lvs. San Francisco	7:00	7:05	7:12	7:15	7:45	7:50	7:57	8:00	8:03	8:10	8:13	8:20	8:23	8:30	8:33	8:40	8:43	8:50	8:53	9:00
Lvs. Oakland Pier																				
Lvs. Fruitvale																				
Arr. San Jose	8:40	8:45	8:52	8:55	9:25	9:30	9:37	9:40	9:43	9:50	9:53	10:00	10:03	10:10	10:13	10:20	10:23	10:30	10:33	10:40
Lvs. San Jose	9:00	9:05	9:12	9:15	9:45	9:50	9:57	10:00	10:03	10:10	10:13	10:20	10:23	10:30	10:33	10:40	10:43	10:50	10:53	11:00
Arr. Los Angeles	4:30	6:00	6:00	6:00	6:45	8:30	8:30													

Schedule above shows the integrating and splitting of through trains at San Jose, California in November of 1955. Both the south and northbound operations are shown, as well as those for the Lark. (trains 75/76) The Daylight was allowed 12 minutes layover at San Jose in each direction. Southbound, the Daylight conflicted with the rush hour commute operation which is critical for there were only two platforms for both north and southbound movements. The illustration above was assembled from pages of the Official Guide to the Railroads.

Figure 25: This timetable is condensed from the Official Guide to the Railroads and shows the complete timeline for the Daylight at San Jose including the rail connections. During some years there were also bus connections – not shown. The guide is now available online in discs from several sources.

Figure 26: San Jose station timetable showing the through services switched throughout the day.

SOUTHERN PACIFIC R. R. SAN JOSE THROUGH TRAIN SWITCHING							
SOUTHBOUND	NORTHBOUND	SOUTHBOUND	NORTHBOUND	NORTHBOUND	SOUTHBOUND	NORTHBOUND	SOUTHBOUND
#90 Coast Mail	#75 Lark	#98 Coast Daylight	#77 Del Monte	#91 Coast Mail	#78 Del Monte	#99 Coast Daylight	#74 Lark
1:50am AR.	6:55am AR.	9:06am AR.	9:18am AR.	3:56pm AR.	4:53pm AR.	4:59pm AR.	9:50pm AR.
2:20am LV.	7:20am LV.	9:18am LV.	9:25am LV.	4:20pm LV.	5:05pm LV.	5:06pm LV.	10:15pm LV.
drops & picks up mail and express cars	splits off sleeping cars for #73 to Oakland	receives chair cars off #110 local & #250 from Oakland	from Pacific Grove-picks up coach for San Francisco	drops & picks up mail and express cars	To Pacific Grove-drops coach from San Francisco	drops chair cars for #255 to Oakland & for local to San Francisco	receives sleeping cars off #76 from Oakland

# MODELING THE DAYLIGHT AT SAN JOSE, CIRCA 1955

Southbound: train 98, commute train 110, and Oakland Daylight 250  
 Northbound: train 99, commute 151, and Oakland Daylight 255.

During the mid 1950s, The pride of the Southern Pacific Railroad, The Coast Daylight, ran with three sections coming together (southbound) at San Jose. Switching passenger trains on a tight schedule was usually as well choreographed as a Hollywood dance routine.

This makes an ideal operation around which to build a model railroad. The scenario can enliven operations of any model railroad simulating Southern Pacific's Coast Line, or it can suggest a freelance operation on a "home road" of the modeler's own creation.

Building my HO model of the Southern Pacific facilities at San Jose brought back the memory of my teen years, being awakened way before sunrise one chilly morning during Christmas vacation when visiting family in California, when I biked to San Jose with my friend Paco, (the only train enthusiast my age I knew) who lived nearby. We watched the commutes and saw the Daylight shuffled at San Jose. The couple of fuzzy black and white photos I shot with the family Brownie camera didn't survive the years and I've always wished I had some good photos of all the trains I saw.



## MODELING SAN JOSE OPERATIONS

This article focuses on the passenger operations at San Jose, but there were dozens of industries served by sidings in the immediate station area, as well as in all directions out of San Jose. Before the area was called Silicon Valley, it was known as the "Valley of the Hearts Delight" for all the fruits and vegetables grown in the area. There were two huge Del Monte canning plants among the industries served by the railroad in San Jose. A variety of steam freight power from 0-6-0 switchers to articulated cab forward engines were used with diesels until the late 1950s, before being replaced completely by diesels.

Track 1 was often used for mail and express cars, making for even more passenger train switching possibilities. Before Caltrain built a canopy over track 1 platform, it could be used as a freight bypass for there was no height obstruction. There was a dedicated freight bypass track on the opposite side of the coach yard for through freight traffic.

Figure 27: 1950s era track diagram of the San Jose station area. It shows the main coach yard for San Jose commute trains and all the station platform tracks. Track 1 did not have a canopy and could be used by freight trains if need be. Outside rush hour, mail and express cars could be unloaded and handled in the mail and express building attached to the station at the south end. Passenger platforms were reached by pedestrian underpass, but photos show commuters running across the tracks. This line has been called the busiest on the SP system, and also the busiest line west of Chicago, and this was probably true, for there were through and local freights in addition to very busy commuter service between San Jose and San Francisco.

The prototype station area (figure 27) is over 3000' from end to end, but the model only needs to hold your longest

train. The design shown in figure 28 uses five tracks to provide for freight and passenger trains. The connection to track 1 is north of the station, but is shown here to make a more compact station layout.

The arrangement shown could be fitted nicely into a dog-bone type layout. I prefer to hide the loops of a

dog-bone with scenery or in tunnels with industrial trackage above. The loops represent San Francisco and Los Angeles. This permits operation of both freight and passenger service with very dense traffic. Outbound trains can be stored on the loop track, to be "dispatched" back onto the mainline as inbound traffic when the operator has time. The dog-bone has

Figure 28: I suggest modeling only the essential trackage to simulate San Jose. More tracks and turnouts can be added if you have more space.

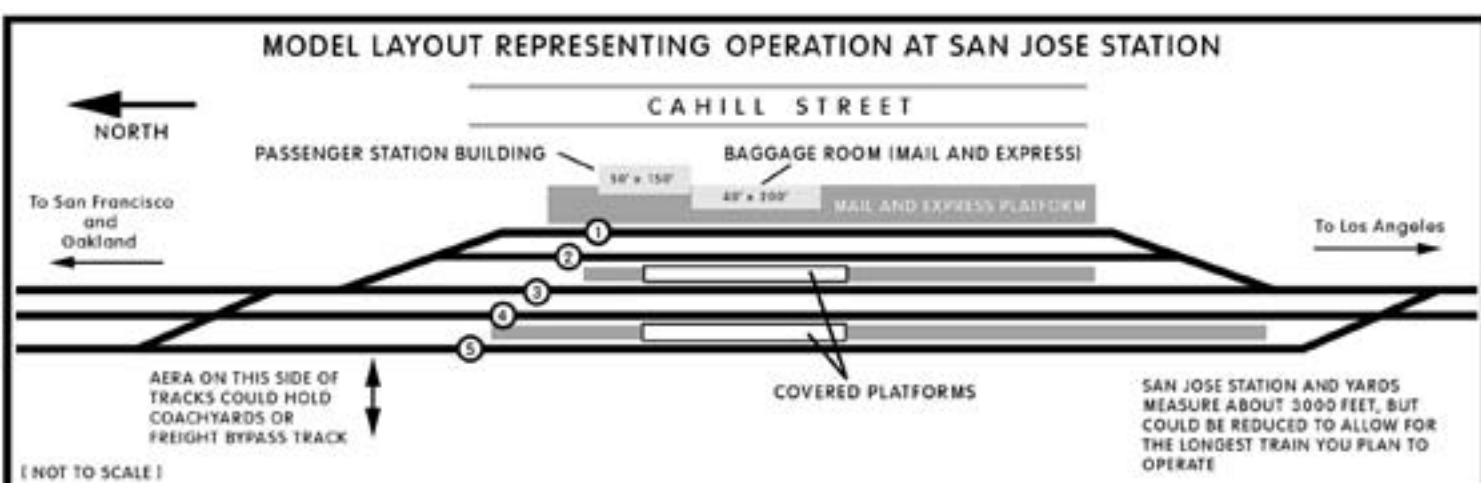
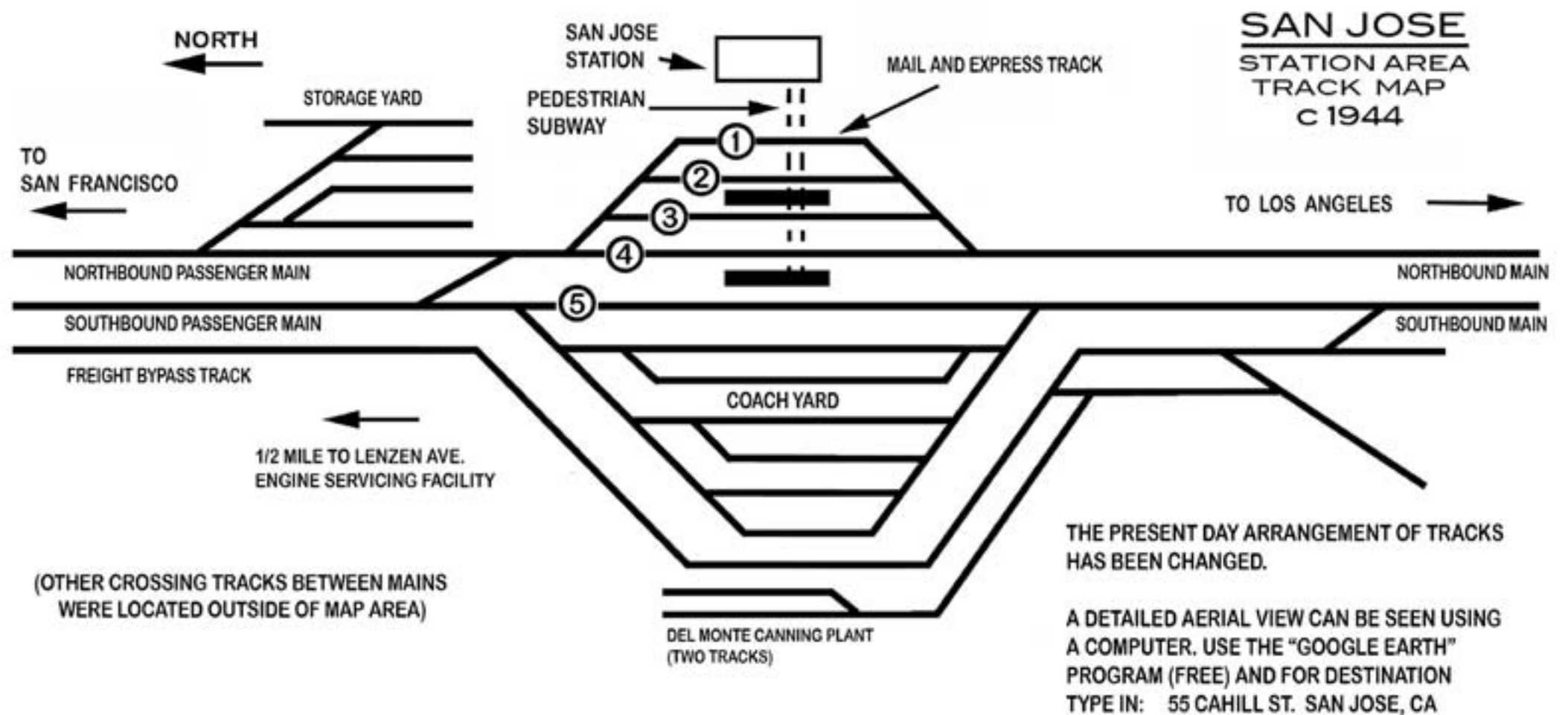



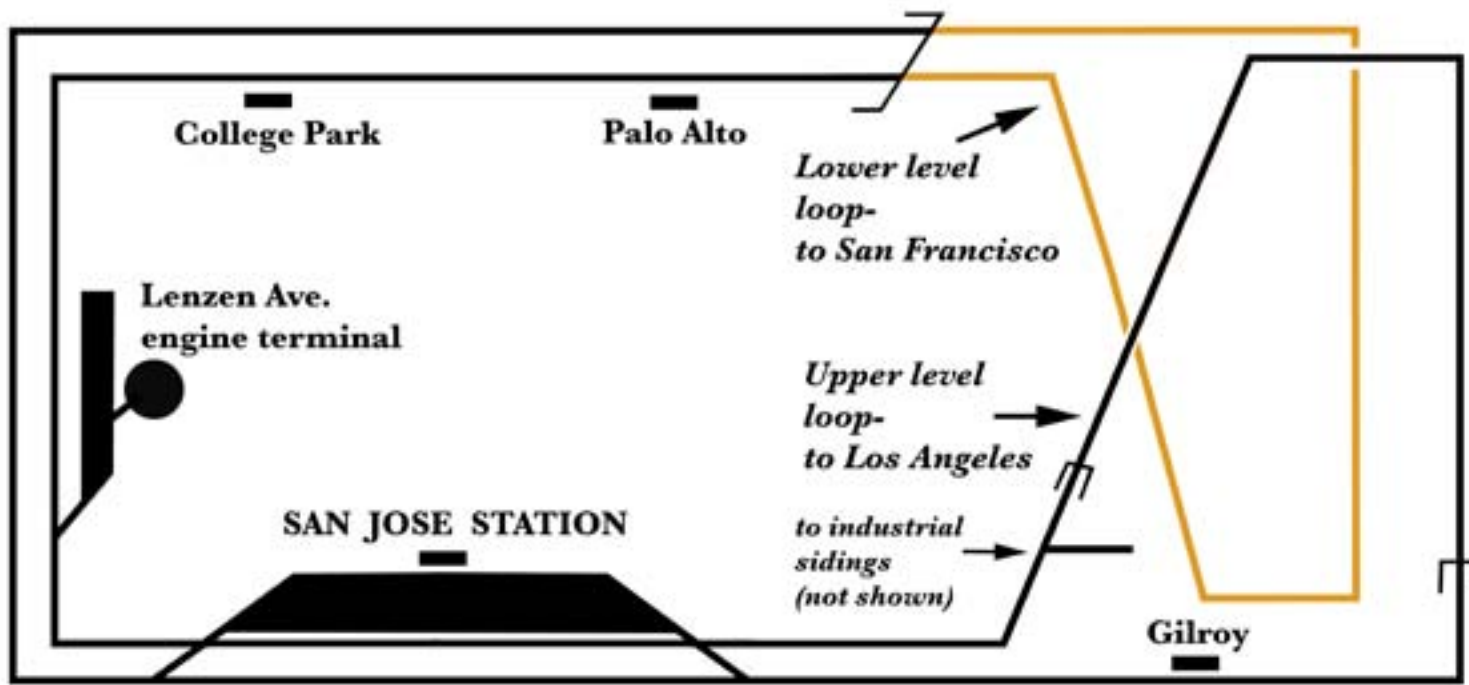

Figure 29: A folded dog-bone layout emphasizing San Jose passenger operation. The end loops are Los Angeles and San Francisco on the other. Hiding the loops makes the space above them available for industries or classification yards for freight service.

the advantage that visitors may enjoy seeing trains run around continuously, for trying to switch a train can be boring any visitors who are not train fans.

The passenger oriented track-plan shown is intended to permit simulating the through train operation at San Jose. This could be simplified to fit on an even smaller home layout by eliminating one or more tracks. Likewise, it could be expanded to full scale by adding coach yard tracks and engine tracks.

To see the arrangement of San Jose today, install the Google Earth program on your computer and type in: Caltrain Station, San Jose CA. It is possible to zoom in for very detailed pictures down to the ties.

The present arrangement of the prototype station is different – old photos show the mail and express track was originally set in pavement, and the

platforms had no canopies. By the late 1940s or early 1950s platform canopies were in place on tracks 2-3 and 4-5 with a new canopy on track 1 being added by Caltrain, probably in the 1980s.

Space west of the station, now used by the light rail system, had coach yards and a single track for a freight bypass of the station area, and sidings into Del Monte canning plant 51 which are now eliminated. The old gasworks is now the HP Arena, and on the south end, a large power substation and high tension lines were installed around 1960.

The old coach yard space is now used for light rail including a ramp up from the short light rail subway running eastwards. The canning plant is about half gone, and the brick shell has been retained in new condos. There was a second coach yard just north of

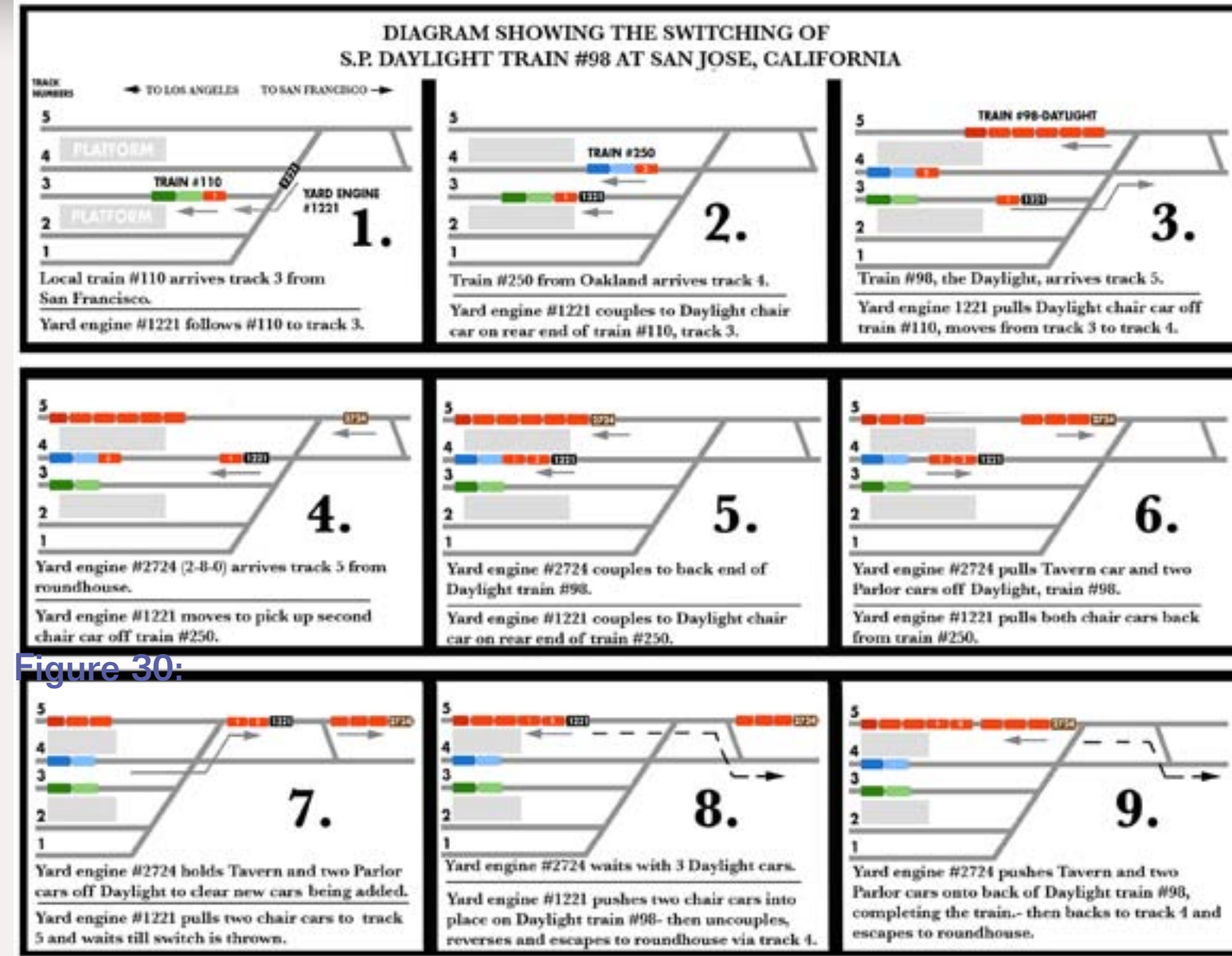

Figure 30:

Figure 30: Switching the Daylight using two yard switchers. There are not many other possibilities considering the work had to be done in twelve minutes! [Click here for a full size image.](#)

the station across Santa Clara Street (figure 27).

Other passenger switching at San Jose included the Coast Mail which picked up and set out a lot of mail and express cars. The overnight San Francisco to Los Angeles Lark had an Oakland connection similar to the Daylight in the evening southbound, and in the morning northbound. A second section running a little late could interfere with the Daylight operation making for interesting situations. Additionally the Del Monte

train from Pacific Grove picked up a coach on the way into San Francisco in the morning running northbound and dropping one southbound in the evening (figure 25).

Commuter consists arriving southbound were cut from their road engines and moved to storage tracks by yard engines. Turning and maintaining commuter and local freight engines happened at the nearest turntable – a few blocks north at Lenzen Avenue. There was also a convenient wye track which SP



# SOUTHERN PACIFIC RAILROAD

CIRCA 1955-58

## CAR-SEATING ARRANGEMENTS FOR COAST DAYLIGHT TRAINS #98 - 99

WINTER CONSIST IS SHOWN

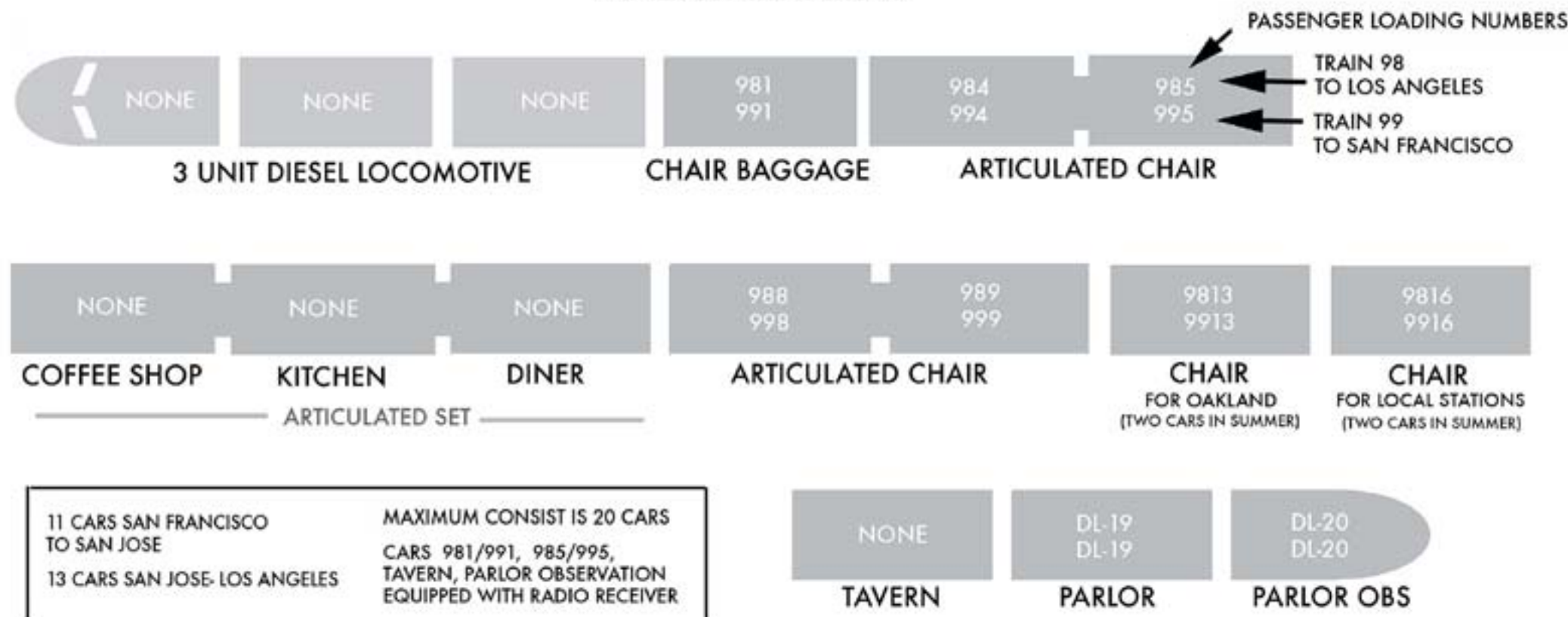

FIVE ADDITIONAL CHAIR CARS, PLUS THE LOCAL AND OAKLAND CARS WERE ADDED IN SUMMER DEMAND SEASON, TOTALLING 20 CARS

yards, can greatly increase interest and action on a model train layout.

Today, the mighty Southern Pacific is gone, integrated into Union Pacific. The commuter line to San Francisco is run by Caltrain, a statewide operating authority, and former long distance SP passenger trains are now run by Amtrak. In addition to the variety of light rail and bus connections, within a few years it is expected to see BART (Bay Area Rapid Transit) entering the San Jose Station too. None of this could have been foreseen while I was growing up when there were fewer and fewer passenger trains running each year, and the end of public transportation seemed imminent. ✓

Figure 31: The arrangement of cars on the SP Daylight in the mid 1950s – date unknown, but as all three sections are described, it was probably between about 1955 and 1959.

employees report was used for large engines or during peak periods.

At the south end of the station area two tracks ran towards Los Angeles, with a branch extending to West San Jose and prior to the 1930s, over the mountains to Santa Cruz on the old South Pacific Coast right of way. This line was cut back to Los Gatos in the 1950s and is now the truncated line to Campbell used for light rail. Commuter trains ran to Los Gatos from San Jose until the early 1950s, and from San Francisco, branching off on the Vasona line at California Avenue in Palo Alto. 4-6-2 Pacific

steam engines ran around the train at the end of the branch and ran backwards back to San Jose where the coaches were stored at San Jose overnight – another possible operation that could be included on a layout.

### MORE ON PROTOTYPE OPERATIONS

There were many other passenger trains being shuffled, and some of these can be simulated on model train layouts. Even today, Amtrak has to shuffle some trains. Passenger operation in conjunction with the more commonly modeled freight

Figure 32: Engine 5600, a GP-9 in off hour commute service with a single gallery type bi-level car at Hillsdale, CA. The first group of SP passenger geeps such as this one had the older cast GP-7 handrail stanchions instead of the pressed metal ones used on most GP-9s. I missed this detail and will change my Proto 2000 models of this class - photo courtesy Bob's Photos.







Figure 33: The Daylight pauses around 1955. A tavern car is shown with the car attendant of the parlor car on the right, with his Daylight painted passenger step. The door is swung inwards to open it, then the trainman or car attendant presses a foot treadle which lifts the vestibule trap cover (hinged floor section) and rotates the steps down into position - *photo courtesy Bob's Photos.*



Figure 34: An articulated two unit chair car. The square recessed door next to the passenger entry is a dumbwaiter (also called a baggage elevator), it permits quick loading of passenger carry-ons without blocking vestibule steps at stations. The photo can be dated in the mid fifties – the car is still in Daylight colors but already has its skirting removed - *photo courtesy Bob's Photos.*

Figure 35: A mid 1950s view of the Daylight leaving San Luis Obispo, CA. This view shows the parlor observation car with its red neon tail sign. Notice the triple bolster trucks. San Luis is close to the mid point between San Francisco and Los Angeles. In the days of steam, locomotives were changed here - *photo courtesy Bob's Photos.*







Figure 36: The current San Jose station. The SP opened it in 1935 after a massive relocation of railroad tracks from the middle of 4th Street. SP architect John Christie designed the building in the Italian Renaissance Revival style. It's similar to the Sacramento station with its large arched windows. The 40 x 80 main building is steel framed, and wings are framed with wood, all clad with variegated blonde brick laid in English Bond pattern. Its total length including the mail and express wing on the left is 390 feet - *Craig Walker photo.*

Victor talks about the Daylight and this article on video.

Victor is a native New Yorker, but he's also lived in California and Arizona over the years. He got his first trains, a Lionel, at age 3. He been modeling since he built an oil storage tank from a coffee can with a paper wrapper and emblem from a gasoline company map. He graduated from the Pratt Institute with BFA and MS degrees and taught fine arts in high and junior high school for 30 years. Victor is now retired.

Victor has written many articles and several railroad related books over the past 35 years. He's done freelance projects for Walthers, Atlas and other model manufacturers.

His article More Realistic Model Windows appeared in MRH issue 4, Oct, 2009.





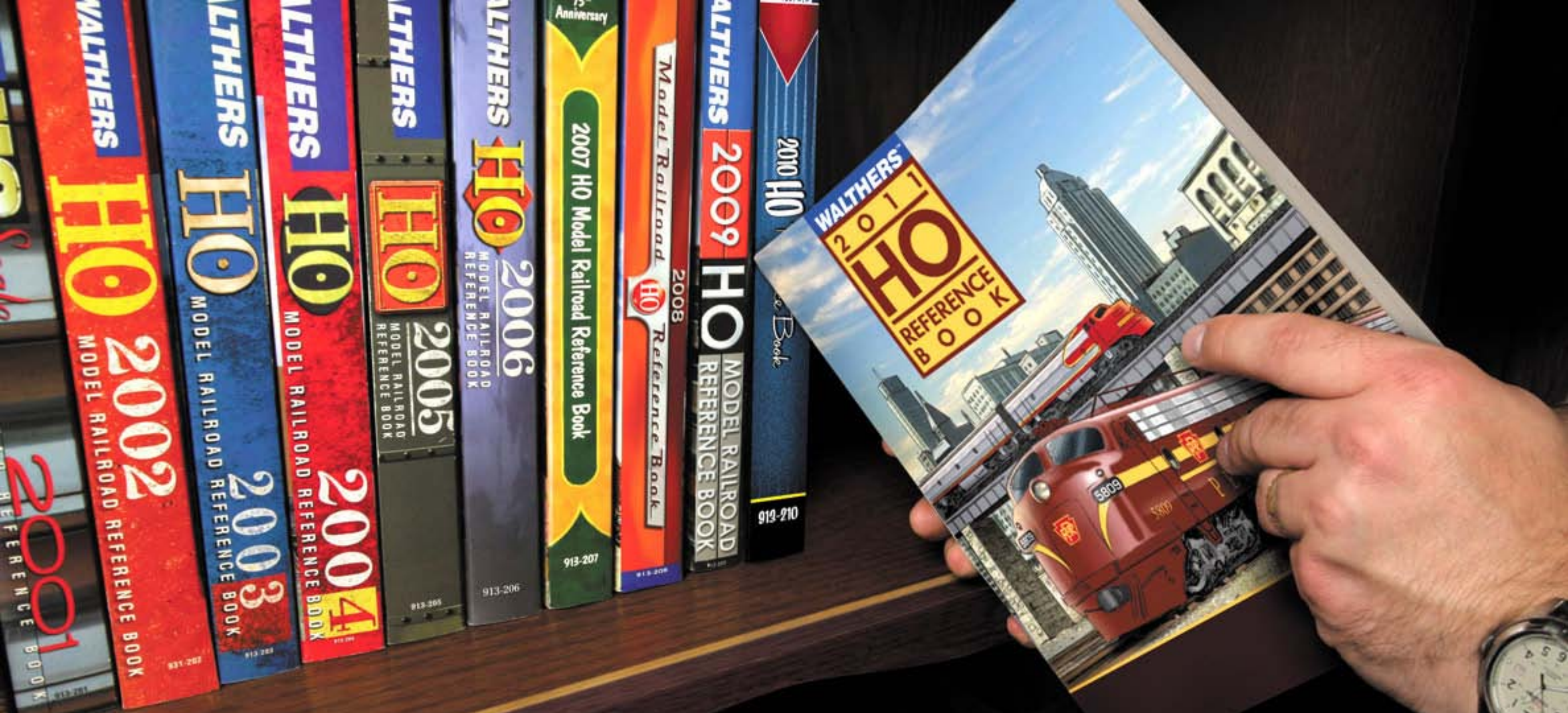

# Today's Reference... for Years to Come.

There's something special about Walther's Reference Books. The smell of ink, the feel of crisp paper. How about the thrill of seeing a must-have item or being inspired to start a new project? Maybe it's the memories of models built in the past. For decades, Reference Books have brought model railroad plans and dreams to life. With their unique mix of products, photos, modeling tips and more, they're a must-have planning guide today, a great source of research information and a fun look-back in future years. The 2011 books are coming soon so reserve your copy today.

Walther's 2011 HO Reference Book  
913-211 September Delivery \$15.98

Walther's 2011 N&Z Reference Book  
913-251 October Delivery \$15.98

To order your book, see your participating dealer, call us at 1-800-487-2467 or visit [walthers.com](http://walthers.com)



©2010 Wm. K. Walther's, Inc.



Customers' #1 Comment -  
**“Why didn't I do this  
sooner?!”**

- Extraordinary Performance
- Radio or Tethered
- Highest Rated DCC System
- Made in the U.S.A.



**Discover the FUN**

Call or Email  
for FREE Brochure  
support@ncecorporation.com

585.265.0230  
9am-4pm EST.  
www.ncedcc.com

**NCE**  
*The Power of DCC*





# INEXPENSIVE MOLDS FOR AN INFINITE VARIETY OF ROCK CLIFFS AND CRAGS

**An easy way to make quick rock molds ...**

— by **Roy Buchanan**  
*photos by the author*

 **Reader Feedback**  
*(click here)* 

**W**ith a two-tiered logging layout measuring 7.5 feet by 10.5 feet, I knew that I was going to use modeler’s license when it came to making mountains. Vertical rock faces and a deep gorge would be necessary.

I looked at purchasing commercial rock molds, but after using a couple of a friend’s molds I realized that repetition was going to be a problem in my small space. Cost was also a concern,

not only for the molds, but also for commercial casting mediums like liquid latex. I tried tinfoil molds and while they work well, I just wasn’t satisfied.

While considering my options I searched various model railroad forums for “rock molds” and found a post where a model railroader mentioned that he used kitchen and bathroom silicone to make his molds. I apologize for not being able to relocate that post and give credit where

due. A heaven-sent message, you might ask? Not quite – there was a learning curve.

The materials and tools required are easily obtainable.

**Materials:**

- rock master
- clear kitchen and bathroom silicone
- used dryer sheets (flattened with an iron)

- water with a few drops of dish soap to make “wet” water

**Tools:**

- caulking gun
- paint brush
- large scissors
- small blocks of wood
- rag (to wipe silicone off fingers)
- old towel or sheet (to protect work surface if needed)

I try to keep my molds under 6 inches over the longest length and about 3/8” to 1/2” deep, if the master allows. There will be times when you’ll want to make deeper molds for protruding cliff faces. Your own experience will prevail here, but I try to keep deep molds to a maximum of 1 inch. Using molds of this size makes mixing the casting medium easier and minimizes waste.

Try not to use master rocks that have deep holes or overhanging protrusions. Features like these will shorten the life of the mold and make removal of castings difficult. Also, the silicone won’t want to separate from the master on overhanging protrusions.

Using this procedure has enabled me to make a wide variety of molds of different types of rocks. I have shared my molds with a friend who has a large railway. Some of the molds have now made dozens of castings using Plaster of Paris and a hard commercial casting plaster. So far none of the molds have worn out or cracked.



## STEP 1: Preparation



Figure 2. Master wetted with “wet” water.

After you have cleaned the master, saturate the area to be molded with “wet” water using a paint brush. Block the master in position on your work surface with the area to be molded on top. (Area to be molded is outlined in white in the photo.)

## STEP 2: Laying Silicone



Figure 3. Placing silicone beads onto the wet master.

Lay beads of silicone side by side over the top of the master and loop them over the edge to the depth desired for the mold. Regardless of how deep you make the mold, casting thickness is determined by the amount of casting medium used when making a casting.



### STEP 3: Smoothing the Silicone



Figure 4. Patting the silicone into place.

Keeping your fingers wet with the “wet” water, work the silicone until the beads have been manipulated into a uniformly smooth surface. Making the surface uniformly level is not necessary. What you want to achieve is a smooth even surface over the master about 1/16” to 1/8” thick. Use firm pressure to ensure the silicone beads blend together and have been worked into all of the cracks, crevices, and surface irregularities of the rock master.

Make sure any protruding areas of the master are adequately covered.



Figure 5. First layer of silicone smoothed out.

- a. It is not possible to use too much water during this stage – keep your fingers wet. The silicone will force excess water out from between the beads and away from deep areas of the master. If silicone does adhere to your fingers, wipe it off immediately and re-wet your fingers.
- b. Failure to press firmly will result in voids on the molds which will show up as small ridges on your castings.



## STEP 4: Reinforcing the Silicone



Figure 4. Used dryer sheet with cut corners.



Figure 5. Folding and securing corners with silicone.

Once you are satisfied with the first layer of silicone, lay a flattened sheet (or strips) of used dryer sheet over the silicone and pat this firmly into the surface. Remember to keep your fingers wet.

a. It will be necessary to fold the corners of the dryer sheet to achieve overall contact between the silicone and the dryer sheet. After you have cut the dryer sheet at the corners, or bulges, and folded the first flap, apply a small amount of silicone over the first flap and under the second flap to be folded down. Pat the folds into place and top with another small dab of silicone to ensure the corner stays locked.

Doing this not only locks the dryer sheet into the corners, but also strengthens the corners. Because most masters are irregular, you may also have to snip bulges along the sides of the dryer sheet and lock into place with silicone.

b. If your master is irregular in shape, then  $\frac{1}{2}$ " – 1" strips of dryer sheet will work better. Ensure any overlapping sections of dryer sheet strips are separated by silicone and pressed firmly into place.



Figure 6. Mold with sealed corners.



## STEP 5: Second Layer of Silicone



Figure 7. Applying second layer of silicone.

After the dryer sheet is bedded firmly in place, bead a second layer of silicone over the dryer sheet and pat into place. Try to eliminate air voids however, small voids are inevitable but will not cause problems. Some irregularity along the edge of your mold between the two layers of silicone is likely to occur. Don't worry about this; the last step will solve this little problem.

a. Once you are satisfied with the mold, let it cure for 8 to 12 hours. The mold will feel firm to the touch when the initial curing stage is complete. The thickness of the silicone will determine the curing time. If the mold feels spongy, or soft, let it set for a few more hours. My molds usually are about 1/8" thick.

b. Out-gassing will continue for a few days, so wait before using or storing the mold inside the house unless you like the smell of silicone.

## STEP 6: Removing and Trimming the Mold



Figure 8. Trimming the mold.

When the mold is firm, you can remove it from the master. Trim the excess dryer sheet and the edge of the mold to the desired depth with the scissors. Both layers of silicone and the dryer sheet should be visible along the edge. Don't worry if you find a few areas on the edges where the silicone and dryer sheet didn't adhere.

Apply a bead of silicone around the edge of the mold and pat it into any voids along the edge to bind the two layers of silicone and the dryer sheet together (Figure 9).

Let the edge bead cure.



## STEP 6: Removing and Trimming the Mold *Continued ...*



Figure 9. Applying the edge bead.



Figure 10. Finished mold.

## Summary

After the edge bead has cured, you are ready to start casting rocks. Coat the mold with “wet” water prior to filling with your casting medium. However, silicone is naturally slippery, so if you forget this stage, don’t worry – the casting will easily separate from the mold.



Figure 11. A rock face made from castings using my silicone molds.



Figure 12. Some of my molds and castings made from them.



Most of my molds are a bit irregular. I use a box filled with foam packing “popcorn” to support and level the molds. A friend uses a box of sand. You will need to support the molds, keeping them level during the casting process to avoid overflows.

Start with small molds and be patient. Once you have mastered the process, making a new mold is easy. With a little practice, you’ll soon have a wide variety of inexpensive rock molds. Cast away and build those mountains!



Figure 13. Foam “popcorn” keeps the molds level.



Roy modeled CP and his private Ghost River Railway in the 70s and early 80s while stationed in Calgary with the Canadian Army. A transfer to Vancouver Island in the mid-80s necessitated a break from model railroading due to the demands of his military career.

Roy retired from the army in 1993, but it wasn’t until the fall of 2009 that circumstances allowed him to re-enter the hobby and begin building his new layout. The Ghost River Railway is a freelanced logging and mining subsidiary of the Canadian Pacific Railway set in the transition era.

Roy and his wife Anne live in Port Alberni on Vancouver Island.

# D e r a i l m e n t s

humor (allegedly)



Early intermodal experiment: After several tests, the railroad decided to load trailers on trains rather than trains on trailers.

*Fred:* Ya know, I’ve been hanging around your railroad room for near ten years now...

*Earl:* Sure, that sounds about right.

*Fred:* And you sure got a bunch of nice trees and bushes and stuff growing here. But I’m kinda puzzled.

*Earl:* Why’s that?

*Fred:* Well, they’re always nice and green and healthy looking, but they never seem to get much bigger. How come?

*Earl:* Bonsai.

Got a good bit of humor? If you’re the first to [submit it](#) and we use it, it’s worth \$10!





# Southern Digital

Specializing in DCC Since 1992

**20% Discount  
on most items!**

DCC Conversions  
DCC Support  
Loco Repairs  
and service.

[www.sodigi.com](http://www.sodigi.com)

(770) 929-1888



**DigiFrame Kit**





# Because a little protection ... goes a long way!

Crossings, Block Signals,  
accessories  
and more



*click for more ...*



[www.njinternational.com](http://www.njinternational.com)

N. J. International (480) 219-4135 [signals@njinternational.com](mailto:signals@njinternational.com)



# HUGE BATHROOMS!



**Let your passengers go in style aboard the new  
Osgood Bradley Deluxe Coach.**

***Click here.***



# Zip Texturing

## Weathering Powders

— by Joe Fugate  
photos by the author



Figure 1: I've used zip texturing weathering powders throughout this scene on my Siskiyou Line Coos Bay branch: on the tunnel portal, on the track, and on the rock outcropping on the left. Weathering powders help tie everything together and give your scenic elements a believable look of having endured wind, weather, and the passage of time.



**Take Zip Texturing to a new level by making and using your own multi-purpose weathering powders ...**

**L**ooking for an inexpensive new weathering approach to get that dusty, dirty look common to the real world? Look no farther than zip texturing's new cousin, weathering powders.

As I continued to experiment with zip texturing, I developed a special type of zip texturing I've dubbed "weathering powders". Weathering powders can be used for all kinds of things: weathering structures, weathering track, weathering locos and rolling stock – and of course, for "weathering" rocks, trees and other natural scenery elements (more on this later).

I use a lot less plaster in the zip texturing formulas for weathering powders, and when I mix them up, I make a much smaller batch. Most commonly, I mix a few tablespoons of a weathering powder.



## Common Weathering Powder Formulas

I've developed standard weathering powder formulas for things like mildew, soot, dirt, slime, grease, grime, rust, and so on. You can (and should) vary these formulas as needed to fit the particular area you're representing in your modeling.

### Mildew

3 parts black  
2 parts brown  
1 part yellow  
5 parts plaster



**Applications:** Any areas that get a lot of moisture, as in evaporation, dew, or runoff from rainfall. Dark mildew is common on older concrete in more humid climates, and on rocks near watercourses.

### Dirt - Brown

1 part black  
2 parts brown  
3 parts plaster

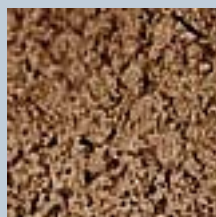

**Applications:** Around the base of structures, on rocks of all kinds, on bridge abutments, and on the lower extremities of rolling stock and locos. Match to the dirt color of the location you're modeling – or the home location of the loco and/or rolling stock.

Like zip texturing, it's the plaster in the mix does the magic. The plaster acts as a binder – just mist the weathering powder with some wet water and let it set up to fix it in place.

These weathering powders are semi-permanent once the plaster sets up. For ordinary scenery elements like

### Grime

2 part black  
1 part brown  
6 parts plaster



**Applications:** Anywhere you want to indicate the general effects of dirt and weather, especially on rolling stock and locos. Grime is a good general purpose weathering powder you can use most anywhere as weathering.

### Dirt - Red

2 parts brown  
1 part yellow  
9 parts plaster



**Applications:** Around the base of structures, on rocks of all kinds, on bridge abutments, and on the lower extremities of rolling stock and locos. Match to the dirt color of the location you're modeling – or the home location of the loco and/or rolling stock.

structures or track, the weathering is quite permanent.

But for something that gets a lot of handling like locos and rolling stock, the weathering does wear off. We'll cover how make the weathering powder more permanent later on in this article.

### Grease

1 parts black  
1 part brown  
4 parts plaster

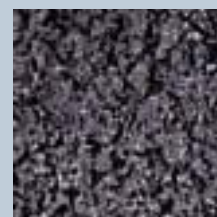

**Applications:** Use in industrial areas where fossil fuels and lubrication use is common. Can also be found on the track in shop areas, around flange greasers, in parking lots, and down the center of highway lanes. Use any place you want to simulate an oil spill or splatters from grease. Can be used in combination with other weather powders to model the presence of grease and dirt buildup.

### Dirt - Tan

1 part black  
1 part brown  
1 part yellow  
6 parts plaster

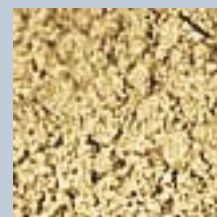

**Applications:** Around base of structures, on rocks, on bridge abutments, and on lower extremities of rolling stock and locos. Lighten a shade with more plaster to simulate loco sand spills on trackwork grades.

## Usage examples

As a kind of zip texturing, weathering powders generally have more pigment and less plaster – which makes their color more intense.

I've found a number of great uses for weathering powders: trackwork,

### Soot

1 part black  
1 part plaster

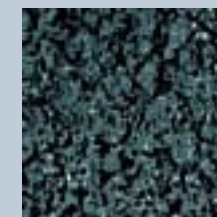

**Applications:** Near or on smoke stacks or chimneys of all types. Soot can also be common on railroad tracks at the bottom of grades or where locos start heavy trains. Soot can be found on rolling stock and locos in the steam era. You may also find soot on diesels, especially if they travel through tunnels (the exhaust knocks steam-era buildup off onto loco roofs).

### Slime

2 parts yellow  
2 parts blue  
1 part black  
5 parts plaster

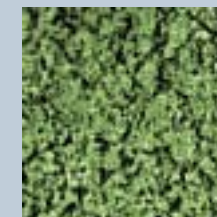

**Applications:** Near the water line on docks, pilings, and rock rip rack. Around constantly wet locations like air conditioners or fountains. Can be seen on boats both in and out of the water in aquatic areas. Often mixed with mildew.

structures, locos, and rolling stock being some of the more obvious things that need weathering.

Weathering powders also work great for weathering rockwork and along the banks of a water course. They also work great for adjusting the coloration of zip texturing dirt areas.



Let's look at each of these usage examples more closely.

**Trackwork:** If you study prototype track photos you will quickly notice the track often weathers differently down the middle than it does along the outside edges.

I've found the weathering powders make a quick and easy way to get a realistic dusty weathering look to my trackwork.

The prototype SP Siskiyou Line has a lot of dark greasy soot down the middle of the rails, as you can see in Figure 2. I just dust my soot and grease weathering powders down the middle of my track, mist it with water to set it up – and I'm in business (Figure 3)!

On sidings, spurs, and Coos Bay branch line, I use a lot of my tan dirt weathering powder to give the track a realistically dusty, dirty look. Since I'm also using tan dirt as the base dirt color on a lot of my layout, this ties the track into the rest of the scenery nicely.

If I want the track to be extra dirty, I brush on more of the weathering powder while the track is wet from being misted with wet water<sup>1</sup>.

**Structures:** Besides the obvious weathering that can be applied to  
*text continues on page 98 ...*

<sup>1</sup> You make wet water by putting a few drops of liquid soap into the water. This breaks the natural surface tension of the water and allows it to soak in much more readily.

**Figure 2:** There's nothing like looking at prototype photos to guide more realistic applications of weathering powders. In this 1980s photo of the SP Siskiyou Line tracks in Roseburg, Oregon, you can see the dark greasy soot-like weathering between the rails.

Many of the locations on the prototype Siskiyou Line have this characteristic dark weathering down the middle of the tracks, so I've tried to duplicate that on my layout using weathering powders.

**Figure 3:** Here's my trackwork with the weathering powders applied. I used HO code 83 Micro Engineering (ME) flex track in the front to represent the Siskiyou Line main. The track in the rear is code 70 ME flex track and represents a passing siding.

Notice how I've weathered the two tracks differently. The main has the characteristic Siskiyou Line soot and grease weathering powders applied, while the siding has tan dirt weathering applied.

I also painted the rail sides of the main using PollyScale Rail Brown and painted the siding rail DRGW Depot Buff, which makes a great "dusty rust" color for rail.

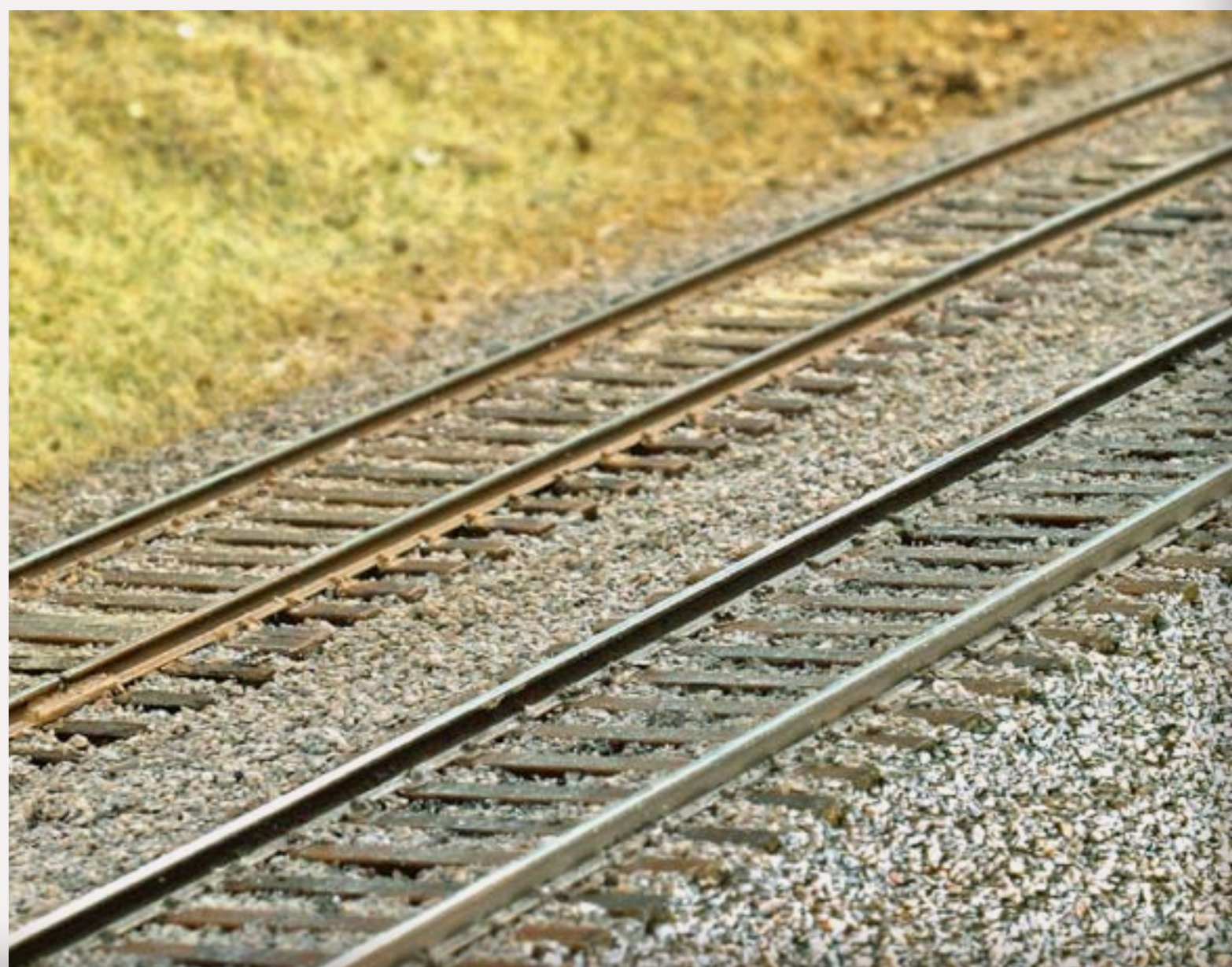





◀ Figure 4: I'm applying some of my tan dirt weathering powder to the lower areas on this SP tool shed as weathering.

Adding weathering powder that matches your layout's basic dirt color to the lower part of your structures anchors them realistically in the scene.

Well maintained structures like homes have less of this weathering, but railroad and industrial buildings often exhibit heavy weathering from less rigorous maintenance. Weathering powders make this simple to add.

## What happened to blue?

Last issue when I introduced my updates to zip texturing, I included blue as a color you needed, but then I never gave any formulas that used it.

In this issue, you can see some of the weathering powder formulas use blue, so I've somewhat vindicated myself.

However, it's worth mentioning that I sometimes add a little blue to my zip texturing mixes, along with a little black, when I want to shift the zip texturing color for use near the backdrop.

Putting in the blue and black adds a realistic sense of distance to the coloring, which is exactly what happens to colors as they recede into the distance. ■

Figures 5 and 6: Weathering ► powders work great for getting the grungy look that was typical of SP locos in the 1980s.

For this Cotton Belt GP40R, I covered the number boards and windows with masking tape cut to fit to protect them. Then I first applied a liberal coat of soot to the entire loco to get a dark faded look all the lettering.

Next I misted the loco with wet water to set the powder in place. While the loco was still damp I applied brown dirt and grime weathering powders to the roof areas, bushing in the direction rainwater would flow. I also hit the back 2/3rds of the roof with another application of soot.

Once dry, I fixed it all in place with an overspray of dullcote.



Figure 5



Figure 6





Joe Fugate models the 1980s Southern Pacific Siskiyou Line in southwestern Oregon and has documented his layout in a series of 5 videos available from [Model Trains Video](#).

Besides being the publisher of *Model Railroad Hobbyist* magazine, Joe has been published a number of times in the hobby press and has done video work under contract for *Model Railroader*.



Figure 7



Figure 8

Figures 7: Keep in mind when applying weathering powders to locos and rolling stock that applying a permanent matte coating to protect the equipment from handling subdues the weathering noticeably. Here, I'm applying tan dirt along the lower extremities of the Georgia-Pacific boxcar. I misted the car with wet water so the plaster in the weathering powder would set up and fix the weathering in place. Once the car had dried thoroughly, I sprayed on Testors Dullcote and let it dry.

Figure 8: The results after the Dullcote. Notice the weathering looks a lot more subdued than it did in Figure 7. I happen to like the more subtle look of this weathering, but if I wanted something stronger, I would apply a strong second coat of weathering and then spray on more Dullcote. I sometimes add 3 or 4 layers of powder and Dullcote to get the look I want.



... continued from page 95

buildings, structures include things like bridges, bridge abutments, and tunnel portals.

For buildings, I often apply a dirt powder weathering mix corresponding to the dirt color that's common on my layout – in the case of my Siskiyou Line, that's tan dirt. See Figure 4.

For bridges, bridge abutments, tunnel portals, and other concrete structures I typically use a mixture of gray dirt and mildew. See the video for application details.

**Locos:** The Southern Pacific has a long reputation of seldom washing its diesel loco fleet, especially in the roads later years of the 1980s and 1990s.

Since I model the 1980s, grungy weathered diesels are a fact of life for me.

In Figures 5 and 6 I show how weathering powders do an effective job of conveying this grungy, greasy-soot look. About all I do is “slop” the powder on and let the water and powder do all the work of creating the subtle variations.

One trick is to apply more weathering powder while the model is still damp from the wet water application. I brush in the direction rain water would flow to create dirt and grime streaks common on outdoor objects that go through rain and weather.

**Rolling stock:** If the SP didn't wash their locos, you can bet they didn't waste time washing their rolling stock!

The techniques I use for locos also apply to rolling stock, although there will be less grease and soot than on locos. See Figures 7 and 8 for a rolling stock example.

**Rockwork:** As I showed last issue in my zip texturing article, using weathering powders on rock faces adds a most realistic look of age to rock faces.

The video demonstrates applying weathering powders to rockwork.

**Water courses:** Weathering powders work great for adding extra color variation along the banks of a river or stream, and along the shore of lakes or ocean beaches.

See the video for some example applications of this technique.

**Dirt areas:** Once I've zip textured an area, I've found it convenient to use weathering powders to adjust the dirt color when needed.

Check out the tunnel portal and bridge installs on the video for examples of how this works.

Now that I've been using zip texturing weathering powders for a couple decades, I can't imagine how I ever did without them before. Try 'em, you'll like 'em!

## Preventing your weathering from wearing off



I use “rattle can” matte fixative spray on weathering powder applications where I expect the model to get a lot of handling.

I don't concern myself with applying any fixative to structures, rockwork, etc. since they don't get enough handling for wearing off to be a concern.

However, locos and rolling stock *do get a lot of handling*, so I use Testor's Dullcote or Krylon UV-resistant Matte spray to protect the weathering.

Be aware that using a fixative matte spray causes the weathering powders to become less apparent. To compensate for this, I tend to overdo my weathering powder application on locos and rolling stock.

After misting my model with wet water, I often will apply still more weathering powder to the moist surface,

which significantly increases the amount of weathering on the model.

After the wet water has dried, I'll then dust on a third layer of weathering just for good measure. If the weathering powder application looks overdone, it's probably about right.

Once I spray the matte fixative spray on, much of that excess weathering powder application disappears.

If too much weathering disappears, once the fixative spray has dried, I'll repeat the three-step process outlined above and then apply another coat of fixative spray.

If you prefer to use an airbrush to apply your matte spray, Testor's Dullcote comes in bottles. Testor's Dullcote is laquer-based, however. If you prefer a water-based matte formula, you can use Microscale's Micro Flat. ■





Some of the finest trees in the hobby ...

... available in any scale!

CANYON CREEK  
**SCENICS**

canyoncreekscenics.com

click to visit our web site

# LISTEN UP!

SPONSORED BY:  
THE MODEL RAILROAD  
HOBBYIST MAGAZINE

The  
**Scotty Mason Show**

THE FIRST INTERNET  
MODEL RAILROADING  
**PODCAST**

Get the Latest Model Railroading  
News, Tips, Reviews & Opinions  
From These Knuckleheads.

Scotty Mason

Jimmy Deignan

Dave Frary

Doug Foscale

Available here or on iTunes

[www.modelrailroadpodcast.com](http://www.modelrailroadpodcast.com)



# Benchwork without tools - 22 stories up!

Building benchwork for an apartment  
railroad – on the far side of the world !

by Thomas Garbelotti



The challenges of building a layout in an apartment are significant. They're even bigger when that apartment is located in the Middle East, far away from local hobby shops and Home Depots. Thomas (Scarpia) Garbelotti continues his tale of ingenuity with the benchwork supports for his new layout.

If you've read my previous article (MRH Issue 9 - Sep/Oct 2010), you know that I prepared for apartment living by pre-building a series of modules while I still had access to my tools and shop in Vermont.

One thing I didn't construct, though, was the benchwork support system

for the modules. I was running low on time prior to my move, and decided to wait until I was on site and look for a local solution. My local solution, however, didn't include a wood shop, building supply company, or a way to transport materials. After taking stock of the situation, it looked like I had three options:

- Construct the benchwork supports from scratch
- Contract a local carpenter to construct them for me from my design
- Use something not specifically designed for the purpose, such as shelving



Figure 1

Figure 1: The components in the empty room.

Figure 2: Assembly begins with a little help.



Figure 2



Building the benchwork supports was possible – I had brought some basic tools with me. But it wasn't desirable. Negatives involved getting and transporting the raw materials (and we had no car), and dealing with the sawdust this would create in our apartment.

Contracting with a local carpenter wasn't a bad idea, as it would handle the big issues: finding and transporting materials and sawdust clean up. Cost, though, can be relatively high. I also still harbor the odd desire to maintain the myth of my independence, even in this new living environment – I wanted to avoid "help" if possible.

Shelving was my fall back option. I looked at several options ranging from a small three-shelf bookcase under each module to more elaborate systems. The key was they had to be available locally. It was this search that brought me to Ikea, the global chain store of home items.

Ikea products are known for many things including their innovative design, inexpensive price, and some would say, a reputation for being products of a temporary quality level. For my purposes though, these features were actually advantages.

Ikea sells a modular storage shelving system called "Gorm". Gorm is available in a variety of components, the most useful for me were the 19" x 30" inch shelves, and 43.5" (110 cm) vertical posts. I selected these two components as the basis of my benchwork supports.



Figure 3

Figure 3: One length of the layout takes shape.

Figure 4: Another section finished.

Figure 5: Each section received metal cross bracing

Figure 6: The metal cross braces didn't reach across every section, so I tied them into the shelves themselves. The one on the left is on the post, the one on the right, the shelf.



Figure 4



Figure 5



Figure 6



The shelving is made of light pine, with holes pre-drilled, and shelf sections nailed together. It allows the builder to adjust the height of the shelves, and they provide shouldered lag bolts needed for assembly.

I measured out what I would need to make this work, stopped by Ikea and picked up the pieces. Ikea delivers resolving the transportation challenge.

Gorm has the added advantage of being almost tool-less. A Phillips head screwdriver and an adjustable wrench were all I needed to assemble all my benchwork (I also used a knife to open the boxes).

Pricing was OK too. The order for my L shaped 10' x 11' layout was under \$260 (prices in your area may vary; delivery cost me an extra \$30).

I included three additional sets of posts in my order. One set of these went to the ends of the outside sections; each was doubled up for added strength. The remaining two sets I placed in reserve stock to be used if needed.

I ordered metal cross bracing from Ikea for each section – mandatory for stiffness (figures 5 and 6).

Each section was assembled with the center posts supporting shelves on either end. Total assembly time was under three hours, using only simple hand tools.

I decided against staining or painting the benchwork because due to the mess factor. The natural wood color



**Figure 7: Ikea is very good about providing hardware. Besides the main mounting bolts, every set includes extra hardware for attaching the shelves to a wall if desired. I didn't do this due to the construction of our apartment, but if you can, your benchwork will be extra stable.**



**Figure 8: I used that adjustable "L" bracket to connect the runs of benchwork together. This also boosted the stability to a large degree.**

**Figure 9: With the final run finished.**

**Figure 10: I was afforded a room full of nice benchwork. Better yet, tons of attractive under layout storage!**





is not unattractive and can be covered with skirting when the railroad is closer to done.

Using a system like this for benchwork support has lots of advantages for the apartment railroader. Ikea offers several widths and sizes, and someone on a tight budget can purchase sections when needed, as their railroad grows. It may not provide sweeping fascias and ponderous peninsulas we all admire, but it is reasonable, inexpensive, and simple to assemble. Sometimes, that's enough. 🧐

### Ikea GORM Shelving - parts needed

WXHxD	Part No.	Description	Qty	Cost	Subtotal
H110CM	200.55.23	Post (2 Pack)	16	AED 11	AED 176
D51cm, W77CM	400.585.17	Shelf	20	AED 25	AED 500
L100CM	87.496.00	Cross Brace	10	AED 15	AED 150
					AED 826
Total - US dollars					\$229.44

Figure 11: Once the modules arrived, I was able to place them and test the fit. Some slight modifications were needed, such as moving some of the connector strips to the other end of the module.

Figure 12: I also needed to remove some of the small angles I'd glued in the corners since the new supports hit them.

Figures 13, 14: Finished module support system and shelving.



**T**homas Garbelotti is a frequent poster on the MRH Forum under the name 'Scarpia'. A native of Vermont, he returned to model railroading after a long hiatus. His chief interest is the Central Vermont railroad, especially the Roxbury area.

Thomas recently relocated from New England to Abu Dhabi, in the United Arab Emirates where he works for New York University helping to establish a new four-year undergraduate school.



The **Model Railcast Show**



Keeping you on the **RIGHT TRACK!**



Click here to learn more ...



Ryan & Tim at Hartford 2009

**(Show hosts)**

Do more. Spend less.  
[model-trains-video.com](http://model-trains-video.com)



**HOLIDAY SALE!**  
**50% off on ALL DVDs**



~~\$19.95~~

**\$9.95**

~~\$29.95~~

**\$14.95**

**HOLIDAY SPECIAL!**  
**Get all 10 DVDs for \$59!**  
(a \$200 savings)



Click to learn more ...

**Remember the reason for the season**





# *An HO Scale Spanish Revival Bungalow in Cardstock*



— by **Isaac Herrera**  
*photos by the author*

 **Reader Feedback**   
*(click here)*



## How to build an eye-catching Spanish colonial Bungalow ...

**F**or years, my layout had this little bald spot on a hill and I couldn't find anything suitable to fill it with. I tried a large Tudor-style house, a billboard, plain grass but nothing seemed to work, and then it

finally hit me – why not a bungalow! To make things a little more interesting, I opted for a Spanish colonial revival style, which is not only eye-catching and easier to model, but also helps to establish the layout's era and locale (1940's California to be precise).

Now, before you run out to the hobby shop to get sheet styrene and window castings, let me say that this entire build consists of little more

than cardstock and paper. More specifically you'll need one sheet of Bristol or illustration board, typing paper, a sheet of celluloid, an empty cereal box (you read that right!), and if you're feeling adventurous, a few scraps of plastic to make the furniture.

The design is for a very basic home consisting of a small living room, kitchen, bathroom and bedroom, plus

a small patio and driveway. It's not supposed to be a specific house, but a composite of the typical traits of this architectural style. If you wish, you may expand it or add a few more rooms using the techniques described here. Because of the large windows on the front, interior detail is a plus, as well as lighting. If you want to leave the inside alone, you can use the drapes and blinds included with the patterns.

My version is made to represent a house built in the 1920's, but by adding or changing a few details, it can fit any time from the teens to the present. Small stuff like TV antennas, AC units, window treatments, and even the typeface used on the house number can effectively place the house on a certain era. But of course, that all depends on your taste.

Now, having laid down the specifics, let's get cracking.

### List of Materials

- 1 sheet illustration board
- 2 sheets white cardstock
- typing paper
- 1 sheet clear celluloid
- cereal box

**Figure 1. The concept: Here's where it all started.** I went for a generic design that incorporated the trademarks of the Spanish Mission Revival style, including tiled roofing, curved parapets and smooth stucco walls. (I had to eliminate the fireplace because of space constraints.)

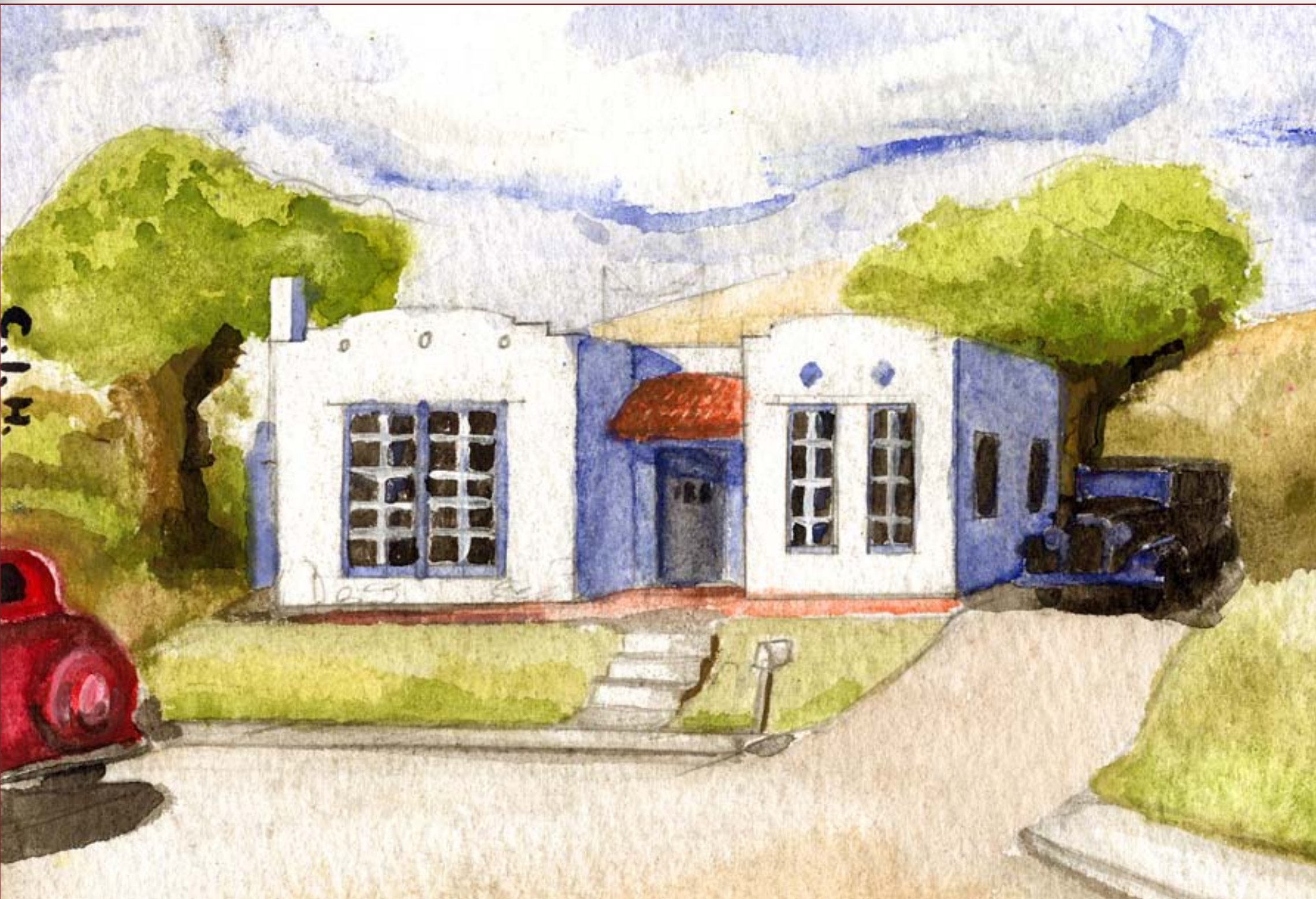



## STEP 1: Flooring



Figure 2. Prepared floor.



Figure 3. Decorative tiles.

To begin, print the floor patterns (pgs 12-14) on white cardstock, then cut out the floor pieces and paste them on a piece of illustration board. For the separate tile parts, use two layers of board to give them the right thickness. Add the decorative tile strips on the visible edges of the raised tile floor pieces and paste them in place. If you'll add interior lighting, cut the hole labeled "Wiring".

## STEP 2: Interior Partitions

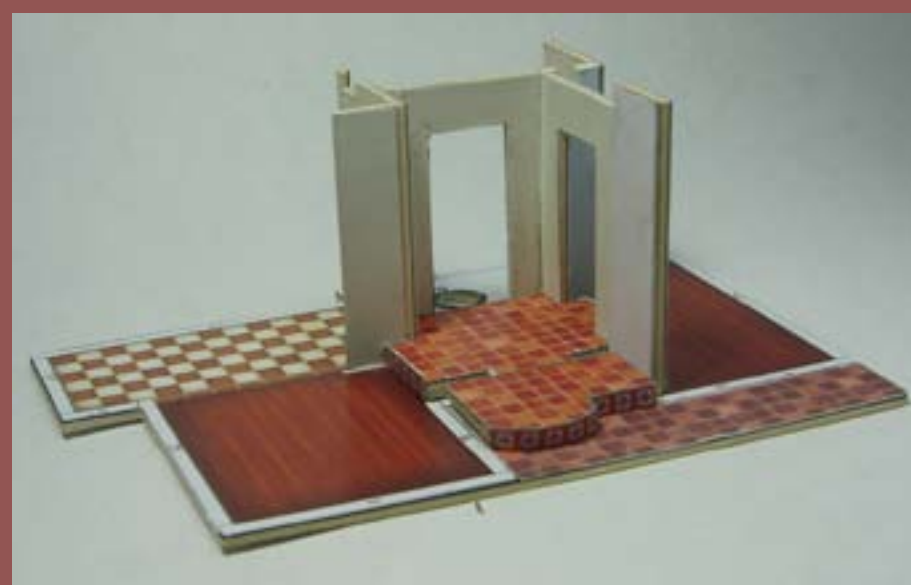

Figure 4. Interior walls in place.



Figure 5. Basic furniture.

Even if you're not detailing the interior, inside walls always help eliminate that "hollow-shell" look. Assemble the interior walls by pasting the patterns (pgs 12-14) on the illustration board and cut out the notches for the wiring. Note that wall 4 has an outdoor portion. Paste the outer wall covering on cereal box cardboard and glue it in place. Paste the interior walls on the corresponding floor markings.

At this point I decided to install a few interior pieces that may be hard to add when the outer walls are up. The bathroom area at the rear doesn't require any detail because it'll be completely blocked from view.



### STEP 3: Windows

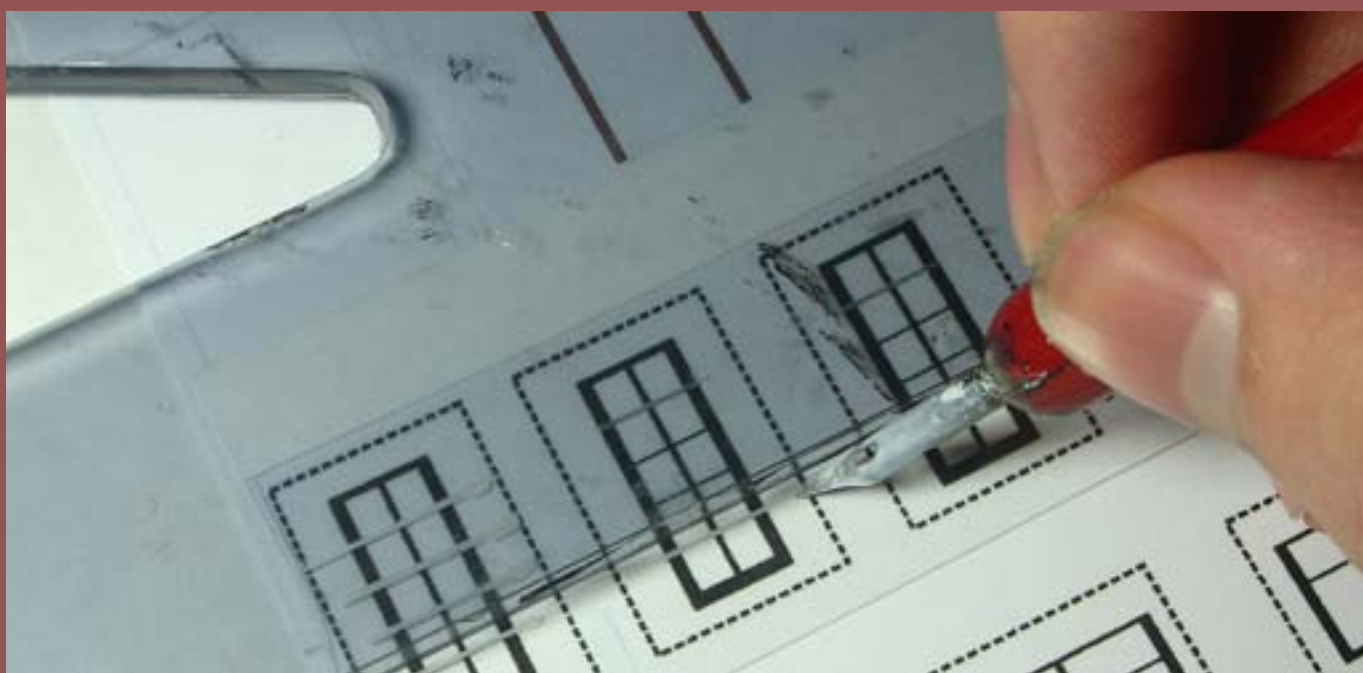

Figure 6. Inking the window panes.

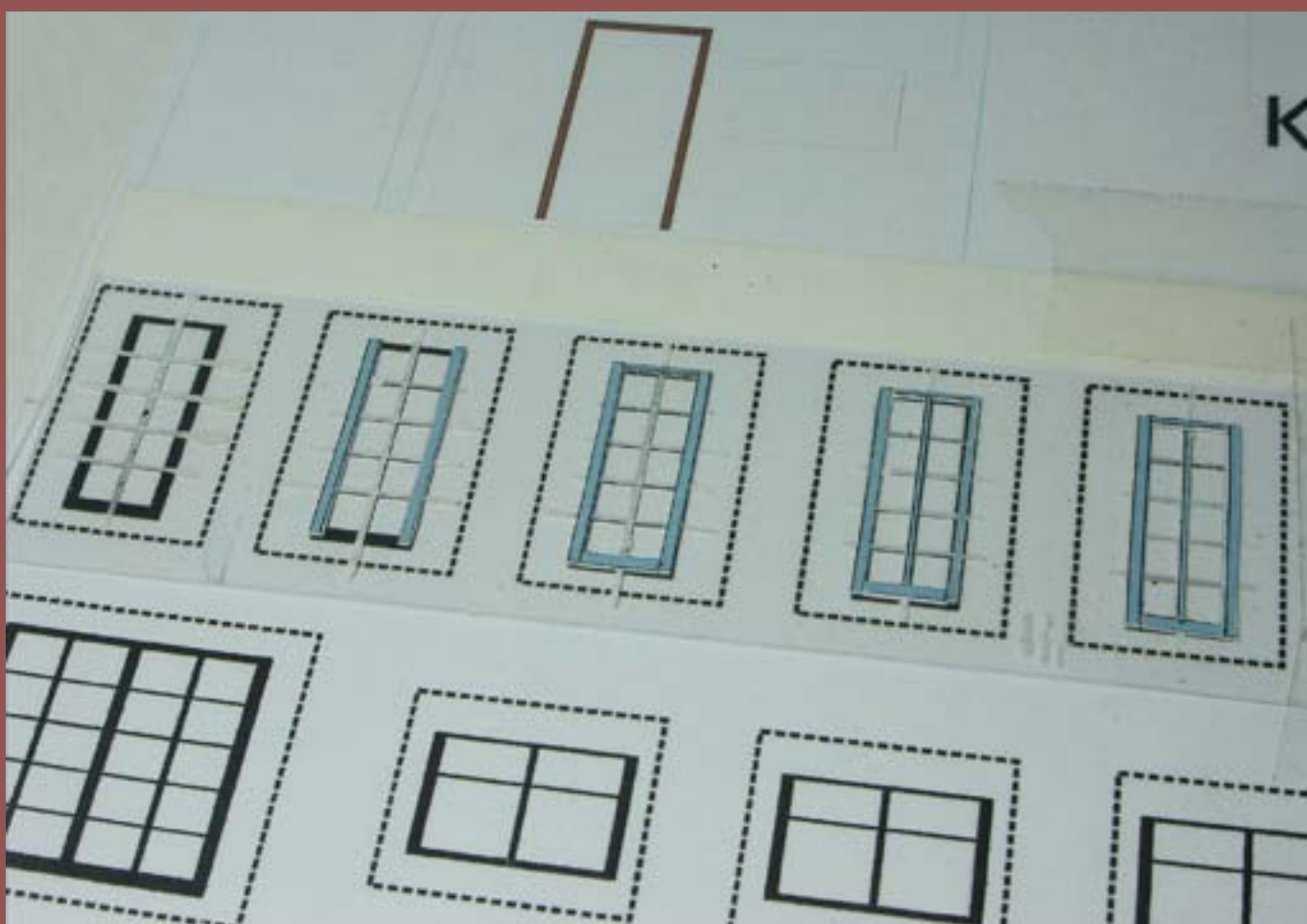

Figure 7. Window construction sequence.

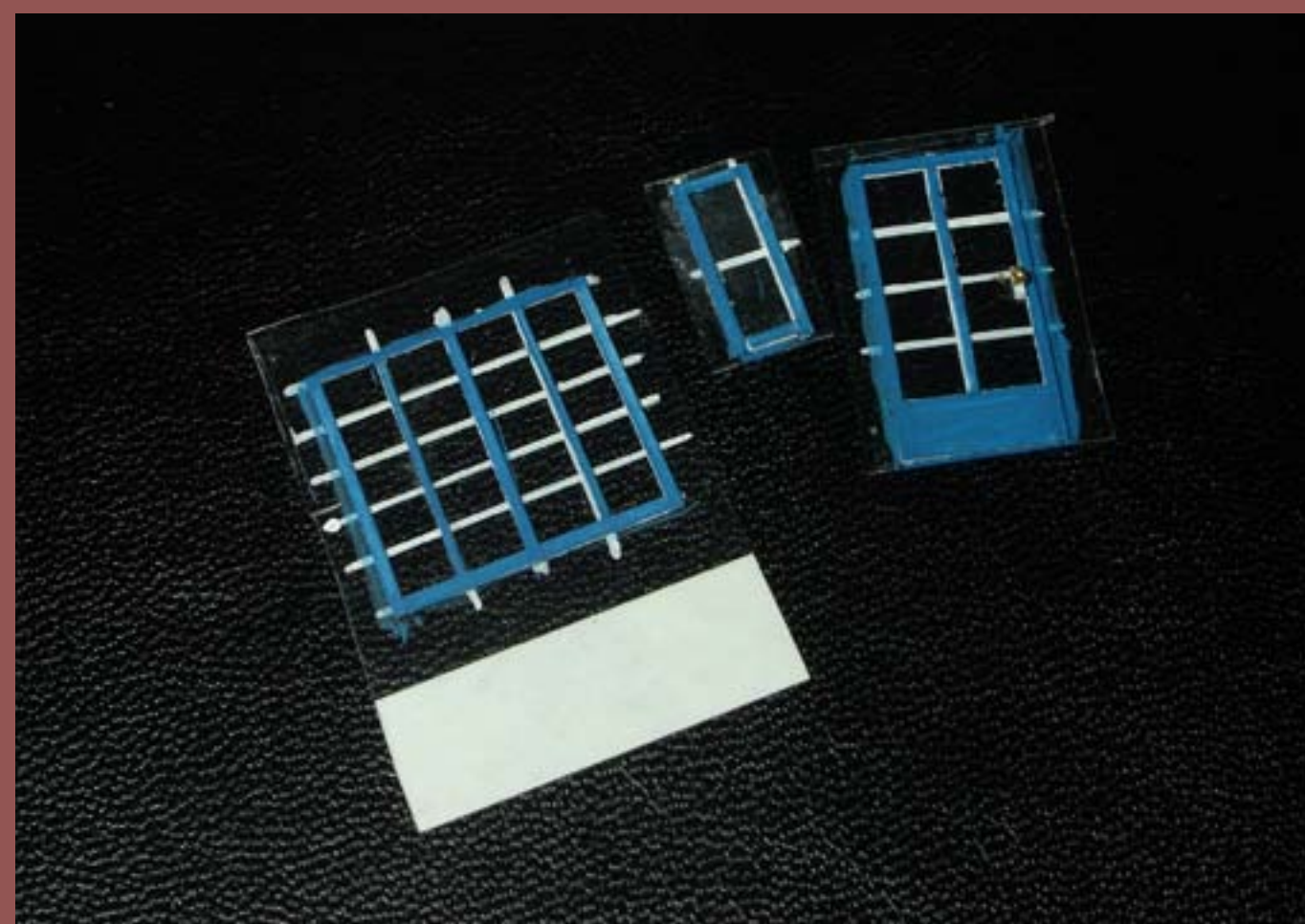

Figure 8. Finished windows.

Here's where it gets a bit tricky. Tape a piece of celluloid to the window patterns (see patterns, pgs 12-14) and trace the mullions with white ink, using a very fine brush or an inking pen and a straightedge. When the ink dries, paste the provided frame strips and carefully cut the finished windows out. Use the same process for the front door. For the bathroom privacy window, dab a thin layer of white glue on the inside to simulate rippled glass. Even though the strips are colored, you may want to touch them up or paint them another color. These are pretty delicate parts, so the patterns include twice the needed material just in case.



## STEP 4: Back Door

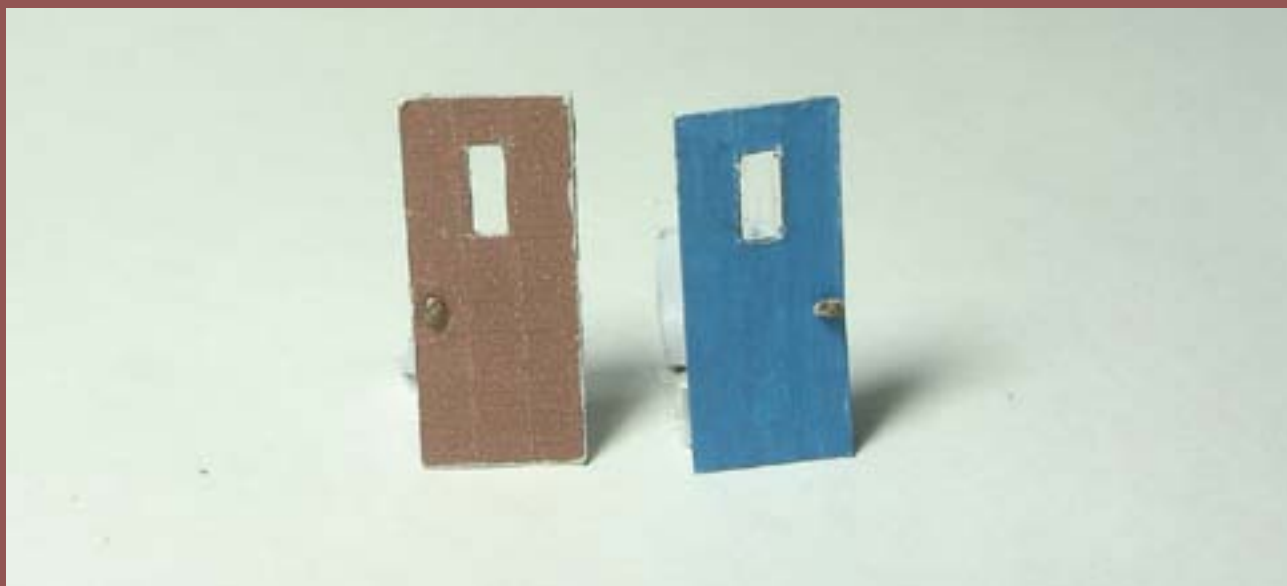

Figure 9. Back door layers.

For the back door, cut the pieces out and paste them on a piece of cereal box board. Add a small piece of celluloid between card the outer layer of the door for the window. The knob is a small wad of paper rolled in white glue and painted with a gold marker. The same technique is used on the front door.

## STEP 5: Walls

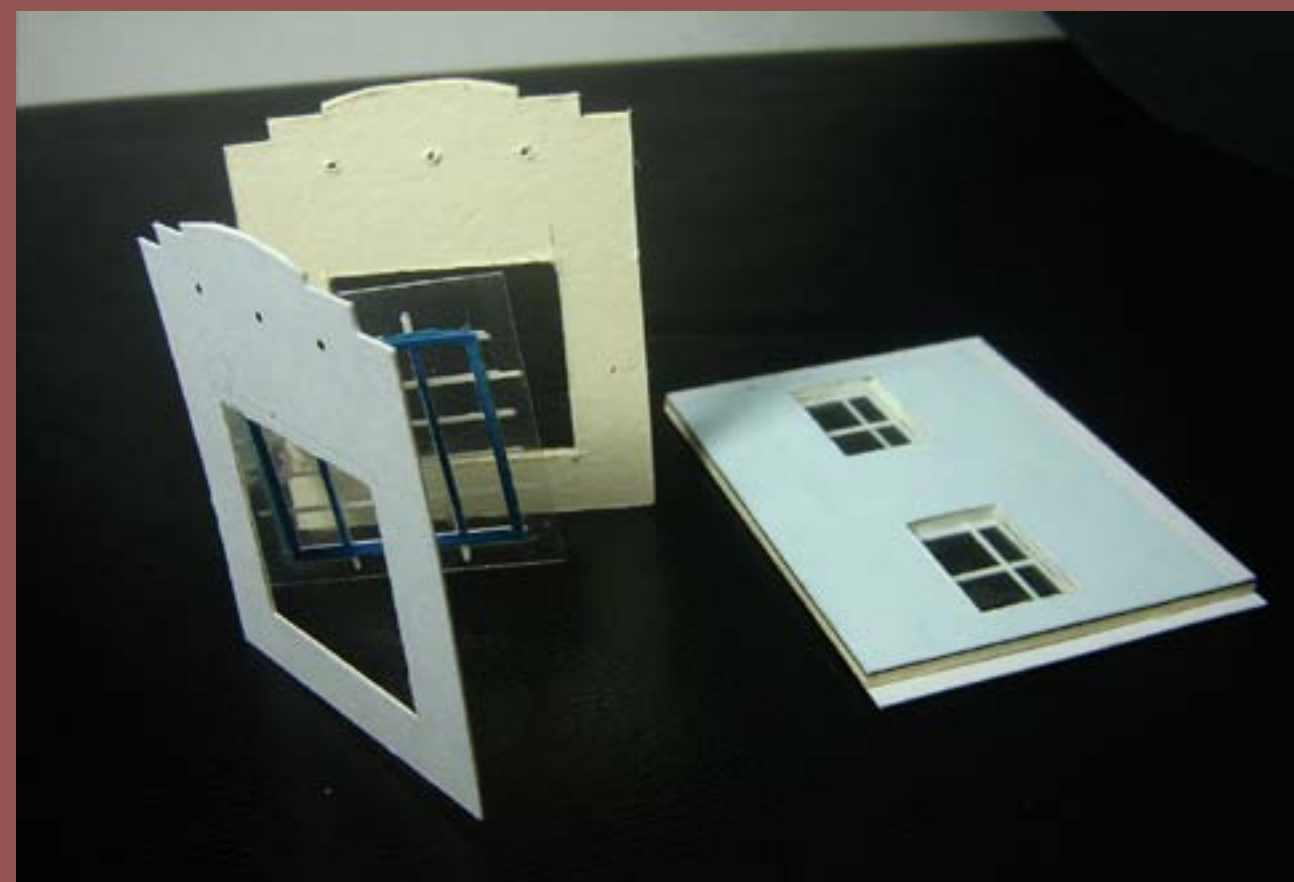

Figure 10. Wall assemblies.

Paste the interior wall pieces on illustration board, cut out the window openings, and cut out the wall. Paint the rims of the window openings white. Add the window pieces to the exterior wall coverings, and paste them in place. It is important that you begin this step with the interior wallpapers because these are the same width as the walls. Some of the outer wall coverings are slightly longer than the wall itself to cover the joints.



## STEP 6: Detailing the Walls



Figure 11. Front wall (above) and rear wall (below).

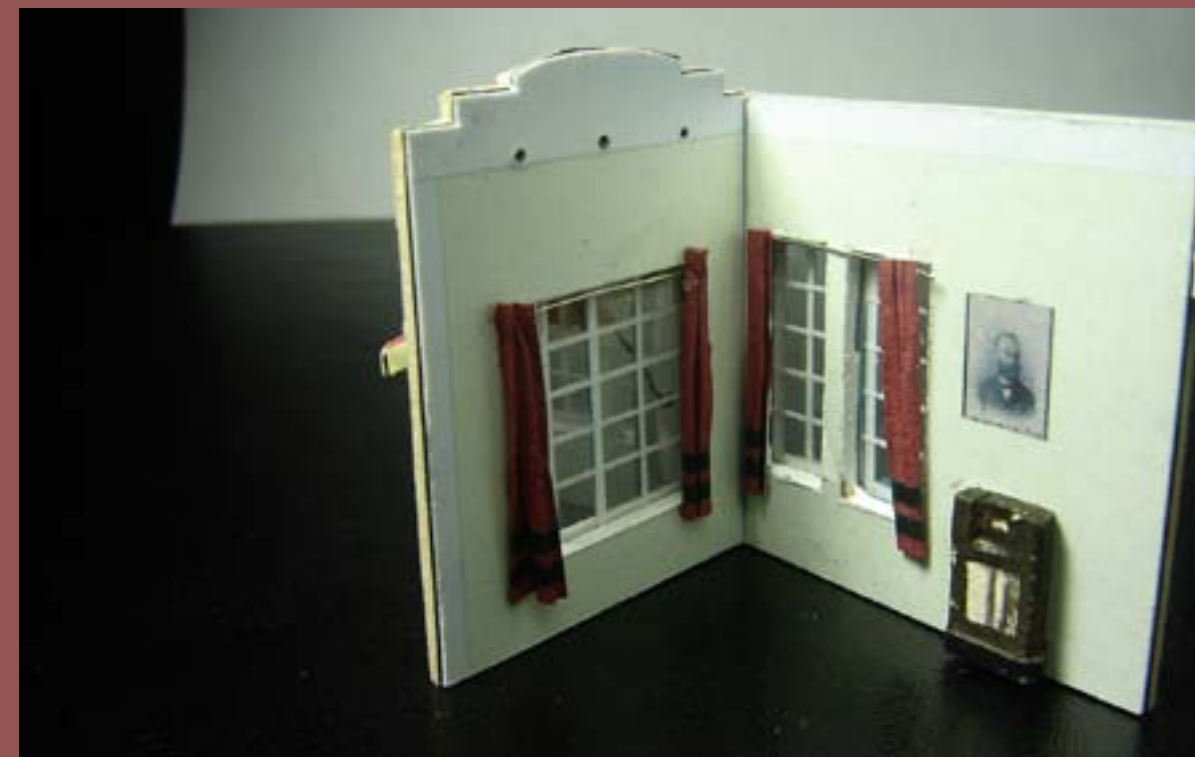
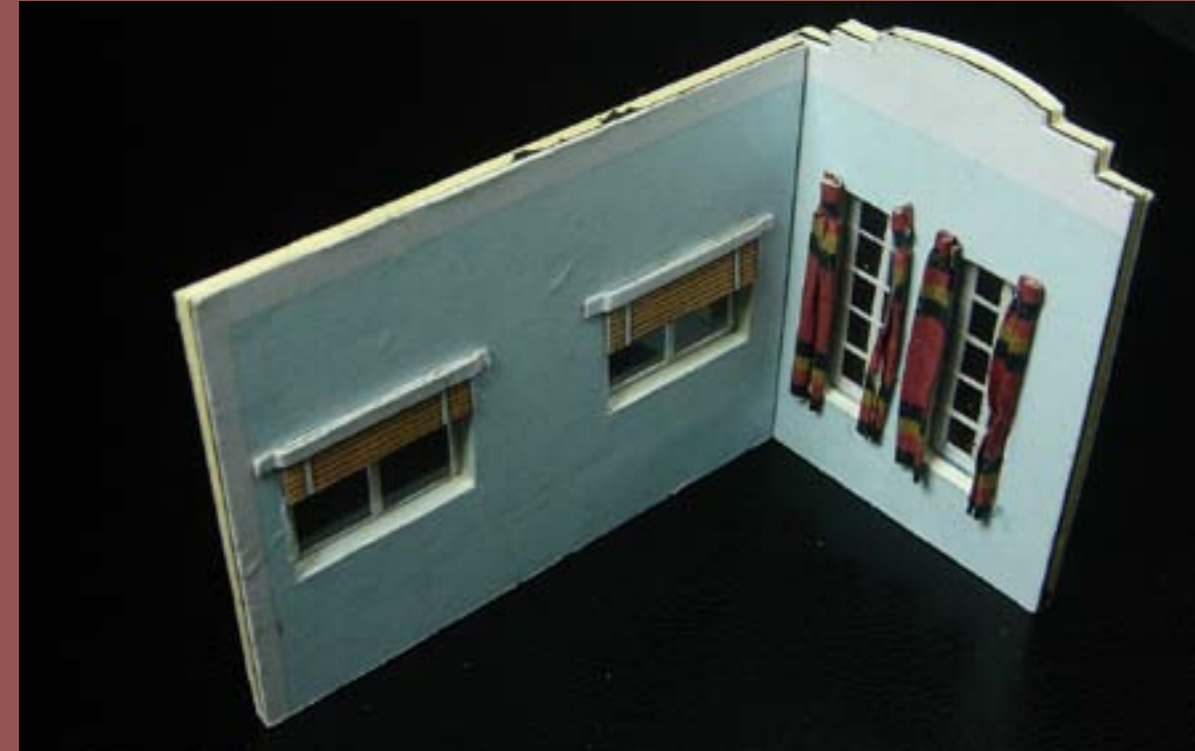

Figure 12. Wall interiors with window dressings.

The front walls have moldings above the windows, which are just strips of card. Same thing for a small step at the rear (Figure 11).

On the inside, add blinds and curtains to the windows, as well as whatever decoration you want to include (Figure 12).



## STEP 7: Detailing the Walls *Continued ...*

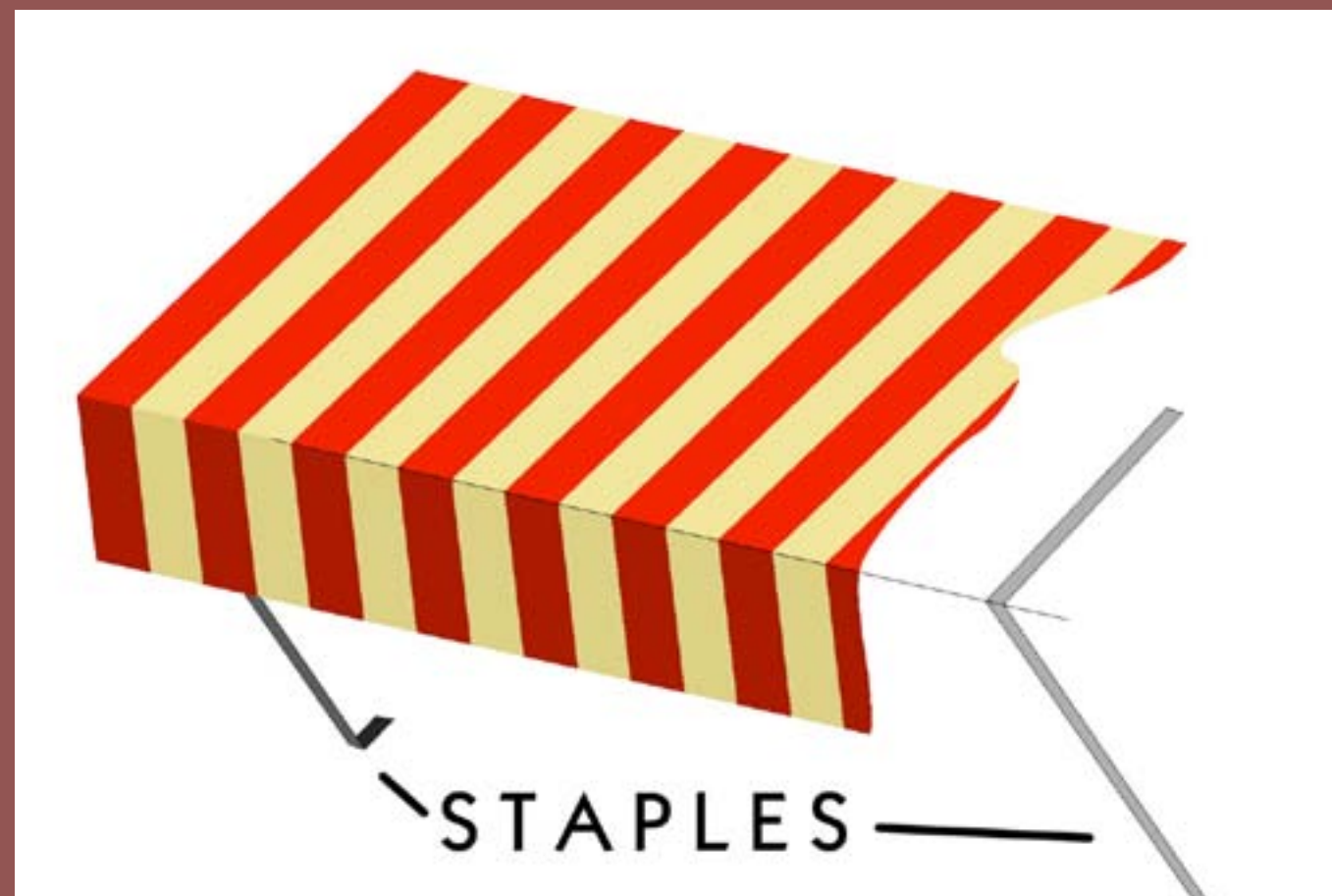
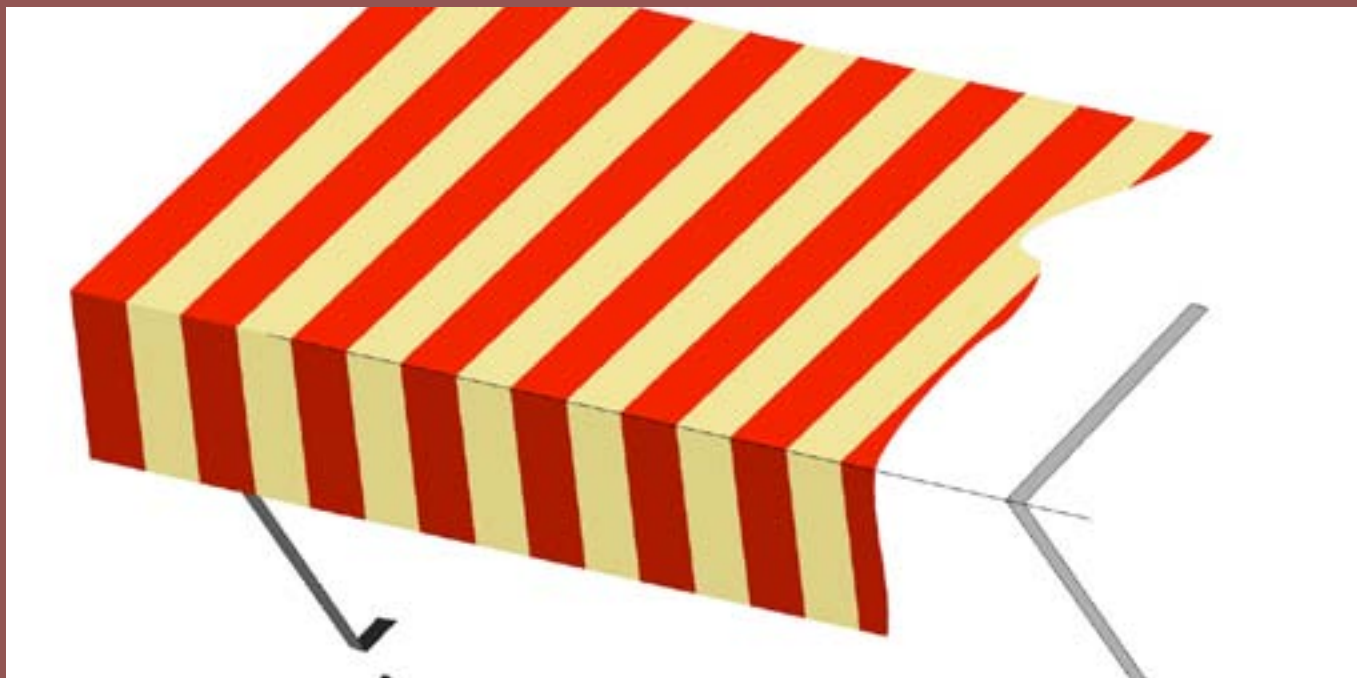

Figure 13. Awning assembly.

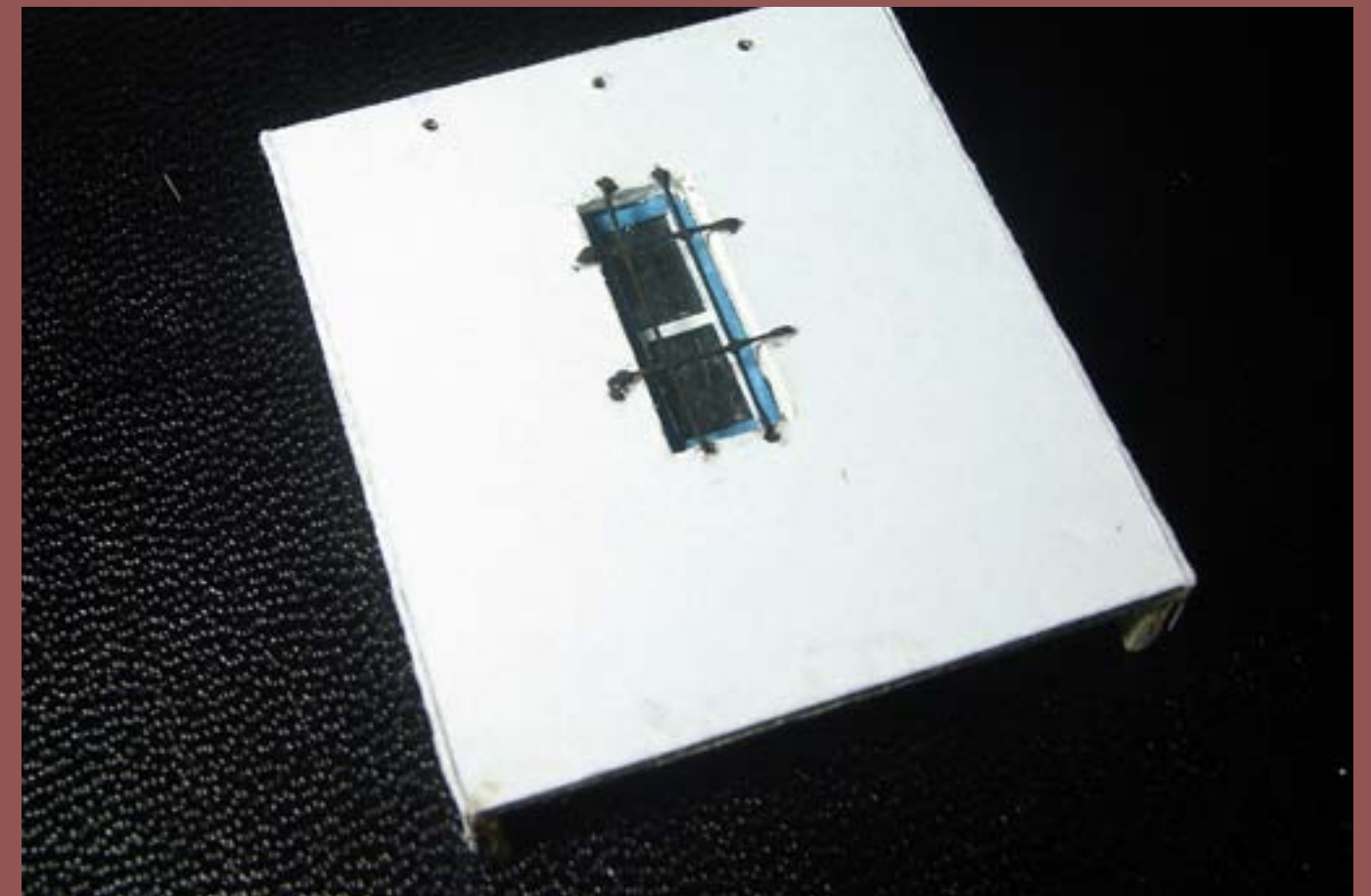

Figure 14. Rear wall showing drains and privacy window. Note “rippled glass”.

For a classic summery appearance, you can add awnings to the front windows, as shown in the illustration on the left – Painted tinfoil or thin tracing paper work great for simulating wrinkled canvas (Patterns include a traditional striped design); and if you opt for an empty interior, it’s a good way to obscure it. One of the front walls and one of the rear ones have dots indicating drains – punch these out with a pin. Small lengths of wire serve as bars on the privacy window at the rear (Figure 14).



## STEP 7: Roof Supports

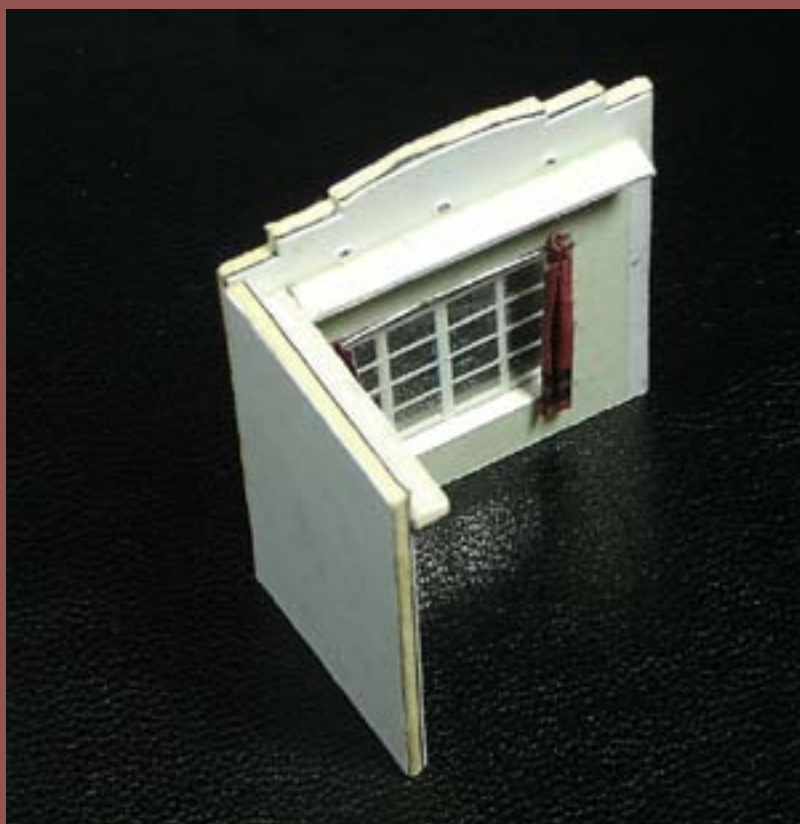

Figure 15. Roof supports.

Before starting on the roof, cut out strips of illustration board (about 4 millimeters wide) and paste them along the insides of the walls below the line. Not only do they hold up the roof, but they also keep light from leaking through the seams. Also, attach the small roof segment on the kitchen area.



Figure 16. Kitchen area roof piece.

## STEP 8: The Roof

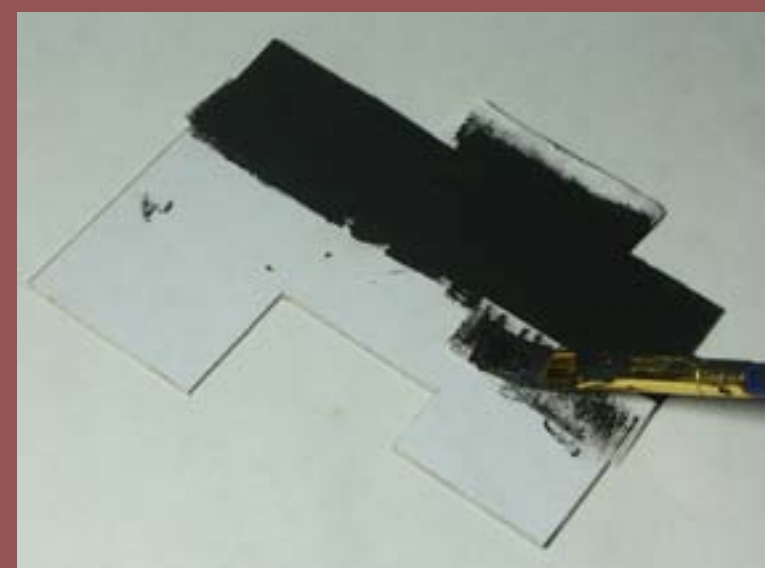

Figure 17. Painting the roof one piece at a time.

Now we'll do the roof. Cut and paste the roof piece on the cereal box board. To simulate a tarpaper roof, cut strips of very thin paper to a scale 36" wide approximately, and paste them on the roof. Paint each strip after gluing it in place so the finished roof doesn't look too uniform. To add a little more texture, pat the freshly painted spot with a napkin. With everything dry, apply a light coat of pastel chalk for a sun-bleached effect. Finally, highlight the seams with a marker. With everything done, trim off the excess "tar paper".



Figure 18. Finished roof.



## STEP 9: Spanish Tiles

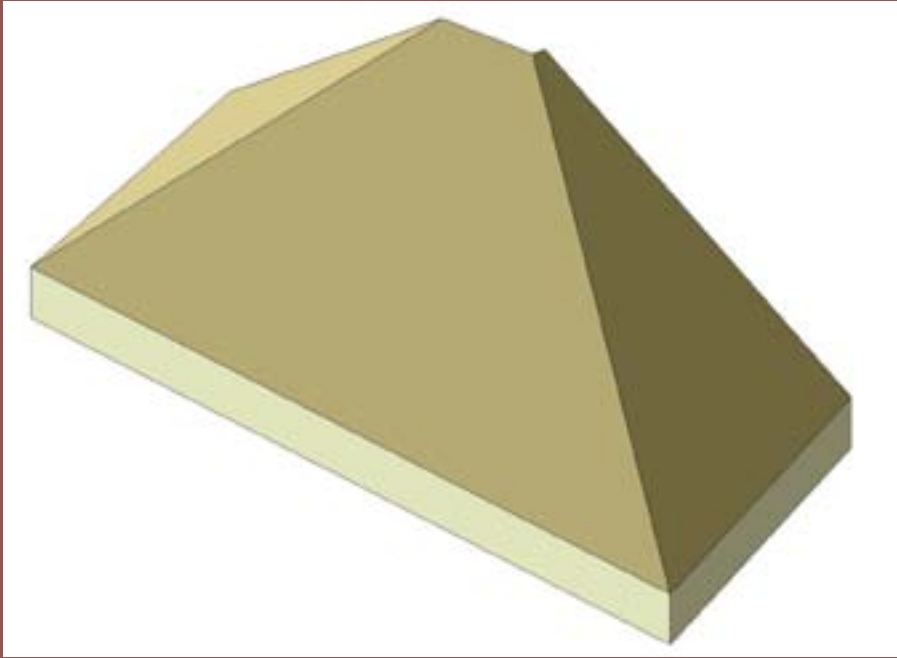

Figure 19. The base.

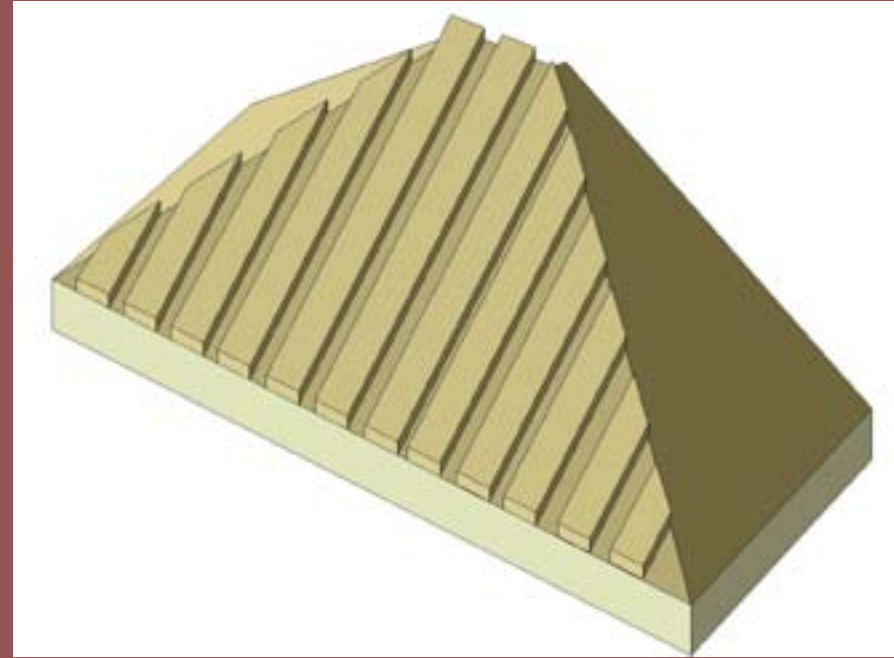

Figure 20. Card strips in place.

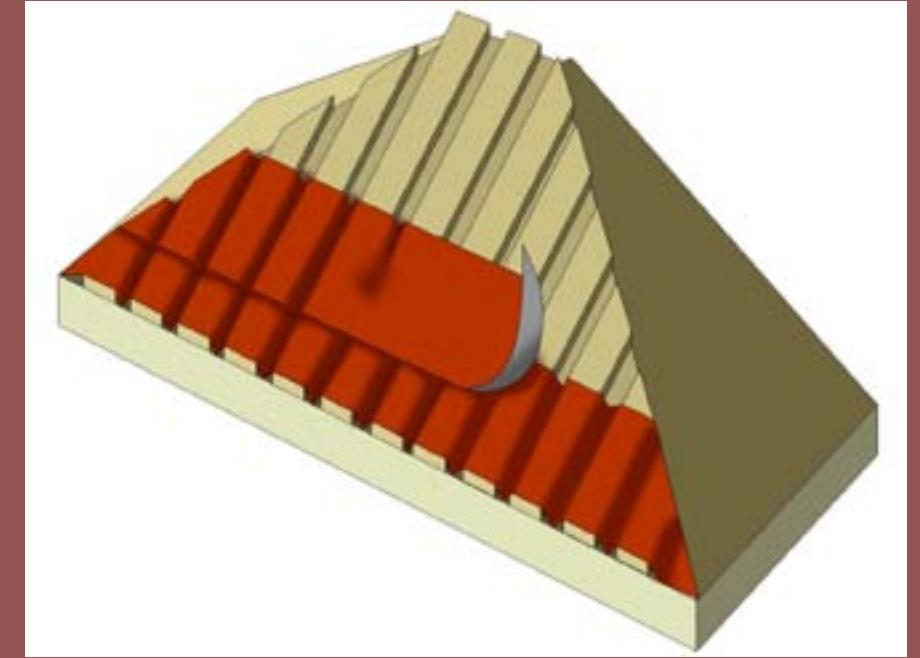

Figure 21. Applying the paper "tiles".

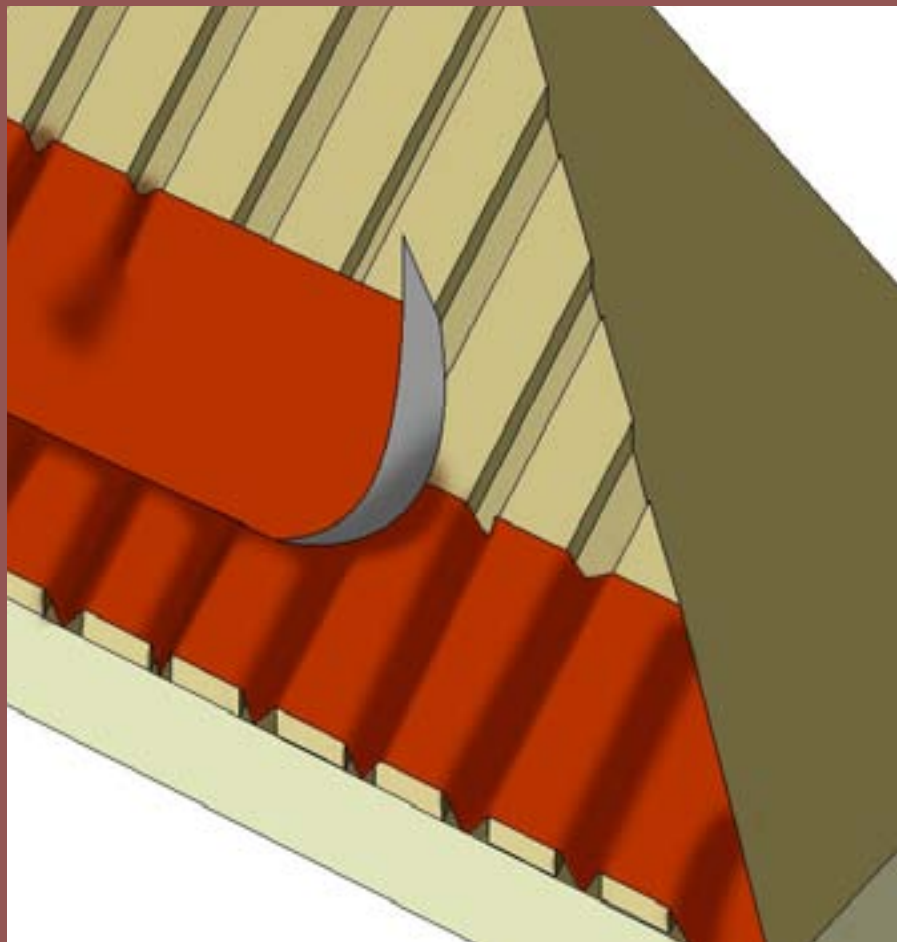

Figure 21b. The finished roof.

One of the trademarks of the Spanish revival style is the tiled roof. I knew that modeling a whole roof this way would be a little too tedious, so I went for a small pitched roof above the front door. To do this, form the roof (Figure 19) and glue thin strips of card about 1 millimeter wide (Figure 20) and cover with paper strips to form the tile rows. As you apply a paper strip, press it between the cardboard strips to form the tiles (Figure 21). Work your way from the bottom, and once you're through, cover the seams using the same layering method. Finally, paint the tiles in the appropriate color and add the supports.



## STEP 10: Lighting

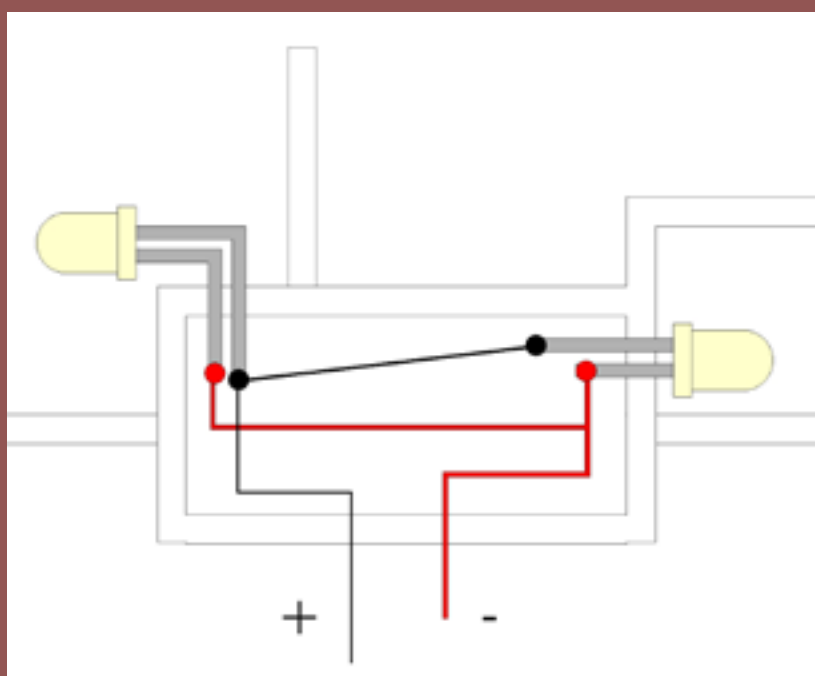

Figure 22. Wiring Diagram.

### CAUTION

Different types of LEDs have different internal voltage drops. If you attempt to operate a LED with a 3.4V internal drop from a 1.5V battery, the LED will very dim – if it lights at all.

Conversely, if you use more volts than the internal voltage drop of your LED you WILL need a current limiting resistor to avoid burning out the LED due to over current.

Check your LED's specs!



Figure 23. Let there be light.

Add two white LEDs in the arrangement shown in Figure 22. Since the house is made of paper, incandescent lamps can be a bad idea due to heat – especially if night-time operation is your thing.

You'll note there are no series resistors – this is because I usually light my structures using batteries, which simplifies the wiring.

I found the glow of the white LEDs a little too bluish, so I gave them a few touches with a yellow marker to warm their light up a little.

## STEP 11: Assembly



Figure 24. Walls are up.

Now that all the pieces are ready, it's time to put them together! Glue the walls in their corresponding places. The thickness of the wall material may be slightly different than the one I used, so you may have to trim the roof a bit. Paint the wall tops white, plop the roof pieces in place and you're basically done.



Figure 25. The roofs are in.



## Finale

Of course, you can still add a few details here and there – small stuff like a TV antenna, an AC unit, a house number plaque, or as in my case, an electric meter I made from scraps and a couple of flowerpots I found in “ye olde junk box”. As for weathering, about the only thing that’ll work here is pastel chalk, and even then it should be applied very carefully. Since it’s a paper model, you won’t be able to clean it up if you overdo it (at least not without tearing the wall). In this case, the light weathering on the walls was the result of (deliberately) handling the model with slightly dirty fingers.

NOTE: See the patterns on the following 3 pages – [Click here to download full-size jpg format patterns](#) for a more accurate print-out.

Isaac Herrera is a 23 year old free-lance graphic designer and illustrator who has been active in the hobby since the age of 10.

In addition to model railroading, his hobbies include photography, animation, vintage clothes and 8mm movies.

## Furniture



You didn’t throw away the leftover bits and pieces from the walls, right? The cutaways resulting from all those door and window openings can be made into simple interior pieces. Most of the furniture in the house was made using leftover bits, and the odd piece of wire (As in the kitchen sink). The rounded armrests on the chair, for example, came from the curved walls from the kitchen area. Kitchen counters are little more than paper and cutouts from the windows. They aren’t perfect or overly detailed but, combined with a few bits and pieces from the scrap box, they can be very effective, especially with the lights on. ■



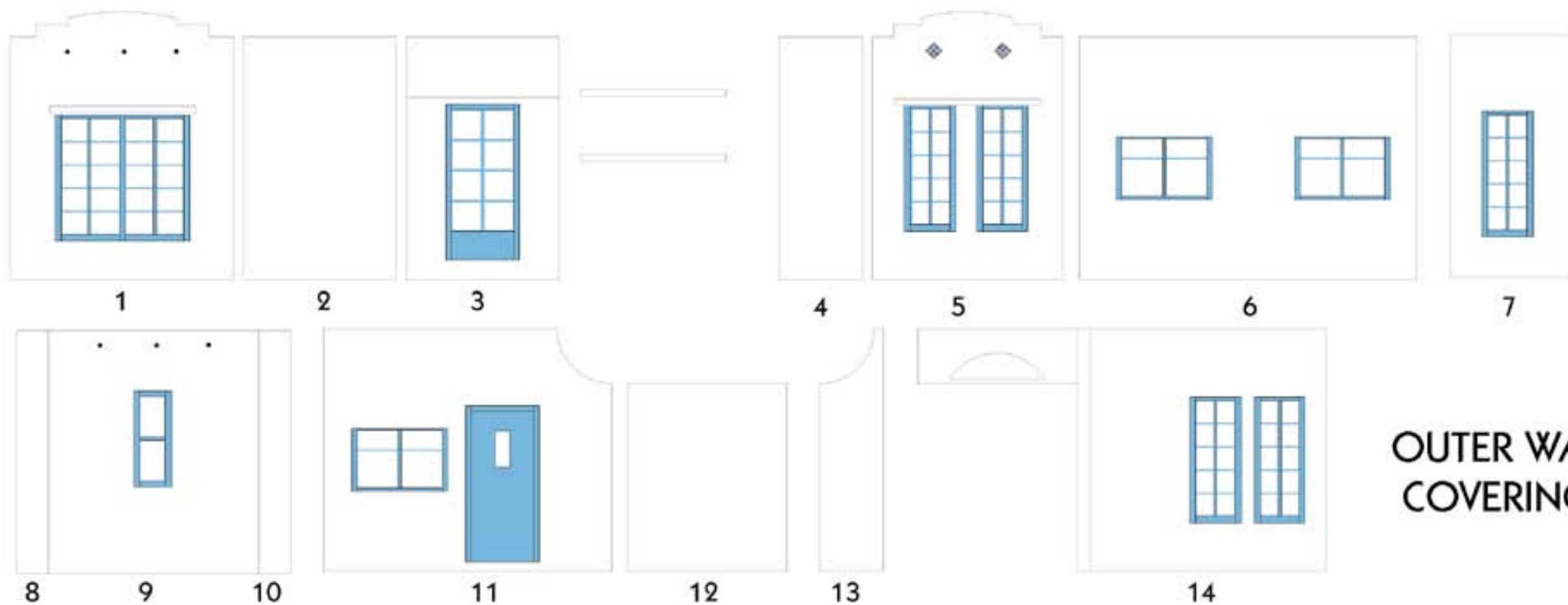

OUTER WALL COVERINGS



FLOOR

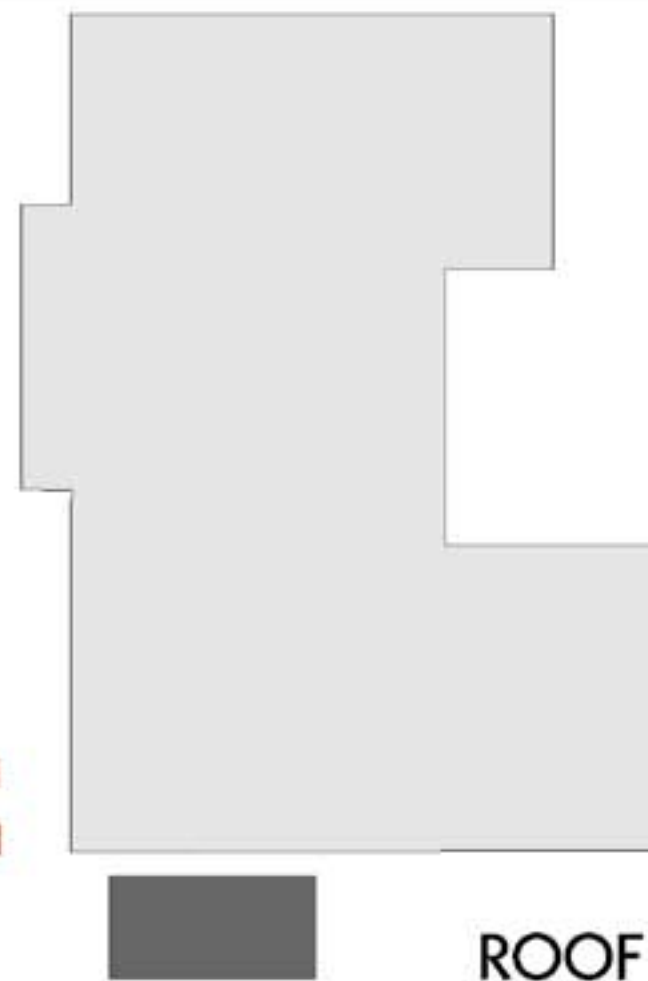

ROOF

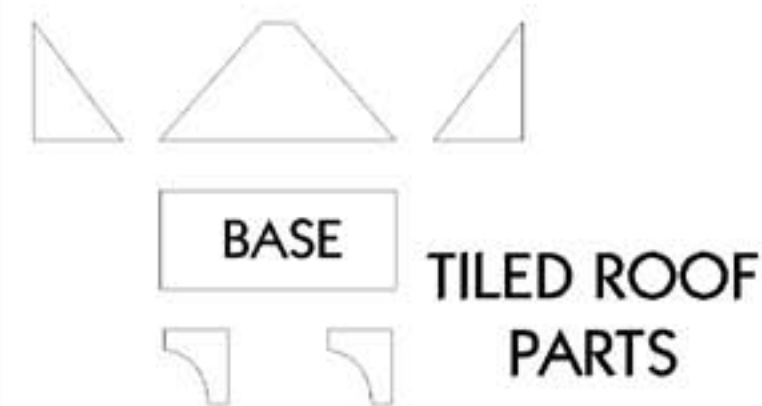

TILED ROOF PARTS

PATTERNS FOR A  
SPANISH  
REVIVAL HOUSE  
by ISAAC HERRERA

PRINT ON 225 gsm. PAPER INCHES MILLIMETERS

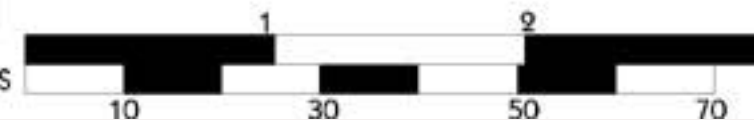





SPANISH REVIVAL HOUSE *by* C. I. HERRERA

PRINT ON 225 gsm. PAPER

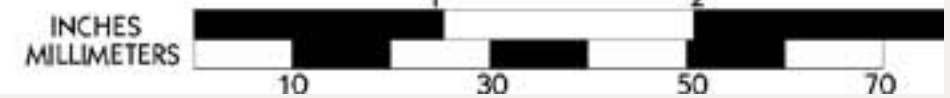



# BLINDS – CURTAINS – AWNINGS

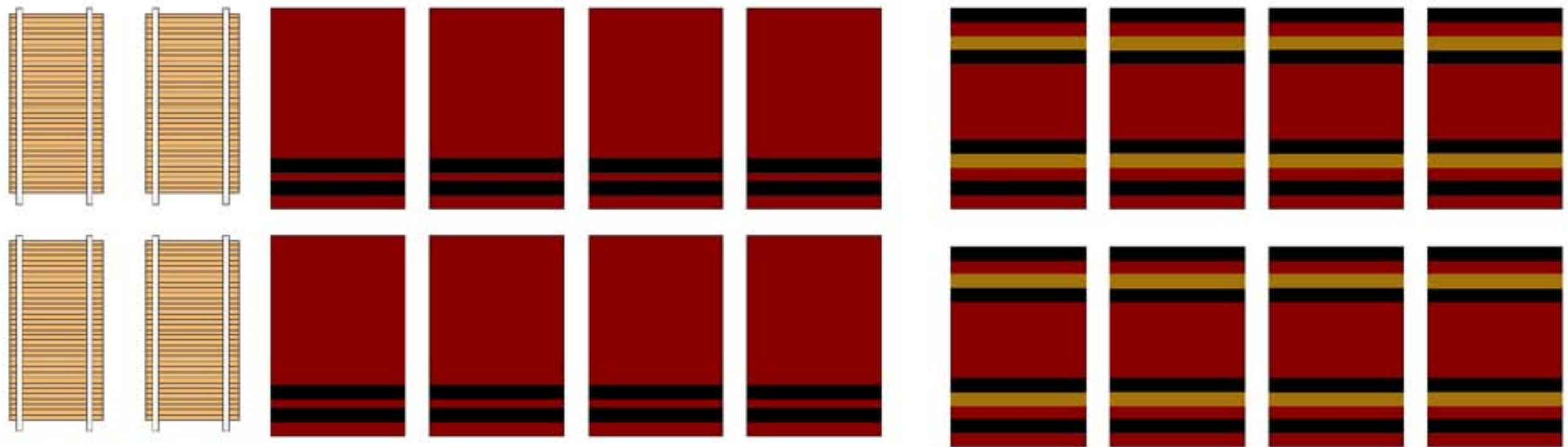
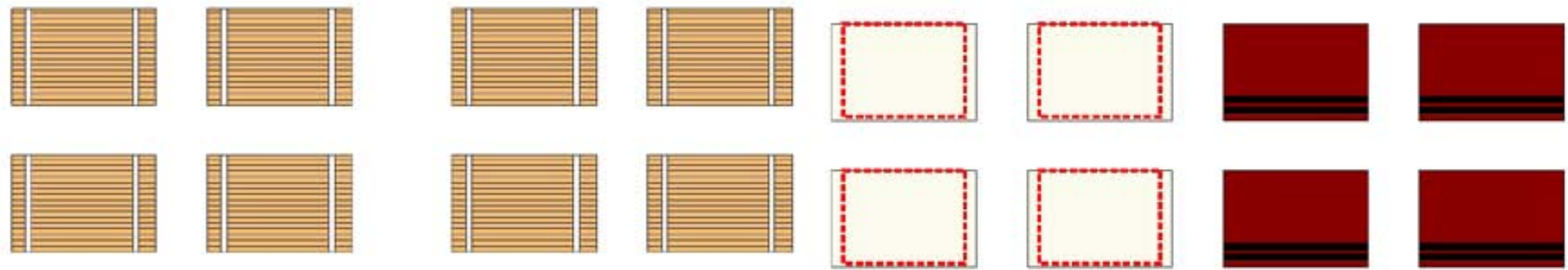
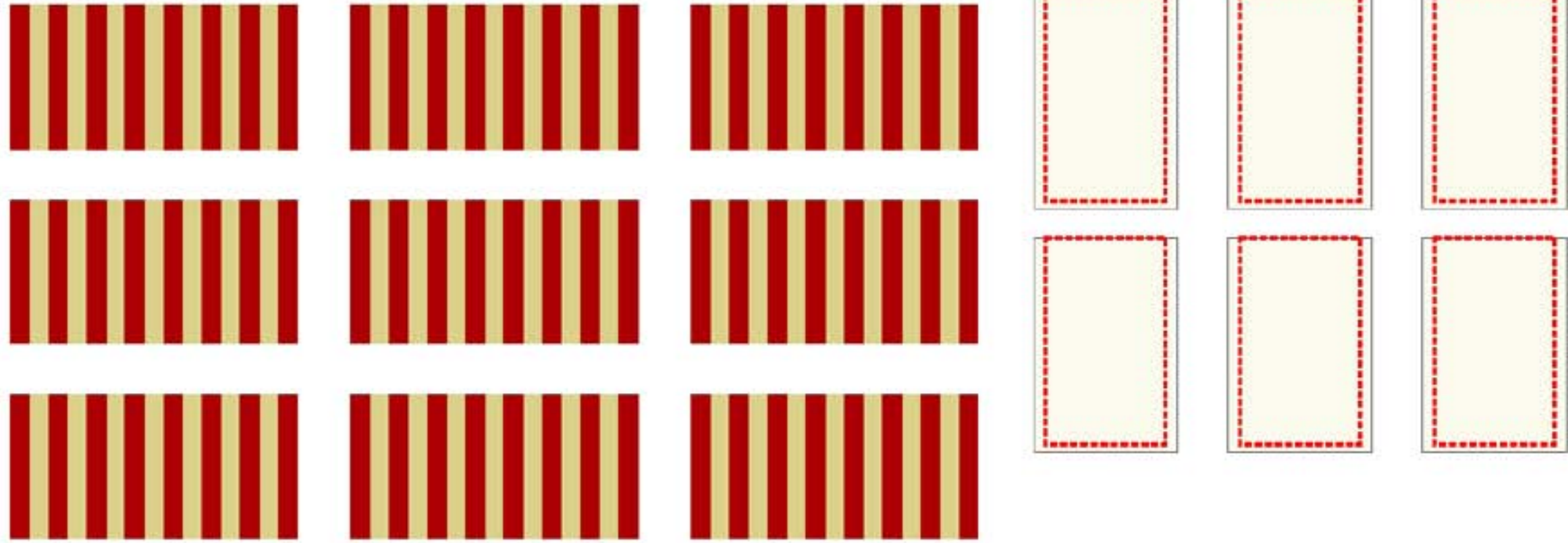









**FIND OUT  
ABOUT OUR  
SUMMER  
LAYOUT TOUR**

# IMPROVE YOUR STRUCTURE MODELING

Learn from the best, well known modelers in the country.

**DAVE REVELIA-DAVE FRARY-BRIAN NOLAN.**

**SCOTT MASON-BRETT GALANT-DOUG FOSCALE.**

**BOB MITCHELL-MIKE ROSE & MORE**

**DON'T MISS OUT**

**SIGN UP NOW FOR PREMIUM CLINICS**

**DOZENS OF VENDORS - CONTESTS**

**css2010.com**

Have you visited the  
**MRH Forum**  
lately?



Interesting recent post:

- Vintage Washington Northern Advertising

Goto [model-railroad-hobbyist.com](http://model-railroad-hobbyist.com)







# ComArt Real Deal Weathering Kit

## First Look

For years Leslie Eaton, MMR, used a set of cosmetic colors for weathering model railroad cars and structures. When Leslie became involved with iwata-medea, they thought that providing a set of airbrush colors, specially mixed to match Leslie's colors of choice made sense. Enter ComArt and Presto, Leslie's weathering colors are now available to everyone.



The Real Deal Weathering Kit, retail price \$35, contains ten colors, packaged in airbrush friendly twist-top bottles with self-contained agitators. While these paints are usable with brushes, using them with a gravity feed airbrush with paint cup is a breeze. Select the paint color you need, shake it thoroughly – the agitator bead inside the bottle should be rattling noisily

– add a few drops of color to the airbrush's cup and start shooting. Need to change colors? Pour out any remaining paint in the cup, add several drops of airbrush cleaner and spray until that is gone, wipe the cup out,



Figure 1

Figure 1: The Real Deal Weathering Kit features colors specified by Leslie Eaton, MMR, front cover.

For additional info: [www.iwata-medea.com](http://www.iwata-medea.com)



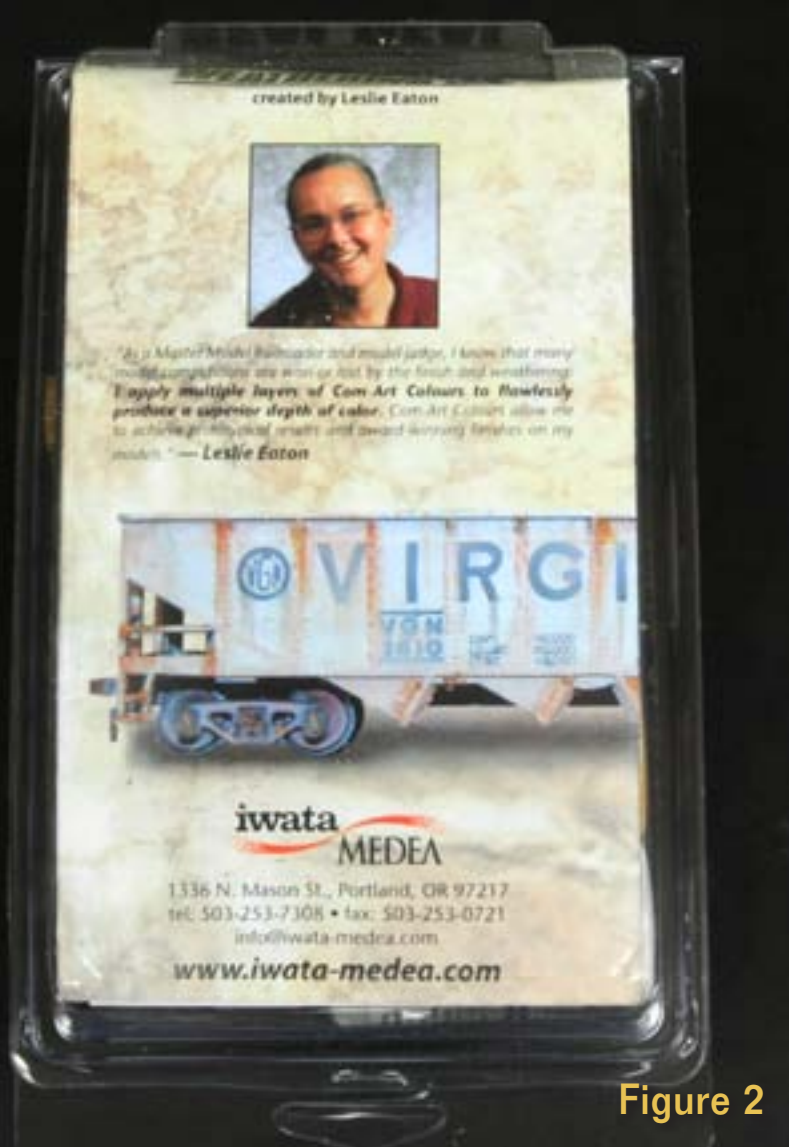

Figure 2

add a few drops of the next color, and resume spraying.

For a continuous blend of colors just keep adding a few drops of new paint to the mix in the airbrush cup.

Figure 2: The back cover of the Weathering Kit box.

Figure 3: Weathering colors:

- Dark Rust - 2 106 1
- Light Rust - 2 105 1
- Opaque Raw Sienna - 1 019 1
- Old Oil - 2 104 1
- Blue Gray Smoke - 2 103 1
- Smoke - 2 002 1
- Light Dust - 2 100 1
- Soft Dirt - 2 101 1
- Fertile Soil - 2 102 1
- Opaque White - 1 002 1



Figure 3

*Remember when?*

# Model Railroad Hobbyist magazine™

*Remember, back issues are for-ever free, too!*



Click here to download back issues

**The Jack Burgess Interview:  
The Yosemite Valley Railroad**

— by Charlie Comstock  
Photos by the author

**W**hen I had the opportunity to interview Jack Burgess for Model Railroad Hobbyist magazine I jumped at the chance. Walking through the double doors from the real world into August 1939 at Portal, entrance to Yosemite National Park, it seemed I already knew the area well, so often has his YVRR been featured in print and video. Jack is both well spoken and knowledgeable.

He is a serious prototype modeler. If it wasn't on the YVRR in August 1939, you won't find it on his model. I felt a bit of trepidation meeting him because my own railroad is largely freelanded. Not a problem. Jack ever the gentleman made me feel welcome.

His layout snakes its way along the Merced River canyon in the Sierra Nevada mountains. Straight track is hard to find once you start up in the hills. Grades are moderate except for a logging incline railroad that the word "steep" fails to describe.

I asked Jack about a number of the scenes on his railroad. His amazing knowledge of details reveals the depth of his research.





# Walther's 2011 Reference Book



As a child, September was always a special time with the appearance of the Sears Wish Book, full of all of the wonderful toys – and especially the train sets – for sale that year.

Now as an adult, the annual Walther's HO Reference Book makes the same time of the year special for HO scale modelers. The 2011 Edition contains 984 pages between its covers, featuring the Santa Fe Super Chief F3 and the Pennsylvania Railroad Broadway Limited E8 on the front, and Los Angeles Union Passenger Terminal on the back.

Inside, the Reference Book is broken down into 23 sections of hobby products, from Locomotives to Books-Videos-Railroadiana, as well as a section on hobby shops and the "Along the Route" historical section that mixes model and prototype railroad historical information in with events on the Walther's company time-line. An additional section, the "Magic of Model Railroading", features pages of model railroading photos - 1st through 3rd places win between \$250 and \$75. Also included are many "Information Station" modeling and prototype tips and trivia.

Both the HO Scale Reference Book and the N&Z Scale Reference Book (432 pages) are on sale now for \$15.98 each.

The Front cover of the 2011 Walther's HO Reference Book.

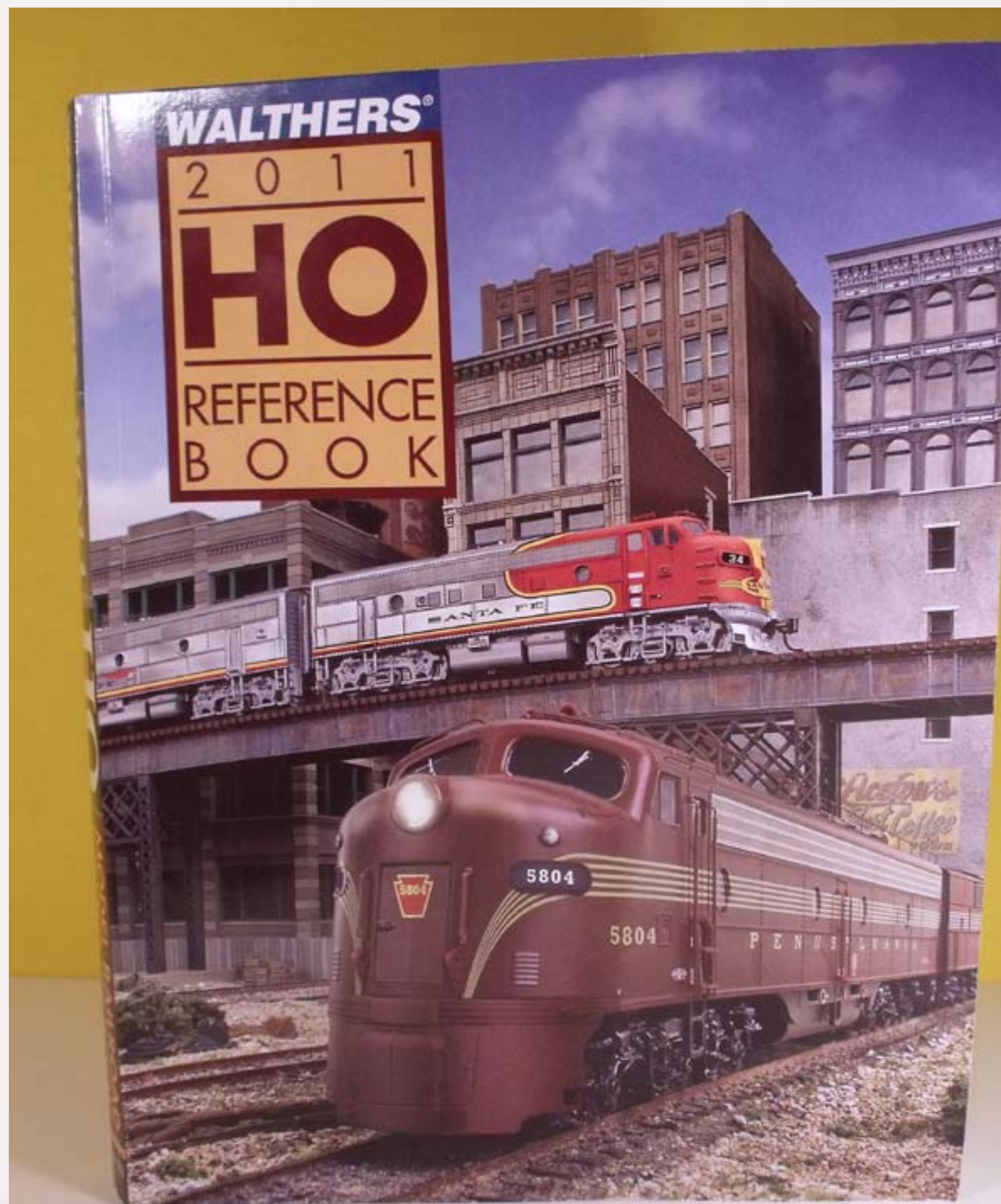





**NEW!**

**VOL. 1**

**\$20\***

**Fillmore Yard on  
GEORGE SELLIOS'**

**HO FRANKLIN & SOUTH MANCHESTER R.R.**

*Only 36  
cents per  
photo*

## Photos of George Sellios' Franklin & South Manchester

- Never-before photographed Fillmore Yard
- Over 50 large high-quality digital photographs

*click this button to ...*

**Download Photos**

*Instant download!*

*\*NOTE: George is generously donating a portion of the proceeds from each collection sold to help keep MRH forever free! Thanks, George!*

# The Sky's the Limit ...

Volume 4: Scenery and bridges  
Part 1  
Featuring Joe Fugate's  
**SISKIYOU LINE**

Volume 5: Scenery and bridges  
Part 2  
Featuring Joe Fugate's  
**SISKIYOU LINE**



## With these scenery techniques!



Click to  
learn  
more ...

Do more. Spend less.

**model-trains-video.com**







## About our narrow gauge and branchline columnist



**Lew Matt** is a published writer, photographer, and illustrator whose work has appeared in many model railroad hobby magazines.

[Click here](#) to learn more about Lew.

# THE LITE AND NARROW: Building an On30 Speeder

## Ramblings on Narrow Gauge and Branchline Modeling

▶ **Reader Feedback**  
([click here](#))



### This month Lew kitbashes some transportation for his trackside crews ...

Several years ago I participated in a speeder rally on the Ma & Pa railroad. This enjoyable experience convinced me I wanted a speeder for my model railroad. I beat the idea around some but didn't get the bug to do it until I saw Walther's *Trackside Structures: Speeder Shed and Speeder*, #933-2701 on sale for more than 60%

**Figure 1: Lew's kitbashed On30 speeder.**

off. I needed the shed for another project, but it was the speeder that really got my kitbash juices flowing.

Although the style of the Walther's speeder is too modern for my era and it lacks the detail level I wanted, it was a starting point. I love operation so a static model just will not do. This easy kitbash is in O scale, but the gauge will be determined by the gauge of the

power truck, so it is equally suitable for standard, 36", 30", 24" or other gauge. I thought about all the under-floor motors that are available but decided to see what I had in my junk box. The solution to my situation became more apparent as I dug deeper into the box.

A brand new, in-the-box HO Bachmann San Francisco Cable car (#60541) turned up and had a perfect diminutive power





Figure 2

**Figure 2: Walther's Trakside Structure #993-2701, Speeder Shed and Speeder. The speeder is gauged for O scale or tinplate track. I bought this for the building but the speeder captured my imagination.**



Figure 3

**Figure 3: The Walther's #993-2701 speeder is too modern for my era and cries out for more detail and character. This unit can be kitbashed to standard gauge, On3, On30, On24 or other gauges depending on the power truck you put under it.**

truck suitable for this On30 speeder kit-bash. The truck ran very well, on the DC test track, outside the cable car body, with just a touch of a wobble, nothing for me to be alarmed about. I also found a broken-up 1/43 scale, Model A "Woody" station wagon I purchased at a flea market for 25 cents that would help backdate the car and give it some home built characteristics.

## Disassembly

The first step was to isolate the power truck and carefully disassemble the speeder and the Model A into their component parts (figures 4 and 5).

The look of the finished speeder came to my mind the same way I see the parts from a jigsaw puzzle forming the completed image. I used the upper portion of the Model A with the radiator grille, front windshield and roof and the back of the car for the body of the speeder.

## Reassembly

The basic Walther's speeder body was the central piece to which everything would attach, but it needed two grooves cut into the inside to clear the small mounting tabs on the sides of the power truck motor (figure 6). I cut down the speeder roof to make the piece that covered the motor housing. Everything fit together nicely and a piece of thin, double sticky Scotch tape held the top of the motor to the inside of the body.

I cut the speeder windshield off and substituted the windshield from the Ford

and used the tailgate and cut-down side windows to make the speeder's back. The sides of the speeder would be open, with rolled weather curtains.

The Ford's roof had to be shortened and glued together. The front of the roof connected to the back of the windshield but the back of the roof connected to the top of the back windows. A little tricky to measure but it worked fine. I cut off the Ford's interior wooden trim and applied it to the inside edges of the new speeder.

## Five Assemblies

I built, painted and weathered the speeder in five separate subassemblies: power truck, roof, front, back and body. I wanted to do as much work as possible while they were flat on the work bench. I only assembled the car when I had most of the detail work done. Before detailing commenced, I test fitted all the pieces using paper rubber cement to temporarily hold them, so I could see what the speeder would look like. Removing the glue after disassembly was easy with rubber cement pick-up from an art store.

I weighted the speeder with #9 lead bird shot poured into every opening and held in place with white glue. Slices of stick-on wheel weights underneath, metal figures and details inside the cab also added much-needed weight. I attached the metal parts to the plastic with Walther's Goo. The extra weight makes the speeder run fairly smoothly. The small wobble



Figure 4

**Figure 4: I took the speeder apart to evaluate the components. I used the chassis (upper left) and the bottom half of the front (lower right) and cut a new lid for the motor housing from the roof.**



Figure 5

**Figure 5: A 1/43 Ford woody provided the other parts for my speeder. Disassembling prebuilt models isn't difficult if you make sure you know where the fastening points are.**



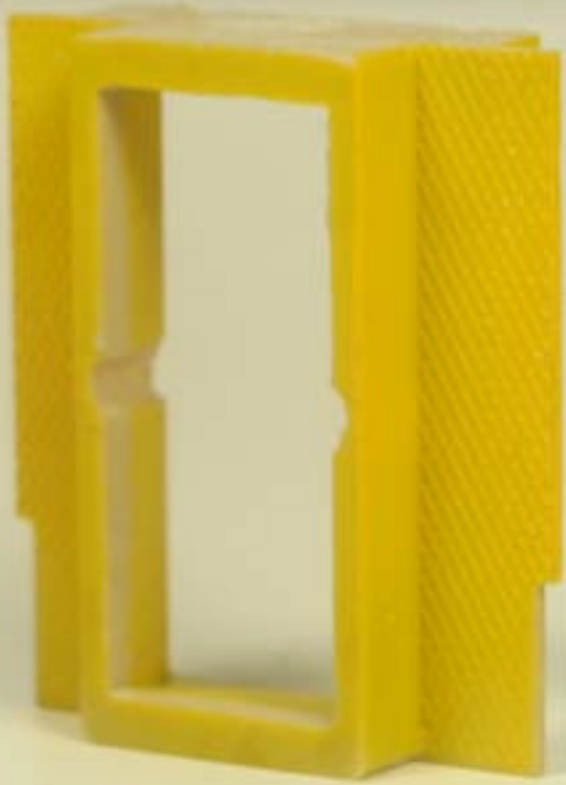

Figure 6

**Figure 6: The chassis of the Walther's speeder required the addition of 2 grooves to allow the Bachmann San Francisco Cable Car power truck (#60541) to fit inside. I made the cover for the chassis motor housing from a cut down section of the original roof.**

reminds me of the constant "nosing" of the speeder I rode so long ago on the Ma & Pa, that inspired this project.

## Finishing Details

I covered the new roof with canvas (single ply facial tissue and acrylic craft paint), adding a few patches to the canvas for good measure. Several layers of facial tissue and paint on the motor cover, cut from the original speeder roof, made a credible cushion on the cover. I glued two of the original gear shift levers to the top of this piece and added one extra stick made from a pin wrapped

with tissue for a handle. Finally I added a hump to the front of the motor cover to match the contour of the radiator on the body making the hump from the spare tire holder on the Ford's front fender, turned upside down.

The front sports the original battery boxes from the Walther's car. I shortened the Ford's radiator to fit, also using its headlights and horn. I cut the windshield and rear windows from .010" clear styrene. I made a tight fitting index card window first, then traced this on the clear styrene with a pin. This reduced my work with the plastic to just touch-up. Even so, my first attempt didn't fit well enough so I made a second.

I blackened the edge of the windshield glass with a Sharpie marker to simulate

**Text continues on [page 129](#)**

**Figure 7: Right side view of the speeder. The rolled up curtain is rolled up facial tissue secured with black sewing thread and colored with a Khaki Prismacolor Premier (#PM-209) marker. The speeder sports a pintle hook rather than a coupler.**

**Figure 8: The fireman's side view shows two of the hand painted metal figures I used to add extra weight. A white metal 55 gallon drum and #9 lead shot poured into every opening also added weight. The extra weight makes the power truck run smoothly.**



Figure 7



Figure 8





Figure 9



Figure 11



Figure 10



Figure 12

Figure 9: I assembled the front of my speeder from the bottom half of the Walther's speeder and the windshield of the Ford. The headlights, horn and radiator are also from the car. There is a Fordson decal on the lower right to help identify the origin of the details.

Figure 10: The rear view shows a fuel tank on the left and a fire extinguisher box on the right. The exhaust system is from the Ford with a scratch-built flap valve on top and a heat shield around the muffler made from roof walk material. Note the broken and crazed window.

Figure 11: I heavily weathered my speeder using a variety of methods: airbrush, washes, powdered colors and dry-brush techniques. The overall effect is convincing.

Figure 12: The speeder runs nicely on DC, even at slow speeds. My next project will be adding DCC and working lights. I am looking at a Z scale decoder that will fit under the roof, hidden by the side curtains. The wires can run down the center rear on the inside and into the chassis to the motor. Sound is harder, where can I put the speaker?



[Text continues from page 127](#)

a rubber gasket. After the speeder body was painted I glued the windshield in place with Crystal Coat.

The back of the speeder is made from 2 side windows from the Ford, on the upper part, and the tail gate on the lower. Scrap pieces became the fuel tank, a vegetable crate became the fire extinguisher box and the exhaust system from the Ford was mounted vertically for the speeder's exhaust.

I made a flapper valve for keeping rain out of the exhaust pipe and a safety cage from roof walk material to cover the "hot" muffler.

I used a hobby knife to "break" one of the rear windows. I simulated 'crazed' glass with small cross hatching. I coated the rear windows with a flat finish making them opaque but I left the front windshield more or less clear.

Finally, I added a pintle hook instead of a coupler at the rear of the speeder.

I spray painted the body parts with Floquil Reefer Yellow and brush painted the roof and cushion over the motor with Prussian Blue mixed with a little black. I over-sprayed the areas that would get decals with Floquil Crystal Coat making a glossy surface for the decals. Decals were *Diesel Details* from Microsoft for "battery

*inside, safety first, fuel, turn off the engine before fueling"* etc. Wherever it seemed appropriate, I put some slogan or sign on the body. A Fordson decal went on the front to reinforce the Ford parts look. I brush painted the power truck black and dry-brushed the spoked wheels yellow.

I set the decals with Microsol, then coated them with Micro Flat. After they had cured for a day, I weathered the parts with Pactra flat enamel

washes, acrylic craft paint washes and ground pastel and chalk powder. All was over-sprayed with Floquil Flat. I added some black pastel to the roof at the exhaust stack. Unfortunately, the weathering covered

most of the decals, you have to look very closely to see them.

I made side curtains from single thickness facial tissue, cut to fit the opening size, then rolled up around a darning needle and tied with black sewing thread. I colored the 'canvas' side curtains with a Prismacolor Premier (#PM-209) khaki marker. I attached the side curtains to the roof using rubber cement.

Whew! It looks good and runs well. The next thing I'll do for my speeder is add DCC, working lights and a trailer. Watch for it! 

## A Short History of Speeders

The small, 4 wheel, maintenance of the way motor cars known as speeders, were used by track crews as transportation to work sites and also for inspecting the *Right of Way* and tracks in their maintenance section. Sometimes speeders were used to scout ahead of a train if there were doubts about track integrity due to a storm or maintenance issues.

Speeders are small, inexpensive vehicles designed to carry from 2 to 6 workers from work site to work site. Many speeders had trailers to carry the worker's tools and supplies.

The speeder was first developed by the Sheffield Velocipede Company in 1893 when they built their first motor car. It was 4' long, seated two and was powered by a small, primitive gasoline engine. This car was little more than an open frame with 2 seats over the motor weighing little more than 150 lbs. Crews had to push the car to start it, and grounded the spark plug to stop.

Fairbanks Morse (FM), of locomotive fame, purchased the Sheffield Velocipede Company in the late 1890s and eventually introduced the first enclosed model, the No. 16, type C. This speeder used a simple two-cylinder, horizontally opposed, two-stroke

engine with direct drive and friction handbrake. Push starting and grounding the spark plug to stop remained.

The Fairmont Gas Engine and Railway Motor Car Company was the most successful speeder manufacturer and produced over 70,000 of them between 1911 and 1991. Fairmont's design was very similar to FM's but they provided covered cabs for crews, were easier to maintain and evolved to belt drives instead of FM's direct drive.

Fairmont eventually introduced 4-stroke engines with air instead of water cooling, cushioned seats, and enclosed, heated cabs. Later speeders could travel at sustained speeds of up to 40 MPH. The speeder passed away with the advent of Hyrail trucks which carry a larger payload and travel equally well on railroad track or roads.

Speeders are still alive and well, in the hands of collectors. You can get more information from the [American Railcar Operators Association](#) (NARCOA) about their history, meets, runs and collecting. There aren't too many railroad experiences that equal the thrill of sitting in one of those little critters and highballing down the tracks with the wind in your hair and the bell clanging.





## About our layouts columnist



**Charlie Comstock** is our layouts editor and columnist.

[Click here](#) to learn more about Charlie.

*Charlie Comstock is ...*

## UP THE CREEK: Modeling a Small Creek - part 3

A regular report on the construction of a 1950s-something layout

▶ **Reader Feedback**  
*(click here)* 

Planting a large cedar and adding some scenic details ...

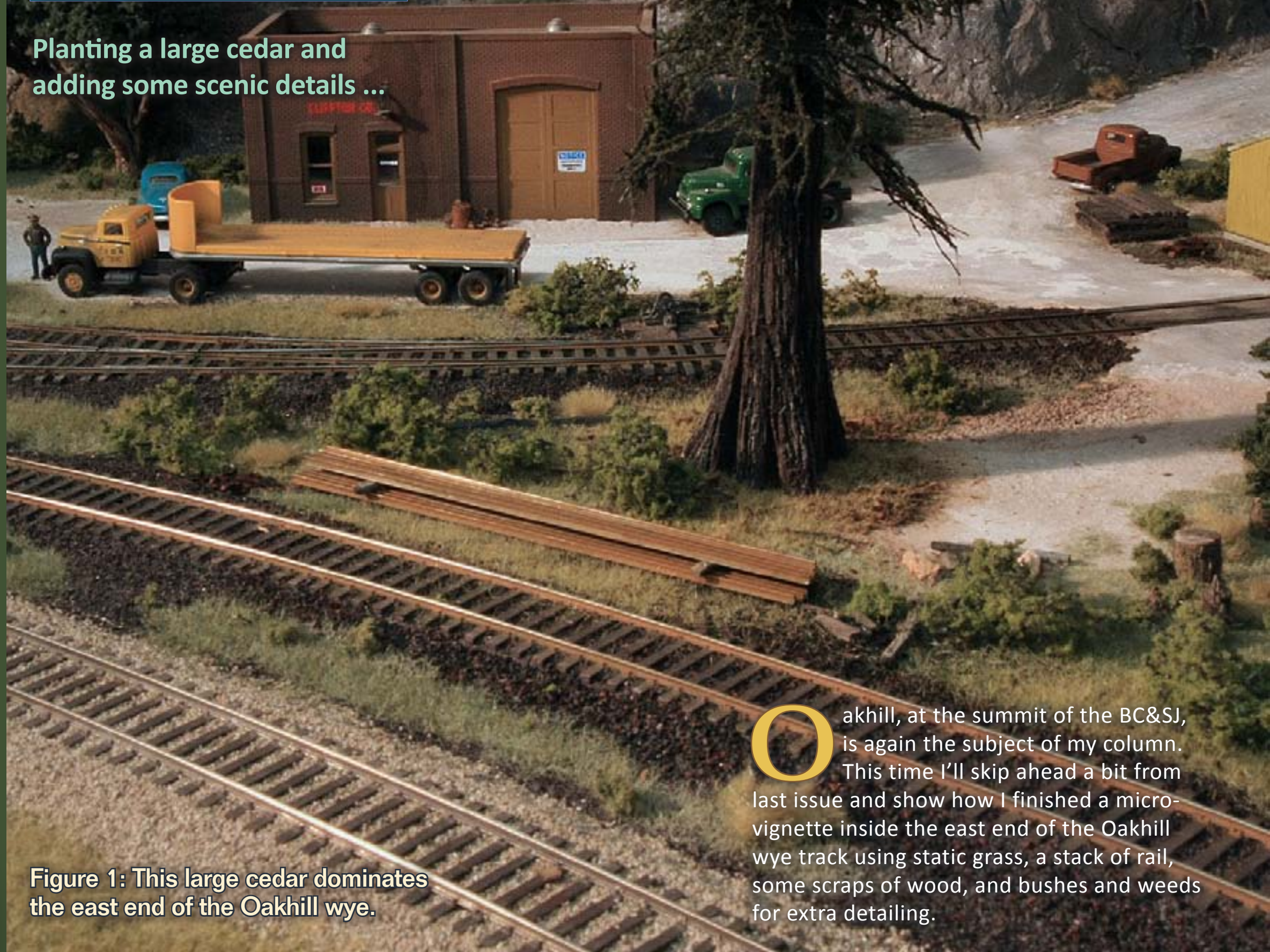

**Figure 1:** This large cedar dominates the east end of the Oakhill wye.

**O**akhill, at the summit of the BC&SJ, is again the subject of my column. This time I'll skip ahead a bit from last issue and show how I finished a micro-vignette inside the east end of the Oakhill wye track using static grass, a stack of rail, some scraps of wood, and bushes and weeds for extra detailing.



FIGURE 2: The scene before tree planting. I've 'grown' some basic static grass in this area.

FIGURE 3: I held the cedar in position so I could see where to make the hole for its mounting spike. This super-detailed tree is from [Canyon Creek Scenics](#), it's been bouncing around my railroad for a number of years looking for a good home. During its journey, its mounting spike came unglued and fell out. No matter – I made a new one out of 12 gauge copper wire.

FIGURE 4: If the ground was soft, like pink foam, I could just 'punch' a tree spike into it. But here, the ground is  $\frac{3}{4}$ " plywood so out came the drill. I measured the diameter of the mounting spike with dial calipers and picked a drill bit to make the hole a bit snug. I don't want the planted tree to be wiggling around. A tip, I put a few little 'tweaks' in the copper wire mounting spike so it wouldn't rattle around in the tree's mounting hole.

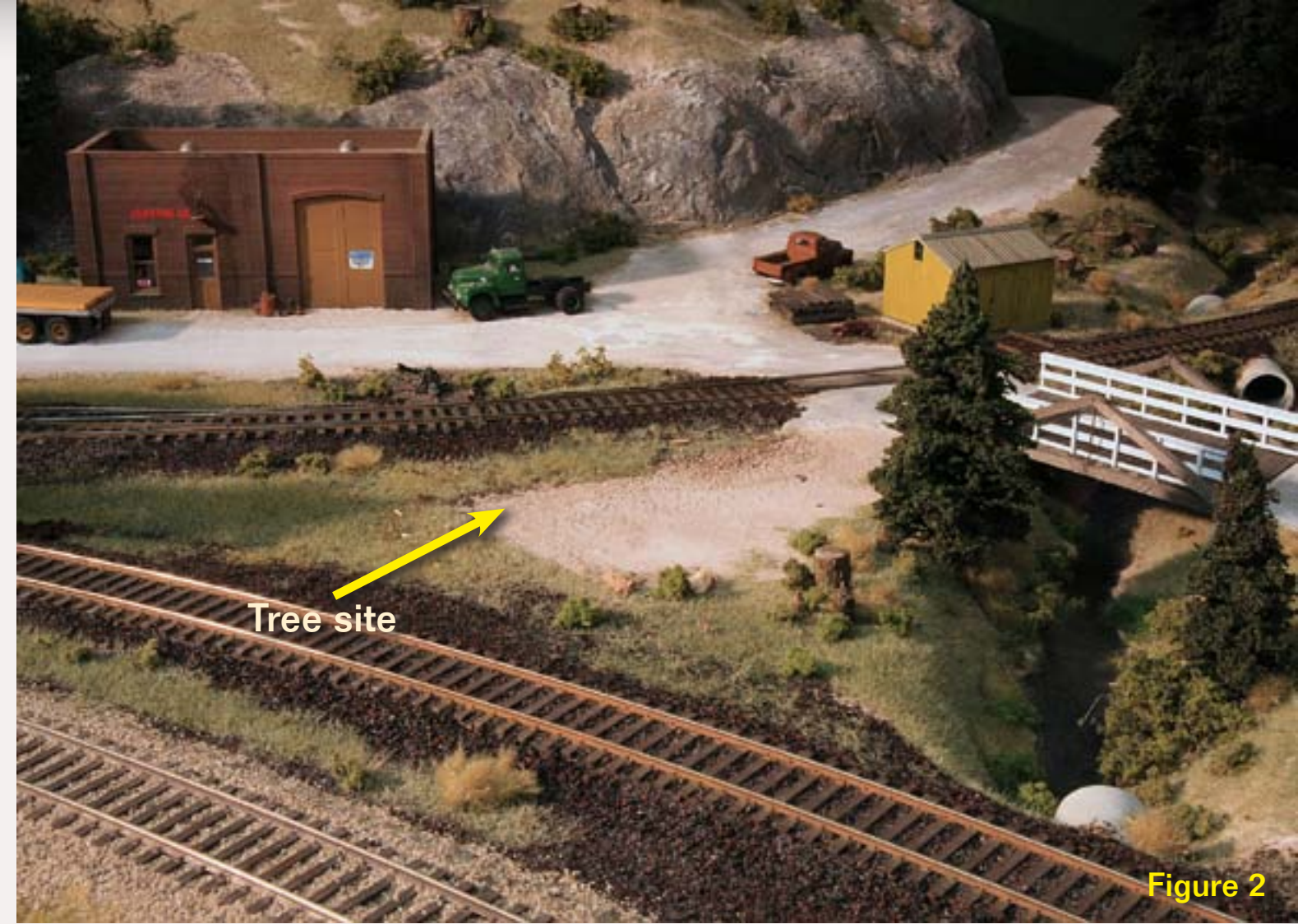

Figure 2



Figure 3



Figure 4





Figure 5

FIGURE 5: I plugged the tree into its new home. Since the trunk is highly detailed (and not perfectly round) I rotated it until I found the best angle for viewing.

FIGURE 6: Once I'd rotated the tree to the best viewing angle I used a pencil to trace the trunk's outline on the ground.

FIGURE 7: Then I added cedar debris to the ground and used a small brush to move it outside the trunk's penciled outline on the ground. These pieces of cedar are leftovers from carving tree trunks



Figure 6



Figure 7

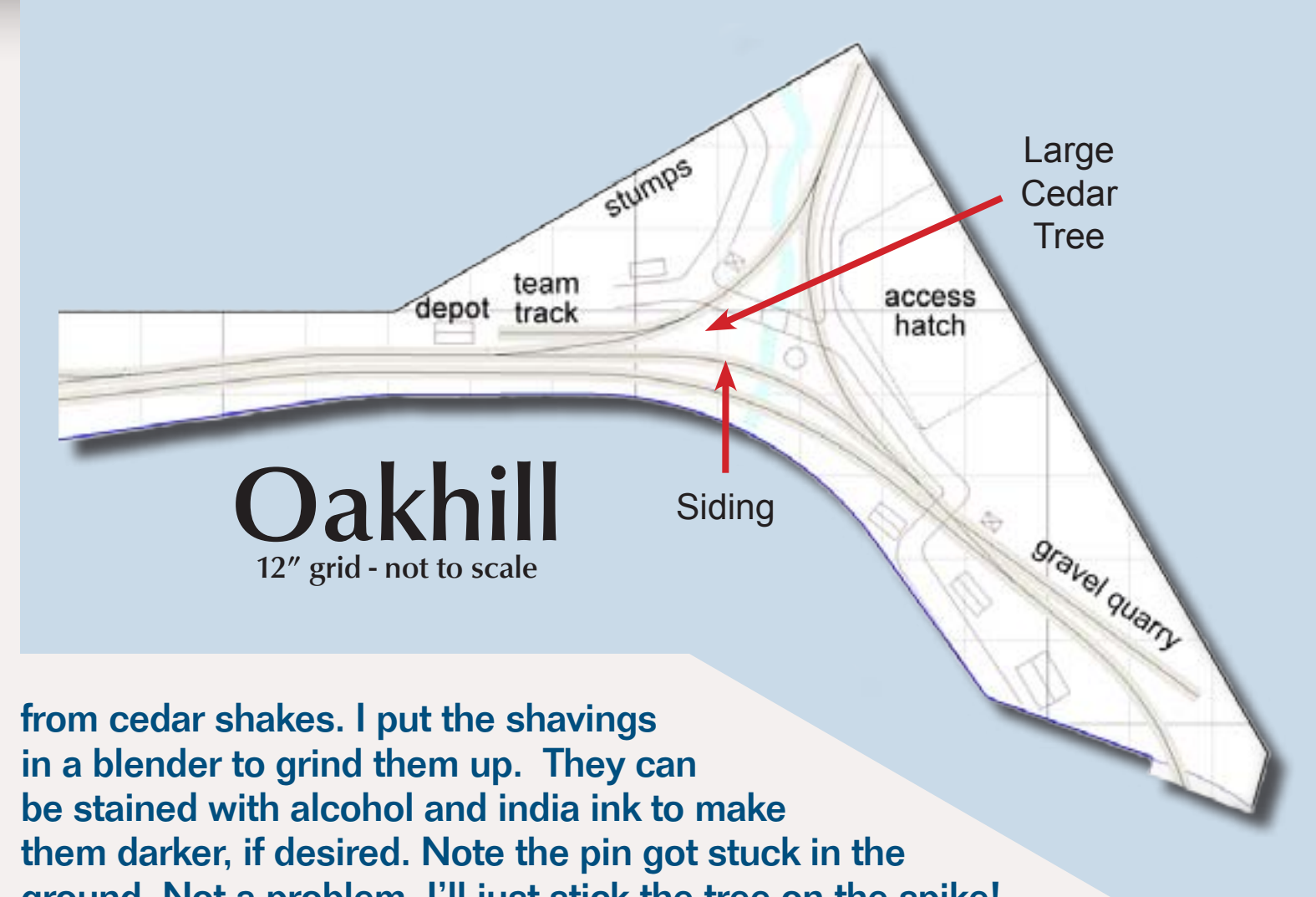

from cedar shavings. I put the shavings in a blender to grind them up. They can be stained with alcohol and india ink to make them darker, if desired. Note the pin got stuck in the ground. Not a problem, I'll just stick the tree on the spike!

FIGURE 8: Once I have the ground-up cedar shaving debris in place I use a small syringe to carefully dribble isopropyl alcohol on them until they and the area surrounding them are completely saturated (figure 8a inset).

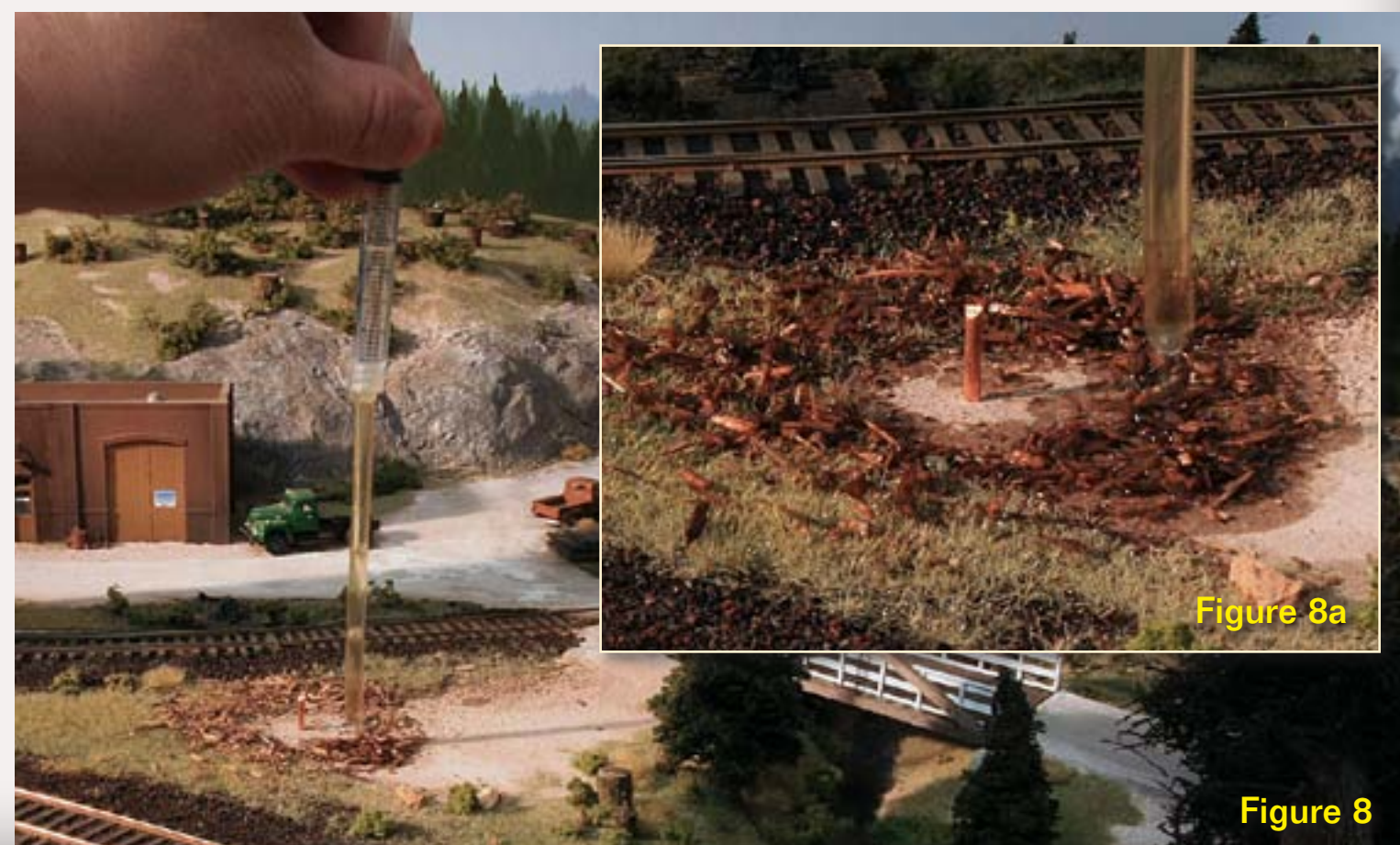

Figure 8a

Figure 8





Figure 9



Figure 10



Figure 11

FIGURES 9,10: Once the cedar debris is saturated with alcohol, I use my usual 50/50 diluted mix of white glue and water to glue it in place. I dribble on the white glue until it's pretty well coated.

FIGURE 11: While the glue is still fresh (wet), I loaded up my Grass Master with a mix of 4 mm Silflor late summer flock, and some 2 mm Harvest Gold and Light Green Woodland Scenics flock. I cut out a paper disk in which I left a small aperture. I put this in the end of the Grass Master to let me work on a smaller area (figure 11a).

FIGURE 12: A view of the tree site, mounting pin, and debris after applying the first layer of static grass.

FIGURE 13: While the glue holding the grass in place dried, I started work on a stack of rail next to the siding. With rail nippers I cut pieces of code 83 rail 39 scale feet long (about 5.25" long) and filed the ends square and smooth. Then I used Floquil paint pens to color the rails, starting with rail brown and finishing with rust. It took several coats to get good coverage.



Figure 12



Figure 13



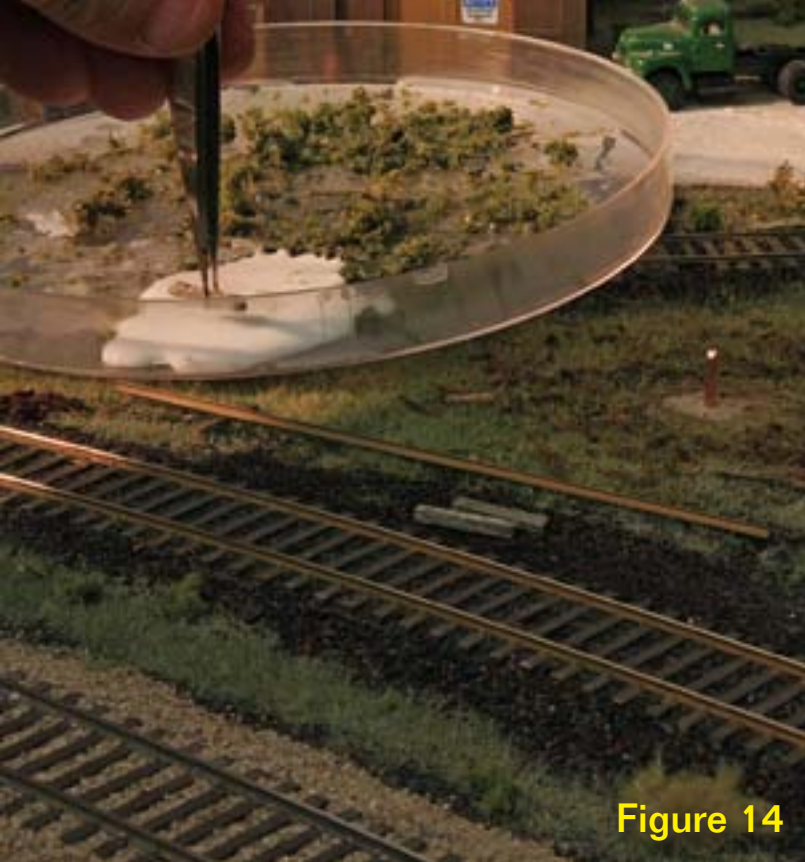

Figure 14

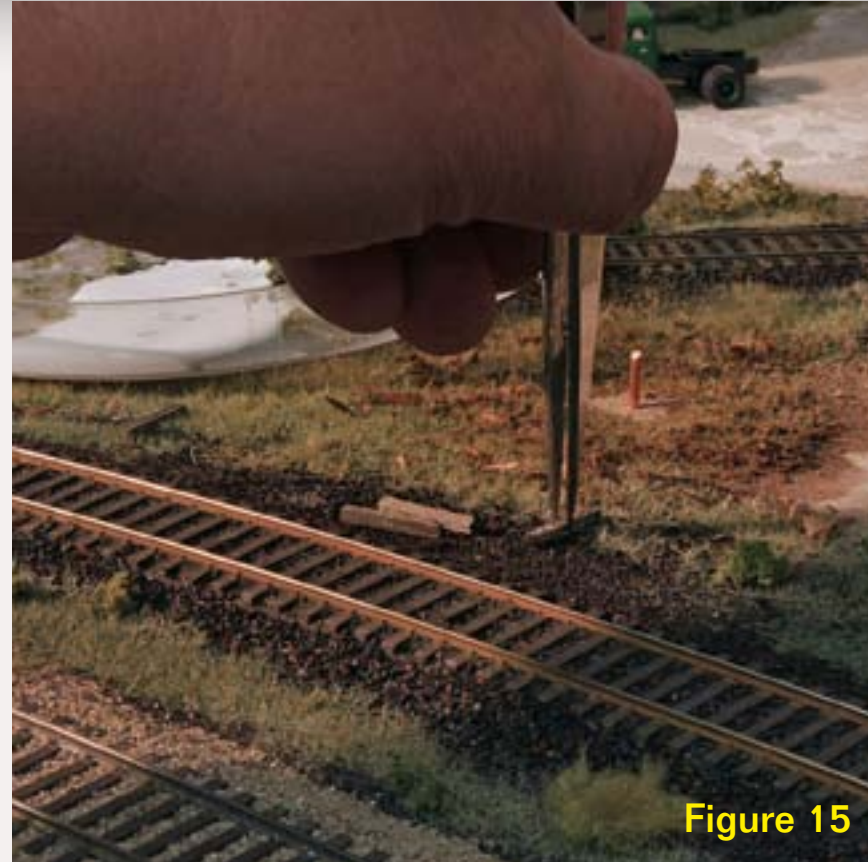

Figure 15



Figure 16

FIGURE 14: I started the rail stack by scraping some left-over wood ties with a razor saw and dunking them in an india ink and alcohol mixture. I cut the ties to length, about  $\frac{5}{8}$ " and used tweezers to dip one side into some full strength white glue.

FIGURE 15: I used the tweezers to place the tie glue-side down, next to the siding.

FIGURE 16: Then I used a toothpick (actually its a switch tie I

whittled to a point) to put a small amount of white glue on top of the wood pieces that will support the pieces of rail.

FIGURE 17: I used tweezers to set six pieces of rail in place on the supports. This was a little tricky. Everything wanted to move around.

FIGURE 18: I glued another set of wooden supports to the tops of the first layer of rails, added some more glue on top of them, then added a second layer of rails on top of the wood supports.



Figure 17



Figure 18





Figure 19



Figure 20

FIGURE 19: The rail stack is ready for BC&SJ MOW crews.

FIGURE 20: Bits and pieces of scrap wood – distressed and weathered.

FIGURE 21: Gluing the scrap wood in place in small piles.

FIGURE 22: Gluing Woodland Scenics fine leaf foliage and Silflor in place for weeds and underbrush. Dunk in white glue and place.

FIGURE 23: (next page) I added some more static grass, a small pile of brown paper tie plates, pressed the cedar onto the mounting spike and presto, the finished micro-vignette!

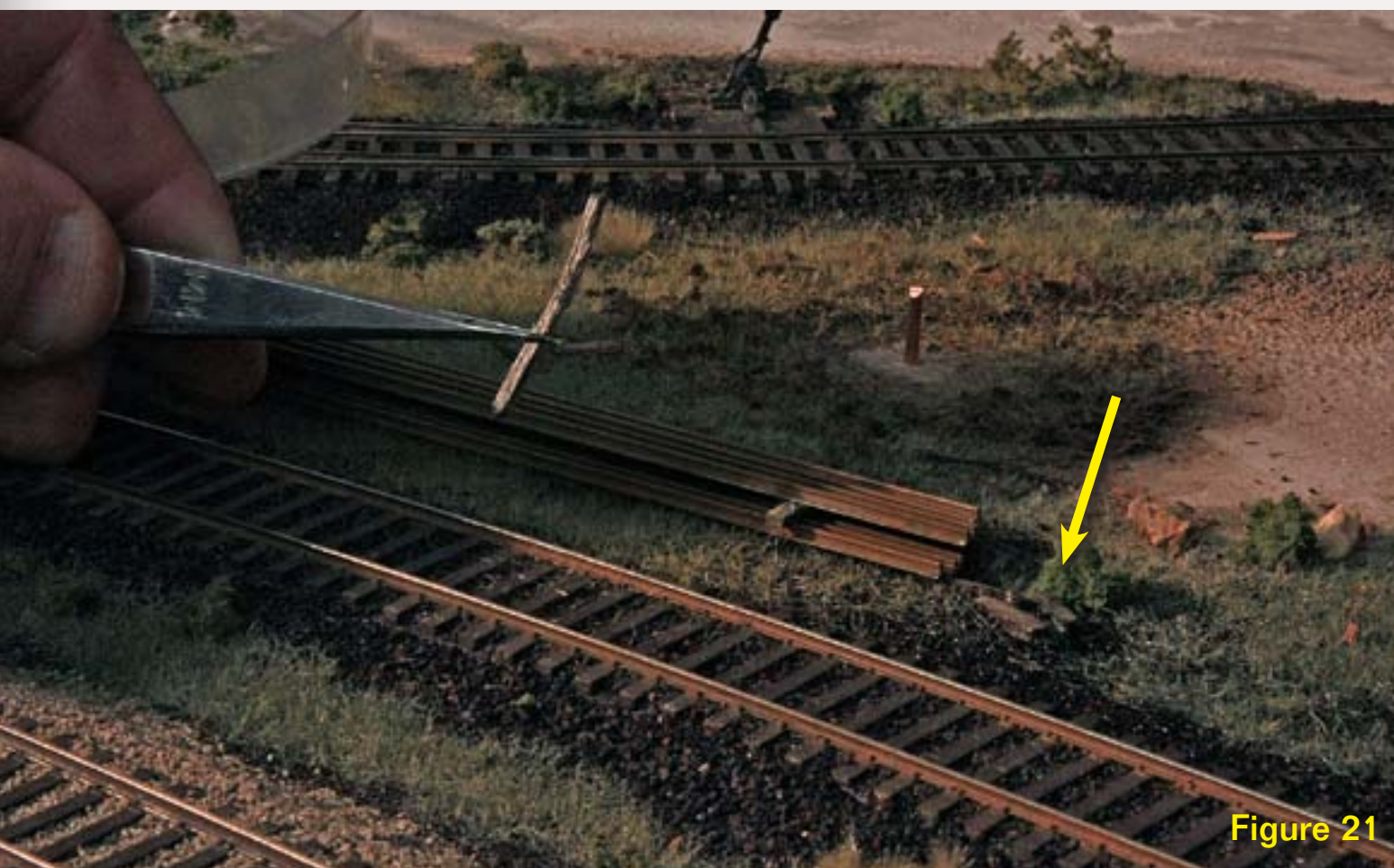

Figure 21

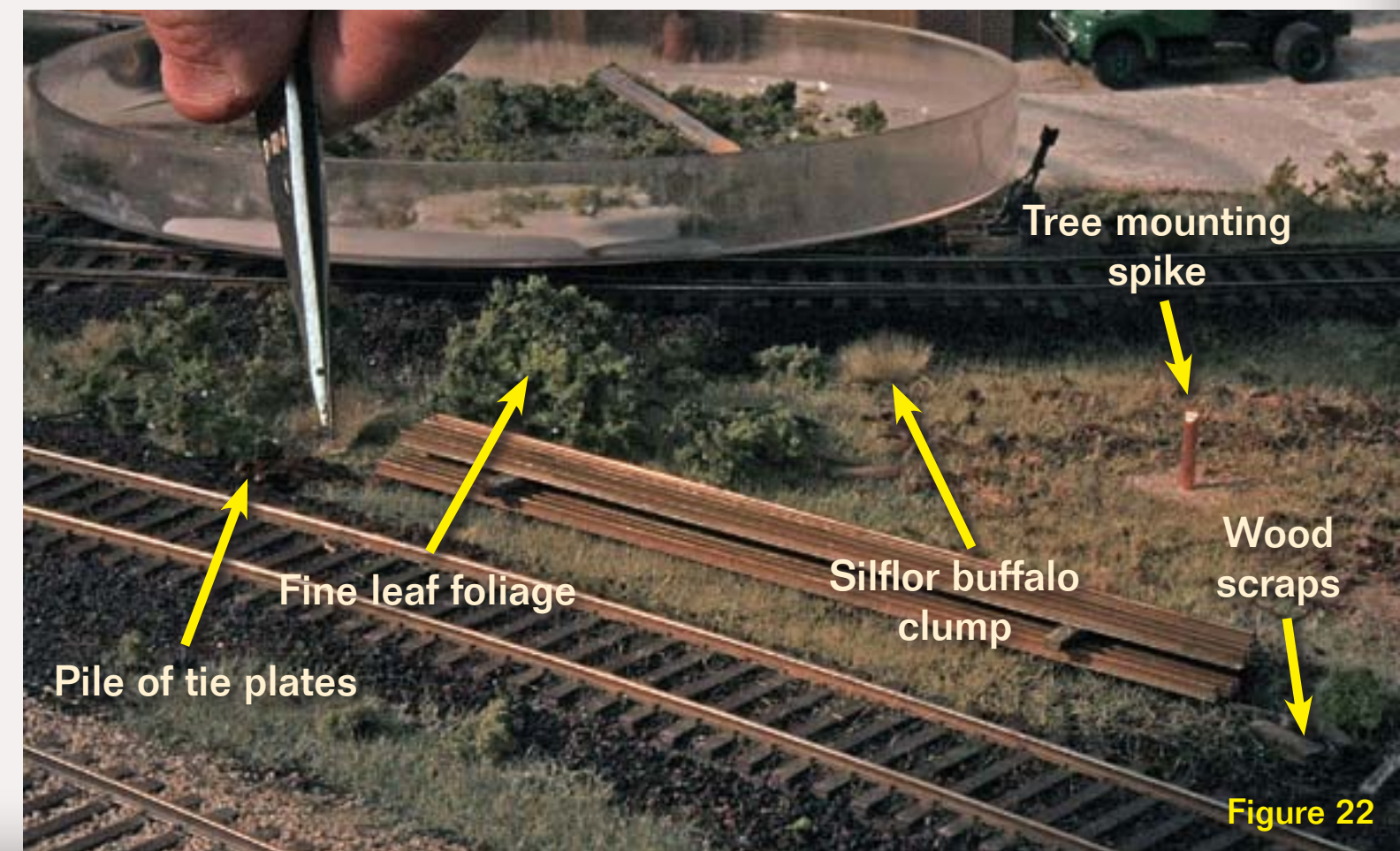

Figure 22

Tree mounting spike  
 Wood scraps  
 Silflor buffalo clump  
 Fine leaf foliage  
 Pile of tie plates





Figure 23



## About our prototype modeling columnist



**Marty McGuirk** is an avid Central Vermont fan, modeling the “Southern New England” – an HO scale proto-freelanced railroad set in the 1950s and based in part on the real Central Vermont Ry.

[Click here](#) to learn more about Marty.

Photos and illustrations by the author unless otherwise credited.

# GETTING REAL: Flipping the Piers

## Adventures in Prototype Modeling



### Layout Design with a saw and screw gun ...

**M**aybe I should title this “flip-flopping the piers.” I started building my HO scale Southern New England Railway with little more than a rough benchwork outline and the idea that the mainline should start at Tidewater and proceed inland through typical New England scenery and small towns before ending at a medium-sized mill town. I figured why waste time drawing a detailed track plan when there’s a railroad to build. That doesn’t mean I don’t have a plan – I’ve just never actually drawn it out. But I’ve built enough railroads over the years that I rely on the vision in my head and a sense of what will fit and result in an appealing scene.

While such a shoot-from-the-hip approach can be great fun and makes me feel like a real maverick, at times it’s also caused me to go back and re-do a few things once I actually see them in three dimensions. Maybe I’m not as good as I think? Nah, that can’t



**FIGURE 1:** During test operating sessions (see [Sea Trials for the SNE in the May/June 2010 MRH](#)) the Thames Street pier area protruded into the aisle and proved a bottleneck for operators entering the layout area. So Marty decided to rework the pier area – again.

be it! Would I change my approach? No way!. If I’d done the “design everything up front” approach I’d still be looking for prototype track maps, or drawing the hundredth plus version of the track plan with the idea of seeing

if I could squeeze just a little more mainline into the space. Instead, I have completed the mainline and most trackwork on a (mostly) double-deck 18 x 48 foot layout in a little less than two years of spare time. Of





**FIGURE 2:** This photo shows the pier area in the early benchwork stages. The narrow aisle to the left of the short wall is visible. It was impractical to penetrate that short wall because the HVAC is on the other side.

course, I've built three yards in that time – which is weird, since there's only one yard on the railroad. In fact, Thames Street Yard, my main classification yard, has undergone more design, revision, construction, and reconstruction than any scene I've ever built on any layout – ever. It's to the point where I've moved tracks and drilled so many holes for switch motors that the underlying  $\frac{3}{4}$ " plywood looks like Swiss cheese!

Part of the problem is the location in the basement. As figures 1 and 2 show, the yard ends in a corner with one long wall behind the yard and

a short wall that juts into the layout room. I can't run the tracks through the wall since the HVAC system is on the other side of the short wall. It is, literally, the "end of the world" for my modeled railroad. It seemed a logical place to put the yard in context with the rest of the layout since it was the place where operators would enter the layout area.

Although the SNE is freelanced, it is based – very closely – on the prototype Central Vermont Railway. So, when it came time to look for inspiration for the SNE pier area and yard I started with the CV's East New



**FIGURE 3:** When Marty first laid out the benchwork at Thames Street Yard he placed the two piers in the correct position relative to the prototype – State Pier to the east, the railroad pier to the west). Although track-laying had progressed on the rest of the railroad, this area was not developing any momentum at all – a sure sign something was amiss.

London yard. The prototype featured two large piers:

- A railroad pier know as the "Long Dock" used by the CV for the railroad-controlled steamships that connected New London with New York City steamboats and also for bulk loading and unloading of barges and cargo vessels – coal from the Hampton Roads area was at one time unloaded into railroad hoppers here.
- The Connecticut State Pier. I've long been aware of the existence of

a large entry on the Historic American Building Survey (HABS) site on Connecticut State Pier ([hdl.loc.gov/loc.pnp/hhh.ct0566](http://hdl.loc.gov/loc.pnp/hhh.ct0566)) with lots of details and data for that pier.

My initial plan and construction matched New London faithfully. The problem was the position of the two piers may have matched the prototype but the south yard ladder and lead was going to be on the railroad pier – towards the back, with the farthest turnouts almost 34" from the aisle. Even before our first test session



I knew this was a potential issue. Not only was the distance a potential problem, the problem would be magnified when it came time to add the warehouse to the State Pier in the foreground since operators would need to reach over the warehouse building to uncouple cars in the south end of the yard.

By this point I'd asked my friend **Frank Hodina** to help me with the yard design – and he actually drew up a track plan for the yard – to date the only section of the SNE track plan that's been written down! (a printout of the plan shows up in some of the photos included here). I changed a few things in Frank's plan, like notching the benchwork (it's the reason the pier in the foreground ends before the one in the back) - creating a small alcove just big enough to let the yard operator reach the rear tracks.

So the week before my first test session I opted for the "historical fiction" approach, completely tearing out the south yard ladder and flipping the two piers. Actually moving the piers was pretty easy albeit very dusty. I set the blade depth on my Skil (circular) saw so it wouldn't cut into the Masonite "water" surface,

fired it up, and ran it through the homasote and plywood. Then I loosened the screws holding the piers in place from below and moved them to their new positions (fig. 4).

During the first Sea Trials operating session we found three problems with it. The first was the length of the classification tracks. Because of the location of the south yard lead, the class tracks were shorter than the average train length (as deter-

**I decided to take the "historical fiction" approach and switch the relative location of the two piers.**

mined by the length of the passing tracks at each station on the rest of the layout.) "Doubling" the train out of yard (ironically, which was done all the time on the prototype in New London) was fun and challenging on

occasion, but could become a bottleneck if it had to be done for every train. Second, even moving the railroad pier to the foreground didn't solve the problem of reaching the tracks to the rear. Although the yard ladder was in easy reach, the State Pier was now 30" or so from the aisle and was a bit of a stretch especially over the yard tracks. Operating procedures could address two of the problems. After all, we could double the trains out of the yard, and the south end yardmaster could use a stool to reach the back track so those problems were solvable. Not such an



**FIGURE 4: About a week before the first test operating session the author tore up the south yard ladder and reworked the pier area. The SNE's two mascots are barely visible to the left, likely wondering why their master keeps messing with the same area of the layout instead of doing more important things – like feeding them!**

easy problem to solve was the way the pier benchwork jutted into the access aisle (fig. 1) making the aisle in front of the yard, always a busy area, tight if more than six people were in the basement. Yet another re-design was in order.

Since I knew I had to modify the benchwork and track I looked at some other options. I was seriously tempted to replace the piers with a freelanced passenger terminal, mocking up a

scene based on White River Junction, Vermont (fig 5). This would have been neat, but the configuration of the basement meant that although the tracks and buildings would look like the prototype White River Junction station area there was no practical way for the trains to arrive and depart the modeled scene. Besides, as neat as White River Junction was, it wasn't New London. And since East New London yard is where I first met the



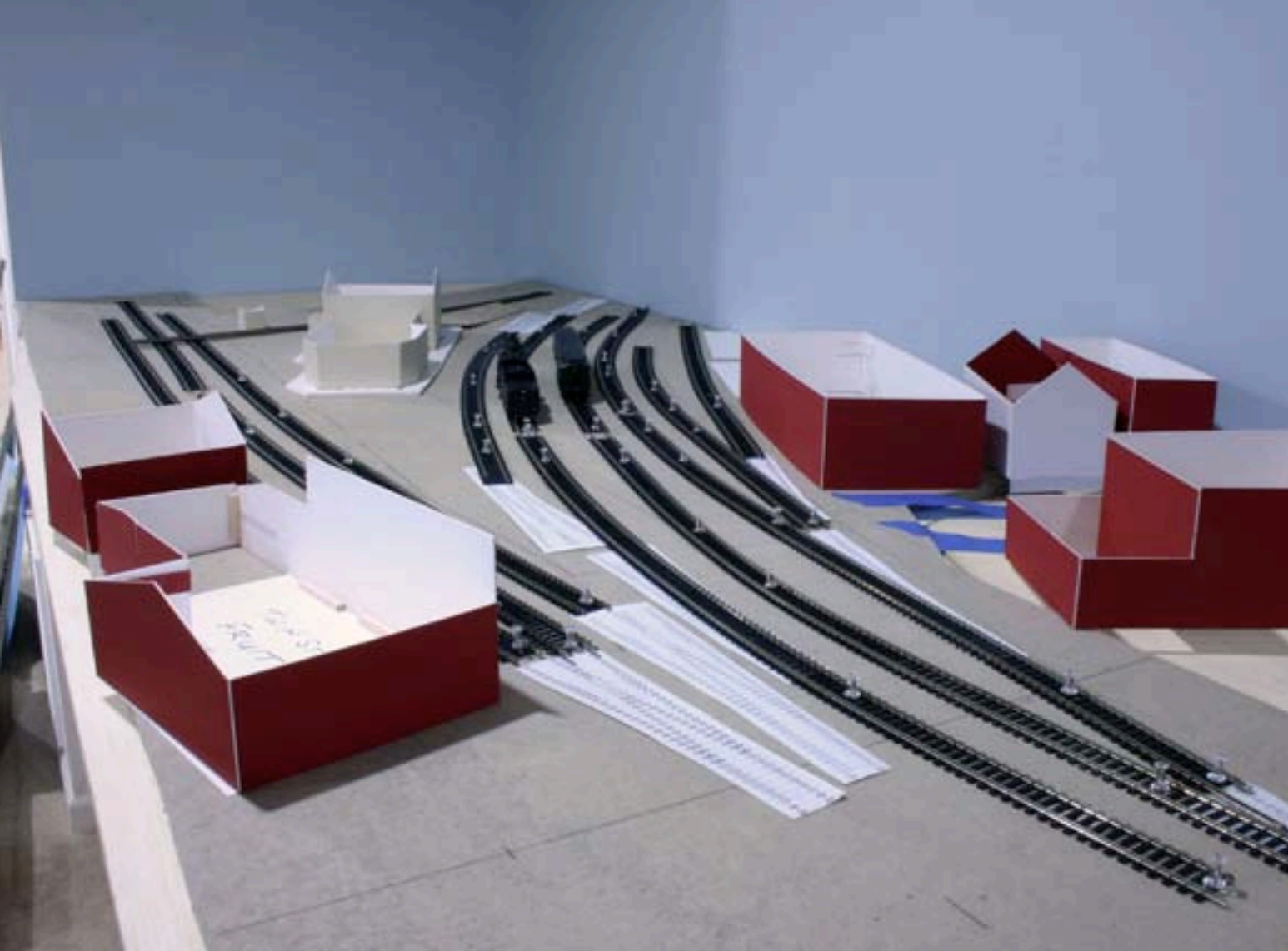

**FIGURE 5:** After realizing the pier area had to be reworked again, Marty considered modeling not New London, Conn., but White River Junction, Vt. This landmark CV scene (mocked up here) would have been wonderful, but the prototype is a through station, and with no practical way for the trains to go to or arrive in this section of the layout room from this idea was scrapped.

CV I wanted the modeled scene, if not an exact duplicate, to be at least look something like East New London.

In the end, a long weekend of benchwork reconstruction produced the current arrangement (figures 6a and 6b). I removed the benchwork that protruded into the aisle and moved the railroad pier to the background. The narrower benchwork eliminated the access problems and

a new ladder made the classification tracks the same length as most of the passing sidings out on the line and long enough to avoid doubling over all but the longest trains.

What of the second pier? A better solution was to add the approaches to the State Pier (in the foreground) and make the somewhat tough decision to not model the pier at all – those lead tracks simply end at the “base”

Prototype dictionary...

## SALTY TALK



I overheard a visitor to the Southern New England discussing some prototype photos of the waterfront planned for East New London:

*“Gee, those little poles in the water are really neat – are you going to include them around your dock? Those boats are heavy, so be sure to use the right size ropes to connect them to the side of the dock. You should run one rope from the pointy end and the other from the back. Most boats have two ropes that cross one another in the middle. Also, where are you planning to get the short metal posts and spiky things that the rigging is looped around?”*

What a pathetic landlubber.

Since we’re discussing a waterfront scenes it seems appropriate to review a few nautical terms. Proper use of these terms will prevent you from sounding like a lubber during your next visit to layout with a nautical theme.

Like railroads, seafarers have developed their own language and words (much of it unprintable!) over the years. Like many railroad terms, nautical terminology is very specific and evolved to save time and avoid confusion – less important on a calm sunny day, but critical at night or in a storm when lives may be at stake if someone misunderstands. Let’s review some of the terms.

There are “boats” and “ships” – and they’re not the same thing. In common usage a boat is any vessel used for rec-

reation or sport although some seamen insist on a strict definition of a boat as a vessel that can be carried aboard ship. So you can hoist a “boat” onto a ship, but not vice-versa, although there are exceptions (U. S. Navy tradition insists on referring to all submarines as “boats,” although you’d be hard pressed to hoist them onto anything!)

“Rigging” is all of the wires, blocks, ropes, spars and other hardware installed above deck with which sails or booms are hoisted and trimmed. You don’t tie a vessel up with “rigging” – you use mooring lines or docklines to secure the vessel to a pier.

The “groups” of pilings you see around piers and wharfs lashed together are referred to as “dolphins” – not to be confused with the pelagic mammal (think “Flipper”) of the same name. Dolphins are a very substantial mooring, dock fender or marker.

Here’s a revised discussion of the same prototype photo:

*“Gee, those dolphins are a really neat detail – are you going to include them around your pier? Be sure to use heavy enough mooring lines and secure the vessel with the appropriate bow and stern lines, as well as the spring lines. By the way, where are you planning to get the cleats and bollards the dock lines are made fast to?”*

Ah, much better.

There’s a number of online nautical dictionary that will help prevent you from sounding like a complete lubber when showing off your harbor scene. A good one is [www.seatalk.info](http://www.seatalk.info)





FIGURE 6a: These two views of the reworked pier area can be seen here (trackwork is still under way). The State Pier ends at the benchwork, an “aisle side” industry. The railroad pier is behind it on the left.



FIGURE 6b: The white posterboard footprint marks the approximate outline of the freight platform and shed. At last, all is right with the world in the Thames Street yard.

An excellent resource for modelers interested in including piers, wharves, or docks on their layout is a book written in 1917, by Carleton Greene called “*Wharves and Piers, Their Design, Construction, and Equipment.*” The book is available online through Google Books. Here’s a link:

[http://books.google.com/books?id=4tG948qe040C&printsec=frontcover&dq=%22Wharves+and+Piers%22+1917&source=bl&ots=ll95rO5qa2&sig=s\\_FYiWvtBu1Slu07LmaUlsPDoOA&hl=en&ei=w6mTTPCnDcGblgfZq8ClCg&sa=X&oi=book\\_result&ct=result&resnum=1&ved=0CBUQ6AEwAA#v=onepage&q=connecticut%20state%20pier&f=false](http://books.google.com/books?id=4tG948qe040C&printsec=frontcover&dq=%22Wharves+and+Piers%22+1917&source=bl&ots=ll95rO5qa2&sig=s_FYiWvtBu1Slu07LmaUlsPDoOA&hl=en&ei=w6mTTPCnDcGblgfZq8ClCg&sa=X&oi=book_result&ct=result&resnum=1&ved=0CBUQ6AEwAA#v=onepage&q=connecticut%20state%20pier&f=false)

of the unmodeled pier at the water’s edge. We still can sort and spot cars for State Pier. All we miss out on is the final move of shoving the cars into position. Frankly, since the State Pier warehouse had the tracks running inside it, not modeling it may be a blessing in disguise. In my experience, having tracks inside a building – especially a really long one – can often become more trouble than it’s worth. But it was a neat building. Perhaps at some point in the future I’ll decide there’s enough room to model just

the north (land side) façade of the State Pier warehouse.

What can you learn from all this? I’m not sure, except that such flip-flopping can result in benchwork that looks more like Swiss cheese than  $\frac{3}{4}$ ” plywood. Perhaps the best lesson is “less is more” and giving in to the temptation to include more track and operating “interest” often results in tight aisles, difficult access, and less enjoyable operation.





## About our N-scale columnist



**John Drye** is our N scale editor and columnist.

[Click here](#) to learn more about John.

# COMME-N-TARY: A Mountain from a Cardboard Box Creating the Alleghenies in N Scale

Modeling in the hobby's most eNgaging scale



**An easy, flexible, and quick approach to making mountains out of inexpensive materials ...**

**M**ountain railroads have always appealed to modelers. The prototype scenery is spectacular and can provide a great-looking stage for our trains. The irregular terrain provides justification for the railroad to double back on itself (an advantage for the often-present model peninsula), and tunnels provide convenient excuses for trains to duck out of sight (Figure 1).

## East Coast Prototype

The east coast version of North American terrain is old geology. As a result, the mountains are relatively gentle and low enough for the tree line to (almost always) reach the top of the terrain. The trees are often mostly or completely deciduous, resulting in a homogenous "blanket" of green. The terrain is often tall enough to tower well above the railroad, naturally creating useful view blocks.

The east coast railroad taking shape in my basement runs through the mountains of Central Pennsylvania. The track plan includes a large central peninsula and above-grade terrain that blends into the backdrop. The basement needs lots of hills and lots of trees.

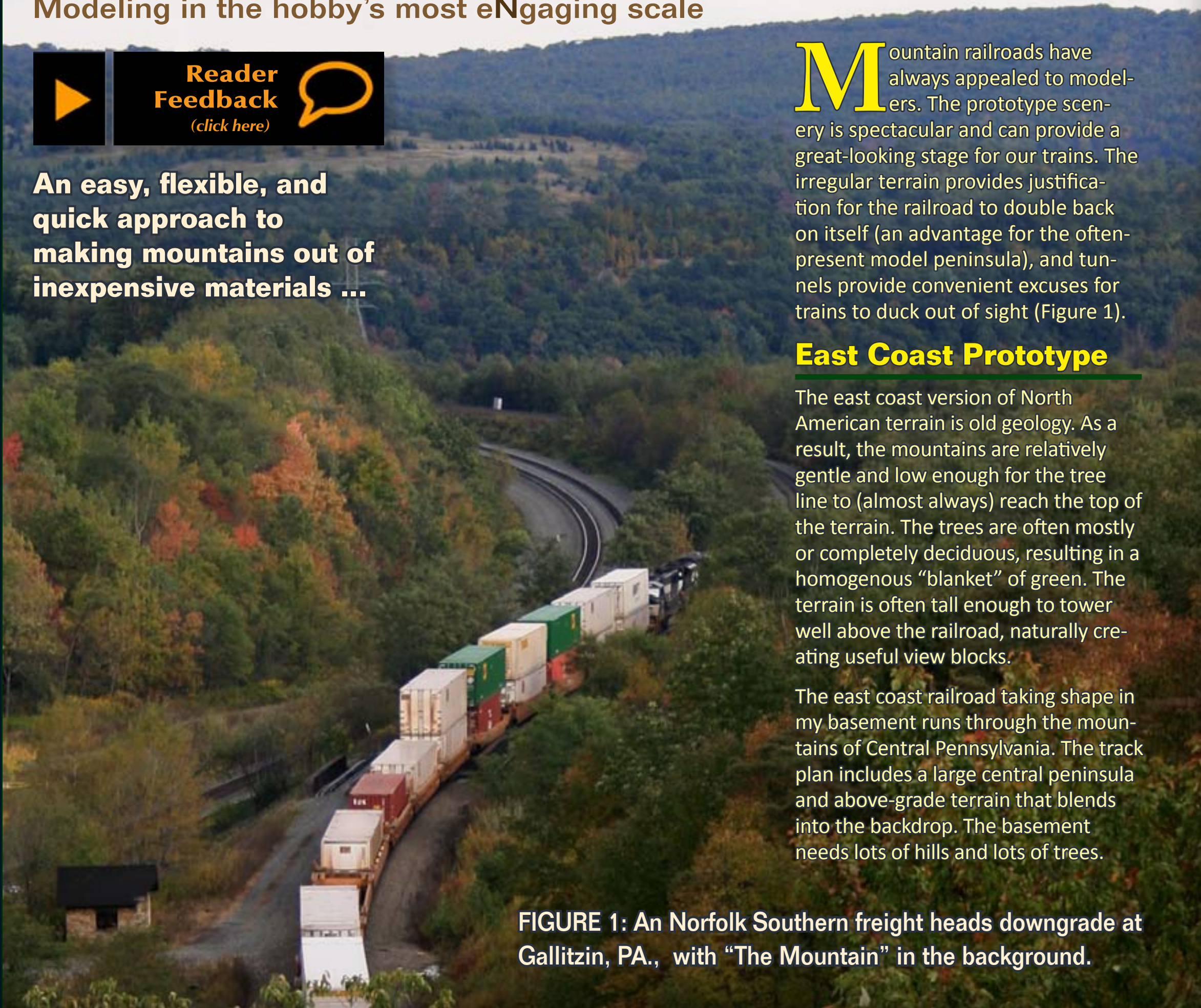

**FIGURE 1:** An Norfolk Southern freight heads downgrade at Gallitzin, PA., with "The Mountain" in the background.



## Process

There are many, many ways to go about building mountainous terrain. Traditional methods have included wire screen, plaster cloth and carved Styrofoam. The approach described in this article combines elements of many of these methods and expands on the brief description of this technique in an earlier column. It has been developed from years of building modules and fixed layouts and includes a few new twists.

## Terrain Contours

The first step is to define the contours of the terrain. For my layout, the track winds its way around the walls of the

basement and then along two sides of a “J”-shaped peninsula.

Along the walls, the terrain slopes up from the tracks to reach the backdrop. There is about 6 inches from the track to the walls. Since the view is nearly straight on, the slope was exaggerated a bit, and the terrain rises about 6 to 8 inches in that distance. The top of the terrain blends into the backdrop and carries the apparent ridgeline well above eye level.

The central peninsula is about 24” wide all around and needed to act as a view-block without incorporating a backdrop.



**FIGURE 2:** Installed plywood contour showing the profile of the terrain at Horseshoe Curve.



**FIGURE 3:** Cardboard grid glued over plywood forms shows the terrain contours taking shape. Note the blue foam on top of the ridge pole.

Several templates were cut from cardboard (more on cardboard later) to find a contour that reached above eye level and also looked right. It is easy to cut away a little cardboard with a box cutter or to hot-glue on more for a little extra height. Spending a little time here to get a shape you are happy with is worthwhile.

Once the proper contour was determined, the cardboard template was traced onto ½” plywood and cut to shape. Kind of like stacking plates in the bottom shelf of a dishwasher, the plywood contours were screwed to the layout benchwork to create the outlines of the central peninsula terrain. Next, a 1 x 4 “ridgepole” was installed between the plywood “plates” to create the top of the ridge. To provide for natural variation in

the ridgeline, inch-thick Styrofoam was cut with a wavy contour and hot-glued on top of the “ridgepole” (Figure 3).

## Weaving a (cardboard) Web

Once the basic shape is defined, the slopes of the mountainside are constructed from one-inch-wide strips cut from cardboard boxes. You can even use the remnants from the contour templates. Cut strips long enough to reach from the benchwork to the top of the ridgepole or to the backdrop. Install these vertical strips about six to eight inches apart using hot glue. Before installing the strips, crumple them by folding back and forth lengthwise to make them flexible. Where a strip meets the backdrop, bend the cardboard downward and



glue the top (not the bottom) side to the backdrop. After the vertical strips are in place, weave horizontal strips in a basket-like fashion and hot-glue in place. The weave will stiffen as the strips are glued, but can be adjusted in the process (Figure 3).

One significant advantage of this approach is the ease of making adjustments at this step. The cardboard weave can be cut apart with scissors, adjusted, and hot-glued back in place. A spring clamp (not shown) is useful to hold the cardboard in place while adjustments are being made (Figure 4).



**FIGURE 4:** The web of cardboard strips creates the outline of the peaks and valleys at Horseshoe Curve.

## Doing the Paperwork

The final step in creating the hillsides is to glue thick construction paper onto the cardboard grid. This paper is sold in rolls and is used to protect floors during home remodeling, and can be found at hardware stores. One roll has lasted for all the mountains on my layout.

The paper can be cut from the roll with a craft knife (be careful) into strips about 12" x 36". Then the paper is crumpled (just like wadding up a bill to throw away). Crumple once, unfold, and then crumple again. This removes all the stiffness from the



**FIGURE 5:** Construction paper has been glued to the cardboard contours and partially painted. Despite the unfinished scenery, a couple of trains have sneaked into the picture.

thick paper and allows it to smoothly match the cardboard contours.

Start by gluing one edge of the crumpled paper to a cardboard strip. Apply more glue to the rest of the cardboard that the paper will cover. I have used hot glue, white glue, and adhesive caulk at this step. The hot glue is useful to “tack weld” a couple of corners in place while the paper is smoothed over the contours. Overlap the next sheet of paper and continue. The paper can be cut or torn into irregular shapes to match the cardboard contours. Keep cutting, crumpling and gluing until the hillside is completely paper-covered.

Adjustments can be made now that the full contours are visible. One

location along the peninsula represents a railroad fill between two folds in the mountain. The original contour included a “divot” as if a giant golfer had taken a hack out of the mountain side. The divot was filled in with crumpled newspaper and more construction paper glued to fill it in. Perfect.

## Paint (undercoat)

Once the contours are adjusted and reinforced, the next-to-last step is to paint the paper to provide an appropriate undercoat for the tree cover. Since almost the entire hillside will be covered in trees, I used very dark grey matt indoor house paint. This ensures that no bright color will be visible underneath the foliage (Figure 6 next page).



## Planting Trees

The last step in creating our mountain majesty is to plant acres and acres of trees. There are several approaches that can be used here as well, including poly fiber, lichen plus flocking, and Woodland Scenics Foliage Clusters®. Foliage clusters seem to do the best job of recreating the uniform look of green deciduous forests. Make sure you don't purchase the similar-sounding and similar-looking Clump

Foliage®, also by Woodland Scenics. Clump Foliage is better for scrub and brush. (Figure 7.)

My layout uses 100% medium green foliage because that looks "right" to me. Others have mixed in occasional clumps of darker and lighter foliage because that's what looks best to them. Fall colors can be used in a similar fashion, but be sure to use restraint in order to avoid a gaudy cartoonish look. In both cases, a



**FIGURE 6:** The terrain above Horseshoe Curve has been painted black in anticipation of tree planting. The trees will be cut back to avoid sparks from that steamer headed downhill, but not this far.



**FIGURE 7:** Here, Mark Andersen, one of the construction crew, plants a few acres above MG Tower. The adhesive caulk is still white in this picture, but will turn clear when it dries.

sprinkling of lighter green ground foam can blend different colors.

The foliage comes in 45 cu. in. bags consisting of a solid clump. The material needs to be shredded into small pieces about  $\frac{3}{4}$ " to 1" in size. This is an excellent task for in front of the TV. A baseball game usually generates a shoebox-full or so before my fingers give out.

After the game, take the shoebox to the layout and spread about a square foot of clear plumbers caulk over the contours. The caulk is tacky enough to hold the foliage on a steep slope and sets up slowly enough to allow

a square foot to be "planted" at a time. For especially steep slopes, hot glue will hold the foliage firmly in place and set up quickly. After a few acres have been planted, go back and look for any gaps and add clumps to fill them in. The terrain needn't be all trees. Grassy fields or rocky slopes can be added on top of the cardboard-paper terrain just as with plaster, wire screen or Styrofoam (Figure 8 next page).

### Advantages and Disadvantages

This approach is quick, relatively inexpensive, and flexible. Building





**FIGURE 8:** Here's an acre of trees along the right of way. The visible gaps will be filled in with additional clusters.

contours with plywood, cardboard, and paper is just as fast as screen and plaster, and is a little less messy. Adjustments can be easily made throughout the process. The final result looks remarkably like deciduous mountains viewed from a distance, especially when representing the distances in N Scale.

This is not the approach for a modular or movable layout. It is less sturdy than plaster or carved Styrofoam, and is vulnerable to damage if struck by objects. While plaster rock castings or carved plaster rocks can be added over the paper (good spot to reinforce with plaster) rocky formations suggest

a different approach. Larger, closer mountains, especially in larger scales, can benefit from a more detailed approach representing individual trees (Figure 9).

### **Summary**

The layout in my basement is slowly being transformed into the Alleghenies of Pennsylvania in this fashion. There are still hundreds of acres to plant, but pretty soon we'll see the railroad of the 50s operating in this beautiful environment. This approach can be used to create the rolling green terrain commonplace in the eastern part of North America (Figure 10).



**FIGURE 9:** Rocks below Kittanning Point are being carved into the scenery by layout sculptor, Bernie Kempinski.



**FIGURE 10:** The forested slope above McGinley's Curve is gradually taking shape.



# REVERSE RUNNING: But We've Always Done It This Way ...

Stepping outside the box with a contrary view



going to learn new things, either. None of us should be so arrogant as to think we know everything about a particular subject, no matter our experience level. Trying a new method just might provide you new insight into the hobby.

## How do YOU learn best?

So where do you learn more? While Model Railroad Hobbyist and other publications are excellent resources, you may find some of the best learning opportunities are just a click away. There are some outstanding posts and blogs on the MRH website by a number of users. For example:

- Scarpia's "Chainsaw" blogs talk about jumping in and trying new techniques.
- Jappe has some great posts and photos of his work
- The J&L Railway blogs, by Jason\_Lachlan\_Railway, demonstrate how a relative newbie is building his first layout.

There are many other examples – you'll just have to check them

out. The best part about the forums is you can ask the author questions, and you'll likely have an answer in a short time.

But don't stop there – create a blog of your own work on the MRH site and you'll tap into a broad experience base to help you while you document your experiences, failures and solutions that others can learn from as well. The more folks do this, the more valuable the MRH forums become as a "one stop shop" for learning and growing in the hobby.

## Do not fear ...

So don't be afraid to try something different and get out of your comfort zone. The worst thing that can happen is you have to do it over again, but that's all part of learning. Next time you do a familiar project, ask yourself if there is a better way. You just might be surprised what you find out ...

new way of doing things as an attack on the old methods. The "we've always done it that way so why should we change" mentality often ends up stifling improvement and progress.

## Old ways / New ways

This is not to say the old ways are all bad. Sometimes, tried-and-true really is that – the best method for doing a particular job in a particular circumstance. But if we never try anything different, we aren't



— by [Dave Kilborn](#)

It's interesting to me how there are those who find something that works for them and will never deviate, while others want to try different things just to see if they'll work. This often manifests itself in the workplace when that group of guys that has been around for 25+ years views a



Clickable Advertiser Index	Page
<a href="#">Accu-Lites</a> .....	17
<a href="#">Alpine Division Scale Models</a> .....	30
<a href="#">Aux-Box</a> .....	60
<a href="#">Bar Mills</a> .....	26
<a href="#">Berrett Hill Trains</a> .....	31
<a href="#">BLMA</a> .....	3
<a href="#">BPL Brassworks</a> .....	11
<a href="#">Canyon Creek Scenics</a> .....	99
<a href="#">CMT</a> .....	7
<a href="#">CSS 2010</a> .....	120
<a href="#">Dallas Model Works</a> .....	4
<a href="#">DCC by Design</a> .....	31
<a href="#">Digitrax</a> .....	10
<a href="#">Fast Tracks</a> .....	5
<a href="#">Fine Scale Miniatures Photo CD</a> .....	124
<a href="#">FOS Scale Limited</a> .....	18
<a href="#">Frenchman River Model Works</a> .....	15
<a href="#">Imagine That Laser Art</a> .....	44
<a href="#">iwata-medea</a> .....	54
<a href="#">Laser Modeling 3</a> .....	14
<a href="#">Litchfield Station</a> .....	43
<a href="#">Micro-Mark</a> .....	19
<a href="#">Model Railcast Show</a> .....	104
<a href="#">Model Trains Video (1)</a> .....	6
<a href="#">Model Trains Video (2)</a> .....	104
<a href="#">Model Trains Video (3)</a> .....	124
<a href="#">Model Trains Weathered</a> .....	29
<a href="#">Modelers Warehouse</a> .....	31
<a href="#">NJ International</a> .....	91
<a href="#">North Coast Engineering</a> .....	82
<a href="#">Paw of a Bear</a> .....	43
<a href="#">Railmaster Hobbies</a> .....	26
<a href="#">Railroad Kits</a> .....	61
<a href="#">Rapido Trains (1)</a> .....	9
<a href="#">Rapido Trains (2)</a> .....	92
<a href="#">RS Laserkits</a> .....	13
<a href="#">Scenic Express</a> .....	59
<a href="#">Scotty Mason Show</a> .....	99
<a href="#">ShelfTrax</a> .....	31
<a href="#">Sidetrack Laser</a> .....	28
<a href="#">Signature Press</a> .....	55
<a href="#">Southern Digital</a> .....	90
<a href="#">Tam Valley Depot</a> .....	57
<a href="#">Walthers</a> .....	81

Clickable Topic Index	Page
<a href="#">Benchwork – Toolless benchwork</a> .....	100
<a href="#">Editorial – Publisher’s Editorial</a> .....	12
<a href="#">Editorial – Reverse Running</a> .....	147
<a href="#">First Look – Com-Art Real Deal Kit</a> .....	121
<a href="#">First Look – Walthers 2011 Reference Book</a> .....	123
<a href="#">Layout Design – Getting Real</a> .....	137
<a href="#">Layouts – Washington Northern Railroad</a> .....	45
<a href="#">Humor – Derailments</a> .....	89
<a href="#">News – Events</a> .....	25
<a href="#">News – November Newsletter</a> .....	20
<a href="#">Prototype – Switching the Daylight</a> .....	62
<a href="#">Q and A – MRH Questions, Answers, and Tips</a> ...	27
<a href="#">Rolling Stock – Lite and Narrow</a> .....	125
<a href="#">Rolling Stock – Passenger Car Modeling - 2</a> .	32
<a href="#">Scenery – Easy Highway Striping</a> .....	58
<a href="#">Scenery – Silicone Rock Molds</a> .....	83
<a href="#">Scenery – Weathering Powders</a> .....	93
<a href="#">Scenery – Up the Creek</a> .....	130
<a href="#">Scenery – Comme-N-tary</a> .....	142
<a href="#">Structures – Spanish Revival Bungalow</a> .....	105

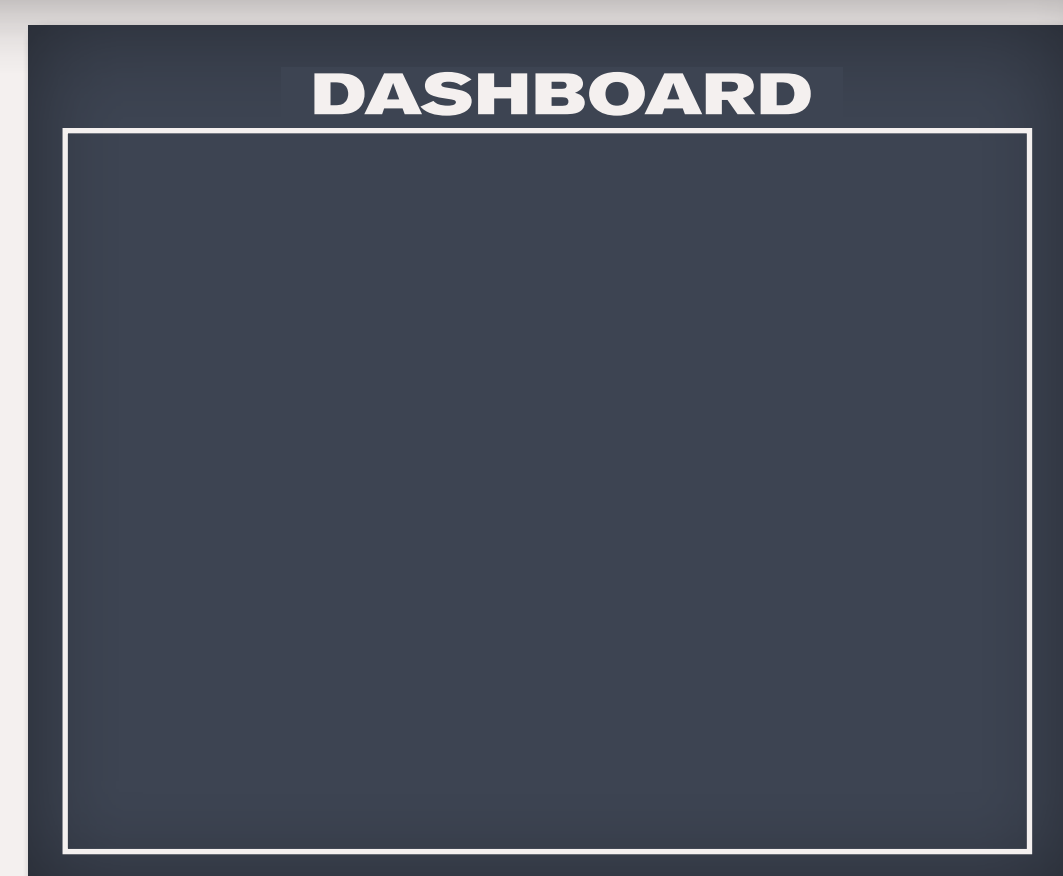

<a href="#">Other – Cover</a> .....	1
<a href="#">Other – MRH Sponsors</a> .....	2
<a href="#">Other – Table of Contents</a> .....	8
<a href="#">Other – Hobby Marketplace</a> .....	31

## For the love of model trains

### Coming in January 2011 ...

- Visit Steve Cavanaugh’s WP layout
- Signals with Plug In Bases
- Fun with Talus
- More One Evening Projects!
- More MRH Questions, Answers and Tips
- Our regular columns

*... and lots more!*

