

Model Railroad Hobbyist magazine™

HAVING FUN WITH TRAINS

Price:
Forever Free
EMBEDDED
Edition

July 2011



N Scale empire!
Al Frasch's BNSF

- Building a helix
 - Speedbashing
 - Homemade lumber loads
 - Selling trains on eBay
- and lots more, inside ...



Front Cover: Al Frasch's N scale BNSF layout qualifies as an "empire" in every sense of the word. We feature Al's 800 square foot *double-decked* N scale layout in this issue. Learn what a double-decked N scale layout built for operation looks like!

ISSN 2152-7423

Editorial Staff

Joe D. Fugate, Publisher
Charlie Comstock, Editor

Columnists

Richard Bale, News and events
John Drye, N scale
Lew Matt, Narrow gauge and shortlines
Les Halmos, Modular railroading

Special Correspondents

Jim Duncan, Layouts and operations
Byron Henderson, Layouts and track planning

Production

Patty Fugate, pasteup and layout
Joe Brugger, copy editing
Mike Dodd, copy editing

Technical Assistant

Jeff Shultz

Advertising Account Manager

Les Halmos



click to learn more about this sponsor



click to learn more about this sponsor



click to learn more about this sponsor



click to learn more about this sponsor



click to learn more about this sponsor



click to learn more about this sponsor



click to learn more about this sponsor



click to learn more about this sponsor



click to learn more about this sponsor



click to learn more about this sponsor



click to learn more about this sponsor



click to learn more about this sponsor



NEW SPONSOR!



click to learn more about this sponsor



click to learn more about this sponsor



click to learn more about this sponsor



click to learn more about this sponsor



NEW SPONSOR!



click to learn more about this sponsor



click to learn more about this sponsor



click to learn more about this sponsor



click to learn more about this sponsor



click to learn more about this sponsor



click to learn more about this sponsor



click to learn more about this sponsor



click to learn more about this sponsor



click to learn more about this sponsor



click to learn more about this sponsor





click to learn more about this sponsor

Modelers! - Click any of the logos above to visit a sponsor's web site and find products that could help with your model railroading projects. Tell them: "MRH sent me!"

Sponsoring Advertisers -

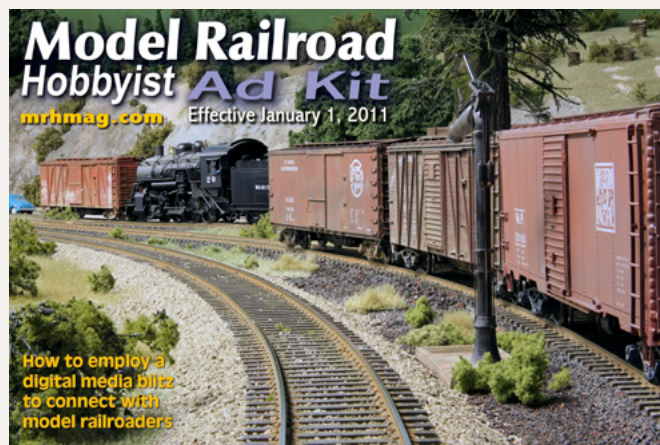
Our sponsors get extra visibility with the MRH web audience (49,000+).



 [Click here to learn how to become a sponsoring advertiser.](#)

A sponsoring ad with MRH is an investment in growing your business.

There's also our Hobby Marketplace!
see [page 26](#) ...

For more model railroading products, including hard-to-find items, also see our [Hobby Marketplace](#) on page 26.

Model Railroad Hobbyist - HOBBY MARKETPLACE

<p>Backdrop Junction Your stop for Model Railroad Backdrops  backdropjunction.com N, HO, O Scales • Custom Orders</p>	<p>Fiber Optics! A NEW Special Offer for our Model Railroad Hobbyist Readers!  www.TheFiberOpticStore.com/MRH</p>	<p>Railpub The source for back issue rail magazines; used, new and out of print rail books. Railroad modeling, prototype, traction, logging, industrial subjects. www.railpub.com</p>	<p>SCOTTY MASON SHOW The Original Model Railroad Podcast www.themodelrailroadpodcast.com Get the Latest Model Railroading News, Tips, Reviews & Opinions</p>
<p>Not just for backgrounds any more. The ONLY craftsman and modeler  www.sansleader.com Available on DVD and Downloads</p>	<p>The Fiber Optic Store.com </p>	<p>PLINE Manufacturers of fine crafted Brass Garden Railroad Trains and spares for the Homebuilder in G, G, Gauge 1, F, F3, S, M45, J2, G, T5 & O scales. We're happy to offer our One-off Brass Model manufacturing services and our Brass Garden Railroad products. www.pline.biz</p>	<p>FINALLY THE RIGHT TOOL FOR THE JOB Retire that Pounce Wheel get the Monster Nail! No More Straight Lines & Square Holes from a Wheel... Create Accurate & Realistic Nail Holes Perfect Scale Spacing  www.monstermodelworks.com</p>

Hey Doc!

I'm worried about my husband's hobby...



COMING SOON



HO SCALE

NEW! **Modern Cantilever RIGHT Hand!**
NEW Right Hand Model! Early Fall

#4030 Left Hand Signal Bridge
#4031 Right Hand Signal Bridge

Assembled, Painted, Lighted!



HO & N

NEW! **Norfolk Southern TopGon Coal Cars**
24 NEW NUMBERS! Late 2011

N #10061-10084 HO #50061-50084

ONLINE AT:   

Blasphemous! Look at everything BLMA has coming!

 ***BLMAmodels.com***
562-712-7085 sales@blmamodels.com

My Railroad

Fast Clocks

Are Here!

Online

Free to Use

6:1 Ratio

4:1 Ratio

3:1 Ratio



Only the coolest kids are Dallas Model Works Members!

 Click to Visit



EXACTRAIL[®]
The Next Generation of Model Railroading

See what's new at ExactRail.com!



P-S 7315 WAFFLE BOX CAR

Available in more than 10 paint schemes!



HO SCALE *Platinum*[®] \$32.95 MSRP

[Click for more details](#)



PS-2CD 4427 COVERED HOPPER

Available in 4 new paint schemes!



N SCALE *N SCALE*[®] \$24.95 MSRP

[Click for more details](#)



72' DECK PLATE GIRDER BRIDGE

Now available unmarked in black and silver!



HO SCALE *EVOLUTION* \$32.95 MSRP

[Click for more details](#)

[Become an ExactRail Insider](#)

[Find an ExactRail Dealer](#)

[Read the ExactRail Blog](#)



1-866-945-1701 | ExactRail.com

Visit ExactRail.com to keep pace with our releases, purchase products or locate a dealer.



Digitrax[®]
Complete Train Control

\$225.00 MSRP

Introducing

ZEPHYR *xtra*

XTRA FEATURES

• 29 Functions • 20 Adresses & Throttles • Recall

XTRA POWER

• 3 Amps • Blast Programming for Sound



Click here to find out more >

Beauty, eh?



CANADA'S WORLD-FAMOUS TRAIN

The Canadian

Main Features

Table of contents

Columns

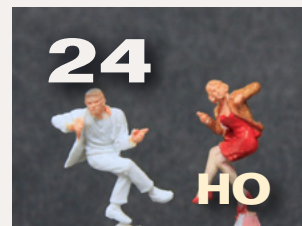

24 **Applying makeup**
Scenery Scene: one evening project!
by Charlie Comstock

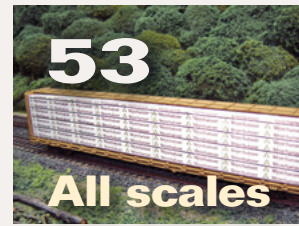

53 **Home-made lumber loads**
Easy loads for your bulkhead flats
by Steve Piroso



27 **Al Frasch's BNSF**
Double-decked N-scale empire
by Charlie Comstock



61 **Building a helix**
One modeler's experience
by Art Houston

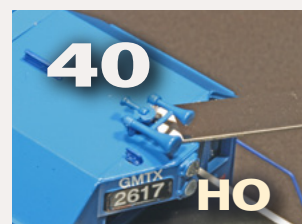

40 **Speedbashing**
Making R-T-R your own in record time
by Matt Snell



73 **eBay for model railroaders - part 3**
Selling model railroading stuff on eBay
by Joe Fugate

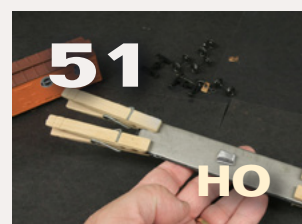

51 **Wheels, weights and couplers**
Car Shop: Rolling stock tuneup
by Charlie Comstock



80 **First Looks:**
A-Line car weights
Aux-Box
by Charlie Comstock and Jeff Shultz

83 **Fish Market**
Lite and Narrow
by Lew Matt

90 **"Pane" of it all**
Modular Adventure
by Les Halmos

96 **Conrail ZTS Layout**
Getting Real
by Mike Rose

105 **Utility Poles**
Comme-N-tary
by John Drye

109 **July Model**
Railroading News
MRH News and Events
by Richard Bale

123 **Achieving Balance**
Reverse Running
by Joe Fugate

15 **Subscriber-only extras**
Bonus downloads

Other Features

10 **Attention to detail**
Editor's Soapbox *by Charlie Comstock*

13 **MRH Staff Notes**
Follow us at X2011W

18 **MRH Q - A - T**
Questions, Answers and Tips

26 **Hobby Marketplace**

125 **Derailments – Humor?**

Model Railroading How-to Videos

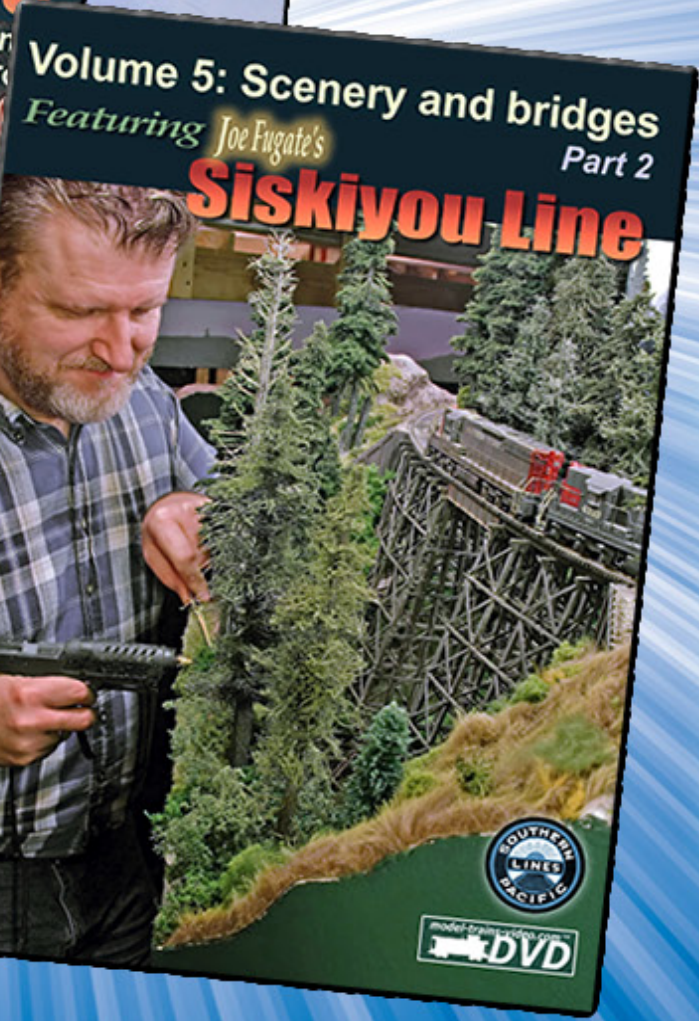
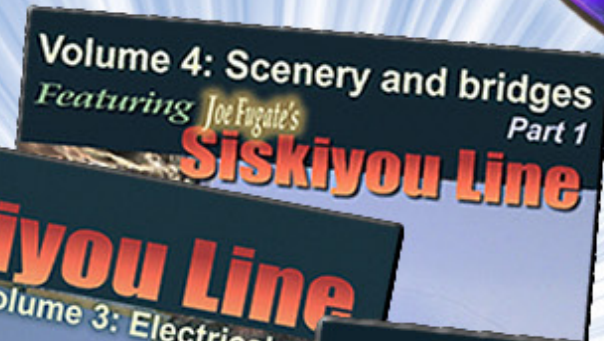
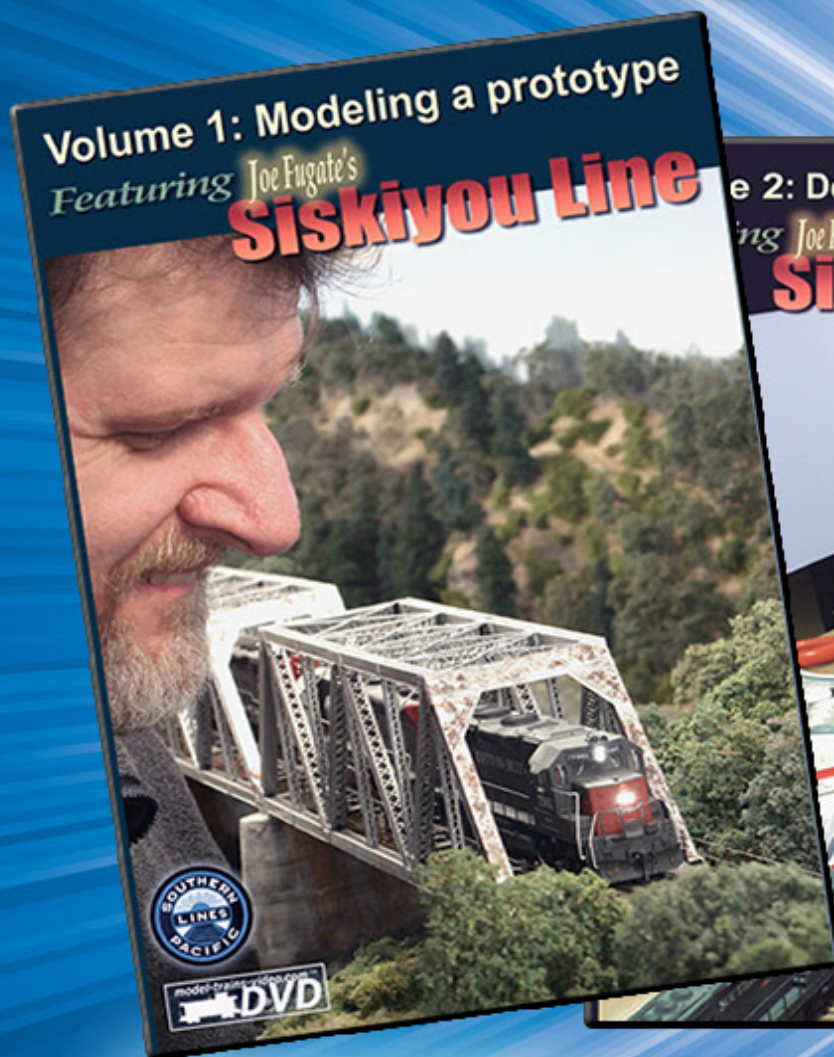

\$24.95 (each)

Get all five for \$99! (save 42%)

"By seeing the right way and the right materials to use I have saved a small fortune in not buying the wrong stuff and saved valuable time by not going about things the wrong way. Money well spent!"

- Andrew Emmerson (I'm not the easiest person to satisfy)



More Results. More fun!

model-trains-video.com



**Click to
learn more ...**



About the Editor



Charlie Comstock has been a regular columnist, author, and editor of *Model Railroad Hobbyist Magazine* since its inception.

To learn more about Charlie, [click here](#).

EDITOR'S SOAPBOX: Attention to Detail

Details are like salt and pepper ...



Legally bland – isn't that the name of a movie? I suppose not, but it easily could be. I think the producer might have been inspired by some plywood model railroad layouts.

I wrote about creativity a few months ago and how it leads to unique model railroads. There's another path to uniqueness, and that's details. Details are the salt and pepper of model railroading. Nicely applied they:

- Help set era and locale
- Tell a story
- Help make a layout seem bigger

It's difficult but possible to go overboard on details – so much going on, viewers don't know where to look next!

I think a high but sane level of detailing really draws viewers into a layout. I like to create what I call micro-vignettes (see [Up the Creek in the Oct 2009 MRH](#)), each of which should hold a viewer's attention while their eyes take it in. By not overwhelming them with details in each area, viewers stay sane while the scenery leads them from one vignette to another, which leads to another, etc. The progression of scenes

Remember when?



FIGURE 1: Micro-vignettes on the BC&SJ. This scene is divided up by the turnout in the foreground, the road, the tracks, and the small cut the train is passing through.

Vignettes

To my mind a vignette implies a backdrop that curves out across the scenery to the aisle edge physically separating the layout into several scenic segments (see Figure 2). Track passes between vignettes by punching through the backdrops.

Although highly effective at separating scenes from each other vignette construction can require much ingenuity from a modeler when it comes to disguising the holes in the sky where inter-vignette trackage passes between scenes. In a mountainous area tunnels are an obvious answer, as are industrial canyons formed by tall buildings in a city scene. But what about modeling rural Kansas or Florida where there aren't many tall buildings and tunnels are few and far between (or filled with water and alligators)?

Micro Vignettes

I've found over the years that dividing layout scenery into small local scenes fools my brain (what's left of it anyway) into thinking that a stretch of track is longer than it is. This happens because instead of sweeping quickly down the benchwork my eyes pause to examine each scene. This is especially true when standing close to the layout, because it takes time to individually examine each scene, it feels like the space is bigger than it is.

So what's the difference between a vignette and a micro vignette? Simple. A micro vignette doesn't use a backdrop



FIGURE 2: Vignettes created by backdrop extensions

curving out to the aisle to demarcate boundaries.

Instead of being separated from their neighbors by a tunnel or an urban industrial canyon, they're delineated by landscape features. I've used as simple a separator as a couple of trees or a creek. Other things I've used include:

- Track passing through a tunnel or a cut in a hill.
- Track passing over a canyon, valley, or river on a bridge
- A change in track gradient
- A row of trees
- A junction
- A building
- A grade crossing

The effectiveness of micro-vignettes at catching and holding your eye depends on details. George Selios is a master of this on his Franklin & South Manchester with its incredible level of detail. It's also true that a micro-vignette may contain other micro-vignettes.

The accompanying photos show some of the micro-vignettes on my Bear Creek & South Jackson Railroad.

Up the Creek: October 2009

MRH back issues, always available!



makes a layout seem larger than it is (a good thing for all but the largest of layouts) because it's broken up – you don't see it all at once.

What kind of detailing? The list goes on nearly forever! If your buildings don't have signs, start there, then weather those buildings. Add pallets, boxes, barrels, crates, or drums on loading docks or along the team tracks. Litter them with busted metal strapping, scrap wood, and maybe some broken glass.

How many kinds of automobiles, vans, pickup trucks, buses, and trucks should there be? Go a little nuts and add working headlights, taillights, and blinkers to them if you dare!

Speaking of lighting, add some scale size streetlights. Paint scale width stripes on roads and add crossbucks, wigwags, or a fully animated crossing guard with sound and flashing lights at grade crossings. Don't forget expansion joints and cracks in concrete roads! Roads in town likely need curbs, sidewalks, manhole covers, fire hydrants, phone poles, stop (and other) signs, stop lights, storm drains, and parking spaces.

Finish your scenery with bushes, trees, forest debris under trees, static grass, rocks at the bottom of a cut, flowers, weeds, talus slopes, etc. Plant some weeds or grass next to tracks or all over some lightly maintained spurs.

Caterpillar tractors might be pulling logs around a stump-filled logging scene. Perhaps a monster John Deere tractor is plowing a field – are your fields fenced?

Add people! Get some unpainted folks and practice painting clothes on them. People standing, people waiting at a bus stop, people in line for a hot dog, workers on loading docks. Cut off an arm and reposition it to get different poses. A motorcycle cop telling a driver "they're in a heap of trouble!", store clerks ringing up purchases, dancers in a low dive with continuous entertainment, young couples out for a stroll, old folks relaxing on a park bench, taggers defacing whatever is handy, train crews in cabs and cupolas, brakemen on the ground, repairmen at the RIP track, etc. How about someone riding an animated bicycle or motorcycle?

Don't forget sounds! Radios blaring from open windows, cars honking at each other in traffic, engines revving, a riveter banging away (tat-a-tat-tat), ships' whistles and gulls at a seaport, workers yelling while they unload trucks – the possibilities are endless!

Study period photos for ideas, or go outside and take a good look at some local railroad facilities. Once you start seeing the detail, everywhere you go will give you ideas. Salt and pepper forever!

Charlie



Reader Feedback
(click here)

NEW from Micro-Mark®

Add Realistic Rivet Heads and Other Details to Any Surface...Easily, Quickly and Economically!



Detailed, illustrated instructions are included in each package

Our Price \$14.95
Introductory Special Price \$9.95

Micro-Mark has done it again! We've developed a way to produce scale size rivet heads and other surface details, such as grillwork and louvers...realistically shaped and contoured...on the surface of our blank decal paper. To add this detail to your model, simply cut out and apply like any other decal... it's that easy! Apply under or over paint to produce the exact effect you desire. Apply to most any surface...up and over curved

surfaces as well as in the flat. Each package contains over 118 square inches (two large decal sheets) of several different rivet patterns in both straight lines and curves, plus bonus louvers and grillwork. Although described below as for HO or O scales (typically for model railroad use), they are useful across various scales.

#84985 HO Scale Surface Detail Rivet Decals #84987 O Scale Surface Detail Rivet Decals

Micro-Mark® www.MicroMark.com
Berkeley Heights, NJ 07922 **1-800-225-1066**

FREE
Catalog with any order!



Whip Your Flextrack Into Shape!

With Fast Tracks *SweepSticks*

Available now for all popular scales in straight and curved sweeps with a large selection of radiuses.



Order online now at:

www.fast-tracks.net/sweepsticks

Notes from the

MRH STAFF

Follow us in Sacramento,
Win an iPad, Getting Real
rebooted, and more ...



We're going on the road for the 2011 convention season, so if you're coming to one of the major model rail-roading conventions below, it's likely you will see some MRH folks there:

- [NMRA National Train Show](#)
(Sacramento, CA) - Jul 7-10, 2011
- [National Narrow Gauge Convention](#)
(Hickory, NC) - Sep 6-11, 2011
- [Fine Scale MR Expo](#)
(Peabody, MA) - Oct 12-16, 2011
- [RPM Conference 2011](#)
(formerly Naperville meet) (Lisle, IL) - Oct 20-22, 2011
- [Craftsman Structure Convention](#)
(Mansfield, MA) - Nov 2-6, 2011
- [Trainfest](#)
(Milwaukee, WI) - Nov 11-14, 2011

Make sure you stop by and say hello!

The first show we'll be attending as you read this is the NMRA National Train Show in Sacramento, CA.



Last issue's ratings

Drum roll please! The five top-rated articles in the June 2011 issue are:

- **4.6** eBay for Modelers - auction strategies
- **4.5** Cascade Southern in N
- **4.4** Build a Tank Load for a Flat Car
- **4.3** Reverse Running: hobby innovators?
- **4.5** One evening project – Crates
- Issue overall: **4.8**

It's crucial for us that you continue to provide ratings for articles. It's your chance to let us know what floats your boat (or train)!

Follow us in Sacramento

Not going to the NMRA National Convention in Sacramento? No matter! You can still follow us and some of the convention highlights via our web site, or on Facebook and Twitter.

We hope to periodically post some quick video on YouTube, as well as post some images on our web site blogs.

If we see anything really cool or amazing, we'll post a picture or video clip of it as soon as we can.

Win a free iPad!

We're giving away a free iPad 2 loaded with all the back issues of MRH at the

Litchfield

STATION



**SPECTACULAR
Pricing On
DCC Products
& Service!**

www.Mr-DCC.com
623-298-7355

A
D
V
E
R
T
I
S
E
M
E
N
T



Sacramento Train show. If you're coming to the train show, make sure you stop by and fill out your entry for the free drawing!

You don't need to be present to win, but if you are present and you win, we'll hand your prize over right then and there.

The iPad's a near-perfect device for reading MRH. You can literally read MRH in your easy chair, in bed, or in the throne room! You can also play the video or animation content as well.

Experts are saying in another 2-3 years, tablet devices like the iPad will become the standard method of reading magazines.

Getting Real rebooted

If you've been paying close attention, you may have noticed our *Getting Real* prototype modeling column has been missing in action the last few months. Marty McGuirk has stepped down as our prototype modeling columnist and we've been courting other contributors for the column.

We've decided to try something new with *Getting Real*.

Getting Real will be written by a number of different prototype modelers so you'll be getting lots of perspectives on this style of modeling.

Mike Rose kicks off the new Getting Real in July. We hope you'll enjoy our new approach and the extra diversity it should bring.

We're looking forward to it!

New eReader edition

With this issue, we're adding a new edition to our lineup of eZine versions: our new eReader edition.

This version is for color eReader devices like the Barnes & Noble Nook Color or the Amazon Kindle Color (coming soon).

The eReader edition is essentially a very simple PDF with nothing fancy, so it will render on a low-end eReader without a problem. None of the hyperlinks or media do anything, but you can read the magazine quite nicely with this edition.

If you want something more complete for reading MRH on an iPad, you'll want to download the Standard Edition for the Mac.

We're committed to making MRH work with all popular digital media reading devices, letting you read it on-the-go any where, any time!

RSLaserKits

Our 7th year of supplying quality kits to the model railroading community. With kits in five scales from O to Z.



HO Log Lodge

Also in N and Z scales

Just the ticket for that lake side resort or mountain ski resort. use it with a few of our log cabins and out house kits for that rustic get away.

Kit includes 1/8" thick bass wood walls, interior frame work, laser cut windows and doors plus Northeastern standing seam roofing. Floor can be made removable so you can detail the interior

Custom Laser Cutting

See our web site for drawing requirements
Call for pricing if you need drawing done.
No job to small from one to 1000



Dealers welcome
www.RSLaserkits.com
5145 Gaffin Rd. SE
Salem, OR 97317
PH: 503 371-4290
Fax 503 585-0850

My helper at work
Our granddaughter Bri
Future model builder



click here

ADVERTISEMENT

LUBRICATION FOR THE NEW MILLENNIUM...

3 HIGHLY CONCENTRATED NANOLUBE
FORMULAS NOW
AVAILABLE TO MODEL RAILROADERS



NANO-OIL.COM 
Nano Technology Lubricants



THE SHAY FIXER
VISIT US AT...
SHAYFIXER.COM 

Specializing in brass Pacific Fast Mail / United geared locomotives

"I use only the finest quality lubricants such as **Nano-Oil** ..."
-The Shay Fixer

StClaire 
Made in U.S.A

**FOR MORE DETAILS
CLICK HERE** 

Advertisement

Mention MRH to vendors

You can help MRH by making a point of mentioning MRH to hobby vendors whenever you are in contact with them.

While we're definitely talking about advertisers, it never hurts to mention MRH to your favorite hobby vendor who may not be an advertiser yet.

And it doesn't take much. If six of you were to speak up about us, that could be enough for a vendor to feel they're getting their money's worth from their MRH ad.

The flip side of this is if none of you say anything, an advertiser can

become an ex-advertiser. We know this has happened, so mentioning MRH counts.

If even *one* of you mentions us, at least they can't use the "no one ever mentioned MRH" excuse!

This is not the only way to measure ad response, but even so, mentioning MRH directly also helps us out.

Advertisers can also have their ad point to a special landing page, or if they provide a phone number, they can put a special extension in their ad.

While these tricks also help our advertisers gauge the effectiveness of their ads with MRH, mentioning MRH as well helps assure

July 2011 Bonus Extras!

Available to Subscribers only!

- DVD-quality versions of this issue's videos
- More lumber load wrapper print-outs!



Click here to access

Sponsored by:



advertisers that MRH is a good advertising investment.

Tracking stats help, certainly, but the most powerful indicator that MRH matters is when advertisers hear from you directly.

This issue's bonus extras

We're changing how you access the bonus extras starting this issue – you need to be a subscriber to access them.

Since subscribing is easy and free, we don't see this as a problem. But a higher number of subscribers is helpful for us when talking with potential advertisers.

We're committed to our forever free model for modelers/readers, so even though we put something in the subscriber-only area, this content will remain forever free.

The bonus goodies won't expire any more. Just like MRH, they'll remain always available and forever free. We hope you'll agree that's actually an improvement!

We also expect to put other special goodies in the subscriber section from time to time – so if you've been on the fence about subscribing, *now's the time to do it.*

To subscribe, just [click here!](#)

 **Reader Feedback**
(click here) 

Model Railroad Hobbyist magazine™

*Want to help support
the leading eZine
devoted to Model
Trains and the people
that have fun with
them?*

*Want to help keep
MRH forever free?*

*Shop our advertisers
and tell them,*

"I saw it in MRH!"



A
D
V
E
R
T
I
S
E
M
E
N
T

Innovative Electronics for Model Railroads

Frog Juicers - Automatic Frog Polarity

Servo Drivers for Turnouts and Semaphores

TAM VALLEY DEPOT

Great Electronics for Great Model Railroads

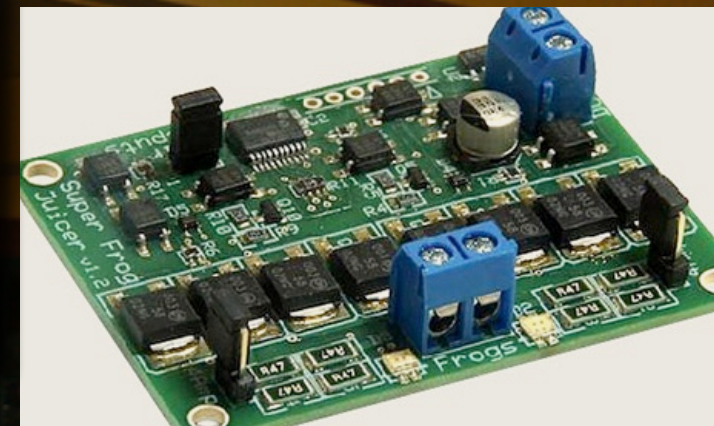

Dual Frog Juicer - a heavy duty (33A) version of our popular DCC frog juicers. The unit can be used to power two frogs in the larger scales, as an automatic, highspeed auto-reverser in all scales and as a highspeed circuit breaker.

www.TamValleyDepot.com

[Click here to contact us by email](#)



NCE Cab06

**Discover the
FUN!**

Now Shipping!

Cab 06 Features:

Select = Select Loco	^Select = Select Accessory
Dir = Direction	^Direction = Recall
0-9 = F0-F9	^0-9 = F10-F19
Horn = Horn	^Horn = Radio Off
^^Select = Macro	^^^Direction = Set Recall
^^Direction = Recall	^^^Horn = 28/128
^^0-9 = F20-F28	

Setup - Hold Select while Plugging In:

Addn - Set Cab Address (1-63)
 Nor = 0=Normal 1=Yard
 Bal = Ballistic Tracking (1-7)
 SH-n = Max Shift Level (0-3)

^ = Shift

Actual Label from the back of the Cab06



- Extraordinary Performance
- Radio or Tethered
- Highest Rated DCC System
- Made in the U.S.A.

NCE
The Power of DCC

Call or Email
 for FREE Brochure
support@ncecorporation.com

585.265.0230
 9am-4pm EST.
www.ncedcc.com



MRH

Questions, Answers and Tips

**Reader
Feedback**
(click here)

QUESTIONS AND ANSWERS

Q: How does a wye track work? How do I build one? Can I use a 24" radius in HO for a wye?

A: Railroads typically use a wye track for two purposes (visualize the letter "Y"):

- To allow trains from a branching track to go either left or right on a main track. The Western Pacific wye at Keddie is an example of this.
- As a turning facility for single ended locomotives or cars. For instance, snow-clearing equipment like plows and rotaries are single-ended.

In the steam era, railroads sometimes built wyes with just enough room to turn the longest locomotive, usually

the assigned helper engine (see figure 1). Typical prototype examples include Cajon Pass on the Santa Fe and Sherman Hill on the Union Pacific.

An engine enters via one leg of the wye and then backs out of the other leg onto the main line, now pointed in the opposite direction. The three track switches of a wye can be less expensive and simpler to maintain than a turntable.

A wye can take several configurations, based on the space available. Some wyes may have the two switches off the main line placed closer together and the top legs of the "Y" actually cross over each other.

Another configuration uses an angled wye (figure 2) where one leg has a

Railroad Wye

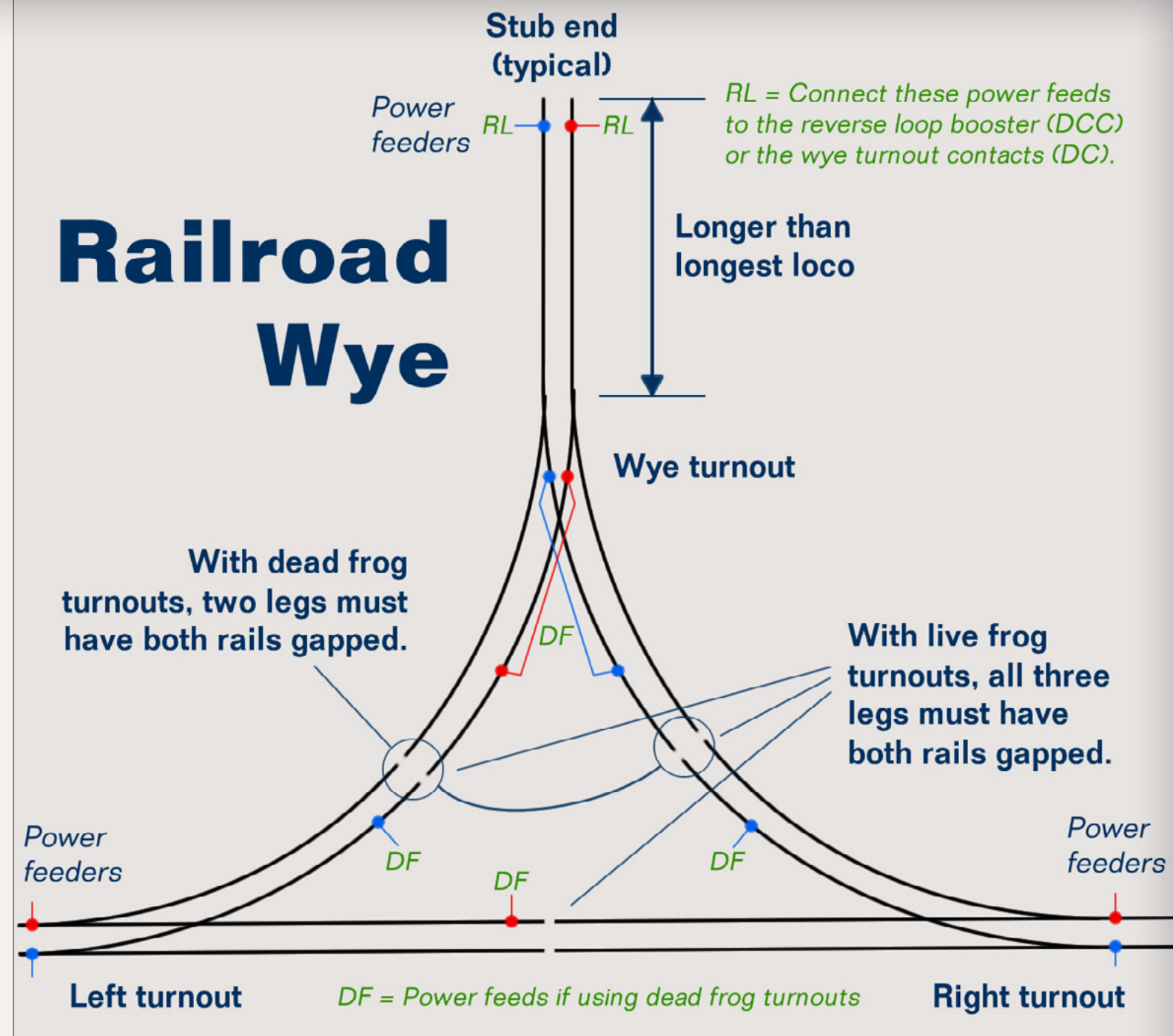

Figure 1: Here's a traditional wye used to turn locos. The stub-ended leg needs to be longer than the longest loco. How the track is gapped and wired depends on whether you're using dead frog (insulfrog) or live frog (electrofrog) turnouts. You'll want to wire the tail track as a reversing loop, either with reversing contacts on the wye turnout with DC, or use an auto-reversing booster with DCC. For more on reverse loop wiring, see the [Mar/Apr 2010 issue of MRH, page 30](#).

tight radius curve. You can often find this sort of wye at branchline junctions where the branch exits the main at an angle.

To build your wye, begin by deciding what the function of the wye is. Is it a junction point where trains come or go from two separate directions onto

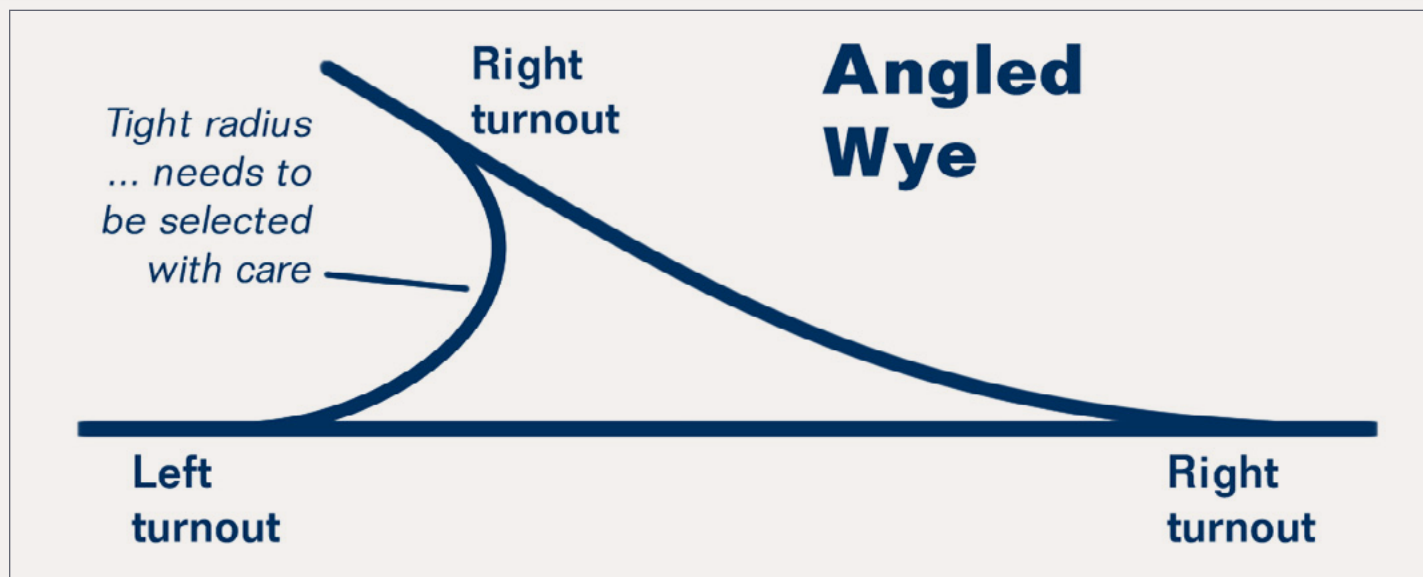

Figure 2: Space-saving angled wye. Watch the radius on the tighter leg and make sure it's large enough to accommodate the equipment that will be using that route.

a branch line or other subdivision? Will your wye be used to turn entire trains, an engine, or a Pullman sleeper so the room windows face the "scenic" views on your railroad. The New York Central for example, turned Pullmans so passengers looked out on the Hudson River rather than facing the bluffs.

Here are some guidelines for constructing a wye, depending on the type you need:

Traditional wye: One right turnout, one left turnout, and one wye turnout. For a tighter radius wye in HO with 24" or tighter legs, use #4 turnouts. For a wye with 25" to 28" radius legs, use #6 switches. For a broad radius "high-speed" wye with legs more than 28" radius, use #8 or larger switches.

Angled wye: Use two #6 turnouts on the broad leg, and use one #4 turnout to exit the main onto the tight leg. If you don't plan to operate long equipment such as 6-axle diesels, full-size passenger or TOFC/auto racks, you can

go as tight as a 22" radius on the tight leg in HO. However, a 24" radius is safer, and a 26" is better still.

"Cross-legged" wye: One each #4 or #6 track switches, one #4 wye switch and either a 45- or 60-degree diamond. Unless you're working in very tight quarters and know what you're doing with trackwork, this wye can be tricky to get operating properly. See MRH, Issue 1, page 19 for a picture of a "cross-legged" wye (model-railroad-hobbyist.com/magazine/back-issues).

For a more thorough discussion of wyes, see the John Armstrong book *Track Planning for Realistic Operation* (Kalmbach). — *Jim Duncan*

Q: I'm using Kadee uncoupling magnets on my layout but the magnets on my main line keep causing false uncoupling on my trains. How do I fix this?



Structures of simple elegance ...

ADVERTISEMENT

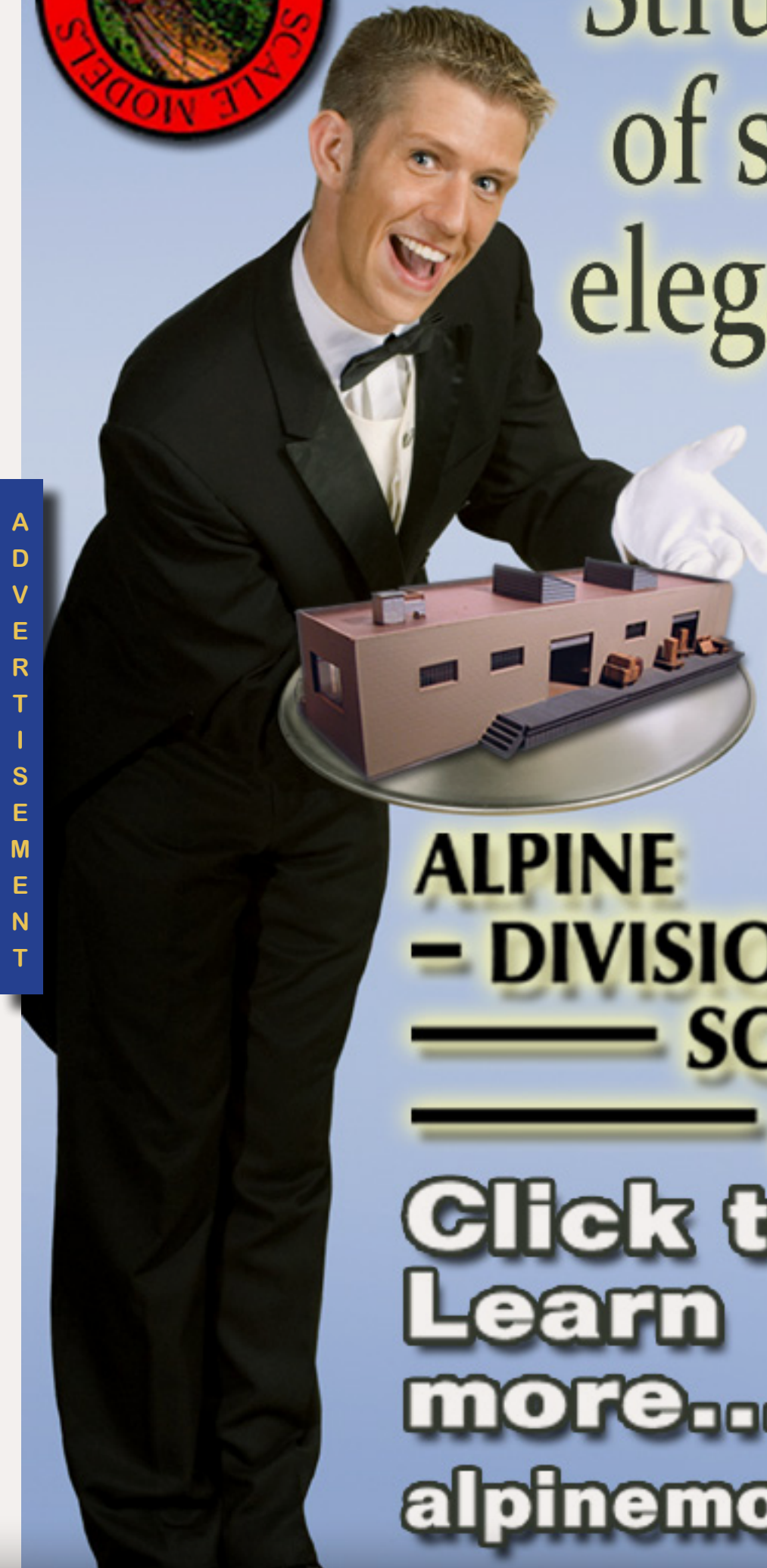

Made in the USA

**ALPINE
— DIVISION
—— SCALE
—— MODELS**

**Click to
Learn
more...** 
alpinemodels.com

A: Stop using uncoupling magnets. While I'm saying that slightly in jest, you should seriously consider not using magnets. In these days of DCC-equipped engines, walkaround throttles (radio or tethered), and walk-in layouts, operators are often up close and personal with their trains. This can be especially true when running on the main line, so it's easy to insert a "pick" into the couplers and give a quick twist to uncouple.

A bamboo skewer can be used as a pick, and plastic picks are available commercially. Using picks instead of magnets allows crews to uncouple anywhere they like, instead of only in a specific spot.

I don't recommend using magnets anywhere – main line or switching complexes. Today's free-rolling cars aren't especially compatible with uncoupling magnets in the track, and the false uncouplings are frustrating. They can turn an otherwise enjoyable operating session into a something of a pain.

A magnet might be okay in one or two locations that are impossible to reach with a pick. If cars sometimes uncouple unexpectedly, do what prototype crews do – blame it on "bad track" (smile). — *Mike Dodd*

Q: What's the best material to use for building roads and streets? Are there commercial products available, or do I need to build them from scratch?

A: I have used several products to build roads on my GM&O Eastern Division. For major concrete highways in HO, I prefer using 1/8" hardboard like Masonite cut to 4 inches wide.

Before installing the road section on the railroad, I give it two coats of gray primer – any of the 99 cent spray cans work fine. I usually have the boys at Lowe's/Home Depot rip cut the Masonite for me into the 4" strips.

A 4' by 8' sheet yields eleven 4" strips and a left-over of about 3 1/4", which I use for narrow roads or driveways. Masonite at the big box home improvement stores usually costs a little less than \$10 per sheet. That's 88 feet of straight pavement, around 88 cents per foot.

For curves I make a template of the planned curve using poster board or 24" x 30" flip chart paper. I put the poster board or paper on the layout and rough cut away anything that won't realistically be a part of the curve and then rough trace the center line of the roadway curve.

After removing the posterboard/paper from the layout, I refine the center line into a smoother curve using a flexible drafting tool (just Google "flexible drafting tool". [Here's one from Amazon.com](#), for example. - ed.)

I measure 2 inches either side of the center line (for an HO road) and make reference marks every few inches. I move the drafting tool (still holding the center line shape) and trace the edges on either side of the center line.

Advertisement



Ordering supplies should NOT be rocket science...

JEFF'S DCC & TRAINS



Click here for more details ...

www.jeffstrains.com



Next, I cut out the template and use it to trace the form onto a suitable piece of Masonite. Finally I cut the shape out of the hardboard with a jigsaw. I sand and smooth the edges and paint it with the gray primer. I then airbrush it with a shade of concrete color appropriate for the age and period of the road. I use hot glue to set it into place on the layout (see figure 3).

If you want a mangled look to your pavement edge to show extreme age and wear, don't sand or smooth the edges but carefully peel away any chips along the pavement edge left by the saw. Lightly sand into these divots before priming but don't over-smooth as you'll want the edge to look ragged.

For shorter road segments, I prefer 1/16" sheet styrene. I especially like styrene for road approaching a grade crossing as it shapes into a natural climb up to the railroad grade.

Both styrene and hardboard are easy to scribe for expansion joints or cracks. For well-aged concrete roads I like to use Krylon Camouflage Tan. Color Place Primer Gray (available at Walmart) also makes a very nice newer concrete color and at 99 cents a can it's hard to beat!

— **Jim Duncan**

Q: At a swap meet, I got a pretty good deal on an HO Fairbanks-Morse Erie-built decorated for New York Central, my favorite railroad. When I got home and looked it over more carefully, I realized it had a 4-wheel truck in the front and a 6-wheel truck in the back. A friend says that is correct prototype

practice. That seems pretty strange to me, plus I have a photo of a real NYC F-M locomotive with two 4-wheel trucks. Did I get suckered into buying a phony model that someone kitbashed?

A: Your model is legit, but it is a C-Liner, not an Erie-Built. In the 1945-55 period, Fairbanks-Morse built two series of diesel locomotives that, at first glance, are very similar. First came the Erie-Built that had two A-1-A (6-wheel) trucks.

In 1950 Fairbanks-Morse launched the C-Liner series with the same body and a slightly longer nose. The C-Liner was available for freight service with two B (4-wheel) trucks or for passenger service with the combination of a B truck at the front and an A-1-A truck at the rear. (*New York Central had eight passenger C-liners, numbered 4500-4507. EMD built 60 FL9 diesels for the New Haven that also had a B+A-1-A wheel arrangement and there may have been similar export locomotives as well. -ed.*)

The 3 axle truck was to help support the additional weight of a steam generator for heating passenger cars.

Life-Like produced an F-M Erie-built in their Proto 1000 line approximately 10 years ago. It was a relatively short production run that used a new body shell mounted on Life-Like's ALCo PA chassis. At about the same time, Life-Like Canada released a C-Liner with B-B trucks.

Based on your description I'm guessing that your model is a passenger C-Liner with a B+A-1-A truck arrangement introduced by True-Train of Canada about 2006. — **Richard Bale**



Figure 3: Jim Duncan uses Masonite hardboard to make concrete highways on his HO GM&O Eastern Division.

Q: What's the best brand of paint for airbrushing? Is one better than another?

A: The "best" paint depends on the user – some people get along with Scalecoat, some like PollyScale, some like Floquil. All are good quality and give good results if you follow the manufacturer's instructions.

Tru-Color Paint (trucolorpaint.com) is the successor to Accupaint and sprays beautifully fresh from the bottle.

PollyScale (testors.com/category/137367/Railroad_Acrylics) usually needs to be thinned to the consistency of low-fat milk for spraying but can also be brushed – nice if you want to stick to one line of paint for everything.

The revised Badger Modelflex (badgerairbrush.com/Modelflex_3.asp) also works very well fresh from the bottle.

Floquil enamels (testors.com/category/133504/Floquil) lay down nice and have a very long shelf life. They also brush in addition to being good for spraying.

Tamiya makes great paint, but not in railroad colors. Testors' Model Master paints are very easy to work with but the colors are geared to model car and aircraft projects.

Because people, airbrushes and spraying conditions vary so widely, the best solution is to buy a bottle or two of different kinds and experiment on scrap projects to find out which is the best fit.

— **Joe Brugger**

Q: Even though I'm using broader curves (36") on my HO layout, can I use a tighter radius in hidden trackage, like a 24" radius? Is that a bad idea?

A: Using a 24" curve radius in HO is not a bad idea if your engines and cars can navigate the tighter curves. Test this before hiding the track. Remember that long rolling stock hangs out more on tighter curves, so check to be sure the overhang won't hit anything on adjacent tracks.

Also make sure to check that your couplers operate reliably on the 24" curves. Body-mounted couplers may cause long cars to derail on tight curves.

As you can see, the track radius you use depends on what equipment you intend to run, and hidden track should be even more foolproof and derailment-proof than visible track.

The very first issue of Model Railroad Hobbyist (model-railroad-hobbyist.com/magazine/back-issues) published "Powerful New Curve Insights for Any Scale" showing how to determine the right radius for your trains.

For short equipment like 0-6-0 steam engines and 40' boxcars, curves of 24" radius are fine in hidden areas, and you can use broader "cosmetic" curves out in the open where they will look good.

But trying to run long engines and long cars on tight curves is asking for trouble.

— Joe Brugger and Mike Dodd



TIPS

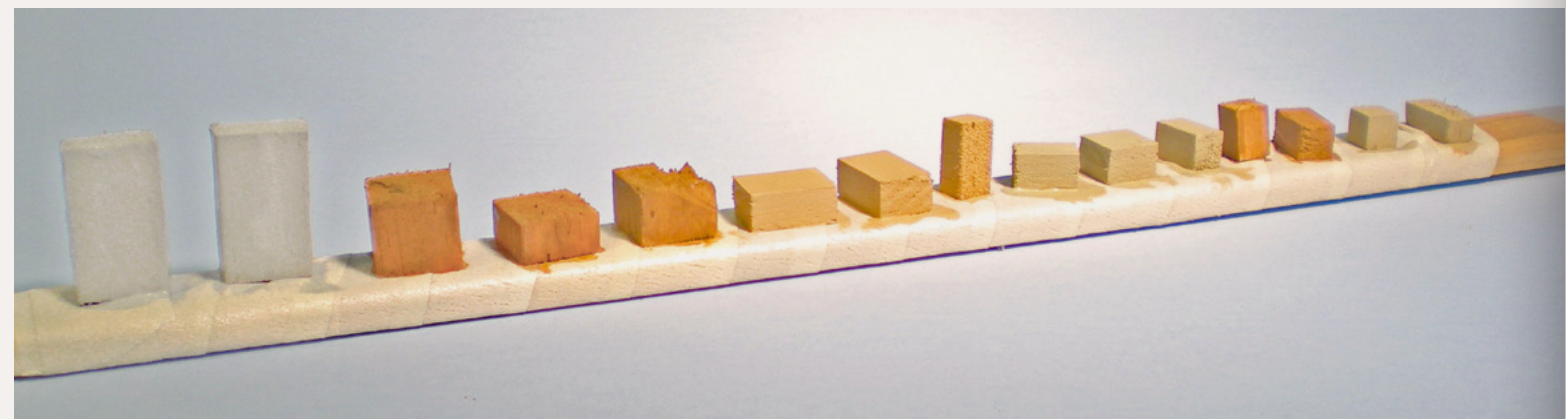

Figure 1: Cut wood scraps into various small sizes and shapes. Use a scale rule if you want, or pose a few figures and other details with the wood to keep the right sense of scale.

Simple HO crates from wood scrap

A great way to create details without breaking the bank is to use simple wood shapes. Save your fancy details for prominent places and use these in the background or inside structures.

For my crates I selected three sizes of wood ranging from 1/2" square to 1/4" square. I sawed the sticks into small cubes and rectangles, sanding away any fuzz or splinters. Next I stuck the wood bits onto my paint stick – a long stick covered with tape, sticky side out.

To color the crates I selected three shades of paint to simulate different types and ages of wood. The colors I used were Raw Sienna, Mudstone and Quaker

▲ Figure 2: A broad variation in wood tones can be created using: Raw Sienna, Mudstone and Quaker Grey from Delta Ceramcoat. The two tall gray blocks will become tool cabinets

▼ Figure 3: The figure on the platform is resting on commercial details, while the crude wooden crates do a fine job of filling the freight house.



Grey from Delta Ceramcoat. Simply squirt a drop of each on your palette and begin painting the wood shapes using the colors as they are. Next, begin gradually mixing the colors with your brush, giving you a wide range of wood shades and tones.

I used the straight Quaker Grey to make a tall 'metal' tool cabinet. Note that I made more than one. I may only use one now but I'll have another on hand for the next place I might need one. This goes for the crates too. Make more than you think you'll need now while you're at it.

After the base color is dry it's time to add simple detail. I painted small dabs of white on several crates. Once this dried I wrote packing instructions on those slips. Actually I just made little lines and dots on the white squares with a fine tip mechanical pencil. You can also use the pencil to create additional detail on the crates like arrows and framing detail.

These are by no means 'super-details', but they work fine to fill the spaces seen through open doors and give the impression that this is a working freight house.

— Galen Galimore

Make your own custom holders

Get yourself a scrap piece of wood or heavy cardboard about the size of your longest locomotive. Now spray *Great Stuff* expanding foam onto the board, usually in two layers. When



GET \$25 PER TIP

We pay \$25 USD for each tip we publish. [So send in your modeling tips to Model Railroad Hobbyist](#) and we'll get your payment to you upon acceptance.

Just think, for only a few minutes effort, you could fund your next piece of rolling stock – or even pay for an entire train if you send in several tips and we publish them!

If you include any photos with your tip, we pay a bonus of \$10 per photo we use with the tip. ■



it's dry, carve out the center with a hobby knife, going deep enough to allow for roof-top details like horns.

With a little imagination you can make holders for just about anything you model. — Michael Dunne



THE PROOF IS IN THE DETAILS AND WE HAVE THE DETAILS FOR YOU IN HO, S & O SCALES

SHINGLES - many variations in Style, Color, Scale and Self-Adhesive or Non-Adhesive Backing.

FENCES - Laser Cut Wood Many Styles

Windows & Doors in Resin Board, Plywood and Cardstock but too many different styles to list all

WHITE METAL & RESIN DETAIL CASTINGS
Many new ones added frequently.

CHECK IT ALL OUT AT WWW.RUSTYSTUMPS.COM

Send \$3.50 for Catalog Specify Scale

Watch for new Kits and detail items that will be coming shortly to our website.

Rusty Stumps
Scale Models

RUSTY STUMPS SCALE MODELS
6785 Cherry Blossom W. Dr., Fishers, IN 46038 - Phone (317) 595-9489

ADVERTISEMENT



The Scenery Scene

Applying Makeup Finger painting and painted people?

– by Charlie Comstock



Ever since Adam and Eve’s misadventure in the Garden of Eden people have needed some kind of clothing or covering. Since fig leaves are few and far between on the BC&SJ, I’d been putting off a major clothing-painting project for all the naked people lurking in

their boxes. But they’ve been getting impatient and want to run around on the layout during the daylight hours without embarrassment.

Well, that’s not quite true. Actually I’d like more people on the layout, but I’ve been putting off their coming out party because pre-clothed, the number of people required would run into some serious \$\$\$, and I had little confidence in my ability to paint-on their clothes myself.

Finally I decided just to get on with it. I had a few boxes of Preiser people stashed away. I pulled them out and decided to try something different. Instead of using PollyScale or some other model train paint, I would attempt to use artist’s acrylic colors.

These come in tubes in different viscosities (Figure 2).

I’d seen a neat idea for holding people while they were painted – glue them to a wooden holder. I tried a few people using this method (Figure 3) – Walthers’ Hob-E-Tac worked well for attaching people to clothespins.

However, many of the folks picked for paint jobs were on sprues. People from the Preiser “sitting people” collection were firmly attached to the sprues so I decided to try painting them while still attached. These people were all cast in white plastic.

Start painting with lighter colors and progress toward darker colors. I found that a mix of yellow, red, and white



Figure 4



Figure 5



Figure 6



Figure 7



Figure 8



Figure 1



Figure 2



Figure 3



Figure 9



Figure 10



Figure 11

produced a reasonable Caucasian flesh color. White and burnt sienna also works. I mixed the paint using a chunk of pink foam as a palette. By mixing tiny amounts at a time, colors will vary from batch to batch, which I think is good (unless you're painting an army where everyone is in the same uniform).

With the faces and hands done, I mixed some red and white and painted a pink dress (Figure 4) following the pink with brown hair and some tinted stockings (Figure 5). I used a few touches of black to simulate shadows up the young lady's skirt (Figure 6).

Then I hit the other figures on the sprue. The fat bald guy got a red shirt, an older lady received a lavender dress, and the other fellow got black hair, a lavender shirt, and red tie (Figure 7).

I gave the fat guy a dark blue jacket and very dark slacks, while the older lady got stockings and blond hair (Figure 8). I kept working on them adding more colors. It was a challenge painting the lady's red high heels without getting red all over her stockings! She appears to be dancing with the fellow next to her (who only has skin paint – so far) rather than sitting (Figure 11).

When the paint dried, I cut their umbilicals with my special despruing nippers and painted the soles of their feet so the white wouldn't show. (Figure 13).

I'm no Michelangelo, but from a distance the results are okay and it only took an hour to put clothes on five people. A few tubes of paint should suffice for hundreds of people.



Figure 12



Figure 13

Advertisement

Watch our website for our monthly specials!

Free Shipping on all US WEB orders over \$100.



CLICK TO LEARN MORE:



<http://www.acculites.com>



Authorized Dealer for: Digitrax, NCE, Soundtraxx, TCS and others.



Backdrop Junction

Your stop for
Model Railroad Backdrops



backdropjunction.com

N, HO, O Scales • Custom Orders

Fiber Optics!

A NEW Special Offer

for our

Model
Railroad
Hobbyist
Readers!



www.TheFiberOpticStore.com/MRH

The
Fiber Optic
Store.com



Railpub

The source for back issue rail
magazines; used, new and out of print
rail books.

Railroad modeling, prototype, traction,
logging, industrial subjects.

railpub.com

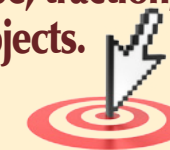

PLINE Manufacturers of fine
crafted Brass Garden Railroad
Trains and spares for the
Homebuilder in GIII, G, Gauge1,
Fn3, SM45/32, Gn15 & O scales.

We're happy to offer our One-
off Brass Model manufacturing
services and our Brass Garden
Railroad products.

pline.biz



Not just for backgrounds
any more.
The ONLY craftsman card model

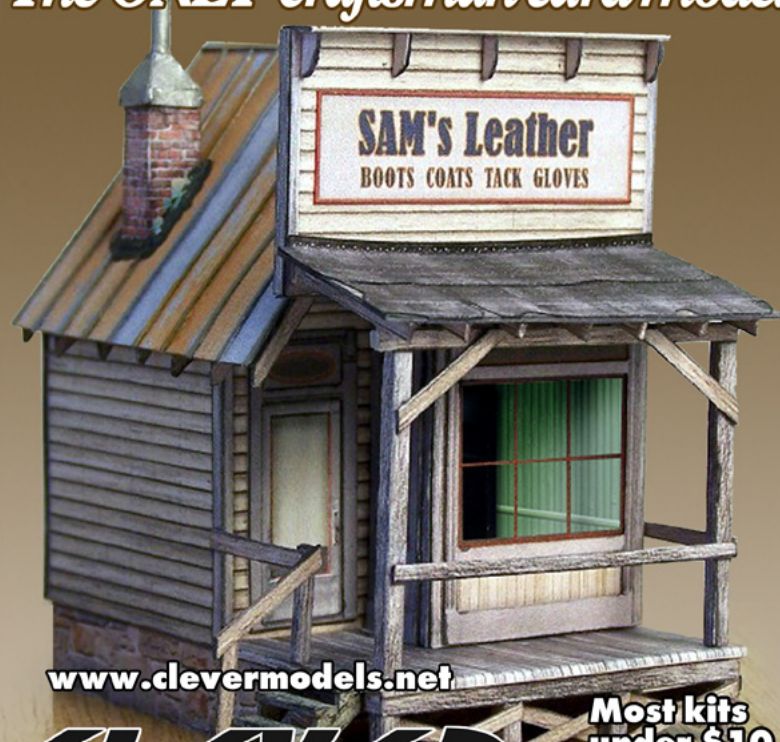

www.clevermodels.net

Most kits
under \$10

CLEVER
models LLC

Available on DVD and Downloads

FINALLY THE RIGHT TOOL FOR THE JOB

Retire that Pounce Wheel get the Monster Nailer

No More Straight Lines &
Square Holes from a Wheel...

Create Accurate &
Realistic Nail Holes

Perfect Scale Spacing



www.monstermodelworks.com

The
SCOTTY MASON
SHOW

The Original Model Railroad Podcaster

www.themodelrailroadpodcast.com

Get the Latest Model Railroading
News, Tips, Reviews & Opinions



Featuring...

Scott Mason

Dave Frary

Mike Rose

Jimmy Simmons

Joe Duckworth

Available on

iTunes

www.themodelrailroadpodcast.com

Built for Operations Al Frasch's N-scale

– by Charlie Comstock; photos by the author

BNSF

Pilchuck Division



**Reader
Feedback**
(click here)



You say you like operations? How many miles of mainline does your layout have? How about 16+, with 11 sidings, and scenery that's nearly complete!

Welcome to Al Frasch's basement, home of the N-scale Pilchuck Division of the BNSF. I first saw Al's layout during a layout tour at a Pacific Northwest Region (PNR) convention in Lynnwood, Washington (just north of Seattle). I knew immediately that MRH needed to come back.

MRH: I'm here with Al Frasch in his double-decked N-scale railroad empire. Al, would you tell me about your layout?

Al: It's a May 1998-based, Seattle, Washington to Vancouver, British Columbia railroad. The mainline is 150 miles in reality compressed to 16.5 miles here, double decked using a helix

MRH: What made you choose N scale?

Al: That decision was made back in the mid '90s when the only space I had was a very small bedroom. After I moved into this house it seemed wise to use my existing investment in equipment and create another layout in the same scale.

That layout started feeling like trains were running in circles, while at the same time I was becoming more interested in operations.

MRH: So you took over the basement?

Al: Yes, I moved into the basement and now have 800 square feet instead of 300 square feet.

MRH: 800 feet of double deck N-scale! How long is the mainline?

Al: 16.5 miles of mainline plus lots of extra trackage.

MRH: That's plenty of track. Are you having regular op sessions?

Al: We run op sessions about once a month. I started on May 11th, 1998 and we progress one day each session. The layout keeps up to 14 or 15 people very busy.

MRH: I bet! You live on Whidbey Island north of Seattle and the local population is a bit sparse. Have you had trouble getting operators to come out here?

Al: One reason for building 800 sqft of double deck N-scale was to give operators a reason to come here. I have people taking the ferry from the mainland and Port Townsend (at the north tip of the Olympic Peninsula). Some come across Deception Pass, an hour

Figure 1 (previous page): Who says an N-scale can't railroad can't look great and operate smoothly? Late afternoon sun slants in as a BN switcher deals with the needs of some industries in Everett. The chain-link fence is a nice touch in the UPS truck loading area.

Figure 2: The Amtrak Cascades, with leased Talgo equipment and an Amtrak F40PH, arrives at a busy Stanwood station.



Figure 2



Figure 3

Figure 3: The North Skagit Turn, heading south to Burlington, passes a sandlot baseball game at Bow – shouldn't they be in school?

and a half car trip. They seem to think the trip is worthwhile.

MRH: I see you have car card boxes and car cards and waybills to manage car routing. How do you control which trains run where? Do you use a dispatcher?

AI: We have a trainmaster who sets up the trains and assigns jobs to the crews. Once assigned a train, we have a dispatcher (who sits upstairs) who controls all the signals and issues track warrants via radio to control train movement on the mainline.

There's also a yardmaster who controls everything in Delta Yard which is a major part of the operations plan. We have three or four manifests that come into Delta Yard and need to be

switched out. Five or six local freights originate there, making it a very busy place. Aside from the yards, the dispatcher controls everything else.

MRH: You aren't using a full CTC system to operate the signals?

AI: No. The signals are operated directly by the dispatcher. They're only red and green – we don't have any signal logic

MRH: Like absolute permissive block?

AI: No, no APB or ABS. I used to have a system where I was using red and green LEDs just to keep people from approaching an occupied section of track. Now it's all controlled by the upstairs dispatcher. We operate using Digitrax DCC with radio throttles, which works well.

There's plenty of work. We run four-hour sessions and don't even come close to finishing all the jobs that are available.

MRH: Which part of the BNSF are you modeling?

AI: Basically it's Seattle to Vancouver B.C., but I don't actually model Seattle or Vancouver. Not modeling the yards in those places saved a lot of space.

The center of the layout is Everett, Washington, where Delta Yard is located. There's a junction to Spokane at the yard. It takes a good 40 to 45 minutes to go around the layout once, from Seattle to Vancouver, if the crew is obeying speed limits. That's a big if, sometimes...

MRH: Everett is north of Seattle?

AI: Yes, the track goes north through Everett to Stanwood, Burlington, Bellingham, and across the Canadian border into New Westminster, B.C.

MRH: So you're not modeling a railroad on Whidbey Island because there are none.

How did you pick Pilchuck Division for your layout's name?

AI: The name came from Mt. Pilchuck, a mountain just east of Everett that you can see from Delta Yard. The Pilchuck division doesn't actually exist. This area is really a part of three other divisions: Cascade, Scenic, and the Seattle divisions.

I call it the Pilchuck Division because I wanted a name that encompassed the entire area I was modeling rather than divide it up into separate pieces.

MRH: I assume it was useful to model a place near your home so you could easily visit the area and shoot photos of what's there?

AI: Well, I don't really model exact locations except in a few cases. The names of all the industries are in fact industries that did exist, but they didn't necessarily look the same as they do now. I have started scratch-building some buildings to look like actual structures along the way. Origin-



Figure 4

nally I wasn't doing that. The names of the towns are correct so anyone familiar with the area will know which towns are north or south of their current location.

MRH: There are some photo backdrops down on the bottom deck. Were those actually taken of the mountains in the area?

AI: Not quite. I got some pictures of the Olympic Mountains and printed them in 4' banner lengths, then glued them to the wall. Some I took off the internet here and there, and still others I shot as panoramic photos, put them into Photoshop, stitched them together, and printed them in 4' lengths. They're purposefully kept fairly low because from eye level on the layout, you don't really see a huge mountain poking up in the air. It's going to be about the height these are.

MRH: So you model the scenery here from an on-layout viewpoint rather than from a giants-in-the-aisle perspective?

AI: It makes it good for photography. But remember, the main point for the whole layout is operations and there's a whole lot of things that I don't worry about that might upset a rivet counter. I don't weather track, I don't weather the locomotives, I don't super detail the locomotives (I did detail one loco but you can't see it – besides the

Figure 4: Fore! Train crews have learned to keep the cab windows closed around hole number 9!



equipment gets handled a lot and the details would get destroyed).

No, my sole purpose for this layout is operations, that's the main drive.

MRH: When did you get started in operations? Which layout was that? This is the fourth layout isn't it?

AI: This is the first one for operations. In 2004 when the NMRA national convention was in Seattle, my upstairs layout, in a 300 square foot room that was basically finished, was on the layout tours and it was pretty nice. I

ran trains around and around for the visitors and people really liked it. But I was starting to think, "Once you've watched it go around in a circle for the 500th time, now what do you do?"

The next week was when I started looking at my space and thinking I should build a bigger layout.

MRH: So now instead of running a train in circles, you use track warrants to regulate the movement of multiple trains at once.

AI: It takes a lot longer to make a trip around the layout, too. It also takes at least 10 to 12 people to run this layout.

MRH: I really like operations myself. It seems to me that if you spend a lot of time building a layout, you ought to use it for something, but not everybody agrees with me on that point.

AI: Some people also look at N scale and think "Operations with N-scale? How can you do that?" It works just fine! I like to promote the concept that N scale operation works very well. In fact, if you like modern diesel locomo-

Figure 5: Who says you can't get good detail in N-scale? Check out the auto-rack unloading ramp from [Train Cat Models](#).

tives and the modern era it's even better – I have trains that run with 30 or 40 cars which is almost long enough. It would be nice to have 100 car trains like the real thing.

MRH: You've got 16 scale miles of track, why don't you have 100 car trains?

Text continues on page 33

Al Frasch's Pilchuck Division of the **BNSF**



Al Frasch retired from 30 years of teaching high school mathematics and moved to beautiful Whidbey Island in 2002. He's been involved in model railroading since the early '90s and started the Pilchuck Division of the BNSF, his fourth layout, in the summer of 2004.

Al enjoys hiking and biking when the weather permits and will travel almost anywhere for a good operating session. He shares his home with two cats – but doesn't negotiate with them for layout space!

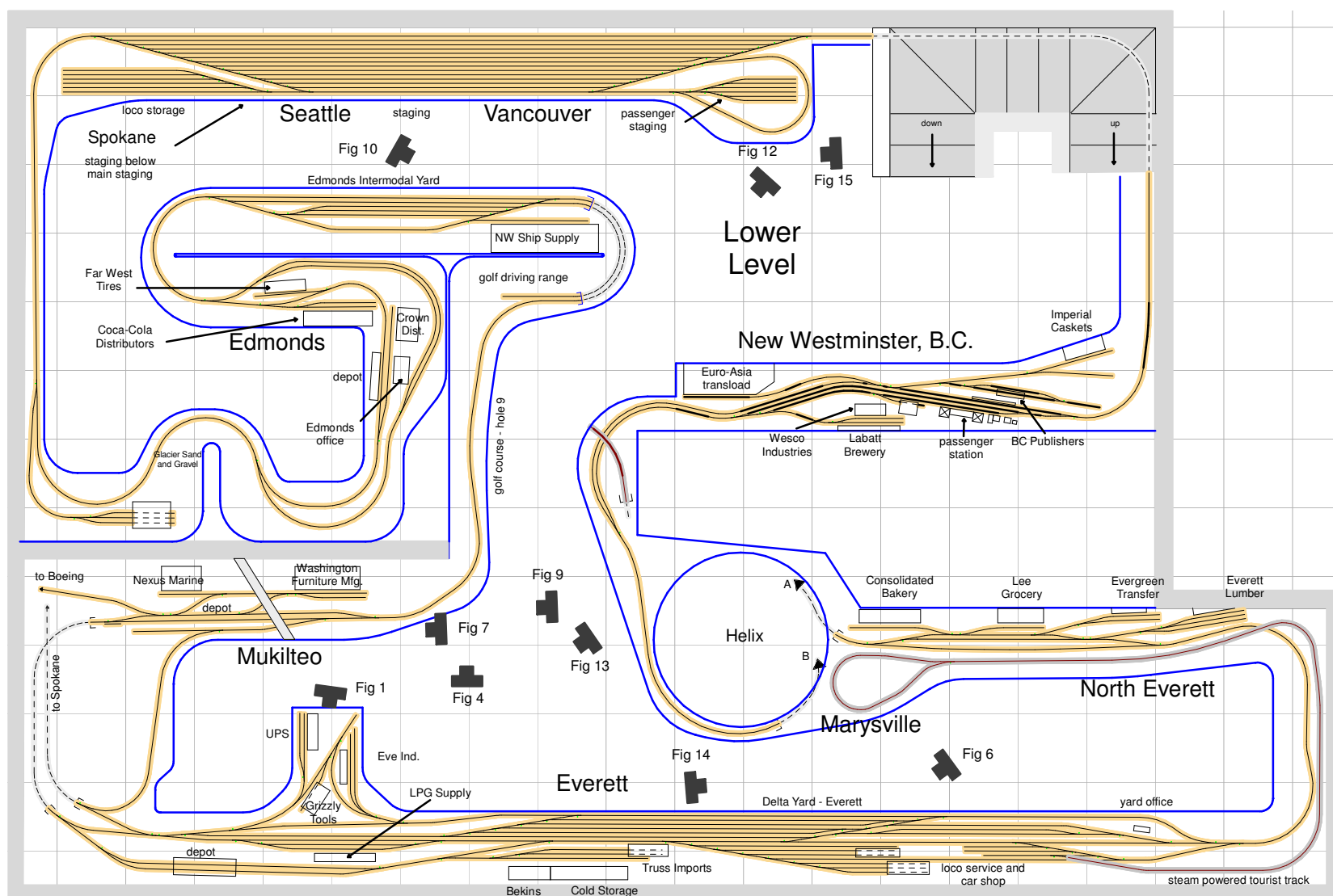
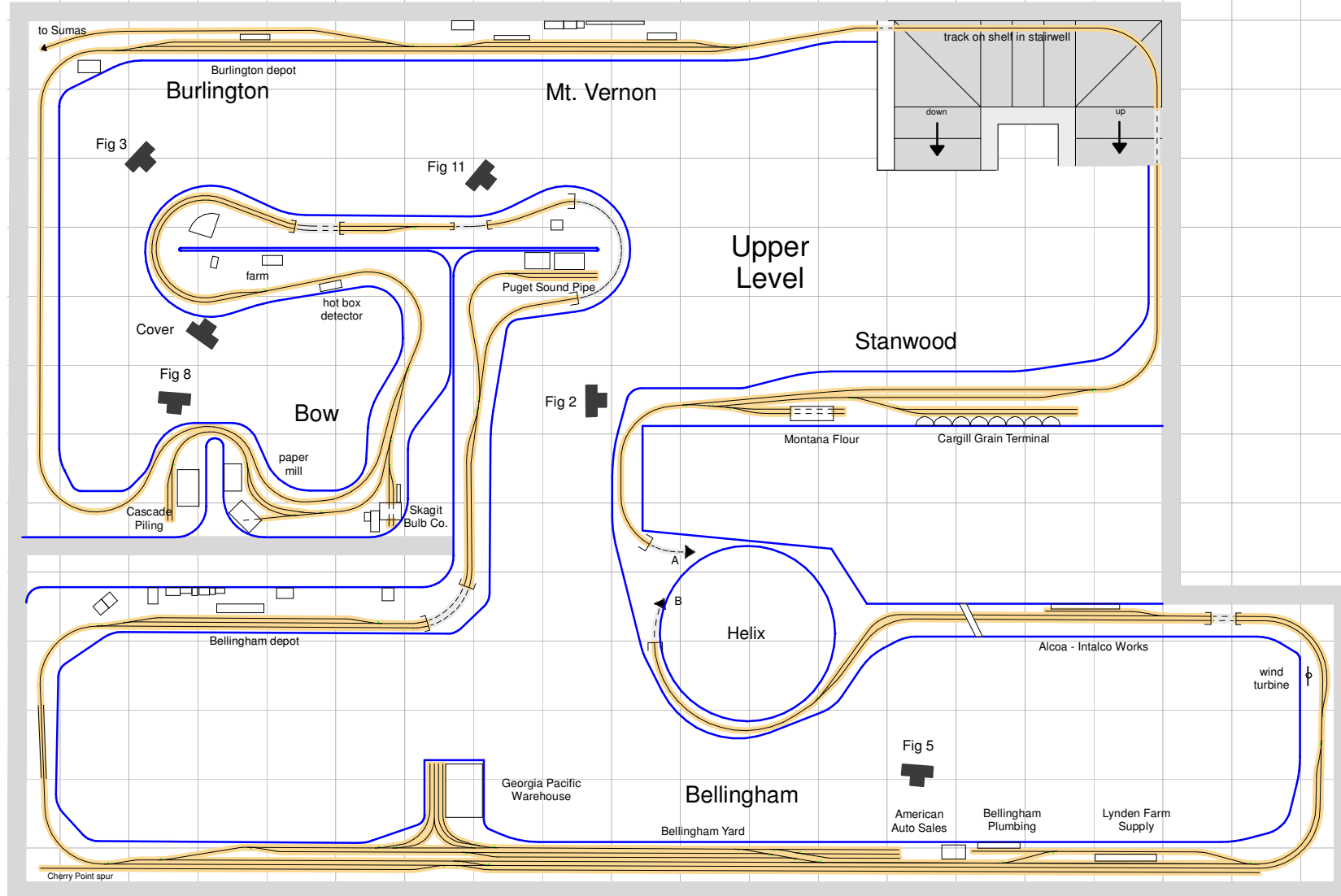

Layout Statistics

- Era: May 1998
- Locale: Pacific Northwest
- Style: Proto-freelance
- Configuration: Double deck with helix
- Scale: N
- Trackplan: Point to point with connecting staging.
- Size: 38' x 25'
- Minimum radius: 20"
- Track: Atlas code 80
- Turnouts: Atlas #6 and #4
- Control: DCC - Digitrax radio
- Elevations: 43" (lower level) to 59" (upper level)
- Roadbed: 1/2" plywood topped with 1" foam
- Staging: 13 tracks ranging from 10' to 23' in length.
- Mainline: 16.5 scale miles
- Helix: 5 laps, double track

24" grid
not to scale

Zoom in to magnify
details



Figure 6

Figure 6: Delta Yard in Everett is the main classification yard on the Pilchuck Division.

AI: No, these are Micro-Trains equivalent couplers. I use code 80 track, it's more than a bit out of scale. However when you're a lone operator, the reliability of code 80 is a good idea. So far it's worked out very well.

I think that if you do a decent job of painting and ballasting the track it helps hide the too-tall rails.

MRH: Is there a particular brand of track you use?

AI: All the track and turnouts are Atlas.

MRH: All the turnouts are #6?

AI: Well, there are a couple of #4s in very tight locations but they're mostly #6s. I haven't hand-built any yet, but there is one section where I really need a curved turnout and I'll be scratchbuilding that one in the future.

MRH: Those truck mounted couplers, do you have problems backing long trains through a turnout?

AI: Usually not. I can usually back up a 25 or 30 car train unless there's a under-weighted flat car in it. Those cars sometimes want to pop off the track. But most of them I can back up without any trouble. Not as good as you'd want.

MRH: Have you considered body mounting couplers instead of truck mounting?

Continued from page 31

AI: I tried a 75 car train once and the couplers pulled apart on the helix. It was just too much weight. I do run a 50 car coal train which gives the dispatcher fits because only 2 of the 11 sidings will hold it if it has to clear the main.

MRH: And since it's a coal train it needs to take the siding a lot?

AI: There are a lot of meets which are 'interesting' shall we say...

MRH: I guess! Back to reliability, how many derailments do you get during a session, excepting crew errors?

AI: Maybe a maximum of one or two other than operator goofs. 90% plus of the problems are because people don't return the switches to their green position. I use all Caboose Industries ground throws and I have their handles painted red and green – the crews are supposed to return them back to green after passing, but that doesn't always happen.

MRH: Do you do anything to your trucks, wheelsets, and couplers to prepare your cars for the layout to make them more reliable?

AI: 90% of my rolling stock is straight out of the box.

MRH: Which brands do you favor?

AI: Ones that look good! Actually Atlas – a lot of Atlas. I like the ExactRail stuff that's coming out, the Fox Valley cars are really wonderful. I use pretty much standard Accumate trucks. They've got truck mounted couplers but I have no trouble with them. The reason I like Accumates is because if somebody destroys a coupler while trying to uncouple – which is easy with the skewer method, I just pop out the old truck and put a new one in.

MRH: HO Accumate couplers have a scissors action. What about their N-scale couplers?



Figure 7

Figure 7: The southbound manifest from Everett rolls by the turnout in Mukilteo leading to the Boeing plant in Everett. The SP loco and train have just negotiated the 6% grade of Japanese Gulch.

AI: Yes, but that would require replacing every truck with new trucks and installing Micro-Trains couplers on both ends of over 500 freight cars. I'm not too excited about the work or the expense. What I have works and I prefer not to mess with things that work.

MRH: Would you like a bigger layout?

AI: This layout is definitely on the margin of being too big for one person to maintain and operate. Luckily I run enough trains around here on a weekly basis – if I do something with a piece of track for instance, it can take 25 minutes to run a train around to that spot to test it. That means I check the track and trains frequently so I find problems right away.

MRH: So you don't have any shortcuts that let you avoid some of the long way around?

AI: I purposely didn't do that. I don't like spaghetti layouts and shortcuts feel like that to me.

MRH: What about scenery? Modeling the area you've chosen you need more than one or two trees.



Figure 8

Figure 8: Cascade Piling in Bow supplies wood and concrete pilings for the docks along Puget Sound and throughout the Northwest.



Figure 9

Figure 9: Rolling under the roadway which connects to the ferry at Mukilteo, the Vancouver to Seattle Through Freight will have to take the siding at Edmonds to let the north-bound Sounder meet its schedule.

AI: I'm kind of jealous of those people from the Southwest! It's all brown and they put a couple of bushes here and there.

MRH: They do need a lot of sagebrush!

AI: But here in the Northwest we have trees. There are 8,000 of them on the layout.

MRH: 8,000! You counted them to make sure?

AI: Close. Commercial fir trees, there are only about a thousand of those. Then there are the good-old Woodland Scenics pine or fir trees and there's a couple thousand of those. The majority, about 5,000 of them are hand-made from sesame bloom.

MRH: You made these yourself?

AI: Yes. I know how many there are because I bought sesame bloom in bundles. I know how many trees I could get out of a bundle and how many bundles I ordered. In an evening I could sit and make 35 or 40 of them ready for dipping and flocking. It definitely took awhile!

You sit there making 60, 70 or 80 trees and you're thinking wow, this is cool, I'm going to fill a whole big area. Then you start planting them and after maybe a square foot you're done. It takes

a lot more trees than one thinks to populate a forest.

MRH: In N-scale, each square foot needs about 4x more trees as HO.

AI: And about 10x as much as O-scale. It's incredible. We get away with making them smaller. My deciduous trees are about 30 or 40 foot tall, close to their proper height. Unfortunately my fir trees and pine trees are not to scale -- real trees would be about 150' or about 10", but trees that tall would look almost out of place on my layout. I use trees to hide the track in a lot of places to break up the track. It makes the runs feel longer that way.

I group the trees in regions. For instance, there is a cluster of deciduous trees, then a cluster of conifers. The idea is to make it feel like you're traveling some distance from one area to another rather than two feet.

MRH: Do you model anything like new growth over a clear-cut?

AI: I included a couple of those with stumps although I don't like clear-cutting.

MRH: How did you pick your deck heights?

AI: Well neither one of them is ideal. When you commit to a double deck layout you know you're not going to get ideal heights. I wanted at least 16" between the decks and I didn't want the top deck any higher than 59" because of my height -- I wanted to be able to see it to work on it! I started with my top deck height then dropped down 16" to 43" for the lower deck.

MRH: How much grade is there on the layout itself?

AI: Except for the helix, zero. My intention before going to two decks was to have it absolutely level so I could run hundred-car trains.

MRH: But the helix was a problem?

AI: The helix was the first thing I built. Then the layout wasn't level anymore! There's a 65' grade at 1.7%, which is two scale miles.

MRH: Of course the region you're modeling is pretty flat...

AI: That's the reason I was OK with no (visible) grades. I try to make the terrain next to the track go up and down rather than the track to give the illusion of a grade. After I put the helix in, it occurred to me I could have put some up to 1.5% grades here and there and still been able to run long trains.

Figure 10: AI paints green and red marks on the handles of his turnout ground throws to make it obvious to the crews which way is the 'normal' direction. Crews are required to return turnouts to 'green' after passing. Northwest Ship Supply opened its new World Headquarters in May and requires 4 to 5 boxcars per day.



Figure 10



Video won't play? [Click here to play it on YouTube.](#)

Simulated Hot Box Detector

Things don't always go right on a railroad. Sometimes knuckles break, drawbars get pulled, and hot boxes or dragging equipment problems occur.

AI's op sessions get treated to a dose of realism with a trackside detector from [Boulder Creek Engineering](#).

This piece of electronics uses sensors placed in the track to detect passing trains. It counts the number of cars and reports the number of train defects found using an audible voice. The voice is very similar to that of a prototype detector except that they use radio to broadcast their report rather than a speaker.

Hot boxes are extremely rare on a model railroad, especially N-scale, so the detector circuit is user programmable to specify how often problems are reported. The programming is simple, but it's recommended to keep the number of reported issues low to avoid tying your railroad up in knots with trains limping to the next siding to set out failing rolling stock!

AI reports that his crews seem to like this device as it helps spice up an operations session.

[Click here to play sample defect report](#)

Figure 11: The Pilchuck Division is dotted with little scenes like this one near Samish.

The ruling grade is the helix -- no doubt about that. I purposely made the helix very large for N-scale so I could keep the grade down but still get the deck separation I wanted. The radius is almost 30", something that would work for HO. The wide radius keeps the grade down and it gives me room to reach in if any equipment ever had problems like a derailment in there.

MRH: I usually get derailments in the hardest place to fish stuff out!

AI: Oh, you mean tunnels where you didn't give access points? If you give access to the tunnel you'll never have problems in there. We all know that.

MRH: What about layout lighting?

AI: Originally I was using C9 Christmas tree lights.

MRH: That was pretty dim wasn't it?

AI: It was very dim even with a light every 3". It was amazing how much electricity they used and how much heat they generated. Then I read on Joe Fugate's website how he was lighting his layout with 25W bulbs every 2'. I tried that but it was still not enough. So I went to 40W compact fluorescent bulbs every 2' and it's much brighter.

MRH: That's the ceiling lights. What about the lights under the upper deck, are those still Christmas lights?

AI: Yes, I took some of the lights I removed from the ceiling and put them



Figure 11

under the upper deck to augment the lighting on the lower deck. They do help, but the upper deck does cast a shadow from the lights in the ceiling, otherwise I'd make the ceiling lights brighter.

I'd like to move the fluorescent fixtures in the ceiling farther out over the aisles so they would illuminate the lower deck more evenly and add some more lights under the upper deck too. But that would be a lot of work and I can't seem to get motivated enough to start.

MRH: How did you do your track plans?

AI: Well, there's really only one way to put benchwork in this room. I built the benchwork, then I bought a roll of Kraft paper and laid it all the way

around on top of the benchwork and drew my trackplan full size, on that.

MRH: On top of the benchwork?

AI: On top of the benchwork using actual turnouts as templates.

MRH: So the subroadbed is all plywood?

AI: The benchwork is 1x4 boxes with $\frac{3}{4}$ " plywood on top and then 1" foam. After I drew the full-size plans I invited people over to critique it. I gave them pens and said mark what does and doesn't work. When they were done I cleaned it up and pinned it up over the layout and laid the track to look like it.

Doing things full-size helps visualize what you're really getting. It's easier

to see where changes could be made than if you're using a CAD program. And no mistakes in room measurement creep in and cause trouble!

MRH: Is the layout finished yet?

AI: No, there are still plenty of places where I can add things and there are modifications going on all the time.

MRH: Well, thanks for having us!

AI: My pleasure!



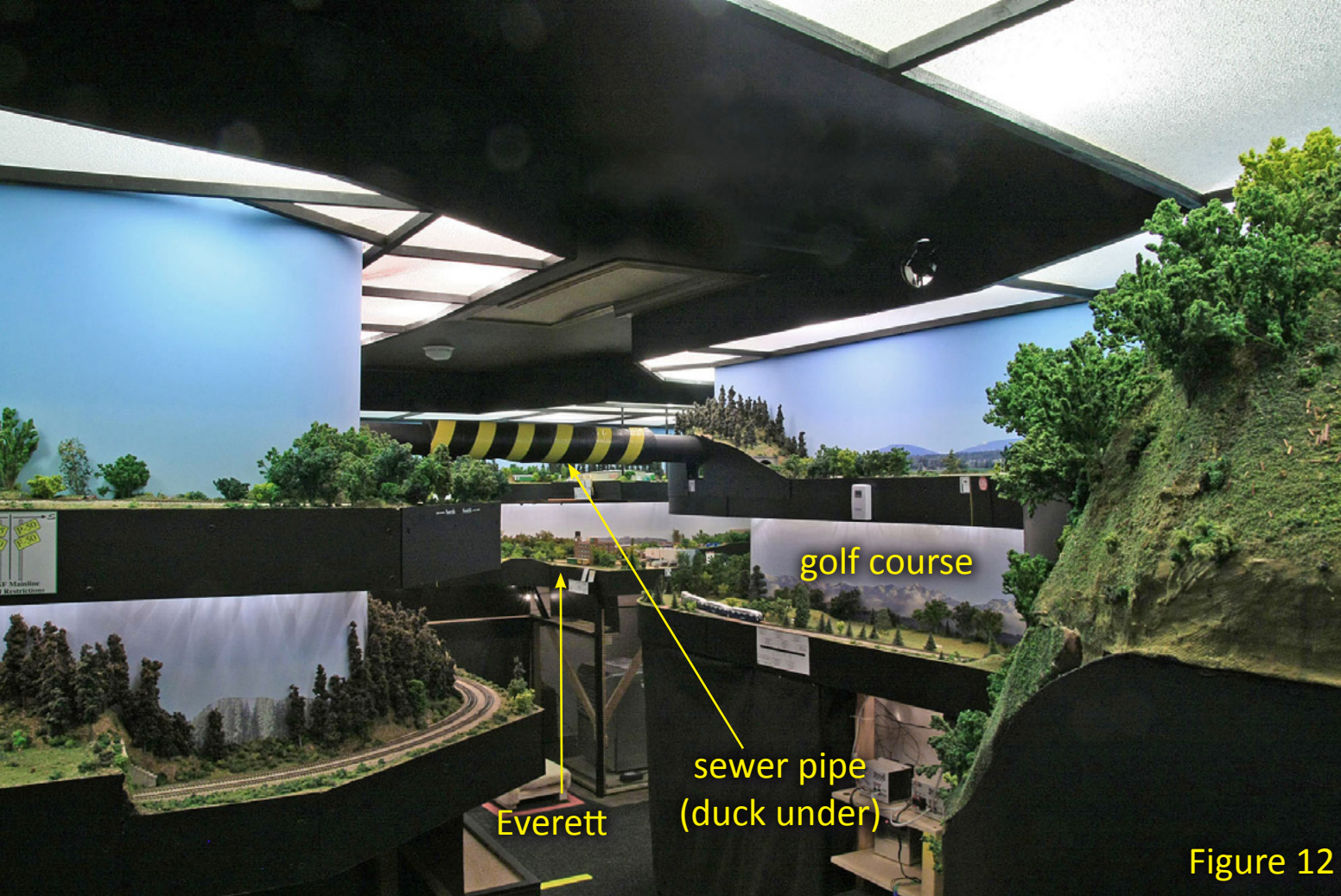

Figure 12



Figure 13

Figures 12 to 15 show what an 800 square foot, double-deck N-scale layout looks like. That's a LOT of N-scale layout. Modeling the Pacific Northwest means a LOT of trees!

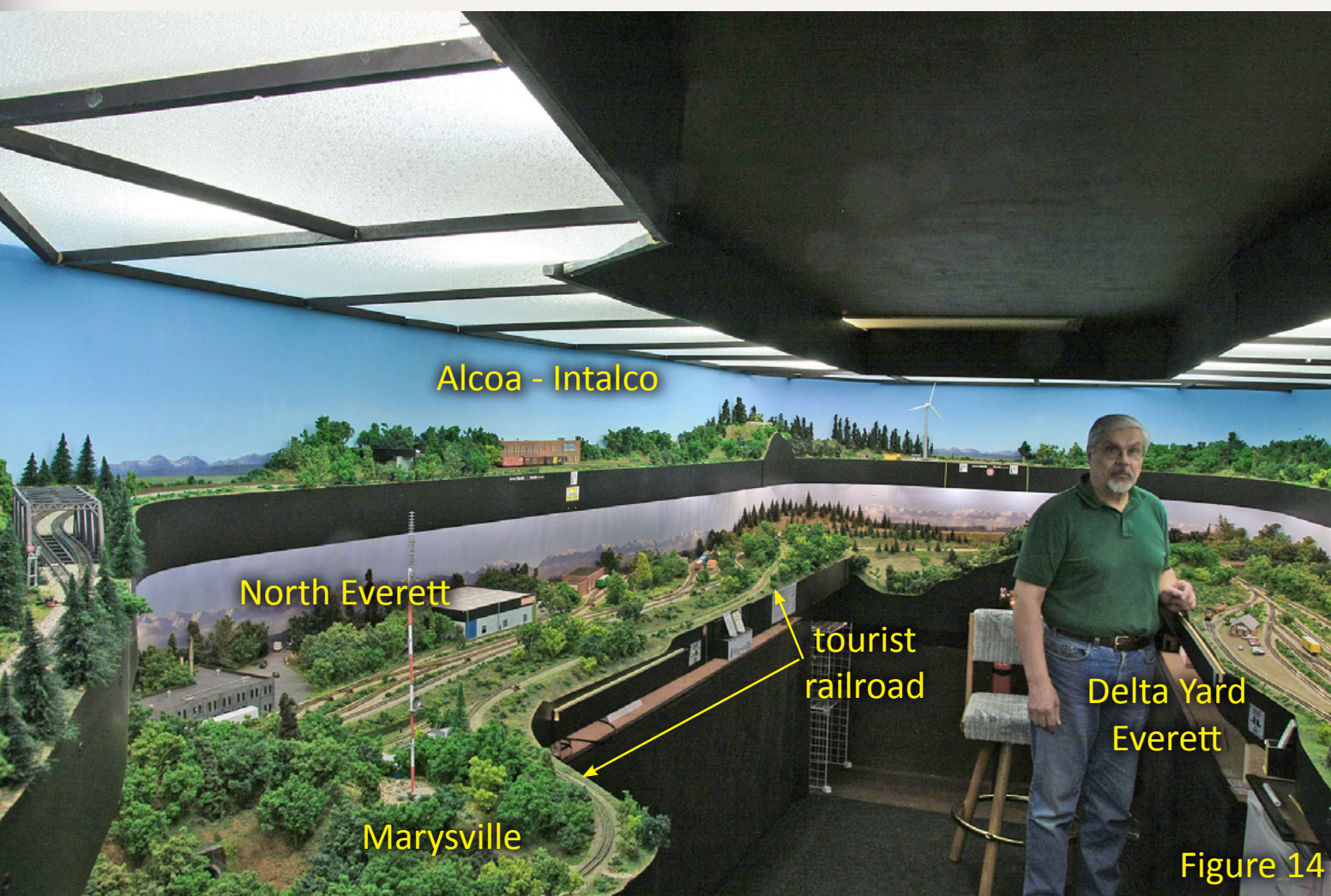

Figure 14

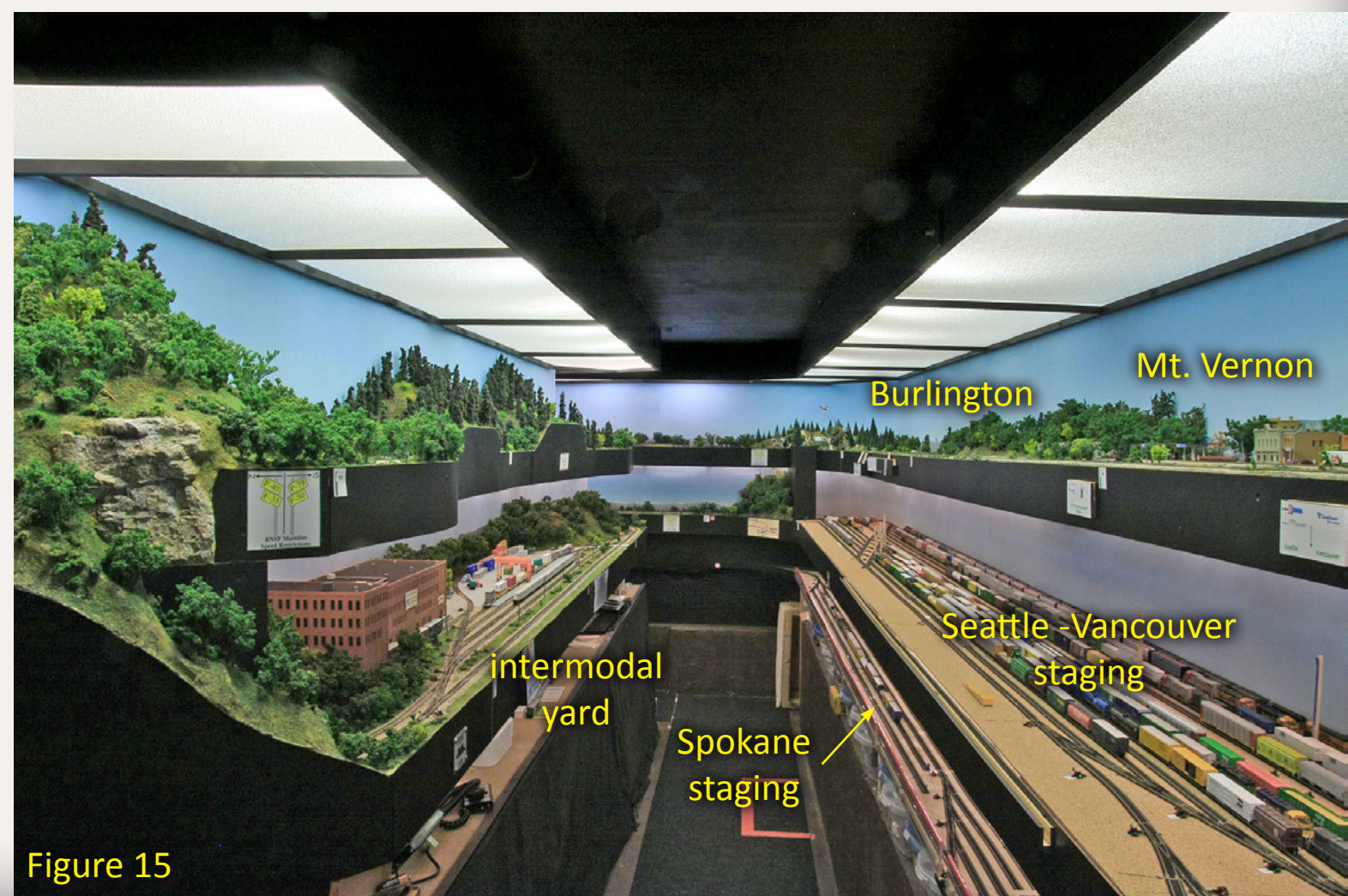

Figure 15

Get Better Sound from your Locomotives

Can't get good sound from your sound decoder? Give our speakers a test drive with your ears.

We offer high quality speakers to enhance your model railroad experience

Dealer inquiries welcomed



RAILMASTER HOBBIES
LAKEWOOD, CA 90713
562-461-8825

WWW.RAILMASTERHOBBIES.COM

Bass Reflex Speakers



High Bass Speakers



Our newest speaker only 14 x 36 x 10 mm
Self-contained ported speaker



Advertisements

*I got my **AUX-BOX**, how about you?*

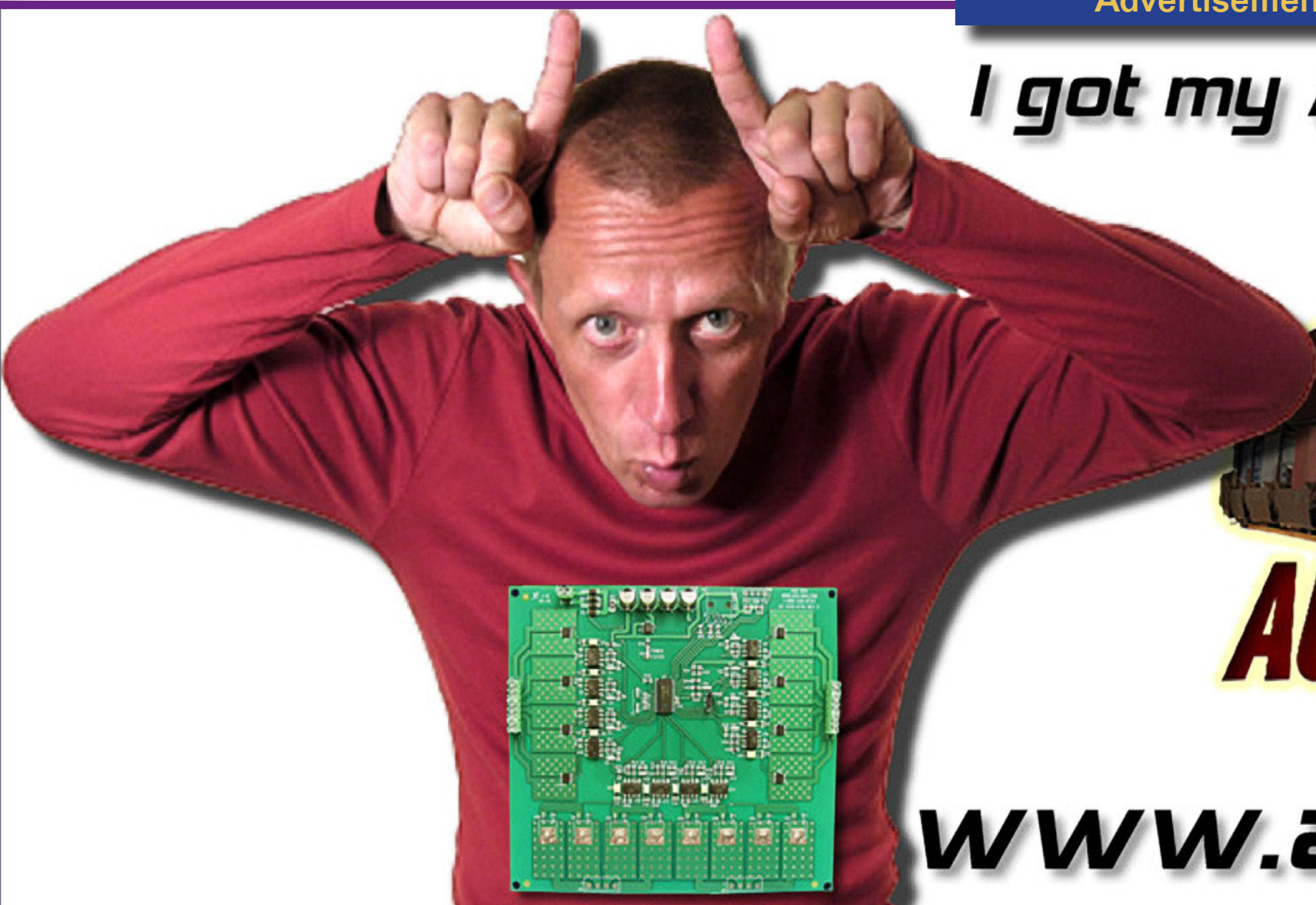

click here for more details...

www.auxboxdcc.com



Speedbashing

Using Ready-to-Run to Complete a Project Faster

– by *M.R. Snell*

Photos by the author



Figure 1: You can't buy this unique "smurf blue" BNSF unit anywhere, but Matt Snell shows you how to speedbash a Ready-to-Run model into this one-of-a-kind loco – all in record time!

Transform a Ready-to-Run model quickly into something unique for your layout by following this example ...

Over the last several decades in the hobby, we've seen a revolution in HO scale product development, transforming the hobby from one of scratchbuilding to

high quality models available straight out of the box. As HO scale now settles into a Ready-to-Run format, many of us may lament the loss of the kits we were familiar with, while contemplating whether HO scale will become a 'cookie cutter' format. While the shift to R-T-R (ready-to-run) may be a hindrance in some respects, such as kitbashing and painting, it can also be used to our advantage through employing R-T-R models to help speed projects to completion.

Recently while contemplating the construction of a BNSF GP38-2 wearing

the unique blue 'smurf' scheme, I studied the locomotive from a different perspective. Like many modern era schemes, this one simply adds home road graphics over an existing paint scheme rather than repainting the entire locomotive. In this case a GATX locomotive wearing EMD's blue, white, and black lease scheme has had its markings replaced with BNSF logos and numbers. This required only minimal repainting to obscure the GATX markings.

Presently unavailable in any form other than painting and decaling, the

question now arose – could I model this scheme using a R-T-R model? Could I modify one the same way as the prototype did, rather than starting with an undecorated locomotive? With a little open-mindedness, an

“Could I modify one the same way as the prototype did, rather than starting with an undecorated locomotive?”



Figure 2: Matt started with this standard Athearn GP38-2 model.

experiment was undertaken using a R-T-R Athearn GATX GP38-2 as a test subject. Soon it became clear that not only could this project be done using a R-T-R model, but I could also save untold hours not having to apply the 3 color paint scheme.

Join me in this journey into Speedbashing, as I transform a factory decorated mass market model into a custom locomotive in only 3 evenings!

Evening One

Day one of the experiment began with studying the detail differences between the BNSF prototype and the Athearn model tailored to a mass market. Typical of most Athearn

“Day one of the experiment began with studying the detail differences between the BNSF prototype, and the Athearn model ...”

R-T-R releases, partial detailing is factory installed leaving the remainder to be completed by the purchaser. When altering a R-T-R model this can be both a blessing and curse, as the detail can save time but also interferes with the modifications you are trying to make.

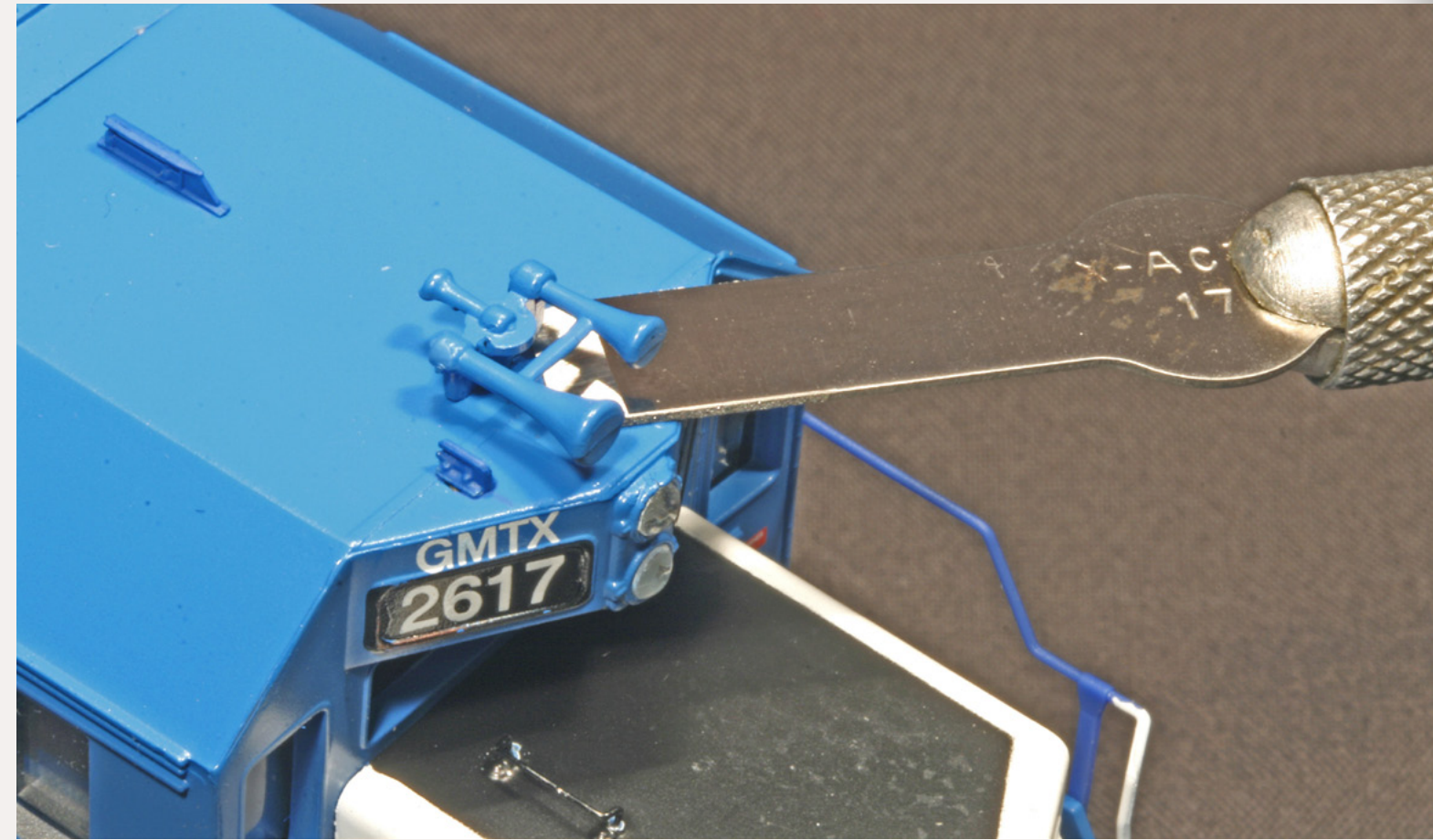

Figure 4: Matt used a #17 X-Acto blade to remove the factory air horn.



Figure 3: In just 3 evenings of simple alterations, Matt bashed this unique model for his layout, based on an actual prototype.



Figure 5: After cutting off the factory air horn, Matt left the mounting stem in the hole to fill it. A little putty and paint will hide the hole completely.

“The second day of the experiment would truly test whether a R-T-R piece could be transformed into a custom model ...”

In this instance the model had factory installed grabirons on the long and short hoods. None of these impeded the project, but rather helped to speed it up saving the time of drilling several dozen #80 holes and installing wire formed grabirons.

On the opposite end of the spectrum is detail which is improper, such as the

horn mounted atop the cab, a staple of many of Athearn's R-T-R locomotives. While this was once a standard mounting location, many roads have chosen to mount their horns atop the long hood to aid in preserving the hearing of the crew. To replicate the BNSF prototype, the cab mounted horn would need to be removed, revealing the downside of factory installed detail (Figure 4).

Removing a large part such as an airhorn will generally leave a gaping hole in the body of the locomotive. However the damage can be minimized by utilizing an old modeler's trick – using the mounting stem of a detail part to fill the hole left by removing the part. I began by

cementing the horn in place from the underside of the cab. Then I cut it off flush with the top of the roof using a #17 X-Acto chisel blade. This allowed the mounting stem of the horn to fill the resulting hole in the roof. To complete the repair, a small dab of putty filled in the seam around the stem. Both stem and putty were then sanded even with the roof surface, leaving only minor paint damage which was easily touched up with an airbrush (Figure 5 previous page, Figure 6).

Now detailing of the locomotive could be completed. I installed basic details left off at the factory, such as lift rings at each mounting dimple cast into the roof, coupler lift bars, MU hoses,

and a trainline air hose on each pilot (Figure 7).

Once the basic details were in place, items specific to this locomotive, such as radio antennas, ditch lights, snowplows, and an aftermarket horn casting were added to the locomotive transforming the body from a mass market model to one specific to the BNSF prototype.

Evening Two

The second day of the experiment would test whether a R-T-R piece could be transformed into a custom model. The factory lettering would have to be modified leaving a surface suitable for 'rebranding'. There

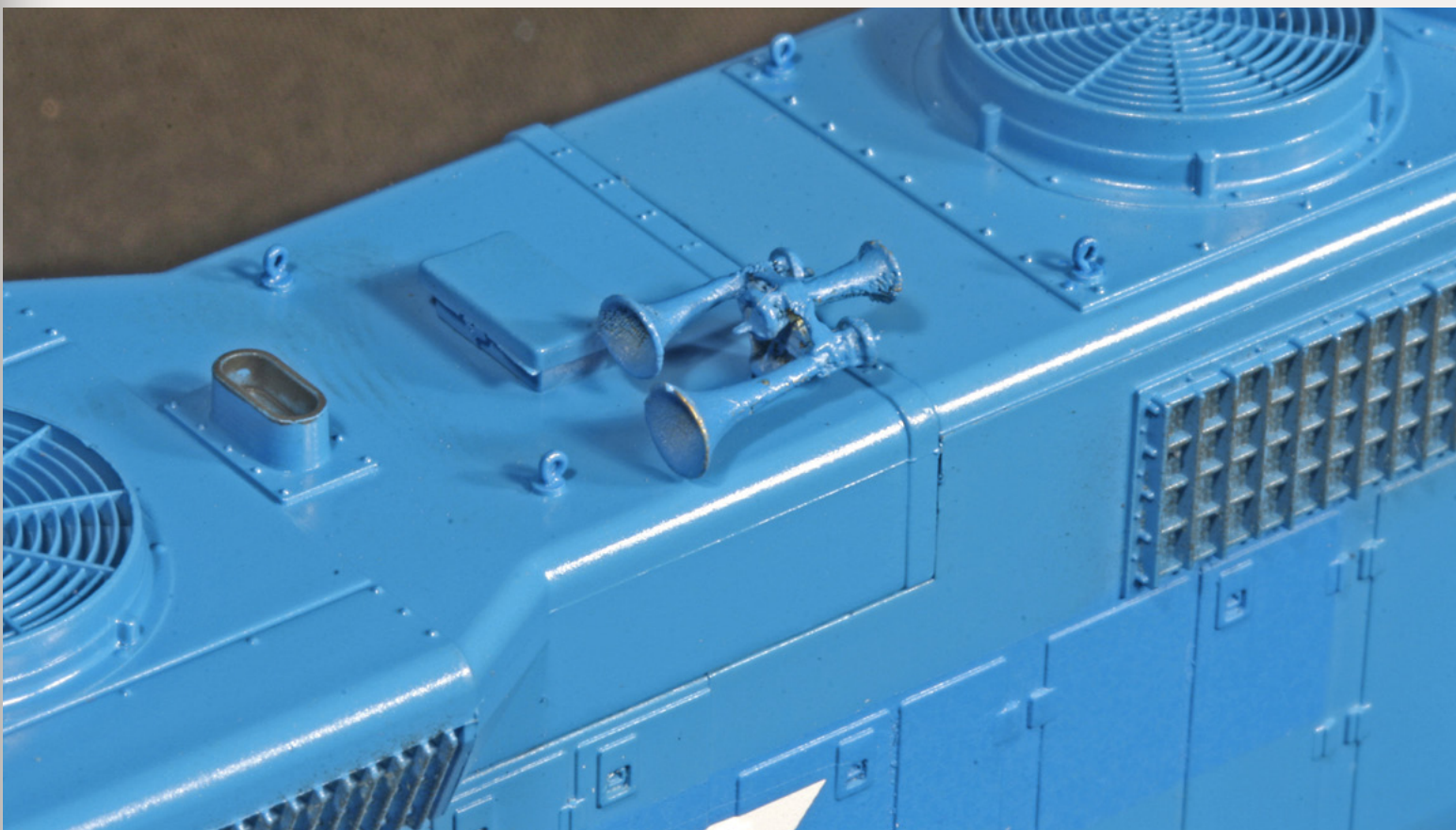

Figure 6: Matt added an after-market air horn mid-hood to match the BNSF prototype. Matt also added lift rings to the hood.



Figure 7: Matt installed ditch lights, coupler lift bar, train air line and MU hoses to the loco pilot – transforming this model into one specific to the BNSF prototype.

are many ways to remove factory decoration, and this project requires removing only the pad printed GATX markings while leaving the 3 color paint scheme intact. This required tight control over what is removed.

One quick and effective method is to wet sand the markings until they are either removed, or smoothed out with the paint layer they have been applied to, allowing them to be easily painted over.

The first step in rebranding the locomotive was to cut several narrow strips of 1500 grit automotive sandpaper, folding each strip over itself

several times until it was semi-rigid, yet long enough to hold firmly. Both the sandpaper and locomotive surface were wetted down. Then the GATX markings were *gently* sanded, using small circular motions. I took care to sand only the markings evenly without gouging (Figure 8-9 next page).

The white lettering color began to bleed across the blue painted surface of the locomotive body, indicating the lettering was being removed, while the paint under it was still intact. To insure that I could properly see the area being worked on, I cleaned it using a damp paper towel, then



Figure 8: Matt cut narrow strips of 1500 grit automotive sandpaper to use for evening two's paint removal tasks.

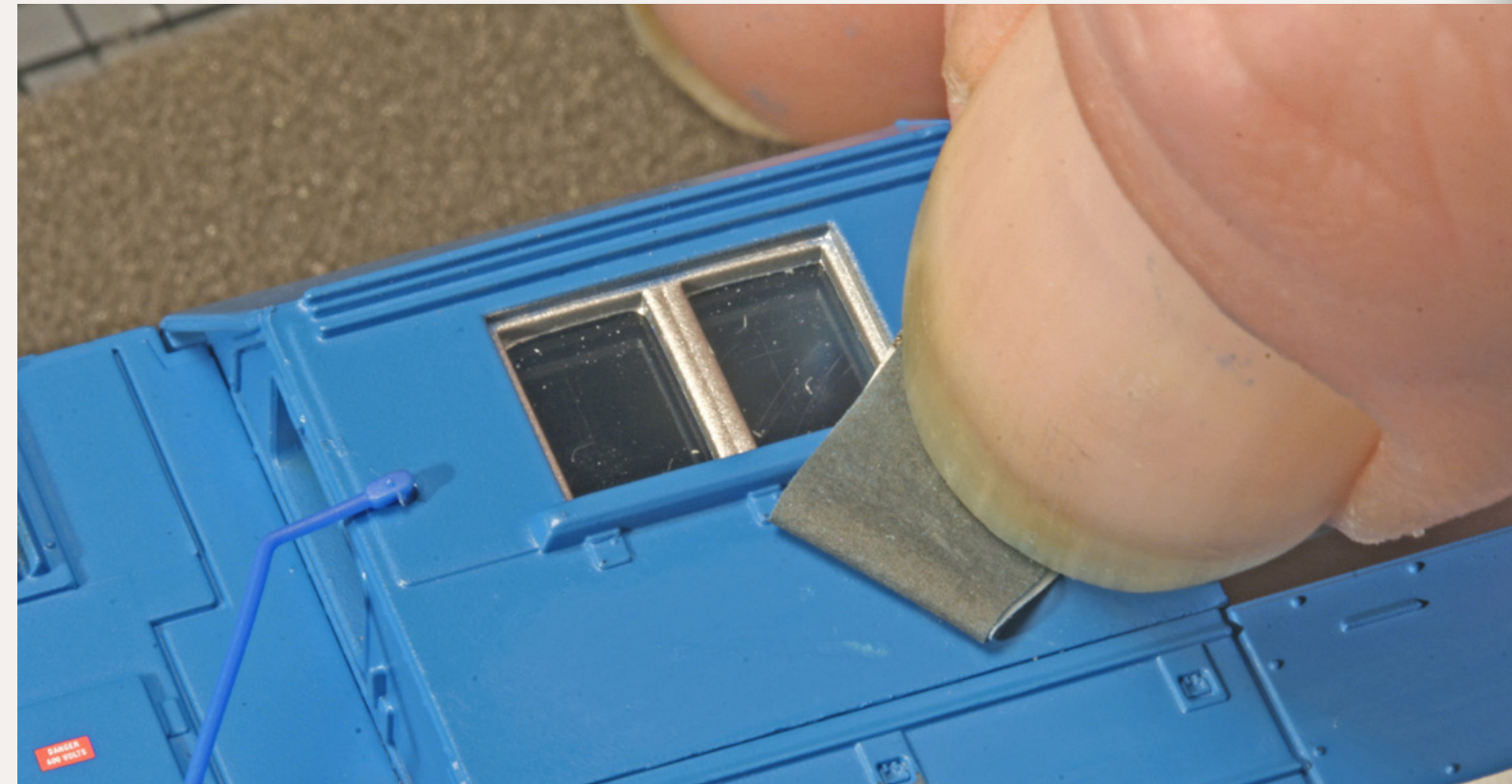

Figure 9: On the smooth cab area, Matt carefully wet sanded and removed the lettering while leaving the body paint intact.



Figure 10: Removing the lettering from the hood area using the sandpaper strips is more challenging, since the body shell is so uneven.

rewetted it. I continued this process until the lettering was removed.

While wet sanding is an effective method for removing factory lettering, it also has several downsides. First it is difficult to remove pad printing around depressions in the model's surface, such as between hood doors and around latches (Figure 10). Fortunately in a project such as this, where a locomotive has been rebranded, it is not critical to remove every bit of pad printed lettering (Figure 11). The concept is to prevent the pad printing from showing through the new paint as solid raised lettering. Once the area has been

repainted, the coating of paint will cover any remaining slivers of lettering. This can also be used to conceal any portions of raised printing left on the surface of the model.

The second downside is that the factory paint will be left with a 'cloudy' appearance. This is a result of minute scratches left in the paint surface by the sandpaper. While this may seem to ruin the surface of the model, it is to be expected. The use of small strips of sandpaper will confine this discoloration only to the areas where the lettering was removed. Since we're

Continued on page 47 ...

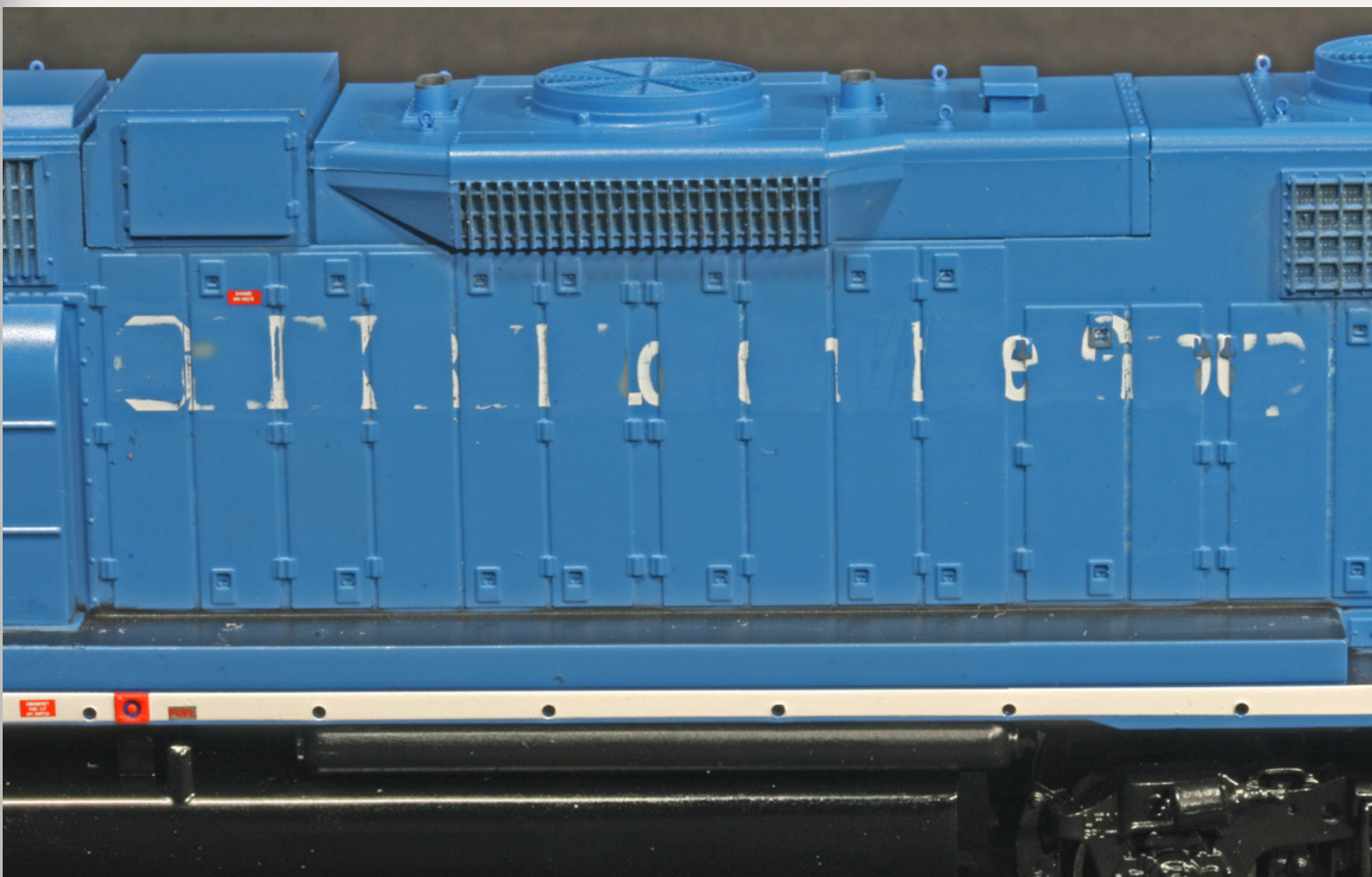

Figure 11: Here's the result after Matt wet-sanded the hood sides with the 1500 grit sandpaper. Remnants of the original lettering remain.



Figure 12: Here is what the lettering looked like on the smooth cab areas before wet-sanding.



Figure 13: After carefully wet-sanding the smooth cab sides area, the lettering has been quite effectively removed with little damage to the original factory paint.



Figure 14: Wet-sanding the nose to remove the lettering also works quite effectively, with little if any damage done to the factory paint.

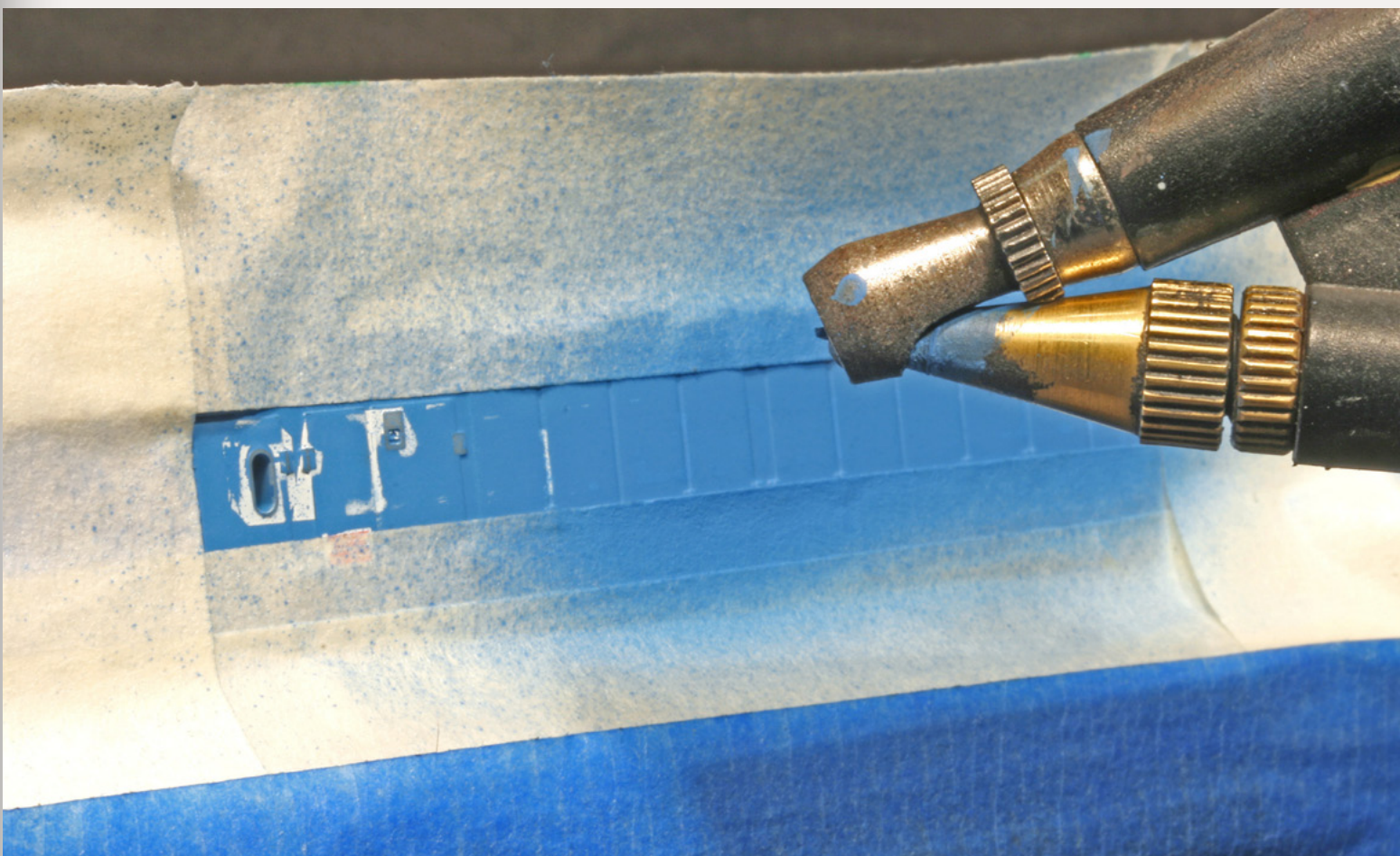

Figure 15: Matt masks and sprays the tough hood area to remove the last remnants of the factory lettering. This is actually not unlike what the prototype did!

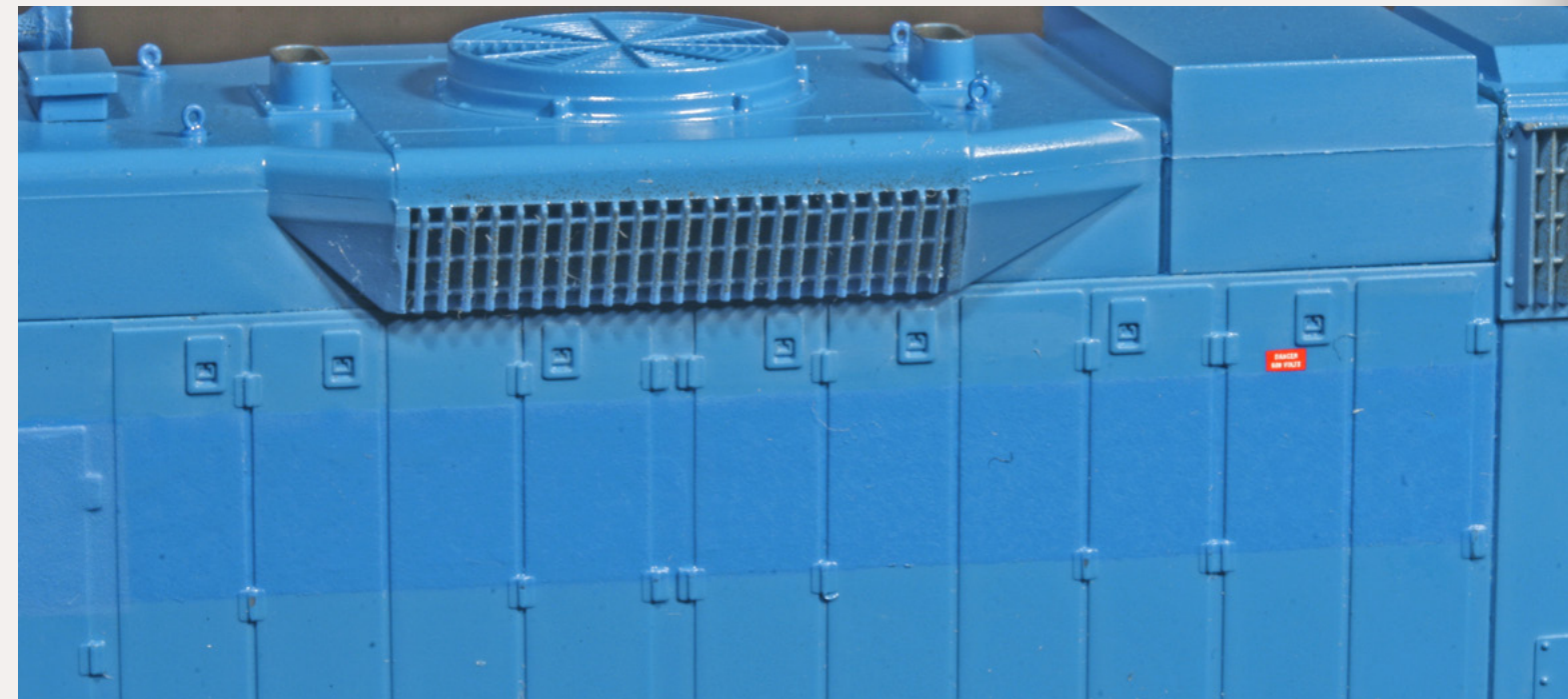

Figure 16: After masking and spraying the hood side, here's the result. Matt deliberately used a paint one shade darker than the model to get the hasty patchwork look of the prototype paint job.

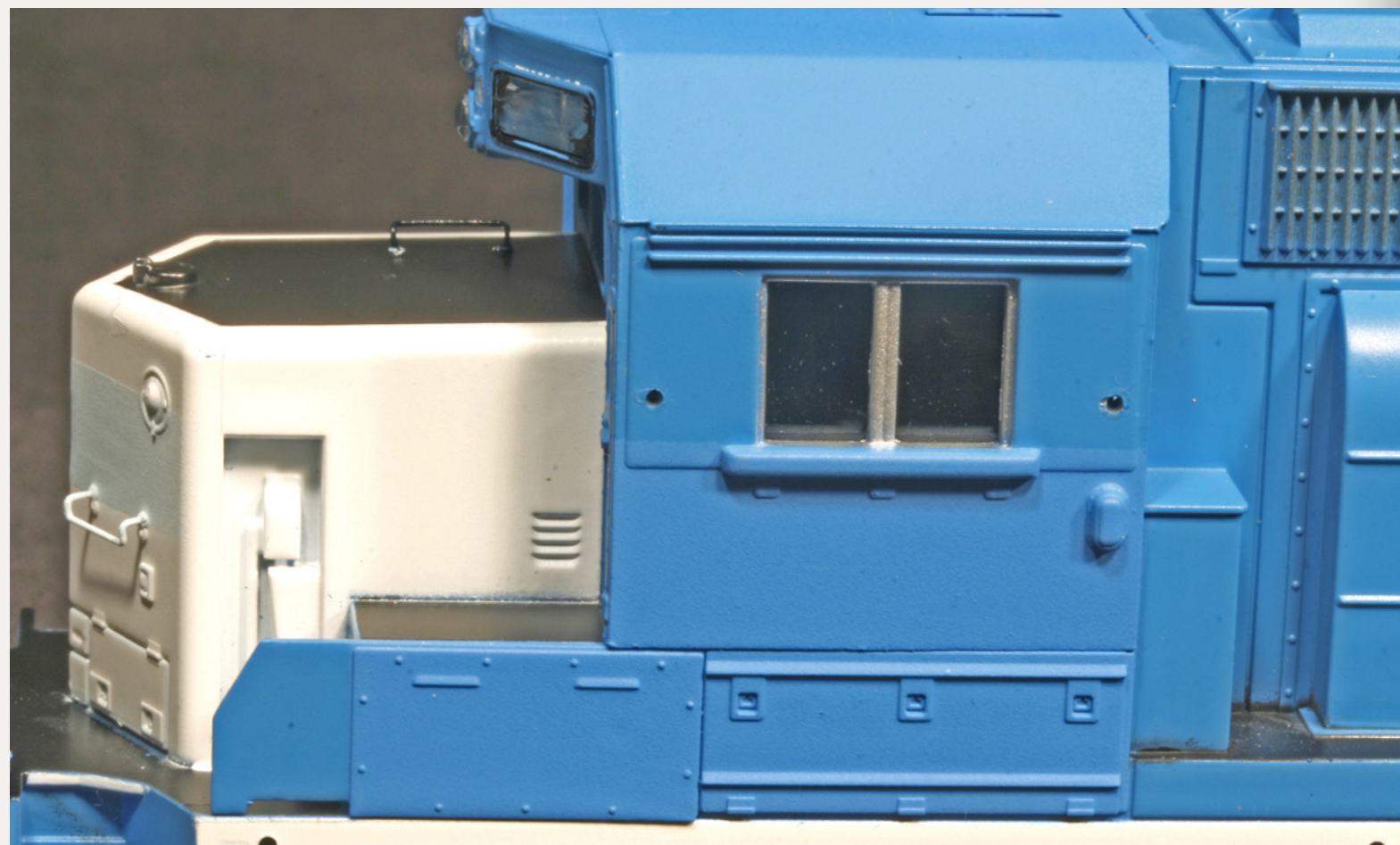

Figure 17: Here's the patchwork paint on the cab side. Again, Matt wants to duplicate the patchwork look of the prototype so he used a blue one shade darker than the factory model.

“Locomotives that have been rebranded without full repainting will generally show signs of ‘patch painting’ ...”

Continued from page 45 ...

following prototype practice, the affected areas will be painted with a color closely matching the body. Once applied, the scratches will be easily filled, leaving a smooth surface suitable for decal application (Figures 12-13, and Figure 14).

Now that the GATX markings have been removed, the model is ready for

a coat of ‘patch paint,’ further obscuring any remnants of GATX ownership while readying it for the new BNSF numbers and logos. Locomotives that have been rebranded without full repainting will generally show signs of ‘patch painting’ – painting over former owners markings using a color closely matching the base color of the locomotive yet leaving a difference visible under close examination.

Each area to be patch painted was masked using a combination of blue painters tape and standard masking tape then airbrushed with multiple thin coats using a paint mixture one shade darker than applied at the Athearn factory. This method allows each coat to dry quickly preventing



Figure 19: Matt sprayed the model with Testors’ Gloss Cote to prepare it for decaling.



Figure 18: Here’s the patchwork paint Matt used on the white nose. Again, the slight color variation to the model is deliberate, to duplicate the prototype’s patchwork look.



Figure 20: On evening three, Matt applies Shellscale numberboard decals to the loco’s number boards.

any paint from bleeding under the masking, and once the masking has been removed, leaves obvious 'patches' indicating the locomotive had received a quick rebranding from another owner (Figures 15-18 previous two pages).

Once the 'patches' were in place a quick spray of Testor's Glosscote left a surface suitable for decaling, completing the paint work which was allowed to dry overnight.

Parts Listing

Athearn #80187 - GATX GP38-2

Detail Associates #1022 - Ditch Lights

Detail Associates #1508 - MU Hoses

Detail Associates #1803 - Sinclair Antenna

Detail Associates #2206 - Lift Rings

Detail Associates #2212 - Coupler Cut Levers

Details West # 155 - Snowplow

Details West # 190 - Air Horn

Details West # 275 - EOT Antenna

Floquil Conrail Blue

Floquil Reefer White

Testor's Gloss Cote spray

ELS Trains Decals - BNSF White/Blue Lettering (for lease locomotives)

Microscale Decals MC4339 - Yellow Data Reflector Stripes

Shellscale Decals #108 - EMD/GE 8" White Numbers & Black Numberboards

Shellscale Decals #114 - Alco Style White Numbers ■



Figure 22: Matt applied number decals onto the black Shellscale number board backgrounds.



Figure 21: Matt applied the large BNSF logo and some yellow sill striping onto his model.



Figure 23: Matt applied some blue BNSF "lease loco" decals to the loco nose where he had painted a patchwork block on evening two.

“... this experiment showed how much time could be saved by starting this project with a Ready-To-Run model ...”

Evening Three

Day three of the experiment would prove just how much time could be saved by incorporating a R-T-R model into this project as all that remained was decal application and reassembly (Figure 19).

I began by reapplying the black numberboard backgrounds using Shellscale EMD/GE numberboards, allowing these to fully dry completely before I moved to the sides of the locomotive (Figure 20).

Once again the R-T-R factory decoration sped things up as the white and yellow sill striping required applying only the yellow portion over the solid white stripe of the factory paint. Completing the sides were new cab numbers and large BNSF ‘wedge’ logos applied to the long hoods. The numberboards were completed using a combination of white Alco style and 8” EMD numbers from Shellscale. After applying the blue BNSF logo to the nose the handrails were reinstalled and it was back to the paint

shop for a quick coat of weathering, completing this custom locomotive in only three days (Figure 21 next page)!

While the methods I used will hardly apply to every situation we encounter as model railroaders this experiment has proven that keeping an open mind can enable us to make our modeling easier by taking advantage of current manufacturing trends. We can either curse the darkness or take advantage of the light, riding the R-T-R wave to make our modeling easier and faster while allowing us to accomplish more in our limited hobby time – in effect “Speedbashing”!



Advertisement

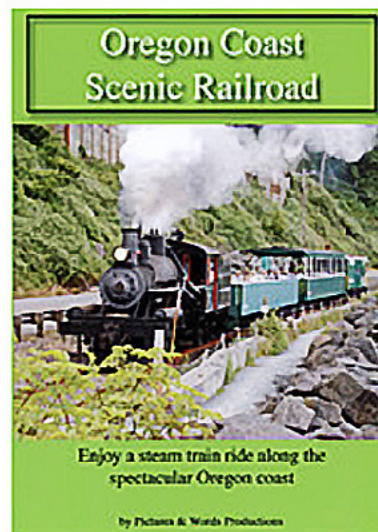

\$18
+s/h

Geared Steam!

Classic restored Heisler action at the Oregon Coast Scenic RR, and the first restored Willamette at the Mt. Rainier Scenic RR! Both DVDs include behind-the-scenes shop visits plus exciting and detailed views of lineside operation.



By Jeff Johnston, producer of “The Steam Loco Weathering Clinic”
www.trainvideosandparts.com

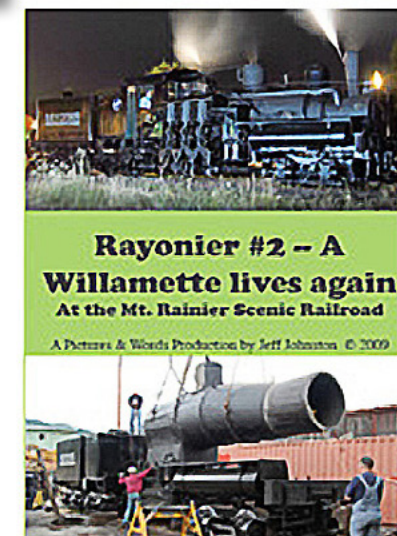

\$22
+s/h



M.R. (Matt) Snell has been a model railroader and railfan for 30 years. His interest in railroading grew while growing up in New Jersey surrounded by freight and passenger rail lines.

Presently residing in Ohio, Matt and his wife Debie share the hobby, modeling the area he grew up in: north-central Jersey.

Their “Conrail New Jersey Division” layout has been featured in *Great Model Railroads*, *Rail Model Journal*, and in the Allen Keller *Great Model Railroads* DVD series. Matt has had articles in *Railroad Model Craftsman*, *RailModel Journal*, *Scale Rails* and *Model Railroader*, as well as online at railroad.net.



Figure 24: Here is Matt's finished "speedbashed" GP38-2 for you to spin and study from all sides. Just click it with your mouse to spin it.

Click-n-spin won't spin? Click here to try it on the web.

THE CAR SHOP



Fine Tuning Rolling Stock for better running

– by Charlie Comstock



or [Tangent](#) car but they look decent, have good lettering, have more robust details, and are considerably less costly. When I set up an assembly line I can put together a bunch of [Accurail](#) kits quickly – a plus when I’m in increase-the-fleet mode.

To ensure the result is a good running, reliable car I use some extra parts.

- Metal wheelsets roll better, don’t attract as much dust, add weight and lower the car’s center of gravity.
- I’ve found Kadee couplers to be reliable and use them exclusively when assembling kits.
- If the car is light for the [NMRA car-weight standards](#), I add self-stick lead weights from [A-Line](#). These come in

1/2 oz. sizes which makes it easy to determine how much to add.

Figure 2 shows all parts, both from the kit and extracurricular, that I used to build this PFE reefer.

I start by weighing all the parts (figure 3). The NMRA car weight standard for HO is 1 oz. + 1/2 oz. per inch of length. So this 6” long car should weigh 4 oz. As it happens the parts for this car (including couplers and metal wheels) weigh 3.9 oz which is awfully close to the desired car weight.

Figure 4 shows the A-line self-stick 1/2 oz. weights I use to add additional mass to cars.

I like to wash the car bottom and trucks and spray them with a light coat



Figure 3



Figure 4

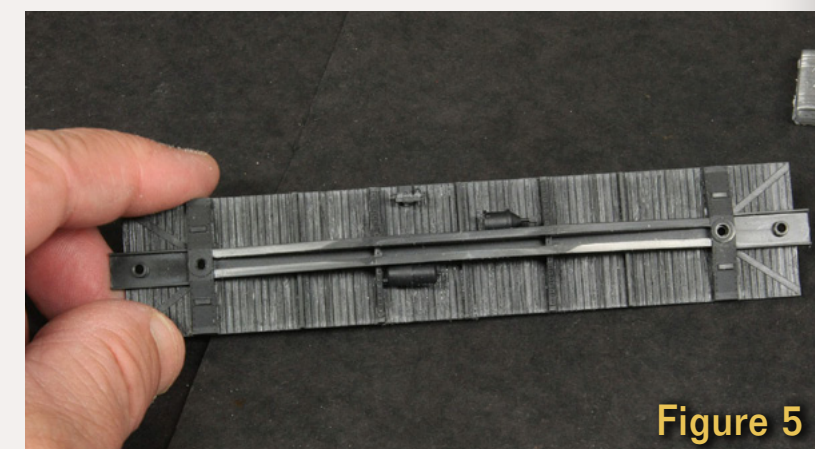

Figure 5



Figure 6



Figure 1



Figure 2



Figure 7

of Krylon flat black to cut the shine. Let the paint set up and then insert the wheelsets.

I assemble the car bottom per directions but clean up sprue marks with a small file. Accurail castings are usually flash free (figure 5). Once the glue holding the ribs and brake gear dries I use a mill file on the top of the floor to remove any protrusions (figure 6).

Walthers' Hob-e-Tac works well for gluing the steel car weight to the floor (figure 7). I use spring-loaded clothes pins to hold it in place.

Older Accurail kits use plastic bolster pins to hold the trucks in place. DON'T use these. They are prone to falling out and causing derailments. Instead I use #2 self-tapping pan head screws (figure 9). Using screws instead of the plastic pins gives you precise control of how tightly the trucks are attached to their bolsters (figure 10). I leave one truck just loose enough to pivot easily. Leave the other a little looser allowing it to wobble a bit. This creates a 3-point suspension that lets the car roll over track irregularities.

No wheel vendor is perfect so check the gauge on all four axles (figure 11). Gauge should be as close to perfect as you can see. If not, get another wheel set!

Coupler height is vitally important. I use a Kadee gauge to ensure it's correct and adjust the dangler height if needed (figures 11 to 13).

Finally I use a black marker to color that brake staff. The hole for it was too tight so I drilled a slightly oversize hole for it, then cemented it in place using gap filling ACC (figures 14 to 18).

Voila! Another car ready for weathering!

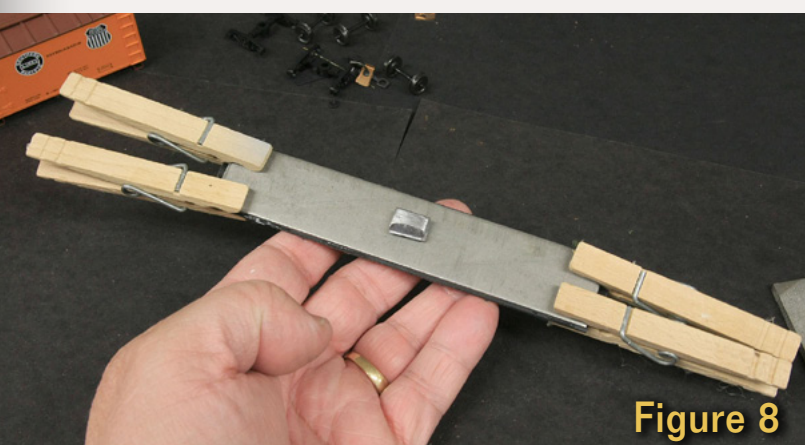

Figure 8



Figure 9



Figure 10

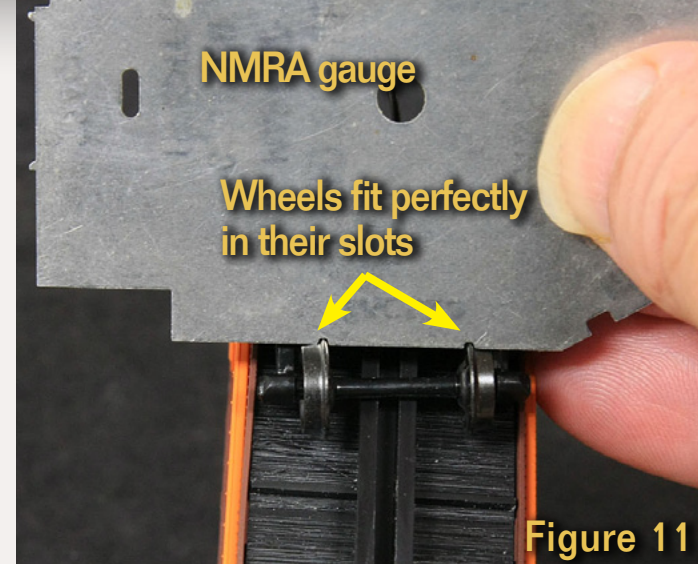

Figure 11

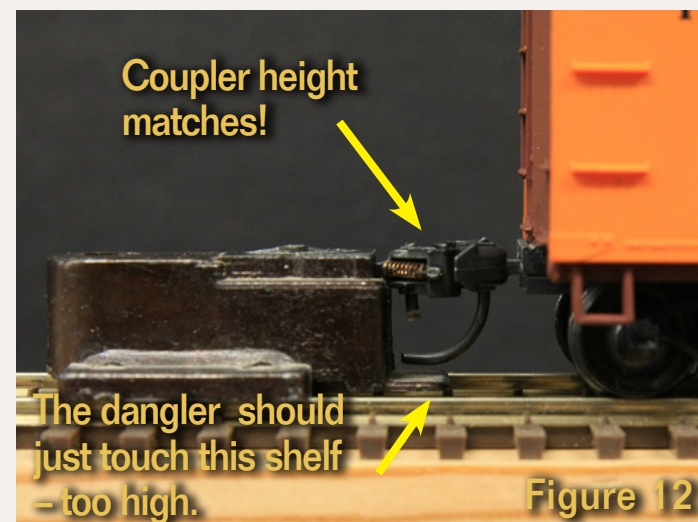

Figure 12

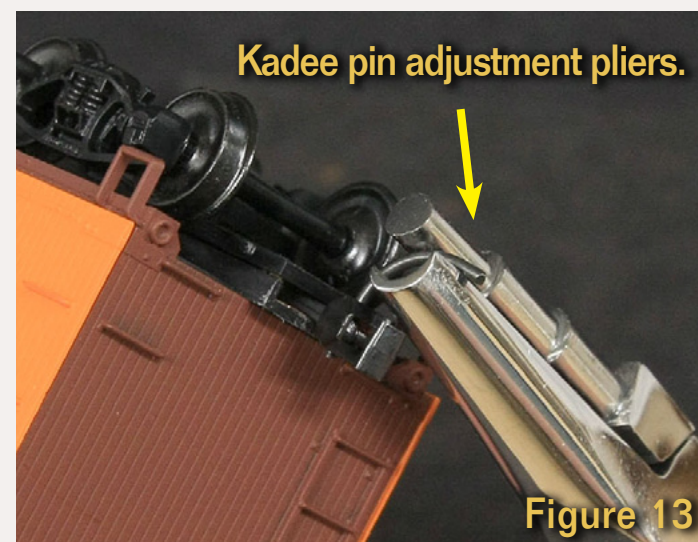

Figure 13

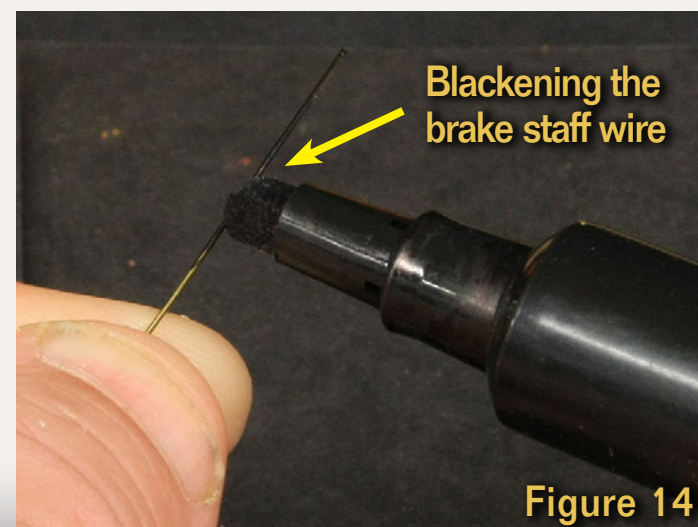

Figure 14



Figure 15



Figure 16



Figure 17

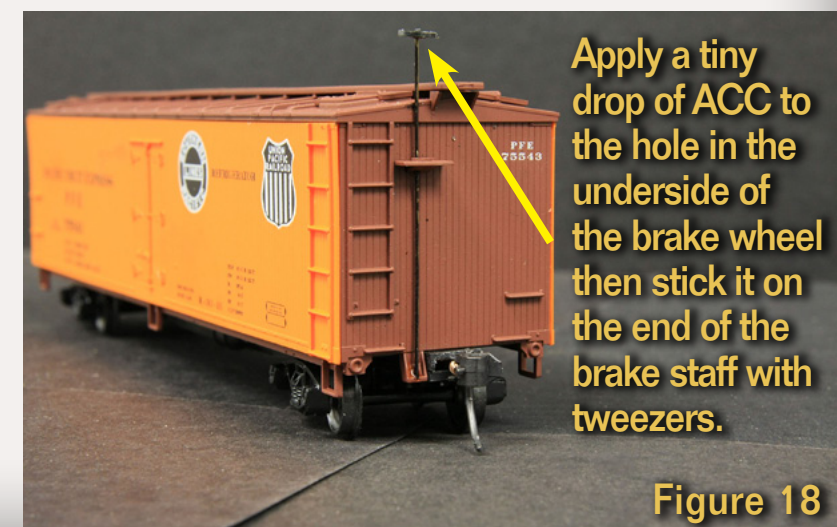

Figure 18

HOME MADE LUMBER LOADS



 **Reader Feedback**
(click here) 

– by *Steve Pirosko*
Photos by the author

Make lumber loads for your center-beam flat cars in no time!

Here's an easy method to make removable lumber loads for your center-beam flat cars or any other car. These loads do not have the detail of the kits you can build that install as individual loads, with all the string and wood

separators. But these loads will do in a pinch until you find the funds or the time to do more detailed loads.

You may find that in the end they never get replaced with more detailed kits because they look darned good on a freight car as is!

You need two things – a computer to print out the logos from various web-sites and some wood blocks cut to fit your cars. I have included some lumber load pages with this article.

Once you scale them to size, the separator line between vertical loads is a 3-point thick black line for HO. The "rigging" is a vertical 0.25-point line.

To make the wood blocks I use .50" thick plywood cut to length and height to fit the various size cars. Adjust the sizing and spacing of the logos and lines to make an exact fit for your specific car. It may take a bit of trial and error with your printer, but usually close is good enough.

Apply a very thin coat of white glue to the backside of the logo sheets and place a block on the sheet, making sure to keep the vertical and horizontal lines square. I find it easier to use a thin ruler to create the first fold before applying the glue.

Figure 1: Having center-beam flats loaded with lumber makes your railroad more interesting since it's now moving freight to market.

Now wrap the sheet around the block to attach all the sides, trim the excess off and fold the ends like a wrapped package.

Presto! You now have a load of lumber to deliver to your customers!

Check out the lumber load wrappers for various companies on the following pages. 

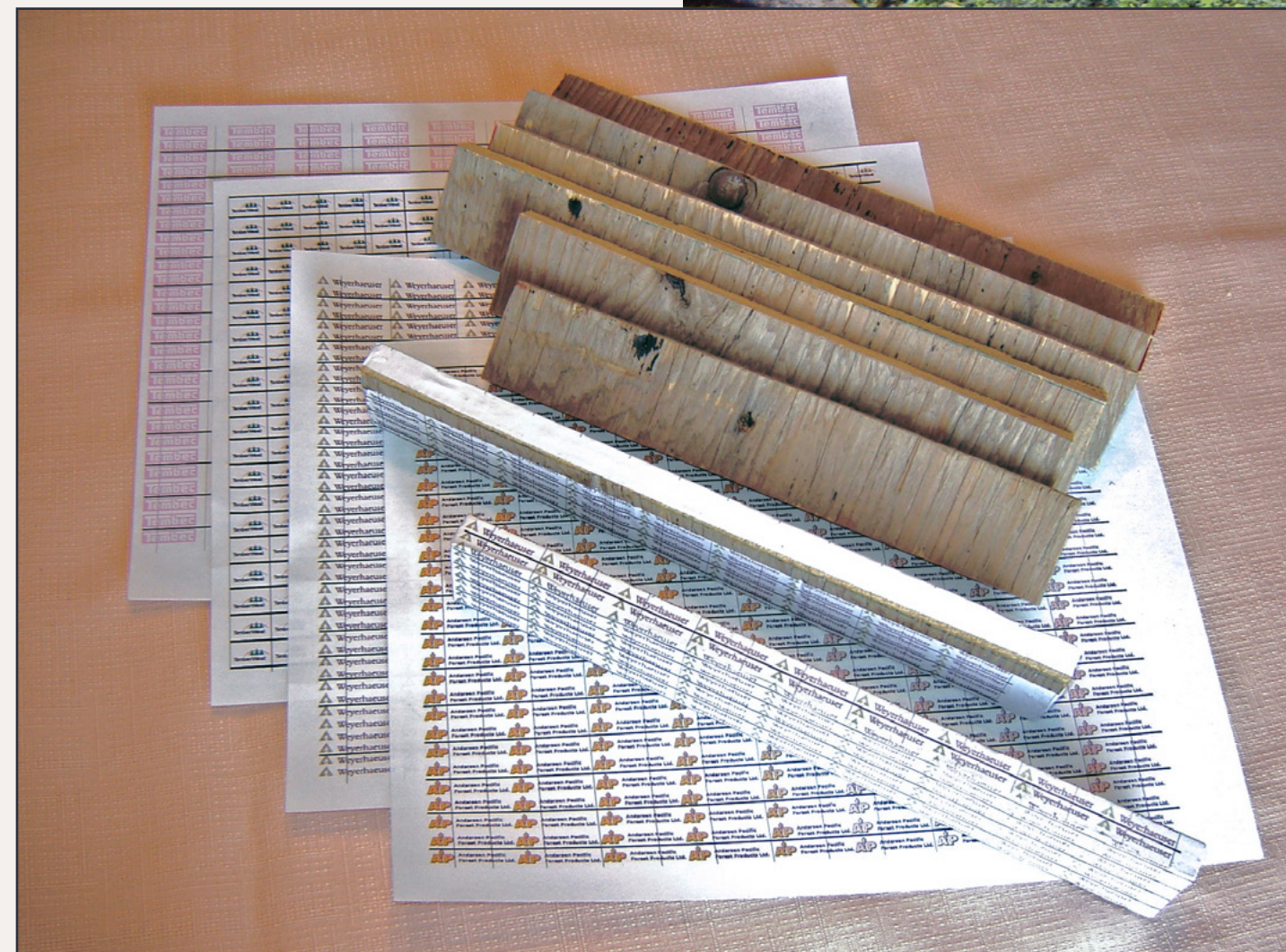
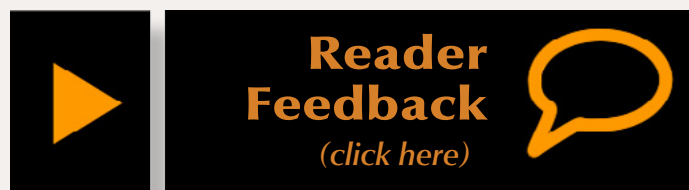

Figure 2: All you need are some scraps of 1/2" plywood and a computer printer to make the paper wrappers for these loads.

Figure 3: You would never know all that's underneath this paper are scraps of 1/2" plywood. As a stand-in, these loads look quite decent, and they sure beat hauling around empties.



Steve Piroso has been model railroading since he was 16 when his older brother bought him a Tyco train set for Christmas. He has had several layouts over the years, and one of his main interests is prototype operations. He models a 13 mile portion of the Canadian National Grimsby sub from the Niagara River bridge to just past Merriton, Ontario.

Steve's other interests include playing hockey and riding his motorcycle. A former long-time Quality Assurance Manager in the automotive parts manufacturing business. He resides with his wife Becki of 29 years and their two teen-aged sons in Niagara Falls, Ontario.

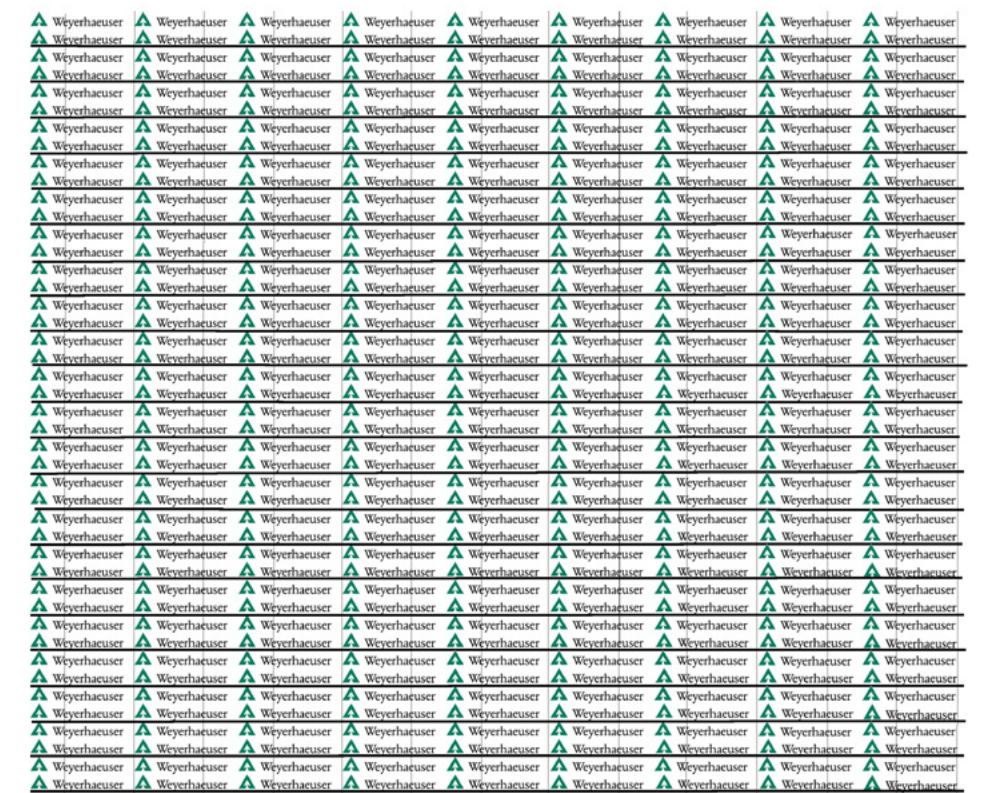

Full size for N scale (54%)



Full size for Z scale (39%)

Figure 4: Weyerhaeuser lumber load wrappers.

In January 1900, Frederick Weyerhaeuser founded Weyerhaeuser Timber Company with 15 partners and 900,000 acres (3,600 km²) of Washington timberland purchased from James J. Hill of the Great Northern Railway. In 1929, the company built what was then the world's largest sawmill in Longview, Washington. Weyerhaeuser's pulp mill in Longview, which began production in 1931, sustained the company financially during the Great Depression. In 1959, the company eliminated the word "Timber" from its name to better reflect its operations.

Full size for HO scale (100%)



Other enlargements are available for other scales in the bonus downloads for the July issue:

[CLICK HERE ...](#)



Full size for HO scale (100%)

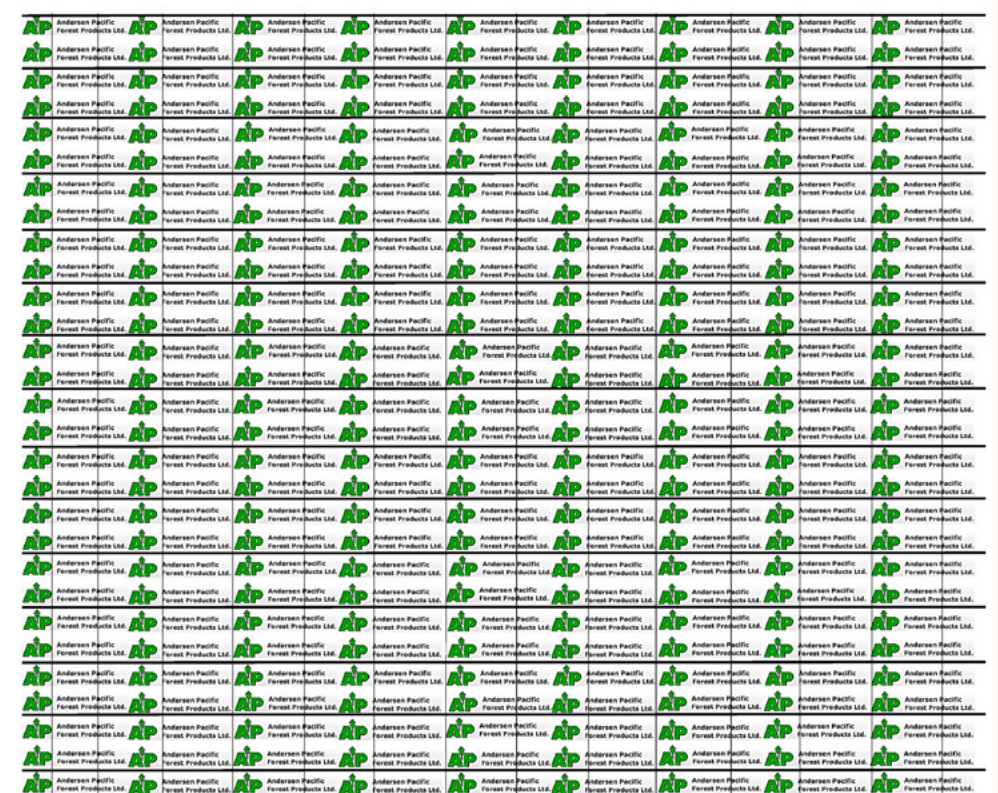

Full size for N scale (54%)

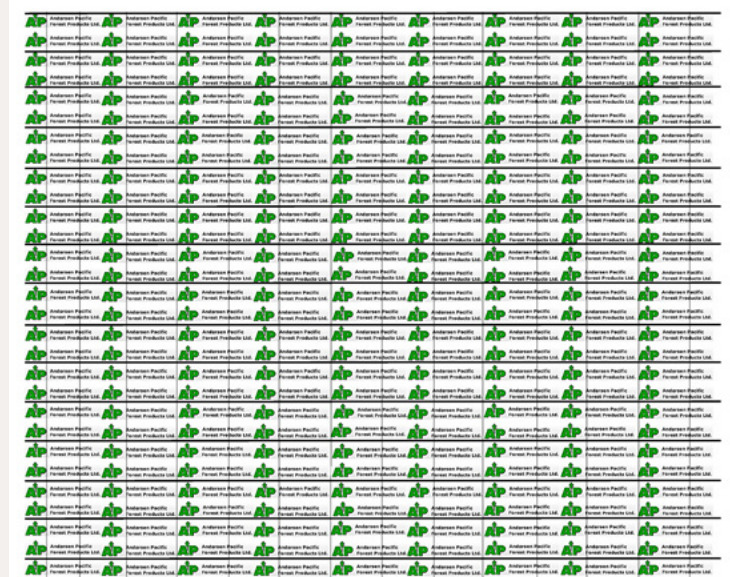

Full size for Z scale (39%)

Figure 5: Andersen Pacific Forest Products load wrappers.

Andersen Pacific Forest Products Ltd. is a Japanese style high-value custom-cut sawmill located in Maple Ridge near Vancouver, British Columbia. This company manufactures high-quality lumber from yellow cedar, western red cedar, Douglas fir, sitka spruce, white spruce, hemlock, and balsam, with a focus on shop and high-grade logs. Established in 1993, through a process of continuous upgrading and supplementary land acquisition, APFP has established recognition as a specialty mill manufacturing consistent high-quality lumber.

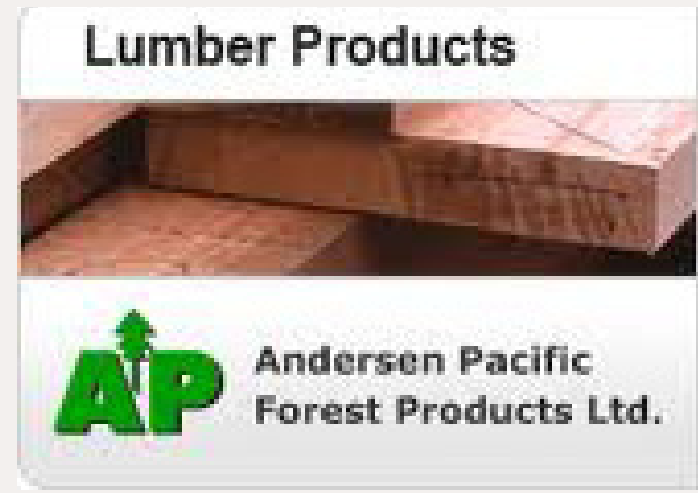

Other enlargements are available for other scales in the bonus downloads for the July issue:

[CLICK HERE ...](#)

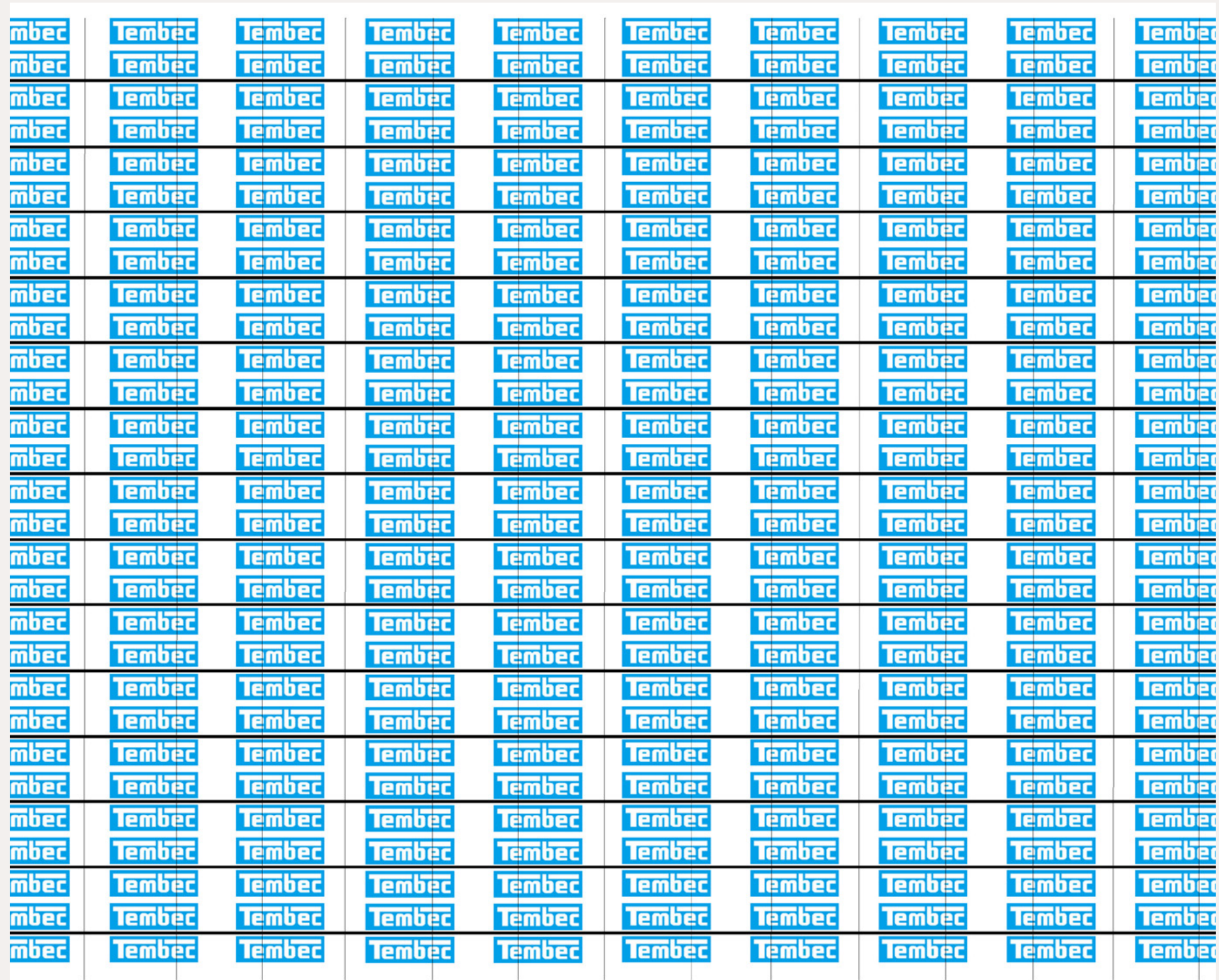

Full size for HO scale (100%)

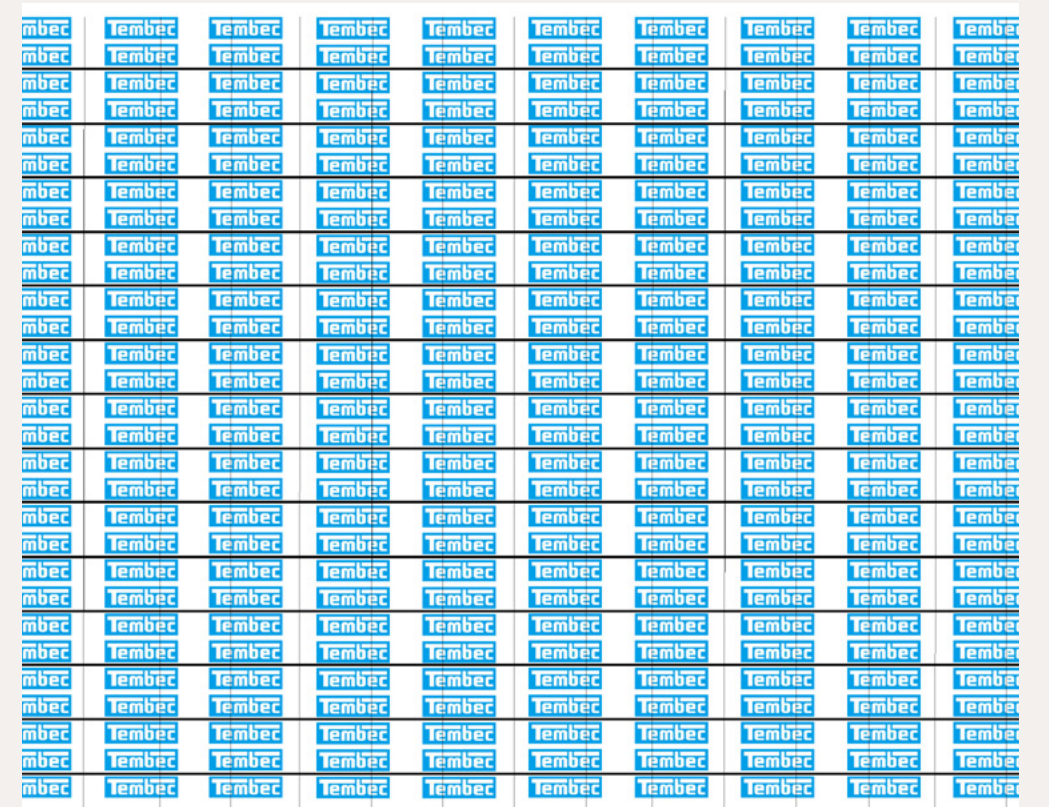

Full size for N scale (54%)

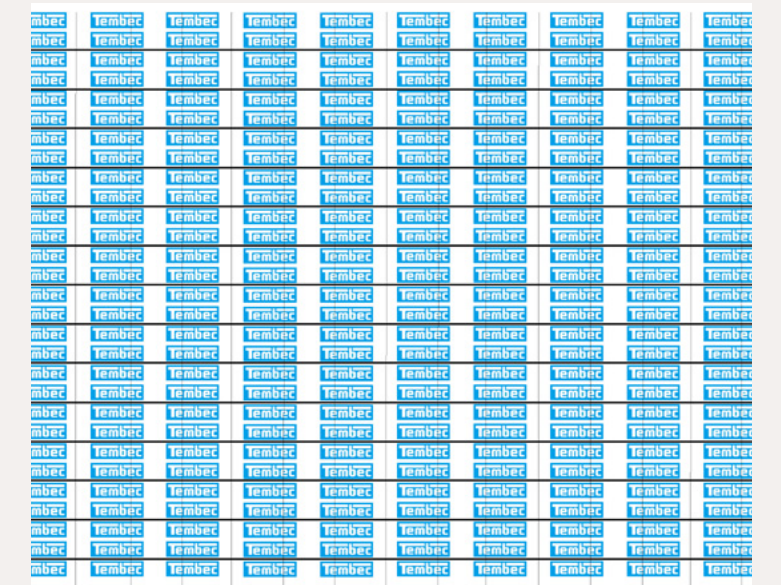

Full size for Z scale (39%)

Figure 6: Tembec load wrappers.

Tembec was created in 1973 in Temiscaming, Quebec by the people of the town in an effort to keep the local economy from collapsing. The mill was purchased by the town, and Tembec was born. The Company has grown from its original mill in Temiscaming with a few hundred employees into an international company with operations in both North America and France. Tembec markets its products worldwide and has sales offices in Canada, the United States, China, Korea, and Japan.



Other enlargements are available for other scales in the bonus downloads for the July issue:

[CLICK HERE ...](#)



Full size for HO scale (100%)



Full size for N scale (54%)



Full size for Z scale (39%)

Figure 7: Timber West Forest Corp. load wrappers.

TimberWest Forest Corp. was incorporated on January 31, 1997, and acquired portions of the business of TimberWest Forest Limited on June 23, 1997, and the private timberlands of Pacific Forest Products Limited on December 10, 1997. TimberWest runs contracted harvesting operations, and both grows and harvests second-growth timber. About 85% of TimberWest's annual private land logging is done in second-growth Douglas fir and hemlock stands.



Other enlargements are available for other scales in the bonus downloads for the July issue:

[CLICK HERE ...](#)



Full size for HO scale (100%)

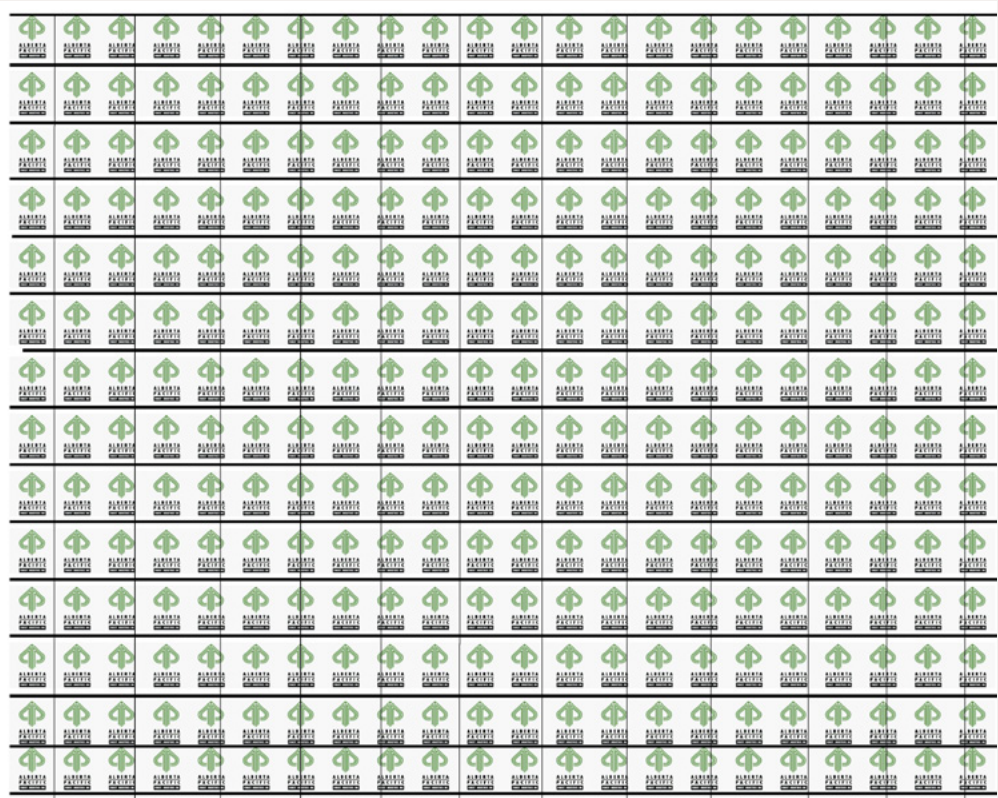

Full size for N scale (54%)

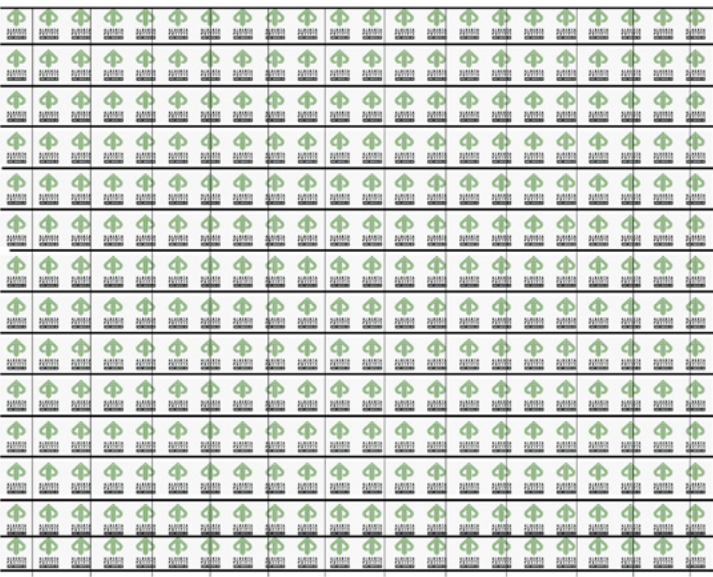

Full size for Z scale (39%)

Figure 8: Alberta Pacific load wrappers.

While the Alberta Pacific (Al-Pac) project was announced in 1989, it wasn't until 1991 that the Alberta government chose Al-Pac from several competitive bids. The company started operations in 1993 under the ownership of Crestbrook Forest Industries, Mitsubishi Corporation, and Kanzaki Paper (later acquired by Oji Paper Company Ltd.). Alberta-Pacific quickly established itself as one of the leading producers of quality kraft pulp, while also attempting to be environmentally responsible in its operation. After acquiring Crestbrook's shares in 1998, the private company is now solely owned by Mitsubishi Corporation (70%) and Oji Paper (30%).



Other enlargements are available for other scales in the bonus downloads for the July issue:

[CLICK HERE ...](#)

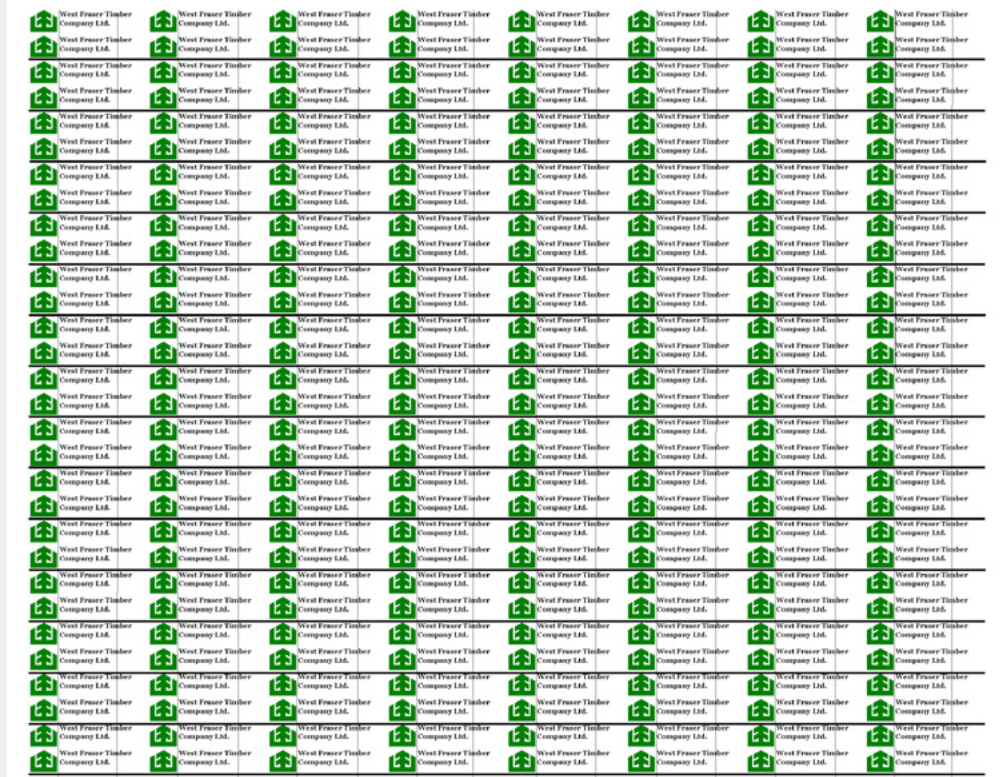
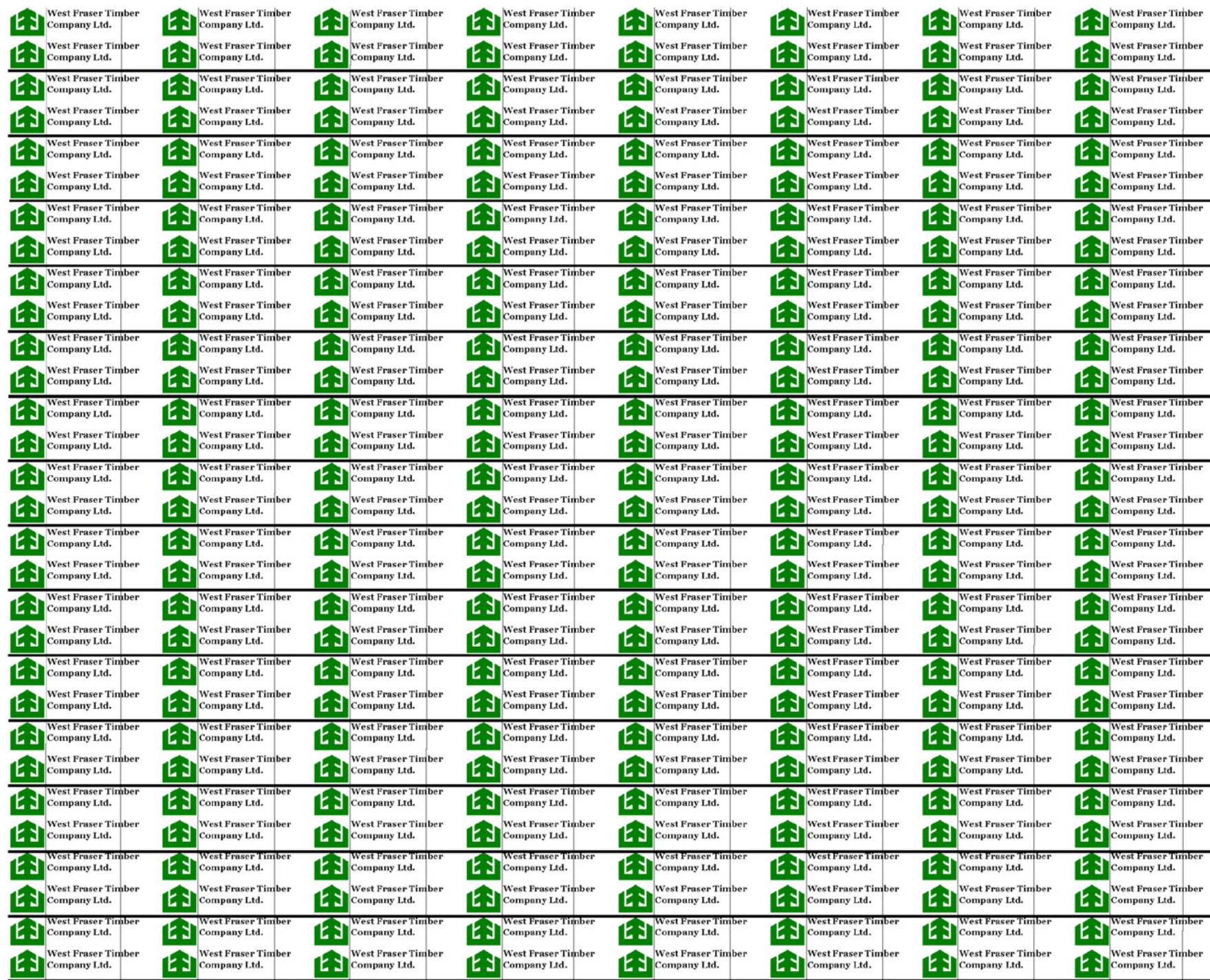

Full size for N scale (54%)

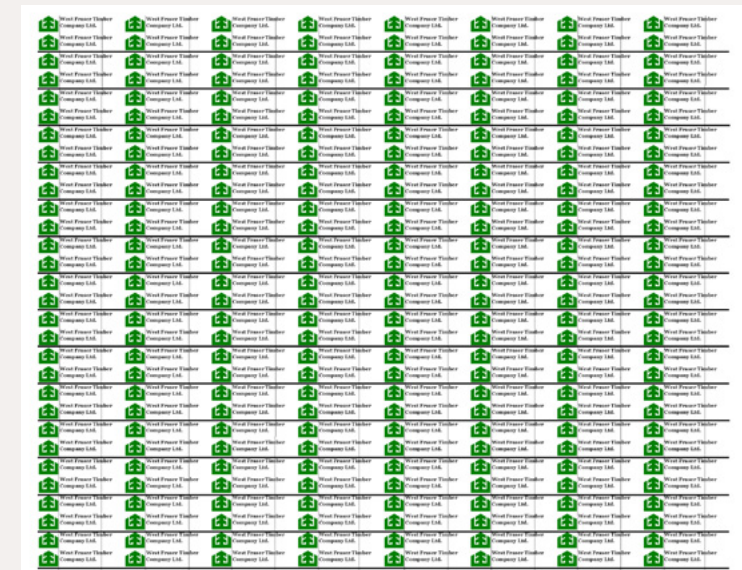

Full size for Z scale (39%)

Figure 9: West Fraser Timber load wrappers.

Full size for HO scale (100%)



West Fraser Timber Company is a Canadian forestry company based in Quesnel, British Columbia that was founded in 1955. West Fraser produces a variety of softwood lumber products which are sold into the North American and export markets. With more than 28 sawmills in British Columbia, Alberta, and the southern United States, West Fraser is a supplier of wood products to both domestic and global clients.



West Fraser Timber Co. Ltd

Other enlargements are available for other scales in the bonus downloads for the July issue:

[CLICK HERE ...](#)

BUILDING A HELIX – One Modeler's Experience

– by *Art Houston*
Photos by the author

Building a 10-turn helix is not rocket science – and if you build it right, it can last you a lifetime ...

I built the original helix for my first Grande Pacific Railroad as described in this article. Fortunately, the construction I used allowed me to dismantle the helix and move it wholesale to my second Grande Pacific Railroad that's now located in Houma, Louisiana.

This is a double-track 10-turn helix with some switches mid-level that exit

the helix, allowing it to feed three different levels. However, my new track plan does not involve using the two mid-helix switches that remain.

I just operate the helix today as part of a long straight run that is

the new Central Division of the Grande Pacific RR.

Follow along now as I describe my helix construction process.

Figure 1: Art built this 10-turn double-track helix for his Grande Pacific Central Division HO layout – and then later moved it lock-stock-and-barrel to his new layout, more-or-less intact! Follow along as Art shows you how he did both the original helix and the relocation to his new layout.



 **Reader Feedback**
(click here) 

STEP 1: Make a Cutting Template

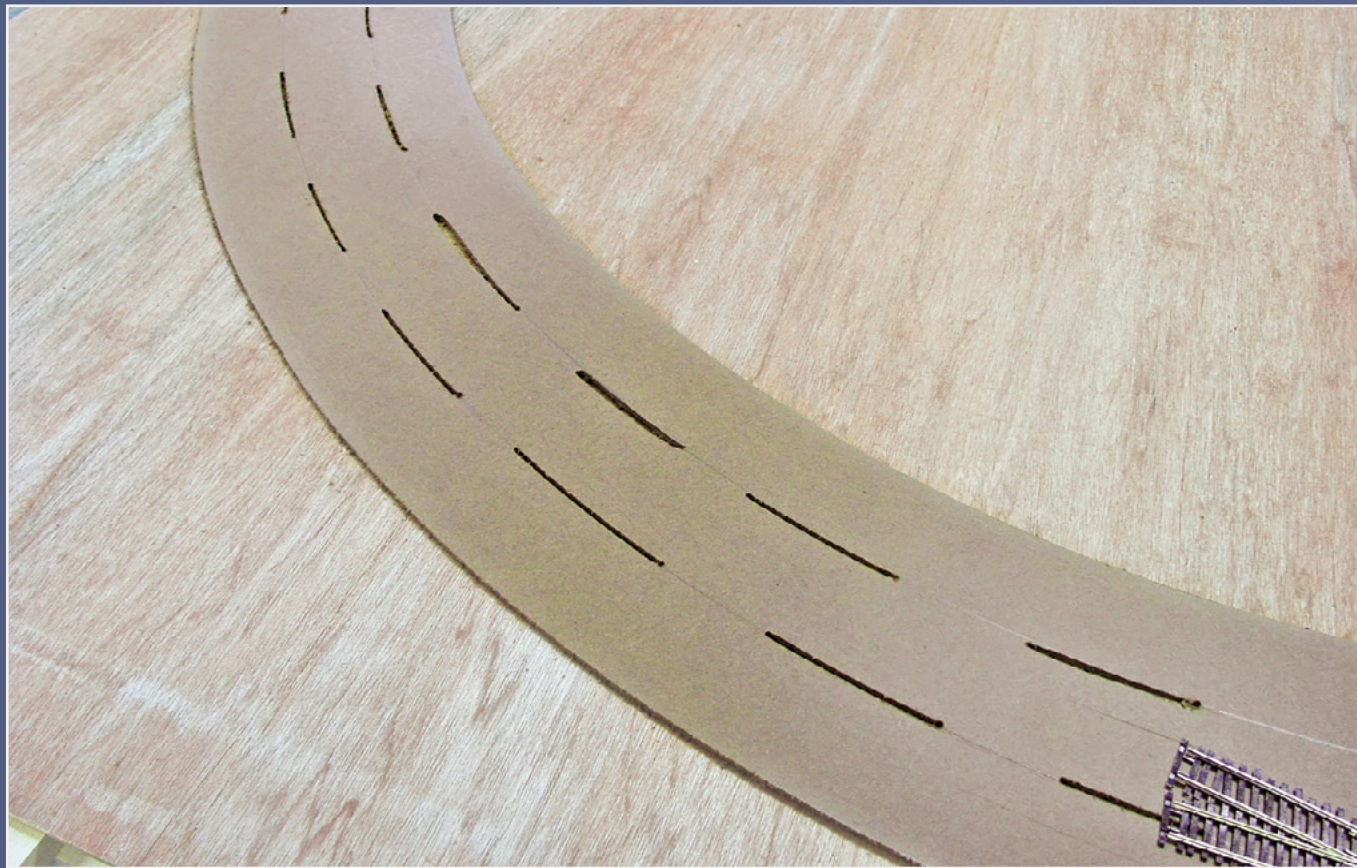

Figure 2: Art's 1/4" Masonite cutting template covering a 120° arc.

For the first step we created a 120° arc cutting template for the helix sub-roadbed plywood out of 1/4" Masonite hardboard (figure 2). The one shown in this picture is a 36" outside and 33" inside radius track center. There is an additional 3" to the outside and to the inside to protect any equipment in the event of a derailment. Total width of the template and each piece of Helix sub-roadbed is 9".

Note the marks I added to the template every 22.5° running across the template in figure 3. These marks allowed us to get whatever combination of length of pieces we needed and to mark the ends and get them square.

I cut the track center marking notches in the template using a router.



Figure 3: Art added marks every 22.5° to the template to aid in making curve sections as long as needed on the plywood.

STEP 2: Cut the Plywood Using the Template



Figure 4: Assistant Dave Abramson marks the 1/4" lauan plywood with all the sub-roadbed pieces, using the template as a guide.

Here in figure 4, Dave Abramson, my right hand, lays out the pieces on a sheet of 1/4" lauan plywood using the template. We tried to get the maximum number of pieces from one 4 x 8' sheet of plywood. It also helps to have a large metal square available as a ruler drawing aid.

We screwed together three sheets of plywood (making a 3/4" thick sandwich of 3 sheets) and cut three sections of sub-roadbed at a time with a jigsaw (figure 5).

I used two sections of 1/4" sub-roadbed laminated together with carpenter's glue to make a 1/2" roadbed sandwich that has no splice plate joints. By staggering the joints in the two laminated layers, I don't need any splice plates, which simplifies the construction of the helix tiers.

Since this method uses the two laminated layers, we needed to cut two sets of sub-roadbed pieces for each tier of the helix. In other words, if it takes 4

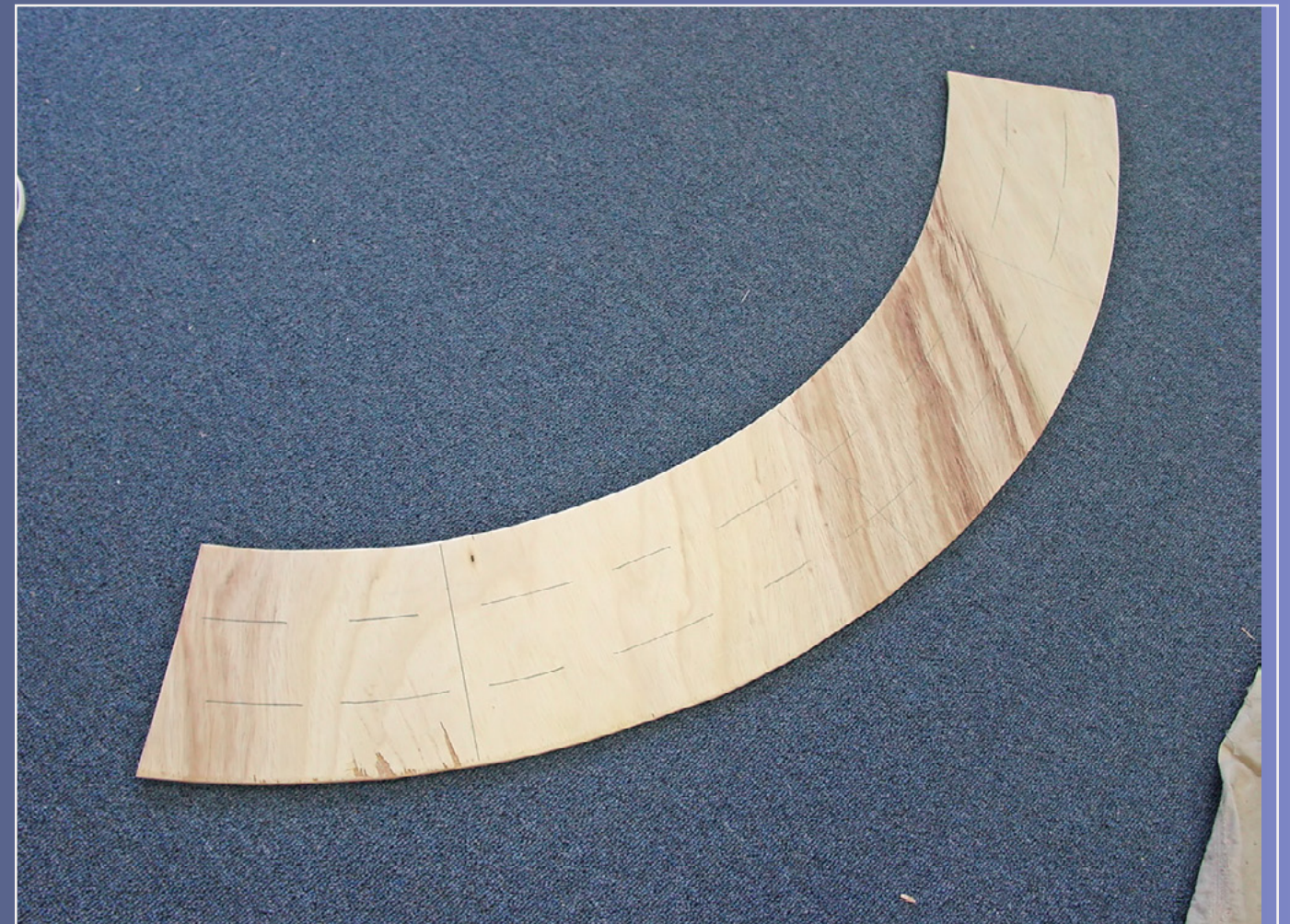

Figure 5: A section of cut out sub-roadbed for the helix. Art cut 81 such pieces of sub-roadbed for this 10-turn helix.

pieces to make one complete circle, we need to cut 8 pieces of the 1/4" lauan plywood and then later laminate them together using carpenter's glue, staggering the joints in the two layers to get one complete seamless circle of 1/2" plywood.

For this helix we cut out 81 sections of sub-roadbed (figure 5). We did make two modified sections since we have switches coming off mid-helix in addition to the top and bottom.

This helix rises 4" per turn. On the 36" radius track, a complete turn is about 18.8', which means a 4" rise is about 1.87% grade. (A 36" radius is a diameter of 72" and $72 \times 3.14 [\pi]$ equals 226" or 18.84 feet.)

STEP 3: Prepare for Assembly

MATERIALS AND TOOLS

ITEM	COMMENTS
Carpenter's glue (yellow not white)	Buy a gallon and save.
Code 100 flex track	I use Atlas. No one will see it once the helix is covered in scenery, so code 100 is fine.
Track nails	I glued down track initially. Do not do this - use track nails instead, and don't press them down too tight. I have had to go back and apply track nails to glued sections that later came up due to expansion.
1/4" lauan plywood	You will have to calculate how much based on how many turns you want in your helix.
1 x 2s	Use these to make the risers. The risers cannot have knots, because of notches that need to be cut in each one. You can see I used 16 risers. If I did this again, I would double it to 32 risers for greater stability.
Plastic trowel with notches	Use this to spread the glue.
Soldering iron	
Solder	
Solder paste	
Rail joiners	
Cork roadbed	
Orbital sander	
Push pins	
Bucket loads of patience	Don't underestimate how much of this you will need.

To start putting this all together, we need to first give it a little thought and planning. My 10-turn helix raises the track elevation by 38". You can make your helix as many turns as you like. My helix raises the trains from 24" to 62" in elevation on the current Grande Pacific Model RR.

If you are going to do a helix this big, keep in mind this thing will be heavy. In my case, I had to go back and reinforce the whole thing to get a level base after it was built, which was tricky – it would have been far easier to make sure I had a good level base to start with. Nothing like 20-20 hindsight.

You will need a lot of materials and a lot of clamps. Figure 6 has the materials list.

First, I made a starter piece as a straight section leading into the first curved piece, so that it makes it to the first 1/16 turn. The next two pieces have to be done at the same time.

Figure 6: List of materials and tools.

STEP 4: Assemble One Tier-Loop At a Time



Figure 7: Able assistant Dave Abramson laminates each tier-loop, leaving the one laminate joint between each tier-loop unglued to allow easy disassembly of each loop later for doing the trackwork. Notice how Dave is offsetting the joints between the two 1/4" laminated layers by about 50%. The result will be a strong 1/2" helix sub-roadbed with no splice plates.

To start assembly of the helix, we laminate one complete circle at a time, but we do not join the individual tier-loop circles just yet. In other words, we leave the overlapping area at the end of each tier and the start of the next unglued end loose – we do not laminate them yet.

But we do keep building up the laminated tiers until we get all 10 levels laminated. It's very important that you leave the laminated joint between each tier unglued!



Figure 7a: We laminate two 1/4" layers of lauan plywood sub-roadbed together using carpenter's glue and clamps to get one 1/2" plywood sandwich. By staggering the joints in the layers, no joint splice plates are necessary.

This allows us to separate each tier-loop circle to easily add the cork roadbed and track. With each of the 10 laminated tier-loops still easy to work with individually, doing the trackwork part is a lot easier than trying to reach into a 4 inch space with your hands and with tools.

STEP 5: Assemble One Tier-Loop At a Time

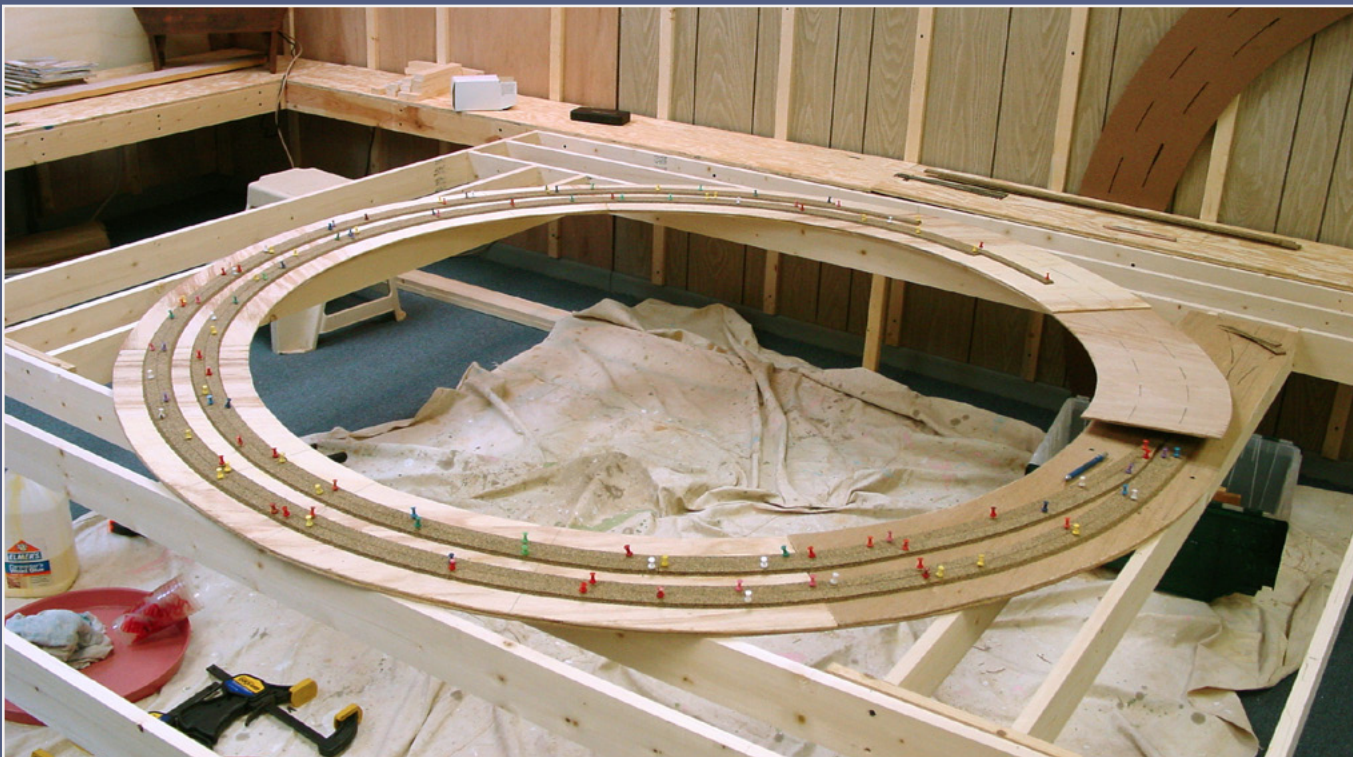

Figure 8: Gluing down the cork roadbed on the bottom tier-loop.

Once all the tier-loops have been laminated (all except one overlap joint between each tier-loop (which we have left unglued for now), we take all the sub-roadbed loops apart and start on the bottom tier-loop with laying the cork roadbed and track. The process goes like this:

1. Glue down the cork on one tier-loop using yellow glue and push pins, and let that dry.
2. Once dry, remove the push pins and use the orbital sander to lightly sand the cork top and joints smooth.
3. Vacuum up the cork mess.
4. Lay the Atlas flex track in place on the cork using push pins to temporarily hold it in place. Fix the track in place using track nails (not glue or caulk). Leave the track nails ever-so-slightly loose. Do not press down too tight, allow the track room to “breathe”.
5. Solder each rail joiner. I pre-solder two pieces of Atlas flex track at a time, and then bend the 6-foot section into place on top of the cork roadbed. This helps eliminate kinks at the joints when done this way. Place the movable rail on the Atlas flex track to the inside. (Or alternatively, you can leave every



Figure 9: Laying the track on the bottom tier-loop. The switch at bottom was removed when I moved the helix to the second Grande Pacific Model RR. Both lines go to staging, one is East Staging and the other is West Staging.

other track rail joint loose [every 6 feet], to allow for the most optimum track contraction and expansion, which is what we recommend. - MRH Ed.)

6. Add the next tier-loop on top of the previous tier-loop, gluing the laminated sub-roadbed joint this time between the two tiers. Taking this approach puts the sub-roadbed track laying out in the open so it's easy to do, laying the track as you work your way up the helix sub-roadbed levels.

It's best to do this work on a solid and level benchwork location where the helix will go permanently. Trying to move an assembled 10-tier helix with all the roadbed and track from one place to another without damage is not easy – do not underestimate how heavy an assembled helix with sub-roadbed, roadbed, and track is!

STEP 5a: Assemble One Tier-Loop At a Time

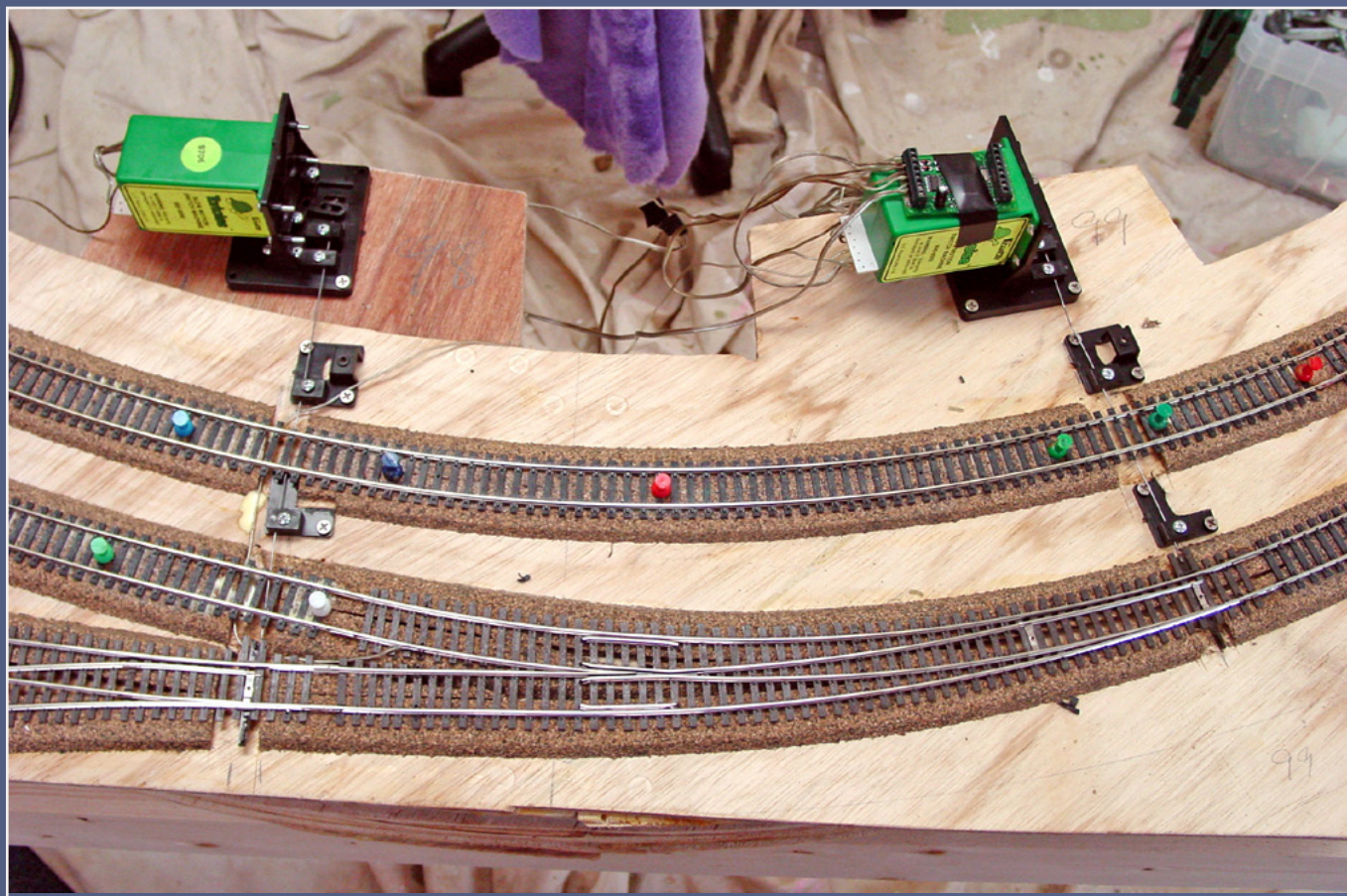

Figure 10: You must side-mount switch machines in a helix, since there's no room under the sub-roadbed for them.

On my helix, I have switches exiting the helix, in this case, off helix tier level 4. I have a switch at 3.5 turns and another at 4 turns that allows trains to enter and exit the outside track of the helix at these points (figure 10).

Keep in mind, you cannot mount a switch machine underneath the track on a helix. I cut some laminate sections with an extension on them to provide a shelf where the switch machine can be mounted.

I use Circuitron's remote mounting kit and I modify it to operate the Tortoise machines off to the side on a shelf. I cut the cable guide into two pieces and use .022" piano wire for throw rods. I run the piano wire under the track by removing a slot in the cork roadbed and I put a short 90° bend in the wire and press it into the hole in point throwbar.



Figure 11: Here you can see how this turnout allows exiting the helix part-way up on the final assembled helix.

In my current operating scheme, these switches are always thrown to the helix route. But the point here is, it's easy to get off or on the helix with a turnout part-way up (figure 11).

STEP 6: Raise the Helix Tiers into Position

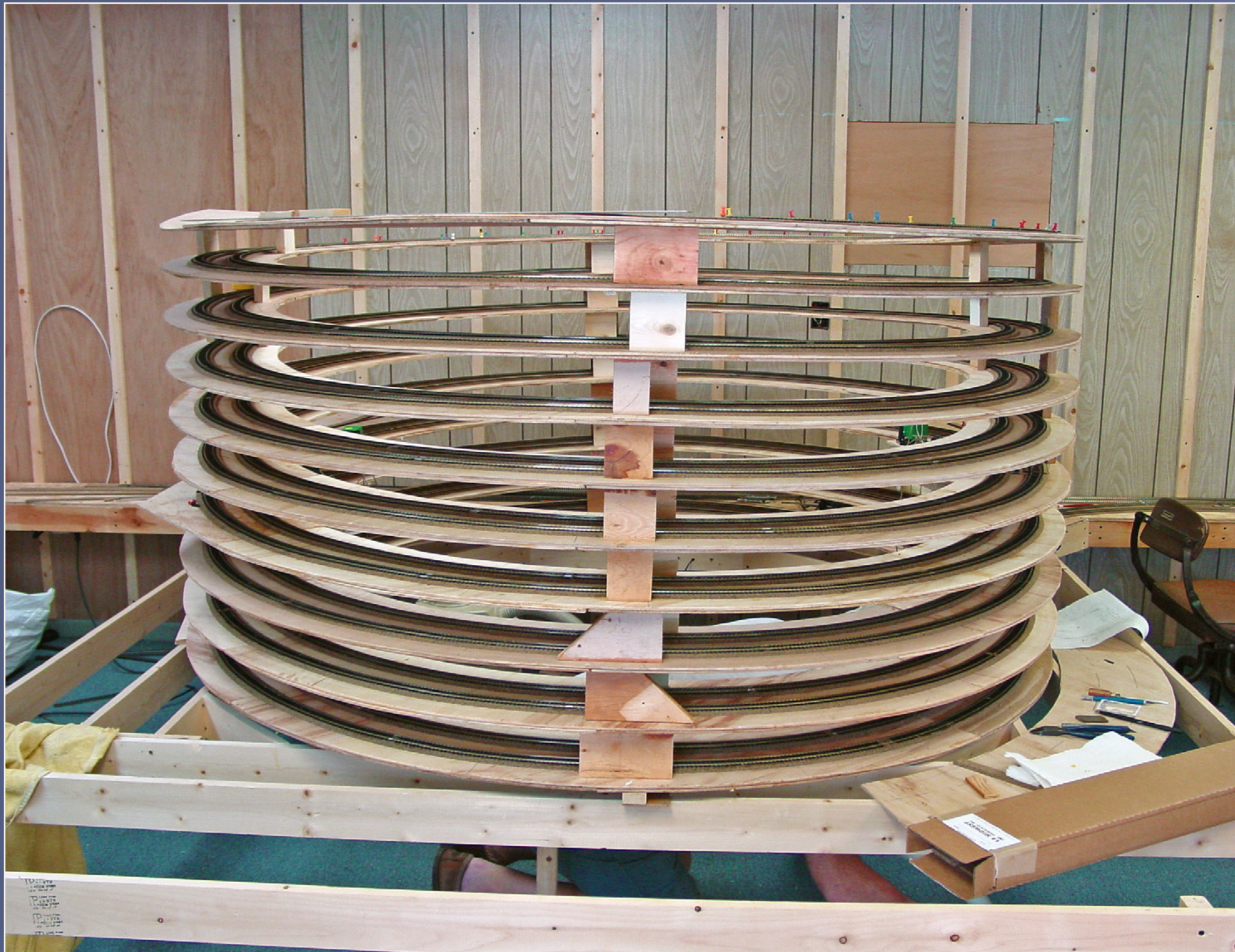

Figure 12: With all the track laid, the helix tiers were temporarily raised into place using scrap 1x4s.

Once all the helix tiers have the track laid on them and have been glued together, it's time to raise the tier-loops into position in preparation for adding the permanent riser supports.

The sub-roadbed starts flush with the top of the benchwork joists. At a quarter of the way around the bottom tier, we added a 1/2" spacer between the bottom sub-roadbed and the top of the benchwork (adding the 1/2" sub-roadbed on top of the spacer makes the total rise equal 1"). Then half way around the bottom tier we added a 1.5" spacer (rise of 2"), then we put a 2.5" spacer at three quarters of the way around (rise of 3"). Finally, at one full turn, we used a scrap of 1 x 4 as a 3.5" spacer, to get the total rise of 4" after one complete circumference of the helix loop.

From there it's just a matter of using 1 x 4 scraps to raise all the tiers into position. Since a 1 x 4 is 3.5" tall, this plus the 1/2" of laminated luan equals a 4" rise, or a grade of 1.87%. We raised the helix with two people, one lifting, starting from bottom and the other person placing the 1 x 4 on edge at each 1/4 turn until we got all the way to the top.

STEP 7: Add the 1x2 Risers

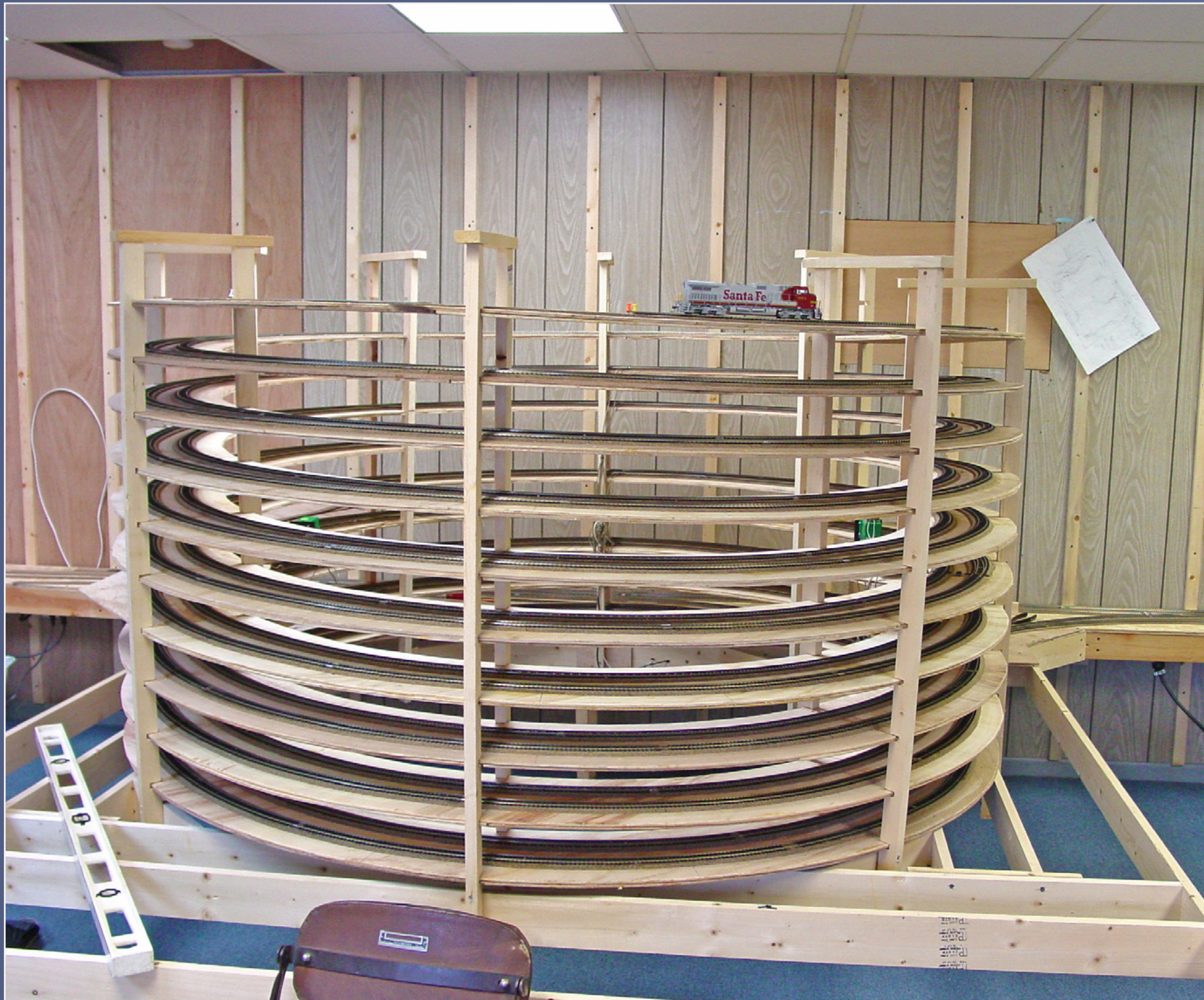

Figure 13: Helix, with all the 1x2 risers added.

With the tier levels raised into position, we added the 1x2 permanent risers to hold the levels in place. We used 16 risers at 8 points around the loop, with an inside and an outside riser at each of the 8 locations. If I were to do this again, I would use 32 risers placed at 16 points around the loop, not 8.

Each riser has 1/2" slots cut 3/4" deep along the wide dimension of the 1x2 (which is halfway through the 1.5" width of the 1x2). We temporarily clamped each riser in place and then marked where each slot would go. All 16 risers were cut at the same time using a radial arm saw.

We did not glue the risers to the lauan, as the sub-roadbed fits snugly into its corresponding 3/4" deep slot. We glued just the top turn into its slot at the top of the riser – this allows for the expansion and contraction of the wood through the seasons. We trimmed the bottom of each riser flush with the benchwork after screwing it into the joist with two 2.5" long dry wall screws (make sure to drill pilot holes to avoid splitting the 1x2 riser).

STEP 8: Integrate the Helix into the Rest of the Layout



Figure 14: Entrance to the bottom of the helix, via a wye. Note the outside track helix exit turnout at tier level 4.

With the helix itself finished, integrate it into the rest of the layout track-work at the top and the bottom, and along any midway points where you exit the helix.



Figure 15: Tier level 4 exit to the middle deck benchwork, with the beginnings of the middle deck taking shape.

STEP 8: Integrate the Helix into the Rest of the Layout *Continued ...*



Figure 16: Here's how I integrated the top of the helix into the upper level on my previous layout.



Art Houston has been surrounded by railroads since birth, because several family members were in the railroad industry. He had his first layout at age 9 and has built over 14 in his life time. He has spent a large amount of time in the hobby developing and promoting operations in the model railroad world.

Art is a graduate of LSU, and is a commissioned officer in the US Army. He also had long fruitful careers in insurance and Phillip Morris USA. He lives in the Houma, LA area, with his wife of 45 years who is still willing to put up with Art playing with trains.

Art is also an NMRA member, and a member of the Mid South Model RR Club. He is currently building the second version of the Central Division of the Grande Pacific Model RR (grandepacificmodelrr.org). Art is always looking for new, or fellow modellers with his interests.

Epilogue: Moving the Grande Pacific RR Helix to a New Home

I moved to a new home and dismantled the original Grande Pacific RR. I kept the helix by removing the risers and bundled the 10 layers as a flat spiral stack of sub-roadbed and track. The helix was stored like this standing on end for over a year. To move it we rolled it around, and once in the layout room, we slid it up onto the new benchwork to get it into place.

When I tried to move the helix, I found out exactly how heavy this thing really is. The central core opening is just over 11 feet across. Once placed on benchwork that's several

feet off the floor, it creates an inner core well over 6 feet high in which you can easily stand.

Similar to the first time we constructed the helix, we installed 1x2 risers and raised the helix into place again.

The fan in figure 18 (next page) forms an important part of air movement in the room. It takes cooler air on floor and throws it up to the ceiling and forces warmer air into the air conditioner.

I built the building housing the new Grande Pacific expressly for a model railroad. The white outlet in figure 18 is for everything but railroad, while the brown outlet is on four separate circuits and is for the railroad only.



Figure 17: I collapsed the helix and added straps to it so we could more easily move it. Here is the helix in its location on the new layout's benchwork.

Figure 19 shows the tracks coming off and on the helix. At this point, you are at yard limits of staging. Track to left is a reverse loop for the bottom level. Where the scenery ends, there will be a backdrop with tunnels. You will not be able to see the helix at some point in the future.

Figure 20 shows the helix in its second home as of October 2010. The layout main line is complete and the helix works great. If you build a helix right the first time, it should almost last you a lifetime. The relocated helix has been turned 180° from its

original orientation, and it has had six switches removed – yet it's still doing what it was built to do over a decade ago! [☑](#)

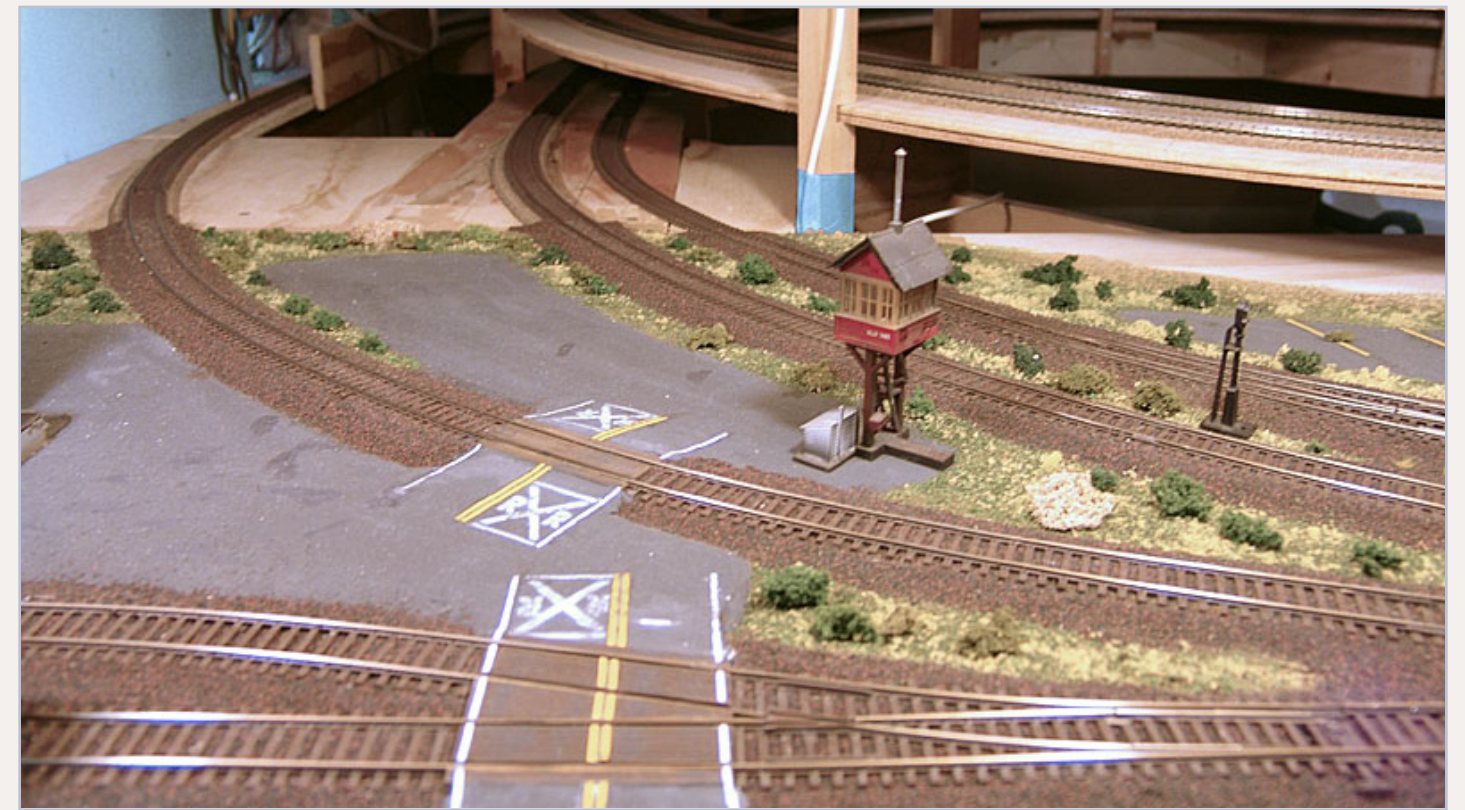

Figure 19: Bottom entry/exit to the helix on the new Grande Pacific RR.

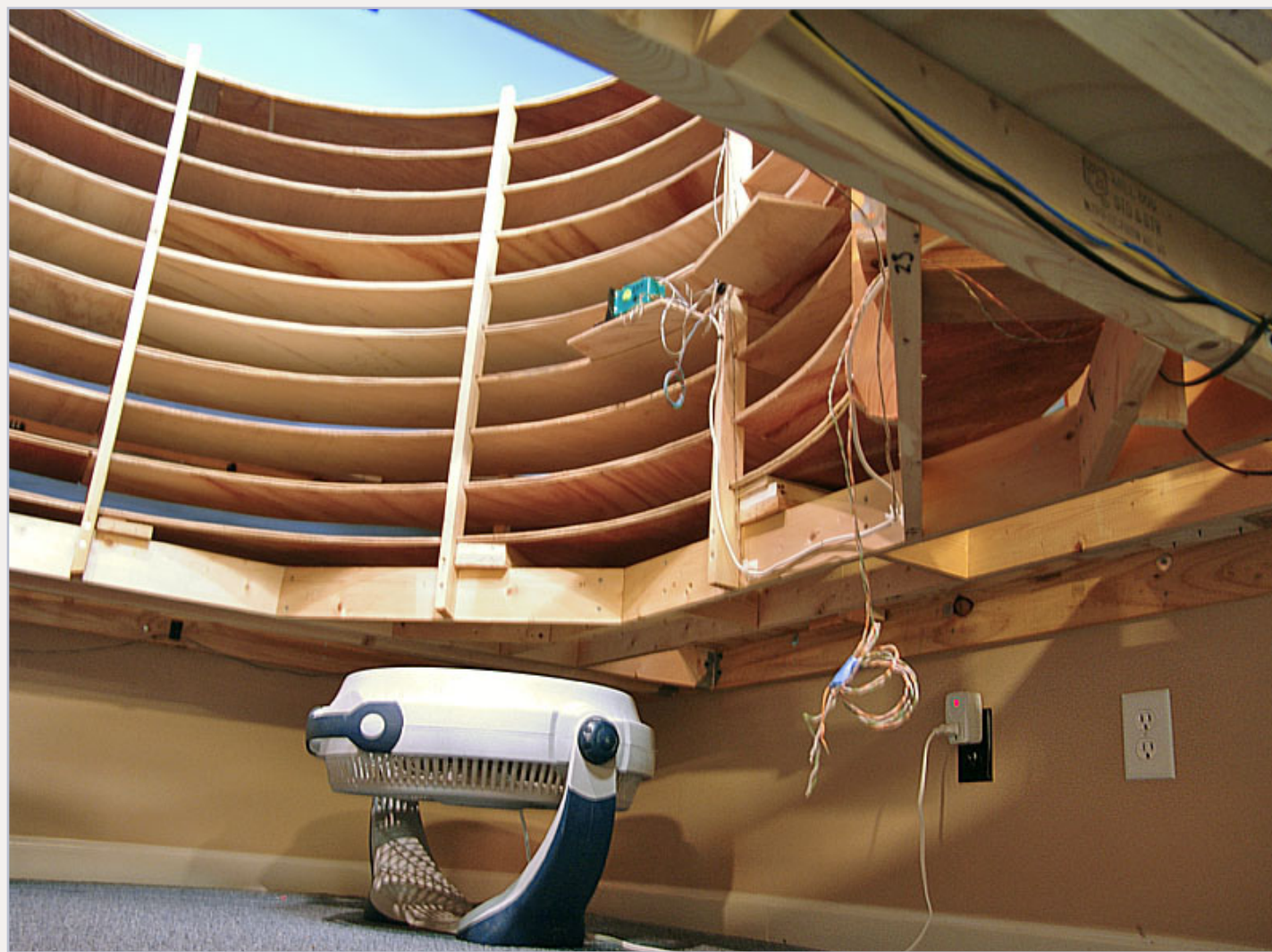

Figure 18: Fan in the center of the helix core for air movement.



Figure 20: The relocated helix in its new home as of October 2010.

eBay[®]

for Model Railroaders



Part 3: Selling — by Joe Fugate



Figure 1: Selling on eBay takes some understanding of how eBay works, so it's best if you first become a somewhat savvy eBay buyer. Parts 1 and 2 of this series taught buying, so now let's learn to sell on eBay!

In part 3, MRH publisher Joe Fugate demonstrates how to sell your model railroading goodies in the world's largest continuous running flea market: eBay!

Selling on eBay takes some understanding of how eBay's specific flavor of auction works if you want to get the best results and to fetch the best price for your wares.

To really understand selling on eBay, you first should learn how to be a savvy eBay buyer. We covered the ins-and-outs of eBay buying in parts 1 and 2 of this series.

Now that you are an experienced eBay buyer, you're ready to move into selling on eBay.

Some have learned eBay well enough they both buy and sell on eBay and make good money doing so. In this article, I'm assuming you aren't wanting to make eBay selling a business venture, but that you're more of a casual seller. Turning eBay into a business is beyond the scope of this article.

Building your eBay rating

If you plan to sell items periodically on eBay, it's important to build a positive rating before you start selling any big ticket items of \$100 or more in price.

That's another reason it's best to start out as a buyer first. You can make a

number of purchases and establish a record of being reliable and trustworthy by paying quickly. After you get a couple dozen purchase transactions under your belt with positive feedback, then you can move on to selling.

It's best to start with a few inexpensive items worth about \$20 or less. That way you can establish your reputation as a trustworthy seller.

Having built up some eBay history with a positive rating, you can move on to selling more expensive items and people will trust you.

It all starts with research

To do well selling on eBay, you need to have a good sense of the value of what you are trying to sell. To know that, you must do some research.

For instance, I have two E&C shops box cars I want to sell. I model the 1980s Southern Pacific and the paint scheme on these cars is from the early 1990s, just before the Southern Pacific sold out to the Union Pacific. So these cars are too new for my railroad.

Before I list these cars on eBay, I research their value by doing some searches on E&C Shops cars others are selling.

I find most E&C Shops kits sell for between \$8 and \$15 (figure 2), so I elect to set the price for my cars at \$10 – actually \$9.99 to keep the price every-so-slightly on the \$8 side of \$10 instead on the \$15 side.

I also note that shipping runs from free to \$7. Shipping tends to be something of a “dance” on eBay.

Some will make the shipping free, but then jack up the asking price of the item, while others will make the price of the item really low, and jack up the shipping in an attempt to make their money on the shipping.

I prefer a middle-of-the-road approach. I like to set the product price to an attractive lower-end price, but charge a moderate amount for shipping. In my case, something less than \$5 but more than \$4 sounds about right to me.

The total cost of most E&C items being sold comes to \$14-\$15 dollars with shipping, so I’m right in the middle with a \$9.99 price and say \$4.50 for shipping. Plus psychologically, \$9.99 as the item price looks better than \$10+.

Once you get savvy to selling on eBay, you realize setting your item price can involve something of a strategy. You want to fetch a decent price for your items without either overcharging people or giving things away for nothing.

Another important key to selling on eBay is to take good quality photos of the items you wish to sell.

Top priority: good photos

If the item you’re selling looks attractive, you’ll typically fetch a nice price for it, which just makes good sense.

The screenshot shows an eBay search results page for 'E&C' model trains. The search bar contains 'E&C' and 'HO Scale'. The results are sorted by 'All items'. The table below shows the following items:

Item Name	Price	Shipping	Time Left
E&C SHOPS HO 50' PS-1 BOXCAR (SANTA FE)# 11475	\$7.99	+\$7.00 shipping	1d 22h 35m
HO E&C Shops PS-1SD Boxcar ATSF Red Oxide # 11441 NIB	\$14.99	Free shipping	14d 18h 32m
HO E&C SHOPS Kit # 0210-4 50' PS-1SD Boxcar BN # 318999	\$14.99	Free shipping	19d 15h 21m
HO E&C 50' PS-1 Boxcar KIT NEW HAVEN # 40501	\$11.00	+\$4.00 shipping	7d 15h 36m
LBF-E&C HO WC-Wisconsin Central 52' Mill Gondola KIT	\$11.99	+\$3.75 shipping	18d 16h 13m

Figure 2: To set my asking price for the E&C Shops cars I want to sell on eBay, I first search for other E&C Shops cars and see what they’re selling for. Most are selling for \$8-15, and I’m interested in a quick sell, so I set my price at the lower end – \$10. Actually, I make the price \$9.99 for the psychological benefit of being under \$10. I also note shipping runs from free to \$7, but the free shipping items have the higher prices (the seller just bundled the shipping into their asking price). I elect for something in the \$4 - \$5 range as reasonable, given my bargain basement product price.

That means you need a decent digital camera and some basic photography skills. If you can take a reasonably nice photo of the item you wish to sell, you should do well selling it on eBay.

It's also important to be as honest as possible about the item you're trying to sell. If it has a defect, be up front about the defect and include a clear photo of the defect.

As long as you're honest about sharing and showing the defect and adjust the price accordingly, you will still find modelers interested in the item – and you may even have a bidding war if more than one person wants the item, defect and all!

Protographing my boxcars

To prepare for listing my E&C box cars, I take some good digital photos of them. The kit boxes have some wear on them, and they also have a few drops of gray scenery paint from having been stored under the layout.

I take two photos of the kits. First, I take a photo of the kit boxes so eBayers can see the box wear – I don't want any secrets here (figure 3).

I also open up one of the kits and lay all the contents out and photograph that for people to see. I want to demonstrate the kit itself is in pristine shape (figure 4).

I try to think in terms of what I'd like to see if I were at a swap meet and was in-



Figure 3: Full disclosure on eBay is important, so when I took the photo of the kit box, I wanted people to see the box show some wear. But the contents inside the box are in great condition, which is why I also wanted to take the photo in figure 4, below.



Figure 4: At a swap meet, I'd want to take any kit I'm thinking of purchasing and look inside. It's no different on eBay. That's why I laid out the contents of one of the kits out and took this photo. This makes it abundantly clear to any potential buyer what they're getting for their money. Such photos helps any eBay sale go smoothly and fetch a good price!

terested in this kit. I'd want to open up the box and examine the contents.

I mount the camera on a tripod and make sure the photos are well lit and in focus. I snap the images and pull them into Photoshop for some quick adjustments to make them look their best.

Avoid retouching the photos. You want people to see the items just as they are, not as some highly air-brushed distortion of reality.

Finally, I downsize the photos from their massive 14 megapixel size to something reasonable like 1900 x 1200 or so using save for web inside Photoshop.

Once I have my item photos, I'm ready to set up my eBay listing.

Setting up my listing

To set up my listing, I log into the eBay site and at the top right click the menu entry **Sell > Sell an item**.

I'm first asked to determine the category for the item, so I type in **HO Southern Pacific SP boxcar** – and eBay recommends a list of categories to choose from (see figure 5).

I select:

Model RR, Trains > HO Scale > Other

The other categories are vendor-specific, like Bachmann and Athearn. E&C Shops is too small of a vendor to have their own category, so **Other** is the best choice in this case.

Continued on page 78 ...

Find a matching category

Enter a UPC, ISBN, or keywords that describe your item.
HO Southern Pacific SP boxcar

For example: Transformers action figure

Buyers will see your listing in the category that you select.

Toys & Hobbies

- Model RR, Trains > HO Scale > Other
- Model RR, Trains > HO Scale > Bachmann
- Model RR, Trains > HO Scale > Accurail
- Model RR, Trains > HO Scale > Roundhouse
- Model RR, Trains > HO Scale > Athearn
- Model RR, Trains > O Scale > Lionel > 1987-Now
- Model RR, Trains > HO Scale > Atlas
- Model RR, Trains > HO Scale > Intermountain

Tip: Reach more buyers by selecting two categories. (Fees apply)

Categories you have selected

- Toys & Hobbies > Model RR, Trains > HO Scale > Other | [See sample listings](#) | [Remove](#)

Figure 5: eBay makes it easy to establish the category for your listing. The listing process starts with this panel asking you to enter some key words about your item. Based on what you type, eBay suggests the likely categories for you. E&C Shops is too small of a vendor to have its own category like Athearn or Bachmann do, so I select the *Other* category from eBay's list of recommended choices.

Helpful eBay links

Set up a favorites folder marked eBay and place these links in it for easy and quick reference.

- Advanced search page:
pages.eBay.com/search/items/search_adv.html
- Search eBay stores:
pages.eBay.com/search/items/search_stores.html
- Announcements and news:
announcements.ebay.com
- Discussion boards:
pages.eBay.com/community/boards/index.html
- Leave feedback:
pages.ebay.com/services/forum/feedback.html
- Rules and policies:
pages.ebay.com/help/policies/overview.html
- End my listing:
pages.ebay.com/help/sell/end_early.html
- eBay fees:
pages.ebay.com/help/sell/fees.html
- eBay Answer Center:
contact.ebay.com/ws/eBayISAPI.dll?CustomerSupport
- 77 tips to selling on eBay:
skipmcgrath.com/auction_sr/77-tips-tools-selling-ebay.shtml
- Auction hints and tips newsletter:
AuctionBytes.com
- Insider secrets to selling on eBay:
reviews.cnet.com/4520-10165_7-5674079-1.html
- Buying on eBay quick tips:
ebay.about.com/od/buyingeffectivel1/qt/be_ataglace.htm

Help buyers find your item with a great title [Get help](#)

* Title ?
HO modern boxcar Southern Pacific SP E&C Shops

Subtitle (\$0.50) ?
[Empty field]

Condition ?
New

◀ Figure 6: The key to a good title is to think “search terms”. I started with the phrase you see here, and then later changed it to “HO boxcar 50’ Southern Pacific SP 286022 E&C Shops” to distinguish it from my other listing of road number 286028. If people search for “boxcar”, “E&C”, “SP”, or “Southern Pacific”, they’ll get a hit with this title.

Bring your item to life

The first picture is free. ?

Add pictures | Remove

1

1. IMG_3954.jpg (1180 kb) [Remove]

For the best quality, use pictures that are more than 1000 pixels in height or width.

Selected: 1 | Available: 11

Select optional picture upgrades

Gallery Plus (\$0.35) ?
 Display large pictures in search results — capture special details or different views for buyers.

Picture Pack (\$0.75 for up to 6 pictures or \$1.00 for 7 to 12 pictures)
 Includes extra pictures and enhanced picture options on your listing page ?

Upload Cancel

Describe the item you are selling

Standard HTML

Arial 10

E&C Shops Southern Pacific
kit is new, although the box
only for one car, road num

Figure 7: eBay makes it easy to upload any number of photos of the item(s) you’re selling. Generally at least two images of the item are advised. The first image is free, and each additional image costs 15 cents. I also opted to go with Gallery Plus for another 35 cents, since that allows people to display the pictures in a larger format, which helps sales.

... continued from page 76

I then get two options for entering a listing: **More listing choices**, or **Keep it simple**. I select More listing choices (see figure 8).

The info eBay wants includes:

- **Title:** *HO modern boxcar Southern Pacific SP E&C Shops* (I later changed this slightly, see figure 6).
- **Condition:** *New*
Used was my other option, and this is a new unassembled kit, so *New* it is, even though the box is a bit worn.
- **Grading:** *C9 Factory New - Brand New*
eBay provides a 1-10 grading system for item quality, and C-9 fits this item the best since it is new, although not in mint condition because of the box wear (see figure 9).
- **Photos:** See figure 7.
- **Description:** See figure 10.
- **Listing designer:** *Default style*.
- **Visitor counter:** *Basic style* (default).
- **Starting price:** *\$0.99*
- **Buy it now price:** *\$9.99*
- **Duration:** *3 days* (default is 7 days).
In this case, I wanted to sell the items fairly quickly.
- **Payment type:** *Paypal* (default).
- **Return policy:** *Allow returns for up to 7 days after the buyer receives the item*.

Figure 8: You can choose between two listing options with eBay – I prefer the *More listing choices* option since that gives me more control over the look of the listing.

Figure 9: Grading allows you some fine-grained categorizing of your item quality. For these E&C Shops kits, I selected *C-9 Factory New* since the kits are new and in pristine shape. I didn't select *C-10 Mint* since the boxes are worn, although the kit contents are brand new.

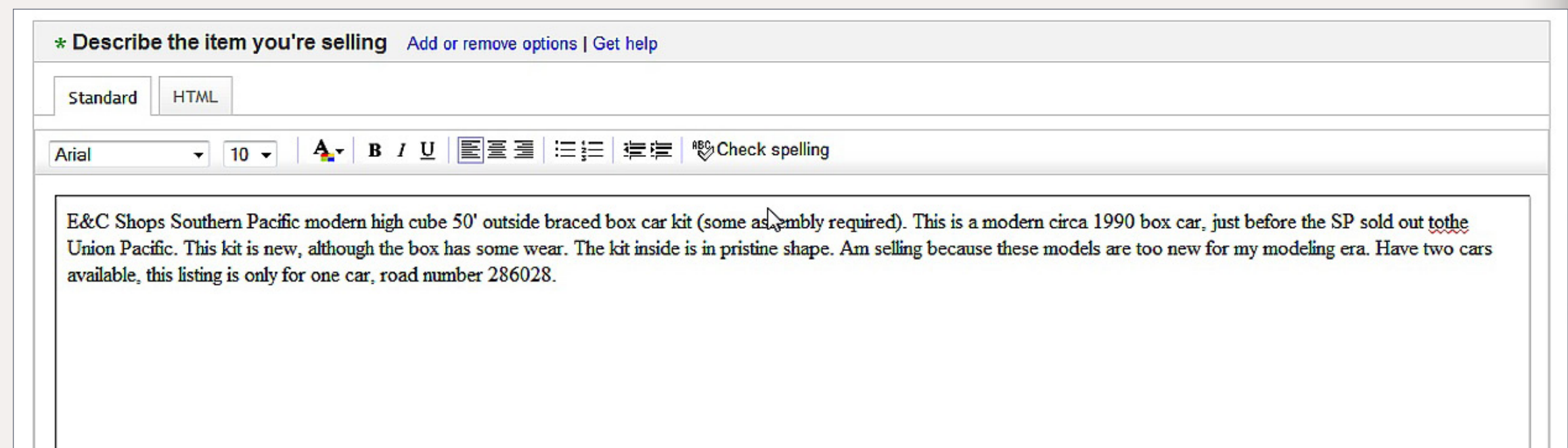
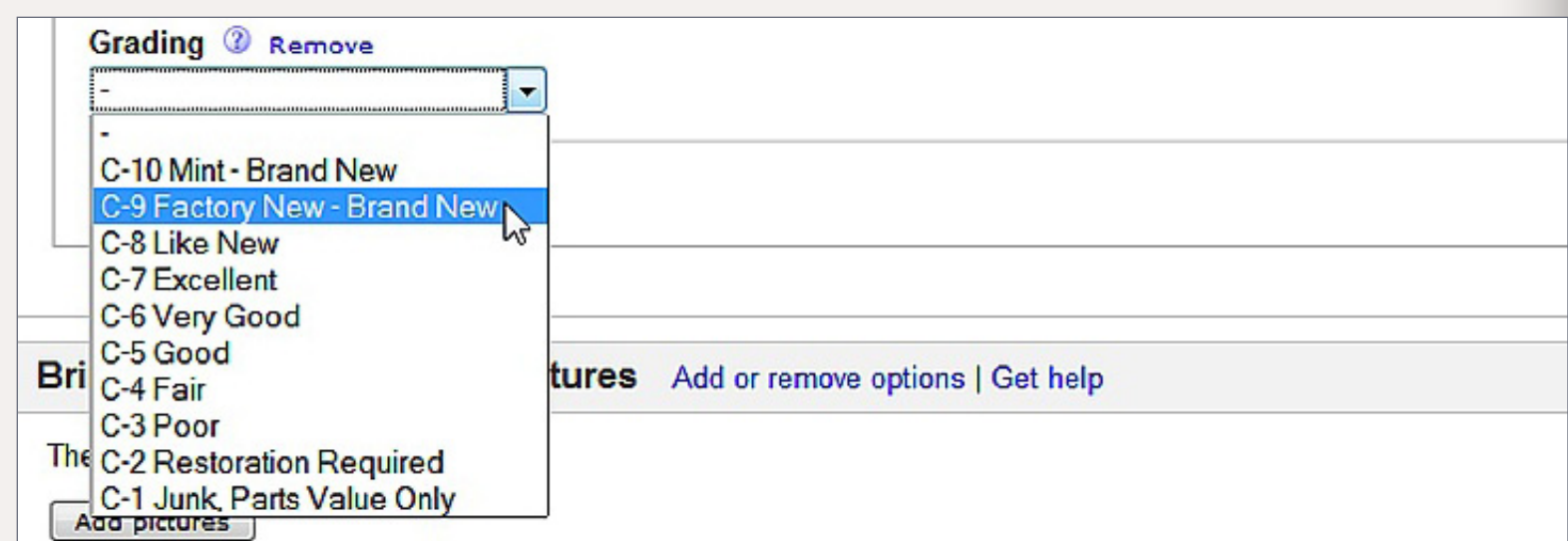
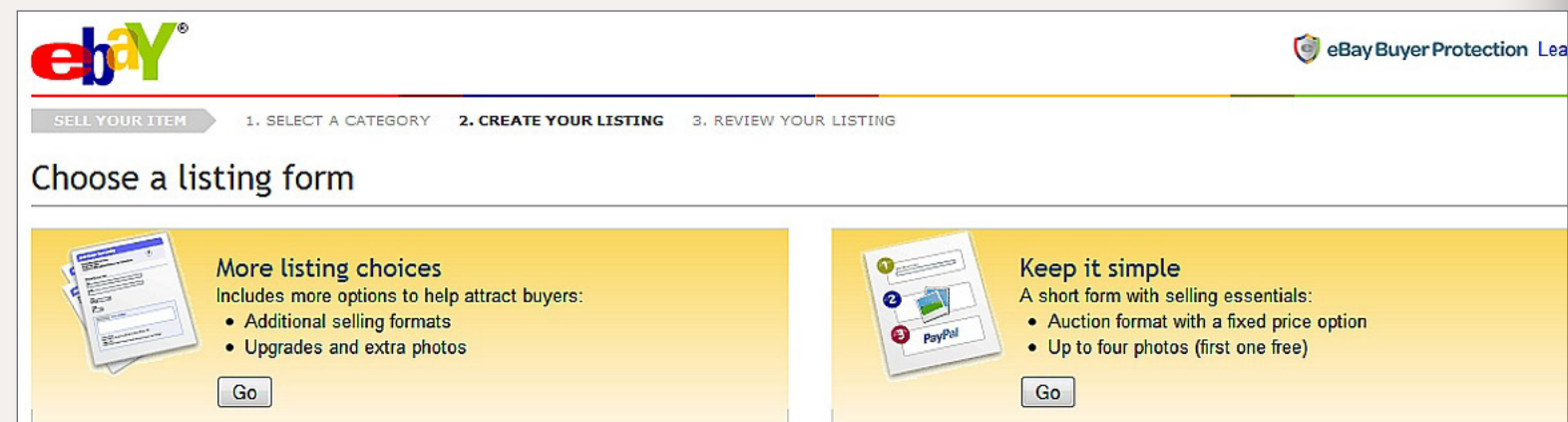

Figure 10: Here's the description I entered for each of these E&C Shops box cars. It's important to describe the item clearly and to point out any flaws such as the box wear. It also helps give potential buyers more confidence if you can explain a sensible reason why you're selling the item(s). Since I have two very similar listings, I also wanted to minimize confusion by clearly specifying the road number on each car.

■ **Refund policy:** *Money back, buyer pays return shipping.*

At this point, the eBay listing costs me 15 cents. I review the mockup of my listing and opt for the **Gallery Plus** option, which provides larger images of the item for an additional fee of 35 cents. I pass (don't select) any of the other listing enhancement options.

My listing costs me a total of 50 cents. I check the box that says, **Save this listing as a template use it to sell similar items**. Finally, I click the **List your item** button to submit my listing to eBay.

I use the sell a similar item link to create the second listing for the other kit I have, road number 286022.

Reviewing the listings

Once I've created both listings, I go review them using the **My eBay** menu on the upper right and select **Selling**.

I can see both entries, and I can easily track views, how many people added the listing to their watch list, and any bids placed.

Now, I just wait for the auction to run its course and see how it does!

Auction outcome

So how did my auction do?

I got one question asking if I would do combined shipping, to which I said, "Yes, \$6 if you buy them both."

No one took me up on the Buy it now option, so the sale of both items became a bidding war. Once the dust settled, I sold both cars to one person for \$7 and \$7, and shipping of \$6.

Actual shipping costs were \$5.50 and eBay charged me 50 cents, so I made \$14 from cars that were otherwise just gathering dust in my stash! ☑

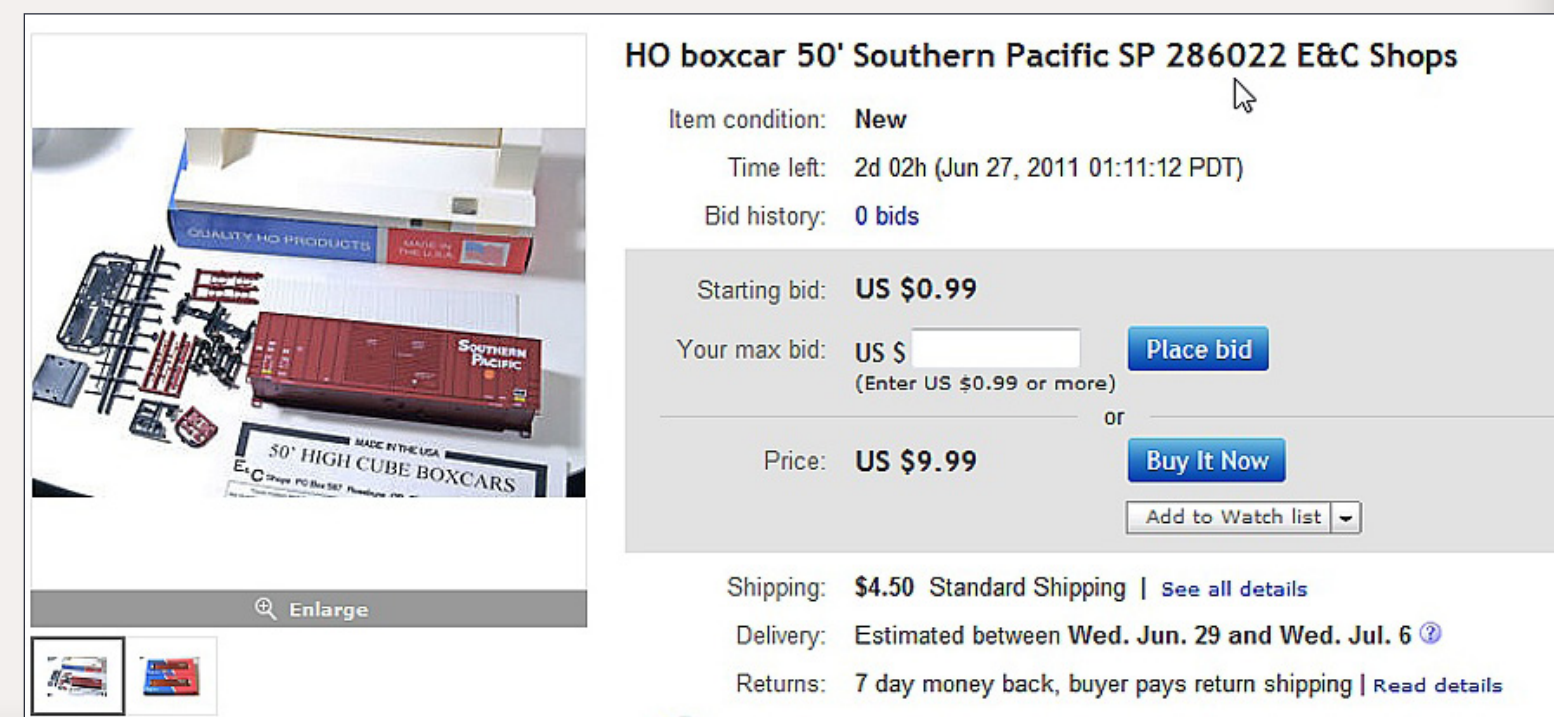
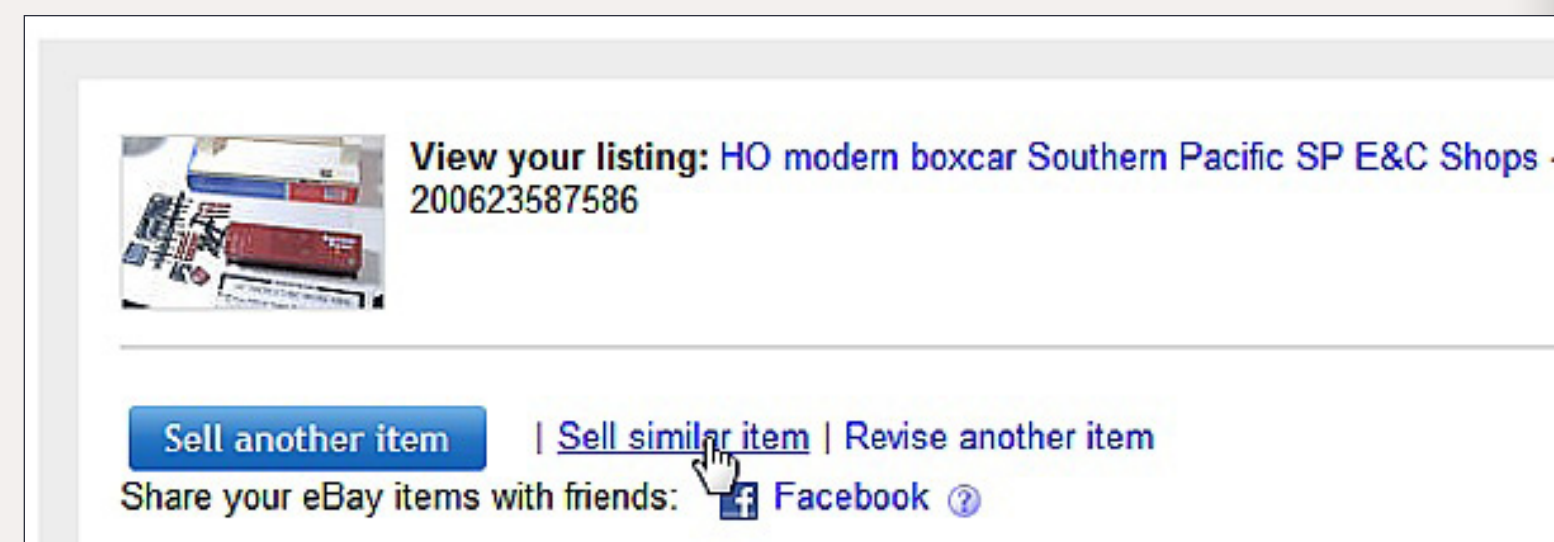

Figure 11: I use the Sell similar item link on my first listing confirmation page to easily enter the listing for my other almost identical E&C box car. This made quick work of listing the second road number, 286022.

Figure 12: Here's how my final listing looks on eBay for road number 286022. The listing for road number 286028 looks virtually identical. If no one takes advantage of the Buy it now option and instead opts to bid on the item, the Buy it now option will disappear and the item reverts to an ordinary auction.



Video won't play? [Click here to play it on YouTube.](#)



A-Line Car Weighting System



– by Charlie Comstock

You've got a new flat car and it looks great. But to your dismay it doesn't always stay on the track. The wheels are in gauge and pivot properly. The couplers are the right height. What's going on here? What about weight? The NMRA recommended practice 20.1 says HO cars should weigh 1 oz. + 1/2 oz. per inch of length. The car is about 8" long so it should weigh about 5 oz. Out comes your postal scale – Whoops! It only weighs 2.5 ounces. Could that be the issue?

Consistently weighted cars are good for operations, especially if you like long trains. A fly-weight car near the head of a 40 car train is likely to have problems staying on the track particularly through tight curves and turnouts.

A-Line, a division of Proto Power West, offers lead in several styles: sheet, pourable, and self-stick weights pre-cut into 1/4 or 1/2 ounce segments.

Adding extra weight to that flat car is a good application for sheet lead. Turn the car over, cut sheet lead to size and glue it between the underbody ribs.

It's easy to add weight to a reefer or boxcar. If you can get inside it, use the self-stick weights (Figure 3) sticking them to the car floor. Otherwise add sheet lead under the car bottom.

A covered hopper is a little tougher. Try pouring the 5/64" lead shot into the car and securing it with white glue. If the car top is already glued in place, drill a small hole in an unobtrusive location in the bottom of the car, pour in the lead, then plug the hole with a bit of styrene or possibly some Squadron White putty. This method also works for tank cars. Some modelers reportedly don't even bother gluing the weights and just let gravity distribute the weight across the bottom of the car.

An open hopper is another problem car when it comes to adding additional weight. If you can disassemble the car or if you're building it yourself, try putting sheet lead in the sloping end plates.



Reader Feedback
(click here)

CAUTION!

Lead is poisonous and will do bad things to you if ingested! ALWAYS wash your hands thoroughly after coming in contact with lead! See a doctor immediately if ingested. Don't leave lead where children or pets can find it.



Different styles of A-Line lead weighting products. Check out the A-Line web site at ppw-aline.com



AUX-BOX DCC Appliance - An Unusual Name for a Useful Device



– by Jeff Shultz

The AUX-BOX, from the MRH Sponsoring Advertiser TrainTek, brings DCC control of your railroad to a new level. At its most basic, the AUX-BOX is a set of 8 programmable, 30V/3 Amp-capable on-off switches controlled through your DCC system, done in the same manner as a stationary decoder. With the AUX-BOX, you can throw turnouts, turn on and off lights and animation, control track power, and do just about anything else that can be controlled by an on-off switch – and even more.

The AUX-BOX is connected to the DCC Power Bus for control, and is programmed and controlled as an accessory through your DCC system. The AUX-BOX supports accessory/stationary DCC addresses between 1-2044, and uses 12 addresses. You can set the first address and the AUX-BOX will automatically fill in the next 11. If you don't want them in order

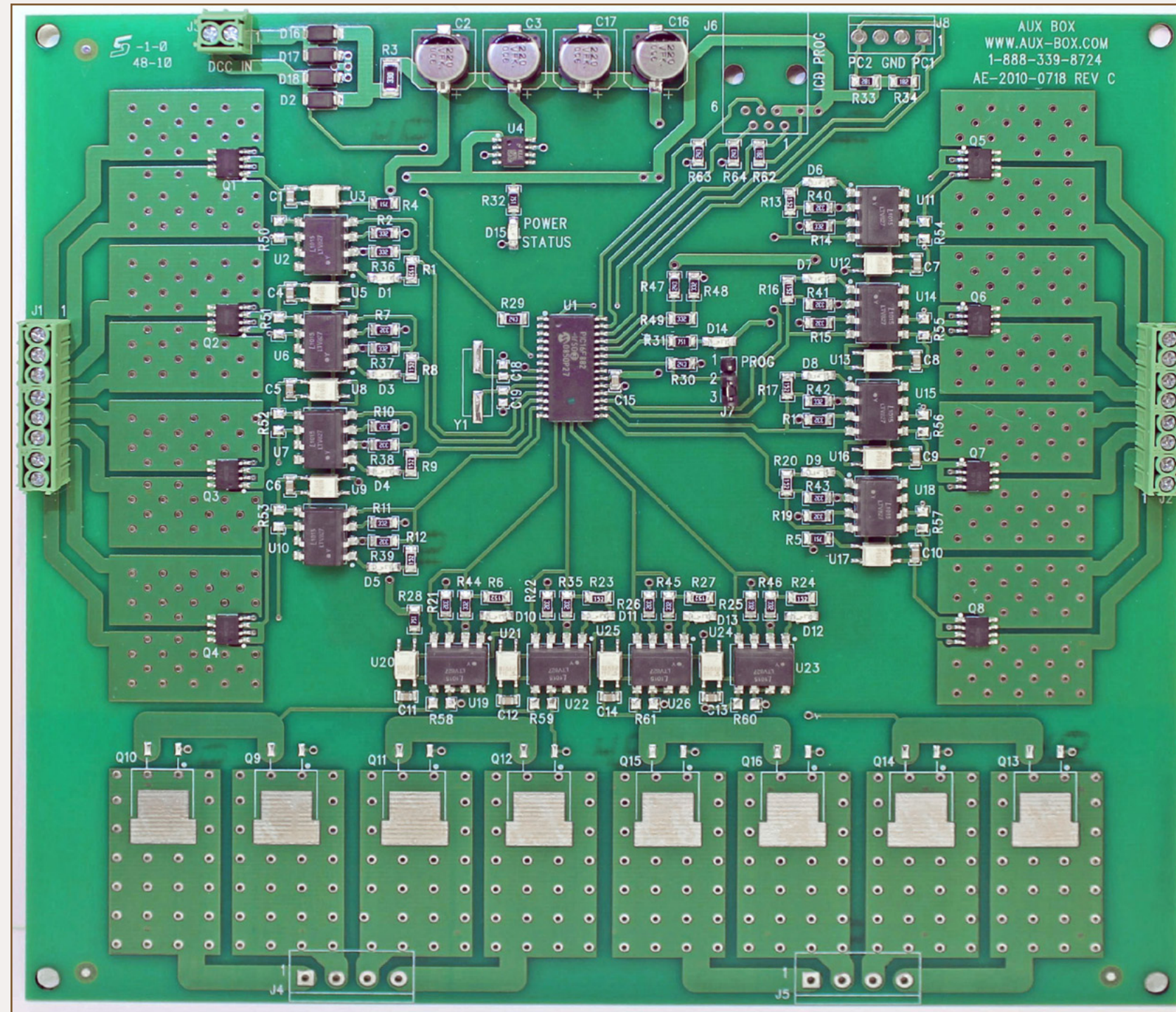

Figure 1: The Aux-Box circuit board.

like that you can set them separately as well. The system currently has 8 switches, with the additional 4 addresses for future expansion – according to the documentation there are provisions for four additional 8- Amp switches. All switches can run completely independent systems

with different power inputs – the switches are optically-isolated from the DCC controller to prevent short-circuits through the AUX-BOX. The AUX-BOX documentation notes that it provides no circuit breaker protection, so if it is set up to turn track power on and off, you should have a separate circuit breaker device. Several are recommended, including the EB Series Circuit Breakers from MRH Sponsoring advertiser NCE, the Digitrax PM42 Power Management System, and DCC Specialties PSX Series Intelligent Circuit Breakers.

What sets the AUX-BOX apart from simple toggle switches is that as a DCC device it's programmable. You can use each switch independently as a SPST device or group them into more complex switches – using all 8 switches together you can create a 4PDT switch, such as would be used to create an isolated programming track on a section of track on a layout. Switches can be set to “reverse”, where the

switch will open in response to a close command, and vice versa. This is used to create DPDT and 4PDT switches, where one side will be on when the other is off. You can also set switches to flash – like a strobe, or combine two switches to flash alternately – like a crossing signal. The flash rate can be modified through values in their CVs.

“With the AUX-BOX, you can throw turnouts, turn on and off lights and animation, control track power, and do just about anything else that can be controlled by an on-off switch – and even more.”

The AUX-BOX also includes connections for two photocells (not included) to automatically control switches – the photocells replace the DCC address for the switch or switches they are assigned to. The inputs are self adjusting – no calibration for ambient light conditions needs to be made. The documentation describes using this feature to turn on a carnival display when someone walks near it. In a similar fashion I’m looking at

using it to turn on an amusement park railroad (Z scale on my HO scale layout) with a fixed voltage transformer.

The AUX-BOX can be used to control powered turnouts, both with power direction and controlling a turnout motor. Because different types of turnout motors have different requirements in power, the AUX-BOX switches can also be set to turn on for a specific amount of time, in seconds (between 1 and 255). Controlling multiple yard tracks in this manner can also be done by a dispatcher using JMRI’s Panel Pro on a PC attached to the DCC Controller.

The AUX-BOX is 7.45” W x 6.75”H (189.23mm x 171.45mm) in size and comes with a one year warranty. It retails for \$119.95.

It’s available at the AUX-BOX website: auxboxdcc.com 

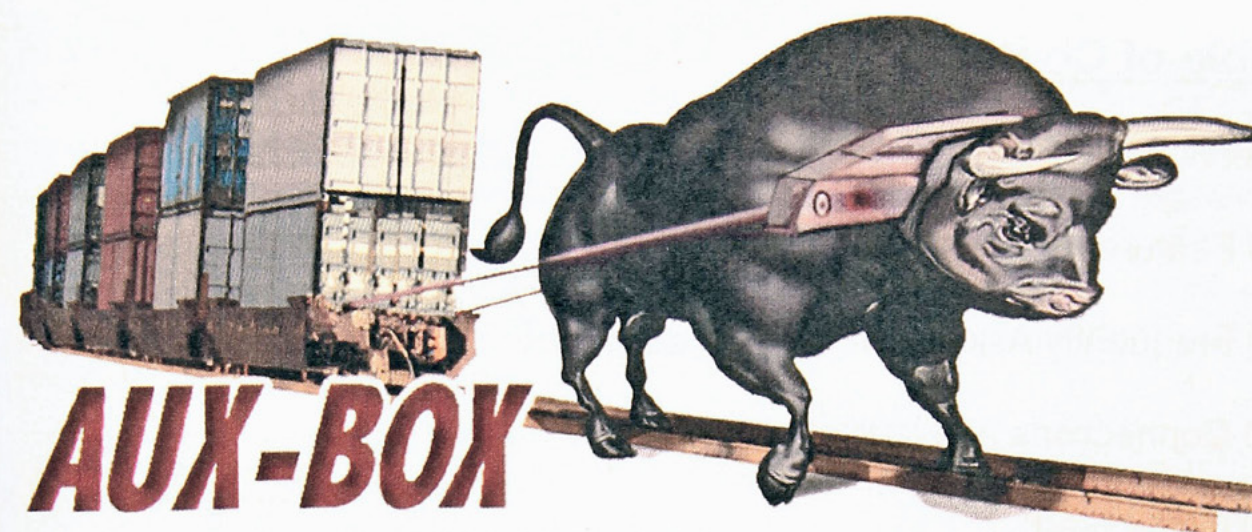

Now you can turn anything on or off with your DCC throttle, just like you’ve always wanted!

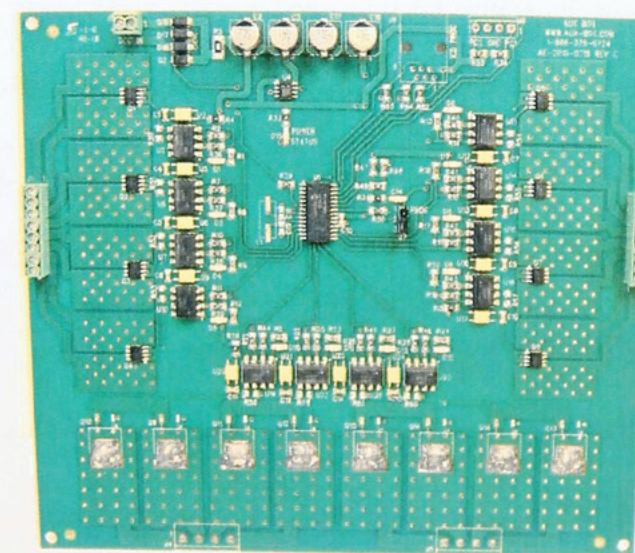

AUX-BOX DCC Appliance™

User’ Guide

Figure 2: The Aux-Box includes a 28-page User’s Guide.



About our narrow gauge and branchline columnist



Lew Matt is a published writer, photographer, and illustrator whose work has appeared in many model railroad hobby magazines.

[Click here](#) to learn more about Lew.



THE LITE AND NARROW: Mortenson's Fish Market Ramblings on Narrow Gauge and Branchline Modeling

Kevin Hunter, mastermind of Berrett Hill Models, (berretthill.com) and one of the movers and shakers of the MAD Module group's scenic Free-mo layout, scratchbuilt an excellent waterside module with an interesting O scale building for his wharf scene, Mortenson's Fish Market. This building is modeled after a typical Eastern Shore or New England, small fishmonger complex found along the coastline from Maine to South Carolina. Kevin named the building for Geren Mortenson, a pillar of the MAD Module community (and a

feisty Norwegian sea dog - but that is another story).

Fishmongers, merchants who buy the fisherman's catch and merchandise it to the population, dominated the fresh fish market in most areas along the east coast of the U.S. for centuries. It has only been a few decades since the last of these colorful entrepreneurs have disappeared from the mainstream food chain. Independent fishmongers are now likely to be found only in smaller communities.

Figure 1: Mortenson's Fish Market and Wharf is a busy place, as the workers put the finishing touches on the new building while trying to get fish orders together for a rail shipment to Baltimore.



The building was constructed from .040 styrene board, overlaid with cardstock that was computer printed with shingles. Kevin used 3M spray adhesive to attach the cardstock to the styrene.

A humidity problem developed: when the paper gets moist, it swells and bubbles or wrinkles appear on the surface. When the paper dries out, everything flattens out again. Kevin's next building will be made from foam core with the cardstock glued on with PVA. This structure may prove to be more compatible with the cardstock

under humid conditions. The windows are Tichy creations, let into the walls. The same shingles were used on the removable roof.

The interior walls are fully detailed, and will eventually be lighted and detailed as a wholesale fish market with lots of wooden crates to hold iced fish for shipping, a counter to display the iced fish for sale, and people busy rushing about moving crates, selling their catch and bidding on quantities of fish for restaurants and grocery store fish counters. Of course, around Chesapeake Bay, a raw oyster



Figure 3: The front of the building is on the north side, facing the wharf. The boss is discussing a fish delivery with a local fisherman, while a worker hauls ice to the waiting railroad car. Looks like someone dumped some ice on the deck, probably from the new fish cart.



Figure 2: The paint is just drying on the Tichy windows as we look at the south side of the building. If you look carefully, you can see through the building as the interior hasn't been fitted yet.

bar is a prerequisite to doing any seafood business.

While Kevin is busy accumulating and fashioning those many small details that evoke the atmosphere, spirit and pace of the fishmonger's business and building, I built a fish cart as one of the major details to support the scene. The cart presented here is the laser kit manufactured by Train Troll (traintroll.com).

In many Northeastern localities, fish carts were used to transport ice and fish from the boats to the fishmonger's place of business where the fish would be butchered, iced and packed for rail or truck delivery to a retailer's store.

The ice is made from poly beads used to fill stuffed toy animals. I tried cutting the pieces smaller to better represent crushed ice, but the poly pellets seem to be able to absorb all the impact from tools and retain their shape. So far, a blender, used dry and wet; a food processor, meat grinder and a Xuron cutter have proved ineffective.

The fish are modeled using the heavy aluminum that wraps Kraft cream cheese, cleaned in lacquer thinner, inked with colored Sharpie and Pantone indelible pens, then washed with thinner to blend the colors.

Manicule scissors are used to cut out the shapes of the different fish. (More on this later!)

Kevin used lots of wooden coffee stirrers to fashion the deck of the wharf area. The boards were hot-glued onto the scale timber framework to give the wharf some flexibility to endure the bumps and shakes from traveling around for display by the

MAD Module group. The ground cover is typical of the MAD Module ground cover.



Figure 4: There is a lot of activity at the main doors as the workers begin to install the interior details, while a carpenter fastens the last of the paper shingles to the styrene walls. It takes a lot of coffee stirrers and BBQ skewers to make the wharf and pilings for Mortenson's Fish Market.

Building a Fish Cart for Mortenson's Fish Market



Figure 5: The finished Train Troll fish cart really adds to the scene at Mortenson's Fish Market. The ice is made from poly beads used for stuffing kid's toy animals.

I saw the ad for the Train Troll (traintroll.com) fish cart about the same time I saw the almost completed Mortenson Fish Market, built by Kevin Hunter. I decided this was a great detail for the fish market and sent off for one to try.

The kit comes in a sealed plastic sleeve with the directions and sheets of thin wood with the parts neatly laser cut. The directions are adequate and I was able to follow them and wind up with a completed model. I used Elmer's white glue

for the entire project. I would recommend some additional bits of information to make a better model.

Use a light gray alcohol-based dye to stain the wood parts while they are still connected to the sheets of thin wood. All of the parts that represent iron were stained with a reddish brown dye. The four pieces used for the iron rim of the wheels are the exception. I stained those black and later, after the piece was assembled, touched them up with a black Sharpie

pen. The brass axle and handle were soaked in "Blacken It" until they were a nice, very dark brown-black color, then set aside until they were needed.

The side and end support pieces were assembled while the sides and ends were still attached to the boards. The instructions call for using the small tick marks engraved on the sides and ends to align the supports. My failing eyes required me to extend those tick marks all the way across the sides and ends and out onto the wood around these pieces so I could see them better.

The Exacto #11 blade is too thick to effectively cut the small connecting pieces holding the parts to the sheet, so I used a single edge industrial razor blade to detach all the parts. The

thin, sharp blade made clean work of the separation with no chance of splitting the wood. A single swipe with a fingernail file cleaned off any remains of the attachment point.

The brass wheel axle and handle were pushed through their respective pieces to size the holes while those pieces were still attached to the board. The additional board around the piece helped to keep things from breaking. I positioned the back of the holes in the cart's handles over a small washer and pushed the brass pins straight down through the hole. The washer kept a good solid backing behind the small cross section of wood, so the piece didn't crack. This method results in a perfect

Continued on page 88 ...

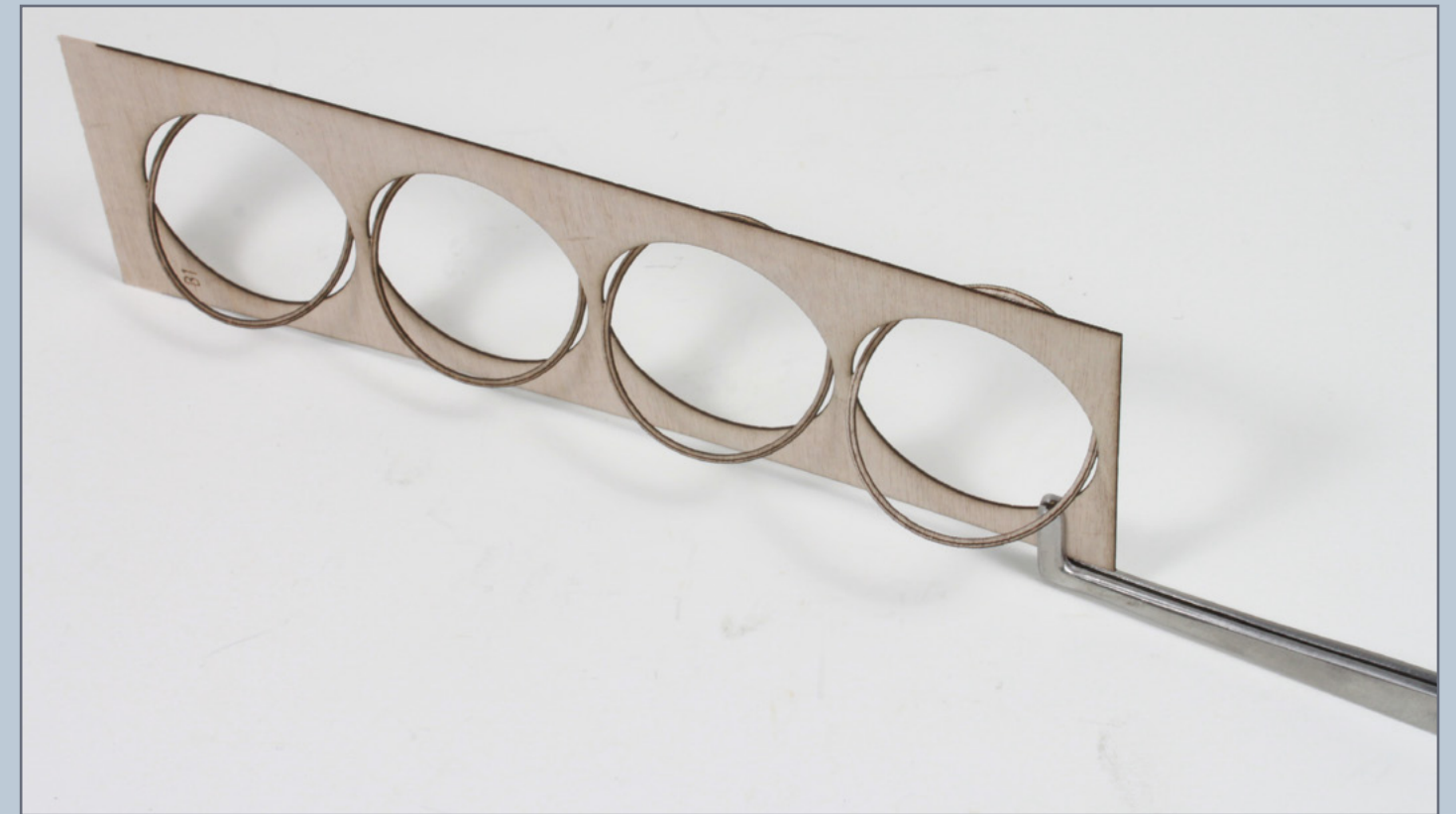

Figure 7: The wheel rims are separate pieces, two to a wheel, front and back, and should be stained black.

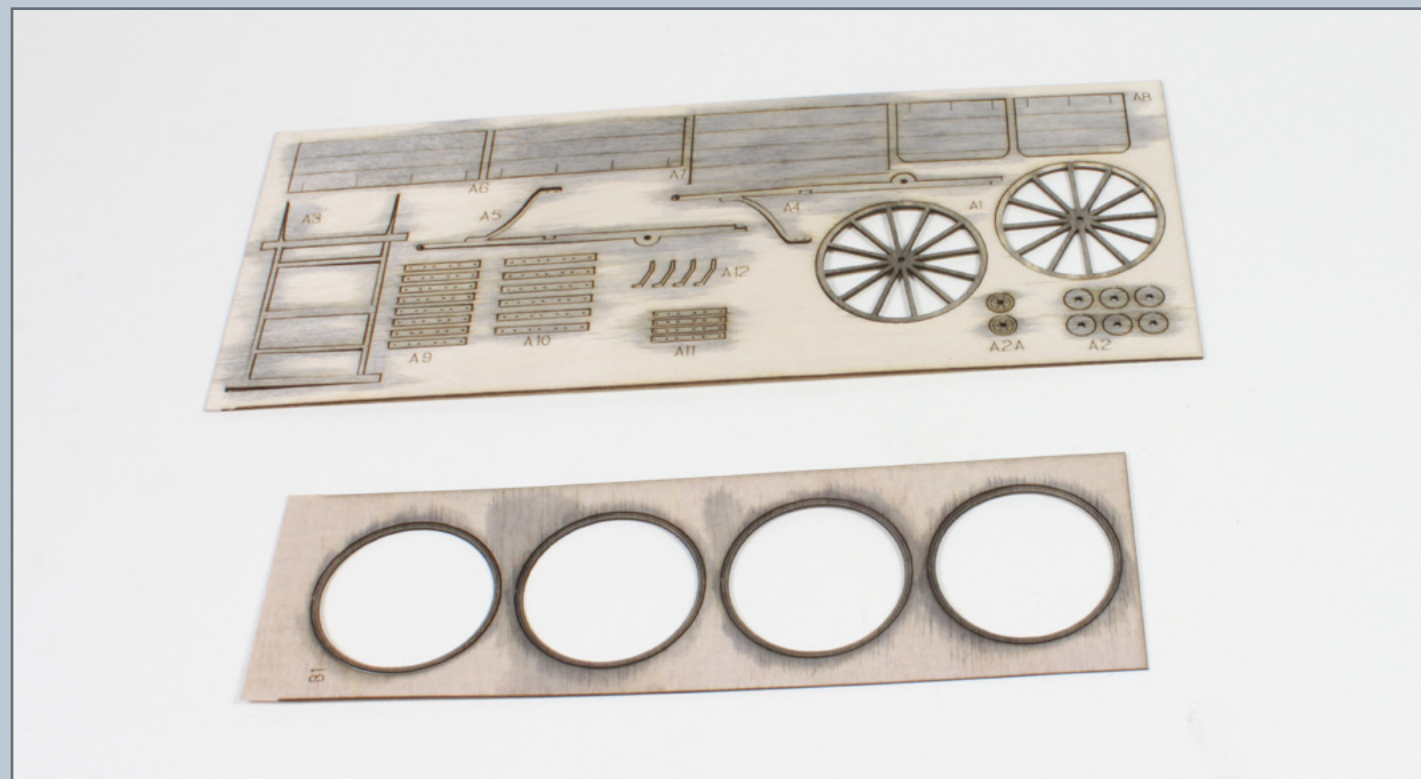

Figure 6: It is easier to stain all the parts while they are still attached to their sheets.



Figure 8: A very light coating of dilute white glue will permanently attach the rims to the wheels.

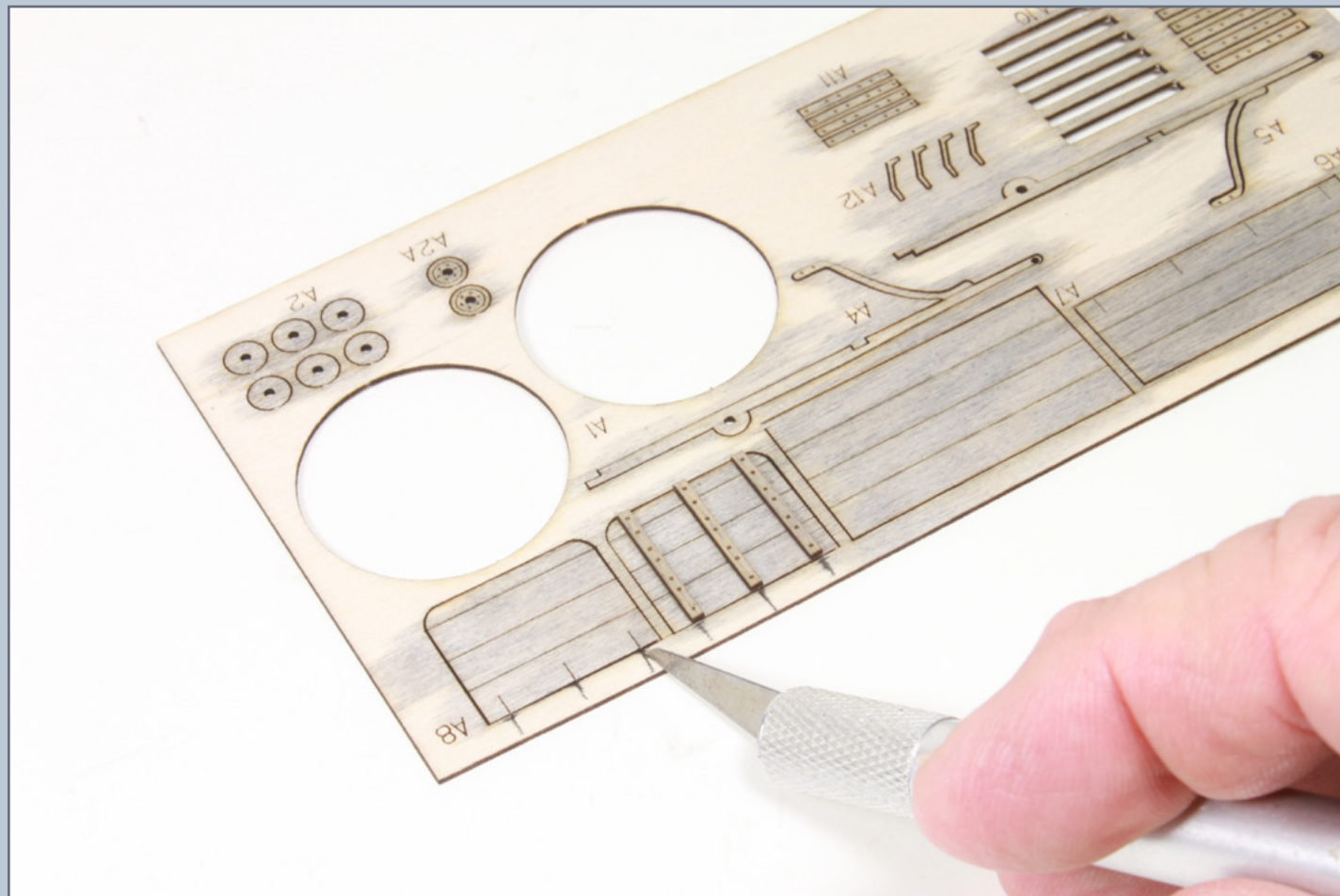

Figure 9: Small tick marks are engraved into the sides and ends to locate the support bars. The marks were extended to assist with the fabrication.



Figure 11: The kit quickly and easily forms into three subassemblies, the wheels, the body and the handles with reinforcements.

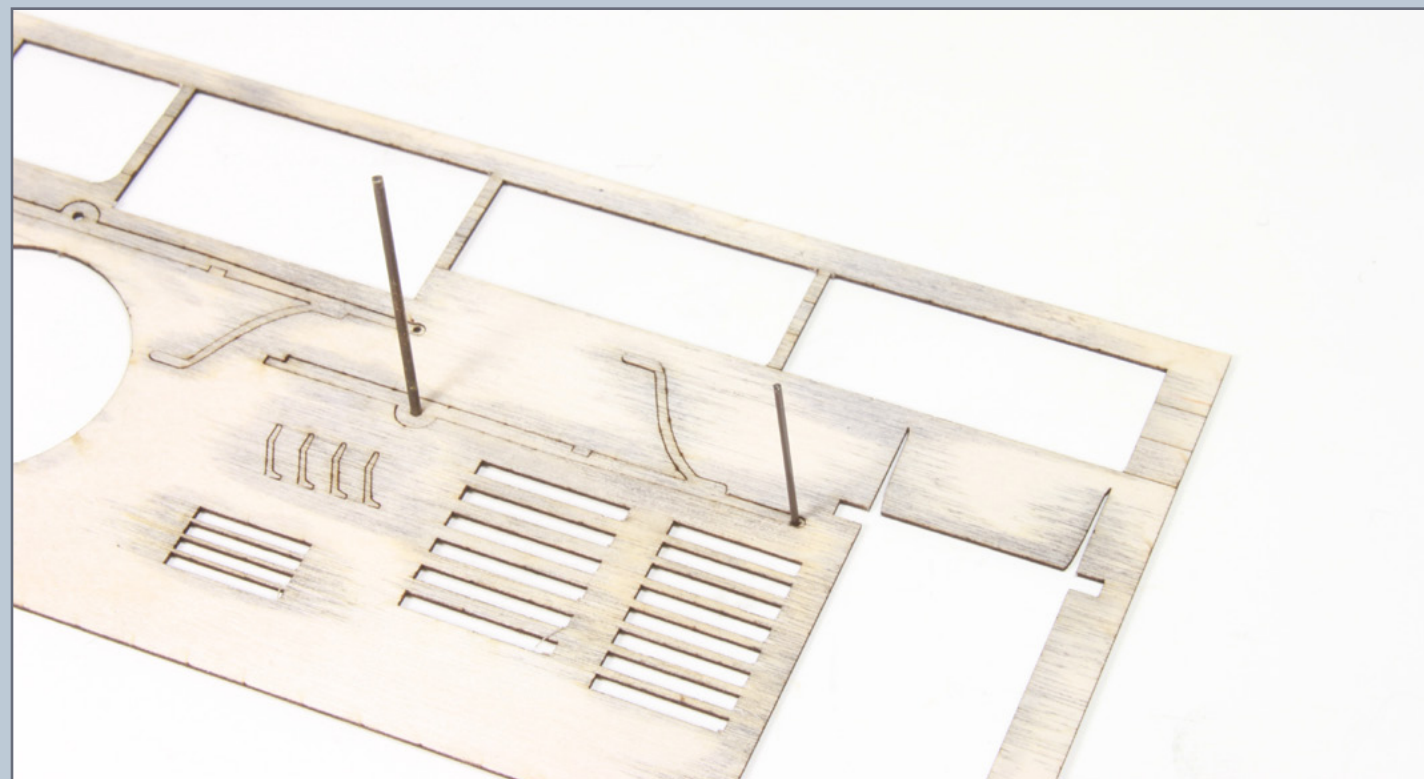

Figure 10: The brass axle and handle are pressed into their holes while the wooden handles are still attached to the sheet



Figure 12: The finished cart, looking from the right side.

Continued from page 86 ...

interference fit with no need to drill or to hold the brass pieces and wood together with glue. The same process was used to push the wheels on the axles.

After the cart was completely assembled and the glue set up, about 30 minutes, I carefully touched up any areas with light gray dye or a Sharpie marker as needed. I will (some day) modify a 1/48 worker to be the “official” pusher of the cart. With the cart full of ice and fish, it looks perfect at Mortenson’s Fish Market.



Figure 13: The finished cart looking at the left side and rear.



Craftsman Structure

C O N V E N T I O N
CSC 2011

November 2nd - 5th, 2011
The Holiday Inn - Mansfield, MA



The ONLY Show
Exclusively for
Scale Model Structure Builders
& Collectors

Sponsored by Model Railroad Hobbyist Magazine

www.csc11.net

MY MODULAR ADVENTURE: Having fun a module at a time

The ongoing story - The "Pane" of it all!



Window treatments can be a "Pane", or several, as we will see in this installment ...

Introduction

Window glass can be simulated in several ways. My preferred method is to use

.005" thick clear-styrene sheets from Evergreen. I tried several other methods, like using canopy glue in each pane, but decided against it for several reasons. One was the sheer amount of windows that I had to cover, and that meant a lot of "Pane" (pun intended). The other was, I felt the look was too "oldish" for what I needed.

I started out by counting the number of windows I would have to add glass to. That came out to a whopping 251, most of which required 3 panes per window. This confirmed that using

clear styrene would be the best solution, and it is a product I am quite familiar with.

Evergreen sells their .005" styrene in 4"x 6" sheets, so I had to come up with a way to simplify cutting all the "glass" I needed. I also had to figure out how to glue the styrene glass in the windows. The following step-by-step process will illustrate my method. So on we go with the task at hand!



Figure 1: – Machine shop walls with "glass".

About our Modular columnist



Les Halmos has been a model railroader since 1979. He's been involved with setting modular standards for the NMRA since 1981. In 2001, he founded the Free-Modu-Rail Group and has been active in promoting Free-mo module standards.

[Click here](#) to learn more about Les.

Photos and illustrations by the author unless otherwise credited.

STEP 1: Assembling Tools and Styrene Used for the Window Glass

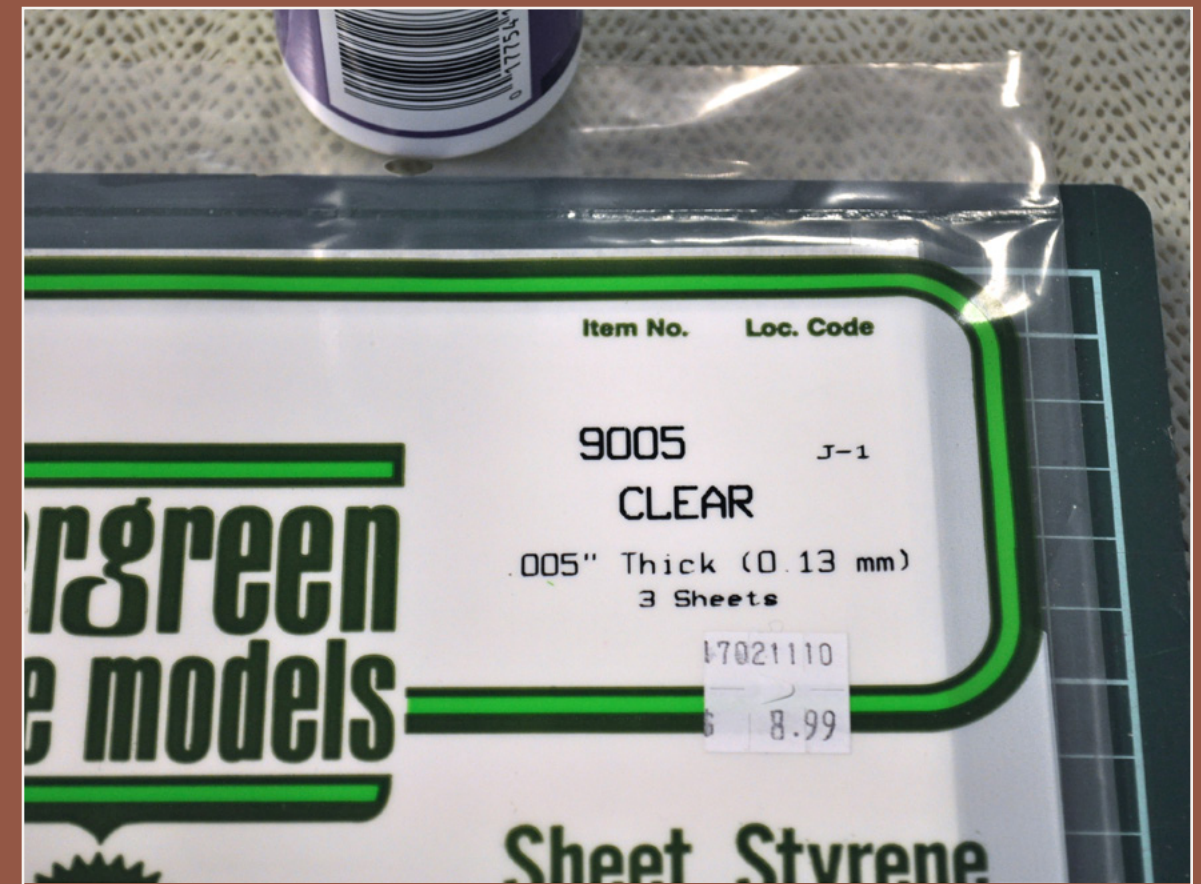

Figure 3: Clear .005" styrene sheets.

Figure 2: All these tools are available from our sponsor Micro-Mark (micromark.com), the suction tool in the picture is an older model. if you go to their website you will notice a new version which is a lot more flexible than mine.

Figure 4: Stainless steel cup (2 for \$1.00 at the Dollar Store), Micro Brush (made by Microbrush International (microbrush.com/hobby/products/ultrabrush/benefits.asp)- these are available from your LHS or dental supply stores), and canopy glue. I add a few drops of water to the canopy glue, which makes it more manageable when applying.



STEP 2: Cutting the Clear-Styrene

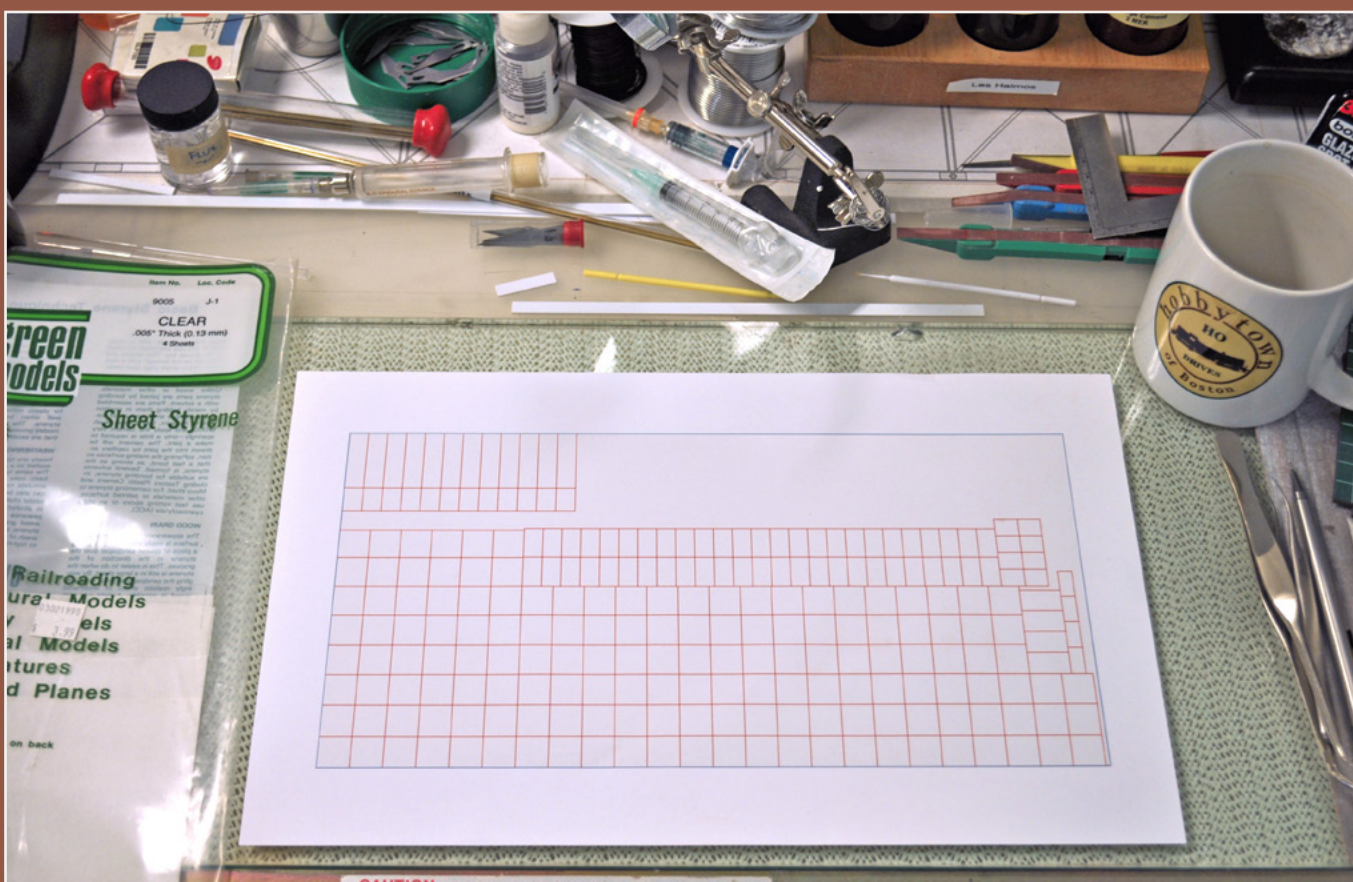

Figure 5: I measured the inside dimension of each type of window, and drew a template, because there is quite a lot of cutting ahead. This template represents only the 5 stalls I am working on, and will have to be repeated for the other 10 down the road. Am I having fun yet?...You bet!

At this point, I wound up with quite a few individual panes for the different windows. I stored them in one of my “Plano” plastic containers, which can be found in the “Hunting/Fishing section” of your favorite Walmart or other department store (figure 7).

I found out while cutting the styrene, there was some slight slippage. Some panes would have to be adjusted along the way. A sharp blade and several light passes when cutting keeps slippage down to a minimum.



Figure 6: – I taped the 4”x 6” styrene sheet to the template, cut out long strips then individual panes!

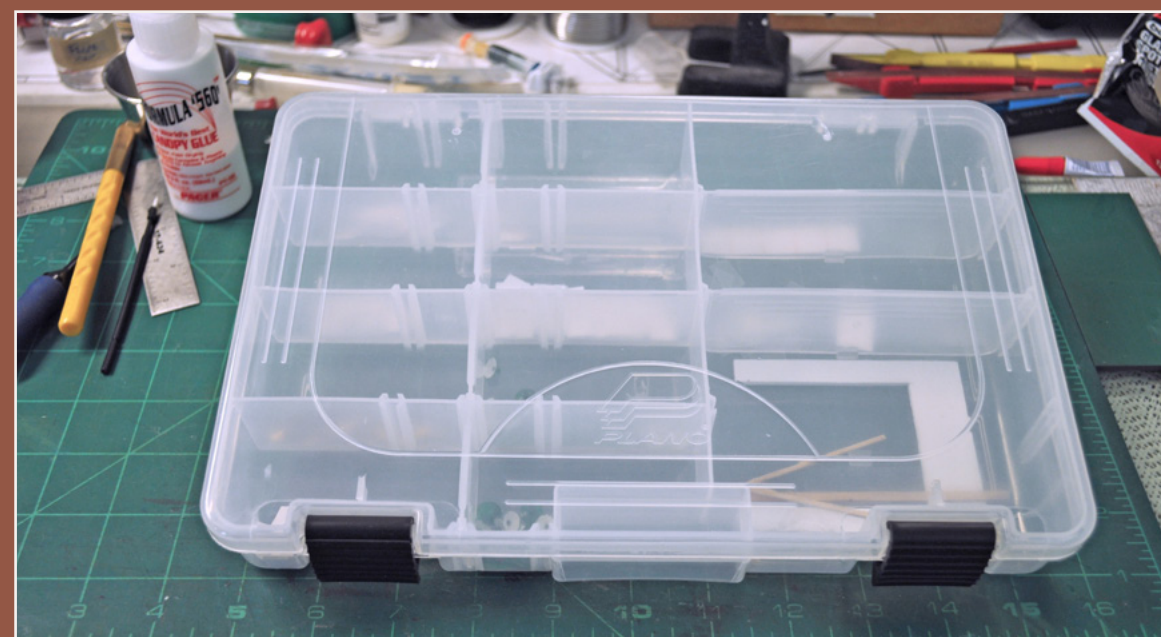

Figure 7: Plano box keeps all parts secure and separated.

STEP 3: Figuring Out How to Glue the Individual Panes in the Windows

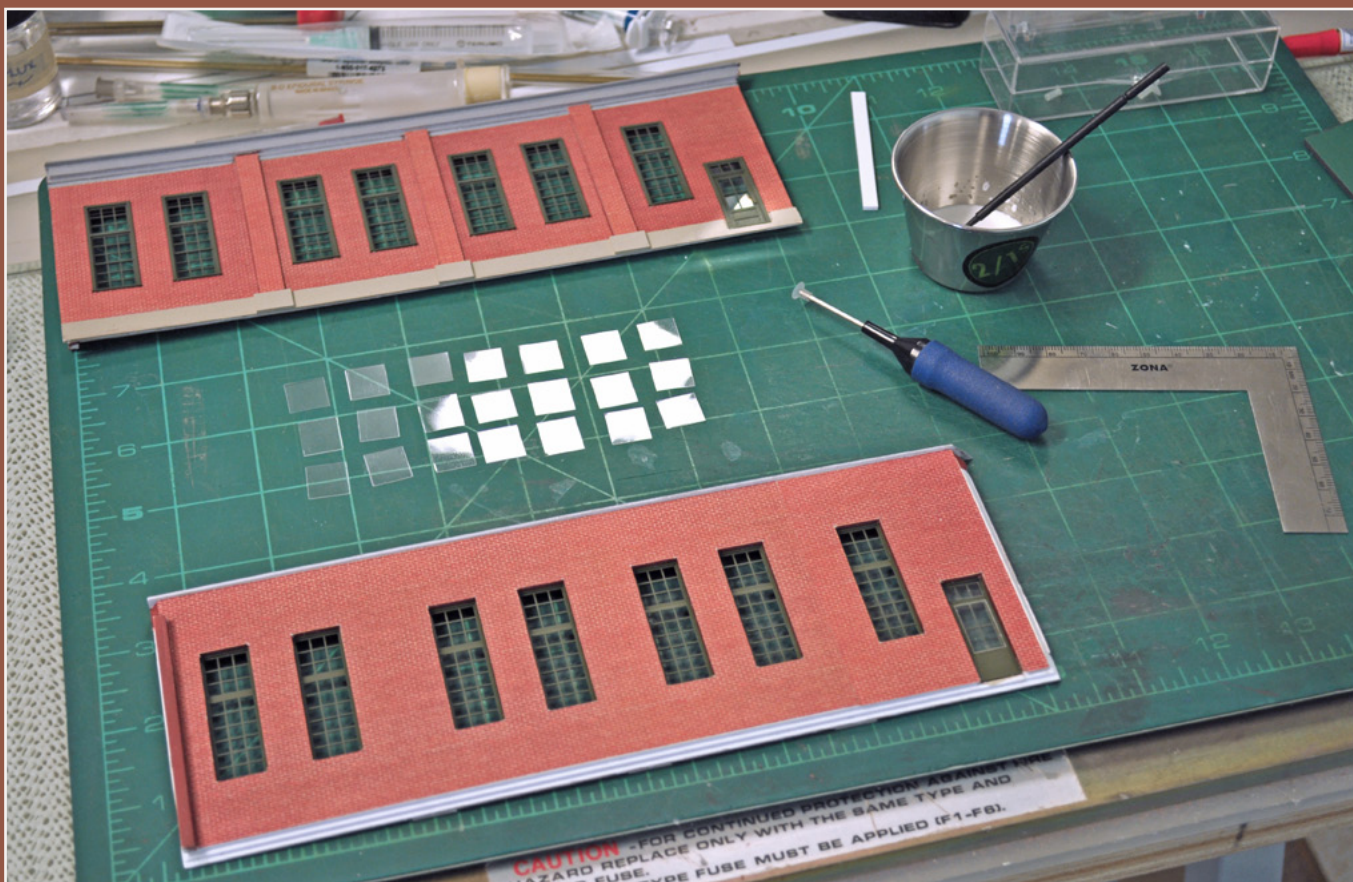

Figure 8: The individual panes for the machine shop walls, test fitted and laid out ready to glue.



Figure 9: The Tichy windows are slightly offset, so using three separate pieces of “glass” makes them seat better. At the same time it makes them look more realistic. It also increased the number of parts, and tested my patience. So far so good. I have a lot of patience when it comes to modeling!

I used canopy glue, which also is used by model aircraft and diorama modelers, for airplane canopies and other windows. The glue becomes tacky fairly rapidly, and is transparent when dry. I tried several methods of applying it to the windows, and finally found one way that worked well for me.

Figure 10: I apply a small amount of the canopy glue to the mullions with the micro brush.



STEP 3: Figuring Out How to Glue the Individual Panes in the Windows *Continued ...*

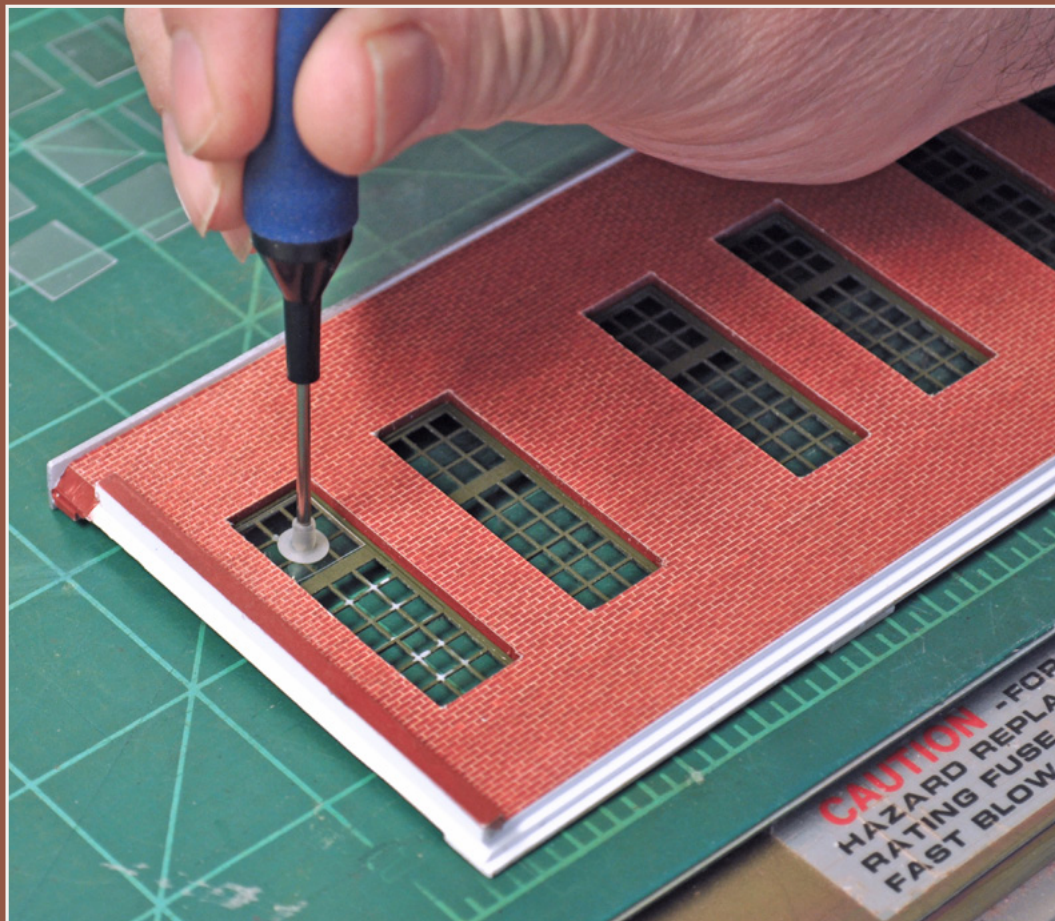

Figure 11: Then I use the suction tool to place each individual pane. That took quite a while for all the windows, but the result was worthwhile. I don't know what I would have done without that suction tool.

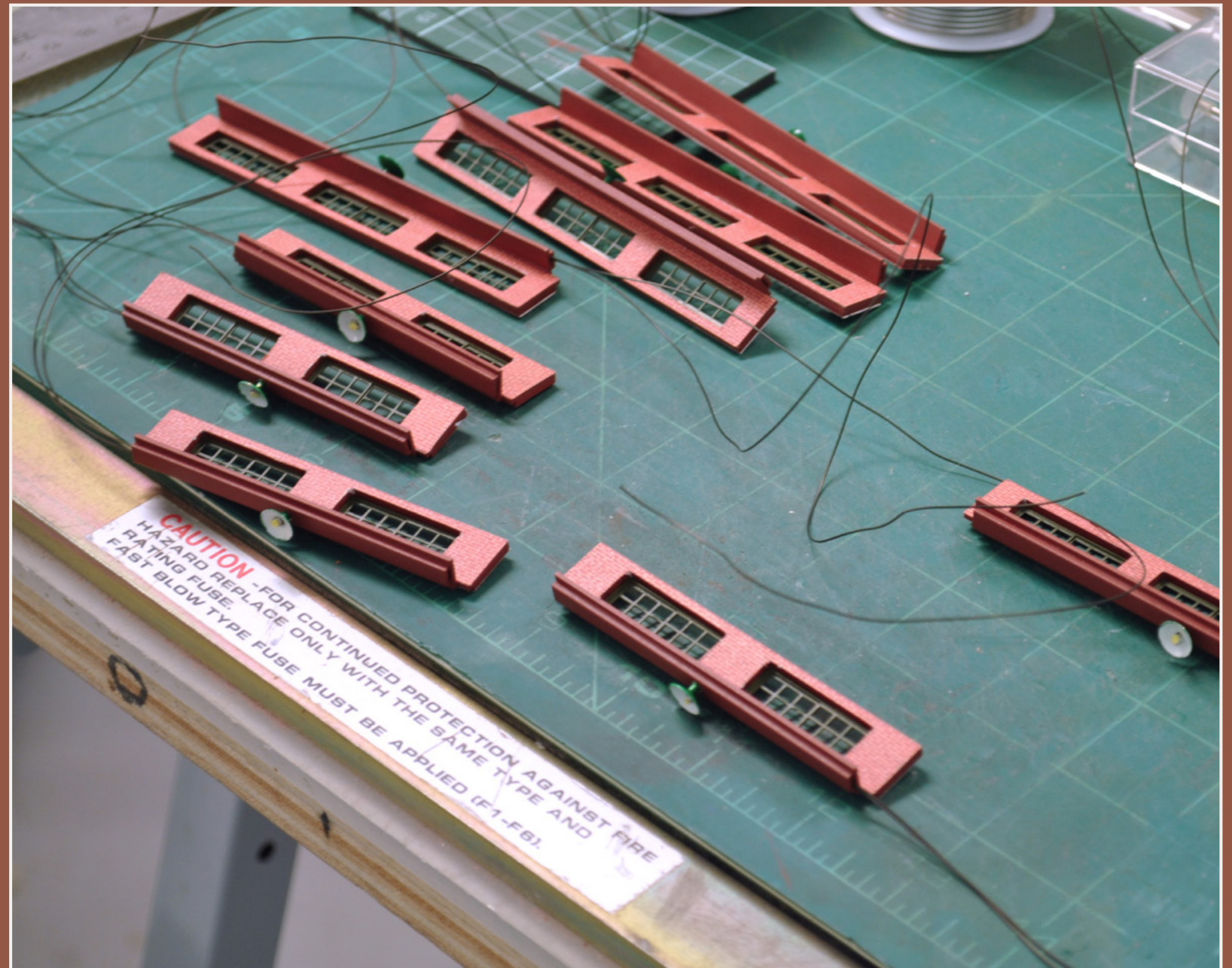

Figure 12: When I figured I was finished, I suddenly realized that I forgot to thread the lampshade wires in the clerestory windows, not to mention install the “glass” ...Oh well, what's a few more hours of “FUN.” Once that was done, I was finally ready to permanently install the walls.

STEP 3: Figuring Out How to Glue the Individual Panes in the Windows *Continued ...*

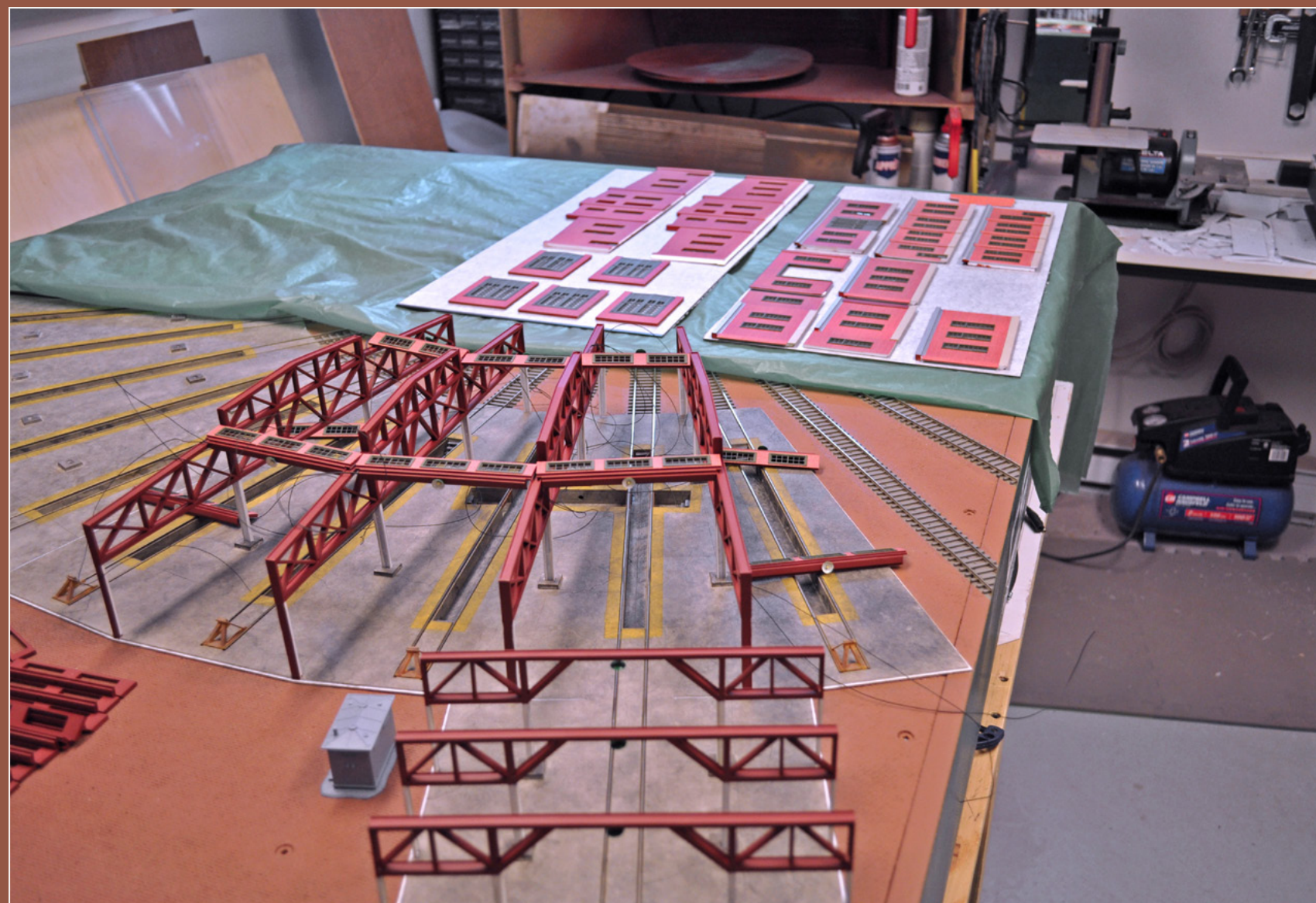

Figure 13: All the parts lined up in a row. The next step is to assemble the five stalls.

Conclusion...

Oh... you noticed that I have not started the assembly yet. Very good observation, but not to worry, it will be in my next column. Before I can assemble the stalls, I still have to find a way to thread the clerestory lampshade wires through the four stall trusses, and through the roundhouse floor. Between now and my next column, the gears are grinding wildly in my head, but I think I have found the solution. The wires should be as well camouflaged as the ones in the machine shop.

So if you are interested to see how that works out, come on back and check out my next column.

I think I'll name it "Final Partial Assembly Finally". Or maybe not... we shall see.

Thank you for reading so far. Based on your feedback, I'm glad that you are enjoying this series. I'll try to make a few videos of the assembly for my next column.



About this issue's prototype modeling columnist



Mike Rose has over 70 published articles in the hobby magazines, as well as contributed photos and essays to a number of prototype and modeling books. Mike's a regular on the Prototype Modeling Meet circuit, giving clinics on a variety of model railroading topics.

Mike's also the owner of Mike Rose Hobbies (mrhobby.com).

Photos and illustrations by the author unless otherwise credited.

GETTING REAL: Mike Rose's Conrail ZTS layout

Adventures in Prototype Modeling

Follow the progress as Mike merges the old with the new on his layout ...



When Joe Fugate approached me about doing a column for MRH, I thought, "why not?", it's like an article. But really, it's not, in that an article has a defined beginning, middle and end, whereas a column is more of an ongoing saga, at least in my case!

Since my articles, in-person clinics, and thoughts tend to lean towards a what's-happening-now mode, this and likely subsequent columns will detail the planning and execution that is going into the final layout expansion at my house.

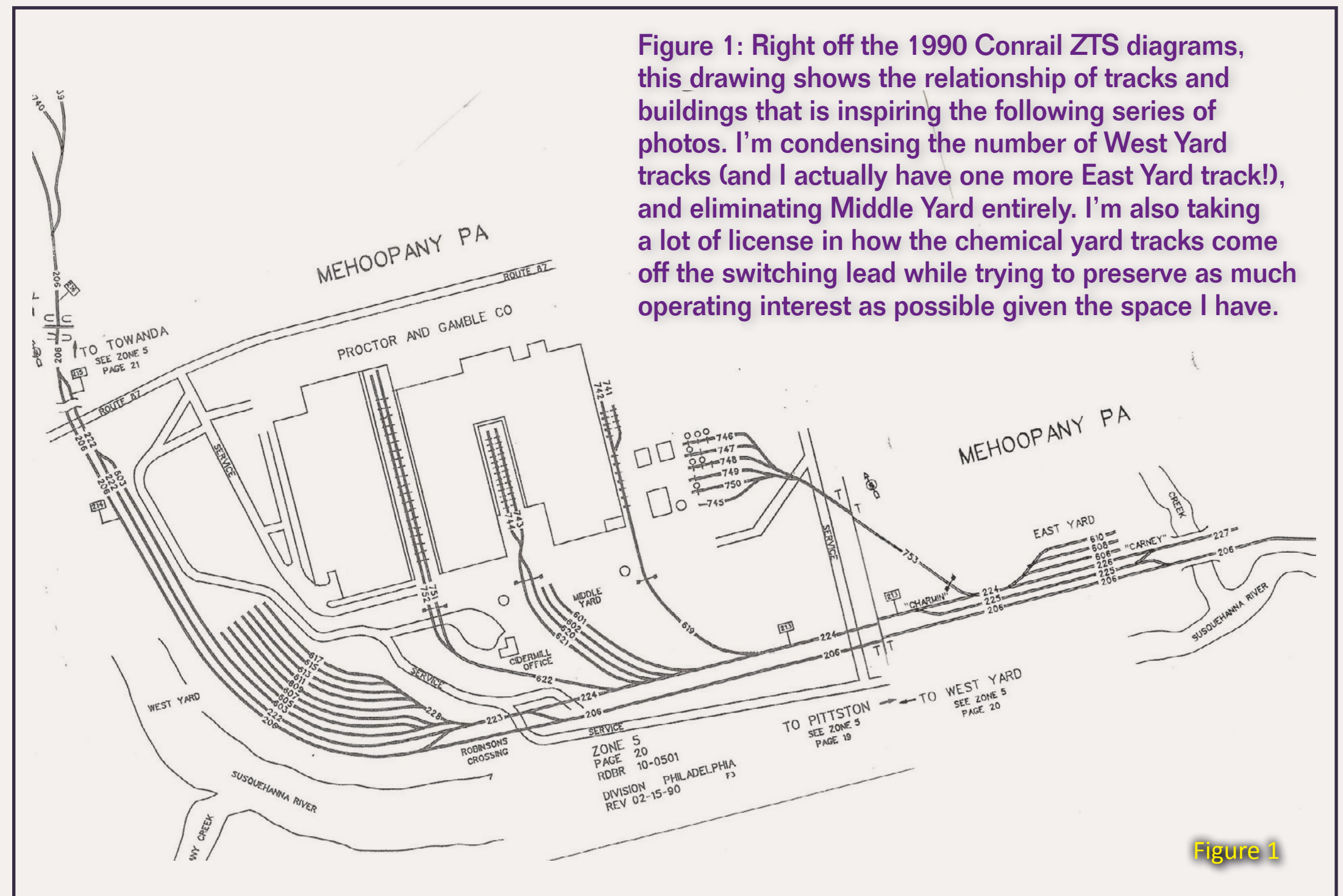

Figure 1: Right off the 1990 Conrail ZTS diagrams, this drawing shows the relationship of tracks and buildings that is inspiring the following series of photos. I'm condensing the number of West Yard tracks (and I actually have one more East Yard track!), and eliminating Middle Yard entirely. I'm also taking a lot of license in how the chemical yard tracks come off the switching lead while trying to preserve as much operating interest as possible given the space I have.

Figure 1

Last summer I had my second annual operating session. It's annual because each one reveals so many things to me that I need a year to incorporate any changes I want to make!

On the first one, I was convinced that the layout had evolved sufficiently from both a completion standpoint as well as a quality standpoint that we could actually run trains in multiple, and we did. I'd tested everything

over and over and my fleet of locos ran flawlessly over the entire layout. All was fine until two friends showed up with sound-equipped locos, and the finicky nature of them showed up every flaw in the track work, particularly the turnouts.

So I embarked on a program to re-vamp all the old Walthers/Shinohara Code 83 pre-DCC-friendly turnouts I had, and also to tweak every single other turnout to perform properly.



Figure 2: I'm experimenting with bridge and abutment locations. The old abutments have been largely removed, including the old center pier. I'm on the fence about putting rocks and brush in the middle where it used to be, or wiping it out for a more standard but perhaps more boring channel. Note that the double stack clearance issues with the stock Walthers bridge have been addressed just like the prototype would have, with top girder modifications.

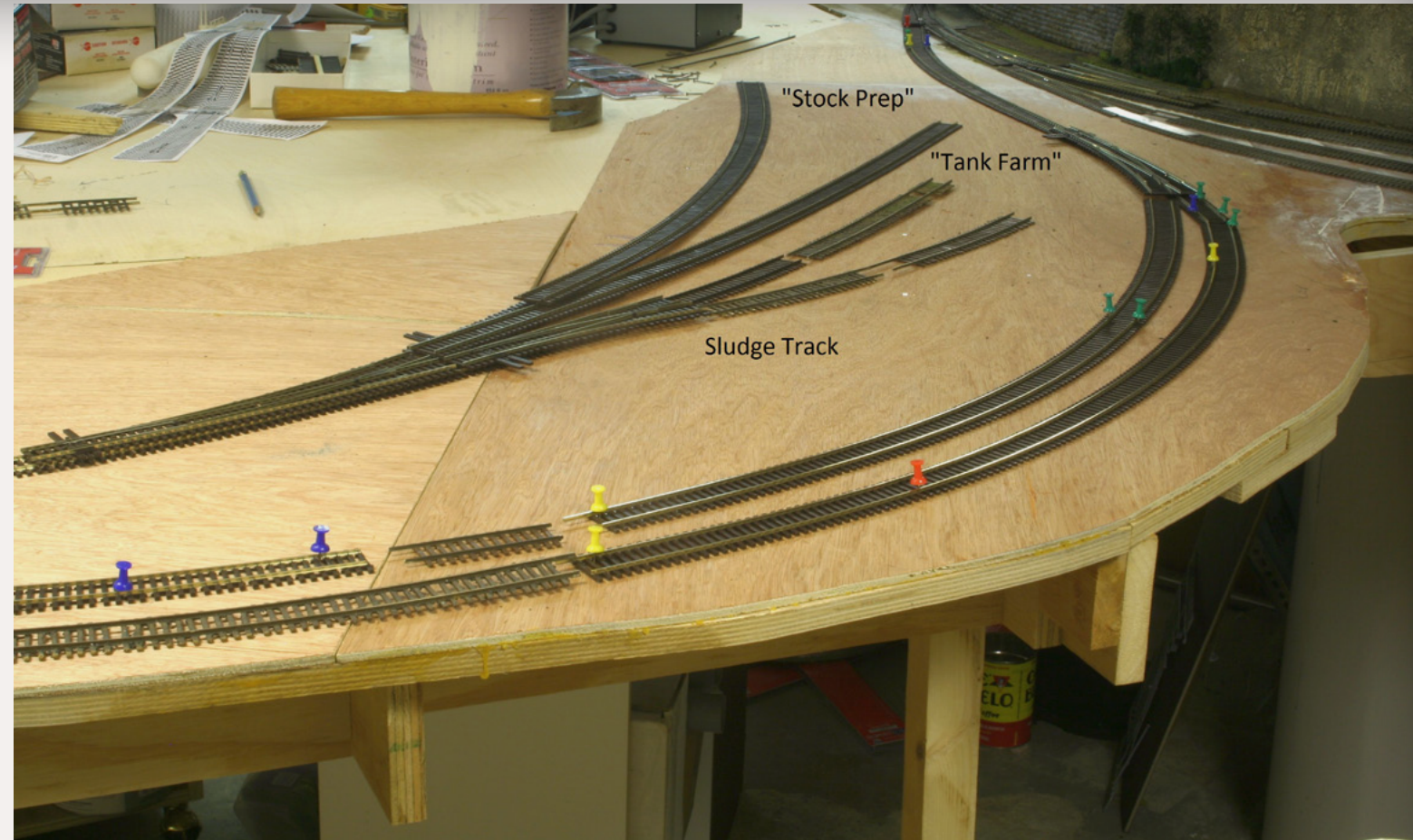

Figure 3: Taken right off the CR ZTS diagrams, the inside tracks will be for chemicals to the paper plant. The far left track, along the building itself, is labeled "stock prep," whatever that is is!

The Shinoharas required me to isolate and power-route the frogs, which made a huge performance difference. But since I'd been using Hanksraft turnout motors rather than Tortoise machines with built-in contacts, I needed to fabricate custom mounting brackets for pairs of microswitches that would be actuated by the swing arm of the linkages used. To say this was more than a minor project is definitely an understatement!

Enough about the last op session. For the most recent one, the trackage and turnout tweaks I performed paid off in a largely flawless operating session, and watching the success of what was going on triggered other thoughts in my mind. By the way, I say "watching"

because I have yet to run a train at my own op sessions! I'm just too busy enjoying railfanning and watching multiple things happening all over my layout, and of course the inevitable minor problem-solving that goes on during the op session itself.

But the question of "when are you going to get rid of your pool table and build the final layout expansion" seemed more timely after the op session was over. After all, I had not played pool in so long that having that much real estate tied up was no longer appropriate. Soon the table was on Craigslist, and sold almost immediately. (I knew I should have asked for more money!)

Layout design began within two weeks of the op session and continued for about two months. I enlisted the services and advice of several close friends who always have good ideas, and a lively debate ensued. Eventually I exercised “CEO” veto power and steered the design and input towards what was consistent with my own vision and also limited the disruption of the existing layout to an acceptable level.

The design goals were as follows:

- Make the best use of the space formerly occupied by the pool table.
- Maintain aisle space and not create a traffic jam problem with the humans.
- Extend the main line to get more run.
- Solve some pesky scenic issues on the existing layout.
- Rearrange the town names for a more prototypical order.
- Create a new and scenically interesting area.
- Do something operationally rewarding.

Figure 4: The two sharply curved tracks lead to the two groups of warehouse tracks between the buildings. The West Yard, dubbed “Charmin Yard”, is also shown, along with a mainline crossover that showed up on the track diagrams. No room for Middle Yard unfortunately. Note that I used a crossing that is not on the prototype diagram to get an extra track in place.

Figure 5: The crossing deviates from the prototype, but solves a problem of placing hard-to-locate tracks. It was the catalyst for talking to Jim Lincoln about building custom track.

So far all goals have been met, or at least they are underway. First, a little about the prototype and how it influenced the design concepts, along with some background.

While my layout was originally designed and conceived as a proto-freelanced layout due to the room constraints I had, over time it evolved into being based on a segment of Conrail that was formerly Lehigh Valley. The modeled segment runs from Pittston, Pennsylvania to the Southern Tier line in Waverly, New York and runs through some of the most scenic territory I’ve ever witnessed.

The curvy nature of the line that runs along the Susquehanna River, backed by steep wooded hillsides, was ideal for model railroad representation, and in many cases the aisle of the layout room represents the river itself. In fact, in many areas I have either modeled or am planning to model at least

Continued on Page 102 ...

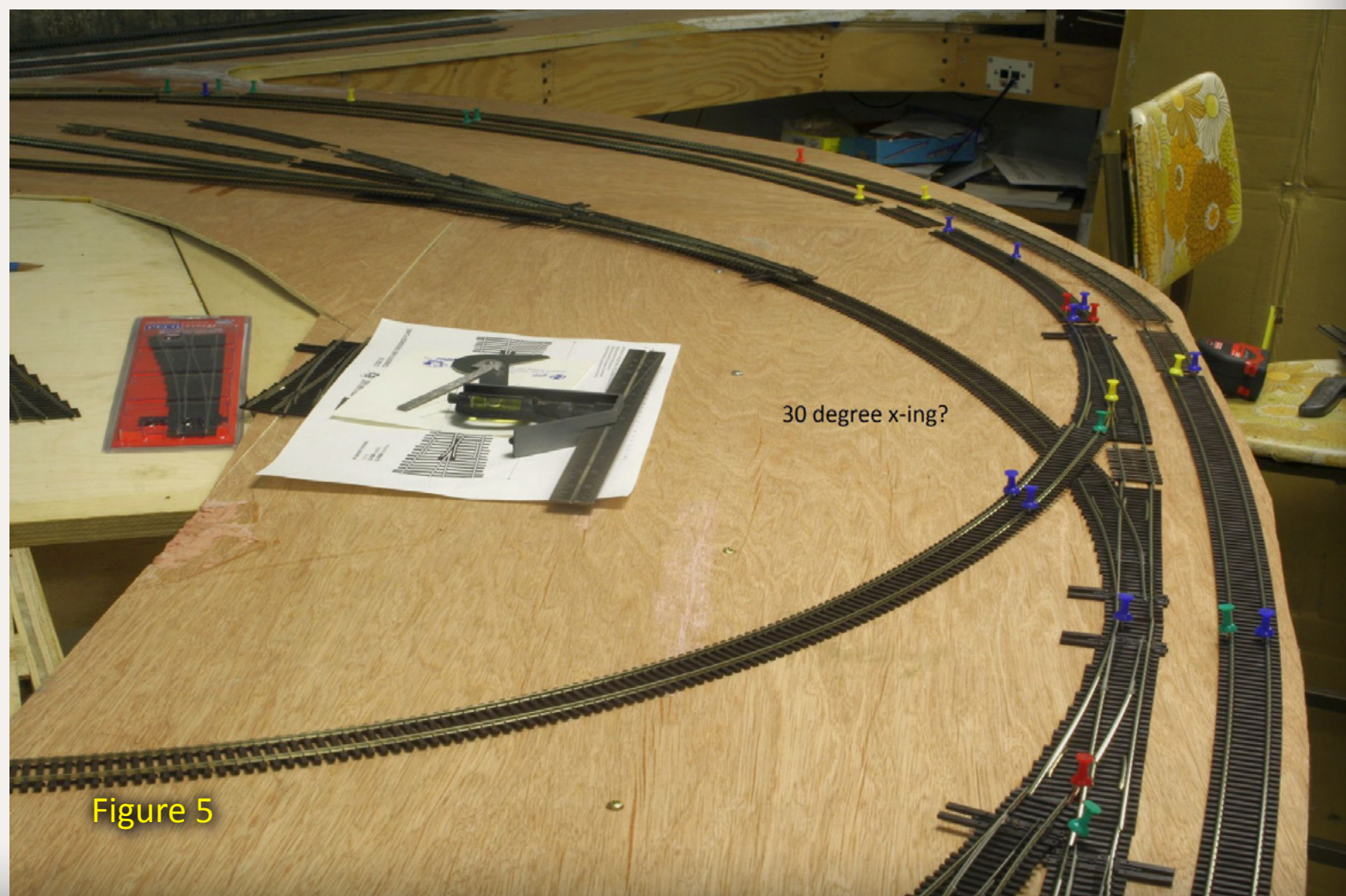
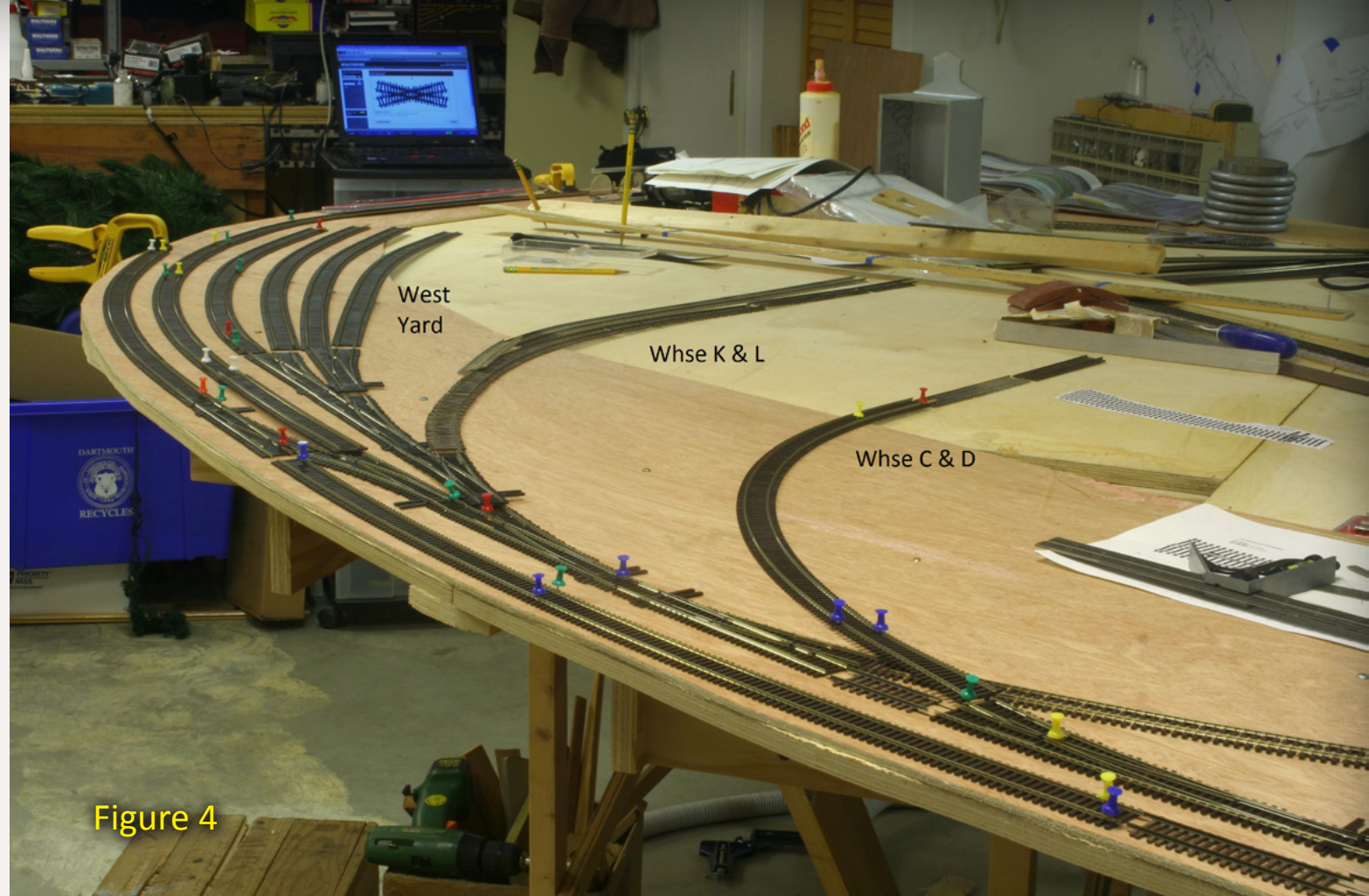



Figure 7

Figure 7: I always find it useful to use stand-ins for buildings when trying to understand track arrangements.

Figure 8: This view shows how I traced out all the track arrangements on the lauan plywood prior to cutting.



Figure 8

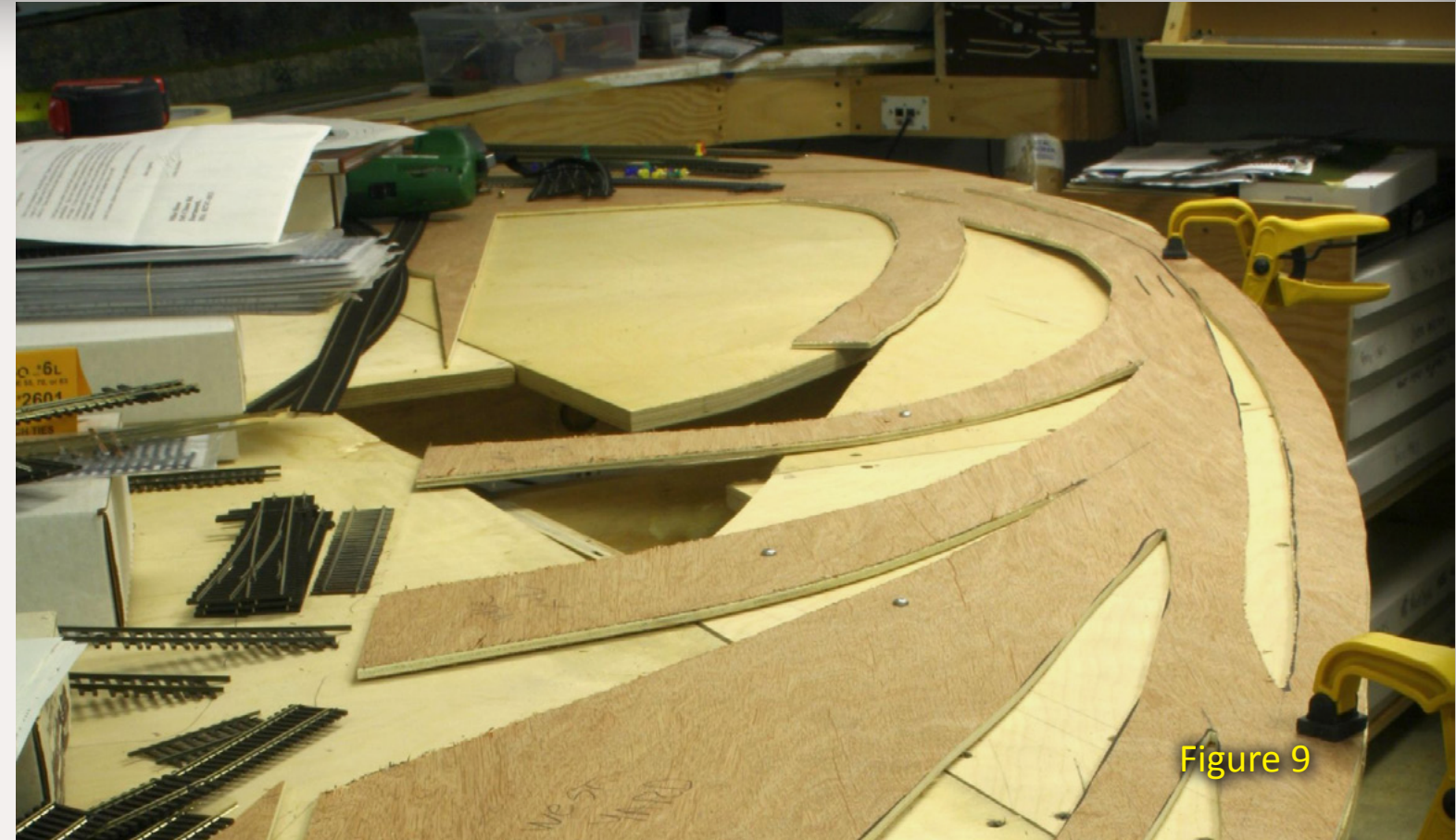

Figure 9

Figure 9: Here we see how the cut-out lauan roadbed was used as the template for cutting the birch plywood sub-roadbed.

Figure 10: Central Valley turnout ties permitted curving where needed to insure proper track flow.



Figure 10



Figure 11



Figure 12

Figure 11: Jim used real wood ties and Proto 87 Stores (proto87.com) metal tie plates for some of the connecting track between his hand-built turnouts.

Figure 12: This is Jim Lincoln's work, a beautiful hand-built custom crossing that makes the industrial sidings work at Mehoopany for me. Those are 30" radius curves crossing each other.

Figure 13: Here you see the town of Meshoppen fleshed out, raised 2", Kintner Milling located, along with streets, other structures, and a stream that will be visible in other shots after this. Note how masking tape has been used to get the concept of the hillside slope angle of repose. This all resulted from a visit from good friend Mike Confalone.

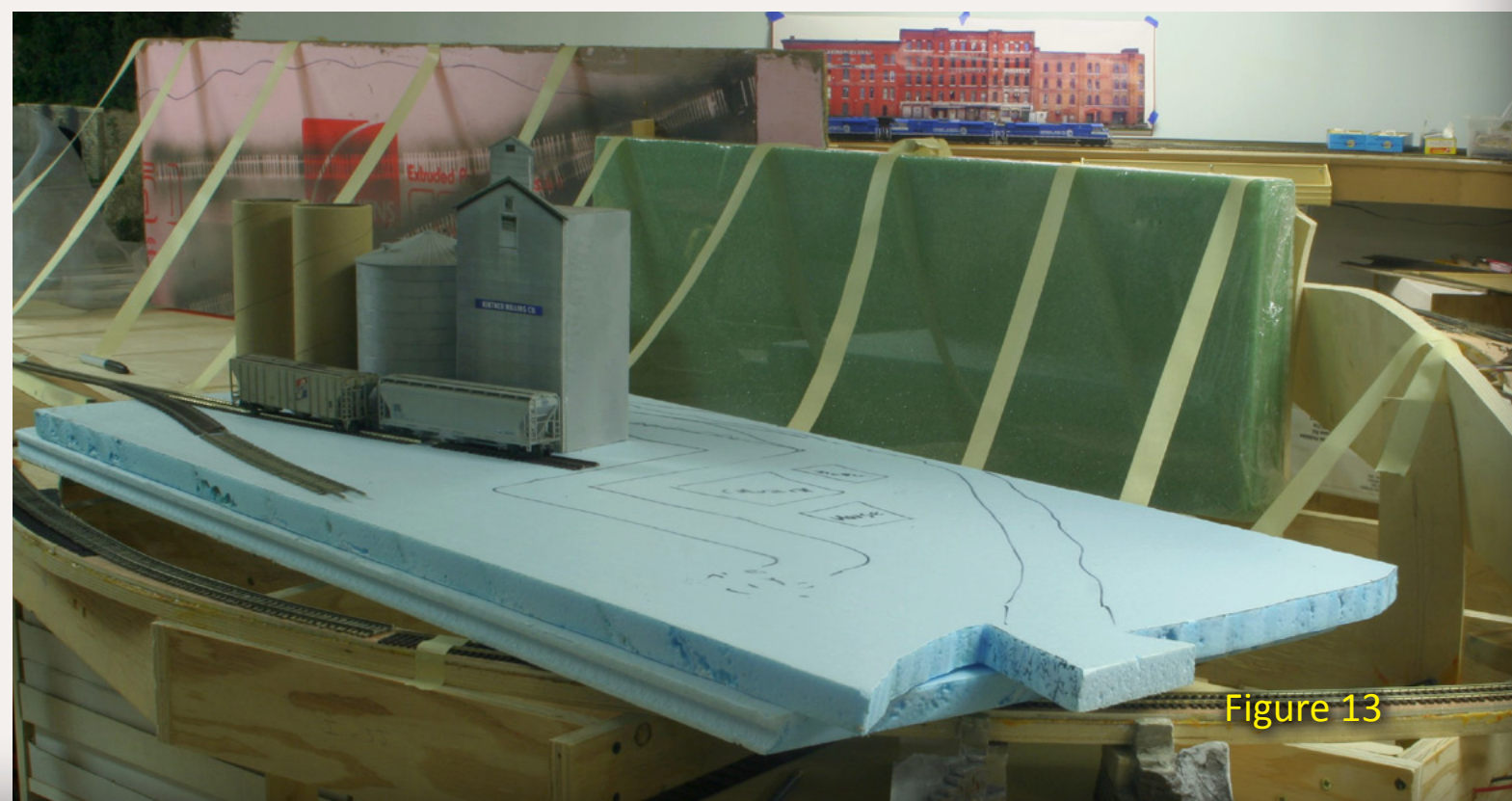

Figure 13

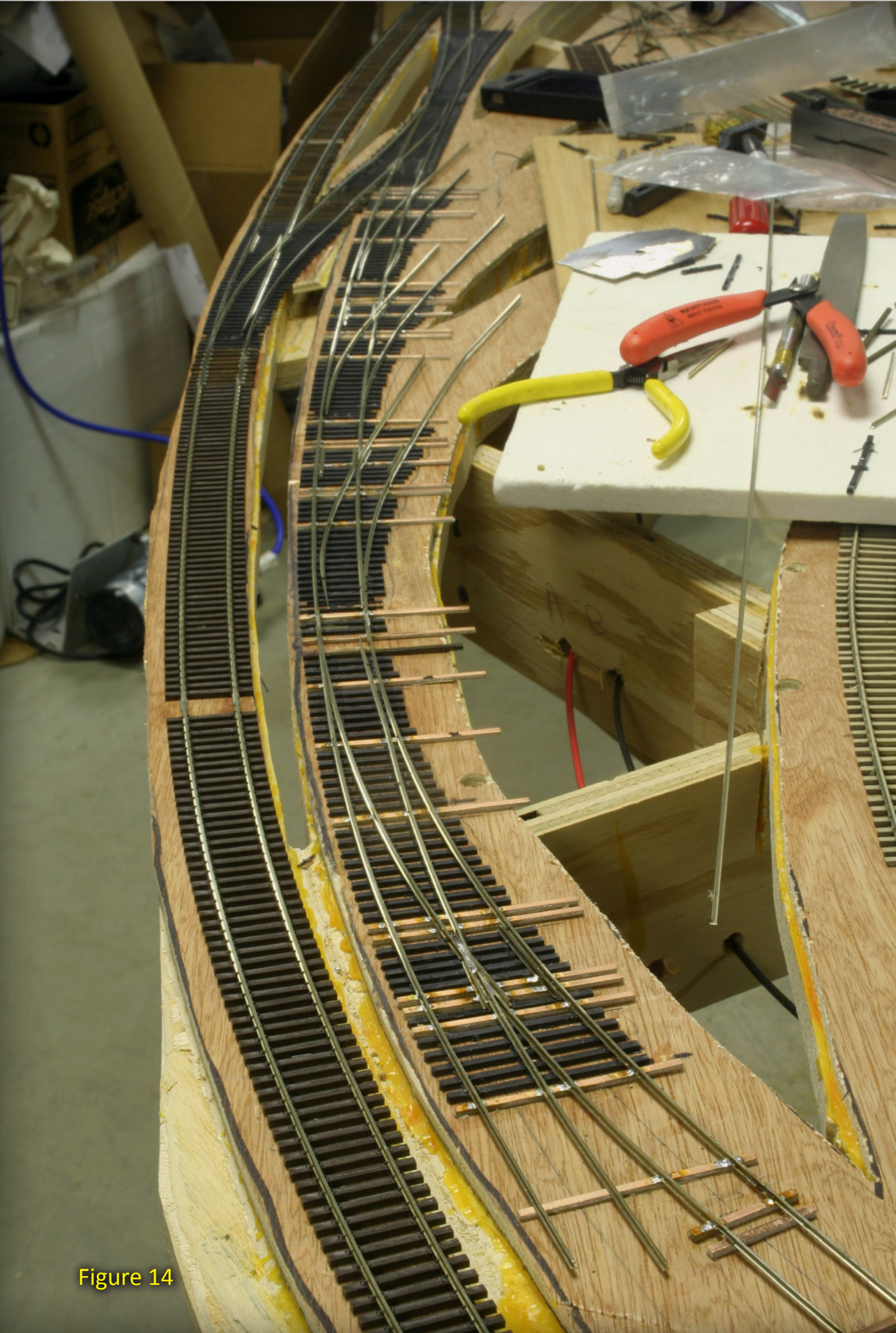

Figure 14

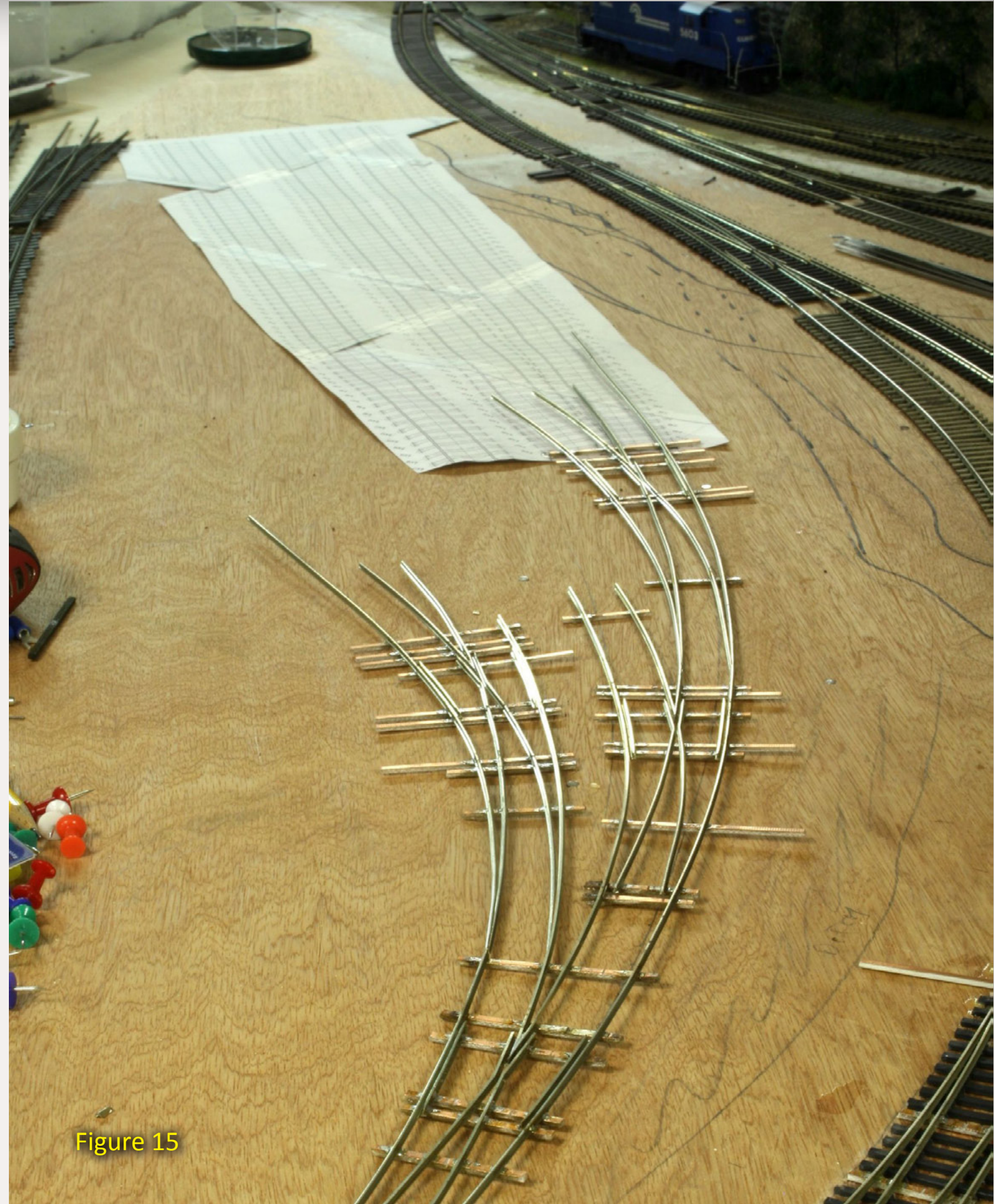

Figure 15

Figure 14: At this point they need gapping, but we continue to be very happy with the elusive “flow” of the track with Jim’s custom turnouts.

Figure 15: Jim showed up with a pre-made assembly of four custom curved turnouts, which fit perfectly with the crossing he’d already made and installed.

Continued from page 98 ...

two or three inches of water at the bottom of a small embankment rather than the standard fascia most folks use. That way layout pictures will typically not have the tell-tale triangle of green-painted Masonite in the photo corner that you see all too often. This is just a personal pet peeve and something I wanted to avoid.

A year or so ago I stumbled across [Conrail ZTS maps online](#), which gave me a visual representation of every mile of the entire Conrail system, including all sidings, and a key to the

tracks that indicated all the industries served. Best of all, the maps were current as of 1990, the heart of my modeling era. While this presented challenges, it also freed me up from certain decisions and enabled me to focus on representing the prototype as fully as possible.

One area that caught my eye was the track chart of Mehoopany, which featured the huge Proctor and Gamble plant there. This plant produced Charmin toilet paper, Pampers diapers, and Bounty paper towels. Located on the bend of a river, it

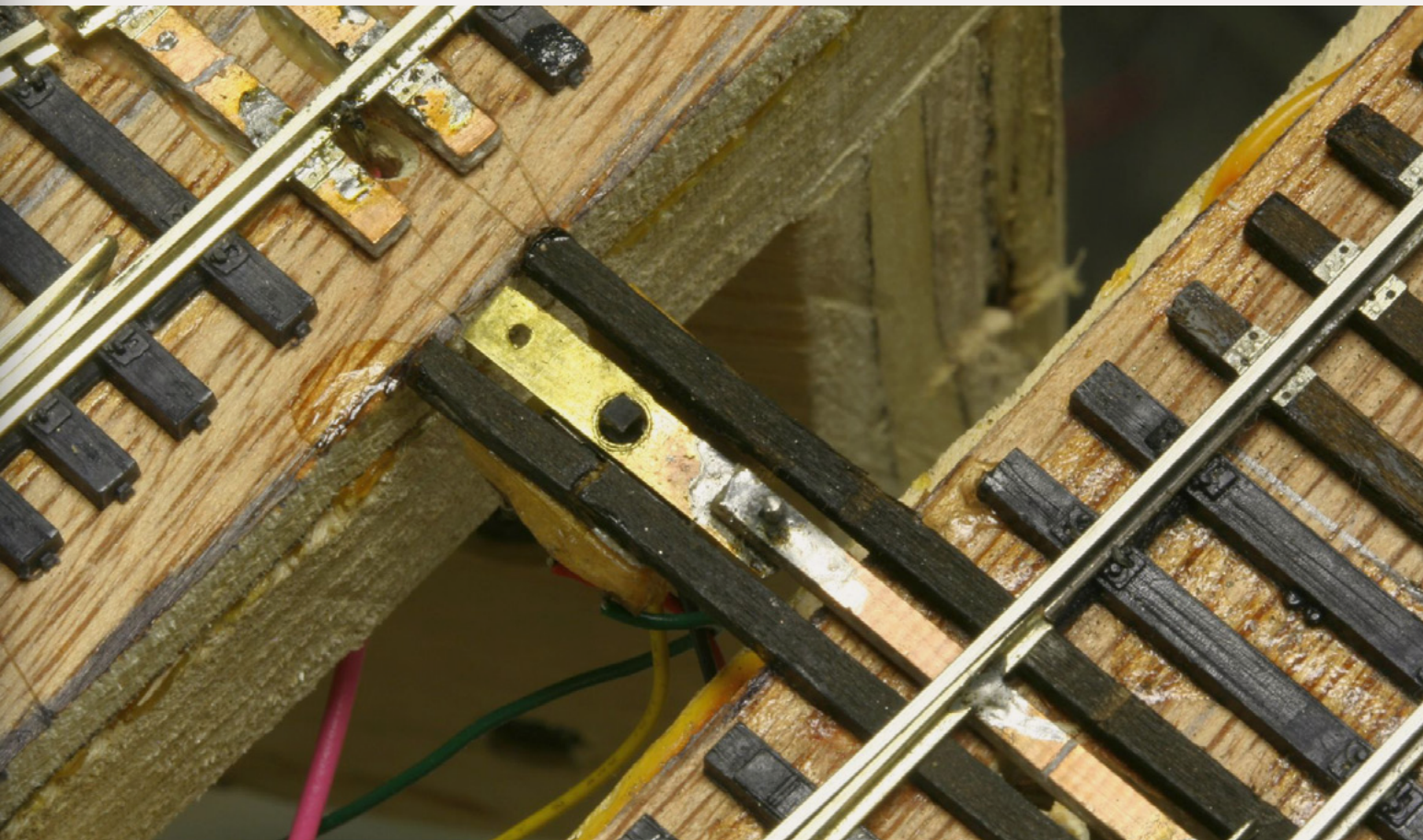

Figure 16: This is the prototype of using a slide switch to hold the points and change the power polarity to the frog. It worked flawlessly, but I had to invent a lot of methodology to do it, and I don't want to repeat this 20 more times! Now it's time to streamline it. (100mm Macro shot)

MODELING BY DAVE FRARY & HAL REYNOLDS
PHOTO BY HAL REYNOLDS

Find us on Facebook

FREE GIVEAWAYS W/ADMISSION!

The Fine Scale Model Railroader Expo 2011

An All New, Multi Scale Structure & Modeling Show

October 13-15, 2011 **Holiday Inn Peabody, MA**
Celebrating the Modeler & the Manufacturer...
See How Kits Get Made! Just 26 Minutes from Boston's Logan Airport

2 Day FSM Open House Visit **George Sellios' World Famous Franklin & South Manchester!**
IT COULDN'T BE EASIER...JUST 10 MINUTES AWAY VIA FREE HOTEL SHUTTLE!

The Kit Factory **Only at the Expo!**
LIVE LASER CUTTING! METAL SPIN CASTING! POUR YOUR OWN PLASTER WALLS! TAKE PARTS HOME!

Dealers SIERRA WEST-CROW RIVER - RAILROAD KITS - VECTOR CUT - BEST TRAINS
SEAPORT MODELWORKS-FOS SCALE MODELS-ATLANTIC SCALE MODELS- LASER MODELING 3
MODEL TECH STUDIOS-PAW OF A BEAR-NEW ENGLAND BROWNSTONE-MOUNT BLUE MODELS
FULL STEAM AHEAD - BLUE RIBBON MODELS - MINUTEMAN SCALE MODELS & more!

Clinics & Workshops
DAVE FRARY - BOB HAYDEN
LOU SASSI - BRETT GALLANT
BOB MITCHELL - KEN HAMILTON
BOB VAN GELDER
RUSS GREENE - DOUG FOSCALE
HAL REYNOLDS - JON ADDISON
CHRIS LYON - BRIAN BOLLINGER
MICHAEL DUGGAN
RICH JOSSELYN & MORE!

FIND OUT MORE AT www.modelrailroadexpo.com

Sea Port Model Works
NORTHEASTERN SCALE LUMBER CO.
THE EXPO IS SPONSORED BY:
CROW RIVER PRODUCTS
Model Railroad Hobbyist magazine

NARROW GAUGE AND SHORT LINE GAZETTE
RAIL SCALE MINIATURES
THE GREAT LITTLE KIT...
Bar Mills SCALE MODEL WORKS
FROM THE GREAT STATE OF MAINE

The Expo is Produced by Kit Manufacturers:
RailroadKITS
FOS SCALE MODELS
Atlantic Scale Modelers
BEST

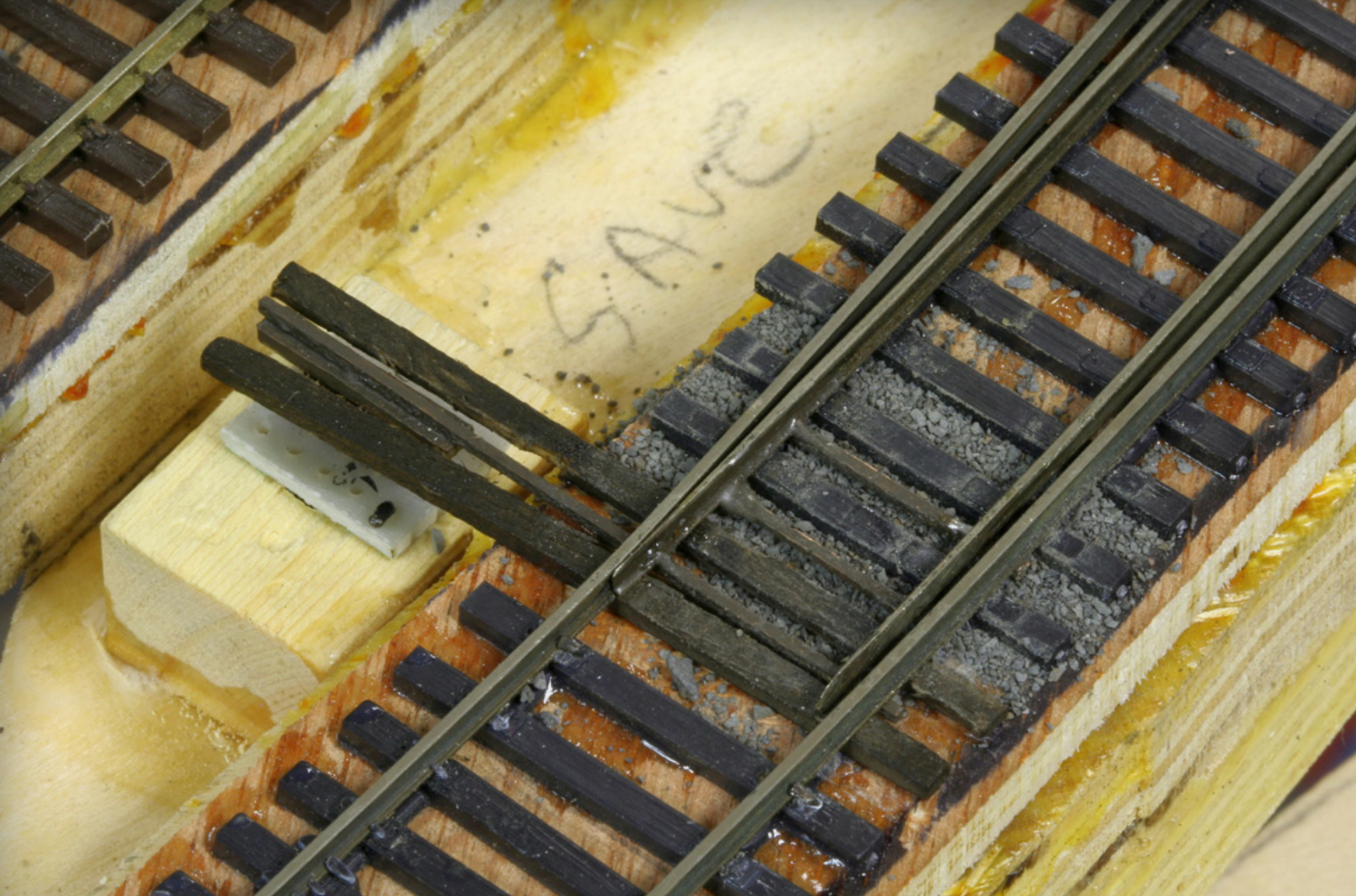

Figure 17: Jim Lincoln came by for much of a Sunday and began to install Z-scale throwbars in place of the old PC board ties he'd originally installed. This view shows the completed assembly with a first coat of paint and a little ballast that Jim just couldn't wait to install!

immediately looked like the end of a peninsula to me!

This is a significant source of traffic even today, and during my modeling era, there were 100 outbound boxcar loads per day. There was incoming traffic for the pulp used (boxcars), and chemical tank cars and covered hoppers as well.

There were also three different yards that supported it, double sidings that went inside the plant to the warehouse shipping area, the ability to cover a

lot of ground with a massive industrial complex, and although I could go on and on, let's just say I was sold!

The pictures will tell part of the story. Look for ongoing updates in what has been an interesting and fulfilling process for all involved.

Look for more Mike Rose "Getting Real" columns in future issues...

Some of the finest trees in the hobby ...

... available in any scale!

CANYON CREEK
SCENICS
canyoncreekscenics.com



click to visit our web site

[Tell a friend ...](#) [Contents](#) [Index](#)

Some Further Thoughts by Mike...

When I first built my house, half the approximately 34'x34' basement was earmarked for the layout. It seemed like a lot of space back then, but at this point in time the layout now occupies about 80-85% of the basement. There are two removable bridges, and while the concept of the layout is point to point north-south, staging represents both points of the compass and completes the eventual loop around the entire basement. Prior to the construction of the peninsula, it took 13 minutes at a

scale speed to cover the entire layout. I'm estimating perhaps another two minutes at least when the new peninsula is included, but I have not yet done this test.

My original goal for the layout was to do a "proto-freelance" short-line in Pennsylvania, which would give me the freedom to run just about any defensible model of locomotive. Times change, much of it based on railfanning and Proto-Meet experiences, and I've moved to a much more prototype-based concept right down to the time period and locale, which is the former Conrail main

line from Pittston, Pennsylvania to the Southern Tier in New York in 1990. The addition of the peninsula project caused us to re-think that a bit and we re-arranged the towns to even more closely follow the prototype in this area. As a result, south staging now represents Allentown, Pennsylvania, and north staging is Sayre, Pennsylvania.

I railfanned all over Pennsylvania and love the variety and rich availability of the main line and short line railroads in that state. I also love the geography and look of the scenery. On the line I chose

to model, the curvy nature of the tracks as it follows the winding Susquehanna River, combined with the steep, thickly wooded hillsides of anthracite country, lend themselves to aisles and benchwork within a basement very nicely!



Figure 18: This is the mostly finished version of the bridge scene that is the transition from old to new sections of the layout. Shown are the prototypes of the abutments created for this bridge by Russ Greene at New England Brownstone.





About our N-scale columnist



John Drye is our N scale editor and columnist.

[Click here](#) to learn more about John.

COMME-N-TARY: Utility Poles Tips for modeling this common right of way detail in N Scale

Modeling in the hobby's most eNgaging scale



Improving and modifying out-of-the box N scale utility poles ...

Utility poles are a little like the postman; often there but seldom noticed. Although these poles are disappearing from today's railroad right-of-way, they were once as common as 40' boxcars. And, like those boxcars, although they look similar, there are many variations.

A Little History

How is it that these poles ended up along the railroad right of way? Samuel Morse (the inventor of the telegraph) was contracted by the U.S. Congress to build a telegraph line from Baltimore to Washington in 1844. His initial underground attempt proved a failure so he strung the wire on overhead poles. He followed with an advertisement for:

"700 straight and sound chestnut posts with the bark on and of the following dimensions to wit: 'Each post must not be less than eight inches in diameter at the butt and tapering to five or six inches at the top. Six hundred and eighty of said posts to be 24 feet in length, and 20 of them 30 feet in length'".

Morse's success prompted telegraph companies to look for land to lay a network of lines between cities. Turns out, land for this grid was already there.



Figure 1: This line of poles shows the variety inherent even in modern utility poles.

The first railroad to offer use of its right of way for a telegraph line was the Delaware and Hudson Canal Company in Pennsylvania where poles were installed beginning in 1850. The New York and Lake Erie realized the utility of having the lines



Figure 2: The rust on these transformers shows that the poles and wires have been in service for a while.

along the tracks and telegraphed the first train order in 1851. Prior to the telegraph, trains operated strictly in accordance with timetables and often had to suffer considerable delay waiting for a late opposing train. That, or risk an unscheduled meet. With the stringing of telegraph lines, an interesting approach to model (and real) railroad operations was born. Those poles (and their replacements) were used through at least the end of the 20th century and are still there in many cases, even if the wires are gone.

Prototype Poles

Prototype utility poles are about 40 feet tall and buried to a depth of about six feet. Poles are usually spaced about 80-100 feet apart in cities and towns (sometimes much closer to accommodate branching utility lines or drops to customers), and between 150 and 300 feet along RR lines (closer on curves, longer on tangents).

They can reach over 100 feet high in order to provide clearance over intervening obstacles. They are harvested from forests all across North America from red cedar, Douglas fir, lodgepole, red, and southern yellow pine. More than a dozen companies supply poles to railroads and other customers. They are often delivered by rail (but that's another story).

Poles can have as many as six crossarms to carry 30 or more separate wires. Each wire is attached to the pole by means of a glass insulator. The insulator is often white although green, blue and other colors are also used. As the wires have disappeared, collecting the excess insulators has become quite a hobby. Examples can readily be found at memorabilia shows or on the internet. Some poles include distribution transformers (that trash can-looking cylinder atop the pole). Many are supported by guy wires, especially end poles and poles that carry branching wires. For additional support, sometimes a push-brace pole is attached at an angle to the first. Especially today, poles also can carry wires down the length of the pole to connect to



Figure 3: End poles often have one or more wires to stabilize them.

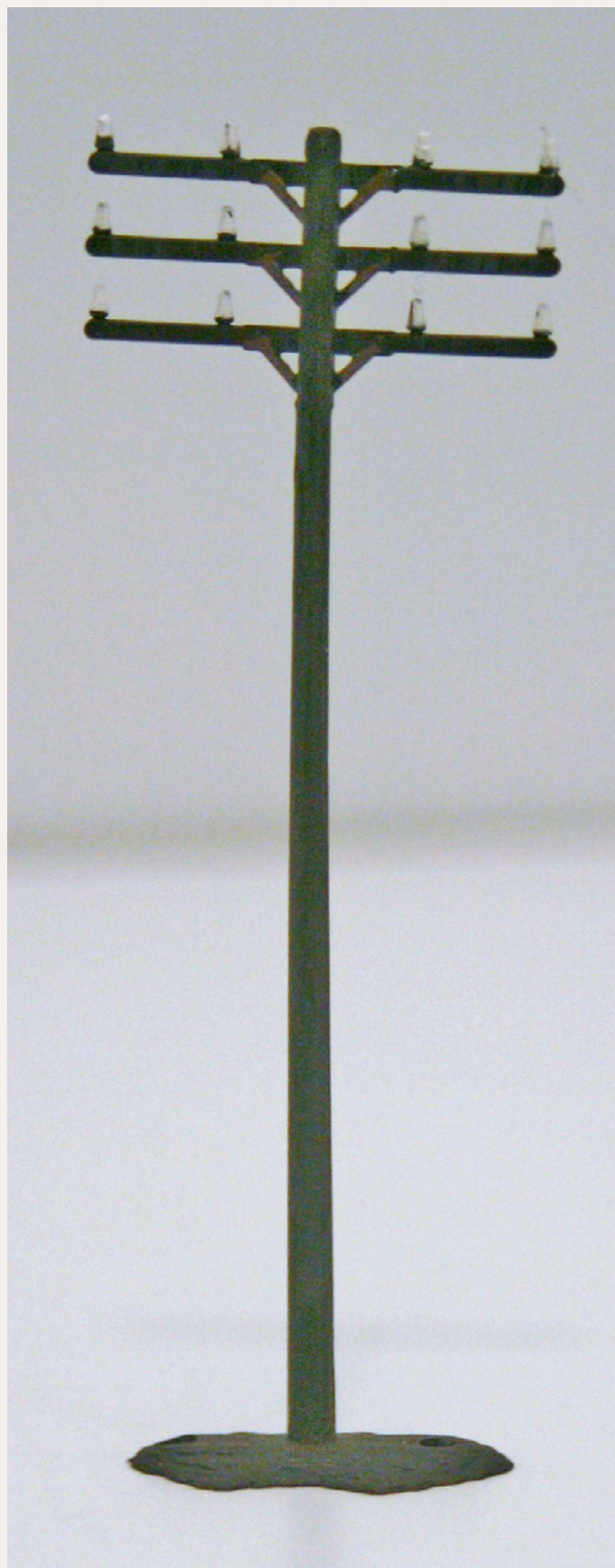

Figure 4: With a little effort, the appearance of the Atlas utility poles is much improved. Painting the insulators white and replacing the plastic shine with a more grimy, railroady color is all it takes.

underground wires (Morse's problem with such wires having been solved in the interim).

Simple Enhancements for "Kit" Utility Poles

Any model right-of-way up through at least the end of the 20th century ought to be paralleled by a line of utility poles. Traffic density usually determines how many wires are carried, and thus the number of crossarms. Several companies, including Atlas, Bachman and MRC offer such poles with a varying amount of detail and number of crossarms. The Atlas kit (the poles only need to be separated from the sprue and painted) is a good place to start. The "kit" includes 12 poles, all with three crossbars, carrying a total of 18 insulators.

First step is to correct the shiny plastic out-of-the box look. Today's poles often have a greenish tint, reflecting the chemical preservatives used to extend the life of the pole. Creosote was often used through the end of the 20th century, producing a blackish tint and strong odor. Take a look at photos from the period you are modeling. The poles will be there in the background in many images; lurking, just like the postman.

For most periods, spray painting with a medium grey color is a good start. Next step is to select a greenish, blackish or other appropriate color. Dilute the paint about 50% and apply generously over the grey undercoat. The idea is to let some of the grey show through.

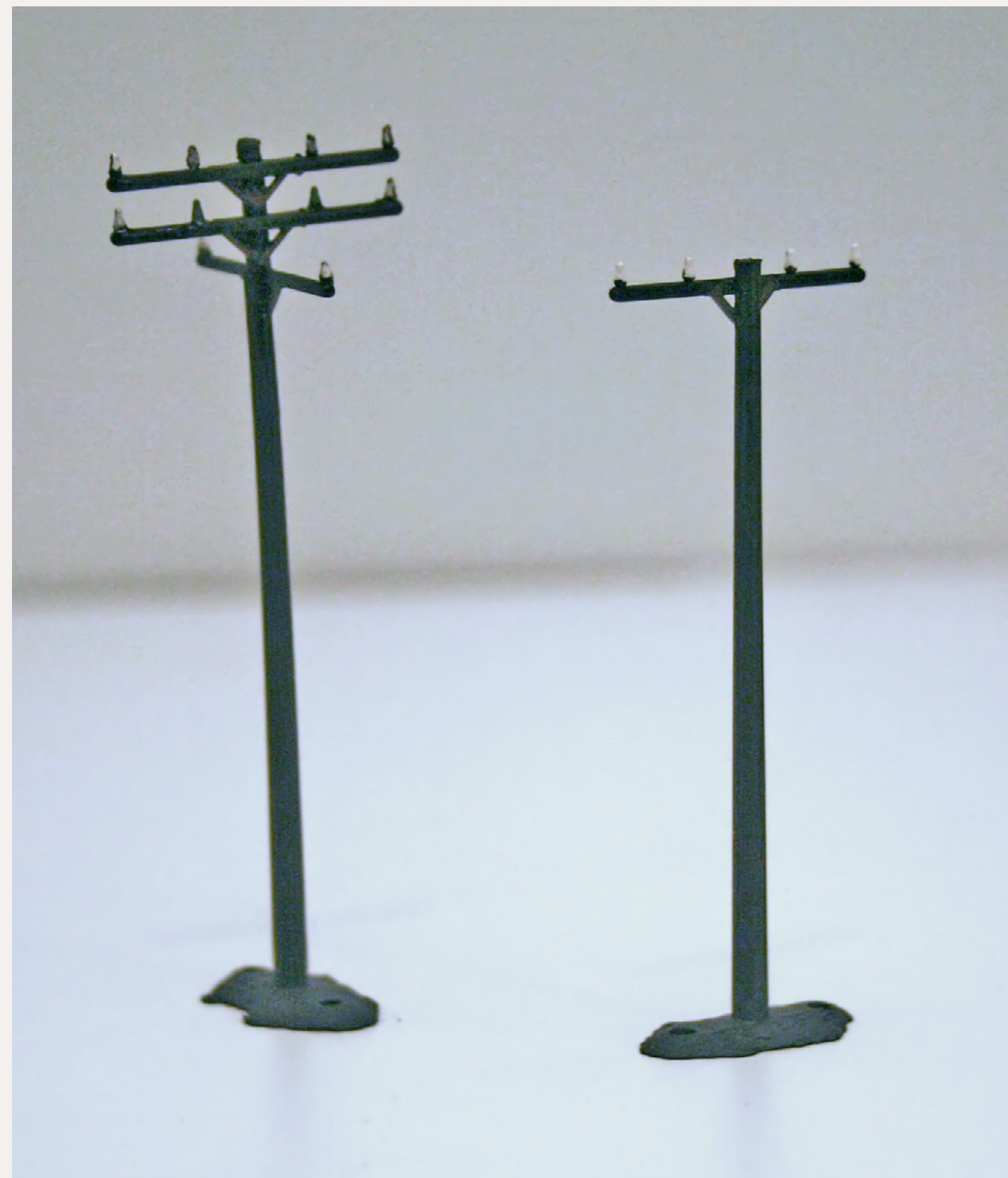

Figure 5: The Atlas poles are easily modified by removing crossarms or insulators or even rotating one or more crossarms 90 degrees to allow branching wires.



Once the paint dries, select (or mix) a color a few shades lighter than the poles. Take a stiff, wide brush and pick up just a little paint. Wipe most of it off with a towel. Then dry-brush this shade over the pole using light, vertical strokes. After a bit of practice, this will achieve the mottled, weathered look of prototype poles.

Insulators and Other Details

Next step is to paint the insulators. White is probably the most common color, but a few green or other colors can be included for a little variety. Take a very small brush and carefully apply your favorite color to the insulators.

Small metal braces support the attachment of the crossarms to the poles. These are usually a rusty metal color although many seem to have once been painted black. The same small brush can be used to pick them out. Some of the Atlas poles have a transformer cast into the crossbars. Unfortunately the casting process allows detail on only one side, so the transformer looks like a trash can split down the middle. This is fine if the pole is facing away from the viewer. Otherwise, the cast-on transformer can be carved off and replaced with a full cylinder from plastic rod. Either way, the transformer should be painted green or grey or another appropriate utility color. A little rust will illustrate that the poles have been in service for a while.

Modifying the Poles for Low Traffic Lines

The three crossarms on the Atlas poles are appropriate for a mid-20th

century medium to heavy density mainline. That's great for my PRR layout. However it is easy to modify the poles for less-busy trackage.

The top one or two crossarms can be carefully carved off to create a one or two crossarm pole. It is also easy to carve off the insulators for two or four wires per crossarm.

Poles with only one or two crossarms are also useful for lines that parallel country roads and city streets.

Wire or No Wire?

The last question is whether to string the wires on the poles. That is up to

the owner. The wires can disappear in photos with the right light or background so your railroad can explain that "the light isn't right" to see your wires. If, however, the light is right, there is a pretty good product to represent the wires. "E Z Line" from Berkshire Junction is thin, springy thread that does a great job of representing wire. The flexibility reduces the chances that a stray 0-5-0 will bring down a whole section of poles. The wire can be attached with a small drop of thin glue. The job is tedious but effective.

Summary

Whether the linemen on your railroad string wire or not, Atlas or other manufacturers' poles can be improved or modified with a few simple techniques, ensuring uninterrupted power to the railroad and on-line industries.

Here is a great website for more information about the details of utility poles and the various sorts of wires they carry.

See this URL for more:

annsgarden.com/poles/poles.htm#tjp 



Figure 6: Empty hoppers rumble past a line of utility poles on my N scale layout. A little paint makes it easy to produce a realistic row of this common lineside detail.

Model Railroad Hobbyist news™

July 2011



**Reader
Feedback**
(click here)



*The Old
Yardmaster*



**The latest model railroad
news, products, and events**

More Changes at Athearn/Horizon. Horizon Hobby is searching for a senior executive to oversee Athearn Trains. The previous director, Paula “Gwen” Mueller, departed in early June after just 18 months on the job. Mueller reportedly had no prior experience with the model railroad industry. Luann Crowley, a Horizon vice president, who managed production scheduling and dealt extensively with Athearn’s Chinese suppliers, has also left the company. The career opportunity posted by Horizon calls for a director of operations to be based in Long Beach, California, with responsibility for the development, design, engineering, and production scheduling of products under the Athearn, Roundhouse and McHenry brand names. The job description calls for significant interaction with Asian suppliers. Experience in the business of model railroading is a plus, but not mandatory.

Meanwhile, MRH has confirmed that Horizon executive, Victor Audo, has been appointed Interim Director of Proprietary Railroad Products. In an interview with

MRH, Mr. Audo acknowledged that he has no experience in the model railroad industry, adding that he is looking forward to a crash course in the hobby at the National Train Show in Sacramento this month...

It appears unlikely that River Point Station will be able to deliver any of the HO scale Dodge Challenger, Dodge Journey, and 1950 Ford Fordor models it announced earlier this year. RPS executive Ronald Elsdorfer said the problem with the Dodge brand is an unsustainable licensing and fee structure. He added that although River Point Station had already secured licensing for the Masterpiece Ford models, that too is now in doubt. While foreign entities can sell a variety of unlicensed North American prototype vehicles at aggressively low prices, ethical American operators, such River Point Station, are obligated to comply with the copyright laws of the United States – which in this case prevents them from offering a competitively-priced product...

Deluxe Innovations is now the authorized distributor of products imported by S&R Models including heavy equipment vehicles and container handling equipment made by Fujimoto. The models are made to 1:150 scale which is generally acceptable for N scale (1:160) scenic use.

For details visit deluxeinnovations.com ...

Wiseman Models (wisemanmodelservices.com) has purchased the inventory and tooling for the precision brass products of The Back Shop from the estate of David Braun. Wiseman has also acquired N Scale of Nevada from the family of the late John Coots, who is best known for establishing SS Ltd. Owner Keith Wiseman is dedicated to keeping some of the better cottage industry specialty products from fading away. In recent years, Wiseman has also acquired Walker Models, Thomas Yorke Products, and SS Ltd. Trucks...

Atlas has organized the Branchline passenger equipment it purchased earlier this year, and is now selling passenger car kits acquired in the transaction. See page 112 for details. Paul Graf, Atlas’ chief operating officer, said the passenger car tooling is now en route to its overseas manufacturing facility where the molds will be sampled and a production schedule established for a run of the full line of passenger cars...

Brian Leppert will soon announce the addition of a USRA Andrews truck to Tahoe Model Works’ highly-rated line of HO scale freight car trucks...

ExactRail now has printed instructions for assembling its undecorated P-S 7315 waffle boxcar kit. They are available for download at exactrail.com/p-s-7315-waffle-box-car-undecorated...

And speaking of ExactRail, the Provo, Utah-based company is looking for a designer with both print and web experience. Resumes should be sent to John Pestana at info@exactrail.com...

Rapido executive Bill Schneider says he will have updated samples of their new HO scale General American wood reefers available for inspection at the National Train Show in Sacramento this month...

Western Prototype Modelers chairman Tim Costello, reports that a full Railroad Prototype Modelers meet will be conducted in Sacramento during the 2011 NMRA National Convention. In addition to the usual model displays and RPM camaraderie, presentations by nationally-recognized modelers and historians are scheduled. The RPM room will be active from noon until 8 PM on July 6 and 7 in the Sacramento Convention Center Complex, 1400 J Street. Complete details on the week-long NMRA convention can be found at [x2011west.org](http://x2011west.org...)...

Our thanks to Buck Dean, an official of the Atlantic Coast Line & Seaboard Air Line Railroads Historical Society, who called our attention to an error in last month's news report. We intended to say that Athearn would be releasing its new GP9 locomotive decorated for Seaboard Air Line, however, in our excitement (and with no thanks our spell-check program) it came out as Seaboard Airlines....

More errors popped up last month in our report on new decals. We erroneously said that the rivets, louvers and grillwork on Micro-Mark's new decals were composed of resin. We subsequently learned that Micro-Mark is using a proprietary material other than resin. Also, we failed to inform readers that the new decals continue to be available at the introductory price of \$9.95 for a package of two sheets. We apologize for the confusion. For additional details, or to order, visit [micromark.com](http://micromark.com...)...

Now let's take a look at this month's wide assortment of new products...

NEW PRODUCTS FOR MULTIPLE SCALES

Prototype Railroad Images (rrimages.net) produces and sells a variety of photo-CDs of railroad subjects. Subject matter covers diesel locomotives, cabooses, MoW equipment, and freight cars of all types. Each CD focuses on the equipment of a particular railroad. Currently available are CDs for Western Pacific, Sacramento Northern, Tidewater Southern, Southern Pacific, Cotton Belt, Pacific Electric, Northwestern Pacific, San Diego & Arizona Eastern, and Burlington

Northern. Prices begin at \$19.95 for a single CD. Owner Peter Arnold said additional subjects under development include Burlington Northern ALCo diesel Locomotives.



Frenchman River Model Works (frenchmanriver.com) has introduced scale wooden barrels in HO, S and O scale. Details of the one-piece, cast-resin barrels include fine wood graining. The barrels are unpainted and come in packs of six priced at \$5.00 for HO, \$6.50 for S, and \$8.00 for O scale.

Also new are unpainted resin-castings of wooden crates sized for S and O scale. These join the previously-released HO scale versions. Cast-in details include nail holes and wood graining. HO crates are six for \$8.00, S scale are six for \$10.00, and O scale crates are three for \$6.00.

Microscale Industries (microscale.com) has introduced a new adhesive and primer that will make it easier for model builders to bond slippery engineering plastics, such as Delrin, to other materials. Microscale's new products include MicroPrep which is used as an undercoat before applying paint or MicroBond to the high-tech plastic.

NJ International, Inc. (njinternational.com) has HO and O scale Powered Blue Flags that, like the prototype, serves to warn operators not to move the protected car. The flag moves from horizontal to a vertical position and has an



illuminated blue light at the top. HO units are priced at \$9.99, O scale units are priced at \$19.99 each. Additional details are available at N.J. International's web site.

LARGE SCALE PRODUCT NEWS



Accucraft (accucraft.com) has introduced this 1:32 scale live-steam model of a Southern Pacific GS-5 locomotive. Handcrafted of brass and steel, the 45mm gauge model requires a minimum radius of 10 feet. It is available in black as well as in the distinctive SP Daylight scheme. Features include ball bearings on all axles, and working Walschaerts valve gear. The limited edition model

is priced at \$5,000 each.



Bachmann (bachmanntrains.com) has updated its 20-year old large-scale Big Hauler 2-4-2 with metal gears, metal gearbox, diecast siderods and trucks. A convenient three-position, center-off switch has been added to provide a choice of operating to NMRA standards or normal large-scale modeling practice. The locomotive comes with a factory-installed speaker and is ready for an

aftermarket DCC decoder and sound system. Bachmann's 2-4-2 was inspired by a prototype Baldwin built for export as well as domestic users. Paint schemes include unlettered black, unlettered black with red windows and white pin-stripes, unlettered green and black with white pinstripes (shown), and Lyn – Southern, a scheme inspired by the Lynton & Barnstaple Railway that served Devonshire County in West England. The model has an MSRP of \$325.00 each.

O SCALE PRODUCT NEWS



Alkem (alkemscalemodels.net) is selling kits for this 19th century switch stand suitable for O, On2, On3, and On30 stub turnouts. The 1:48 scale kit uses a fold-up design to simplify construction. The lever arm and the pivot point have two positions to allow the stand to control a conventional two-way stub turnout, or a three-way or double-slip stub turnout. The modeler is given a choice of four different types of targets in each kit. They may be ordered direct through the above web site at \$9.99 each.



Aspen Modeling Co. (theaspenmodelingcompany.com) has expanded its line of O and S scale figures with the addition of an exceptionally well-sculptured steer. The cast resin body comes with a choice of three heads: looking left, right or down. Each version of the unpainted model sells for \$8. Other critters in the Aspen line include a buffalo, pack mules, grazing cow, bull, longhorn cattle, sheep, and horses in a variety of positions and harnesses.

Protocraft (protocraft.com) has brass models of a 1922-era wood-sheathed ice-refrigerator car that follows a prototype built by AC&F for ART, NWX, and URTX. Many of the prototypes saw service well into the 1950s. Handcrafted in Korea by Boo-Rim Precision, the models are available in O scale as well as Proto:48 with a



choice of either Simplex arch bar or Bettendorf-type trucks. All wheelsets have ribbed backs and are made of sintered metal. Couplers are not included, however, the cars are designed to accept either a Protocraft or Kadee® coupler box. The cars are priced at \$279 each.

HO SCALE PRODUCT NEWS



New items from **Accurail Inc.** (accurail.com) this month include an HO scale kit for a Texas & Pacific 50-ton offset-side two-bay hopper car at \$13.98 each. Additional new items include kits for 55-ton USRA two-bay hoppers decorated for Boston & Maine, and Norfolk & Western at \$12.98 each. Accurail also has a CNJ 41' AAR steel gondola available singly at \$13.98, or in a 3-pack with different car numbers at \$39.98.



Athearn Trains, division of Horizon Hobby (athearn.com), has announced two new road names for its HO scale Genesis series EMD GP7/GP9 locomotives due in March, 2012. The GP7 will be available in Santa Fe's black scheme with zebra stripes. The GP9 will be decorated for New York Central with a gray body and lightning stripes. Each road name will be offered in four numbers. Features include wire grab irons, etched grilles, operating headlights with microbulbs, and several road-specific details. Standard DC versions will have an MSRP of \$179.98 each, while units equipped with a DCC decoder and Tsunami Sound™ will be \$279.98 each.

Athearn will have a significantly upgraded version of the old MDC 24' ore hopper car in December decorated for Bessemer & Lake Erie, Missabe & Iron Range, Lake Superior & Ispeming, and Milwaukee Road. In addition to a removable injection-molded load of raw ore, the cars will feature a heavy cast metal underframe, metal RP25 wheelsets, and McHenry knuckle couplers. Each road name will be available on individual cars at \$18.98 each, and in four 6-packs, all with different car numbers. That's a total of 25 numbers for each road name.

Atlas Model Railroad Company (atlasrr.com) has combed through and reorganized all of the finished-goods inventory it acquired from Branchline earlier this year and has submitted a list of the available passenger car kits to its dealers. The original Blueprint series featured authentic paint schemes, and easy construction. Details provided on all kits include full interiors with scale window glass, appropriate roof vents and air conditioning ducts, correct body details such as belt rails and rivet patterns, correct air condition system (ice-activated, steam-ejector, or Pullman's own mechanical and brine system), complete

end-details such as operating diaphragms, uncoupling levers, and appropriate air, steam, and signal lines. Underframe details include appropriate generators, air tanks, steam traps, and brake rigging. All Atlas Branchline-series passenger kits are \$39.95 each. The seven car types available now include:

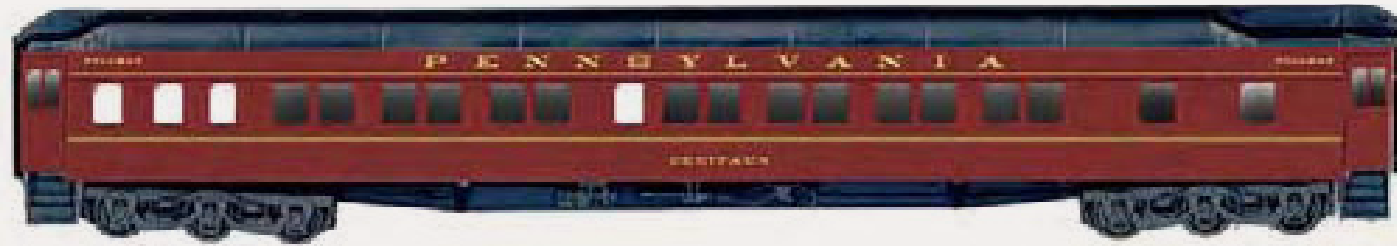

Pullman 8-1-2 sleeper (8 sections, 1 drawing room, 2 compartments) in 10 road names with full lettering and car names including PRR "Centhill" (Atlas #B5022) shown above.



Pullman 10-1-2 sleeper (10 sections, 1 drawing room, 2 compartments) available in the Missouri Pacific Eagle "Lake Fortuna" scheme shown above (Atlas #B5210) plus 16 additional roads.



Pullman 12-1 sleeper (12 sections, 1 drawing room) shown here decorated as Norfolk & Western "Sunstar Rose" (Atlas #B5334), also available in 21 other road names.



Pullman 14 section sleeper is available decorated in 11 railroad liveries including the NYC "Park Point" (Atlas #B5404) shown above.



Pullman 6-3 sleeper (6 compartments, 3 drawing rooms) is currently available in 8 road names including Seaboard's "Glen Crag" (Atlas #B5617) shown above.



Coaches include this 80' paired-window layout decorated for Baltimore & Ohio (Atlas #B5702). A Milwaukee Road version is also currently available.

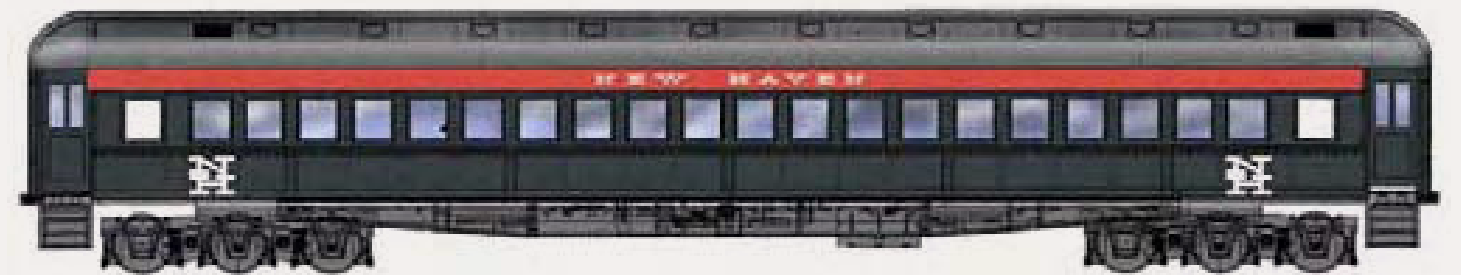

This 80' single-window coach is available now for 10 roads including this McGinnis style New Haven version (Atlas #B5117). The prototype of this model was built by Pullman, ACF, Standard Steel and others for the New York Central System. Cars of essentially the same design were built for many other railroads.



Bachmann (bachmanntrains.com) is offering this "modern" version of a classic 4-4-0 American locomotive with DCC and no sound at \$300, or with DCC and Tsunami® by Soundtraxx.® at \$445.

The boiler, chassis, and frame of the HO scale model are diecast metal. Other features include a cog V-belt drive system, operating headlight, a detailed back-head, and painted engineer and fireman.

It is available decorated for Louisville & Nashville #144, Southern #3858, Seaboard #106, Great Northern #124 (green & black), and B&O #1401. The model is also available unlettered, painted black with graphite smoke box and firebox.



Blackstone Models (blackstonemodels.com) is taking advance reservations for an HO_{N3} scale East Broad Top 3-bay hopper car. The three-foot EBT hauled a variety of bulk freight during its six decades of operation but the main traffic was always coal. Blackstone's ready-to-run cars are expected to have their usual attention to detail including wire grab irons, full brake and underbody rigging details, Vulcan trucks, and factory installed couplers. Multiple decorating schemes will be offered at \$54.95 each as well as weathered at \$59.95 each.



Broadway Limited (broadway-limited.com) has announced a new Southern Pacific class AC5 4-8-8-2 Cab-Forward steam locomotive. BLI has produced Cab-Forwards in the past, however, models in this new release are the first to be offered with the new Paragon2 sound and control system. Principal features include dual-mode DC and DCC operation with back-EMF motor control, and recordable DCC operation for automated playback. Additional features include synchronized puffing smoke, prototypical operation for headlight and cab light, ABS plastic body with die-cast chassis, all-wheel drive and pickup. The MSRP is \$499.99 each.

Bowser Manufacturing (bowser-trains.com) is taking preorders for an ALCo Century C-628 diesel locomotive that will be produced from revised tooling. The HO scale ready-to-run model is in Bowser's Executive Line of deluxe models that feature such details as MU Hoses, air hoses, windshield wipers, operating headlight, window glass, can-motor with flywheel, blackened nickel-silver wheels with RP25 flanges, and knuckle couplers. Decorating schemes include two road numbers each for Lehigh Valley (snowbird), Lehigh Valley (Cornell red), Delaware & Hudson (above), N de M (Nacionales de México), Hamersley Iron, L&N, and FCP (Ferrocarril Del Pacifico). A choice of operating systems include standard DC at \$189.95, and DCC with SoundTraxx® sound at \$299.95. Availability is scheduled for January 2012.

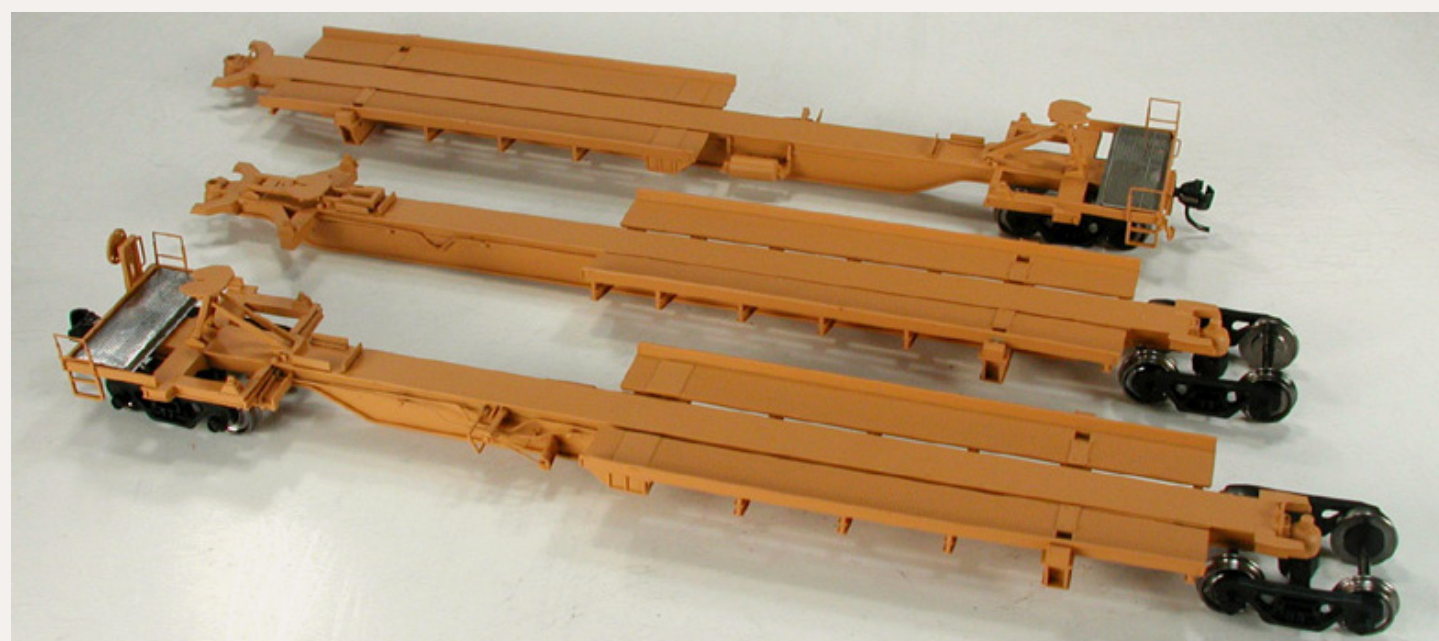

Bowser is also taking preorders through July 15 for January delivery of 3- and 5-car sets of Trinity 53' RAF53C spine cars. The ready-to-run cars will feature plastic and die-cast metal construction, chemically-etched walkways, positionable hitches (collapsed or raised), and Kadee® couplers. The 3-car set will be priced at \$99.95, while the 5-car set will be \$164.95. All units will have unique car numbers.

Brass Car Sides (brasscarsides.com) is preparing HO and N scale photo-etched brass sides for the Great Northern 1947 Empire Builder and 1951 Western Star. The project will include streamliner sides for GN and CB&Q's lunch-counter-lounge-dormitory car, and GN's Lake series cars built to Pullman plan 7498. The brass sides include the original full skirting with etched line details and grab iron holes. The center skirts may be removed to model the cars in their later appearance. The HO sides are sized to fit Walthers Empire Builder Ranch and Lake dining car bodies. N scale sides are designed for use with the American Limited Models core kits. Visit the above website for additional details including pricing and ordering requirements.



Grandt Line (grandtline.com) has a limited supply of HOn3 Colorado & Southern/Rio Grande Southern steel underframe stock cars. The kits are available in a special 2-pack at \$50 direct plus shipping. Visit the above web site to order.



ExactRail (exactrail.com) has released another run of HO scale Pullman-Standard 7315 cu ft waffle boxcars. Road names on this second release of the 60' car includes L&N NW, BNSF, DT&I, CSXJ, ATSF, and the Southern scheme shown here. An undecorated kit is also available. The car comes with Kadee® #58 couplers, and 100-ton ASF ride-control trucks with 36" machined wheels. The Platinum series car has an MSRP of \$32.95.

InterMountain (intermountain-railway.com) plans to deliver an HO scale P-S 5277 cu ft exterior-post boxcar early next year decorated for Railbox (original scheme), Railbox (late scheme), BN, CSX, RF&P, SSAM (Wisconsin Central) St. Mary's, and Valdosta. The cars will have etched metal crosswalks and will be priced at \$33.95 each.

InterMountain will also deliver an HO scale milk car next January/February that will feature an etched-metal running board, wire brake rigging, and wire grab irons. Road names will be Borden's, Dairyman's League, Whiting Milk Company, Chateau Martin, H.P. Hood & Sons, and United Farmers. It will also be available as a maintenance of way water car for GM&O, and Illinois Central. The MSRP will be \$32.95.

GHB International (ghbintl.com), an established importer of a variety of models including HO and O scale traction equipment, has announced plans to import an HO scale model of the 1937 Reading Crusader that operated between Jersey City and Philadelphia. Like the prototype, the GHB train set will consist of a streamlined 4-6-2 Pacific locomotive and five cars including a diner, two coaches, and two observations (only the locomotives required turning at each terminal). The DCC-ready locomotive will be offered in road numbers 117 and 118. Availability is expected late this year or in early 2012. Pricing information is pending.



Motrak Models (motrakmodels.net) has released a new HO scale laser-cut kit for a small maintenance-of-way shed. The kit is composed of laser-cut wood walls, laser-cut peel-n-stick 3-tab shingles, and Tichy doors and windows. Instructions include a template for assembling pallets. The finished structure is 3" tall, and has a footprint of 5-1/2" x 2-1/2". The kit sells for \$38.00 plus \$8.00 shipping to any US or Canadian address.



M.T.H. Electric Trains (mthtrains.com) is quoting a fall delivery date for a new HO scale GG-1 electric locomotive. Features of the metal die-cast model include LED lighting, remotely controlled Proto-Couplers that can be triggered with any DCC controller (available on Proto-Sound 3.0 equipped models only), motorized automatic pantograph operation, and a 12-volt 5-pole skew-wound motor with a flywheel. The GG-1 will be available in eight paint schemes including PRR-Tuscan red with 5 stripes, PRR-Tuscan red with single stripe, PRR-Brunswick green with 5 stripes, PRR-Brunswick green with single stripe, PRR-silver scheme, Amtrak, Conrail, and Penn Central. The model will be available with either Proto-Sound 3.0 for both standard DC and DCC operation, or with Proto-Sound 3E+ for 3-rail AC operation when using the Märklin DCC system. Both versions have a retail price of \$419.95 each.

Northwest Short Line (nwsl.com) has a new kit to convert a Bachmann® Spectrum® 3-truck HO standard gauge Shay locomotive to HOn3. The conversion project is for experienced modelers, and while instructions are included in the kit (#2730-6 at \$44.95 each), NWSL owner Dave Rygmyr cautions that unless you are an advanced modeler, you may want to consider having the complex conversion done by a professional builder. The kit includes a Sensi-Press tool specially made for this conversion, and a V-plate to facilitate removing the factory axles from the wheel. If a Sensi-Press is not available, the tool can be chucked in a drill press. The brake parts are lost-wax brass castings and the axles are machined from brass and Delrin. The special styrene bolsters in the kit were produced using Rapid Prototyping (RP) – a good example of how complex parts can be produced in low-volume without the expense of machining a metal mold. According to Rygmyr, if a metal mold had been required the conversion kit would not have been made. Only a limited number of the conversion kits will be made and there will be no further production. It will not be cataloged and will not be advertised.



Precision Scale Co., Inc. (psc1.virtualfocus.com) has announced a project to import HOn3 scale models of D&RGW head-end cars, including an RPO, baggage, and combine car in a variety of paint schemes found on the prototype from the 1930s through the 1960s. The combine and baggage cars will be available both with and without a cupola. The cars are being handcrafted in brass in Korea by Boo Rim Precision Company. Pricing and availability dates are pending.

Red Caboose is preparing two versions of its general-service drop-bottom gondola for release early next year. Cars with steel sides will be available for Illinois Central-Mainline, D&RGW, Milwaukee Road, and Southern Pacific – all in a choice of six road numbers at \$33.95 each. A composite version with steel sides and plywood extensions will be priced at \$36.95 each. Road names will include Southern Pacific (beet service), SP&S (woodchip service), and Western Pacific (woodchip service). The last two cars will be available in six different numbers while the SP version will come in 12 numbers. Red Caboose models are distributed by Intermountain Railway Company at intermountain-railway.com.



Rapido Trains, Inc. (rapidotrains.com) has announced new Via Canada paint schemes for its HO scale LRC (light, rapid, comfortable) coach and club car. The Canada logo and large waving flag, seen here, were applied to the prototype in 1998, and the new VIA 1 logo was added in 2002. Rapido says its latest edition will feature post-1992 interior colors, and the slightly darker exterior blue and

yellow shades used in recent years on the Bombardier-built prototype. The cars have an MSRP of \$74.95 each. Information on availability is pending.



Rapido has released HO scale Canadian Pacific coaches in both the CP Block (top) and CP Rail Action Red (above) decorating schemes. Check with your dealer for immediate availability since these models arrived slightly ahead of schedule.



Rapido and Rocky Mountaineer Vacations joined forces to create these handsome Dayniter Coaches in the distinctive Rocky Mountaineer paint scheme. They

are available exclusively through Rocky Mountaineer Vacations at <https://souvenirs.rockymountaineer.com/rmv-c-55-heritage-collection.aspx>. The collection includes a baggage car, Red Leaf coach, and a Whistler coach.

Cast resin projects currently under development at **Smoky Mountain Model Works** include an SAL class B-7 40' boxcar with turtleback roof with special Silver Meteor decals, and an Erie-Lackawanna transfer caboose. Details on the HO scale kits should be available soon at smokymountainmodelworks.com.



Stella Scale Models (stellascalemodels.com) is selling an HO scale craftsmen kit for Snyder Milling Company. The still-standing prototype was built in 1899 in Nazareth, New Jersey. Originally known as the Flory Milling Company, the name was changed to Snyder in 1939. Stella's kit is composed of three stand-alone structures with laser-cut walls, roof cards, shingles and acrylic window glazing. Details include resin building foundations, retaining walls, roof vents, waste bin, barrels, trash cans, and brooms, plus Tichy windows and doors. Footprints are 4-1/4" x 12" for the main building, 3-1/2" x 5" for the barn, and 6" x 6" for the elevator. The elevator has an angled wall for installation along a curved track and the structures can be arranged in a variety of ways to fit available layout space. The kit is priced at \$274.95 plus \$6.50 shipping and handling. Free shipping is offered until September 1, 2011.

Sunshine Models has a number of HO scale resin kits on their long-range production schedule including, automobile cars for Soo Line 75400 series outside-braced 1-1/2 door cars from the 1920s and '30s, Illinois Central 40' and 50' square-corner automobile cars, Wabash 1920s-era 10' IH outside-braced auto cars, and similar single-sheathed auto cars from the CNW, Pere Marquette, and Missouri Pacific. Prototypically-accurate boxcar kits under development include Cotton Belt 20000 series 50' car with ACR sides and an 8' single door; Mather's

tallest boxcars for AC&Y, GM&O, MRS, and Trona; and a slightly shorter version of the car for Ball Line. Stock cars on Sunshine's schedule include a CNW car rebuilt with Viking roof and Dreadnaught ends in 1927 from single-sheathed boxcars, an ATSF rebuilt stockcar, and a series of Fowler 8' IH boxcars that Rock Island converted to stock cars after World War II. Sunshine does not have a presence on the Internet, but pricing, kit details and ordering information is maintained by Jim Hayes at sunshinekits.com.

Sylvan Scale Models (isp.ca/sylvan) will soon release new HO scale vehicle models including a unique Southern California Helm's Bread truck, and 1933 Willys coupe, sedan, and panel trucks.

Walthers (walthers.com) has released three new HO scale ready-to-run passenger cars decorated for a variety of roads. A 24" minimum radius is recommended for the cars, which have an MSRP of \$64.98 each.



In addition to the PRR-Fleet of Modernism scheme shown here (Walthers #932-15255), this Pullman-Standard 85' streamlined smooth-side 4-4-2 sleeper with skirts is also available for PRR-standard scheme, CNW, NP, and NYC.

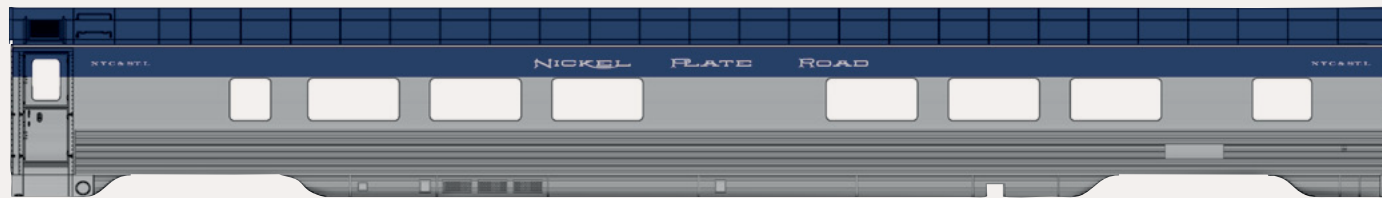

The Pullman-Standard 52-seat coach shown here for the Nickel Plate Road (Walthers #932-15304), is also available decorated for ATSF, Chicago & North Western, Denver & Rio Grande Western, PRR, Rock Island, and Union Pacific. The 85' car will have either fluted or smooth sides as appropriate to the prototype road.



This 73' Pullman-Standard baggage car is available for Canadian National, Chicago Great Western, Great Northern-Big Sky scheme, GM&O, L&N, and Kansas City Southern (Walthers #932 15055) as illustrated here.

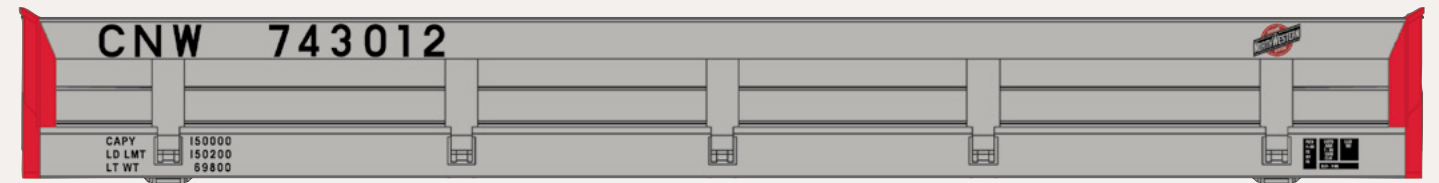

A delivery date of January 2012 has been announced for several Walthers products including new road names for this Platinum Line™ Difco® 100-ton pneumatic dump car. Decorating schemes will include British Columbia Railway, CP Rail, Chicago & North Western, DMIR, Green Bay Western, and L&N. The MSRP will be \$34.98.

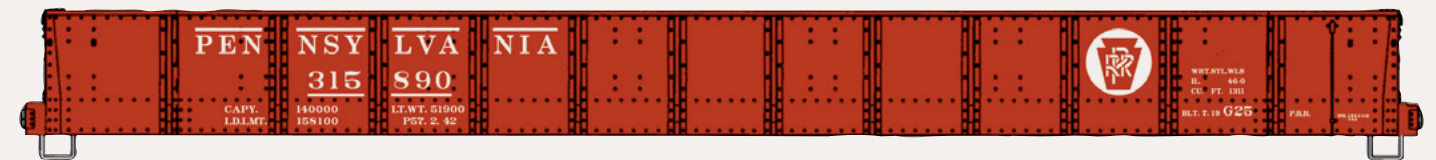

Additional freight cars due next January include a Platinum Line™ 46' USRA steel gondola decorated for PRR, B&O, NKP, and NYC. It will be priced at \$24.98.



An HO scale model of an Evans 50' boxcar will be available in January 2012 decorated for Canadian National, Conrail (blue with Penn Central patch), Conrail (U.S. Savings Bond scheme), and Western Pacific. The MSRP will be \$19.98.

Walthers has set a January delivery date for Proto 2000® EMD SD9 diesels decorated for BNSF (BN patch), Conrail (PRR patch), Southern (phase 2), and Southern Pacific (phase 1, black widow). Notable features include 14:1 helical gears, LED constant and directional headlights, metal grab irons and lift rings, and a high-torque can motor. The HO scale ready-to-run model will be available for DC operation at \$199.98, or with SoundTraxx® DCC at \$299.98. This January release is in addition to a production run due this October of SD9s decorated for BN, Chessie/B&O, D&RGW, and Great Northern.

A Proto 2000® model of General Electric's U28/30B (with technical specs similar to the SD9) is also scheduled for release next January. It will be decorated for

CB&Q (U28B phase 2 in Chinese red and gray), L&N (U28B phase 2 in gray with yellow nose), Conrail (U30B phase 1), and Western Pacific (U30B phase 1 in green & orange). The HO scale ready-to-run model will be available for DC operation at \$199.98, or with SoundTraxx® DCC at \$299.98.

N SCALE PRODUCT NEWS



Bachmann (bachmanntrains.com) has introduced a DCC-equipped model of an EMD GP7 diesel locomotive. Electro Motive Division introduced the prototype of the first generation of general-purpose locomotives in 1949. Bachmann's N scale ready-to-run version comes with an NMRA-compliant DCC decoder (for speed, direction, and lighting), and LED lighting. Paint schemes include PRR, Chessie, B&O, and New York Central. Clinchfield and Union Pacific models will also be available with dynamic brakes. The ready-to-run model has an MSRP of \$109.00.

Centralia Car Shops is preparing new tooling for a modern smooth-side baggage car that will be released after the first of the year in 16 road names and schemes. The list includes Amtrak, Chicago Great Western, Burlington Northern, Chicago Northwestern, CB&Q, Delaware & Hudson, Canadian National, Illinois Central, NYC, Great Northern, GN (Big Sky blue), Penn Central, Rock Island, Northern Pacific, Union Pacific, and Milwaukee Road. The Milwaukee car will be available in one car number, all others in two numbers. All versions are priced at \$49.95 each. Centralia Car Shops models are distributed by InterMountain Railway Company at intermountain-railway.com.



ExactRail (exactrail.com) has released an N scale PS-2, 4427 cu ft covered hopper car decorated for BNSF, TLDX (Archer Daniel Midland), TLDX (Continental Grain Company), and Milwaukee Road, as shown here. Features of the ready-to-run model include an etched stainless-steel roof walk, McHenry knuckle-sprung trucks, and Athearn 100-ton trucks with machined 36" wheels. The ready-to-run model is priced at \$24.95.

InterMountain (intermountain-railway.com) plans to deliver an N scale P-S 5277 cu ft exterior-post boxcar early next year decorated for Railbox (original scheme), Railbox (late scheme), BN, CSX, RF&P, SSAM (Wisconsin Central), St. Mary's, and Valdosta. The cars will have etched metal crosswalks and will come with MicroTrains® trucks and couplers. The MSRP will be \$19.95 each.

InterMountain will also deliver an N scale milk car next January/February that will feature an etched metal running board, wire brake rigging, and wire grab irons. Road names will include Borden's, Dairymen's League, Whiting Milk Company, Chateau Martin, H.P. Hood & Sons, and United Farmers. It will also be available as a maintenance-of-way water car for GM&O, and Illinois Central. The MSRP will be \$19.95.

Kato USA (katousa.com) has a limited quantity of N scale Kobo Custom Jet RDC's for

immediate shipment at \$295.00 each. The N scale model replicates the one-of-a-kind New York Central M-4979 Jet-Powered RDC built in 1966. Equipped with a pair of J47 boosters, similar to those used on Boeing's B-47



Stratojet bomber, the modified RDC-3 broke land-speed light-rail records with speeds of over 183 miles per hour. Kato's N scale version comes with DCC to control speed, horn, and jet engine sound with variable levels for jet engine. The headlight, tail lights, and flickering booster ignition light are also controlled by DCC.



Here's an early look at Kato's KCS Southern Belle SD70ACe due to be released in late July. The same SD70ACe production release will include a rerun of the popular George Bush locomotive from UP's Heritage Fleet.

Trainworx (train-worx.com) is soliciting reservations now for delivery in December of new 4-bay open hopper cars decorated for Seaboard System, Conrail, Norfolk Southern, and two Illinois Central paint schemes: with split-rail logo in red, and with bold ICG lettering.

NEW DECALS, SIGNS AND FINISHING PRODUCTS

CustomTraxx (customtraxx.com) has introduced an upgraded decal set for Lehigh Valley Transit. The decals are intended for use with KND Enterprises HO scale resin-cast 700 and 1000 series steel interurban cars. Set CN-1030 is priced at \$13.95.

Jerry Glow has designed an HO scale decal set for IGA to fit a MiniMetals delivery truck. The set sells for \$5.00. Glow also has an IGA Super Markets store sign to fit City Classic market structure. It is priced at \$2.00. New railroad decals under development include ACL and SCL



40' boxcars with roof hatches. Visit home.comcast.net/~jerryglow/decals.html for ordering instructions, as well as a current list of railroad decals available.

A price increase on all **Microscale** (microscale.com) decals became effective July 1, 2011. The company said they have been avoiding making the change for some time but the ever increasing cost of raw materials could no longer be absorbed. On a more positive note, Microscale has released three new lettering sets this month including HO scale decals for The Great Northern Empire Builder from 1920 to 1950, including Pullman-owned cars. New HO and N scale lettering sets are available for Union Pacific 57' ARMN rebuilt reefers and TRINcool reefers, also Illinois Terminal Railroad second generation locomotive stripes. Almost ready for release are Amtrak Anniversary locomotives schemes including the F40PH.

Mount Vernon Shops (mountvernonshops.com) has HO and N scale decal sets for PRR class ND, NDa, N6a, and N6b wood cabin cars. The lettering is for the period preceding the introduction of the Shadow Keystone scheme in 1954. Division and region assignments for the entire Pennsylvania system are included. The HO set is priced at \$15.00 and contains sufficient material to letter up to 12 cars. The N scale set is priced at \$5.00 and will letter one car.

Underground Railway Press sells a wide variety of structure signs including decals for an extensive collection of T2 Ghost Signs made from photos of real signs. Each decal set includes 4 to 10 pre-weathered signs of various sizes. The sets are available in HO at \$5.00, and O scale at \$8.00. The entire collection is illustrated in URP's 2011 catalog, which also lists hundreds of scale drawings for sale. Plans are available for logging, mainline, narrow gauge, traction, and shortline railroad equipment, and related structures. To obtain the catalog send \$2.00 to Underground Railway Press, PO Box 814OM, Brevard NC, 28712.

WrightTrak (wrighttrak.com) has HO scale decals for B&O class M53/M53A wagon-top boxcars. The Baltimore & Ohio Historical Society has approved the accuracy of the decals, which are priced at \$5.00, plus \$1.00 shipping and handling.

DISCLAIMER

The opinions expressed in this column are those of the writer and do not necessarily reflect the opinion of *Model Railroad Hobbyist* or its sponsors. Every effort is made to provide our readers with accurate and responsible news and information, however, neither *Model Railroad Hobbyist* or the writer of this column can be held responsible for any inaccuracies or typographical errors that may inadvertently appear in this column.



Selected Events

July 2011

CALIFORNIA, BAY AREA, July 10-14, Bay Area Garden Railway Society Convention, self-tour of approximately 50 garden layouts. Info at bagrs.org.

CALIFORNIA, McCLELLAN, (Sacramento area), July 13-17, National Summer Steamup, headquartered at Lions Gate Hotel, 3410 Westover St., phone 916-643-6222. Includes

operating small-scale live steam equipment from around the world. Send inquiries to steamup@summersteamup.com.

CALIFORNIA, SACRAMENTO, July 3-9, Combined NMRA National and National Association of S Gaugers Annual Conventions, Sheraton Grand Hotel. Info at x2011west.org.

CALIFORNIA, SACRAMENTO, July 6-7, Railroad Prototype Modelers Meet (in conjunction with NMRA National Convention). Includes RPM clinics and model displays (no contests). Sacramento Convention Center Complex, 1400 J Street. Info at x2011west.org.

CALIFORNIA, SACRAMENTO, July 7-9, National Train Show, Sacramento Convention Center. Info at x2011west.org/trainshow.html.

CALIFORNIA, SAN DIEGO, through July 29, Railroad Summer Camp for Kids at San Diego Model Railroad Museum, 1649 El Prado, Balboa Park. Sessions include museum tours, railroad history, railroad workbooks, railroad safety education, diesel/steam engine mechanics, and assembling a model railroad freight car. Registration open for six 5-day sessions in three different age groups. Details from Olga Cortes at 619-696-0199 or visit sdmodelrailroadm.com/#/summer-camp/.

ILLINOIS, ROCK ISLAND, July 21-24, Train Festival 2011, train rides, cab tours, cabooses rides, exhibits, and family fun. Info at trainfestival2011.com.

August 2011

CALIFORNIA, BUENA PARK, August 7, Railroadiana & Transportation Show, UFCW Hall, 8550 Stanton Avenue (at Crescent Avenue). Info at californiaexpress.net.

FLORIDA, THE VILLAGES, August 20-21, Rail Expo 2011, model train and railroadiana show, Lake Miona Rec Center, 1526 Buena Vista Blvd. Info from Alan Goldberg at amgold15@hotmail.com.

ILLINOIS, COLLINSVILLE, (St. Louis area), August 5-6, St. Louis RPM Meet. Vendor displays and operating FreeMo layout. Clinicians include Rob Adams, Ed Hawkins, Chuck Hitchcock, Keith Jordan, Daniel & John Kohlberg, David Lehlbach (Tangent Scale Models), Nick Molo (Moloco), Clark Propst, Dave Schroedle (Protoweathering.com), and Mont Switzer. Gateway Convention Center, One Gateway Drive. Info from John Golden at golden1014@yahoo.com (812) 929-7181, or Dan Kohlberg at paducah@mindspring.com.

VIRGINIA, LYNCHBURG, August 13, Lynchburg Rail Day sponsored by Blue Ridge Chapter of NRHS. Train exhibits, models, displays and slide shows. For details visit blueridgenrhs.org.

WASHINGTON, SNOQUALMIE, August 19-20, 17th Annual Northwest Logging Modelers Convention, Snoqualmie Depot, 38625 SE King Street. Vendor displays, model contest, vintage machinery, clinics and layout tours. Additional info from Clark or Lloyd at loggingmodeler@gmail.com or phone 310-951-9097.

Future

CANADA, ONTARIO, October 2, 2011, 7th Annual Muskoka MR Layout Tour. Twenty home layout tours from N to G scale in Alliston, Beeton, Stroud, Orillia, Severn Bridge, Gravenhurst, Bracebridge, and Huntsville. Tour maps available September 1. For info contact roger.berkeley@primus.ca or Al Crisp at beez_al@bell.net.

CONNECTICUT, ORANGE, October 9, 2011, New Haven & Derby Model Railroad Club's 19th Annual Model Train Show at High Plains Community Center, 525 Orange Center Road. Vendors, operating layouts in HO, N, T, S and O gauges, clinics, door prizes, food, ample free parking and wheelchair accessible. Info at newhaven-derbymodelrailroadclub.org.

ILLINOIS, LISLE, October 20-22, 2011, RPM-Conference (formerly Naperville RPM). Produced by Joe D'Elia. Speakers TBA. Hickory Ridge Marriott (630-971-5000) railroadprototypemodelers.com.

KANSAS, BENTON (Wichita area), November 5-6, 2011, Railroad Prototype Modelers Meet, Benton Lions Community Center, 150 S. Main Street. Info at midcontinentprototypemodelers.org.

MARYLAND, ELLICOTT CITY, September 1-4, 2011, Steel Mill Modeler's Meet, Turf Valley Resort. Includes layout tours, seminars, models, and displays focusing on modeling steel mills in all scales. Sponsored by Magarac Society. Info at peachcreekshops.com/2011steelmeet.php.

MARYLAND, TIMONIUM, October 29-30, 2011, Great Scale Model Train Show & Railroad Marketplace at Maryland State Fairgrounds. Produced by Howard Zane and Ken Young.

Selected Events *Continued ...*

MASSACHUSETTS, MANSFIELD, November 2-5, 2011, Craftsman Structure Convention, Holiday Inn. Info at csc11.net.

MASSACHUSETTS, PEABODY, October 13-15, 2011, The Fine Scale Model Railroader Expo, Holiday Inn. New event includes extended paid clinics from experts including Lou Sassi, Dave Frary, Bob Hayden, and Bob Mitchell. For clinic fees and additional details visit modelrailroadexpo.com.

MICHIGAN, LANSING, September 24-25, 2011, American Heritage Festival, sponsored by Lansing MR Club, includes operating club layout, HO modular layout, working blacksmith, wood carvers, wagon rides, and tour of Woldumar Nature Center. At former Grand Trunk Western Millet Depot, 5309 Old Lansing Road. Info at lmrc.org.

NORTH CAROLINA, CARY, October 27-30, 2011, NMRA Mid-East Regional Convention, Embassy Suites Hotel at Raleigh-Durham-Research Triangle East, 201 Harrison Oaks Blvd. Info at mer.nmra.org.

NORTH CAROLINA, HICKORY, September 7-10, 2011, 33rd National Narrow Gauge Convention, Hickory Metro Convention Center. Layout tours, clinics, vendor displays, prototype events and narrow gauge camaraderie. Speakers are Trains editor Jim Wrinn and David Pfiesser from National Archives. Headquarters hotel (Crown Plaza) is sold out. Visit web site at narrow-gauge2011.com for information on alternative hotel space.

OHIO, MOUNT VERNON, September 17 thru Oct 6, 2011, exhibit of "Life Along the Line," original railroad photography of O. Winston Link, at B&O Depot, 507 West High Street. Hours and fee information available at mount-vernondepot.org.

VIRGINIA, VIRGINIA BEACH, September 17-18, 2011, NMRA Tidewater Division Annual Train Show, Hall D Virginia Beach Convention Center. Info at nfr-nmra.org.

Future 2012

MICHIGAN, GRAND RAPIDS, July 29-Aug 4, 2012, NMRA National Convention and National Train Show.

PENNSYLVANIA, MALVERN, March 23-25, 2012, RPM-Valley Forge Meet. Info at phillynmra.org/RPMMeet.html.

Future 2013

NEW MEXICO, ALBUQUERQUE, June 6-9, 2013, Rails Along the Rio Grande 2013, NMRA, Rio Grande Division 6, Rocky Mountain Region Convention at Marriott Pyramid North. Layouts, clinics, tours, train show, opsig sessions, UPRR modelers showcase night, BNSF RR modelers showcase night, banquet and more. Info from Al Hovey at alhovey@comcast.net. ■



About our news and events editor

Richard Bale writes our news column under the byline of *The Old Yardmaster*. He has been writing about the model railroad trade for various hobby publications since the 1960s.

He enjoys building models, particularly structures, some of which appeared in the June 2006 issue of *Model Railroader* magazine.

Send us your product announcements

If you are a hobby manufacturer with a product announcement, just [click here](#) and submit your announcement to us.

Our web site and free magazine reach continues to grow, so get on board with this new media train that's hard to stop!



REVERSE RUNNING: Doing the hobby well: Achieving balance

Stepping outside the box with a contrary view



Givens and druthers tend to be personal choices. No one can dictate them for you. You need to reach down inside, pull out your desires, and then sort them into “required” or “optional.”

layout was shown at all, it was all-too-often a Plywood Pacific.

But the hobby has evolved since then to focus a lot more on building nice layouts. I like to think of it as “model railroading in the large” and I believe it’s an approach that’s more enticing to potential model railroaders.

As the owner of a large basement empire myself (my HO Siskiyou Line takes up about 1100 square feet), I can tell you a large home layout project is an exercise in balance, to be sure.

I must set priorities and focus on what matters most or I could become overwhelmed. And feeling overwhelmed is no way to do a hobby!

At its heart, that’s what Allen McClelland’s “good enough” philosophy is all about. It’s about how to do a larger hobby project well, but not get overwhelmed. New modelers entering the hobby would do well to heed the “good enough” concept.

So how does the “good enough” philosophy look in practice?

Don’t bother detailing the backs of buildings that no one will ever see. Don’t bother putting underbody detail on all your rolling stock since that’s generally not visible anyhow. And don’t worry that your nicely-

weathered locomotives are not super-detailed. Aim for balance! Aim for a consistent look and don’t waste time on doing anything in excess. Seek a balance that gives you time to enjoy all parts of the hobby!

That’s what I love about Al Frasch’s N scale layout that’s the cover story in this issue. While Al’s layout is not superdetailed, it is *consistently detailed everywhere!* The first thing I noticed when I visited Al’s large N scale layout was: *the whole thing looked finished.*

Unfortunately, the hobby press tends to focus on layouts more toward the superdetailed end of the spectrum because they take good close up photos. But when you visit those layouts, generally you will find they’re far from finished.

Not Al Frasch’s layout. It looks “done” everywhere. Nothing was super-detailed, as a closeup photo of the layout shows. Still, a consistently finished-looking layout is a sensory delight to behold.

I applaud Al Frasch for achieving a masterful sense of balance with his layout. While it’s not superdetailed, it’s still a rare achievement that needs to be celebrated and put forward as an excellent example of how to achieve balance in the hobby!

But by taking the time to write down your givens and druthers, you can focus on what matters and not fret over things that are optional.

The givens and druthers example with layout design suggests a secret to achieving balance in the hobby: it’s *setting realistic expectations.*

For instance, having a large layout – and I define “large” as being over 500 square feet or over 50 square meters – but also expecting contest-level detail *on everything* probably isn’t realistic unless you have way more resources than the typical hobbyist.

The model railroading hobby started out being about nice models. You can tell that by looking at model railroading magazines from the 40s and 50s. Many of the photos published were of nice individual models. And if a



— by Joe Fugate

In today’s fast-paced world, there’s no end to the demands on our time. Doing the hobby well can be a tough balancing act.

The layout design concept of “givens and druthers” is one good example of balancing hobby issues – in this case how to create a balanced, yet satisfying layout design.

A *given* is something that just is and not subject to change or debate. A *druther* is a desire, wish, or “if there’s any way” hope. But in the final analysis, if it just doesn’t work, a druther can be jettisoned.

Clickable Advertiser Index	Page
Accu-Lites	25
Alpine Division Scale Models	19
Aux Box DCC.Com	39
Backdrop Junction	26
BLMA	3
Canyon Creek Scenics	103
Clever Models	26
Craftsman Structure Convention	89
Dallas Model Works	4
Digitrax	6
ExactRail	5
Fast Tracks	12
Jeff's DCC & Trains	20
Litchfield Station	13
Micro-Mark	11
Model Trains Video	9
Monster Modelworks	26
Nano-Oil	15
NCE	17
Pline	26
RailMaster Hobbies	39

Coming in the August 2011 issue

- Modeling with the new rivet decals
- Nick Muff's amazing Kansas City layout
- Building a prototype-based loco roster
- Modeling an A-frame turntable
- Coupler tune-up tips
- New one evening projects

... and lots more!

Clickable Advertiser Index, continued	Page
Railpub	26
Rapido Trains	7
Rslaserkits	14
Rusty Stumps	23
TAM Valley Depot	16
The Fiber Optic Store	26
The Fine Scale Model Railroader Expo	102
The Scotty Mason Show	26
Train Videos and Parts	49

Clickable Topic Index	Page
Derailments	125
Editorial – Editor's Soapbox	10
Editorial – Reverse Running	123
First Look – A-Line Car Weighting System	80
First Look – Aux-Box Appliance	81
Internet – Ebay for Model Railroaders III ...	73
Layouts – BNSF Pilchuck Division	27
Layouts – Getting Real	96
Locos – Speedbashing	40
News – July Newsletter	109
Bonus Extras	15
Q and A – MRH Questions, Answers, and Tips ...	18
Rolling Stock – The Car Shop	51
Rolling Stock – Home Made Lumber Loads ...	53
Scenery – Applying Makeup	24
Structures – The Lite and Narrow	83
Structures – My Modular Adventure	90
Structures – Utility Poles	105
Staff Notes	13
Trackwork – Building a Helix	61
<hr/>	
Other – Cover	1
Other – MRH Sponsors	2
Other – Table of Contents	8

For the love of model trains



**Derailments, humor,
and Dashboard on
next page ►**



Three guys go hunting. Bill, Ben and Barney. Bill goes out first to hunt his deer. Bill's hobbies are hunting, fishing and mountain climbing.

One hour later Bill returns to camp hauling a trophy buck! "How did you get that big buck so fast?", chorus Barney and Ben.

"Easy", says Bill. "Walk, walk, walk, find the tracks, follow the tracks, walk, walk, walk." "Bam! I shot the buck."

"I'm gonna get me a trophy too!" Ben hollers, and off he goes. Ben's hobbies are, hunting, fishing and hiking.

30 minutes later Ben struggles into camp with an even larger buck than Bill's! "How did you get that huge buck so fast?", exclaim Bill and Barney.

"Easy", says Ben. "Walk, walk, walk, find the tracks, follow the tracks, walk, walk, walk." "Bam! I shot the buck."

Barney can't believe it. "How am I gonna beat that", he mumbles, as he sets off. Barney is a model railroader.

5 minutes later Barney limps into camp, bruised, battered and bleeding! "Barney what happened", shout Bill and Ben.

"E-E-Easy", Barney stammers. Walk, walk, walk, find the tracks, follow the tracks, walk, walk, walk, BAM! I got hit by the afternoon train.

If you're the first to [submit a good bit of humor](#) and we use it, it's worth \$10!

When talking to hobby vendors, please remember to mention MRH.



Reader Feedback
(click here)

