

Model Railroad Hobbyist magazine™

HAVING FUN WITH TRAINS

Price:
Forever Free
STANDARD
Edition

August 2011

MRH EXCLUSIVE:
2011 National Train Show Report!

**Nick Muff's Kansas City Southern
Weathering Empty Scrap Gons
Build a Gallows Turntable Kit
Ballasting N Scale Track
and more!**

**Victor Roseman –
Detail your models
with realistic rivets**





Front Cover: Victor Roseman built this diorama to show crews hard at work riveting new body panels on freight cars. Victor discusses prototype riveting, various schemes for embossing rivet detail in sheet metal or plastic, and introduced decal rivets, a new and easy method of adding highly realistic rivets to models.

ISSN 2152-7423

Editorial Staff

Joe D. Fugate, Publisher
Charlie Comstock, Editor

Columnists

Richard Bale, News and events
John Drye, N scale
Lew Matt, Narrow gauge and shortlines
Les Halmos, Modular railroading

Special Correspondents

Jim Duncan, Layouts and operations
Byron Henderson, Layouts and track planning

Production

Patty Fugate, pasteup and layout
Joe Brugger, copy editing
Mike Dodd, copy editing

Technical Assistant

Jeff Shultz

Advertising Account Manager

Les Halmos



click to learn more about this sponsor



click to learn more about this sponsor



click to learn more about this sponsor



click to learn more about this sponsor



click to learn more about this sponsor



click to learn more about this sponsor



click to learn more about this sponsor



click to learn more about this sponsor



click to learn more about this sponsor



click to learn more about this sponsor



click to learn more about this sponsor



click to learn more about this sponsor



NEW SPONSOR!



click to learn more about this sponsor



click to learn more about this sponsor



click to learn more about this sponsor



click to learn more about this sponsor



NEW SPONSOR!



click to learn more about this sponsor



click to learn more about this sponsor

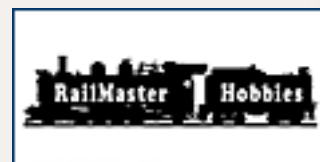

click to learn more about this sponsor



click to learn more about this sponsor



click to learn more about this sponsor



click to learn more about this sponsor



click to learn more about this sponsor



click to learn more about this sponsor



click to learn more about this sponsor



click to learn more about this sponsor



click to learn more about this sponsor



NEW SPONSOR!

Modelers! - Click any of the logos above to visit a sponsor's web site and find products that could help with your model railroading projects. Tell them: "MRH sent me!"

Sponsoring Advertisers -

Our sponsors get extra visibility with the MRH web audience (49,000+).

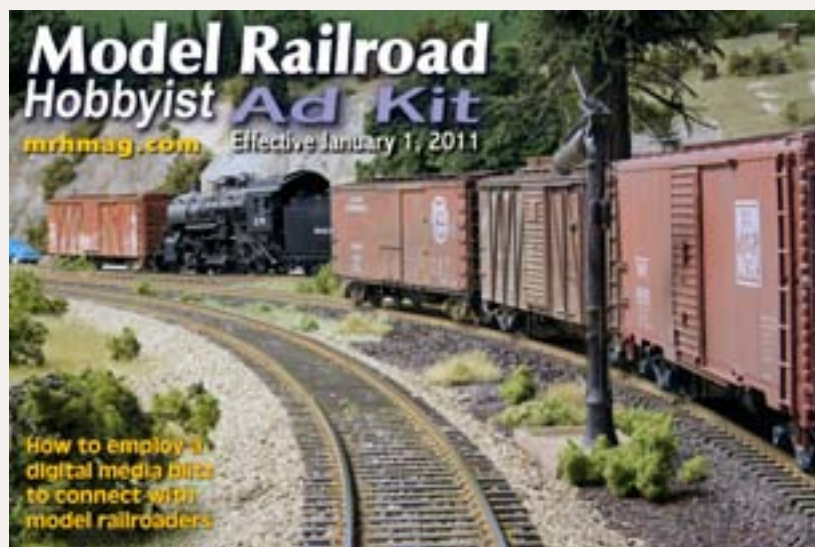

Click here to learn how to become a MRH sponsoring advertiser.

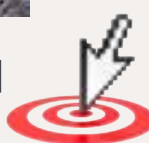

Check out our Hobby Marketplace

on [page 24](#) for more model railroading products and items.

Hey Doc!

I'm worried about my husband's hobby...

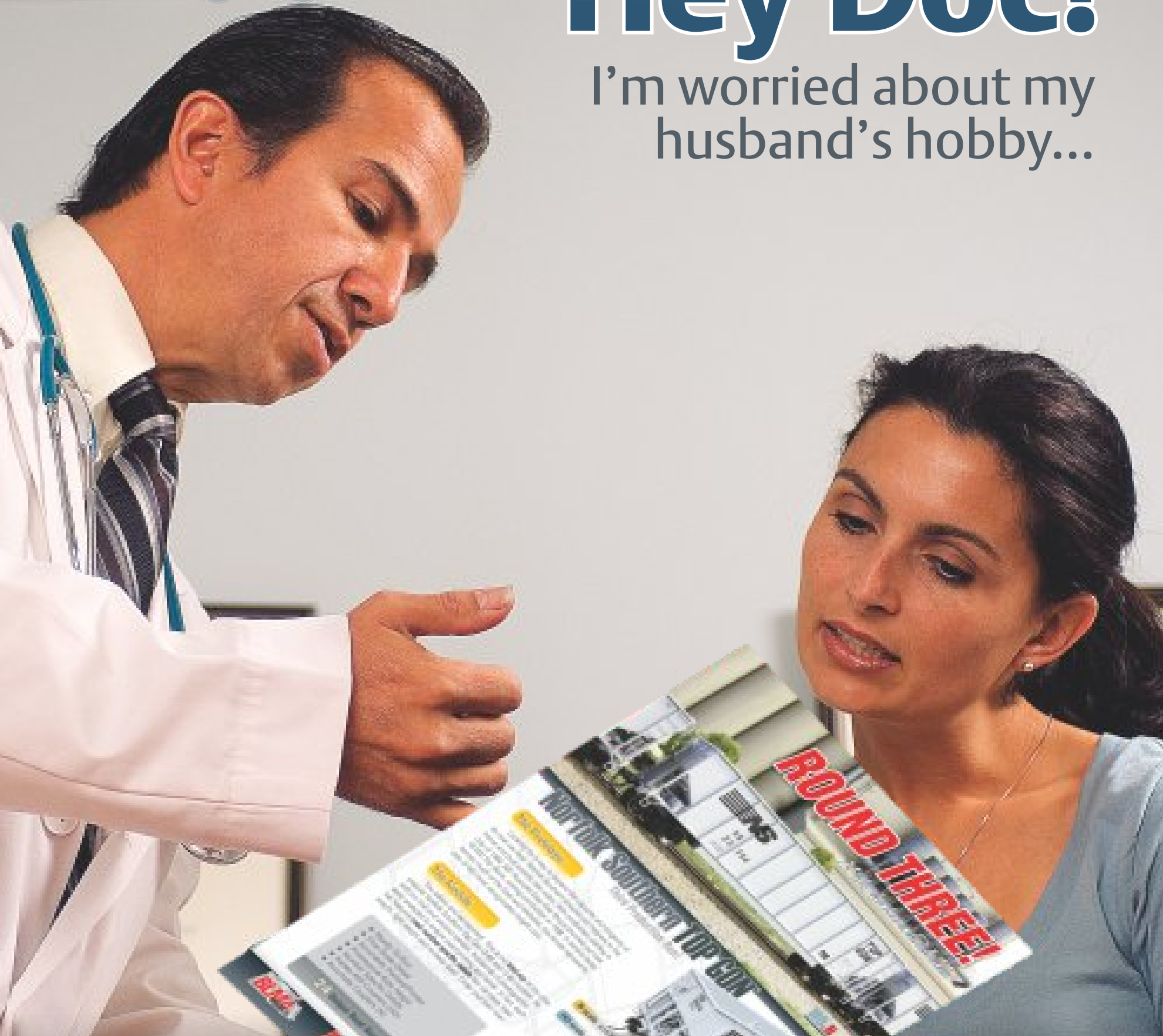

COMING SOON



HO SCALE

NEW! **Modern Cantilever RIGHT Hand!**
NEW Right Hand Model! Early Fall

#4030 Left Hand Signal Bridge
#4031 Right Hand Signal Bridge

Assembled, Painted, Lighted!

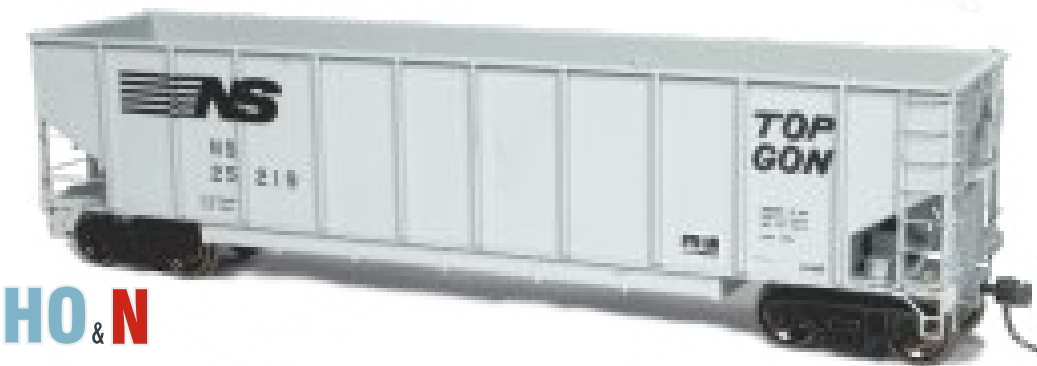

HO & N

NEW! **Norfolk Southern TopGon Coal Cars**
24 NEW NUMBERS! Late 2011

N #10061-10084 HO #50061-50084

ONLINE AT:   

Blasphemous! Look at everything BLMA has coming!

BLMAmodels.com

562-712-7085 sales@blmamodels.com

**IN THIS ECONOMY
ONLY A MODEL RAILROADER
COULD BE HAPPY WHEN
THE LIGHT AT THE END OF THE TUNNEL
TURNS OUT TO BE**

A TRAIN.



Click on the light.
Get a new Sale item every time. 



EXACTRAIL[®]
The Next Generation of Model Railroading

See what's new at ExactRail.com!



HO In stock now! Contact your local dealer or visit ExactRail.com to order!

GREENVILLE 60' BOX CAR

HO SCALE *Platinum*® \$36.95 MSRP



MAGOR 4750 COVERED HOPPER

Available in MILW, ACL, GN, SOO, PRR + undecorated kit!



HO SCALE *Platinum*® \$44.95 MSRP



FMC 4000 GONDOLA

Available in RTIX (2), SEPX, BN, UP, CNW + undecorated kit!



HO SCALE *Express*® \$22.95 MSRP

HO Coming in August!



GREENVILLE 65' MILL GONDOLA

HO SCALE *Platinum*® \$34.95 MSRP



Become an ExactRail Insider

Find an ExactRail Dealer

Read the ExactRail Blog



1-866-945-1701 | ExactRail.com

Visit ExactRail.com to keep pace with our releases, purchase products or locate a dealer.



Digitrax[®]
Complete Train Control

\$225.00 MSRP

Introducing

ZEPHYR *xtra*

XTRA FEATURES

• 29 Functions • 20 Adresses & Throttles • Recall

XTRA POWER

• 3 Amps • Blast Programming for Sound



Click here to find out more >

THEY'RE BAAAAAACK!



**WITH UPDATED POWER TRUCKS AND GEARBOXES
FROM \$299.95 PER TRAIN**

TurboTrain®

Main Features

Table of contents

Columns

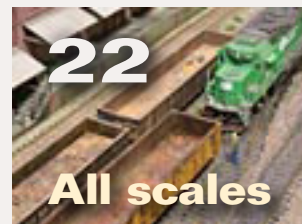

22 **Weather Scrap Service Gons!**
Scenery Scene: one evening project!
by Kevin Klettke



60 **Build a HOn3 Gallows Turntable**
Salina gets a turntable
by Wolfgang Dudler

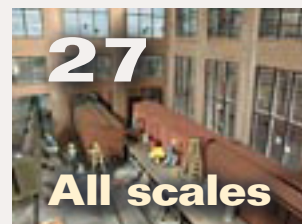

27 **Adding Realistic Rivets**
Using decal rivets
by V.S. Roseman

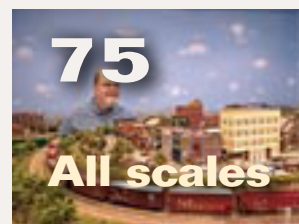

75 **Adding Background Sounds**
Using cheap MP3 players
by Rick Wade



44 **Prepping a Car for Club Ops**
The Car Shop: one evening project!
by Joe Brugger



79 **X2011W Train Show Report**
MRH news bulletin
by Richard Bale

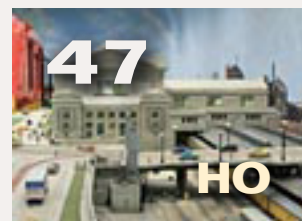

47 **Dr. Nick Muff's KCS Layout**
Modeling Kansas City Union Station
by Charlie Comstock



127 **Derailments**
Humor?
by MRH staff

92 **On30 Cattle Guard**
Lite and Narrow
by Lew Matt

96 **Building a Diesel Roster**
Getting Real
by Joe Fugate

103 **Track Ballasting**
Comme-N-tary
by John Drye

109 **August Model Railroading News**
MRH News and Events
by Richard Bale

125 **Table vs Shelf**
Reverse Running
by Joe Fugate

16 **Bonus Downloads**

Other Features

10 **Running in the Dark**
Editor's Soapbox *by Charlie Comstock*

17 **MRH Q - A - T**
Questions, Answers and Tips

12 **MRH Staff Notes**
Returning from X2011W

24 **Hobby Marketplace**

NCE Cab06

**Discover the
FUN!**

Now Shipping!

Cab 06 Features:

Select = Select Loco	^Select = Select Accessory
Dir = Direction	^Direction = Recall
0-9 = F0-F9	^0-9 = F10-F19
Horn = Horn	^Horn = Radio Off
^^Select = Macro	^^^Direction = Set Recall
^^Direction = Recall	^^^Horn = 28/128
^^0-9 = F20-F28	

Setup - Hold Select while Plugging In:

Addn - Set Cab Address (1-63)
 Nor = 0=Normal 1=Yard
 Bal = Ballistic Tracking (1-7)
 SH-n = Max Shift Level (0-3)

^ = Shift

Actual Label from the back of the Cab06



- Extraordinary Performance
- Radio or Tethered
- Highest Rated DCC System
- Made in the U.S.A.

NCE
The Power of DCC



Call or Email
 for FREE Brochure
support@ncecorporation.com

585.265.0230
 9am-4pm EST.
www.ncedcc.com



About the Editor



Charlie Comstock has been a regular columnist, author, and editor of *Model Railroad Hobbyist Magazine* since its inception.

To learn more about Charlie, [click here](#).

EDITOR'S SOAPBOX: Running in the dark

Hey! Who turned out the lights?



My good friend and ex-yardmaster Terry took Amtrak from Klamath Falls to the Portland, Oregon area for a visit. I offered to host a BBQ for him and a few other close friends.

After dinner we ended up in the train room. I'd agreed to run foreign power that night – normally foreign power is excluded during formal op sessions but this was informal. John B. brought over two locos, so on the track they went. He ran them around solo for a while before I suggested he couple onto the reefer express in Salem staging. Soon he was heading upgrade to Oakhill with 24 reefers and a caboose.

After watching a while I thought (or perhaps Horace Fithers told me to) I should switch to night lighting. John's locos had nice bright headlights. Click, click, click, click, click.

"Hey! Who turned out the lights!" echoed through the room. The moonlight (blue rope lights in the ceiling) seemed really dim but after a minute eyes adjusted and we watched headlights flash on and off while passing through tunnels 2 and 3.

Five minutes later the reefers arrived at South Jackson and the

Superintendent of Nearly Everything suggested running the train back up the hill. That's when things got interesting. It seems there were too many reefers for the motive power and we'd need to add a helper. By moonlight.

I've never run a night session on the BC&SJ so there aren't any flashlights laying about. Uncoupling the caboose and locomotives in the moonlight proved a challenge but someone pulled out a cell phone to use as a flashlight and John managed get coupler picks into the coupler knuckles and run around his train before heading bravely toward the hill.

Joe B. fetched another throttle, dialed up the 2-10-2 helper engine, and set out after the under-powered reefers.

The reefers barely made it past Deschutes Jct. before the power started slipping wheels. The BC&SJ doesn't permit pushing on occupied cars, so the train eased down the hill and set out the hack on the Mill Bend siding just

as the helper showed up, backed onto the hack, then pulled forward to couple onto the rear-most reefer.

This time the assault on the 2.8% grade succeeded. Joe cut off the helper at Oakhill using more cell phone illumination to see what he was doing with his uncoupling pick. The reefers continued on to Salem and the helper returned down the hill to South Jackson.

Surprisingly, a good time was had by all. Both the crews and the onlookers enjoyed themselves immensely. In fact, it was strongly hinted that I should use night lighting during a 'real' op session – a request I'd figured would only come once in a blue moon. With a supply of LED flashlights letting crews see to uncouple and read car numbers, perhaps night operations would be feasible? Of course, the moon did happen to be blue that evening ...



Cutting off a helper in Oakhill using a cell phone to augment the moonlight.

LUBRICATION FOR THE NEW MILLENNIUM...

3 HIGHLY CONCENTRATED NANOLUBE
FORMULAS NOW
AVAILABLE TO MODEL RAILROADERS



NANO-OIL.COM 
Nano Technology Lubricants



THE SHAY FIXER
VISIT US AT...
SHAYFIXER.COM 

Specializing in brass Pacific Fast Mail / United geared locomotives

"I use only the finest quality lubricants such as **Nano-Oil** ..."
-The Shay Fixer

StClaire 
Made in U.S.A

**FOR MORE DETAILS
CLICK HERE** 

Advertisement

Are you a Model Railroad Hobbyist guru?

Take the MRH who - what - where - when quiz!









Select one of the covers (on the right) to answer each question:

1. In which issue did the first Scenery Scene appear?
2. Which issue had two layout tours?
3. Which cover is from January 2010?
4. Which issue had a layout modeling a TV show?
5. Which issue had no layout tour?
6. Which issue presented three ways to build a static grass applicator?
7. Which issue featured Lance Mindheim?
8. Which issue introduced the concept of the *Chainsaw Layout*?

Bonus: How many issues of MRH have been published as of August 2011?

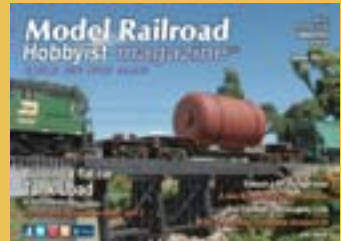
Scoring: 0: *That's sad!* 1-3: *Do you actually read MRH?* 4-5: *At least you paid some attention when reading.* 6: *Lookin' good!* 7: *Impressive!* 8: *Obi-wan has taught you well.* 9: *King of the MRH foamers!*

[Answers on page 74](#)

a. 	b. 	c. 
d. 	e. 	f. 
g. 	h. 	i. 

Notes from the

MRH STAFF

X2011W iPad winner, model or modeler, MRH index, July's ratings, and more ...



And the winner is ...

We've been back from the X2011W national convention for a couple of weeks now and we're almost fully



E.W. Czerwinski, posing with the iPad he won in the MRH giveaway at the 2011 National Train Show

recovered. It was quite a high intensity week of full immersion trains. Lots of great clinics, great layouts,

great modelers, and three days of the National Train Show. Speaking of which, the MRH iPad giveaway was very popular. There were hordes of people coming by the booth throughout the show to sign up for their chance at the iPad. Late Sunday afternoon Craig Martyn (of BLMA) happened to be walking by our booth and he was asked (coerced?) to pull an entry out of the hat (actually a box). Drum roll please! And the happy winner is E.W. Czerwinski of Truckee, California! Congratulations E.W. and enjoy all those issues of our favorite model train magazine.

July's ratings

The five top-rated articles in the July 2011 issue of MRH are:

- 4.5 Al Frasch's N-scale BNSF
- 4.6 Building a Helix
- 4.5 Speedbashing
- 4.5 Home-made lumber loads
- 4.4 Modular Adventure – Pane of it all
- Issue overall: 4.1

Please continue to rate the articles – the more people who take a few moments to do so, the better we are able to judge what you, our readers would like to see. This is your shot at letting us know what kinds of articles float your boat (or train)!

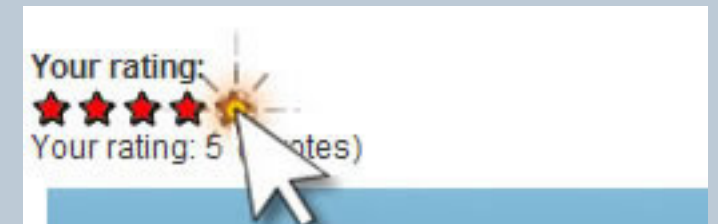

Advertisement

Watch our website for our monthly specials!

Free Shipping on all US WEB orders over \$100.



ACCU-LITES, inc

Your DCC Center!

CLICK TO LEARN MORE:



<http://www.acculites.com>



Authorized Dealer for: Digitrax, NCE, Soundtraxx, TCS and others.

Have you seen the **NEW** Bar Mills web site?

THE GREAT LITTLE KIT...
207-929-3400 • P.O. Box 609, Bar Mills, Maine 04004

Bar Mills
SCALE MODEL WORKS

FROM THE GREAT STATE OF MAINE

Home | Craftmen Structure Kits | Audio HowTo's | Video Clinics | Contact | View Cart

What's new at
BAR MILLS

Here we are in our 18th year!... Glad You Came Along! Welcome to the new website... sit down, relax, take out your teeth stay awhile!
Model railroading is a great hobby... yes, we are preaching to the choir and we know it... but just the same the staff here at Bar Mills is excited to be able to offer so many cool things on this new website. From a "Readers Poll" to our new "Modeler's Corner" our fellow

A Tour Of The New Website

Take a tour of our shop...
CHECK IT OUT

Modeler's Corner

And don't miss our new VIDEO CLINICS section!



Click here to **CHECK IT OUT!**

ADVERTISEMENT



Nope, that's not really Craig Martyn in the MRH booth banner, but as Jeff Shultz put it, "the resemblance is frightening!"

Modeler or model?

Speaking of Craig Martyn, a funny thing happened at the MRH booth during the show. If you've been with MRH for a while you know how Joe Fugate, our founder and publisher, likes to put friendly faces in ads to give them a personal touch. Well, there were two giant vertical banners at the MRH booth at the National Train Show and you'll never guess who appeared to be on one of them!

No, that's not really Craig Martyn, but it had us all speculating about Craig having a secret second career as a model in addition to being quite the modeler!

Searching MRH back issues

It seems a long time ago (and yesterday at the same time) we started publishing MRH. Did you know August 2011 is our 18th issue? It's hard to believe there have been that many!

But that makes for a problem. Tell me, in which issue was *Computer Generated Window Treatments* published? How about *LED structure lighting*, *Modeling the Modern Era*, or the *SP 4449 Excursion*?

MRH is now fully indexed by Rod Goodwin's [The Railroad Index](#). Rod fully indexes all MRH articles (unlike some other model train indexes).



HO, DCC & All Scales
Always on SALE

Authorized dealer for:



Atlas • Bachmann • AccuRail



AUGUST Specials
(while supplies last)

- **Digitrax systems**
- **Soundtraxx decoders**
- **Kadee goodies**
- **NCE systems**
- **RailPro *HOT!***



Click now for more ...

ADVERTISEMENT

To use the index either click the link above, enter

the-railroad-index.com/rd_item_control.php

in your browser, or go to the Magazine item in the Nav Bar at the top of all MRH web pages (mrhmag.com) and select the Index (Rod Goodwin) menu item.

Once in the index type "MRH" and your search string. Entering "MRH" will report only hits in Model Railroad Hobbyist. For example:

MRH on30 water car

The index site wades around in its database for a moment and up pops:

West Side Lumber Co. Wooden Water Tank Car; Lew Matt; Model Railroad Hobbyist Apr 2011 pg 92 [VISIT](#)

Click VISIT and you're taken to the Reader Feedback page for this article. Why the reader feedback page? From this page you get the front page of the article so you can quickly see if this is where you want to be.

From there you can return to the index, or click "Download this issue!" to download the back issue or if you click on the image (labeled "Want to read this article? CLICK HERE") you'll be taken directly to the article in the read-it-online version of that issue of MRH. How cool is that!

Calling All Authors ...

The number of authors that are submitting to MRH these days is gratifying. If you have a camera (and aren't afraid to use it!) and a project you're thinking

of tackling, shoot lots of photos while you're working on it, then let us know about it!

We have a new (well not completely new – it's been running for several months now) website for submitting articles (and other items) to MRH. Get out your web browser and go to mrhmag.com. Once there click 'Authors' on the top nav bar, then select the 'Submit an article' menu item. Fill out the forms and click **SUBMIT ARTICLE** (at the bottom). Note that we require content to be submitted in a zip file. If you don't have a zip utility try using [ZipCreator](#). It's free and easy to use and it runs on Windows, Mac, and Linux. It's a lot easier for us to handle a single zip archive than to keep track of lots of individual files.

Do be sure you remembered to include your name, address, email address, and phone number(s) with each submission. Yes, some authors do forget this information.

We'll try to get back to you in a week or two but sometimes when we're really busy it may take longer. If you've not heard from us for several weeks, send an e-mail asking about your article.

You don't have to be ...

You don't have to be nuts to work at MRH, but sometimes it helps. We had a wonderful time at the 2011 National

Convention in Sacramento. Great clinics, good friends, great layouts to visit, and the California Railroad Museum a few blocks down the street.

But it's always hectic getting ready to go to a major show and this time both Joe and Charlie were giving two clinics each. Plus the July issue had to be released before we could leave. Somehow, there wasn't time to get a head start on August so after the 10 hour drive home we were faced with reality – there are only three weeks before the August issue is due out! Somehow, we managed to make it happen, but like I said about being nuts ...

Please mention MRH

It may seem like a broken record (how many of you know what a broken record is?) but please, *when you shop at one of our advertisers, especially if you make a purchase, please mention that you saw their ad in Model Railroad Hobbyist.* That little extra bit of effort on your part helps them know that the money they spend with us is money well-spent!

MRH and Train Shows

MRH plans to attend the following shows over the next six months.

- **National Narrow Gauge Convention** (Hickory, NC) - Sep 6-11, 2011
- **Fine Scale MR Expo** (Peabody, MA) - Oct 12-16, 2011

- **RPM Conference 2011** (Lisle, IL) - Oct 20-22, 2011
- **Craftsman Structure Convention** (Mansfield, MA) - Nov 2-6, 2011
- **Trainfest** (Milwaukee, WI) - Nov 11-14, 2011
- **Amherst Show** (Milwaukee, WI) - (Springfield, MA) Jan 28-29, 2012

If you're there, drop by the booth and say hello!

Bonus extras

MRH is continuing our new way of handling the bonus extras in the August issue. The bonus extras won't expire, but you will need to be a subscriber and log in to get them. Since subscribing is free we don't see this as being a big deal. As mentioned last month, increasing the size of our subscriber base is a big deal. The bigger the better for us – especially when talking with potential advertisers.

We remain committed to keeping MRH *forever free* for readers, so even though something may require a subscriber login, it will still be free.

As mentioned already, by doing the bonus goodies this way, we'll keep them available forever – no expiration date for back issue goodies. We hope you'll agree this is an improvement.

We also expect to put other goodies in the subscriber area from time to time

Add a New Dimension with Fiber Optics!

From creating a star filled universe to adding micro-lighting to your scale models ~ Fiber Optics can bring an exciting new dimension to your layout.



Click on this ad to learn more about fiber optics.

You'll also learn about a special promotion created just for our MRH readers!



Achieve Interior Lighting without hot spots using Solid Core Side Glow Fiber Optics!



www.TheFiberOpticStore.com/MRH

[The Fiber Optic Store.com](http://TheFiberOpticStore.com)

– such as the pdf files of the clinics presented by Joe and Charlie at the NMRA National Convention in Sacramento.

If you haven't subscribed to MRH yet, now is the time to do it! It's simple, just [click here!](#)

It's YOU!

Just a quick word of thanks to YOU, our readers. Without you, MRH wouldn't exist let alone have reached 18 issues with more coming soon!

Thank you readers! You make it both possible and worthwhile.



Model Railroad Hobbyist magazine™

Want to help support the leading eZine devoted to Model Trains and the people that have fun with them?

Want to help keep MRH forever free?

Shop our advertisers and tell them,

"I saw it in MRH!"

A
D
V
E
R
T
I
S
E
M
E
N
T

August 2011 Premium Extras!

Available to subscribers!

- DVD and HD quality versions of this issue's videos
- Special, 30 minute version of the interview with Dr. Nick Muff about his terrific HO scale KCS layout. The truth about the F7 cab in the basement!



Click here to access

Some of the finest trees in the hobby ...

... available in any scale!

CANYON CREEK
SCENICS
canyoncreekscenics.com



click to visit our web site

MRH

Questions, Answers and Tips

 **Reader
Feedback**
(click here) 

QUESTIONS AND ANSWERS

Q: Should I solder my flex track rail joints?

A: Soldering flex track joints isn't necessary if you install power feeder wires on every section, for a reliable electrical connection. An alternative is soldering two sections of flex track together and using one set of feeder wires for every pair of flex track sections. This halves the number of feeders, and the soldered rail joints provide suitable electrical connectivity. If you do this, install the feeder wires near the soldered joint so the rail's electrical resistance is split equally in both directions.

Leave the other end of each section unsoldered to allow for expansion and

contraction with changes in room temperature and humidity.

— *Mike Dodd*

Q: Is drywall mud a good material to use for building scenery?

A: The answer is yes and no. Drywall mud (often called spackle) like plaster, is a gypsum product. But it's more porous, much softer, and much weaker than plaster. It can also be re-wetted and smoothed when dry, an advantage over plaster.

Unlike plaster, it dries rather than sets, so if you apply a thick layer it can take a very long time to dry. Keep your final layers around $\frac{1}{16}$ " or less in thickness. You can apply it up to $\frac{1}{4}$ " thick, but expect significant cracking and surface

deformations, since it can experience significant shrinkage as it dries. If this happens, wait for it to dry, then apply another, thinner layer on top to fill in any cracks that formed.

Because it is relatively weak, don't try using it to build thin (or thick) shell scenery. It's best used as a finishing layout over other materials such as plywood or pink foam where you can smooth the surface before it dries. Mud sands easily when it's dry, BUT huge amounts of very fine dust result from even minor sanding. Use a vacuum while sanding to maintain dust control. You'll probably want to mask off anything that would suffer from a layer of whitish plaster-like dust on it.

When spreading spackle over pink foam or other shiny surfaces, paint them with flat latex house paint first. This will give the surface enough tooth for the drywall mud to adhere. Thin layers of mud directly on smooth pink foam surfaces will almost certainly come loose at some point – probably sooner rather than later.

The best way to smooth drywall mud is to apply it with a 6" putty knife, taking care to smooth the surface the best you can. When dry, sand it lightly to remove any major seams, then use a very wet (but not sopping) sponge to smooth the surface.

I have used this method to build model dirt and asphalt roads. Keep the final

layers very thin to avoid cracking and wait for it to dry thoroughly before sanding and sponging. Drying can be sped up significantly by aiming a fan at the wet drywall mud.

Some people have reported luck using drywall to model waves in water, but I've not tried that. I have however, had excellent results using drywall mud to smooth the bottom of ponds, creeks, and rivers prior to painting them and filling them with Envirotex® or some other clear casting medium. I use the wet sponge method to smooth these areas.

When applied in more than a $\frac{1}{8}$ " thick layer drywall mud is likely to crack when it dries. This can be used to model roads with cracks in them. But it's very hard to control how much and where the cracking occurs.

Drywall is relatively forgiving if you make mistakes. Just add a little more and re-smooth it.

— *Charlie Comstock*

Q: I'm getting ready to do a power truck conversion project that requires attaching a bracket to the chassis with a 2-56 screw. The instructions say I should use a #41 bit to drill a hole in the bracket, then use a #50 bit to drill a hole in the chassis for a 2-56 tap. Do I really need to buy both drill sizes?

A: To make the initial hole in the chassis for a 2-56 tap, you will need to use a #50 bit. The hole in the bracket must be larger to allow the threaded screw to pass freely. As noted in your instructions, a #41 bit is the recommended size for the bracket hole. However, you could probably get by using the same #50 drill, then enlarge the hole with a needle file or a reamer to clear the threads of the 2-56 screw.

— *Richard Bale*

Q: I am just about ready to pour some two-part Magic Water resin for the stream. Anybody have suggestions for tinting it? This should be a muddy creek.

A: The manufacturer's website recommends tinting and coloring Magic Water using solvent-based products such as Testors, Modelmaster, Floquil, or other oil-based enamels. Indelible ink also works. Water-based coloring doesn't dilute as well.

If you desire a transparent water effect, use only a small drop or two of paint in a batch. It's a good idea to test your 'recipe' before pouring on your layout.

— *Charlie Comstock*

Q: I like the looks of freight car wheels with ribs on the back. Is it okay to use them on my 1980s era layout?

A: First of all, one of the principles of

model railroading is to have fun, so you are free to do pretty much whatever you want with your own rolling stock. However, if you are interested in following prototype practice, a few facts about freight car wheels will help you make your own decision.

From the earliest days of railroading most freight car wheels were made of cast iron. Some cast iron wheels had spiral ribs designed into the back of the wheel for added strength. Ribbed-back wheels were popular from about the mid-1920s through the late 1930s. Beginning in the 1920s, wrought steel wheels, which are stronger than cast iron, gained some usage, especially in high-speed service and on cars subject

to heavy loads. Wrought iron wheels were used in increasing numbers in regular freight cars from the 1940s on. Cast iron wheels, including those with ribbed backs, were outlawed for interchange service by the AAR in 1958. As the deadline approached, the ban was extended until January 1970. Some railroads continued to use ribbed-back wheels on home equipment such as cabooses and maintenance-of-way cars into the 1990s.

— *Richard Bale*

Q: I have a friend who models the early 1900s. He was talking about arch bar trucks? What are these? Are they still in use?

Advertisement

**Daddy Got HIS Aux-Box ...
Now everyone is happy!**

**"Taking model railroad control
to the next level ..."**



AUX-BOX

click for more ...

www.auxboxdcc.com





HO scale arch bar truck under a Rivarossi log car.

A: Arch bar trucks are an older style that came into use around 1900. Their side frames were made of riveted-together metal straps. They lasted in interchange service until the very early 1940s, but some stayed in home road service into the 1960s or longer. There are a number of model arch bar trucks available in several scales from companies such as Tahoe, Tichy, Kadee, and others.

— Charlie Comstock

Q: I like to operate my layout, but car card boxes protruding into the aisles are a problem. Is there a way to build 'flush' car card boxes?

A: Yes! Rick Fortin has car card boxes recessed into the fascia of his layout. The car cards lie flat instead of being vertical. They take almost no space and don't protrude into aisles at all.

— Charlie Comstock

Recessed car card boxes on Rick Fortin's HO layout.



Litchfield
STATION

Summer is more FUN with our DCC Products and Service!

A
D
V
E
R
T
I
S
E
M
E
N
T

www.Mr-DCC.com
623-298-7355



TIPS

Keeping Athearn locomotive wheels clean

Short of replacing the wheels with NWSL or other aftermarket wheels, I "polish" the wheels using *Mother's Mag and Aluminum Polish*. I also have used *Flitz Polish* (it's a bit more abrasive, I use it only for stubborn wheels). DO NOT use this procedure with other brands of chrome or nickel plated wheels – you'll remove the plating.

Here's the procedure:

- Set up a short piece of track on a test stand of sorts. I tacked 2' of flex track on a 1"x3" board and added a couple of wires to hook up a good power pack. I used an old MRC Tech II 1500 for this. If you use DCC, set CV29 to dual mode per your decoder manual.
- Get some Handi-wipes or equivalent.
- Put some polish on a Handi-Wipe and place the wipe on the track.
- Place your engine on the test track next to the wipe, hold it by the rear coupler, and slowly increase

power to full throttle. Allow the locomotive to move forward until one truck is on the wipe and polish. Hold the engine in position with wheels slipping, working it gently back and forth. You will see two lines of black crud on the wipe. Slide the wipe sideways to keep the wheels on a clean spot. Repeat for the other truck.

- Repeat the last step with a clean wipe to remove traces of polish.

Check the wheels, they should be cleaner and shiny. Repeat if necessary. Electrical contact should be much better and the wheels should stay clean, longer.

— Nelsonb111563



GET \$25 PER TIP

We pay \$25 USD for each tip we publish. [So send in your modeling tips to Model Railroad Hobbyist](#) and we'll get your payment to you upon acceptance.

Just think, for only a few minutes effort, you could fund your next piece of rolling stock – or even pay for an entire train if you send in several tips and we publish them!

If you include any photos with your tip, we pay a bonus of \$10 per photo we use with the tip. ■

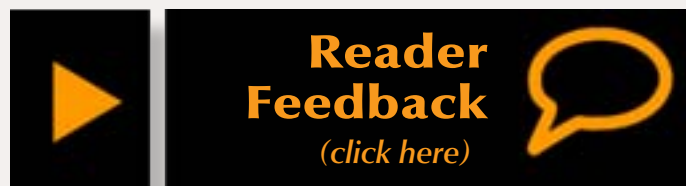

RS Laser Kits

In our 7th year with over 40 structures in 4 scales

New in O scale



L.G.'s Billiards

Foot print 4 1/2"x 7" including porch



Dave's Hardware

Foot print 5 1/2"x 6"

Both buildings include laser cut board and bat siding on a card substructure, metal and or roll roofing and at least 3 name choices.

All in stock Aspen N, Nn3 and Z products are 10% off for the month of August.

See web site for list

Custom Laser Cutting

For Price List Send Large SASE Dealers welcome

www.RSLaserkits.com

5145 Gaffin Rd. SE

Salem, OR 97317

PH: 503 371-4290 Fax 503 585-0850



My helper at work
Our granddaughter Bri
Future model builder



click here

ADVERTISEMENT



The Amherst Railway Society Railroad Hobby Show

Our 2012 Show will be

January 28 & 29, 2012

Save the dates!

About The Show

Every year late in January or early in February, the Amherst Railway Society holds its Railroad Hobby Show at the Eastern States Exposition Fairgrounds (The home of The Big E) in West Springfield Massachusetts. More than 25,000 railfans and public attended the Show each of the past three years.

The event features real life railroads and scale model railroads, historical societies, travel agencies, art shows, flea market dealers, importers, manufacturers and photographers. You have to see it to believe it!



Click to learn more ...





The Scenery Scene

Scrap Gondolas Weathering Empties ...

– by Kevin Klettke



Gondolas in scrap metal service are among the most abused of freight cars. The nature of their cargo scars them with a layer of rusty debris, dust, and dirt covering their floor and sides. Small chunks of scrap metal

the unloading process missed may also be present. These cars are almost never cleaned because the next load is usually the same dirty cargo.

Most of us weather the outside of our gondolas, but we seem to seldom model the beat-up interior visible in empty cars. The process described here is simple – you could weather a fleet of scrap gondolas in an evening using items you most likely already have (figure 2).

What’s more, all of my removable scrap loads fit right over the top of these “weathered empties” without disturbing the finished effect.

I’ll start with a Milwaukee Road 62’ mill gondola that I’d previously weathered on the outside and patched out for my Washington Northern layout.

Apply a liberal coat of rust- and dirt-colored artists oil paint to the entire inside of the car (figure 3). Thin the paint to the consistency of latex wall paint. Coat the sides using vertical strokes.

Sprinkle pencil shavings and any small, appropriate-looking odds and ends from your scrap box on top of the wet paint (figure 4). Make the floor debris random and uneven. Small piles tend to accumulate in the corners, simulat-

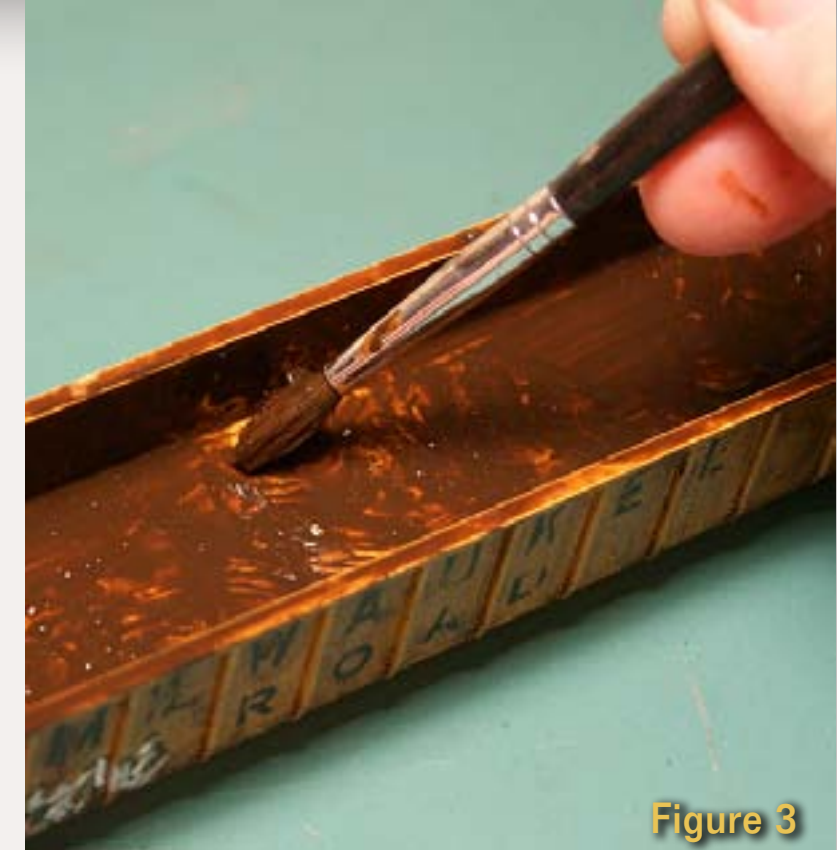

Figure 3



Figure 4



Figure 1



Figure 2



Figure 5



Figure 6



Figure 7

ing the rust and small pieces of scrap left after unloading. You may want to use a small drop of CA to secure any larger pieces.

Next, sprinkle on some weathering powder or chalk. Not much is needed here. Use several colors, again making the distribution random.

Liberally dribble paint thinner over the chalk and pencil shavings with an eye dropper. This will dissolve the weathering powders and bond the powders and 'scrap' together (figure 5).

Use the cheap paint brush, lightly dabbing the chalk areas to disperse and flatten any large globs of weathering powder (figure 6). Try not to blend the color too much. Just soften the edges to avoid a speckled look.

That's it! Set your gondola aside to dry. This may take 24 hours or more. When

the interior of the car is dry, your debris should be held in place by the cured artist oils. I like to give the sides a light dusting with brown weathering powder to tone down any shine that may be present (figure 7). You can also give the finished interior a shot of matte fixative to help hold everything in place.

I'm sure you'll agree the results are more realistic and interesting when your empty gondolas roll by on their way to the scrap dealer for another load.

Bill of Materials

- **Artist Oil Colors:** An inexpensive brand works fine. I use Raw Sienna, Burnt Sienna, Raw Umber, and Lamp Black
- **Paint Thinner:** I prefer Mona Lisa Odorless brand. Use any solvent-based product in a well ventilated area.
- **Weathering powders:** I use Bragdon Weathering Powders, but other brands or even pastel chalks should work fine. Oranges and browns are the colors needed.
- **Large Brush:** I use a cheap brush that I can abuse without regrets.
- **Palette:** For thinning the oil paints.
- **Eye Dropper:** This item isn't absolutely necessary, but I find it makes things easier.
- **Debris:** Shavings from my pencil sharpener.

A
D
V
E
R
T
I
S
E
M
E
N
T



DecoGrass is a fine 2mm tall grass material that is supported on a nearly invisible backing. It may be placed as is or pulled apart and blended with other DecoGrass or ground foam and soil scenic textures. Each sheet measures approximately 11" x 5½".

-  **RED CLOVER DECOGRASS®**
-  **GOLDENROD DECOGRASS®**
-  **LIGHT GREEN DECOGRASS®**
-  **MEDIUM GREEN DECOGRASS®**
-  **DRIED GRASS TONE DECOGRASS®**
-  **GOLDEN GRASS TONE DECOGRASS®**
-  **ALPINE MEADOW DECOGRASS®**
-  **NEW! BURGUNDY MULE DECOGRASS®**
-  **NEW! WILD VIOLET DECOGRASS®**

Click for more - lots more!



Model Railroad Hobbyist - HOBBY MARKETPLACE

The **SCOTTY MASON** SHOW

The Original Model Railroad Podcaster

www.themodelrailroadpodcast.com

Get the Latest Model Railroading News, Tips, Reviews & Opinions



Featuring...

Scott Mason

Dave Frary

Mike Rose

Jimmy Simmons

Joe Duckworth

Available on

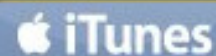

www.themodelrailroadpodcast.com



Trainfest Railroad Hobby Show

West Allis, WI, Nov 13-14

- QSI Sound Demos
- QSI titans in Stock!
- Show Specials

Summer Sizzler DCC Sale

Effective Aug 10 - Sep 10, 2011

DIGITRAX

STARTER SETS	LIST	SALE
Zephyr X	225.00	169.95
S. Emp. Builder X	355.00	264.95
Super Chief 5AX	455.00	374.95
Super Chief 8AX	475.00	364.95
Radio S. E. Builder XD	575.00	455.95
Radio S. Chief 5A XD	665.00	495.95
Radio S. Chief 8A XD	685.00	510.95
THROTTLES		
DT402	185.00	144.95
DT402R	250.00	189.95

NCE CORP

STARTER SETS	LIST	SALE
PowerCab	199.95	155.95
Power Pro	529.95	412.95
Power Pro 10	649.95	506.95
Power Pro-R	699.95	545.95
Power Pro 10-R	849.95	662.95
THROTTLES		
Cab-06R	189.95	151.95
Cab-06	99.95	79.95
Pro Cab	159.95	124.95
Pro Cab-R	249.95	194.95

DCC Specialties

ITEM	LIST	SALE
RRampMeter I.	64.95	54.95
RRampMeter II.	94.95	79.95
RRampMeter III.	104.95	89.95
RRampMeter HP	124.95	104.95

MRC

Prodigy Adv 2 Wireless	639.98	349.99
Prodigy Adv W'less Cab	199.98	119.99
Prodigy Advance 2	429.98	249.95
Advanced 2 Cab	124.98	74.99



Pinewood Plaza, 57 River Rd, Suite 1023
Essex Junction, VT 05452
info@TonysTrains.com • fax 802-878-5550

- * FIRST in DCC Sales & Support
- * Installations and Loco Work
- * Club Demos & Discounts
- * We Guarantee Your Satisfaction

800-978-3472
INFO, QUESTIONS, CATALOGUE
TonysTrains.com



How to Paint a Steam Locomotive



Co-sponsored by
Badger
Airbrush
Company

By Jeff Johnston

Your complete how-to guide for painting your own steam locomotive models. Follow step-by-step as we paint a Bachmann 2-8-0, a brass M&WRy Mikado and a brass SPLCo Shay.

A TWO DVD set!

\$27
+s/h

Make the Leap!
Paint brass or plastic steam locos like the experts! Learn the tips and tricks to make your motive power look like proto power! Then add realistic weathering to complete your steam roster. See details on these volumes at:
www.trainvideosandparts.com

Check our website for our complete range of DVD offerings!
By Jeff Johnston, producer of fine modeling and prototype videos

\$20
+s/h

Steam Loco Weathering Clinic



Presented by Jeff Johnston
Author, The MDC Shay Handbook

Bonus feature!
Weathering an SP Cab Forward



Your easy and complete how-to guide for weathering any steam locomotive model

A Pictures & Words Production © 2008

Backdrop Junction

Your stop for
Model Railroad Backdrops



backdropjunction.com
N, HO, O Scales • Custom Orders

FINALLY THE RIGHT TOOL FOR THE JOB

Retire that Pounce Wheel get the Monster Nailer
No More Straight Lines &
Square Holes from a Wheel...
Create Accurate &
Realistic Nail Holes
Perfect Scale Spacing



www.monstermodelworks.com

*Tired of old structures
on your modern layout?
We can help!*

Click Here for more details...
www.summit-customcuts.com

TRAIN & TOOL SALE!

EXCLUSIVE PRODUCTS INSIDE EVERY ISSUE
Micro-Mark
THE SMALL TOOL SPECIALISTS INDEX PAGE 78
KNOCK OUT SALE!
SAVE UP TO 70%
Sale Starts June 14th 2011
FREE CATALOG!
ORDER TOLL-FREE: 1-800-225-1066

Not just for backgrounds
any more.
The ONLY craftsman card model

www.clevermodels.net
Most kits under \$10
clever models LLC
Available on DVD and Downloads

Need help with DCC?

We tailor DCC to your
Givens & Druthers

DCC by Design

offers service to help you
enjoy your layout

Learn more at
www.dccbydesign.com

Need Quality Train Audio for your Layout?

Don't waste your life savings on expensive
"synthesized" sounds.

We Have over 70 "Real Life" hour long cd recordings!

- Both Diesel and Steam
- ALCO - EMD
- BNSF - Heavy Steam High Quality!
- Light Steam
- And Many Many More!

MyTrainSounds.com



Model Railroad Hobbyist - HOBBY MARKETPLACE

Some folks will
go to any length
to get one of
our videos ...



Click to
learn more ...

More Results.
More fun!
model-trains-video.com

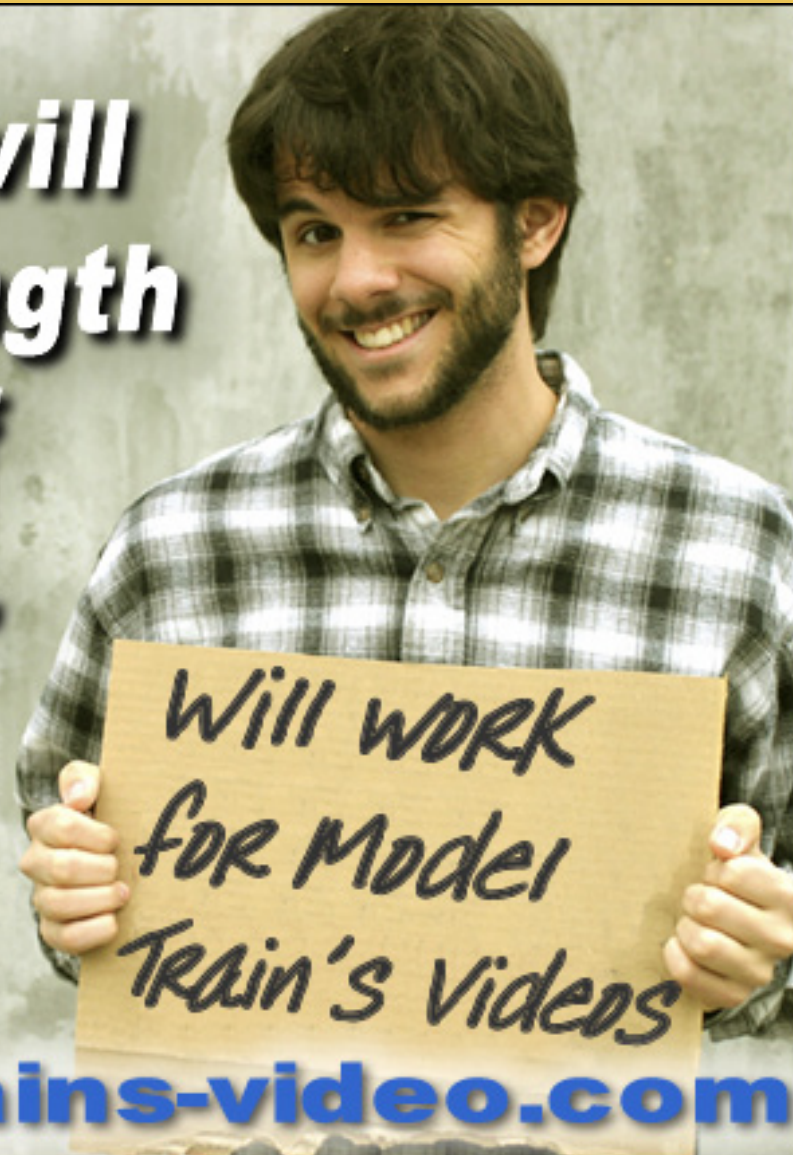

A
D
V
E
R
T
I
S
E
M
E
N
T

The *Model Railcast Show*

Keeping
you
on the
**RIGHT
TRACK**



Click here to
learn more ...



(Show host,
Ryan Andersen)

SCALE RULERS \$4 each

over **150** scales

Metric or Imperial

www.rulers-of-the-world.com



Railpub

The source for back issue rail magazines;
used, new and out of print rail books.

Railroad modeling, prototype, traction,
logging, industrial subjects.

www.railpub.com



**Model
Railroading
Radio on the
internet!**

Add Realistic Rivets to Your Models

– by V.S. Roseman

Model photos by the author

Have you ever wondered why older rail-road rolling stock has all those rivet heads? How the prototype applied rivets? How can they be modeled? Continue reading and all will be revealed.

This car shop, modeled by Victor, shows a number of crews busy at work hot-riveting cars. Victor needed to perform plastic surgery on the riveters because no commercial riveter figures were available.



▶ **Reader Feedback** 
(click here)



Learn how to install rivets on your models – without a forge or hammer ...

From the early days of rail-roading, metal parts of trains were riveted together. Rivets were heated red hot and inserted in pre-drilled holes. They were held by the head on one side with the shank penetrating the two pieces of metal to be joined. The shank was pounded with a hammer to form a flare which held the parts together. As the rivet cooled it shrank making a very tight joint.

Open or semi-open rivets are used in other industries such as leather or clothing. Tiny hollow (tube) rivets are used by modelers to join valve gear parts of model steam locomotives. These rivets are cold formed by tapping the head with a hammer while the open end is held against a cone-shaped die forming a flange.

In the early 1900s, all-steel rolling stock, such as hopper cars, started to appear, followed by passenger cars and other types of freight cars.

Steam locomotives had riveted boilers, cabs, and tenders. Even frames were riveted before the coming of unit cast frames. An interesting fact: I was examining an EMD passenger “E” unit close up and noticed the round-head fasteners on the carbody were not rivets but actually bolts! Simulating these on a model could use the same processes as rivets.



Figure 1

Figure 1: For many years, starting in the early days of steel rolling stock, cars were built on either a bar underframe or fish-belly girders and riveted together. Riveted car construction continued until the early 1930s when welding replaced riveting on passenger cars.

A forge, often oil fired, heated rivets red hot. A worker adding or repairing steel side sheets on a car used tongs to take a rivet from the forge and toss it to a second worker who caught it in a metal cup, retrieved the

rivet with tongs and placed it in a hole through two overlapping steel side sheets on the car. A worker with a pneumatic hammer would pound on the rivet, while on the opposite side of the steel sheets another worker held a bucking bar with a die on the end to form the red hot rivet shank into a domed shape.

The rivet shrank as it cooled, pulling the two pieces tightly together making a strong joint.

Individual body panels were sometimes replaced on boxcars or other rolling stock, as

evidenced by photos in *Trains and Railroad* magazine showing cars lettered “NORFOLK WEST AND ERN” or with the huge billboard letters “B&-” on a Baltimore and Ohio car. Sometimes single or double sheathed wood-sided cars were upgraded with steel sides.

This scene represents a busy outdoor repair shop working on various boxcars. The gantry in the rear was used to lift bodies on and off car frames.

Model Rivets

Simulating rivets on model trains has always been a problem. Until the 1950s, sheet metal toys and models required complicated equipment to stamp rivets into bodies’ sheet metal.

When die-cast models appeared, they had rivet heads built into their tooling. But die-cast model trains often lacked fine details – they were difficult to cast and the steel dies needed were very expensive.

Die-casting was succeeded by injection molded plastic models in the 1950s – the tooling was very similar to that used for casting in metal. In some cases it was converted from metal to plastic casting. Although injection-molding plastic required very expensive tooling, tens or even hundreds of thousands of units could be made before the mold wore out.

Other model train manufacturers used high quality printing to lithograph rivets on train models. The Marx company that made inexpensive 027 trains in the 1950s, had a deluxe line of freight cars that had printed rivets and were very realistic when seen from normal viewing distances.

W.K. Walthers, manufacturer of the most complete line of heavyweight passenger cars, made kits with wood roof and floor, die-cast ends, and thin stamped steel sides with all the windows pre-cut for the modeler.

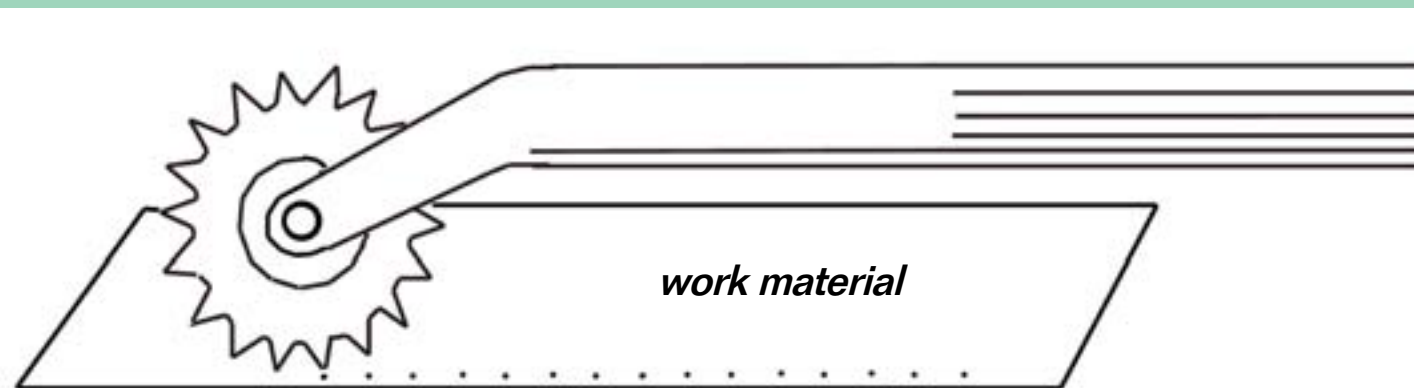

Pounce Wheel used to emboss rivets in thin material

Figure 2: Pounce wheel (or riveting wheel), a simple device for embossing rivets in thin, soft material such as paper or plastic.

Lift the weighted arm and let it drop. Lifting the same amount for each rivet ensures consistency

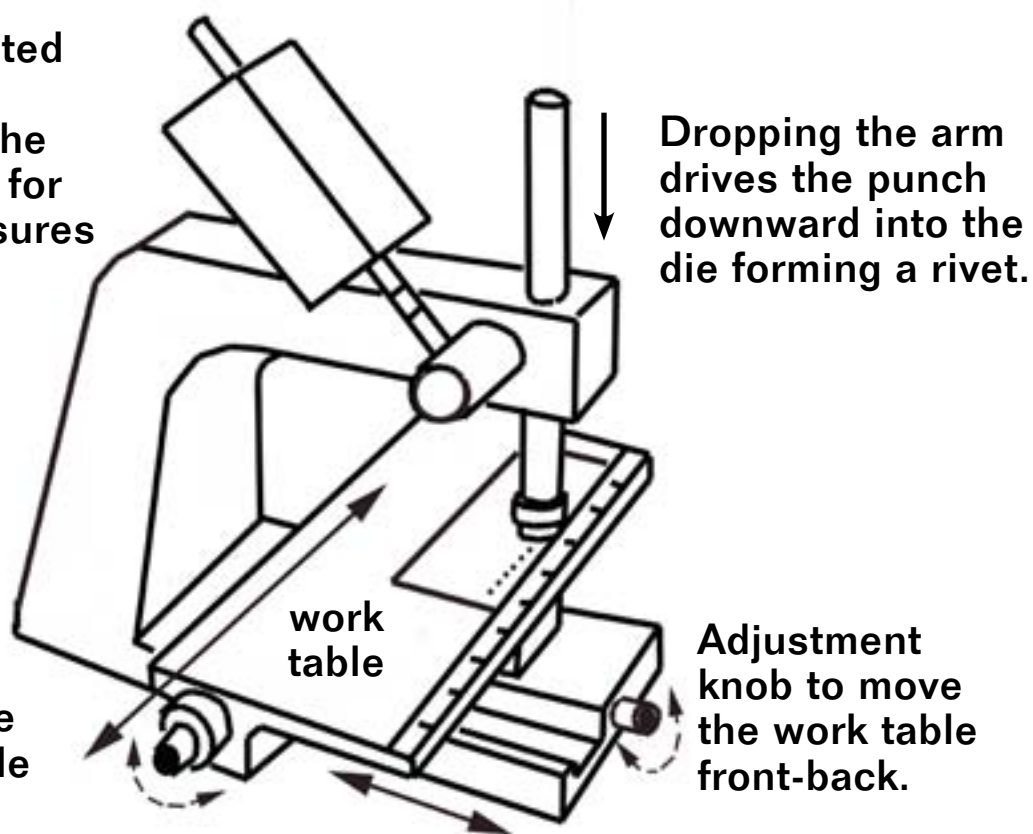

Dropping the arm drives the punch downward into the die forming a rivet.

Adjustment knob to move the work table left-right.

Adjustment knob to move the work table front-back.

Figure 3: Rivet machine based on an arbor press. The specially tooled die and punch make very precise and consistent rivets in thin metal or styrene. The screw driven work table allows precise positioning for each rivet. But it requires great operator concentration.

Walters stamped the rivets using a foot-treadle-operated machine. However each group of rivets required a separate operation, adding to cost of a kit.

Today, plastic models include different sizes and patterns of rivets. An unprecedented number of highly accurate engines and rolling stock are now available.

Do It Yourself Rivets

Some of us are always looking for cars or engines that are not available. This leads to scratchbuilding or modifying existing models. As we become more sophisticated modelers, accurate rivet details become more important.

I have been building model trains for many, many years and have tried many methods to simulate rivets. Each method has advantages and drawbacks. My success varied greatly.

Some modelers chisel the rivets off an old plastic freight car with a sharp X-acto blade, carefully saving them. They place the rivets on the model one at a time and glue them in place. I tried this method but found the tiny rivet heads extremely difficult to accurately place and glue and I had problems leaving glue stains around the rivets. I admire people who can use this method, but it clearly is not for me.

I searched the aisles of craft stores and found paints that went on thick enough to make rivets when applied with a toothpick. Trying to make dots

of paint the correct size and accurately lining them in rows up was tedious. In the end, no matter how careful I was, I always found too many blob-like rivets or alignment problems.

I tried using pounce wheels, normally used by seamstresses (figure 2), to emboss rivets. Making rivets by embossing them in thin styrene was disappointing. I attempted embossing rivets in thin paper with a pounce wheel. Then I laminated the strips on my models. It worked, sort of – but I could never find an old clock gear or a pounce wheel that produced good quality HO scale rivets.

I tried a purpose-built riveting tool based on an arbor press, with a screw feed table (figure 3). I created a single row of rivets to see how they would look. They were excellent – the tool's punch and die formed perfect rivets. But keeping track of how many turns of the screw feed were needed to move the work table to the next location took so much concentration that doing a single row gave me a headache. I also realized that making even one mistake while embossing a piece of a locomotive cab or freight car would require starting over. I don't have the concentration required so I sold the tool.

Some modelers have converted sewing machines (figure 4). They use a punch instead of a needle. The fabric feed mechanism advances the sheet brass or styrene letting the operator make very evenly spaced rivets. I've never tried this method, and do not

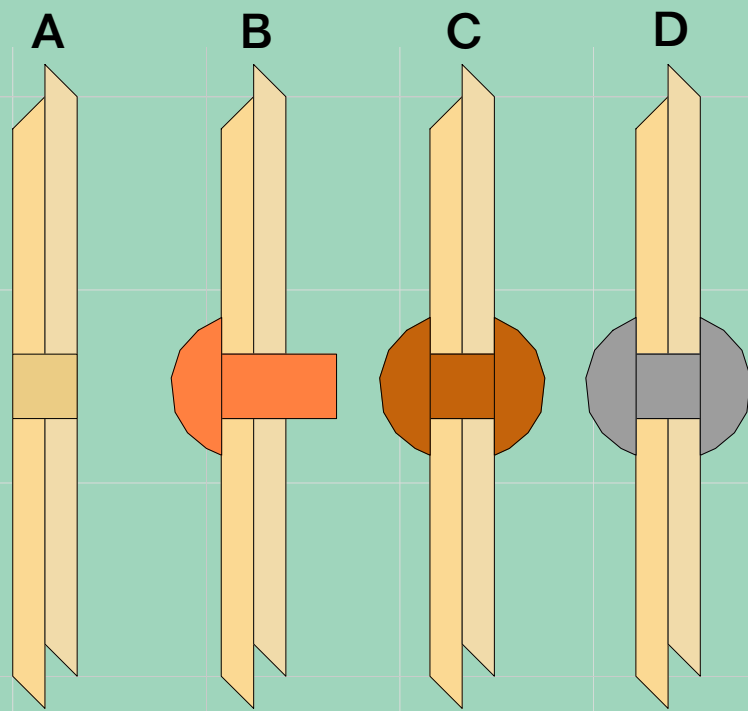

A. Sheets of material held together with hole bored for the rivet.

B. Red-hot rivet inserted in hole ready for shaping.

C. Rivet shank is formed into a round shape with a pneumatic hammer and bucking die.

D. The formed rivet shrinks as it cools holding the sheets of material tightly together.

Figure 4: How hot-ripping works.

know anyone who has actually done it, but I hear it is a very accurate way to make rows of rivets.

Rivets on Decal Sheets

Fortunately for modelers a new rivet-head simulation technology has appeared. Both Archer and Micro-Mark are producing decal sheets with patterns of scale rivets.

Also available are other hard-to-model details such as louvers for diesel hood units, and welding seams.

Prototype Rivet Sizes

Decal rivets have made modeling this detail much easier. Now that modelers can reasonably model rivet head

sizes the question arises, "What is the right size?"

Those of us who want to use scale or near scale rivet sizes will have to do some research. I was surprised to find that railroad car and locomotive manufacturer plan sheets do not usually show rivet sizes. I have found some plans and erecting cards that indicate rivet sizes for some useful equipment, and have measured rivets on some prototypes I found locally. Figure 6 is a chart I developed with some of the sizes I found. For greatest accuracy, measure the actual equipment you are modeling, or the closest substitute you can find.

In some cases, threaded bolts are used instead of rivets. When these have round or pan heads, they can be

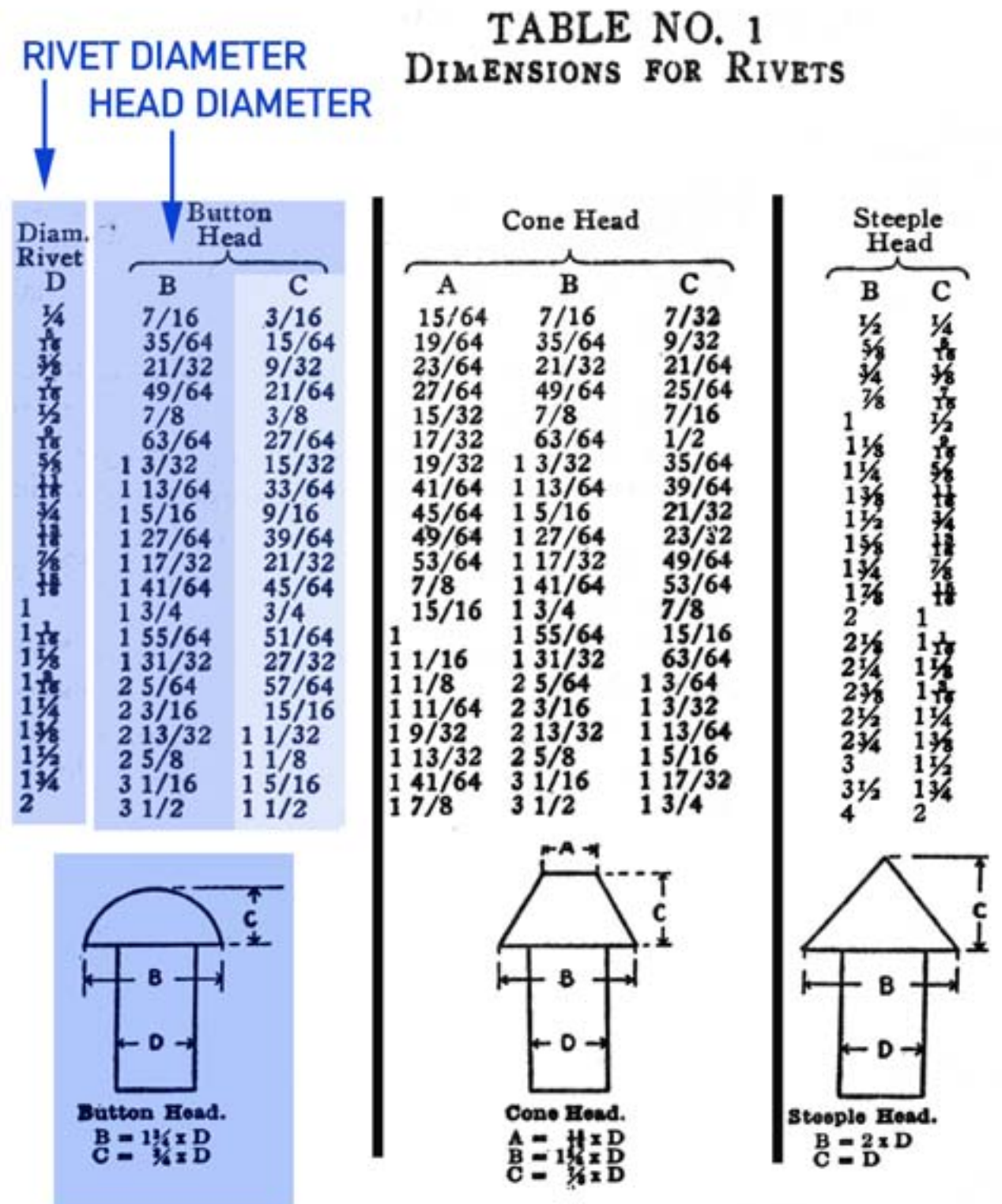

Figure 5: Chart from the 1930 Locomotive Cyclopaedia describing rivet forms and head/shank size relationship.

modeled using decal rivets. Where bolt or rivet sizes are specified on a plan, it is for the shank size, not the diameter of the head.

Fortunately, I found a chart in the 1930 Locomotive Cyclopedia showing shank diameters and appropriate head sizes. Figure 5 shows that round and cone head rivets have a head size 1.75 times the shank size. Catalogs of modern rivet manufacturers show that while there is some variation, most head diameters are still close to 1.75 times the shank although pointed steeple head rivets have heads twice the shank diameter.

In searching for rivet sizes on plans and by measuring prototype rolling stock, I found several rivet head sizes that should be useful. As the chart (figure 6) is from a very limited number of samples, this is just a starting point, and represents equipment built between about 1910 and 1930.

The ability to model rivets precisely introduces other interesting factors.

Deceptive Rivet Sizes

I found what appeared to be two different sizes of fasteners used on a 1911 steeple cab locomotive. The head diameters measured exactly the same when I checked them with a digital caliper. But close examination of a photograph showed some heads appeared larger than others. The heads *appearing* to be larger had

a hemispherical shape. These turned out to be slotted, round-head bolts. The rivets next to them had a lower profile head – sometimes called a mushroom head, brazier head or pan head (figure 7). The lower head of the rivets cast a smaller shadow making them appear smaller than the hemispherical bolt heads in photographs!

On the next track, I found some equipment with many coats of paint built up around rivets, forming a fillet which made the rivets look larger than equipment that had been stripped before repainting. The extra paint can mislead a modeler researching rivet sizes from photographs.

I also found it was very difficult to compare rivets on photographs of two similar pieces of equipment unless both subjects are photographed under the same lighting conditions. Rivets in sunlight, for example, do not look the same as rivets under indoor lighting.

Archer Rivets

The Archer name is well known in the field of military modeling. They now offer decal sheets of tiny dots of resin deposited onto Microscale decal film for simulating rivets. A wide variety of rivet sizes and spacings are available. The miniature rivets are perfectly sized, shaped, and spaced.

Rivet sizes are clearly specified on the Archer packaging and in the catalog.

RIVET SIZES FOR SOME SAMPLE ROLLING STOCK TYPES		ACTUAL RIVET HEAD SIZE
RIVETS ON SIDE SHEETS OF PASSENGER CARS EXPRESS CARS. BOX CARS ELECTRIC LOCOMOTIVE CARBODIES	3/8" RIVET HEADS	.004"
	5/8" RIVET HEADS	.007"
<i>RIVET HEADS MEASURED FROM PROTOTYPE EQUIPMENT</i>		
BELT RAILS (DOUBLE RIVET ROWS)	1" RIVET HEADS	.011"
TANK CARS. STEAM LOCOMOTIVE TENDERS	11/16" RIVETS (RIVET HEADS = 1-1/4")	.014"
	3/4" RIVETS (RIVET HEADS = 1-5/16")	.015"
	7/8" RIVETS (RIVET HEADS = 1-17/32" or approx. 1-1/2")	.017"
<i>RIVET SHANK SIZES INDICATED ON PLAN SHEETS AND ERECTING CARDS</i>		

Figure 6: Chart showing some applications of different sized rivets from plans and measured from prototype riveted equipment.

Each sheet has many rows of rivets. I've found them easier to use than other methods I've tried and they produce better results, making them well worth the price.

Archer decals should be handled pretty much as you would an ordinary Microscale decal. Prepare your model for riveting the same way you prepare it for decaling – glossy surfaces work best for receiving decals.

In my first project I used a dark undercoat, but this made it difficult to align the rivets because they disappeared against this background! Try to use a light color so the rivets can be easily seen and properly aligned with model edges or guide lines.

Eliminating dust as you work is essential. Dust that has settled on a model can look like extra rivets after the

Figure 7: Bolt and rivet heads look similar but cast different size shadows.





Figure 8

Figure 8: Prototype photo of an SP class 120-C-3 tender.
 –Photo by Gene Collora.

Figure 9: Partially completed tender with some rivets applied.

Figure 10: Archer rivets being applied like a decal. The swab is loaded with water to keep the decal moist as it slides off the backing.

Figure 11: My finished model of a Southern Pacific class 120-C-3 Vanderbilt tender with Archer rivet detail.



Figure 9

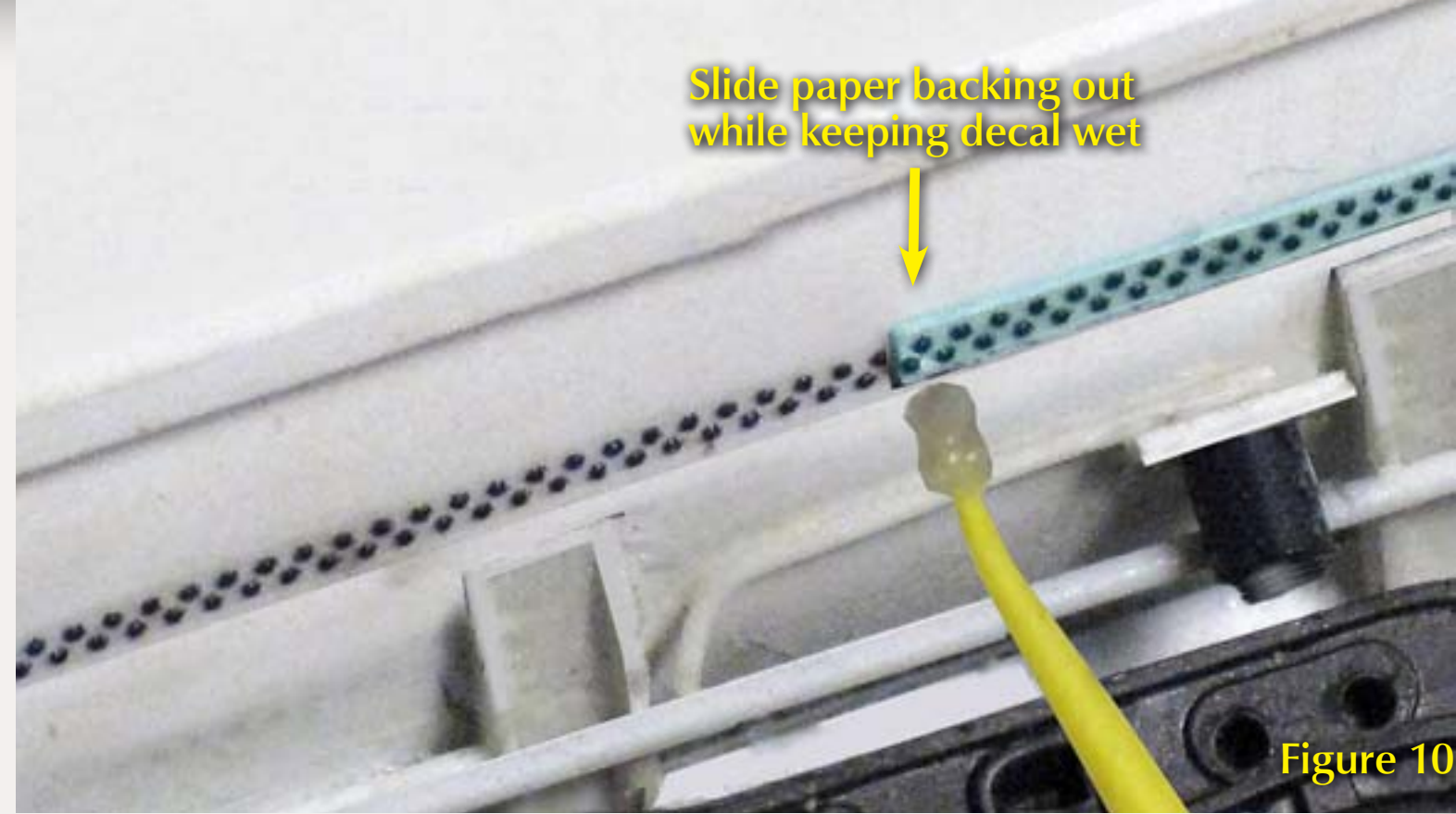

Figure 10

model is painted. Wipe down your model with a microfiber cloth to eliminate both oil and water based dirt particles. A clean square of material from an old tee shirt is okay, but paper towels leave specks of dust and paper lint can scratch paint, and should be avoided.

In a dry climate, or in winter when home heating dries out the air, the

dry air permits nearly invisible particles of dust to fly about. In winter, running a hot water vaporizer to moisten the air reduces this problem significantly. A humidifier will have the same effect, and either of these tends to reduce dry skin and other discomforts you may experience.

I go one step farther and use an electrostatic air cleaner to suck dust out



Figure 11



Figure 12

Figure 12: “A” end of my Reading XMT boxcar built from the Red Caboose X29 kit.

Figure 13: “B” end of Red Caboose Models X29 converted to Reading XMu class boxcar using Archer rivets. The body was made taller using part of a second body.



Figure 13

of the air. It’s amazing how much airborne crud these will catch! They are available with permanent or replaceable filters.

Once I received my first sheets of Archer rivets, I went to work on a few projects that I had been putting off for a long time because I didn’t have a good method for adding rivet detail.

Riveting a Tender

The Vanderbilt tender, named for its inventor, Cornelius Vanderbilt III, has a distinctive cylindrical water tank. Although many railroads used this style of tender, ironically the New York Central did not.

I needed a tender for a Southern Pacific engine and decided to scratch-build a class 120-C-3 tender. I learned a lot about building Vanderbilt tenders from this model. The Southern Pacific normally paired 120-C-3 class tenders with Pacifics and Mountains although they were sometimes used with Consolidations when extra capacity was needed.

The core of my tender is PVC tubing. I packed lead wool (from a plumbing supply company) into the back of the tube, and cut small discs of sheet lead for the front to properly weight it. There is room for a decoder in it, but if I built another, I would use thin-wall brass tube which has a larger inside diameter.

My model does not exactly match the riveting arrangement shown in the

photo because I used a different tender as my pattern, and these varied somewhat even within the class.

Sanding rivets off a model, then adding new ones is a relatively easy way to change a tender. Unique riveting patterns can be created with the wide variety of decal rivets.

Early Steel Boxcars

I’ve always liked New York Central and Reading Company early all-steel boxcars. I remember seeing those cars on a local freight at Hicksville, Long Island, not far from my home when I was a youngster.

The Reading class XMT boxcars and New York Central cars in lot 504B

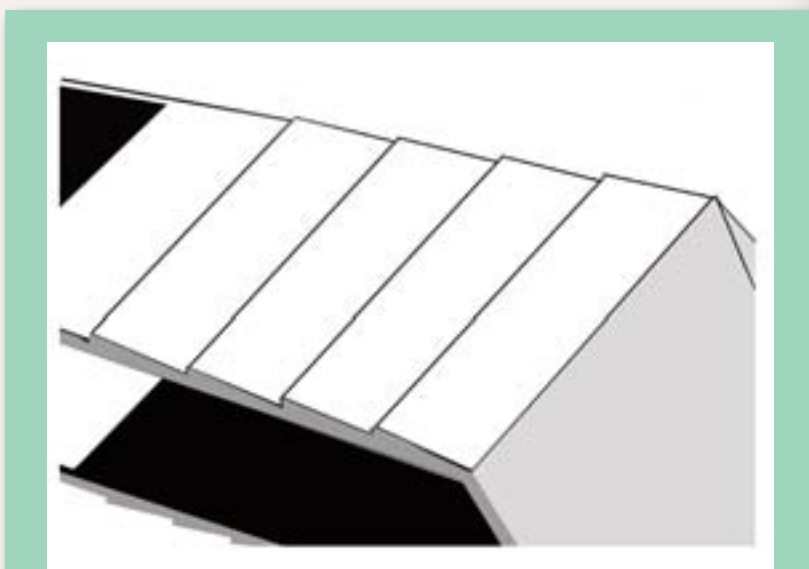

Figure 14: Sanding down the sides of the Red Caboose and Walthers models is complicated by the fact that the overlapping steel sheets of the prototype are simulated. The “ramp” effect shown is exaggerated.



Figure 15



Figure 16

Figure 15: An unmodified Red Caboose X29 with 10 side panels.

Figure 16: The new eight panel rivet pattern made with Archer rivets on the Red Caboose model creating a Reading XMt class boxcar.

were dimensionally similar to the ARA all-steel boxcar design. The Pennsylvania Railroad X29 has the same dimensions as the ARA car and models are available in HO and O scale but with a plate roof and other details specified by the Pennsylvania Railroad. The biggest difference between the X29 and the ARA car is the number of side panels. The X29 has ten while the Reading and NYC cars (as well as those of other railroads) have eight panels. The X29 models are easily converted to either New York Central or Reading cars using rivets decals.

Reading Company's first all-steel boxcars, in class XMt, were built in two

groups. American Car and Foundry built cars with corrugated ends, but the Standard Steel Car Co. built cars numbered in group 100500 to 100999 with flat plate ends like the X29 models. These cars had drop rungs instead of ladders, but I have not been able to verify which the New York Central Lot 504B cars had. Reading class XMu cars were slightly newer and their interior was 8" taller. Otherwise they were similar to X29 cars. The New York Central usually ordered freight cars in lots of thousands, but there were just 100 cars in Lot 504B.

Red Caboose made an excellent HO kit, now available ready-to-run from Intermountain. I was in touch with

Red Caboose, and they have a limited number of parts which they are willing to make up as kits on request. There was also a Train Miniature ARA all-steel boxcar often called an X29. These cars had a standing seam roof unlike the plain steel plate roof of the X29. These cars are now available from Walthers in a three pack of built up cars. Atlas has a well detailed O scale X29 car.

I began work on the Red Caboose car which comes decorated for the Reading and also as a 1924 PRR X29. Any of the Red Caboose models with plate ends can be used for this project. I sanded down the rivets from the car sides being careful to avoid removing the rivets on the ends and top edge of the sides.

Once the rivets were sanded off I saw the manufacturer simulated

the pattern of overlapping steel side sheets by thickening the car side at one edge of each panel in a series of little "ramps" (figure 14). I realized it would be a lot of work to sand the sides flat, so I began the project again with a Walthers (ex Train Miniature) "X29" model with a standing seam roof, similar to the Reading and New York Central cars.

Since this model was first produced nearly forty years ago and has molded on details, I figured the sides would be flat, making easy to remove the rivets. Unfortunately, Train Miniature also simulated the overlapping panel "ramp" design. I ended doing a lot of sanding since I made several cars. In hindsight, instead of sanding down the "ramps" simulating the overlapping side sheets of the car, it might have been easier to cut out and replace the car sides with sheet styrene.



Figure 17



Figure 18

My finished models show the Archer rivets and the prototypical riveting pattern. I believe they are similar to the originally molded on rivets in size and form.

Once I removed the detail from the car sides, I sketched the side panel seam locations on the model and scribed these carefully using a machinist square and a Squadron scribing tool (SQ-10202). This tool is intended to create panel lines on aircraft and does not raise a "bow wave" of compressed plastic on the sides of scribe lines. I used Archer decal sheet

88014 which has patterns closely resembling the rivet arrangement I found in photos of the prototype. Determining the correct rivet set to use requires being a rivet counter! The only way to get this right is to count the rivets in a row and compare this to the Archer sheets. I hope the scaled samples I have included in this article will be of help to modelers.

I applied one coat of Testors Modelmaster dark tan paint (so I could see the rivets) and applied the Archer decals using Micro Set decal setting fluid (figure 20). While these



Figure 19

Figure 17: Partially completed Walthers (ex Train Miniature) X29 converted with 8 side panels using Archer rivets and new ladders and grabs.

Figure 18: Red Caboose model showing the new riveting used to make an 8 panel car.

Figure 19: Walthers (ex Train Miniature) 8' 7" interior height X29 boxcar in Nickel Plate Road colors with original 10 panel sides.

Figure 20: Applying rivet decals using Microscale Micro Set.

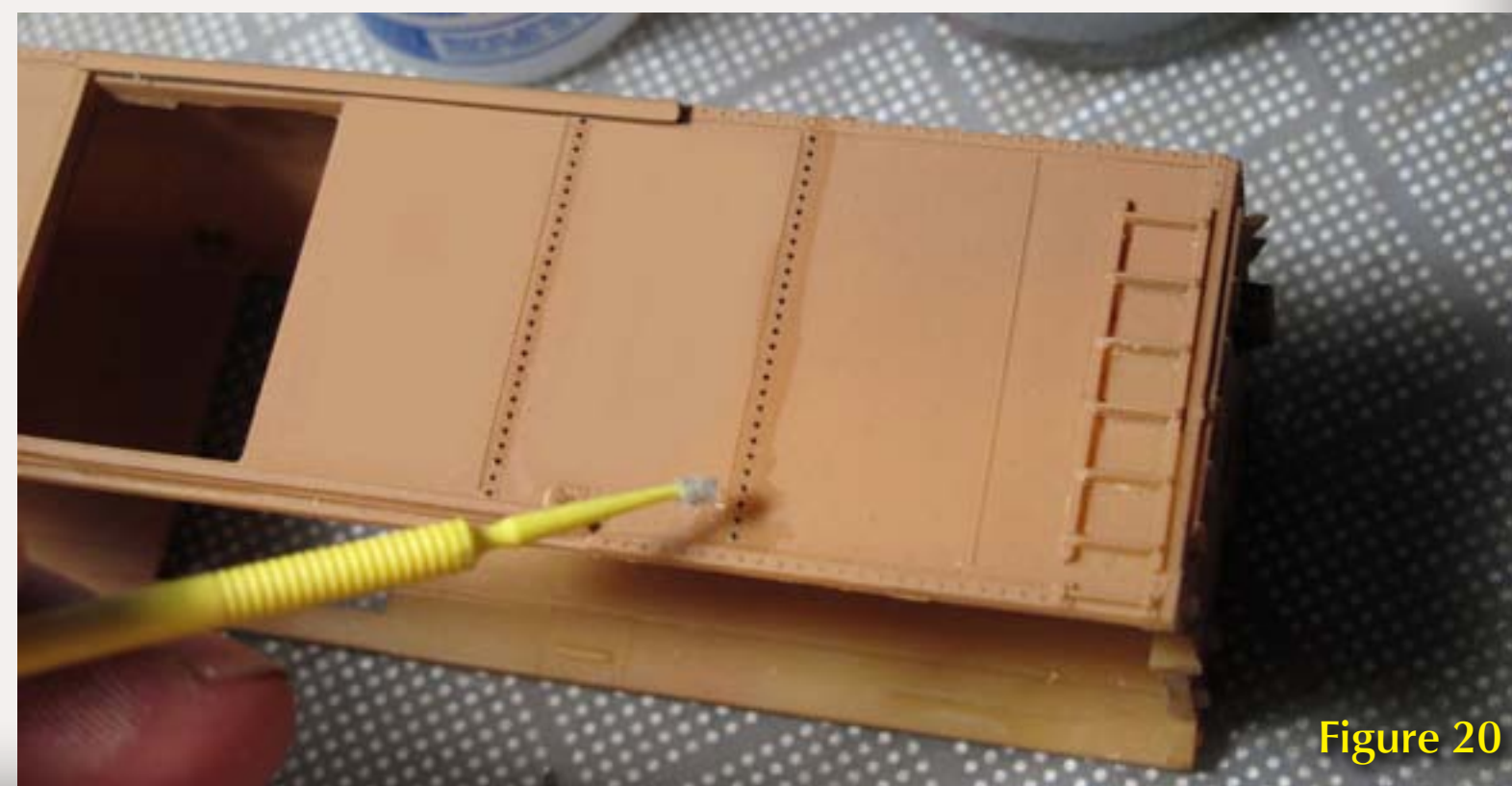
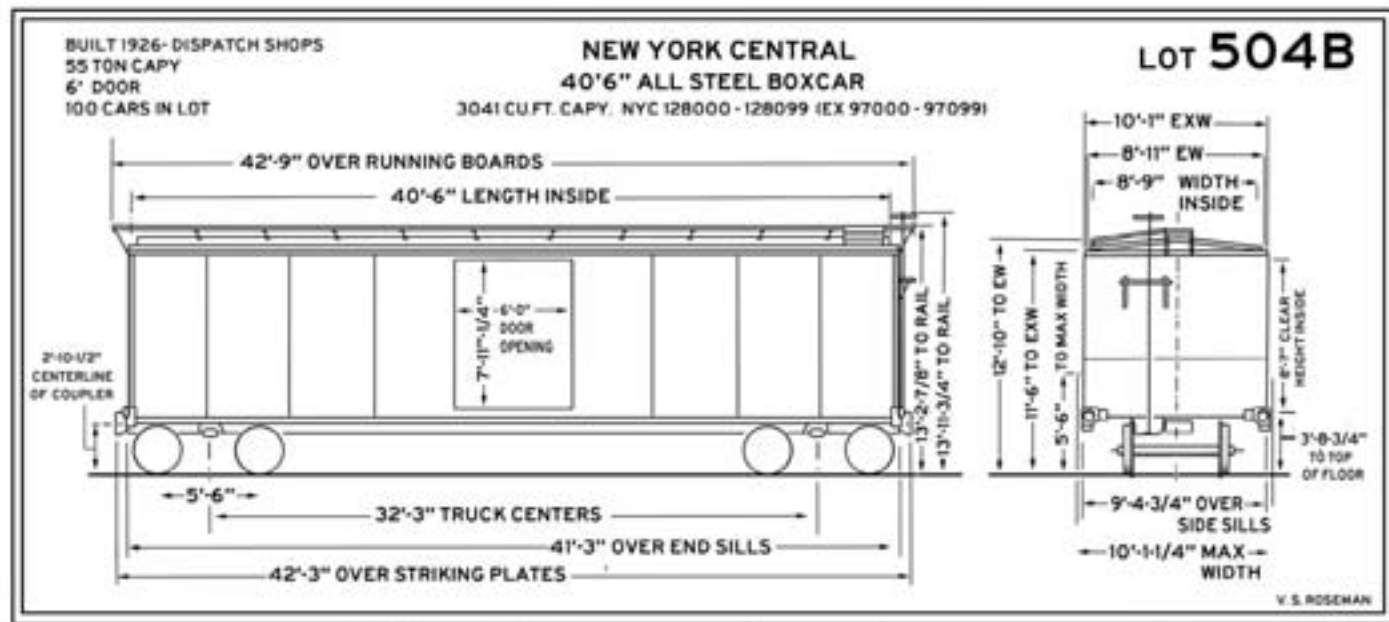

Figure 20



THE DIMENSIONS OF NEW YORK CENTRAL LOT 504B CARS ARE NEARLY IDENTICAL WITH PENNSYLVANIA RR. X29 AND READING XMT BOXCARS

Figure 21: Diagram of New York Central Lot 504B boxcars. Diagram for a Reading XMt boxcar would be similar.

READING COMPANY					
CLASS	I.H.	CAR NUMBERS	NO. CARS	BLT.	CARBUILDER
XMt	8'-7"	*100000-100499	500	1925	AMERICAN CAR & FOUNDRY CO.
XMt	8'-7"	100500-100999	500	1925	STANDARD STEEL CAR CO.

* XMt cars numbered 100000-100499 have corrugated Murphy ends.
 XMt cars are dimensionally similar to X29 models but have drop rungs instead of ladders.

XMu	9'-3"	101000-101399	500	1925	PRESSED STEEL CAR CO.
XMu	9'-3"	101400-101799	400	1930	STANDARD STEEL CAR CO.
XMu	9'-3"	101800-102399	600	1930	AMERICAN CAR & FOUNDRY CO.
XMu	9'-3"	102400-102999	600	1930	BETHLEHEM STEEL CO.

XMu cars have flat plate ends and details resembling the X29 models but are 8" taller

Figure 22: Numbering system for early all-steel boxcars on the Reading Company.

decals will be sealed with layers of top coat paint, I wanted them to adhere well to the primer coat, so they would not rub off. I suggest handling the finished cars carefully.

It seemed like a good idea to leave wide areas of decal film alongside the rivets to have the greatest surface area for adhesion to resist the handling that train models get on layouts. Unfortunately the edges still showed even under two more coats of paint. So I cut the decal film on my second model as close as possible to the rivets. This made the film nearly invisible.

I also was a bit more patient with the second model. There were a few small wrinkles in the film which look a bit like stray rivets. I used more decal setting fluid to solve this issue.

Once the decals had thoroughly dried, I painted my cars and lettered them using CDS dry transfers.

Most or all of the Reading XMt cars had unique Taylor trucks, but later on, other truck types were common. They are such a hallmark of Reading equipment that I will change them out if I can locate some Taylors somewhere.

The Reading XMu car I built is similar to the ARA 8' 7" Interior height car, but has 9' 3" interior height and the 8 panel sides. Some modelers may want to ignore the 8" difference, but it is not difficult to increase the height of the carbody. Plain styrene can be used

or an extra X29 body can be cut to augment the body height. One body can provide enough material for several conversions.

For those who look closely at weathering, most of the early all-steel design boxcars eventually had corrosion problems with the lower edges of the side sheets, and segments were often cut out of the car side and replaced with new metal. On some cars the corrosion was sufficiently advanced when they reached a repair shop that a single steel strip was welded between the door and the end on both sides. This is easy to simulate by adding an 8" scale plain styrene strip to the bottom of the car butted against the sanded down sides without smoothing down to eliminate the joint. Some of these cars went through their later years with a scar across the whole car side.

The stirrup steps for this project did not arrive and the modern angled type I used temporarily for the photos should actually be outside mount plain step units.

Louvers on a Diesel

Early diesel locomotives had vent openings on their car bodies covered with metal mesh. These were gradually replaced by louvers. Baldwin diesel switchers and road switcher units, Alco and EMD yard engines and road switchers often had dozens of these louvers that are difficult to simulate



Figure 23

on models. EMD “F” units had louvers between their portholes and some railroads, such as Baltimore and Ohio, plated over the portholes on some of their passenger “E” unit diesels adding louvers instead.

Trying to model these with paste-on louvers added extra thickness which looked unrealistic. It’s possible to salvage louvers from an old locomotive body by cutting them out of the shell and inlaying them into your model, but this requires a great deal of precision to get a precise fit.

Archer now offers various sized louvers that can be cut to the desired height, greatly simplifying modeling this feature.

Atlas HO scale FP7 diesel engines were made in Austria by Roco a number of years ago. They modeled the late phase FP7 diesel engines with the more modern F9 style “sideways” louvers between the portholes. I needed the earlier type of EMD louvers. Archer set #88038 contains louvers measuring 12” wide in HO scale, very close to the size of those used on the EMD diesels, slightly narrower than the prototype (figure 23).

I filled the recessed louver openings of the Atlas body with Squadron white putty (figure 24). About an hour later, when it had dried, I sanded the puttied surface until I had a good smooth finish. I painted the model pale grey (figure 25) as the first coat, and applied Archer louvers (figure 26).

I cut a long strip of louvers from the Archer sheet and used my NWSL Chopper II to chop this to short lengths with 10 louvers in each piece.

Align the louvers on the locomotive body by taping a ruler or straight strip of cardboard to the body as a guide. If you have a good eye, you can try it without the guide. I applied the Archer louvers using Micro Set as shown. Painting the engine light gray makes the dark louvers easier to see when applying them.

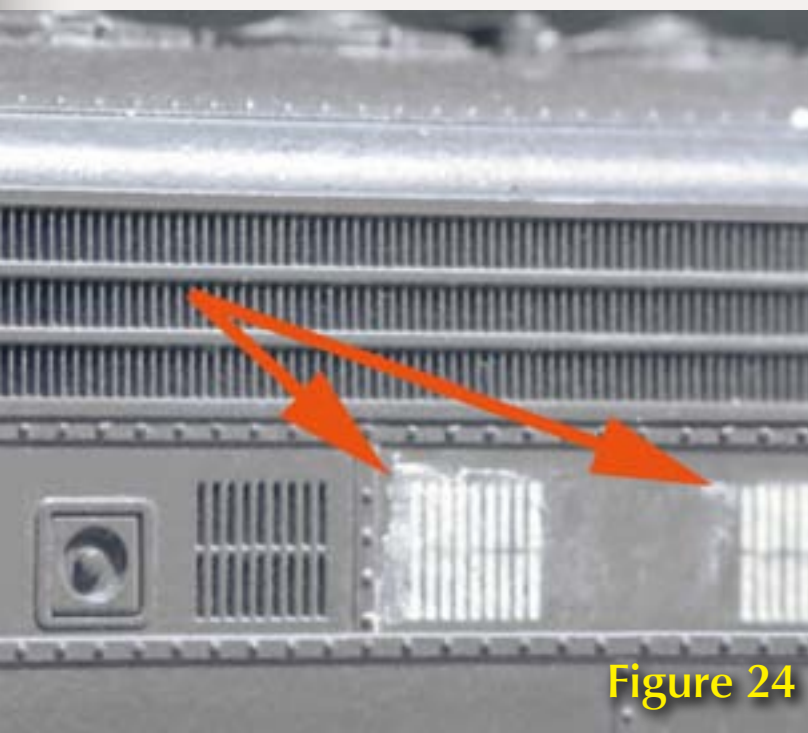

Figure 24

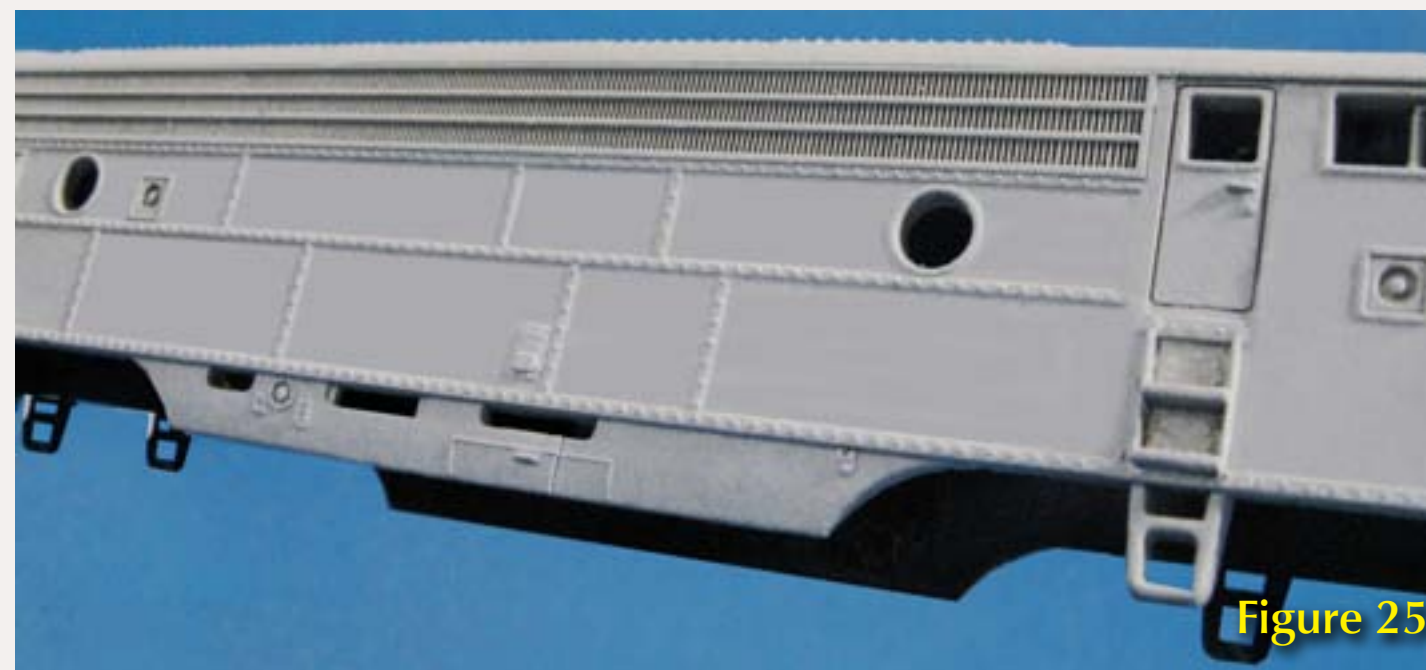

Figure 25

Figure 23: Atlas HO scale FP7 model (above) showing the late phase side grilles between the portholes. The second engine, (below) has been converted to the earlier type of side grilles with Archer louvers.

Figure 24: The side grilles on the Atlas body shell are recessed and should be filled with Squadron White putty.

Figure 25: FP7 shell with original louvers filled and painted.

Figure 26: Slide the louvers from the decal sheet on to the engine side or apply them with tweezers floating them off the backing film.

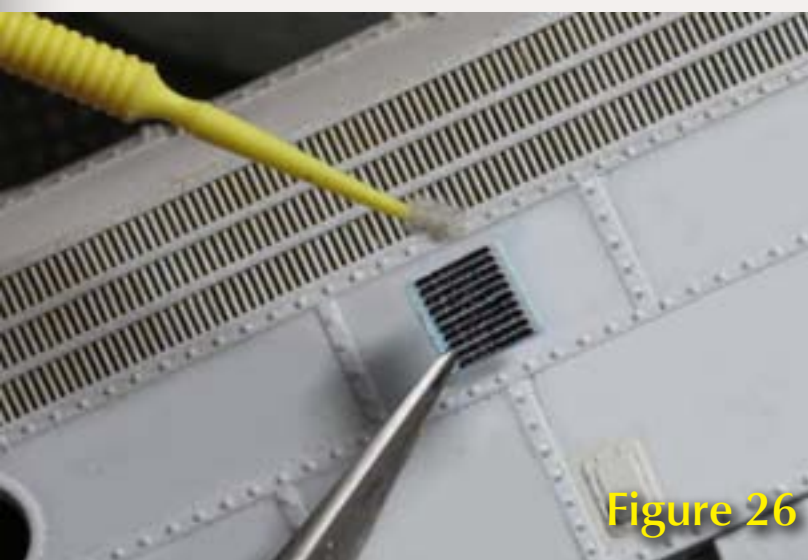

Figure 26

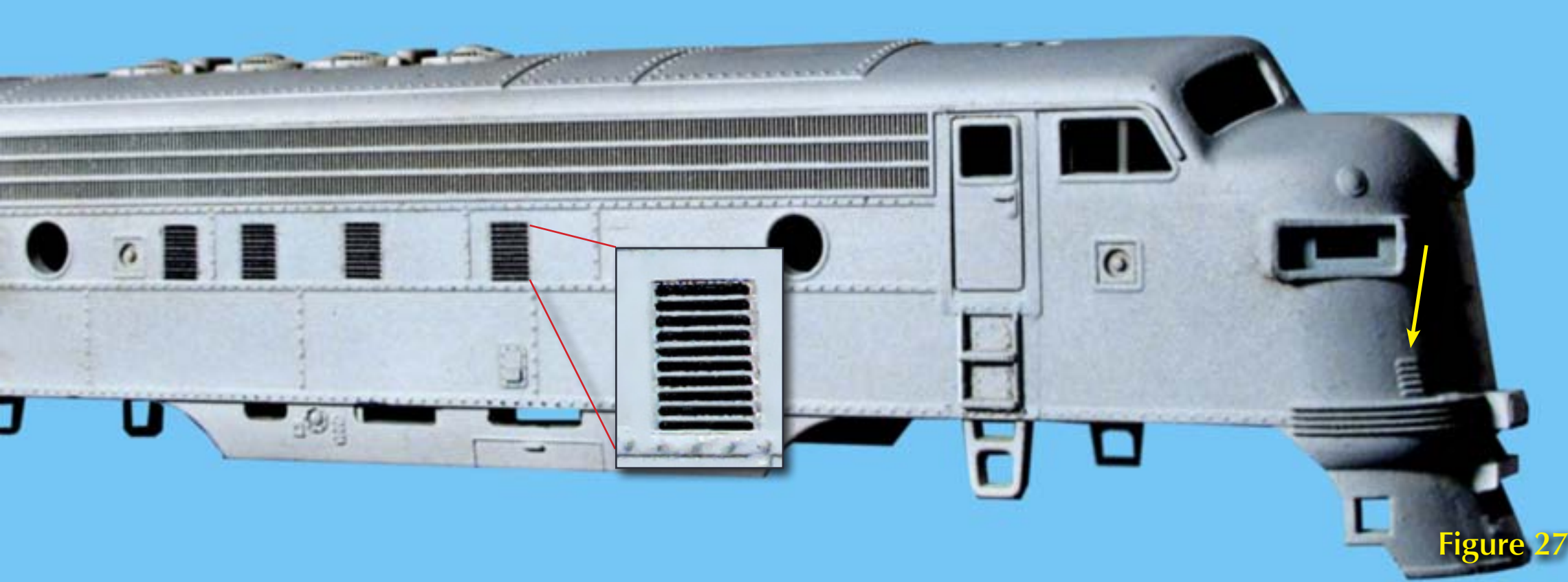

Figure 24: FP7 body with the decal louvers applied.

If you have trouble sanding off the mold parting line on the nose without damaging the smaller louvers there (figure 27), sand them off and replace them with Archer #88039.

There are many other uses for louver decals such as on factories, outdoor air conditioners, ventilators, or exhaust fans.

Figures 28 and 29 show a selection of Archer rivet sheets. Note the tank car rivets. These will let you back date a welded tank car to become a riveted tank car where dimensions are similar. Cars that are missing some rivet detail or have incorrect rivets can now be easily upgraded.

Archer has other interesting decal items such as rough weld lines resembling field repairs to military equipment. These could be useful in adding some "texture" to metal silos or various types of holding tanks or vessels.

The rivets will also be useful for S scale and for O or larger scale applications as well. Archer, being a military oriented firm has sets of fasteners in larger sizes made for military models. You can always re-scale any of these sets, ignoring the scale indicated where they fit your particular application. (For example, one inch rivets in HO scale would be very close to half inch rivets for "O" scale.

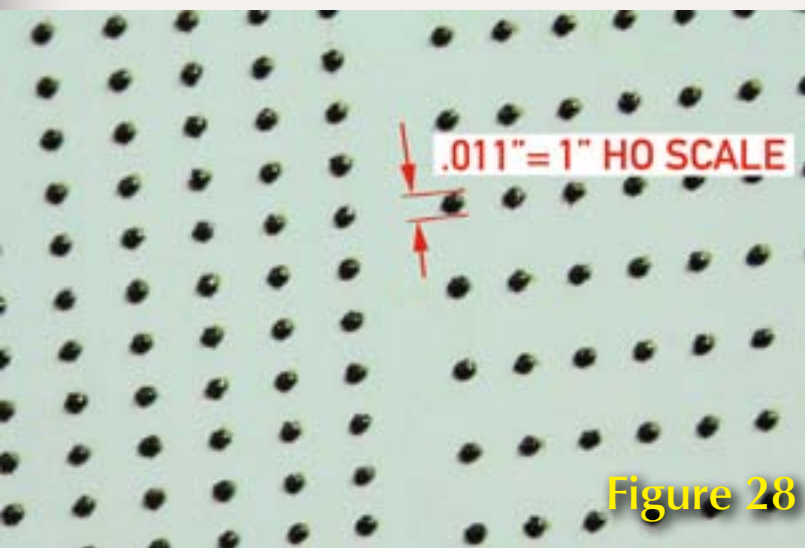

Figure 28

Figure 27: The body shell with the Archer louvers in place. Note the smaller louvers on the nose (yellow arrow).

Figure 28: Close-up of Archer rivet sheet 88015 showing .011 inch rivets (1 inch rivets in HO scale).

Figure 29: Archer rivet sheet information.

Figure 29

AR 88014 - .008" rivets (aprox 11/16" in HO)

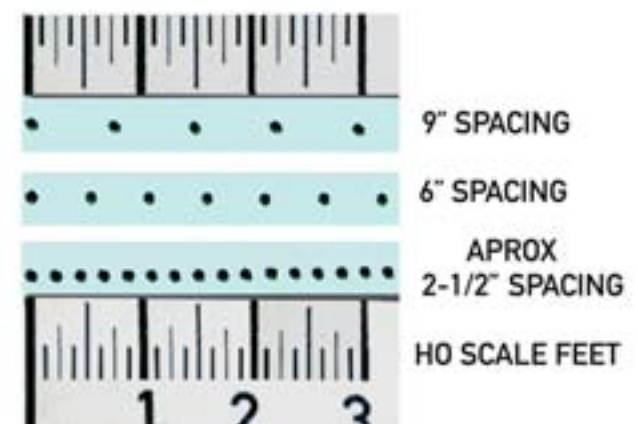

AR 88025 - 7/8" HO rivets

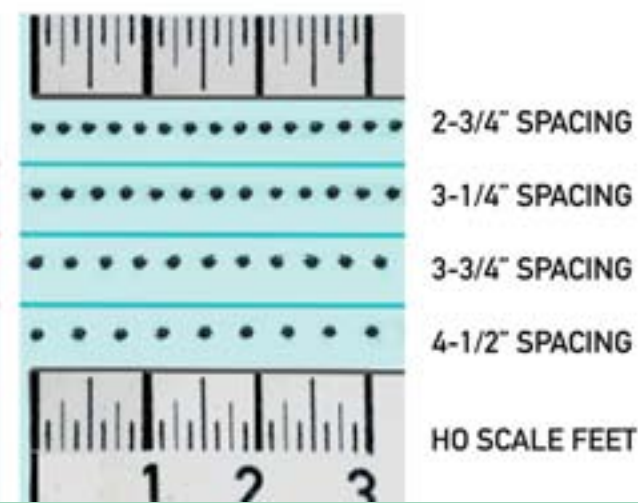

AR 88015 - .011" rivets (aprox 1" in HO scale)

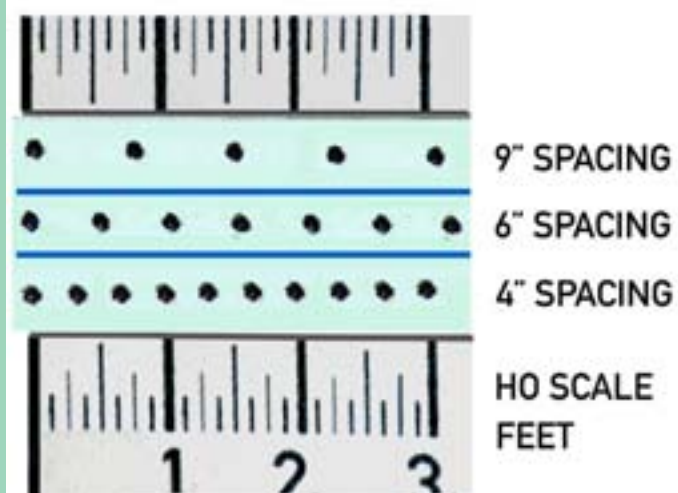

AR 88031 - double row HO tank car rivets

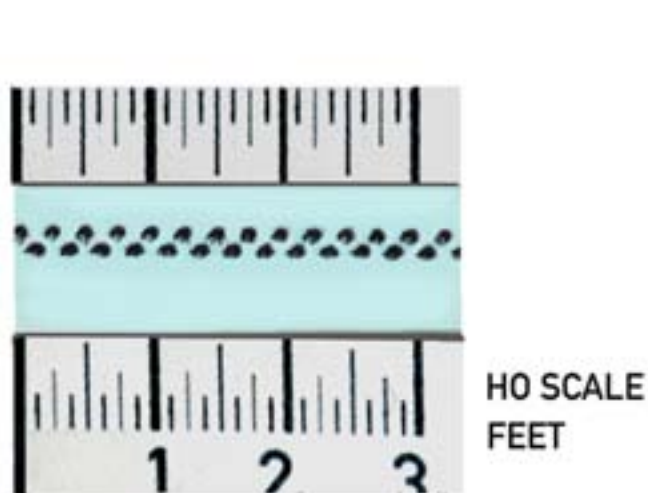

AR 88038 - 12" louvers

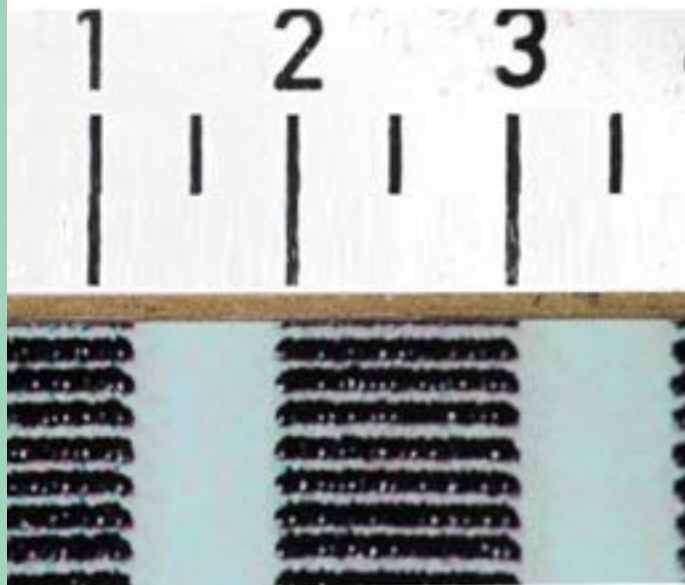

AR 88039 - 6" louvers

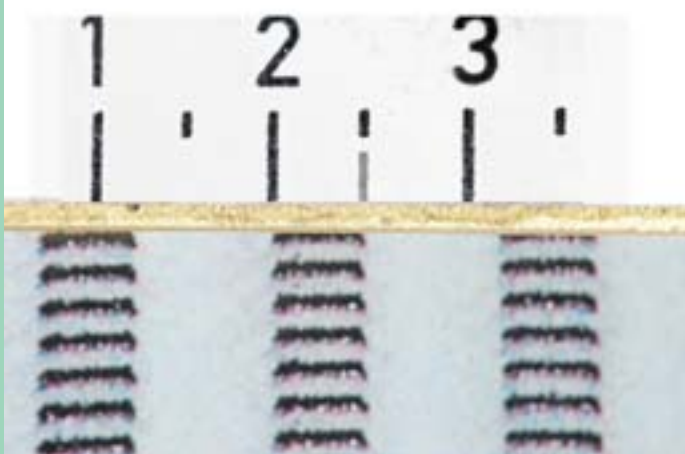

Figure 30: Archer louvers

Archer Fine Transfers
PO Box 1277
Youngsville, NC 27596

Office hours: 8AM EDT-Noon M-F
919-570-1026

e-mail: info@archertransfers.com
and help@archertransfers.com

This is a useful product, and while \$14.98 per 3x5" sheet may seem expensive, there are a lot of rivet strips on each. More importantly, after having used different riveting methods, I feel that Archer rivets let me easily produce high quality results.

The photos of some of the Archer sheets (figures 29) show strips of the rivet size and spacings on each, along with an HO scale rule for comparison. Despite the illustrated catalog, it is not easy to tell exactly what the rivet spacings are for particular applications, and I hope the photos here will make it easier to select the best sheets for your applications.

An important note about the photos of the rivet sheet samples shown here: I photographed them using a microscope lens with a diaphragm. If samples appear irregular in these photos, it is due to the extreme enlargement. Under normal viewing conditions, or with an ordinary magnifying glass after being painted, the Archer rivets look as good as those on top quality injection molded or resin models.

Micro-Mark Decal Rivets

[Micro-Mark](#) sells rivet decals for HO and O scale. Micro-Mark's HO scale decal rivet set #84985 is arranged in four similar assortments on an approximately 7x10" sheet. Each segment includes several riveting patterns plus other useful raised forms and shapes.

Micro-Mark HO sheets have four similar segments.

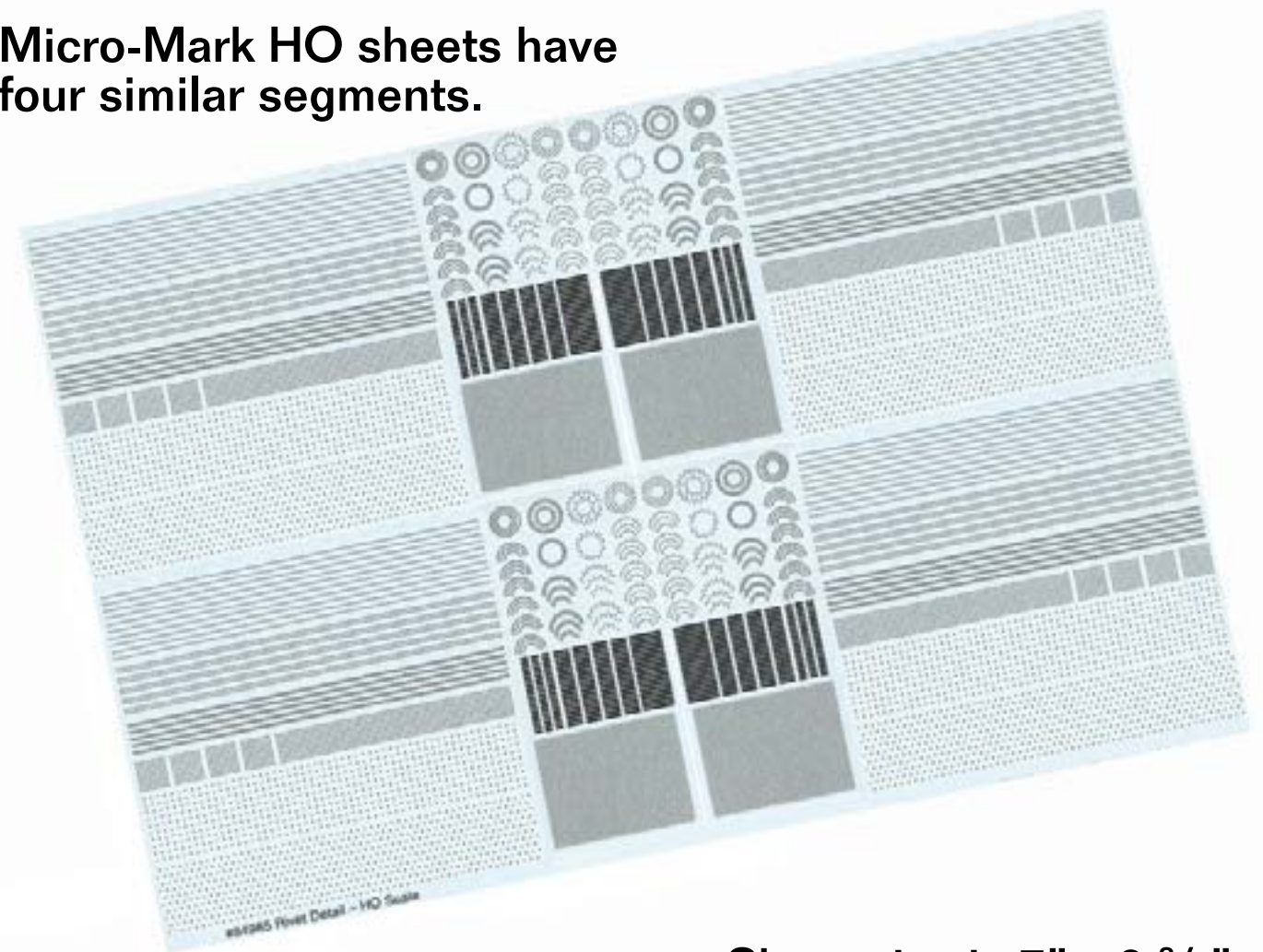

Sheet size is 7" x 9 3/4"

Figure 31: Micro-Mark HO rivet decal sheet.

Included are patterns of rivets arranged in grids which can be used as single or multiple rivet rows. There are several staggered rows of rivets, as well as closely spaced staggered rivet sets, as seen on tank cars, for example. There is a grid of lines, plus some louver strips.

The Micro-Mark set includes a number of interesting circular rivet patterns which can fit pipe nipples, circular hatches or for other similar applications. Using the Archer product, the modeler cuts strips of rivets

and notches between each for this application.

Micro-Mark does not specify its rivet sizes or spacings, but I have shown an HO scale rule next to each portion of the Micro-Mark sheet to help the modeler judge the actual sizes and spacings. I measured the rivets and they are approximately 1 1/3" in diameter, over the rivet head.

Micro-Mark HO and O scale sets each include two sheets. The Micro-Mark O scale set, #84987, due to the larger size

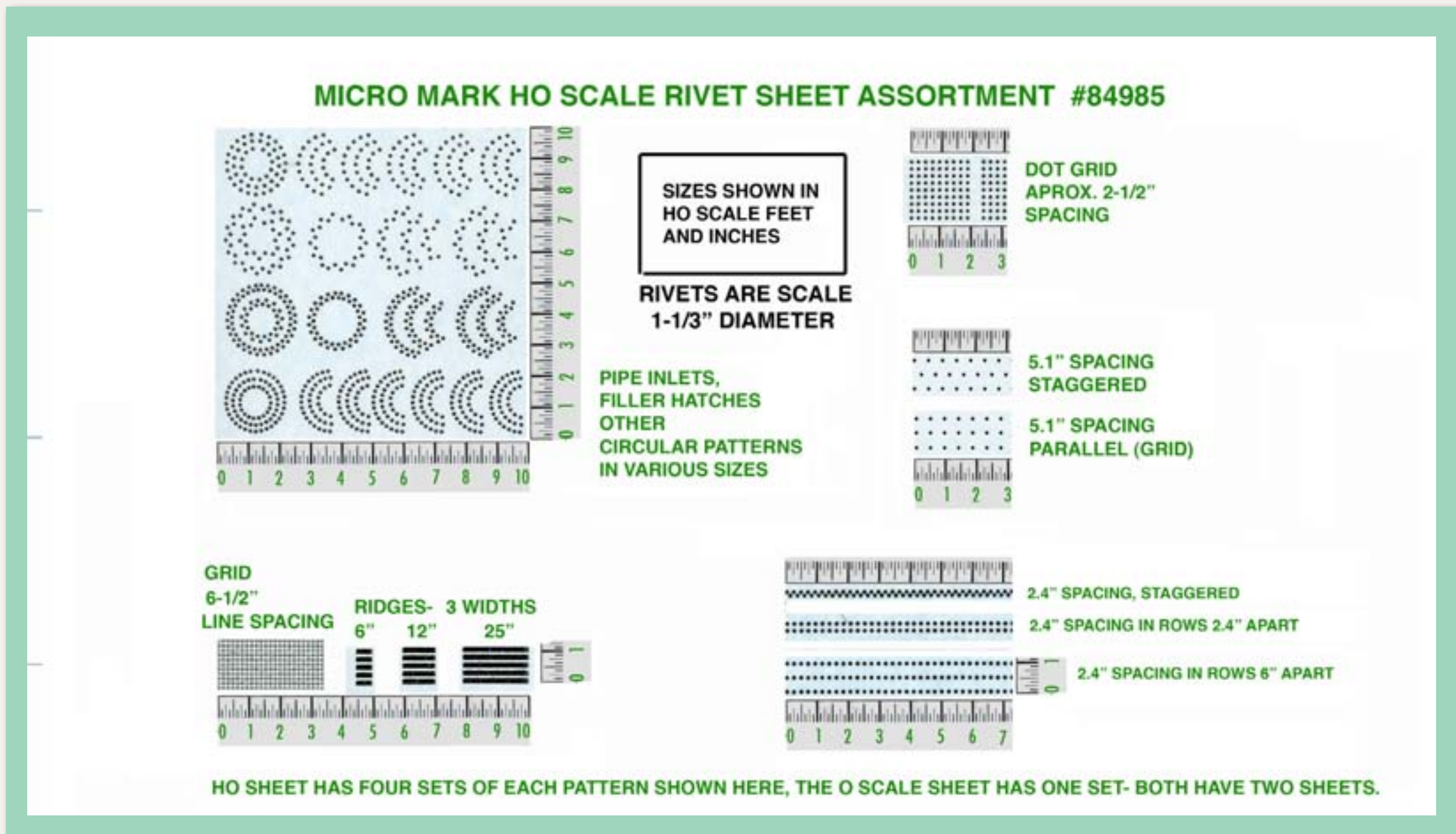

Figure 33

have only one assortment per sheet, a total of two per O scale set.

In addition to the obvious use for O scale projects, the O scale rivets can be used for HO scale bridges and similar applications requiring larger (about 2") rivet heads. Conversely, the HO set can provide smaller rivets for O scale applications. Either set can be used S scale.

Application Tips

Both the Micro-Mark and Archer rivet products are waterslide decals – the raised rivet rows are to be

Figure 32 (above left): Micro-Mark rivets measurements are not specified. The scales shown are HO to help modelers find the closest to their chosen application.

Figure 33 (above right): Micro-Mark HO staggered rivet row pair used as head rivets at the end of the tank are similar to those on Imperial Oil Co. 10,000 gallon tank cars built by Canadian Car and Foundry in 1922. Micro-Mark individual rivet rows simulate the joint along the tank. The tank is mounted on an Athearn tank car frame and is a model in progress.

cut into strips and soaked in water. Distilled water sold in supermarkets for ironing is the most pure and mineral free water available, although tap water works too. Once soaked, the clear carrier film with the rivets can be slid from the backing paper onto the model.

I applied the Micro-Mark rivets on models as per their instructions, using the vinegar smelling “set” type decal setting fluid first, then later adding the “sol” solvent type. I found both makers’ products to be quite durable, but as there is not much actually holding the decal to the

model I suggest handling any decal-riveted cars carefully.

Rivet Comparison

Under a microscope, the Micro-Mark rivets have a smooth raised disk form, while the Archer rivets are more grainy in appearance. Once



Figure 34



Figure 35



Figure 36

Figure 34: Micro-Mark rivets on an 8-panel boxcar conversion.

Figure 35: Archer rivets on an 8-panel boxcar conversion.

Figure 36: Victor's model of a PRR 13,900 gallon tender using Micro-Mark rivet decals.

on a model and painted with one to two coats of paint (I used both ModelMaster and Tamiya with equally good results), there is no visible difference between the two products, even under a magnifying glass.

My first attempt at using the Micro-Mark decals produced results that appeared to have unevenly sized rivets and spacings. Close examination showed the problem was air had become trapped under the decal film near the rivets. Take care that any air bubbles are pierced with a pin, or flooded with decal solvent. When this is done, both products have evenly sized and spaced rivet forms.

Archer has a wide variety of rivet sizes and spacings plus many other types of fasteners including weld lines, tread-plate, and woodgrain sheets, and a catalog devoted to their line of decals.

The Micro-Mark decal rivets are much less expensive and all their decal styles are included in the single set with 1 1/3" rivet head diameter. While this is more limited, there are many applications for rivets of this size, and the many different spacings in the set, plus all the louvers, grids and other accessories make this a very useful product.

Decal rivets open up new possibilities. Many years ago, I built several steam locomotives and tenders, but I didn't have a good method to model rivets. Now I do!

 **Reader Feedback** 
(click here)



Victor is a native New Yorker, but he's also lived in California and Arizona. He's been modeling since he built an oil storage tank from a coffee can with a paper wrapper and emblem from a gasoline company map. He graduated from the Pratt Institute with BFA and MS degrees and taught fine arts in high and junior high school for 30 years. Victor is now retired.

Victor wrote *Switching the Coast Daylight* which appeared in the Nov 2010 MRH and *More Realistic Model Windows* in the Oct 2009 MRH.

Can it be???

Come check us out and discover a new world of resin kits allowing you "scratchbuilt" results in just a few evenings time! After all... you really don't want to be a model ship builder... do you?

Easy...
AND
Resin?

Parts straight out of the box... seriously!



A
D
V
E
R
T
I
S
E
M
E
N
T

ARE YOU ...



Nick Muff at the throttle in his basement ...

HAVING FUN WITH TRAINS?

Model Railroad Hobbyist magazine™

More fun per pound than any other leading model-train magazine!



Frenchman River Model Works

www.frenchmanriver.com

THE CAR SHOP



Freight Car Setup For Club Ops

– by Joe Brugger



Coming up with the right mix of freight cars for operations can be tricky. Busy, operating layouts can be hard on rolling stock.

Steel coil cars stand out in a train, and my club layout, the Columbia, Cascade & Western, needs a half-dozen to feed a steel fabricator. A number of vendors have made coil steel cars over the years. Walthers produced a 55' Evans coil steel car back in the days of white cardboard

box kits. The same model was later sold ready-to-run in Walthers' Gold Line. When an unbuilt kit for C&O 306501 turned up (cheap) at my local hobby shop, home it went. The stenciled build date is 1-77, so it fit right in.

My club has standards for appearance, weight, rolling quality and couplers. Here's how I meet those standards.

I start by replacing the kit's plastic wheels with metal wheels after cleaning up the truck bearing surfaces with *The Tool*. With a cotton swab, dab a bit of powdered graphite into the side frames so the car will roll down a standard grade. Atlas, Kadee, Proto 2000 or Intermountain wheels work.

Install Kadee #148 standard-head, metal-whisker couplers and check the height of the coupler head and curved metal trip

pin. The "A" end of the car was a little low, so a red fiber washer now rides between the truck and the bolster.

The coupler box lid and pivot were drilled and 2/56 screws inserted to keep the lid from popping off under strain. The CC&W will have some long 2% grades when the railroad is complete. A 2/56 screw is pretty big; most cars with snap-on coupler lids can be fixed with 1/72 screws. Mark the center of the pivot post with a pin before drilling a hole for the screw.

Sill steps on the kit measured about 6" thick so I nipped them off and drilled the side sill for metal A-Line #29000 Style A stirrup steps. They have a finer cross-section and will be more durable. No more broken stirrup steps!



Figure 4

Figure 1: With new wire side sill steps, a light coat of weathering, and some fine tuning, a 20-year-old Walthers steel coil car kit is ready to operate. Somewhere between my workbench and the club, a stacking bracket went missing. I'll need to make a replacement from styrene shapes.

Figure 2: Frank A. Phillips Jr. photographed a prototype car from the same class in the late 1970s in Alexandria, Va. (Photo from RR Picture Archives, used with permission).

Figure 3: A 2/56 screw ensures the coupler box lid stays in place. A-Line wire side sill steps replace the plastic originals. A light coat of thinned Roof Brown PollyScale tones down the dark blue underframe.

Figure 4: A black fine-point Sharpie or a dab of paint will tone down the jarring shiny screw tip protruding through the coupler pivot. A better solution would be a smaller screw that doesn't go all the way through the housing.



Figure 1



Figure 2

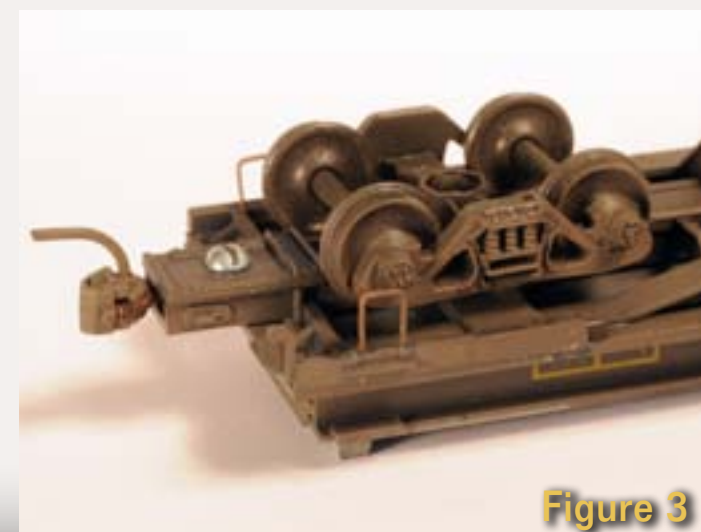

Figure 3



Figure 5

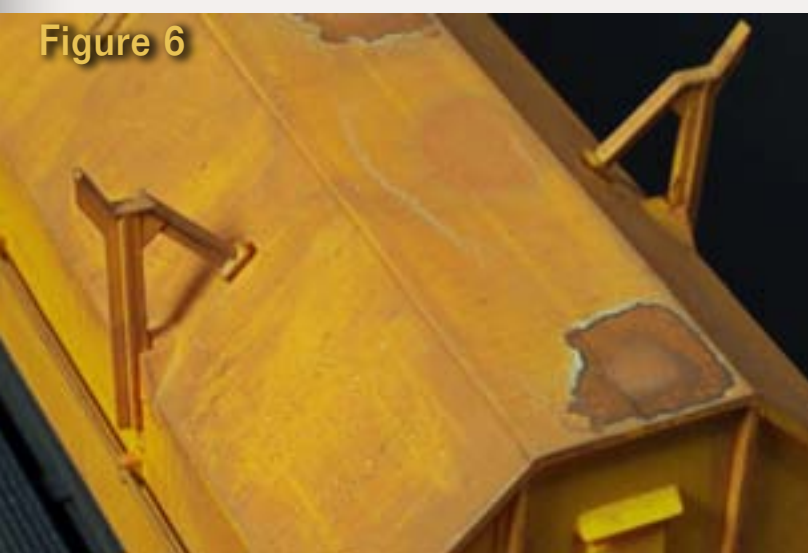

Figure 6

Car Department Review Form	
Road Name: <i>CC&W</i>	Car # <i>306501</i>
Car type# <i>Flat-Steel</i>	Car Length: <i>50'</i>
Weight: <i>5.3</i> (In Ounces)	Car Owner: <i>1BR</i>
Couplers Checked: for Ht. and Sag <input checked="" type="checkbox"/> A <input checked="" type="checkbox"/> B End <input checked="" type="checkbox"/> Face filed	
Wheelsets: In-Gauge <input type="checkbox"/>	
Rollability Checked: min. 2% SLOPE or less <input checked="" type="checkbox"/>	
Center of Gravity Checked: min. 45 degrees <input checked="" type="checkbox"/>	
Items needing repair, repaired or added: _____	
Ver. 11.11.10 Equipment inspected by: <i>Mike</i> date: <i>6/27/11</i>	
Released for registration: Date: <i>6/27/11</i> yes <input checked="" type="checkbox"/> no <input type="checkbox"/>	

Figure 7

Figure 5: Lead shot, held in place with Elmer's glue, increases weight.

Figure 6: Stacking brackets on the hood add character.

Figure 7: Each car that's put into service on the Willamette Model RR Club's layout, the Columbia, Cascade & Western, has to be checked for conformance to standards.

Lead shot in the load wells brings the car up to the 5.3 ounces the club standard requires for its length. Elmer's Glue holds the shot in place and can be soaked out later if we decide to add coil steel loads. The club's weight requirement is borrowed from La Mesa Model Railroad Club standards and is heavier than NMRA recommendations.

All cars on the CC&W must be weathered. With couplers, rolling qualities, and weight taken care of, I airbrushed a 1:10 weathering mix of PollyScale Roof Brown and distilled water. A couple of drops of Testors Universal Acrylic Thinner make the thinned paint flow and atomize better. The same mix of Mud was lightly sprayed to highlight the underframe and running gear. I brushed the metal railings on the coil hoods with yellow before applying a rusty-looking wash of burnt sienna acrylic tube paint. Half a pea-sized dab thinned in a saucer of water is plenty, with a drop or two of alcohol to make it flow.

Once my work was done, the car went into the "To Be Checked" box at the club. I filled out a Car Department Review Form, listing the road name, number, type and length. Club members can't sign their own cars in, so someone else rechecked the wheel sets and couplers, rolled it down the test grade, and tipped it 45 degrees to see if it would right itself instead of falling over.

From there, it will be logged into the club's inventory and a car card printed before it moves to the staging yard, ready for service.

ADVERTISEMENT

Innovative Electronics for Model Railroads

Frog Juicers - Automatic Frog Polarity
Servo Drivers for Turnouts and Semaphores

TAM VALLEY DEPOT

Great Electronics for Great Model Railroads



Dual Frog Juicer - a heavy duty (33A) version of our popular DCC frog juicers. The unit can be used to power two frogs in the larger scales, as an automatic, highspeed auto-reverser in all scales and as a highspeed circuit breaker.

www.TamValleyDepot.com

[Click here to contact us by email](#)



Craftsman Structure

C O N V E N T I O N
CSC 2011

November 2nd - 5th, 2011
The Holiday Inn - Mansfield, MA



The ONLY Show
Exclusively for
Scale Model Structure Builders
& Collectors

Sponsored by Model Railroad Hobbyist Magazine

www.csc11.net

Going to Kansas City ...
Nick Muff's HO scale

Kansas City Southern

– by Charlie Comstock; photos by the author except where noted



 **Reader Feedback**
(click here) 

Figure 1: Can you say “yard throat?” This maze of track routes trains through the Kansas City Union Station (or around it). The Union Station is the centerpiece of Nick’s layout.



Figure 2: Visitors to the KCS descend these steps to what seems to be a full-size station platform.

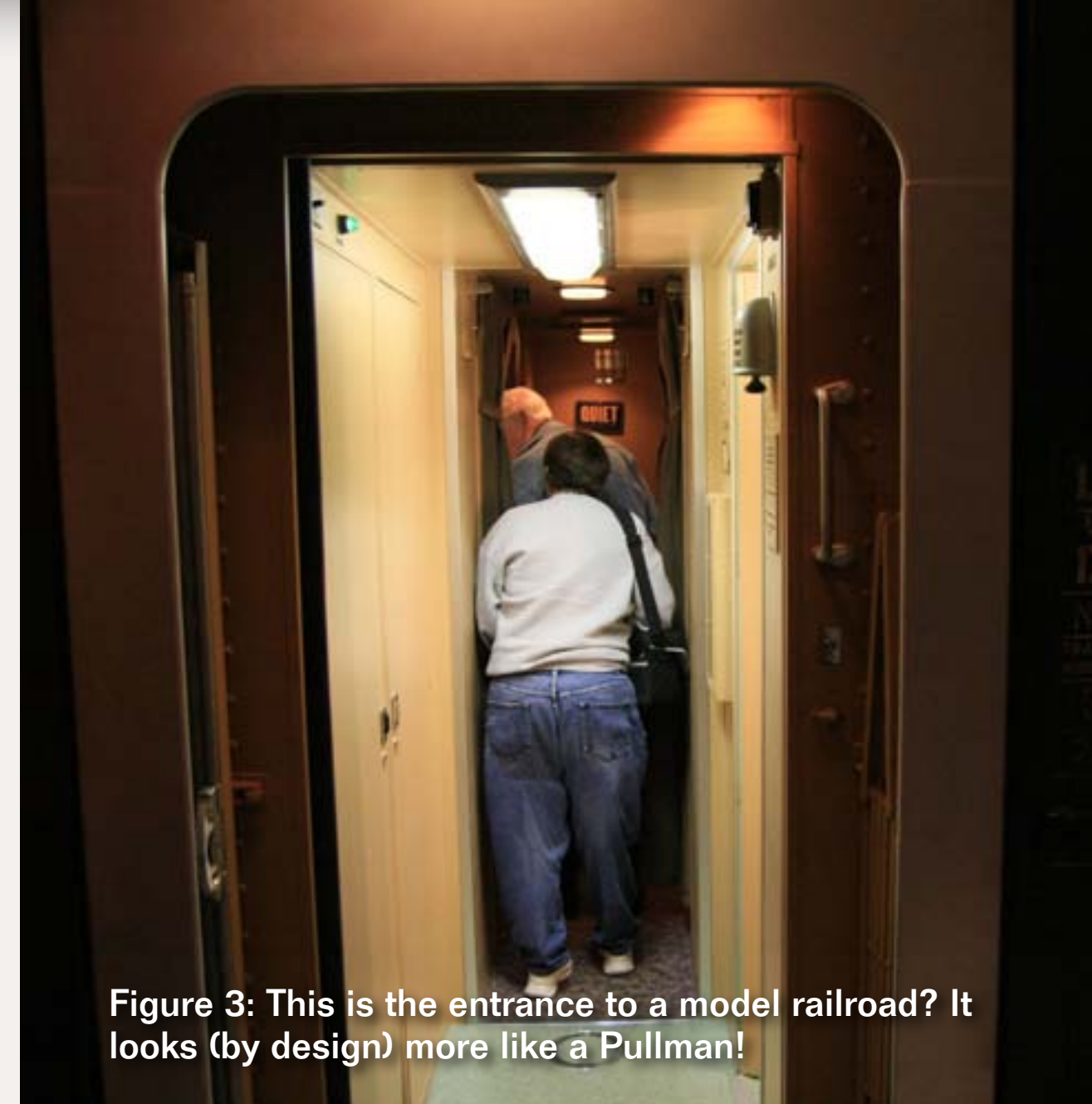

Figure 3: This is the entrance to a model railroad? It looks (by design) more like a Pullman!



Figure 4: At the far end of the Pullman is a simulated dining car with real railroad linen and china.

Last fall I attended the NMRA Pacific Northwest regional meet at Lynnwood, Washington. One of the layouts open for the meet was Dr. Nick Muff's Kansas City Southern. A bunch of us rode a mini-bus to his home where we were met by Nick. He led us down a flight of stairs (figure 2) into what seemed like a passenger station. The walls were painted to make us feel as though we were standing on a passenger platform. Simulated station sounds added to the experience – train arrival and departure announcements, the rumble of diesel prime movers, squealing flanges and brakes, and the crowd pushing past us. Yet we were in the basement under Nick's home instead of a late '40s or early '50s train station.

Nick pressed a button and a pneumatic door slid open revealing what appeared to be a Pullman car (figure 3). We were led past a roomette, a bathroom (yes it works), and a small museum including Miss Southern Belle (a life size mannikin). At the far end of the car is a small buffet/lounge area (figure 4) complete with a table covered with KCS linen,

Figure 5: The front of Union Station shows the attention to detail Nick has lavished upon his layout. Note the working headlights and taillights in all the vehicles as well as the chandeliers inside the station. It's possible there are more LEDs on this layout than are currently in-stock at Digi-Key!



Figure 5

china, and flatware. Period appropriate magazines and newspapers occupy a small side table. A bar supplies liquid refreshment.

Another button press by Dr. Muff and the side of the car slid open and we stepped into the model train area. This space has covered backdrops reaching the ceiling, dedicated layout lighting that cycles between day and night complete with thunderstorms, and a highly-detailed layout depicting Kansas City in the late '40s. The layout isn't complete yet, but what is there takes your breath away. For one thing, nearly every vehicle has working headlights and taillights. There's also a meticulously modeled and detailed Kansas City Union Station.

Yet, the first thing in the room that catches your eye isn't the backdrop, or Union Station, or the layout. Instead it's a real F7 cab (figure 11). That's not a typo! While the passenger car is a mock-up, the cab is the genuine article. Nick rescued the cab from a scrap yard near Tacoma and moved it north



Figure 6

Figure 6: Nick is fascinated by passenger train operation. The fascia in front of Union Station folds down to reveal two fully detailed subterranean levels.

Figure 7: The first level handles baggage and express for trains to local destinations.

Figure 8: The lowest level handles baggage and express for through trains. It also houses the station's backup power plant.



Figure 7



Figure 8



Figure 9

to where his train room was being excavated. A friend with a truss business came out with his crane several times to move the cab out of the way of the construction, finally setting it in place in its new basement home.

After seeing this I knew I had to return and shoot it for MRH. Luckily, Nick thought that was a good idea too. With scheduling issues, it took several months before I managed to return. In the meantime, Nick finished even more of his railroad, including a number of animations.

Some of the animations are “neon” signs while others are mechanical, including a Rock Island locomotive shuttling coal hoppers, a moving crane, and a Coppertone sign with the dog tugging at the little girl’s bathing suit.

Nick is a gracious host and very knowledgeable about the KCS. We discussed too many things during the interview for them all to make it into this article, so be sure to check out the video clip on page 58. Or download the full 30 minute video from the [MRH bonus area](#).

Thanks for the tour Dr. Nick!

Figure 9: The Railway Express Agency annex to the station. Even compressed by 20% this is a long structure.

Figure 10: Note all the detail Nick lavished on the REA building – cobblestone paving, lights everywhere, the building interior, electrical panels, and proper signage.



Figure 10



Figure 11: This F7 cab is not a mockup. Nick rescued it from a scrap yard torch and installed it in his basement with the help of a crane owning friend. According to a visiting train engineer it's not prototypical because everything in it works (except the prime mover) – the headlight will give you a sun burn and the horn will destroy your hearing. Plans for the future include mounting it on hydraulic struts and controlling locos on the layout from the engineers seat.

Layout Statistics

Era: Late '40s, early '50s

Locale: Kansas City

Style: Protolance

Configuration: Kansas City – single deck, under-construction mainline – multi-deck with helix

Scale: HO

Trackplan: Loop to loop.

Room size: 30' x 40', 9' 6" ceiling

Lighting: Can lights, computer controlled day/night cycle

Sound: 20 MP3 players providing local sound zones

Minimum radius: 36"

Track: code 83

Turnouts: #6 with Tortoise machines

Control: DCC

Elevations: 46" to 56", lower level 28"

Roadbed: 3/4" plywood modules topped with 1/2" Homasote

Staging: 6 hidden tracks north end, 2 hidden tracks south end

Union Station: 6' wide x 4' deep, approx. 80 lbs. assembled.

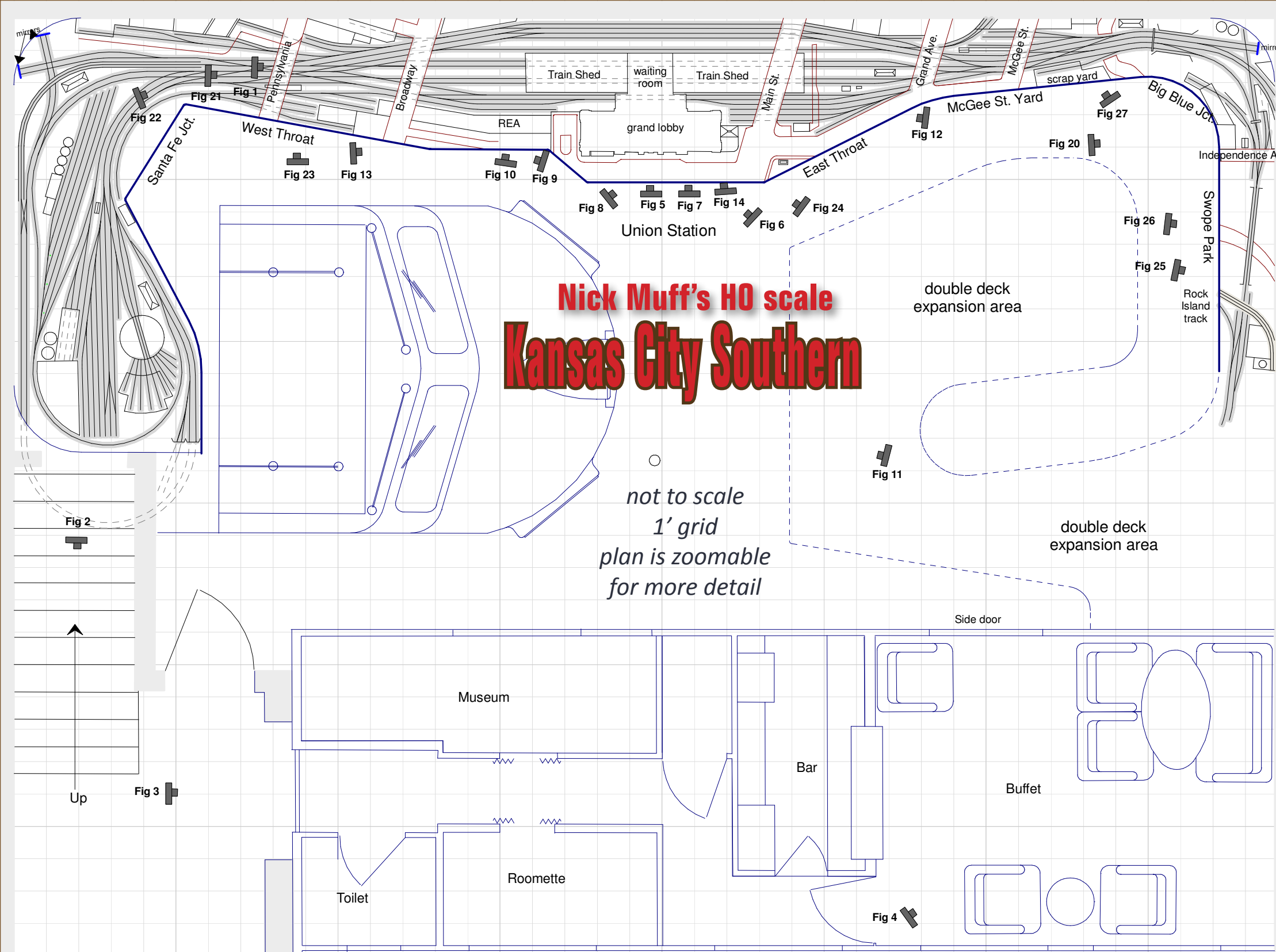

Nick Muff grew up in California's San Fernando Valley with SP Daylight GS-4's and cab-forwards running behind his home and has been modeling in HO scale for over 50 years. In his teen years, he documented the West Side Lumber Co. just before and after its closure, including two weeks on the track into the woods with a home-built speeder.

His interest in the Kansas City Southern and Kansas City Union Station developed from summer train trips to visit his grandparents in northwest Arkansas. The most memorable train for him was the KCS Southern Belle.

Nick enjoys using CAD and has produced over 100 plans and articles for rail magazines. For the past 12 years

he's been involved in research, drawing, and production of HO brass models of Midwestern locos and passenger equipment.

He and his wife Sue have enjoyed 44 years of marriage and have two grown children. He is a practicing radiation oncologist in Washington state.



Figure 12 – Nick Muff photo



Figure 13 – Nick Muff photo



Figure 14

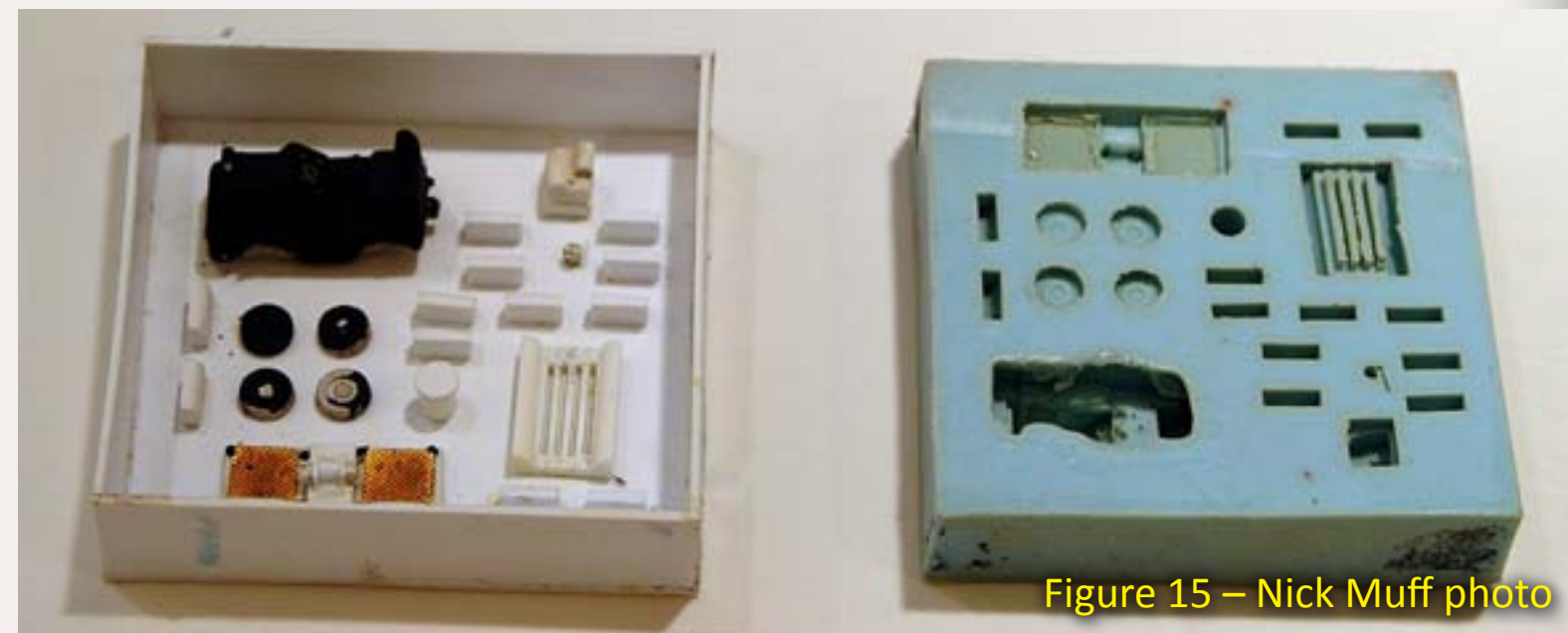

Figure 15 – Nick Muff photo

Figures 12 to 14: The Kansas City Union Station was a mammoth undertaking. Nick cast most of the wall features in resin after making molds of styrene masters. He devised a technique where he could cast an entire corner section in one piece by putting a large block of Styrofoam in the mold cavity to leave a hollow interior. The result is an incredible building with no cracks or seams on the corners.

Figure 15: A master and the mold made from it.

Figures 16 to 19 (next page): If you think it looks good on the outside, it has a fully detailed interior, too!



Figure 16 – Nick Muff photo



Figure 18 – Nick Muff photo



Figure 17 – Nick Muff photo



Figure 19 – Nick Muff photo

Figure 20: The automated day / night lighting includes lightning and thunder.
– Nick Muff photo





Figure 21 – Nick Muff photo

There are thousands of LEDs on the layout and they make the scenes really come alive when the night lighting is active.

Figure 21: Union Station yard throat.



Figure 23 – Nick Muff photo

Figure 22: Approaching the yard.

Figure 23: Highway overpass.

Figure 24: Union Station at night with lower decks visible.



Figure 22 – Nick Muff photo



Figure 24



Figure 25 – Nick Muff photo



Figure 25: A hobo camp complete with flickering campfire. They'll sing "The Wabash Cannonball" for you if you press the button on the fascia!

Figure 26: A string of reefers caught on the Swope Park viaduct.

Figure 27: Looks like Nick built so fast he generated lots of scrap materials.

 **Reader Feedback** 
(click here)



Figure 26



Figure 27

FREE GIVEAWAYS
W/ADMISSION!

Find us on
Facebook

The Fine Scale Model Railroader Expo 2011



An All New, Multi Scale Structure & Modeling Show

October 13-15, 2011 Holiday Inn
Peabody, MA
Celebrating the Modeler
& the Manufacturer...
See How Kits Get Made! Just 26 Minutes from Boston's Logan Airport

2 Day FSM Open House

Visit George Sellios' World Famous
Franklin & South Manchester!

Clinics & Workshops

- DAVE FRARY - BOB HAYDEN
- LOU SASSI - BRETT GALLANT
- BOB MITCHELL - KEN HAMILTON
- BOB VAN GELDER
- RUSS GREENE - DOUG FOSCALE
- HAL REYNOLDS - JON ADDISON
- CHRIS LYON - BRIAN BOLLINGER
- MICHAEL DUGGAN
- RICH JOSSELYN & MORE!

IT COULDN'T BE EASIER...JUST 10 MINUTES AWAY VIA FREE HOTEL SHUTTLE!

The Kit Factory

Only at the Expo!

LIVE LASER CUTTING! METAL SPIN CASTING! POUR YOUR OWN PLASTER WALLS! TAKE PARTS HOME!

Dealers

- SIERRA WEST-CROW RIVER - RAILROAD KITS - VECTOR CUT - BEST TRAINS
- SEAPORT MODELWORKS-FOS SCALE MODELS-ATLANTIC SCALE MODELS- LASER MODELING 3
- MODEL TECH STUDIOS-PAW OF A BEAR-NEW ENGLAND BROWNSTONE-MOUNT BLUE MODELS
- FULL STEAM AHEAD - BLUE RIBBON MODELS - MINUTEMAN SCALE MODELS & more!

FIND OUT MORE AT www.modelrailroadexpo.com

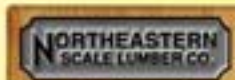

THE EXPO IS SPONSORED BY:



The Expo is Produced by Kit Manufacturers:



Remember when?

BRINGING YOUR LAYOUT ALIVE

Done correctly, a properly positioned detail can provide the illusion of movement to any static scene.

by Bob Grech
Photos by the author

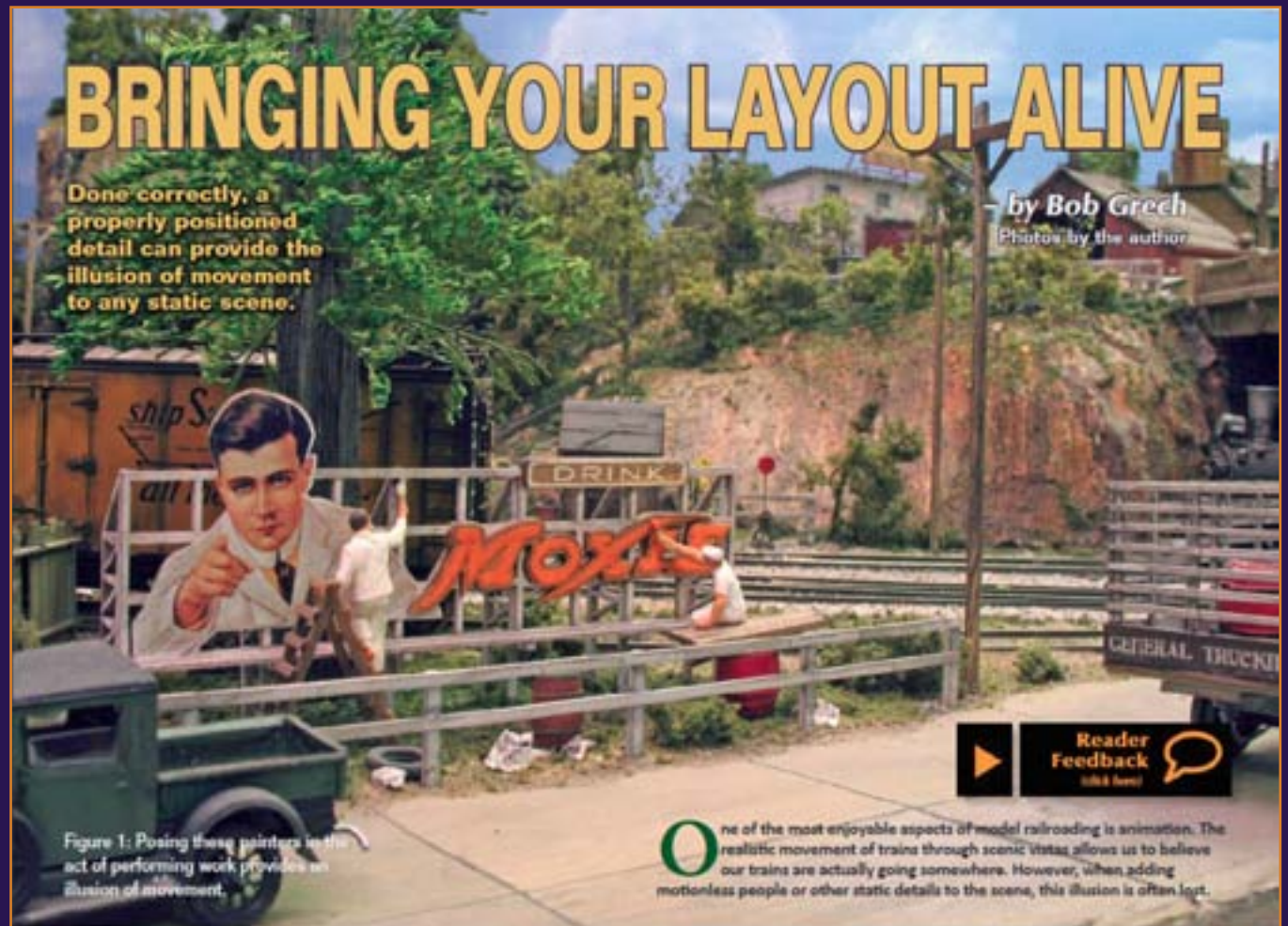

Figure 1: Posing these painters in the act of performing work provides an illusion of movement.

One of the most enjoyable aspects of model railroading is animation. The realistic movement of trains through scenic vistas allows us to believe our trains are actually going somewhere. However, when adding motionless people or other static details to the scene, this illusion is often lost.



[Bringing Your Layout Alive](#) - Mar/Apr 2010 page 80

ALL back issues of MRH all always available!

Just surf over to

model-railroad-hobbyist.com/magazine/back-issues

Model Railroad Hobbyist magazine™



A GALLOWS TURNTABLE FOR SALINA

– by *Wolfgang Dudler MMR*

Photos by the author

On a narrow gauge railroad, there are often steep grades, helper service, and turntables to turn the helpers. Follow me while I assemble a Sequoia Scale Models HOn3 turntable.

I have built a number of turntables for staging yard modules, but they were very simple versions that were manually operated. Salina on my HOn3 railroad needed an armstrong (manually-operated) turntable. I wanted a detailed prototypical model for this turntable.

With narrow gauge, you often have steep grades which need helper service.

Stations at the top and bottom of a helper district usually have a wye or turntable, and the station at Salina is no exception. The prototype for this gallows turntable is at Laws, California on the Southern Pacific Narrow Gauge.

Friends suggested that I install a motor under the Salina turntable, but this type of turntable was operated with muscle power so I kept it manual.

The project was a good learning exercise and a lot of fun. Read on to see my step-by-step building process.

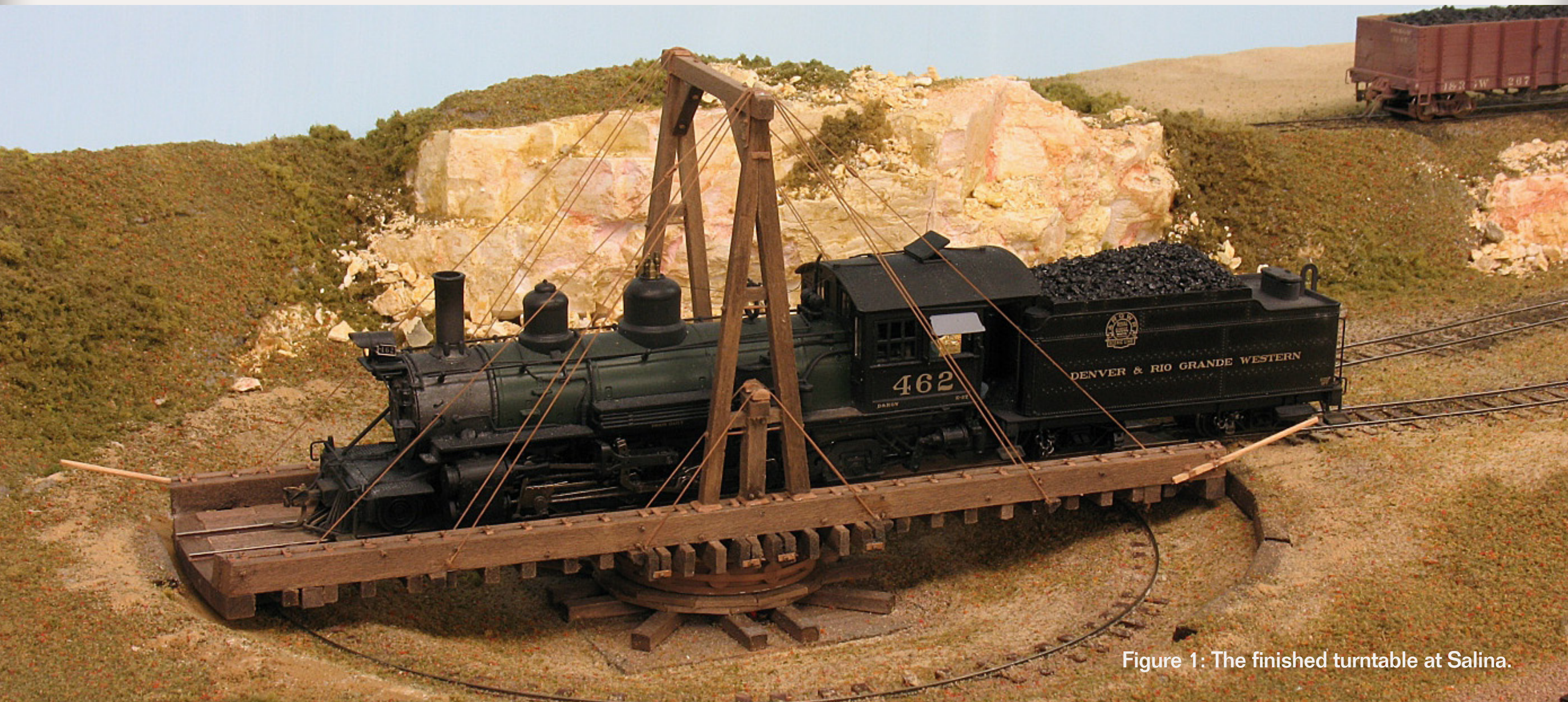

Figure 1: The finished turntable at Salina.

STEP 1: Parts and Preparation



Figure 2

Figure 2: I began my turntable with the Sequoia Scale Models kit, which saves time and is not as costly as scratchbuilding would be. The kit includes all the parts needed – wooden parts as well as cast metal ones.

Figure 3 and 4: I stained the wood parts, and airbrushed all the cast metal parts a rusty color.



Figure 3



Figure 4

STEP 2: Cross Beams and Stringers

5

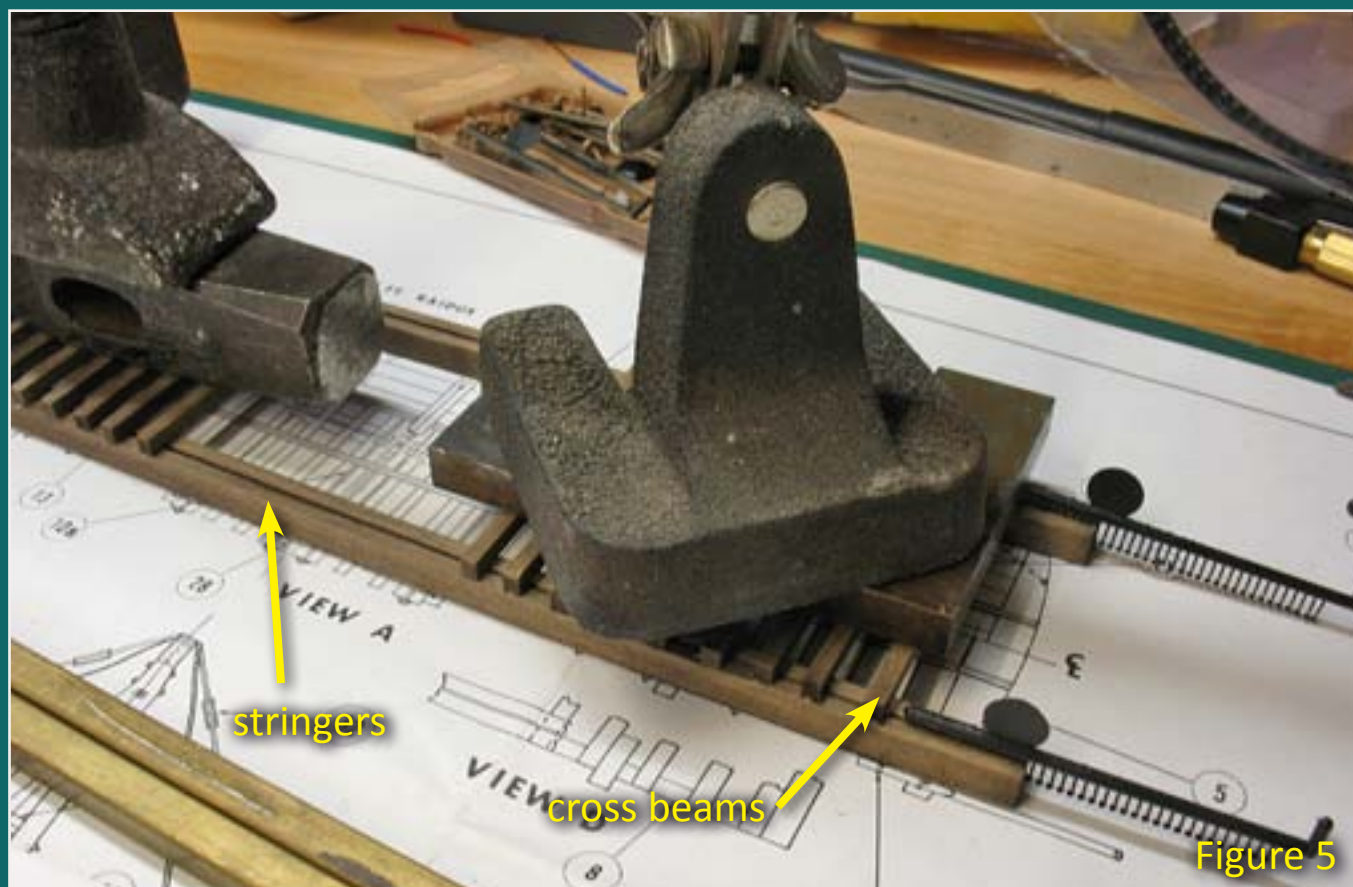

Figures 5-6: I started by laying out the four stringers on the template then glued the cross beams to them. This was opposite the directions which suggested laying the cross beams out on the template and gluing the stringers on them.

Figure 7: I sanded the two end beams into shape using a copy of the template as a guide, before gluing them in place.



STEP 3: Truss Rod Anchor Supports and Rails

5

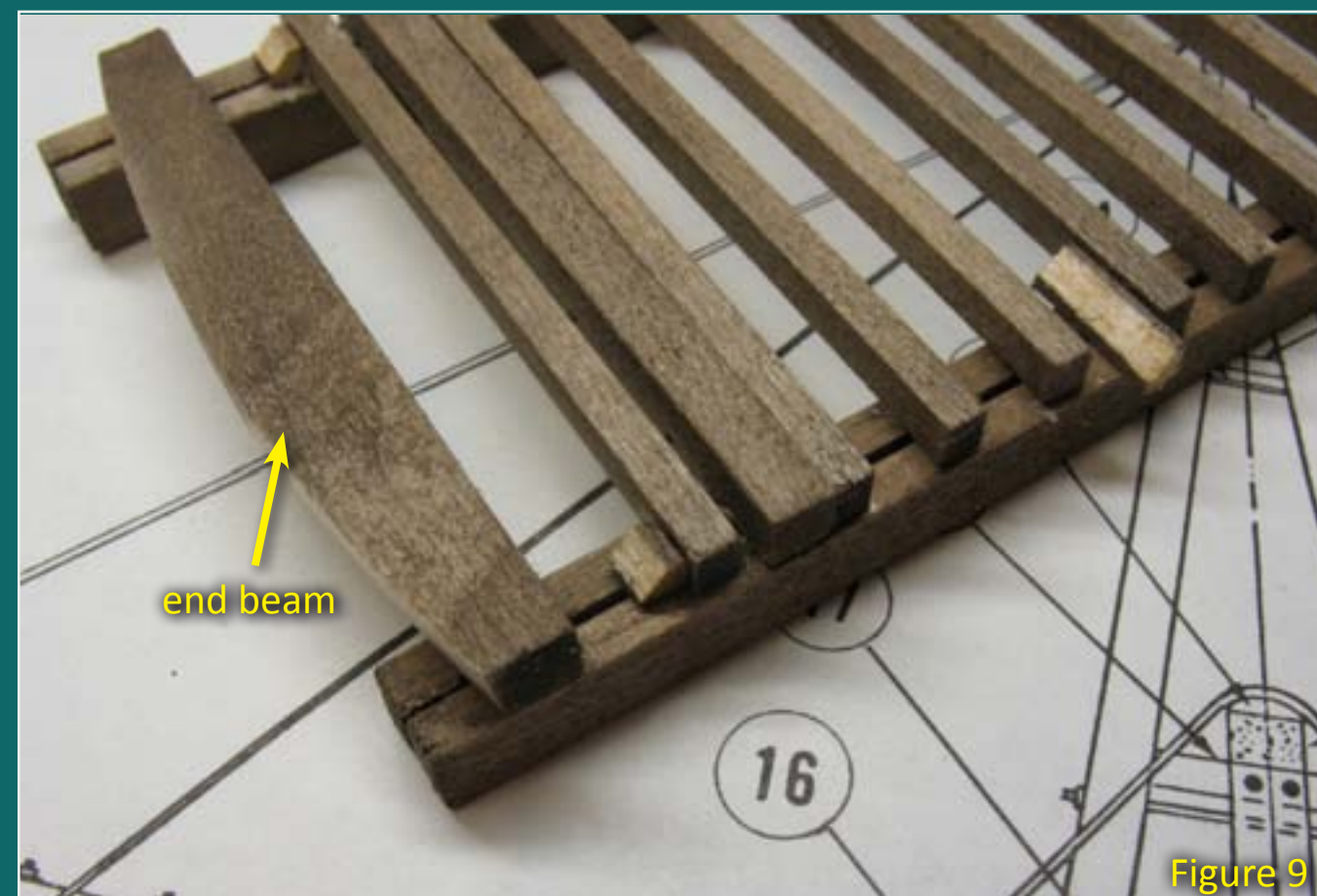
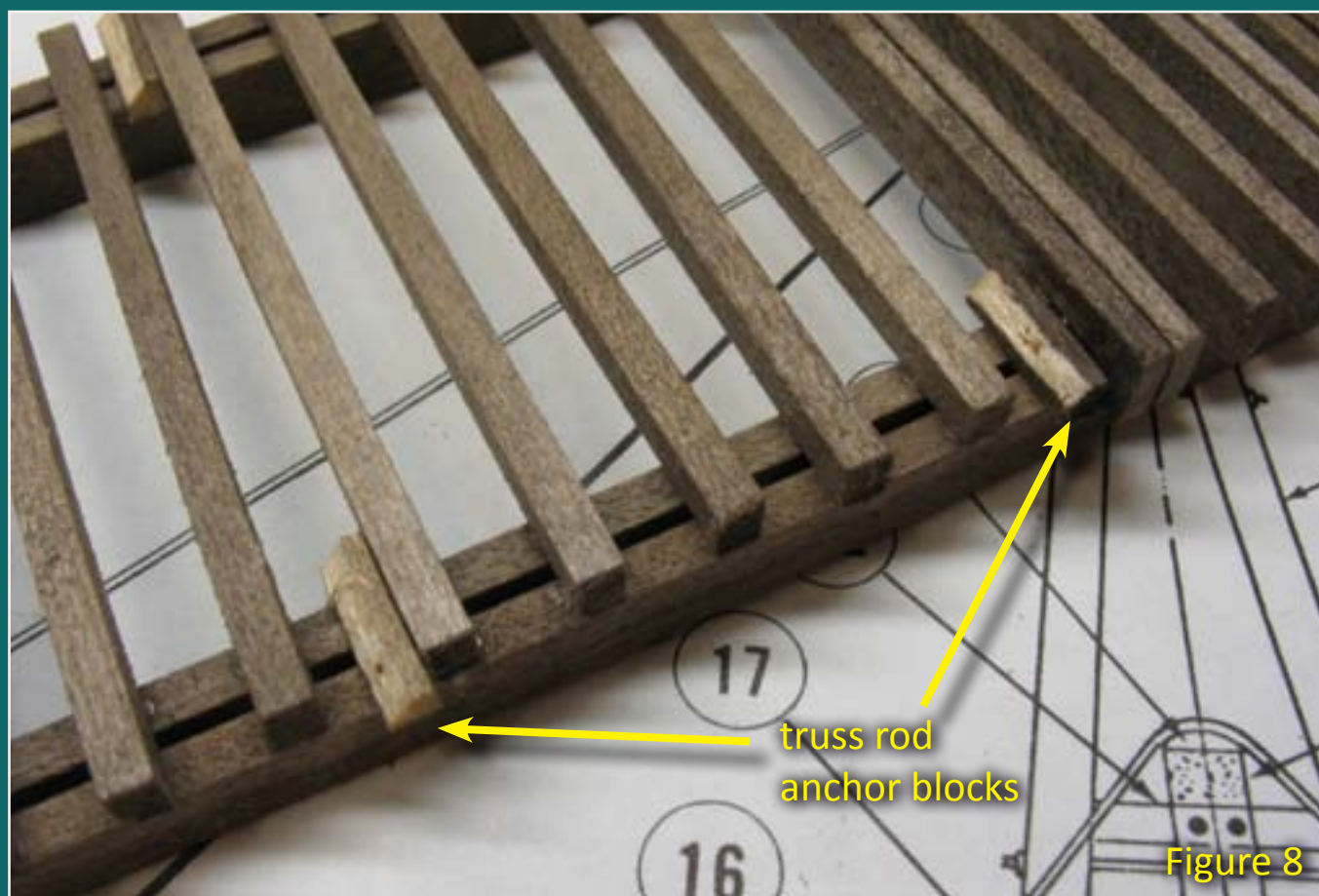

Figures 8 and 9: I cut eight truss rod anchor support blocks from the supplied wooden stock and glued them in place per the template.

Figure 10: I pre-weathered the code 40 rail and glued it in place with CA.



STEP 4: Adding the Nylon Line Truss Rods

5



Figure 11

Figure 11: The following step took time. I cut four pieces of nylon line for each side of the turntable then glued one end of each piece between pairs of cross beams. I had to hold each end in place until the glue dried, then I cut off any excess line protruding beneath the turntable. The other end is long enough to simulate the truss rods running up to the gallows frame.

STEP 5: Placing the NBWs

5



Figure 12

Figures 12 and 13: I also glued the cross beam truss rod saddles. You have to look carefully to pick them out.



Figure 13



Figure 14

Figures 14 and 15: Placing the NBWs was fun, but the kit contained only one type of NBW. I airbrushed the styrene NBW castings, cut them from their sprue, and applied them per the kit's directions.



Figure 15

STEP 5: Building the Wood Rings

5

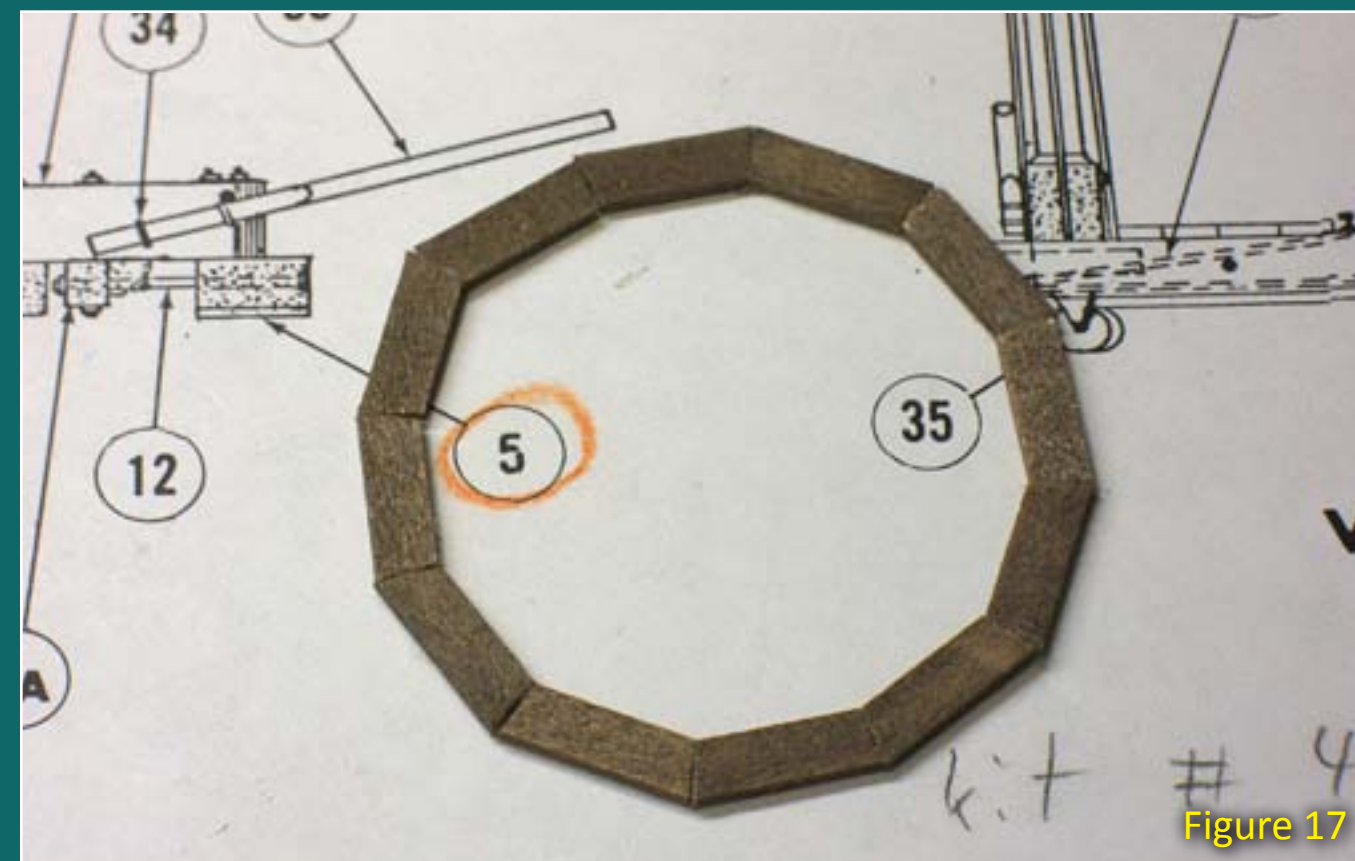
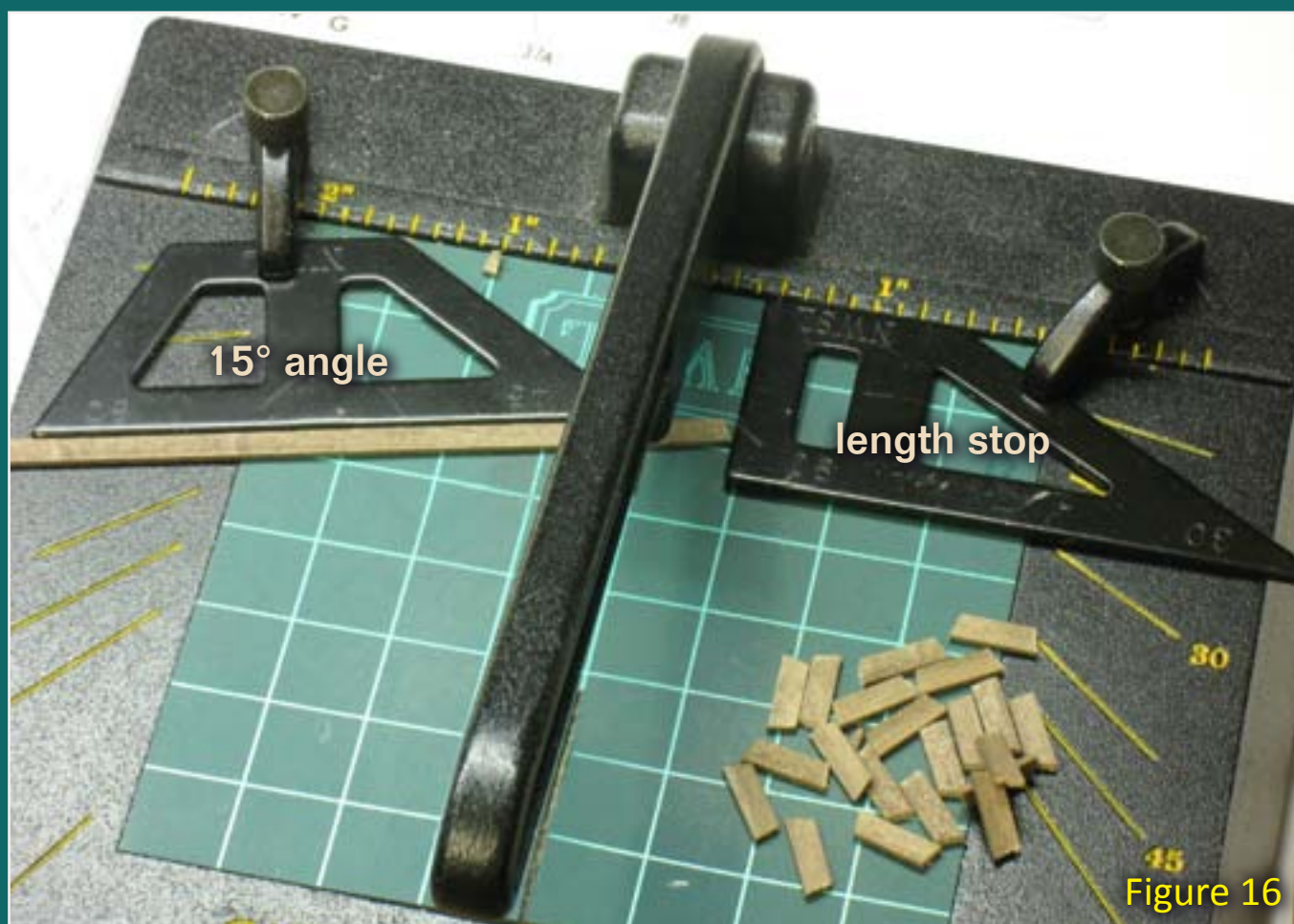

Figures 16-18: For the three sets of wood bearing rings, I used the chopper. First I measured a 15° angle. The stop on the right side let me cut each wood bearing piece the correct length.

I placed a piece of plate glass over the drawing of the bearing ring. Then I glued each of the 12 wooden ring pieces together. When the glue dried I removed the rings from the glass with a knife.

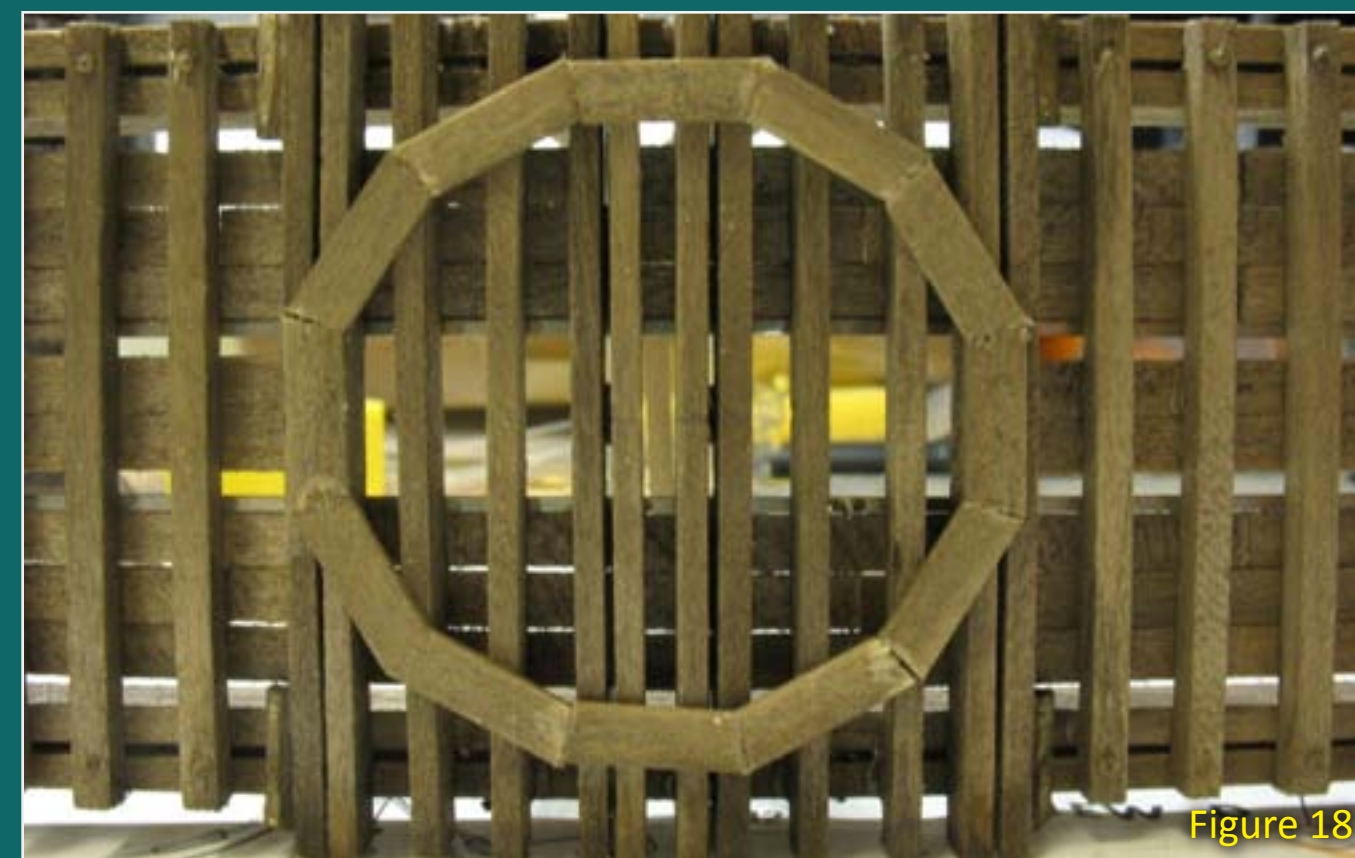

STEP 6: Building the Gallows

5



Figures 19-20: I notched four 6" x 12" x 4'7" vertical posts at one time with a small file. These will become the short saddle posts.

Figure 21: Using the instructions I built the gallows frame.



STEP 6: Building the Gallows *Continued...*

5



Figure 22: I made a mistake with all those nylon threads. I twisted two and glued them. I am waiting for someone to notice this.

Figure 23: The support wheels will ride on the pit rail.



Figure 23



Figure 24

Figures 24 and 25: I used aluminum foil to make the pole fasteners.



Figure 25

STEP 7: Building the Track Power Transmission Ring

5

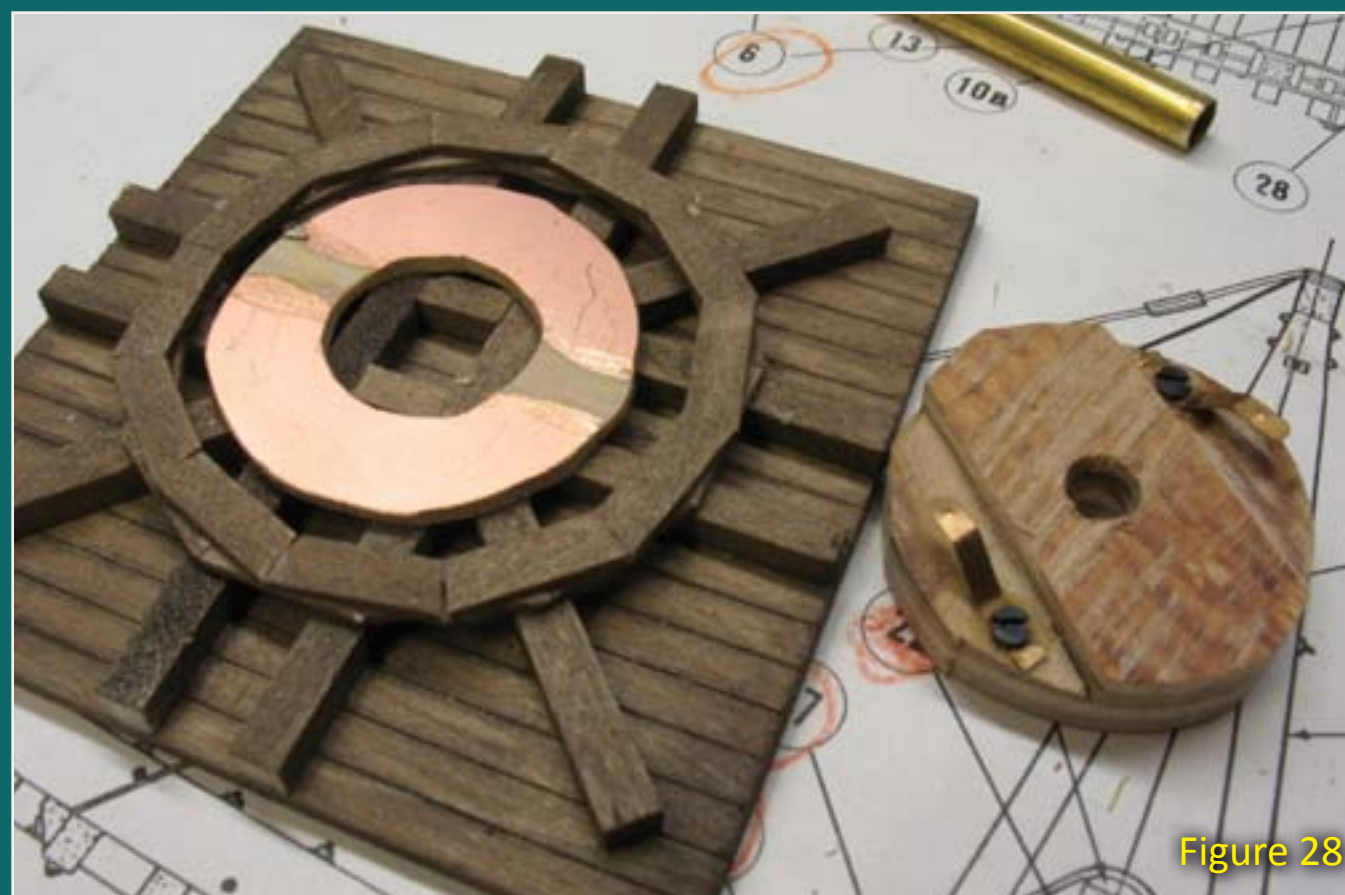

Figures 26-29: I made the electric pickup ring out of PC board. Two wipers were needed – one for each rail.

The wood ring is centered on a piece of 5mm brass tube which will be inserted in a 6mm tube in the center of the turntable pit.

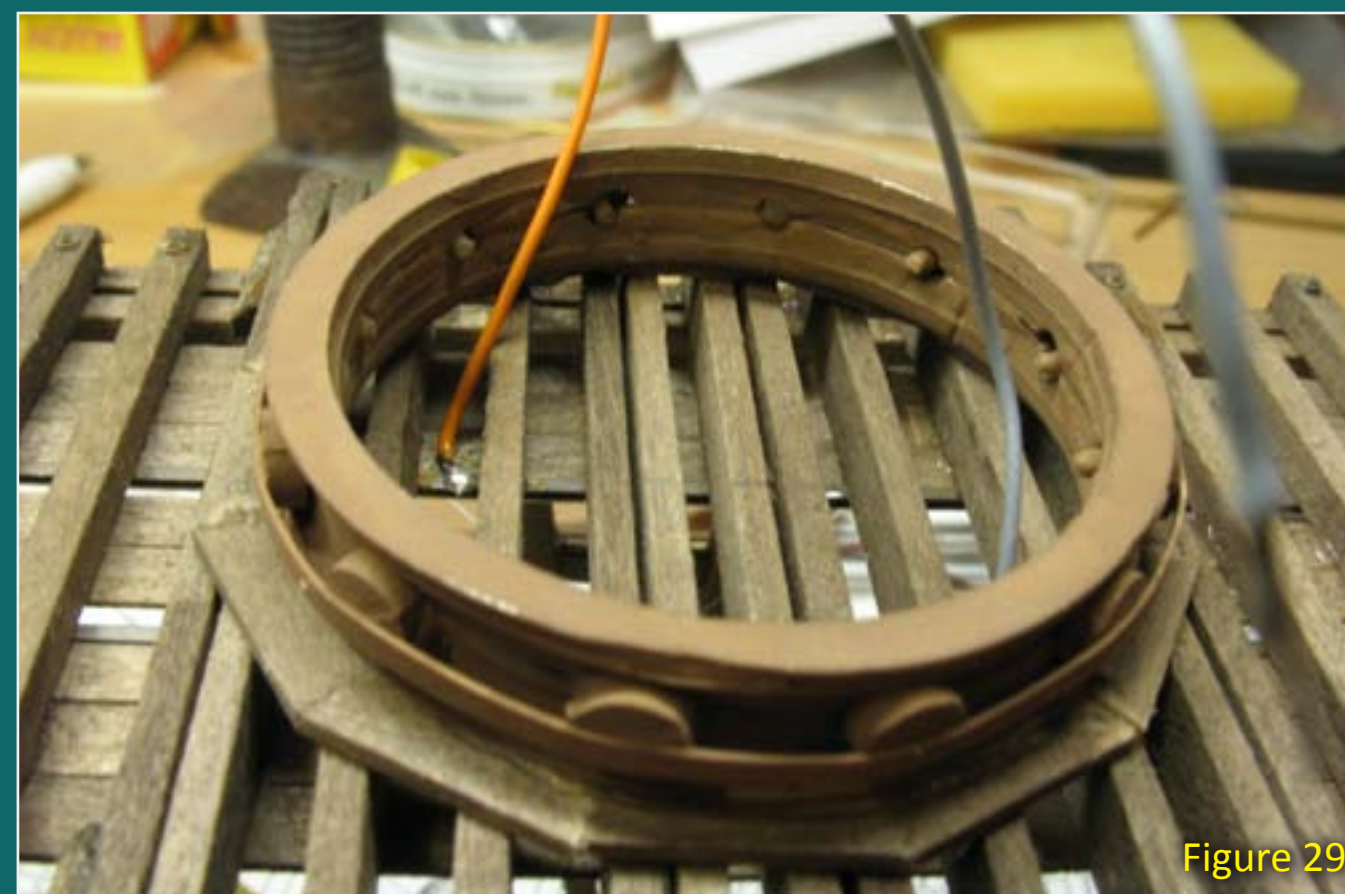

STEP 8: Building the Pit

5



Figure 30

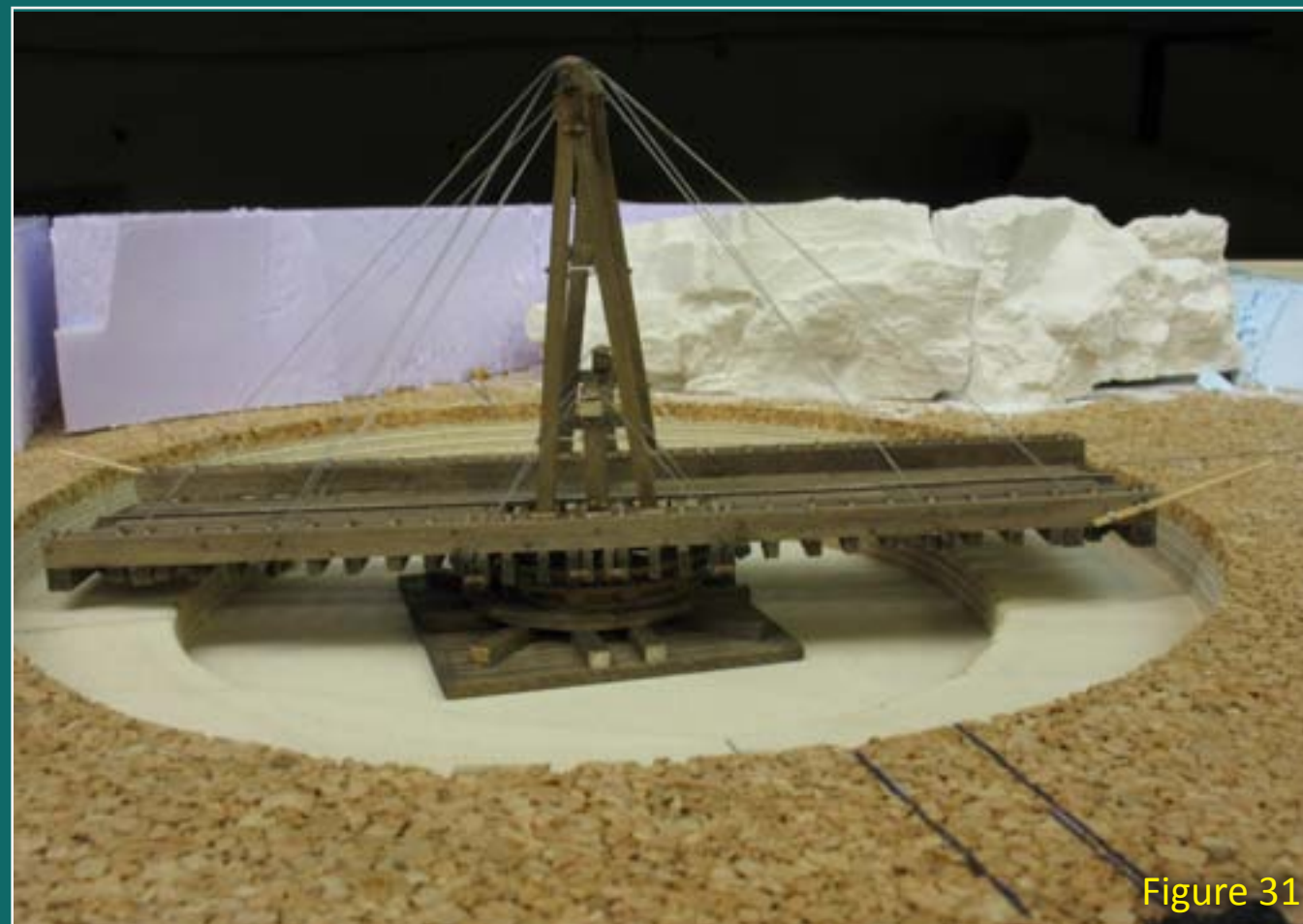

Figure 31

Figures 30 and 31: I made the pit using layers of plywood. The bottom of the pit is also plywood.

Figure 32: I used a drill stand to drill a perfectly vertical hole in the bottom of the pit. This hole must also be perfectly centered in the pit as the turntable will pivot around it.



Figure 32

STEP 8: Building the Pit *Continued...*

5

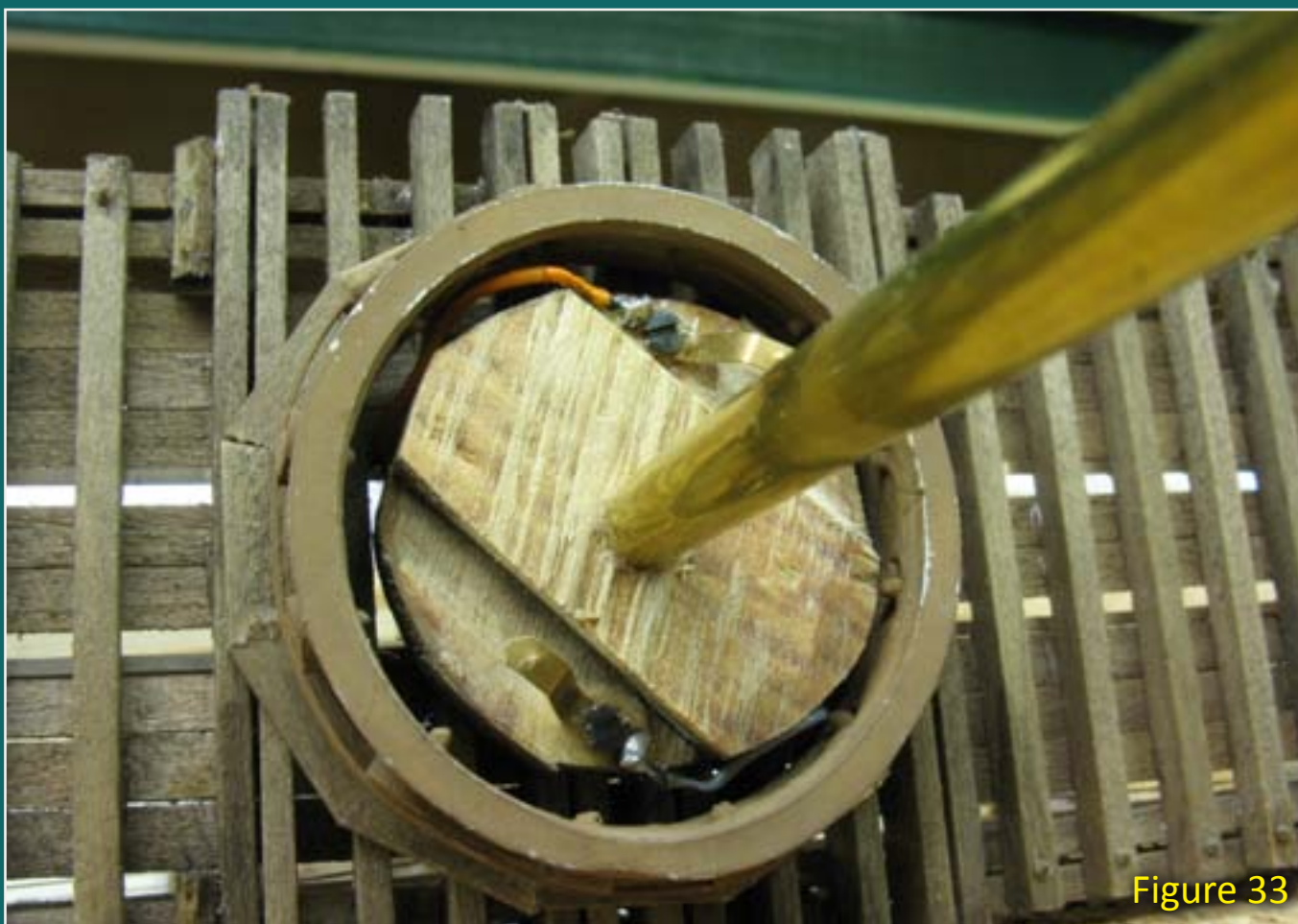

Figure 33

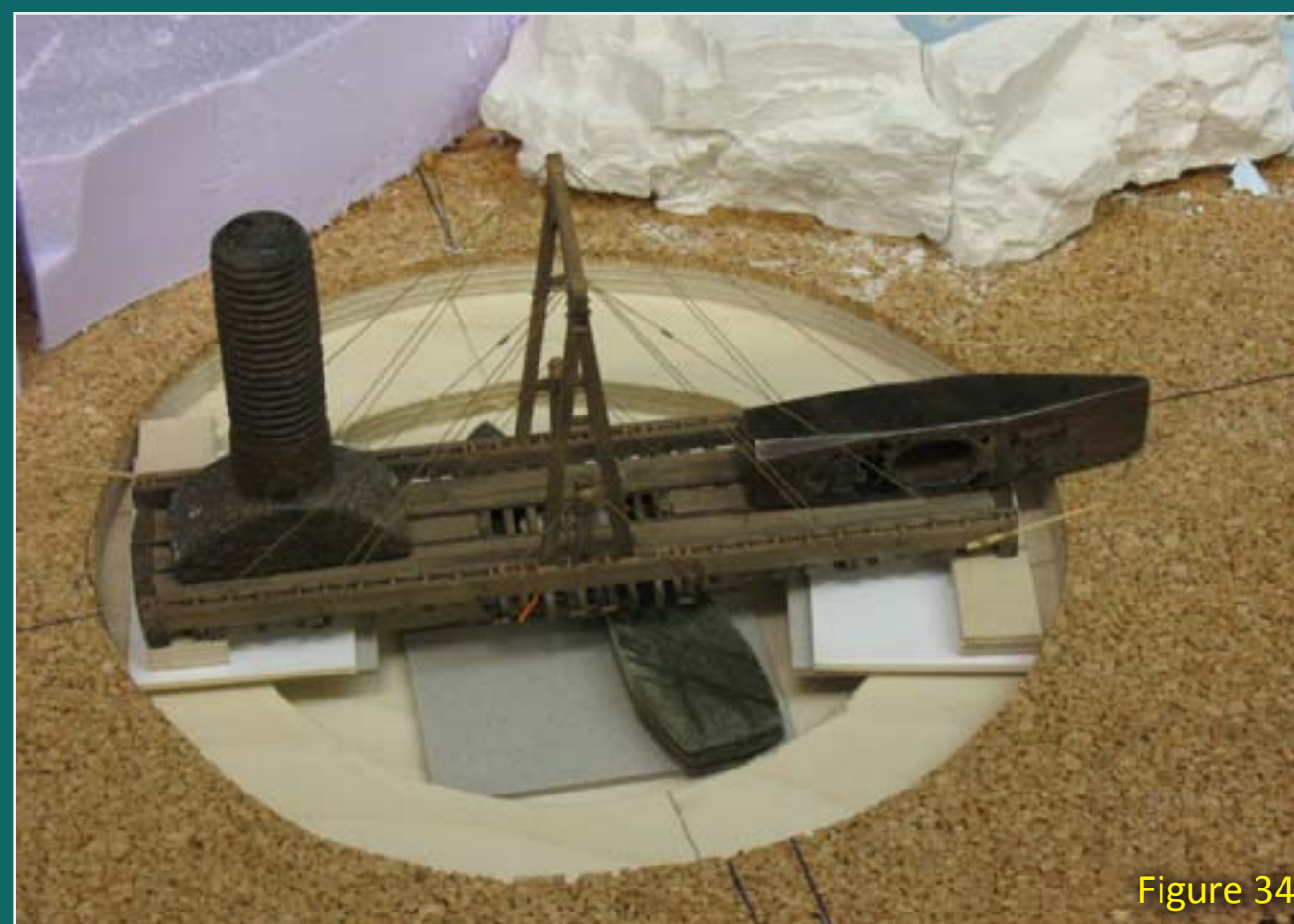

Figure 34

Figures 33 and 34: Next I glued the bridge to the bridge support, having previously inserted the 5mm brass tube into the disc and the 6mm brass tube into the pit.



Wolfgang Dudler, MMR, got his first toy train at age of 3 in 1949. In 1961, the Wall was built dividing Germany and he and his family started a new life in West Germany.

He married and started a job as a teacher, then got back into railroading with an N-scale layout. In 1980 he started building in HO scale.

Wolfgang had several European style layouts before he started on the HO scale [Westport Terminal RR](#), which uses modular construction which allows him to adjust his layout easily to the available space. Lately, Wolfgang has started building in HOn3.

In October 2010 he earned MMR 452. Congratulations Wolfgang!

STEP 8: Building the Pit *Continued...*

5



Figure 35

Figure 35: With the bridge in place, I marked the line for the pit rail with a diameter of 48 scale feet (168mm). The pit rail is made of one half piece of Micro Engineering code 40 flex track.

Using some math, πD says the pit rail is 528mm long.

Figure 36: The power distribution ring is made of PC board. It is gapped into two halves which allows the rails to automatically change polarity as the bridge swings around.

Figure 37: I took this photo with a mirror in the pit to show the underside of the turntable bridge.

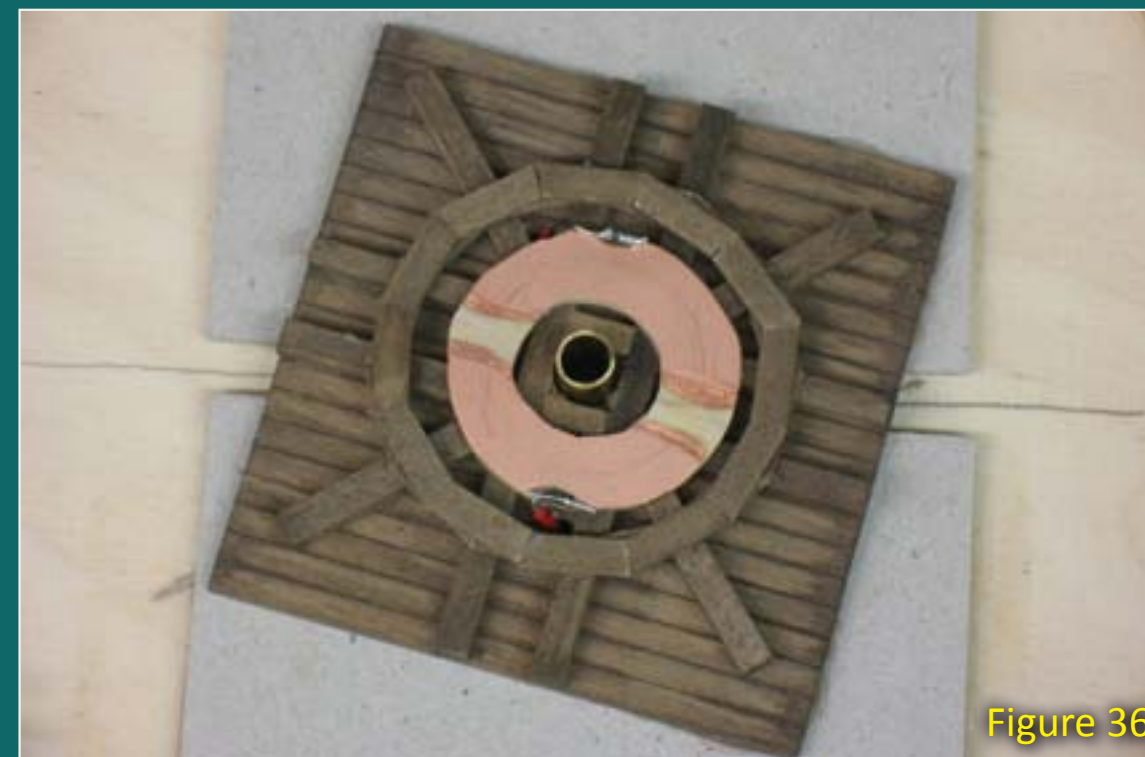
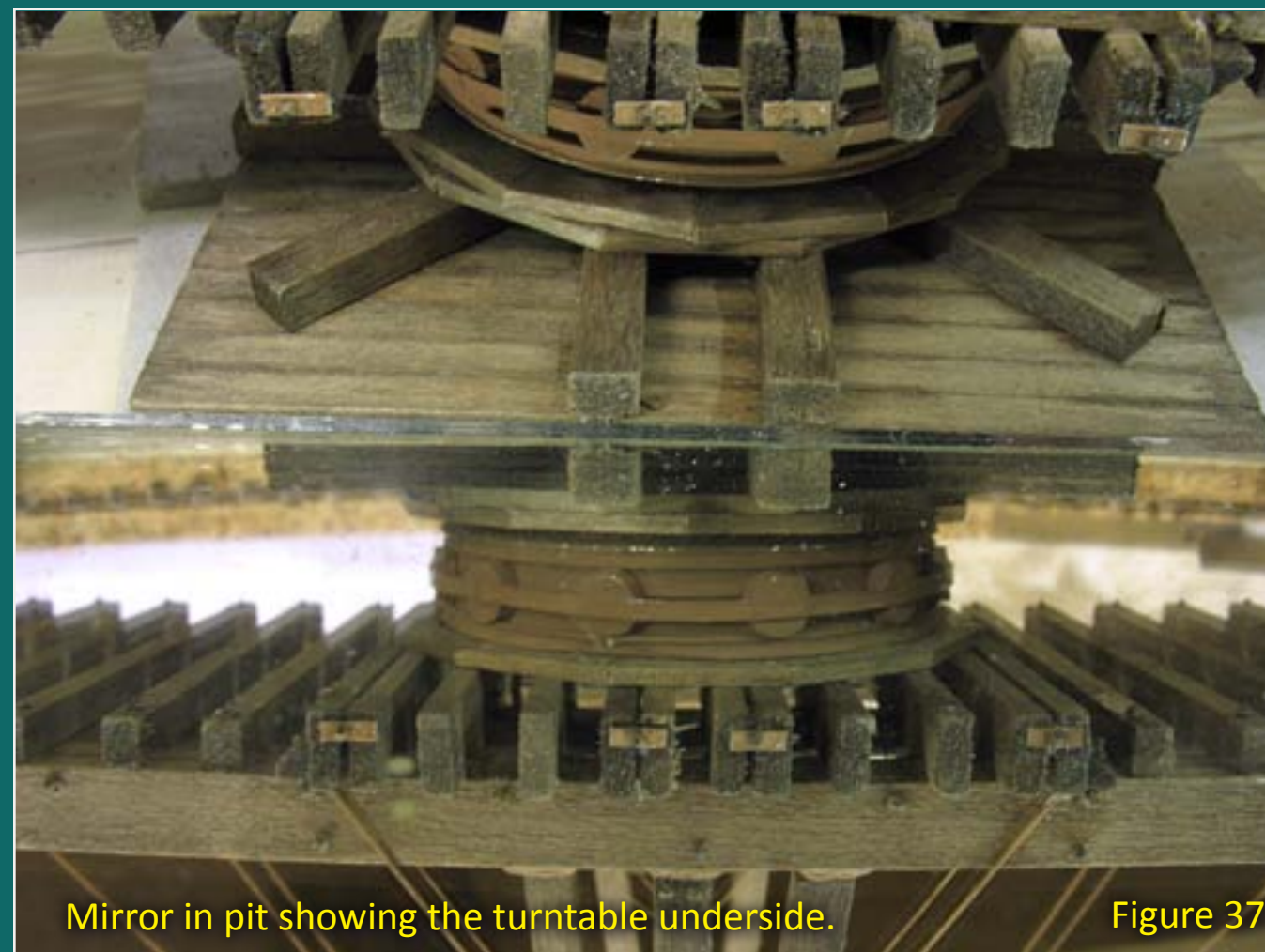

Figure 36



Mirror in pit showing the turntable underside.

Figure 37

STEP 10: The Finished Turntable

5



Figure 38



Figure 39

Figures 38: Here's the finished turntable, with the powered approach track.



This video shows my finished gallows turntable in operation. It still needs a little adjustment but works for turning engines at Salina.



We offer high quality speakers to enhance your model railroad experience



RAILMASTER HOBBIES
LAKEWOOD, CA 90713
562-461-8825

WWW.RAILMASTERHOBBIES.COM

Dealer inquiries welcomed

Bass Reflex Speakers



High Bass Speakers



Our newest speaker only 14 x 36 x 10 mm
Self-contained ported speaker



Product Lines we carry: **BLMA • Broadway Limited • Cal-Hobby • Division Point Models • ESU-LokSound • Exactrail • Hobbytime Distributors • Intermountain Railway • Kadee • Lenz (Decoders) • NorthWest Short Line • Precision Craft Models • Reboxx • The Coach Yard • Walthers** and many others

Our prices are very reasonable. Many items discounted. Click to visit us online - or drop by if you're in the Lakewood area!

Advertisement

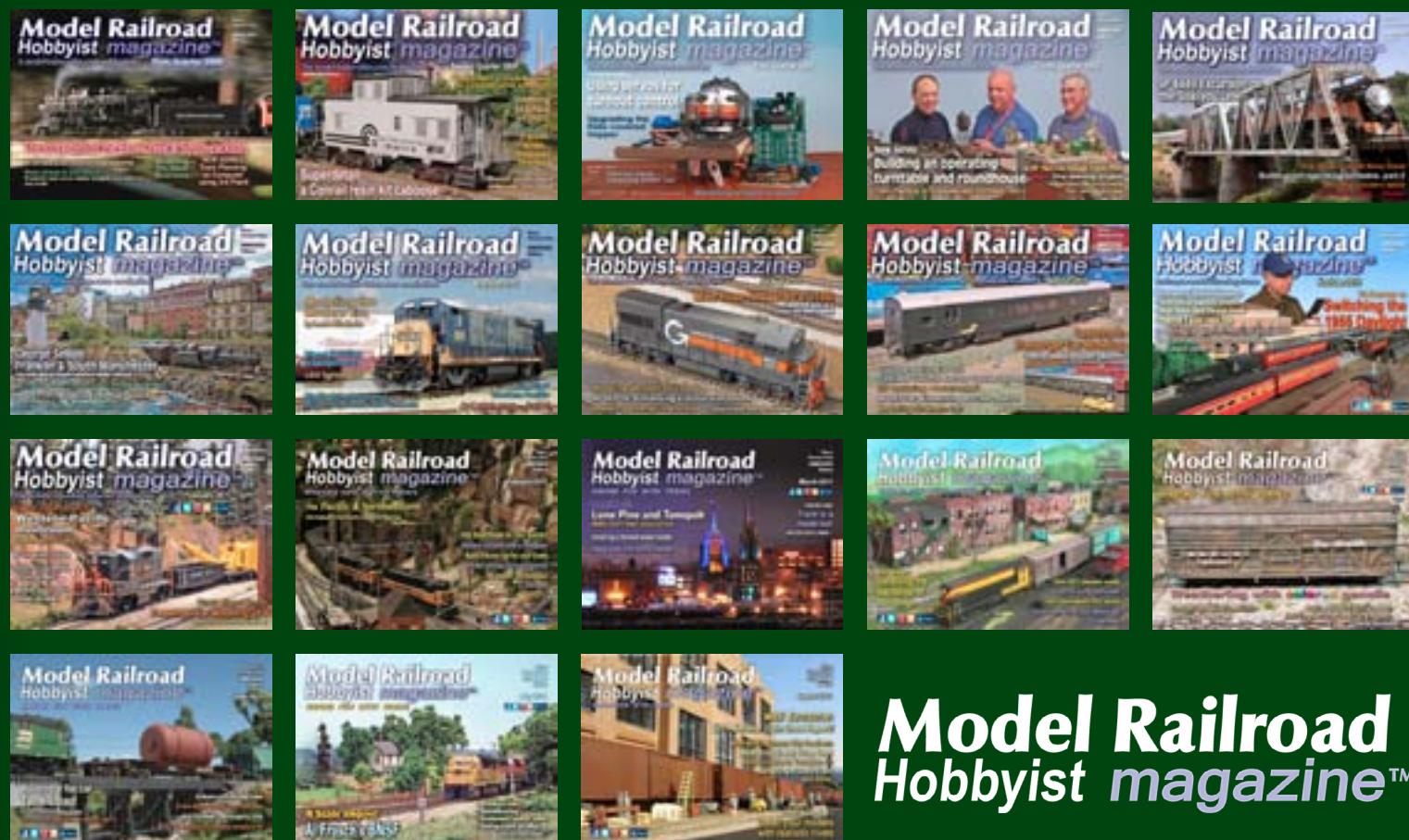

Model Railroad Hobbyist magazine™

Not a subscriber yet?
Stop missing 100+ pages of great content each month!

Subscribing is FREE and you'll be notified each time a new issue is ready!

Plus subscribers get anytime access to the MRH bonus features. No expiration date!

Click [here](#) to find out how.

Answers to the quiz on [page 11](#):

1. Which issue had the first Scenery Scene? **g** - Oct 2009, Flower Power
 2. Which issue had two layout tours? **b** - Mar 2010, George Selios and Craig Bisgeier
 3. Which cover is from January 2010? **d**
 4. Which issue had a layout modeling a TV show? **c** - Feb 2011, Erik Kalinsky modeled Northern Exposure.
 5. Which issue had no layout tour? **i** - Apr 2009
 6. Which issue presented three ways to build a static grass applicator? **b** - Mar 2010
 7. Which issue featured Lance Mindheim? **a** - May 2010, *Modeling the Modern Era*
 8. Which issue introduced the concept of the Chainsaw Layout? **f** - Jan 2009, *Chainsaw Railroads* was the first Reverse Running.
- Bonus question: How many issues of MRH have been published as of August 2011? August 2011 is the **18th** issue of Model Railroad Hobbyist.

Background Sounds

– by Rick Wade
Photos by the author

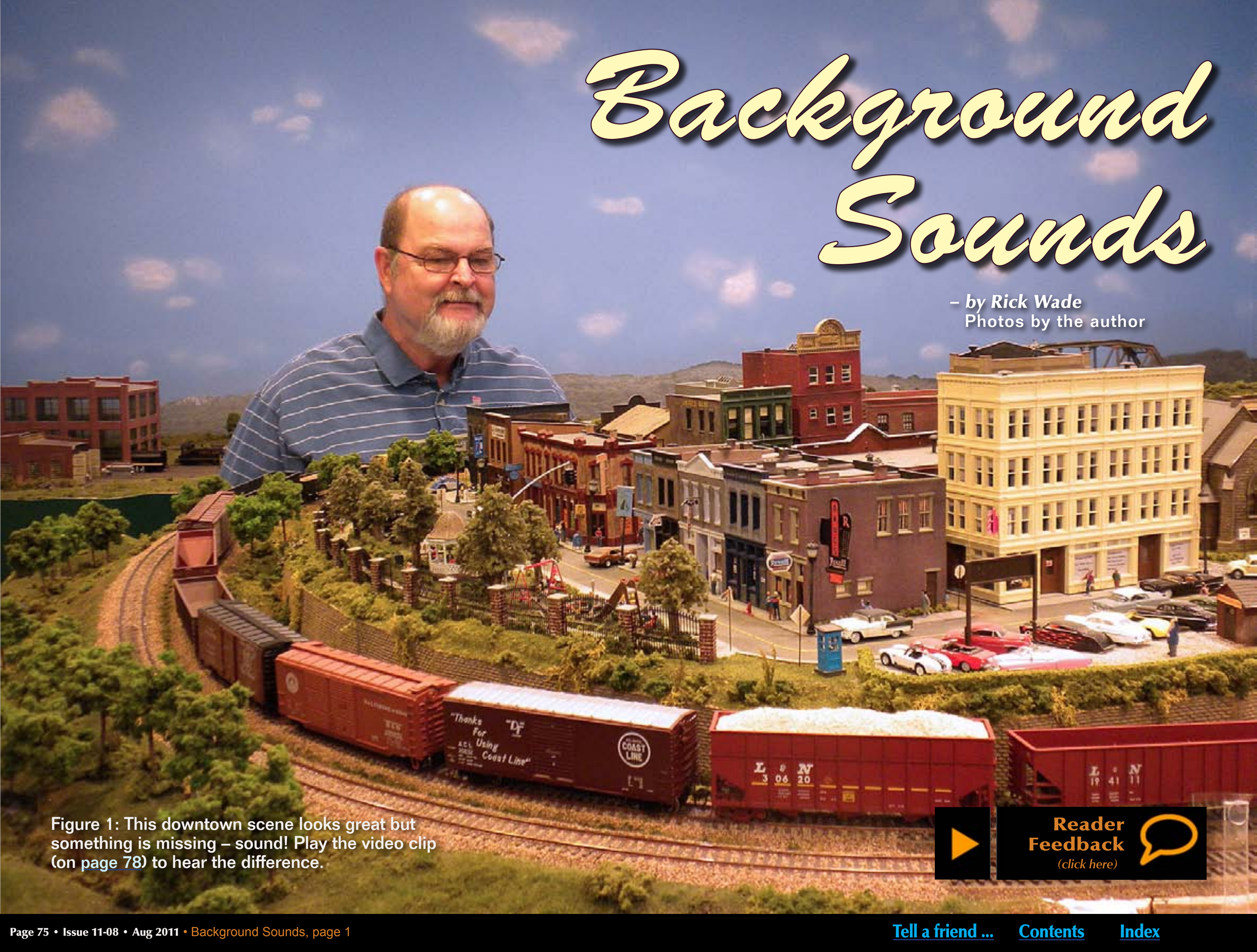

Figure 1: This downtown scene looks great but something is missing – sound! Play the video clip (on [page 78](#)) to hear the difference.

 **Reader Feedback** 
([click here](#))

On Rick Wade's Richlawn Railroad, you can listen to the urban hum of downtown, the clamor of the railroad shops, and a gentle waterfall ...

Many of us already enjoy the benefits of sound equipped locomotives on our layouts. My non-sound equipped units have been "demoted" to occasional duty or are linked up in consists with a sound loco. Just as sound locomotives increase your model railroad enjoyment, background sound can also

enhance the realism of your layout when it is done correctly.

What do I mean by "done correctly?" For background sound to be an asset it should follow a number of guidelines:

- It should be relevant; that is, it should "match" the area modeled. It doesn't make sense to have a sound track of a waterfall when there is no waterfall in sight.
- The duration and how frequently the loop is played should be appropriate. A sound loop that is 90 seconds long and repeats almost continuously will drive you and your visitors crazy!

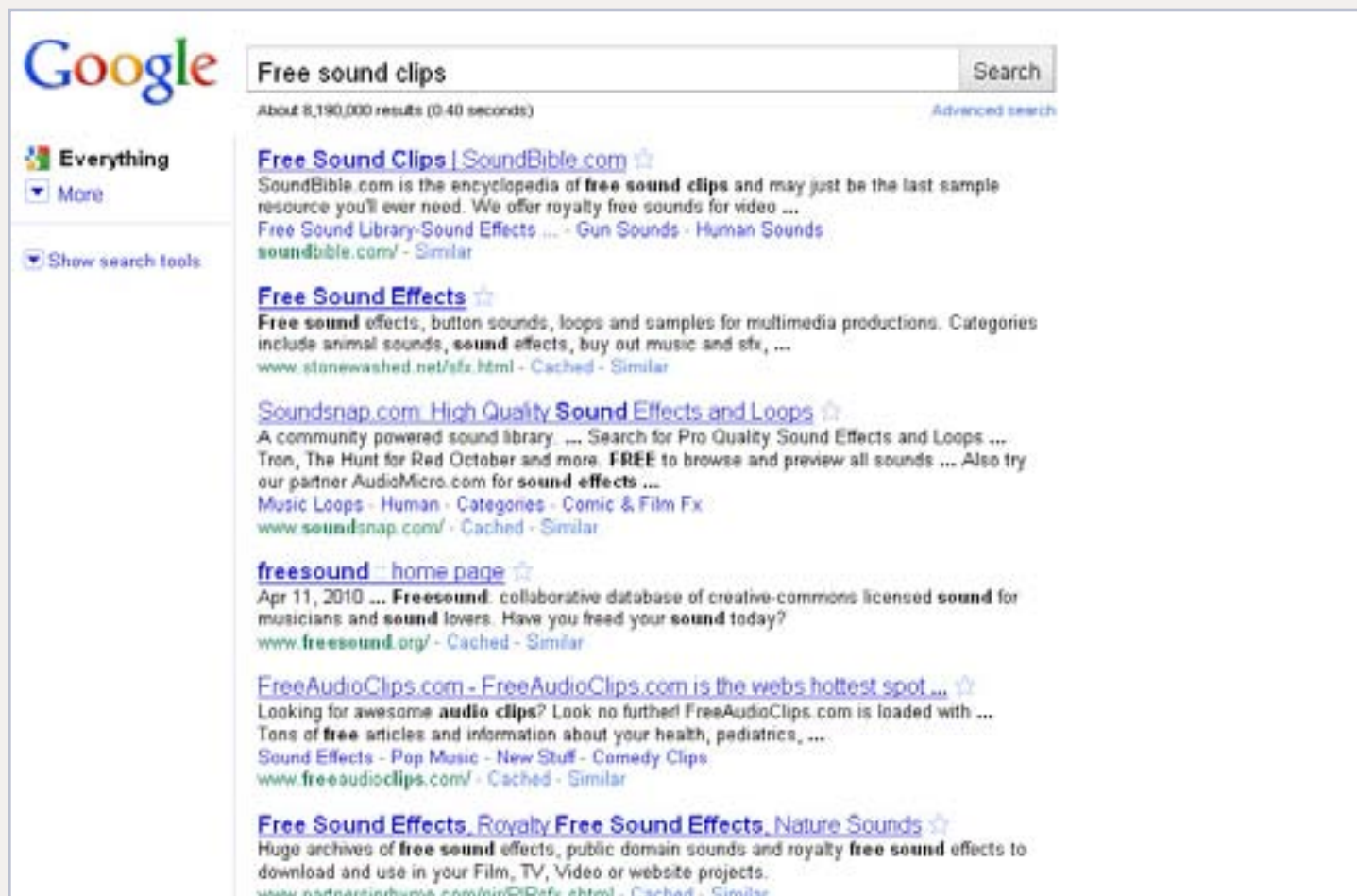

Figure 3: Many websites offer free sound files. I searched for files that fit my needs, such as "machine shop sounds" for the engine service facility.



Figure 2: I bought a cheap MP3 player like this one on eBay for \$6.00. It comes with earphones and I'll use their wiring to connect to a speaker. When purchasing a MP3 player make sure that it uses battery power (AAA). Don't get the kind that is charged through a USB port on your computer.

- The volume should be at the correct level – probably lower than you expect. Background sound is just that – background. It shouldn't overpower the scene or the locomotive sounds.

So far, I have background sound in three areas: downtown, the round-house and shops, and the waterfall. I load free downloadable sound files on cheap MP3 players and wire them to speakers to provide the sound.

Once I've downloaded the sound files, I use an audio editor, Windows Movie Maker™, to build the files I'll install in the players. Figure 4 shows how I created the sound file for the downtown area.

Some of the files have different volume levels, so I use the audio software to normalize them to the same level. Then I adjust individual tracks to make some sounds louder than others, like big trucks which obviously would be louder than some other sounds.



Figure 4: Once I'd downloaded sounds off the internet, I used Windows Movie Maker™ to create the sound files for loading in my MP3 players. Here I'm editing the sound clip for the downtown area.

I try to use one audio track for each type of sound. This makes it easier to adjust the volumes of multiple sounds going into a MP3 track. It also makes it easier to see the timing of the sounds relative to each other on the sound track.

Don't make all sounds the same volume. Large trucks should be louder than bird calls. Use the editor to experiment until you find a mix that sounds good to you. Don't forget periods of silence to rest your ears!

You don't need a dedicated audio editor to perform surgery on sound files. Most inexpensive home video editors will work quite nicely slicing and dicing sound effects or adding special effects like reverb.



Figure 5: I downloaded the edited sound files into my MP3 player. Since the player is stereo it can play two separate sound files at the same time – one each on the left and right channels. I only used one track for this clip, putting it on both channels.

I cut the “buds” off of the headset that came with the player and soldered the wires to a speaker from an old stereo system. The wires are very small, so take care when handling them.

I was lucky with my speaker; it matched the impedance of the MP3 player and worked fine. You may need to experiment to find one that works.

When creating a sound track, insert periods of silence for spacing between the individual sounds. This will help avoid the continuous roar effect and give your and your visitor's ears a rest.

I save my output files in MP3 format even though some of original files were WAV format. MP3 files take less storage space, so more sounds can be installed in a small player. ✓



Figure 6: Speaker placement is important to get good sound. I experimented with different locations and distances from the layout until it sounded right to my ears. I set the volume levels depending on the other noise in the room. If I'm railroading by myself, I keep the level very low. If I have an open house with lots of people, I'll turn it up so my background sounds can be heard over the noise.



Adding background sound to your layout doesn't have to be expensive or difficult. With low-cost MP3 players, speakers, and free sound files, you can enjoy the extra dimension of realistic sound as it helps bring your layout alive.



Rick Wade grew up in the east end of Louisville, Kentucky during the '50s and '60s. This gave him lots of opportunities to watch Louisville & Nashville trains passing only 200 feet behind his home. His first real layout was an HO scale beauty his father helped him build when he was 8. They built it on a sheet of 3/4" plywood and rolled it under his bed when it wasn't in use.

In 2006, he purchased a DPM kit and assembled it. He enjoyed the experience so much he bought another, and

another – he was hooked. With the finished kits mounting up, the only logical choice was to build a railroad.

His wife helps him with scenery on the layout, and encouraged him to expand it into the present layout room.

His favorite part of railroading is still structures, with scenery a close second. He still loves watching L&N trains rumbling through his '60s and '70s landscapes and taking him back to his childhood memories.

Sacramento Train Show Report



by Richard Bale

Model Railroad Hobbyist attended X2011W – the 2011 NMRA National Convention in Sacramento, California last month. Part of the convention is the National Train Show – three days of manufacturers, vendors, and train-a-holics checking out the latest and greatest stuff. MRH shot Click ‘n Spins of many new items and video interviewed some interesting folks (right-hand column).

An enjoyable part of wandering the aisles of the National Train Show is observing people as they discover new and exciting items. Here are a few things I saw that seemed especially interesting.

[Railscale Miniatures](#)’ beautiful display of Delwin’s Boat & Net Storage, an amazing HO scale kit created by master craftsman Dario Le Donne. My favorite structure at the show.

[Rapido](#)’s Canadian passenger train had an extremely realistic looking stainless steel finish. Each car has a unique and highly detailed underframe, too.

[Athearn](#)’s forthcoming Southern Pacific class C-50 caboose in several sub-classes with lots of details appropriate to each version. This may be the best plastic caboose ever produced. Better than brass at half the price. Truly beautiful and meeting the Genesis standard.

Kids going nuts at the operating children’s layouts – notably the Lego display.

I was surprised to see steam-era freight car historian Richard Hendrickson quietly huddling with David Lehlbach, owner of contemporary car-maker [Tangent](#). Later, when I kidded David about the potential “clash of eras” he said a surprising number of customers have been asking for older equipment. This will bear watching.

The vast selection of signals in the [NJ International](#) booth.

The hordes at the [Fast Tracks](#) booth keenly watching Tim Warris fabricating turnouts quickly and easily.

Several people I spoke with thought the decorating on [BLMA](#)’s 63’ Trinity reefer was some of the best they had ever seen. Craig Martyn was pleased!

[Bowser](#)’s PCC car being demonstrated by trolley-guru George Huckaby. It was equipped with an engineering sample of a [SoundTraxx](#) decoder providing gong, pneumatic door operation, compressor, motor-generator start up, and brake lights coming on when the car slows to a stop. Might be available late this year.

The Stanton Cab at the [North West Short Line](#) booth. The well-engineered compact Stanton motorized power truck leaves room in body shells for other goodies like a 3-hour battery, RF-receiver, and DCC decoder. Track power is unnecessary, but if present, will charge the battery.

Elizabeth Allen’s mostly scratch built Southern Pacific SDP45 on display in [Cannon](#)’s booth. A perfect replication of the prototype in both physical details and patina!

And there’s more – check the Click ‘n Spins on the following pages!

2011 National Train Show Interviews (click thumbnail to view)

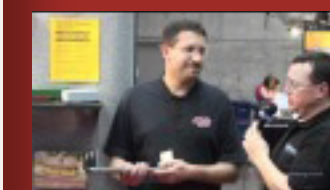

Atlas Interview



Scenic Express Interview

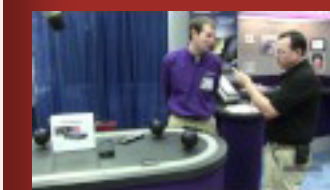

SoundTraxx Interview



BLMA interview



ExactRail Interview

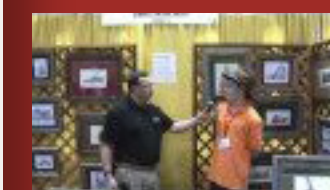

Kendall Collins Interview



Walthers Interview



Figure 1: Alameda Car Works - large scale, working, Sheffield No. 1 car manufactured by Sheffield Velocipede Car Company.



Figure 2: Athearn - HO scale GP9



Figure 3: Athearn - HO scale SP C-50 caboose



Figure 4: Atlas - N scale coil car



Figure 5: [BLMA](#) - HO scale Trinity reefer



Figure 6: Bowser - HO scale C630M



Figure 7: [Canadian Model Trains \(CMT\)](#) - HO scale St. Charles caboose prototype



Figure 8: [ExactRail](#) - HO scale Trinity reefer



Figure 9: Kato - N scale MP-36



Figure 10: North American Railcars (NAR) - HO scale potash hopper



Figure 11: Rapido - HO scale URTX reefer



Figure 12: [Walthers](#) - HO scale high level coach with step-down and tail sign



About our narrow gauge and branchline columnist



Lew Matt is a published writer, photographer, and illustrator whose work has appeared in many model railroad hobby magazines.

[Click here](#) to learn more about Lew.

Reader Feedback (click here)

THE LITE AND NARROW: Cattle Guard – An Unusual and Interesting Bit of Roadbed Detail Ramblings on Narrow Gauge and Branchline Modeling



In our continuing project of looking at modeling fences and railroad rights of ways, it is important to consider how trains can get through a fence but the cattle can't. Cattle guards were invented in the 19th century to enable trains to safely pass through the fence but not require a person to disembark from the train to open and close a gate.

Cattle have cloven hooves and do not like to step on sharp or unstable, upward thrusting objects such as a split rail or an "L" angle iron with the sharp, pointed edges facing up, or a small to medium diameter round

pipe. The floors of cattle guards can use any horizontal objects laid side-by-side parallel to the rail, that present unstable footing for the bovine.

The earliest cattle guards were made from split red oak rails with a triangular cross section about 3" high by 3" wide at the base, laid side-by-side between the rails and spiked to the ties, pointed edge up. Small, round sapling tree trunks about 2" to 3" in diameter and stripped of bark were also used. As the design evolved, steel angle iron and pipe replaced the wood as they last longer and require less maintenance. Today, cattle guards

Figure 1: Cattle guards are a great way to allow the trains through and keep the stock from wandering. They also make an interesting scenic detail, and could be a scene focal point along the right-of-way.

are made from precast concrete or U shaped pressed steel sheets with the curve up and resting between the rails like large corrugations.

The same flooring material was added to each side and flanked the rails sufficiently to allow wide railroad

Continued on page 94 ...

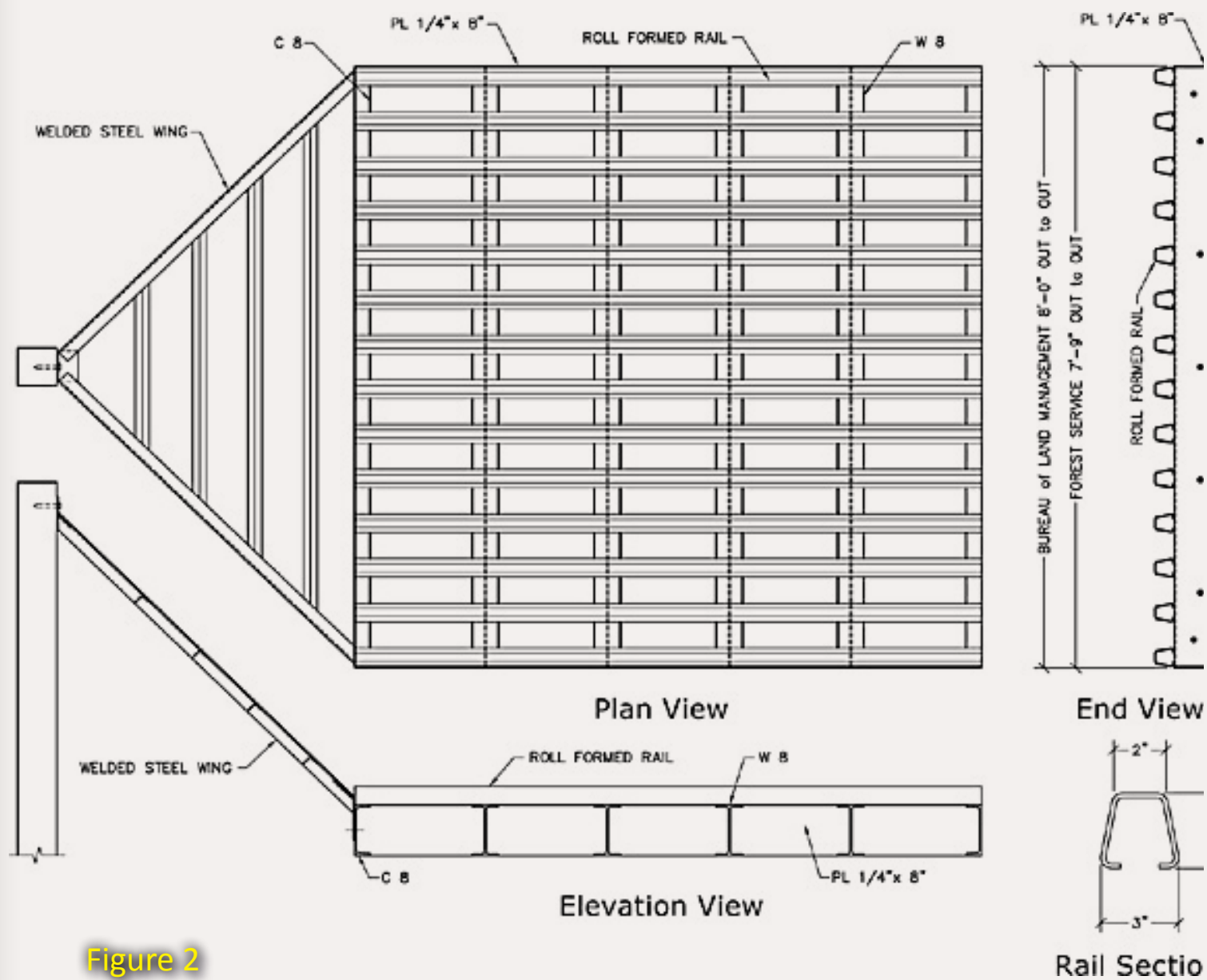

Figure 2

Figure 2: This is a diagram of a road crossing cattle guard. The only difference between this and a railroad guard is that the bars run across the path of travel, but on the railroad, the bars run parallel to the path of travel. ©2010 Big R Bridge • Greeley, Colorado (www.bigrbridge.com).

Figure 3: The earliest cattle guards were made from split rails. Although they worked well, wood was not a good choice for maintenance-free operations, especially when it was in contact with the ground.

Figure 4: This is the framework of timber located under the split rail cattle guard. The frame holds the wood rails in place. Note that the side frame pieces have a bottom spacer to bring the bottom of the split rails up to a position level with the ties.

Figure 5: This tool is used to strip out hull planking for model (wood) ship building. It was very useful to strip cut the rails for the cattle guard, as they are only a scale 3" wide and then taper smaller.



Figure 3



Figure 4

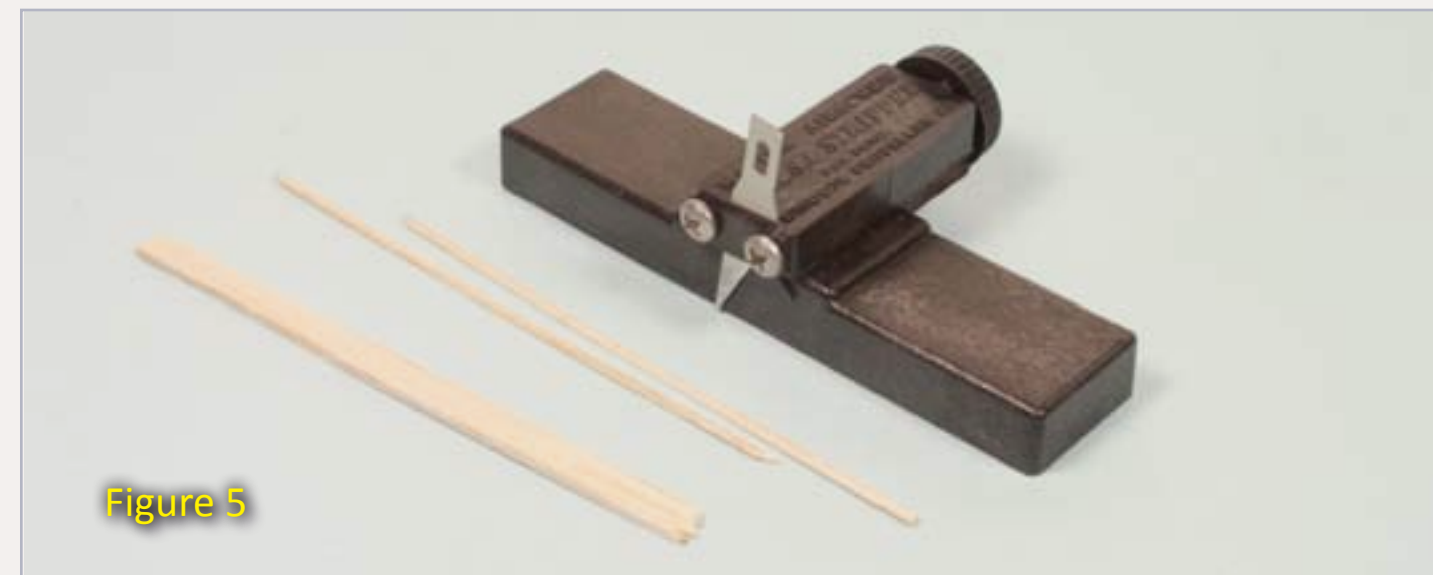

Figure 5

Continued from page 92 ...

equipment to pass but not allow the cattle to bypass the guard. The terminal sides are each made from small timbers, structural steel shapes or a combination of both, into a triangular shaped structure, very much like a fence sloped at a 45 degree angle with the base against the floor of the cattle guard and the apex of the triangle attached to the adjacent fence posts. The opening under this piece was closed off with boards (see figure 6) attached to both the side piece and the fence post.

It is not unusual for the cattle guard to be placed over a shallow ditch, narrow gully or small dry gulch, as the

open space under the ties added to the cattle's fear factor. Not only is the surface not flat and disagreeable to their hooves, but there is the opportunity to step through the guard and break a leg. The space under modern cattle guards is frequently dug out just to enhance this fear factor in the stock. In most cases, the floor of the cattle guard is elevated a few inches above the ballast between the ties (figure 8).

If you have an adjacent road surface, parallel to the railroad, it would be prototypical to install a cattle guard in the road along side the guard in the tracks, in line with the fence. Both of the guards can be made of the same materials and techniques, but



Figure 6: The later cattle guards replaced the wood floor with iron for longevity. This model represents the type that used small diameter round iron pipe. Note that the triangular shaped side piece of the cattle guard is attached to the top of the fence post and the space between the tapered side and the fence post are filled in with boards.



Figure 7: To keep the cost down and simplify construction, these "pipes" are pieces of angel hair pasta, painted gray, then weathered with Prismacolor sepia marker and drybrushed Floquil rust. The pipes were spaced 3" center to center, attached to a thin framing piece of wood at either end with carpenters yellow glue, then spray painted with gray primer. Once the pasta is sealed in paint, rodents and insects won't pay any attention to it, and it is much easier to work with than brass rods.

roadway cattle guards should have the flooring running perpendicular to the flow of travel, in other words, the floor material crosses the road from side to side. Your scale model motorcyclists and bicyclists will certainly appreciate this feature (figure 9).

Construction of the model cattle guard is rather simple, as it doesn't require exact measurements and takes about 45 minutes from start to finish, including painting and weathering. You can make the parts at the bench and take them to the railroad

to install, or you can build in place. I like my creature comforts, so I prefer to build at the work bench and then bribe one of my grandchildren into standing in an uncomfortable position and overreaching into the layout to do the installation.

When you install the guard, make liberal use of the NMRA track gauge for flange clearance between the rails and allow plenty of side clearance outside the rails especially if you are installing the guard on a curve. If possible, strive for installation on as

straight of a piece of track as possible. Before you permanently glue the guard in position, check all the clearances with your widest and fussiest-tracking equipment.

Painting and weathering of the cattle guard follows standard modeling practices. If the guard is made from unpainted wood, then distress the wood and apply a weathered wood stain before gluing together, I used Hunterline's black weathering stain. The steel parts are painted NYC gray and then washed with Hunterline's black weathering stain, and when dry, dry-brushed with a light coat of Floquil rust. A black Sharpie marker was used to make nail holes in the timbers.

I use Carter's paper rubber cement (available from big-box and office

supply stores) for the trial-fit construction of projects, as it makes a good temporary bond, if you only apply it to one side of the joint, and is easy to pull apart when you want it to, but will otherwise hold the project together for a considerable amount of time. The used bits of rubber cement are easily gathered up with a ball of dried rubber cement or artist's rubber cement pick-up. Once you are comfortable that the cattle guard works well, you can make it permanent. I carefully positioned mine in a pool of diluted white glue and allowed it to dry overnight.

A cattle guard makes a nice bit of scenery and adds a nice detail touch to the usually unassuming trackwork. It is large enough to be seen easily, but it is unobtrusive enough to

blend-in well. A cattle guard could make a nice addition to your layout, with several cows clustered around, contemplating making a run for it. ☑

 **Reader Feedback**
(click here) 

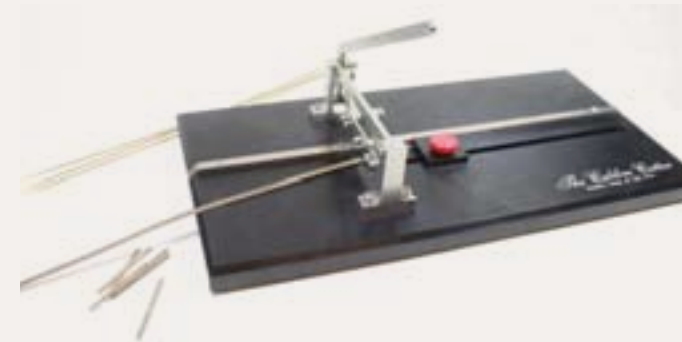

Figure 9: A Chopper is used to ensure that all the pieces of flooring are the same length. The machine cuts the pasta pipe, wood timbers and cardstock angle iron cleanly. Note: crease or score and fold the cardstock angle pieces before you cut them to size; otherwise it will be very difficult to fold a piece of paper 3 scale inches wide.



Figure 8: Angle iron was another of the modern cattle guard construction materials. This is a cattle guard that appears on one of the modules of the Great Lakes Group. I photographed this cattle guard at the 2009 Midwest Narrow Gauge convention but failed to note who built the model and the module it was on.



Figure 10: A home-made gauge is used by the railroad crew to check the side clearance of the cattle guard.

About this issue's prototype modeling columnist



Joe Fugate is MRH's Founder and Publisher. He's also an avid SP diesel-era modeler, with his prototype-based Siskiyou Line layout perpetually in the 1980s.

Photos and illustrations by the author unless otherwise credited.

GETTING REAL: Building an accurate diesel loco roster

Adventures in Prototype Modeling

Joe Fugate discusses how he developed a prototype-based loco roster for his SP Siskiyou Line ...

My HO Siskiyou Line is now forever 30 years behind the current date, which means right now it's August 1981 on my model railroad.

like to see the comment thread for this issue's column build a list of resources for other roads as well, making this a truly universally helpful column.

Motive Power Annuals

For the 1980s Southern Pacific, some great annual reviews have been published. These fabulous books are



While I'm going to discuss the diesel era Southern Pacific, many of the other class 1 railroads also have similar sources for this kind of information. I'd

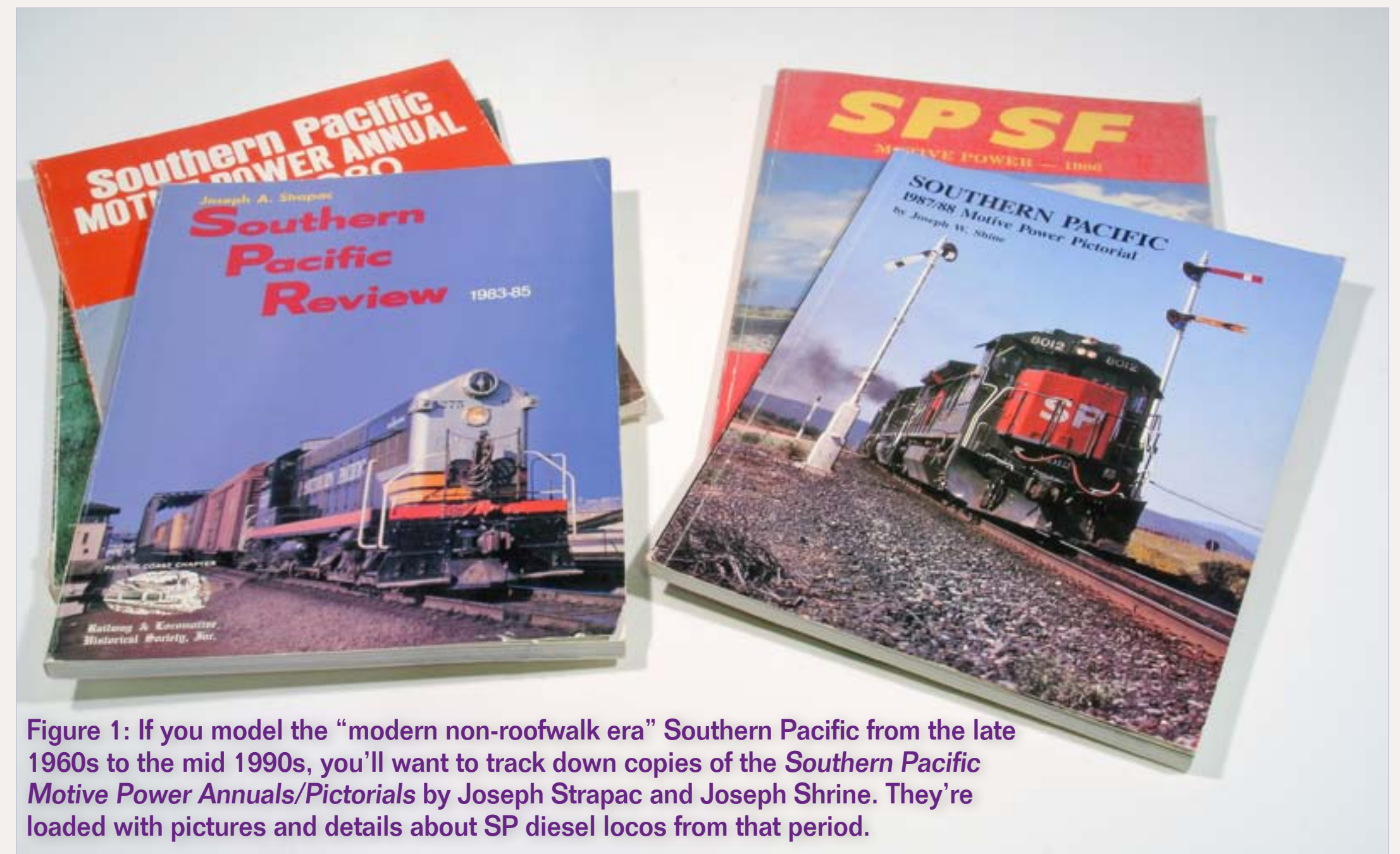

Figure 1: If you model the “modern non-roofwalk era” Southern Pacific from the late 1960s to the mid 1990s, you'll want to track down copies of the *Southern Pacific Motive Power Annuals/Pictorials* by Joseph Strapac and Joseph Shrine. They're loaded with pictures and details about SP diesel locos from that period.

loaded with photos and descriptions of every class of diesel on the roster.

They also feature a complete loco roster list, giving each class of loco, how many locos are in the class, the number range, and any special notes about that class.

As a bonus, many of the annuals also feature an in-depth section on some part of the railroad's equipment. For instance, the 1981 annual has extensive discussion and illustrations of SP and Cotton Belt steel cabooses.

Since these books are out of print, I had to keep an eye out for them at swap meets, on Amazon's used book section and on eBay. Diligence paid off – I was able to get a complete set of the annuals from the later 1970s to the end of the 1980s over a couple year's time.

Southern Pacific Dieselization

As a diesel-era modeler, I find knowing the history of how my prototype Southern Pacific dieselized to be very helpful in understanding how to develop an accurate diesel loco roster.

For this topic, I found the book *Southern Pacific Dieselization* by John Bonds Garmany. John Garmany covers the very beginnings of diesels on the SP in the late 1930s all the way to the Amtrak era.

The book also features a comprehensive diesel loco roster in the back, with copious notes about variations and modifications.

With the advent of the first second generation diesels in the 1960s, the SP renumbered their entire diesel fleet.

I've found Garmany's comprehensive roster, renumbering information, and GRIP rebuilding data to be extremely valuable in my loco roster research.

For instance, Garmany lists the different SD40 L-window configurations by exact loco number. From there as the locos were later rebuilt in the 1980s, I could determine exactly which rebuilt loco had which window configuration. That's something not listed in any of the other rosters or motive power annuals.

Southern Pacific Dieselization is still in print and available from Amazon.com and hobby shops.

Photo Collections

In addition to collecting books to use as resources for building a realistic prototype diesel roster, I have built a collection of photos.

Since I railfanned the SP Siskiyou Line in the 1980s, I have photos in my own collection of various diesels on the line at that time. This means I can validate certain loco numbers to have run on the line during that decade.

A number of books have been released over the years that also cover the SP in Oregon and Northern California. Using these books, I am able to extend my list with additional

Figure 2: John Garmany's book *Southern Pacific Dieselization* is packed with useful data for even the more modern SP diesel modeler. Not only does Garmany cover the entire dieselization process of the SP, he discusses second generation diesels in detail. The book provides a comprehensive all-time SP and Cotton Belt diesel roster in the back of loaded with copious notes on each loco class. I consider this book a must-have for any SP diesel-era modeler.

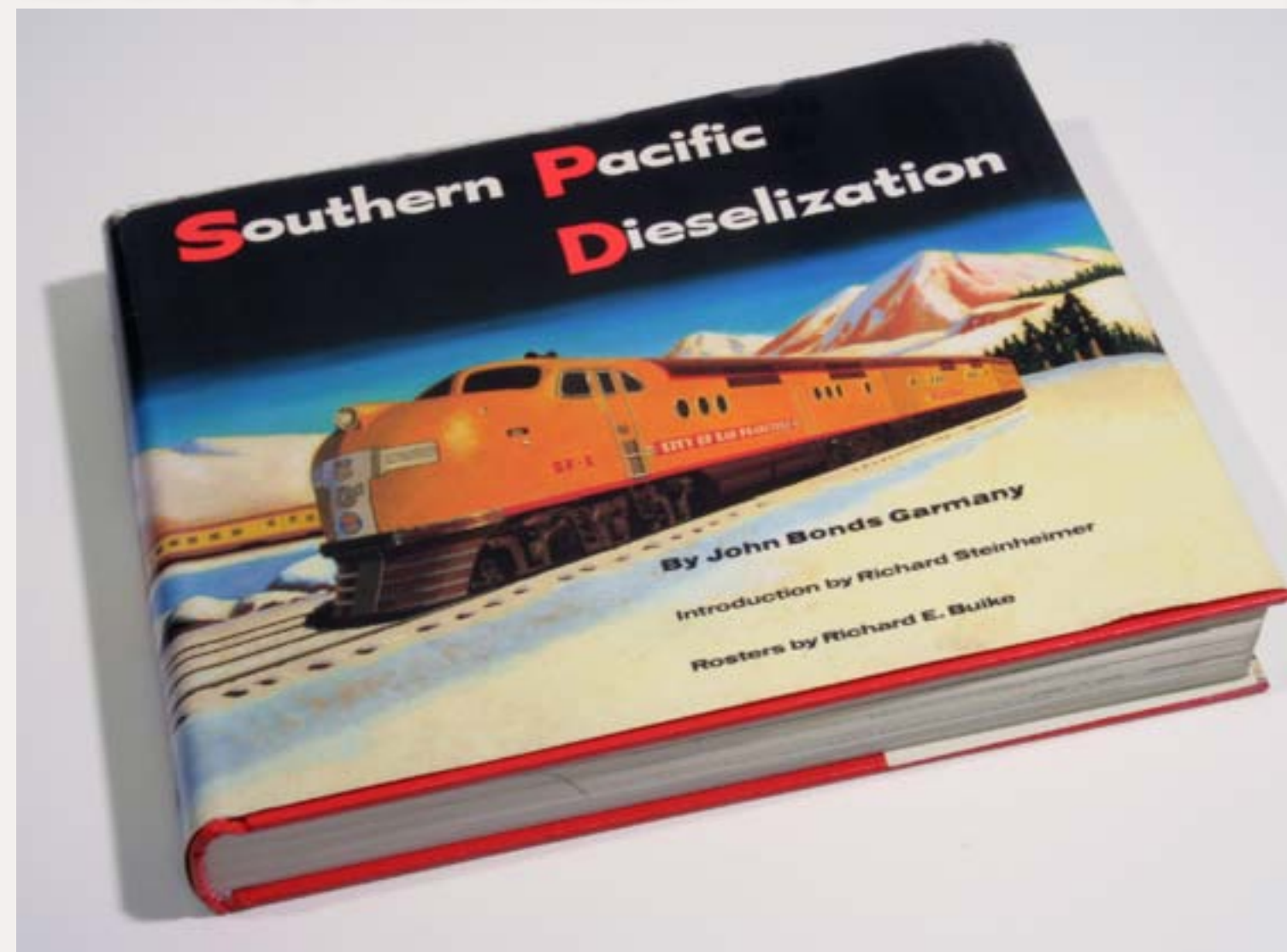

locos I can prove actually ran on the Siskiyou Line in the 1980s.

Building My Roster

Once I had the list of loco numbers and their sources, I was able to build a list of locos for my roster.

I used Microsoft Excel to make the roster, and I included references to the photo source that validate the

loco actually ran on the Siskiyou Line in the 1980s.

I also used the *Southern Pacific Dieselization* book's all-time roster to compute a proper ratio of each loco class. That way I would not have a wildly disproportionate number of locos in a given class on my Siskiyou Line layout.

When designing my layout, I estimated I could run up to 14 trains on

my layout in a typical op session. Each train would have between 2 and 5 locos, depending on if it's a local or a through train, and if it's going over a grade and needs helpers.

However, I can say the average per train would be about 4 locos, and then I need to include a few extra as switchers.

If I take 14 trains per op session and multiply it by 4 locos per train, I get 56 locos. Adding switchers for my layout's two yards plus some spares, that's maybe 7 more, totalling 63 locos for my roster.

Next, I looked at my photo collection and determined which classes of locos were common on the Siskiyou Line.

GP9E, Phase II: Rebuilt to modern electrical standards as part of the GRIP program in the 1970s, hence the E designation. Phase II GP9s have five 36" fans on the roof (figure 3).

Total in my roster: 4 locos.

GP9E, Phase III: Rebuilt to modern electrical standards in the GRIP program. Phase III GP9s have three 48" fans on the roof (figure 4).

Total in my roster: 2 locos.

GP40R: Cotton Belt GP40s bought in the early 60s, then rebuilt during the early 1980s to run as TEBU mothers, hence the R designation (figure 11).

Total in my roster: 4 locos.

GP40-2: Late GP40 locos with improved dash 2 electrical components (figure 7).

Total in my roster: 3 locos.

TEBU: Tractive Effort Booster Units – slugs with a low hood full of concrete and traction motors on all 4 axles. TEBU's get their power from the mother GP40s (figure 8).

Total in my roster: 2 locos.

SD9E: SD9s that have been rebuilt to modern electrical standards as part of the GRIP program (figure 5).

Total in my roster: 12 locos.

SD9E, Kodachrome: Rebuilt SD9Es repainted to the SPSF merger paint scheme circa 1986 (figure 6).

Total in my roster: 2 locos.

SD40R: SD40s were rebuilt to modern electrical standards in the 1980s, hence the R designation (figure 15).

Total in my roster: 6 locos.

SD45: Six axle SD45s with the distinctive flared radiator section at the top rear of the hood (figure 13).

Total in my roster: 6 locos.

SD45R: SD45s rebuilt during the 1980s to modern electrical standards, giving the R designation (figure 12).

Total in my roster: 6 locos.

Continued on page 100 ...

Figure 3: Phase II GP9E 3408, on the Siskiyou Line (1990).

Figure 4: Phase III GP9E 3840, in Roseburg Yard (1987).

Figure 5: SD9E 4422, in Roseburg Yard (1987).





Figure 6



Figure 9



Figure 7

© 2000 R.L. Dengler



Figure 10



Figure 8

© 1999 R.L. Dengler



Figure 11

© 2001 R.L. Dengler

Figure 6: SD9E 4354 in Kodachrome paint, Oakland, OR (1989).

Figure 7: GP40-2 7943 in Roseville, CA yard (1981). From espee-railfan.net.

Figure 8: TEBU 1601 in Roseville, CA yard, (1981). From espee-railfan.net.

Figure 9: SD40T-2 8299 in Sutherlin, OR (1987).

Figure 10: SD45T-2 9313 in Sutherlin, OR (1987).

Figure 11: GP40R 7961 in Sacramento, CA yard (1982). From espee-railfan.net.

Figure 12



Figure 13



© 2007 Dennis Mutulo

Figure 14



Figure 12: SD45R 7482 in Oakland, OR (1987).

Figure 13: SD45 9058 in Sacramento, CA (1986). From espee-railfan.net.

Figure 14: SD45T-2 9318 in Kodachrome paint, Oakland, OR (1987).

Continued from page 98 ...

SD40T-2: Distinctive SD40-2 “tunnel motor” locos with the low air input screen at the back of the long hood (figure 9).

Total in my roster: 10 locos.

SD45T-2: The SD45-2 version of the “tunnel motor” locos (figure 10).

Total in my roster: 5 locos.

SD45T-2, Kodachrome: SD45T-2 tunnel motor locos that were repainted into the SPSF merger scheme circa 1986 (figure 14).

Total in my roster: 1 loco.

My main requirement to include a given loco number in my roster is

to find a photo of it running somewhere on the SP Siskiyou Line during the 1980s. My sources include my own photo collection, books, and the internet.

Once I am able to establish that a given loco number did run on the Siskiyou Line sometime during the 1908s, then I am free to draw on images of that loco number from anywhere during its lifetime as a detailing resource.

Some of the photos in this article don't show the loco on the Siskiyou Line, but the loco number shown did run on the Siskiyou Line sometime

Figure 15



Figure 15: SD40R 7361 in Oakland, OR (1987).

during the 1980s. I selected the photos to appear in this article primarily because they are in my personal collection or we have permission to use them in this article.

In some cases I need to speculate a little on what may have happened to some of the details and weathering. Such is the life of a historical modeler!

Building the Roster in Excel

I used Microsoft Excel to build my roster list. Originally I was using 2 digit addresses in all my locos, so it was important to me that I only had one loco in each address. To maintain this restriction, I only used the last 2 digits on the cab.

However, five years ago, I finally decided DCC 4-digit addressing and consisting had progressed enough that limiting myself to 2-digit addresses was no longer required. My NCE system, for example now allows me to refer to loco consists using the 4-digit address of the lead loco.

I now have more than one loco in some last-two-digit slots, such as 4408 and 1608.

On the right is my current Excel loco roster listing.

Figure 16: Here's my Excel loco roster listing. The lines shaded gray are actually on the layout. Originally, I was using 2-digit loco addresses, so I organized the list that way.

DCC#	Loco #	Type	Reference
0	****	****	No **00 loco yet identified
1	1601	TEBU	
2	9402	SD45T-2	JF Collection
3			
4	4304	SD9E	JF Collection
5	1605	TEBU	
6	4406	SD9E	SP Oregon Division, pg 21
7	4407	SD9E	SP Oregon Division, pg 24
8	4408	SD9E	JF collection, SP Oregon Division, pg 18, 59
8	1608	TEBU	(renumber to 1605)
9	4409	SD9E	
10	7510	SD45R	SP Oregon Division ...
11	4411	SD9E	SP Oregon Division, pg 22
12	8312	SD40T-2	
13			
14	7514	SD45R	Web (low mounted brakes)
15	4415	SD9E	SP Country, pg 35
16	8816	SD45	Rails in NW, pg 54, 74
17	4317	SD9E	SP Oregon Division, pg 45
18	9318	SD45T-2	JF Collection (Kodachrome)
18	****	****	Filled temporarily with loaned UP loco
19	7319	SD40R	Shasta video
20	7320	SD40R	
21			
22	4422	SD9E	JF collection
23	4323	SD9E	SP Country, pg 31 (top view), JF collection
24			
25	4425	SD9E	SP Oregon Division, pg 38
26	7426	SD45R	Web (low mounted brakes)
27	7527	SD45R	Web (low mounted brakes and bell)
28	7328	SD40R	SP Review 1981, pg 109
29			
30	8330	SD40T-2	JF collection
31	4431	SD9E	JF collection
32			
33	4333	SD9E	SP Oregon Division, pg 16, 23, 28
34	8334	SD40T-2	Web
35	9235	SD45T-2	Web
36	7636	GP40-2	Pentrex, Best of 1990 video; Shasta video
37	9237	SD45T-2	
38	9038	SD45	Web(high mounted brakes)
39	7339	SD40R	JF Collection
40	3840	GP9E	JF collection (ph III rebuild)
41	9241	SD45T-2	
42	9342	SD45T-2	JF Collection (to be finished)
42	3942	GP9E	SP Oregon Division, pg 23
43	7943	GP40-2	SP Oregon Division, pg 34
44	7444	SD45R	SP Oregon Division, pg 96, 98
45			
46	7546	SD45R	JF Collection
47	8247	SD40T-2	SP Oregon Division, pg 46
48	3348	GP9E	JF Collection
49			

DCC#	Loco #	Type	Reference
50	3750	GP9E	JF collection
51	7551	SD45R	First SP unit painted in Kodachrome
51	8351	SD40T-2	SP Country, pg 49 - snoot version
52	7452	SD45R	JF Collection
53			
54	4354	SD9E	JF collection
55			
56	6856	SD45T-2R	SP Oregon Division, pg 46
57	9157	SD45T-2	Web
58	9058	SD45	Web folder (low brakes)
58	7358	SD40R	Shasta video
59	3859	GP9E	SP Cntry, pg 48 (ph III), SP OR Div, pg 31, 100
60	7960	GP40R	Web folder
61	7961	GP40R	Web folder
61	7361	SD40R	JF Collection
62	4362	SD9E	In photo of 4407 (Coos Bay) on Web
63	4363	SD9E	SP Oregon Division, pg 45 (Kodachrome)
64	4364	SD9E	SP Oregon Division, pg 15
65	7365	SD40R	Web folder
66	7966	GP40R	SP in Oregon Pictorial, pg 116, 118
67	7967	GP40R	Backwoods Railroads; SP in OR Pict, pg 131
68	7468	SD45R	Web (low mounted brakes)
69	7469	SD45R	JF Collection
70			
71	7371	SD40R	JF Collection
72	8372	SD40T-2	SP Country, pg 45 - snoot version
73	7373	SD40R	SP Oregon Division, pg ?
74			
75	9075	SD45	SP Country, pg 7 (color - high brake cylinders)
76			
77	8277	SD40T-2	JF Collection
78			
79	7479	SD45R	JF Collection (several)
80	3780	GP9E	JF collection
81			
82	7482	SD45R	JF Collection (several)
83			
84	9084	SD45	Web (low mounted brakes)
85	4385	SD9E	SP Country, pg 41
86			
87	8887	SD45	SP Country, pg 39 (high brakes)
88			
89	4389	SD9E	SP Country, pg 41
90	9090	SD45	Web (high brakes)
91			
92	9092	SD45	SP in OR Pict, pg 163, 203, web (high brakes)
93			
94	4394	SD9E	SP Oregon Division, pg 4
95	8295	SD40T-2	SP Country, pg 7 (color)
96			
97			
98	9398	SD45T-2	SP Country, pg 73,89
99	8299	SD40T-2	JF collection



Above: The west end of the Siskiyou Branch was served by a local, operating out of...

Figure 17: I found this image of SD9E SP4408 on the Siskiyou Line in the book *Southern Pacific Oregon Division* (Jennison and Neves). This photo, along with a shot from my own personal collection of 4408 taken in Oakland, Oregon, during 1987 tells me 4408 was a frequently seen loco on the Siskiyou Line.

Now you can see how I established my loco roster. The next stage will be to begin collecting the actual locos for my layout. We'll cover that in future installments of the *Getting Real* column.



Figure 18: We'll cover specific loco types and how I detailed the models to match the prototype in future *Getting Real* columns.



Reference Sources

Here's a key to the references I mention in my roster listing.

JF Collection: Images I have in my own personal photo collection.

SP Oregon Division: 128 page hardcover book published by Hundman Publishing in 1997. [Available on Amazon.com.](#)

SP Country: 199 page book, *Southern Pacific Country*, published by Trans-Anglo Books in 1987. [Available on Amazon.com.](#)

SP in Oregon: 320 page book, *Southern Pacific in Oregon*, published by Pacific Fast Mail in 1994. [Available on Amazon.com.](#)

SP Motive Power Annual 1986: 128 page book, *SPSF Motive Power 1986*, published by Four

Ways West Publications in 1986. [Available on Amazon.com](#) used.

Rails in the Northwest: 80 page book published by the Colorado Railroad Museum in 1978. [Available on Amazon.com](#) used.

Backwoods Railroads: 168 page book published by the Washington State University in 1994. [Available on Amazon.com.](#)

Shasta video: VHS Video produced by Icon Video Productions in 1996. Video is out-of-production so you'll have to Google the web and/or watch eBay to find a used copy.

Pentrex Best of 1990 video: VHS video produced by Pentrex with a number of railroads featured, one of which is the SP Siskiyou Line in 1989. Video is out-of-production, so you'll have to Google it or watch eBay. ■



Figure 19: *Southern Pacific Oregon Division* is one of the books I referenced while building my loco roster list.



About our N-scale columnist



John Drye is our N scale editor and columnist.

[Click here](#) to learn more about John.

COMME-N-TARY: Ballasting a Four-Track Mainline Applying cinders and granite to Pennsy's Great Broad Way!

Modeling in the hobby's most eNgaging scale



Tips and techniques for creating a smooth running and great looking mainline in N scale. Four tracks are optional!

Ballasting a four-track mainline is much like ballasting a single-track mainline, except that you use a lot more ballast! The key in both instances is to progress slowly and carefully and to not expect to get it all done in one "go."

On the prototype, ballast provides support and stability for passing trains, allows for prompt drainage, inhibits vegetation growth, and makes for efficient maintenance. Common ballast materials include quartz, granite, or limestone. The material can be a foot or more deep under the track itself, level with the tops of the ties, and sloping down several feet or more to the sides of the rails.

On our models, ballast enhances the realism of the right of way, and can

be combined with proper drainage ditches, sub-roadbed, wayside structures, and other materials that make our railroad look like it is working for a living!

Preparations

A key element of smooth railroading is to make absolutely sure that the trackwork is in good shape before applying any ballast. The best way to do that, of course, is to run trains. After all, that is what we are about:

long trains, short trains, heavy trains, light trains, helpers (snappers on the PRR) if you plan to use them, passenger trains, the largest and longest cars you plan on operating. Be sure to run in both directions, across all turnout positions; over and over until every train runs without a hiccup.

Make sure all feeders as well as any additional wiring for signals, detection or other operations are wired and functional. Then take a long look



Figure 1: The first step in the ballasting process is to make sure trackwork is smooth, functional, and cleaned up from the construction process.

“Depending on the construction material used, a drainage ditch can be provided along one or both sides of the mainline.”

at curves, easements, turnouts, and super-elevation to make sure all is smooth and gentle.

The sub-roadbed can also use some attention before applying ballast. The split variety of cork material allows for smooth application of the roadbed along curved trackage, but often leaves an irregular edge on at least one side. Both edges can be sanded

to achieve a 45-degree slope, allowing an efficient application of ballast. We used a simple sanding block tool to achieve a consistent profile between the individual tracks. In some areas of complex trackage, it can be easier to use a large (2” or 3” wide) piece of cork instead of the split version. This allows more flexibility in placing individual turnouts and matches the prototypes’ even layer of ballast in these areas.

Realistic representation of the sub-roadbed includes provision for track drainage. Depending on the construction material used, a drainage ditch can be provided along one or both sides of the mainline. Many mainlines also include a service road,



Figure 2: Several light airbrush passes of your favorite “track color” ensures an even, thin, smooth coat.



Figure 3: Ballast can be applied using a small bottle, folded index cards or with a variety of commercial products.

sometimes using an abandoned parallel track

Painting the Rail

Once you are satisfied with the way the railroad runs, it is time to paint the track and ties. A double-action airbrush is a good choice here. The double action allows for careful control of where the paint gets applied. It is still a good idea to tape switch points to retain clean contact between the moving and stock rails. The rails can be touched-up by hand with a small brush afterward.

Rail colors vary by time period, use, geographic location, and a number of

other factors. Color photos help, but remember that lighting conditions can cause significant variation in the apparent color. I settled on Floquil Grimy Black for the initial color. It appears to be a good match for the color of mid-1950s rail on a road that still used a considerable amount of steam. Modern photos appear to show a more rusty brown color, perhaps because of the lack of a steady rain of cinders.

The Grimy Black was applied in a few careful coats, making sure the sides of the rails are fully covered, especially the outside tracks. A rail-cleaning tool can be used immediately after painting to quickly remove most

“The last step before applying the ballast itself is to add materials that represent the subroadbed.”

of the paint from the tops of the rails. The paint will be more difficult to remove once it dries thoroughly, requiring a little more elbow grease. Inspect the paint carefully between coats, identifying areas missed in previous passes. A few light coats cover thoroughly but leave less paint than a single heavy-handed pass.

Subroadbed

The last step before applying the ballast itself is to add materials that represent the subroadbed. On a heavy-duty mainline like the PRR, the tracks are supported by a significant amount of cinders below the ballast. Less material is used on lighter lines, but except on the lightest of logging and narrow gauge railroads, there is at least some rock or other material used to stabilize the ballast. For the four-track PRR mainline, I applied dark grey cinders along both sides of the tracks, right up to the ties. Some of this material will be covered by ballast later, but that’s OK. It will look just like the prototype that does it



Figure 4: There are commercial products for spreading ballast into a smooth even layer, or you can use a small household sponge.



Figure 5: Final positioning of the ballast layer can be accomplished by using a small stiff artist’s brush.



Figure 6: After the ballast is exactly where you want it and not where you don't, the whole area is wetted-down using a gentle spray.

the same way. In some places, I used cinders to cover the sides of fills or to represent areas where track had been removed, leaving the cinders behind. The cinders are affixed the same way as the ballast, which we'll get to in a moment.

Spreading Ballast

There are a number of sources for N scale ballast made from a variety of organic and non-organic materials. The ballast comes in different sizes, and some labeled "N Scale" is somewhat oversize. What may appear OK to the naked eye will look like small boulders to the camera. My own preference is

for the smallest size rock ballast that I can find, in a blend of light grey colors.

The key to getting this ballast onto a good-looking, smooth-running ballasted mainline is to get the

"The key to ballasting a good-looking, smooth-running mainline is to get the ballast only where you want it to go and nowhere else."



Figure 7: Once the area is thoroughly soaked, 50-50 diluted white glue is applied using a small bottle.



Figure 8: The glue will sink into the wetted area and spread throughout the soaked ballast.



Figure 9: Before beginning to ballast complex track areas, tape over switch points to maintain electrical contact. The taped areas can be covered using a small paintbrush.

“The roadbed deserves just as much attention as a well-painted car or locomotive, so it is worth taking some time here.”

ballast just where you want it to go, and nowhere else. We want it to cover between the ties (fully on a main line, less elsewhere). The ballast should cover the sides of the ties, all the way to the edge, and slope gently down to the sub-roadbed.

There are a number of ways to get the ballast down in just the right spots – a folded 3 x 5 card, a variety

of commercial applicators, or a small paint bottle. In any case, the first step is to spread ballast along the mainline in a neat, manageable pile between the ties. Next is to use a small stiff paintbrush, soft sponges, fingers, or other tools to spread the ballast across the ties.

The roadbed deserves just as much attention as a well-painted car or locomotive, so it is worth taking some time here. Use the brush or other applicator to brush the ballast material off the tops of the ties and the sides of the rails. On the PRR, our track gang worked on two or three tracks at a time, in two- to three-foot lengths. Once you have ballast spread

along and between the tracks, it is time to step back and take a look from several different angles.

Applying Glue

When you are satisfied with the application, it is time to glue the ballast in place (without disturbing your careful work). The model PRR uses diluted white glue, applied with an eyedropper or small bottle. First, however, the material needs to be thoroughly wetted to ensure the glue spreads throughout the ballast. The secret to ensuring a good soaking is to add a drop of dishwashing detergent to the water, creating what is commonly called “wet water”. An

alternative is denatured alcohol, which also has the low surface tension that allows the wet water to spread out. Be sure to use this in a well-ventilated area. Apply until the ballast surface appears moist.

Now that the material is thoroughly wet, the diluted white glue (about 50-50 glue-to-water, also with a drop of detergent to help it flow) can be (gently) applied to the ballast. Drip a small drop of glue every inch or so along the track, enough that the white color spreads to cover all the applied material. The glue will quickly settle into the ballast and the white color will disappear. Now, find another project that will keep you



Figure 10: An spraying with “wet water” helps ensure the glue thoroughly permeates the ballast.

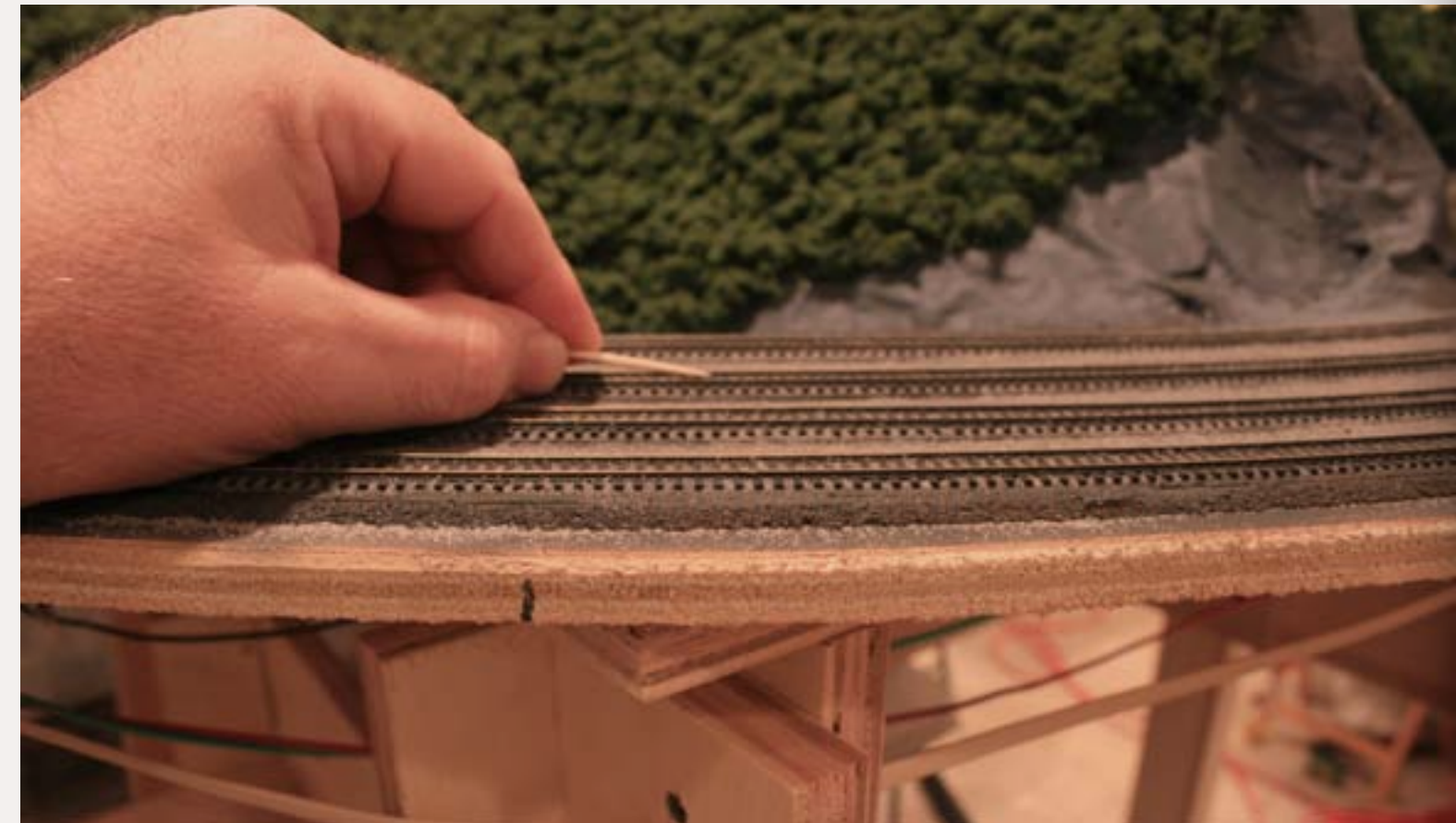

Figure 11: A toothpick helps remove ballast that has strayed to the sides of the rails without harming the paint underneath. A wooden golf tee can be used for the same purpose.



Figure 12: The four-track mainline is beginning to take shape. Note that there are still some areas that will need another coat before the gandy dancers are through.

busy for 24 hours – enough time for the glue to thoroughly dry.

When you return to the roadbed, the ballast should be as hard as a rock. Test by gently pressing on the material. If it crumbles, then the water did not penetrate sufficiently into the ballast to hold it firmly in place. Wet again (thoroughly this time) and apply more glue. Go back and finish that project you started.

If the ballast is solid, great. Look carefully for places where the coverage is uneven or for open spots. Go back and carefully apply more ballast to

get the even coverage we are looking for. Do the wet water / white glue / other project trick a time or two if necessary. Patience and care is the key at this point. No need to get it all done at once. Inevitably, some ballast will creep up the sides of the rail, just where we don't want it. A toothpick is a good tool to remove the stray ballast without harming paint or the remaining material.

Finishing Touches

Mid-20th-century ballast on Class 1 main lines often looked as if "it was applied with tweezers." One way to

get this knife edge is to tape off the grey ballast and paint to match the cinders. Another is to apply a final layer of ballast along a tape or ruler edge. Gentle application of water and glue is key here. Modelers of the Penn Central era might want to go in the opposite direction.



“The trackside drainage ditch can be filled with gloss medium to represent standing water, with tall weeds, or both.”

On mountain railroads (like the PRR), the locomotive sand used to get heavy trains up grades can be suggested by a very light application of off-white paint sprayed on the uphill track(s) only. Go very gently here, with a heavily diluted spray, until you see just a hint of white.

The trackside drainage ditch can be filled with gloss medium to represent standing water, with tall weeds, or both. A service road can be modeled with cinders and a little vegetation. New or used railroad ties can be scattered alongside the right of way to represent old or upcoming trackwork. There are a number of built-up or kit structures to represent electrical sheds common along the tracks, especially near interlocking or sidings.

Summary

Careful work in the application of ballast and enhancing the right of way will provide a good-looking and smooth-running backdrop for our hard-working trains. 

 **Reader Feedback** 
(click here)

Model Railroad Hobbyist news™

August 2011



**Reader
Feedback**
(click here)



*The Old
Yardmaster*



**The latest model railroad
news, products, and events**

We were saddened to learn of the passing of William D. Middleton, whose prose and photographs helped inform and entertain rail fans of all persuasions. He covered a wide range of railroad subjects, but for many of us, his authoritative books on passenger cars and electric railroads remain unsurpassed. His body of work encompassed more than twenty books – all of which are worthy of collecting. Mr. Middleton died at his home in Livonia, New York, July 11, 2011. He was 83...

We send our best wishes to modeling-wizard Terry Wegman who is slowly recovering from critical renal failure, liver shut-down, and depression. Get-well wishes can be sent to Terry at the Huntington Beach Hospital, 17772 Beach Blvd, Huntington Beach, CA 92647...

Best wishes also go to InterMountain CEO Frank Angstead who is recovering from knee surgery...

The roster of talented clinicians scheduled for the Fine Scale Model Railroader Expo 2011 continues to grow, with the call-board currently listing the names of

Jon Addison, Mike Baker, George Barret, Brian & Jill Bollinger, Michael Duggan, Jack Ellis, Doug Foscale, Dave Frary, Brett Gallent, Russ Greene, Ken Hamilton, Troels Kirk, Dario La Donne, Chris Lyon, Bob Mitchell, Bruce Nickerson, Dave Revelia, Hal Reynolds, Lou Sassi, and Bob Van Gelder. The event is scheduled for October 13-15, in Peabody, Mass. Additional details are listed in our Selected Events report on [page 123](#).

Look for Sergent Engineering to announce Type H Tightlock couplers in the near future. Also under development is a clever uncoupling wand that slips under passenger car diaphragms...

San Juan Decals is for sale. The eight-year-old firm specialized in thin-film decals primarily for D&RGW, Colorado & Southern, and other narrow gauge operations. In addition, San Juan took over the decal production of Foothills Model Works a few years ago. The business is scheduled to cease operations at the end of August. Anyone seriously interested in buying the company should contact Warren Griffith at 970-946-3834.

We had a great time at the National Train Show in Sacramento, meeting new people, chatting with old friends, and taking a close look at all the wonderful goodies on display. The event was well-attended, with the gate tally reported at 19,800 for the three-day public event...

Among the busiest booths at NTS was Kadee's, with Alan Vezzani and Sam Clarke answering dozens of questions about the many variations of their ubiquitous couplers...

Congratulations to E.W. Czerwinski of Truckee, California, who won the Model Railroad Hobbyist drawing for a free iPad. To get E.W. started, all past issues of MRH were loaded into the iPad...

Despite the bleak economy, model railroad manufacturers, including many who attended NTS, are showing their confidence in the future by continuing to make costly investments in new tooling. For example, Trainworx is currently preparing tooling for a 28' drop-frame parcel-pup with dollies, and a 40' Strick exterior-post flex-van container – all in N scale. ExactRail will soon announce a 65' mill gondola, Eastern Seaboard Models is cutting dies for three variations of an N scale X-58 boxcar, Micro-Trains is tooling-up for a Z scale PFE class R30-2 wood-sheathed ice-reefer for introduction late this year, and Broadway Limited is finalizing new tooling for an HO scale New York Central steel boxcar with both 4/4 Dreadnaught and 7/8 corrugated ends...

Our news report this month includes information about lots of new and exciting products, including many that were introduced at the National Train Show in Sacramento, California. You'll also see reference to some interesting video

interviews Jeff Shultz conducted with several manufacturing officials at NTS. Be sure to check them out.

NEW PRODUCTS FOR MULTIPLE SCALES

Scenic Express (scenicexpress.com) showed several new items at the National Train Show including some impressive Giant Sequoia trees that come 10", 15", 24", and 36" tall. Other unique products included new wild grass from Germany that offers the same results as static grass but does not require any expensive electronic application equipment. The new material is available in eight colors in both 6mm and 2mm heights. For additional information about these and other innovative scenery products, click on model-railroad-hobbyist.com/MRHT_2011_NTS/Scenic-Express to watch MRH's exclusive interview at the National Train Show with Scenic Express CEO Jim Elster.

O SCALE PRODUCT NEWS



Among the many items being shown in **Bachmann's** (www.bachmanntrains.com) large display booth at the National Train Show, was a pilot model of their forthcoming On30 14-ton two-truck Stearns/Heisler locomotive. The Spectrum-series ready-to-run model is based on an early Heisler manufactured in the late 1890s. The model, illustrated here by a pre-production test sample, will be available this fall decorated for Colorado Mining Co., Midwest Quarry & Mining Co., and Greenbrier & Big Run,

as well as an unlettered version in plain black, black with white pinstripes, and black with red window frames, white tires, and white running board stripes. The ready-to-run model has an MSRP of \$419.00 each. The model comes with DCC for speed, direction, and lighting control. It is ready for a plug-and-play sound module that is sold separately at \$119.00. On3 modelers will undoubtedly be quick to convert this model to their fractionally wider track gauge.



Sidetrack Laser (sidetracklaser.com) has introduced this Crew Truck conversion kit that fits on a Bachmann On30 rail truck. The kit sells for \$32.95 and features laser-cut components, an assembly jig, special graphics, and Berkshire Valley cast detail parts. The rail truck and figures are not included.



Sidetrack Laser also introduced its new Main Street Garage at the National Train Show. The finished structure has a footprint of 8.5 x 8.5 inches. The O scale kit sells for \$89.95. The vehicle and figure are not included (see picture previous page).



Morgan Hill Models (morgan-hillmodels.com), a firm that has previously focused on On30 rolling stock, has released its first structure kit – and they picked a gem. Hobbyists will recognize The Perkins Produce Company, a classic three-story trackside building that first appeared as a construction article by Earl Smallshaw in a 1974 edition of *Model Railroader* magazine. It was subsequently made available as an HO scale kit. Morgan Hill's O scale laser-cut version was engineered with assistance from master builder Bill Banta. The kit is priced at \$169.00 with only 50 scheduled to be run.

S SCALE PRODUCT NEWS

Alpine Division Scale Models (www.alpinemodels.com) has entered the S scale field with the introduction of George's Feed & Grain. The model uses the well-established mat board and wood construction technique with Grandt Line windows and doors, and Tichy details including a crane and barrels. The kit is priced at \$49.99.

HO SCALE PRODUCT NEWS

Accurail (www.accurail.com) has completed new tooling for an HO scale 40' steel refrigerator car with traditional hinged doors. The initial release, scheduled for late July or early August, will be for data-only cars in both yellow and orange. No

shipping dates yet, but fully-decorated cars expected to be released soon will include Northern Pacific, NYC-MDT, Fruit Growers Express, Milwaukee Road-URTX, Burlington Route, PFE (SP/UP), Illinois Central, Bangor & Aroostook, Rock Island-URTX, and Great Northern. The cars will have an MSRP of \$14.98. Accurail has also finished new tooling for a similar car with a plug-door. Other car kits scheduled for release this month include an Erie 50-ton offset twin hopper car, and a 40' single-sheathed wood boxcar decorated for Maine Central, Pennsylvania Railroad, and Great Northern. All have a list price of \$13.98.

One of the more exciting new items on display in **Athearn's** (athearn.com) NTS booth were pre-production samples of their new HO scale C-50-7 Southern Pacific steel bay-window caboose. Future releases of the Genesis model will include SP class C-50-4, C-50-5, C-50-8, C-50-9, and Western Pacific's 480-class cabooses. The initial release, due to arrive in February 2012, is for two versions of the class



C-50-7 SP/SSW caboose – in Gothic lettering in five road numbers, and in Roman lettering with three road numbers. An undecorated version will also be offered. Special features include see-through steps and end platforms, flush window glazing, and etched-metal window screens. Each version of the ready-to-run model will be available with or without lighting. Lighted cars will be equipped with LEDs controlled by an on-board Soundtraxx® system with a built-in capacitor for non-flickering lights. Operating lights include a roof-mounted directional LED “frog-eye” marker. Non-lighted cars will have LEDs installed in the marker lights with wires leading to the caboose interior.



All versions of the caboose will come with new 50-ton trucks with elliptical springs, rotating bearing caps, electric generator (shown in blue), and electrical pick-up capability. The trucks will also be available separately. See our exclusive 360° Click-n-Spin view of Athearn's SP caboose on [page 82](#).



MRH Photo by Jeff Shultz

Atlas Model Railroad Company (atlassrr.com) showed this preliminary engineering sample of a newly-tooled HO scale FMC 5077 cf Plate B boxcar. The model represents an early 1970s-era FMC design with a wide end panel, and Youngstown door with a roller lift lever. Although not visible here, the car will have Freightmaster ME-10 cushion draft gear. Atlas plans to finish the ready-to-run model with .008" wire grab irons. .

Among the new items featured in **Bachmann's** (www.bachmanntrains.com) exhibit booth was this ALCo 1,000 hp S4 diesel switcher. The ready-to-run HO scale

model is expected to be ready by October and will come in both DCC-ready versions at \$89.00 each, and as a DCC-equipped Soundtraxx® version at \$159.00 each. Decorating schemes will include Western

Maryland (speed writing version), Southern Pacific (orange and black), New York Central System-P&LE, Santa Fe (zebra scheme), Union Pacific (Dependable Transportation slogan), and Erie.

Also on display in the Bachmann booth was an engineering sample of an HO scale 2-6-0 Mogul steam locomotive based on

a prototype built by the American Locomotive Company. The ready-to-run engine will be available in November as a DCC-ready model at an MSRP of \$115.00 each, and as a DCC-equipped version with Soundtraxx® sound at \$176.00 each. Both versions will be available decorated for Pennsylvania, New York Central, Canadian National, Santa Fe, Union Pacific, and Boston & Maine. Some details on the final production version may differ slightly from the above illustration.

Bachmann has set an October delivery date for a Baltimore & Ohio class EM-1 2-8-8-4 Spectrum-series HO scale steam locomotive with DCC. It will have an MSRP of \$425.00 each. The model comes ready for a 16-bit Tsunami® plug-and-play sound module which is sold separately at an MSRP of \$119.00 each.



Bachmann's new FA2 and FB2 ALCo diesel locomotives will be delivered in October from all-new tooling that, among other details, reflects the increased length of the FA2 over the earlier FA1. The FA2 and FB2 models will be offered as DCC-ready versions with an MSRP of \$95.00 each, or DCC-equipped with sound on-board at \$165.00 each. The initial release of the ready-to-run models will be decorated for Canadian National, New York Central, Erie & Lackawanna, Louisville & Nashville, Pennsylvania (single-stripe Keystone scheme), and Baltimore & Ohio.

Bowser (bowser-trains.com) attracted lots of attention at NTS with decorated samples of its newest Montreal Locomotive Works Century C-630M Executive series diesel locomotive. Upgraded from the original Stewart tooling including such details as etched-metal radiator running boards, and a heavier frame. Road names will include Canadian National (both zebra stripes and wet noodle), BC Rail (two-tone green or red,



white, and blue), Canadian Pacific (script or Multimark), Arkansas & Missouri, Cape Breton & Nova Scotia, Western New York & Pennsylvania, and Pacific Great Eastern. The Reading Lines locomotive shown here is from an earlier production run. Available for DC operation at \$169.95, or with SoundTraxx™ DCC sound decoder at \$269.95. See our exclusive 360° Click-n-Spin view of Bowser's C-630M diesel on [page 85](#).

George Huckaby demonstrated a Bowser PCC trolley equipped with a special Tsunami™ Sound system that included an automatic-sequence of the trolley gong, passenger stop signal, pneumatic door opening and closing, motor generator startup and running, and the brake light at the rear of the PCC coming on as the car came to a stop. The system is still under test and should be available late this year.



New items in the **BLMA** (blmamodels.com) exhibit booth included a modern right-hand cantilevered signal bridge that complements the previously-released left-hand version. The modern HO scale double-track bridge comes fully assembled with four operating signal heads with a total of 12 separate micro LEDs. The nicely detailed plastic structure features etched-metal handrails and walkways. The signal bridge has an MSRP of \$89.95 each.



Also featured in the BLMA booth were preliminary samples of the third release of the company's 88' F89-J flat car. Era-specific details on the 1970s yellow TTX cars include positionable ACF hitches, wood and steel risers, appropriate bridge plates, and cut levers. HO versions are expected to arrive this month, with the N scale models due in the 4th quarter of 2011. Click on model-railroad-hobbyist.com/MRHT_2011_NTS/BLMA to see MRH's exclusive interview at the National Train Show with BLMA founder and CEO Craig Martyn.

The Blackstone (www.blackstonemodels.com) booth at NTS was full of activity with Nancy Workman and Jarrette Ireland fielding questions from enthusiastic

customers. Major announcements included details on another release of Blackstone's renowned HOn3 K-27 2-8-2 Mikado. Scheduled to arrive in the spring of 2012, the new production run will include a late 1940s version of RGS 455 with its post-wreck cab. The run also includes RGS 453 as a switcher with its unique dog house. All units will be sound-equipped. Non-weathered K-27 locomotives will have an MSRP of \$475.00. Weathered versions will be listed at \$530.00. Advance reservations close August 13, 2011.



Blackstone also announced a new run of its HOn3 narrow frame and frameless tank cars with new road numbers. The narrow-frame cars were built in the 1920s by mounting standard gauge tank cars on steel channel framework. They were equipped with arch bar trucks with a 4' 8" wheelbase. The UTLX frameless GRAMPS tank cars were originally built from standard gauge cars in the early 1930s. Many of this class had the prominent silver letters emblazoned across the sides of the tank. The run will include three narrow-frame UTLX cars with yellow lettering for road numbers 13178, 13036, and 12975. Also available are three frameless style tank cars with the "Gramps" logo and UTLX road numbers 55276, 55190, and 55347. All of the variations will be available both weathered at \$59.95, or non-weathered at \$54.95. Delivery is planned for this fall.

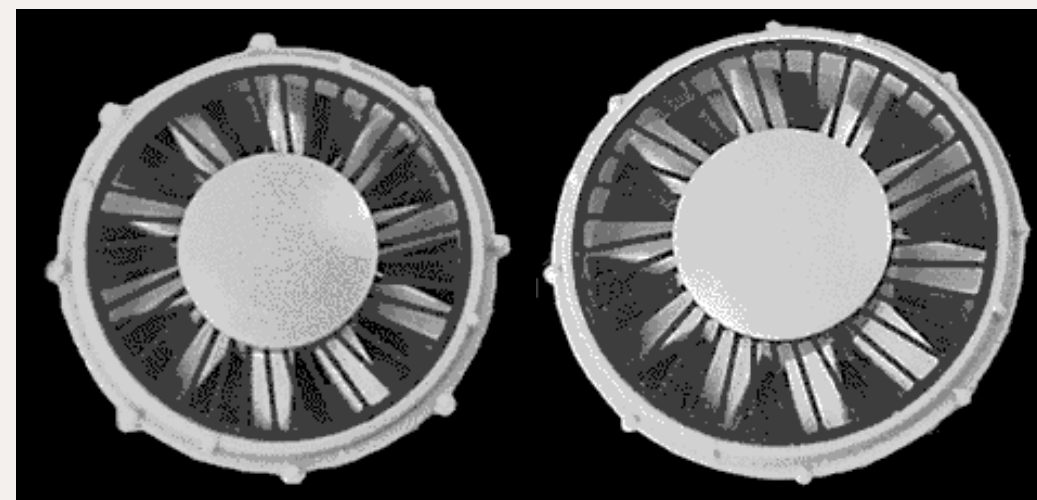

Dave Hussey, owner of **Cannon and Company** (www.cannonandco.net), showed a range of detailing components at NTS including two new diesel fans. At the left is a 36" cap-top radiator fan used

on first generation EMD diesels including F units, GP/SD7, GP/SD9, GP 20, SD18 and SD24. Item RF-1707 is priced at \$16 for a set of four fans. On the right is a 48" cap-top dynamic fan used on first generation EMD diesels equipped with dynamic brakes including F units and GP7 and GP9. Item DF-1854 is priced at \$9.50 for two fans.



Con-Cor (con-cor.com) has announced several new road names for its HO scale 1920s-1950s heavyweight branchline-com-

muter-suburban (B-C-S) cars. The cars have full interiors with constant lighting that operates on both DC and DCC systems. The prototype B-C-S cars were used by many railroads, and the 65' length makes them suitable for operating on layouts with track radius as tight as 18 inches. New road names announced at Sacramento include Southern Pacific (Daylight, red and orange), Southern Railway (Crescent, two-tone green), Rio Grande (silver and Aspen orange), Royal American Shows (red and yellow), Chesapeake & Ohio (George Washington, Pullman green), Nickel Plate Road (Pullman green), and New Haven (Hunter green).

Based on positive responses from dealers and hobbyists, Jim Conway has decided to make a limited re-run of the HO scale Chicago, North Shore & Milwaukee ElectroLiner. As with the original run, this release, set for late this summer, will be for four-car sets with full interior detailing and lighting priced at \$459.98. Additional coaches will be available separately at \$149.98 each. Con-Cor will offer an optional add-on sound decoder that will also be compatible with the initial run of ElectroLiners. The decoder will be priced at \$74.98.

Con-Cor is also taking reservations for an HO scale version of the New Haven Comet train set – a permanently-coupled double-ended diesel-electric streamliner that debuted between Boston and Providence in 1935. The distinctive prototype was built with federal funding by a consortium of the Goodyear Company and Germany's Zeppelin Corporation. Con-Cor's HO scale version will consist of a three-car set priced at \$459.98. An additional coach will be offered at \$149.00. The set operates on conventional DC and is DCC-ready. An optional sound decoder is sold separately at \$64.98. Con-Cor had a pilot model of the



Comet operating in their booth at the National Train Show.

Con-Cor expects

to deliver its HO scale Pennsylvania and Long Island MP54 MU commuter cars in October. The project involves three body types: coach, coach-baggage combine, and baggage-mail. Each type will be available with or without a pantograph in several different decorating schemes for both Pennsylvania Railroad and the Long Island Railroad. The ready-to-run models will have finished interiors with lighting and will be capable of running off overhead wire if desired. An optional DCC sound decoder will be available. Complete details are available at www.con-cor/HO-Powered-mP54.html.

Models on display in the **ExactRail** booth included their new Magor 4750 cf hopper, shown here in GN livery, a 64' reefer, a Greenville 60' boxcar with several new road names, and a new FMC 4000 cf high-side gondola shown below decorated for CNW. See our exclusive 360° Click-n-Spin of ExactRail's new 64' Trinity reefer car on [page 87](#).



Click on model-railroad-hobbyist.com/MRHT_2011_NTS/ExactRail to see MRH's exclusive interview at the National Train Show with ExactRail founder and CEO John Pestana.



The latest from **Fos Scale Models** (fos-limited.com) is Weltyk Marine, an attractive HO scale waterfront structure with a footprint of 6" x 5.5". A unique detail of the craftsman kit is the large laser-cut double-doors at the front of the building. Other laser-cut features include clapboard walls, wood and chip-board roof sections, skylights, corrugated metal roofing, and rolled-paper roofing. Additional items include Tichy plastic windows, detail metal castings, assembly templates, and instructions. Although designed as a boat repair house, the structure could easily be adapted to a small engine house. The limited edition kit is priced at \$49.95.

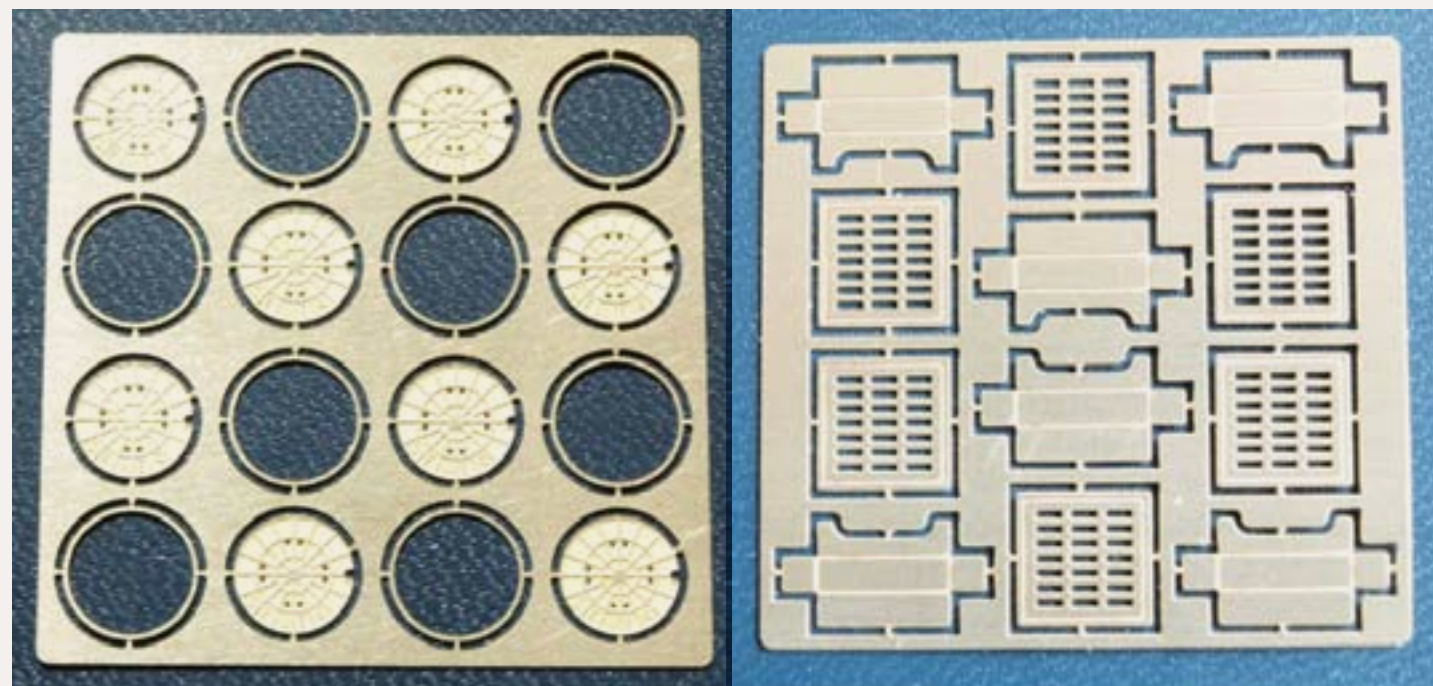

Great Lakes Models (greatlakesmodels.com) has introduced etched-brass street details that includes manhole covers, storm sewer grates, and sewer inlets. The HO scale versions are patterned after real items located in Milwaukee – specifically at the intersection of West Duluth Avenue and South Massachusetts Avenue. The items, however, are generic and nearly identical to those used throughout the nation. A sheet of six sewer grates and inlets, or a sheet of eight manhole covers and rings sells for \$3.95 each.

InterMountain Railway Company (intermountain-railway.com) demonstrated a pre-production sample of their forthcoming HO scale wide-cab SD40-2 diesel at the National Train Show. The test unit was authentically decorated like the Canadian National prototype.

InterMountain is currently booking reservations for several new HO scale models with delivery scheduled for February/March 2012. The items include a USRA gondola in six road numbers each for CB&Q, Southern Pacific, C&NW, Southern, Missouri Pacific, Michigan Central, Monon, and Pennsylvania. The ready-to-run cars have a list price of \$31.95 each. Also Pacific Fruit Express class R-40-10 reefers in several schemes including PFE-Overland herald, PFE-double herald, PFE-1942 scheme, PFE- black and white herald, PFE-Express (green), ART, and Western Fruit Express. The cars have an MSRP of \$32.95 each.

Milwaukee Road rib-side boxcars are also scheduled to arrive in February/March. They will be decorated for Route of the Hiawathas, Route of the Hiawathas with original door, the late Milwaukee Road scheme with angled herald, and a modern version without a running board. The cars have a list price \$31.95.

Jay-Bee Models has introduced precision metal wheelsets with built-in resistors to trigger signal and occupancy circuits. The HO scale turned-brass wheelsets come in 28-, 33- and 36-inch diameters, and are priced respectively at \$29.00, \$32.00, and \$34.00 for a package of twelve. The wheelsets are available with various resistive ratings from 5.1K to 39K ohms per axle. Bulk pricing is also available. To order or for additional details contact Jim Bennett at jbennett7031@yahoo.com or phone 630-832-3615.

New products due from **Kadee Quality Products** (www.kadee.com) this month include a PS-2 covered hopper decorated as SSW #77158 in the 1957 as-built light gray scheme. The ready-to-run HO scale model is priced at \$42.95. Coming next month is a PS-1 50' boxcar with 10' doors decorated as Western Maryland #35073. The car has a functioning cushion underframe and comes in the original 1965 as-built red oxide paint. It is priced at \$35.95.



Scheduled for delivery in October is a Western Pacific PS-1 40' boxcar with a 7' Youngstown door. The HO scale model will be decorated in the 1951 as-built scheme with boxcar red paint. It will be priced at \$33.95.

Kato USA (katousa.com) had good news for HO hobbyists, with information that it will release several 1:87 projects in the upcoming year. The first HO scale release, due later this year, will be a rerun of General Electric's AC4400CW, the alternating-current companion to the C44-9W "Dash-9". Decorating schemes for the ready-to-run AC4400CW will include Union Pacific "Building America" #5780, BNSF Heritage II #5622, and Canadian Pacific "Golden Beaver" #9608. Pricing was not firm at press time but is expected to be in the \$180 to \$190 range.



Neil Stanton, the engineer who developed the versatile and smooth-running Stanton power truck, demonstrated his latest idea in the **NorthWest Short Line** (nwsl.com) NTS display booth. Called The Stanton Radio CAB System, Neil used a hand-held controller (called an S-CAB) to communicate, via radio signal, directly to a receiver, DCC decoder, and battery, all compactly installed in the model locomotive. No change is required in existing layout wiring be it DC or DCC. In fact, the system even works on non-powered track. If track power is available it can be used to provide real-time battery charging to the onboard battery. Complete details and specifications are available at nwsl.com/cab.

Rapido's (rapidotrains.com) display booth at the National Train show was ably staffed by Bill Schneider and Don Garcia, both knowledgeable about trains, and their com-

pany's products.



Models featured included the latest version of Rapido's forthcoming 37' General American Transportation (GARX) wood side reefer. Bill

reviewed some of the fine details upgraded since the preliminary test sample made its debut at the Cocoa Beach RPM meet in January. Rapido has developed a reputation for replicating car underframes as faithfully as the more-visible features – and the GARX reefer promises to be no exception. Rapido is committed

to making the model as accurate as possible, and expects to make additional adjustments in the tooling before releasing it for production. Jason Shron and his team are to be commended for allowing modelers to scrutinize their preproduction samples, and most importantly, for listening to constructive criticism with an open mind.



Road names scheduled for the initial release of the HO scale reefer include American Stores (built 1937, mid-late 1950's scheme), Dubuque (built 1937, mid-late 1950's scheme with large herald), Dugdale (1939 as-delivered scheme), GARX - Refrigerator (1939 as-delivered scheme), Hormel (1937 as-delivered scheme), Hygrade's (built 1940, mid-late 1950's

scheme), Kingan (1940 as-delivered scheme with large herald), Morris Rifkin (1940 as-delivered scheme), Oscar Mayer (built 1939, late 1940s scheme with large herald), Swift (built 1937 with 1950 scheme on red body), Tobin Packing (built 1937 as delivered scheme) URTX - Refrigerator (built 1938 as delivered scheme), and undecorated. The reefer will have an MSRP of \$39.95 each. Availability is expected late this year, but Rapido sets manufacturing quantities to fill reservation only, so interested modelers should place their reservations without delay.

See our exclusive 360° Click-n-Spin view of Rapido's new GARX reefer car on [page 90](#).

Rapido's beautiful HO scale CP Canadian was on display along with handsomely-decorated FP9A and F9B diesels. Although Rapido's booth was too small to operate the full-length Canadian, Dan Garcia arranged to run the train on the Edmonton Society of Model Railroad Engineers' large modular layout late Sunday afternoon. The complete Canadian – all ten cars with an A-B-A lash-up at the point -- looked magical as it snaked its way through the layout's beautiful scenery.

RSLaserKits (rslaserkits.com) is taking reservations for the firm's latest limited-run kit. Named Keystone Mill, the craftsman-style kit is based on a structure built in Pennsylvania in the late 1800s that is still in use today as a lumberyard. Among

the kit's many features are laser-cut sides using Northeastern lap siding wood and a stone foundation cast by Downtown Deco. The finished HO building has a footprint of 12" x 5". The HO scale kit is priced at \$149.99. Please see our N scale report for an illustration of a finished model of the Keystone Mill.



Sidetrack Laser (sidetracklaser.com) unveiled its new Golden West Fruit Packing & Cold Storage complex at NTS. The HO scale kit is offered in two parts to spread out the cost as well as the construction time. The Fruit Packing section sells for \$165.95, the Cold Storage section for \$121.95. When purchased together, the cost is \$249.95. Features of the complex include laser-cut structural components, cast detail parts, Grandt Line doors and windows, and a complete selection of appropriate graphics.



Smoky Mountain Model Works has a resin kit for an HO scale Southern Railway Pullman-Standard "Silerside" aluminum gondola. Using drawings provided by the Southern Railway Historical Society, Jim King developed the patterns for the model using 3D CAD and rapid prototyping technology. The kit consists of a one-piece resin body casting, urethane underframe, hidden weight, and Kadee #153 whisker couplers. Additional details include Tichy AB brakes, steps, grab irons, and trucks with Kadee 36" wheelsets. Silerside is available with vermillion (1960 original) or green (mid-1960s) decals. The craftsman-type kit is priced at \$42.00 each. To order visit smokymountainmodelworks.com/SR_silerside_gons.html.



During this year's National Train Show, **Tangent Scale Models** (tangentscale-models.com) announced the immediate availability of new HO scale Bethlehem Steel quad hoppers – with coal loads. Variations include Union Pacific H-100-16 (freight car red with large white Union Pacific on the sides and FCR trucks), Union Pacific H-100-19 (FCR with large white Union Pacific on the sides, and FCR trucks), Union Pacific H-100-18 (black body with yellow ends, and large white Union Pacific on the sides), Bessemer & Lake Erie (black body in six road numbers, plus unnumbered), Clinchfield class FH19 (in 12 road numbers, plus unnumbered), Illinois Central Gulf-Centralia Quad (in six road numbers, plus unnumbered), Louisville & Nashville (black in six road numbers, plus unnumbered). All unnumbered models come with a decal set of assorted numbers in appropriate fonts. The ready-to-run models of the Bethlehem Steel quad hopper are \$32.95 each with discounts available for quantity purchases



Tangent also announced the availability of its ACF 52' 6" welded 70-ton drop-end gondola in seven new paint schemes plus two previously-released versions with new numbers. In addition to the Pennsylvania Railroad G31B shown here (with early shadow Keystone in FCR with 1957 paint date in 12 numbers), the HO scale model is also available decorated for Conrail GE51D (Conrail brown in six numbers), Penn Central G31A (1973 green repaint scheme in six numbers), Sacramento Northern (1959 scheme with black body and yellow lettering in three numbers), Southern Pacific G-70-8 (1951 black scheme with white lettering

in six numbers), Southern Pacific G-70-12 (1953 FCR scheme with three numbers different from previous releases), Southern Pacific (Gothic scheme with 1966 repaint date in 12 numbers), Wabash (1951 black scheme with three numbers different from previous releases), and Western Pacific (original 1959 scheme with black body and yellow lettering in three numbers). Tangent's ready-to-run HO scale gondolas are equipped with 70-ton ASF A-3 Ride-Control trucks with all-metal wheels, and Kadee® couplers with cut bars. They are priced at \$30.95 each with discounts available on quantity purchases.



Tangent will release its acclaimed Pullman-Standard PS-2CD 4000 covered hopper in several new road names. In addition to the CGW (CNW Clinton green repaint scheme with Employee Owned placard) shown here, Tangent also has the car decorated for Atchison, Topeka, and Santa Fe (original 1963 mineral red paint in six numbers), Great Western Malting-NAHX (original 1963 gray scheme with Rocky Mountain logo in two numbers), Rock Island (1970s ROCK blue repaint, in two road numbers), and Rock Island (original 1962 gray scheme in two road numbers). The ready-to-run models come with Kadee® couplers, and 100-ton N-11 trucks with metal wheels. They are priced at \$42.95 each with quantity discounts when purchased direct from Tangent. An undecorated kit is available for \$24.95.



The Texas Western Model Railroad Club is selling a Pennsylvania X29 boxcar with shadow Keystone herald. The model is based on a **Red Caboose** kit and features include a vertical brake shaft, flat plate end, PRR 2d-F8 trucks

with InterMountain metal wheelsets, and Kadee® couplers. The HO scale model is available in six road numbers at \$32.95 each plus shipping. To order visit shop.twmrc.org or contact the Texas Western Club at (682) 587-2092.



MRH Photo by Jeff Shultz

Walthers (www.walthers.com) had several new and future HO scale items on display in their NTS booth including early samples of the new El Capitan passenger cars. Of special interest was this preliminary engineering sample of a Pullman-Standard 50' coal gondola that has been economically designed to allow hobbyists to assemble an inexpensive unit train. The car is the introductory model in a new series of affordable products to be marketed as Walthers "Mainline" series.

Click on model-railroad-hobbyist.com/MRHT_2011_NTS/Walthers to see MRH's exclusive interview at the National Train Show with Walthers marketing VP Michael Stephens. You can also view our exclusive 360° Click-n-Spin view of Walthers' new Santa Fe high-level stepdown coach with drumhead on [page 91](#).



Walthers has scheduled another release of its 85' C&NW-UP pool cars to arrive in late February 2012. The cars are decorated with Armour yellow and gray to match

Union Pacific “City” series pool cars. Road number decals are supplied with the ready-to-run models. Additional details include factory-installed grab irons, and tinted windows. The release will include a baggage car, a 48-seat diner, a café-lounge, and the baggage-dormitory car illustrated above. The cars will have an MSRP of \$69.98 each.

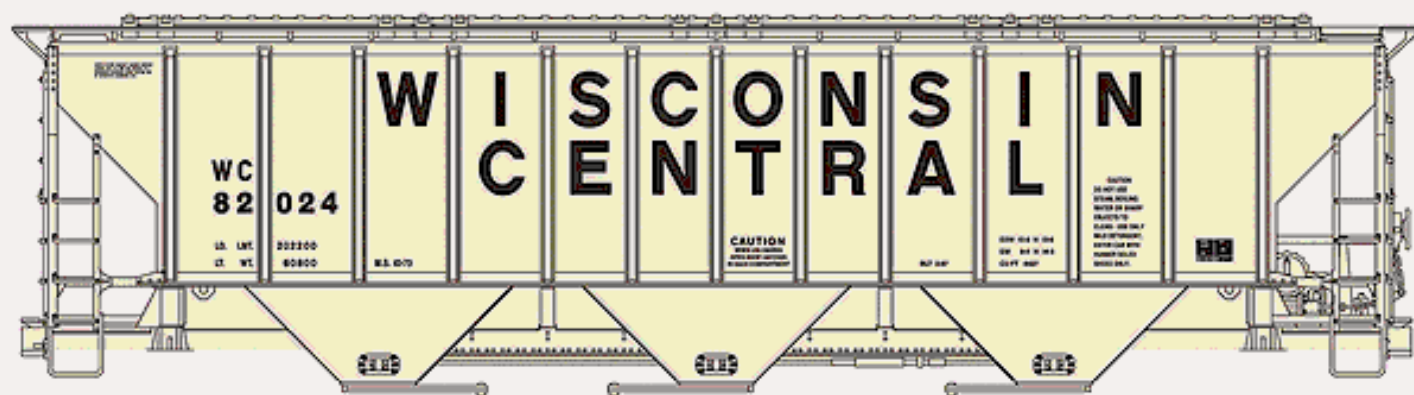

Also due from Walthers next February are PS 2CD 4427 cf covered hoppers with roof trough hatches and center discharge gates. Special features of the Platinum series cars include factory installed grab irons and other details. In addition to the Wisconsin Central version shown here, the cars will also be available decorated for IMCX, Wisconsin & Southern, Canadian Pacific, HJPX, The Andersons AEX, BNSF, and ATSF. The ready-to-run HO scale models will have a list price of \$37.98 each.

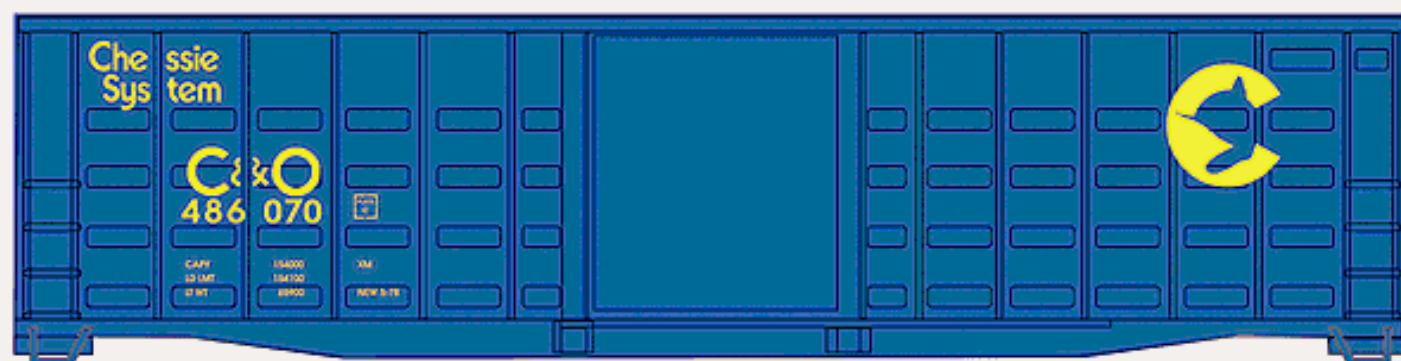

Walthers has scheduled a February delivery date for the next run of its Pullman-Standard 50' waffle-side boxcar. Decorating schemes will include Burlington Northern (Cascade green), and D&RGW (Action Road slogan on orange and black car body). Both cars will have Superior doors. Youngstown doors will be used on a CNW (boxcar red), and Chessie System/C&O cars shown here. The HO scale ready-to-run models will have an MSRP of \$19.98.

N SCALE PRODUCT NEWS



Bachmann Trains (www.bachmanntrains.com) used the occasion of the National Train Show to announce it would begin shipping an N scale ALCO RS-3 diesel locomotive in early September. The ready-to-run model comes with a dual-mode NMRA-compliant decoder and DCC installed for speed, direction and lighting. Mechanical features include eight-wheel drive and machined brass worm bearings. In addition to the PRR unit shown here, other roads will include Boston & Maine (maroon, yellow and black), D&RGW (yellow and black), Western Maryland (speed lettering, black and yellow), Southern (black and gray with Dulux gold), and New York Central (black with lightning stripe). The RS-3 will have an MSRP of \$120.00.

Also scheduled to arrive from Bachmann in September is an ACF 50' 6" outside-braced sliding-door boxcar decorated for McCloud River, Middletown & New Jersey, RailBox, Providence & Worcester, Chattahoochee, and Burlington Northern. The N scale car has a list price of \$18.95.



BLMA (blmamodels.com) showed preliminary samples of new road names for its N scale ACF 70-ton 52' gondola. They included Conrail, Southern Pacific, Western Pacific, ACL, and Pennsylvania Railroad. The cars ride on 70-ton solid-bearing trucks with 33" metal wheels. Craig Martyn noted that in response to

customer suggestions, the tooling has been modified to minimize the protrusion of the coupler beyond the end sill. The change allows for broader curve radius and closer coupling.



Also featured in the BLMA booth were preliminary samples of the third release of the 88' F89-J flat car. N scale versions of the 1970s-era yellow TTX cars are due to arrive in the 4th quarter of 2011. Click on model-railroad-hobbyist.com/MRHT_2011_NTS/BLMA to see MRH's exclusive interview at the National Train Show with BLMA founder and CEO Craig Martyn.

InterMountain Railway Company (intermountain-railway.com) is currently booking reservations for an N scale USRA gondola with delivery scheduled for February/March 2012. The cars will come in six road numbers each for CB&Q, Southern Pacific, C&NW, Southern, Missouri Pacific, Michigan Central, Monon, and Pennsylvania. The ready-to-run N scale models have a list price of \$21.95 each.



Kato USA (katousa.com) plans to deliver its N Scale SD90/43MAC diesel this December decorated in the cream-and-crimson scheme of the Indiana Rail Road, as well as the more familiar liveries of Union Pacific and Canadian Pacific. The UP and CP units will come in two new road numbers. Prices were not firm at press time but are expected to be in the \$110 to \$120 range. Reservations are due August 26, 2011.

In collaboration with custom model builder Charlie Hopkins, Kato USA is offering customized versions of its N scale GE ES44AC "Gevos." The models will have several enhanced details painted-on, such as stripes on the steps, white-painted

safety railings on both the front and back of the locomotive, painted coupler cut bars, nose windows, and detailed fuel tanks. They will be priced at \$130 with delivery expected in late September. For more information visit katousa.com/Zcart/index.php?main_page=index&cPath=65_78_140.



RSLaserKits (rslaserkits.com) is taking reservations for an N scale craftsman kit for Keystone Mill. The craftsman style kit is based on a structure built in Pennsylvania in the late 1800s that is still in use as a lumberyard. Among the kits many features are laser-cut sides using Northeastern lap siding wood and a stone foundation cast by Motrak. The finished N scale building has a footprint of 6.5" x 2.5". The kit is priced at \$49.99.

Soundtraxx® (soundtraxx.com) has a new system called SurroundTraxx, that uses multiple-speakers to provide realistic sound for N scale and small narrow gauge equipment. There are no speakers or other sound-related components in the locomotive. The system uses multiple audio speakers strategically placed around the layout. Using digital signal processing (DSP) technology in conjunction with block detection techniques, SurroundTraxx reproduces the sound made by each train on the layout and directs the sound to the speaker

closest to the train's location. As a train moves along the tracks, SurroundTraxx makes continuous adjustment to the sound level of each speaker so that the sound appears to follow the train. Using a cross-fade algorithm that factors in train speed, direction and distance between speakers, the sound is switched smoothly from speaker to speaker. Click on model-railroad-hobbyist.com/MRHT_2011_NTS/SoundTraxx to see MRH's exclusive interview at the National Train Show with SoundTraxx sales manager Jarrette Ireland.

Trainworx (www.train-worx.com) has N scale 86'6" High-Cube eight-door auto-parts boxcars in several new paint schemes including CB&Q, CSX, GTW, Norfolk Southern, and Penn Central. Visit the above web site for details on subtle variations in the paint schemes and road numbers available.

NEW DECALS, SIGNS AND FINISHING PRODUCTS

Traction specialist, **CustomTraxx** (decals@customtraxx.com), has released an HO scale decal set (CN-044) for Philadelphia & West Chester Traction Company and Philadelphia Suburban Transportation Company. The lettering set can be used to accurately decorate either the 1914-built Jewett 40-44 series interurban resin shells available from KND Enterprises (pknd.com), or the 1919,1925,1926-built Brill 45-76 series center-door interurban resin shell kits available from Miniatures by Eric (miniaturesbyeric.com). Item CN-044 has a list price of \$17.95.

The newest decal sets from **Jerry Glow** (home.comcast.net/~jerryglow/decals/) include an Armour 37' wood meat reefer in both the early lettering scheme or with the revised logo. A billboard style is also available. Other new decals include a Charleston & Western Carolina steel rebuild of a USRA double sheathed boxcar. Jerry's decals are available in all scales. Visit the above web site for pricing and ordering instructions.

Microscale (microscale.com) has released eight new decal sets that cover the life of Amtrak locomotives. Set -100 covers Amtrak Phase I (1971-1975) E, F, SDP40F and P42 locomotives. Set -423 Amtrak Phase II SDP40F, F40PH, and P42 locomotives. Set -424 covers Amtrak Phase III (1980-1996) F40PH Anniversary locomotives. Set -362 covers Amtrak Phase III (1980-1996) E60CH, FL9, SDP40F, and P42 locomotives. The lettering sets are priced at \$5.75 for N scale (add 60 as a prefix to the part number), and \$7.00 for the HO sets (add 87 as a prefix). Coming next month are new sets for Great Northern Big Sky freight cars, and white Southern Pacific Fruit Express reefers.

Mount Vernon Shops (mountvernonshops.com) has HO scale decals for pre-war Pennsylvania Railroad class GLa and GLg Circle Keystone hopper cars. Set HO-GLA will letter up to eight cars. Also new is a large decal set for four pre-war carbon black covered hoppers including Spheron, J.M. Huber, United Carbon, and SHPX. Both sets are priced at \$9.00 each.

DISCLAIMER

The opinions expressed in this column are those of the writer and do not necessarily reflect the opinion of *Model Railroad Hobbyist* or its sponsors. Every effort is made to provide our readers with accurate and responsible news and information, however, neither *Model Railroad Hobbyist* or the writer of this column can be held responsible for any inaccuracies or typographical errors that may inadvertently appear in this column.



About our news and events editor

Richard Bale writes our news column under the byline of *The Old Yardmaster*. He has been writing about the model railroad trade for various hobby publications since the 1960s.

He enjoys building models, particularly structures, some of which appeared in the June 2006 issue of *Model Railroader* magazine.

Briefly noted at press time...

Walthers Donating to California Museum

During the combined NMRA National Convention/National Train Show held in Sacramento, California, Walthers announced it would produce a special HO scale Proto series model of Southern Pacific's EMD E9A locomotive #6051. The announcement was made at the California State Railroad Museum (CSRM) during a special banquet held near the beautifully restored prototype #6051. In support of the CSRM, Walthers pledged to donate \$10 from each model sold to the museum.

In addition to the SP Daylight paint scheme, the specially produced model will include many features unique to the big E9A prototype including a five-chime air horn, boiler room vents, 48" dynamic brake fan, small back-up light, see-through Farr grilles, freight-style pilot, nose-mounted Gyra-Light and headlight, front access hatches on both right and left sides, ladder stand-offs on the nose, left and right MU hatches on the nose, whip radio antenna with conduit, and vertically mounted cab wind deflectors. The special model will be available for standard DC operation without sound at \$199.98, and with DCC-Tsunami® Sound at \$299.98. Delivery is expected in March 2012. The model can be preordered at the museum store or at csrcm.org/store.



San Juan Decals,

a supplier of high quality narrow gauge decals, has been acquired by Dan Peterson (see earlier announcement on page 109). Dan, who is a narrow gauge modeler, will relocate the business to Apple Valley, Minnesota, near Minneapolis. He plans to keep offering the entire existing product line and will continue to operate as San Juan Decals. Until Dan gets a chance to update his web stie, he can be reached at dpeters@frontiernet.net

James Weaver 1950-2011

Atlas Model Railroad Company executive vice president James J. Weaver passed away July 16, 2011. Mr. Weaver assumed responsibility for the production of all Atlas-O products when he joined Atlas in 1996. He became the driving force behind the success of Atlas-O. Approaching the senior scale differently than most manufacturers, Weaver told an interviewer a few years ago, "Our goal was to approach O gauge from a new perspective. We wanted to design our trains as a scale item, with 2-Rail first, then adapt them to 3-Rail, which was the opposite of what other companies were doing at the time." Mr. Weaver was a long-time resident of Dunellen, New Jersey. He was 60 years old.



Send us your product announcements

If you are a hobby manufacturer with a product announcement, just [click here](#) and submit your announcement to us.

Our web site and free magazine reach continues to grow, so get on board with this new media train that's hard to stop!

DON'T HIDE YOUR INTEREST

If you found an interesting announcement in The *Old Yard Master*, tell them,

you saw it in

**Model Railroad
Hobbyist magazine™**



Selected Events

August 2011

CALIFORNIA, BUENA PARK, August 7, Railroadians & Transportation Show, UFCW Hall, 8550 Stanton Avenue (at Crescent Avenue). Info at www.californiaexpress.net.

FLORIDA, THE VILLAGES, August 20-21, Rail Expo 2011, model train and railroadians show, Lake Miona Recreation Center, 1526 Buena Vista Blvd. Info from Alan Goldberg at

amgold15@hotmail.com.

ILLINOIS, COLLINSVILLE, (St. Louis area), August 5-6, St. Louis RPM Meet, with vendor displays and operating FreeMo layout. Clinicians include Rob Adams, Ed Hawkins, Chuck Hitchcock, Keith Jordan, Daniel & John Kohlberg, David Lehlbach (Tangent Scale Models), Nick Molo (Moloco), Clark Propst, Dave Schroedle (Protoweathering.com), and Mont Switzer. Gateway Convention Center, One Gateway Drive. Info from John Golden at golden1014@yahoo.com (812) 929-7181, or Dan Kohlberg at paducah@mindspring.com.

VIRGINIA, LYNCHBURG, August 13, Lynchburg Rail Day sponsored by Blue Ridge Chapter of NRHS. Train exhibits, models, displays and slide shows. Info at www.blueridgenrhs.org.

WASHINGTON, SNOQUALMIE, August 19-20, 17th Annual Northwest Logging Modelers Convention with vendor displays, model contest, vintage machinery, clinics and layout tours. Snoqualmie Depot, 38625 SE King Street. Additional info from Clark or Lloyd at loggingmodeler@gmail.com or phone 310-951-9097 or visit <https://sites.google.com/site/nwlmconvention/>.

September 2011

MARYLAND, ELLICOTT CITY, September 1-4, Steel Mill Modeler's Meet, includes layout tours, seminars, models, and displays focusing on modeling steel mills in all scales. Sponsored by Magarac Society. Turf Valley Resort. Info at www.peachcreekshops.com/2011steelmeet.php.

MICHIGAN, LANSING, September 24-25, American Heritage Festival, sponsored by Lansing Model Railroad Club, includes operating club layout, modular layout, working blacksmith, wood carvers, wagon rides, and tour of Woldumar Nature Center. At former Grand Trunk Western Millet Depot, 5309 Old Lansing Road. Info at lmrc.org.

NEBRASKA, NORTH PLATTE, September 16-18, Rail Fest 2011, UP heritage steam engines, tour of Bailey yard, and model train display. Info at nprailfest.com.

NORTH CAROLINA, HICKORY, September 7-10, 33rd National Narrow Gauge Convention featuring layout tours, clinics, vendor displays, prototype events and narrow gauge camaraderie. Speakers are Trains editor Jim Wrinn and David Pfeiffer from National Archives. Hickory Metro Convention Center. Headquarters hotel (Crown Plaza) is sold out. Visit web site at narrow-gauge2011.com for information on alternative hotel space.

OHIO, MOUNT VERNON, September 17 thru Oct 6, "Life Along the Line," exhibit of original railroad photography of O. Winston Link, B&O Depot, 507 West High Street. Hours and fee information at mountvernondepot.org.

VIRGINIA, VIRGINIA BEACH, September 17-18, NMRA Tidewater Division Annual Train Show, Hall D, Virginia Beach Convention Center. Info at nfr-nmra.org.

Future 2011

CANADA, ONTARIO, October 2, 7th Annual Muskoka Model Railroad Layout Tour. Visit 20 home layouts from N to G scale in Alliston, Beeton, Stroud, Orillia, Severn Bridge, Gravenhurst, Bracebridge, and Huntsville. Tour maps available September 1. For info contact roger.berkeley@primus.ca or Al Crisp at beez_al@bell.net.

CALIFORNIA, LOS ANGELES, November 5-6 and 12-13. Pasadena Model Railroad Club Sierra Pacific Lines Fall Show. One of the world's largest layouts with over 1,700 feet of mainline track, 42 inch minimum radius, controlled by 10 mainline cabs. 5458 Alhambra Avenue. Info at pmrrc.org.

CONNECTICUTT, ORANGE, October 9, New Haven & Derby Model Railroad Club's 19th Annual Model Train Show featuring operating layouts in HO, N, T, S and O gauges, clinics, vendors. Free parking and wheelchair accessible. High Plains Community Center, 525 Orange Center Road. Info at newhaven-derby-modelrailroadclub.org.

ILLINOIS, LISLE, October 20-22, RPM-Conference (formerly Naperville RPM). Blue-ribbon list of speakers includes Frank Angstead, Mike Boland, Michael Borkon, Jack Burgess, Bob Chapman, Bill Darnaby, Jeff English, Tim Fredricks, Stephen Funaro, Richard Hendrickson, Robert Heninger, Chad Hewitt, Steve Hile, Roger Hinman, Chuck Hitchcock, Tyrone Johnson, Bob Karig, Tony Koester, Martin Lofton, Pierre Oliver, Bill Pistello, Ramon Rhodes, Mike Rose, Dick Ryker, Bill Schaumburg, Mike Schleigh, Gene Semon, Andy Sperandeo, Bob Sterner, Mont Switzer, Tony Thompson, Charlie Vlk, Bill Welch, and John Westly. Hickory Ridge Marriott (630-971-5000).

Selected Events *Continued ...*

KANSAS, BENTON (Wichita area), November 5-6, Railroad Prototype Modelers Meet, Benton Lions Community Center, 150 S. Main Street. Info at midcontinentprototypemodelers.org.

MARYLAND, TIMONIUM, October 29-30, Great Scale Model Train Show & Railroad Marketplace at Maryland State Fairgrounds. Produced by Howard Zane and Ken Young.

MASSACHUSETTS, MANSFIELD, November 2-5, Craftsman Structure Convention, Holiday Inn. Info at csc11.net.

MASSACHUSETTS, PEABODY, October 13-15, Fine Scale Model Railroader Expo, Holiday Inn. New event includes extended paid clinics from experts including Lou Sassi, Dave Frary, Bob Hayden, and Bob Mitchell. For clinic fees and additional details visit modelrailroadexpo.com.

MICHIGAN, LANSING, November 3-6, NMRA North Central Region, Lansing Legacies Convention. More than 25 clinics including make-and-take clinics, operating sessions, prototype tour, visits to 25 home layouts including narrow gauge and traction. HQ at Ramada Inn, 7501 W. Saginaw Hwy. Info at lansinglegacies2011.webs.com or send email to lansinglegacies2011@yahoo.com.

NEW YORK, ALBANY, December 4, NMRA Berkshire Division and Train Associates present Great Train Extravaganza, free seminars, operating layouts in most scales, 200 sales tables. Empire State Convention Center. Information www.gtealbany.com or call (518) 668-9892.

NORTH CAROLINA, CARY, October 27-30, NMRA Mid-East Regional Convention at Embassy Suites Hotel, Raleigh-Durham-Research Triangle East, 201 Harrison Oaks Blvd. Info at mer.nmra.org.

OHIO, WEST CHESTER, October 29-30, NMRA Cincinnati Division 7, Annual Model Train Show. Lakota West High School, 8940 Union Centre Blvd. Info at cincy-div7.org.

Future 2012

MICHIGAN, GRAND RAPIDS, July 29-Aug 4, 2012, NMRA National Convention and National Train Show, gr2012.org.

PENNSYLVANIA, MALVERN, March 23-25, 2012, RPM-Valley Forge Meet. Info at phillynmra.org/RPMMeet.html.

Future 2013

NEW MEXICO, ALBUQUERQUE, June 6-9, 2013, Rails Along the Rio Grande 2013, NMRA. Rio Grande Division 6, Rocky Mountain Region Convention with clinics, layout tours, train show, OpSig sessions, UPRR and BNSF modelers showcase night, and banquet. Marriott Pyramid North. Info from Al Hovey at alhovvey@comcast.net. ■



Send us your event announcements

If you have model railroad related open house, show, or other event announcements, just [click here](#) and submit your announcement to us.



Reader Feedback
(click here)



REVERSE RUNNING: Think shelf, not table!

Stepping outside the box with a contrary view



tous 4x8 layout that's on the cover of beginners' books. Unfortunately, as layout designer Byron Henderson is quick to point out, the 4x8 is a very poor user of space.

A huge problem is one of access. You can't easily reach across a 4-foot distance, so you need "access space" all around the 4x8 sheet – or at least on 3 of the 4 sides. Access space translates as "aisle". A typical minimum aisle width is 24". If you're realistic about it, you'll need a (4' + 2' + 2') x (8' + 2') 10' space to house that 4x8 layout.

If you think shelves-around-the-wall instead of table-in-the-middle, you can get a much larger and more interesting layout in that same space. With 24" deep shelves on all sides of that room, you'll get 56 square feet vs the 32 square feet of that 4' x 8'. Almost double the layout space in the same 8' x 10' area! Continuous running is possible but a drawback is the need to duck under to get inside the layout (or provide a liftout section).

Think for a moment about real railroads. They go from point A to point B – they aren't loops that connect back up with themselves. Let's leave a 3' x 2' clear access section in front of the entrance doorway. Now we're down to 50 square feet, still much more than a 4' x 8' with access aisles on three sides, but no duckunder.

By moving to a shelf along the wall, you get a layout configuration that aligns much better with the linear nature of real railroads. By moving to a shelf configuration instead of a table one, you automatically start thinking point-to-point and staging – taking you to the next level of creative thinking for a layout that's going to be more satisfying to operate.

What if you need to use the room for other purposes? That 4' x 8' layout leaves a 8' x 10' room useless for anything but trains (and under-layout storage). But with 24" shelves around the walls, there's still a 4' x 6' open area in the middle. If you really need free space, use 12" shelves and the open area increases to 6' x 8'! Build the layout 60" high and you can easily tuck a bed or desk under it.

If you look at the history of the hobby, you can see the development cycle of moving from table to shelf in our collective consciousness as model railroaders. Layouts in the '40s and '50s were mostly tables in the middle of the room, with operating pits or access hatches galore. They were difficult to build, hard to scenic, tough to maintain, and a pain to operate.

Thanks to constant pressure to improve the art of track planning from innovative layout designers like the late John Armstrong, by the '60s we

started to finally get it. Shelves give us more room to work than tables!

By the '70s, walkaround shelf-based designs started to become accepted and then expected as a best practice. Modern layout designers automatically turn to shelf rather than table. The table's shortcomings are now obvious.

Given that table designs are rife with shortcomings, when will we break the mold and promote shelf designs over table designs on the cover of hobby books for beginners? Are we leading newcomers down a primrose path by promoting table designs as great starter layout options?

One of the first concepts we need to teach hobby newcomers is: "think shelf, not table!"

That way, they can start off right away on the proper footing.



— by Joe Fugate

Those of us who have been in the hobby for a while can forget that certain key hobby concepts aren't always obvious to newcomers.

One such concept is: think shelf, not table. Huh? Why is that?

Most newcomers contemplating a starter layout think of the ubiqui-

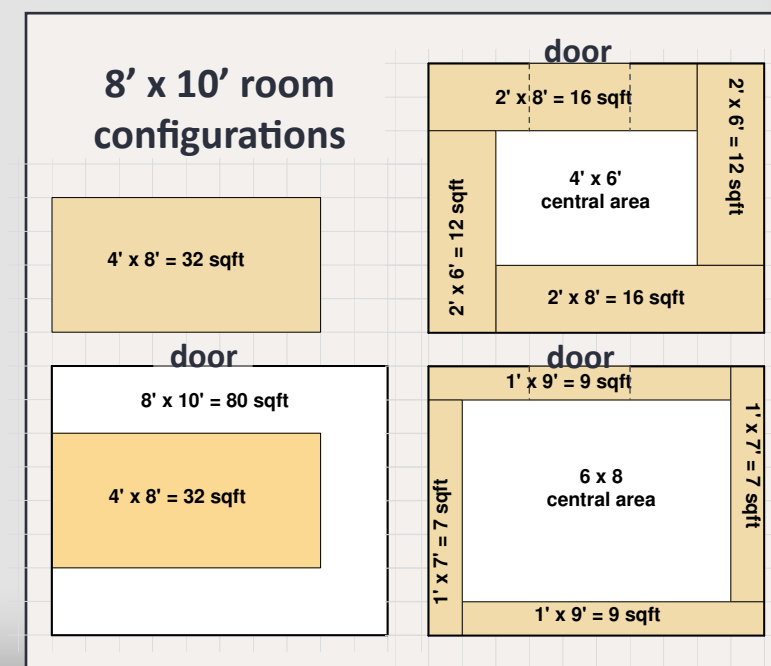

Clickable Advertiser Index	Page
Accu-Lites	13
Amherst Railway Society	21
Aux Box DCC.Com	18
Backdrop Junction	25
Bar Mills	14
BLMA	3
Canyon Creek Scenics	16
Clever Models	25
Craftsman Structure Convention 2011	46
Dallas Model Works	4
DCC by Design	25
Digitrax	6
ExactRail	5
Fiber Optic Store	15
Fine Scale Model Railroader Expo	59
Frenchman River	43
Litchfield Station	19
Micro-Mark	25
Monster Modelworks	25
Model Trains Video	26

Clickable Advertiser Index, continued	Page
Nano Oil	12
NCE	9
QT Audio	9
RailMaster Hobbies	74
Railpub	26
Rapido Trains	7
R.S. Laser Kits	20
Rulers of the World	26
Scenic Express	23
Scotty Mason Show	24
Summit USA	25
TAM Valley Depot	45
Tony's Train Exchange	24
Train Videos and Parts	24
Yankee-Dabbler	14
Hobby Marketplace	24

Clickable Topic Index	Page
Derailments	127
Editorial – Editor's Soapbox	10
Editorial – Reverse Running	125
Layouts – Nick Muff's Kansas City Southern	47
News – August Newsletter	109
News – Sacramento Show Report	79
News – Selected Events	123
Prototype – Accurate Diesel Roster	96
Q and A – MRH Questions, Answers, and Tips ...	17
Rolling stock – Adding Realistic Rivets	27
Rolling stock – Prepping a Car for Club Ops .	44
Rolling stock – Weathering Empty Gons	22
Scenery – Comme-N-tary	103
Scenery – Lite and Narrow	92
Sound - Adding Background Sounds	75
Trackwork – Building a Gallows Turntable ...	60
Staff Notes	12
Other – Cover	1
Other – MRH Sponsors	2
Other – Table of Contents	8
Other – Bonus Downloads	16

For the love of model trains

Coming in the Sept 2011 issue

- La Mesa club layout update – first views of the Tehachapi Loop
- Poor man's jig-built turnouts
- Locomotives as loads – modeling deadheading locos by Matt Snell
- Simplified Card Order system
- New "From the Workbench" article series – one evening projects on steroids!
... and lots more!

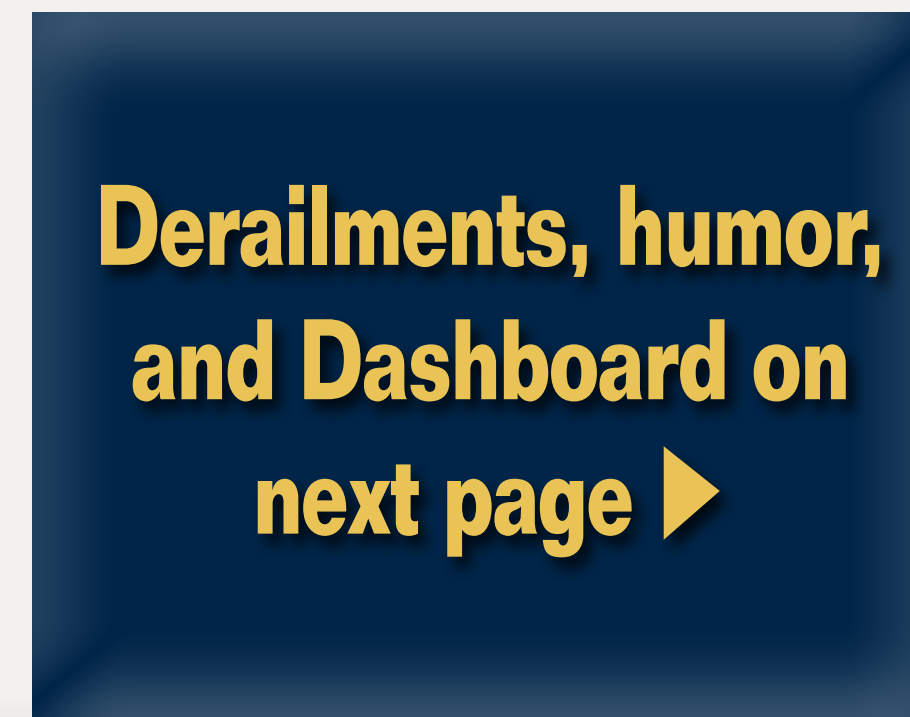
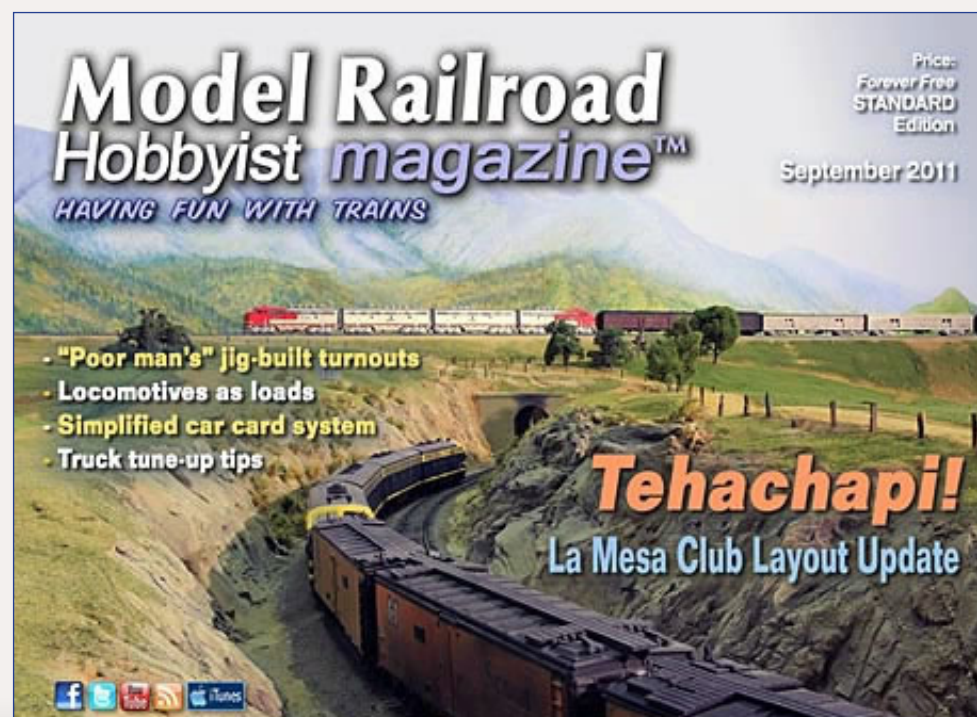



"Here I am at the Waverly Model Engineering Society, where they build the cutest widdle toy trains you ever saw, along with widdle houses and itty-bitty people too! Ain't that ADORABLE?"

It was so dark you could hardly see your hand in front of your face. A switcher was shoving a cut of cars up the yard lead. A switchman on the roof of the lead boxcar was swinging his lantern in a slow come-ahead when the car lurches. He loses his grip on the lantern and it soars through the air. As luck would have it, a guy walking by on the ground catches it in mid-air and tosses it back up to the switchman on the roof who continues his slow come-ahead signal! A moment later the cars stop abruptly and the engineer of the switcher runs up and shouts to the man on the roof.

"Lemme see you do that again!"

"Do what again?"

"Jump off the roof of that boxcar and back up!"

Q: What kind of passenger car must never be pushed?

A: A PULLman.

If you're the first to [submit a good bit of humor](#) and we use it, it's worth \$10!

When talking to hobby vendors, please remember to mention MRH.