

# Model Railroad Hobbyist magazine™

Price:  
Forever Free  
**STANDARD**  
Edition

February 2012

**HAVING FUN WITH TRAINS**

**Don Spiro's**

## Realistic Winter Trees

- Installing DCC decoders
- What happened to Mount Allen?
- Light up an HO brakeman's lantern!
- 22 stories up – photo backdrop
- An out-of-service train order signal and lots more, inside ...





**Front Cover:** Don Spiro models the late fall / early winter season. See how he builds some great looking super detailed winter trees using natural tree trunks he found growing in his yard!

ISSN 2152-7423

**Editorial Staff**

Joe D. Fugate, Publisher  
Charlie Comstock, Editor

**Columnists**

Richard Bale, News and events  
John Drye, N scale  
Les Halmos, Modular railroading  
Lew Matt, Narrow gauge and shortlines  
Bruce Petrarca, DCC

**Special Correspondents**

Joe Brugger, Questions and answers  
Jeff Shultz, First looks

**Production**

Patty Fugate, pasteup and layout  
Joe Brugger, copy editing  
Mike Dodd, copy editing

**Technical Assistant**

Jeff Shultz

**Advertising Account Manager**

Les Halmos



click to learn more about this sponsor



click to learn more about this sponsor



click to learn more about this sponsor



click to learn more about this sponsor

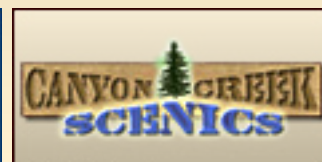

click to learn more about this sponsor



**NEW SPONSOR!**



**NEW SPONSOR!**



click to learn more about this sponsor



click to learn more about this sponsor



click to learn more about this sponsor



click to learn more about this sponsor



**NEW SPONSOR!**



click to learn more about this sponsor



**NEW SPONSOR!**



click to learn more about this sponsor



click to learn more about this sponsor



**NEW SPONSOR!**

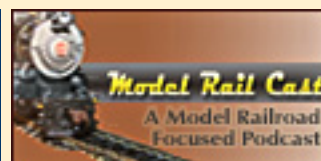

click to learn more about this sponsor



click to learn more about this sponsor



**NEW SPONSOR!**

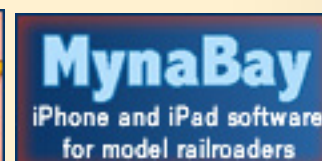

**NEW SPONSOR!**



**NEW SPONSOR!**



click to learn more about this sponsor

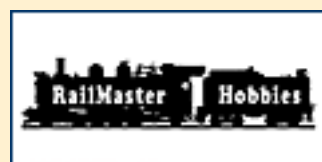

click to learn more about this sponsor



click to learn more about this sponsor



click to learn more about this sponsor



click to learn more about this sponsor



click to learn more about this sponsor



click to learn more about this sponsor



click to learn more about this sponsor



click to learn more about this sponsor



**NEW SPONSOR!**

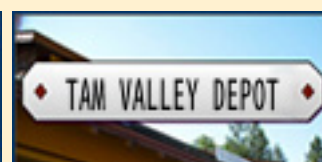

click to learn more about this sponsor



click to learn more about this sponsor



**NEW SPONSOR!**



click to learn more about this sponsor



**NEW SPONSOR!**

## MRH sponsors

**Remember to tell them: "MRH sent me!"**

### Learn about becoming a Sponsoring Advertiser!

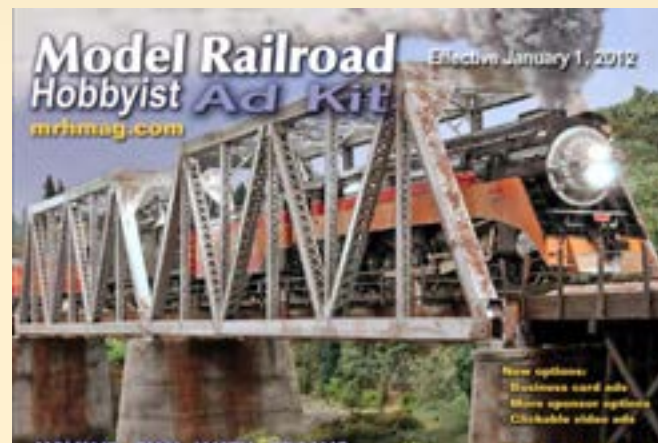

MRH Sponsoring Advertisers get extra benefits such as logo placement and banner ads on the MRH web site (64,000+ unique visitors in Jan 2012). Click [here!](#)

### Need something? See our Hobby Marketplace!



For more model railroading products, including hard-to-find items, see our [Hobby Marketplace](#) on page 51.

..... When we said .....

# GRAB YOUR PIPE

This isn't **exactly** what we had in mind.



## The **NEW** PTTX F89-J

Flat cars can carry almost anything, but a PTTX ACF F89-J was purposely designed to carry pipe – and lots of it! Fitted with wood cross beams, the PTTX fleet was **designed to accommodate pipe and bulk loads** of varying diameter and weight. Featuring new, side-mounted brake rigging and other PTTX-specific detail, these models roam the rails today, delivering pipe and bulk loads all over North America. Order yours now!

.....

**ORDER BY:** March 1, 2012    **DELIVERY:** 4th Quarter, 2012

**N scale** \$28.95    #13023 - 13032    PTTX Yellow

**HO scale** \$39.95    #51023 - 51032    PTTX Yellow

### PTTX FEATURES

- First Ever PTTX Flat in ANY Scale!
- Accurate Details For Pipe Hauling
- Razor Sharp Printing & Lettering
- HO Scale: Kadee #156 Couplers
- N Scale: Body-mounted Micro-Trains Couplers
- Look For Our Pipe Load Announcement!

.....

★ **COMING SOON:** All-new Pipe Loads and PTTX conversion kits for your favorite flat cars!

Photo By Joe Shaw



# BLMAmodels.com





**EXACTRAIL**<sup>®</sup>  
The Next Generation of Model Railroading

See what's new at [ExactRail.com](http://ExactRail.com)!

# Express<sup>®</sup> Series from ExactRail



## FMC 4000 Gondola

Available in CNW, SEPX, RTIX & Kit

HO SCALE Express<sup>®</sup> \$22.95 MSRP 



RTIX



SEPX



RTIX



CNW

## Gunderson 5200 Box Car

Available in MP, SSW, SLSF, MNS, BNSF & Kit

HO SCALE Express<sup>®</sup> \$21.95 MSRP 



MP



SSW



SLSF



MNS



BNSF

## Gunderson 2420 Gondola

Available in UP, MP, CNW, PC, SSW, CSXT, SP & Kit

HO SCALE Express<sup>®</sup> \$21.95 MSRP 



UP



MP



PC



SSW



CSXT

 Become an ExactRail Insider

 Register your ExactRail Product



1-866-945-1701 | [ExactRail.com](http://ExactRail.com)

Visit [ExactRail.com](http://ExactRail.com) to keep pace with our releases & purchase products.

WALTHERS



# The Santa Fe El Capitan

The HI-LEVEL Train That's Fun For Everyone!



## El Capitan features:

- Based on Equipment used from 1956 to 1971
- Real Metal Finish Simulates Stainless Steel
- Prototypically Accurate Window Tinting
- All Grab Irons Factory Installed

*Coming Soon*

## Hi-Level Car LED Interior Lighting Kits

- 932-1055 For El Capitan Hi-Level Cars \$15.98
- 932-1056 For El Capitan Step-Down Hi-Level Coach w/Tail Sign \$16.98

### PROTO 2000® HO Santa Fe 37-Class F7 Diesels



#### Detailed to Match 37-Class F7s in service 1956-60

- Real Metal Finish
- Available with Full-Feature Tsunami® Sound & DCC Decoder
- April 2012 Delivery

#### A-B Sets

TSUNAMI® SOUND & DCC \$479.98 EA  
 920-40687 #39L & 39A Sold Out  
 920-40688 #39C & 39B Sold Out  
 STANDARD DC \$329.98 EA  
 920-47687 #38L & 38A Sold Out  
 920-47688 #38C & 38B Sold Out

#### Matching A Unit

TSUNAMI® SOUND & DCC \$259.98 EA  
 920-40689 #41L Sold Out  
 920-40690 #41C Sold Out  
 STANDARD DC \$169.98 EA  
 920-47689 #40L Sold Out  
 920-47690 #40C Sold Out

#### Matching B Unit

TSUNAMI® SOUND & DCC \$259.98 EA  
 920-40691 #41A Sold Out  
 920-40692 #41B Sold Out  
 STANDARD DC \$169.98 EA  
 920-47691 #40A Sold Out  
 920-47692 #40B Sold Out



HO 63' Budd Railway Post Office #89-98  
In Stock 932-9730 \$69.98



HO 73' Budd Baggage Car  
In Stock 932-9740 \$69.98



HO 85' P-S Baggage-Dormitory Transition Car #3477-3479  
January 2012 932-9750 \$74.98 – Preproduction model shown



HO 85' Budd Hi-Level 68-Seat Step Down Coach #528-537  
February 2012 932-9760 \$79.98



HO 85' Budd Hi-Level 72-Seat Coach #700-724  
March 2012 932-9770 \$79.98



HO 85' Budd Hi-Level "Sky Lounge" #575-580  
April 2012 932-9780 \$79.98



HO 85' Budd Hi-Level Diner #650-655  
April 2012 932-9790 \$79.98



HO 85' Budd Hi-Level Step Down 68-Seat Coach w/Tail Sign #528-537  
May 2012 932-9761 \$79.98

See Preproduction Samples Online  
walthers.com/fbelcapitan

To find a Hobby Shop near you, call 1-800-487-2467 or visit [walthers.com](http://walthers.com).

\* Sold Out at Walthers — See your Local Hobby Shop.

Delivery date and prices shown were accurate at press time, for updates visit [walthers.com](http://walthers.com). ©2012 Wm. K. Walthers, Inc

# Main Features

## Table of contents

## Columns



### Fastening coupler box covers

Car shop: one evening project

by Joe Brugger



### Points of Light

Using micro-LEDs in interesting places

by Dr. Geoff Bunza



### Building realistic winter trees

Super detailed trees without leaves

by Don Spiro

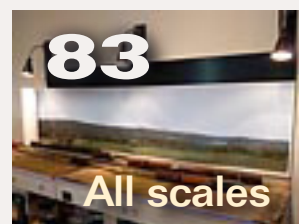

### 22 stories up - photo backdrop

How to make and install photo backdrops

by Thomas Garbelotti



### Out-of-service train order signal

Build a lineside detail for your layout

by Tom Patterson

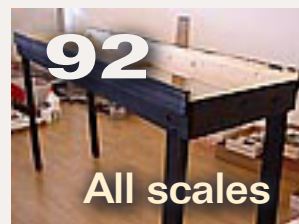

### Build a Module Cradle

Interchangeable framework and scenery

by Dirk Reynolds

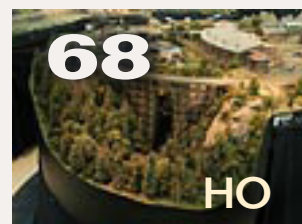

### Mount Allen is gone!

More changes on George Sellios' F&SM

by Charlie Comstock

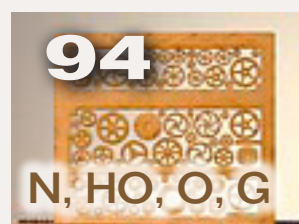

### First Look: VectorCut laser details

MRH expanded First Look!

by Don Spiro

### 20 Roundhouse roof!

Modular Adventure

by Les Halmos

### 29 Peninsula construction!

Up the Creek

by Charlie Comstock

### 40 Coal marshalling yard

Comme-N-tary

by John Drye

### 45 Wired decoders, part 2

DCC Impulses

by Bruce Petrarca

### 103 February Model

Railroading News

MRH News and Events

by Richard Bale

### 119 MRH, track planning

paralysis

Reverse Running

by Joe Fugate

### 13 Subscriber-only extras

Bonus downloads

## Other Features

### 8 Overcoming Lethargy

Editor's Soapbox by Charlie Comstock

### 51 Hobby Marketplace

Vendor ads

### 10 MRH Staff Notes

A surprise and other stuff

### 97 MRH Trackside Showcase

New product photo gallery

### 15 MRH Q - A - T

Questions, Answers and Tips

### 121 Derailments

Humor?

# SO UGLY IT'S GORGEOUS!





## About the Editor



**Charlie Comstock** has been a regular columnist, author, and editor of *Model Railroad Hobbyist Magazine* since its inception.

To learn more about Charlie, [click here](#).

## EDITOR'S SOAPBOX: Overcoming lethargy

### Getting started ... again ...



**T**he leftovers from the New Years Eve feast are finally gone. The Christmas tree has been taken down and the ornaments stored. The unbridled enthusiasm that came with the holiday erodes fast as the realities of life reassert themselves.

It's easy to come up with a list of train room tasks that rivals the length of an Espee freight train with three sets of mid-train helpers. Everything seemed easy when it went on the task list. Now the enormity of completing even the simplest project seems daunting. Before I can finish task A, I need to get B done. But B depends on C and D, and D depends on E. Eagerness evaporates. Face it, often the hardest part of any model railroad project is getting started.

What to do now? Luckily, your layout isn't a job complete with a boss yelling at you to quit messing around and get working (unless you're a professional layout builder).

If you're not one of those self-starting types endowed with rigid self-control (and self-scheduling, too) here are some suggestions:

If your task list seems gargantuan, look for something you can do without waiting for other tasks to be completed. Tackle a small structure or weather a freight car or two.

Try joining (or forming) a round-robin group where each week a different member hosts the group. Usually the first thing group members do upon arrival is inspect the layout to see what's new. It might be new scenery. It might be new rolling stock. It might be new benchwork. It might be something invisible such as a new ops plan. Having friends kidding you about "finally gettin' sumptin' done on yer layout" is a great motivator.

Sometimes round-robin groups run trains on the host's layout. Sometimes they build stuff. Scheduling a work session will motivate you to get enough prep done to prepare for the work night, so the extra manpower has stuff to do. You can make lots of progress this way.

If you don't want the regular commitment of a round-robin group but do have a couple of buddies you can trust with a screwdriver or jigsaw, invite them over to work on the layout with you. I know from personal experience it's a whole lot easier to slice up sheets of plywood with a table saw when someone else helps. Again, it helps to prepare for the night's tasks before your friends arrive.

Friendly, construction-oriented sessions can be encouraged with the discrete (or blatant) use of goodies. A box of Pepperidge Farm cookies, a pan of brownies, or even a bowl of grapes go a long way toward making an evening work session more enjoyable. Save the beer until later if you're using power tools.

If you're up for a challenge and there's a meet happening in your area, volunteer to have your layout open. Knowing that 50 or more people are going to show up on your doorstep in the (uncomfortably) near future inspires a lot of progress and you're likely to get some nice warm fuzzy feelings from the visitor's comments.

But if you really don't feel like doing anything on the layout, don't. Forced layout labor is a shortcut to TTBO (total train burnout). Go out to dinner with your wife, catch a game on the tube, or play Parcheesi with the kids. If those aren't options, try calling a buddy and playing (or working) on their layout.

It's important to remember, building a layout is more like a marathon than a sprint. So take it easy, and have fun with your trains.





**Digitrax**<sup>®</sup>  
Complete Train Control

**\$225.00 MSRP**

Introducing

**ZEPHYR** *xtra*

## **XTRA** FEATURES

• 29 Functions • 20 Adresses & Throttles • Recall

## **XTRA** POWER

• 3 Amps • Blast Programming for Sound



**Click here to find out more >**

## Notes from the

# MRH STAFF

**A surprise, survey reminder, Lew Matt update, linking to MRH, finding articles ...**



## A surprise in this issue!

We debut our new [MRH Trackside Showcase](#) in the February 2012 issue. It's intended to be a place where we can

leverage our page real estate to show off the great models being released by hobby manufacturers today.

We present a large photo of each model so you can see all the cool details, plus we'll feature a 3D click-n-spin or video for at least one of the models in each Trackside Showcase. We also include our trademark Reader Feedback button so you share your thoughts on these models and see what others are saying, too.

## January ratings

The five top-rated articles in the January 2012 issue of MRH are:

- 4.6 Photo-laminated structures
- 4.6 Up the Creek – Peninsula construction

- 4.5 DCC Impulses - Wired decoder installation - part 1
- 4.5 Build a railcar barge
- 4.4 Columbia River N Scale club
- Issue overall: 4.6

**Please rate the articles in each issue!** We depend on your feedback to help us plan future issue content. If you wish we'd cover something different, your rating can alert us to this wish.

## Why subscribe?

Not a MRH subscriber? Why not? Here are some reasons to take the plunge:

- Subscribers are notified automatically each time a new issue of MRH is released. Come 'n get it!

- Subscribers get access to ALL the great bonus extras for every issue of MRH, past and present. Things such as HD (hi-def) versions of the article video clips, the slide show tour of the La Mesa club's 8000 square foot Tehachapi Pass layout with lots of photos not in the article, the extended length interview of Nick Muff in his basement next to his real F7 cab. And more...
- Subscribers support MRH. If you'd like to keep reading your FREE train magazines, then subscribe! When we tell our advertisers we have over 20,000 subscribers, they smile. When they smile we smile. When we smile, we work hard to produce more great issues of *Model Railroad Hobbyist*.

## ADVERTISEMENT

# Backdrop Junction

**Your stop for  
Model Railroad Backdrops**



**backdropjunction.com**  
**N, HO, O Scales • Custom Orders**

Help keep MRH free!  
When you talk with a hobby vendor, mention that you read

**Model Railroad  
Hobbyist magazine™**

Not sure how to subscribe? It's easy!  
Just surf over to

[mrhmag.com/user/register](http://mrhmag.com/user/register)

and fill in the form. We'll need an email address to send you notifications, but we promise never to share your email address with anyone.

## MRH reader survey

We've been running a survey since November to find out how and why you, our readers, access and read MRH.

We'd like to know which devices (PC, Mac, iPad, Kindle, etc) you use to read MRH, whether you download multiple copies of MRH to different devices, and so on. We're also asking why you read MRH, and what points you might make if recommending MRH to a new modeler.

Your answers will help us plan MRH's direction in 2012 and beyond. Sure, we're free, but the value we provide to you, our readers, better be more than the zero cover price, or we're heading down a dead-end track on a wharf at run 8!

So [please take the survey](#) – it shouldn't take you more than 10 minutes.

## Lew Matt status

Lew continues to struggle with health problems. His attitude is good, though, and we're all hoping he'll be back behind the keyboard soon. Your prayers for healing and swift recovery are welcome.

## In this issue

February brings another line-up of great content for you.

**My Modular Adventure:** Les Halmos is back, this time working on the roof for his roundhouse.

**Up the Creek:** Charlie Comstock, finishes the helix and starts on other parts of the peninsula benchwork. Includes full layout plans.

**Commentary:** John Drye tells us about modeling the coal operation at Cresson on his N scale PRR railroad.

**DCC Impulses:** Bruce gets down and dirty about hardwiring decoders into locomotives including details for putting a decoder in an Athearn blue-box loco.

**Coupler Pocket Tool:** Joe Brugger shows how using a tool from A-Line makes securing coupler box covers easy. No more couplers popping out of their boxes!

**Making Winter Trees:** Don Spiro, a first-time MRH author, shows how he makes extremely detailed winter (no leaves) trees.

**Out of Service Train Order Signal:** Tom Patterson, (upgrading a [Central Valley](#) truss bridge, [Nov 2011 MRH](#)) tells how he modeled an out-of-service train order signal.

**What Happened to Mount Allen:** More changes on George Sellios' Franklin & South Manchester.

ADVERTISEMENT

# Innovative Electronics for Model Railroads

Frog Juicers - Automatic Frog Polarity  
Servo Drivers for Turnouts and Semaphores

## TAM VALLEY DEPOT

Great Electronics for Great Model Railroads



Keep your frogs well juiced and always in the right polarity with our DCC Frog Juicers. Just hook up one wire to the frog from our juicers and the electronics do the rest! Thousands of satisfied and happy frogs in all scales swear by them.

[www.TamValleyDepot.com](http://www.TamValleyDepot.com)

[Click here to contact us by email](#)



**Points of Light:** Dr. Geoff Bunza, another first-time MRH author, shows how to light up the lantern carried by an HO scale brakeman!

**22 Stories Up – Photo Backdrop:** Thomas Garbelotti, frequent MRH forum contributor, shows how he built a really nice Vermont photo backdrop while living in the Middle East!

**Building a Module Cradle:** Dirk Reynolds, yet another first-time MRH author, shows a great idea for modular model railroading.

**The Old Yardmaster:** Richard Bale's regular report on industry happenings, announcements, and events. and more ...

## Linking to MRH

We're looking for the missing links (and no, we're not getting into paleontology although there are rumors of Athearn blue box freight cars appearing in some cave drawings). Do you have your own website or an online presence somewhere in inter-space? Want to support your favorite free, online, model train magazine?

Linking to [model-railroad-hobbyist.com](http://model-railroad-hobbyist.com) from your website helps improve MRH's position in Google search results. Google ranks results by popularity and having lots of links to the MRH website tells Google that we're pretty popular.

Check out [model-railroad-hobbyist.com/spread\\_the\\_word](http://model-railroad-hobbyist.com/spread_the_word) for how to do this (and some cool MRH banners).

Help us end the missing link problem!

## Email blasts

Perhaps you're wondering why you get a (usually) weekly email from MRH? The answer is simple: this is how we keep you up on what's happening around MRH.

These emails notify you when a new issue of the magazine comes out or point out some interesting things happening on our website.

The overwhelming majority of the responses we receive about these

emails is positive. In today's super busy society it's hard to remember things such as when to look for a new issue of the MRH or to scan the forum for some more great threads (if you haven't visited the [MRH forum](#) lately there's some great stuff out there!).

If you're wondering why we do this, the answer is simple; we live and die by circulation (like most magazines) and sending these emails results in significantly more circulation and web visits to our site – both very important to our advertisers (who pay for your free magazine).

A very few readers have complained these emails are getting annoying.

## ADVERTISEMENT



# Southern Digital

Specializing in DCC Since 1992



### DigiFrame Kit



20% Discount  
on most items!

[www.sodigi.com](http://www.sodigi.com)  
(770) 929-1888

(Photo from our N-Scale layout)

We're sorry, but it's part of the price of keeping MRH free. By comparison, people on the Amazon.com mailing list receive emails several times a week (and sometimes a day!)

We also include links to some of the best threads on the MRH website each week, so even if you've already seen the issue, don't overlook the links to other content on the MRH website. There's some great stuff there, some of it as good as what's in the magazine each month!

## Finding Articles

Are you lost in space? Or rather, are you lost in MRH? You know the article you need for the project you're just starting, but you can't remember where it is! Now that MRH has been around for over three years and has published two dozen magazines, it's getting hard (even for us) to remember which articles were in which issue – or even all the articles we've published.

If you're like me, and the little gray cells are in need of fresh vacuum tubes, the [Rod Goodwin index](#) is the answer. Go to the menu bar on a [mrhmag.com](#) website page, choose the Magazine menu, and about half-way down, Index (Rod Goodwin).

This will take you to Rod Goodwin's excellent train search resource. To find stuff in MRH articles use a

search string that starts with "mrh" (upper or lower case doesn't matter).

For example, searching on "mrh decrepit track"

returns the following hit:

Modeling Decrepit Spur Tracks;  
Are those sidings or rollercoasters?  
Charlie Comstock; Model Railroad  
Hobbyist Jul 2010 pg 102 [VISIT](#)  
[EDITOR](#) [INSPECT](#)

Clicking the VISIT link will take you to the reader feedback page for the Modeling Decrepit Spur Tracks article. From there you can download the July 2010 issue, or click the large thumbnail image (the one labeled "Want to read this article? CLICK HERE") and jump directly to the article in the online edition of the July 2010 magazine. How cool is that?

After three years, the MRH website, especially the forum, has gotten kind of large. Use the SEARCH field on the main page (in the upper right corner just under the feature sponsoring advertiser logo). Type the words you want to search for and hit enter (or click SEARCH).



## February 2012 Premium Extras!

*Available to subscribers!*

- DVD and HD quality versions of:
  - Using a biscuit joiner to reinforce joists with gusset plates on the Bear Creek & South Jackson



**Q:** How do we give our readers over 100 pages of quality content, for free, each month?

**A:** It's simple, the advertisers pay for your magazine!

When you shop, be sure to tell them:

*"Thank YOU for supporting MRH!"*



# Train Service November 18, 2011

Arrive in  
Concord, Ontario

Depart to  
Local Stores

## HO SCALE MP40-3C

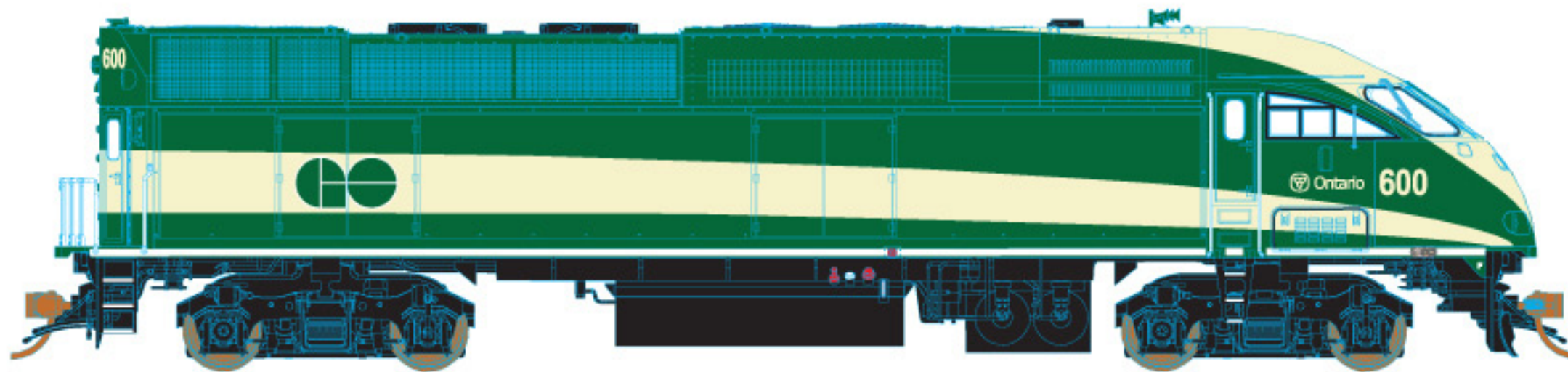

Kindly leave enough time to get you to  
your local hobby shop before train departure



*... or click to visit our website!*



# MRH

## Questions, Answers and Tips



### QUESTIONS AND ANSWERS

**Q: What is a marshalling yard?**

**A:** It certainly has nothing to do with the OK Corral. “Marshaling yard” (also spelled with two “l’s,” in British/European/Pennsy/Canadian Pacific-speak) is what many railroaders in the United States and on the Canadian National call a classification yard.

Railroads use classification yards to collect and sort (classify) freight cars for forwarding to their destinations.

For example, suppose a train from Green River, WY arrives at the Pocatello, ID yard. The yard crew breaks the train down to begin classification. Cars that are waybilled to destinations switched by trains originating at Pocatello will

be sorted into one track, cars headed for points north into another, and cars destined for the Pacific Northwest into a third. Trim crews will pull the strings of sorted cars and assemble these groups and others into new trains according to the traffic plan.

Pocatello formerly had a hump yard, built to handle high volumes of traffic. In a hump yard, cars are classified by pushing them slowly up a hill (or “hump”). They are uncoupled at the top of the hump and roll downhill through a series of switches into the designated track. Retarders are used to control the speed of a car as it rolls. This task is now accomplished by flat-switching – a switch engine shoves cars into the designated tracks.

The time and crew expense required for classifying trains explains the popularity of unit trains. A train consisting of auto racks carrying imported autos from Vancouver, WA to a distribution center in the Midwest doesn’t need to be switched at all en route. A container train can run from the docks in Portland to Chicago, stopping only for crew changes. Coal is generally loaded at a mine and moves directly to a power-generating plant. Sometimes coal cars from several mines are combined into a single unit train.

Log into the Union Pacific site at [www.uprr.com/customers/intermodal/featured/joliet.shtml](http://www.uprr.com/customers/intermodal/featured/joliet.shtml) to get an overview of how traffic in and out of the Chicago area is handled.

A classification yard is often part of a larger complex that might include an engine terminal, a car repair shop, or an interchange yard to hold cars destined for a connecting railroad. At bigger sites, trains will terminate in an arrival or receiving yard, where they are broken down to be reclassified. Some high-volume industries like plastics manufacturing or the auto industry might be served by specific yards where freight cars – loaded or empty – are held until they’re needed

— MRH

**Q: Where can I get good custom decals for my freelanced railroad?**

**A:** You can make your own using an ink jet or laser printer – as long as you don’t want them to be white.

**Figure 1: Albina Yard, in Portland, OR, where lines from California, Washington and Idaho meet, classifies Union Pacific Railroad traffic moving into and out of the Portland area.**



Figure 1

<b>CCW X806</b>	<b>CCW X807</b>
CCW X805	CCW X806
<b>CCW X806</b>	<b>CCW X807</b>
CCW X803	CCW X804
<b>CAPY 10000</b>	<b>CAPY 10000</b>
<b>CAPY 10000</b>	<b>CAPY 10000</b>

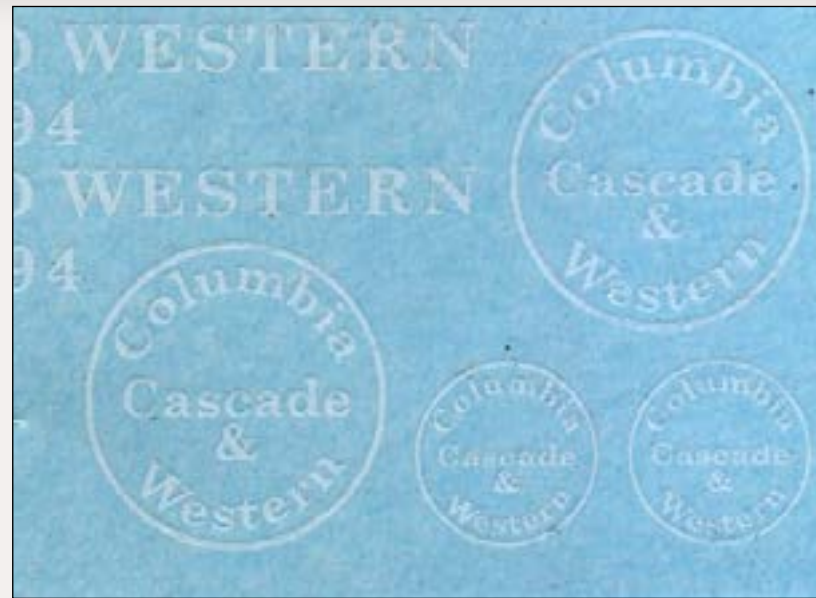

Figure 2: Rick Andrews printed a decal sheet of black numbers and reporting marks (left) using Microsoft Excel software and Microscale decal paper. The blue with white lettering (above) is a custom decal sheet printed by ELS Trains.

Create your design using a drawing program like Corel Draw ([www.corel.com](http://www.corel.com)) or Inkscape ([inkscape.org](http://inkscape.org)). Using a drawing program for lettering and heralds produces scalable vector graphics (SVG) whose size can be adjusted larger or smaller without a loss of quality.

Print a couple of tests on plain printer paper to be sure the size is correct, then print onto the commercial decal paper that's correct for your type of printer. Coat the sheet with Microscale liquid decal film or with two or three light coats of Krylon clear acrylic spray, and let it dry for a day or two before applying.

Outfits like FedEx Office and Office Depot may be able to do laser printing on decal paper for you – check with the local manager for their capabilities and requirements.

If you need white lettering, you can buy white-surface decal paper and

create a “patch” of the engine or car color, with clear lettering allowing the white base color to show through. Matching the car color in the patch will be tricky. In your drawing program, set the background color, then use “white” as the font color. The output decal is white graphics (unprinted area on white decal paper) with a color-printed rectangle around it.

Pulsar, [www.pulsarprofx.com/decalpro](http://www.pulsarprofx.com/decalpro) has a “dry-transfer” system that allows ANY color, even white, using extremely thin foil sheets. Watch the video at [www.pulsarprofx.com/decalpro/Vertical/1\\_MENU/1a\\_Home/hobby/Hobby.html](http://www.pulsarprofx.com/decalpro/Vertical/1_MENU/1a_Home/hobby/Hobby.html) to learn how it works.

If you don't want to print your own, Rail Graphics ([www.railgraphicsdecals.com](http://www.railgraphicsdecals.com)) has been in business since 1979 and produces a high-quality product. So does Microscale ([www.microscale.com/custom.htm](http://www.microscale.com/custom.htm)). In both cases,

ADVERTISEMENT

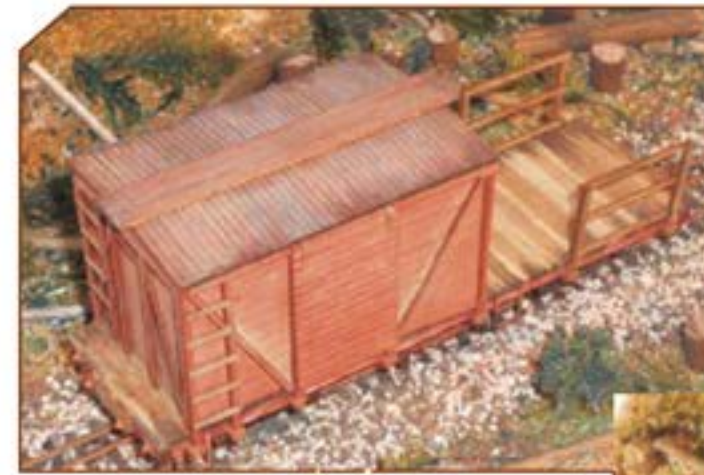

### ← MOW/Logging Caboose

Now in HO, HO<sub>N</sub>3, On30, N and Z

### ↘ Open Crew Car

Conversion kit for On30 Bachmann flat car – based on a Weyerhueser car on the Vail-MacDonald branch.



### ← Randolph Depot

Now in HO coming in N soon  
This charming Victorian Depot will be at home on any layout. Two building options and metal casting included

### Potato House →

Now in HO and N, soon in O

The perfect small warehouse with many door and window options. Barrels and pallets included.



Custom Laser Cutting and design  
Dealers welcome



click here

# Rslaserkits



5145 Gaffin Rd. SE • Salem, OR 9717 (503) 371-4290 • Fax: (503) 585-0850

E-mail: [Sales@rslaserkits.com](mailto:Sales@rslaserkits.com) Web site: [www.rslaserkits.com](http://www.rslaserkits.com)



the minimum orders might be better suited to a club, historical society, or a small manufacturer than an individual who doesn't want to do more than a few cars. Read the commercial printers' web pages carefully for help with design and formatting.

Kadee now offers custom decals made using an ALPS thermal printer. Go to [www.kadee.com/printing/alpscustom.htm](http://www.kadee.com/printing/alpscustom.htm).

Other outfits include:

- ELS Trains [elstrains.com](http://elstrains.com)
- Highball Graphics [www.mgdecals.com/homepage.htm](http://www.mgdecals.com/homepage.htm)
- Cedarleaf Custom Railroad Decals [gold.mylargescale.com/](http://gold.mylargescale.com/)

[stancedarleaf/webpagedecals/CustomDecalsx.html](http://stancedarleaf/webpagedecals/CustomDecalsx.html)

Custom decal makers come and go. Many of them are part-time enterprises and can be slow to respond. Study their websites for prices, design requirements and set-up fees.

[Walthers.com](http://Walthers.com), [micromark.com](http://micromark.com), and McGonigal Paper & Graphics ([www.mcgpaper.com/decals.html](http://www.mcgpaper.com/decals.html)) sell decal paper. Paper for ink jet and for laser printers has different surfaces, so you'll need to know which printer will be used before ordering paper.

More information is available at [www.micromark.com/html\\_pages/instructions/decal\\_instruction.htm](http://www.micromark.com/html_pages/instructions/decal_instruction.htm)

Also, check out the lengthy custom-decal discussion in this thread at [model-railroad-hobbyist.com/node/2386](http://model-railroad-hobbyist.com/node/2386)

— Joe Brugger

**Q: I've seen structures with interior lights that "glow" in the dark – the walls aren't opaque enough to keep light from propagating through them. What are some ways to keep this from happening?**

**A:** If you have an unassembled "flat kit," the cheap and easy way is to clean the walls, then lay them flat on a sheet of newspaper and spray their inside surface with flat black paint. Presto! No light leaks. Once the black paint has

dried, go ahead and paint and detail the outside of the walls in the usual way. Using black paint to light-proof kits with thin, light-colored walls, can result in a greenish color cast. Using white (Krylon® is good) avoids this, but you'll need multiple coats. Silver or aluminum paint also block light very well, and along with white are easily over-painted with a lighter color, such as yellow, if the interior walls will be detailed.

If you don't want to use paint, glue black paper to the inside walls, then carefully cut out the window openings with a sharp hobby knife.

Once the walls are made opaque, consider installing cardstock or styrene

#### ADVERTISEMENT

## Get Better Sound from your Locomotives

Can't get good sound from your sound decoder? Give our speakers a test drive with your ears.

We offer high quality speakers to enhance your model railroad experience

Dealer inquiries welcomed



**RAILMASTER HOBBIES**

**9815 WALNUT ST #106  
BELLFLOWER, CA 90706  
562-867-5627**

**WWW.RAILMASTERHOBBIES.COM  
SALES@RAILMASTERHOBBIES.COM**

Bass Reflex Speakers



High Bass Speakers



When it comes to speakers we have high quality speakers to fit many different applications. We are also a full line hobby shop. Need anything? We are an authorized dealer for Soundtraxx, Digitrax, Athearn, Walthers and many others. We provide quality speakers for your DCC sound systems and quality service.

floors and interior walls to control which parts of the building are lit and which remain dark.

If the kit is already assembled, you will need to pry off the roof or floor and mop paint onto the inside with a brush.

— MRH

**Q: What are mail storage cars?**

**A:** Mail storage cars carried bulk volumes of mail from point to point, and were sealed while in transit to prevent tampering. For example, a mail-sorting center in Atlanta would gather material destined for Chicago and points west and north. All of that mail could be routed together and wouldn't need to be touched again for resorting until the car was opened after its arrival in Chicago.

Cars for this service had to be weather-tight, but unlike a baggage or railway post office car (RPO), didn't need facilities for attendants. Many specialized mail storage cars looked

**Figure 3: Plastic drawer mat on a "mole" staging shelf, keeps cars from rolling over the edge.**



like baggage cars and were equipped to be handled in passenger trains. Ordinary baggage cars were also used for stored-mail service.

In the days of mass-circulation magazines such as "Life," mail storage cars would be loaded at the printer for distribution. Old schedules show mail trains that often consisted of several mail storage cars, one or more RPOs, and some basic passenger accommodation.

Many modelers are more familiar with RPO service, which operated like a local post office. Cars ran specific routes, picking up and delivering mail, while workers sorted the mail as the car rolled along. Many were even equipped with slots in the car sides for mailing letters.

— MRH



# TIPS

**Plastic drawer mats prevent "mole" staged cars from rolling**

The wood storage shelves in the Willamette Model Railroad Club's "mole" staging area posed a problem – free-rolling freight cars wouldn't stay put. To keep valuable rolling stock from taking a dive to the concrete

ADVERTISEMENT



**80-2050-1 Southern Pacific Alco PA A-Unit with DCC/DCS Proto-Sound 3.0**

- Separately Applied Handrails & Grab Irons
- Authentically Detailed ABS Body
- Operating Diesel Smoke
- Powerful 12-Volt 5-Pole Precision Skew-Wound Flywheel Equipped Motor
- Full Digital Sound
- On-Board DCC Receiver
- Cab Figures
- Constant Voltage Rule 17 Directionally Controlled Headlights
- Lighted Cab Interior
- Lighted Marker Lights
- Illuminated Number Boards
- Interchangeable Set of Kadee® Couplers
- Detailed Truck Sides
- RP-25 Metal Wheels Mounted On Metal Axles
- Locomotive Speed Control in Scale MPH Increments
- Authentic Paint Scheme
- All Drive Wheels Powered
- Operates on Code 70, 83 & 100 Rail 18" Radius Curves
- Kadee® Compatible Remotely Controlled Proto-Couplers

**80-2128-1 Union Pacific 4500 Turbine with DCC/DCS Proto-Sound 3.0**

- Separately Applied Handrails & Grab Irons
- Authentically Detailed ABS Body
- Operating Diesel Smoke
- Powerful 12-Volt 5-Pole Precision Skew-Wound Flywheel Equipped Motor
- Full Digital Sound
- On-Board DCC Receiver
- Lighted Cab Interior
- Constant Voltage Rule 17 Directionally Controlled Headlights
- Lighted Cab Interior
- Lighted Marker Lights
- Illuminated Number Boards
- Interchangeable Set of Kadee® Couplers
- Detailed Truck Sides
- RP-25 Metal Wheels Mounted On Metal Axles
- Locomotive Speed Control in Scale MPH Increments
- Authentic Paint Scheme
- Operates on Code 70, 83 & 100 Rail 18" Radius Curves
- All Drive Wheels Powered
- Kadee® Compatible Remotely Controlled Proto-Couplers

See why **M.T.H. HO Locomotives Do More**

See Them At Your Local Dealer [www.mthHOtrains.com](http://www.mthHOtrains.com)

Follow Us Online!

Contact us to join our mailing list for \$5.00, or to sign up for our FREE e-newsletter

HO TRAINS THAT DO MORE

7020 Columbia Gateway Drive, Columbia, Maryland 21046 phone: 410-381-2580 fax: 410-381-6122 ©2012 M.T.H. Electric Trains

floor, club member Jan Klimas covered them with “Rationell Variera” waffle-weave plastic drawer mats from IKEA.

These grippy, clear plastic mats come in 59-1/4” x 19-5/8” sheets for \$3.99. They’re easy to trim with scissors, stay where placed on a shelf, and the grid texture keeps cars from rolling.

Tool and kitchen stores sell other styles and colors, with and without adhesive backing. Say “no” to more death-defying freight car stunts.

— Joe Brugger

### Under-the-fascia curtains

Under-the-fascia curtains, such as those on Patrick Pope’s HO scale Cotton Belt layout, hide raw benchwork and the clutter that almost inevitably accumulates under most layouts.

Figure 4: Curtains look good and hide the boxes, supplies, or other stuff, that seem to often accumulate under a layout.



Figure 5: Spring-loaded clothes pins make curtain installation and removal easy.

Patrick hot-glued spring-loaded clothespins to the inside of his fascias to hold the curtains. This makes curtains easy to install and remove and is very inexpensive.

— Charlie Comstock

 **Reader Feedback**  
(click here) 

 **GET \$25 PER TIP**

We pay \$25 USD for each tip we publish. [Send your modeling tips to Model Railroad Hobbyist](#) and we’ll get payment to you upon acceptance.

Just think, for only a few minutes effort, you could fund your next piece of rolling stock – or even pay for an entire train if you send in several tips and we publish them!

If you include any photos with your tip, we pay a bonus of \$10 per photo we use with the tip. ■

ADVERTISEMENT

# Delrin to Styrene to Metal

## OH MY!



### MicroBond Ultimate System Pack

Every adhesive you need to assemble the majority of kits with plastic/metal parts and etchings.

Limited time through the Microscale website!

View our new releases [Newsletter](#)



Please join us online, via our website, facebook, and twitter!

  [microscale.com](http://microscale.com) 

MADE IN THE USA



## About our Modular columnist



**Les Halmos** has been a model railroader since 1979. He's been involved with setting modular standards for the NMRA since 1981. In 2001, he founded the Free-Modu-Rail Group and has been active in promoting Free-mo module standards.

[Click here](#) to learn more about Les.

Photos and illustrations by the author unless otherwise credited.

# MY MODULAR ADVENTURE: Having fun a module at a time

## The ongoing story - Roofing the Roundhouse!



### Cover me up! Winter is here, may I please have my roof?

**W**ow, I figured building roofs for this project would go like lightning. Wrong! After a lot of research I was no further ahead than before – is it going to be a tarpaper roof, or maybe some combination of corrugated metal with tar?

Because I based my design on the Heljan roundhouse to some extent, I might as well do the same for the roof. The Heljan kit has a steel roof, and because I was modeling my roundhouse in the late '60s, that would be a good choice. So I headed for the Web and check out how steel roofs were built.

I found a picture on the web that was very close to the Heljan roof. Well, that really sealed my choice.

Prototype: [www.futureroof.com/standing-seam-roof](http://www.futureroof.com/standing-seam-roof)

Heljan: [www.heljan.dk/webkontrol/modul/filarkiv/visfil.asp?id=2145](http://www.heljan.dk/webkontrol/modul/filarkiv/visfil.asp?id=2145)

One thing I did not like on the Heljan model was the design of the smoke stacks. I decided to use the ones in the Walthers Modular kit instead, as you will see.

I had pre-cut all the roof panels. Now it was time to do some detailing. I figured things would go quickly ...

Figure 1: Roof over the machine shop and first stall.



Figure 1

## STEP 1: Preparing the styrene panels



Figure 2: From experience, I know that styrene does not take paint very well unless the surface is prepared ahead of time. To do this, I usually sand each piece to roughen it up a little giving it some tooth.

Figure 3: Each panel was sanded using a motor tool. It really pays to invest in one if you do this often. Make sure you wear a dust mask, because it makes a lot of styrene dust.

Figure 4: You can easily see the difference on this piece. The sheen is gone in the sanded area. The paint will stick to this much better than to shiny-smooth styrene.



## STEP 1: Preparing the styrene panels (continued)



Figure 5

Figure 5: I chose Evergreen styrene strips, 2" x 6" and 2" x 12" for the caps. Although they seem to be over-scale, once installed they look nice and have the prototype look I was after.



Figure 6

Figure 6: Once all the roof pieces are sanded and fitted by cutting out the tabs, I was ready to start adding the styrene strips. Guide lines printed on a piece of paper helped me uniformly space all the pieces.

## STEP 2: Gluing the styrene strips



Figure 7

Figure 7: Using the drawing as a guide, I positioned the strips and glued them to their roof panel with MEK. I use a syringe to apply MEK because I can precisely control how much MEK I use – at least most of the time. More on this later ...

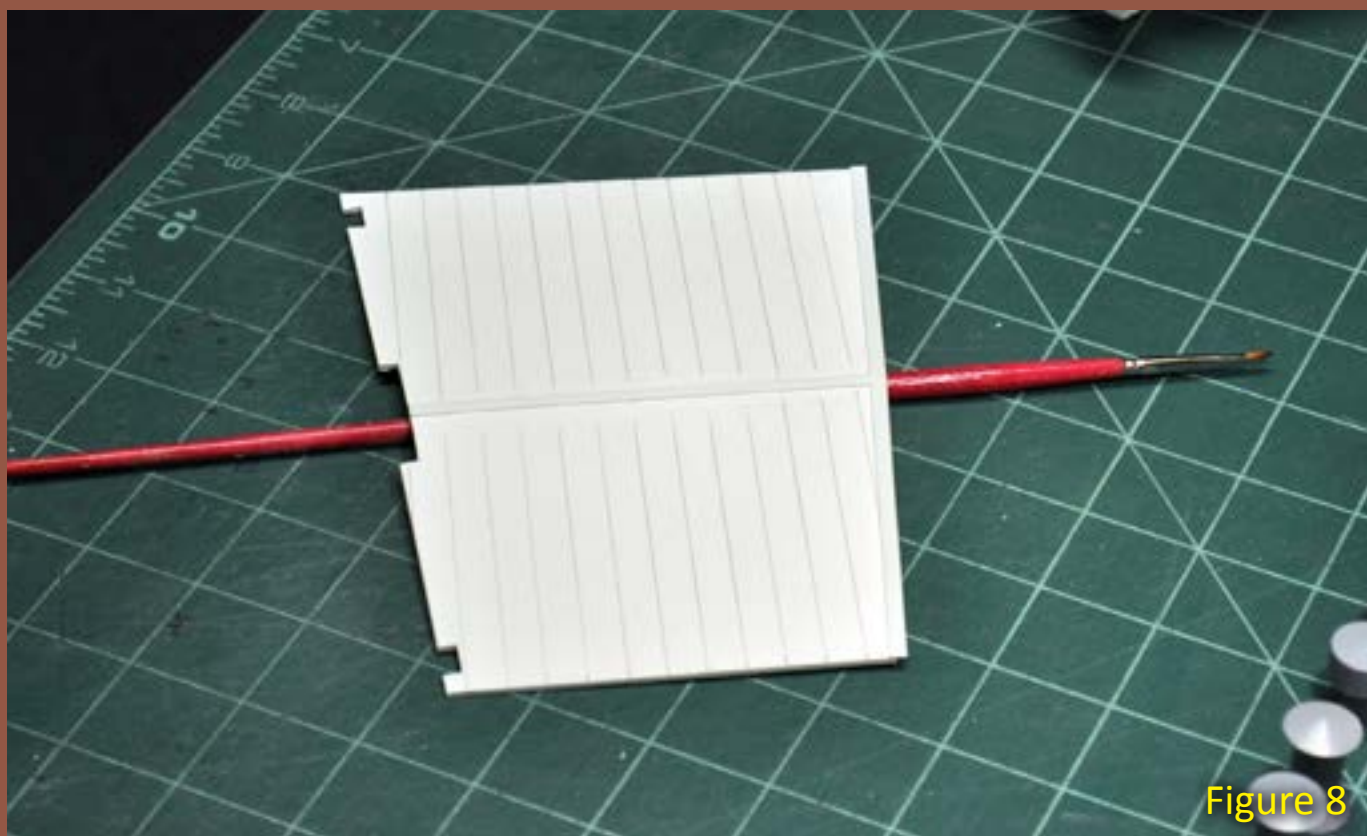

Figure 8

Figure 8: I originally made the middle portion of the roof with two pieces. I discovered Murphy had stepped in – they were cut a bit undersized. Oh well, you can't always get everything right. I cut a new piece for this part of the roof. This time I used a single piece, which worked out great.

### STEP 3: Sanding and filing

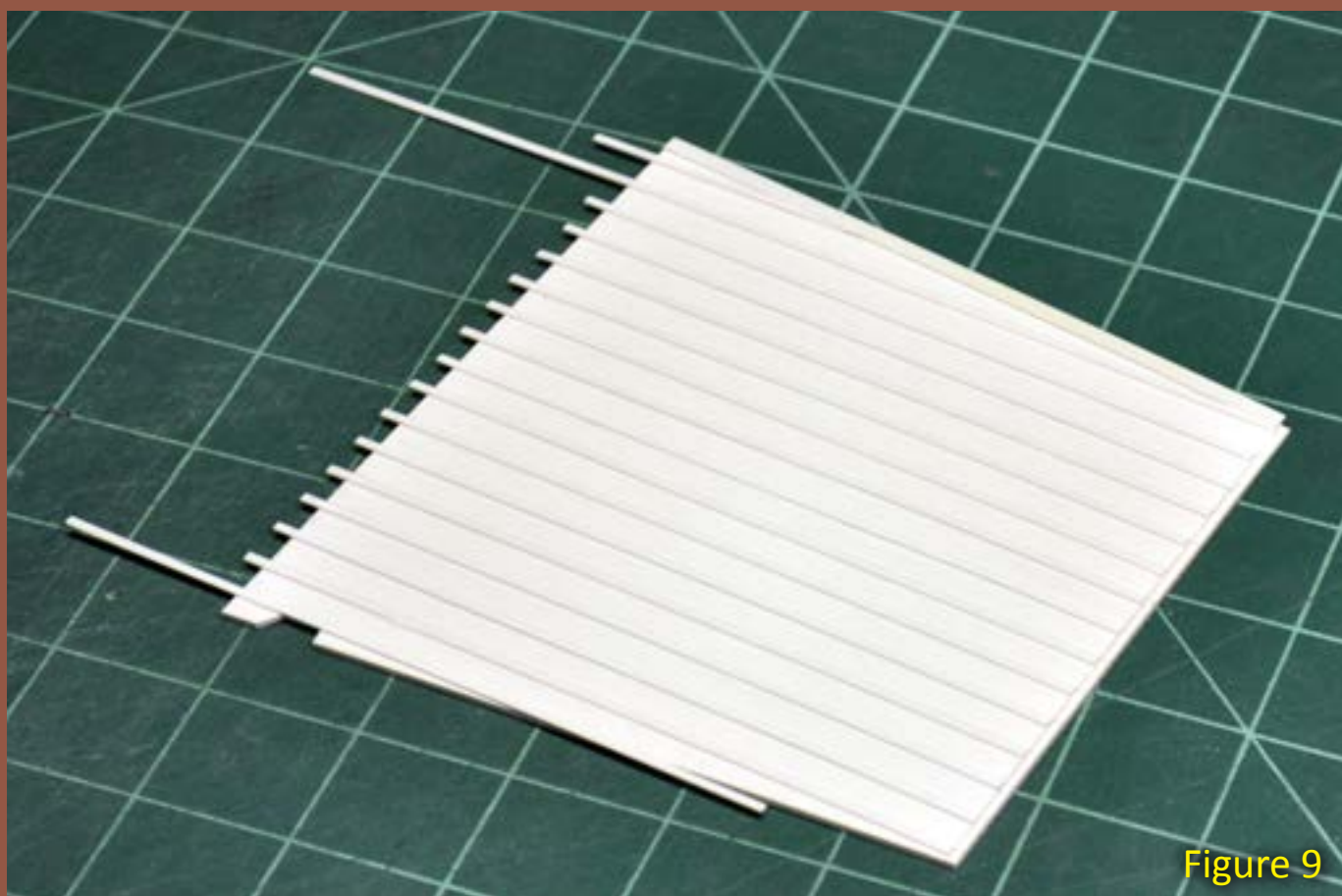

Figure 9

Figure 9: Once the strips dried I did some trimming. Cutting strips over-length and trimming them after assembly gives a neat and well-finished appearance.



Figure 10

Figure 10: Despite using the syringe to dispense MEK, I'd managed to get some excess between the ribs in a place or two which messed up the plastic surface. Being as careful as possible, I filed and sanded this area smooth.

A lot of the extra time I spent building roof pieces went into this step. However, the extra work resulted in a much better looking piece. The roof will be highly visible, not a great place for goofed-up modeling.



## STEP 4: Stacks and vents



Figure 11: I considered scratch building stacks, but finally decided to use Modulars components from Walthers. I picked the Tall Monitor Vent with Flanged Stack for the machine shop, and the Capped Exhaust Stack for the stalls. In my opinion, these look just right.

Figure 12: I'm assembling the stall stacks (and doing a little sprue removal at the same time). In my next column, I'll show how I scratchbuilt the bottom portion, which was positioned right over the steam engine stack.

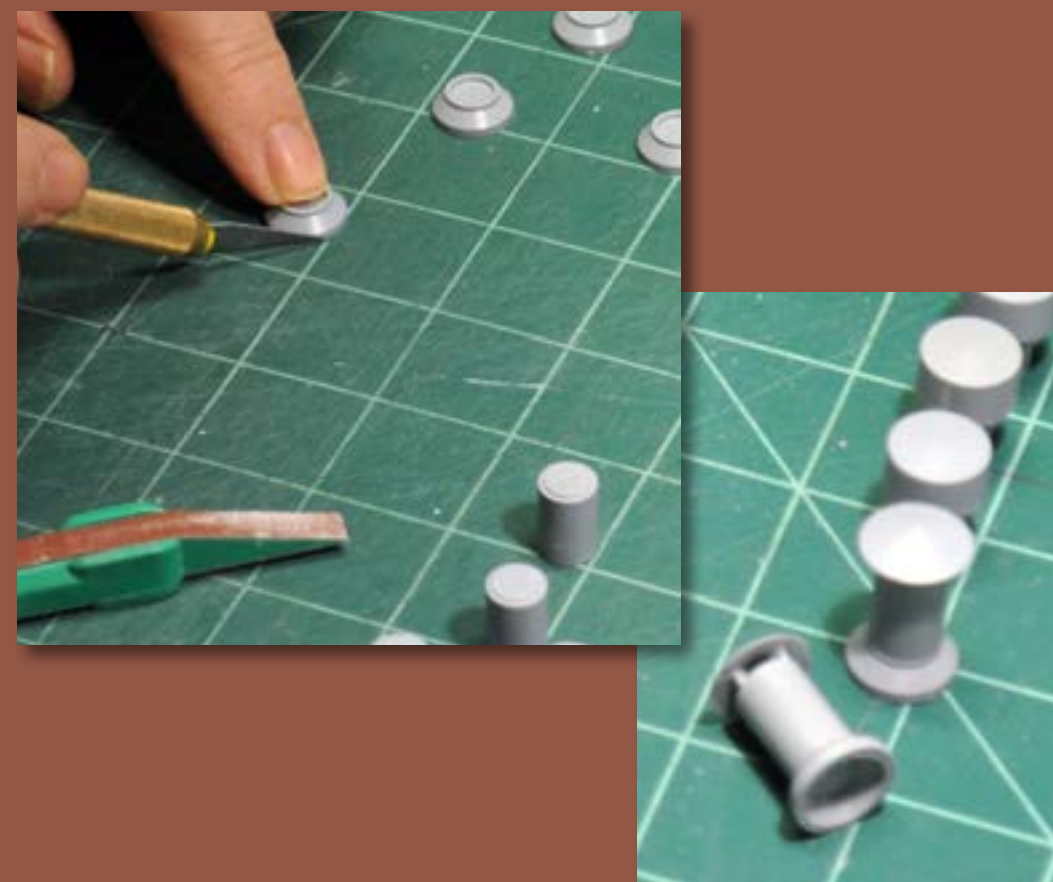

## STEP 5: Drilling and installing stacks and vents



Figure 13



Figure 15

Figure 13: Next I drilled the holes for the stacks and vents to a size just shy of their outside dimension using my drill press and Forstner bits. Then I carefully enlarged them with a file so the stacks just fit. I didn't want interior lighting to leak through the joints after they are assembled. The machine shop got industrial vents that require a 5/16" hole.

Figure 14: The stall stacks were a little more finicky to install. Due to the pitch of the roof, I drilled the 9/16" holes on a slight angle making sure the stacks would be perpendicular once installed.

Figure 15: The machine shop and stall #1 roofs ready for final fitting, before painting and final assembly. To display the interior, I'm making all my roofs removable, except the center portion of the stalls.



Figure 14

## STEP 5: Drilling and installing stacks and vents



Figure 16

Figure 16: Here is the final look; I will be installing some caps on the brick wall (on the right) to hide the edges. Once painted and weathered, it should look good. Four more stalls, then I can start working on the other ten stalls. Lots more fun and games ahead!

### Conclusion:

In my previous column I said, “I will cover building and installing removable roofs and adding some preliminary scenery to the module.” Well, every day is a learning experience, and underestimating time required to do a job is something I am starting to get used to. As they say, if you’re going to do a job right, take your time. It seems like every time I rush things, I have to do them over, or I can’t sleep at night.

In my next column (I am being a little less optimistic here), I will try to finish the roofs for the other four stalls and get them all painted. Then it will be time to add some pavement around, and leading up to, the turntable pit.

Thank you again for reading so far. Please click on the feedback button; your comments are most welcome.



# Discover the FUN of DCC!

Full Featured  
at an Entry Level Price



**Power Cab™**

**SB3a™**



Mid Level Home System

Use your Home  
Equipment at  
the Club!

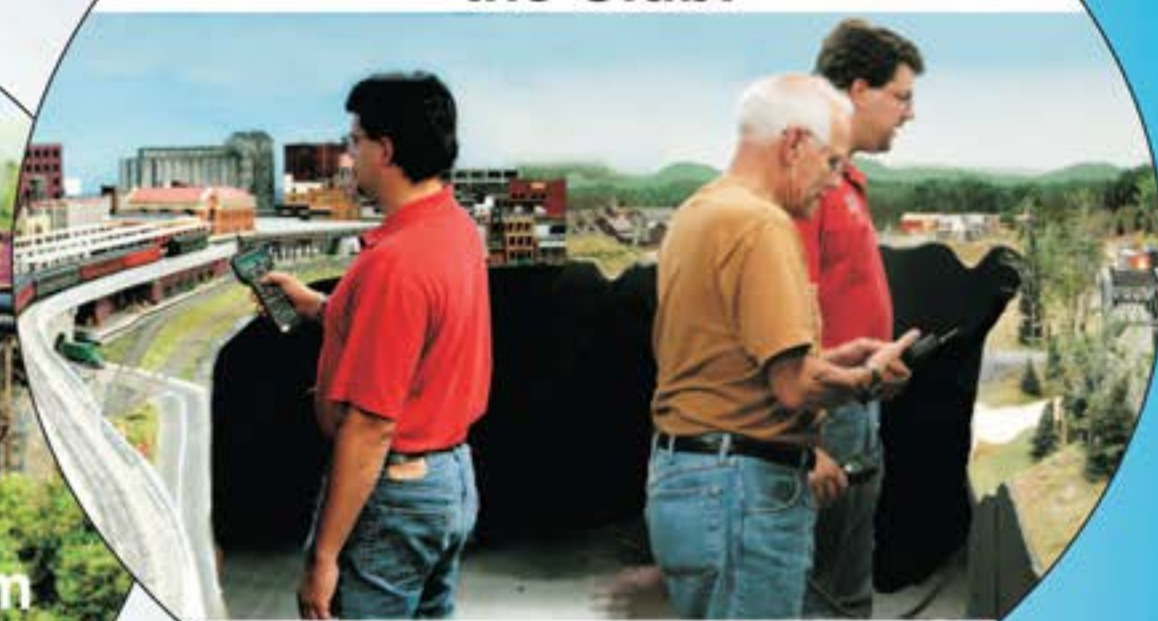

**PH Pro™**

The "Nothing Wasted Growth Path" all the way to Club Size

- Extraordinary Performance • Radio or Tethered
- Highest Rated DCC Systems • Made in the U.S.A.



Call or Email  
for FREE Brochure  
support@ncecorporation.com

585.265.0230  
9am-4pm EST.  
www.ncedcc.com

**NCE**  
*The Power of DCC*

# UP THE CREEK: Peninsula Construction!

A regular report on the construction of a 1950s-something layout

Part 2 - Finishing the helix and expanding the helix table benchwork ...

About our  
layouts  
columnist



Charlie Comstock became the MRH editor in the March 2011 issue.

[Click here](#) to learn more about Charlie.

In the last episode we left our intrepid helix heroes hard at work laying flex track on the inner and outer routes of the helix. Lots of progress and no visible signs of dizziness (yet). Before tackling the second lap, it is a good idea to drill any needed holes in the roadbed and solder all track feeder wires. Doing this after the lower lap is covered isn't fun.

You'd be amazed at how easy it is to forget that drilling a hole works best when there's room for the drill – or maybe you wouldn't?

## Optical Detector Holes

I plan to make my own optical train detectors with an infrared LED shining upward and an infrared photo transistor detecting reflections from the bottom of passing cars and locomotives (figure 1). I made a jig out of a scrap piece of oak to guide the drill when boring the holes between the rails (figure 2). Positioning counts. With a band saw, I cut grooves that slip over the rails to center the holes under the track.

I'm planning four sets of detectors for each lap in the helix (eight detectors per track, 16 overall). They'll allow crews who don't want to bend over and peer under the upper deck to keep track of their train's progress up

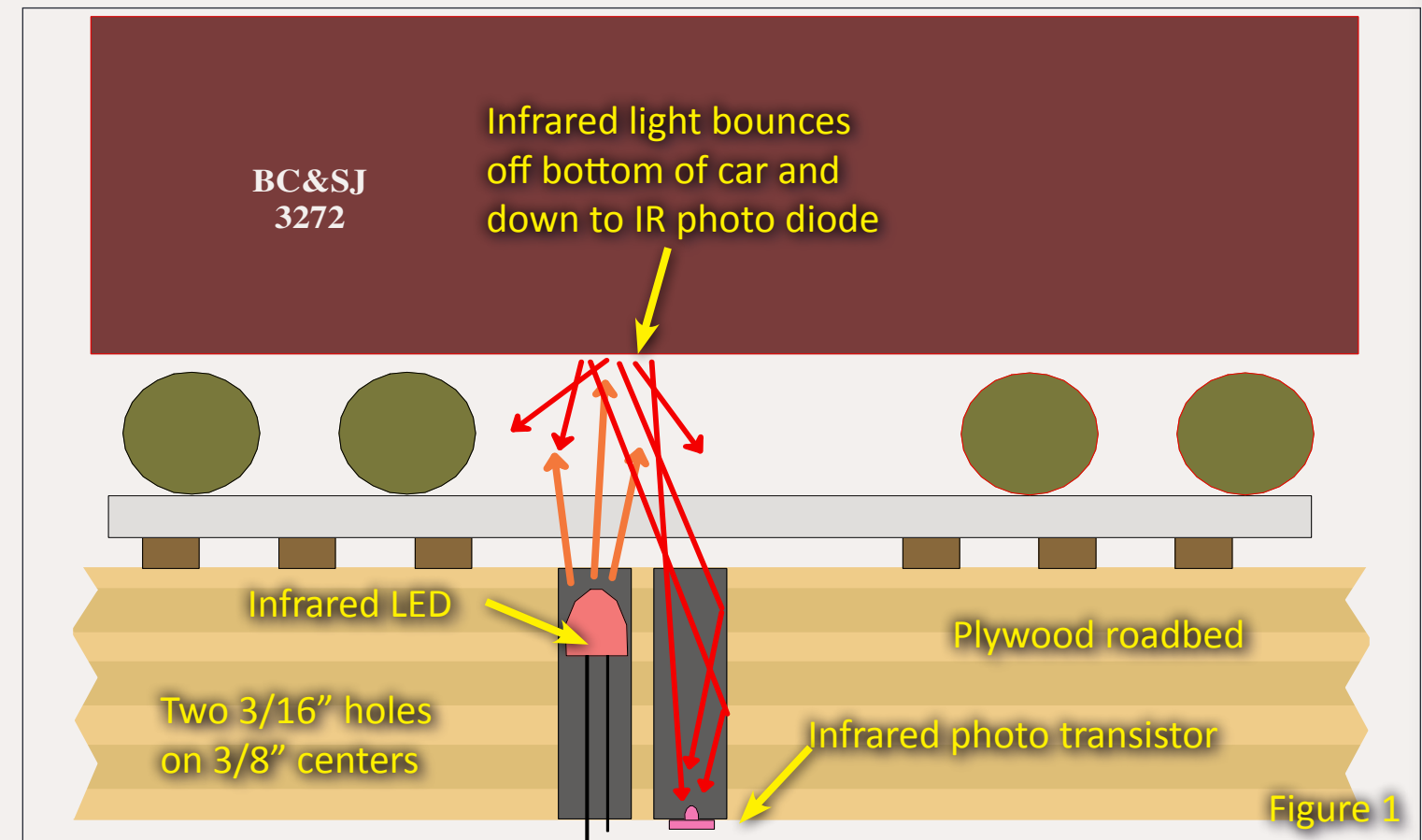
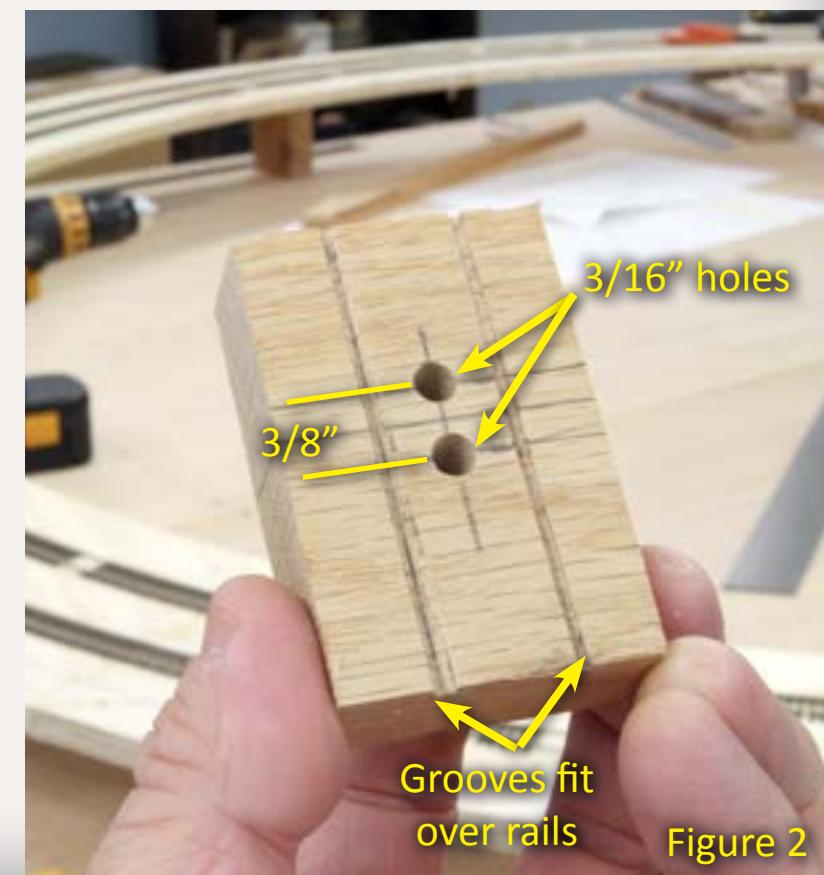

Figure 1: Holes in the roadbed contain an infrared LED and photo transistor. Light bouncing off the bottom of a passing train is detected by the photo transistor.

Figure 2: Hole drilling jig for lining up the holes in the roadbed for the infrared LED and photo transistor.

and down the double-track helix. I'll be writing more about optical detector electronics when I build and install it. In the meanwhile, I need to remove three ties and drill a pair of holes at each detector location.



 **Reader Feedback**  
(click here) 



Figure 3

Figure 3: Removing three ties where each optical detector will be mounted.

Figure 4: Holding the hole-drilling jig firmly in position with the rails running through its slots, and carefully drilling holes for the infrared LED and photo transistor.



Figure 4

I also soldered 22-gauge solid track feeder wires to the rails at this time, bringing them out to the edges of the helix roadbed where they'll connect to 12-gauge stranded bus wires.

Because the helix leads down to the main staging area configured as a large balloon loop, the two tracks in the helix have opposite polarity. I'll need to change the polarity of the DCC signal for the helix and staging area depending on the position of the turnouts in the junction at the top of the helix. The upper deck is also a (convoluted) reverse loop which makes this more complex. I'll explain further when I install Tortoises in the top-of-the-helix junction.

## Building the Second Lap

With the lower lap detector holes drilled and feeder wires soldered in place, it's time to start on the second lap of helix roadbed.

I considered, then rejected the idea of gluing the second lap roadbed pieces in place directly above the lower lap. I figured the rails on the lower lap would make it difficult to get the joints to sit smooth and flush. Also I needed a place to put wax paper under the joint (to avoid gluing the helix laps together!) and I was concerned the rails might tear the wax paper and let glue drips get through with disastrous results.

The answer (at least my answer) was to use another piece of plywood under each joint, letting me make wax paper sandwiches (figures 5 and 6).



Figure 5

Figure 5: I clamped a piece of scrap plywood under each of the joints in the second lap roadbed to "splint" the freshly biscuited joint. The track on the first (lower) lap roadbed made simply clamping the two laps together a poor choice. Using the scrap keeps the joints nice and flat.

Figure 6: Three more pieces of roadbed added to the second lap, waiting for the yellow carpenter's glue to completely dry before unclamping.



Figure 6

I was careful to align the curved helix roadbed segments over the helix edge markings we made on top of the helix table with the trammel when we were getting started.

I continued adding pieces of curved roadbed until a partial piece was needed at the top of the helix. This piece was rather short. I wasn't comfortable with two joints about 12" from each other so I cut out a couple of curved 1x1 roadbed braces. I glued these to the edges of the roadbed where they wouldn't interfere with trains passing by – at least I hope so! They made the short pieces feel stiffer.

I laid flex track on the second lap, propped up the roadbed for drill clearance, and bored holes for the optical detector components, then soldered track feeder wires in place.

## All-thread Rod

Things were starting to get exciting at this point – it was time to go vertical. Since I wasn't sure exactly how high the top of the helix needed to be to match the benchwork on the wall across the aisle, I chose to use all-thread rod to support the helix. This stuff looks like the threaded end of a bolt or machine screw but there's no head. It's literally "all thread". It also helped that my train buddy Mike Talviste had a bunch of 3/8" all-thread left over from another project and he let me use what I needed.

What about the spacing of the supports? Too far apart and the roadbed

might sag. Too close and I'd spend unnecessary money on hardware. I chose to use 14 pairs of supports or 28 supports total. Once I'd marked the helix road bed pieces I drilled through both laps and the top of the helix table trying to keep the drill as vertical (plumb) as possible (figure 7). Note the

**Figure 7: Boring the 3/8" diameter holes for the all-thread used to support the helix roadbed.**

**Figure 8: 3/8" lock washers, washers, nuts, and all-thread.**

**Figure 9: The secret to getting all those nuts onto the all-thread without actually going nuts! Get the nuts started, then spin the all-thread with the drill while holding the nuts and they scoot up and down quite rapidly. If you're not holding a nut, it spins too and doesn't go up or down.**

**Figure 10: Mike adjusting nuts and washers on a piece of all-thread after using the drill.**

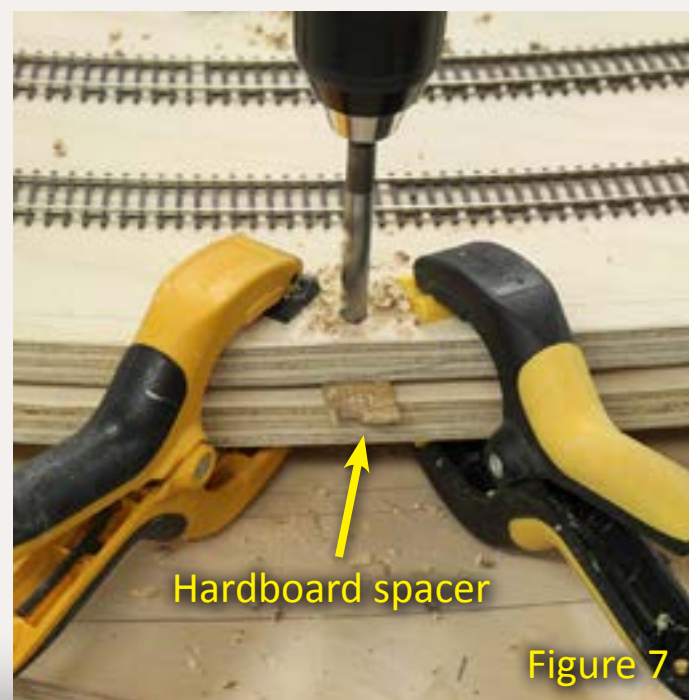

Figure 7



Figure 8



Figure 9



Figure 10

scrap piece of 1/4" hardboard used to separate the roadbed laps and prevent twisting or warping from the clamps.

When the helix is extended to its full elevation the geometry will change slightly and the holes won't be exactly vertical any more, nor will they be exactly above each other. But with only a 1.6% grade I figured the errors would be inconsequential and this, in fact, proved to be true.

Once the holes for the all-thread were bored, I propped the helix roadbed into approximate position. I used four pieces of 2x4, cut to height for quarter points of the helix, to support the lower lap. The upper lap supports were easy – they were all 3-1/2" high. I was very gentle while manipulating the helix roadbed to avoid undue stress on those biscuited joints.

Making ferrous (magnetic) saw dust in the train room seemed like a bad idea, so I cut the all-thread to length in the garage. Each pair of pieces was a slightly different length. After they were cut, I used my belt sander to smooth their ends to avoid getting nasty gashes while handling them. This ruined a belt – using a grinder would have been better.

To install the all-thread from the top, screw a nut on one end, place a washer below it, and insert it in a hole in the upper lap roadbed.

Once it's protruding through the upper lap roadbed, thread a washer, two more nuts and another washer before inserting it in the lower lap

roadbed. Using a drill to spin the rod made this go faster (figure 9). Once the rod is through the lower roadbed add another washer – nut – nut – washer set, and start the rod through the top of the helix table. This gets tricky at the lowest part of the helix – not much room for fingers there!

Once the all-thread supports with their nuts and washers were in position, we added a washer, lock-washer, and nut under the helix table and tightened it down.

Adjusting the nuts above and below the roadbed was a lot of work. Starting with the helix propped near its final elevation helped avoid a case of train room insanity. Once the nuts were tightened the helix got really stiff!

There is a lot of 3/4"x8" bracing under the helix table. The bottoms of the all-thread rods penetrated in places where they were "obscured" by the bracing. If the rods are in a place where you might rise up, be sure to cover them with something soft to avoid gashing your scalp!

The sidebar on [page 35](#) shows the bracing under the helix table.

## Cutting Out the Access Pit

Up to now the helix table surface had remained more or less intact. I used a trammel to finish drawing the curved track center lines. Having to thread the trammel between the helix supports made this more difficult. But better now than after the access pit (and the



Figure 11



Figure 12



Figure 13

**Figure 11:** After drawing the outlines of the central helix pit, I started cutting with my trusty jigsaw. I didn't want lots of dust in the train room so I held a vacuum directly in front of the saw's business end. It doesn't work perfectly; fine dust gets sucked up but some of the chunkier stuff escapes – luckily the escapees are too heavy to stay airborne and drift over to the parts of the layout with finished scenery.

**Figure 12:** I cut the pit hole by myself, so after cutting a little, I screwed scraps of wood to the "hole" to keep the plywood from tearing loose when I finished cutting the outline of the hole.

**Figure 13:** The helix table has two sheets of plywood on it, so the pit is cut out in two pieces. Here I'm removing the first one. The cleats kept it from falling and splintering the last bit of plywood.





Figure 14

Figure 14: I've almost finished cutting out the second part of the central helix pit. Again I'm using cleats to prevent the heavy chunk of plywood from falling. The vacuum greatly reduces the dust released into the layout room.

Figure 15: Removing the final piece of plywood from the helix access pit.

center point for these curves) is cut out. Once I was confident the mainline, branchline, and staging lead curves were properly located, I drew the outline of the access pit on the plywood, and attacked it with my jigsaw and a vacuum cleaner (figures 11 and 14).

As I cut out the access opening, I screwed a few scraps of wood to the section I was cutting out to keep it from falling when I finished the cut (figure 12). I was working by myself and if the plywood wasn't supported, its weight would cause it to splinter when the cutting was nearly complete – I hate splinters. Once both pieces were removed I sanded the edges smooth.

### Testing

I used the new helix access pit to run 12-gauge bus wires around the edges



Figure 15



ADVERTISEMENT

Installing DCC sound just **NOT** your thing?  
**Trust Traintek for sales and installation of sound decoders from these fine vendors!**



*"Taking model railroad control to the next level ..."*



**See us at the Amherst Show, Jan 28-29, 2012!**

**traintekllc.com**

Click here for more details...



**"Traintek was the way to go!"**



Still painting your models with brushes?



Let an Iwata airbrush turbo-charge your painting!



Click here for more details...

[www.iwata-medea.com](http://www.iwata-medea.com)

**iwata**  
**Revolution**

Quality, Performance and Value



A  
D  
V  
E  
R  
T  
I  
S  
E  
M  
E  
N  
T

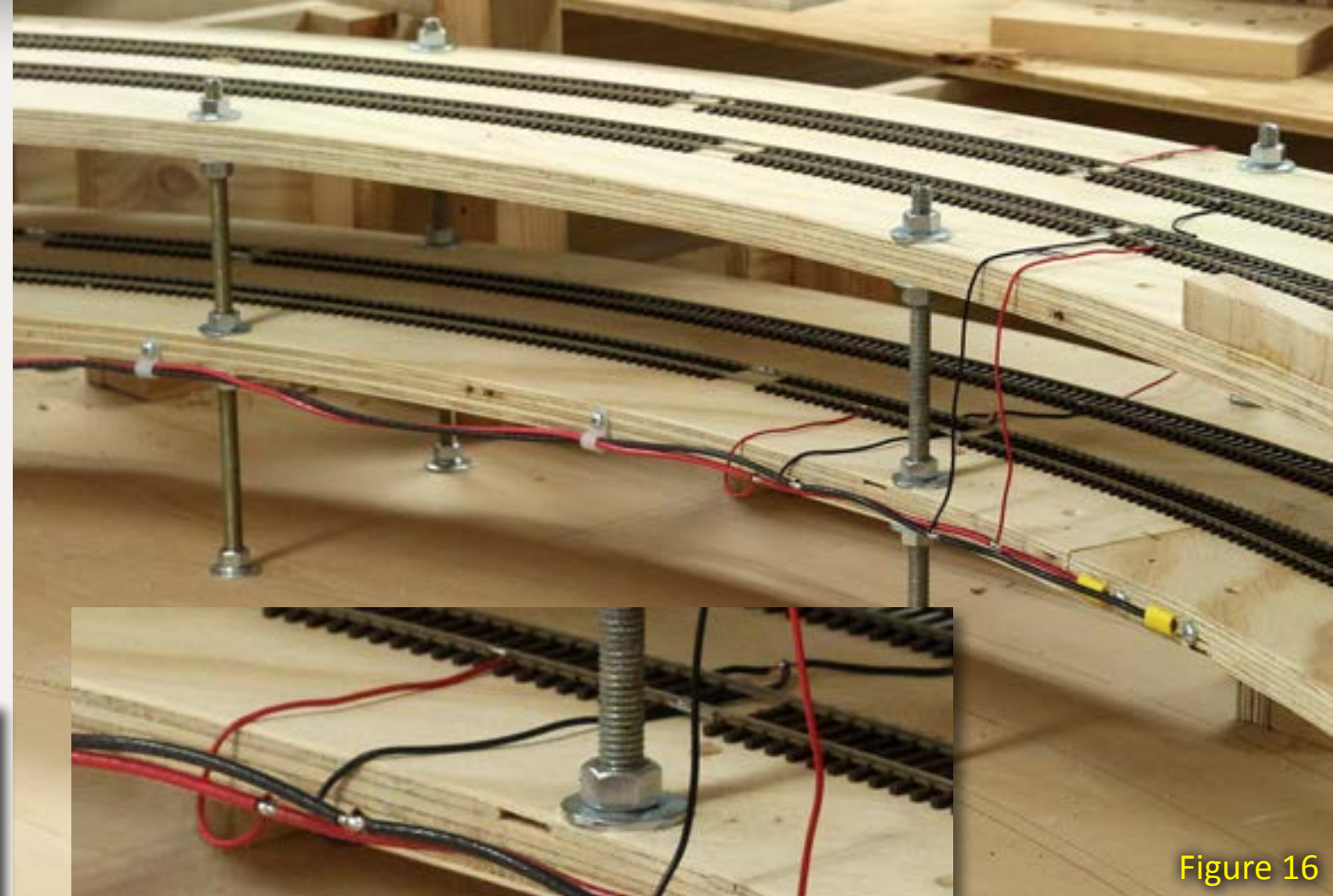

Figure 16

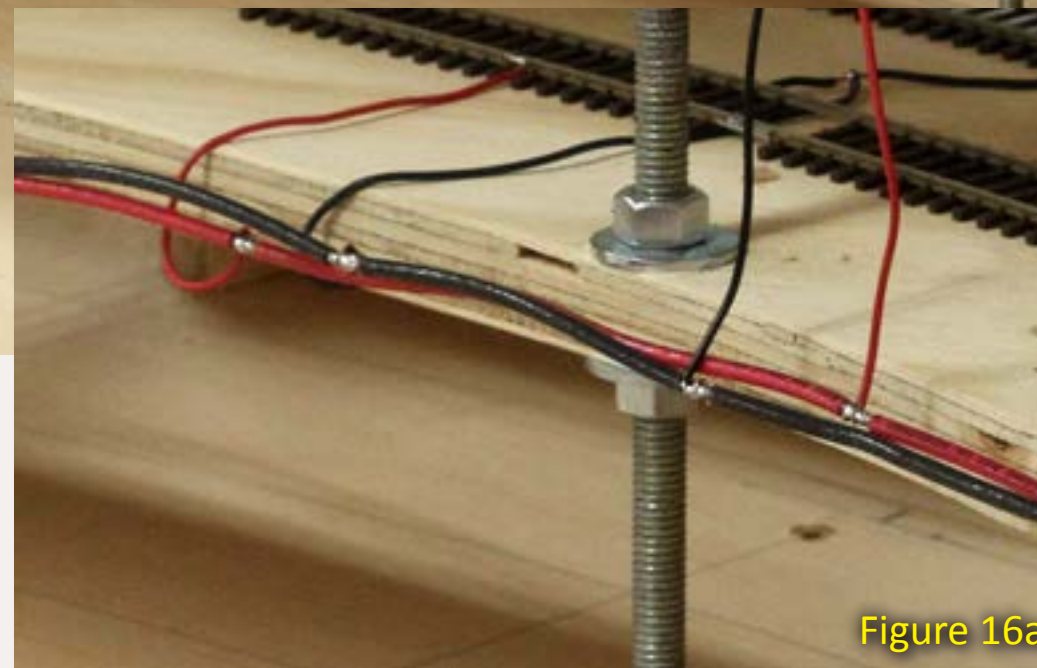

Figure 16a

Figure 16:  
I wired the tracks in the helix using my regular method – 22

of the lower roadbed using plastic cable clamps to hold them in place (figure 16 and 16a). I soldered the 22-gauge feeders to the bus wires for reliability.

I ran the bus wires down to the base of the helix and temporarily connected them to a barrier strip until I install the polarity-reversing circuitry.

The next step was power testing. I gapped the rails just before reaching the wye turnout at the top of the helix, and connected the bus wires for one track to a DCC booster. Oops, short circuit! It took a couple of tries before I figured

gauge solid feeder wires and 12 gauge stranded bus wires. The staging area at the bottom of the helix is on a balloon loop. This means that the two tracks in the helix have opposite track polarities.

Polarity-reversing circuitry will be necessary to prevent shorts at the top of the helix where the two tracks join. Rather than an auto-reverse unit, I'll be using a pair of 4PDT relays wired to the Tortoise contacts.

out where all the gaps needed to be – a drawback of working a 2 a.m.!

I grabbed a pair of Kato RSC2 locos – they’re great for testing as they’re notoriously persnickety about track-work, and set them on the helix. Up and down the rails they went. Hurrah!

I like to run helpers for over-tonnage trains, but I don’t use them unless they’re needed on my helper grade. I tried to design the grades in the layout so the helix wouldn’t be the ruling grade because helpers in a helix aren’t much fun. Trains from lower deck staging need to make it up the helix without helpers, yet that same train might need help on the 2.8% grade between Mill Bend and Oakhill, How much could a set of unassisted locos pull up the helix?

I started coupling cars behind the two RSC2s. They easily towed 40 ‘50s-era freight cars up the helix. I added my masonite-pad track cleaning car (which weighs a ton). The train still moved fine. For good measure I stuck six full-length passenger cars on the train. The RSC2s were now breaking a sweat but they were still dragging all that equipment up the hill without spinning their wheels.

The 1.6% grade on a 43” radius curve in the helix wasn’t going to be the ruling grade – my helper operation should run as planned.

## **The rest of the benchwork**

Although the helix table is a whopping 8’x 8’, the area of the layout it

## **Holding up the Helix**

Q: What supports my monster helix, the joists protruding from its sides, a bunch of other tracks, 4-foot-tall back-drop, and a considerable amount of scenery?

A: A “helix table” supported by sturdy 4x4 legs. The top is 3/4” plywood and there are a lot of 3/4” x 8” joists bracing the table surface (figure 17).

The helix table needs to be STRONG so its joints are screwed and glued. Screws alone would allow tiny amounts of slippage that would eventually turn into sagging.

The 4x4 legs are bolted to the floor using 3/8” concrete anchors. 8” wide plywood side plates are screwed to the tops of the legs. Internal joists connect to the side plates with 2x2 cleats screwed and glued in place (figures 17, 18, and 19).

The tops of ALL the side plates and joists were liberally coated with yellow glue (figure 20) and two 4x8 sheets of plywood were screwed on top (figure 21). This is not a place to skimp on the yellow glue – screwing into plywood side grain isn’t particularly strong.

The final touch were 3/8” lag bolts tying the side plates to the 4x4 legs. This helix table is sturdy!



Figure 17

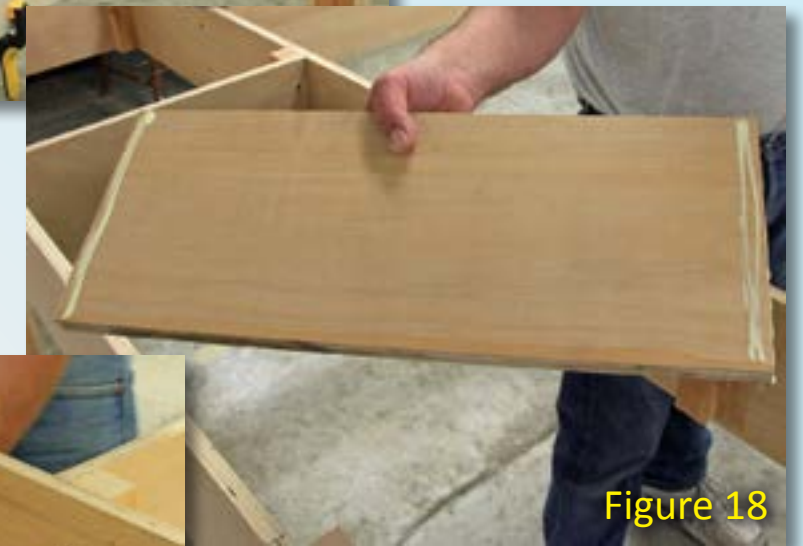

Figure 18



Figure 19



Figure 20



Figure 21



Mike (under the table) is driving screws through the side plates into the cleats. **Figure 22**



**Figure 24**



**Figure 23**

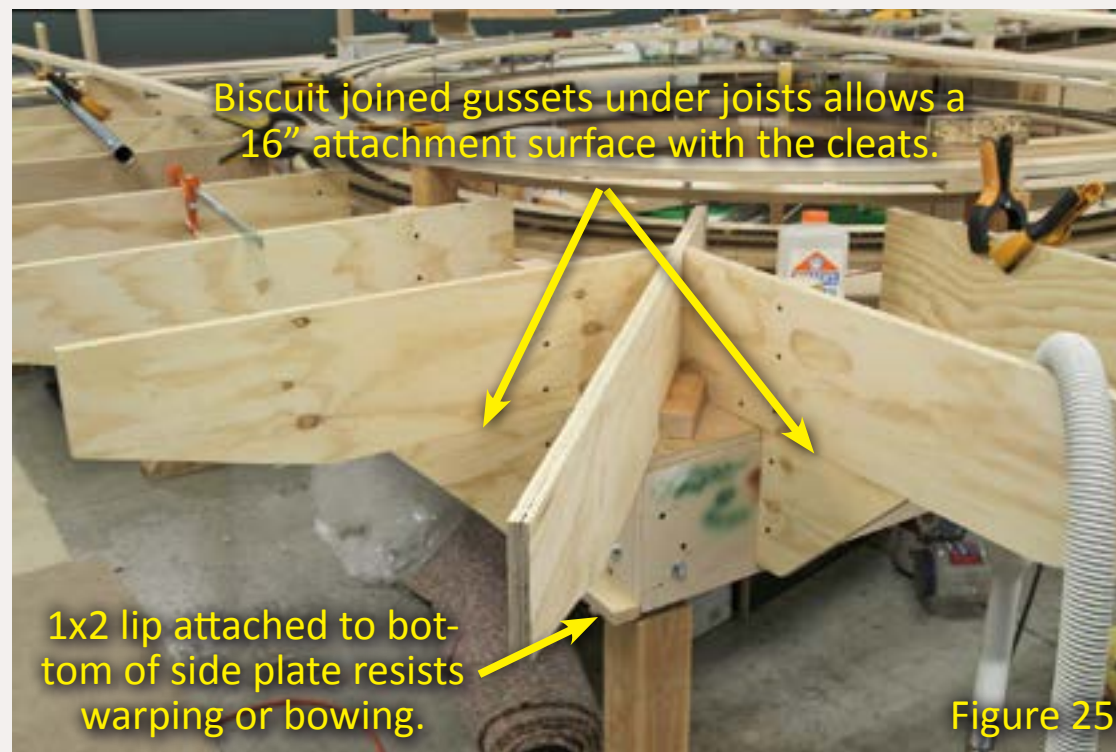

1x2 lip attached to bottom of side plate resists warping or bowing. **Figure 25**

**Figure 22:** I decided to screw and glue 2x2 cleats to the helix table side plates to hold the joists. Doing this with a two-man crew avoided a lot of crawling back-and-forth since the screws needed to go through the side plates and into the cleats for maximum strength.

**Figure 23:** I clamped a few joists in place to get an idea of aisle size. After living with 7' aisles they seemed small but still OK. The joists are 8" wide pieces of 3/4" plywood.

**Figure 24:** We did a lot of joist clamping!

**Figure 25: TROUBLE!** After Mike and Joe left I discovered that the joists were alarmingly flexible when attached only to the 8" of the cleats that protruded above the helix table surface. The solution was obvious – I added gusset plates under the table-end of the joists.

Guess how I attached those gussets? If you said biscuits, you're right! And by cutting the joists and gussets separately I was able to avoid wasting a lot of plywood cutting out odd shapes.

Check out the video on [page 37!](#)

has to support is much larger. The next step was to extend the helix table with joists cantilevered out from the side plates.

Why cantilevered construction? I like to keep the area under the layout free from legs as much as possible. It looks cleaner, or maybe it's because I tend to store so much junk down there!

My crew, Joe and Mike, screwed and glued 2 x 2 x 16" cleats to the side plates (figure 23). The screws need to go through the plywood into the cleats for strength. The joists are screwed to the cleats (I wanted to be able to remove them if necessary).

This area of the layout is called Browning and the roadbed surface there is about 11 inches above the top of the helix table. The 8" wide joists, mounted with their bottoms riding on the table surface (figure 23) will have a few inches of clearance between their tops and the bottom of the Browning roadbed for switch machine linkages and wiring.

An 8" attachment point between the joists and cleats didn't work well – the 2x2 cleats flexed at the bottom of the joists which resulted in unacceptable deflection at the joist ends. The answer was to biscuit-join gussets under each joist where they meet the cleats. This eliminated cleat flexing issues. But there was another issue.

The next problem was caused by deforming of the side plates. If a joist was attached to the side plate



Figure 26

where an under-the-table joist was located, it was very stiff. Otherwise the side plate deformed, letting the end of the joist move up and down. We addressed this problem by screwing and gluing a 1x2 "lip" at the bottom of the side plate turning it into an L-girder (figure 25). Now the joists were stiff! I beveled the ends of the joists for better access to the area underneath them.

**Figure 14: Cantilevered joists extend the size of the helix table considerably without adding legs.**

Stay tuned for more peninsula construction in the March MRH.

[BC&SJ track plans on next page.](#)



A clipping from the

# South Jackson Gazette

## Tracks Getting Hot!

To the horror of the BC&SJ engineering team, it was recently discovered that having trains running around in circles generates heat, and lots of it.

It appears the centrifugal force generated by going in circles causes excess friction between the wheels and the outer rails. The result is the track becomes smokin' hot.

As prominent local, Horace Fithers described it, "I was over near to South Jackson while these railroad boys were testing that newfangled track that goes around in circles. Anyway, they was running their train 'round and round – frankly I'm surprised that Ol' boy Ace Wheeler who was driving didn't git plumb dizzy! Anyway 'round and 'round it went and I started

smelling sumptin' smoky like. Now given that the ground in these parts is mostly plywood, we don't take no take chances when we smell smoke. So I started yellin' for the fire department."

"It were lucky that our fire marshall, S.T Behr was nearby and came on the run carrying an extinguisher. "

As it turned out, for once, where there was smoke, there wasn't fire. But the track was getting awfully hot. In the meanwhile Charlie Comstock, grim faced president of the BC&SJ railroad, suspended testing until "we get to the bottom of this mess."

At the South Jackson Tavern, rumor had it that operation might resume sooner rather than later. It seems the engineers borrowed a concept from their computer designing buddies and built a heat sink around the curved track to take away the excess heat. As a bonus, it appears the heat sink fins will serve well to support additional countryside for the trains to run through.

Said one unidentified patron at the tavern, "I suppose management will claim they done it all on purpose to make the world larger!"

This reporter doesn't know how the idea of heat sinks came about, but he hopes they will work. ☒

\* Enjoy the Gazette? Read more at [bcsjrr.com](http://bcsjrr.com)



Heat sink fins to dissipate the dangerous amounts of heat generated by wheel and rail friction as trains traverse large amounts of circular trackage.

**Bear Creek & South Jackson  
upper deck  
large grid = 5'**

Helix table

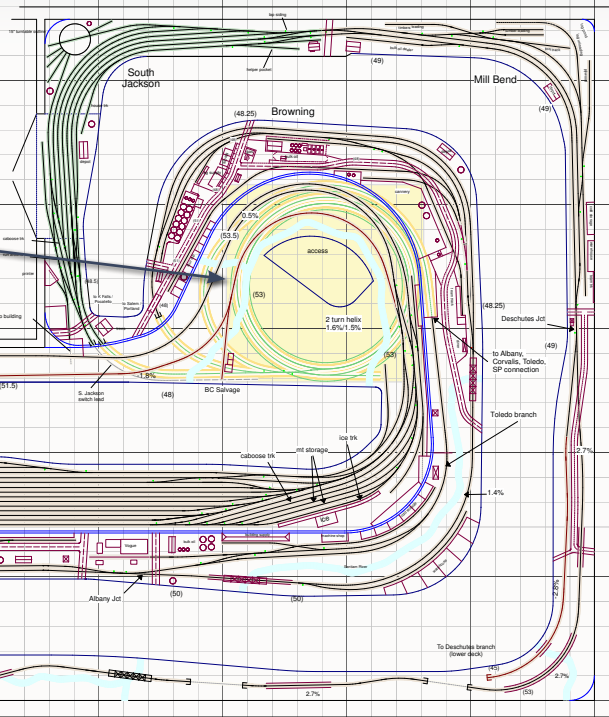

Figure 27

Figure 27: The current BC&SJ upper-deck plan. The peninsula is still under construction – there is no upper-deck yet. South Jackson, shown in green, has been substantially redesigned compared to the “scrap box” version (called that because it was hastily thrown together using plywood, screws, track, and wire salvaged from the previous BC&SJ). Zoom to expand the track plan for readability or [click here](#) to download a .pdf file of the plan.

Figure 28: The current BC&SJ lower deck plan. The helix is built but none of the main staging tracks are in place yet. Zoom to expand the plan for readability or [click here](#) to download a .pdf file of the plan.

**Bear Creek & South Jackson  
lower deck  
large grid = 5'**

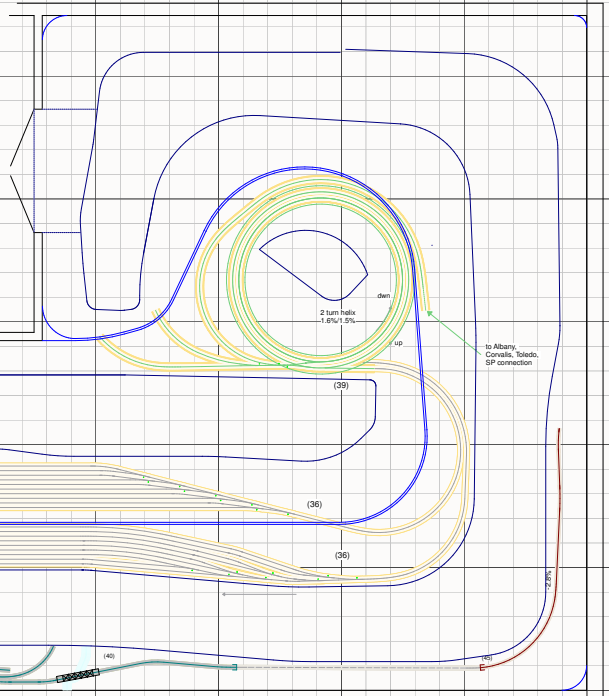

Figure 28



**Litchfield  
STATION**

*Covering  
ALL Your  
Train Control  
Needs!*

ADVERTISEMENT



**RailPro™  
Products  
& More!**

**www.Mr-DCC.com  
623-298-7355**

# The Sky's the Limit ...

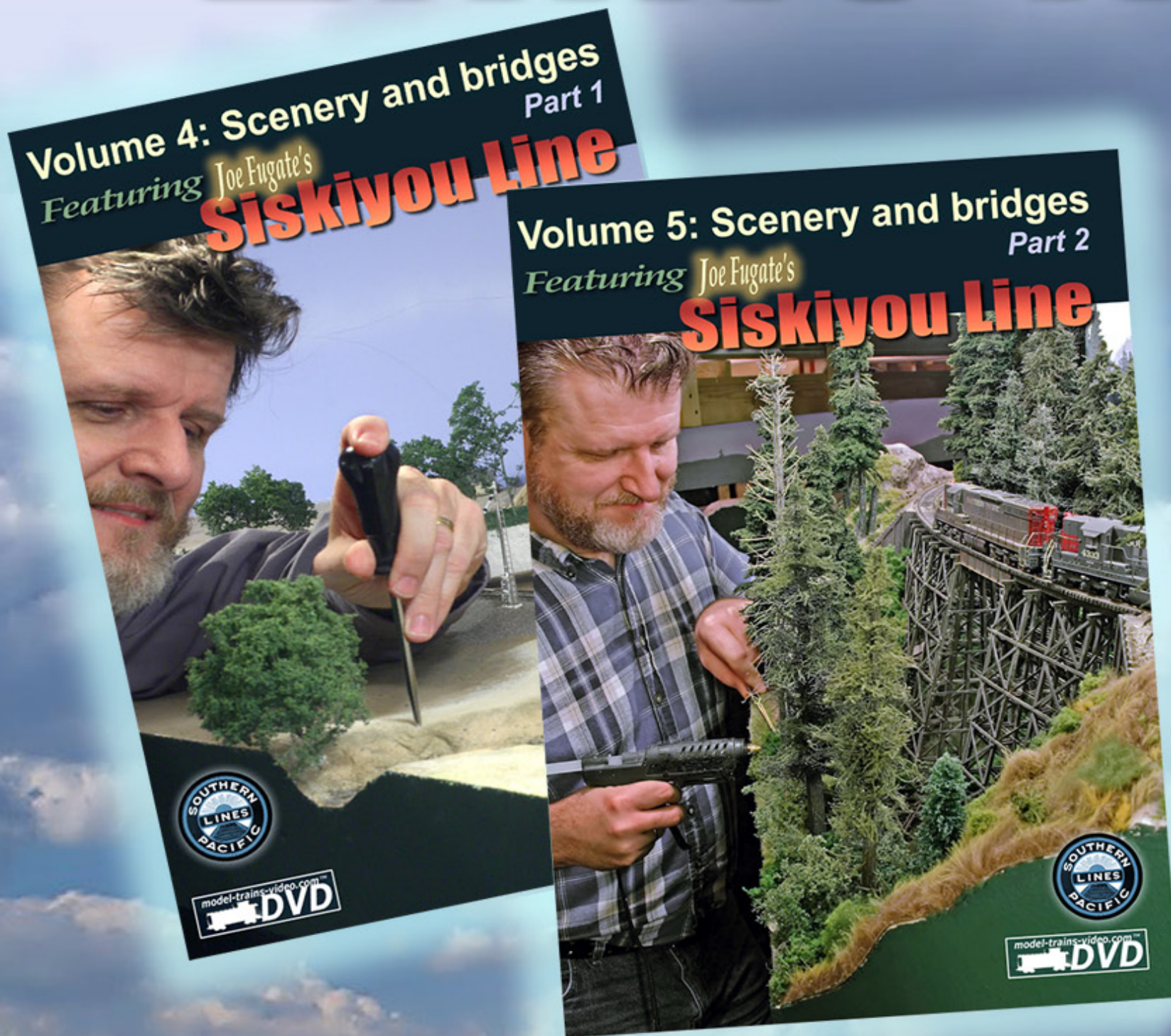

**With these scenery techniques!**



Click to learn more ...

Better, faster ... **more fun!**



**[model-trains-video.com](http://model-trains-video.com)**



## About our N-scale columnist



**John Drye** is our N scale editor and columnist.

[Click here](#) to learn more about John.

# COMME-N-TARY: Coal at Cresson Adding coal operation to the PRR Horseshoe Curve

## Modeling in the hobby's most eNgaging scale

 **Reader Feedback**  
*(click here)* 

### Conducting local coal operations using a marshalling yard ...

One of the objectives for the design of my Horseshoe Curve layout was to include some local trains in addition to the parade of mainline trains making their way up and down the mountain. While there wasn't room to model coal mines on the layout, there was space for the coal marshalling yard at

Cresson. This article describes design, construction, and planning for the local coal operations.

### History

Coal has been mined in this part of Pennsylvania since the late 1700s. Early settlers dug coal for use by village forges and blacksmiths. By the mid-1800s coal and coke was being used by iron foundries in the city of Johnstown and elsewhere. The Pennsylvania Canal and Allegheny Portage Railroad, completed in 1834, was used to transport this coal from the mines to consumers. A few years later, the Pennsylvania Railroad replaced canal boats with railcars, and the first coal made its way around Horseshoe Curve.

But the PRR wasn't the only railroad hauling coal from the mines. The Berwind-White Coal Mining Company began in 1886 with a single mine south of Johnstown and quickly expanded to operate a fleet of cars serving mines across the state. The Cambria Iron and Steel Company also operated mines and a small fleet of hopper cars and there were others, too. Many of these companies interchanged cars with the PRR. By 1901 there were more

**Figure 1: Operations from Cresson Yard involve hauling hoppers such as these PRR and Berwind two-bay cars from the yard downhill to staging.**



Figure 1



than 100 large coal mines in Cambria County alone, and the horseshoe curve boasted four tracks.

## Yard design

The prototype Cresson yard stretches west from the railroad's main line, with an engine facility at the junction of the yard and main. A wall in the basement would interfere with the prototype arrangement; so on the layout, the yard and engine facility parallel the main. There is still room for four yard tracks and a selectively-compressed engine facility. The prototype tracks extend from the yard north and west into the coal fields. On the layout, this extension disappears behind a stand of trees, just before it bumps into the corner of the room.

The four tracks hold at least three trains of hoppers ready to be worked while leaving space for run-around moves. Each track will hold 10-15 cars. The trick is how to integrate these consists into an operating session.

## Construction

The yard was built as part of the Cresson module. As with other areas of the layout that include lots of turnouts, the track was laid on a section that is similar to a portable layout module. Clearly, the layout crew's experience with NTRAK modular model railroading had an influence on construction techniques. The Cresson module includes a four-track coal yard, engine facility and

the four-track main, including some crossovers and an additional track to help manage trains adding or detaching helpers at the top of the hill.

After the track was laid, the module was turned on its side to make installing switch machines and track feeders easier (figure 2). The crew certainly appreciated the lessened chances for dripping solder on their noses compared with crawling under the layout to wire this area. Once the wiring was done, the module was turned right-side-up and tested.

When the adjoining trackage was complete, the module was installed on the existing sub-bench work. Cresson fits between the upper entrance to the staging yard and another module representing Gallitzin. Gallitzin went through the same process and was installed next to Cresson. On these and the other modules, the track was not laid

**Figure 2: Here's a view of bottom of Cresson module with Steve Jackson, one of the layout crew. The module uses conventional construction, with a plywood top framed with dimensional lumber. This allows cookie-cutter cuts to provide the required elevation.**

**Figure 3: Leonard White demonstrates that working on the underside of the layout is much easier when it can be done at the workbench.**



Figure 2



Figure 3



Figure 4

**Figure 4:** Runaround connections are provided for three of the four yard tracks, allowing trains to arrive with empties and depart with loads.

**Figure 5:** A pair of Fairbanks-Morse locomotives pulls a cut of hoppers from track 2 while another string waits its turn. The schedule will include four sets of loads and two of empties – plenty of coal to keep the steel mills humming.



Figure 5

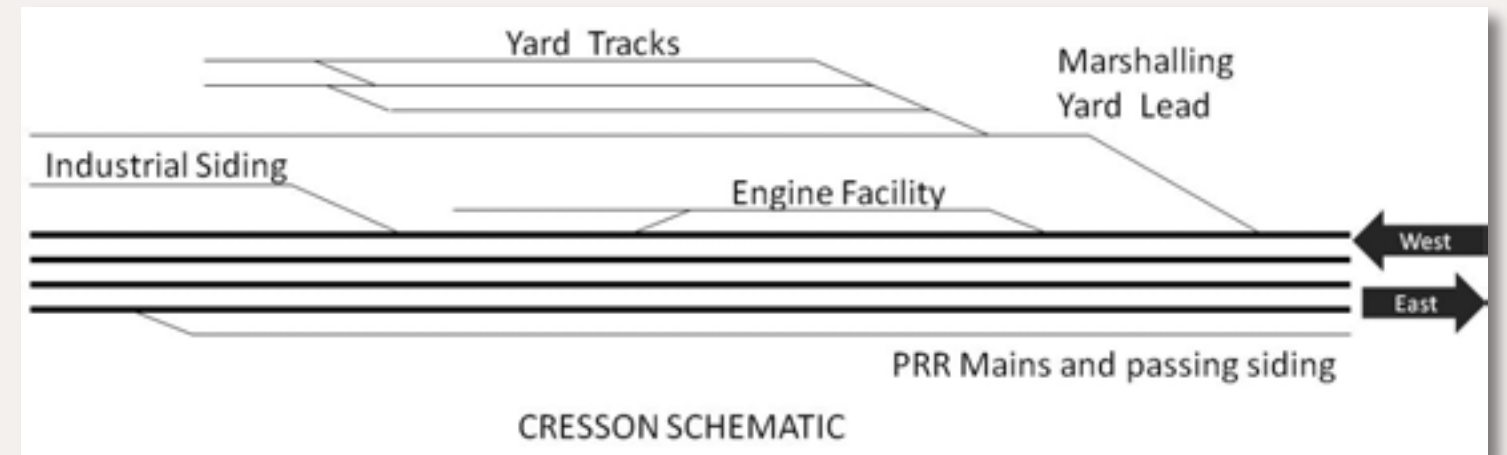

right up to the edge of the module. Instead, a foot-long gap was left so that the connecting tracks could be laid smoothly between modules. After this track was laid, more testing took place.

Because the tracks are all stub-ended, magnetic uncouplers will be used at the end of the yard tracks. This ought to make it easier to manage traffic.

## Operations

On the prototype, trainloads of hoppers were brought into Cresson day and night. Hoppers still pass through Cresson today, traveling from nearby coal mines. The yard also sees covered hoppers carrying salt from another local mine.

Because there are no coal mines on the layout, we will have to make do with pre-staged strings of hoppers to represent coal loading. It would be nice to re-stage loads during an operating session, but we haven't yet figured out a way to do that. Perhaps that's a topic for a future layout upgrade?

For now, the four tracks provide room for at least three consists of hoppers. Many of these will be PRR cars. Others will be from coal operations in the area or cars acquired from other nearby coal-hauling railroads. Fortunately there is a vast selection of 1950s-era hoppers available from a variety of manufacturers.

Bowser offers the PRR GLa two-bay hopper in a variety of PRR schemes as well as many coal short line liveries. Perhaps the most important of these is Berwind, famous for its circle in a box emblem. Atlas offers cars painted for the Cambia and Indiana and almost everyone who makes cars in N scale makes a coal hopper of one sort or another. It will not be difficult to acquire the 60 or so loaded and empty cars required to support the mines.

The simplest way to simulate coal operation would be to haul a consist of empties from staging to Cresson, leave the hoppers in the yard, and pick up a string of loads to return to staging. However, the yard track arrangement allows only two such round trips per

session. That's not sufficient to keep the mills in Pittsburgh running.

So, a session will begin with the yard crammed full of hoppers, a string on each of the four tracks. This is not an arrangement that will make yardmasters happy because the yard is log-jammed. The solution is for the first train to Cresson to run light up the hill, with only engines and a cabin car (caboose on the Pennsy). The

train runs around the cabin car using mainline crossovers (checking with the dispatcher, of course) then backs onto the first string of hoppers. The hoppers are pulled onto the main and backed onto the cabin car. After an air test, the coal heads down the hill.

The second train does the same thing – with two empty yard tracks, a runaround becomes available. The last two trains of a session take

advantage of the runaround and bring empties up the hill. The empties are pulled into the yard and the engines use the empty track to escape, couple on to a set of loads, then the cabin car, and request permission to occupy the main.

Occasionally a consist of empties will include a boxcar to deliver supplies to the mines. The unloaded car will return with the loaded coal

**Figure 6: The downhill train pulls out onto the main, running wrong-way past an uphill freight. The coal drag will utilize the next set of crossovers to get to the appropriate track for the rest of the run downhill to staging.**



Figure 6

# Model Railroad Hobbyist magazine™

Now in our 4th year

HAVING FUN WITH TRAINS



May 2010

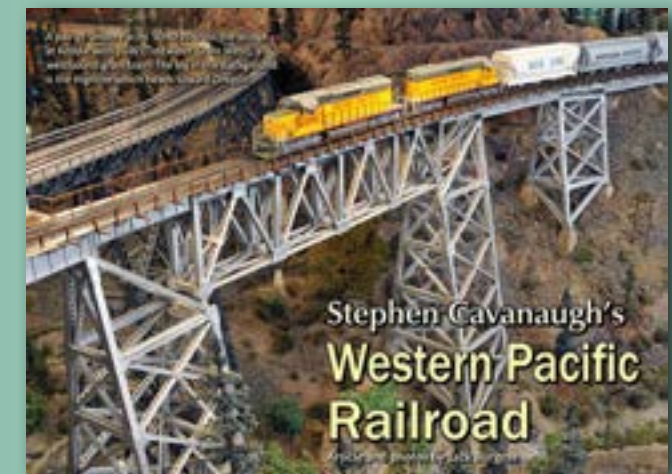

January 2011



March 2011

*Add Raised (3D) Rivet Heads and Other Details to Any Surface...Easily, Quickly and Economically!*

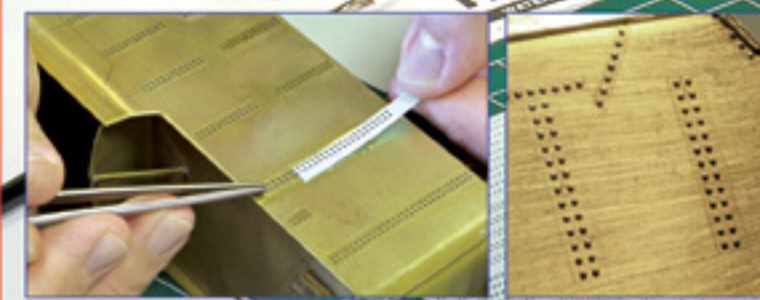

**Only \$1495**  
for 2 Large Decal Sheets



Same tender...after detailing, painting and lettering. Rivets remain highly visible...even after painting!

Micro-Mark has done it again! We've developed a way to produce scale size rivet heads and other surface details, such as grillwork and louvers...realistically shaped and contoured...on the surface of our blank decal paper. To add this detail to your model, simply cut out and apply like any other decal... it's that easy! Apply under or over paint to produce the exact effect you desire. Apply to most any surface...up and over curved

surfaces as well as in the flat. Each package contains over 118 square inches (two large decal sheets) of several different rivet patterns in both straight lines and curves, plus bonus louvers and grillwork. Although described below as for HO or O scales (typically for model railroad use), they are useful across various scales.

#84985 HO Scale Surface Detail Rivet Decals #84987 O Scale Surface Detail Rivet Decals

**Order online at [www.MicroMark.com](http://www.MicroMark.com)**

ADVERTISEMENT

hoppers. At some point we may try to figure out how salt operation can be incorporated in a session. At least covered hoppers do not have to be restaged, they look the same whether empty or loaded.

The first scale mile or so of the trip back to staging is wrong-way running. That is, the downhill train uses the uphill tracks. The PRR built long flyovers at several points, including one at Cresson, to alleviate this problem, but there is not room on the layout for these. Hopefully the dispatchers will relish the challenge of getting the coal back onto the correct track.

The bridge for the flyover at Cresson is a distinctive hallmark structure. For this reason it will be included as part of the scenery, but the tracks will be non-operational.

**The way ahead**

Right now, initial testing of the yard tracks is underway. It is often a good idea to run trains for a while on newly-laid track, to ensure everything is functional. It's much easier to adjust tracks or replace turnouts before ballast and scenery is in place. Pretty soon though, the PRR hopes to begin supplying power plants and steel mills across the region with coal hauled out of western Pennsylvania, through Cresson and around Horseshoe Curve. ✓

**Reader Feedback**  
(click here)

**Model Railroad Hobbyist magazine™**

Now in our 4th year

**HAVING FUN WITH TRAINS**

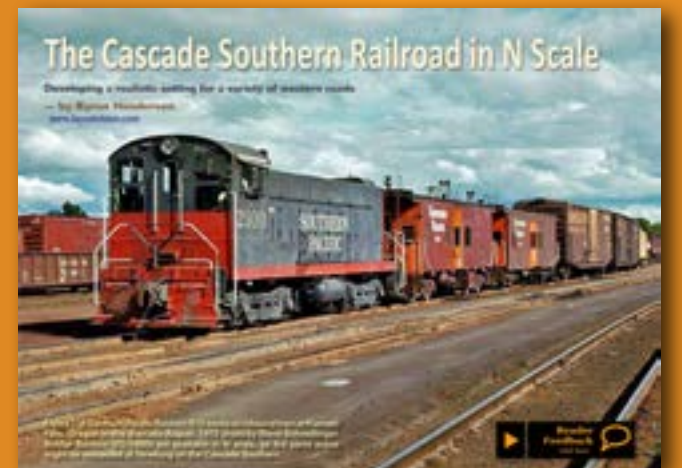

June 2011



April 2011

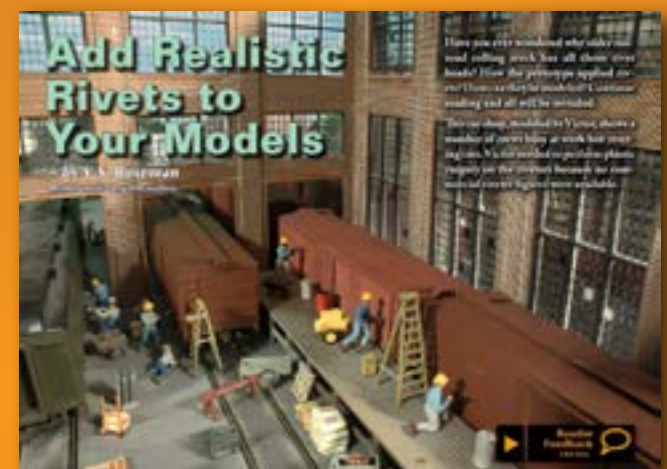

August 2011



## About our DCC columnist



**Bruce Petrarca** is a well-known expert on all things DCC.

[Click here](#) to learn more about Bruce.

Photos by author unless otherwise noted.

# DCC Impulses: Wired Decoder Installation - part 2

## How to tame difficult locomotives

### What to do when YOUR locomotive is driving you loco ...

Last month, I laid some groundwork for decoder installation: skills, tools, supplies, motor isolation and some other concepts ([model-railroad-hobbyist.com/magazine/mrh-2012-01-jan/dcc\\_impulses](http://model-railroad-hobbyist.com/magazine/mrh-2012-01-jan/dcc_impulses)). You might want to review that column before you press forward in this one – what I will be discussing here is based on items discussed there.

Most of my examples will be HO (as that is the most popular scale), but many of the concepts apply to other scales.

I covered plug-in decoders last November ([model-railroad-hobbyist.com/magazine/mrh-2011-11-nov/dcc\\_impulses](http://model-railroad-hobbyist.com/magazine/mrh-2011-11-nov/dcc_impulses)). This column will deal with soldering decoders into a locomotive.

Let's review the goals of an installation:

- Removing the connection between the rails and the motor
- Inserting the decoder

Figure 1: Schematic for DCC decoder connection – adapted from a SoundTraxx drawing

- Adding lights and other functions.

### Don't Reinvent the Wheel

If you can find installation hints or instructions for the combination of locomotive and decoder you're using, check them out, and if they make sense, follow them. Sometimes you may find installation examples for similar locomotives or decoders. Even though they're not exactly what you're looking for, they can be useful, too.

If you haven't already acquired a decoder, do some research on which decoders make the most sense for your locomotive.

This column may give you some ideas regarding an installation. You may be able to use them for your situation.

### Cooling

I'm going to start by discussing something many folks ignore – how to cool the decoder. All electronics generates

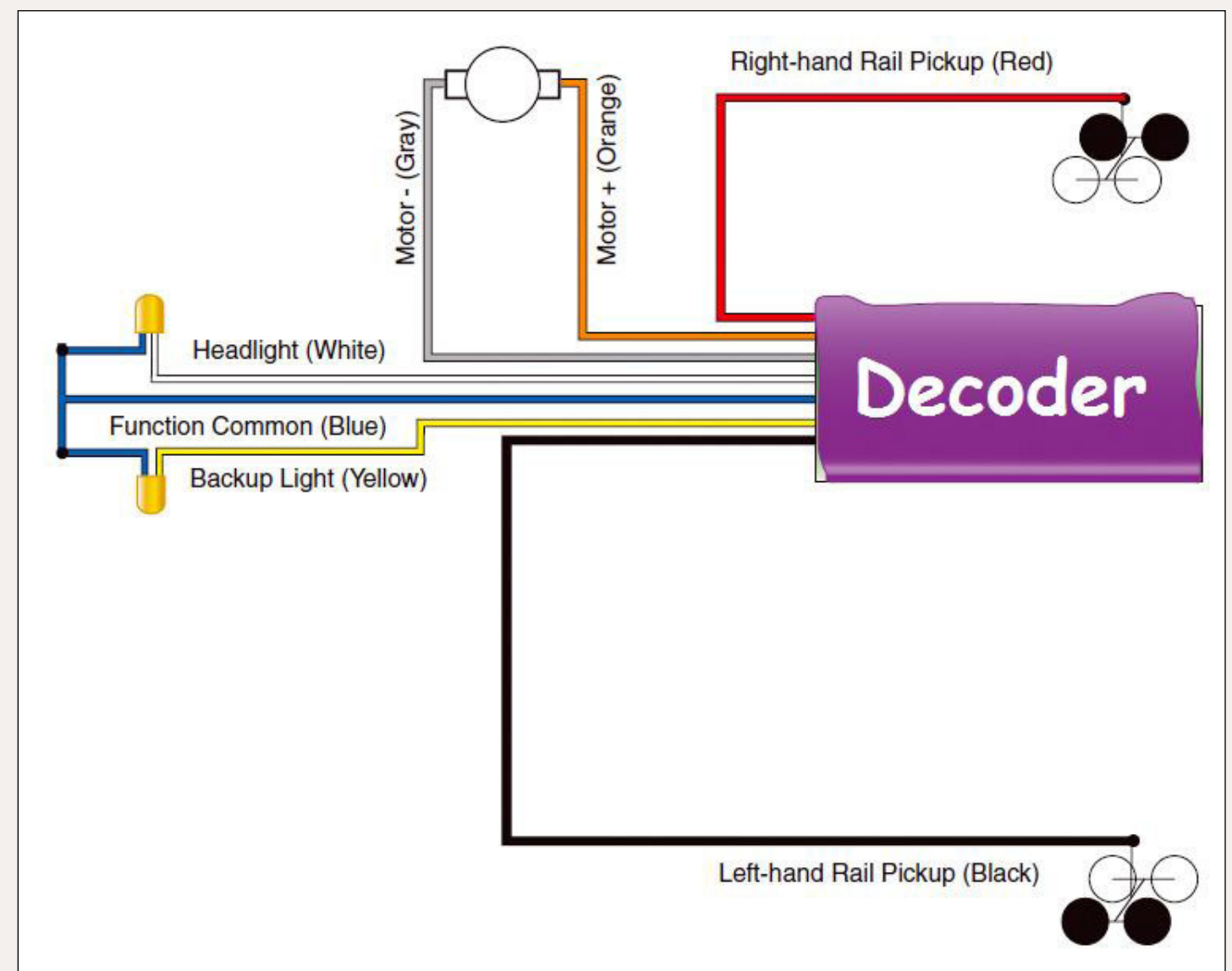

 **Reader Feedback**  
*(click here)* 

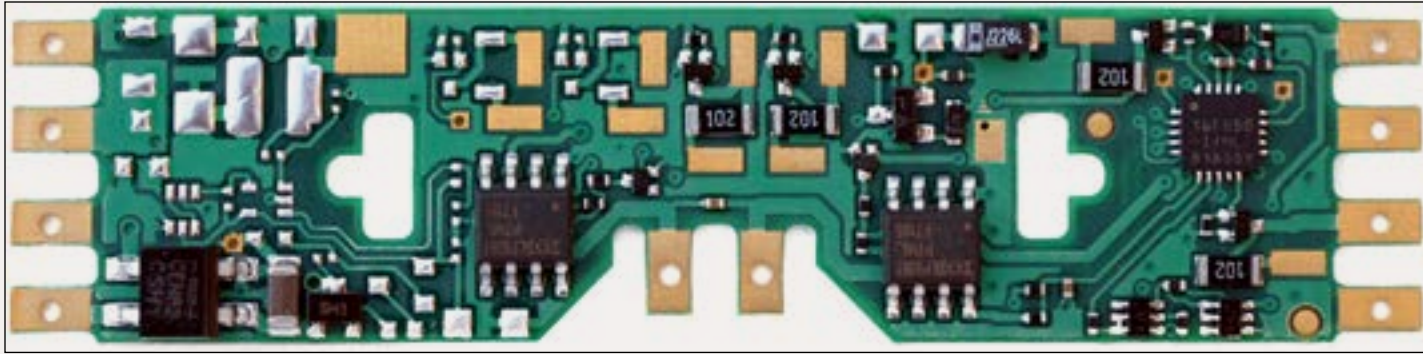

**Figure 2: The TCS A4X decoder is an example of an open board decoder – photo courtesy of Train Control Systems.**

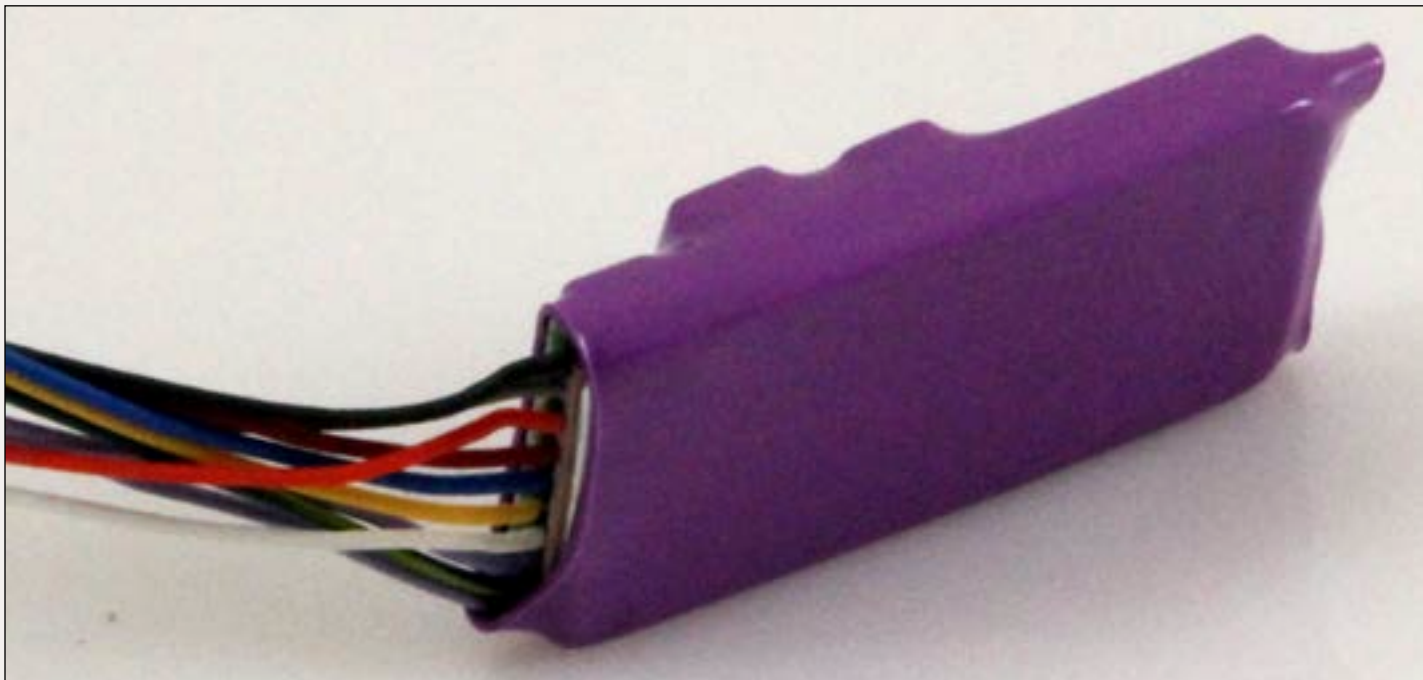

**Figure 3: The SoundTraxx Micro Tsunami is an example of a wrapped decoder. In this photo, the heat sink side is toward camera.**

heat when operating. Getting rid of the heat is essential to longevity.

You may have installed many decoders without considering the heat issue. But eventually, you'll find an installation where some extra attention is needed in that department. By keeping heat management in the back of your mind, you can't go wrong.

If the decoder is an open board as shown in figure 2, don't cover it up – it is expecting to see what is called

“free air” for cooling. Wrapping it in tape will “insulate” it, raise its operating temperature, and reduce its life..

Others, such as the Micro Tsunami decoders from SoundTraxx, come wrapped in plastic heat-shrink tubing (figure 3). DON'T remove the tubing, even to take a curious peek inside.

Many “wrapped” decoders have a heat sink – often looking like a large flat raised area. If at all possible, mount this type of decoder with the heat sink

(the flat area) in contact with a metal surface inside the loco. This lets the locomotive frame help suck heat out of the decoder. The extra heat dissipation may not be needed, but running cooler won't hurt.

I often use a very thin bead of caulk to hold decoders in place. The caulk has relatively good heat conduction and can be peeled off easily if you need to remove the decoder. I use blue masking tape to hold everything in place while the caulk sets. Be sure to remove the blue tape before you replace the locomotive's body shell!

### **Pickup Wiring**

DCC track signals include both the power to run a locomotive and the control signals that tell the decoders to move the train forward or backward, how fast, etc. A consistent connection between the track and the decoder is basic to reliable operation.

I cannot stress enough the need for good quality wheels. If there is lots of corrosion and pitting on your electrical pickup wheels, you may want to reconsider converting the loco to DCC unless you can replace the wheels. Nickel silver wheels are best.

The more wheels that pick up power, the better. We will discuss adding pickup wipers on some types of locos later in this column.

If you're wiring an A / B set of FT units and the locomotives will be

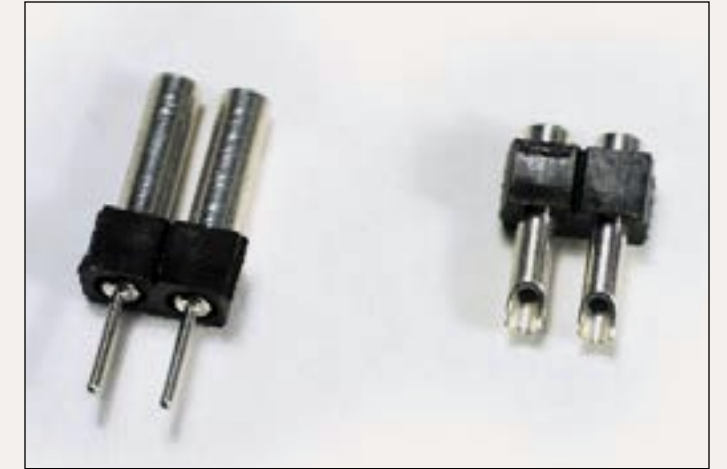

**Figure 4: SoundTraxx 2-pin connectors – photo courtesy of SoundTraxx**

permanently joined with a drawbar, why not connect the track power (picked up from the wheels) in both units? Heat shrink tubing works to hold the wires on the drawbar.

If the units can be uncoupled, F3s for example, I like to use a small 2-pin connector, like the SoundTraxx 810012 (figure 4), between units.

This allows a power connection between units but still lets you separate the units for hostling or running independently. One of the most reliable DCC installations I've ever seen was an A-B-B-A set with all units interconnected – sixteen wheels picking up power from each rail and distributed to all four units!

If your locomotive has relatively stiff wires between the trucks and motor, they may prevent the trucks from swiveling smoothly. I recommend replacing them with the extremely flexible “2951” wire

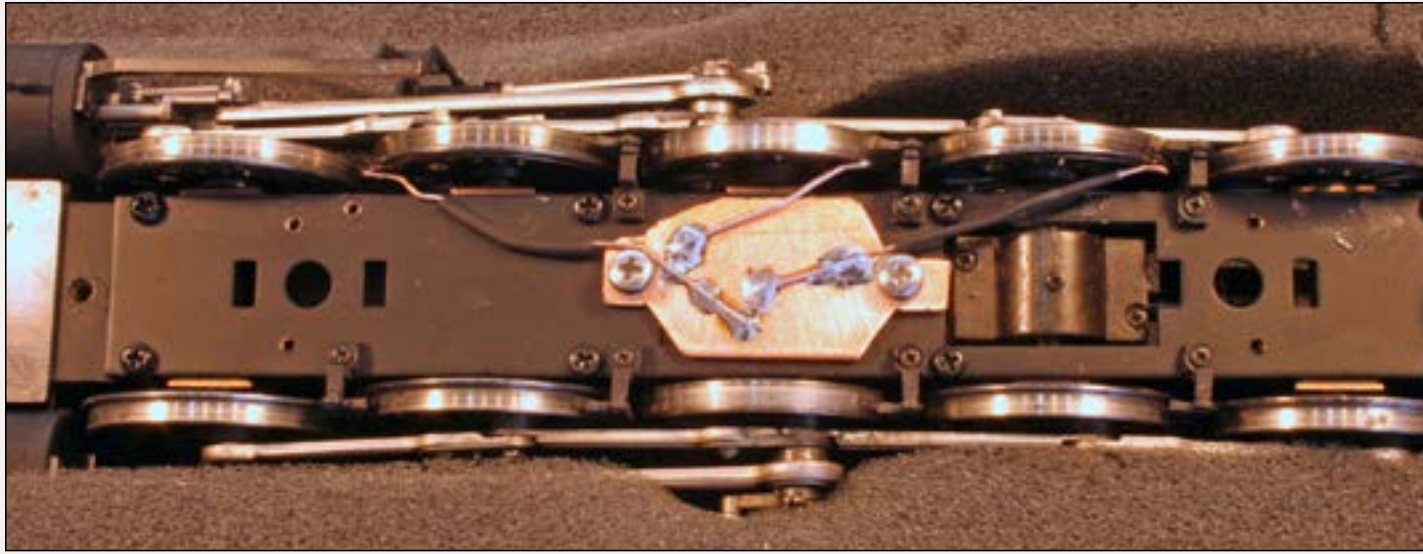

**Figure 5: Added opposite rail pick-ups in an O-scale brass loco - similar pick-ups were added to the tender on the opposite side. The drivers equipped with wipers are insulated between the wheel tread and the inner parts. Note the wipers only touch the outermost portion of each wheel to avoid bridging the insulation and causing short circuits.**

(29 awg, 51 strands) I discussed last month. Solder the wires in place; don't rely on push-on connectors.

All right, let's get into specific types of model locomotives.

## Brass Locomotives

Most brass steamers (and many brass diesels) as well as some early plastic steamers have what I call the "brass design". That means power from one rail is picked up by the wheels in the engine and the other rail by the wheels in the tender. This may also occur with the front and rear trucks on a diesel. This is problematic with DCC. The loco may hiccup on long insulated-frog turnouts or track that isn't perfectly clean.

Adding "keep-alive" capacitors or another energy storage system helps. But nothing will fix poor power pickup

better than adding wipers to additional wheels. I use phosphor bronze wire soldered to a small piece of printed circuit board (figure 5).

Examine the engine closely to determine how much of the wheel is electrically connected to the rail. Some steam engine wheels are insulated just beneath the tire (rim). Wipers are trickiest to install when only the tire of the wheel is electrically connected to the rail. Pickup wipers must contact the tire but NOT the wheel.

Other wheels, such as those in a tender or a diesel, are insulated at the axle. Wipers can make contact nearly anywhere on the back of these wheels without creating a short circuit. Use your buzzer, discussed last month, to test the wipers for shorts before proceeding with decoder installation.

Remember to provide room for side-to-side movement of the wheels as the locomotive goes around tight curves. The length of the wipers in figure 5 let them do this.

## Frame to One Rail

Many early models of diesel locos had one rail connected to the frame of the loco and the other connected to an internal contact. The most common example of this is the Athearn "blue-box" series. Early Life-Like Proto 2000 units were a close copy of Athearn in many ways, including power pickup.

You MUST isolate the motor from the frame for a DCC installation in these locomotives (a DCC motor drive wire shorted to track power – the frame – will kill a decoder). The sidebar shows the steps needed to prepare a "blue-box" locomotive for DCC.

## HO Life-Like S-1

A special case of a loco with the motor connected to the frame is the Life-Like HO-scale S-x loco series. All locos in this series (S-1, S-2, S-3 and S-4) are the same internally and need the treatment specified here.

The motor must be removed and an orange wire soldered to the lower terminal. The terminal is then surrounded with a single layer of Kapton tape to insulate it from the frame before reassembly (figure 6).

## Split Frame

Many locos have this type of design; each half-frame is insulated from the other and connected to its respective rail. Examples include: Bachmann HO diesels and some of their steamers, most N-scale locos. The Kato HO

**Figure 6: Life-Like Proto 2000 S-1 type motor with an orange wire added and insulated with Kapton tape, ready for reinstallation.**

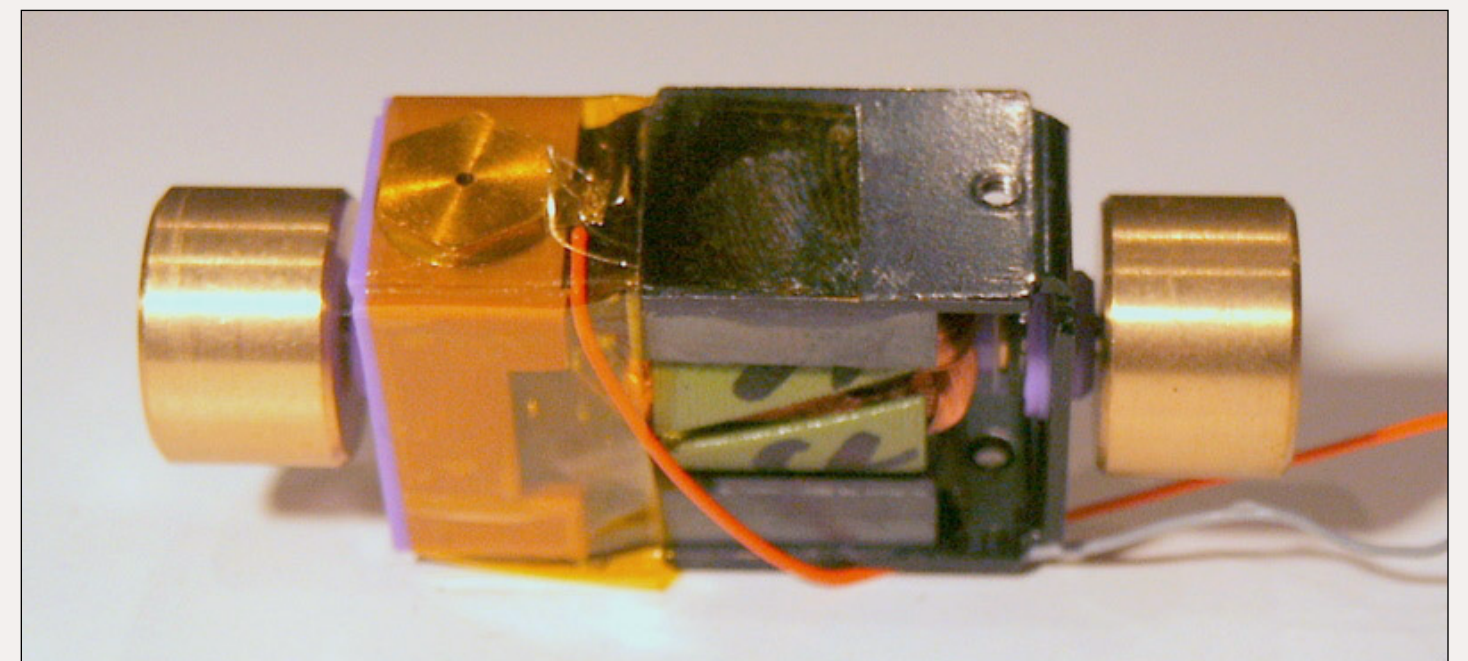

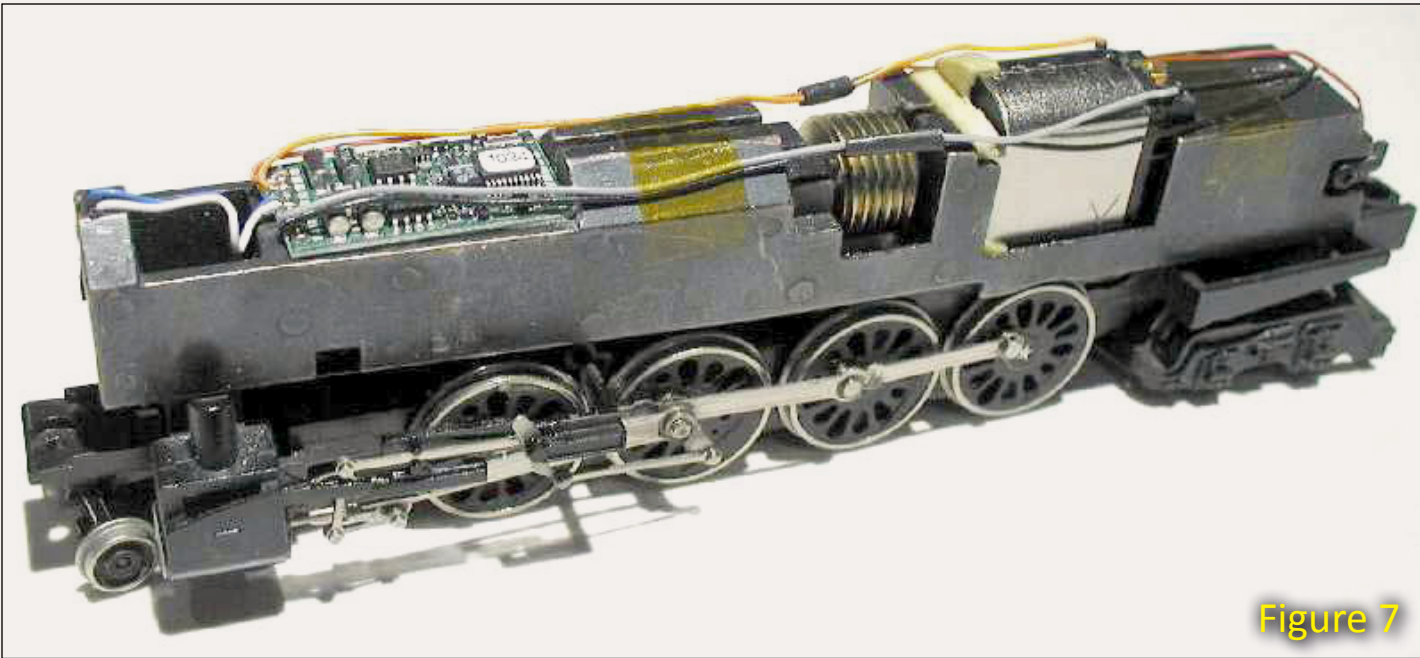

Figure 7

Figure 7: Bachmann GS-4 split frame HO locomotive.

Figure 8: Atlas N-scale C-420 split frame loco with the TCS-AMD-4 decoder installed – photo courtesy of Train Control Systems

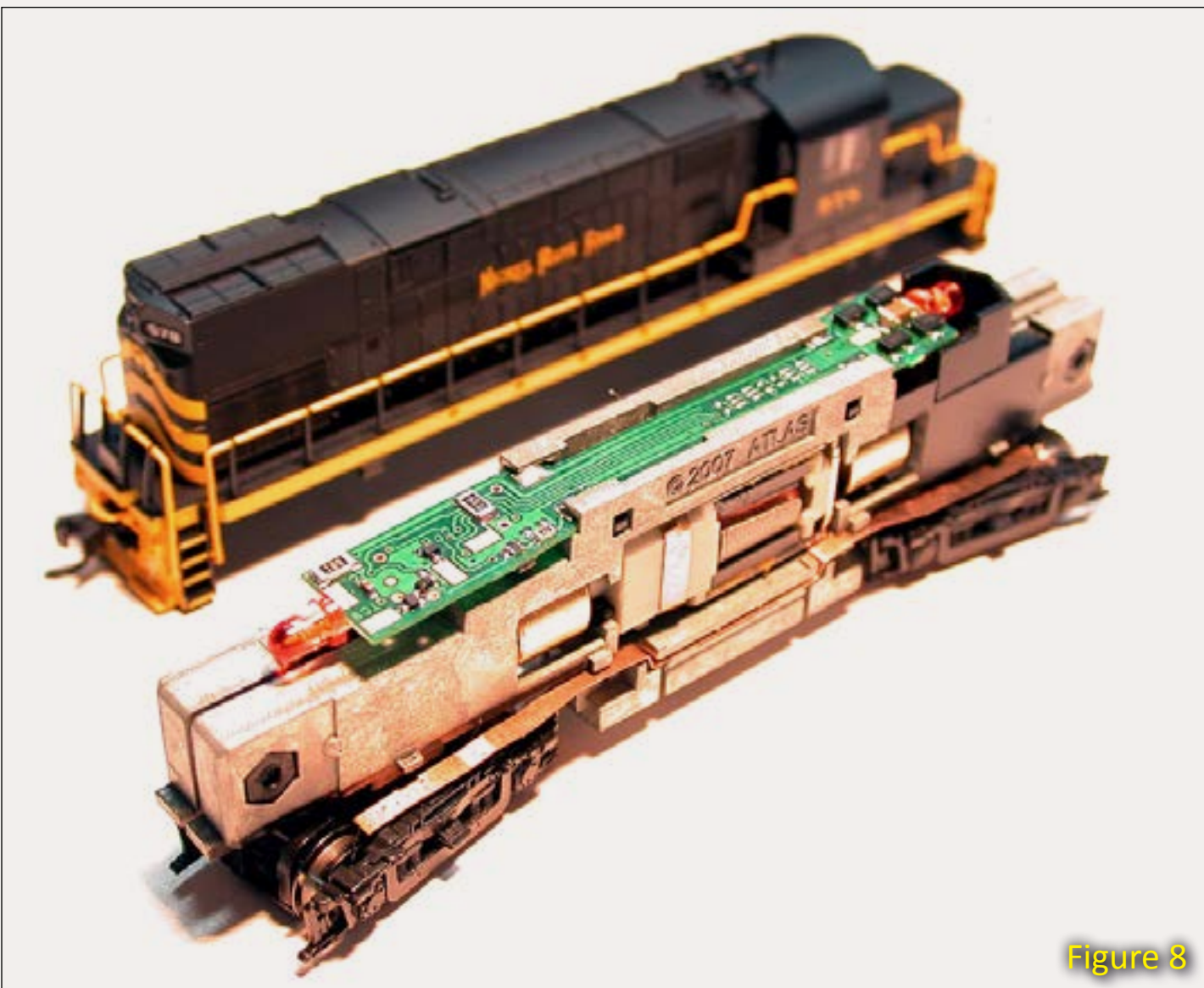

Figure 8

scale NW2 is a popular example of this kind of frame.

The challenge with most of these is isolating the motor from the frame. A reason for designing a loco this way is simplifying the motor connection for the manufacturer. The trucks connect to each frame half directly and the motor is buried inside the frame. Mechanical contact strips let the motor pick up power from each frame half.

These locos usually require a bit of machining or some fancy insulating technique to get the motor disconnected from the side frame. Then the decoder is wired between the frame halves and the motor.

An example of this technique is the older HO-scale Bachmann GS-4 loco shown in figure 7. The decoder's track connections are wired to the frame halves. The motor is insulated from the frame halves and wired directly to the decoder orange and gray wires.

N-scale split frame diesels frequently have loco-specific decoders. The decoder manufacturer designs the isolation of the motor into their circuit boards. Be sure to follow the manufacturer's directions, paying close attention to insulating the motor connections from the frame halves.

The loco shown in figure 8 came with a board incorporating LEDs for lighting, and providing the motor connections. The drop-in DCC board handles the motor connections.

I mention these in the context of wired decoders, because they frequently need some work to connect the motor to the decoder.

Many of these designs rely on contact pressure between motor tabs and pads on the decoder. I frequently need to solder some "2951" wire between the contact and the decoder pad for reliable operation.

Testing the loco on the programming track will often reveal an immediate need for this if you cannot read or write the CVs in the decoder.

### Totally Isolated

If your loco has wires directly from insulated contacts on the motor to the track pickups, it is probably totally isolated.

Use your buzzer for a quick check. Disconnect both wires from the motor. Connect one lead from your buzzer to one motor contact. Probe all the wheels with the other buzzer contact. For good measure, repeat for the other motor contact. If it doesn't buzz, then you are ready to go. Just install the decoder!

Even some N scale locos are designed with isolated motors.

Figure 9 shows a Kato N-scale PA. As built, the truck power contacts come through a plastic insulator and contact strip assembly that conducts track power to the motor and a light board.



Install a decoder by applying Kapton tape to the contact strips where the motor tabs touch them to isolate the motor. The decoder sits on the strips and is held down by the motor tabs.

## Programming Track

When you finish your install, the programming track is your best friend! I know you really want to run your loco right away. Resist this temptation!

Put the loco on a programming track (not programming on the main) and read the address. If you can read the address, write the new address into the decoder and read it back. If you can read and write on the programming track, you've probably correctly isolated

the motor from the track power. If you get errors or cannot read the decoder, thoroughly check all your wiring. Use the buzzer to check for motor-track isolation. Remember the buzzer will show continuity between the rails because the DCC power supply connects them!

In future columns, we will get into lighting and sound installations.

Thanks for reading and for all the encouraging comments on the Reader Feedback MRH web pages.



**Figure 9: Kato N scale PA shown with the contact strips covered with Kapton tape ready for reassembly with the Digitrax DN-163K0a decoder.**

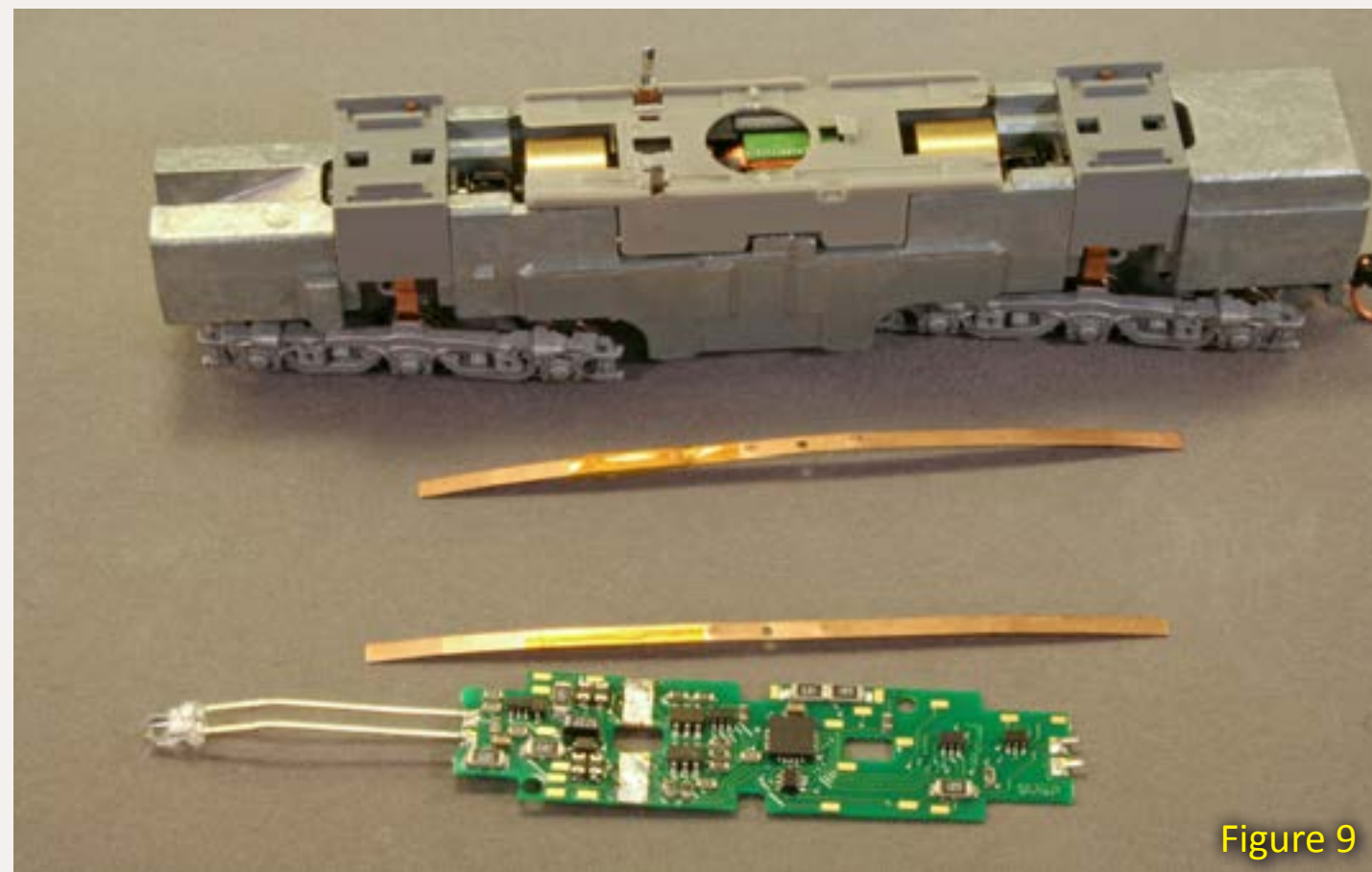

## Preparing an Athearn blue-box locomotive for decoder installation

Start by removing the motor from the frame. Cut a piece of 0.01" thick styrene about 1-1/2" long and 1/4" wide to insulate the motor contact area (figure 10a).

3/8" or wider Kapton tape holds the styrene strip in place (figure 10b). Caulk is an alternative to the tape.

Cut the tabs off the bottom motor contact spring (figure 10c) smoothing it so no pointed ends can press through the newly installed insulation. Replace the motor contact on the insulator (figure 10d).

Next it's time to solder decoder wires to the motor – gray for the bottom sidebar text continues on next page

**Figure 10a: Athearn blue box loco: Plastic sheet cut to fit and installed in the motor contact area as an insulator.**

**Figure 10b: Kapton tape added to hold the plastic insulator in place.**

**Figure 10c: Tabs cut off lower motor contact strip – removed from motor for clarity.**

**Figure 10d: Motor contact strip (without motor) positioned above the plastic insulator demonstrates its final position.**

**Figure 10e: Both wires connected to truck for best power pickup.**

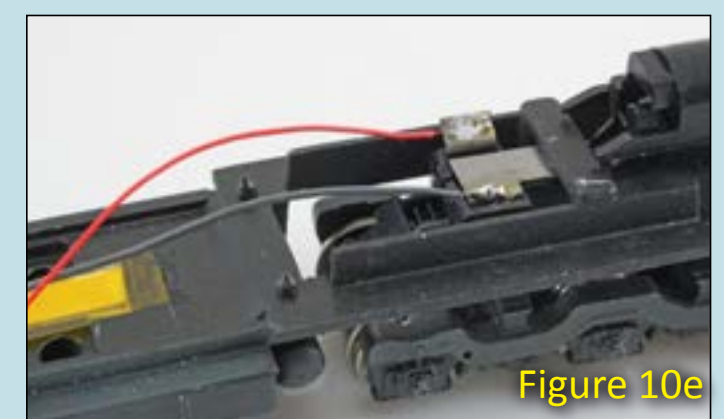
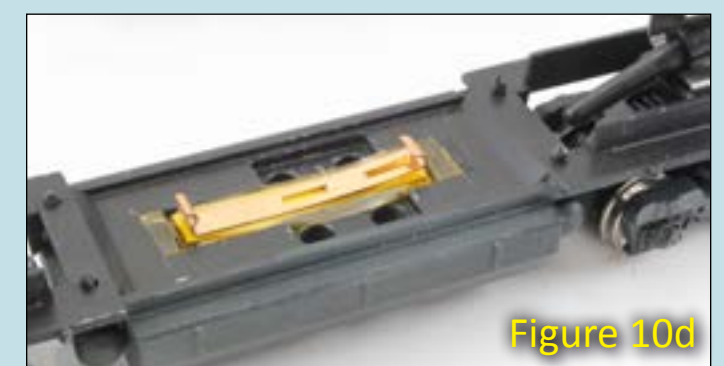
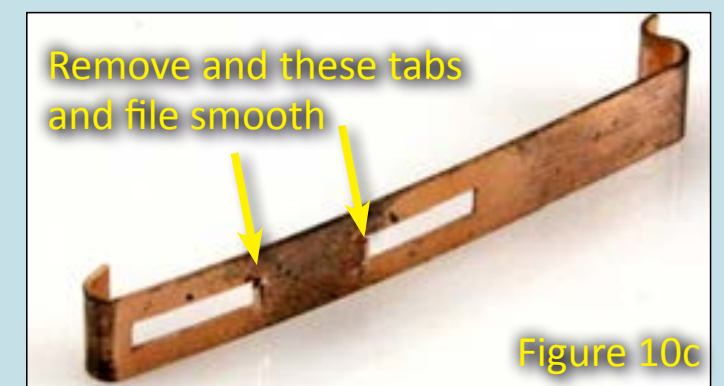

## Preparing an Athearn Blue-Box Locomotive for Decoder Installation (continued)

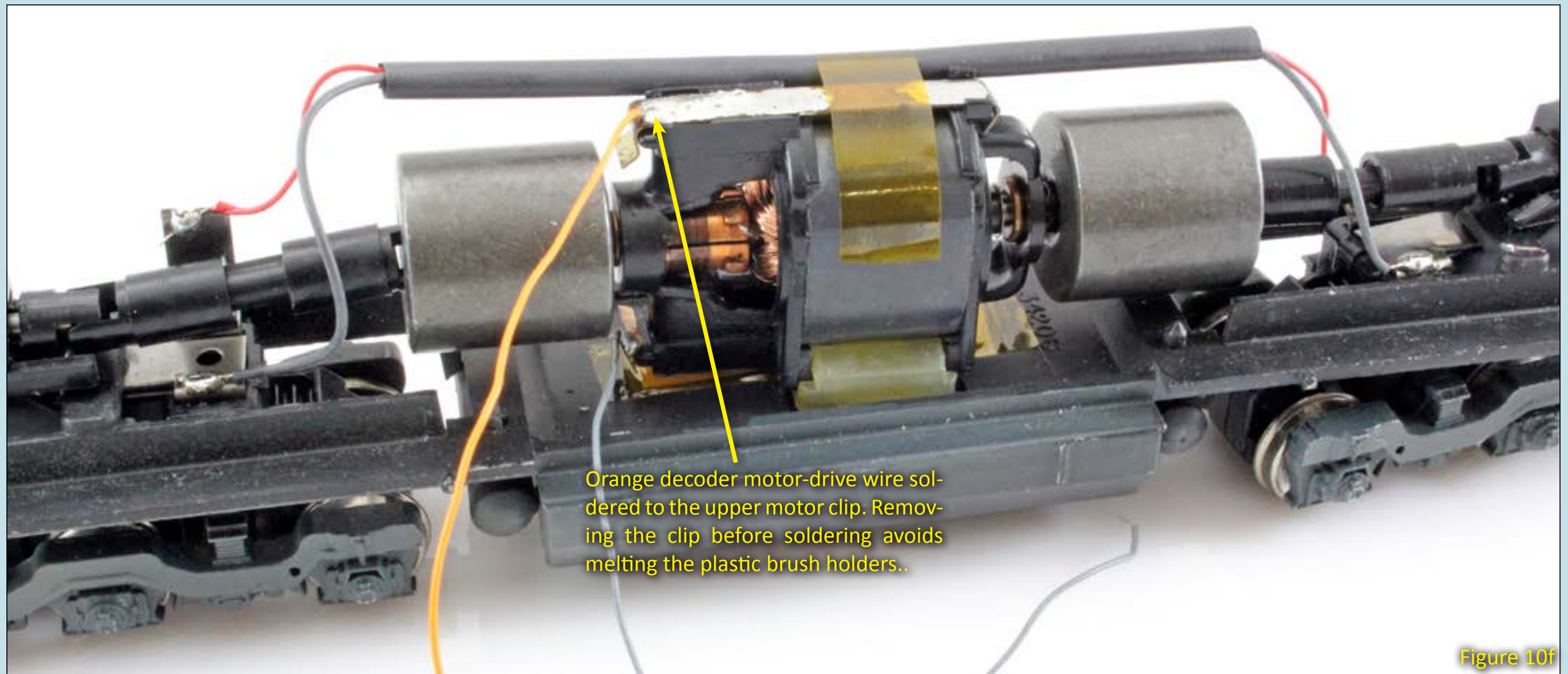

Figure 10f

### Figure 10f: The motor isolation is complete. This locomotive is ready for decoder installation.

contact, orange for the top. There are two ways to do this:

- Remove the clips from the motor before soldering. Watch out! Make sure the brush springs and brushes don't "run away" and take care when reassembling the motor.
- Solder the decoder wires to the clips without removing them from the motor. Get in and out QUICKLY

to avoid melting the plastic brush holders. If damaged, the motor may not run properly anymore.

Even being a better than average solderer, I prefer removing the clips. It's too easy to melt the plastic brush holders. Or replace the stock 3-pole Athearn motor with a new 5-pole motor from A-line ([ppw-aline.com/re-power.htm](http://ppw-aline.com/re-power.htm)).

The red decoder wire connects to the top of BOTH trucks. The contacts can be cut back or left full-size (figure 10e).

For the best performance, I recommend that you solder the black decoder wire directly to the trucks, as shown in figure 10e. I ran a piece of "2951" wire between the two trucks. This step eliminates the sliding contact between the trucks and the frame from the electrical path – fewer places for poor contact to impact operations.

Alternatively, the black wire can be soldered to the frame contact on the front of the loco or screwed to the frame in a convenient place.

Figure 10f shows the loco with the motor isolated, ready for the decoder installation. I used a piece of shrink tubing (a soda straw will work, too) to keep the wires from getting tangled in the drive train.

Why not change the wheels for nickel silver, while you are at it? Northwest Short Line makes replacements.

## Grand Rails 2012

77th Annual NMRA National Convention



July 29 - Aug. 4

NMRA National, Grand Rapids, MI

**Grand Rails 2012**

[www.gr2012.org](http://www.gr2012.org)

### Big City Convention...Small Town Atmosphere

**RailPro**<sup>TM</sup>  
NEW TECHNOLOGY



Click here to watch our new video!



For more information visit our Internet site:  
[www.RingEngineering.com](http://www.RingEngineering.com)

**HOBBY MARKETPLACE** ads are economical and effective.

Click [HERE](#) to learn more.

### TRACKSIDE FLATS

1/4 inch thick 2D background buildings on foamcore starting at \$3.99 each

[www.tracksideflats.com](http://www.tracksideflats.com)

Click to learn more ...

Add incredible depth to your layout in less than an inch of space

### NEW! "Combo Right Clamp"<sup>TM</sup>

Customer Requested Special Features + Soldering & Gluing all in one new clamp

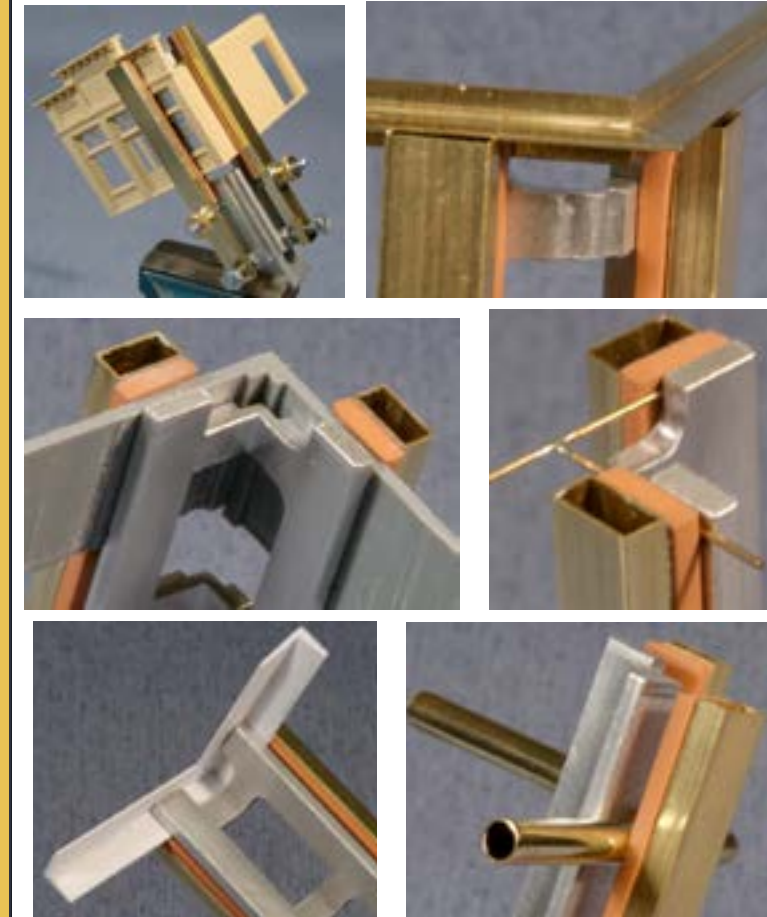

Some Special Features of New "Combo Right Clamp"<sup>TM</sup>

- Hi Temp. Silicone Rubber Pads** for any type soldering
- Vice Tab** securely holds clamp in vice to free your hands
- Medium Grooves** for aligning tube material
- Mini Grooves** for aligning small wire (above left)
- Open End Notch** for structural shapes (above right)
- Thumb Nuts** for easy adjusting End Screws (not shown)
- Relief Notches** for parts with "Boss" at part edge

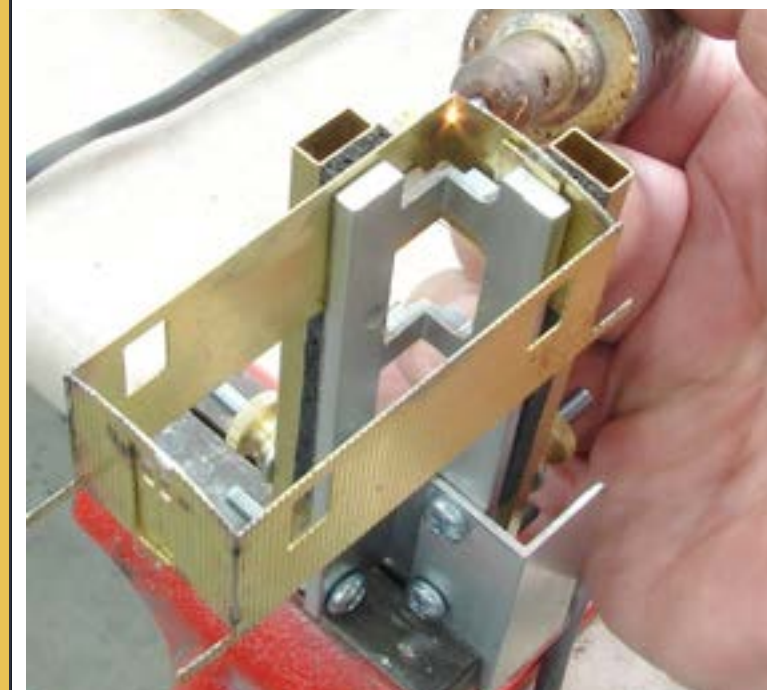

Pre-Production "Combo Right Clamp"<sup>TM</sup> with Hon3 brass caboose

**Coffman Graphic Solutions Co.**

1500 River Circle, Richmond, KY 40475-7907

Phone: 859-527-0476, Fax: 859-527-0485

[www.coffmaneng.com](http://www.coffmaneng.com) [randy@coffmaneng.com](mailto:randy@coffmaneng.com)

# Model Railroad Hobbyist - HOBBY MARKETPLACE

## Railpub

The source for back issue rail magazines; used, new and out of print rail books.

Railroad modeling, prototype, traction, logging, industrial subjects.

[www.railpub.com](http://www.railpub.com)

## Rulers of the World

Scale Rulers \$4 each  
Over 150 scales!

Metric or Imperial

[www.rulers-of-the-world.com](http://www.rulers-of-the-world.com)

## DCC by Design

Can't remember which cars you've bought?

## Yard Boss

Model Train Inventory Software

Just \$12 with code MRH0511

Download free trial now!

[www.dccbydesign.com/yb-mrh0511.html](http://www.dccbydesign.com/yb-mrh0511.html)

## The Proto:87 Stores

Home of the Prototypically Accurate and Ultra Realistic Model Track Project (and much more).

21st Century Professionally Engineered, for strength, reliability, and phenomenal accuracy. Fully NMRA Warranted. Even compatible with Code 88 wheelsets!

[www.proto87.com](http://www.proto87.com)

## Great Decals!

is now selling decals produced by *After Hours Graphics* for Midwestern railroads. Roads offered include C&O, Cincinnati Union Terminal, Conrail, CSX, DT&I, Great Miami, Indiana and Ohio, Interstate, NKP, Norfolk and Western, Pere Marquette, Southern, Transkentucky, and private labels Dow and Owensboro Grain.

For the complete list, see:

[www.greatdecals.com/AfterHours/AfterHoursList.html](http://www.greatdecals.com/AfterHours/AfterHoursList.html)

Great Decals!

P. O. Box 994, Herndon, VA 20172

## Your Text Ad

Could be here for a remarkably affordable price!

[model-railroad-hobbyist.com/advertise-with-us](http://model-railroad-hobbyist.com/advertise-with-us)



Tired of old structures on your modern layout? We can help!

Click Here for more details... [www.summit-customcuts.com](http://www.summit-customcuts.com)



Recommended installation tool

Goes on easy

All Scales

All Brands

Make a Tire or Retire

99% Know It Works!

Green Grip from a Jar

[WWW.BULLFROGSNOT.COM](http://WWW.BULLFROGSNOT.COM)



Get the Latest Model Railroad News, Tips, Reviews & Opinions

## The SCOTTY MASON SHOW

The Original Model Railroad Podcast

- Monthly Interviews
  - Modeler's Spotlight: Top Modeler's Talk
  - Narrow Gauge Modeling w/Chris Lane
  - Contemporary Modeling w/ Mike Rose
- More Product Announcements & Reviews

Our feed has changed! To get the latest shows, please search Scotty Mason and subscribe to the new feed!

[www.TheModelRailroadPodcast.com](http://www.TheModelRailroadPodcast.com)

Scott Mason Jimmy Simmons Mike Rose Joe Duckworth



## True Scene Modeling

NEW FusionFiber

Dependable Quality. Easier than Plaster!

**SATISFACTION GUARANTEED!**

[www.truescene.com](http://www.truescene.com) or 716-523-7305

# THE CAR SHOP



## Coupler box lids An easy way to screw them in place ...



— by Joe Brugger

On small, flatland layouts, coupler box covers popping off are rarely a problem. But as train lengths increase and grades climb, snap-on and friction-fit coupler box lids show the strain. When helpers are used to push a train up a hill, increased buff forces can shove a drawbar up and down, levering the cover off and causing a train to pull apart. The solution is to put a screw through the coupler box cover, holding it in place.

A-Line has introduced tools to aid in this conversion. Parts are available individually or in combinations. My local hobby shop stocked #11003, which includes two machined brass jigs, a 2-56 tap, a half-dozen black 2-56 screws, and a set of printed in-

structions. A-Line also sells #50 drills, packages of 50 2-56 screws, and packages of 25 metal coupler box covers.

The drill jig is a press fit over the coupler mounting post and centers a #50 drill. If the work is firmly supported, the jig also helps to keep the drill bit

vertical. After drilling the pilot hole with a pin vise, follow up with the tap jig to cut threads for the 2-56 screw.

Yes, it's possible to center a drill and tap a hole without these tools. But for an individual or a club with a lot of cars to convert, the jigs save time

Figure 1: A-Line #110033 tools to drill and tap couple box lids.

Figure 2: The set includes brass jigs for a #50 drill and a 2-56 tap, as well as a half-dozen screws, and printed instructions.

Figure 3: Pop off the coupler box cover, press fit the drill jig over the mounting post, and drill a hole using a #50 drill in a pin vise.

Figure 4: The resulting hole is clean and centered, with no spreading of the mounting post. Notice the hand-located (and off-center) hole for the truck mounting.



Figure 1



Figure 2



Figure 3

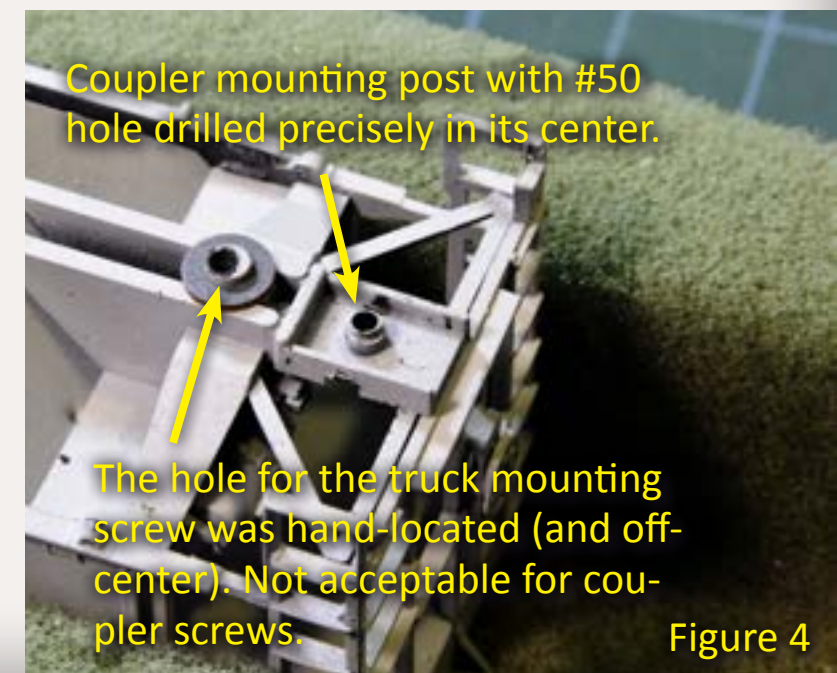

Coupler mounting post with #50 hole drilled precisely in its center.

The hole for the truck mounting screw was hand-located (and off-center). Not acceptable for coupler screws.

Figure 4

and allow repeatable quality – standard coupler mounting pins are barely larger than a #50 drill and an off-center hole can ruin an underframe.

Drilling and tapping blind is a little unusual. Because the jigs fit snugly over the post, the jigs must be removed a couple of times to clear cutting chips. The tight fits also keep the post from

**Figure 5:** Press-fit the tap jig over the post and cut threads for the 2-56 screw. The jigs need to be removed occasionally to clear chips from cutting.

**Figure 6:** The tapped hole is ready for the cover to be screwed down.

**Figure 7:** This snap-on Athearn metal cover is firmly secured in place. No more pop offs!

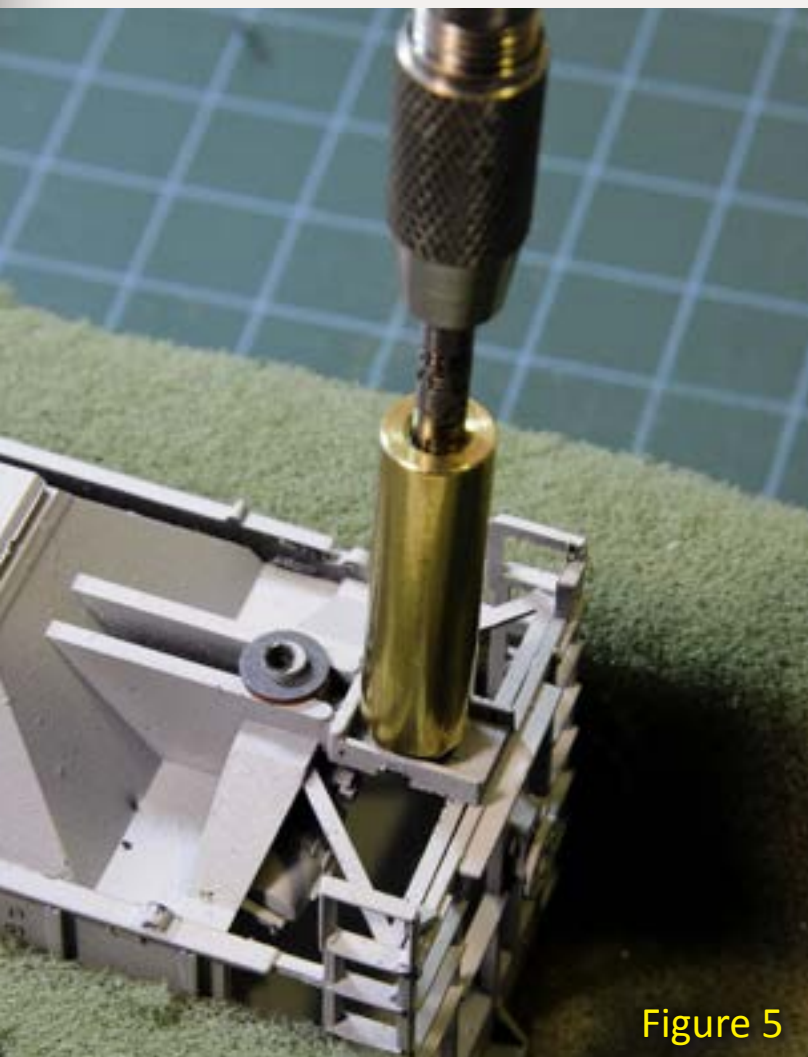

Figure 5

spreading sideways, so couplers will still swing freely.

The tap has a .1" square base that might be too big for some pin vise collets, so check your tools before starting to work.

A-Line, PO Box 2701, Carlsbad, CA 92108, [ppw-aline.com](http://ppw-aline.com).

The suggested retail price of the #11003 Bulls Eye Drill Jig, Tap Jig & 2-56 Tap set is \$22.95.

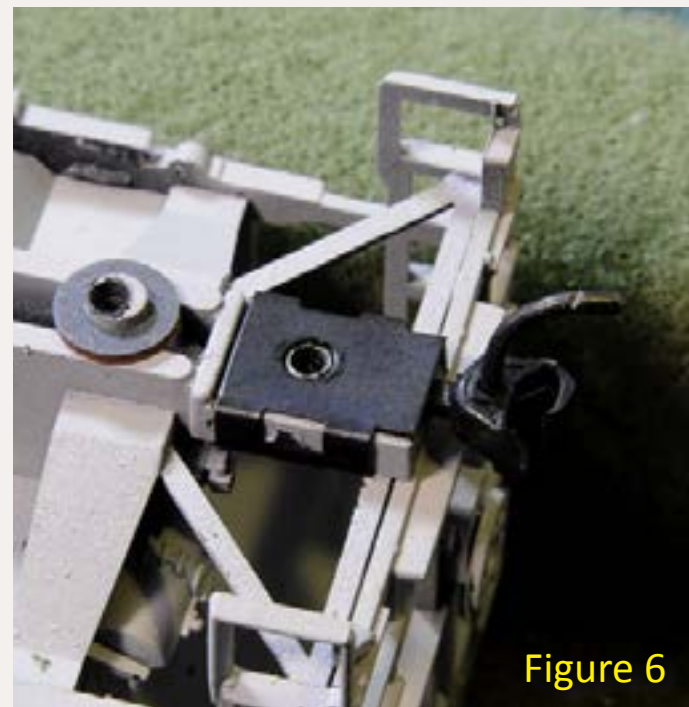

Figure 6

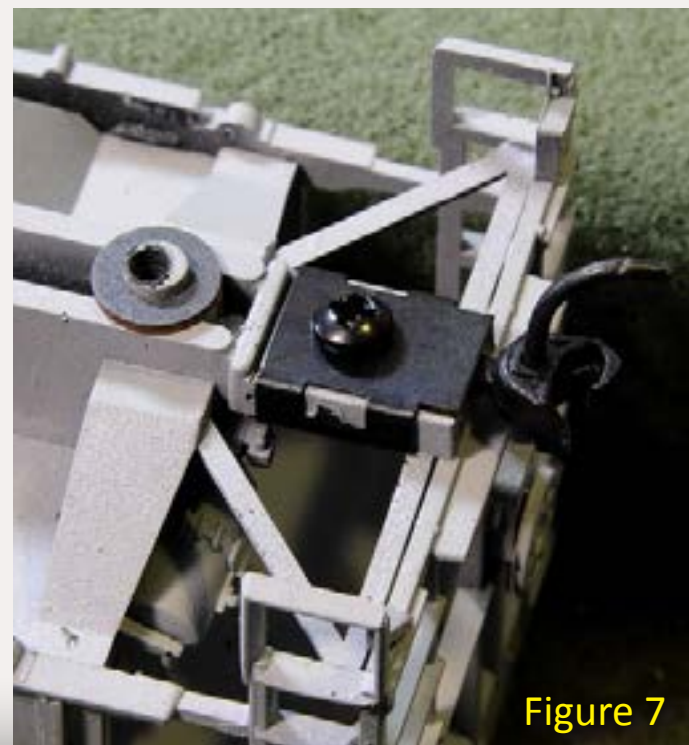

Figure 7

ADVERTISEMENT

**(727) 457-9227**

*We love trains!*



**YD** **Yankee Dabblers.Com**

Click to see specials in these categories



**Authorized dealer for:**



**Atlas • Bachmann • AccuRail**

**FEBRUARY Specials (while supplies last)**

- **RailPro HOT!**
- **Digitrax systems**
- **Soundtraxx decoders**
- **RailMaster speakers**
- **Kadee products**
- **NCE systems**



**Click now for more ...**

# Making Realistic Winter Trees

One branch at a time

– by Don Spiro



Through a few decades of trial and much error I've managed to lump together enough skills to build benchwork, lay fairly realistic track, weather and detail locomotives and rolling stock, and get them to move smoothly. I've created scenes, and on my recent layout have come to enjoy scratchbuilding structures more than anything else. Making a tree though? I have found trees to be one of the most daunting subjects to credibly model. I have used a lot of tried and proven methods to model the "deciduous canopy" which covers the region my layouts have been based on: north-west New Jersey and northeast Pennsylvania. Everything from poly fiber-puff ball forests to commercial



tree kits to foam glued on twig armatures, and you name it in between I've tried; none though have been anything approaching visual success. I modeled the summer season on my previous layout and let's just say that after applying a lot of green textures and some random tracts of highly questionable forestation, overall the scenes were pretty much decidedly-challenged.

We moved from New Jersey to Arizona in '01 and my medium-large basement layout in Jersey gave way to a much smaller and manageable shelf-style layout in a small bedroom in the Sonoran. Back in Jersey I spent many pleasurable hours riding a mountain bicycle over the abandoned ROWs of the Susquehanna, Lehigh New England, and the Lackawanna Sussex branch; all were rural, single-track backwoods railroads and these explorations became the inspiration for what I model.

## Modeling Fall or Early Winter

I took lots of photos each time I went out, especially in the late fall/early winter when the leaves were down, so barren shrubbery and ground cover allowed the compelling remains of culverts, depot foundations, cattle underpasses, mile markers, cuts, fills, and in rare instances a structure or two, to be easily seen.

I reasoned that similar open views would be afforded on a layout by



Figure 2

modeling the leaves-down cycle of trees. I'd also become enamored of a few spectacular fall/winter layouts in print over the years: Bill Henderson, Paul Dolkos and Mike Confalone in particular. The mood and feel of their layouts was like few others I'd seen; you could almost feel the crisp air, hear the rustle of downed leaves and smell the heady aroma of wood stoves. I decided early-on to set the new layout in the late-fall/ early-winter season.

## Super Trees

To model a late-fall/early-winter landscape, I tried [Scenic Express](#) "Super

Trees." The reviews of these trees were positive and I was blown away by their fine detail, realistic branch structure, and ease of preparation for the layout. I worked them into a Depot/General Store scene (figure 2), the first on the layout.

Preparation was as easy as Scenic Express illustrated, and I didn't have to do the final greening stage since there are no leaves on the trees. There was an immediate sense of a chilly day in late fall – bare branches and ground up leaves for ground cover; the scene looked great. The height of the trees with their dense

**Figure 2: This depot/general store scene is where I realized that while the "winter" trees had a realistic overall look and color and did impart a feel of early winter, the trunks of the taller trees were not near the diameter of a real tree that size.**

bare branches complemented the structures. Their neutral gray color enhanced even the most drab and muted structure color.

The ease of making these trees and the realistic results astounded me. I figured I'd finally gotten the hang of making realistic trees. Not quite.





Figure 3

**Figure 3: My neighbor's "severely pruned" tree which inspired the tedious but highly realistic technique I evolved to model early winter trees.**

Digital cameras are one of THE most useful modeling tools to come along. Now I photograph all my projects every step of the way – photos don't lie. When I photographed the depot scene, somehow it didn't look as real as in person. Although the trees' branch structure looked great, the trunks were almost bulimic in

appearance. They simply lacked the girth of a 40+ foot tall tree's trunk.

When looking at the scene in person, the lack of tree trunk girth was not readily noticeable. Our brains are pretty good at seeing what we want them to see. However, when closely examined in a photo, the sapling diameter trunks jumped off the image like a flashing dashboard warning light.

Disappointed, I actually stopped building scenery for a year or so and got lost in more attainable model and layout projects. All the while I kept pondering the tree trunk issue. I needed a tree trunk solution or interest in the layout was going to tank.

### **Thicker Trunks and Limbs**

Tucson experienced a 4-day, hard freeze last winter, affecting all flora including cactus. A neighbor's non-indigenous acacia tree suffered severe freeze damage, losing all its leaf structure. One afternoon a crew appeared and removed all the branches, leaving the trunk and the abbreviated stumps of the amputated limbs; it looked like a prop from the movie Beetlejuice (figure 3).

That mutilated acacia looked exactly like some cuttings I took from decorative conifer bushes we removed from around the patio in New Jersey. At the time the cuttings seemed to have some tree-making potential although they looked odd – just like

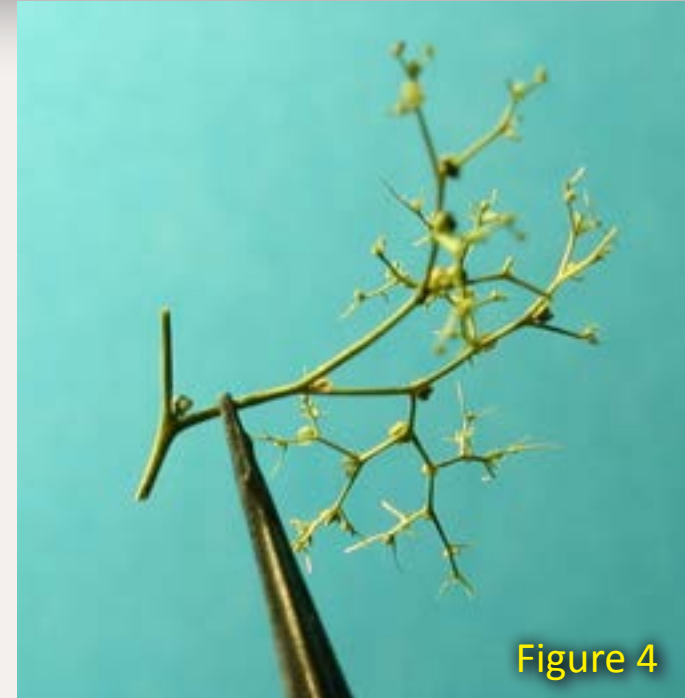

Figure 4



Figure 5

**Figure 4: When clipping Super Tree branches, leaving a "T" makes gluing them to the armature much easier. It also lets one glue the branches closer together to form a fuller canopy.**

**Figure 5: How the T-section of the branch is glued to the limb.**

**Figure 6: Similar to figure 5 but showing how the branch canopy becomes fuller by gluing the tips of Super Tree branches or single branches in tight clusters. Either works well.**

**Figure 7: A finished tree prior to painting and two armatures with their limbs "whittled" to a natural taper ready for branches to be glued on. The figure and vehicle provide a height reference telling us that these aren't wimpy little trees.**



Figure 6



Figure 7

the neighbor's acacia. I had tossed the cuttings into a box and when we got to Arizona they went into a garage cabinet, out of sight and mind.

When I saw the neighbor's freeze-damaged and severely-pruned tree, a light went on. If the branches could be cut off a real tree leaving an odd looking trunk and stumpy limb structure, then might it be possible to add branches to a model limb structure and create a decent model tree?

I dug out the box of cuttings from New Jersey and retrieved the bag of Super Trees that had been tucked under the layout for the past year. When I pulled a rather robust looking tree from the clustered mass it began to crumble back into the bag. By the time I had pulled it out completely, it had shed everything except the girth-challenged trunk. The Sonoran desert had desiccated the entire bag. Even immersion in boiling water, an overnight soaking in 5W30 semi-synthetic motor oil or a vat of KY Jelly wasn't going to rehydrate these mummified trees. I noticed though, that despite losing their mass and tree-like appearance, what was left were some of the most delicate branch and limb structures I'd seen.

## Making a Tree

The basic technique for making this style tree is simple but time-consuming. I glued Super Tree branches to the trunk armature cutting. This

sounds simple and acutely boring, right?? Well yes and no.

I experimented with a few adhesives: Walthers Goo, a hot glue gun, and Aleene's Tacky Glue available at Michaels Craft Stores ([www.michaels.com/Aleene%27s%C2%AE-Original-Tacky-Glue%C2%AE/gc0040,default,pd.html](http://www.michaels.com/Aleene%27s%C2%AE-Original-Tacky-Glue%C2%AE/gc0040,default,pd.html)).

Walthers Goo exhibited all its nuanced and peculiar molecular qualities; it got stringy and lumpy where branches were attached to limbs and stuck up the ends of the tweezers after adding a few branches.

The hot glue resulted in zillions of ultra-fine threads which made the tree look like it had been TPed or was part of the set for a giant spider horror movie.

Aleene's Tacky Glue worked best. True to its name it is tacky – you only have to hold a branch to a limb for a few seconds and it is attached enough to move on to the next branch. It dries quickly too.

To keep things from getting out of hand, i.e., bits of branches getting stuck everywhere, I placed a couple of handfuls of the disintegrated trees into a large shoe box. Next I chose what I thought to be one of the more realistic "trunk/limb" cuttings (figure 8 - left armature). A few of the limbs were too tall so I trimmed them back until I had what appeared to be the core limbs of a



# WOW!

ANIMATED LIGHT WORKS USA  
BY MILLER ENGINEERING  
**NEON BILLBOARDS**  
NEON SIGNS, ANIMATED SIGNS & BILLBOARDS

A  
D  
V  
E  
R  
T  
I  
S  
E  
M  
E  
N  
T



## Reddy Kilowatt



**Click  
each  
sign to  
see it in  
action!**



## Texaco



## Budweiser



## OK Used Cars



**Also see our other neon  
sign offerings ...**

**Click for more - lots more!**

Look at these

# WOW!

FREE

## BAR MILLS VIDEO CLINICS



Instructional Videos



Click here to SEE FOR YOURSELF!



Figure 8

Figure 8: On the left is an armature cut from the patio conifer. The middle armature is ready for branches to be glued to the limbs. The limbs have been whittled to a taper and additional limbs added to the trunk armature. I did this to give the finished tree a more rounded shape compared to the armature on the left. On the right is a finished tree ready for painting.

I used figures and vehicles to show the tree's size (and they make for a much cooler photo!) The vehicles and figures remind me of scenes in *Millers Crossing*.

tree. I drilled a small hole up into the bottom of the trunk and used ACC to glue a 2" length of florist wire in the hole. The wire allows you to poke a small hole into your scenery and place the wire in it. If you don't like its position you have only a small hole to cover as you search the landscape for the perfect spot.

Among the fragments of Super Trees were small tapered clusters from the tops and branch ends. These had enough branch structure

remaining with a spreading shape that was perfect for the ends of limbs and the top of the tree.

### One Branch at a Time

I gently picked up a branch with tweezers, applied a small amount of Tacky Glue to the end(s) that will touch the limbs, and stuck it in place with the branches oriented away from the limb. As I added these to the armature, I could see a tree emerging (figures 4 to 6)! One

ADVERTISEMENT



Figure 9



Figure 10

at a time, I continued gluing the branches to the limbs, working from the limb-ends inward towards the trunk. Yes, you're right, I did say "one at a time", and yes, I doubted my sanity at this point.

A lot of trial and error ensued. The Super Tree branches have a nasty habit of sticking to each other much like sprigs of organic Velcro®.

Branch placement was crucial. I found out that sticking the very end of the branch to a limb made a very weak joint – Aleene's Tacky Glue needs some surface area to do its adhesive magic (figure 4).

Some of the Super Tree branches were curved. Others had much longer stems. These offered more usable surface for gluing the branch to the

limb. This technique made gluing branches to limbs a bit easier. After a fair amount of frustration, gestures, and verbiage not for the faint of heart I ended up with a pretty decent tree, certainly better than anything I had ever made previously, and I hadn't even painted it yet.

I used an aerosol can of Krylon gray primer from Ace Hardware to paint it. Painted, this looked like one realistic, early-winter tree. That is, until I stuck it into a piece of foam in a rough scene on the layout and shot a few quick photos of it. To my eyes it looked better than any tree I'd made before. But in the photo, shortcomings became obvious.

## **Good, but not Great**

The most glaring problem was the abrupt transition (no taper whatsoever) from the stumpy ends of the limbs to the delicate of branch clusters (figures 9 and 10). Were I modeling a season where trees have leaves, this might not be a problem, as the lack of taper would be much harder to see. But a leafless winter tree hides nothing, including unrealistic limb to branch transitions. Another noticeable problem was the lack of density of the branches, a function of not being able to lay them up close together because of the Velcro®-like tendencies of the fine branches. I stayed with it and found solutions for these problems.

**Figures 9 and 10: I used the trees at a rural junction of a branchline off the main. The structure is a scratchbuilt model of D&H's YD Cabin in the mountains at Ararat summit on the Pennsylvania Division.**

**I start my scenes by roughing in the landforms, adding some vertical elements and taking photos from a number of different angles. The photos guide the placement of additional elements. These are the first two trees I made – note the lack of taper of the tree limbs.**



Figure 11



Figure 12



Figure 13

Figures 11 to 13: Different angles of the Junction scene. Look closely to see how the limbs “evolved” from blunt ends to tapered limbs such as one would see on a real tree in early winter. Ballast, more foreground rocks, and final details need to be added. At this stage, the trees impart a sense of realism I had never previously attained.

## Enhancing the Process

I started whittling the limbs to taper them – just about the oldest technique for working with wood, and the simplest and least time-consuming for tapering a limb branch. I took an #11 hobby-knife blade to a limb on a new clipping, and in no time had tapered the limb. Soft hands are a key here. Too much pressure on the knife amputates limbs instead of tapering them.

Now for the branch density (or rather the lack of it). Clearly there had to be a better and easier way to glue the Super Tree branches to get the density of a tree in winter. Closer examination of a length of the Super Tree branch provided a solution. Instead of snapping each individual branch from the donor limb, I snapped the limb on either side of the small branch, which yielded a more user-friendly “T” (figure 4) that was much easier to glue to the tree.

The top length of the T provided a more robust surface for the glue. The T also let the branches project out more from the limb allowing closer spacing and greater density. Finally, using the T of the branch allowed me to work branches around a limb a full 360° so the branches could be placed very close to each other.

Those Velcro-like ends could be placed along a limb with much greater precision. It was a lot like assembling a three-dimensional puzzle. Over time, it got easier and faster.

Once the gray Krylon had dried, the photos showed tree number two looking more realistic than the first one, but there was still one more issue. I took four photographs, turning the tree 90° in each. The tree had a decidedly two-dimensional appearance – most of the main limbs joined the trunk in a single plane. As a result, the tree was rather flat, but with good branch structure. This flatness works well when up against the backdrop, but foreground trees needed to be full all around, more 3-dimensional.

## **Making 3D Trees**

There was an easy solution – add more main limbs! I had more trunk/limb armatures than the layout would ever need, so I went through them looking for ones with one or two really exceptional limbs. I clipped these off, tapered them with the hobby knife, drilled holes in the trunk of the tree, and cemented the new limbs in place. In no time I had an armature with realistic limbs all around. When I added the branches and painted this tree, the result was good enough to qualify as a foreground model! It had the necessary

**Figure 14: I often like to replicate prototype photos I've taken over the years. This scene was inspired by a photo I took at Montpelier, Vermont a couple of decades ago. It's nighttime, and a depot and surrounding trees are "spotlighted" by an approaching train. When I saw this photo on the monitor, I knew the tedium of gluing branches to armatures one-at-a-time, had been amply rewarded!**



Figure 14

trunk girth, realistically tapered, 3D limbs, and dense branch structure. This tree closely resembled the trees in my photos along the abandoned Susquehanna mainline.

## Hints and Tips

Here are a few things to keep in mind should you wish to have a go at making winter trees. First and foremost, they are very time-consuming. Don't even dream that you're going to have a hillside of trees after an hour or two. That's not going to happen. You know from past experience that the really realistic modeling techniques take time – like distressing individual boards on the side of a building, shingling a structure, or painting figures. For all intents and purposes, you are sculpting a tree with natural materials, separately gluing each branch in place.

The materials, like any creative medium are not easy to work with at the outset. "What am I getting in to?" is a question you'll ponder often during the first tree. But hang with it for at least three or four trees. The learning curve is steep with this process, but after a few trees you'll make a good one and after that your skills (and speed) will improve rapidly. As you whittle, snip and glue branches, seeing improvement each time, you'll get into a zone that will make the process almost creatively-satisfying, and the time factor shortens.

Here's another thing to remember. Even if you have a large layout, you don't need a lot of these trees – one or two next to a favorite structure

model or a few blended into the foreground of a scene, will add a level of realism that will blow you away. These are foreground trees for sure. The scene shown in this article is only 30 inches long and 12 inches wide – a narrow space I really didn't know what to do with. Note there are only six of the "scratchbuilt" winter trees, the rest of the scene is forested with smaller trees or pieces of Super Trees straight out of the box, plus a few small commercial pine trees.

Early winter is a time when one can see and appreciate a landscape, especially one that happens to have a railroad cutting through it. The time invested in a few of these trees goes incredibly far in increasing the realism of this and any seasonally-similar scenes. 



## What You'll Need

**Tree cores or armatures** – Commercial armatures are available from Woodland Scenics, Bachmann, and other suppliers. You'll need to figure out what kind of glue to use to attach natural limbs to plastic. Aleene's may work.

Several "natural" offerings such as sagebrush are available from scenery supply dealers – an Internet search should lead you to them.

Sorry, I don't know the type of conifer bush I snipped for mine; perhaps some kind of Juniper? They are prolific as decorative yard elements in the northeast and no doubt elsewhere. Good armatures are between the outer foliage and the trunk. A few trips to your backyard or the woods should eventually yield a plant or bush with a suitable branch structure for tree trunks and limbs. If you harvest your own, give them time to dry before starting to make trees.

**Scenic Express Super Trees** – Hands-down, this is one of the better tree

making products I've used. Order from their web site – [www.sceneryexpress.com/products.asp?dept=1007](http://www.sceneryexpress.com/products.asp?dept=1007) (be sure to mention MRH!) The basic tree material is available in 1/4- or 1/2-bushel packages, and is a real bargain – it goes a long way on a layout. Many of the trees can be used as-is for small or medium trees straight out of the box, and they'll blend nicely with the ones you make.

- A good fine-point tweezer
- Hobby knife with a supply of new #11 blades
- Fine-point scissors
- Aleene's Tacky Glue and florist wire from Michael's or other craft stores.

Patience – this is as important as all the previous tools.

Soothing or inspiring background sounds compatible with the above-mentioned patience. Music, talking books, or TV (if you're good at multi-tasking) are all good.

Don Spiro is a photographer, writer and jazz drummer wannabe living with his soul mate in the light and space of the Southwest in Tucson, Arizona. He can't seem to remember a time when trains; real and model, didn't just blow him away. Rather than being a typical model railroad, his freelanced North Jersey layout is four continuous shelves around a 10 x 10 room which are constantly changing dioramas depending on his current interests. For the past few years, he's been drawn back more and more to the B&O on Staten Island, where he grew up in the '50s and '60s, and the layout is beginning to reflect that. Don says the hobby is filled with some of the most talented and creative artists one could find in any medium, who are a constant source of inspiration to him. It's a pleasure for him to call many of them friends.

# BUILD AN OUT-OF-SERVICE

# TRAIN ORDER SIGNAL

– by Tom Patterson

**M**any years ago, train order signals were an integral part of timetable and train order operations. These signals were used primarily to stop trains at telegraph offices in order to receive orders from the dispatcher. As improved communication and signaling methods were developed, such as CTC, train order signals were phased out. In some cases, the blades on the signals were removed while the telegraph office was left in place. After seeing photos of several of these decommissioned signals, I decided to scratchbuild one for my layout.



Figure 1: Coal Extra 158 passes an out-of-service train order signal standing forlorn, at Petersburg Junction on the author's layout.





Figure 2

**Figure 2: Semaphore signal at the Radial Railway Museum – photo by Todd Sestero, used by permission.**

I began by searching for photos and plans on the Internet. My primary inspiration was a picture of a semaphore signal at the Radial Railway Museum, shown in figure 2. More semaphore photos are available at [www.railroadsignals.us/museums/radial/index.htm](http://www.railroadsignals.us/museums/radial/index.htm). The square casing at the top of the signal showed me a way to attach the brackets that held the signal blades in place.

I cut a 4" piece of 3/32" brass tubing for the signal mast. This length allows the mast to extend below the scenery for additional support. Next, a short piece of 3/64" brass rod stock is inserted in the top end of the mast using ACC to secure it in place. The brass rod should extend a scale 9 inches above the top of the mast and

is used to support the square tubing used for mounting the brackets. Finally, cut a 7/64" piece (about 9 HO scale inches) of 3/32" square brass and glue it to the protruding piece of 3/64" brass tubing (figure 3).

The brackets that held the signal blades in place present a challenge. Rummaging through my collection of parts, I came across some old Athearn handrail stanchions. They have a small loop formed at one end and appeared to fit the bill. To form the brackets, grab the handrail stanchion with needle-nose pliers on either side of the loop and press gently against the stanchion (figures 4 and 5).

The slight bend allows the loop to stand off slightly from the mast and

closely resembles the brackets in figure 2. Form four brackets and glue one to each corner of the square brass at the top of the mast. Figure 6 shows the first stanchion glued to the corner of the square brass mast top.

A number of the photos I've seen of out-of-service train order signals show the actuating mechanisms for the blades still in place. It appears as though the control pipes were cut just below the blade when the blades were removed. The remainder of the mechanical linkage remains with the exception of the control pipes that went into the train order station.

To model the actuating linkages, begin with the bracket that holds the control pipes in place. For this I used .010" x .030" brass flat bar. One piece of the bracket has a loop in it to go around the mast and the other piece is straight. While it would be more prototypical to have a loop in

**Figure 3: Insert a small piece of 3/64" brass rod into the 3/32" mast. The rod should extend a scale 9" from the top of the mast. Then glue a scale 9" piece of 3/32" square tubing to the rod.**

**Figure 4: Using needle-nose pliers, grasp the handrail stanchion by the loop.**

**Figure 5: Create a small bend by gently pressing on the stem of the stanchion.**

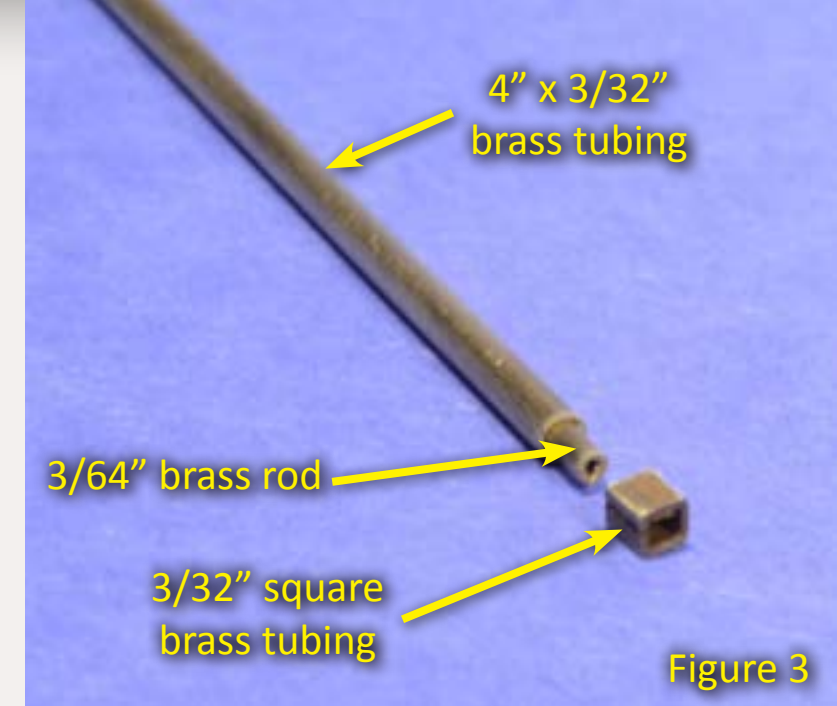

Figure 3

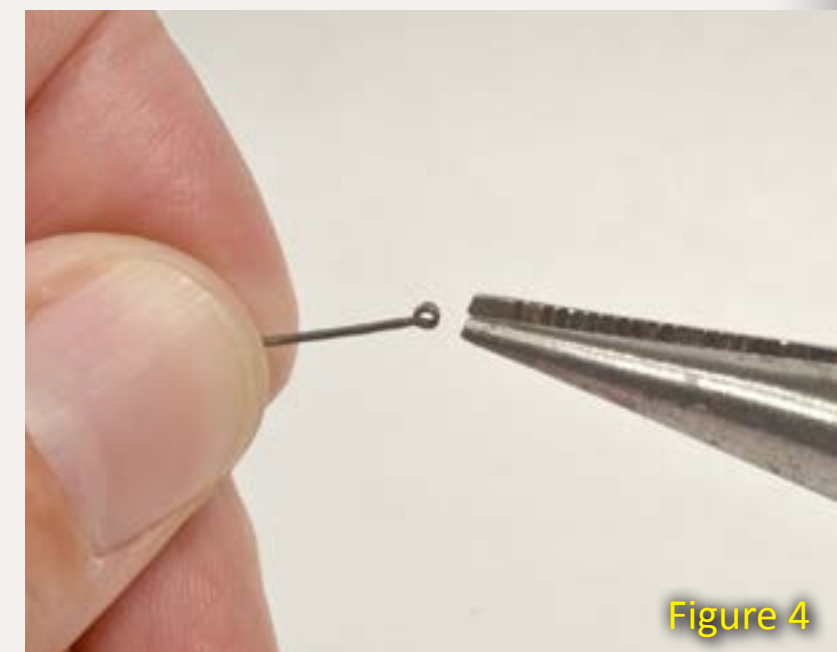

Figure 4



Figure 5



Figure 6

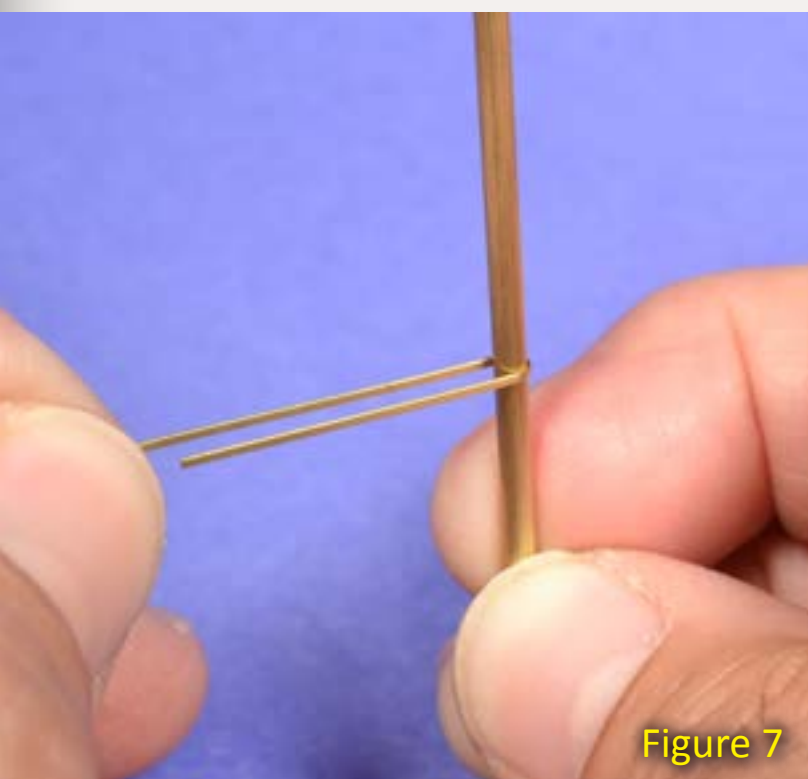

Figure 7

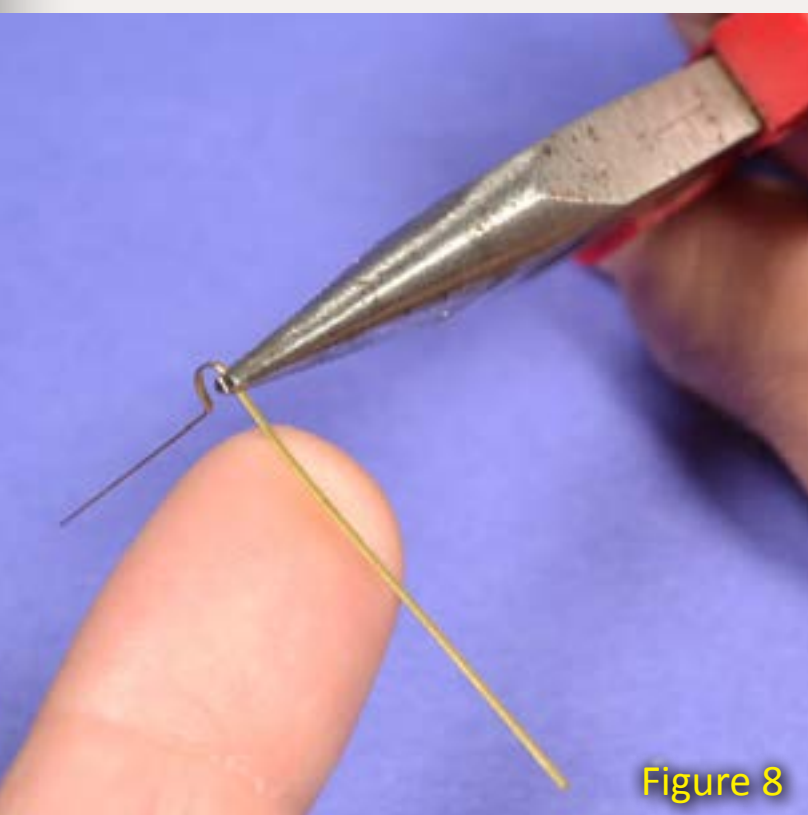

Figure 8

each piece and have them join at the center of the mast on each side, the loops would have been too small to manage, at least for me. Start by forming the brass into a loop by wrapping it around the mast (figure 7).

Next, grab the loop just inside of the curved portion with needle-nose pliers and then bend the outer portion to a 90-degree angle (figure 8). Bend the other side in a similar fashion. The total length of this bracket, from side to side, is 3 scale feet, so cut another piece of the flat brass to this length. Center the piece with the loop against the piece that was cut to 3 scale feet and snip either end of the piece with the loop. Glue the bracket with the loop to the mast 10' from the top, and at a 45-degree angle to the brackets at the top. The straight piece will be mounted after the control pipes are in place. Figure 9 will help visualize this step.

I modeled the control linkages using two levers cut from pieces of brake rigging that I had in a parts box and some .010" diameter wire. Mount the levers 16 scale feet from the top on

**Figure 6: Attach the handrail stanchion to the square tubing.**

**Figure 7: Wrap the .010" x .030" brass strip around the mast to form a loop with the correct radius.**

**Figure 8: Grab the brass strip just inside the loop and bend the outer portion at a 90-degree angle. See also figure 9.**

either side of the mast. Be sure that the levers are parallel to the bracket with the loop mounted at the top of the mast earlier. Cut two pieces of .010" diameter wire to match the distance from the lever to the center of the square tube at the top of the mast. After attaching the wire to each lever and the bracket with the loop, glue the 3' long piece of straight brass flat bar to other side of the bracket with the loop. Figure 9 shows the completed installation of the levers, the control pipes and the brackets.

I made the ladder from some brass ladder stock that I had on hand, but there are a number of other options available from numerous suppliers. I bent the top and the bottom of the ladder at 90-degree angles and then bent the sides so that the ladder would press fit onto the mast. I touched each side with a small bit of ACC to fasten the ladder in place.

The last step is to attach a base to the mast. I used the base that came with an Oregon Rail signal kit because it was handy, but you could easily fabricate your own. In fact, all of the other signals on my layout have a base that was fabricated from 1/8" brass tubing and .010 styrene. I simply cut a small piece of the tubing for the base and cut the bottom plate out of styrene using a standard hole punch. Figure 10 shows one of these bases. The bottom of the base should be 26' from the top of the mast. I used a piece of a C.C. Crow bridge pier for the foundation. A chunk of styrene would also work.

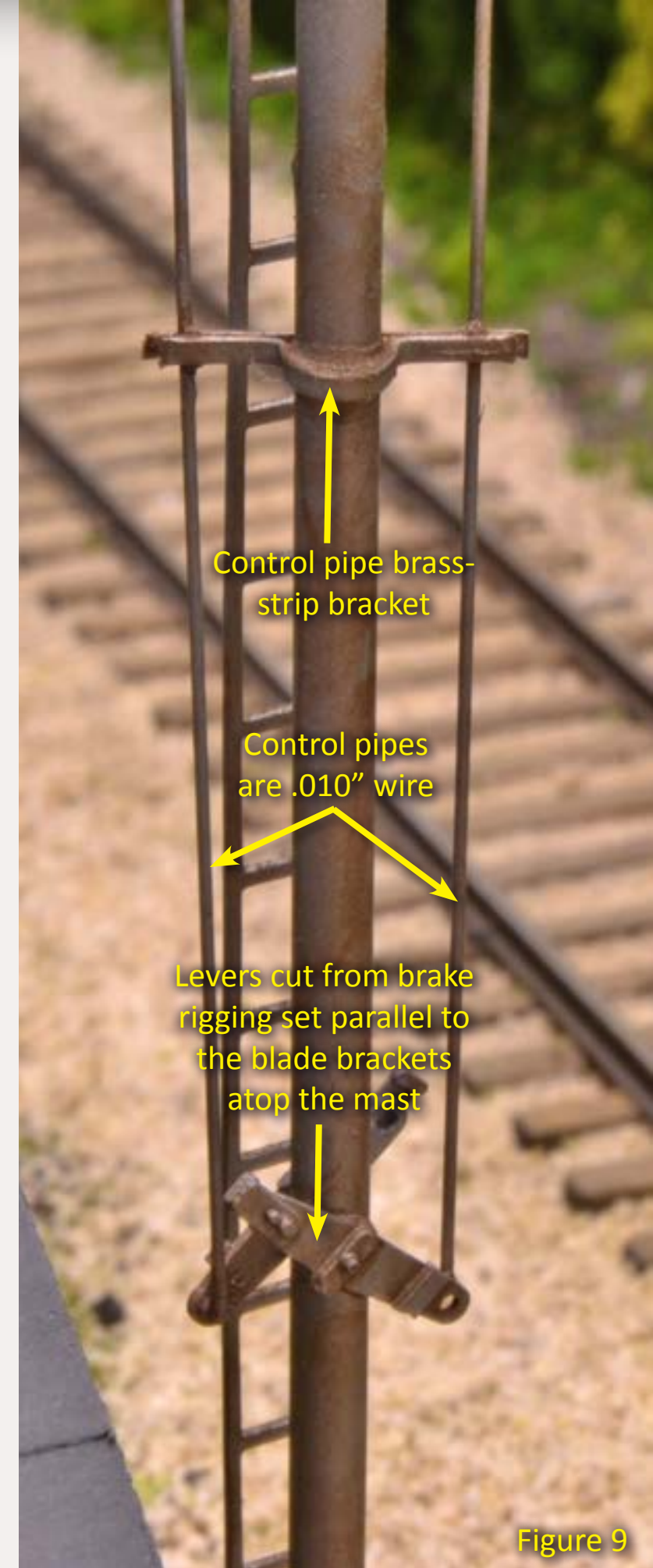

Figure 9

**Figure 9: The levers, .010" wire control "pipes", and brass strip bracket attached to the mast.**



Figure 10

Figure 10: As an alternative to the Oregon Rail Supply base, make a base from like the one in this photo from 1/8" brass tubing and .010 sheet styrene.

Figure 11: The finished signal installed at Petersburg Junction.

After weathering the signal with some artist's acrylic burnt umber, I drilled a hole in the center of the foundation and glued it to the mast with 2-part epoxy. Then I weathered the foundation and installed the signal at Petersburg Junction on my layout where it stands as a reminder of times past.



Tom Patterson got his start in model railroading with a Lionel train set at Christmas back in the '60s. That train set eventually became part of his first layout. Tom re-entered model railroading in the late '70s and has been working on his current layout, the HO scale Chesapeake, Wheeling and Erie Railroad, a free-lanced coal hauler set in West Virginia, for almost 20 years.

Tom and his wife have two grown children and live in Cincinnati, Ohio. They enjoy hiking, biking, reading and spending time with their family, which includes two rescue mutts and a large number of saltwater fish.

Tom's been published in MRH before – [Kitbashing a Central Valley Truss Bridge – Nov 2011](#).



Figure 11

## Bill of Materials

**K&S Engineering (Walthers part #s):**

3/64" brass rod 370-1619  
[www.walthers.com/exec/search?quick=370-1619](http://www.walthers.com/exec/search?quick=370-1619)

3/32" brass tube- round 370-1268  
[www.walthers.com/exec/search?quick=370-1268](http://www.walthers.com/exec/search?quick=370-1268)

3/32" brass tube- square 370-1503  
[www.walthers.com/exec/search?quick=370-1503](http://www.walthers.com/exec/search?quick=370-1503)

1/8" brass tubing- round 370-127  
[www.walthers.com/exec/search?quick=370-127](http://www.walthers.com/exec/search?quick=370-127)

**Detail Associates (Walthers part #s)**

Brass flat bar .010 x .030 229-2524  
[www.walthers.com/exec/productinfo/229-2524](http://www.walthers.com/exec/productinfo/229-2524)

Round brass wire .010" [www.walthers.com/exec/productinfo/229-2503](http://www.walthers.com/exec/productinfo/229-2503)

**C.C. Crow concrete bridge footings**  
[www.cccrow.com/pages/ho-con-pg.html#foot](http://www.cccrow.com/pages/ho-con-pg.html#foot)

Brake rigging parts (used for control levers)



# Mt. Allen is Gone!

More changes on George Sellios'

## Franklin & South Manchester

– by Charlie Comstock



Figure 1: The F&SM spreads out before you as you enter the layout room. Mount Allen at the tip of the center peninsula in fall 2009 with scenery all the way to the floor.



Calling all cars, calling all cars – be on the lookout for missing mountains in the vicinity of Mount Allen and Bedford Falls.

I had the opportunity to revisit the Franklin & South Manchester in January a year ago. Rumors circulated that George Sellios, talented modeler extraordinaire, had been making some changes to the layout. The rumors were true.

The first thing you need to understand about George is that he's a builder and he's darned good at it. What most of us would take a month to fuss over and zig-zag our way to completion, he'll finish off in a few days. He builds fast and he does super-detailing like all get out. Seriously.



Figure 3



Figure 2

George also likes to see his trains running. Years ago there was a mountain ridge behind what is now called Colbert on the central peninsula. It came out to improve the view across the room. In the [March 2010 issue of MRH](#) we documented some of the other changes he'd been making such as daylighting a tunnel behind Belverton.

Change is the natural order on the F&SM, so it was only natural that changes would continue.

**Figure 2: Entering the tunnel through Mount Allen in fall 2009 before the mountain disappeared.**

**Figure 3: The trestle spans the deep gorge between the Mount Allen tunnel (left) and Colbert yard (right). The scenery here went all the way to the floor, and was one of the first things visitors to the F&SM saw when they entered the layout room.**

The first obvious change I noticed was that Mount Allen was gone. The trestle is still there but the mountain and tunnel have gone AWOL. The other change was the daylighting of a bunch of previously hidden track behind Bedford Falls. Check out the differences for yourself!

As I write this, George is working on more changes in the Franklin area. What's next?

**Figures 4 and 5: Gargle Oil Company, one of the building complexes taking advantage of the newly-open space formerly occupied by Mount Allen.**

**Figure 6: The trestle still spans the gorge but the floor to railroad scenery now stops at knee level.**

**Figure 7: The tracks here were hidden from the light of day. No longer. Engineers can now breathe while they round this curve.**



Figure 4



Figure 5



Figure 6

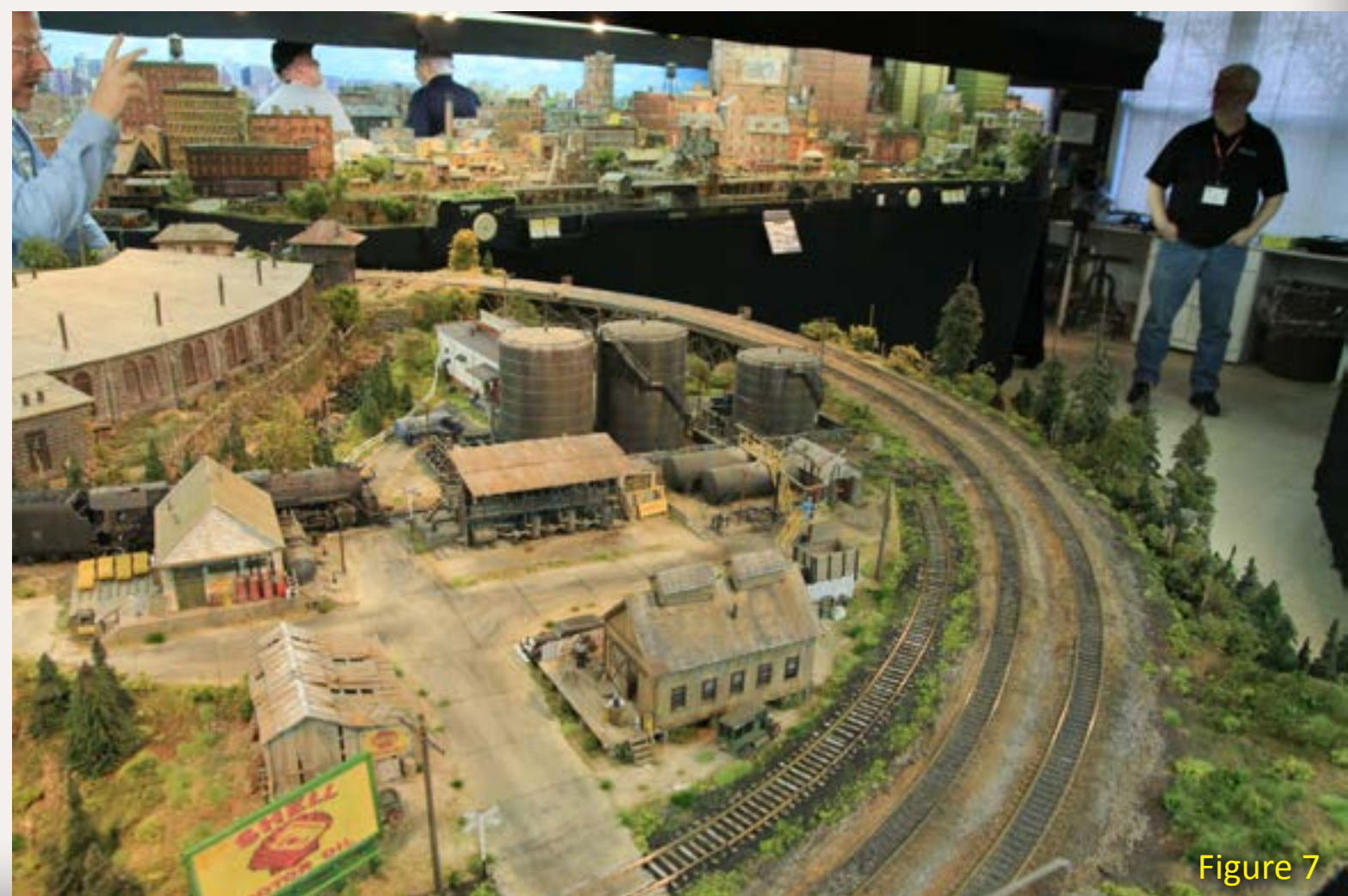

Figure 7



Figure 8: Bedford Falls and the mountainside behind it in fall 2009.



Figure 9: Bedford Falls with NO mountainside behind it in January 2011. Also missing is the Bingo Cigar Company.

 **Reader Feedback**  
*(click here)* 



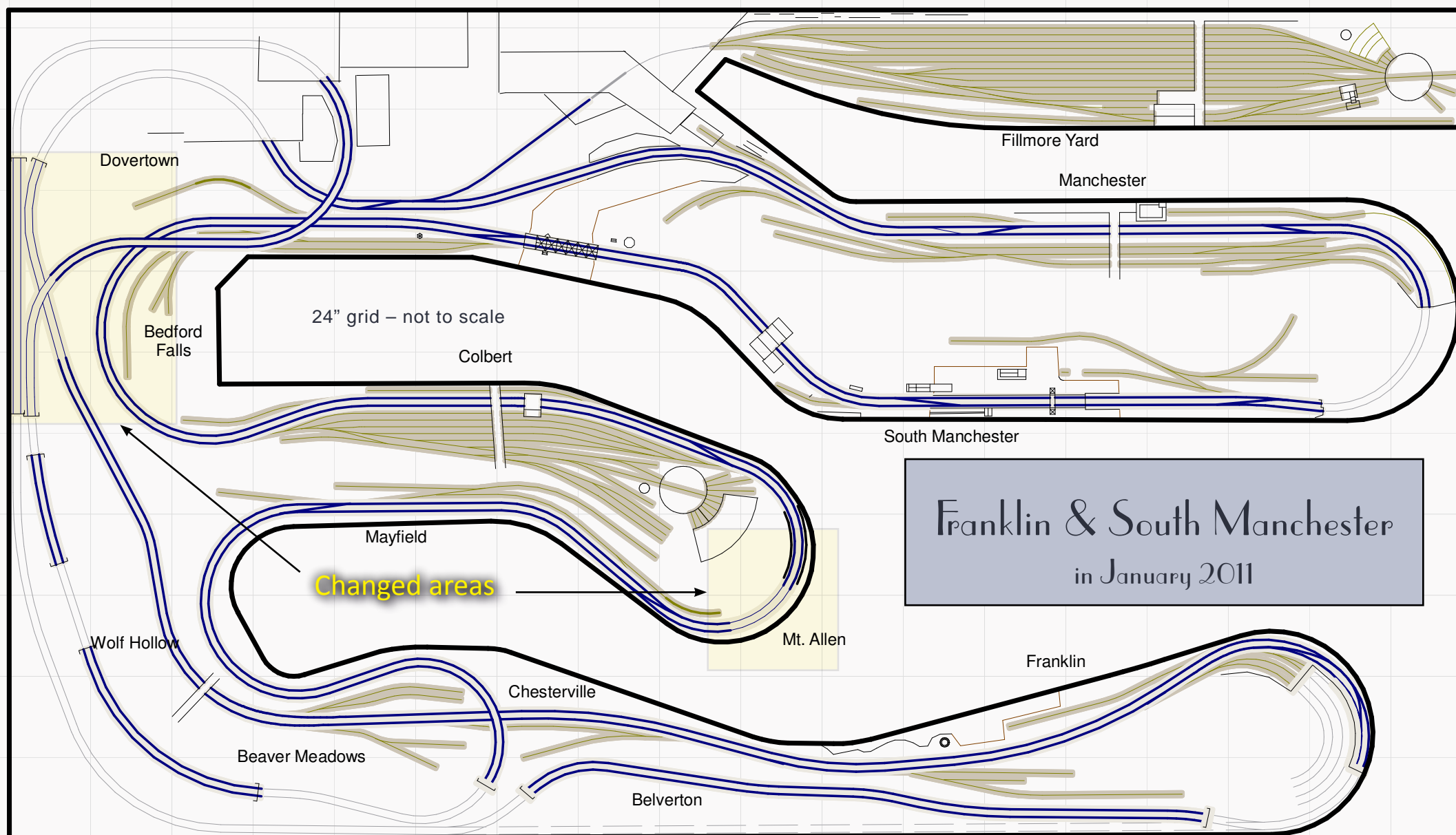

**Learn how to make scenery like this!**

**Click to see how ...**

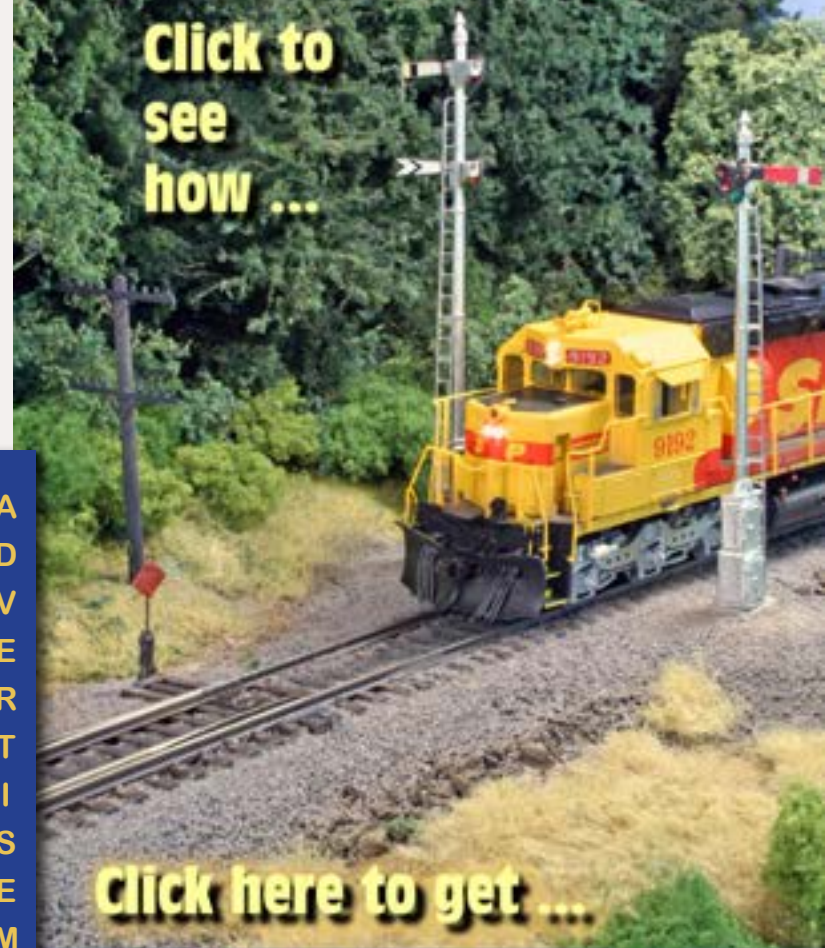

**Click here to get ...**

**Full step-by-step details in these two videos!**

**Click for more ...**



**Better, faster ... more fun!**

**model-trains-video.com**

*Remember when?*

**March 2010**

All back issues are available **FREE** all the time!

**Model Railroad Hobbyist magazine™**

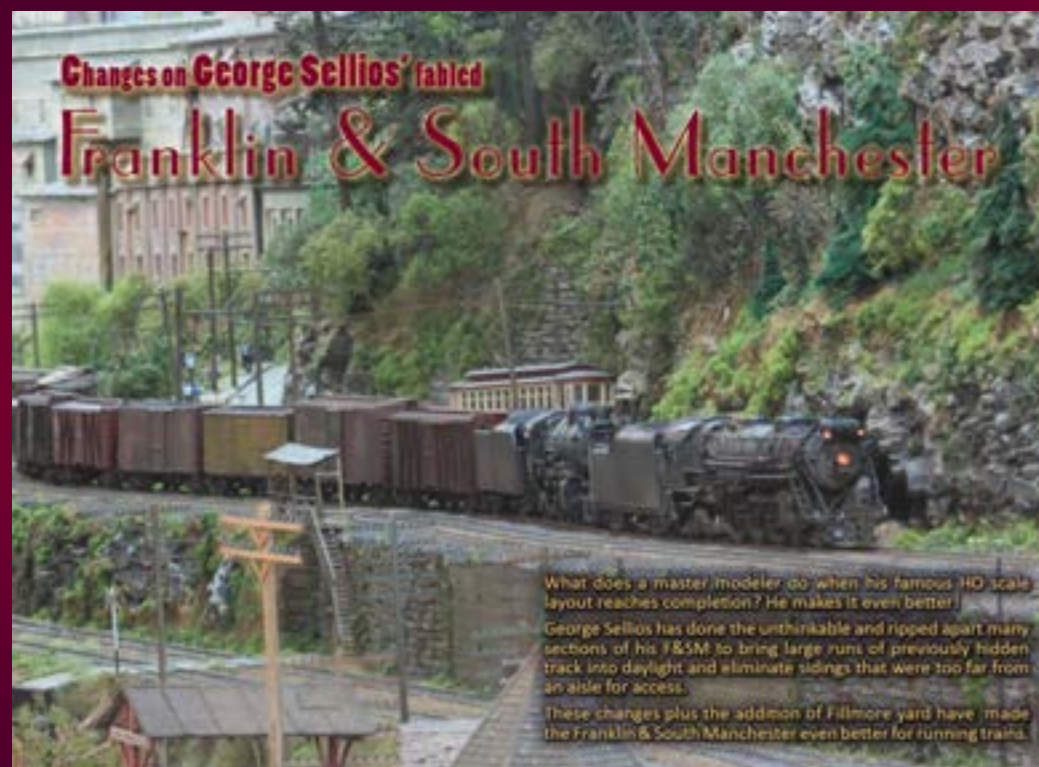

**Changes on George Sellios' fabled Franklin & South Manchester**

What does a master modeler do when his famous HO scale layout reaches completion? He makes it even better!  
George Sellios has done the unthinkable and ripped apart many sections of his F&SM to bring large runs of previously hidden track into daylight and eliminate sidings that were too far from an aisle for access.  
These changes plus the addition of Fillmore yard have made the Franklin & South Manchester even better for running trains.

# Points of Light

Using micro LEDs in your layout

– by *Dr. Geoff Bunza*

Model photos by the author



 **Reader Feedback**  
*(click here)* 

If you could light up the head of a pin, what would you do with it? Answer: light a model railroad, of course! In this article we'll look into new surface mounted device (SMD) light emitting diodes (LEDs), how to work with them, light them up, and put them into some interesting places.

Opportunities exist for lighting the “unlightable”: desk lamps, hand kerosene lamps, headlights, marker lamps, number boards, ditch lights, vending machines, vehicle turn signals, etc.

LEDs come in many different packages, but the ones I'll talk about are a fraction of an inch on a side, the smallest being .04" by .01" – these are sometimes called 0401 LEDs. Other sizes and designations include 0402, 0603, 1206, 3528, PLCC, etc. (figure 2).

LEDs are current sensitive or current oriented devices, not power oriented like incandescent bulbs. This means the light emitted by them is proportional to the current going through them, not the voltage across them. When using different LEDs, it is very important to supply them with the proper current. When in use, we often find the voltage across them to be different, sometimes even with the same family

and type of LED, operating at the same current. Later, I'll show you how to avoid these problems!

## Tools

I've discovered many things since starting to use these tiny LEDs (sometimes called nano-LEDs or Micro-LEDs). Among the first lessons I learned was that handling these successfully required new approaches and some slightly different tools (figure 3).





Figure 5

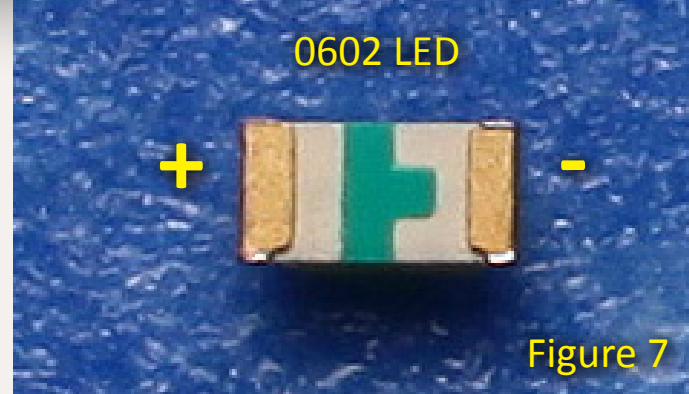

Figure 7

Figure 5: Bottle of appropriate liquid flux and some tiny applicators.

Figure 6: Homemade tool to hold LED and wires for soldering.

Figure 7: Bottom of a 0602 LED showing its polarity marking "T".

Figure 8: LED test probes improvised using scribers and spring loaded clip leads with hooked ends.

and extra lighting to my workbench too. They help a lot.

You can make an interesting "tool" for simultaneously holding the thin wires and LEDs in place (figure 6). This is made by soldering two flat-nose electrical clips (Radio Shack stock number 270-373) to a small piece of sheet brass (or other flat metal). Note that the clips stick out from one side and the left clip protrudes from the end about 1/8" more.

The left clip's jaws are covered with heat shrink tubing to protect the fine wire that they will hold. Place the tool in a clamp, and hold the tinned end

of a very thin piece of wire (I use 38 gauge magnet wire) against the SMD LED held by the right clip, so it can be tack soldered to the LED. Remember, minimize the independent movements required in performing every step with the LEDs. A similar tool can be purchased from [engineering.com/other\\_cool\\_tools.htm#LEDholder](http://engineering.com/other_cool_tools.htm#LEDholder)

## LEDs

The first problem, once you get one of these LEDs out of their package, is identifying which side is which! Most, but not all, of the ones I use have a green "T" on their underside. If you can find it and then see it, the head of the "T" marks the positive side of the LED. The narrow bottom marks the negative terminal (figure 7).

While trying to identify the contacts, I have "launched" more of these tiny devices than I care to think about into the farthest reaches of my workroom. So, I started simply putting them face down on the blue tape on my workbench, clipped two test leads to a scribe or pin (figure 8), then quickly touched the pins to the LED in each direction to check polarity. A current-limited low voltage source like a laboratory power supply set at 2.5V and 10ma is good for this, but I've also used a 9-volt battery with a 2000 ohm resistor just as effectively. There are many warnings not to reverse bias a LED (apply a negative voltage to the positive terminal) but I've yet to harm any LEDs with this technique. Most LEDs can take a reverse voltage for a

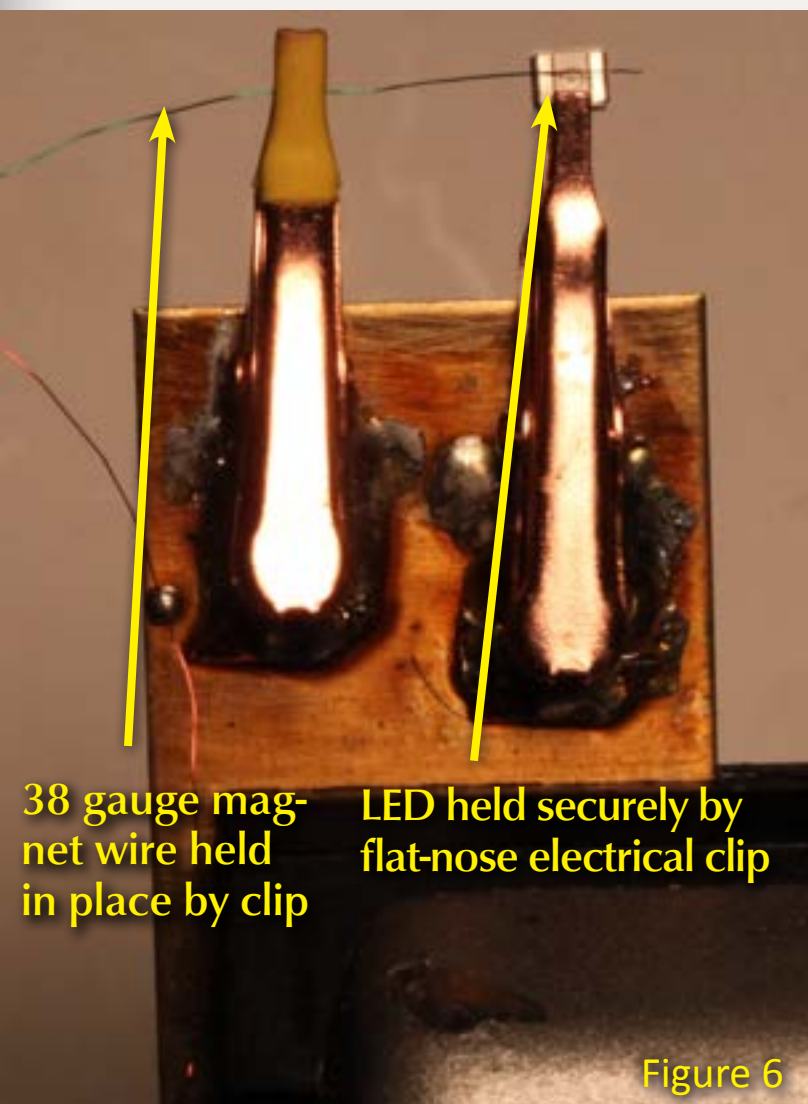

Figure 6

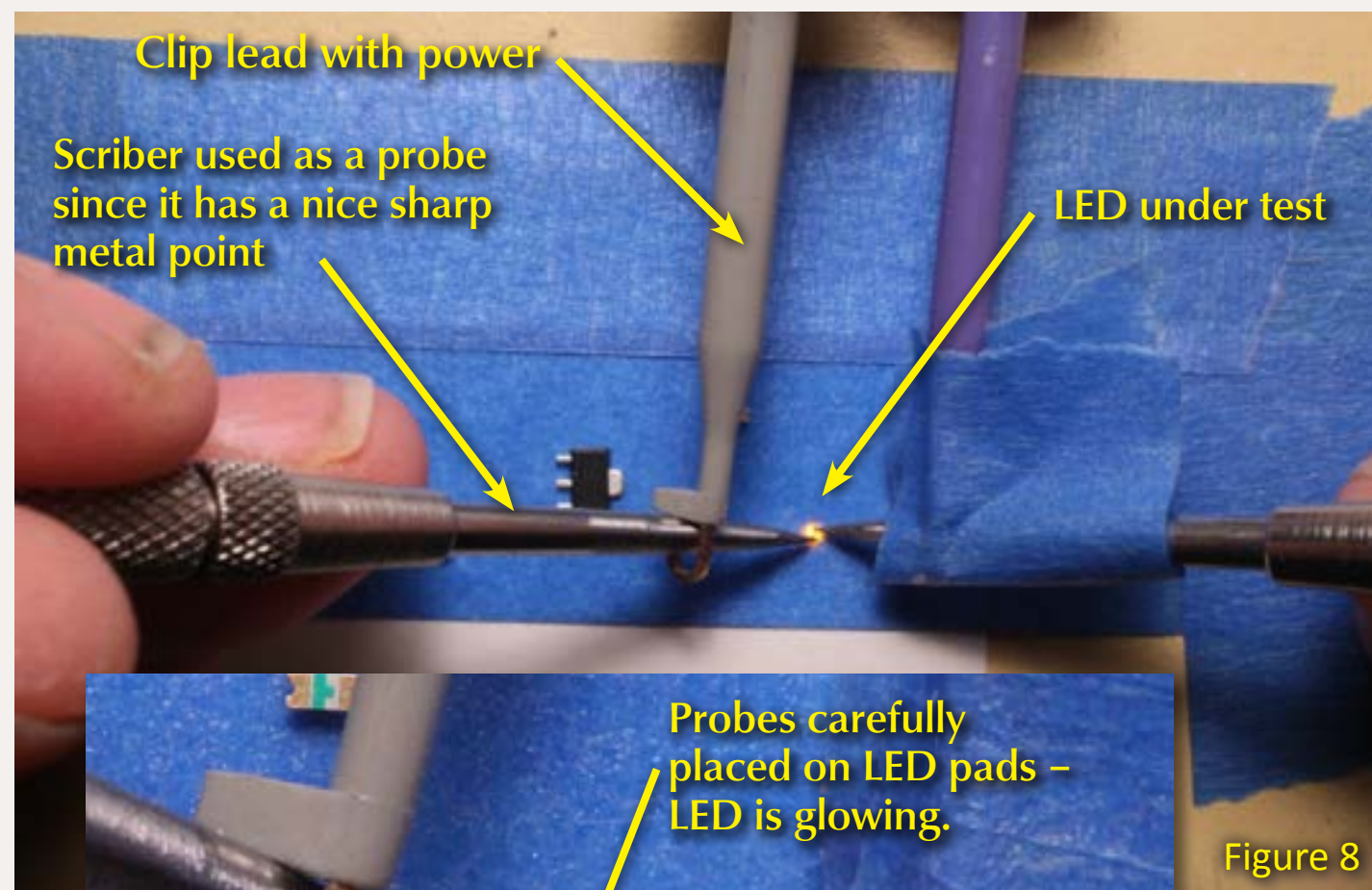

Figure 8

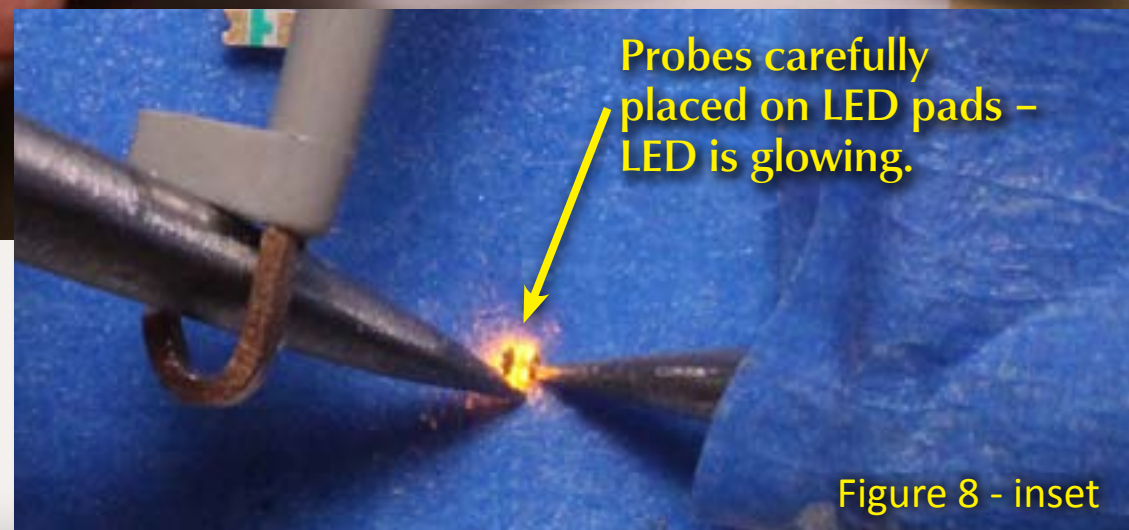

Figure 8 - inset

38 gauge magnet wire held in place by clip

LED held securely by flat-nose electrical clip

Clip lead with power

Scribe used as a probe since it has a nice sharp metal point

LED under test

Probes carefully placed on LED pads - LED is glowing.

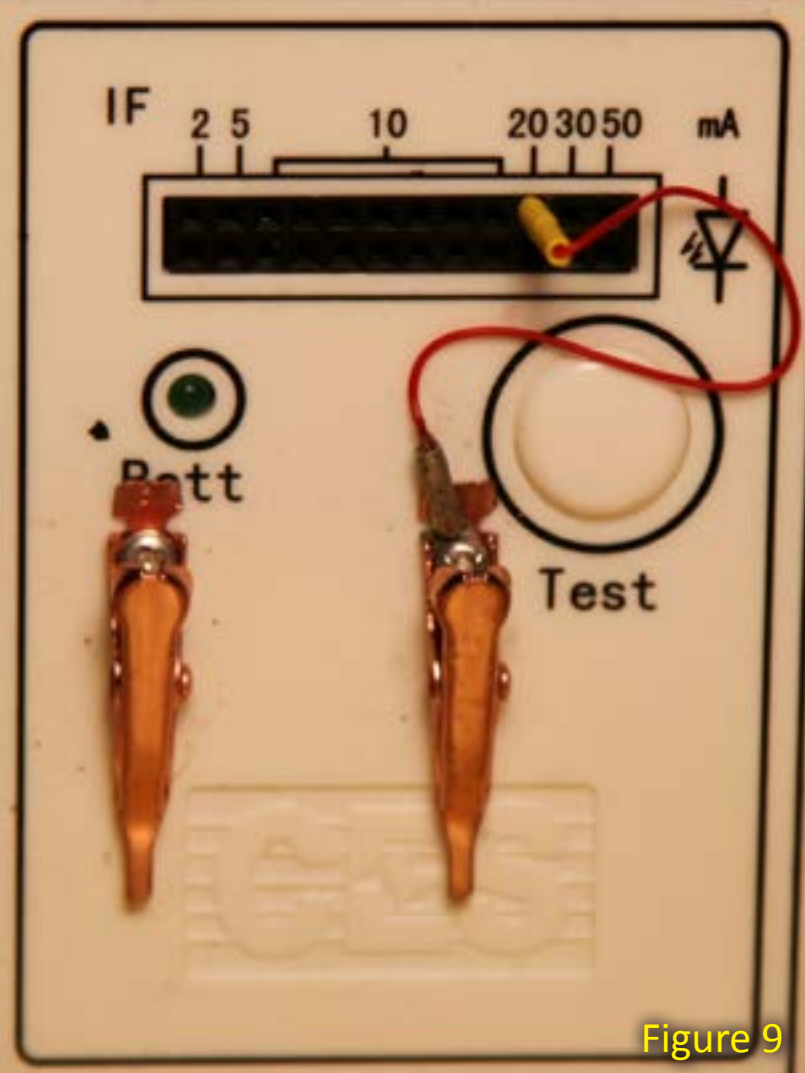

short period (a tap) as long as it's in the same range as the forward voltage that would be applied.

Small, low cost LED testers are also available. Most are just a 9 volt battery switched in series with one or more resistors to vary the current to the LED

**Figure 9: A commercial LED tester with clip leads added by the author.**

**Figure 10: Dipping the end of a piece of 38-gauge magnet wire briefly into a ball of solder (on the tip of a small soldering iron) will strip off SODERON insulation and tin the end of the wire.**

**Figure 11: The tinned wire end.**



**Figure 10**



**Figure 11**

under test. Several places sell them, including: [www.surplusgizmos.com/LED-Tester\\_p\\_1803.html](http://www.surplusgizmos.com/LED-Tester_p_1803.html). I added the clips (in figure 9) to hold the tiny magnet wire leads. The left clip is internally connected to the lower (ground) sockets.

## Wire

The intent of using these tiny LEDs is to tuck a light source into impossibly small cavities in a model. In order to do this well, the two wires powering the tiny LED must also be tiny. I use 38 gauge magnet wire, a very thin copper wire with an even thinner coating of insulation. This type of wire is sold in many diameters with at least three different kinds of coated insulation. Try to find wire with a SODERON® coating by the Essex Group or equivalent.

The coatings are available in a few colors. Try to get two different colors so the LED leads can be color coded. Red on the positive terminal and green on the negative terminal saves me a lot of time when hooking up the LEDs.

If you melt a bit of solder on the tip of your iron, and stick the end of a length of wire about 1/16" into the blob for a fraction of a second (figure 10), the insulation burns off and leaves the wire end tinned (figure 11).

## Wiring the LEDs

Now the fun begins! Place a LED face down on your blue bench tape, and make sure you know which side is positive and negative. Wet each contact on the LED with a tiny amount of rosin

flux. Melt a bit of solder on your iron. Then tin each contact. Place an appropriately colored wire on the LED so the tinned wire end is on the proper contact. Then press the wire onto the tape to hold it in place (figure 12).

Gently touch the LED/wire combination with your soldering iron to make the connection. You only need a fraction of a second for this. Repeat for the other side, then test the LED (figure 13).

Insert the LED in your holding tool (attached to something solid). Stretch (gently!) the two LED leads out and clamp them side by side into a "twisting tool" made by soldering another flat-nosed clip to a 6" brass rod (figure 14). Hold the tool's handle between your fingers with the wire stretched out, and twirl the handle to twist the wires together. This will make the LED easier to handle. Test the LED again to make sure everything still works.

For the smallest LEDs it's easier to use sticky blue tape to hold the LED while twisting its leads. The holding tool (figure 6) has difficulty holding onto the tiniest ones, but works well on the larger devices.

Read more about LED wiring here: [www.engineering.com/micro\\_wiring.htm](http://www.engineering.com/micro_wiring.htm).

## Light Up Your World with a Hand Lantern

Let's modify a plastic HO scale figure to hold a lighted kerosene lantern. See figure 15.

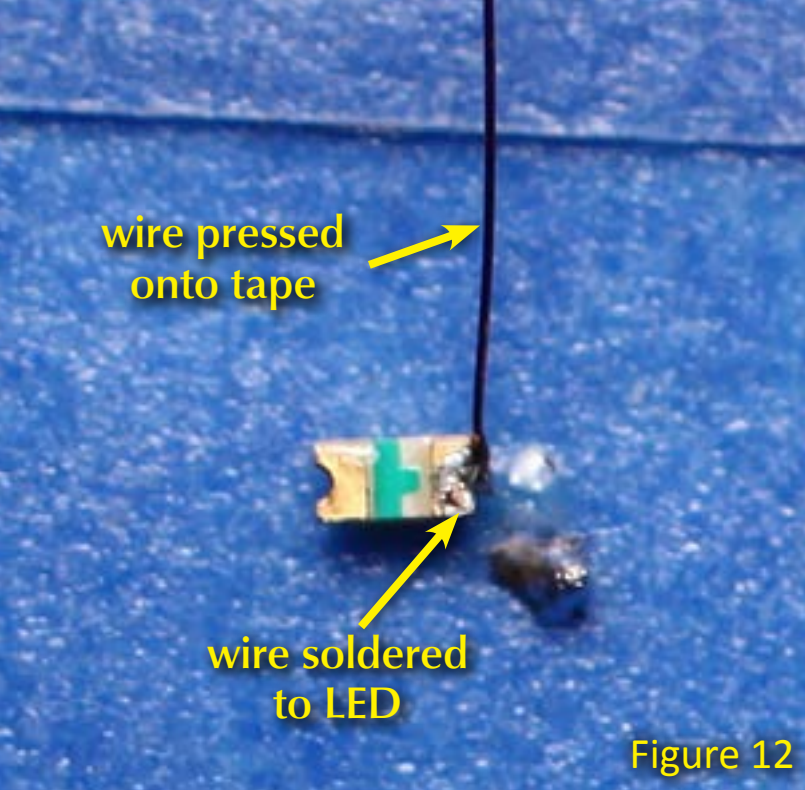

Figure 12

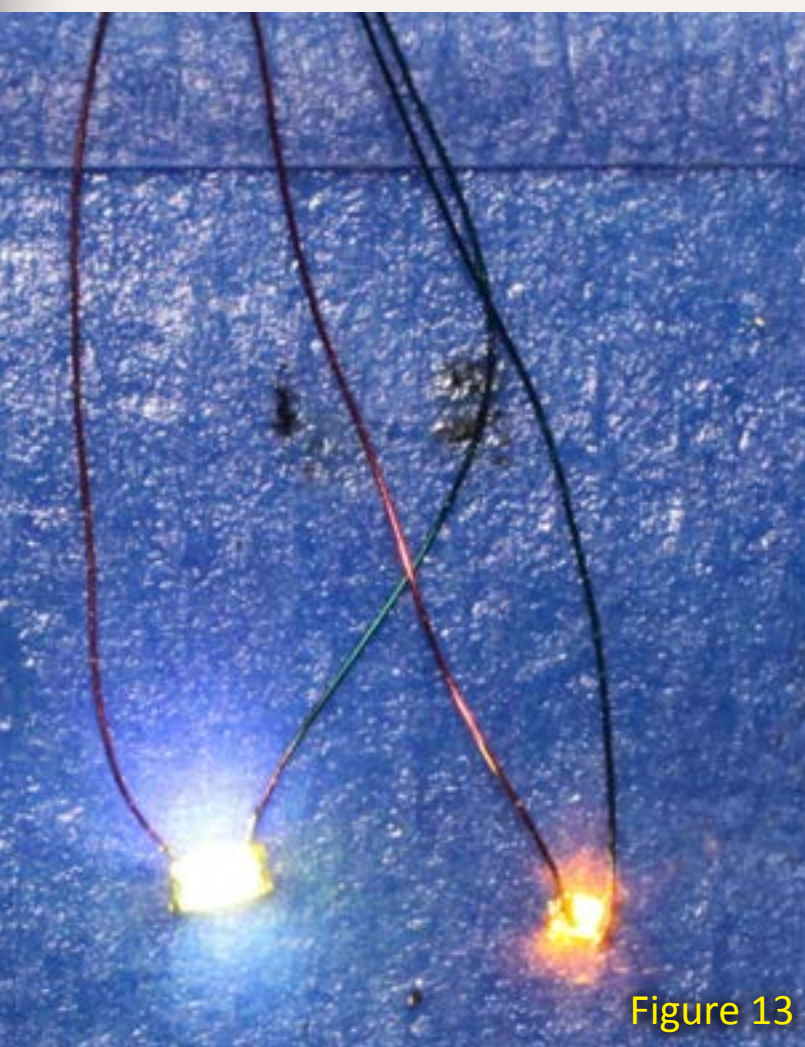

Figure 13



Figure 14



Figure 15

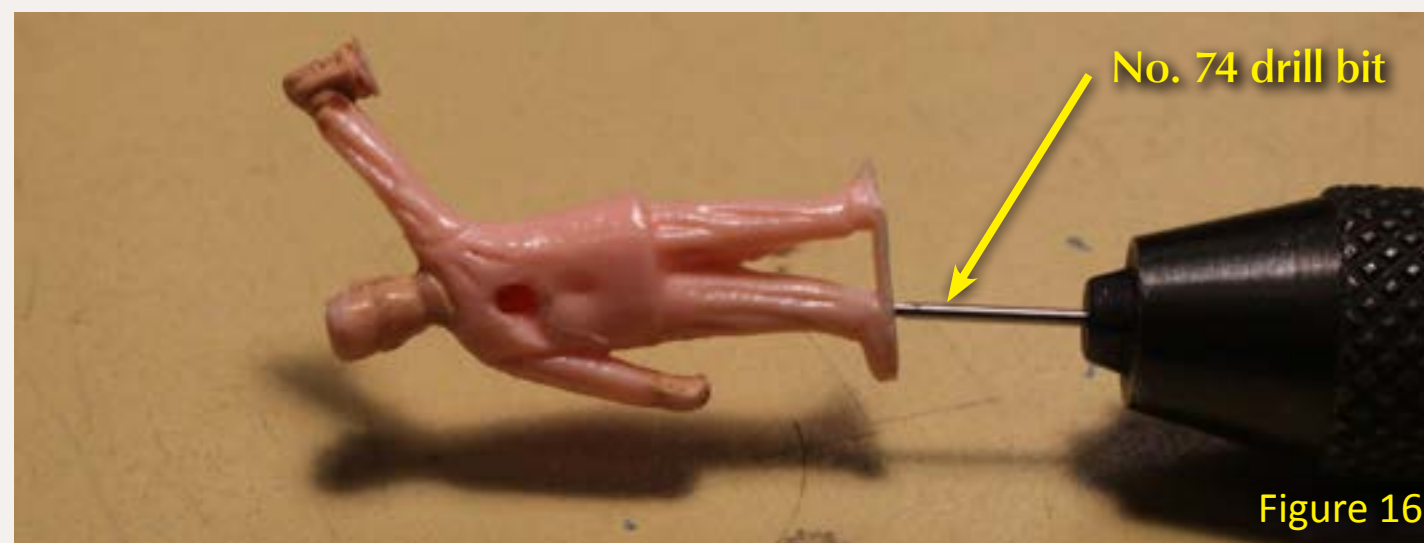

Figure 16

Figure 12: 38-gauge wire soldered to the negative terminal (note the direction of the "T") of a 0602 LED.

Figure 13: Testing the newly wired LEDs. Note the different colored wires – green for negative, red for positive. Color coding the wires solves the otherwise nearly impossible problem of determining which lead is which.

Figure 14: Homemade tool to twist the LED leads.

Figure 15: Bringing a kerosene lantern to life with a micro LED.

Figure 16: Talk about a root canal! Drilling a hole for the LED leads in the poor flagman's leg with a number 71 bit.

Select a figure with an appropriate pose to hold a lantern. If it has a base, remove it to allow accurately positioning the drill location. Drill through the leg up into the torso with a #74 drill bit in as light a pin vise as you have. I expand the hole by following up with a #71 bit (figure 16).

Drill from the back into the figure with a #60 bit to pick up the first hole and prepare to drill the next hole through the arm to the wrist (figure 17). Drill into the back of the figure's wrist or wherever you want the wires to exit (figure 18). I removed the bottom of the lantern from my figure.

Next, get a supply of #10 clear glass seed beads from a craft store. Seed beads come by the thousands in small tubes. If you're picky about which beads you use, a 0402 LED will fit in the hole. Otherwise, use a moto-tool with a small grinding bit to enlarge the hole until the LED fits. This takes a good eye and patience. Punch out a base for the lantern from .040" white styrene, or slice off the end of a styrene rod, and glue to the bead. I do this operation in batches (figure 19).

Prepare a 0402 LED, solder wire leads to it, and twist the leads together all the way up to an eighth of an inch to the LED. Now, glue the light-emitting side of the LED into the bead hole with clear glue – I use watchmaker's crystal mounting glue or ACC. After the glue dries, test the LED again to make sure you didn't tear a wire loose, then glue the lantern glass to



Figure 17



Figure 18



Figure 19

Figure 17: Drilling out the arm for the LED leads.

Figure 18: Drilling out the wrist for the LED leads.

Figure 19: Seed beads with styrene lantern bases attached.

the hand of the figure, wrap the leads around the hand of the figure and twist slightly to close the loop. Thread the wires inside the figure's arm to the torso and out, and then thread through the leg to the foot (figure 15).

Be sure to test the LED after each operation. Those tiny wires are easy to break. Finish painting the figure and mount or display. The figure here is an old Bachmann Plasticville worker, trimmed and painted with base removed. The original figure is on the left. Any figure with a suitable pose can be used.

### Applying Rule 26

Railroad operating Rule 26 typically states: "A blue signal, displayed at one or both ends of an engine, car or train, indicates workmen are under or about it; when thus protected it must not be coupled to or moved. Each class of workmen will display the blue signals and the same workmen alone are authorized to remove them. Other equipment must not be placed on the same track so as to intercept the view of the blue signals, without first notifying the workmen."

You can implement Rule 26 on your railroad (or show it being done) by wiring a figure holding a blue lantern with a special mount and regulator described here. I started with another old Plasticville figure from my junk box. This time the arm holding the lantern is down. I drilled through the leg so the hole exits under the arm. The wire leads take a short run down the back of the arm to the hand for the lantern

LED, and are painted over hiding them quite well. The glass seed bead is colored with Tamiya clear blue paint or with a blue permanent marker – both work well (figure 20).

After testing to see if the LED works, put the figure aside and cut a 1/8" strip of single-sided printed circuit (PC) board (PC ties work too). The length of the strip should fit loosely between the rails of HO scale track, with maybe a 1/32" clearance on both sides. Cut two piece of very thin phosphor bronze strip metal (I have used track sliders, old relay contact strips, and even flattened Kadee coupler springs) long enough to bend around the ends of the strip of PC board.

Solder a phosphor-bronze strip to each end, then bend the strips around the PC board ends, and test for a good fit between the rails. You know you've got it right when you can easily insert and remove the strip repeatedly. You can adjust the "spring" ends by bending the phosphor bronze strip away and towards the end of the PC strip (figure 21).

Quite often, LEDs are powered from a DC power source through a resistor. Here we are going to use another small SMD (surface mount device) to power our lantern – a Supertex CL2 constant current LED driver. This current regulator is specifically designed to power LEDs. You can learn more about it here: [www.supertex.com/pdf/data-sheets/CL2.pdf](http://www.supertex.com/pdf/data-sheets/CL2.pdf) and can order it from [Mouser.com](http://Mouser.com) and other places. It is

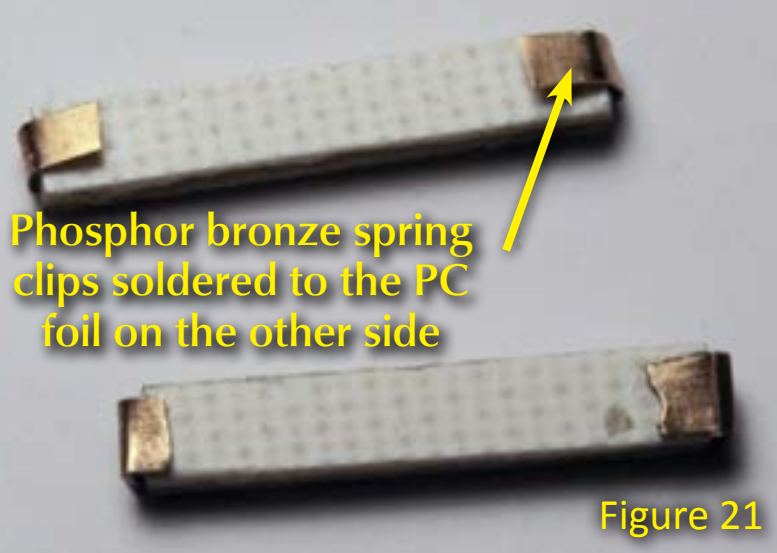

Figure 20

Figure 20: A workman carrying a blue lantern to flag under Rule 26.

placed in series with the LED and limits the current to a maximum of 20ma, regardless of the voltage placed across the pair – up to 90 volts (figure 22).

With a razor saw, make two cuts through the copper on the soldered side of the PC strip as pictured in figure 23. Remove the "V" wedge with a hobby knife. This will provide clearance



Phosphor bronze spring clips soldered to the PC foil on the other side

Figure 21

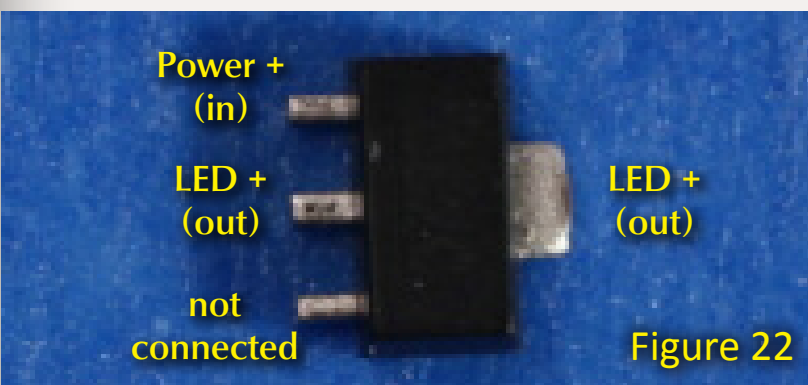

Figure 22

Figure 21: SINGLE-sided PC board for mounting the workman.

Figure 22: CL2 current regulator. There are two output pins (both connected to each other) leading to the LED(s) being current limited.

Figure 23: Gaps in the foil of the PC board figure base.

Figure 24: CL2 mounted on PC board.

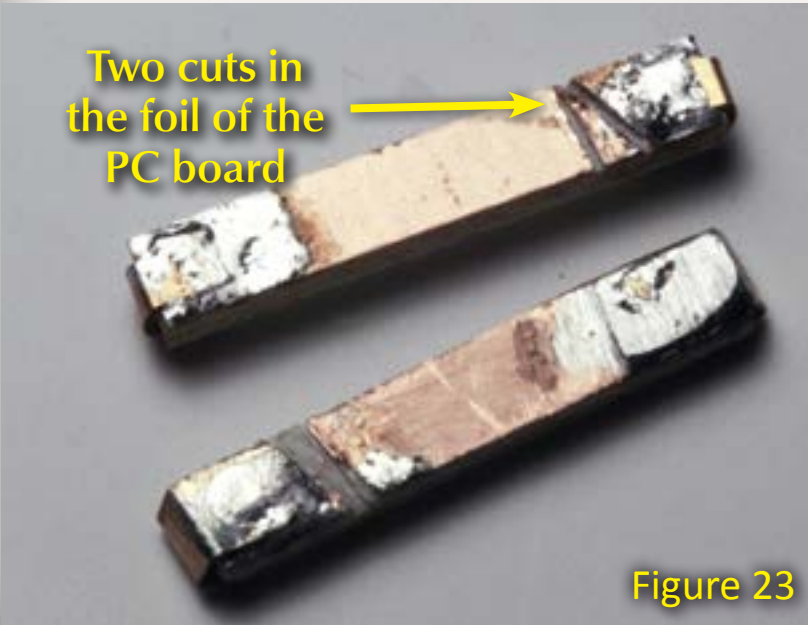

Two cuts in the foil of the PC board

Figure 23



CL2 regulator soldered across the cuts in the PC board foil.

Figure 24

for the back contacts of the CL2 regulator so you can solder it to the strip. Clip off the third “no connection” pin from the CL2.

Then tin, place, and solder the CL2 on the center strip. The isolated piece of copper will connect to the plus/positive/+ side of the LED leads. The end away from the CL2 will connect to the neg/negative/- side of the LED, which wires the series CL2-LED pair directly across the rails. Remember that DCC will drive an AC (varying) voltage across the rails when powered, and the regulator will limit the current to the LED (figure 24). Make another cut between the rail contact and the CL2 and solder a diode (almost any will do) across the cut with the cathode (negative side of the diode) towards the CL2 and the anode (the positive side of the diode) towards the track contact. This will protect the LED from

the reverse DCC voltage and rectify the signal.

I drill a number 71 hole right at the PC cut, thread the wire from the lighted figure through, and glue the figure to the PC strip with ACC glue. Solder the LED leads to the proper contacts after very carefully trimming and tinning the leads. Paint the strip a dark brown, and place your trainman ready to signal that his train cannot be moved (figures 25 and 26)!

I also use this type of lighted figure placed alongside the track to note when I have powered off a staging or storage track. In this case the blue lantern is lighted when the power to the track is off, using a separate set of contacts on the power switch to the track. When the power is on, the lamp goes out, reminding me of track status at a glance.



Phosphor bronze rail contact

CL2 regulator

Figure 25

Figure 25: The Rule 26 workman.

Figure 26: The Rule 26 workman with illuminated lantern powered through the rails.



Figure 26



## Industrial Lamps and Shades

Prepare a 0603, 0402, or 0401 white or yellow LED by soldering two leads to it and twisting the wires together. Paint the contacts of the LED black to keep them together and dull the color and shine. Obtain an industrial lamp shade (Grandt Line, Tichy, Miniaturics, and Campbell Scale Models, and others offer variations. See figure 27.

Pick your favorite and paint the underside white, tan, or off-white, and the upper side a dark green or red. Some need to have a number 71 hole drilled through their middle. Thread the LED leads through the hole and cement the LED to the underside of the shade facing down. These can be hung from

**Figure 27: An assortment of different lamp shades – Grandt Line, Tichy, Miniaturics, and Campbell Scale Models.**

a ceiling, from a wall bracket, from a bracket on a pole, and from horizontal feeder wire – all prototypical locations – with great effect. Depending on the color of your chosen LED, you may wish to tint it with Tamiya clear paints or permanent marker pens, to “warm” the color to your taste, especially if you are using the bluish white LEDs.

It’s definitely a good idea to check the colors of your LEDs BEFORE assembling shades or installing them in figures.

### Lighting a Loco Headlight

Prepare a 9823 white LED by soldering two leads to it and twisting the wires together. Paint the contacts of the LED black to keep them together and dull the color and shine. Punch out a piece of paper or thin plastic about 1/8 inch in diameter. Punch a small hole in the middle and thread the 9823 lead wires through the middle so the paper acts as an insulator for the LED in the headlight housing. Typically, I drill out

the housing to fit the LED, and blacken the inside. The wire can come out of the headlight casing through a number 71 hole. Placing the hole at the lower rear or bottom is often the easiest for running the wires into the body shell. Punch out a small disc of clear plastic for the front lens and cement it in place after painting the headlight. If you power this LED with a CL2 regulator, it is VERY bright. So bright, in fact, that it will light up a wall from two feet away. I actually like the effect, but normal people might like to power it from a DCC decoder through a limiting resistor, valued around 1000 Ohms (figure 30) reducing the brightness a bit.

### Lighting a Marker Light

Prepare a 0603 white LED by soldering two leads to it and twisting the wires together. You could also use a 0402 white LED. Once mounted, twisted, and tested, paint the contacts of the LED with a thick enough coating of your favorite paint to insure the

contacts are insulated (Black enamel paint works well when used sparingly. It’s thick right from the bottle and does not attack plastics). While it dries, paint the marker lamp housings (I use [Utah Pacific](#) marker lights), and let dry.

Fill in the lamp holes with either transparent color paint of choice, or micro glaze followed by a coat of transparent paint or permanent marker. You could also use transparent marker jewels.

Depending on the size of the LED, either insert it partway into the marker lamp and glue, or glue to the base and then mount the marker on the car.

Marker lights come in pairs so I use the CL25 regulator (the 25ma version of the CL2) to drive the two LEDs wired in parallel (figure 31). There is more info for the CL25 at: [www.supertex.com/pdf/](http://www.supertex.com/pdf/)

**Figure 28: Lamp shade parts.**

**Figure 29: Lamp with shade in operation.**



Figure 27



Figure 28



Figure 29



Figure 30

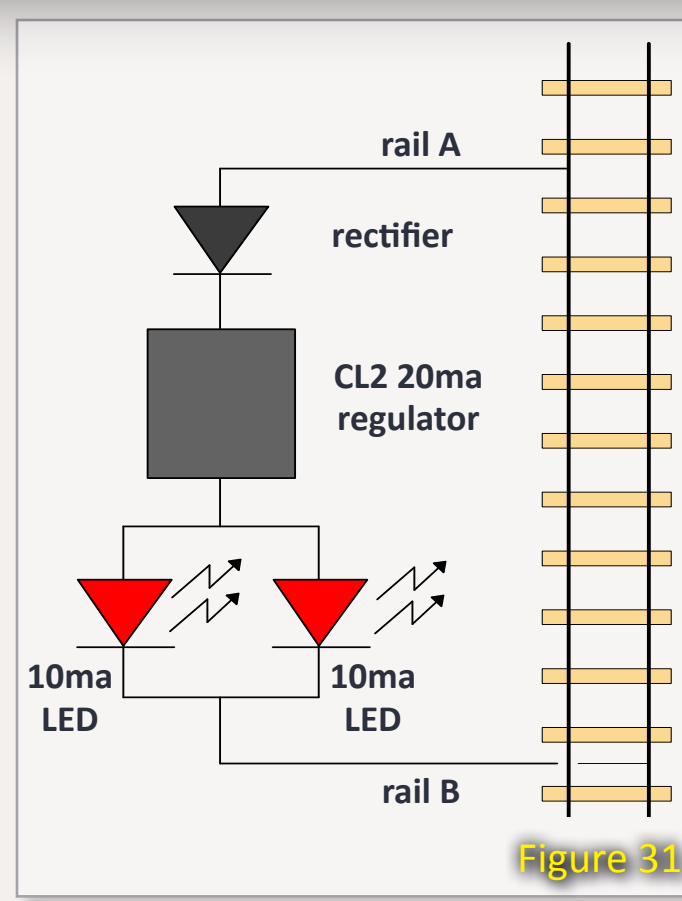

Figure 31



Figure 32

Figure 30: A LED headlight can be bright enough to really light up the track at night. It also runs cool so plastic body shells don't melt. It uses next to no current so decoder function outputs aren't strained.

Figure 31: Schematic showing two marker light LEDs wired in parallel with each other and in series with a current regulator and diode rectifier.

Figure 32: Marker light on the side of a NYC caboose.

[datasheets/CL2.pdf](#). This way each LED is lit with approximately 12.5ma. You should use the same type LED in each marker for this to work correctly.

## Experiment!

There are many variations of these lighting installations to be found. Invent some of your own.

The inspiration for my LED experiments came in part from Laurie McLean MMR. Read about his work in "Electronics and Animation – Surface Mount LEDs" by BHI Publications. He also has a number of interesting,

animation related videos on [youtube.com](#). Search using his name or YouTube id – scoopmmr.

Experimenting with tiny points of light goes much better when accompanied by large doses of patience and fine music! Have fun!

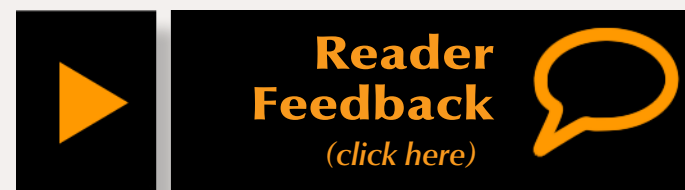

which spawned his interest in realistic animation and lighting. He models the New York Central, and sometimes the Great Northern, paying little heed to timeframe. On occasion, Geoff reverts to HO<sub>n</sub>30 modeling of strange, narrow critters from the woods of Maine.

Geoff Bunza started as a model railroader when he received a Mantua train set for Christmas, at age 6. He fed his interests through college becoming a member of the Tech Model Railroad Club (TMRC) at MIT and getting his degrees in Electrical Engineering. He has collected Lionel HO trains for many years,

Geoff has been diverted from model railroading over the years by engineering and management challenges in computer design, automatic test systems, electronic design automation, and starting five companies. He is blessed with his wife, Lin, in marriage for 32 years and their two terrific sons. He is a life member of the NMRA.

# 22 Stories Up

The saga of building a layout thousands of miles from the nearest hobby shop continues ...

# Building a Backdrop



**One of the major challenges I face in this hobby as an artistically challenged person, is creating a good looking backdrop ...**



Thomas Garbelotti is a frequent poster on the MRH form under the name 'Scarpia'. A native of Vermont, his chief interest is the Central Vermont railroad, especially the Roxbury Northern Division.

Thomas recently relocated from Vermont to Abu Dhabi, in the United Arab Emirates where he works for New York University helping to establish a new four year undergraduate school. He finally got to visit Egypt and the pyramids – "Didn't they use a quarry railroad to move stones?"

Thomas has written two other articles for MRH: [Model Railroading 22 Stories Up \(September 2010\)](#) and [Benchwork without Tools \(November 2010\)](#).



**M**y artistic lackings were causing me concern when it came to painting a backdrop. Additionally, I have recurring concerns about my limited work space in an apartment and the difficulty of having raw materials cut to the dimensions I need in Abu Dhabi.

When I lived in New England it wasn't a big deal to pick up a sheet of hard-board at the local store, take it home in my truck, then rip it to the width I needed. Now, the ability to complete those simple tasks is half a world away.

I began looking for a backdrop solution, based on the following criteria.

- Only a few visible seams
- Movable (not fixed to the walls)
- Little or no mess during construction
- Artistic abilities not required

Research led to the following options:

- A fabric-based background – think non-pleated curtains. This idea seemed a bit hard to pull off, even though the concept was intriguing.
- A hard surface with a painted background. Even though my skills in this area are shockingly absent, I figured I could learn.
- A hard surface with a photographic background. This seemed more workable than paint – there would be less mess, and I wouldn't have to learn how to paint.

## The Image

I settled on the photographic option and promptly paid a visit to the Backdrop Junction website, [backdropjunction.com](#). Viewing their selection made me realize that shipping a printed backdrop half way around the world seemed a little silly (and expensive). It occurred to me

there are a number of print shops where I live; what I needed was a suitable image.

Naturally, nothing in my personal photo collection seemed usable. I'd seen some photo backdrops on another layout from LARC Products – [larcproducts.com](#), so I ordered a set of images from them.

LARC offers a 4 DVD image set that includes background images, signs, textures, interior scenes, etc. that can be printed out and used as needed. I was most interested in a set from their 3rd DVD, a grouping named Heidt's Hills (figures 2 and 3).

This image's late summer colors and scene seemed like it would match well with my Montpelier Junction modules. It's a composite of 11 different images and measures 88" wide by 11" high, a good size for my project.



Figure 2

Figure 2: Heidt's Hills set before software alteration. Note the slight exposure differences in the panels.

Figure 3: Heidt's Hills set after editing with Photoshop.

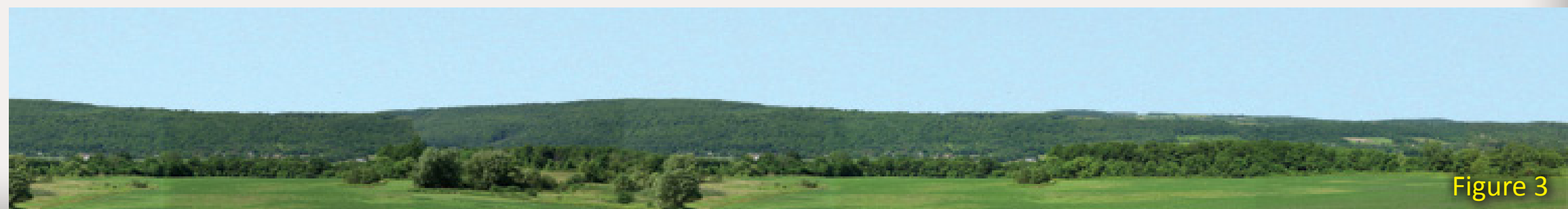

Figure 3

LARC recommends printing each section separately, and then removing the sky from the prints before applying them over a background pre-painted with a sky image. This avoids any problems with slightly different exposures of the component photos.

I find it hard to leave well enough alone and I wanted minimal seams. How could I rejoin all the pieces into a single image file? I figured I could take this file to a local printer and have them make a single large print for me.

I also thought that I could stitch the photos together, increase their width, and paint additional sky so I wouldn't need to paint or otherwise add the sky behind the print.

This evolved into a major operation since the individual shots provided by LARC varied enough in exposure and alignment to need a lot of rework. Fortunately I have both experience with and access to Adobe Photoshop. A couple of hours in front of the computer resulted in a workable 120" by 20" background image. The file size? A single, (not so) tiny 16.1 gigabytes!

### Mounting

Now it was time to consider how to support the backdrop. Despite my attempts at thorough planning prior to leaving New England, I hadn't given this any real thought. I faced another



Figure 4

Figure 4: For sizing, a couple of foam boards go up. These are 1 meter boards, and just miss the 4 foot module length.

### ADVERTISEMENT

Watch our website for our monthly specials!

Free Shipping on all US WEB orders over \$100.



**ACCU-LITES, inc**

Your DCC Center!

CLICK TO LEARN MORE:



<http://www.acculites.com>



**Authorized Dealer for:  
Digitrax, NCE, Soundtraxx,  
TCS and others.**

New Innovation

# LUBRICATION FOR THE NEW MILLENNIUM...

## NANO-OIL.COM

Nano Technology Lubricants

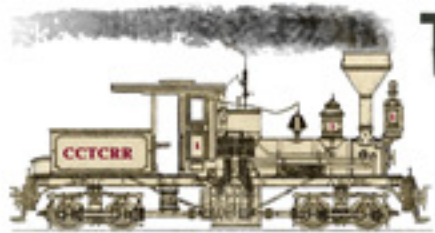

### THE SHAY FIXER

VISIT US AT...

SHAYFIXER.COM



Specializing in brass Pacific Fast Mail / United geared locomotives

"I use only the finest quality lubricants such as **Nano-Oil** ..."  
-The Shay Fixer



## StClaire

Made in U.S.A



# DRAMATICALLY REDUCES LOCO AMP DRAW ...

## For more details click here



### ADVERTISEMENT

Figure 5: A quick print of the backdrop on plain paper, taped to the foam board, provides an example of how it will look.



Figure 5

hurdle too; I wanted better lighting on the layout – the single light fixture in the room just wasn't sufficient.

Since it's hard for me to get plywood or lumber and I have no place for a shop, I needed a different solution than I would have chosen in New England. I ended up making another trip to IKEA where I picked up a few more GORM 110cm post sections, and a few inexpensive (about \$7) lights.

My idea was simple – mount GORM posts on the back of the modules, spaced to support sheets of foamcore. Each GORM post will carry a light fixture. The photographic background is attached to the foamcore,

and we're done! Now to see if the idea will actually work.

With the pieces in hand, I looked at actually mounting the system. Step one was marking the modules where the risers would attach and removing any overhanging foam from those areas.

I chose black foamcore instead of something light (and possibly blue), because sky blue foamcore wasn't available. I also figured the seams between the sheets of foamcore would be less visible with black and with the sky as part of the print I wouldn't need to paint one. The black band at the top should give the



Figure 6

Figure 6: Only the portion of the risers that will be visible above the foamcore backdrop panels needed paint. I wasn't concerned that the wood would warp in our climate-controlled apartment.

Figure 7: While the printers were busy with the background I had plenty of time to mount the black foamcore on the risers for the first two modules.

Figure 8: When the new backdrop print arrived from the printers, I rolled it out across the black foamcore (without adhesive) to see how it would look. The answer was, pretty darn good!



Figure 7

impression of a lighting valance without actually having one.

I painted the risers black to blend in, and then mounted the lights on them (figure 6). The power cords from the lights are concealed behind the foamcore.

## Printing the Backdrop

With this worked out, it was time to shop some local printers, and find out how much it was going to cost to print a 10' long photo!

A print shop located not far from my residence assured me they could do the job. In for a penny, in for a pound, as they say, and I contracted with them

for a total of \$60 US. I'm a big believer in getting what you pay for, so I was a bit concerned about the quality (I know this can cost over three times as much at print shops in the US), so it was with some trepidation I retrieved the actual print a week later.

I rolled it out for examination along the backdrop support and was pleased by the result! The print shop used a matte surface, reducing reflective glare which can be substantial in the room at certain times of day.

I closed the curtains to check the lighting situation using only the room and the layout lights. It turned out to be less even across the layout surface than I'd hoped. But from operator angles, it was

acceptable. An overhead valance would have been a better solution, but the extra construction would have brought a new set of problems – it would have been much more complex for an entirely free-standing set of modules.

I had also considered a short shelf along the top, above the background photo but below the lights. I didn't do this because of concerns the Gorm brackets didn't have the structural strength to support the additional weight of the shelf without bending. A full lighting valance might also have caused structural problems. With that in mind, I decided to stick with these lights, but I did switch to floodlight bulbs for smoother illumination.



Figure 8

With appropriate ground cover and scenery in place and some foliage in between the module top and the background, it looked like the background image and the layout would blend well (figure 9).

The backdrop arrived from the printer with a white border. Since I wasn't intending to model the snowy season in Vermont, I cut off the bottom border before mounting (figure 11). This also lets the print sit a bit lower.

My household is fortunate enough to come equipped with a paper-handling expert – scrapbooking skills do come in handy. After some quick consultation, my wife decided that two-sided mounting tape would be

the best way to attach the print to the black foamcore backdrop support (figure 14).

We figured putting the tape on the foamcore, then attaching the print would result in the smoothest

**Figure 9: Checking how the printed background, temporarily rolled into position, looks with the lights on.**

**Figure 10: From an operator's view point angle, the lighting is OK, but there are still some heavy shadows in spots.**

**Figure 11: I checked the lighting from ground level, too. Down there it looked pretty good.**



Figure 10



Figure 9



Figure 11



backdrop (figure 15). With the background print on its bottom edge, starting at the right end, we carefully attached the print to the taped foam-core, smoothing out the image with our hands.

## Blending it in

On most layouts the backdrop is built either before or during the benchwork construction. My backdrop construction was in reverse from that.

Another issue for me was how to blend the modeled foreground with the printed backdrop. Because this layout is designed to be broken down and moved should the need arise, and because the backdrop came after the layout, I couldn't just build a berm of

plaster between the foreground and the background.

Instead I used strips of painted pink foam pre-covered with scenery (I

**Figure 12: The full backdrop support installed with lighting.**

**Figure 13: The backdrop print came from the printer with an unsightly white border. I removed the border along the bottom.**

**Figure 14: We decided to use 3M double-sided tape to mount the background print.**

**Figure 15: Applying the double-sided tape on the backdrop support.**



Figure 13



Figure 12



Figure 14



Figure 15

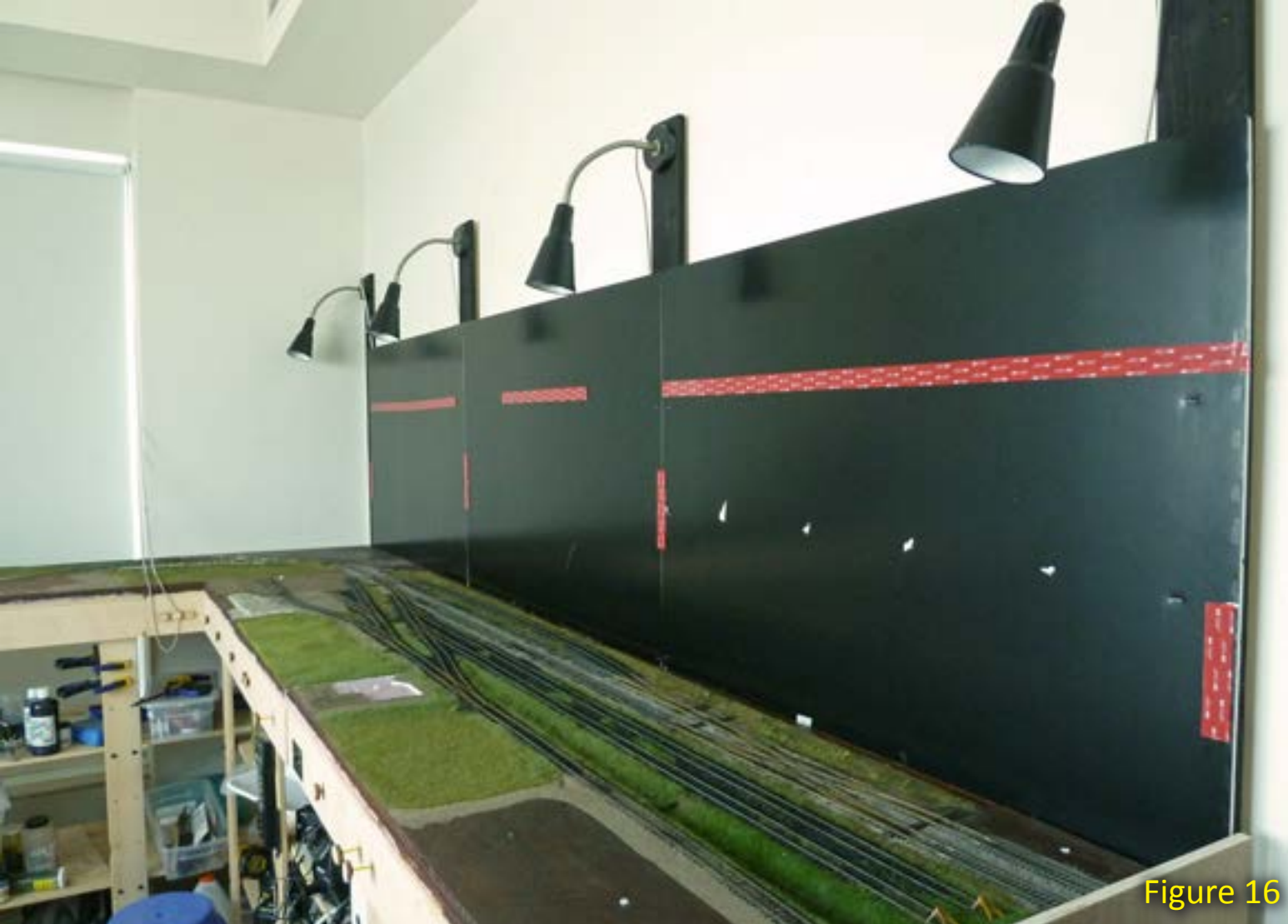

Figure 16

Figure 16: The tape installed on the backdrop support.

Figure 17: Finally, the background print is mounted!

Figures 18 and 19: I disguised the joint between the layout and the backdrop by adding prepared strips of pink foam-based ground.

didn't want to be subjecting the new backdrop to scenery mess) to hold the bottom edge of the backdrop in place. These strips will be covered with 'clean' scenery – grass, trees, and bushes to hide the transition.

It's clear that creating a backdrop to compliment your layout can be a challenging experience and sometimes a

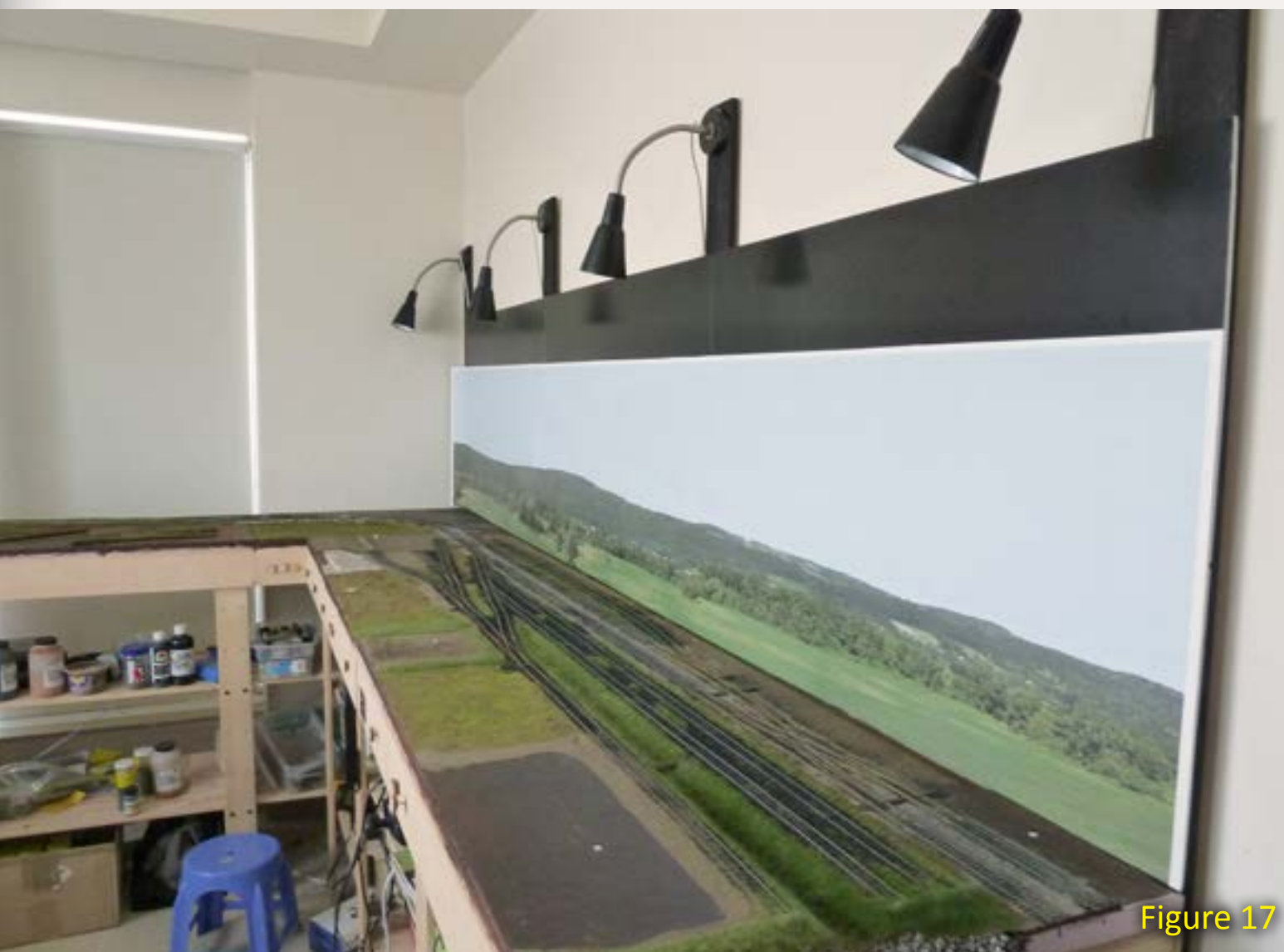

Figure 17



Figure 18



Figure 19



Figure 20

Figure 20: I poked some trees into the foam strip to help disguise the foreground to background transition.

Figures 21 and 22: After adding static grass, some vegetation, and trains, the scene is looking pretty darn good!

Figure 23: It's hard to believe this Vermont scene is in an apartment 22 stories up in a Middle East desert!

frustrating one. Whether you choose a simple sky-colored backdrop, a hand-painted masterpiece, or a photomural, the difference it makes is readily apparent – even in a small apartment!

 **Reader Feedback**  
*(click here)* 



Figure 21



Figure 22



Figure 23

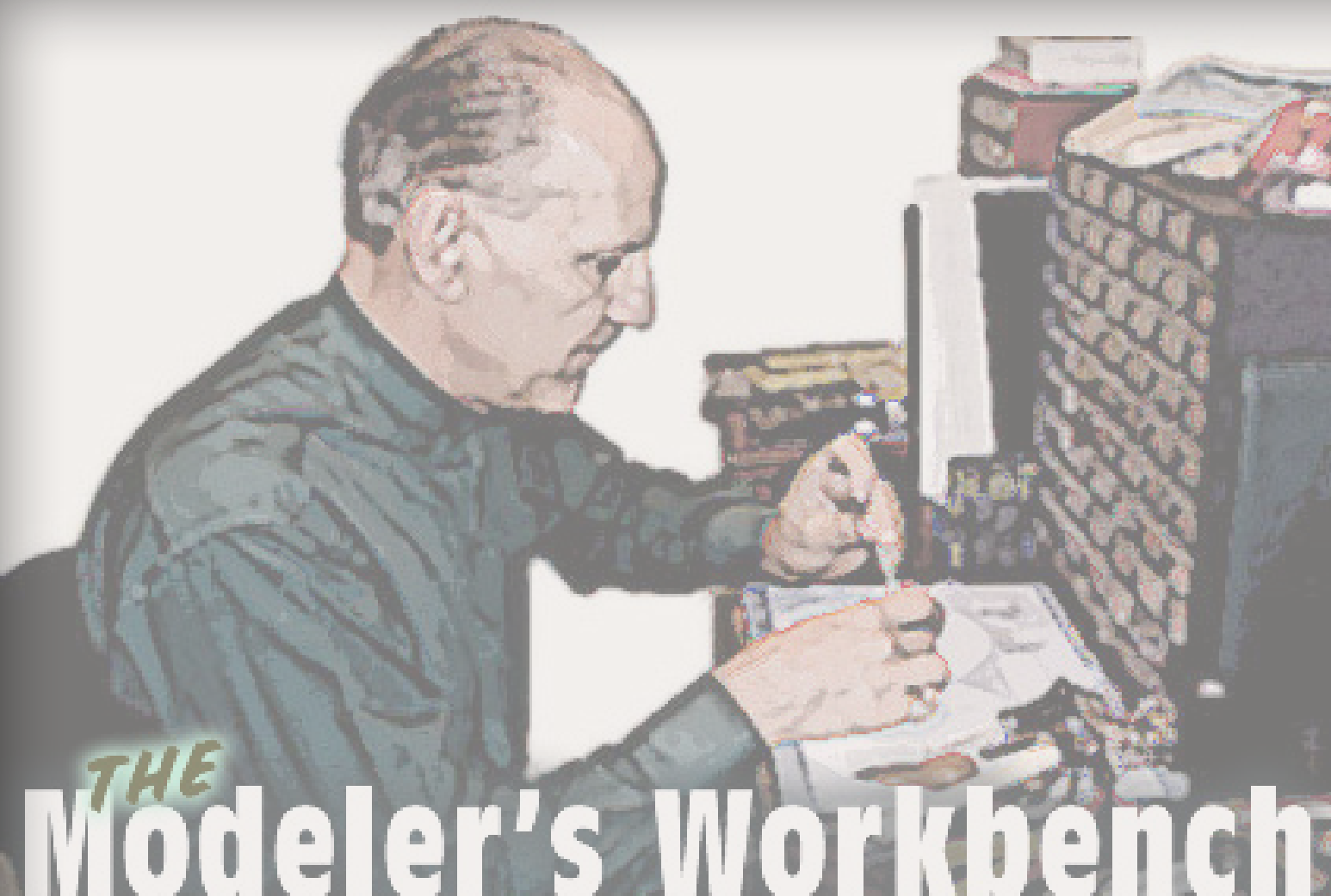

Figure 1: Using a cradle – an assembly of legs, sides, and ends – to support interchangeable “scenic” components allows Dirk to easily change which modules he’s displaying at a meet without having to build each module from the ground up.

## BUILD A CRADLE TO SUPPORT INTERCHANGEABLE MODULES

– by Dirk Reynolds



If you’ve been a regular attendee at train shows you may have noticed many of the modular layouts seem to be the same year after year. Sometimes it seems their builders created them, then rested.

I had the same issue with my modules until I figured out a way to make changing them easy. Instead of tear-

ing a module apart and rebuilding it as a new one, what if I could create a new scene while still keeping the old one? Why spend money and time on carpentry for the frame and legs of another module when I could create a new scene? Interchangeable frames (which I call “cradles”) and scenes which sit on top of them were the answer. I can lift the current scene out of a cradle and drop in a new one.

The key was how to securely connect scenes to the cradles. I used rims made of 6” trim (base) boards along

Figure 2: All the wood joints are glued and screwed for strength.



Figure 1



Figure 2



Figure 3

the sides (figure 3) to hold the pink-foam-based scenes in place. The legs may be unbolted for transportation.

I built my cradle to Free-Mo standards, but cradles can be built to any standard you choose, such as N-trak.

I built the first module cradle in about five hours. The sides and ends are 1x6



Figure 4

Figure 3: I used baseboard trim for the rim boards. These extend 2" above the frame sides and hold the foam-based scenes in place.

Figure 4: The cradles needed stiffening. A 2x2 brace screwed and glued in place worked nicely.

Figure 5: Removable legs are mandatory for a traveling module. A 54" module height dictated 45" long legs. I used a C-clamp to hold the legs firmly in place while I drilled holes for 5/16" bolts and T-nuts. Each leg received two bolts installed at an angle for extra rigidity.



Figure 5

pine, the rim boards are 5" decorative pine baseboards (normally they'd be used where a wall meets the floor in a house). Legs are 2x4s. My cradle is 8' long by 2' deep by 54" high from the top of the four pieces of 2" thick foam (figure 6) to the floor. The legs have 5/16" lag screws screwed into their bottoms to provide height micro-adjustment.

The sides and ends are joined using drywall screws and yellow carpenter's glue. The rim boards protrude 2" above the sides and are glued in place.

Work carefully! Precision is needed when building the cradles and the scenes to ensure interchangeability.

Now when it's time to head to a meet with my modules I pick the scenes I want, grab the same number of cradles, load up and go!



Figure 6



Figure 7

Figure 6: A cradle with four layers of 2" thick pink foam ready for scenery contour carving.

Figure 7: The final step in building the basic cradle is painting it.



### Dirk P. Reynolds

When Dirk started serious model railroading in 1981, Missouri Pacific equipment was hard to find. He had to paint ALL of his passenger and diesel equipment.

He was a teacher for 7 years, then opened a hobby shop in 2001. In 2008, he got a masters degree in counseling from Missouri Baptist University. He is currently building his personal layout, set between 1940 and 1970, while studying for his Licensed Professional Counselor exam.

# Vector Cut: wood laser-cut detail parts



yard parts for strewing behind a service station, to items which one does not usually look for such as hamburgers and hot dogs on a bun or donuts and bagels! Most details are cut from .0145" wood sheet; some of the finer and "wispiers" details are even thinner. Here's a good representation of their details line:

**Tools:** Let's get small. Really small! This collection of diminutive pliers, open-end wrenches, pipe wrenches, box wrenches, and paintbrushes could have come right out of an old Sears catalog. A second sheet supplies an even smaller set of wrenches. These are marvelous in their minuscule precision and cost \$7.75.

**Old Car Scrapyard:** There are two frets in this incredible set; the first is .0145" thick and includes floor pans, leaf springs, radiators, surrounds, and grilles. You can model these built up or in separate pieces. There are hoods with vents, dashboard instrument panels sans instruments, firewalls, wheel rims, a few hoods and upper and/or lower control arm suspension bits and doors. Not only is there an outer door with a teenie opening where the handle once attached, but there is an inner framework. When the two are sandwiched together, they form an

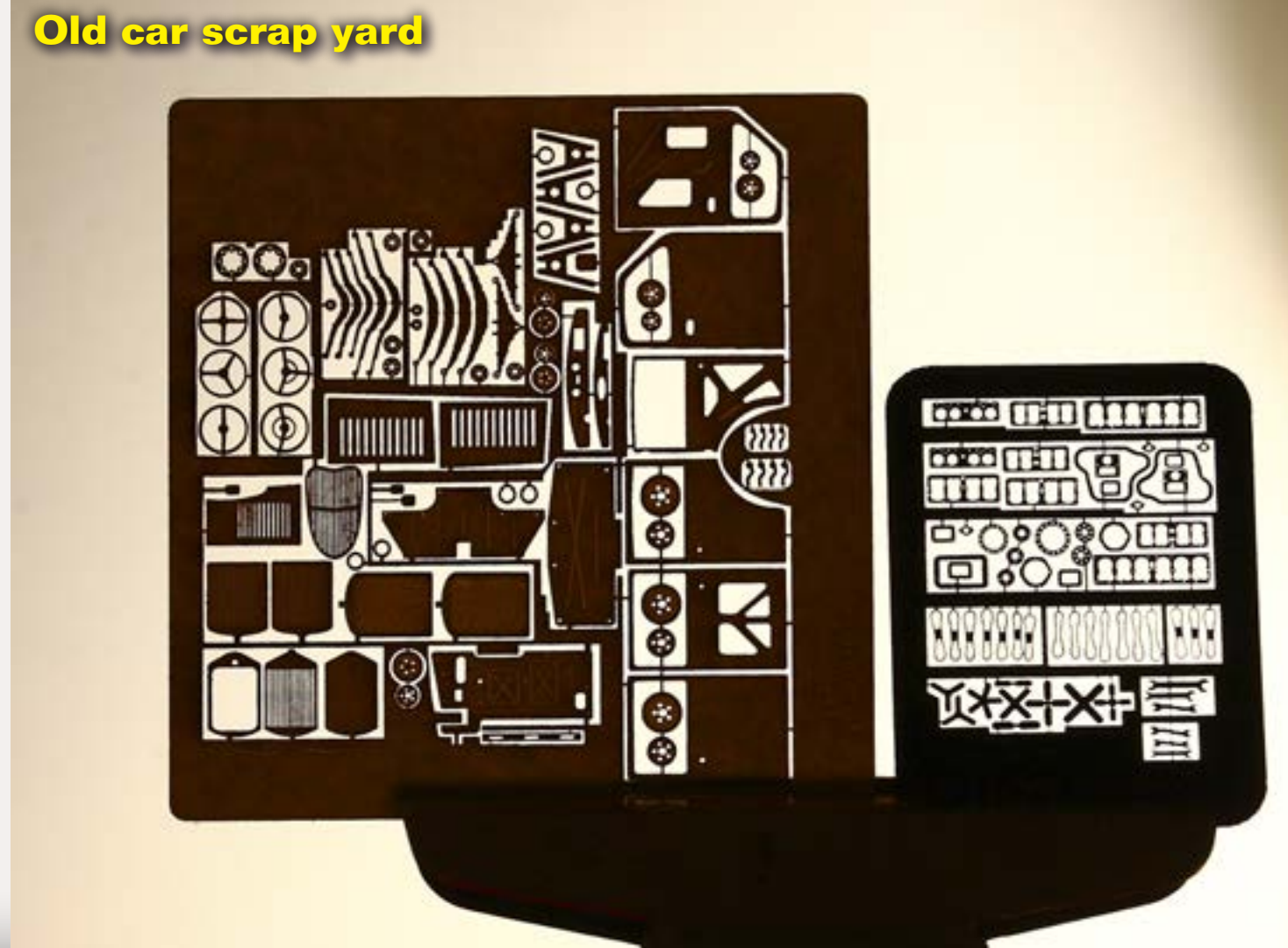

– by Don Spiro

I found Vector Cut during one of those late night, looking for nothing in particular, searches on the Internet. Ahh the Internet; where interesting things seem to live. With a bit of rooting around you often run across small and often obscure manufacturers well deserving of more broad popularity.

Vector Cut ([www.vectorcut.com](http://www.vectorcut.com)) is one of those. They produce a line of laser-cut structure kits, wood decking for ship models, and a simply astonishing and highly creative line of fine detail parts. From hard-to-find junk

accurately detailed '30s-era car door. Finally there are a half-dozen steering wheels. These are nice enough I suspect they'll never be used as junk but as replacement wheels for vehicles that suffer from steering wheels so thick no 1/87th motorist could ever get their hands around them. A few of the wheels even have horn rings; truly the epitome of laser cutter art.

Wait, there's more! A smaller and thinner fret has fan belts, all types and styles of engine gaskets, different size fans and tools. I found the radiator hose gasket to the engine block to be THE single most astonishing detail part produced in all I sampled.

Gas and service stations will become even more of a focal point on many layouts with this set creatively strewn about. This set lists for \$15.95.

**Flowers:** These are incredibly small. Instead of cutting them from the frets, use a toothpick to punch them out, yielding a petal-like edge. Flowers come in two sets, each of which has two differently-colored sheets. A set will fill the flower beds of even the greenest-thumbbed gardener on your layout. A modest \$5.75 for immediate home improvement!

**Gears:** This assortment includes a myriad of different size and styles gears. There are also some rather fine brake wheels for those modeling freight cars with brake staffs. A fine set of details to toss about an industrial location. Gears sell for \$8.95.

**Luncheonette Letters:** A much-needed detail for structure modelers. These are perfect for any downtown eatery. The letters come in 12 and 14 inches (HO scale) and yes, they have applications beyond just eateries. The crispness of each letter will pop off any style background; just what DPM, City Classics and other structure models have long been missing. Price for this set is \$10. Other font styles and numbers are listed on their website.

**Porch Chairs:** A typical but often tough to find detail for front porches set in any era. People of all ages love to sit on porches and these chairs offer 1/87th respite like you've never seen. This set has enough pieces for three high-back chairs and two rockers. For assembly Vector Cut recommends an Opti-Visor so you can see what you're working on. The components are exquisitely small and will be a challenging and ultimately satisfying test of fine motor skills during assembly. This set sells for \$7.50.

**Screen Doors and Window Fans:** Many layouts are set in the summer when it's a bit hot out. Before air conditioning, home owners opened windows and doors and used screens and fans to cool down the wife and kids.

This set includes three styles of screen doors cut to fit [Tichy #8033](#) four-panel door. The styles range from Sears-like simplicity to ornate Victorian. Some of the finest screen mesh I've seen is included. There are three styles of window fans sized to fit [Tichy #8024](#)

## Flowers



## Gears

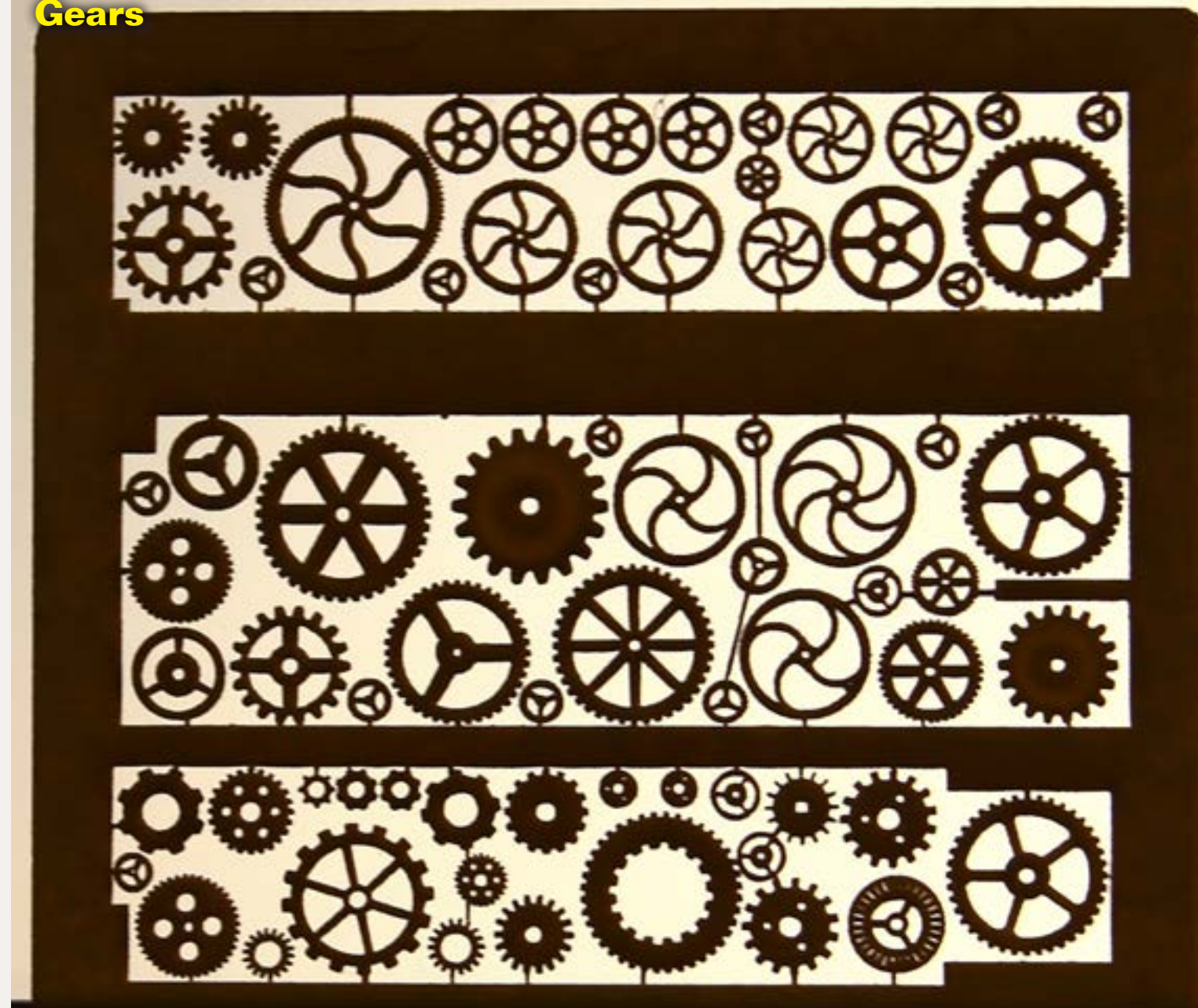

## Luncheonette letters



2 over 2 style windows. The smaller fans can be cut and modified to fit smaller windows and door transoms. This set lists for \$8.50

Check out the Vector Cut website at [www.VectorCut.com](http://www.VectorCut.com) and prepare to be blown away by how far the art of laser cutting has evolved. I've only shown a smattering of their offerings. Details are available for N, HO, O, and larger scales.

If you're looking to boost to your creativity, these details might just be what the doctor ordered.

One more thing. In a day and age of high and sometimes exorbitant shipping and handling fees, a number of their detail sets come with free shipping.

Small really has gotten a lot better!



HO scale chairs assembled from the sheet on the far left – photo courtesy VectorCut.



## Chairs / Screen doors and window fans

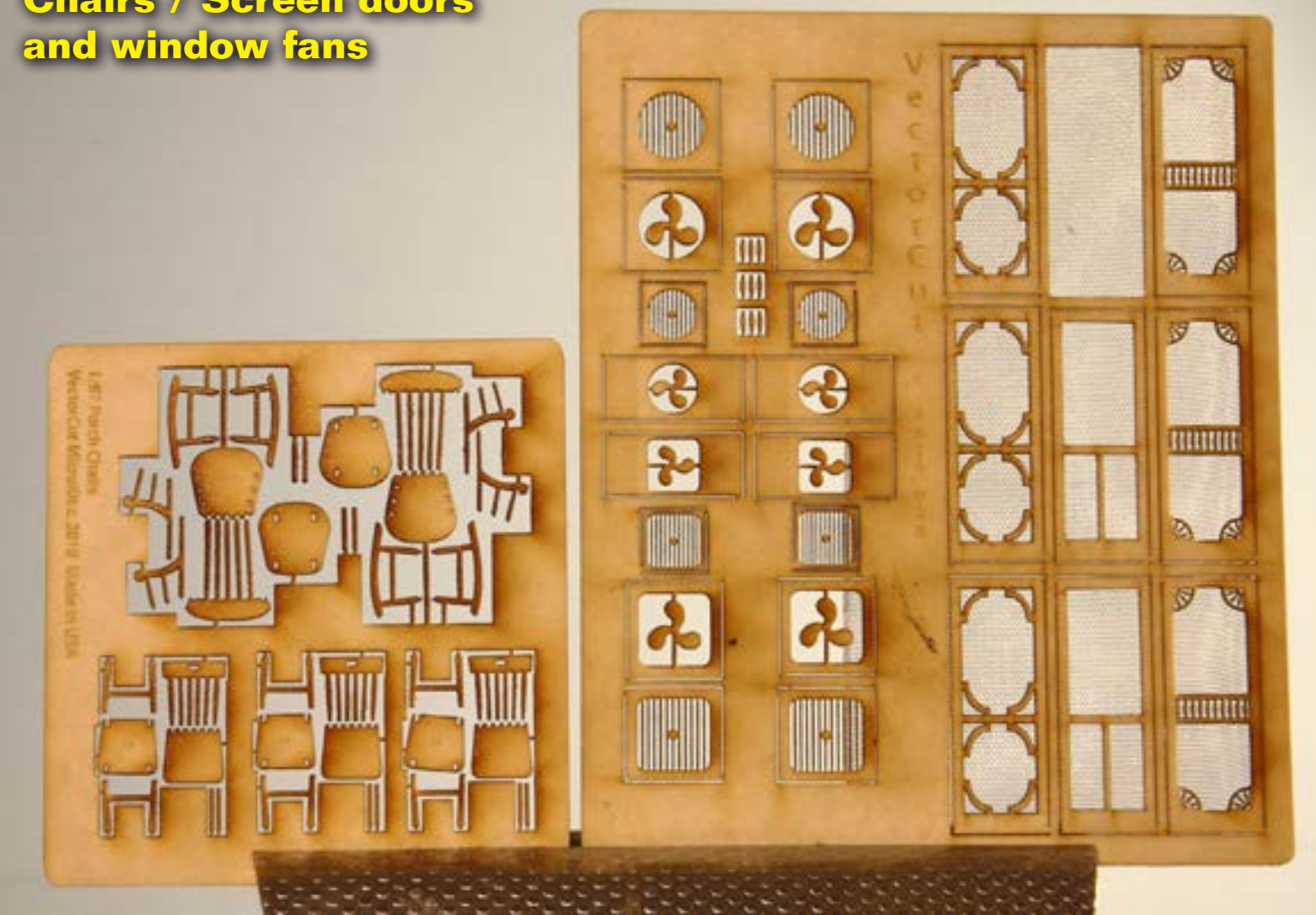

**Q: How many modelers does it take to screw-in a light bulb?**

**A: None! Real modelers solder their bulbs in place!**

**Q: How many modelers does it take to install a turnout?**

**A: Only one – if they get the “point”.**

**Q: How many modelers does it take to read a FREE model train magazine?**

**A: All of them!**

## Model Railroad Hobbyist magazine™

Helping to conserve your hobby \$\$\$ for what really matters – track, locos, strip wood, structures, turnouts, plaster, pink-foam, trees, plywood, decoders, freight cars, static grass, details, conventions, plaster, ...



## TRACKSIDE SHOWCASE

### Sunset Models: Virginian AE 2-10-10-2

→ [Visit 3rdrail.com](http://3rdrail.com)



This exquisite **O scale** brass model of a Virginian Railway class AE 2-10-10-2 was hand-crafted in Korea and imported by 3rd Rail division of Sunset Models. American Locomotive Works built ten of the huge prototypes in 1918 for the Virginian.

Due to clearance limitations en route, the locomotives were delivered without cab or the front (low-pressure) cylinders, which were installed on-site. At 48 inches in diameter, the low-pressure cylinders were the largest ever used on a U.S. steam locomotive. The highly-detailed model features a precision mechanical transmission driven by a 9000 series Pittman motor through a ball bearing gear box.

Operation is compatible with DCS, TMCC, Legacy, and conventional control. The model is available for either 2-rail or 3-rail operation at \$1,999.95 each from 3<sup>rd</sup> Rail division of Sunset Models Inc.

▶ **Reader Feedback**  
(click here) 

# TRACKSIDE SHOWCASE

## Athearn: EMD SD70M-2 Diesel

→ [Visit athearn.com](http://www.athearn.com)



The modern SD70M-2 diesel locomotive was developed by EMD to meet strict emission standards imposed by the EPA. The diesel's 74' 3" frame mounts a 16-cylinder engine capable of generating 4,300 horsepower. External spotting features include a full-height nose door, rectangular windshields, large flared radiators with two fans, and the dynamic brake equipment located at the rear of the long hood.

Athearn's **HO scale** version of the modern SD70M-2 decorated for Florida East Coast is a good example of the high caliber of commercial models available to today's model railroad hobbyists.

Zoom in on this MRH Trackside Showcase photo and examine the detail on and above the HTC high-traction six-axle trucks, the clarity of the fine paint lines, and the variety of lettering, signs, and labels applied to the injection molded body. In addition to the FEC livery shown here, the Genesis series model is also available decorated for Canadian National and Norfolk Southern.

Athearn offers a standard DC model at a suggested list price of \$189.98, as well as a DCC/sound version at \$289.98.

## TRACKSIDE SHOWCASE

### Bachmann: Classic 2-6-0 Mogul

→ [Visit bachmanntrains.com](http://bachmanntrains.com)



Bachmann Trains' new **HO scale** 2-6-0 steam locomotive replicates a classic Mogul prototype built by American Locomotive Works during the early 1900s. In addition to the Pennsylvania Railroad paint scheme illustrated here, the model will also be available decorated for New York Central, Canadian National, Boston & Maine, Santa Fe, and Union Pacific.

The 1:87 scale model has die-cast chassis and cylinders, metal valve gear and side rods, operating LED headlight and backup light, metal uncoupling levers, metal handrails, and Bachmann's E-Z Mate® Mark II knuckle couplers.

The ready-to-run locomotive is available with DCC sound and a dual-mode NMRA-compliant decoder at a list price of \$175.00. A DC (DCC-ready) version is also available at \$115.00.

# TRACKSIDE SHOWCASE

## ExactRail: Pullman-Standard Waffle Side Boxcar

→ [Visit exactrail.com](http://www.exactrail.com)



Southern Railway's car number 528611 epitomizes the rugged 60' waffle-side boxcar seen all across America. ExactRail has produced **HO scale** models of the Pullman-Standard 7315 cu. ft. car in several additional schemes including L&N, NW, BNSF, DT&I, CSXT, ATSF, Milw Rd, NS, UP, and GTW.

Among the model's numerous features are drop-down brake rigging, separate door bars, separate door tracks, wire uncoupling levers, and an outstanding

replication of a steel-nailable floor. The waffle model comes with ASF 100-ton Ride Control® trucks equipped with 36" metal wheelsets.

ExactRail's ready-to-run model has an MSRP of \$34.95. Although some road names may be sold out at the factory, your favorite hobby dealer may still have exactly the model you're looking for.

## TRACKSIDE SHOWCASE

### Rapido: CSX Wide-Vision Safety Caboose

→ [Visit rapidotrains.com](http://rapidotrains.com)



This heavily signed HO scale CSX wide-vision “Safety Caboose” is from a custom run produced by Canadian-based Rapido Trains for the Great Lakes Division of CSX Corporation.

The 1:87 scale model replicates a prototype introduced by the Canadian Pacific Railroad in 1972. During the following decade, CP’s Angus Shops in Montreal produced more than 300 nearly identical cabooses that came to represent the zenith of the car type.

Rapido offers this highly-detailed ready-to-run HO scale model decorated for CB&Q, Conrail, Canadian Pacific - Engineering Services, Delaware & Hudson, Denver & Rio Grande Western, Essex Terminal Railway, Missouri-Kansas-Texas, and New Brunswick Southern.

The model has an MSRP of \$74.95.

# TRACKSIDE SHOWCASE

## Accurail: NP Swing-Door Reefer

→ [Visit accurail.com](http://www.accurail.com)



Click on the image to spin the model a full 360 degrees. See it from all sides!

Accurail has recently introduced a moderately priced kit for this 40' steel refrigerator car with four-foot wide swinging doors. Soon after WWII, Pacific Car & Foundry began building the prototype car in large numbers for the Fruit Growers Express consortium which included Western Fruit Express and Burlington Refrigerator Express. A nearly identical car was also built for Pacific Fruit Express.

In addition to the swing doors, other identifying features include improved Dreadnaught ends and diagonal panel roofs. Accurail also has kits decorated for Great Northern-Western Fruit Express, New York Central Merchants Despatch, Fruit Growers Express, Milwaukee Road-URTX, Burlington Route, Pacific Fruit Express-SP/UP, Illinois Central, Bangor & Aroostook, and Rock Island-URTX.

The **HO scale** kits have a list price of \$15.98.





## About our News & Events Editor



Richard Bale writes our news column under the byline of *The Old Yardmaster*. He has been writing about the model railroad trade for various hobby publications since the 1960s.

He enjoys building models, particularly structures, some of which appeared in the June 2006 issue of *Model Railroader* magazine.



**Reader  
Feedback**  
(click here)



# MRH News Desk: The Latest Model Railroad News, Products, and Events

## February 2012

### Major Fire Strikes Woodland Scenics

Woodland Scenics is recovering from a fire that destroyed two of the company's seven manufacturing buildings last month. Investigators blamed the source of the fire on an exhaust fan motor. An early assessment indicated that damage was not as devastating as initially thought. "We operate from multiple buildings that are spread all over town," said Gale Cousins, Woodland Scenics director of sales. "We only lost two of those buildings and fortunately they housed just a small portion of our manufacturing facilities." Company CEO Dwayne Fulton said, "We are very grateful that none of our employees were injured. We have some clean-up to do, but everyone is safe and everyone is still working, and we're back to shipping every day." Headquartered in Linn Creek, Missouri, Woodland Scenics was founded in 1975 by Dave Osment. In addition to Woodland Scenics, the company markets products branded Design Preservation Models, Landmark Structures, Built-&-Ready, and Pre-Fab...

### Athearn Anticipates Delays On Some Products

In mid-January, Athearn, division of Horizon Hobby, announced that delivery of some new products may be delayed due to the unexpected shutdown of one of its contract manufacturers in China. Athearn's announcement came after international financial agencies reported that Creative Masters Limited (CML) had filed for bankruptcy. Earlier reports said CML had not reported a profit since 2009. CML is headquartered in Kowloon Bay, Hong Kong, with manufacturing facilities in Donnguan, PRC. In addition to Athearn, CML manufactures model railroad products for Hornby, Fleischmann, and Roco. A major segment of CML's business is diecast vehicles which it manufactures for Corgi, Tamiya, Mattel, PMA Models, MBI, SMS, Bianti, and First Gear. CML also produces Keepsake Collectible Ornaments for Hallmark Cards Inc.

Noting that it has other manufacturing partners in China, Athearn said it expects to meet the scheduled delivery date of late March for its DDA40X and SD70ACe/SD70M-2s Genesis locomotives, as well as the Genesis SP bay-window caboose. Delivery information about other products initially expected to arrive this year is pending...

### John Engstrom to San Juan Car Co.

San Juan Car Company (SJCC) has named John Engstrom general manager of the Colorado-based company. Engstrom, who is widely known in the hobby industry, recently retired from Athearn, division of Horizon Hobby. He had been a senior executive with Athearn for the past 17 years. SJCC was founded in 1987 by the late John Parker. Last fall, Parker sold SJCC to a corporation led by Bob Staat, founder of the McHenry coupler line, and a member of the Model Railroad Hall of Fame. Engstrom's association with John Parker and his family covers nearly four decades. Parker sold his Oakland-based Reed's Hobby Shop to Engstrom in 1975. The store was moved to La Mesa, California where it continues to thrive. In a recent email, Engstrom said, "For the foreseeable future, San Juan Car Company will stay in Durango and continue to produce narrow gauge kits and ready-to-roll cars in On3 and On30."

### RPM Meets Gaining in Popularity

Independently produced mini-conventions for railroad prototype modelers (RPM) continue to grow in both attendance and importance. Jeff Aley, clinic chairman of Prototype Rails held last month in Cocoa Beach, Florida, reports that about 250 modelers attended this year's meet. Jeff said he is drawn to RPM meets for the clinics, the chance to study the variety of models on display, and the opportunity to commiserate with like-minded people and old friends. And, in the case of Prototype Rails, the mild Florida winter weather is hard to beat. If you haven't attended a gathering of prototype modelers, you are missing an enjoyable experience and

important facet of our hobby. Check the Events listing on [page 116](#) for details on coming meets...

### **Black is Environmentally Friendly**

Sergent Engineering will begin replacing the rusty brown castings in its coupler kits with black castings. The manufacturing process to obtain a black finish on the castings is apparently safer and more environmentally responsible than the method that was used to get the rusty brown finish. Assembled couplers will still be available with a rusty brown finish, but the color will be obtained through the use of paint rather than a chemically applied treatment...

### **Nat Polk's Grandson to Head Family Business**

Scott Polk has been named president of Polk's Model Craft Hobbies Inc., of Irvington, New Jersey. The company includes Polk's, Aristo-Craft Trains, and RMT by Arist-O. Scott has a strong background in the computer world, and is expected to expand the company's Internet opportunities. Scott is the grandson of Nat Polk, who founded the family-owned enterprise more than 70 years ago...

### **Motrak Has Moved**

Motrak Models has relocated to 5645 Pope Street, Hope Mills, NC 28348. The new email address is [motrakmodels@nc.rr.com](mailto:motrakmodels@nc.rr.com). The company's phone number remains (813) 476-4784....

### **Walthers Forced to Raise Some Prices**

In January, Walthers notified their dealers of pending changes in both the retail and wholesale price of selected Walthers-brand products. The announcement said escalating prices from off-shore manufacturing sources forced the changes. The new prices became effective January 16, 2012. The MSRP (manufacturer's suggested retail price) of Walthers, WalthersTrainline™, WalthersMainline™, and Life-Like™ products were increased about ten percent. WalthersPROTO™ products and Cornerstone™ HO and N scale kits remain unchanged. Walthers said current pricing will be held for new items announced but not yet delivered. Hobby dealers were also notified of some changes in the wholesale discount structure of selected product lines...

---

## **NEW PRODUCTS FOR ALL SCALES**

**Deepwoods Software** has released version 2.1.29b of the Model Railroad System. A free collection of small software programs and programming libraries, the Model Railroad System is primarily designed for use on Linux computer systems, although many of the programs have also been converted to work under

Windows. In addition to several utility programs for managing freight car movements, identifying the proper resistor values for projects, camera view area calculations, and creating employee timetables, there are also programming libraries which can be used by other programs to perform certain tasks such as communicating with C/MRI and Lenz XpressNet, communicating with Azatrax's USB sensor and actuator units, parsing XTrkCAD layout files, and communicating with the Rail Driver control console. Information and downloads for the Model Railroad System can be found at [www.deepsoft.com/home/products/modelrailroadsystem](http://www.deepsoft.com/home/products/modelrailroadsystem).

---

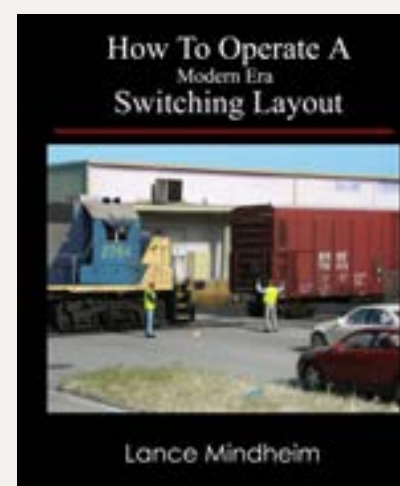

**Lance Mindheim** has added a new title to his series of books on switching layouts. "How to Operate a Modern Era Switching Layout," is a logical sequel to the author's earlier book, "How to Design a Small Switching Layout." The new 108-page book offers a range of helpful suggestions on setting up and running an operating session. Special attention is given to car movement strategies, job planning, prototypical paperwork, prototype rules, and prototype operating procedures. Operating examples and a bonus track plan are included. The 8" x 10" soft cover book has a list price

of \$25.75. It is available from [Amazon.com](http://Amazon.com), Caboose Hobbies in Denver ([www.caboosehobbies.com](http://www.caboosehobbies.com)), or [ModelTrainStuff.com](http://ModelTrainStuff.com). The book is available in the UK from [titfield.co.uk](http://titfield.co.uk).

---

**Yosemite Models** ([yosemitevalleyrr.com](http://yosemitevalleyrr.com)) has several CDs available that contain an immense amount of information about the Yosemite Valley Railroad. The information is of value both to historians and modelers. The collection, which has been assembled over many years by noted modeler Jack Burgess, includes descriptive details, hundreds of photographs, and nearly 100 scale drawings of YV structures and equipment. Although the drawings are for prototypes of the Yosemite Valley Railroad, many items such as water tanks, oil tanks, stations, boxcars, flat cars, and bridges, are representative of period structures and equipment used by a variety of American railroads. For details on all of the CDs and ordering information, visit [yosemitevalleyrr.com/yosmtmdl.htm](http://yosemitevalleyrr.com/yosmtmdl.htm).

---

## **O SCALE PRODUCT NEWS**

**Atlas-O** ([atlaso.com](http://atlaso.com)) is booking dealer orders for a third quarter delivery of its 50' PS-1 steel boxcar as built in the 1950s and '60s by Pullman Standard. Two road numbers will be available for Baltimore & Ohio, Burlington, Erie Lackawanna,





Jersey Central, Nickel Plate Road, Penn Central, and Spokane Portland & Seattle. An undecorated model will also be offered. Separately-applied details on the ready-to-run car will include grab irons, ladders, brake line details, and an etched-metal running board. Road specific details include either Pullman-Standard or Youngstown doors, and 50-ton Bettendorf roller bearing trucks or 70-ton roller bearing trucks with rotating bearing caps. The model will be available for both two-rail operation with scale couplers compatible with Kadee® products, and for three-rail operation with diecast articulated couplers. The three-rail trucks are pre-drilled to accept Adjust-A-Coupler® scale couplers which are sold separately. The suggested price is \$69.95 for three-rail cars, and \$75.95 for two-rail.

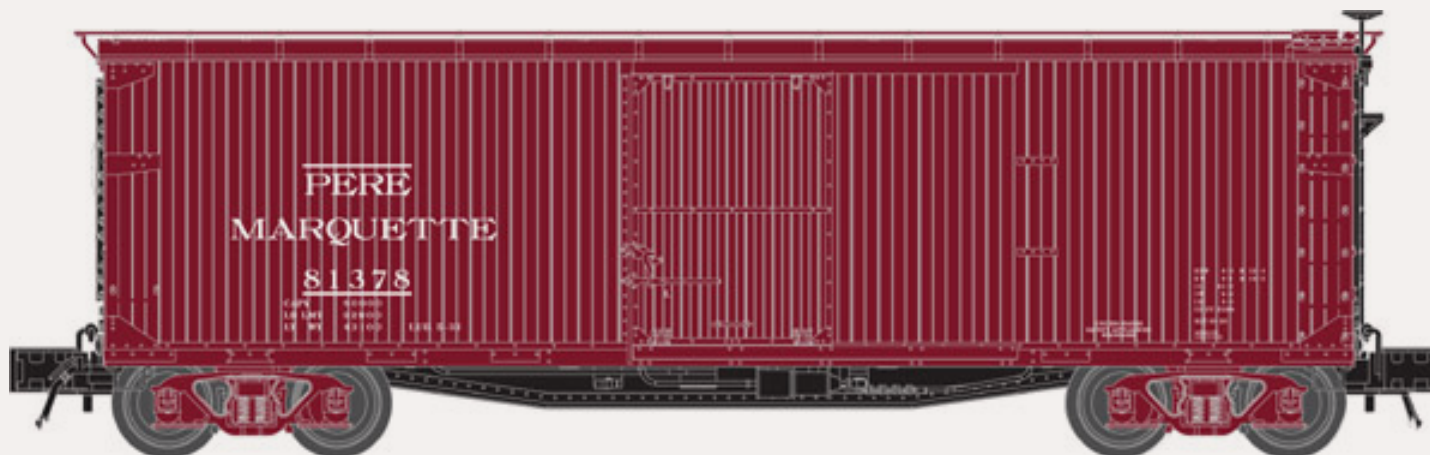

Atlas O has announced new paint schemes for the next production run of its USRA double-sheathed boxcar. The model replicates prototype cars built under United States Railway Administration specifications beginning in 1918. Atlas O body-mounted scale couplers are used on both two-rail and three-rail versions. The trucks on the three-rail cars are pre-drilled to accept Atlas O Adjust-A-Coupler®. The cars will be equipped with diecast Andrews trucks, and with different steel ends depending on the practice of the prototype road. The cars will be decorated for Elgin, Joliet & Eastern; Union Pacific; Lehigh Valley; Missouri Pacific; North Western Pacific; and Pere Marquette. An undecorated model will also be in the mix. Cars ready for three-rail operation will have an MSRP of \$59.95 each. The two-rail version will list at \$65.95 each.



**Frenchman River** ([frenchmanriver.com](http://frenchmanriver.com)) has an O scale kit for a New England lobster shack that consists of a one-piece cast resin building with all the details and shingles cast in place. Each shingle was individually placed on the master to create a realistic texture. Additional components include five pewter buoys, eight pewter lobsters of various sizes, four laser-cut lobster traps, and four laser-cut lobster boxes. The traps and boxes utilize an easy, fold-up assembly method. Laser-cut window material and rope are included. The kit sells for \$32.00. Visit the Frenchman River website for information on additional waterfront items including piers, sea walls, and a lobster boat.

## S SCALE PRODUCT NEWS

**Doctor Ben's** ([debenllc.com](http://debenllc.com)) has introduced shake-shingle roofing material specifically intended for modelers working in S scale. The peel-and-stick material has the appearance of wood, but is only .006" thick. It comes in 8-1/2" x 5-1/2" sheets at \$9.89 each. The shingles are created by a precision plotter, a process not to be confused with laser cutting. Extensive instructions with ideas for weathering are included. Visit Dr. Ben's website for information on a wide range of material for building, painting, and weathering in all popular scales.

## HO SCALE PRODUCT NEWS

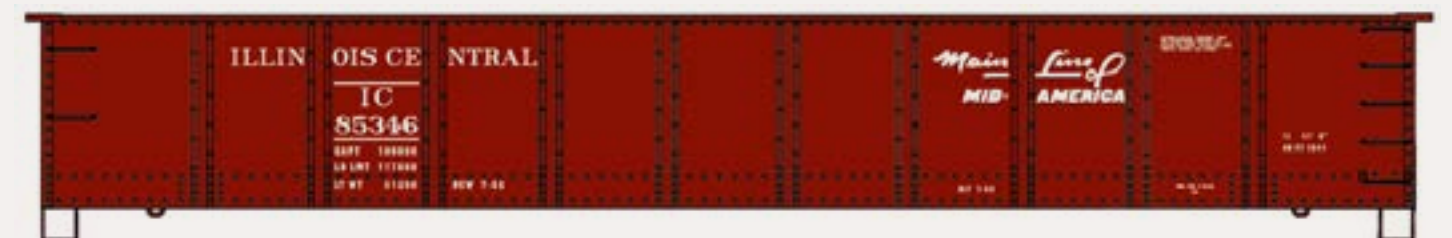

**Accurail** ([accurail.com](http://accurail.com)) is selling a special three-pack of kits for 41' AAR steel gondolas decorated for Illinois Central. The three-pack has a suggested list price of \$42.98. Individual cars are also available at \$14.98 each. All of the IC cars have different road numbers.



Accurail has also released a kit for a 50' exterior-post Canadian Pacific steel boxcar with special DOT reflective graphics. The HO scale kit is priced at \$14.98 each.

Other new HO kits available from Accurail include a Burlington/CB&Q aluminum 55-ton USRA twin-hopper with Everywhere West slogan at \$13.98 each, a CMO/North Western 50-ton offset-side twin-hopper at \$14.98 each, and an 89' partially-enclosed bi-level auto rack car decorated for Southern Railway at \$22.98 each. Also a special Duluth, Missabe & Iron Range two-car set consisting of a 40' wood reefer and 40' double-sheathed wood boxcar at \$29.98.



Athearn, Division of Horizon Hobby ([athearn.com](http://athearn.com)) will begin delivery next month of the Genesis Union Pacific DDA40X diesel locomotive. In addition to separately-applied details such as wire grab irons and see-through brake intakes, the model has a number of prototype details specific to the particular phase and era being modeled. These include anticlimbers, electrical cabinet doors, cab sub-base doors, handrails with or without ACI placards, solid or chain end-rails, fuel tanks, roller bearing truck sideframes, horns, rooftop details, and cab sunshades or awnings. The windshield wipers, walkways above the fuel tanks, and grilles on the radiator and dynamic brake housing are all etched-metal. Electrical features of the HO scale ready-to-run model include dual motors and 16-wheel pickup. Sound versions have an MSRP of \$499.98 and come with dual Soundtraxx® Tsunami® decoders with authentic DDA40X sounds recorded from UP prototype #6936. Standard DC non-sound units list at \$369.98. They are ready for DCC using Athearn's Quick-Plug technology. Note that two decoders are needed per locomotive.



Athearn has released the Southern Pacific class C-50-7 version of its new HO scale steel bay-window caboose. Some of the many features of this Genesis series model include see-through steps and end platforms, flush window glazing, and etched-metal window screens. Each version of the ready-to-run model is available with or without lighting. Lighted cars will be equipped with LEDs controlled by an on-board Soundtraxx® system with a built-in capacitor for non-flickering lights. Operating lights include a roof-mounted directional "frog-eye" marker. Non-lighted cars will have LEDs installed in the marker lights with wires leading to the caboose interior. The caboose rides on Athearn's new 50-ton trucks with elliptical springs, rotating bearing caps, and electric generator. The trucks come with electrical pick-up and will also be available separately. Future releases are planned for SP class C-50-4, C-50-5, C-50-8, C-50-9, and Western Pacific's 480 class cabooses. An undecorated version will also be offered.



Also coming next month is Athearn's Genesis series SD70ACe HO scale locomotive decorated for CSX (YN3 yellow nose scheme), Ferromex, and Montana Rail Link in four numbers each, plus UP locomotive No.1988 in the MKT "The

Katy” heritage scheme as seen here. The ready-to-run model features a full-height nose door, rectangular windshields, dynamic brake equipment mounted at the rear of the long hood, and the familiar flared radiators with twin fans. Additional features include dual flywheels, all-wheel drive and electrical pick-up, cab interior including a video camera (non-working), correctly sized operating ditch lights, MU hoses, coupler uncoupling bars, train line air hoses, safety tread walkways, etched see-through grilles, and wire grab irons. Sound versions have an MSRP of \$289.98 and come with DCC and a Soundtraxx® Tsunami® decoder. Standard DC non-sound units list at \$189.98.



Atlas ([atlasrr.com](http://atlasrr.com)) plans to begin shipping its new HO scale 40' wood reefer cars in the second quarter of 2012. The ready-to-run cars offer new decorating schemes on the old Branchline Blueprint series which replicated URTC, MRX, NWX, and WRX prototypes built in the late 1920s to 1930s by AC&F.

Two numbers each will be available for Fruit Dispatch Co –NRCC ( banana logo), Narragansett Ale-NBRX (above), Edelweiss Beer-URT, Grand Union-OREX, Tivoli



Beer-TUX (above), and Fruit Growers Express-FGEX (ventilator and refrigerator slogan). Features include two different styles of roof hatches, separate door locking- bars, individual grab irons, ladders, and wire uncoupling bars. The ready-to-run cars have an MSRP of \$29.95 and come with Accumate® couplers. An undecorated version is available at \$24.95.



Do your couplers droop? **A-Line Division of Proto Power West** ([www.ppw-aline.com/tools.htm](http://www.ppw-aline.com/tools.htm)) has the cure. A-Line's new Bulls-Eye Drill Jig is designed to easily end the problem of drooping couplers on Athearn rolling stock. The simple fixture is used as a guide to drill a perpendicular hole through the exact center of the coupler box-pin, which can then be tapped for a 2-56 screw. Holding the coupler box cover properly in place with a 2-56 x 1/8" screw solves the problem and insures that the coupler will be positioned at the proper height for trouble-free operation. The Bulls-Eye Drill Jig is priced at \$8.95. For additional information see [page 53](#) of this issue of MRH.

BLMA ([blmamodels.com](http://blmamodels.com)) will produce an HO scale model of a PTTX flat car. The prototype cars were created in the 1990s when the Trailer Train Company refitted a fleet of 1960-era F89-J flats with wood crossbeams to transport pipe and other oversize or over weight bulk loads. Designated PTTX, the cars received additional modifications such as side-mounted brake controls. BLMA will replicate the prototype by modifying its own F89 models with new tooling for the deck braces and brake rigging. BLMA's PTTX ACF F89-J's will feature Kadee™ #156 couplers and 70-ton trucks with 33" metal wheels. Ten road numbers will be available at \$39.95 each. Details on suitable pipe loads and a PTTX conversion kit will be announced soon.

ExactRail ([exactrail.com](http://exactrail.com)) has released its HO scale Evolution Series Vert-A-Pak auto rack car in three numbers each for five road names including Missouri Pacific, Southern Pacific, Seaboard Coast Line, SLSF, and Florida East Coast, as seen here. The innovative car transported automobiles mounted vertically on each of its 30 massive doors. Developed originally by Southern Pacific and ACF Industries, the auto carriers were eventually acquired by major railroads across the country. The HO scale cars have an MSRP of \$29.95. They come with



McHenry #41 knuckle spring couplers, and Barber 70-ton low-profile trucks with 28" machined wheels.

---

**Fos Scale Models** ([foslimited.com](http://foslimited.com)) is selling a DVD that features the well-known HO scale Pennsy Middle Division layout originally built by Dave Frary for Model Railroader Magazine some 20 years ago. Jimmy Deignan has restored and expanded the layout with many craftsman structures, rolling hills, rivers, and a new densely-packed waterfront area. In addition to a layout tour, the DVD features four how-to demonstrations by Dave Frary, Hal Reynolds, Jimmy Deignan, and Doug Foscale. The DVD is priced at \$29.95. A preview is available on You Tube at [http://railroadkits.com/store/index.php?main\\_Pg=product\\_info&cPath=3&products\\_id=62](http://railroadkits.com/store/index.php?main_Pg=product_info&cPath=3&products_id=62).

---

**InterMountain Railway Company** ([intermountain-railway.com](http://intermountain-railway.com)) is finalizing new tooling for an HO scale EMD SD40-2 diesel locomotive. Delivery of the first production run is expected in August or September. InterMountain says it will eventually offer every configuration EMD produced. Owner-specific details on the ready-to-run model will include different noses, headlights, radiator grilles, and dynamic brakes. Road names on the first run include ATSF (yellow warbonnet), Burlington Northern (green scheme), CSX, Norfolk Southern, Union Pacific, GATX, MEC (Pan Am Railway), and Iowa, Chicago & Eastern. The model comes with Kadee® couplers. Non-sound models will have an MSRP of \$149.95 and will come with a factory installed DCC decoder that will function on analog DC or DCC. Sound models will be \$224.95 and come with SoundTraxx® Tsunami® DCC decoder. The prototype SD40-2 was one of EMD's most popular locomotive. Between 1970 and 1989, nearly 4,000 locomotives were sold, with about 700 of them going to Canadian roads.



The latest release of EMD FT A-B diesel sets from InterMountain are scheduled to arrive at dealers early this month. Road names include CB&Q, New York Central, Northern Pacific, Southern, Western Pacific, Rock Island, Reading, Missouri Pacific, Milwaukee Road, and Seaboard. Road names on the next release, which is expected in July or August, will include Baltimore & Ohio, Santa Fe (blue with cigar wrapper, above), Atlantic Coast Line, Chicago & North Western, Boston & Maine, and EMD Demonstrator. The HO scale ready-to-run models come with Kadee® couplers and will be sold as A-B sets only. Standard DC versions in the summer run will have an MSRP of \$219.95 per set. DCC versions, with optional Soundtraxx® Tsunami®, will list at \$359.95.



Freight cars due from InterMountain this summer include another release of its 4750 cu. ft. three-bay covered hopper. The ready-to-run HO scale cars will have etched-metal roof walks, appropriate trucks with metal wheelsets, and Kadee® couplers. Six numbers each will be produced for Soo Line, BNSF, CSX, Pittsburgh & Lake Erie, AOK (CNW restencil, above), Norfolk Southern, DME, and Frisco. The models will have an MSRP of \$32.95 each.

---

**Kato** ([katousa.com](http://katousa.com)) offers several of its HO and N scale locomotives with undecorated shells. Other than painting and lettering, the models are fully assembled with all details, motor, power chassis, and trucks ready for painting. Although the undecorated models have some details already installed, Kato's no-glue assembly method allows items to be easily removed for painting. HO scale locomotives available undecorated include an EMD SD70MAC with high number



boards and nose headlight at \$150.00, and a Santa Fe-style EMD SD40-2 with a roof-mounted air conditioning unit and rear-mounted air horn at \$179.00.



**Motrak** showed this HO scale structure kit for Consolidated Auto Parts Company, at Prototype Rails in Cocoa Beach, Florida, last month. Owner Jeff Adam said the freelance structure receives products by rail and distributes to

local auto parts stores by truck. The kit is composed of laser-cut clapboard siding walls, tarpaper roofing material, Tichy windows and doors, Best Trains white metal detail parts, special signage, scale lumber, and assembly templates for making the loading docks. Motrak's new laser-cut wooden crates are a nice little bonus. The finished structure has a footprint of 9-1/2" by 4" by 3-1/4" high. Kit #87706 lists for \$75.00, plus \$8.00 shipping to US and Canadian addresses. To order, or for additional information, visit [motrakmodels.net](http://motrakmodels.net).

**Rapido Trains** ([rapidotrains.com](http://rapidotrains.com)) has selected the unique GMD1 for its next diesel locomotive. General Motors Diesel (GMD), the Canadian subsidiary of General Motors Electro-Motive Division (EMD) built 102 of the 1200 hp diesels between 1958-1960. Canadian National got 96, units with the remaining six going to Northern Alberta Railway. CN units had a mix of four-wheel and six-wheel Flexicoil trucks. All of the NAR GMD1s had six-wheel A1A-A1A Flexicoil trucks. Although similar in general appearance to EMD's SW1200, the GMD1 had a



Photo courtesy of Brian Schuff

longer chassis and an unusually large headlight/number board fixture. Brian Schuff's photo of CN prototype No. 1007 shows the interesting mufflers, headlight assembly, and anachronistic marker lights. Rapido's Jason

Shron, who claims he fell in love with the GMD1 the first time he saw one, says, "It's so ugly, it's gorgeous." Preliminary test samples, details about road names and numbers, production schedules, and pricing will be released late this spring or early summer.

In other news, Rapido has dropped plans to produce an HO model of the Fairbanks Morse C-Liner locomotive. Difficulties in sourcing the three-axle rear truck, combined with limited pre-orders, deemed the project not financially feasible.



**Red Caboose** has scheduled a July/August release date for the next production run of its Type 103W 10,000 gallon welded tank car. New road names for the HO scale ready-to-run model will include

Texaco (silver tank), DODX (gray tank), SHPX, Tidewater Flying A, and Richfield. Popular road names being repeated in this release will be GATX Flying A (above), and Sunoco. The ready-to-run model will have an MSRP of \$34.95 with each road name being available in six different numbers. Red Caboose brand products are marketed by InterMountain Railway Company ([intermountain-railway.com](http://intermountain-railway.com)).

**Scale Creations** ([scalecreations.com](http://scalecreations.com)) has introduced an HO scale kit based on the Pennsylvania Railroad Station that from 1858 until 1969 was located in West Chester, Pennsylvania. Features of the laser-cut basswood kit include a detailed laser-engraved brick face on the exterior walls, ornate custom windows with decorative stonework trim, and laser-cut shingles for the front door and window awnings. The finished structure has a footprint of 13" x 7". The kit is available at an introductory price \$125.00 until March 31, when the price will increase.



**Scott Mason** ([scottymason.com](http://scottymason.com)) has introduced Baker Coal Company, a five-building HO scale craftsman structure kit that includes a coal shed and scale house (above left), office building (above), and a Railroad Express Agency building and depot (left). The company office has a trackside dock for handling lime, bagged coal, feed, hay and seed. The Baker's Junction

depot is patterned on similar structure built in the late 1800s at Vergennes, Vermont. The coal shed is based on a prototype still standing in Rutland, Vermont. Scotty said inspiration for the two-story REA building came from a structure that existed until the late 1970's in his hometown. The kit includes laser-cut clapboard siding, Hydrocal® plaster castings, scale stripwood, Tichy windows and doors, chipboard material, over 50 cast white-metal details, assembly templates, and a detailed instruction book. The limited edition kit – only 300 will be produced – is priced at \$280.00 each.

**Smoky Mountain Model Works** ([smokymountainmodelworks.com](http://smokymountainmodelworks.com)) is selling a craftsman kit for a prototypically accurate HO scale model of a Southern Railway 70-ton 52' 6" steel gondola as built by Pullman Standard. Kits are available for the 1953/1958 to mid-1980s version with Roman style lettering, or with



sans serif block lettering (above) as seen on prototypes from the early 1960s to the mid-1990s.

In an attempt to keep the price of his specialty kits as inexpensive as possible, Jim King, owner of Smoky Mountain Model Works (SMMW), is now offering all of his kits in two forms: As in the past, kits will be available with all components needed to finish an authentic model, while the newly introduced Econo-Kits (designated by the "e" at the end of the part number) will include only components that are produced by SMMW, or that may be difficult for modelers to find.

The Econo-Kit version of the SR gondola will be priced at \$30.00 each and will include a one-piece resin body casting, separate underframe and resin details, a car weight, stainless steel photo-etched U-loop tiedown strip, decals, and detailed instructions on a mini CD. The standard version of the SR gondola kit is priced at \$45.00 and includes all of the items in the economy kit plus Tichy AB brake components, ladders, steps, wire, end grabs, Tichy trucks with Kadee™ wheel sets, Kadee™ brake wheel, and Kadee™ #153 couplers. For additional details or to order visit the website.



**Sunshine Models** (PO Box 4997, Springfield, MO 65808) has HO scale prototypically-accurate resin kits for 9'11" and 10'3" single-sheathed Mather wood boxcars. Kits for the 9'11" cars are available with X-braced wood ends for Akron,

Canton & Youngstown 1200 series cars, and for Muncie & Western Ball Line cars. Note the Mather sectional roof and X-braced wood ends in the photo of The Ball Line car. The taller 10'3" Mather car, introduced about 1941, is also available with X-braced wood ends, tongue and groove doors, and decals for Manufacturers Railway, Gulf Mobile & Ohio, Trona Railway, and ACY.



Sunshine also has the 10'3" ACY and GM&O cars with improved Dreadnaught ends and Pullman steel doors (above), as upgraded on the prototype beginning in the mid-1940s. Sunshine kits come with extensive instructions and a prototype data sheet, proprietary decals and all necessary detailing parts except trucks and couplers. They are priced at \$42.00 each.

Add \$4.00 shipping on up to five kits, or \$8.00 for six to 10 kits. Customers should expect to wait up to six months for delivery. Sunshine does not accept credit cards. Sunshine does not have a presence on the internet and does not use email. The experience can be maddening, but if you are into prototype steam-era freight cars, the effort is worthwhile. To learn more about what is available and how to order, send a stamped self-addressed envelope to the above postal address. Additional information is available at [sunshinekits.com](http://sunshinekits.com), which is not associated with Sunshine Models but maintains a reasonably current list of all products along with helpful hints on how to order from Sunshine.

**Tangent Scale Models** ([tangentscalemodels.com](http://tangentscalemodels.com)) has released another run of its HO scale ready-to-run 52'6" 70-ton welded gondolas with drop-ends, as built by ACF. In addition to the Pennsylvania Railroad class G31B, shown at the top of the next column, in the 1959 late Shadow Keystone scheme, Tangent also has the PRR welded gondola decorated for the 1960s plain Keystone scheme, 1951 scheme with Equipco brake wheel, and the 1957 early Shadow Keystone scheme. Additional road names include Penn Central (class G31B in PC green);



Conrail (class GE51D); Delaware, Lackawanna, & Western (black with Road of Anthracite slogan and Equipco brake wheel); Atlantic Coast Line (black body with white delineators and Equipco brake wheel); Wabash (1951 black scheme with Universal brake wheel); Sacramento Northern (1959 black scheme with yellow lettering); and Western Pacific (1959 black scheme). Three versions of Southern Pacific are also available - class G-70-8 painted black, class G-70-12 from 1953 in freight car red, and the 1966 repaint with Gothic lettering. Pricing is \$32.95 each. Quantity discounts are available on direct orders. Visit the above web site for details or call 828-279-6106.



**Walthers** ([walthers.com](http://walthers.com)) is booking dealer orders now for a late August delivery of 82' steel Pullman sleepers in five different configurations. The five layouts of the classic heavyweights include a 10-1-2 (top photo), 12-1, 8-1-2, 6-3 (lower photo), and 14-section sleeper. The WalthersProto™ series HO scale models will be available in Pullman green and two-tone gray. The cars will have full

underbody detail including a generator, brake cylinder with levers, air conditioning housing, and a battery box. Other features include individual grab irons, air conditioning ducts as appropriate, sprung operating diaphragms, six-wheel trucks with 36" turned metal wheels, and ProtoMAX™ metal knuckle couplers. The ready-to-run Pullmans will have an MSRP of \$64.98 each.



Also due from Walthers in late August is a new run of 55' Evans cushion coil cars with both round and angled removable hoods. Cars decorated for MILW (above), Reading-RDG, and CSXT (item 920-105201) come with angled hoods. Cars for Illinois Central and CSXT (item 920-105202) have round hoods. Details on the HO scale ready-to-run models include etched-metal walkways, individual grab irons, lift brackets, and stack brackets. The WalthersProto™ series cars have an MSRP of \$41.98 each.

Walthers has four new Mainline series cars scheduled for late August, including a 40' plug-door boxcar decorated for ACL-FGE, Conrail, ATSF, PRR, Soo Line, and BN-Western Fruit Express at an MSRP of \$21.98 each. Also a three-bay 50' PS2-SD 2893 cu. ft. covered hopper painted and lettered for Central of Georgia, Illinois Central, Reynolds Metals-NAHX, and Southern at a list price of \$24.98 each. The third car in the release is a 40' steel meat refrigerator car decorated for Bookey-URTX, Raskin-URTX, Hormel-NADX, and Royal-ART. The meat reefers have an MSRP of \$21.98 each. The final item in the August WalthersMainline™ release is a six-pack of 50' Bethgon Coalporters decorated for Kansas City Power & Light-KCLX, Public Service of Colorado-PSCX, Northern Indiana Public Service-NORX, and Wisconsin Public Service Co-WPSX. Each 6-pack will have an MSRP of \$129.98.

**Woodland Scenics** ([woodlandscenics.com](http://woodlandscenics.com)) has introduced an clever new method for cleaning track and wheels. The cleaning tools are suitable for HO and N scale. The basic system is scheduled for release in late February with an MSRP of \$34.99. Named Tidy Track™, the new rail and wheel maintenance system can be viewed on You Tube by clicking on <http://youtu.be/kiH6qg6ruSw>.

## N SCALE PRODUCT NEWS

Here's some welcome news! **Atlas** ([atlasrr.com](http://atlasrr.com)) has reduced the price on the next release of its N scale General Electric Dash8-40C/CW locomotives. Models with a DCC decoder installed will have an MSRP of \$164.95 (down

from \$189.95). Standard DC models will be at \$124.95 (down from \$149.95). Limited Edition models will be an additional \$5.00. Dash 8-40CW road names will include BNSF Heritage 3, Conrail (blue & white), CSX Spirit of America, CSX (YN2), and Santa Fe.



Due to arrive in the second quarter are Dash 8-40C locomotives decorated for Union Pacific (above), CN (black/red/white), CN-15th Anniversary (black/red/white), and CSX (YN3 yellow nose), plus a limited edition GE demonstrator. Undecorated models of the Dash 8-40C will be available for both Phase 1 and Phase 2 versions.

**BLMA** ([blmamodels.com](http://blmamodels.com)) is working on an N scale version of a PTTX flat car. The prototype cars were created in the 1990s when the Trailer Train Company refitted a fleet of 1960-era F89-J flats with wood crossbeams to transport pipe and other oversize or over weight bulk loads. Designated PTTX, the cars received additional modifications such as side-mounted brake rigging. BLMA will replicate the prototype by modifying its own F89 models with new tooling for the deck braces and brake rigging. BLMA's N scale PTTX ACF F89-J's will feature Micro-Trains® couplers, 70-ton ASF ride control trucks with BLMA's 33" metal wheels. Ten road numbers will be available at \$28.95 each. Details on suitable pipe loads and a PTTX conversion kit will be announced soon.





ExactRail ([exactrail.com](http://exactrail.com)) has released an N scale version of the Trinity TRINCool 64' reefer car decorated for UP/ARMN in 24 different road numbers. Priced at \$29.95 each, the ready-to-run model features body mounted draft boxes with Micro-Trains® 1016 couplers, separately applied uncoupling levers, wire grab irons, etched-metal reefer platform, and ASF 100-ton trucks with machined 36" wheels.



ExactRail has its N scale Evolution Series Vert-A-Pak auto rack car available in three numbers each for three road names including Illinois Central, Florida East Coast, and Seaboard Coast Line as seen here. The innovative car transported automobiles mounted vertically on each of its 30 massive doors. Developed originally by Southern Pacific and ACF Industries, the auto carriers were eventually operated by a wide range of railroads across the country. The N scale cars have an MSRP of \$24.95. They come with McHenry N scale knuckle spring couplers, and Athearn 100-ton trucks with 36" plastic wheel sets.

InterMountain Railway ([intermountain-railway.com](http://intermountain-railway.com)) has set a late summer release date for another run of EMD FT diesels in A-B sets. Road names will be produced for Baltimore & Ohio, Santa Fe (blue cigar wrapper), Atlantic Coast Line, Chicago & North Western, Boston & Maine, and EMD Demo. The N scale



ready-to-run models will have an MSRP of \$199.95 per set. They will be DCC-ready and come with Micro-Trains® couplers.



InterMountain has scheduled another release of its 4750 cu. ft. 3-bay covered hopper to arrive late this summer. The ready-to-run N scale cars will have

etched-metal roof walks, and Micro-Trains® trucks and couplers. Six numbers each will be produced for Soo Line, BNSF, CSX, Pittsburgh & Lake Erie, AOK (CNW restencil), Norfolk Southern, DME, and Frisco. The models will have an MSRP of \$22.95 each

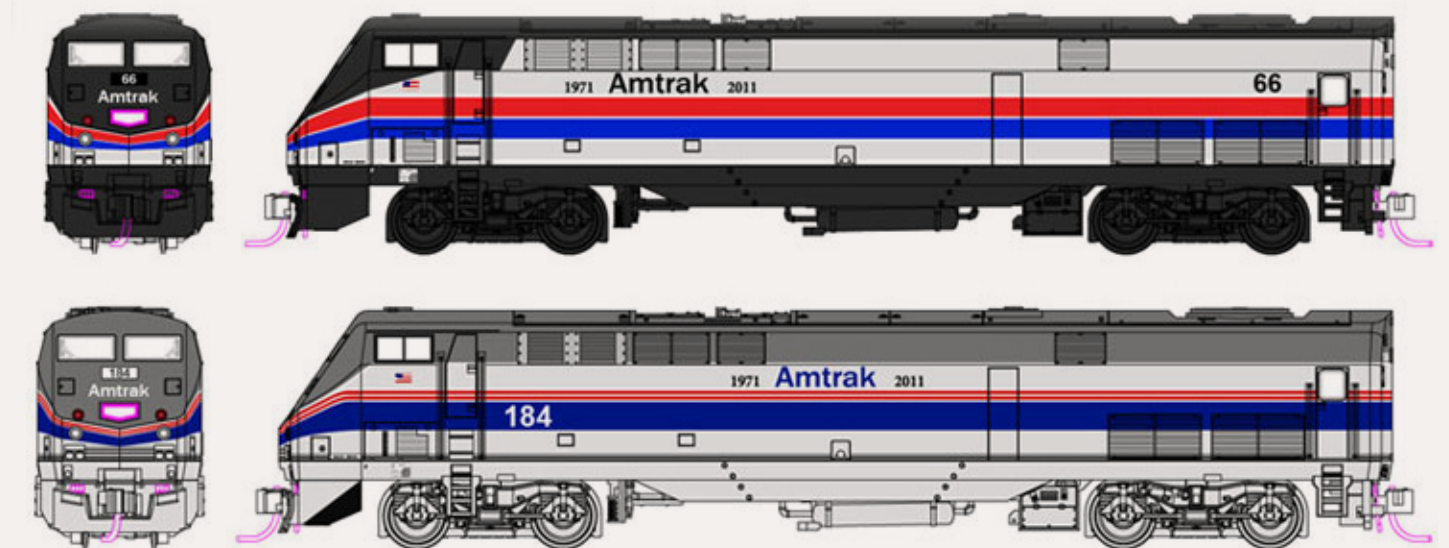

Kato USA's ([katousa.com](http://katousa.com)) series of N scale models in historic Amtrak livery continues this month with the arrival of General Electric P42 Genesis locomotives painted in Amtrak's Phase I scheme. The series, which marks Amtrak's 40th Anniversary, began a few months ago with the release of EMD F40PH locomotives in the Phase III Heritage scheme. The program is scheduled to conclude in May with the arrival of GE P42 locomotives decorated in Amtrak Phase II (top) and Phase IV (bottom) paint schemes.



Kato offers several of its HO and N scale locomotives with undecorated shells. Other than painting and lettering, the models are fully assembled with all details, motor, power chassis and trucks ready for painting. Although the undecorated models have some details already installed, Kato's no-glue assembly method allows details to be removed for painting. N scale locomotives available undecorated are a GE C44-9W Dash-9 with high number boards, six steps and narrow front hand railings at \$105.00; EMD SD70MAC with high number boards and nose headlight at \$105.00; Budd RDC-1 or RDC-2 unlettered but with body painted in a stainless steel finish at \$80.00 each.

**Trainworx** ([train-worx.com/12-1trailers.pdf](http://train-worx.com/12-1trailers.pdf)) is taking reservations for a new 28' drop-frame parcel pup trailer with matching dolly. The trailers will be painted gray and numbered for three different eras. Six road numbers will be available for each era. The early version will include a decal set with DOT striping, and alphabets to allow the modeler to create various parcel companies. A second modern version with DOT striping will be painted and numbered.

**Woodland Scenics** ([woodlandscenics.com](http://woodlandscenics.com)) will soon introduce a ingenious new method for cleaning track and wheels. Named Tidy Track™, the new rail and wheel maintenance system can be viewed on You Tube by clicking on [youtube/kiH6qg6ruSw](http://youtube.com/kiH6qg6ruSw). The cleaning tools are suitable for HO and N scale. The basic system is scheduled for release in late February with an MSRP of \$34.99.

## Z SCALE PRODUCT NEWS

**Full Throttle** ([wdwfullthrottle.com](http://wdwfullthrottle.com)) of Leesburg, Florida, has expanded its selection of cylindrical hoppers to include cars decorated for Canada Wheat Trade



(CNWX). The red scheme features a yellow wheat logo. The cars are sold in a 2-pack with a list price of \$54.00. The cars are manufactured for Full Throttle by Bowser. The products are available through dealers or direct from the above website.

**Stonebridge Models** ([stonebridge-models.com](http://stonebridge-models.com)) has introduced Jay Kay Appliances, a Z scale kit based on a furniture store in Hillside, Michigan. Although the kit consists of more than 50 parts, the manufacturer states it is easy to build. The kit features detailed high-pressure resin castings molded in three colors, plus precision laser-cut windows and doors, and numerous detail parts including a dozen household appliances. The assembled structure has a footprint of 2.5" x 4" x 1.95" high including an optional back extension. The Z scale kit is priced at \$49.00.

## NEW DECALS, SIGNS AND FINISHING PRODUCTS

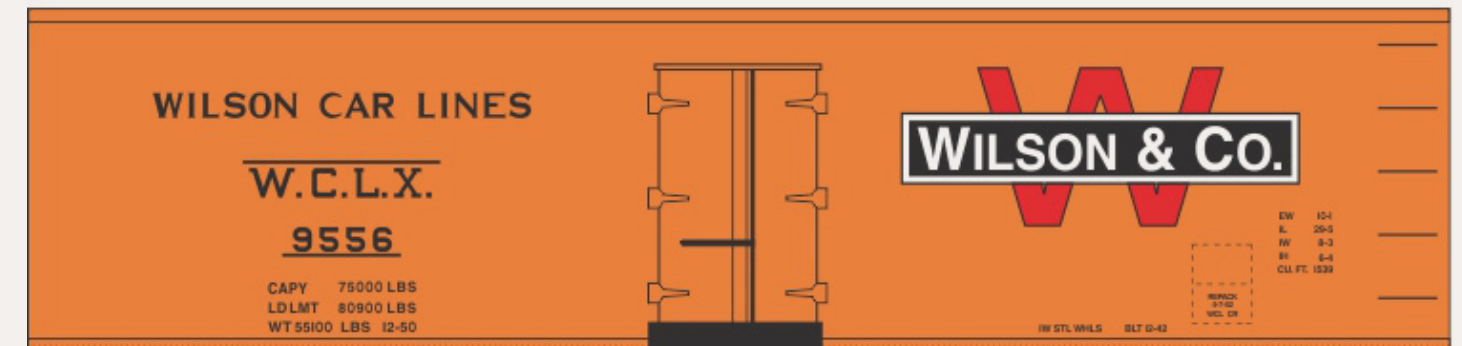

**Jerry Glow Decals** ([home.comcast.net/~jerryglow/decals.html](http://home.comcast.net/~jerryglow/decals.html)) is has three different lettering schemes for Wilson (WCLX) 36' wood refrigerator cars. The sets are for cars numbered 8101- 9600 which covers the operating life of the reefers from the steam-era to the 1960's. The sets are \$5.00 each. Although the lettering set was developed for a 36' car, Jerry says Wilson used the same scheme on 40' cars.

**Mask Island Decals** ([maskislanddecals.com](http://maskislanddecals.com)) has new lettering sets to decorate a Walthers pulpwood rack car for Southern SIECO or GSC. The sets include end-of-car data, and multiple "Loan Only To" data for additional routing. The decal sets are priced at \$6.00 each, and will letter two cars.

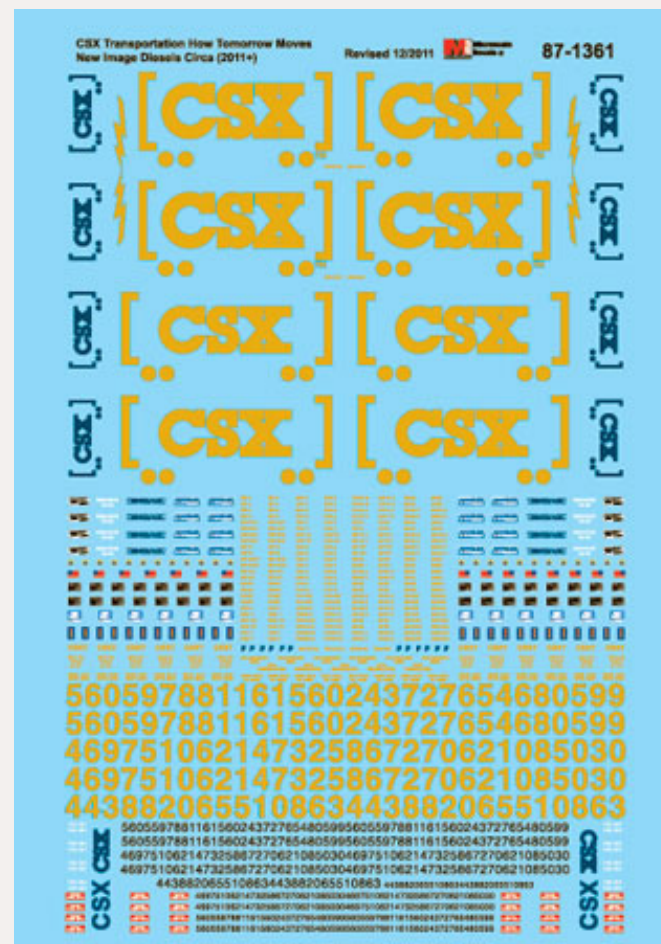

**Microscale** ([microscale.com](http://microscale.com)) has new HO scale decal sets for ATSF 40' trailer (above left), and CSX ES44AC and EMD second-generation diesels with "boxcar" logo (above right). Also new is VIA Rail Canada Renaissance scheme for F40PH-2 diesel locomotives. Expected soon are decal sets for Oregon, California & Eastern boxcars; Tropicana reefers; C&NW insulated boxcars, and BN woodchip gondolas.

**San Juan Decals** ([sanjuandecals.com](http://sanjuandecals.com)) has released HOn3, Sn3, and On3 scale lettering sets for D&RGW C-16 Bumble Bee scheme. The sets include stripes (3" wide, spaced 3" apart) and white numbers for the headlight. Also new are standard-gauge HO scale decals for Pacific Electric steam locomotives. Artwork on this special SP project was created by Paul Koehler, vice president of the Southern Pacific Historical & Technical Society. The Pacific Electric Railway & Historical Society also cooperated and authorized the use of archived PE images.

**DISCLAIMER**

The opinions expressed in this column are those of the writer and do not necessarily reflect the opinion of *Model Railroad Hobbyist* or its sponsors. Every effort is made to provide our readers with accurate and responsible news and information, however, neither *Model Railroad Hobbyist* or the writer of this column can be held responsible for any inaccuracies or typographical errors that may inadvertently appear in this column.

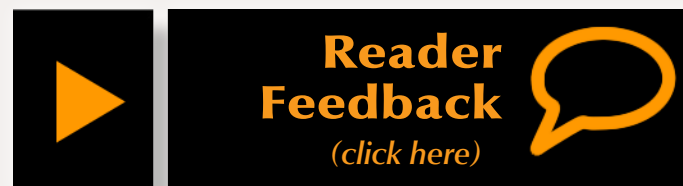

**Briefly noted at press time...**

... Athearn Division of Horizon Hobby displayed pre-production samples of a GP38-2 diesel locomotive at the Amherst Train Show held in late January, in West Springfield, Mass. Produced from all-new tooling, the HO scale GP38-2 will be available initially for Southern Pacific, Missouri Pacific, Southern, and Canadian National. Specific details unique to each road name will be a feature of the ready-to-run Genesis series model. Some of the special details include a short hood with an 81" nose and chicken-screen radiator grille on the MP unit, and a Canadian comfort cab and dual snow plows on the CN model. The SP version represents EMDs later production with an 88" nose and special light package. SR's diesel features a high-hood, split radiator grilles with wider spacing on the fan housings, and an oil-bath filter system for the dynamic brake housing. Athearn's product development manager, Mike Hopkins, said the first release is scheduled for November. MSRP will be \$179.95 for a standard DCC-ready unit, and \$279.98 for locomotives with DCC and a Soundtraxx® Tsunami® decoder. Watch for a complete report on specific details for each road name in the next edition of MRH.

... Atlas Model Railroad Company has purchased Walthers line of O scale structures. The products will be marketed under the Atlas O brand name. The announcement was made jointly by Atlas CEO Tom Haedrich, and Phil Walthers, CEO of Wm. K. Walthers, Inc.

... Model Railroad News, which ceased publication last October, expects to return to print in March. The monthly magazine has been acquired by White River Productions which currently publishes NMRA Magazine and several historical society periodicals. Tony Cook, who joined MRN in May of last year, will serve as editor of the revived publication. White River Productions says it intends to honor unfulfilled RLN subscriptions.



## Selected Events

### February 2012

**CANADA, ONTARIO, COPETOWN** (Hamilton area), February 12, Copetown Train Show presented by Canadian Association of Railway Modellers and Rapido Trains. Community Centre, 1950 Governors Road. A combination railfan and prototype modellers meet with representatives from railway historical associations and many Canadian model manufactures. Info at [caorm.org/copetown](http://caorm.org/copetown).

**SCOTLAND, GLASGOW**, February 24-26, 56th Annual Model Rail Scotland, presented by the Association of Model Railway Societies of Scotland. The Scottish Exhibition & Conference Centre, Halls 3 and 5. Details at [www.modelrail-scotland.co.uk](http://www.modelrail-scotland.co.uk).

**CALIFORNIA, BUENA PARK**, February 12, Railroadiana & Transportation Show featuring railroad collectibles, memorabilia, books, and artwork. UFCW Hall, 8550 Stanton Avenue. Info from Renee Orton at [reneeorton@hotmail.com](mailto:reneeorton@hotmail.com).

**CALIFORNIA, INDIO**, February 17-26, Coachella Valley Model Railroaders Open House during Riverside County Fair & Date Festival, featuring 80 x 16 foot HO layout operating two-way traffic on 2500 feet of track. Riverside County Fair Grounds, 82503 Highway 111. Info at [cvmrr.com](http://cvmrr.com).

**CALIFORNIA, SANTA CLARA**, February 9-11, 22nd Annual O Scale West (includes 6th Annual S West meet), model displays, vendor tables, movies, swap meet, and layout visits. Hyatt Regency. Info at [oscalewest.com](http://oscalewest.com).

**COLORADO, ESTES PARK**, February 18-19, Rails in the Rockies. Layouts, exhibits, and vendor tables. Hosted by Estes Valley Division, RMR, NMRA. Mountain Park Inn. Info at [coloradotump@yahoo.com](mailto:coloradotump@yahoo.com).

**KANSAS, WICHITA**, February 11-12, Train Show & Swap Meet, sponsored by NMRA Chisholm Trail Division and Engine House Hobbies. Cessna Activity Center, 2744 George Washington Blvd. Info from Phil Aylward at 316-830-3498, or email [aylward1@cox.net](mailto:aylward1@cox.net).

**MARYLAND, TIMONIUM**, February 4-5, Great Scale Model Train Show, featuring over 800 vendor tables. Maryland State Fairgrounds. Info at [GSSTS.com](http://GSSTS.com).

**MISSOURI, KANSAS CITY**, February 18-19, Great Train Expo. American Royal Complex. Info at [greattrainexpo.com](http://greattrainexpo.com).

**MISSOURI, SAINT CHARLES**, February 4-5, Great Train Expo. Saint Charles Convention Center. Info at [greattrainexpo.com](http://greattrainexpo.com).

**NEW MEXICO, ALBUQUERQUE**, February 16-18, 27th Annual Sn3 Symposium. Ramada of Albuquerque (I-40 at Eubank), phone 505-296-4853. Info at [Sn3-2012.com](http://Sn3-2012.com).

**OHIO, DAYTON**, February 25-26, Great Train Expo. Hara Arena. Info at [greattrainexpo.com](http://greattrainexpo.com).

**OREGON, PORTLAND**, February 25-26, World's Greatest Hobby on Tour. Oregon Convention Center. Info at [wghshow.com](http://wghshow.com).

**TEXAS, HOUSTON**, February 11-12, Great Train Expo. Reliant Park. Info at [greattrainexpo.com](http://greattrainexpo.com).

**TEXAS, HOUSTON**, February 18, Greater Houston Train Show, sponsored by San Jacinto Model Railroad Club. How-to demonstrations, model and photo contests, operating layouts, vendor tables. Stafford Centre, 10505 Cash Road. Info from [sanjac.leoslair.com](http://sanjac.leoslair.com).

**UTAH, SALT LAKE CITY**, February 4-5, World's Greatest Hobby on Tour. South Towne Expo Center. Info at [wghshow.com](http://wghshow.com).

### March 2012

**CANADA, ONTARIO, TORONTO**, March 17, Annual Toronto Railway Prototype Modelers Meet featuring expert clinicians, unique show-and-tell, and open discussion of displayed items. Humber College, North Campus, Building B, rooms B201& B202. Info from Brian Gauer at [bdgauer@rogers.com](mailto:bdgauer@rogers.com).

**CALIFORNIA, BAKERSFIELD**, March 10-12, Annual Model Train Show, sponsored by Golden Empire Historical & Modeling Society, with over 100 dealer tables, operating layouts and live steam. Kern County Fairgrounds, 1142 South 'P' Street. Info [gehams.net](http://gehams.net).

**CALIFORNIA, PERRIS**, March 3, Railroadiana and Model Railroad Swap Meet. Southern California's largest swap meet featuring operating prototype equipment. Orange Empire Railway Museum. 2201 S. "A" Street, off Highway 215. Info at [oerm.org](http://oerm.org).

**CALIFORNIA, STOCKTON**, March 10, Winterail, Railroad Photography Exposition and Railroadiana Show. Scottish Rite Masonic Center. Info at [winterail.com](http://winterail.com).

**IDAHO, LEWISTON**, March 25, Lewis-Clark Railroad & Collectables Swap Meet, featuring 100 plus vendors, model and toy train collectables, operating layouts, and a special clinic by Disney designer Robert Olsewski. Nez Perce County Fairgrounds. For info, contact Mike McGee 208-816-6072 or Wayne Walling, [msgtusaf@clarkston.com](mailto:msgtusaf@clarkston.com).

**ILLINOIS, LOMBARD**, March 16-18, Chicago O Scale Meet, layout tours, clinics, model contests and vendor tables. West Lombard Yorktown Center. Info at [marchmeet.net](http://marchmeet.net).

**ILLINOIS, SPRINGFIELD**, March 8-10, Railsplitter 2012, NMRA, Midwest Region, Illinois Valley Division annual convention. Abraham Lincoln Hotel. Info at [railsplitter2012.org](http://railsplitter2012.org).

**MASSACHUSETTS, TAUNTON**, March 10, NER/NMRA Spring Training Model Railroad Clinics/Train Show featuring John Pryke. Info at [hubdiv.org](http://hubdiv.org).

**MICHIGAN, FARMINGTON HILLS**, March 18, TrainOrama Extra 2012. Flea market for train buffs and modelers sponsored by The Redford Model Railroad Club. Costick Community Center. Info from Pierre Willerment at 734-953-2546.

**MICHIGAN, TAYLOR**, March 11, NRHS and Society of N-Scalers Railroad Memorabilia & Model Train Show, Taylor Town Trade Centre. Info at [www.societynscalers.com/trainshow/showpage.html](http://www.societynscalers.com/trainshow/showpage.html).

**NEW YORK, BATAVIA**, March 25, Great Batavia Train Show hosted by Genesee Society of Model Engineers. Batavia Downs Casino. Info at [gsme.org](http://gsme.org).

**OHIO, CINCINNATI**, March 10-11, World's Greatest Hobby on Tour. Duke Energy Center. Info at [wghshow.com](http://wghshow.com).

**OHIO, KIRTLAND**, March 17-18, Railfest 2012, NMRA MCR Division 5. Operating layouts, historical displays, live steam display, dealer tables. Lakeland Community College. Info at [railfest.org](http://railfest.org).

**OKLAHOMA, TULSA**, March 23-25, NMRA Indian Nations Division 3rd Annual Tulsa Area Layout Design and Operations Weekend. Speakers include Steve Davis, Tom Fausser, Dick Hovey, John McBee, Lance Mindheim, Dave Salamon, and Jim Senese. Shriner's Temple, 28th & Sheridan. Info at [ldopsig-meet.tulsanmra.org](http://ldopsig-meet.tulsanmra.org).

**OREGON, BEAVERTON**, March 31, A gathering of N scale modelers from the Pacific Northwest. N-trak modular layout, swap meet, and clinics. 10am to 4pm at Valley Catholic High School (west of Murray Blvd. between TV Highway and Farmington Rd.). Info at [meetnmarch.org](http://meetnmarch.org).

**OREGON, ELSIE**, March 3, Annual Pacific Model Loggers' Congress, Camp 18 Logging Museum and Restaurant. Information, including new rules for special awards sponsored by Woodland Scenic, available at [pacificmodelloggerscongress.com](http://pacificmodelloggerscongress.com).

**OREGON, PORTLAND**, March 10, Swap Meet sponsored by Willamette Model

Railroad Club. Over 110 tables of model railroad equipment in all scales, railroad memorabilia, books, photos and more. Kleiver Memorial Armory, 10000 NE 33rd Dr. Free Parking. Additional details from Steve Cook at [wmrswap-meet@yahoo.com](mailto:wmrswap-meet@yahoo.com).

**PENNSYLVANIA, MALVERN**, March 23-25, RPM-Valley Forge Meet, sponsored by NMRA, MER, Philadelphia Division. Model displays, vendor tables, tours, and operating session on Sunday. Clinicians include Keith Albright, Keith DeVault, Ralph DiBlasi, Bruce Elliott, Nick Fry, Jim Harr, Dave Hopson, Larry Kline, Vince Lee, George Losse, Rich Newmiller, Ed Olzewski, and John Teichmoeller. Desmond Great Valley Hotel & Conference Center. Info at [phillynmra.org/RPMMeet](http://phillynmra.org/RPMMeet).

## Future 2012

**AUSTRALIA, NEW SOUTH WALES, ALBURY**, MAY 26-27, Murray Railway Modelers Annual Show, featuring N, HO and O scale layouts, model displays, vendor tables, and Thomas the Tank Engine. Mirambeena Community Centre, Lavington. Info at [murrayrailwaymodellers.com](http://murrayrailwaymodellers.com), or contact John Harvey at [mrmshow@gmail.com](mailto:mrmshow@gmail.com).

**CANADA, BRITISH COLUMBIA, SQUAMISH**, July 13-15, Pacific Great Eastern Railway 100th Anniversary Convention, sponsored by PGE-BCR Modellers Group. Clinics, operating layouts, displays, model contest, prototype displays, and rides on 7.5" gauge Mini Rail. CN Roundhouse & Conference Centre, West Coast Railway Heritage Park, 39645 Government Road. Info including registration fees and options available from Brian Clogg at [bcclogg@shaw.ca](mailto:bcclogg@shaw.ca) or phone 604-588-2194.

**CANADA, ONTARIO, OTTAWA**, May 5-6, Ottawa Train Expo, featuring layouts, models, displays, clinics, demonstrations, and tours. Billed as the largest train show in Eastern Canada. Carleton University Fieldhouse. Info at [ottawatrain-expo.wordpress.com](http://ottawatrain-expo.wordpress.com).

**ARIZONA, WINSLOW**, April 17-27, Winslow Railroad Days and Arizona State Centennial. Prototype displays and operating layouts. Hubble Trading Post, 523 W 2nd Street. Info at [tucsonontrak.com/ASWMRR/ASWMRR\\_Winslow\\_Page.html](http://tucsonontrak.com/ASWMRR/ASWMRR_Winslow_Page.html).

**INDIANA, ELKHART**, April 13-14, Michiana Model Railroad Symposium, sponsored by NMRA Michiana Division, featuring Friday night banquet, clinics, layout tours, and railfanning. National New York Central Railroad Museum. Info at [michiana-nmra.org](http://michiana-nmra.org).

**INDIANA, MARTINSVILLE**, April 14, Train Show and Swap Meet, hosted by

NMRA Central Indiana Division. Dealer tables, operating layouts, clinics, model judging including popular vote contest. Martinsville National Guard Armory, 1900 Hospital Drive. Details at [cid.railfan.net](http://cid.railfan.net).

**ILLINOIS, COLLINSVILLE** (St Louis area), July 27-28, 6th Annual St Louis RPM Meet, hosted by Lonnie Bathurst, John Golden, and Daniel Kohlberg, with clinics, local and national vendor displays and sales tables, representatives from railroad historical societies, Freemo display, and more. Gateway Convention Center, One Gateway Drive. Info available from John Golden at [Golden1014@yahoo.com](mailto:Golden1014@yahoo.com) or Dan Kohlberg at [paducah@mindspring.com](mailto:paducah@mindspring.com).

**KANSAS, MERRIAM** (Shawnee area) June 25, 9th Annual Narrow Gauge Meet, sponsored by Kansas City Area Narrow Gaugers. Includes clinics by Dennis Brandt and Miles Hale MMR, and tours to the HOn3 layouts of John Vandenberg (D&RGW) and Doug Taylor (East Broad Top). Johnson County Library, Antioch Branch, 8700 Shawnee Mission Parkway. Advance registration required by June 20, 2011. Inquiries to Larry Alfred at [captlalfred@gmail.com](mailto:captlalfred@gmail.com).

**MICHIGAN, GRAND RAPIDS**, July 29-August 4, NMRA National Convention and National Train Show. NMRA headquartered at Amway Grand Plaza Hotel, phone 800-253-3590. NTS August 3-5 at Devos Place Convention Center. Info at [gr2012.org](http://gr2012.org).

**NORTH CAROLINA, BREVARD**, October 12-13, Narrow Trak 12. Details pending.

**OHIO, CLEVELAND**, October 11-14, iHobby Expo, annual hobby industry trade show, IX Center. Details at [ihobbyexpo.com/publicinfo.htm](http://ihobbyexpo.com/publicinfo.htm).

**OHIO, HILLIARD**, May 18-20, 4th Ohio N-scale Weekend, hosted by Central Ohio N-trak. Franklin County Fairgrounds. Info at [centralohiontrak.org/](http://centralohiontrak.org/).

**OHIO, MARION**, April 12-14, Central Ohio RPM, Marion Union Station. Info at [hansmanns.org/meet](http://hansmanns.org/meet).

**OREGON, MEDFORD**, May 2-6, Siskiyou Summit Joint PCR/PNR Convention, with clinics, contests, LdSig and OpSig meetings, layout and prototype tours, plus special Train Mountain outing. Red Lion Hotel. Details at [pcrnmra.org/conv2012](http://pcrnmra.org/conv2012).

**OREGON, EUGENE**, April 21-22, 24th Annual Swap Meet & Train Show, sponsored by Willamette Cascade Model Railroad Club. Events Center at Lane County Fairgrounds, 796 West 13th Avenue. Info from Lee Temple [ttandt@ram-mail.com](mailto:ttandt@ram-mail.com) or phone 541-954-4917.

**PENNSYLVANIA, LANCASTER**, October 11-13, Fine Scale Model Railroader Expo, includes activities at the Strasburg Railroad and The Pennsylvania

Railroad Museum. Lancaster Host Hotel & Conference Center, Strasburg. Info at [modelrailroadexpo.com](http://modelrailroadexpo.com).

**PENNSYLVANIA, LEESPORT**, August 10-12, Greater Reading Narrow Gauge Meet. Operating displays, dealers, clinics, and demonstrations. Leesport Farmers Market Banquet Hall, Arlington Drive. (On Route 61, accessible from Route 78 and Route 222). Info at [nateslightironhobbies.com/narrow-gaugemeet.htm](http://nateslightironhobbies.com/narrow-gaugemeet.htm).

**PENNSYLVANIA, MONACA**, April 1, Beaver County Spring Model Train Show. Center Stage, 1495 Old Brodhead Road. Info at [bcmrr.railfan.net](http://bcmrr.railfan.net).

**WASHINGTON, BELLEVUE**, September 12-15, 32nd National Narrow Gauge Convention. Meydenbauer Convention Center. For hotel info visit [seattle2012.com](http://seattle2012.com).

## Future 2013

**AUSTRALIA, MELBOURNE**, April 12-14, 2013, 13th National Australian N Scale Convention, Rydges Bell City Event Centre, Preston, Melbourne. Info at [convention2013.nscale.org.au](http://convention2013.nscale.org.au) or send email to [nscale2013@bigpond.com](mailto:nscale2013@bigpond.com).

**CALIFORNIA, PASADENA**, August 28-31, 2013, 33rd National Narrow Gauge Convention. Hilton Hotel, 199 S. Los Robles St. Info at [33rdnngc.com](http://33rdnngc.com).

**MINNESOTA, BLOOMINGTON**, April 25-28, 2013, 28th Annual Sn3 Symposium. Ramada Mall of America Hotel. Info at [Sn3-2013.com](http://Sn3-2013.com).

**NEW MEXICO, ALBUQUERQUE**, June 6-9, 2013, Rails Along the Rio Grande, NMRA Rocky Mountain Region, Rio Grande Division 6, convention with clinics, layout tours, train show, OpSig sessions, UPRR and BNSF modelers showcase night, and banquet. Marriott Pyramid North. Info from Al Hovey at [alhovey@comcast.net](mailto:alhovey@comcast.net). ■



**Send us your product announcements**

If you are a hobby manufacturer with a product announcement, just [click here](#) and submit your announcement to us.

Our web site and free magazine reach continues to grow, so get on board with this new media train that's hard to stop!



**Reader Feedback**  
(click here)



# REVERSE RUNNING: Curing track planning paralysis – learning your lines

Stepping outside the box with a contrary view



– by Joe Fugate

Every so often on the web forums, you'll see a post that goes something like this:

"I have this space for a layout but I'm stuck. I can't come up with a good track plan; can you guys help?"

Yep, another case of track planning paralysis.

I think the reason for track planning paralysis is simple – you haven't got a clue what all those little lines on a track plan do.

The prototype doesn't lay track somewhere because it looks cool or would be fun to operate. The prototype uses

the track to transport freight and people from point A to point B.

They're in business to provide efficient transportation and make a profit. Track is expensive to lay and maintain, so they won't put in any more track than what they need to do the job. Every track has a purpose – do you know what those purposes are?

If you want a track plan that promotes interesting and realistic operation, then you need to understand what those lines on a track plan are all about.

John Armstrong's classic book, *Track Planning for Realistic Operation*, has a lot of the insight you need. Type

it into Google and you'll find many places you can purchase a copy.

Once you get this book, read it through carefully from cover to cover. Then go back and read it again.

Another good way to gain track-purpose insight is to run trains on other layouts, especially layouts that host realistic operating sessions. If you're serious about getting this experience, join the Operations Special Interest Group ([opsig.org](http://opsig.org)).

Most people who get track planning paralysis have no model railroad operations experience. Once you know what the lines on the track plan do, you're much better prepared to know what a good track plan needs.

Actual running time on other model railroads that host realistic operation sessions has other benefits such as finding out ahead of time what you do and don't like. For instance, you may find you love yard switching, but road running bores you.

If you know this, then your layout design will tend to emphasize yards and minimize mainline running. What interests you becomes the focus, and everything else is there in a supporting role. It's much better to discover this before you build the benchwork and lay the track rather than afterward!

Operating on other model railroads also brings out your interests regarding era and prototype. Do you prefer steam or diesel? Branchline operation or double-track railroading in the heyday of named passenger trains? Or perhaps you prefer modern run-through double-stacks?

Once you have a better sense of what you want (and maybe even more importantly, what you don't want), you have what you need to get past track planning paralysis.

If you can't get operating experience on other model railroads, another approach you can use in the modern computer age is virtual railroading with Microsoft Train Simulator, Trainz, or with the Train Player package that allows you to run trains on track plans (including model plans).

The point is, to find out what those lines on a track plan let you do, you need to run trains on those lines so you know.

When you can look at a track plan and see the purpose for each train that will run in your mind's eye, then you will find track planning paralysis has been cured. Next patient!



Clickable Advertiser Index	Page
<a href="#">Accu-Lites</a> .....	85
<a href="#">Backdrop Junction</a> .....	10
<a href="#">Bar Mills</a> .....	59
<a href="#">BLMA</a> .....	3
<a href="#">Bullfrog Snot</a> .....	52
<a href="#">Coffman Graphic Solutions</a> .....	51
<a href="#">DCC by Design</a> .....	52
<a href="#">Digitrax</a> .....	9
<a href="#">ExactRail</a> .....	4
<a href="#">Great Decals</a> .....	52
<a href="#">iwata-Medea</a> .....	34
<a href="#">Litchfield Station</a> .....	38
<a href="#">Micro-Mark</a> .....	44
<a href="#">Microscale</a> .....	19
<a href="#">Model Trains Video</a> .....	39
<a href="#">Model Trains Video</a> .....	73
<a href="#">M.T.H.</a> .....	18
<a href="#">Nano-Oil.com</a> .....	86
<a href="#">NCE</a> .....	28

Clickable Advertiser Index	Page
<a href="#">NMRA Grand Rails 2012</a> .....	51
<a href="#">The Proto:87 Stores</a> .....	52
<a href="#">RailMaster Hobbies</a> .....	17
<a href="#">Railpub</a> .....	52
<a href="#">Rapido Trains</a> .....	7
<a href="#">Ring Engineering</a> .....	51
<a href="#">Rulers of the World</a> .....	52
<a href="#">RS Laser Kits</a> .....	16
<a href="#">Scenic Express</a> .....	58
<a href="#">The Scotty Mason Show</a> .....	52
<a href="#">Southern Digital</a> .....	12
<a href="#">Summit USA</a> .....	52
<a href="#">TAM Valley Depot</a> .....	11
<a href="#">Trainside Flats</a> .....	51
<a href="#">TrainTek</a> .....	33
<a href="#">True Line Trains</a> .....	14
<a href="#">True Scene Modeling</a> .....	52
<a href="#">Walthers</a> .....	5
<a href="#">Yankee Dabber</a> .....	54

Clickable Topic Index	Page
<a href="#">Benchwork - Module cradle</a> .....	92
<a href="#">Benchwork - Photo backdrop</a> .....	83
<a href="#">Benchwork - Up the Creek</a> .....	29
<a href="#">DCC - DCC Impulses</a> .....	45
<a href="#">Editorial - Editors Soapbox</a> .....	8
<a href="#">Editorial - Reverse Running</a> .....	119
<a href="#">First look - VectorCut details</a> .....	94
<a href="#">Layouts – Mount Allen is gone!</a> .....	68
<a href="#">News – February Trackside Showcase</a> .....	97
<a href="#">News – February Newsletter</a> .....	103
<a href="#">News – February Events</a> .....	116
<a href="#">Operations - Comme-N-tary</a> .....	40
<a href="#">Q and A – MRH Questions, Answers, and Tips</a> .	15
<a href="#">Rolling stock – Coupler box covers</a> .....	53
<a href="#">Scenery – Super detailed winter trees</a> .....	55
<a href="#">Structures – My Modular Adventure</a> .....	20
<a href="#">Structures – Out of service train order signal</a> .	64
<hr/>	
<a href="#">Other – Cover</a> .....	1
<a href="#">Other – MRH Sponsors</a> .....	2
<a href="#">Other – Table of Contents</a> .....	6
<a href="#">Other – Staff Notes</a> .....	10
<a href="#">Other – Hobby Marketplace</a> .....	51
<a href="#">Other – Derailments</a> .....	121

**For the love of model trains**



### Coming in the Mar 2012 issue

- Working semaphores with servos
  - Modeling the Nevada-California-Oregon in the modern era
  - The next installment of building the BC&SI peninsula
  - Weathering a scrap metal service gondola
  - Operating the Willoughby Line
- ... and lots more!

**Derailments, humor,  
and Dashboard on  
next page ►**



## HOW TO HIDE A HELIX:

#38



Bathroom.

### True story ...

I was at the Brooklyn roundhouse while a steam engine was being fired-up to pull a passenger excursion. In walked an obviously excited railfan with his wife and three kids in tow. As he passes by, I overheard him telling his family how big and powerful the engine was and that if the boiler ruptured, all the high pressure steam would turn them into lobsters before they could escape. Just then the safety valve on the roundhouse compressed-air drier lifted with a deafening SSSSHHHHHHHH. I've never seen people move so fast in my life!

If you're the first to [submit a bit of good humor](#) and we use it, it's worth \$10!



**Reader  
Feedback**  
*(click here)*



↓ [Printer-Friendly Version](#)

↓ [Download PDF Version](#)

# When talking to hobby vendors, please remember to mention MRH.