

Model Railroad Hobbyist magazine™

Price:
Forever Free
STANDARD
Edition

August 2012

HAVING FUN WITH TRAINS

Animating an Athearn crane

EXCLUSIVE!
Grand Rails National
Convention Report

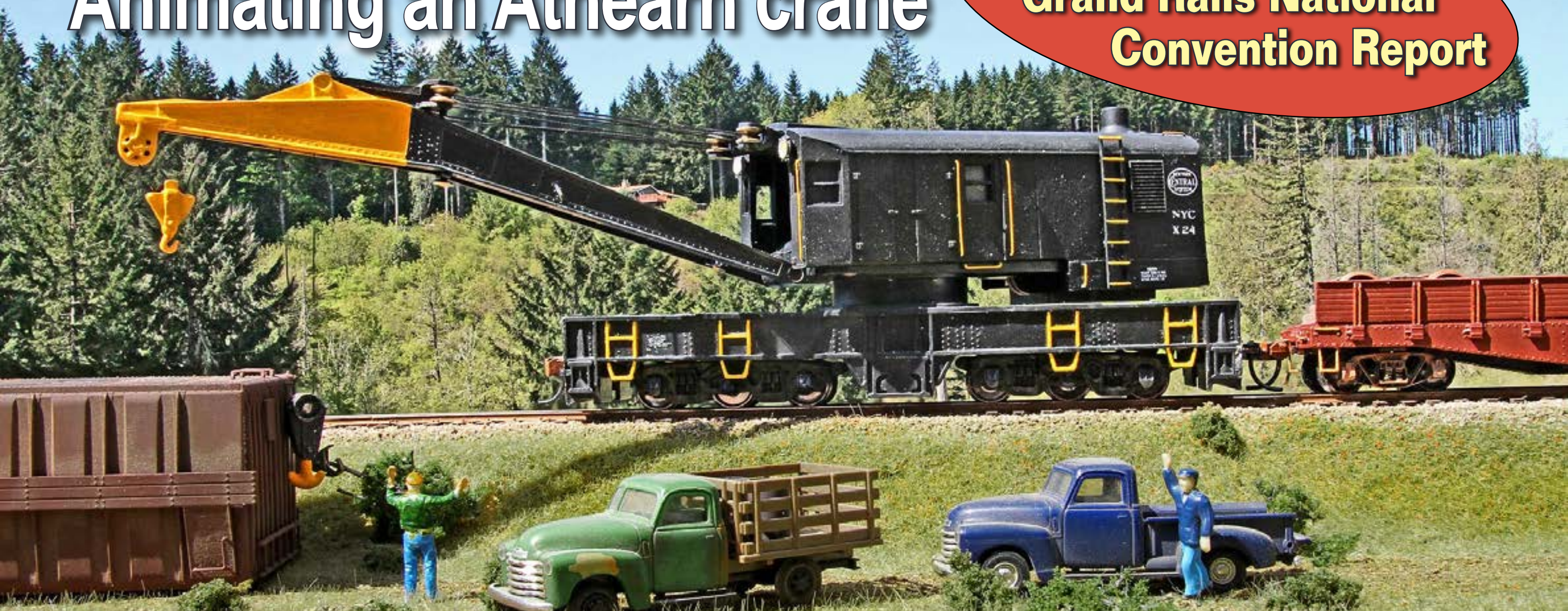

- Modeling CP's Sudbury Division
- Steam loco scratchbuilding, part 3
- Build a CTC-style control panel
- EMD GP38-3 kitbash

... and lots more, inside!

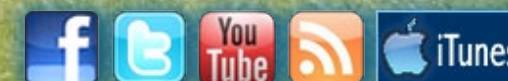



Front Cover: Geoff Bunza shows how to take an Athearn crane car and turn it into a great DCC animated model. Charlie Comstock posed Geoff's crane on his outdoor photo diorama and shot this photo showing it in action.

ISSN 2152-7423

Editorial Staff

Joe D. Fugate, Publisher and Editor

Columnists

Richard Bale, News and events
John Drye, N scale
Les Halmos, Modular railroading
Bruce Petrarca, DCC

Special Correspondents

Joe Brugger, Questions and answers
Jeff Shultz, First looks
Charlie Comstock, Contributing editor

Production

Patty Fugate, pasteup and layout
Joe Brugger, copy editing
Mike Dodd, copy editing

Technical Assistants

Jeff Shultz
Jimmy Simmons

Advertising

Les Halmos, Account Manager
Daniel Nava, Advertising Assistant

Published for the glory of God.



click to learn more about this sponsor



click to learn more about this sponsor



NEW SPONSOR!



click to learn more about this sponsor



click to learn more about this sponsor

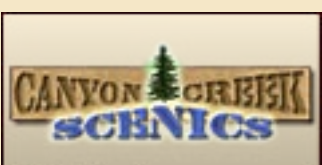

click to learn more about this sponsor



click to learn more about this sponsor



click to learn more about this sponsor



click to learn more about this sponsor



NEW SPONSOR!



click to learn more about this sponsor



click to learn more about this sponsor



click to learn more about this sponsor

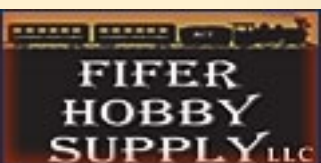

NEW SPONSOR!



click to learn more about this sponsor



click to learn more about this sponsor



click to learn more about this sponsor



click to learn more about this sponsor

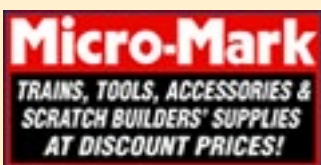

click to learn more about this sponsor



click to learn more about this sponsor



click to learn more about this sponsor



click to learn more about this sponsor

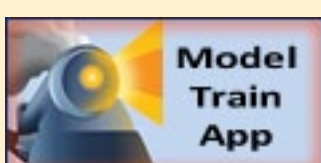

NEW SPONSOR!



NEW SPONSOR!



click to learn more about this sponsor



click to learn more about this sponsor



click to learn more about this sponsor



NEW SPONSOR!



NEW SPONSOR!



NEW SPONSOR!

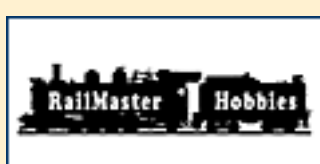

click to learn more about this sponsor



click to learn more about this sponsor



click to learn more about this sponsor



NEW SPONSOR!



NEW SPONSOR!



click to learn more about this sponsor



click to learn more about this sponsor



click to learn more about this sponsor



NEW SPONSOR!



click to learn more about this sponsor



click to learn more about this sponsor



click to learn more about this sponsor



NEW SPONSOR!



NEW SPONSOR!



click to learn more about this sponsor



click to learn more about this sponsor



click to learn more about this sponsor

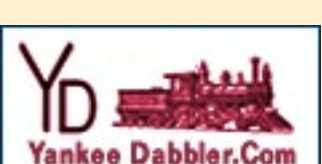

click to learn more about this sponsor

Remember to tell our sponsors: "MRH sent me!"

Want your logo on this page? Click to find out how....

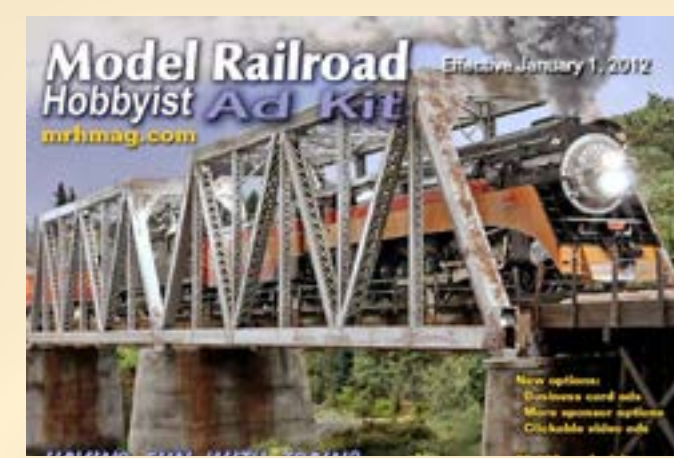

64,000+ audience as of Jan 2012. Click [here!](#)



Need something? See our Hobby Marketplace!





302 District Ct., Fullerton, CA 92832 Sales@blmamodels.com

THINK BIGGER

TRIPLE TRACK MAINLINE
ASSEMBLED & LIGHTED
SIX OPERATING HEADS

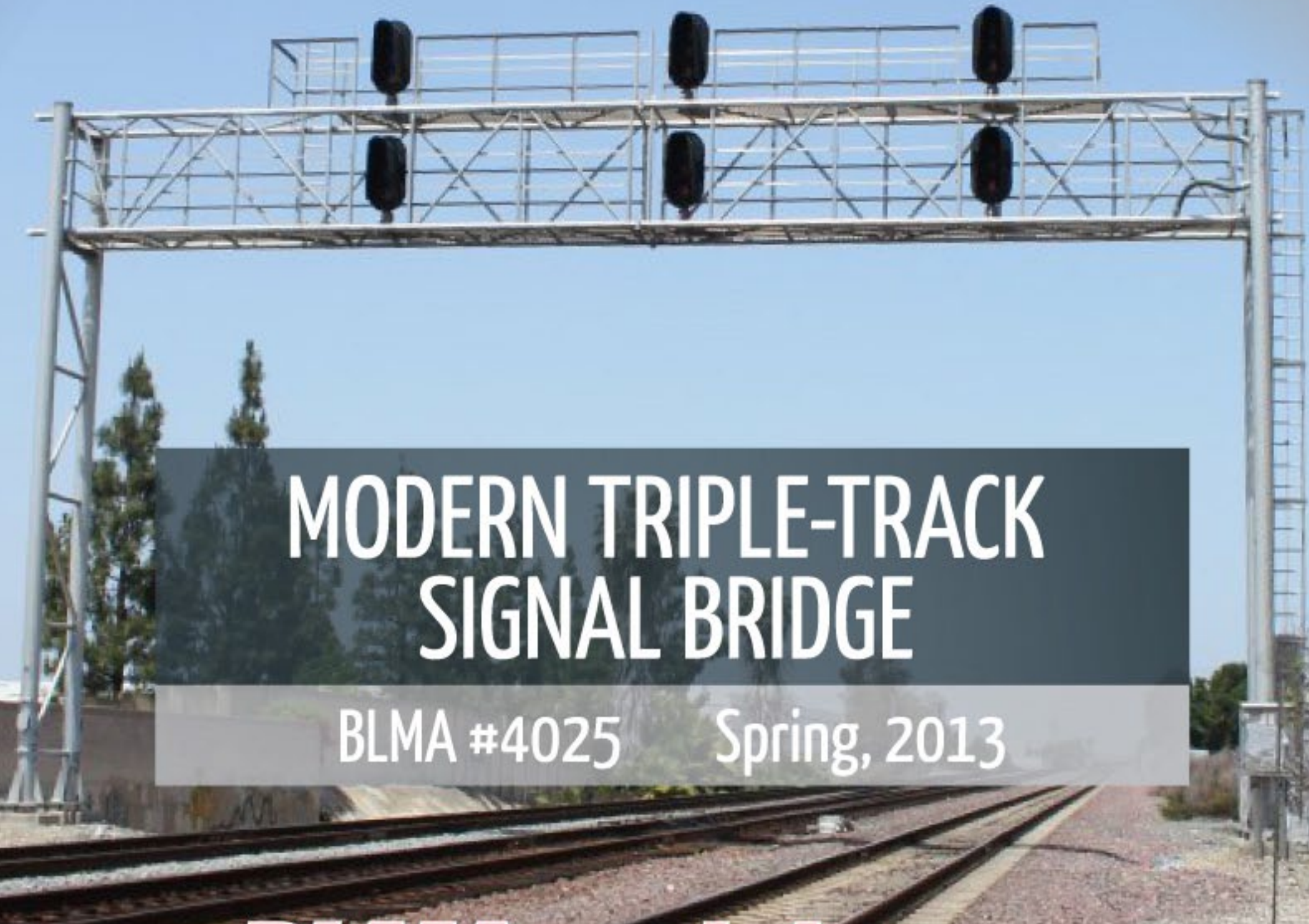

**MODERN TRIPLE-TRACK
SIGNAL BRIDGE**
BLMA #4025 Spring, 2013



SEE MORE AT ***BLMAmodels.com***





EXACTRAIL[®]
The Next Generation of Model Railroading

ALL EXACTRAIL PRODUCTS NOW AVAILABLE
ONLY DIRECT FROM THE MANUFACTURER

Follow us:



See what's new at
ExactRail.com

PS-2CD
4427
COVERED HOPPER
HO

INSIDER

Be the first to know about the next release!

Join our Insider newsletter for the latest news and product announcements from ExactRail.

Coming this month

Our most popular road names &
new paint schemes!

WM (Chessie System), UP, NP, SOO
& SOO ColorMark



NCE Provides the FULL Spectrum of DCC

- Highest Rated DCC Systems
- Made in the U.S.A.
- Extraordinary Performance
- Radio or Tethered

You don't have to learn it every time you use it

Call or Email
for FREE Brochure
support@ncecorporation.com

585.265.0230
9am-4pm EST.

 www.ncedcc.com

NCE

The Power of DCC

Operations on Steve Levine's On30 Layout

Did You Know?

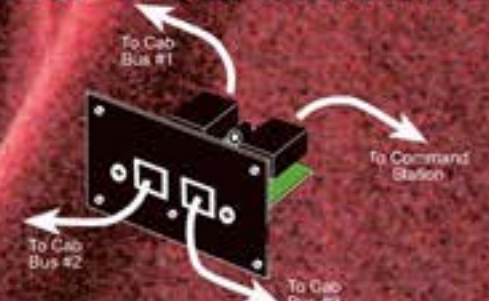

You can use a UTP panel as a three way "Y" splitter and go two or even three ways with your Cab Bus!

Main Features



53 Bring a wrecking crane to life
Animating an Athearn crane
by Dr. Geoff Bunza



108 Scratchbuilding a steam loco – part 3
Getting the loco you want using styrene
by Kenneth Rickman



70 CTC-style control panel
Keeping a traditional look to your panels
by Royce Brown



124 MRH Product showcase
Exceptional products photo gallery
by the MRH Staff



73 Kitbash an Norfolk Southern GP38-3
Modeling a modern diesel rebuild
by Matt Snell

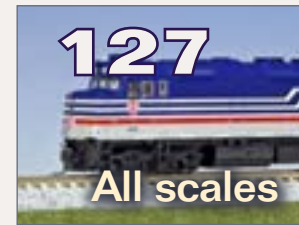

127 August Model Railroading News
MRH News and events
by Richard Bale and Jeff Shultz



93 Modeling the CP Sudbury
How this club models the 1970s CP Rail
by Jurgen Kleylein



144 Grand Rails 2012 Report
MRH report on the NMRA National Show
by the MRH Staff

Other Features

8 New MRH contest
Publisher's musings *by Joe Fugate*

50 Hobby Marketplace
Vendor ads

11 MRH Staff Notes
MRH on Facebook, and more ...

164 Derailments
Humor?

16 MRH Q - A - T
Questions, Answers and Tips

Columns

20 Getting the sound out
DCC Impulses
by Bruce Petrarca

31 Safe Traveling for N scale
Passengers
Comme-N-tary
by David L. Salsbery

37 Doing the blacktop
Modular Adventure
by Les Halmos

162 Making the right choices
Reverse Running
by Joe Fugate

14 Subscriber-only extras
Bonus downloads

No Two Alike...



The most detailed F-Unit ever!

PUBLISHER'S EDITORIAL: New MRH contest – get started with \$500

Musings from MRH's founder

About the Publisher



Joe Fugate is the featured expert in many [Model-Trains-Video.com](#) videos, and he's also the founder and publisher of **Model Railroad Hobbyist Magazine**.

To learn more about Joe, [click here](#).

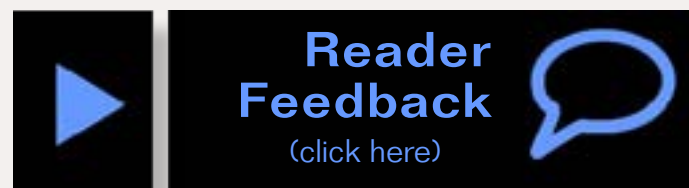

With this issue of MRH, we're kicking off a contest: Help a hobby newcomer get started right in the hobby of model railroading in an affordable way.

Let's say a hobby newbie comes to you, tells you they have \$500, and they'd like to get started in model railroading. What would you recommend?

In a nutshell, that's our contest!

The contest has few rules. You can only spend \$500 and you need to get an operating layout as a result.

You can assume basic tools like a hammer, saw, drill, pliers, screwdrivers, hobby knife, motor tool, and a soldering iron. But not much more.

You can't assume fancier tools that a typical newcomer might not have, like a table saw, router, lathe, and so on.

Do not include the cost of tools. Just stick with fairly common tools most will have access to (a jigsaw, motor tool, and a soldering iron are okay).

The \$500 will need to cover benchwork, roadbed, track, wiring, control

system, rolling stock, locos, structures, and scenery.

You can do used items from common online sources like eBay or the Yahoo yard sale lists, as long as the items often appear frequently as something for sale. Rare or hard-to-find items don't work.

You can use any scale from Z to G, because we don't want to put any limits on your approach.

Your submission needs to include an itemized list, expected cost, and sources. Also include a sketch of the layout plan and a write-up of your rationale and approach.

We want to encourage contest entrants to think outside the box, which is why we're not putting a lot of constraints on this contest. The MRH staff will judge the entries and select the winners.

Winners will get their winning entry published (and get paid for the resulting article), and we'll also provide a nice selection of prizes, worth a hundred dollars or more, donated by MRH sponsors.

The deadline for the contest entries is November 30th, 2012 (postmarked or submitted to us online by midnight Pacific time on that date). We will announce the winners in the January

issue of MRH and publish the winners from February through April.

What criteria will the judges use to select the winners?

We will be looking for the most creative use of the \$500. For example, who says the benchwork even needs to be wood? Or that the structures need to be fancy kits?

We'd like your entry to have good future expansion potential. Don't just make a super cheap one-off that you can't expand or do more with. This is to get someone started with \$500, not to show them how to invest in a dead-end hobby!

You also don't need to spend the full \$500 - doing more with less will play a big part in selecting the winners. That said, those able to do the most with the full \$500 will also be a factor.

We'd like to show that getting into the hobby doesn't have to be expensive.

January, when the first of the winning entries will be published, is when a lot of newcomers will be entering the hobby, so here's your chance to help them get started without a huge outlay.



FOR Model Railroaders

BY Model Railroaders

Great products. Exceptional service. Serious fun.™

Find products from over 100 model railroad companies at HorizonHobbyTrains.com. All the brands you love—Athearn®, Lionel, Bachmann and more—are right there. You'll also enjoy:

- Same-day shipping
- Our deal-filled Savings Station
- eGift certificates

Everything we sell is backed by the best customer service and support available. Our service center team is standing by to help you get the most from whatever you buy. At HorizonHobbyTrains.com, we take having fun very seriously.

Visit HorizonHobbyTrains.com. Exclusively Trains.



©2012 Horizon Hobby, Inc. All rights reserved. Athearn, Serious fun and the Horizon Hobby logo are trademarks or registered marks of Horizon Hobby, Inc. All other trademarks, service marks and logos are property of their respective owners. 36139

GREAT PRODUCTS



EXCEPTIONAL SERVICE



SERIOUS FUN™



Containerterminal

ALCAU CENTRAL



The Amherst Railway Society Railroad Hobby Show

Our 2013 Show will be

January 26 & 27, 2013

Save the dates!

About The Show

Every year late in January or early in February, the Amherst Railway Society holds its Railroad Hobby Show at the Eastern States Exposition Fairgrounds (The home of The Big E) in West Springfield Massachusetts. More than 25,000 railfans and public attended the Show each of the past three years.

The event features real life railroads and scale model railroads, historical societies, travel agencies, art shows, flea market dealers, importers, manufacturers and photographers. You have to see it to believe it!



Click to learn more ...



The Complete Brick Building System

from Monster Model & Laserworks

-Walls -Corners -Arched Lintels -Chimneys -Columns
Build Anything...

Plus Detail Parts like Security Bars...

N Scale
HO Scale
S Scale
O Scale
G Scale

Ask About Our

\$5

Custom Cut

*With 12"x4" Brick Sheet Purchase



Ask about our Custom Services
-We'll cut any of your designs
-Lintels engraved into the walls
-3D Concrete Cornice

www.monstermodelworks.com

ADVERTISEMENT

Notes from the

MRH STAFF

MRH on Facebook, New sponsors, MRH Gen 2 update ...

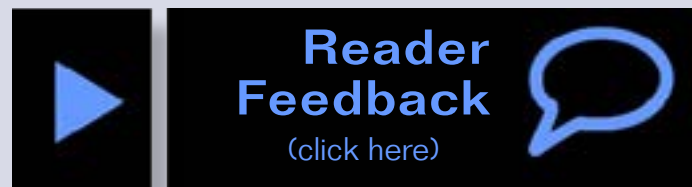

MRH on Facebook

MRH has a good Facebook presence, and if you want to stay on top of hobby vendor releases, you should go click "like" on our Facebook page: facebook.com/mrhmag ... that way you'll get an email notification whenever we post something new.

You don't do Facebook, you say?

You're definitely in a fast-shrinking minority these days. Facebook has

almost a billion members now, and if Facebook was a nation, it would be one of the largest nations on the planet!

You should give Facebook another look if you're not on there. Still, if you insist on remaining a Facebook holdout, yet you'd like to keep up on our Facebook page updates, then there's always our Facebook RSS feed: mrhmag.com/facebook/rss ... if you subscribe to this feed using an RSS reader, then you will get updates directly in your reader, but you don't need to belong to Facebook!

Don't have a clue what an RSS reader is?

Then you're missing out on one of the best ways to keep up on website updates and avoid email spam.

See our video on RSS feeds for Model Railroaders:

mrhmag.com/MRHT_RSS-feeds-for-MR ... you'll be amazed at what a time-saver RSS feeds can be.

New sponsors

Five new sponsoring advertisers this time!

New York Central System Historical Society (nycshs.org): If you have any interest in the New York Central, then



the NYCSHS is a group for you. Their number one mission is preserving

the legacy of the New York Central System through preserving the system's traditions, documents, records, and artifacts. As a member, you get the Central Headlight, their official publication. In addition, they publish a free modeler's PDF called the NYC Modeler's magazine. Make sure to tell them thanks for becoming an MRH sponsor.

Fifer Hobby Supply:

(fiferhobby.com): If you model in N or

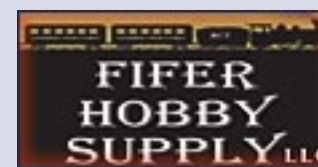

HO scale, then you owe it to yourself to check out Fifer. They are a

well-stocked online hobby shop with how-to information, modeler photo galleries, and links to useful model railroading resources. Drop by their HO and N websites and say thanks for coming on as an MRH sponsor!

Model Train App:

(modeltraindb.com): Model Train App

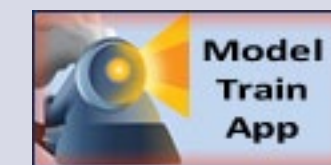

specializes in model railroad apps for iPhones and iPads. If you

have model railroad trains and equipment and own an iOS device, then their app can be quite handy. You can track information about not only about your current items, you can also track your desired collection. Take your inventory with you to train

Your rating:  (Your rating: 5 out of 5 votes)

July 2012 MRH Ratings

The five top-rated articles in the [July 2012](#) issue of MRH are:

- **4.6** DCC Impulses - Enhancing your DCC system
 - **4.5** Creating a realistic pipe load
 - **4.4** Reverse Running - Hobby too serious?
 - **4.4** Railfanning the Pine Ridge Railroad
 - **4.3** Scratchbuilding a steam loco, pt 2
- Issue overall: **4.5**

Please rate the articles!

Click the reader feedback button on each article and select the star rating you think each article deserves. **Thank you!**

shows or local hobby shops for quick access to what you already own, and what you “need” for your layout. Visit their website and say welcome onboard as a new MRH sponsor!

Reynauld’s Euro Imports:

(reynaulds.com): Reynauld’s focus is



European and German model railroading and railroad history.

Their family has been involved with German railroading since 1904. Even though Reynauld’s speciality is non-US railroads, their website has prices listed in US dollars, minimizing any hassle or confusion over exchange rates. Their prices are quite competitive and they have a huge inventory. Check out their website and say thanks for becoming an MRH sponsor!

Short Hill & Western:

(shorthillwestern.com): Short Hill &



Western started 28 years ago. They offer many fine detail parts and

kits, focusing on quality fine scale modeling at great prices. They produce all their products in the US, and they purchase their materials from US-based suppliers. Because they sell direct-only, they pass the savings on to you, the modeler. Go take a look at their website and say thanks for becoming an MRH sponsor!

Hobby Marketplace ([page 50 this issue](#)): Remember to visit our MRH

Hobby Marketplace, which houses our economy ads. New smaller, non-sponsoring advertisers appear in there as well.

Remember to look beyond just the sponsors page if you want to see all the advertisers who have products you might need!

MRH Gen 2 update

Last issue we announced a new format change coming in January that we’re calling MRH Generation 2. This change will allow you to get a version of MRH that’s very readable on mobile devices like iPhones or Android Phones.

With this change comes a new version of MRH – the HTML5 HD version. You’ll need a current browser to read it, though.

If you’re using Internet Explorer, you want to be on version 8 or greater. Version 7 won’t cut it for the new HTML HD version of MRH. You’ll need to be on a version of Firefox greater than 4, while almost any version of Safari or Chrome will work fine.

For those of you who love the PDF versions, we’ll be going to just two versions: the Standard and the Embedded. All the other versions can be replaced by the HTML HD version.

However, we will encourage you to move to the new HTML HD version because eventually, that’s all there

iwata

by ANEST IWATA

Just Rolling By...

Make It REAL With Iwata Climb Aboard!



Visit... www.iwata-medea.com To Check Out Our Full Product Line!

Models By... Alan Houtz,
North American Prototype Modelers

A
D
V
E
R
T
I
S
E
M
E
N
T

will be – and it will display great on anything.

With this format change, we'll also be retiring our Flash download wizard. Now to download an issue you just click "Start Reading Now" and the HTML HD version will come up in your web browser. You can keep reading the online version or use the download button right on the cover to copy the issue to your computer.

This new download button will let you choose if you want to download one of the old PDF formats or if you want to try one of the new HTML formats: HD or ePub.

MRH Gen 2 arrives January 2013.

Blog / Forum: What's the difference?

On the surface MRH website blogs and forums look similar because both have an initial post followed by additional posted comments and discussion.

The word "blog" is short for weBLOG: think of it as a public diary or journal. The physical equivalent of a blog is a meeting where you, the blog owner, stand at a podium and pontificate about something. It's your meeting and you control the agenda.

The lead post of blog threads often have a running theme like building your home switching layout or working on the club layout.

Because a blog is more of a personal journal, wandering a bit from pure trains is considered okay. You might post a blog on MRH about funny railfanning stories, for example. Not exactly trains, but there is a train element in the first post you make to start your blog thread. Blogs tend to be more personal opinion on a subject because we all consider a blog to be "your blog" and it's about you in some way.

A forum, on the other hand, is more like an impromptu meeting somewhere: no one owns the meeting and no one is in charge. Someone will make a comment (the first post of a forum thread) and then a discussion goes from there.

This means a forum is more like a bull session or a party discussion than a lecture with a host in charge. Because a forum is topic-based and a personal journal, a forum thread needs to be more train-oriented than a blog.

If you start going on about some personal thing in a forum thread, then we consider you to have hijacked the thread – a somewhat rude thing to do. But wandering a bit afield in blog discussions is considered more normal.

Hope that helps make the distinction more clear. Since both a blog and a forum have a starting post and comments, they can look quite similar on the surface, but as you can see, their focus tends to be quite different.

ADVERTISEMENTS

HO, N, Z AND O-SCALE PREMIUM LASER STRUCTURES

RSM precision cut laser structures offers a level of realism rarely seen in Model Railroad structures on the market today. What separates our structures from other laser kits on the market is our engraving process. We don't just use the laser to cut our parts we actually engrave our parts. The engraving process on all RSM models gives each model realistic wooden grain, brick and stone textures, giving each RSM model the ultimate detail.



THE GRASSELLI TOWER

The Grasselli Tower once stood along Kennedy Avenue in East Chicago, Indiana - guarding the junction between the IHB, EJE, and B&OCT. The "Grasselli" tower today was refurbished and is now located in Judson Indiana. It is now owned by the Hoosier Valley Railroad Museum.

\$59.95 RSM #201001 Z Scale Laser Cut "Grasselli Interlocking Tower

\$94.95 RSM #451001 O Scale Laser Cut "Grasselli Interlocking Tower

\$69.95

RSM #871001 HO Laser Cut "Grasselli Interlocking Tower
RSM #601001 N Scale Laser Cut "Grasselli Interlocking Tower

THE CASTLE CAR WASH

The "Castle" Car Wash is a famous Route 66 landmark built in the mid 1920's located in Chicago Illinois, structure still stands today as a historical land mark.



\$59.95 RSM #201002 Z Scale Laser Cut "Castle Car Wash

\$94.95 RSM #451002 O Scale Laser Cut "Castle Car Wash

\$69.95

RSM #871002 HO Laser Cut "Castle Car Wash
RSM #601002 N Scale Laser Cut "Castle Car Wash

Dealer Pricing Available

Toll Free 1-888-762-6872

REYNAULD'S
FULL STEAM AHEAD SINCE 1904
EURO IMPORTS, INC.

122 N. Main Street
Elburn, IL. 60119
www.reynaulds.com/rsm.aspx
info@reynaulds.com
facebook.com/ReynauldsEuroImports

Interested in O Scale?

THE

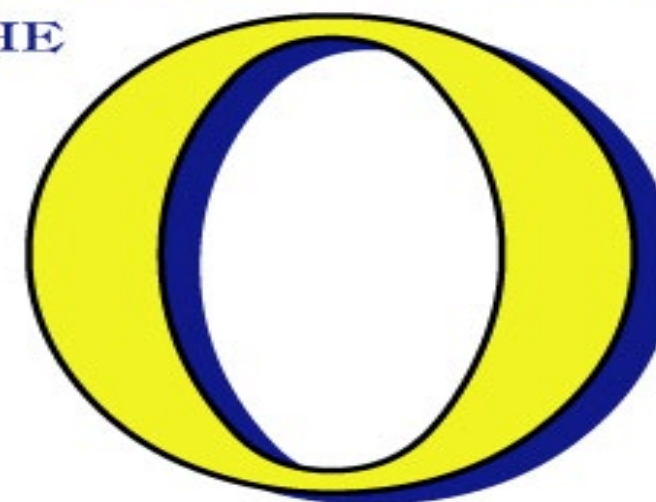

SCALE
RESOURCE[®]

www.oscaleresource.com

Listings of O Scale manufacturers, dealers, and suppliers.

Some MRH website and PDF tips

If you are starting a blog post or a new forum thread, make your initial post very short - just a sentence or so, and don't post any photos or media in your initial post. Then post a comment to your initial post and put all the detailed content, photos, and media in your second post.

The MRH site repeats the first post across thread pages, and if you make a really long initial post, then that really long content gets redisplayed on every page of the discussion thread - which gets kind of annoying if the initial post is very long.

Better is to make your initial post short and sweet, then put all the verbose content in your second post, so it does not repeat on every page of the discussion thread.

We get the question now and then about how to extract just a single article from an issue as their own little PDF. You can do this with Adobe Acrobat Pro (not free). Recently it occurred to us you can also do this using CutePDF, which is free.

In this issue

We delayed this issue release a week and put 18 pages of coverage from the just-completed Grand Rails National Convention. We believe this is some of the best coverage of any NMRA National Train Show, ever

– and it's being published mere days after the event!

Bruce Petrarca's column this time is one of our favorites: How to get the sound out. We first saw Bruce present this information at an NMRA National as a clinic, and it was simply delightful. You're in for a treat with this issue's DCC column!

Guest N scale columnist David Salsbery provides us with a very practical N scale piece on transporting N scale equipment safely. We find David's solution to be especially clever. It's one of those "why didn't I think of that?" solutions to a common N scale modeler's problem.

Les Halmos continues his fascinating roundhouse and turntable module build this issue, this time covering how to do blacktop paving.

Dr. Geoff Bunza (Micro LEDs author) returns to our pages with a fabulous piece on animating an Athearn crane. The lights and action on this model will astound you, and give you ideas on how to not only animate this crane, but tackle other animation projects as well.

Royce Brown shows how to build control panels that have a railroad CTC look to them ... great fun!

We continue the series on how to kitbash / scratchbuild a steam loco using styrene. Ken Rickman shows you more great techniques this issue! Regardless of what you're building

in styrene, the tips in this series will prove valuable.

Matt Snell kitbashes a modern Norfolk Southern GP38-3 rebuild from a GP50. True-to-form, Matt's article gives you all the details of the process, step-by-step.

The MRH website has some real gem posts on it, and this issue's Modeling the CP Sudbury Division article is an excellent example. Almost all the material for this article was harvested off the MRH website or the club's website. The resulting article shows a club layout that's one of the hobby's best!

In this issue's Reverse Running "devil's advocate" column, Joe Fugate points out how important it is to make good choices with what you focus on in the hobby. None of us have unlimited hobby time, so knowing where not to spend time is as important as what to focus on, as Joe points out.

Finally we have the MRH Product Showcase photo gallery and our usual new product news, loaded with photos and information.

We hope you'll enjoy this issue of MRH, our largest ever!

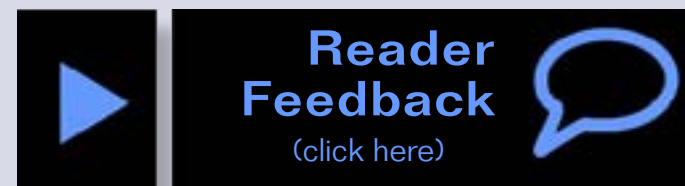

August 2012 Premium Extras!

Available to subscribers!

DVD and HD quality versions of the videos in this issue, plus ...

Also get these extras:

- Animating Athearn Crane files
- Full Grand Rails raw photo collection

Click here to access



Layout tours – Trackwork – Structures – News – Track Planning – Be – e – w
Ga
ions – New techniques – DCC – Mod-
ular modeling – Modeling water
– Road – Full – Track de-
signs – Small layouts – Weathering
– First la – Signals
– Curvature guidelines – Clickable
ad links – Video – Operation – Pro-
totype modeling – Lighting – MRH
forum – In – re – back
– Questions Answers and Tips – Up-
coming event – Tunnel lin-
ers – Building signs – Modeling the
Modern – Scen-
ery Scene – Painting equipment
– Rolling stock tuning – The Tool
Shed – Layout owner interviews –
Show floor coverage – Sta – grass
guns – Kit – LFO –
Scratch building – Highway stripes

Model Railroad Hobbyist magazine™

HAVING FUN WITH TRAINS

Subscribing MATTERS!

(even though it's free)

It helps MRH get more advertisers

Click here to
subscribe!





SO REAL... You'll Think You're There!
LokSound Select - 3 SIZES, ENDLESS POSSIBILITIES

INDUSTRY LEADING MOTOR CONTROL
4 OR 8 Ohm SPEAKERS!

- Multiples Bell types
- Multiple Brake squeals
- 4 or 6 Output functions depending on the style
- Up to 4 Primer Movers or Steam Sounds on EACH decoder
- 16 Very Playable LOUD Horns or Whistles depending on Profile
- All Changeable by using ONE CV! No Programmers or Boosters needed!*

Small Size
BIG POWER! 1.1 Amp!
LokSound Select
"4 AUX"



\$99.99

NEW 2011

LOKSOUND SELECT

Only Available From ESU LLC (USA)

ONE SIZE FITS ALL!
LokSound Select "DIRECT"



\$109.99

6 Outputs!
 LED Resistance Built In!

NEW 2011

LOKSOUND SELECT

Only Available From ESU LLC (USA)

Tiny Size,
HUGE Versatility!
LokSound Select
"MICRO"



\$99.99

NEW 2011

LOKSOUND SELECT

Only Available From ESU LLC (USA)

*ESU LokProgrammer needed to "Replace" Sound and for Firmware updates, not for normal editing

www.LokSound.com • 477 Knopp Drive Muncy, PA • 570-649-5048

Now on Facebook!



MRH

Questions, Answers and Tips

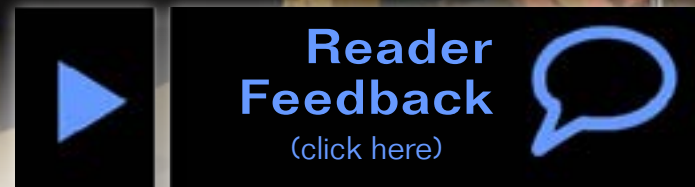

QUESTIONS AND ANSWERS

Q. I have attempted to find a book, article, DVD or anything on the proper use of the bells and horns. By proper use I mean the correct toots and clappers that you should hear at crossings, backing up, moving forward and for everything else. Can someone please direct me to the correct information?

– comicorner

A. Horn and whistle signals are covered by Rule 15 on most North American railroads. We found these in the “General Code of Operating Rules,” 1989 edition, and scanned the rule book pages so you can see them exactly as they appear. Take note of the third paragraph, on using radio instead of a whistle. The arrival of reliable two-way radios in the 1970s changed crew communication quite a bit.

If you are operating an outdoor garden railroad, have fun. If you are operating indoors, think about how much noise correct whistle signals will add to the op session and adjust the volume accordingly.

If you want your own rule book, copies of the GCOR and specific company books are available online and at swap meets. An alternative for modelers is the “Condensed Code of Operating Rules” that Steve Karas and R.S. Hamner compiled. See sample pages, and how to get a copy, at <http://rail-groupchicago.org/CCOR.html>

[See the online discussion of whistle rules at model-railroad-hobbyist.com/node/8483]

– MRH

Q. How do you block cars for a local freight? All the cars to one station together?

A. Block cars for convenience and efficiency. There are a couple questions here – what is the best order, and who does the blocking. Every conductor will have a slightly different technique. But we’ll offer some guidelines.

A yard crew will often assemble cars for a local in “station order,” placing cars right behind the locomotive

for the first areas to be switched. So a train that works from Albany to Berwind, Corydon and Denver will leave Albany with Berwind cars at the front of the train, Corydon cars in the middle and Denvers on the tail end.

If the local goes from A to B and then back to A, they might do all trailing points outwards (from A to B), then on the return trip all previous facing points become trailing points and can be worked without time-consuming run-around moves.

1 commenced sufficiently in advance to afford warning, but not less than one fourth mile before reaching crossing, if distance permits, and continuing until crossing is occupied. If distance does not permit, ringing of bell must be commenced sufficiently in advance of entering crossing to provide warning. Bell must be rung elsewhere when necessary as a warning signal.

15. REQUIRED WHISTLE SIGNALS: When visibility is impaired by weather conditions, the whistle must be sounded frequently.

In the event of whistle failure, the bell must be rung continuously while moving.

Radio may be used in place of whistle signals, except Rules 15(a), 15(l) and 15(n), to convey information.

The required whistle signals prescribed below are illustrated by “o” for short sounds and “—” for longer sounds:

SOUND	INDICATION
(a) Succession of short sounds	To be used when an emergency exists, alarm for persons or livestock on the track. When this signal is heard by crews on other trains or engines, movement must be stopped until it has been determined it is safe to proceed.
(b) —	When standing; air brakes are applied, pressure equalized.
(c) — —	Release brakes. Proceed.
(e) oo	Acknowledgment of any signal not otherwise provided for.
(f) ooo	When standing: Back. Acknowledgment of 8(c).
(g) oooo	Call for signals.
(h) — ooo	Flagman protect rear of train.
(i) ooo —	Flagman protect front of train.

19

SOUND	INDICATION
(j) — — — —	Flagman may return from west or south.
(k) — — — — —	Flagman may return from east or north.
(l) — — o —	Approaching public crossings at grade, to be commenced sufficiently in advance to afford warning, but not less than one fourth mile before reaching a crossing, if distance permits, and prolonged or repeated until crossing is occupied by engine. If distance does not permit, whistle signal must be commenced sufficiently in advance of entering crossing to provide warning.
W.P. SI SPSI P12	This signal must also be used to warn employees when view is restricted.
	EXCEPTION: This does not apply to engine when shoving cars.
(m) o —	Inspect brake system for leaks or sticking brakes.
(n) — o	When operating against the current of traffic approaching stations, junctions, railroad crossings at grade and obscure curves; or preceding the signals prescribed by 15(j) and 15(k).
	17. HEADLIGHT DISPLAY: Except as provided in Rule 17(B), the headlight must be displayed bright to the front of every train by day and by night.
	It must be extinguished when a train is stopped clear of the main track or is stopped on main track to meet a train within block system limits.

20

1: CCOR whistle rules 1 and 2.

From This:



Model Train App

To This:

www.modeltrainapp.com

Your trains and equipment... at your fingertips!

Click Here for Special Offer

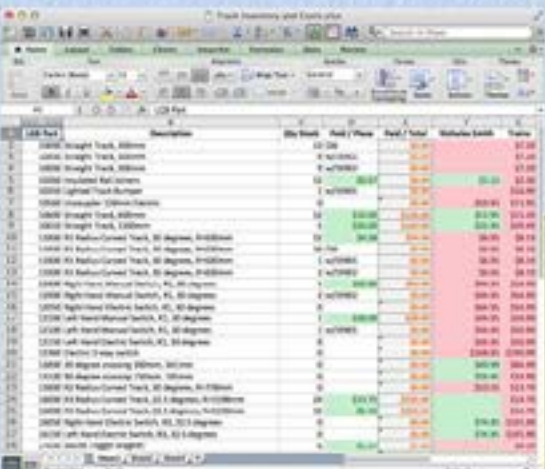
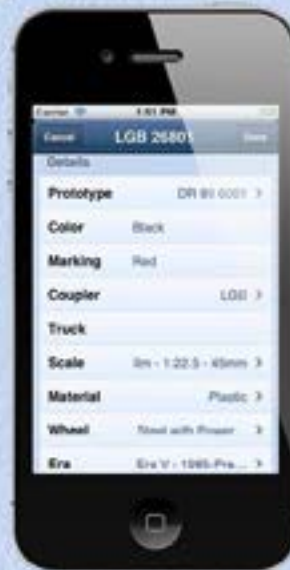

You basically want a “easy in, easy out” scenario each time you stop to do work. Having the cars to be switched placed next to the engine allows the crew to get in and out of trailing-point switches without moving the entire train every move. (Trailing points are when the engine can pull ahead on one track, throw the switch, and then reverse into another. Facing points are when the two routes are ahead of the engine.)

Having cars at the head end also improves visibility for hand/lantern signals.

Here’s an important point: When you figure out a useful sequence, make a blocking diagram showing the order of the cars from the engine back and hang it up where the yard and local crews can refer to it.

In an ideal world, the train should be blocked before it sets out along the main. Doing this work in the yard allows more time to work (other trains can use the main) and the access to multiple tracks makes it easier to sort the train. Whether the yard or local

crew does this is up to you and probably depends on who has the bigger workload, and how much space is available in the yard. On a lightly-used line, the local crew might do its sorting at a siding somewhere along the way without interfering with other trains.

What about the cars you are picking up? Often these are placed at the tail end of the train, so all of the set-outs are in their convenient spot by the engine. If the job is a turn that goes back to its originating terminal, the



2: The “W” post on the Cumbres and Toltec Scenic Railroad [link: cumbrestoltec.com] tells the engine crew they are approaching Mud Tunnel. The circular “10” sign is a speed restriction. Photo by Sharon Evans.

US & CANADA only

YES, this is a card model!

Z, N, HO

DigCom
DESIGNS
PAPERCRAFT
for today's RR modeler

High-Quality
Intermodal Card
Models you can
Show Off!

digcomdesigns@hotmail.com



Free Samples
DOWNLOAD NOW!

2012 Catalog
DOWNLOAD NOW!



GET \$25 PER TIP

We pay \$25 USD for each tip we publish. [Send your modeling tips to Model Railroad Hobbyist](#) and we'll get payment to you upon acceptance.

Just think, for only a few minutes effort, you could fund your next piece of rolling stock – or even pay for an entire train if you send in several tips and we publish them!

If you include any photos with your tip, we pay a bonus of \$10 per photo we use with the tip. ■

New Innovation

LUBRICATION FOR THE NEW MILLENNIUM...

NANO-OIL.COM

Nano Technology Lubricants



THE SHAY FIXER

VISIT US AT...

SHAYFIXER.COM 

Specializing in brass Pacific Fast Mail / United geared locomotives

"I use only the finest quality lubricants such as **Nano-Oil** ..."
-The Shay Fixer



StClaire

Made in U.S.A 

DRAMATICALLY REDUCES LOCO AMP DRAW ...

For more details click here

ADVERTISEMENT

pickups might be left on a side track to be picked up on the return trip.

These are just general principles and railroads worked out their blocking according to their own specific need. Other factors that affect the placement of cars in train are shifting loads and cars carrying hazardous materials.

We can take these up in a future QAT and invite people to share too.

Thanks to Erik Wejryd, Olav M., Mike Ruby, Steve, Chris, Mark Pierce, NJ Devils Fan, and Charlie Comstock for the extended blocking discussion at mrhmag.com/node/866. - MRH

Q. What are the basic pros and cons of weathered flex track and or

non-weathered track? Is there any down side to using weathered track? Is it worth the added cost to avoid hand-painting the rails?

A. The only weathered flex track on the HO market in recent years comes from Micro Engineering, which uses a chemical process. The weathering makes the rail "sticky" in the plastic tie strip and many people find it pretty annoying to install. If you have a low tolerance for painstaking adjustments, it's not for you.

Should you buy unweathered track and paint it before installation, the same issue applies. The paint makes it harder to flex the rail, the paint is likely to chip off, and the little plastic spike heads on the tie strip can leave bright dots on the

side of the rail, forcing you to do some tedious touching up.

As far as weathering installed track in place, Jeff Shultz points out, "The cons are simple -- you slip and you've got a mess to clean up in order to get electrical conductivity back. And maybe a big brown splotch on your ballast that you really didn't want there. The pros - it looks good when done right."

Our club's resident track painting artist uses a flat brush, not a pointed one, to paint rail and the process goes pretty quickly. The flat holds more paint than a pointed brush and when used on edge, lays down a fine line. - MRH

Q. I plan to build a number of undecorated cars. The decals I have are

just a series of numbers from 0 to 9. My fear is that getting the numbers straight and vertical will be difficult. Should I use a tape to help line things up? Is there an easier way to do it?

A. Terry Roberts, who has been building freight cars since they had stone wheels, advises using a straight edge to cut the numbers from the full sheet. This gives a reference for positioning the decals both side-by-side, and top-to-bottom. Using two adjacent numbers from the sheet can save time. Some decal sheets have random numbers so this can be done more often.

Taping or clamping a straight edge to the car can help alignment. Tape can help on a rounded body like a covered

hopper or tank car, but don't put the tape right on the line where the lettering goes. Just give yourself a reference line for spacing.

Some people can simply eyeball car numbers. Whole road names can be done a letter at a time if your eyes are good. It's not that hard, although it can be tedious. Look for rivet lines or the edge of the car body for reference.

Ken Rickman says, "In extremely cramped quarters (Spelling out SOUTHERN in 4" letters on a steam loco cab, for example) I have been known to apply alternate letters, or the first, last, and center letter, in order to both get the spacing and position correct and let one letter dry a little before putting the next one down."

"For complex things like a curved word," Ken says, "I make a pattern out of paper, laminated with packing tape, and cut holes where the letters go, then tape it to one side of the car so that I can flip it back and forth."

"Even if the number isn't exactly straight, who cares?" Ken asks. "If it looks right to your eyes on the work bench, then it will look right to your eyes later on the layout."

— MRH



TIPS

Here's a simple idea for making a custom hex driver. While it won't last forever, it's cheap and easy to re-make, and will work well when working on a project on a Sunday afternoon.

Cut a 1/2" length of styrene tube that is about the same size as the hex head you want to make a socket for. Also cut a piece of tube the next size larger, and glue them together.

When the glue dries, glue them into a hole in the end of a wooden dowel. Alternately, you could leave either tube long, and use that as a handle or mount into a pin vice. The point is simply to make a convenient handle.

Take a brass hex head screw of the size you want a driver for, and insert it into a hole in a block of wood. A washer may help to hold the screw steady, and the hole should be a fairly tight slip fit on the threads of the screw, so that it will stay perpendicular to the surface of the wood.

Heat the head with a soldering iron for a few seconds, and press the styrene tubes straight down on the hot brass. With a little care, the styrene

3: Using the head of a brass screw as a pattern makes the styrene socket a perfect fit. You can see where the styrene has melted in forming itself.

Photo by Ken Rickman.



4: The completed custom hex driver tool, ready for use. If you make more than one size, it helps to label them. This one is for a 0-80 screw.

Photo by Ken Rickman.



will take a perfect impression of the hex head, which will be a nice tight fit for use as a driver. Clean up the end with files or sandpaper if necessary.

When the hole becomes worn, simply repeat the process to renew the socket. If you're careful not to get

things too hot, you can make a custom driver for any screw which is already on a model.

— Ken Rickman

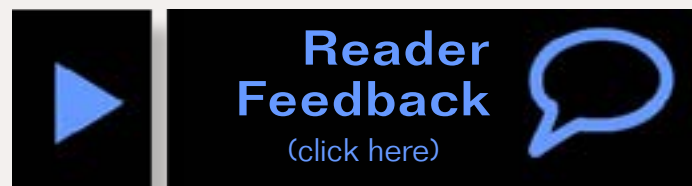

About our DCC columnist



Bruce Petrarca is a well-known expert on all things DCC.

[Click here](#) to learn more about Bruce.

DCC Impulses: How Do I Get the Sound Out?

Your Guide to Efficient Sound Installations

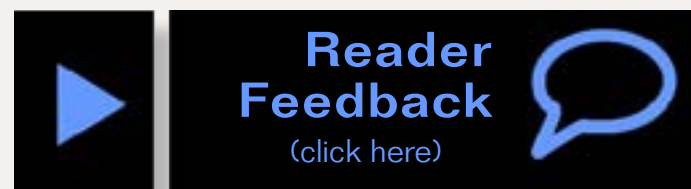

Getting your money's worth out of your loco ...

When I began doing DCC sound installations over a decade ago, I drew on what I learned in school, in physics class and in the process of designing speakers for my stereo. I didn't have the money to buy a set of speakers, so I designed my own when I was in high school.

The best enclosure for a speaker is an infinitely large board with the speaker

in the middle. There is no "box" to color the sound or reduce the efficiency of the speaker.

If you can't make the board infinite, the next best thing is to make it large enough so that the sound traveling around the edge is out of phase and won't cancel the sound coming off the other side. See the sidebar on page 28.

The speakers that will fit in HO locos only require about 8 inches of total path length to keep the sound from canceling.

Knowing this, and not having a large variety of boxes (enclosures) on the market back then, I began installing

speakers in the hoods of diesels as shown in 1.

This loco got the full treatment, including LED lighting. The loco was disassembled and the weight was machined flat down to the top of the motor to provide room for the decoder and the speaker.

In this installation, the sound from the cone of the speaker goes up through the fan grilles. Life-Like very nicely covered the fan grilles near the cab (round black plastic pieces in the roof of the shell), so the sound from the magnet side of the speaker cannot wrap around using that short path.

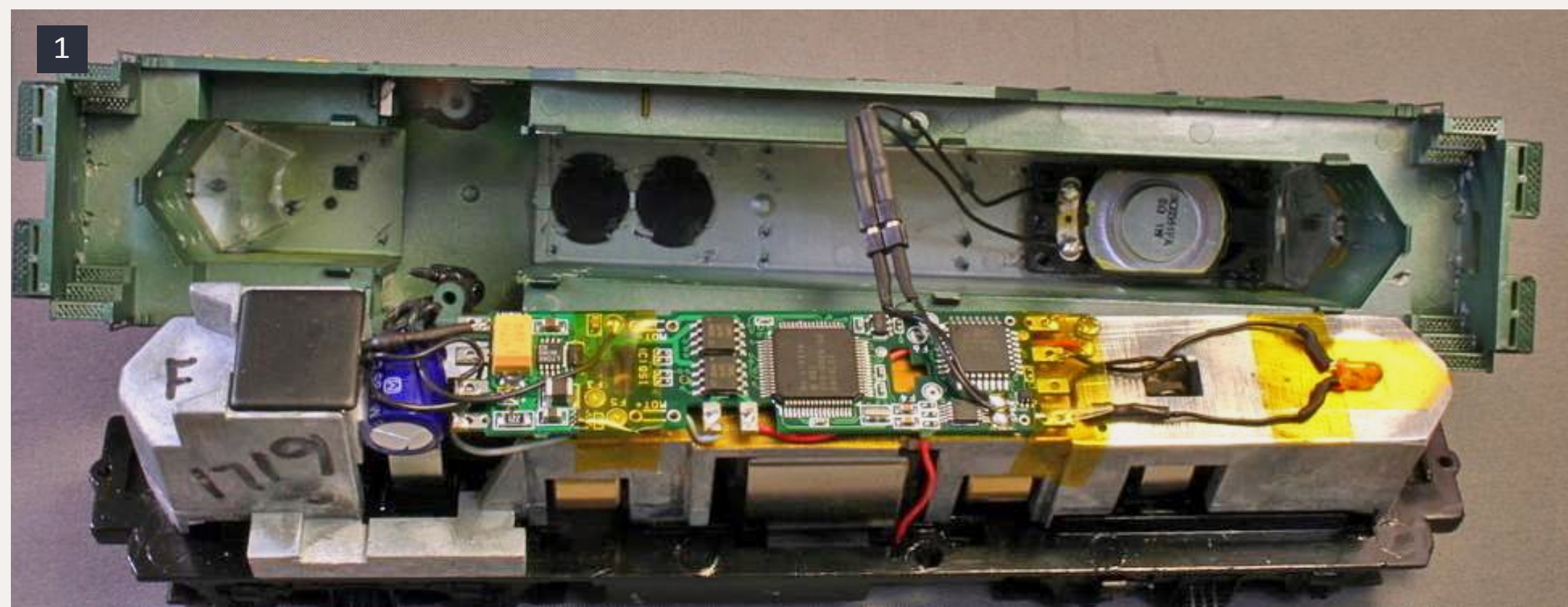

1: Life-Like Proto 2000 GP9 with the speaker firing out through the fan grille.

The close clearance between the weight and the shell for the back ¾ of the loco forces the sound from the magnet side of the speaker to travel all the way to the front truck opening to get out. By the time it travels back to where the speaker is located, it has traveled at least 12 inches, so it won't cancel the sound coming out through the grills.

I didn't consider this "thinking outside the box" was unique until I started getting requests for installations from all over the world, as far away as India.

I asked a fella from South Carolina, when he booked the installation, why he was sending his locos to me in Arizona. He said that he had a friend who had a loco that I had put sound in. That loco sounded so much better than the rest of his fleet that the friend's wife, sitting downstairs in the

living room, could tell when he was running "my" loco upstairs on the layout.

This led me to realize that I was doing something that few other installers were doing: working outside the box!

I started demonstrating this technique at clinics around Arizona and all the way to several NMRA national conventions. I found folks were amazed.

I did have an attendee at one of the national conventions come up to me and say, "I did sound for years for Bob Seeger. I know that the physical concepts you discuss are correct. I just never thought of applying them to my models before. Thanks."

That's why I am writing this column and why I developed the accompanying video. You might want to stop now and watch the video before you read on (see video below).



This month's SMP, on page 29, will deal with how to connect more than one speaker to a sound decoder.

Some terminology

A cross section of a speaker with the parts labeled is shown in 2. While this details many internals of a speaker, for this column the major items of concern are the magnet, the cone and the frame.

Seeing this cross sectional diagram should help you understand how, when the speaker moves back and forth, it compresses air on the side that the cone is moving toward. For more technical details, see the sidebar on page 28.

In this column, I'm going to refer to a sound wave generated on the cone side of the speaker as positive pressure and that from the magnet side as negative pressure.

Yes, sound comes off both sides of the speaker and, no, it doesn't matter which side of the speaker faces the listener.

Side note on bass

The name for low frequency sound is pronounced like a piece of sports equipment (base) and spelled like a fish (bass). Don't ask me why, I'm just the messenger.

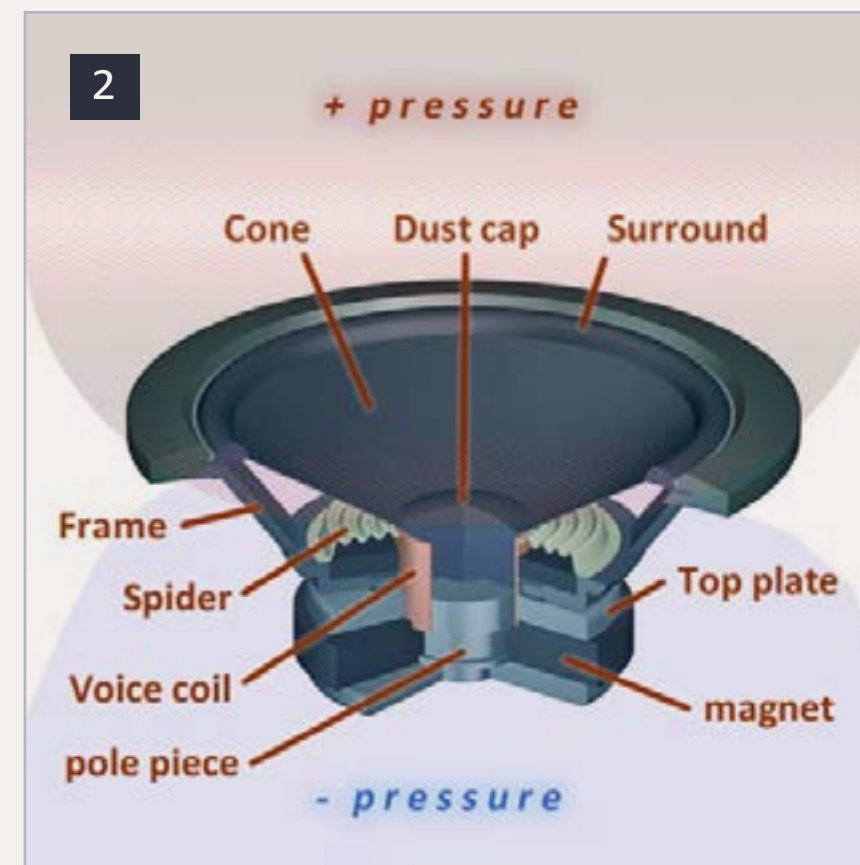

2: Speaker Cross-section with parts labeled – adapted from Wikipedia.

An efficient speaker system

The more efficient you make the acoustic design (the speaker system) the better the final sound will be. The amplifier won't be as taxed and the subtle nuances of the sound will be more evident with an efficient system.

The examples I'll use will be for HO scale, as that is a very popular scale and the smallest scale where truly good sound can be consistently reproduced, in my opinion.

However, these principles will apply in all scales. Acoustic design principles are universal.

Physics are in control

“Nothing beats cubic inches” was the motto of drag racers in the 1960s. That is true in speakers, too. We can tweak a bit, but, in general, the bigger the speaker, the better the sound.

You will get proportionally weaker sound with less bass when you don't have the room for larger speakers.

Reproducing bass, like diesel rumble, requires moving a lot of air, which means a large speaker with a lot of cone movement.

The best laid plans ...

The first step is planning. This can range from fairly trivial to extremely complex. If you fail to plan, then you plan to fail.

How I plan for sound

1) I select a decoder with adequate motor and light power and the correct sound set for my loco. My budget for money and available space are part of the selection criteria.

2) Next, I look for the largest speaker(s) that I can fit into the loco with a minimum of modification to the loco. Here is where I make the decision “box or no box?”

3) Finally, I look at the lighting. Can I use the original lights? Should I replace them with LEDs? Do I want to add lights (like a strobe) or split functions (marker lights or ditch lights on separate functions from the head-light)? Does the decoder I selected in #1 have enough function outputs for the lights I've planned?



3: SoundTraxx Tsunami aftermarket installation in an Atlas SD-35 designed for sound.



HO F7 A/B DIESEL SETS

AB, Single A and Single B Units Now In-Stock At Your Local Dealer

Choose from:

- Sound-equipped versions with built-in DCC decoder
- DCC-ready versions awaiting your preferred decoder



80-2114-1 Santa Fe F-7 A/B Set With Proto-Sound 3.0

Featuring:

- 2 Cab Figures
- LED lighting
- Powerful 5-pole 12-volt DC motor
- Available In **FIVE** Different Roadnames
- 28 DCC Functions*
- Kadee® Couplers
- Remotely Operated HO Scale Proto-Couplers*
- RP-25 Metal Wheels Mounted on Metal Axles
- Lighted Cab Interior
- Illuminated Number Boards
- Lighted Marker Lamps
- Locomotive Speed Control in Scale MPH Increments*
- Operates On Code 70, 83 & 100 Rail Curves

* Proto-Sound 3.0 Equipped Models Only

M.T.H.
ELECTRIC TRAINS™
HO TRAINS THAT DO MORE
www.mthHOtrains.com

Follow Us
Online!



You



See why
M.T.H. HO Locomotives
Do More



©2012 M.T.H. Electric Trains

Frequently #2 changes the space budget and may change the decisions in #1 and #3. Yes, this can be a long and repetitive process, not unlike designing a track plan for your layout. Both projects are full of compromises and accommodations.

If you know of a similar loco that has sound that fits your desires, find out how that installation was done. Don't reinvent the wheel!

The speaker alone

The sound coming from a speaker just sitting in the air without an enclosure or baffle will not be very satisfying, as you can hear on the video.

Acoustic path

The sound must get from the speaker to the listeners' ears. Sound travels in waves, like ripples on a pond. There must be a clear path from the speaker to the ear.

Since most of us are above our locos as they are running on the layout, an acoustic path from the speaker out the top of the loco to our ears is functionally the best.

I saw a loco where the owner cut a hole in the top of an oil tender and used 2-56 machine screws to bolt the speaker outside the top of the tender with the magnet inside the tender and the cone facing out. The result wasn't pretty but it had a great path to the listeners' ears.

The opposite case came several years ago from a customer who complained

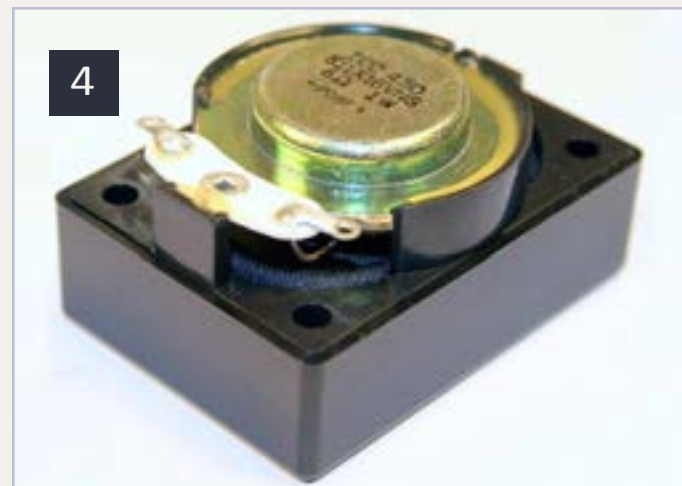

4: 28 x 40 mm speaker in a machined enclosure – The Box.

about the sound level after he installed a decoder in his Bachmann Consolidation, "just like the example on your web site." I suggested that he send the loco to me for programming. When it arrived, I discovered that it needed more than just having a few CVs adjusted. He hadn't done the installation at all like my web site example. I found the speaker floating freely inside the tender box (no baffle or enclosure) with no provision (holes) for the sound to come out of the tender. Yup, you had to put your ear against the tender shell to hear the loco sounds. I reworked it similarly to the Bachmann Consolidation example on page 24.

The box

Let's start out with some examples of installations that use an enclosure or box.

One way to eliminate the cancellation is to use a machined or molded enclosure that snaps over a speaker, as shown in 4. To my ear, the box

TAM VALLEY DEPOT

Great Electronics for Great Model Railroads

Frog Juicers Automatic Frog Polarity Servo Drivers for Turnouts and Semaphores

ADVERTISEMENT

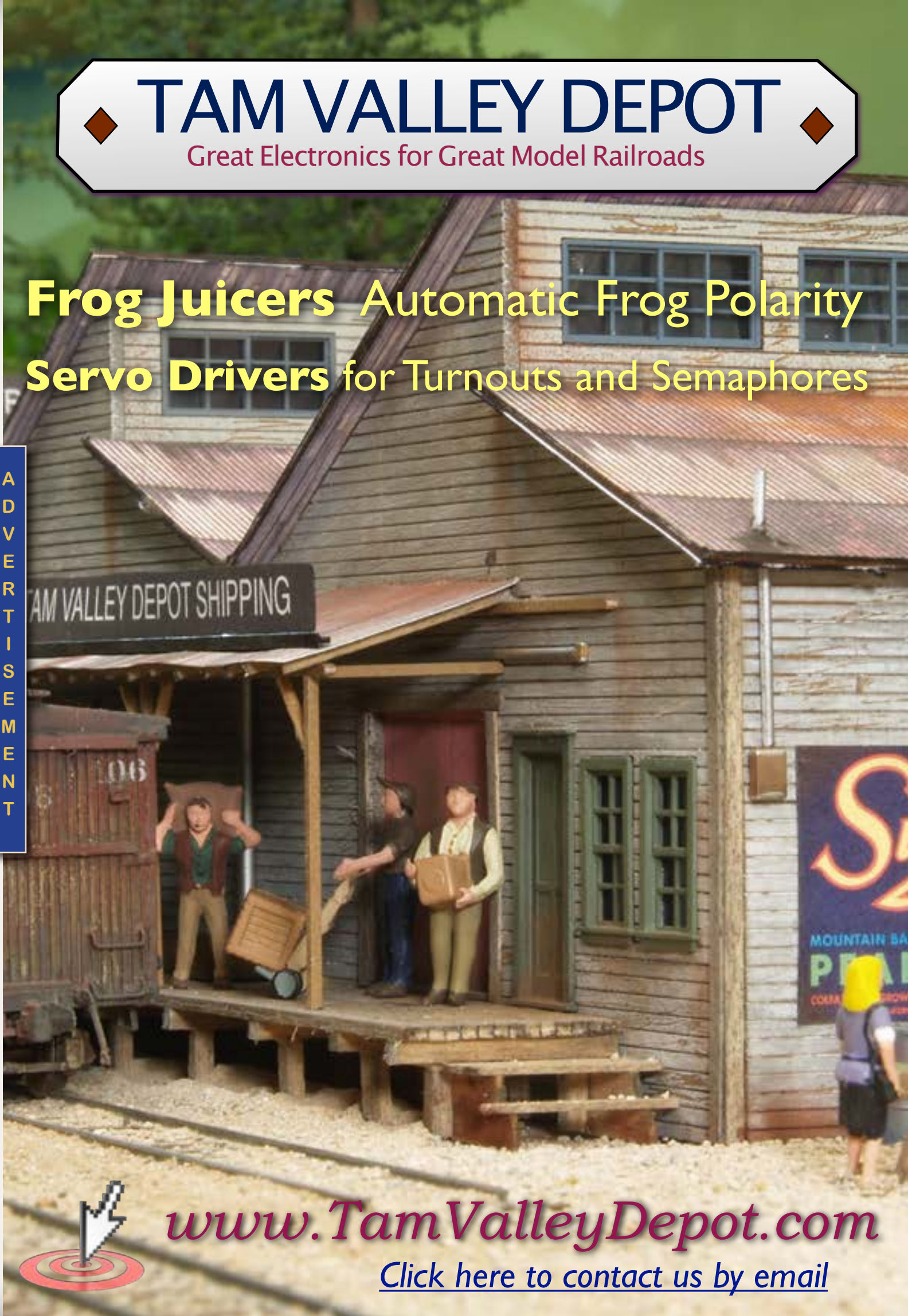

www.TamValleyDepot.com

[Click here to contact us by email](mailto:info@tamvalleydepot.com)

reduces and colors the sound when compared with the speaker in a baffle. Check out the comparison on the video and see if you don't agree.

Most steam loco installations fit this style, as they use the tender shell as a big box. The larger the box, the less it colors the sound. I like to install the speaker under the coal or wood load. That way, the sound can be channeled upward toward the listeners' ears.

Let's look at a typical example:

Bachmann Consolidation

Here is how I did it in a Bachmann Consolidation. Follow along with my discussion with figures 5, 6 and 7.

Firstly, I mounted the speaker (a 28 x 40 mm unit) in the area below the coal load. This is shown in 5. A few bits of styrene were necessary to complete the "sound board" acoustically separating the magnet side from the cone side. I mounted the speaker magnet side up to take advantage of the shape of Bachmann's plastic coal load.

The area on the cone side of the speaker is open into the main tender shell. You can't see this detail in 5, as it is below the speaker on the cone side.

Next, I drilled about a hundred holes in the coal load. I used a #70 drill in my motor tool and randomly drilled from the inside out. That is the trick! If you drill from the outside in, the drill will always be in the bottom of the molded coal features and be very

predictable. By drilling inside out, the resulting changes to the molded coal are more random. The coal load (after the drilling) is shown backlit in 6 to reveal the many holes that give the sound a path to the listeners' ears.

The final installation of the coal load into the tender is shown in 7. I used a bit of caulk to hold it in place – easily

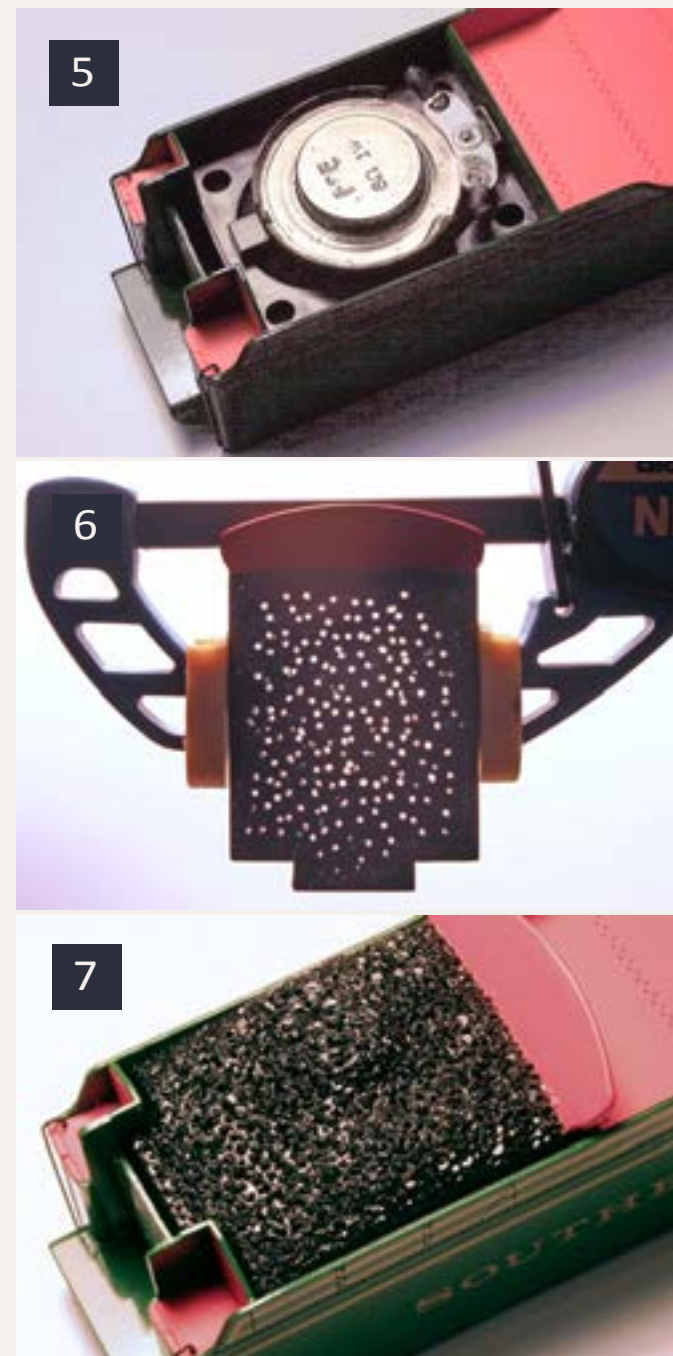

5-7: Details of a sound installation in an HO Bachmann Consolidation.

removed if necessary. The holes are almost invisible.

Brass diesels

One of the best ways to get the sound out of brass diesel locos that have lots of open fan grilles is to use a box. I have installed enclosed speakers inside many of these locos, allowing the sound to make its way out the many openings in the brass shell.

This is one place where I find that spending the extra money and purchasing a manufactured enclosure (as shown in 4) or an enclosed speaker is the best use of time and resources.

Thinking outside the box

Okay, but let's get to the basis of this column, thinking outside of the box: building a speaker baffle, not an enclosure.

There are a few things that will allow the sound out without having the positive and negative pressure waves cancel.

Route positive pressure one direction and negative pressure another. For example, positive pressure goes up through the fan grilles and the negative pressure goes down through the loco and out the front truck, as shown in 1.

An alternative method is shown in 8. The speaker was cantilevered off the rear of the weight of this Atlas GP-7. Then I cut some plastic pieces to bridge between the speaker and the loco frame on both sides and the rear

of the speaker. This routes the positive pressure out the rear truck and leaves the negative pressure to find its way through the loco to the front truck area before it exits.

To avoid cancellation, the shortest trip that the sound can make between the cone side and the magnet side of the speaker should be at least 8 inches (8).

Direct high frequencies up by routing the sound from one side of the speaker out the top of the loco or tender, if possible.

Seal around the speaker. What does this mean? I use caulk to adhere speakers to the shell or plastic parts that make up the baffle. I use styrene cement to assemble plastic parts into baffles or sound boards to route the pressure waves where I want them. This is a bit like a megaphone in some cases.

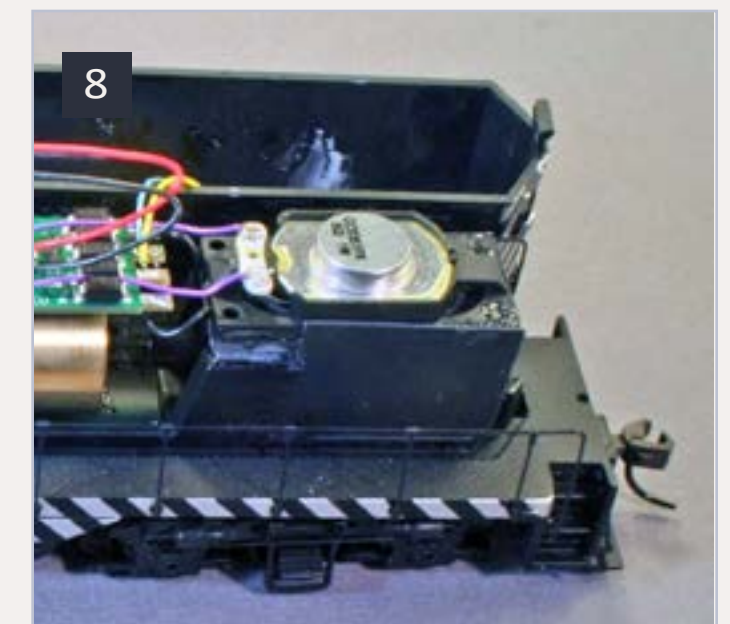

8: Atlas GP7 with the speaker over the rear truck.

Where speakers are cantilevered, as seen in 8 and 9, I mount them as close as possible to the shell. I use caulk to adhere them to the frame. I know some folks who have used foam weather strip to enhance the seal between the speaker and the shell. Personally, I find this makes the loco too difficult to open and close. I will, however use plastic to extend the edges of the speaker down to the frame, as shown in 8.

Warning, don't get caulk or any adhesive on the cone or the surround of the speaker. It will reduce or eliminate the sound from the speaker.

Atlas' sound design

The Atlas factory sound design, as shown in 3, on page 22, utilizes the "out of the box" concept. The positive pressure from the speakers is forced

out near the front truck. The negative pressure makes the long trip to the rear truck and out.

Kato SD45

Another example of a way to get the sound out when there are no open fan grills in a diesel shell, still thinking outside the box, is shown in 9.

In this case, I cantilevered a 16 x 35 mm speaker over the rear truck. I positioned it as far back as possible in the shell. The speaker is held down with caulk.

Photo 9 was taken before styrene pieces, as shown in 8, were added to enhance the sound. This enhancement is especially noticeable before the shell is in place.

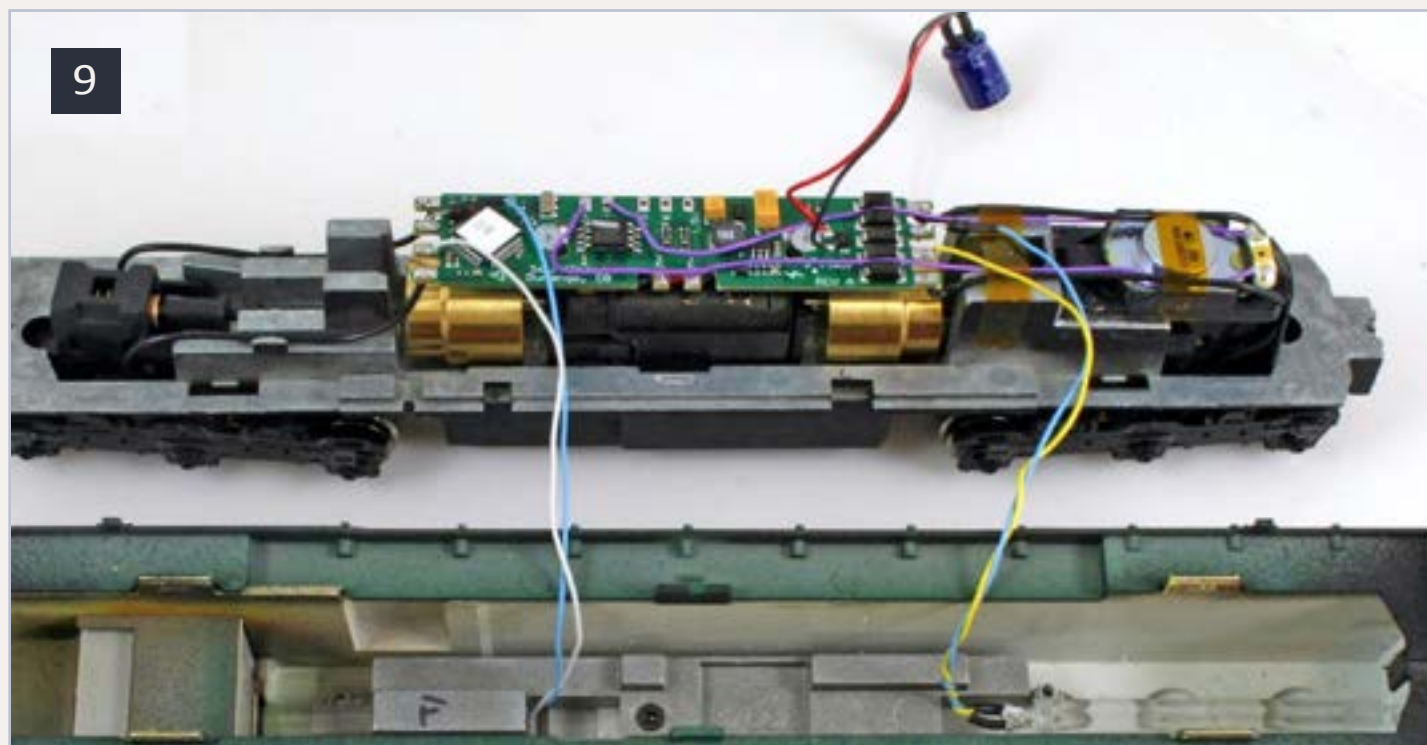

9: Kato SD-45 with the speaker cantilevered over the rear truck.



WOW!

ANIMATED LIGHT WORKS USA
BY MILLER ENGINEERING
NEON BILLBOARDS
NEON SIGNS, ANIMATED SIGNS & BILLBOARDS

ADVERTISEMENT



**Reddy
Kilowatt**



Texaco



Budweiser



**OK Used
Cars**

**Click
each
sign to
see it in
action!**



**Also see our other neon
sign offerings ...**

Click for more - lots more!

Bose Wave Radio

Just a side point here, the acoustic design of the Bose Wave Radio is arguably one of the most efficient and best bass reproducing systems in the world for its size.

How do they do it? Basically the same way I'm suggesting. They just have the advantage of knowing their speakers very well and being able to design the path to the outside world consistently so that they can actually phase the bass frequencies to add, not just "not cancel".

Speaker selection

Okay, what should you look for in a speaker? I spent years at Litchfield Station searching for the best

speakers I could find in a given size. Every speaker type I sold was tested for performance and consistency. If you have a dealer that is that committed to helping your sound installation projects, then they deserve your financial support.

I have seen folks buy inexpensive noisemakers, masquerading as speakers and then not know why their installation doesn't sound good. \$100 for a decoder, but only \$1.49 for a "speaker" doesn't make sense to me.

Buy quality product from a reputable dealer. Good speakers cost about \$10 or less. Don't scrimp.

Here are important specifications to look for when selecting speakers.

10

DECODER	IMPEDANCE
Digitrax	8 - 32 ohms
LokSound Select	4 - 8 ohms
LokSound V3.5	100 ohms
LokSound V4.0	4 - 8 ohms
SoundTraxx Older	8 ohms
SoundTraxx Tsunami	4 - 16 ohms

10: Impedance table.

ADVERTISEMENT

Watch our website for our monthly specials!

Free Shipping on all US WEB orders over \$100.



ACCU-LITES, inc

Your DCC Center!

CLICK TO LEARN MORE:

<http://www.acculites.com>

New ACCU-LITES exclusive!

Tortoise SNAPS 8-position block wiring quick connect socket



Authorized Dealer for: Digitrax, NCE, Soundtraxx, TCS and others.

Get Better Sound from your Locomotives

Can't get good sound from your sound decoder? Give our speakers a test drive with your ears.

We offer high quality speakers to enhance your model railroad experience

Dealer inquiries welcomed



RAILMASTER HOBBIES

9815 WALNUT ST #106

BELLFLOWER, CA 90706

562-867-5627

WWW.RAILMASTERHOBBIES.COM

SALES@RAILMASTERHOBBIES.COM

ADVERTISEMENT

Bass Reflex Speakers



High Bass Speakers



When it comes to speakers we have high quality speakers to fit many different applications. We are also a full line hobby shop. Need anything? We are an authorized dealer for Soundtraxx, Digitrax, Athearn, Walthers and many others. We provide quality speakers for your DCC sound systems and quality service.

11



11: A 27 mm high-bass speaker.

Size – The speaker(s) must fit your plan. Buy from dealers who tell you all the dimensions before you buy.

Ohms – Your decoder will be looking for a specific load impedance. This

table shows the target load impedances for several different decoders. See the SMP on page 29 for details on how to wire multiple speakers (10).

Watts – The wattage rating for a speaker is the maximum that the speaker is designed to withstand. Yes, folks frequently use speakers with lower wattage ratings than the decoder driving them. Why? Because they want a specific size and can only get that size in the lower rating. They are asking for trouble. Most HO and smaller decoders put out one watt. A few are rated up to two watts. I look for speakers that are rated 1-watt at a minimum.

High-Bass – This is a name applied to a style of speaker that is gaining

popularity amongst model railroaders. They use a very soft surround and a metal cone to get enough cone movement to reproduce an extra octave of bass over similarly sized conventional speakers. An example is shown in 11. For those of you who aren't musicians, an octave is twice as much; say extending the cutoff from 400 Hz to 200 Hz. No, this extra sound is not free; they are physically much deeper than their conventional counterparts. If you have the depth available, they will generally give you the best sound possible.

Frequently, the larger cone excursion necessary to achieve the better bass response also allows the speaker to handle more power (higher wattage

rating). The cone of some high-bass speakers actually comes forward beyond the mounting ring by up to 0.02 inches on peaks. Take care when mounting such speakers to provide for this throw.

My web site has an entire page devoted to speaker selection and wiring: mrdccu.com/curriculum/speakers.htm.

Polarity

Some speakers and decoders have polarity markings (a + sign or color dot). These raise a question with modelers as to what they do with them. With a single speaker installation, don't even think about them.

They don't matter to you. If you are doing a multiple speaker installation, they matter. I cover that in this month's SMP, on page 29.

Design the Install

Just to recap, here are the items to consider, when thinking "out of the box":

Go large in speaker size and use a high-bass style speaker if you can fit it.

Match the speaker impedance to what the decoder wants.

Use the speaker, the locomotive internals and plastic to separate the positive and negative pressure waves and route them out so that the total path from one side of the speaker to the other is 8 or more inches.

Consider the sound path from the speaker to your listeners' ears. Make it as direct as possible with a minimum of obstructions.

Seal the speaker to the mounting with caulk. Why caulk? It is easy to remove if the speaker fails or you decide to change the design later.

Why do I talk mm?

Most of the speakers available for our hobby come from the notebook and tablet computer industry. They are almost exclusively made in China, where technical references are metric. The most accurate way of referring to a speaker size is in

millimeters. Get a set of calipers that measure in millimeters and you've got it covered.

More examples

My web site has lots of examples of various installations, some "out of the box" and some using enclosures in different scales. Go to mrdccu.com/install and navigate from there.

Until next month

Have fun experimenting with these concepts. Watch the video again, perhaps.

Use the Reader Feedback link to vote for this column and to discuss what you find in it. I hope you rate it "awesome"...

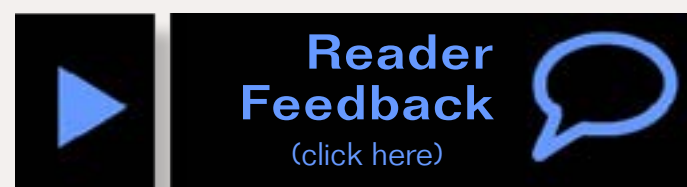

Sound Waves and Phase

Let's look at phase and cancellation in a simplistic way. You don't need to know this to apply the principles of this column, but inquiring minds want to know.

Sound is pressure waves, as noted in the column. They travel with a speed that varies depending upon what medium they are in: air, water, etc.

The sound waves coming off opposite sides of a speaker are out of phase with each other (180°). When the cone is moving away from the magnet, it is generating positive pressure in front of it and negative pressure behind it.

If these waves are allowed to interact with each other immediately, they cancel out. This is a speaker in free air with no baffle or enclosure.

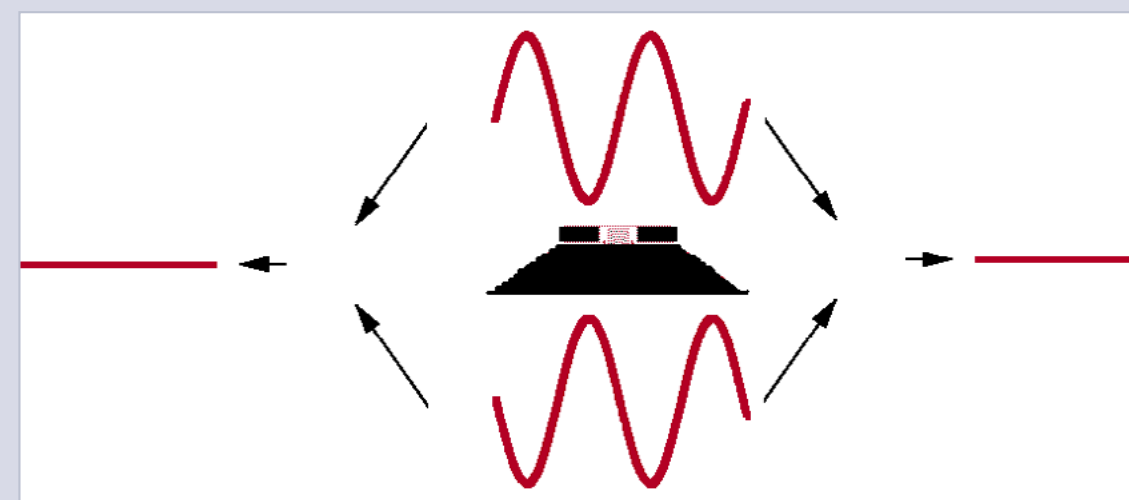

However, if either wave is delayed before they are allowed to mix, they won't cancel. This delay occurs when they are forced to travel a distance related to the wavelength of the lowest frequency to be reproduced.

In the Bose Wave Radio discussed in this column, the path length is selected so that very low bass arrives at the front of the radio at the same time. This way, the waves actually add to each other. ■

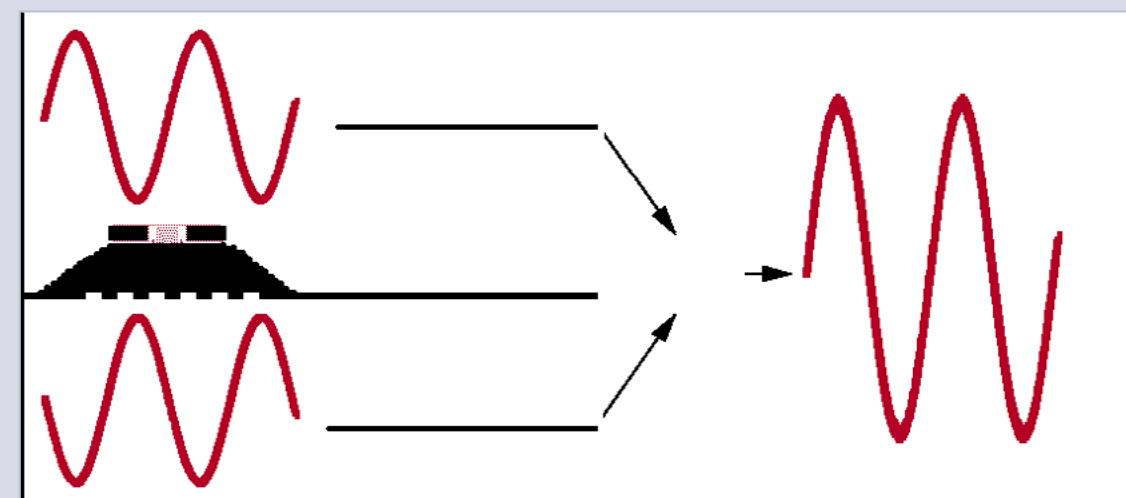

SMP* from Mr. DCC – How do I connect multiple speakers to my decoder safely?

Once you know the impedance your decoder wants to see, you can design a multiple speaker installation to provide that value. The table on page 26, shows the impedance range for many decoders. Our challenge is to connect multiple speakers and be within that range.

12



12: A series-parallel wiring of four speakers.

Since it is the most popular range, I'll show you how to create an 8 to 16 ohm load for the decoder when wiring multiple speakers!

Two speakers

To connect two speakers, select identical 4- or 8-ohm speakers. Mount them side by side or across from each other in an "A" frame, if your loco has one. Wire them in series aiding. That means that you connect the positive lead of one speaker to the negative lead of the other and then connect the remaining two terminals to the decoder, through a coupling capacitor, if required for your decoder (usually older decoders). The capacitor can be connected instead of the wire between the two speakers, if that is more convenient.

If your speakers are not marked with a polarity mark, you can physically

13

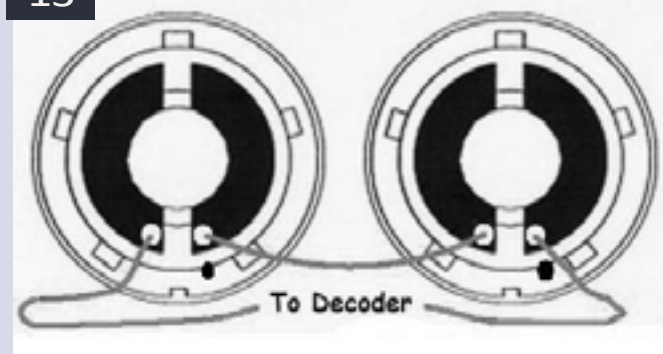

13: Two identical speakers wired in series aiding – the effective impedance is twice that of each speaker individually.

line them up together and mark the terminal on the same side of each of them, as shown in 12.

Two 4-ohm speakers wired in series will give an 8-ohm load when wired this way. Two 8-ohm speakers will provide a 16-ohm load.

Four speakers

Four speakers are easy, too. If you have the room this is a fantastic installation. Mount four identical

14

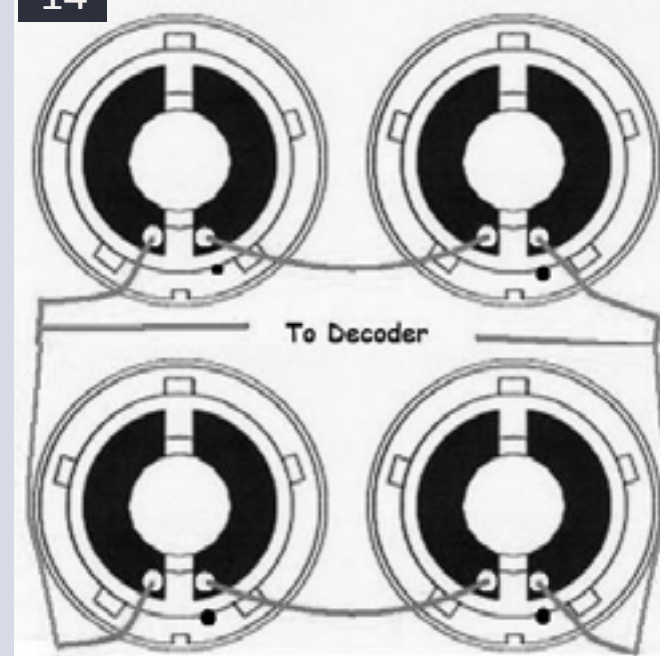

14: Four identical speakers wired in series-parallel – the effective impedance is exactly that of each speaker individually.

speakers in a line (as in 12) or a 2 x 2 array (as in 13). Wire two sets of 8-ohm speakers in series aiding, as discussed previously. Then you connect the two series sets in parallel. See 14. This provides the desired 8-ohm load.

A four-speaker inline arrangement is shown in 12. It uses 27 mm (1.1 inch) high-bass speakers. They are mounted on a styrene soundboard ready for use in an O-scale F3A under the fan grills.

Three speakers

Three speakers are only practical when you have 4-ohm speakers available. Wire the three 4-ohm speakers in series, just as shown for two speakers above. The resulting impedance is 12 ohms.

Now that you have used the polarity marks to connect the speakers together so that they won't cancel each other, you needn't worry about which wire goes to the terminal marked "speaker +" on the decoder. It doesn't matter.

* SMP comes from the Amtrak world and is short for Standard Maintenance Procedure. ■

ADVERTISEMENT

Your Local
Online
HO & N
Scale Hobby
Shops

575-523-9743
fiferhobby.com
fiferhobbyho.com



Digitrax[®]
Complete Train Control

\$225.00 MSRP

Introducing

ZEPHYR *xtra*

XTRA FEATURES

• 29 Functions • 20 Addresses & Throttles • Recall

XTRA POWER

• 3 Amps • Blast Programming for Sound



Click here to find out more >

COMME-N-TARY: Safe Traveling for N Scale Passengers

Modeling in the hobby's most eNgaging scale

About our
N-scale columnist



David L. Salsbery is our guest N scale columnist.

A Portland, Oregon native, David's been modeling trains since he was 12.

David got more serious in the '90s when he discovered N scale. After building some small layouts, David discovered modular and club railroading. His current Stevens Pass oNetrak layout models the Great Northern.

David owns his own painting contracting business.

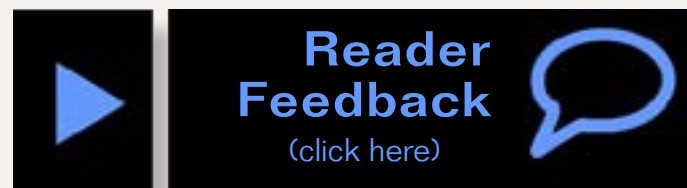

Minimize the risk of damage to your N scale equipment when transporting it ...

This N-scale rolling stock is traveling in a foam lined, lightweight, durable plastic case (1). These cases are manufactured by Dosko Sport, Gun Guard and others for safely transporting rifles and hand-guns (2). Since the cases carry fire-arms they may also be locked. Some heavier cases have locks built in, but the lightweight plastic cases provide holes for adding your own locks. These work excellently for safely transporting model trains to shows, clubs and other locations without damage (3 next page).

Most cases I found have egg carton shaped foam cushions to carry guns. This is great for guns but not so great for trains, however the cushions are smooth on the other side. Reversing the cushions in the case creates a smooth surface on both sides of the case which is almost perfect for using them to transport model trains (4 next page).



1: Lightweight, durable plastic case with foam lining.



2: Single rifle 'Gun Guard' case in front of two rifle 'DoskoSport' case.

The first few times I used the cases there was some movement of the rolling stock which caused some details to snag and break off. To remedy this problem I added some extra foam strips to create channels or barriers to keep the rolling stock from sliding around. This worked great ! I found some foam pads made with the same

type of foam as was in the cases, at my local general merchandise store. They had several sizes and thickness. I even found the same color. I purchased a piece of foam one inch thick and 24 x 48 inches. Since these were sold in 'sheet' material, I would have to cut it for my purpose. Scissors did not work well to make straight



3: Open two rifle DoskoSport case with about 100 N scale cars.



4: Egg carton shape foam and smooth reverse side.



5: Foam strips test-fitted before gluing.

clean cuts so I used a razor knife and a metal straight edge. I found that "squishing" down the foam when cutting it with the blade made a lot cleaner cut.

I first laid down a piece of plywood to cut on. This keeps the razor knife sharp longer and protects the work area from the knife. Then I used the straight edge to flatten the foam to make clean, straight cuts with the razor knife. My straight edge is a 48-inch metal ruler found in the hardware section of many home improvement stores. The strips that I cut are about a half an inch square.

I laid out some rolling stock and the foam strips to plan out where I wanted to glue the strips (5). Woodland Scenics 'Foam Tack Glue' is what I used to fasten the strips to the base foam. Using my straight edge as a guide, I squeezed out a line of glue, then stuck the foam to it. I allowed the glue to dry overnight. The foam strips are narrower than the rolling stock so that the top foam touches the up side of the rolling stock, keeping them from sliding sideways when the case is closed, while the newly added strips keep the rolling stock from sliding up and down (6 next page).

This method was not enough protection for some early era TOFC (trailer on flat car) cars in my fleet that have some delicate details. I built a special case for these with wider foam strips so the top foam does NOT touch the upside of the cars when the case is closed. The 1 inch foam worked great for this. I glued the strips in as before,

then added dividers to make compartments for each car with short pieces of foam glued on the bottom and the ends. I included some compartments for empty flat cars. A small block of foam is used to keep them from moving and protect the details from breaking off (8).



6

6: End view shows rolling stock sticks up above foam strips.



7

7: This shows the individual compartments for the TOFC case.



Beat the Heat

with

Our Cool

**DCC Model
Train Products**

and

**Professional
Installation!**



A
D
V
E
R
T
I
S
E
M
E
N
T

www.Mr-DCC.com

623-298-7355

1-(888)-395-3976

The single rifle 'Gun Guard' cases also make great train cases. I use a 10" x 48" case to hold two full train sets, head end cars, and several locomotives. These cases have a clean, rectangular shape, can hold many cars, and are still pretty compact. Most of this case is usable space. I like these cases because they have a clean rectangle shape, hold many cars but are still pretty compact (9).

There are many different size cases. A medium size two layer 12x16 case is mostly used to transport locomotives. There are also pistol cases that do not

hold much, but can be useful to transport a locomotive or two (10-11).

I especially like the DoskoSport cases. The 14" x 50" two rifle case holds a lot of cars. They also have nice secure latches. I don't have to worry about my trains getting damaged in transport, or a bunch of little plastic boxes. I don't usually store trains in these cases, but I do not worry about them being in there for a long time. I do usually take the locomotives out (12 next page).



8: Close up of TOFC loaded and empty. Empty has a small block of foam to hold it in place.



9: This single rifle case holds two entire passenger trains.



10: Locomotive cases.

11



11: The smaller locomotive case.

Since these cases are almost 4 inches thick, they can also be used for HO scale. Here is a 2 rifle DoskoSport case that I used for an HO scale. passenger train. I don't store this trainset in this case. I only use it for transporting (13).

I purchased my cases locally at an outdoor sporting goods store. You may find them in your area or on-line.

Do an internet search for Doskosport or Gun Guard gun cases.

Here's a sample link: exploreproducts.com/plano-double-rifle-case.htm.

Here's to getting all your N scale rolling stock to travel safely!

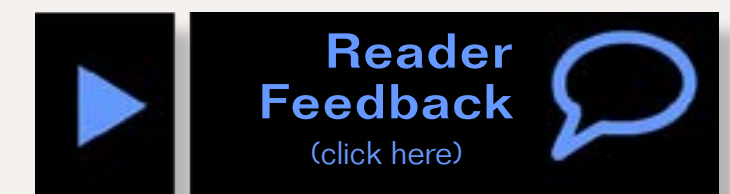

12



12: The DoskoSport cases.

13



13: This two rifle case is 4" thick and can hold HO trains.

Only available
from Canada,
you say?



NEW!!!
Road Numbers



NEW!!!
Paint Scheme

...Pity



HO Scale



N Scale

Exclusive to:



About our Modular columnist



Les Halmos has been a model railroader since 1979. He's been involved with setting modular standards for the NMRA since 1981. In 2001, he founded the Free-Modu-Rail Group and has been active in promoting Free-mo module standards.

[Click here](#) to learn more about Les.

Photos and illustrations by the author unless otherwise credited.

MY MODULAR ADVENTURE: Having Fun a Module at a Time

The ongoing story...

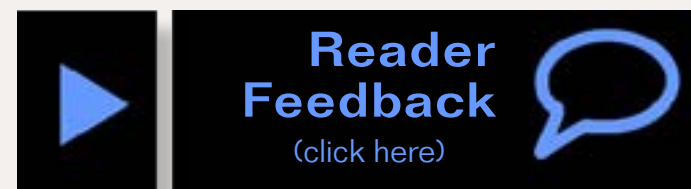

The roofers are on strike, so on to the blacktop ... well maybe not so black, let's see ...

Actually the roofers are not on strike, I just ran out of materials to finish the stall roofs. It is really frustrating having to wait to get supplies shipped to you when you don't have a local LHS that carries scratchbuilding supplies. The four other stalls' roofs will have to wait. I hope it doesn't rain too much!

Meanwhile I decided to install the roads and the asphalt between the tracks in front of the roundhouse. While I was waiting, I printed out a copy of the module and its adjacent ones to study where the best place would be to put the asphalt. You would think that with ACAD it would be a simple thing to do. Well guess again. Doodling and shading by hand works a lot quicker, but first I had to figure out which buildings to use and where they will go.

With a copy of the drawing and some fiddling around with the buildings, I

finally got a pretty good feel where everything will fit. Next I shaded the areas where I would put the asphalt.

Let's go through the 5 steps it will take to complete laying the asphalt:

1. Choosing the buildings.
2. Choosing the method and materials.
3. Cutting and assembling the pieces.
4. Installing and painting the rail to rail pieces.
5. Cutting, installing and painting the track to track pieces.

I went through my extensive inventory of buildings bought with the firm intention of building them all and putting them on my layout ... I can hear you snickering in the background ... well ... I did find some. I really enjoyed building these kits and positioning them on the module. It was a nice change of pace. They are partially assembled ready for painting and final assembly, which will come later once the asphalt contractor has finished his job. Nice Caterpillar!

On to step 1.



1: OK, how about "graytop"?

STEP 1: Choosing the Buildings



2: I needed a warehouse, LaserKit #701 (General Service Building), and Foreman's Office LaserKit #712 (Two Story Depot), both manufactured by AMB (American Model Builders). These kits are now out of production.

Alright, back to the blacktop. There are as many ways to simulate asphalt as there are modelers. Well, maybe not that many, but there are quite a few to choose from. I tried several ways – plaster of Paris, joint compound, Hydrocal, plain styrene, basswood, Sintra, and a few more. When building the modules for Free-Modu-Rail, I came upon what is referred to as Duraplast. It is similar to Gatorboard or Gatorfoam, with the difference that the top and bottom layers are made of styrene.

While playing around with it, I noticed that I could rip the styrene right off the board, leaving a .018 thick strip with one smooth side and one rough side. The rough side looked like it could be painted to look like asphalt or concrete.



3: I also wanted a building where turntable operations could be overseen and control of the crossing, so I chose LaserKit #709 (Yard Office), also by AMB.



4: Wow! These LaserKits sure have a lot of parts! Here they are ready for paint ... later.

STEP 2: Choosing the Method and Materials



5: The Duraplast comes in different thicknesses. This sheet was approximately ¼ inch thick. Once stripped, all that's left is the foam which I will use later.



6: Choosing the color was a little more involved. I started out by trying Woodland Scenics Top Coat, but I found it to be too dark for what I had in mind. I prepared two mixtures by adding some white to the Top Coat. When I had two shades I was happy with, I had a pint of latex made of each one. I finally ended up using the lighter color.



7: On the prototype the shade looks lighter in the sunshine. With some weathering, I will try to simulate this. I might even be convinced to plant some static grass.

8

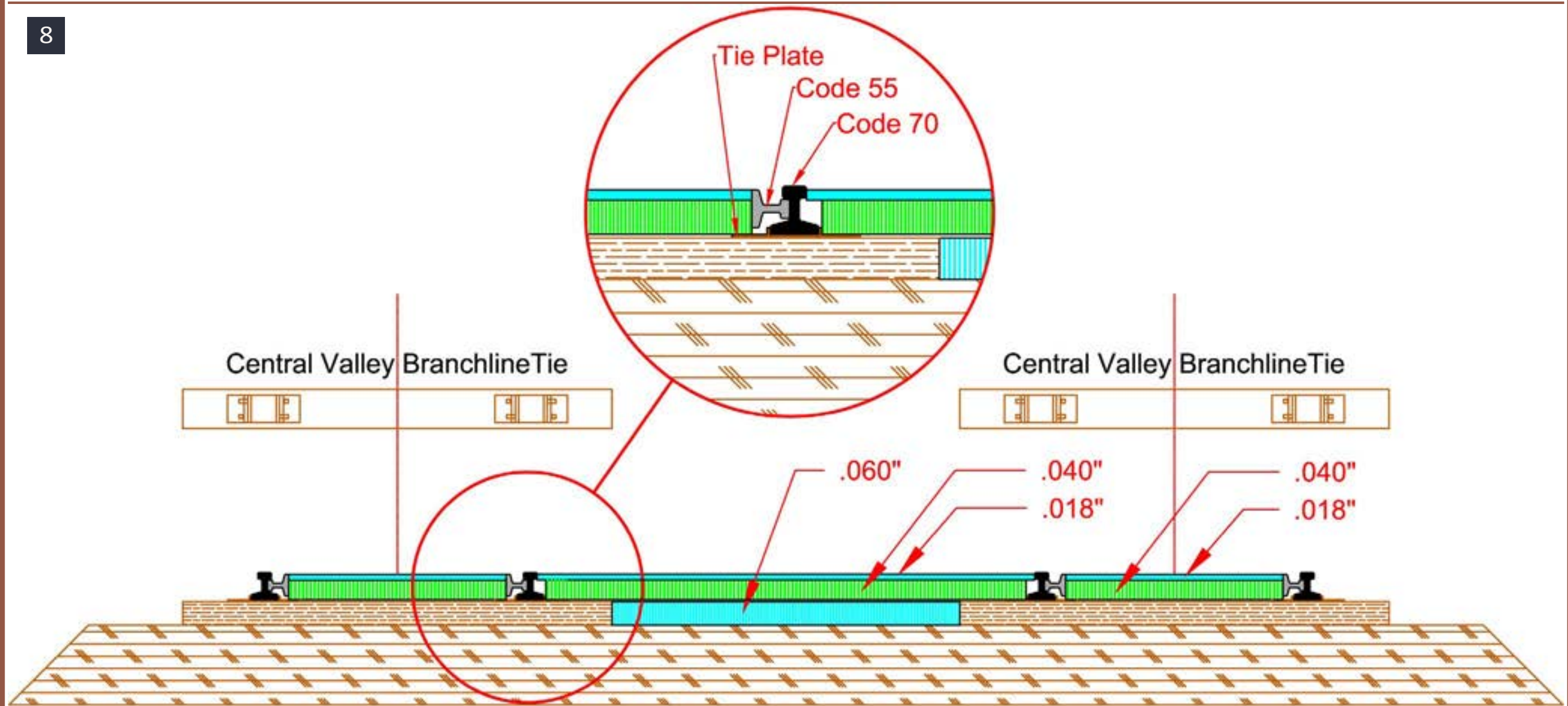

Asphalt detail using styrene strips and Duraplast "blacktop"

That pretty much confirmed which method I would use. I took some additional measurements, rail height of stall tracks .070", styrene available, .060", .040", the Duraplast top and bottom layers .018". I had to take into account the height of the ties .060", and the tie plates on the Central Valley ties strips .005". I decided to use Code 55 rail on its side with .040" styrene, covered with .018" Duraplast layer to place between the rails.

8: Asphalt detail.

Then I calculated what I would require between the track, which was .060" styrene between the ties covered with .040" styrene on top of the tie plates and .018" Duraplast layer on top between the rails. This is all fine and dandy but how about a drawing (see above)?

STEP 3: Cutting and Assembling the Rail to Rail Pieces



9

9: I figured that by using the drawing as a template I could measure and cut the styrene to size. After a failed first attempt, it was back to the old adage, measure twice or more, and cut only once. Although the drawing is perfectly to scale my fat fingers when installing the track were not, so there were some slight differences, I compensated where needed.



10

10: To simulate the prototype, I decided to use Code 55 rail on each edge between the Code 70 rails on the stall tracks, so I measured and cut 30 rails to length.



11

11: The prototype used old rail to form flangeways. Although it looks like ballast between the rails, it is actually past-due asphalt.

STEP 3: Cutting and Assembling the Rail to Rail Pieces *Continued ...*



12: I taped the rails together and ground the ends to even up and to remove any burrs.



14: Once I figured out the dimensions between the rails, I cut the .040" styrene pieces.



13: I painted the rails on three sides with Floquil Rail Brown. The unpainted ends will butt up to the roundhouse base, and won't be visible. Neither will the unpainted bottom sides, which will be facing down.

STEP 3: Cutting and Assembling the Rail to Rail Pieces *Continued ...*



15: When I cut styrene either on a bench saw or with a utility knife, there were always ridges and/or imperfections on the edges. So I do what the pros do, use a 1" very sharp scraper to clean up the pieces. You would be surprised how well this works.

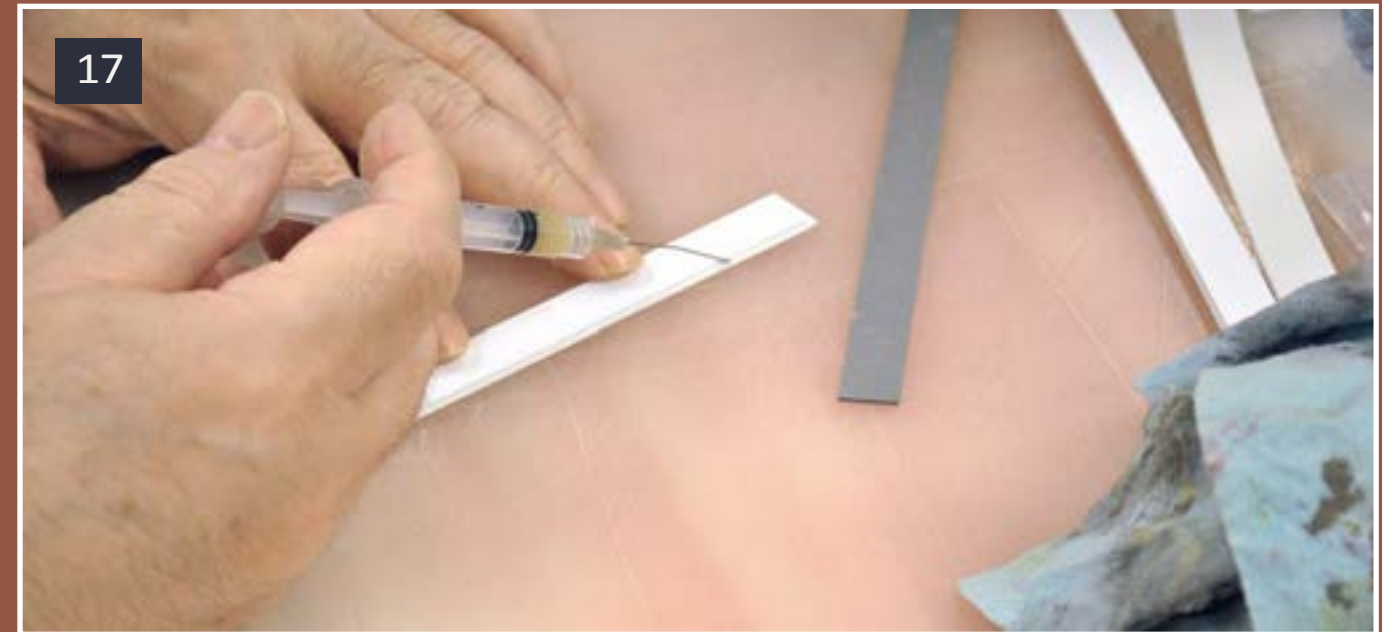

17: I cut the Duraplast slightly larger and placed it rough side down. Then I put the .040" styrene strip on top and glued it with MEK using a syringe. Word of warning: after applying the MEK, make sure you place all the pieces on a flat surface with some weight over them to prevent warping while they dry. More precisely, until the solvent evaporates.



16: Once all pieces have been cut and trimmed, they were ready to be glued together.



18: Here is what happens if you don't! I can't use these, so I cut and glued some new ones.

STEP 3: Cutting and Assembling the Rail to Rail Pieces *Continued ...*



19: This time I wasn't going to take any chances. As you may have guessed, I do love the Barge/MEK mixture, and this time, I will use it.



20: There will not be any warping. I placed all the pieces between two acrylic sheets, and topped it off with an iron. The next day they were all as straight as arrows.

Rslaserkits



Speeder Shed

Now in N and Z scales soon in HO

N and Z scales include the speeder and code 40 rail and laser cut tie strip for the speeder track

Carl's Cabin

Now in N coming in HO soon

The perfect cabin for your logging or mining camp or use for housing on the wrong side of the tracks. Includes extra material to use for the piers and bracing when placed on a sloping lot. We have also included the out house.



Plywood decks

Conversion decks for the MT 4500 series N scale 50 ft flat cars
Update your fleet now, four decks in a pack

**See us in Seattle at the
2012 Narrow Gauge Convention**
Custom Laser Cutting and design
Dealers welcome



click here

5145 Gaffin Rd. SE • Salem, OR 9317 (503)371-4290 • Fax:(503)585-0850

E-mail: Sales@rslaserkits.com Web site: www.rslaserkits.com



ADVERTISEMENT

STEP 4: Assembling and Painting the Rail to Rail Pieces

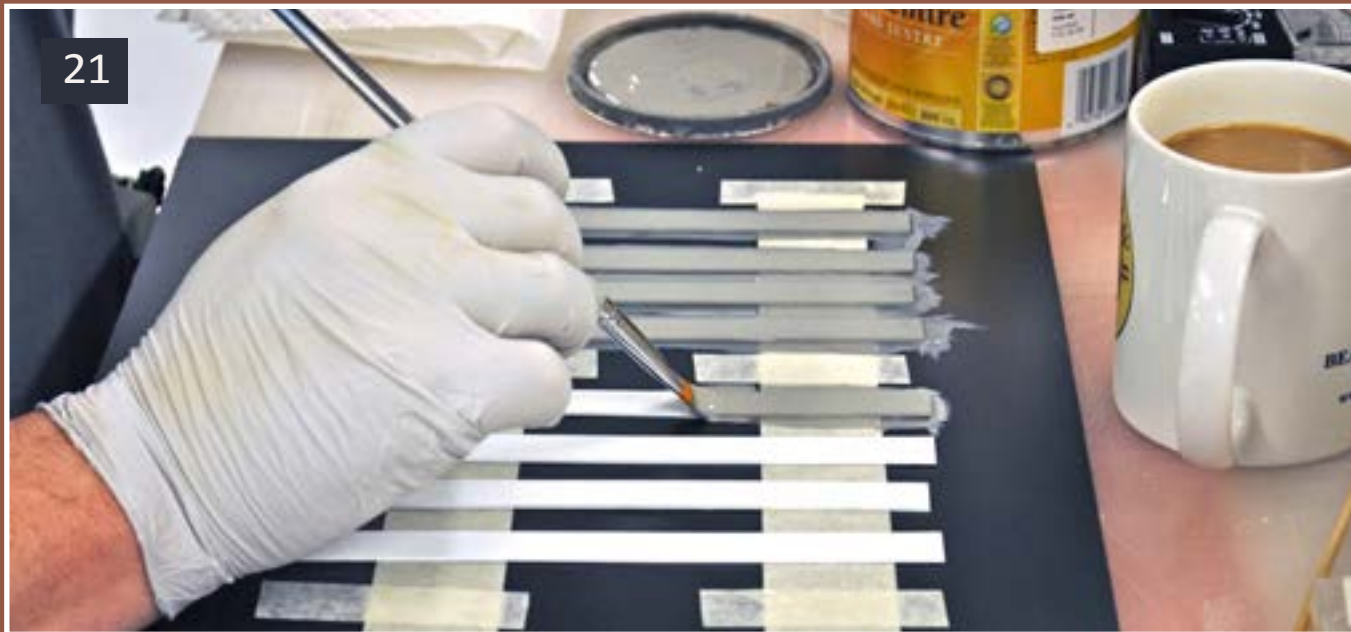

21: I attached the individual strips to masking tape with the rough side of the Duraplast facing up. Then I painted them using the lighter latex asphalt color.



22: The next day they were thoroughly dry, and I prepared and positioned the Code 55 rails and the asphalt pieces for application of the Barge/MEK solution. I did not like the adherence, so I switched back to my tried and true. I coated the sides of the asphalt pieces, and the base of the Code 55 rail.

23: I placed the assembly painted side down, and pressed the base of each Code 55 rail to the sides. I made sure to leave the unpainted portion of the rail facing up. As you can see on the drawing, (8) the edges of the rails are flush with the top of the asphalt.



STEP 4: Assembling and Painting the Rail to Rail Pieces *Continued ...*

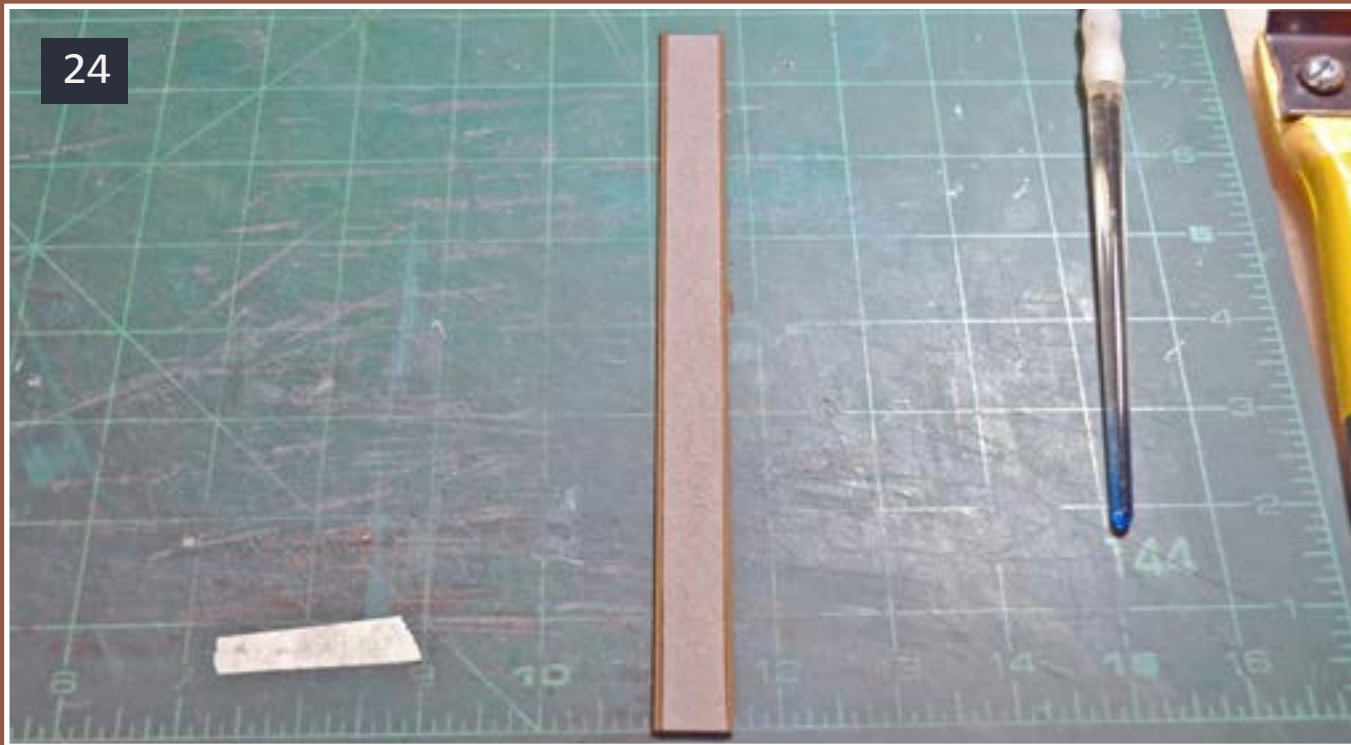

24

24: Voilà, the final result, with a little weathering and by adding crack lines this should do the job. I made 14 more like this one for each stall track.



26

26: Now that the 15 stall tracks are completed, let's move on to step 5.



25

25: The next day they were thoroughly dry, and I prepared and positioned the Code 55 rails and the asphalt pieces for application of the Barge/MEK. I coated the sides of the asphalt pieces, and the base of the Code 55 rail.

STEP 5: Cutting, Installing and Painting the Track to Track Pieces



27: One of the 3 pieces is made of .060" styrene and goes between the ties and another .040" between the tie plates, I applied the Barge/MEK to all surfaces including the roadbed. I installed each of them on the module.

I need 3 pieces of different sizes and widths to close the gap. If you look at the drawing (8) again, you will notice that this time I come right up to the rail without leaving a gap for the wheel flanges like the rail to rail ones.



28: I coated the bottom of the .018" Duraplast with glue and placed it on top.



29: To finish the job I masked the rails and painted the asphalt.

STEP 5: Cutting, Installing and Painting the Track to Track Pieces *Continued ...*



30: Finished stall tracks, .040" styrene, topped off with .018" Duraplast. Looks good!

Conclusion:

In my next column I will continue with the asphalt that leads up to the roundhouse, and the service and parking areas around it. With a little luck I will have some time to finish the roofs, if my supplies finally arrive. I am starting to see some tangible results as I get further and further along with this project. And who knows, I might be doing some ground cover and ballasting next. I also have to finish building the structures that I will install.

I purchased a copy of Helicon Focus (photo stacking software), and hopefully my pictures will be more in focus. I still need to work on the lighting and a few more items.

Thank you again for reading thus far. Please don't forget to click on the feedback button. Your comments and critiques are most welcome.



31: Finished asphalt between the tracks is one thickness of .060" styrene, one of .040", both topped off with .018" Duraplast, properly rolled. This method leaves just enough space below the rails so that I can clean them without damaging the surface of the asphalt.

Looking at the finished product, I am not displeased with the results, even if I do say so myself. Now I will do the same between the other 14 tracks and also tackle the access roads and parking areas.

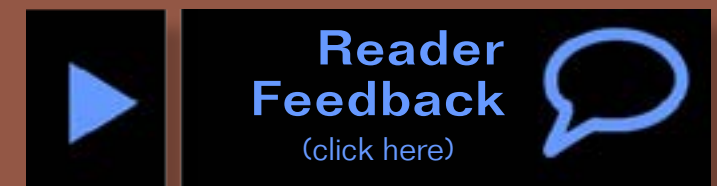

**Reader
Feedback**
(click here)



The One and Only RRampmeter on Sale:

Effective Sept 10-Oct 10, 2012

The amazing RRampMeter designed for Model Railroaders by DCC Specialties does what no other meter can do!

Easy walk-around measurements of layout voltage drops, accurate booster output setup to optimum voltages for decoders and sound units.

- The only inexpensive device that accurately measures DCC Volts/Amps.
- Also measures AC and DC Volts/Amps.

Costs less than DVMs that cannot measure DCC. Ver I, II, & III rated at 9 Amps and Ver IV rated at 20 Amps. Measures true RMS Volts/Amps, +/- 2%.

- Suitable for all scales.
- No batteries required.
- Designed for Left or Right-hand use.
- PCB length 5.63"; Enclosure length 4", width 2", height 1.25"
- 3 Styles Available:

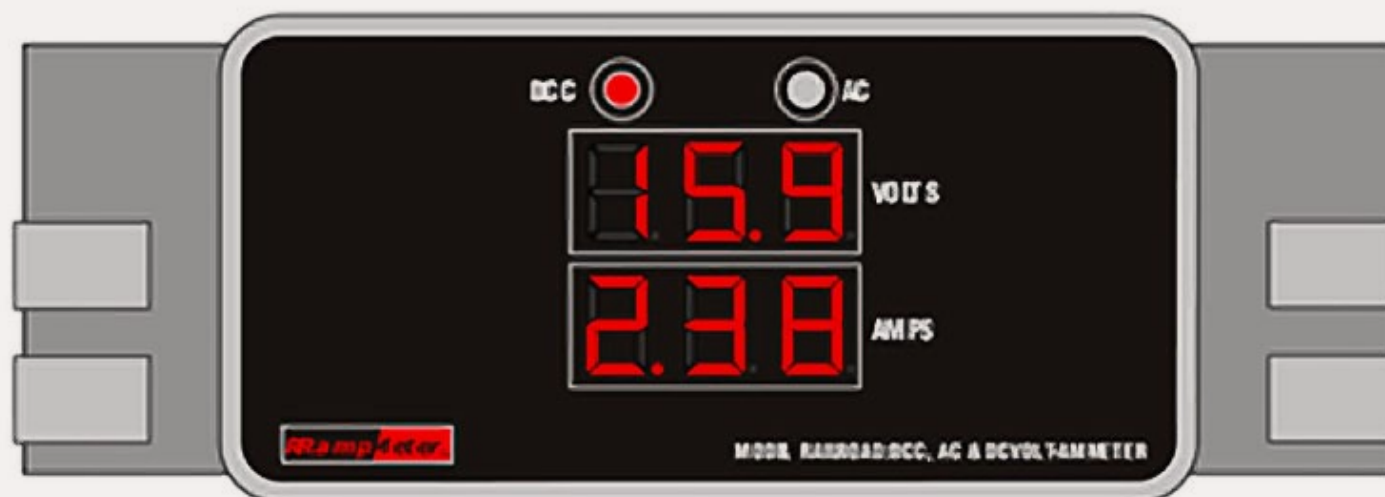

VIDEO DEMO!

Watch this cool RRampMeter video courtesy of RealityReduced.com.

1. Version I RRampMeter Circuit Module without enclosure
2. Version II RRampMeter with Enclosure and Clip Leads
3. Version III RRampmeter Same as II with Battery backup for measurements below 7 Volts
4. Version IV RRampmeterHP
Same as III but for large Scale high voltage and current applications:
DCC: 38.6 v and 18-20 Amps
AC: 27.6 v and 18-20 Amps
DC: 38.6 v and 18-20 Amps

Version	List	Sell	Save
I	\$64.95	\$49.95	\$15.00
II	\$94.95	\$69.95	\$25.00
III	\$104.95	\$74.95	\$30.00
IV	\$124.95	\$89.95	\$35.00



Hobby Tools, Trains, Supplies and More... **ON SALE!**

Micro-Mark SUMMER 2012 SALE
THE SMALL TOOL SPECIALIST
SAVE UP TO 75%

PRICE BUSTERS

Shop On-Line Order Today

FREE CATALOG!

www.MicroMarkTrains.com
Berkeley Heights, New Jersey 07922

STREAMLINED BACKSHOP SERVICES

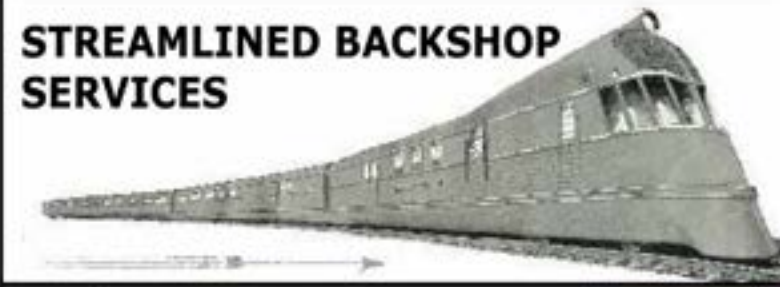

www.SBS4DCC.com

Looking for a signaling solution or fast clocks? Look no further!



Please visit our website and online store!

21175 Tomball Pkwy Phone: (281)251-5813
Suite 287 <http://www.logicrailtech.com>
Houston, TX 77070 info@logicrailtech.com

ON3 - ON30



Click to visit ...

WWW.SANJUANCARCO.COM

Affordable custom and modular benchwork.



Backdrop Junction

Your stop for Model Railroad Backdrops



backdropjunction.com
N, HO, O Scales • Custom Orders

Goes on easy

All Scales
All Brands

Make a Tire or Retire

Green Grip from a Jar
WWW.BULLFROGSNOT.COM



Recommended installation tool

SNOT = SAND

99% Know It Works!

Please click on ads ... every click on an ad keeps MRH coming to you completely free!

HOBBY MARKETPLACE ads are economical and effective.

Click [HERE](#) to learn more.

CLEVER models LLC
CRAFTSMAN CARDSTOCK MODELS
PRINT, CUT, FOLD & PASTE
FAST, FUN RESULTS.
Most kits under
\$10.00
Order online, DVD's and Instant downloads
www.clevermodels.net
Finished model exactly as shown no additional weathering required



Build Great Modules
modularrailroading.com
Click for more... 

Modular Railroading Handbook



Structures & Rolling Stock
Boats & Doll Houses
Visit our eBay Store
stores.ebay.com/OHkwari-Sales
Email for 10% discount

Model Railroading
for 60 years 

OHKWARI SALES
PO Box 12362
Casa Grande, AZ 85130
520 518-5368
ohkwari@gmail.com



True Scene™ Modeling
NEW **FusionFiber™** 
Dependable Quality. Easier than Plaster!
SATISFACTION GUARANTEED!
www.truescene.com or 716-523-7305

Your ad could be here
and reach up to 64,000.
Click to find out how.

we're upping the game, August 2012...

rti

railflyer technologies inc.™

Click, see what's up
www.railflyermodel.com

On-site micron machining & injection mould tooling, turn-key OEM solutions
6 years locomotive R&D, state of the art battery/wireless control

DCC by Design

Can't remember which
cars you've bought?

Yard Boss

Model Train Inventory Software
Just \$12 with code MRH0511
Download free trial now!

www.dccbydesign.com/yb-mrh0511.html

Great Decals!

is now selling decals produced by *After Hours Graphics* for Midwestern railroads. Roads offered include C&O, Cincinnati Union Terminal, Conrail, CSX, DT&I, Great Miami, Indiana and Ohio, Interstate, NKP, Norfolk and Western, Pere Marquette, Southern, Transkentucky, and private labels Dow and Owensboro Grain.

For the complete list, see:

www.greatdecals.com/AfterHours/AfterHoursList.html

Great Decals!
P. O. Box 994, Herndon, VA 20172

The Proto:87 Stores

Home of the Prototypically Accurate and Ultra Realistic Model Track Project (and much more).

21st Century Professionally Engineered, for strength, reliability, and phenomenal accuracy. Fully NMRA Warranted. Even compatible with Code 88 wheelsets!

www.proto87.com

RULERS of the WORLD

Scale Rulers \$4 each
Over 150 scales!

Metric or Imperial

www.rulers-of-the-world.com

Your Text Ad

Could be here for a remarkably affordable price!

model-railroad-hobbyist.com/advertise-with-us

Yes, Virginia,
MRH back
issues are
indexed.

Just click
here to find
out more...

New HO
Scale
figures -
like you've
never
seen!



HO
scale



Look for these and other HO scale figures at www.truelinetrains.com or check your local dealer.
Available in packs of 6 at better stocked Hobby Stores across the world.

Bring a Wrecking Crane to Life

With Micro Motors and Sound Decoders



by Dr. Geoff Bunza
Photos by the author except
where noted otherwise

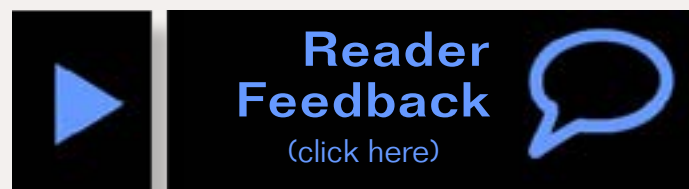

Figure 1: A NYC crane, prepares to lift an errant box car back onto the track. Geoff fully animated this HO scale Athearn crane with sound and working lights – Charlie Comstock photo

Like the prototype, model railroads often have a wrecking crane standing by, waiting for action. Some of the larger cranes were quite powerful and looked as impressive as the locomotives or cars they were called upon to lift.

Older steam cranes, such as the Athearn 250-ton crane model, had

a boiler, pistons, gears, and accompanying machinery which included front and rear lights, work lights, a whistle, and sometimes (though rarely) a bell. One 120-ton Southern Pacific crane which I inspected had no fewer than nine external lights! The whistles were usually a smaller, single chime, used to warn of impending crane movement.

One to three hooks were used for lifting, each rated for the maximum weight that it could lift.

Outriggers were deployed on both sides at the front and rear to stabilize the crane when lifting heavy loads. These “I” beams were pulled out and placed upon wooden blocks or cribbing (manually, by the way) to steady

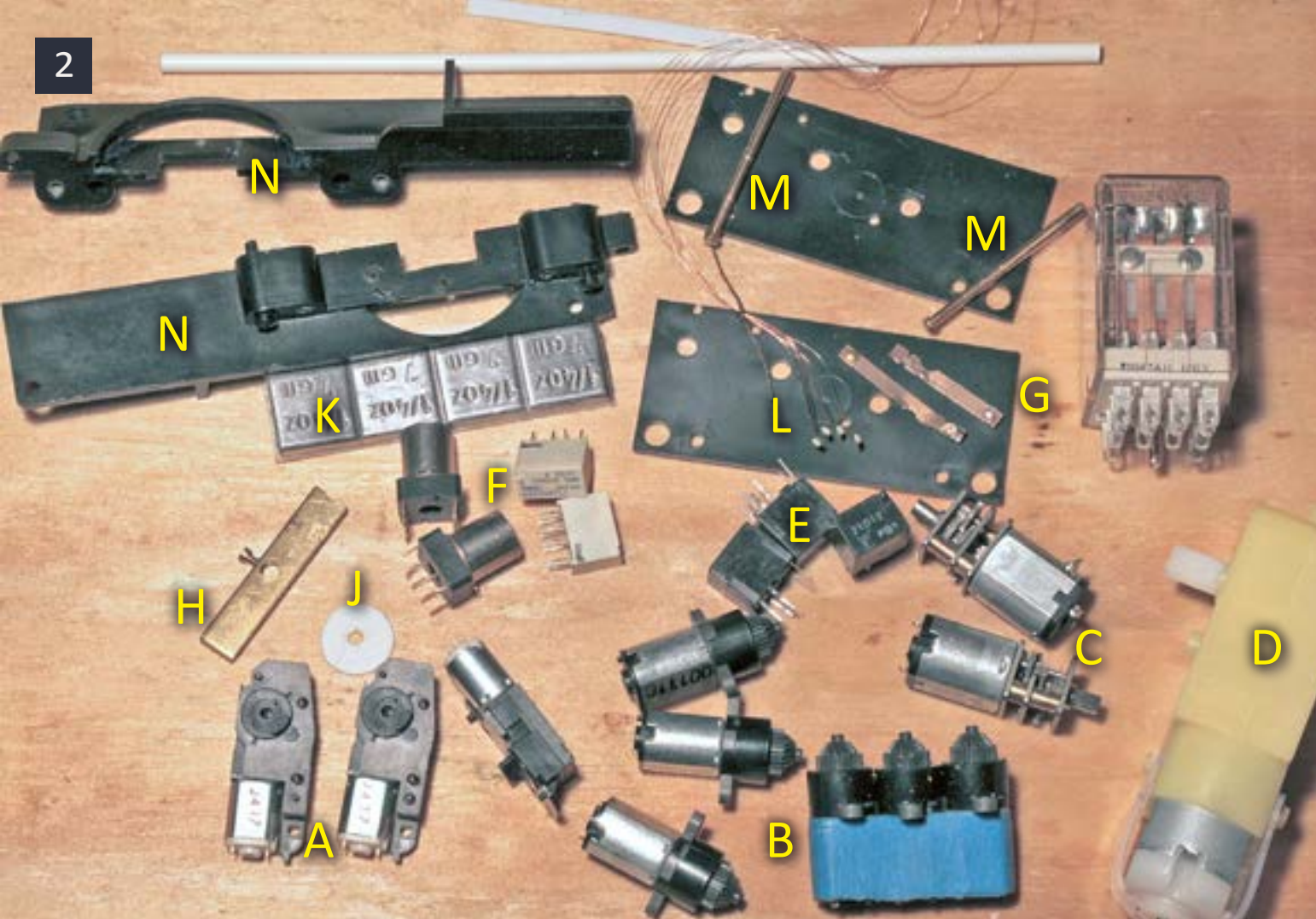

2: The bits and pieces used in my crane modification.

A – Boom and hook gear motors

B – I considered, but didn't use these gear motors

C – Cab rotation drive motors

D – This drive was rejected because of its size

E – These 12V SPDT relays control power to the drive motors

F – Other relay possibilities

G – Big relay and disassembled contacts used for well wiper

H – Holding bar for bracing the cab rotation drive axle

J – A side of the boom and hook cable spindles

K – Lead weights

L – Micro LED's (0603) with attached wire leads

M – Sprung pogo contact pins

N – Cab base halves

the crane. When the crane boom was deployed to the side, this allowed lifting heavier loads without tipping the crane or torquing the frame. Many railroads distinguished between derricks and cranes. Derricks were most often used for clearing wrecks and were heavy lifters (>100 tons). Cranes usually had longer, lighter booms, and could be equipped with clamshells, draglines, or electromagnets for maintenance jobs.

Some cranes were self-propelled but a top speed of a few miles per hour limited them to repositioning themselves at a wreck site. Sometimes these were called locomotive cranes. Most steam cranes were not self-propelled. Once in place, a steam crane created quite a show – lights, sound, and action.

I love animating things and I couldn't resist bringing life to the motionless and silent crane in my yard.

Getting Started

The Athearn steam crane (more correctly labeled steam derrick) model has been available to HO modelers for over 50 years. It represents one of the larger (but not largest) railroad steam wrecking cranes ever made.

The Louisville and Nashville (railroad.net/articles/railfanning/worktrains2/media/LWF0027.jpg) and Southern Pacific railroads (railpictures.net/viewphoto.php?id=127831) had cranes very close to the Athearn model. I wanted to capture its look,

sound and feel, but I didn't feel compelled to recreate a specific prototype.

Low cost miniature gear motors, micro LED's, and Digitrax fully programmable DCC sound decoders (SDN144PS) allowed me to bring my venerable Athearn model crane to life.

Finding the right components took a while – I've collected small motors and gears for many years. You can see many of the parts I used (and some others I collected) in figure 2. I purchased my gear motors off eBay. Together with bits of styrene, brass, and some wire, I launched into the project. This is how I went about it.

Electrical Contacts and Cab Drive

I am going to assume you already know how to assemble and disassemble the Athearn kit. I obtained a couple of assembled cranes at a local swap meet for experimentation.

Good power pickup from the rails is a necessity. The later version of the Athearn crane has six-wheel buckeye trucks with plastic frames. Intermountain metal wheel sets can be inserted in the truck by spreading the frame slightly (3). To insure good conductivity from the rails, I chose to use a combination of flat shim stock and wire contacts.

You'll notice that the wire contacts use multiple thin wires, helping insure electrical contact while traversing irregular



3: Spread the truck frame sides to insert Intermountain metal wheel sets.

track. Cut a 1/8" wide strip from a sheet of 0.003" phosphor bronze shim stock ([Tomar](#) wiper kit H-825), and slip it under the axles on the uninsulated side of the axle. Drill a small hole on each truck frame rib. File or sand the heads of small or medium rail spikes to expose bare metal and insert them into the holes with the spike heads overlaying the contact strip.

Carefully solder the spike head to the contact strip. Then solder a four to six inch piece of thin, very flexible wire to one of the spike heads. Feed the wire through the second mounting hole on the truck.

The trucks are mounted facing opposite directions so one feeder draws power

4a and 4b: Phosphor bronze contact wipers must be added to the crane's trucks for primary power pickup.

5: Add phosphor bronze wires to wipe the backs of the insulated wheels. When these wipers are added to the axle wipers (in figure 4), track power is picked up by 10 wheels, eliminating sound decoder dropouts due to poor electrical connection.

from the right rail and the other truck will pick up power from the left rail.

Optionally, wire contact wipers can be added to the insulated wheels for improved electrical pickup. This will give your crane 10- or 12-wheel electrical pick up. Cut a piece of 1/16" x 0.010" brass strip, then then solder a pair of 0.008" phosphor bronze wires, bent into a shallow "V" shape. Use a pair of wires to create a "bifurcated" contact for each wheel to improve electrical conductivity (5).

Glue the brass strip to a piece of .020" styrene slightly wider than the brass to prevent shorts with the middle axle. Drill holes and mount the wiper assembly using rail spikes as with the

previously described pickup wipers in figures 4a and 4b. Take care not to deform the contact wires. Make sure the wires touch the back face of the wheels but are well above the axle. Trim the excess wire, and solder 4" to 6" of flexible wire to the brass strip and feed it through the second open frame hole. Be sure to color code each track's wiper wires.

Preparing the Well

Set the trucks aside. Now we'll prepare the "well" where the crane connects with the chassis.

A gear motor, with its shaft fixed to the chassis and the crane cab attached to its body, will rotate the crane. Besides securing the drive motor shaft, we're also faced with getting the two electrical connections (from the rails) into the cab. The cab can turn 360 degrees—so wire connections are not practical. They could become severely twisted and break.

We need to drill a vertical hole for the motor shaft in the exact center of the crane well's bottom. Measure the inside of the well, divide by two, and using a compass, draw a circle with this radius on a thin piece of sheet plastic or card stock. Make sure you can see the center point of the circle clearly.

Carefully cut out the disk with a pair of scissors – it should be a perfect fit in the bottom of the well. If not, re-do the process until it does—I needed three attempts before I got it right (6). Mark the center of the bottom of the well

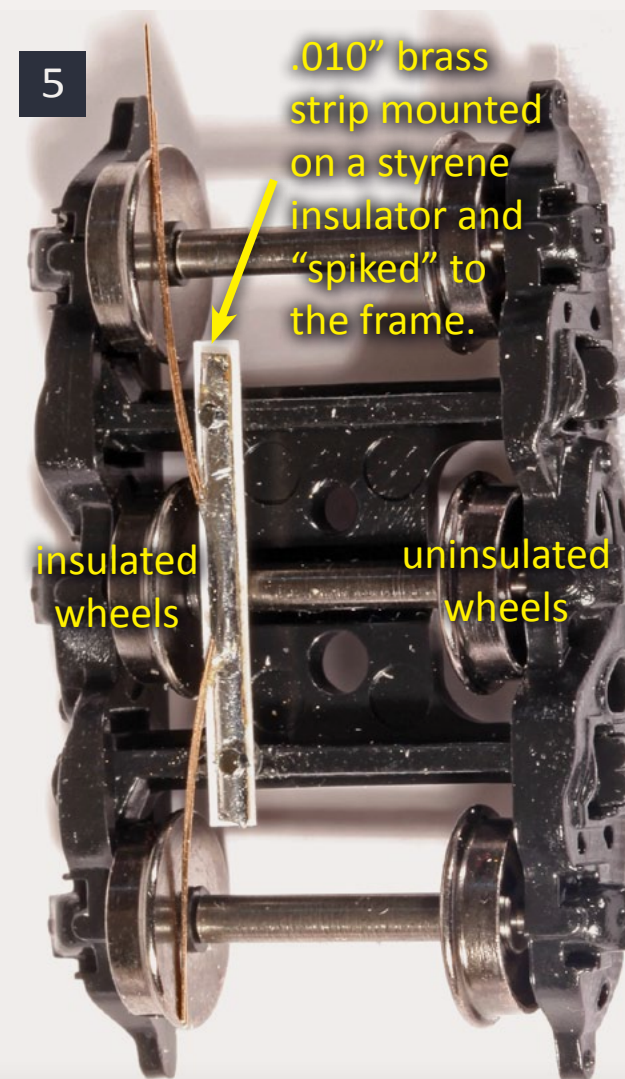
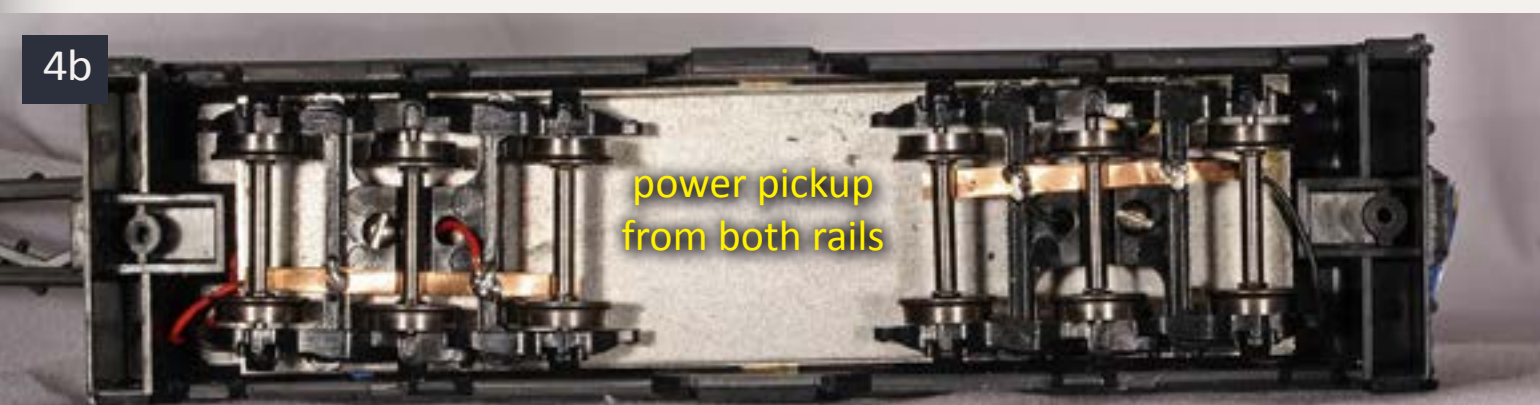
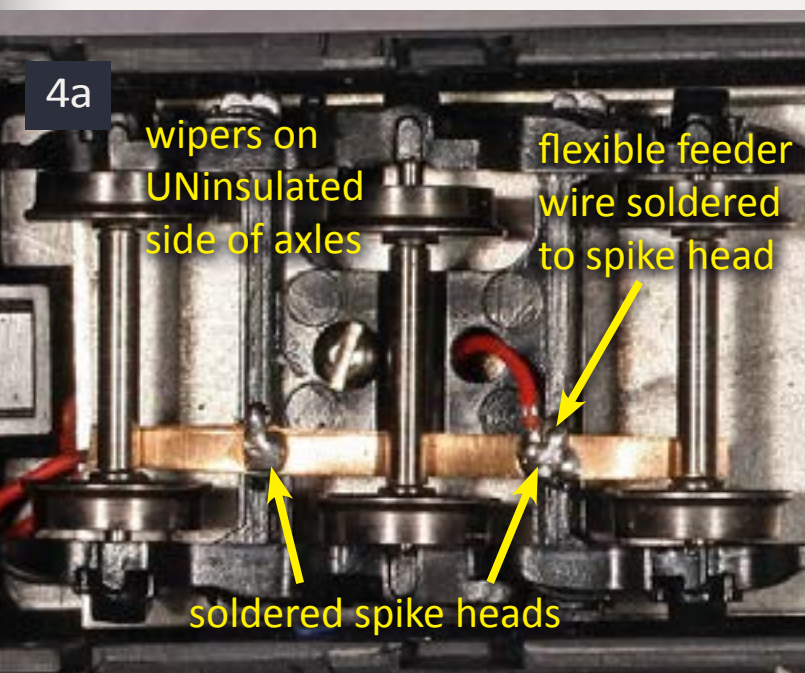

6

A circle template of thin styrene or card stock helps find the precise center of the well.

The compass used to draw a circle left this pin prick at the center of the circle.

the "well" where the cab will mount

6: Cut a circle of material that will fit exactly in the well as a way to locate the precise center of the well.

7: The bottom of the frame, must be ground away to make the bottom corners square.

7

hole drilled in the center of the well

material removed to make a square corner

with a scribe or pin. Remove the disk and drill a hole for the gear motor axle used to turn the cab – 3 millimeters in my case. Take care that the hole is drilled vertically. If you have a small drill press, use it.

Turn the chassis over and note the corners along the side opposite the

well-bottom-hole are not square. Square them off for about 3/8" with a mototool using a router or grinding bit on either side of the hole.

Now cut a length of brass 1/4" by 3/32" bar stock to just barely fit across the bottom of the chassis. It should be an easy but snug fit. Now center it over the

8

#0-80 set screw

motor shaft

8: The brass mounting bar with the shaft of the cab-rotation motor installed. The 0-80 screws prevent the shaft from rotating.

hole you drilled before, then mark and drill a vertical hole of the same diameter through the brass. My motor's shaft already had a flat on the end of the axle. If yours does not, make one.

Drill and tap holes for #0-80 screws which will hold the axle in place. This way the motor and gearbox will turn with the crane cab as a unit when mounted (8). Check that you can insert the motor axle and tighten the holding screws with ease.

Getting Power into the Cab

I chose to pass one rail's power through the gearbox and shaft. The other polarity would require wipers on a contact surface. I came up with two ways to make wipers and contacts: a washer in the bottom of the cab well and a strip around the wall of the cab well. You can use either (or both) of these methods.

I started by drilling two #60 holes in the bottom of the well near the

longitudinal center line of the chassis. Make them as close to the walls of the well as possible. Track power wires will pass through these holes.

I chose to use copper tape to make a contact surface around the inside of the well (9). The tape must lie perfectly flat against the well with a carefully fitted butt joint. As the contact slider moves across the joint, it can hang up on bumps or imperfections and rip the tape apart. Thread a small wire through one of the #60 holes in the bottom of the well and solder it to the bottom edge of the foil.

For the floor contact method prepare a "washer" of .005" to .008" thick phosphor bronze shim stock. Draw two circles on the stock; one the same radius as the crane well, the other with a radius about 1/4" smaller. Cut out the washer (outer circle) – scissors work well for this. Removing the inner part is trickier. I drilled lots of holes around

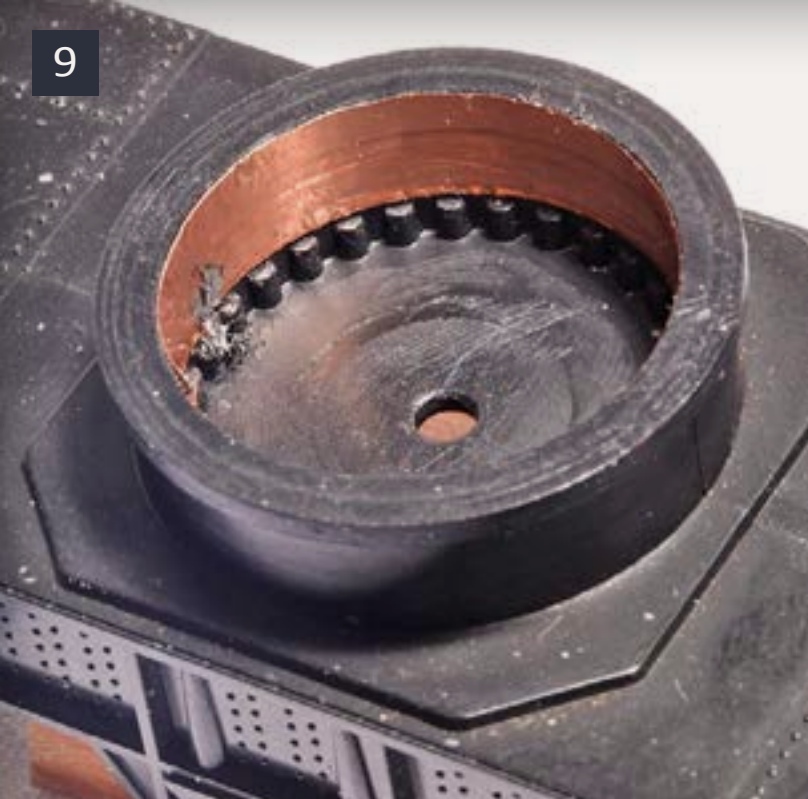

9: Copper foil around the side of the well provides a contact surface for track power.

10: A phosphor bronze “washer” on the bottom of the well provides an alternate source for track power. Both contact surfaces are for one rail. The other rail’s power will be fed through the metal gear box.



Figure 10

the inner line, then cut through them with a sharp hobby knife. The edge was pretty rough so I filed it smooth. Make sure the washer’s hole is large enough to clear the motor’s gear box. If the washer and gearbox touch you’ll have a short circuit.

Solder a small wire to the top edge of the phosphor bronze washer making sure the washer lays flat after the wire is connected.

Insert the wire through one of the holes you drilled and test fit the washer in the bottom of the well. If it fits and lays flat, glue the washer in place with ACC making sure it’s centered in the well.

Figure 10 shows both the well floor contact and wall contact strips with the motor and gear box in place.

Mounting the Cab

Screw the two pieces of the cab floor together. Center them above the well and scribe the dimensions of the gear-box on the cab floor. Remember we are mounting the gearbox shaft-down in hole in the bottom of the well.

Disassemble the floor halves and cut out the opening for the motor. This should be a loose fit over the motor, but the flat sides of the motor will press against the sides of the rectangular cutout to move the cab.

It is very important that the cab floor rotates easily around the well. Take time to smooth the floor and well mount until you can rotate the assembled halves easily.

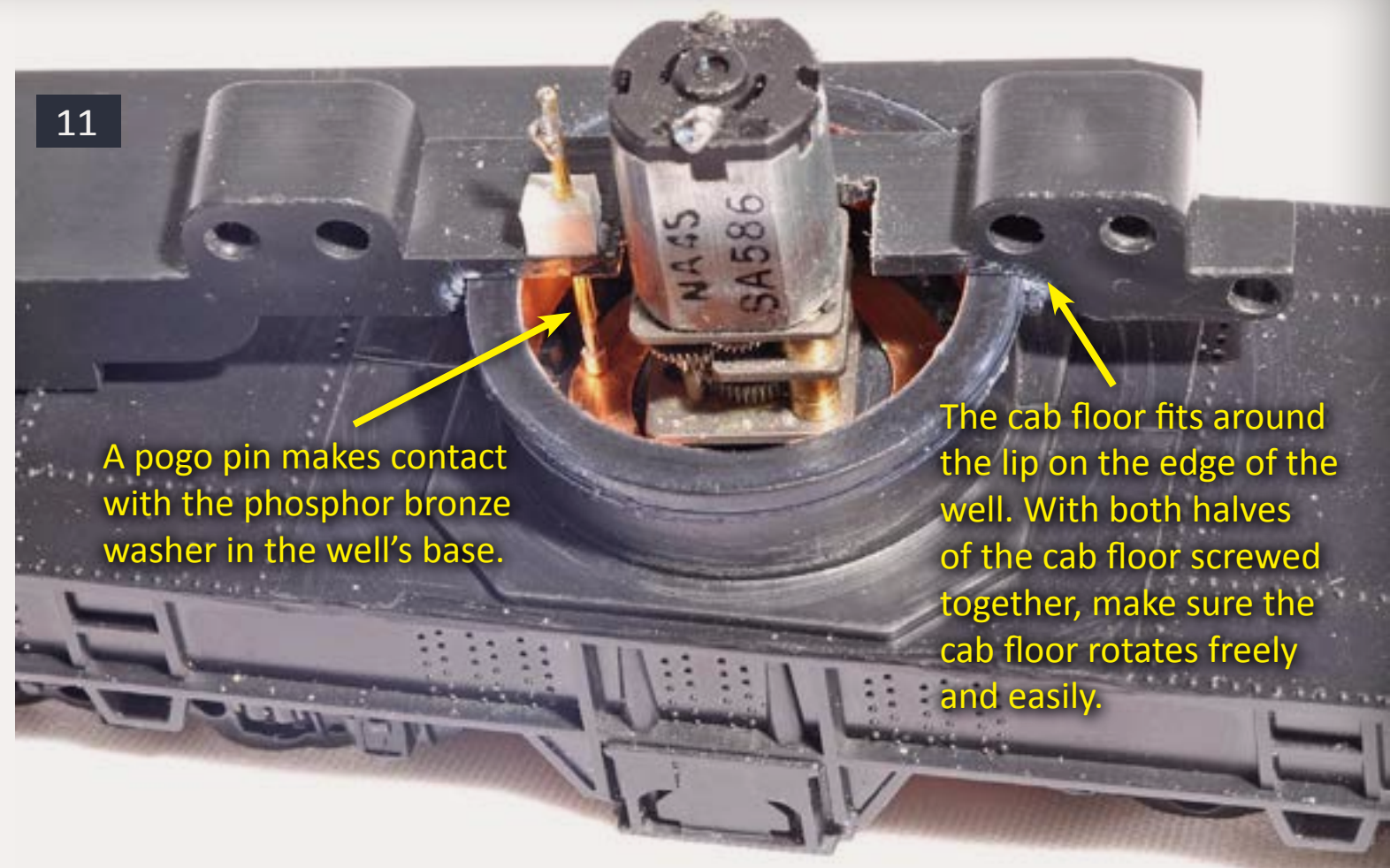

A pogo pin makes contact with the phosphor bronze washer in the well’s base.

The cab floor fits around the lip on the edge of the well. With both halves of the cab floor screwed together, make sure the cab floor rotates freely and easily.

11: One half of the cab’s base with cut-out for the motor and with a pogo pin power pickup installed.

Remove the floor and insert the gear-motor attaching its shaft to the brass mounting bar under the frame, using the set screws to hold it in place.

Hook up some temporary power connections and test run the motor to ensure it is vertical and rotates freely under its own power. Assemble the floor around the motor and gearbox and test run it again.

It took me over an hour to get the motor to smoothly rotate the cab. I’ve done this for several models and found the adjustment process was slightly different for each. A touch of plastic compatible Teflon grease may help.

Widening the opening in the floor may be intuitive, but can increase the play

in the mechanism. If you cut too wide an opening, cement plastic strips to the floor, to narrow the gap.

Adding Power Contacts

Now we need a way to get power from the contact strips in the well floor and/or walls, to the electronics in the cab (12).

For the bottom washer contact, I found what are sometimes called pogo pins (available from www.adafruit.com and www.goldmine-elec.com). They are straight, spring loaded pins (11).

If you use these, drill a mounting hole through the cab floor and in a 1/8” by 1/8” styrene mounting pad allowing

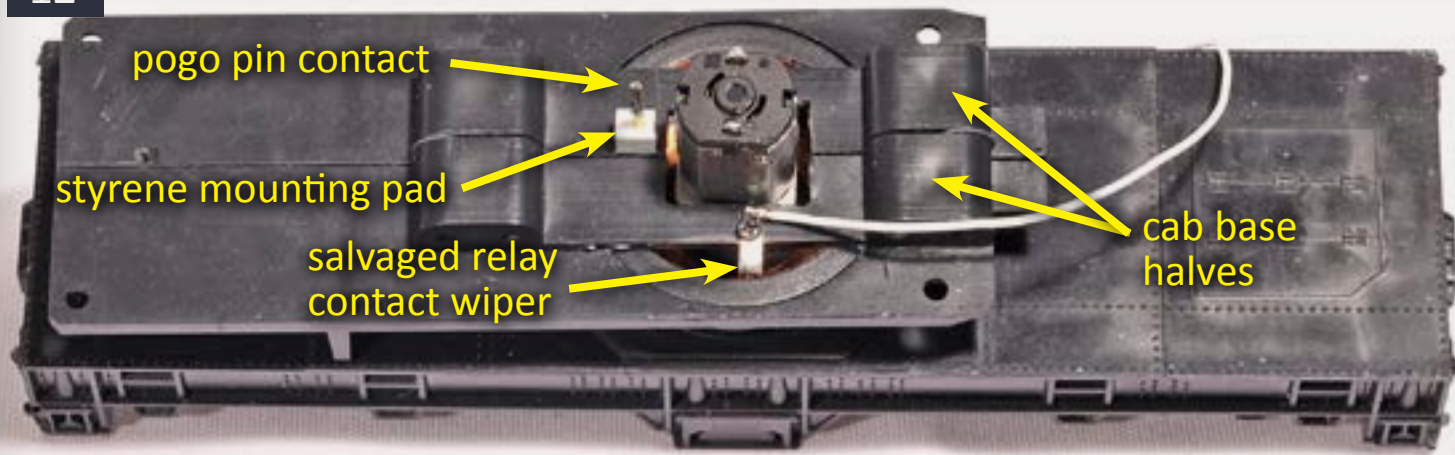

12: The cab base, installed over the cab rotation drive motor with both pogo-pin and contact wiper electrical pickups.

the spring contact to gently hit the center of the well's phosphor bronze contact washer with a slight compression of the pin. If the contact end of your pin is serrated or very sharp, file and sand it smooth to minimize friction and wear. If you experience continuity problems, use two pogo pins, wired in parallel, on opposite sides of the motor.

For side wall contacts you can use wipers made of phosphor bronze, either wire, or strips. Alternatively, a salvaged contact from an old relay works well. I used the latter – they have polished contact nubs which make good contact with the copper tape. Bend the contacts so they gently touch the inner wall. I screwed them onto the cab's floor (12).

NOTE: If you use both types of contacts (floor and wall), make sure the friction isn't excessive which makes the motor work too hard.

Now install the motor and cab floor assembly. Temporarily attach one motor electrical contact to either (or

both) sliding contact(s) and the other motor electrical terminal to the metal gearbox or motor housing. Test the assembly by connecting power to the brass motor mounting bar and the feeder wire(s) to the phosphor bronze washer or wall contact foil from below the chassis. If you did everything right, the cab floor should rotate freely, moving indefinitely in each direction without problem.

Boom and Hook Drive

Trim back the small gear motors (13) as much as possible (cutting and filing) so two of them can be stacked and screwed with 0-80 screws after holes are drilled and tapped.

Then glue the stack to a .040" styrene base plate which sits on top of a spool mounting plate cut to fit the inside width of the back of the crane's cab (14). Three miniature relays will be glued, side-by-side to the bottom plate.

I made the drive spools for the boom and hook cables from .010" styrene

sheet and a styrene tube (15). I cut two disks and drilled them to clear a 2-56 screw, then cut a length of 3/16" tube and drilled it to also clear a 2-56 screw.

The 2-56 screw needs to be cut to length and goes into a tapped hole in the gear drive. I had to use a bottoming tap – one that cuts threads all the way to the bottom of a hole – as the

hole is very shallow. Assembly is easy – one styrene disk goes on the screw, then the tubing, then the other disk.

The gear drive has a plastic nub protruding from the spool mounting plate (13). I filed it down to a pin and made a corresponding hole in the inner spool disk. This locks the spool

13: Boom/hook drive gear motor before trimming.

14: Drive motors (with spools) after trimming and mounting.

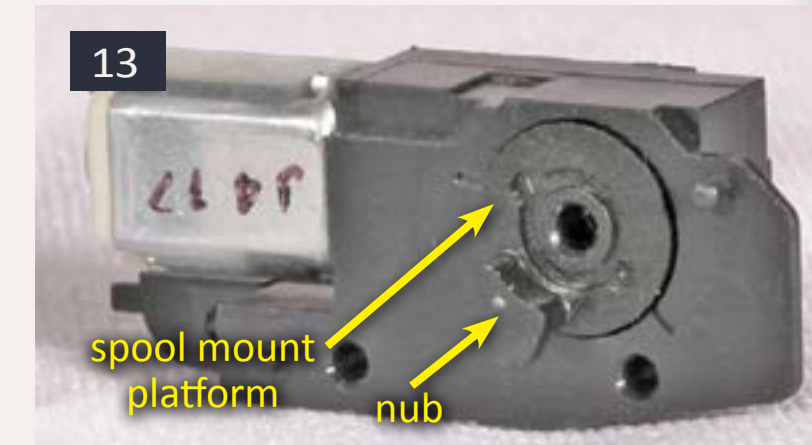

14

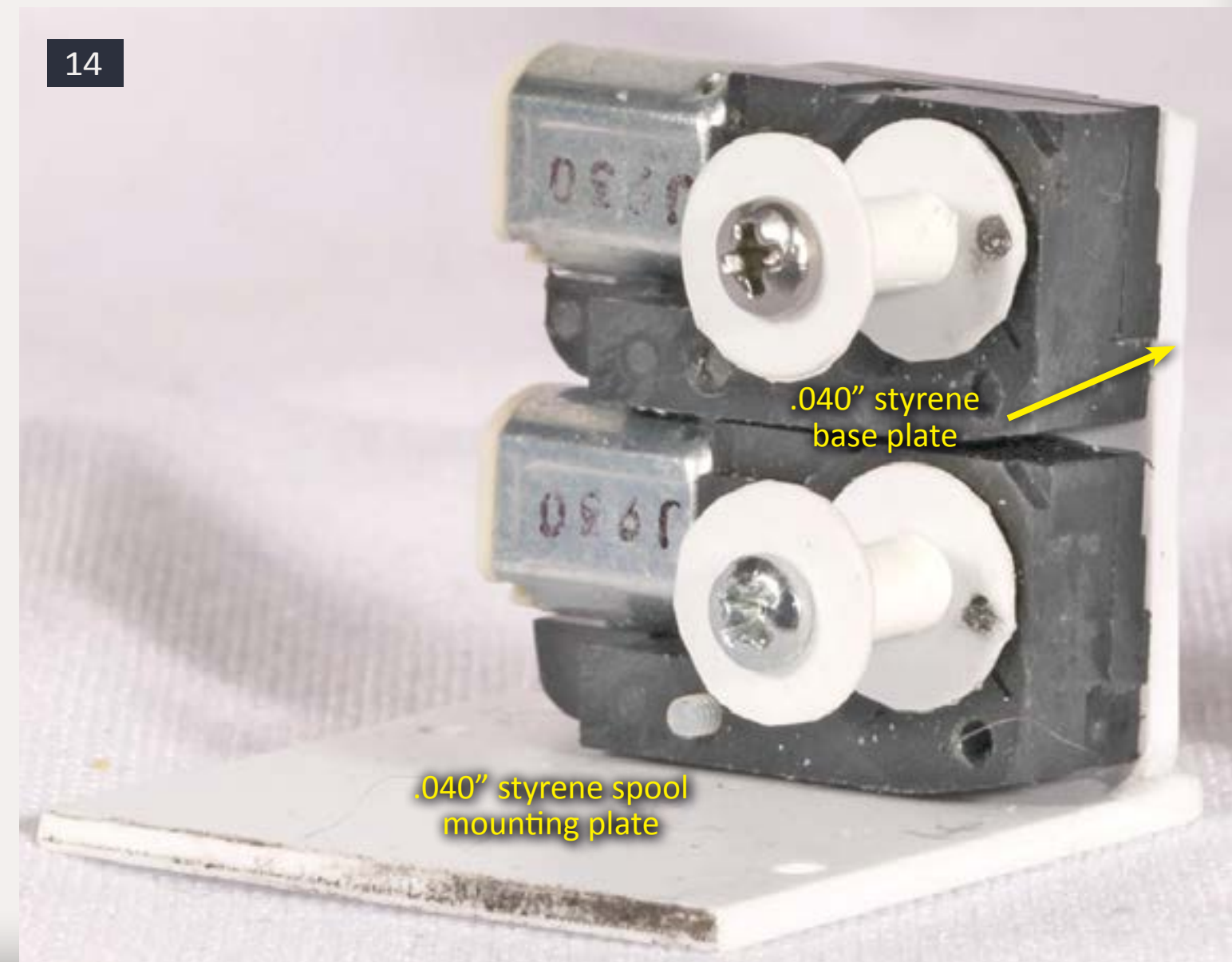

Dual cable spools, one for the boom, the other for the hook.

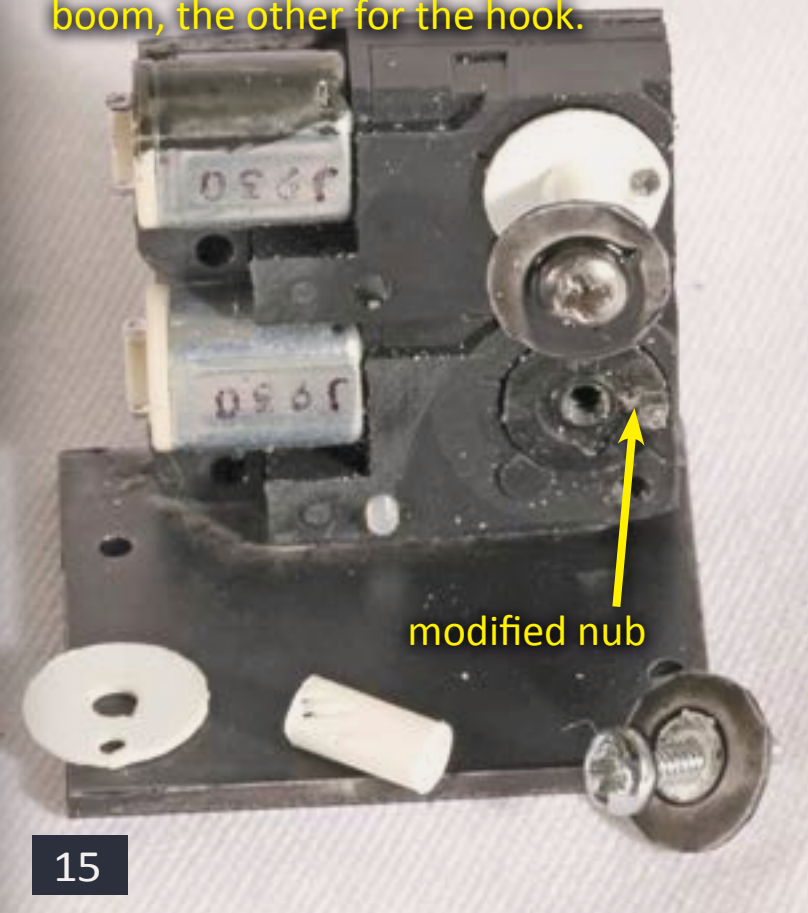

15

Three 12-volt relays

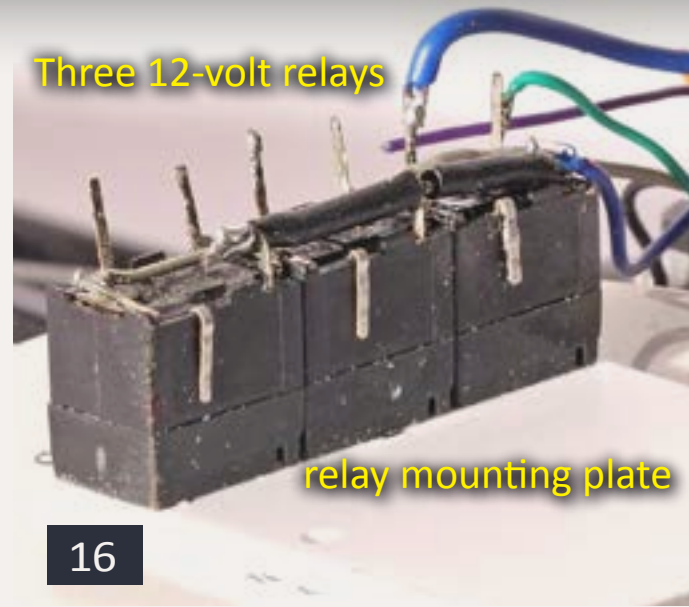

relay mounting plate

16

15: Drive spool parts.

16: Motor control relays mounted on bottom plate.

17: Mechanical assembly with cab floor, motors, relays, boom, and sound decoder.

and mounting plate together so I don't have to overtighten the 2-56 mounting screw (likely stripping the threads in the shallow hole).

The relay assembly and the motor assembly are screwed to the floor assembly of the cab to facilitate disassembly if needed. If you glue the plates to the cab floor, only glue them to one half of the floor so you can still separate the floor halves if needed.

I found that nylon thread was best (strong and flexible) for the boom and hook cables. I used lighter thread for the hook than for the boom – this was important since the metal hooks

are not very heavy and they need to put tension on the "cables" to keep them taut. The hooks were attached normally (via Athearn instructions), but I made sure the routing back to the take-up spools was smooth and unobstructed. I added a small piece of tubing between the boom beams to widen the take-up path for the main hook. This prevented the main hook cables from twisting together when the hook was raised or lowered.

I attached the cables to the spools by loosening the spool assemblies, winding the thread around the screw once between the sleeve and the end disk, then retightening the screw to hold it

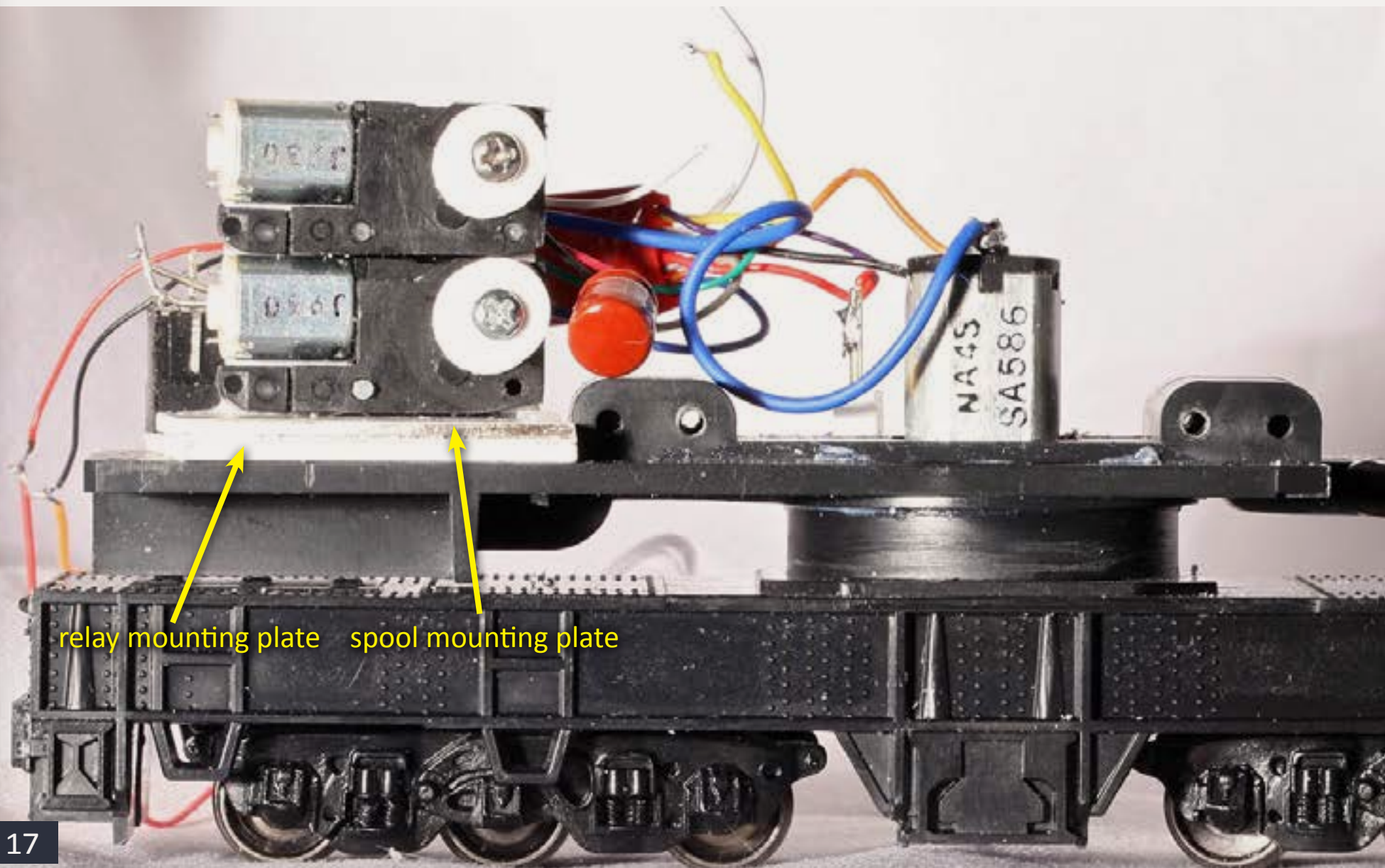

17

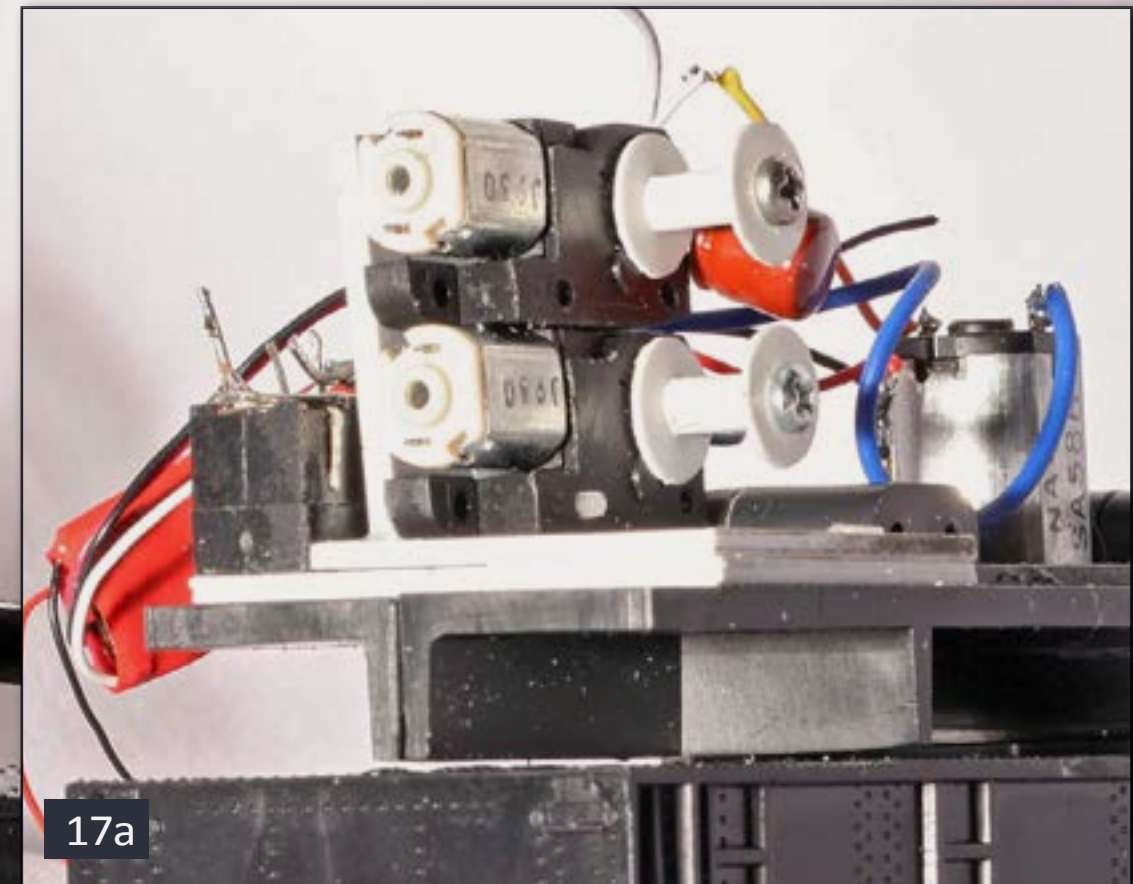

17a

in place. I applied power to the spool motor while applying a little tension to the thread to wind it onto the spool.

Wiring

The wiring is straightforward, even though figure 18 makes it look complicated. A Digitrax SDN144PS sound decoder is the heart of the crane.

The “throttle” controls the speed of rotation, boom, or hook movement after connecting that motor to the decoder using F1, F3, or F4.

Note: I remapped the function output wires of the SDN144PS using configuration variables.

I custom programmed the decoder with prototype crane recordings (mostly taken from a Southern Pacific 120-ton

crane at [Antique Powerland in Brooks, Oregon](#)) for all decoder sounds.

Because space in the crane’s cab is at a premium, I removed the eight-pin plug from the decoder and soldered wires directly to it to save precious space.

The F0 output (white wire) drives the two front spotlights wired in parallel and fed through a CL25 current regulator. The two LEDs are wired in

parallel and share the 25ma equally. Operating them at 12.5ma reduces the brightness, but these are still very bright 0603 sunny white LED’s.

The other three decoder functions (Yellow, Green and Violet) power very small, single pole double throw (SPDT) 12-Volt relays (from All Electronics www.allelectronics.com/make-a-store/item/RLY-616/MICROMINIATURE-12-VDC-SPDT-RELAY/1.html). When a function is activated (F1,F3,F4), the corresponding relay connects the decoder’s motor control output (gray wire) to the appropriate motor.

The maximum motor speed (output power) should be limited to avoid burning out the tiny 5-volt motors. I did this using decoder CVs but putting a current limiting resistor in series with the motors would also work. Yes, I learned to limit the motor power the hard way – after I burned out one of the larger cab rotation motors!

To make the sound audible, I mounted a 0.75” 8-ohm speaker in the bottom of a cut off pill bottle, sealing it with glue. This enclosure, albeit crude, vastly improves the sound quality. I finished it by painting it black.

I needed two more functions to activate the rear light and the under-boom utility lights. A Digitrax TF4 function-only decoder programmed for the same DCC address filled the bill. I was using F5 for my bell so the TF4 was programmed to respond to F6 and F7. I used the Yellow (F6) and

Crane Wiring

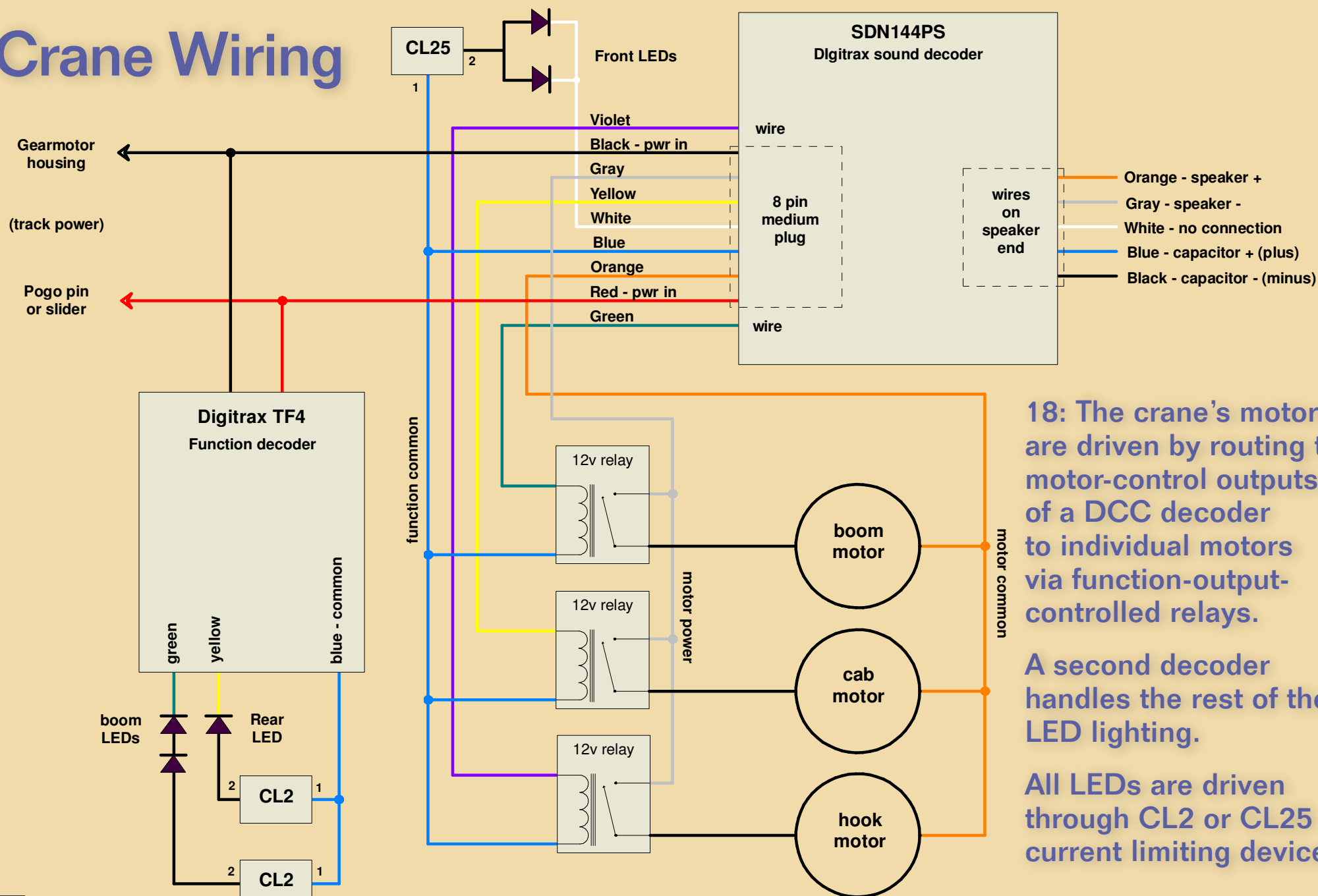

18: The crane’s motors are driven by routing the motor-control outputs of a DCC decoder to individual motors via function-output-controlled relays.

A second decoder handles the rest of the LED lighting.

All LEDs are driven through CL2 or CL25 current limiting devices.

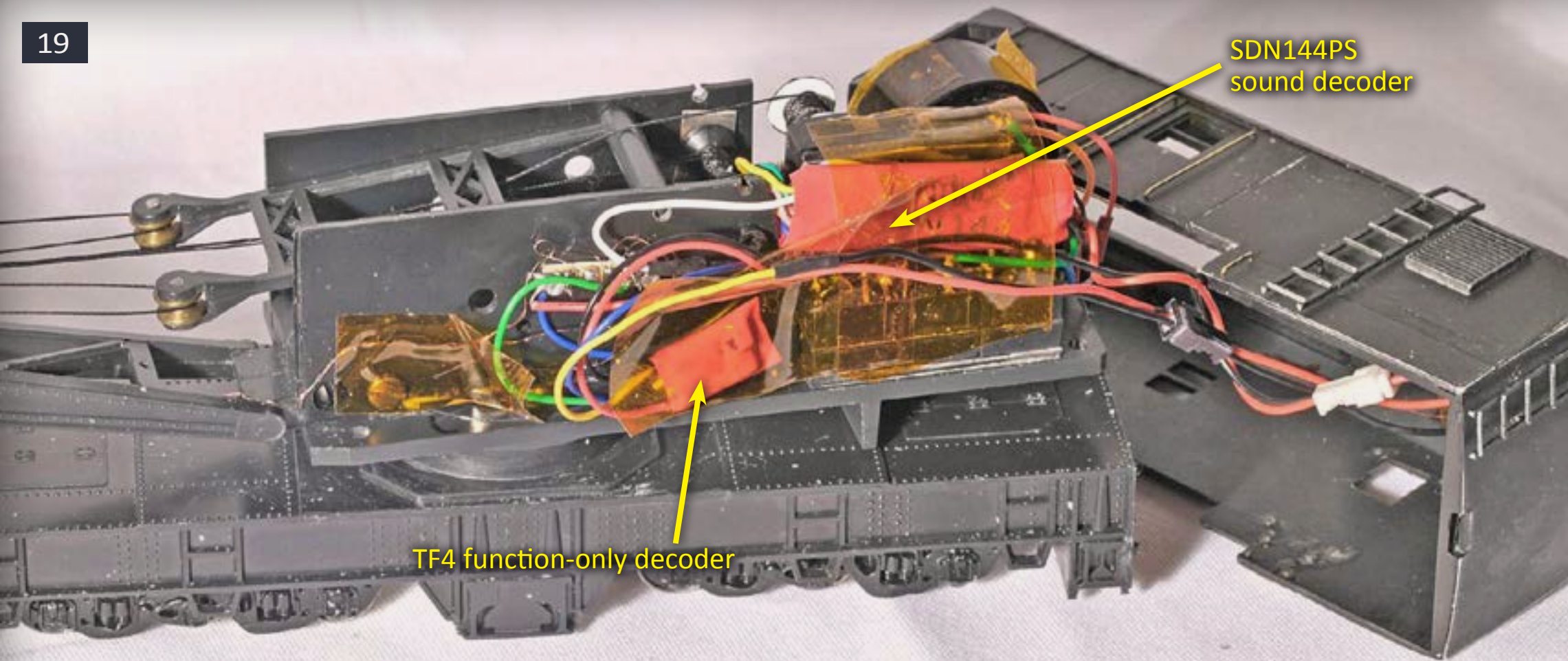

Figure 19: Decoders and other wiring shoe-horned into the crane's cab. Geoff was very careful to keep the wiring from fouling the cables that raise and lower the boom and hook.

Green (F7) wires for the rear and boom lighting (19).

Program the two decoders separately, then double check them BEFORE soldering them in place. Because their addresses are set the same, once connected to the same track power wires they can't be individually programmed.

The orange and gray motor-power decoder wires are connected to the cab rotation, boom, and hook motors through the relay contacts.

Depending on how you program your decoders, this may preclude your ability to read the value of a CV. Set it up correctly before assembly and test them out first. Note also that the

two boom lights are 0603 LED's wired in series, this time, driven by a 20ma CL2 current regulator. (See my article in the [February 2012 Model Railroad Hobbyist](http://model-railroad-hobbyist.com/magazine/mrh-2012-02-feb/points_of_light) (model-railroad-hobbyist.com/magazine/mrh-2012-02-feb/points_of_light). This lights each LED at its maximum operating 20ma current, regardless of voltage, yielding bright lighting – just the way I like them (20).

The wire feeds to the forward and rear lights on the cab shell are run through two 2-pin 2mm tiny male/female connector pairs, to make disassembly and maintenance easier. The fine magnet wires require gentle handling. Once in place, I secured the wires and decoders with pieces of Kapton tape (21).

Throughout the project I thought that I would simply glue the secondary hook (the small front hook) in place since I didn't intend to power it. As it turned out, all animation assemblies fit outside of the original Athearn mechanisms for the boom and hook spools. So I reassembled the original sides and added one of the original Athearn spools for the front hook, which I could manually adjust for desired hook placement.

Other Cab and Boom Mods

Cranes were non-revenue equipment and were usually assigned to railroad division maintenance sections. They sometimes received some very rough treatment, and often were repaired locally. Patches, window and door replacements, and other



Geoff Bunza started as a model railroader when he received a Mantua train set for Christmas, at age 6. He fed his interests through college becoming a member of the Tech Model Railroad Club (TMRC) at MIT and getting four degrees in Electrical Engineering. He has collected Lionel HO trains for many years, which spawned his interest in realistic animation and lighting.

He models the New York Central (he's a member of the NYC Historical Society) and sometimes the Great Northern, paying little heed to timeframe. On occasion, Geoff reverts to HOn30 modeling of strange, narrow critters from the woods of Maine.

Geoff has been diverted from model railroading over the years by engineering and management challenges in computer design, automatic test systems, electronic design automation, and starting five companies. He is blessed with his wife, Lin, in marriage for 33 years and their two terrific sons. He is a life member of the NMRA.

customizations were common. I have yet to find pictures of two similar cranes exactly alike owned by the same railroad. So there is plenty of leeway for detailing.

My first attempt to test the mechanism caused the crane tip over backwards from the added weight of the electronics in the rear! So I added lead counterweights with

double-sided tape and ACC glue to the front inside cab walls, being careful not to block the windows (20).

The very front top window was filled in on the right (typically engineer's) side. Vertical window mullions were cut out as well as some horizontal ones (see photos).

Louvers were added to both sides towards the rear, as well as a small

hatch and whistle on the roof. Handrails and grab irons were fashioned from .015" brass wire. The entire rear wall was sanded smooth and covered with a sheet of .005" styrene (23).

The left rear side was sanded smooth and likewise covered, reshaping the lower outline to one which appeared to be more commonplace to me. Ladders were also added to the left and rear sides (24).

20: The in-cab wiring. Note the generous amounts of Kapton tape holding things in place.

21: Other side view of the cab wiring showing the 3/4" speaker's home.

22: Counterweights added to the front of the cab balance the weight of the electronics.

23: Modifications to the right side of the cab.

20

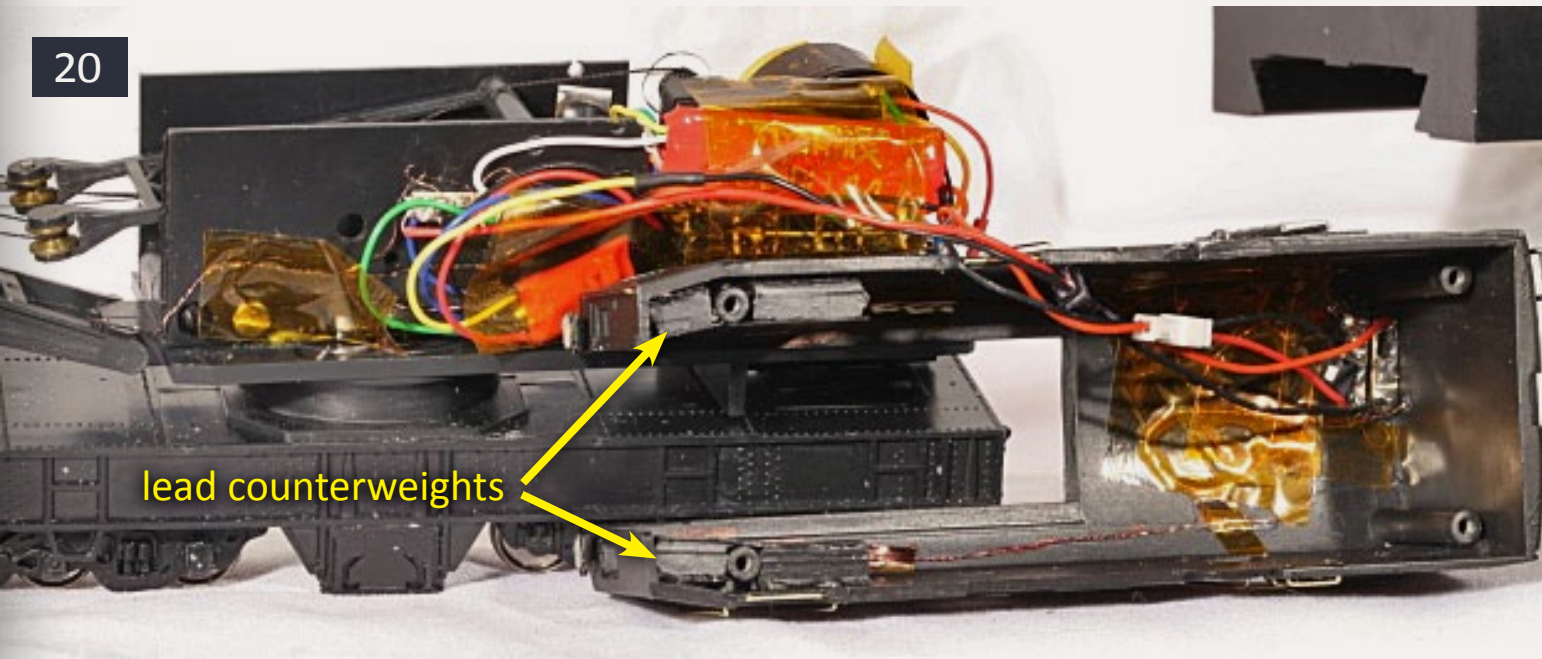

lead counterweights

21

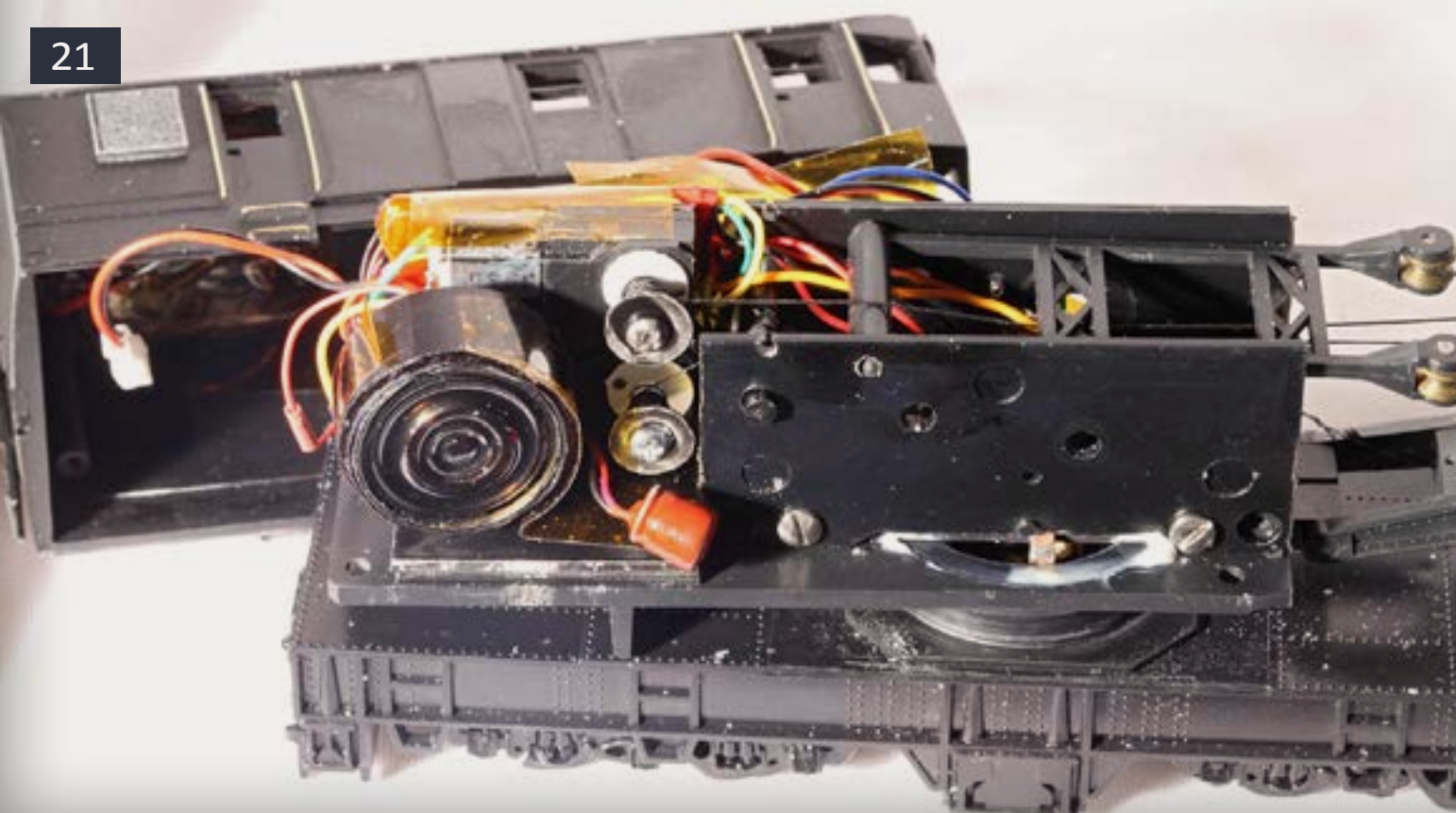

22

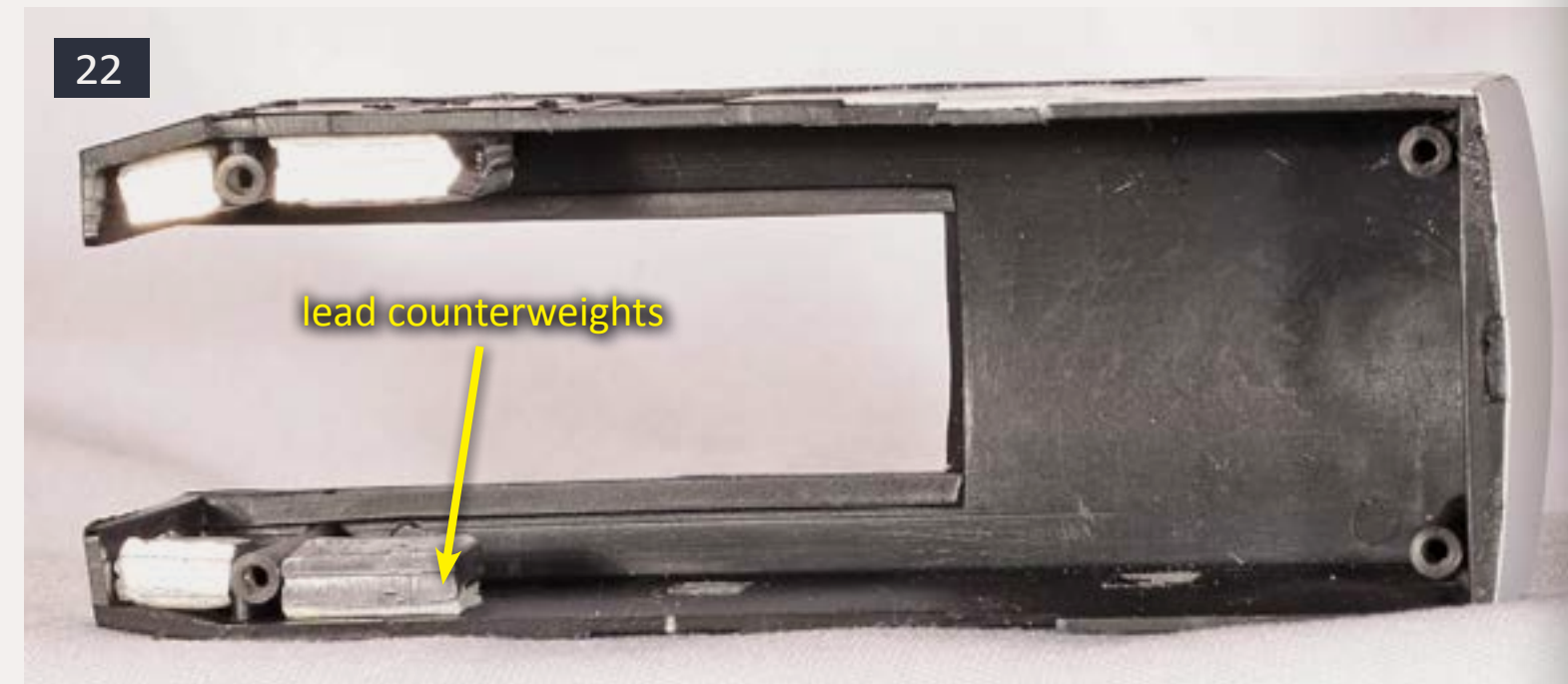

lead counterweights

23





24: Modifications to the left side of the cab.

25: A front light mounted on the cab.

26: Rear lighting – a 0603 sunny white LED in a housing.

27: Head lights in their housings.

Holes were drilled to mount the front spotlights and handrails. The Cal-Scale #190-304 Light-Switcher casting is a very close representation to several that I have seen mounted on cranes (25).

The rear light is a Cal-Scale 190-413 Modern GE 44 tonner light mounted in a short section of plastic tubing. Each casting is drilled for the 38-gauge wires of the pre-wired 0603 sunny white LEDs (available from Ledbaron (stores.ebay.com/ledbaron)).

I painted the reflectors bright silver and glued the LED in place on an insulator of painted paper with canopy glue. White glue, Krystal Kleer, or watch crystal cement would also work as they all dry clear. Each light then was covered with a punched

out cover of untreated .005" clear styrene. I also used the clear styrene to glaze the windows. They received a spray of Dullcote before installation to give them a uniform "dirty" look (27).

The crane boom received lead weights. They were cut to fit just behind the main hook pulley (28) and glued in place with ACC and painted. This provided additional counterweighting of the cab, but more importantly put tension on the boom-lifting cables.

I added two boom work lights using [Tichy](#) lamp shades and 0603 golden white LEDs (29). I selected LEDs with a warmer yellowish tint to match the prototype's incandescent bulbs in a reflector.

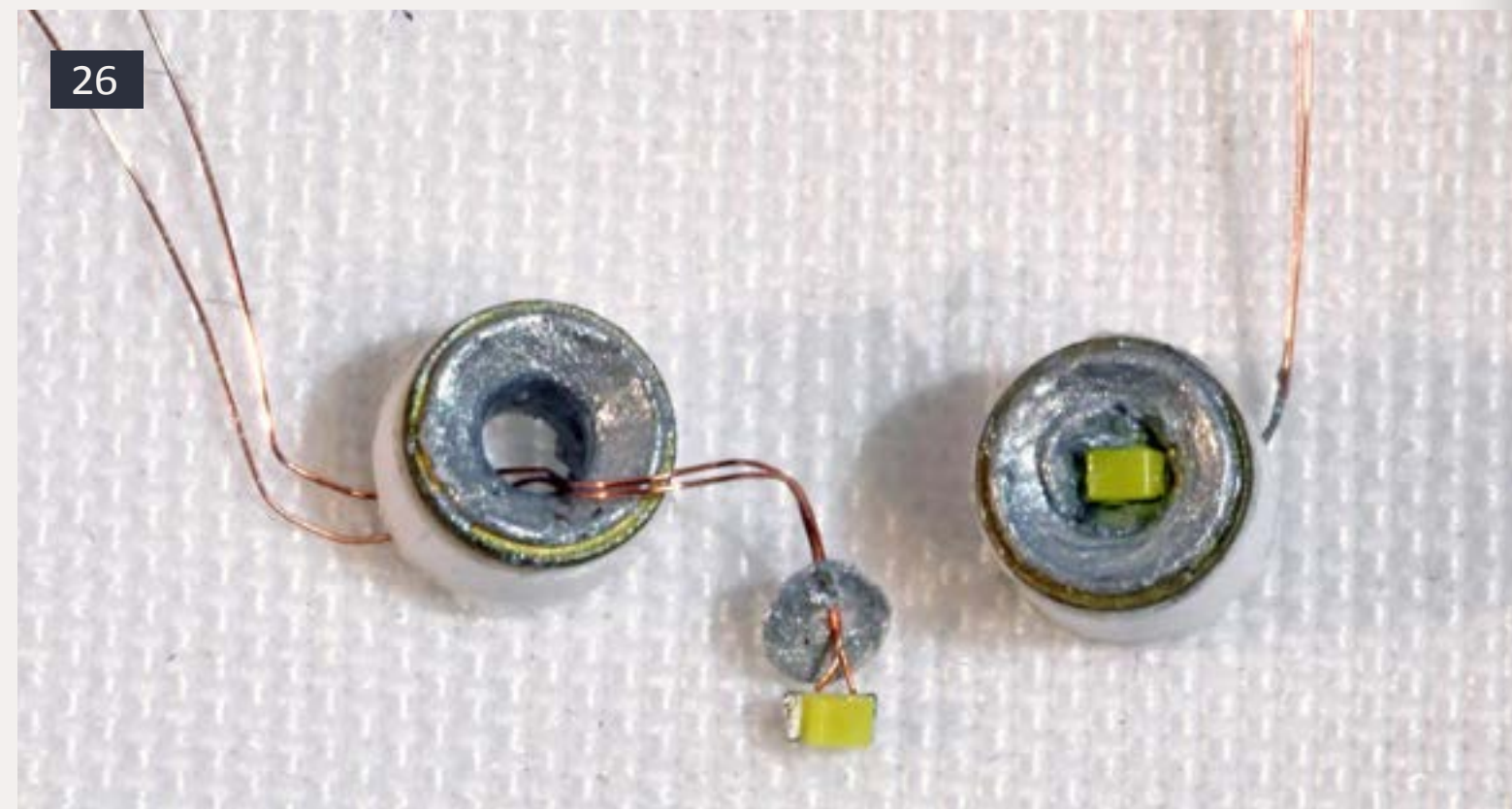

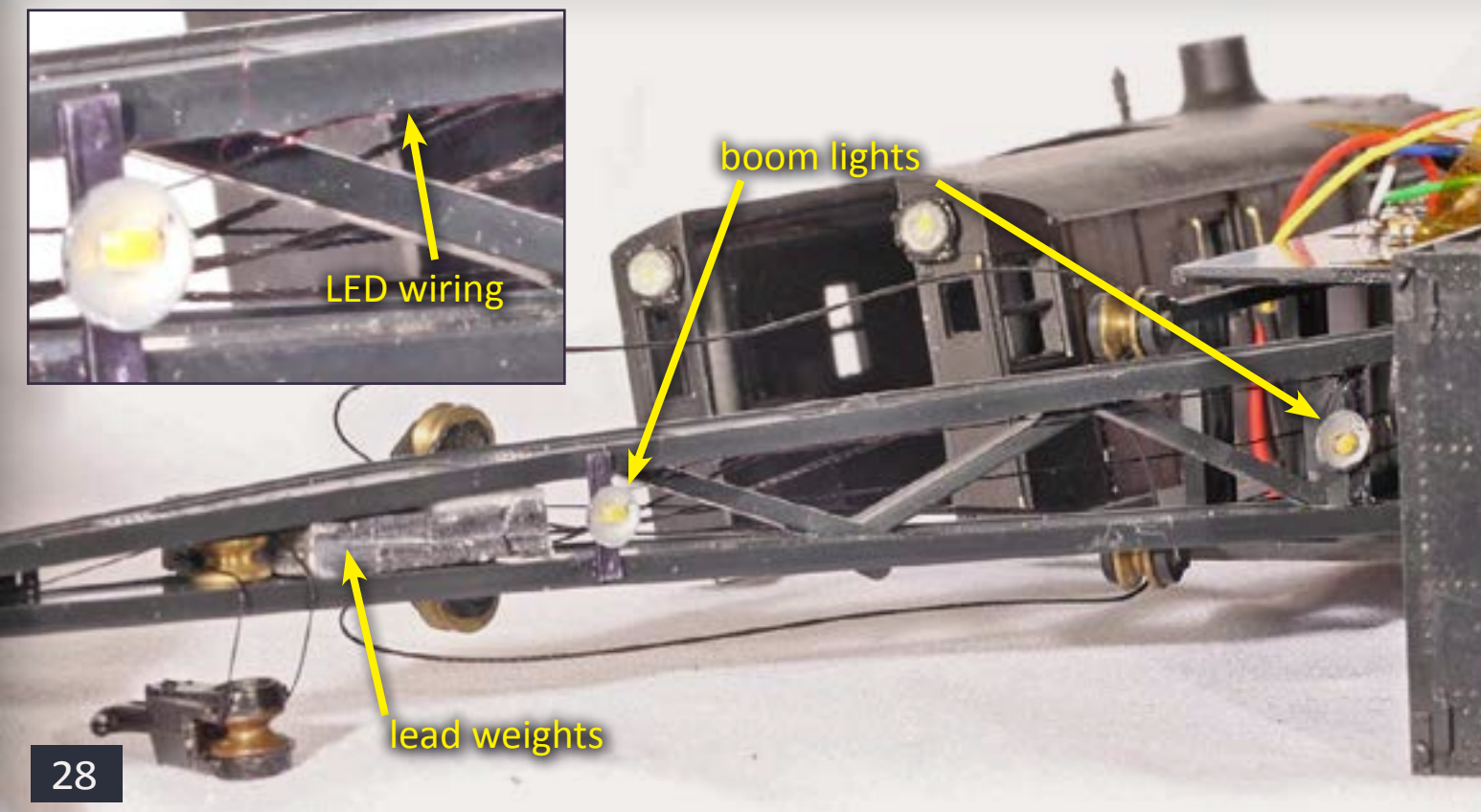

28

28: The weighted boom with lights.

29: Boom lights.

30: The assembled crane with its tender – Charlie Comstock photo

The forward boom light was mounted on a painted plastic strip and glued to the bottom of the boom. The other light was directly glued to the boom. I twisted the tiny LED lead wires together and ran them along the bottom of the boom

to the cab, spot gluing them in three places. A coat of paint further disguised the wiring.

Once assembled and painted the crane was starting to look good (30).

Giving the Crane a Voice

Sound decoders are produced by several manufacturers. I settled on the [Digitrax SDN144PS](#) as sound decoder for this project. It fit in the limited cab space and is completely programmable when it comes to sounds – both the sounds themselves and their sequencing. It would have been perfect if it had two more functions. Oh well, I used a [Digitrax TF4](#) decoder to solve that issue.

My attempt at sound decoder programming was greatly simplified by the use of a freely available program named SPJHELPER developed by Fred Miller

(fnbcreations.net/spjhelper/index.html). I highly recommend it as Fred has done a remarkable job. You will need a Digitrax PR2 or PR3 to load the sound program and sound recordings with the Digitrax Soundloader that SPJHELPER creates. The details of sound sequencing and programming are beyond the scope of this article but some basic information is present in the sidebar Programming the Digitrax sound decoder.

The SPJ program sequencing is shown in the Sound Sequencing sidebar and my complete sound project (including SPJ file) may be [downloaded here](#).

I edited recordings of several 120-ton steam cranes for use in my sound project (see the Sound Sequencing sidebar). Sounds include background steam hiss, mechanical linkages, gear



29



30

rattles, pumps, and a single-chime, triple-toot whistle.

The sounds are coordinated with function key presses for cab, boom, and hook movements. The throttle controls the speeds. If a function key is pressed and the throttle is set to zero, no additional engine sounds are generated.

Functions are assigned as follows:

- F0 – Front spot lights
- F1 – Select cab rotation*
- F2 – Whistle (Always a triple toot)

- F3 – Select boom motion*
- F4 – Select hook motion*
- F5 – Bell
- Boom lights
- Reverse light
- F8 – Mute

* F1, F3, and F4 select which feature of the crane will move. Actual movement is controlled using the throttle.

The large number of CVs involved suggests using software such as Decoder Pro to set their values (31).

The sound files were custom made for this project using Fred Miller’s Sound Project software.

Project Cost

The major costs for this project were:

- DCC decoders – about \$61
- Gear motors – less than \$20
- Other parts – less than \$20

If you don’t have the ability to program the decoders yourself, paying someone else will increase costs.

You could simplify this project (and save a few \$\$) if you use one function key to turn on all the lights and omit the TF4 decoder. You could also eliminate the boom lights, or the main hook motion control to simplify the project.

Crane Technique

I love to watch the crane in action. I run it around my layout coupled to its boom tender car (33 and 34). Once at the “wreck site”, I raise the boom and turn the cab 180° so the boom extends

Decoder Configuration

I set up the crane’s decoders with the configuration values (CVs) shown in the two tables to the right.

Due to the large number of CVs using computer software (such as DecoderPro from the [JMRI – Java Model Railroad Interface – group – jmri.org](http://www.jmri.org)) is a good idea. This software will remember the CV settings making it easy to reprogram a decoder should it lose its memory or if you decide to build a second crane.

Decoder Pro is free but you’ll need an interface for your computer to talk to your DCC system. Unfortunately, not all DCC systems support such an interface. Digitrax and NCE do.

Digitrax SDN144PS (sound decoder):
ID: NYC_X-24 DCC Address: 24

CV	Value		CV	Value		CV	Value		CV	Value	
	Dec	Hex		Dec	Hex		Dec	Hex		Dec	Hex
1	24	18	39	0	00	71	44	2C	94	251	FB
2	3	03	40	0	00	72	53	35	95	128	80
3	0	00	41	0	00	73	62	3E	105	0	00
4	4	04	42	0	00	74	71	47	106	0	00
5	92	5C	49	0	00	75	80	50	132	64	40
6	47	2F	50	0	00	76	89	59	133	63	3F
7	16	10	51	0	00	77	98	62	134	32	20
8	129	81	52	0	00	78	107	6B	135	0	00
9	0	00	54	80	50	79	116	74	140	50	32
11	6	06	55	128	80	80	125	7D	141	28	1C
16	0	00	56	80	50	81	134	86	142	5	05
17	0	00	57	6	06	82	143	8F	143	35	23
18	0	00	58	15	0F	83	152	98	145	48	30
19	0	00	60	0	00	84	161	A1	146	36	24
21	0	00	61	0	00	85	170	AA	147	64	40
22	0	00	62	0	00	86	179	B3	148	64	40
29	3	03	63	0	00	87	188	BC	149	30	1E
33	1	01	65	2	02	88	197	C5	150	9	09
34	1	01	66	128	80	89	206	CE	151	12	0C
35	2	02	67	8	08	90	215	D7	152	38	26
36	0	00	68	17	11	91	224	E0	153	5	05
37	4	04	69	26	1A	92	233	E9	154	60	3C
38	1	01	70	35	23	93	242	F2	155	0	00

Digitrax TF4 (function only decoder):
ID: YC_X-24_TF4 DCC Address: 24

CV	Value	
	Dec	Hex
1	24	18
7	254	FE
8	129	81
17	0	00
17	0	00
18	0	00
29	6	06
49	0	00
50	0	00
54	64	40
61	0	00
62	0	00
63	0	00
64	2	2

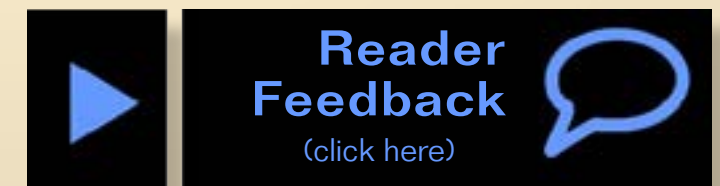

beyond the end of the train and is ready for work.

Don't forget to blow the whistle before any major movements to warn the crew for safety's sake!

Enhancements

A crane could be placed at a wreck site, and computer control could wake it up from time to time, swinging the

boom around. Couple it to a loco and have it move the crane around, working to "clear" the wreck.

If you can find out how to add another motor and relay the secondary hook could also be raised and lowered.

I'm considering adding someone shouting "Take it easy!" or "That'll do!" – perhaps after a long motion. Coordinated

movement at the door of the boom tender facing the crane is also possible. A figure could open the door and shout "Watch out!" to the crane operator. Or a man on the ground could have his arms move to guide the crane operator.

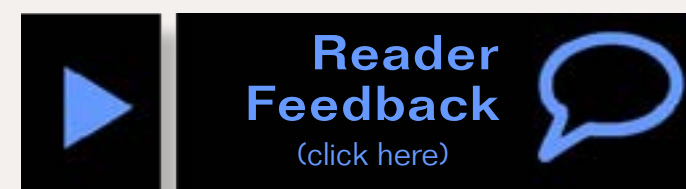

Come up with some other additions to bring your own wrecking crane to life and keep your right-of-way clear!

"I love animating things and couldn't resist bringing the motionless and silent crane in my rail yard to life."

Sound Sequencing

Sound sequence summary. Click [here](#) to download the complete set of sound sequencing files.

Events in Voice 1

```
E:0 Trigger when FKey 8 Turn On
Set Mute ON
=====
E:1 Trigger when FKey 8 Turn OFF
Set Mute OFF
=====
E:15 Trigger when FKey 1 Turns ON
Test Memory Slot 0 for 1
Branch to Tag No. 1
Set Volume by value in CV 140
Play Sound Clip 4 Looping
Play CraneBoomEnd.wav Once
Set a Tag No. 1
=====
E:8 Trigger when FKey 3 Turns ON
Test Memory Slot 0 for 1
Branch to Tag No. 0
Set Volume by value in CV 140
Play Sound Clip 4 Looping
Play Sound Clip 1 Once
Set a Tag No. 0
=====
E:11 Trigger when FKey 4 Turns ON
Test Memory Slot 0 for 1
Branch to Tag 2
Set Volume by value in CV 140
Play Sound Clip 4 Looping
Play Sound Clip 1 Once
Set Tag 2
```

Events in Voice 2

```
E:3 On Power Up
Enable Motor
Set Timer 1 by CV144
Set Memory Slot 0 to 0
Set Timer 2 by CV151
=====
E:2 Trigger when Moving Turns ON
Set Memory Slot 0 to 1
=====
E:7 Trigger when FKey 2 Turns ON
Set Volume by value in CV 147
Play Sound Clip 10
Play Sound Clip 11 Once
Play Sound Clip 12
=====
E:10 Trigger when Moving Turns OFF
Set Memory Slot 0 to 0
=====
E:9 Trigger when Power While ON
Set Volume by value in CV 149
Play Sound Clip 16 Once
```

Events in Voice 3

```
E:6 Trigger when FKey 5 While ON
Set Volume by value in CV 146
Play Sound Clip 9
Delay per value in CV 150
=====
E:4 While Timer0 is On
Set Timer 0 by CV142
Set Volume by value in CV 143
Play Sound Clip 5 Looping
Set Timer 0 by CV141
=====
E:5 While Timer1 is On
Set Volume by value in CV 145
Play Sound Clip 13 Once
Play Sound Clip 14 Once
```

```
Play Sound Clip 14 Once
Play Sound Clip 14 Once
Play Sound Clip 14 Once
Play Sound Clip 15 Once
Set Timer 1 by CV144
=====
E:12 While Timer2 is On
Set Volume by value in CV 153
Play Steam_blow_run.wav
Play Sound Clip 0 Once
Play Steam_blow_run.wav
Set Timer 2 by CV151
=====
E:13 Reset CVs when Decoder Reset
Set CV 132 to 64
Set CV 135 to 0
Set CV 139 to 31
Set CV 140 to value 50
Set CV 141 to value 28
Set CV 142 to 5
Set CV 143 to 64
Set CV 144 to value 37
Set CV 145 to 64
Set CV 146 to value 50
Set CV 147 to value 55
Set CV 148 to 64
Set CV 149 to value 30
Set CV 150 to value 9
Set CV 151 to value 12
Set CV 153 to value 64
```

CVs Used

```
CV8 - Default Reset [9]
CV58 - Master Vol 0-15 [15]
CV60 - Sound Scheme [0]
CV132 - Notch Rate [64]
CV135 - Mute Volume [0]
CV139 - Distance Gauge [31]
CV140 - Chuff Volume [50]
CV141 - Compressor Cycle Time [28]
```

```
CV142 - Compressor Run Time [5]
CV143 - Compressor Volume [64]
CV144 - Water Pump Cycle Time [37]
CV145 - Water Pump Volume [64]
CV146 - Bell Volume [50]
CV147 - Whistle Volume [55]
CV148 - Blow Down Volume [64]
CV149 - Boiler Volume [30]
CV150 - Bell Rate Delay [9]
CV151 - Hiss Cycle Time [12]
CV153 - Compressor Volume [64]
```

Function Keys Used

```
F1 - Cab
F2 - Whistle
F3 - Boom
F4 - Hook
F5 - Bell
F8 - Mute ON/OFF
```

Sound Files Used

```
Clip#0 - Silence
Clip#1 - CraneBoomEnd.wav
Clip#2 - Steam_blow_run.wav
Clip#4 - CraneBoom.wav
Clip#5 - Steam_airpump.wav
Clip#9 - CraneBell.wav
Clip#10 - CraneWhistleStart.wav
Clip#11 - CraneWhistleRun.wav
Clip#12 - CraneWhistleEnd.wav
Clip#13 - Steam_water_start.wav
Clip#14 - Steam_water_run.wav
Clip#15 - Steam_water_end.wav
Clip#16 - CraneIdle.wav
```

Programming the Digitrax Sound Decoder

Reprogramming a Digitrax SDN1144PS sound decoder is possibly a little beyond the comfort zone of many model railroaders.

- The “normal” set of control variables (CV’s) must be set. Remember, there are two decoders with the same decoder address in the crane. Most functions are re-mapped. For example, the yellow wire of the SDN1144PS is normally connected to a backup light – because I use this wire to select cab rotation I reprogrammed it to respond to F1 – much more convenient.
- New, crane appropriate sounds, must be created for the decoder. This requires a source of sounds (I used my own and Youtube video/audio snippets) and sound editing software to trim the samples and apply noise reduction, emphasis, and volume adjustment. The files are saved in 11.0 kHz, 8 bit, mono .WAV format.
- Sounds must be provided for all functions (boiler background, mechanical/gear sounds, steam hiss, single chime whistle, and bell. Many sound decoders don’t allow reprogramming all of these.
- Sounds and actions must be sequenced – this works with the

remapped functions and multiple sound files. In some cases, such as mechanical movement, sound generation depends on motor speed.

The Digitrax SDN144PS decoder makes all of this possible (many other sound decoders don’t allow this level of reprogramming). It has three voices, each of which can independently play a sound in a prioritized sequence!

I have not mastered sound sequencing, but Fred Miller’s SPJHelper tool (fnbcreations.net/spjhelper/index.html) made it a lot easier – if not possible. SPJHelper takes the sound files and an orderly, prioritized representation of the sound and function sequencing, reformats it all, and generates code for the microcontroller in the decoder. It outputs a Digitrax compatible sound project file (an .spj file) to the Digitrax Soundloader programmer for decoder programming via a PR3 interface.

This is a bit larger project than setting momentum CV’s and changing a decoder address. All my working files are available for [download](#) to give you a head start on your project.

Don’t let the challenge scare you off. This is a tremendous starting point for a myriad of fantastic scale model animation projects to come!



Check out the crane in action in this video!



33: Geoff detailed the crane’s tender with spare truck and miscellaneous stuff appropriate salvaging wayward freight cars – Charlie Comstock photo.

34 (next page): The wrecking train, loco, tender, and crane make an interesting addition to a layout – Charlie Comstock photo.



Enter
the MRH
contest!
Click here for details ...



Get great prototype info from
the people who lived it...

Join Today!

Regular memberships only \$39 per year.



Models by Jim Six, NYCSSH Member

Are you a fan of the New York Central? Are you interested in prototypical modeling? As a member of the New York Central System Historical Society, you will receive the **Central Headlight**, our quarterly, acclaimed magazine, and chat with NYC fans and modelers on our NYCSSH members-only Yahoo Group. You can attend our annual conventions, and benefit from the first-hand knowledge of former NYCS employees and from the expertise of NYC historians, researchers, modelers and writers who will help you with answers to questions about NYCS history, locos, rolling stock, structures, and operating practices. Modelers check out the **NYCentral Modeler** at http://www.nycshs.org/nycentral_modeler.php **Do it right! Join today!**

Visit our website and join today. <http://www.nycshs.org/>



NEW YORK CENTRAL SYSTEM

HISTORICAL SOCIETY, INC.

DEPT N • P.O. BOX 130 • GATES MILLS, OH 44040-0130

Want more in-depth videos from MRH staff and authors?

Then [click here](#) ...



model-trains-video.com

“Comprehensive package of ‘lead by example’ for the expert and the less-talented alike ... in-depth covering of all the disciplines involved in the hobby.”
— Andrew A.

A CTC-style Control Panel

Keeping a Traditional Look and Feel

– by Royce Brown

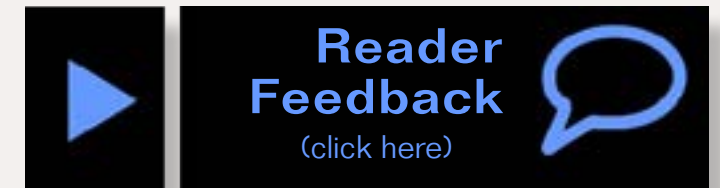

When faced with building a control panel for my layout's yard, I spent many hours deliberating alternatives. Many model railroaders use commonly available DPDT toggle switches to control turnouts. They can be located on a track schematic right at the position of the switch to be controlled.

But I started thinking a CTC style panel would be cool. Rix Products (rixproducts.com) makes CTC levers for switch machine control and I elected to give those a try. Control Train Components (ctcparts.com) also sells components that enhance the appearance and operation of model railroad CTC machines

Because the switch levers would be placed in rows and columns, similar to a CTC machine, reference numbers are needed to indicate which lever controls which switch. While this might be a bit less user friendly, I really like the Rix Lever2 (part # 628-0061) because to me, it looks much more "railroady". I've often envied those who have Union Switch & Signal or General Railway Signal style CTC machines to control their layout.

To make my CTC style control panel, I decided to place the track schematic

1. View of my CTC styled control panel.

1

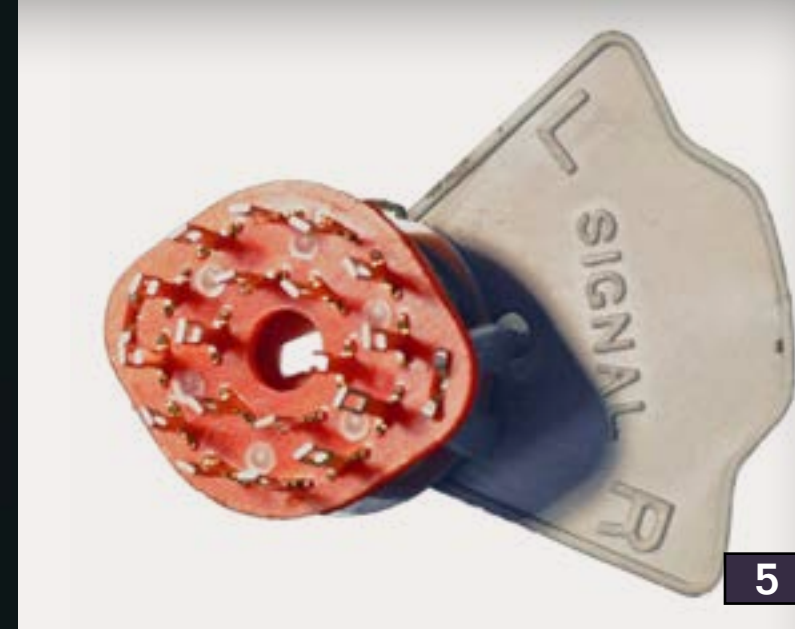

2. The front and sides of the panel enclosure are cut from a sheet of 1/8" Masonite.

3. CTC control levers on Royce's yard control panel with labels.

4. The painted bezel of a RIX CTC turnout control.

5. 6-pole 2-position rotary switches are used to control switch machines and signals.

6. Rotary switch wiring.

above the levers, somewhat like real CTC panels.

Trying to place the controls at the frog of the turnouts on the schematic would have greatly increased the panel size. I found that having a reference number at each turnout location on the schematic, and a corresponding number at the turnout control, turned out to be surprisingly easy to use (3).

Initially, I prepared a trial cabinet from 1/8" Masonite. Later, I planned to fabricate a permanent panel and cabinet from sheet metal. However, the masonite cabinet works well enough that I decided to make it permanent.

I painted it with a can of cheap spray paint that looked close enough to US&S green to suit me.

The RIX plastic legend plates come unpainted. One side is marked "switch" and the other is marked "signal" for those building a CTC machine. RIX recommends painting them glossy black, and letting them dry. Then lay them flat on fine grain sandpaper and gently move them in a circular motion until the paint is removed from the raised lettering (4). This leaves the lettering sharp and crisp.

The instructions included with the RIX kit specify rotary (wafer) switches with obsolete part numbers. After searching the catalogs of various electronics suppliers on the internet, I managed to find appropriate parts. Mouser Electronics (www.mouser.com) is the only supplier I found for 6-pole 2-position switches (5). The manufacturer is

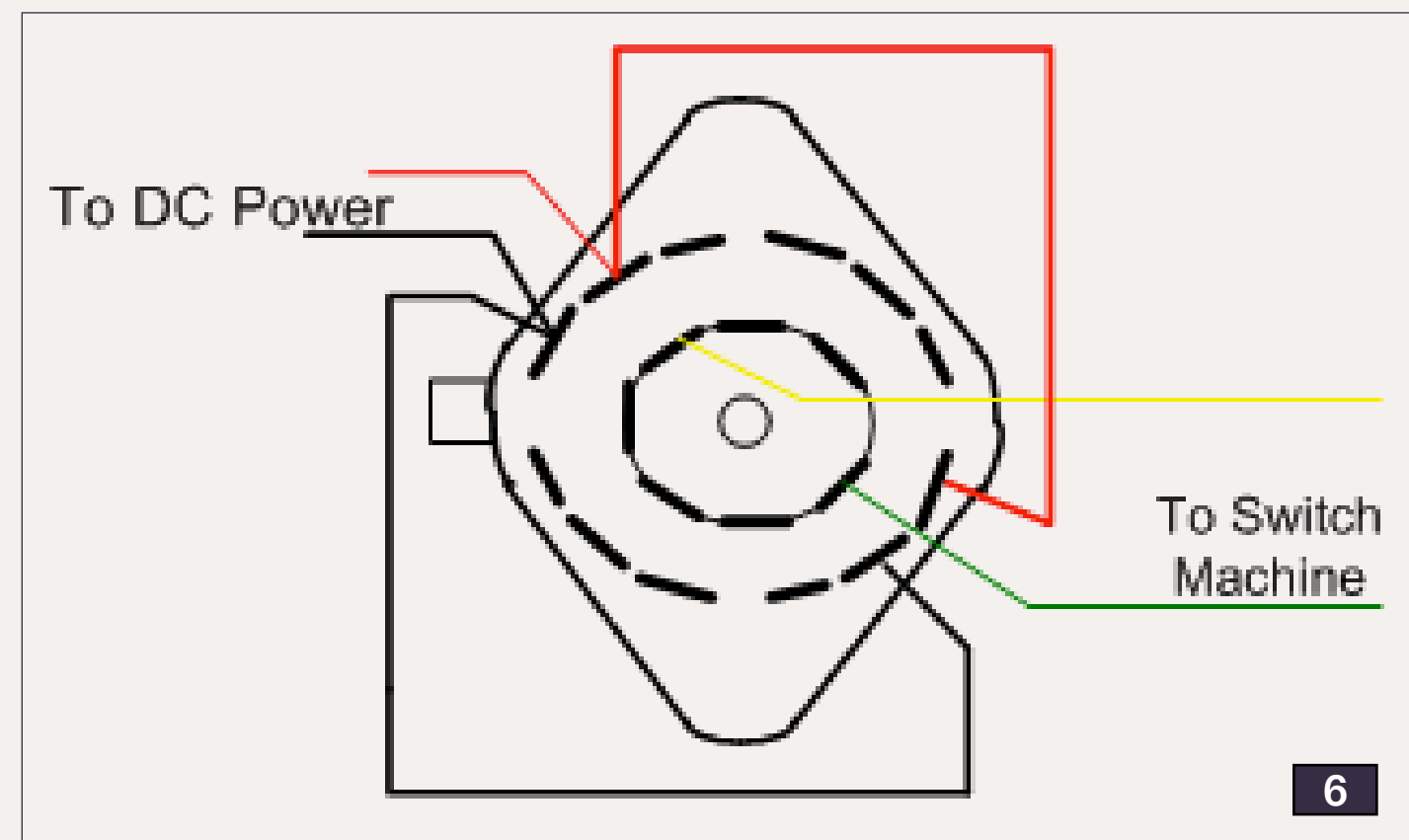

Alpha and the Mouser part number is [SR2511F-0602-19FOB-E9-N-W](http://www.mouser.com/ProductDetail/Alpha/SR2511F-0602-19FOB-E9-N-W).

The shaft has a flat milled on it – when viewed from the end, it has a 'D' shape. The RIX levers don't use set screws – an advantage because they won't get loose on the switch's shaft. The extra poles on the rotary switches could be used to activate signals or control panel LEDs.

I spent some time puzzling out which switch terminals to use to get the DPDT

operation needed to control my switch machines. Once I got it right, I made a drawing of the switch terminal wiring (6) and saved it for future reference. I figured there was little chance I'd remember how to wire these switches in the future. Now I just pull out the diagram and wire away.

Refer to figure 7 for switch installation. Insert the rotary switch through the panel, legend plate and steel washer and secure it in place with the hex nut.

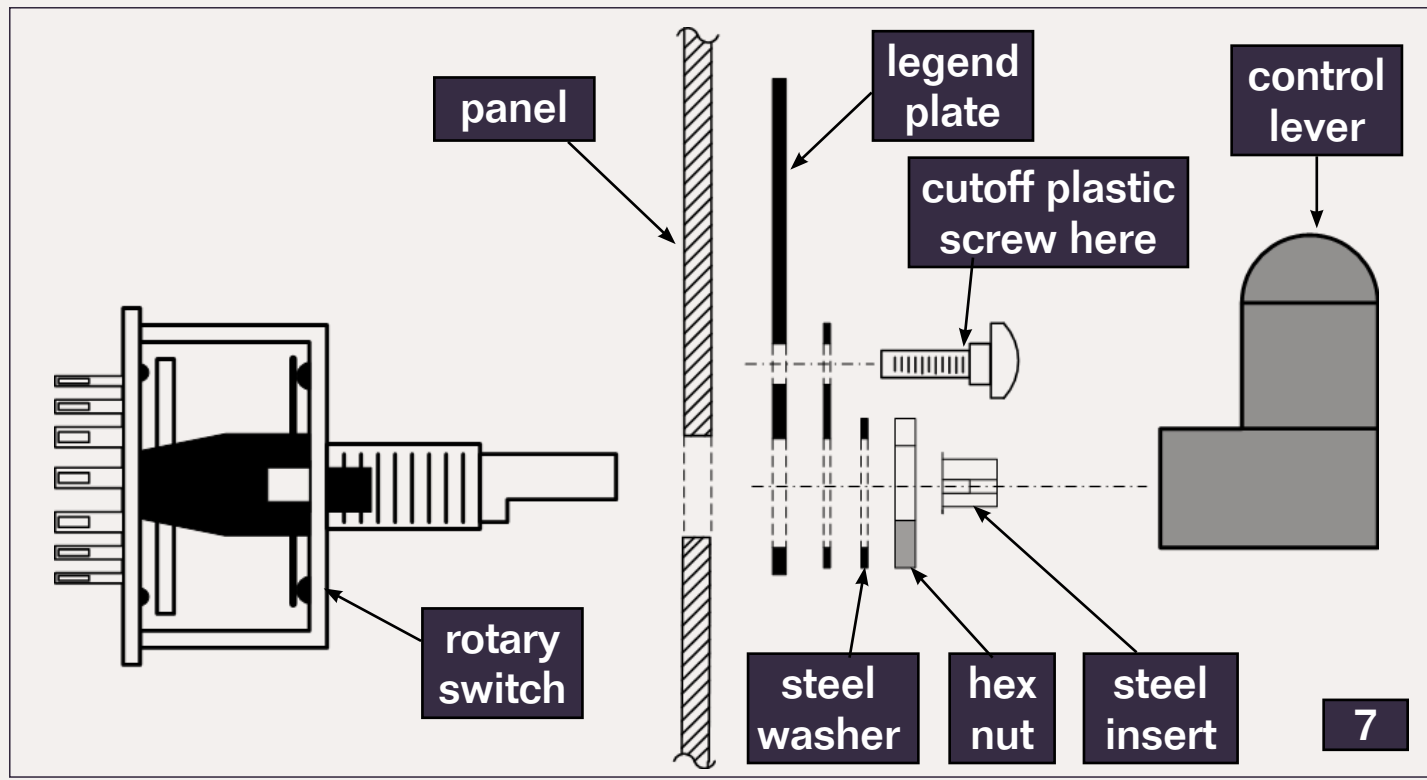

7. Exploded cross section view of the CTC switch assembly. From left to right are the rotary switch, control panel, legend plate, plastic screw, steel washer, hex nut, steel insert, and control lever.

Press the steel insert into the control lever body, then press that onto the rotary switch shaft. You'll need to do this a few times before you learn the correct rotary switch orientation to get the control lever to point the proper direction.

I want the control lever handle to indicate whether the turnout is set for straight ahead or for the diverging route. The "switch" legend plate is marked with an N (normal) and an R (reverse). N is used when the straight route through the turnout is selected. R (reverse) selects the turnout's diverging route.

After installing and wiring a turnout control, if the lever position is incorrect or doesn't match the turnout position, reverse the incoming DC power.

Using these switches and the RIX CTC levers are a little more costly than using DPDT toggle switches. Each RIX kit comes with enough hardware for two switch installations and is priced at \$9.95. Mouser charges \$2.77 per rotary switch for orders of 1 to 49 and the cost drops for larger orders. A DPDT toggle switch costs about \$4.

I'm thinking of buying a large quantity of these switches because in the digital age of push buttons and touch screens, rotary switches are quickly becoming "antiques."

I discovered another thing after I built the control panel. Since the switches aren't on the track diagram, the diagram stays cleaner – my panel has fewer dirty finger prints or smudges than some of my friend's



Royce Brown

Royce Brown got an American Flyer train set at age 7 and has been involved with model railroading since then. He's currently building an HO scale home layout based on the Frisco, and two On3 layout modules for the local narrow gauge group in the Norman, Oklahoma area where he resides. He's an electrical engineer with the US Department of Defense.

more conventional panels that use toggle switches.

What began as an experiment in control panel construction left me very happy with the results. My layout might not ever grow to the point of justifying a full-blown CTC machine, but I'm enjoying my CTC styled control panel. To me, it just makes it more "railroady", furthering my enjoyment of our hobby!

Reader Feedback
(click here)

Remember The Rock magazine

20-plus back issues!



◆ **Modeling articles in every issue**

◆ **Read how to operate like the real Rock Island**

ADVERTISEMENT

THE ROCK ISLAND MODELER

Modeling

mid 60s era Standard Wood Caboose

Modeling

all ROCK all the time!

Learn More

THE ROCK ISLAND MODELER

Modeling

A MUG ON A PLUG FIT FOR A SLUG

www.andoverjunction.com

Modeling a Modern Rebuild: Creating a Norfolk Southern GP38-3 from an Athearn GP50

– by *M.R. Snell*
Photos by the author



Follow the steps the Norfolk Southern took to update an old locomotive for local use ...

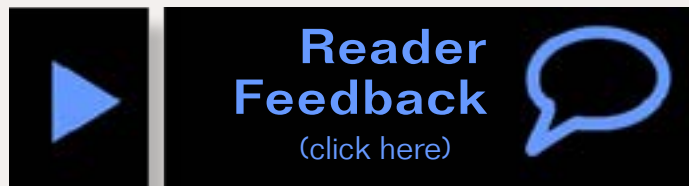

In-house locomotive rebuilding programs have been around for many years, prolonging the life of locomotives otherwise rendered obsolete. One such program is the GP38-3 rebuild program of the Norfolk Southern Railway. This downgraded GP50 road locomotives to GP38 standards, which made them suitable for local and switching duty. Between February 2004 and

April 2007, the NS Juniata Shops outshopped 37 units (NS 5801-5837), converted from 1980's era GP50 models originally purchased by the Southern Railway. During the conversion, the locomotives' 645F engines were converted to 645E specifications. Their turbochargers were replaced with blowers, and the control stands were changed from long-hood to short-hood forward operation.

As modelers we are less concerned with what's under the hood than the hood itself. The exterior modifications resulted in replacement of the high short-hood and locomotive cab with a low short-hood, and a new cab. The long-hood featuring the tall GP50 radiator grilles was retained. While rebuilding programs can dramatically change the look of a locomotive,

they can also result in more subtle changes. Less pronounced were modifications to the roof of the long-hood, including the removal of the middle radiator fan, conversion of the single exhaust stack to an air filter housing, and the addition of new exhaust stacks suited to the prime mover conversion.

Modeling a rebuilt locomotive such as the Norfolk Southern GP38-3 can be a fun project that will allow you to sharpen your kitbashing skills without requiring extensive experience. This makes it an excellent project for novice kitbashers. Let's follow along constructing NS 5804, a rebuilt GP38-3, by kitbashing an Athearn GP50 model.

The first step in modeling any locomotive is research. In our digital world,

firsthand access to a particular prototype is no longer necessary because researching particular locomotives or freight cars is as close as your fingertips using the Internet. Multiple websites provide extensive research material, including history and photos, which are necessities when modeling a particular prototype. In the case of Norfolk Southern rebuilds, a wealth of information can be found at the following websites:

Lance Myers' Altoona Works – altoonaworks.info

NS Locos.com – nslocos.com

Railroad Picture Archives – rrpicturearchives.net

Chris R. Toth's NS Locomotive website – nsdash9.com

1



2



STEP 1: Choosing a Suitable Model

The first step in a locomotive kitbashing project is to choose a suitable model as a starting point. In this case we're basing the model on a GP50. The Athearn GP50 will provide a suitable kitbasher-friendly model, which is available in R-T-R form. The older classic 'Blue Box' kits can still be found on hobby store shelves or at train shows, and both versions offer up a model that can be easily modified.



STEP 2: Disassembling the Locomotive

With our model chosen, we can now begin kitbashing, beginning with disassembling the Athearn locomotive. The model consists of two main components – the frame and a molded shell with a removable cab and dynamic brake blister. The first step is to remove the shell from the frame. Remove the handrails and couplers, then lift the shell from the frame while pressing inward on the mounting tabs located on the underside of the fuel tank. The cab can be removed by pressing inward on the cab mounting tabs while lifting the cab from the shell.



STEP 2: Disassembling the Locomotive *Continued ...*

Next remove the 'glass' insert from the cab, lift off the dynamic brake blister and weights from the molded shell, and remove the kickplates located along the locomotive's walkways. Press outward on the mounting pins, pulling them from the molded shell. These steps will leave a one-piece molded shell ready for modification.

In the case of the NS GP38-3, half of the changes have been done for us as the Athearn model is a low short-hood version rather than the high short-hood option favored by the Southern Railway. Since no major modifications are needed at the front of the locomotive, work can begin at the rear by removing the center radiator fan.

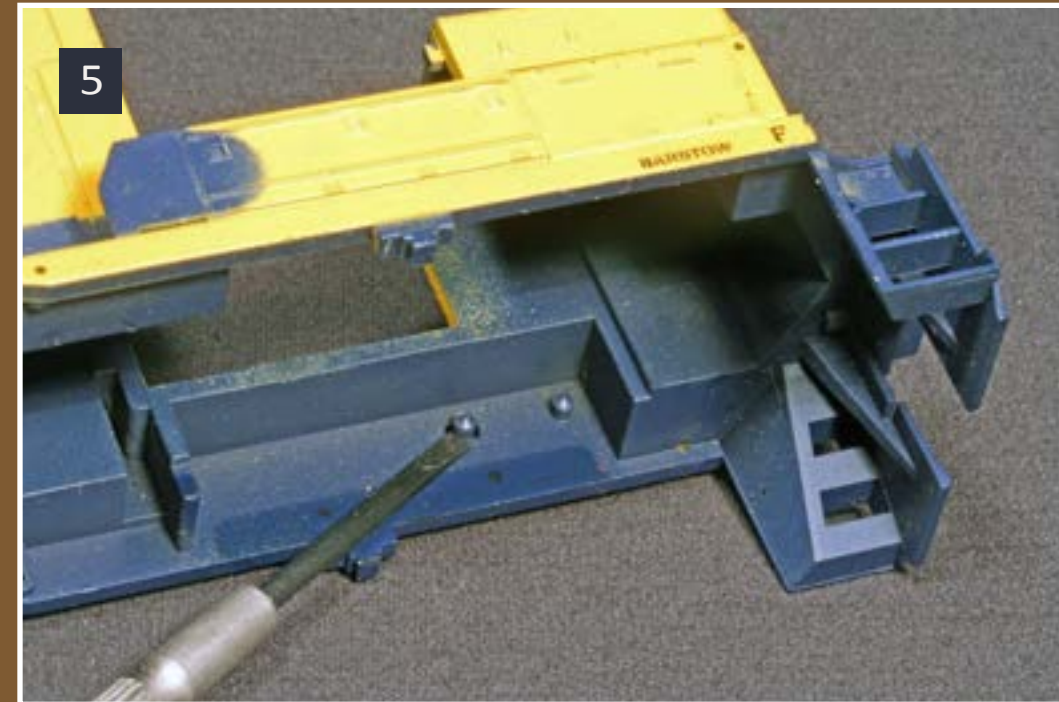
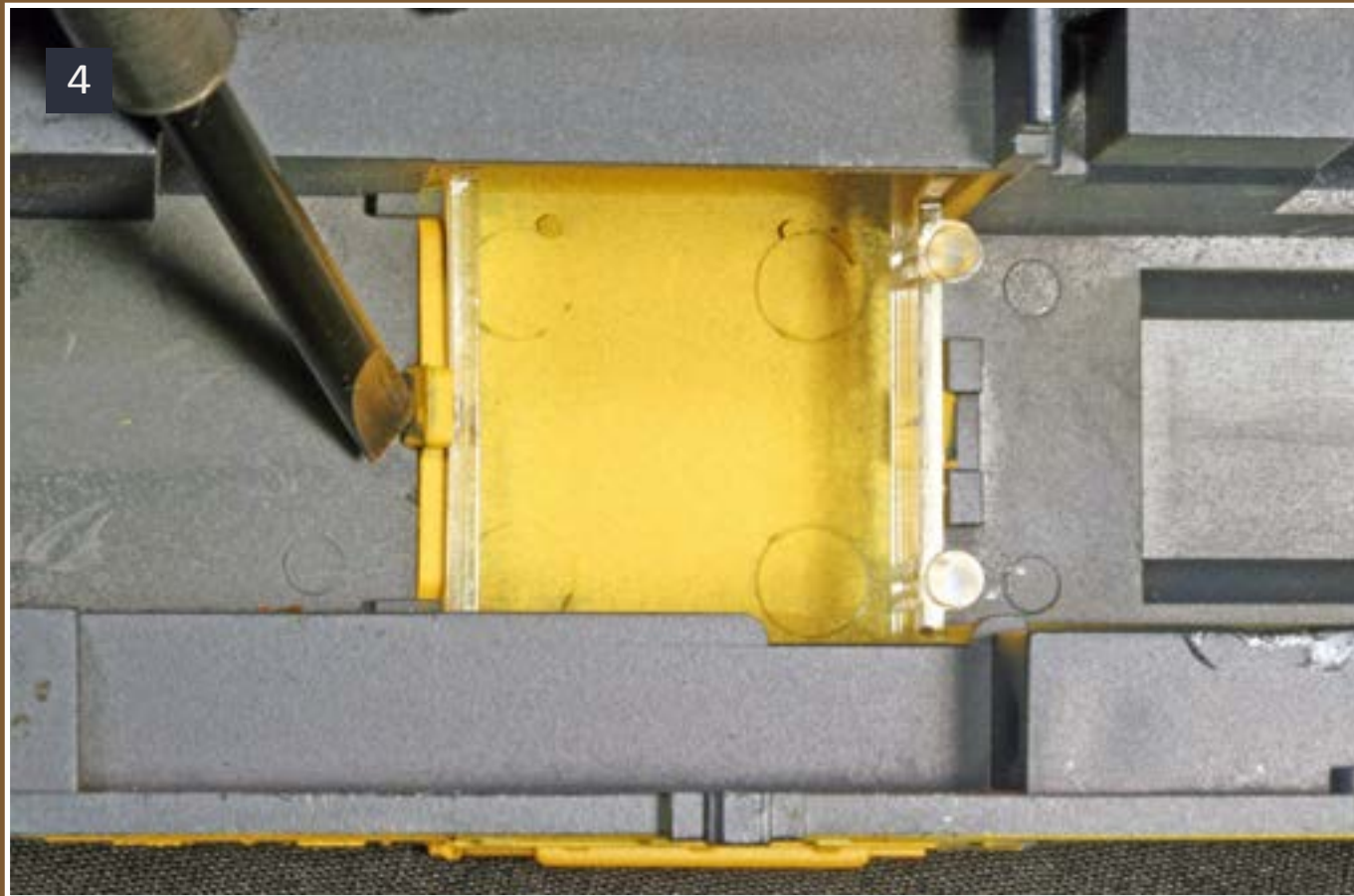

STEP 3: Removing the Center Fan

There are several methods for removing a molded part such as the radiator fan. One of the easiest is to drill a hole through the fan's center, removing the bulk of the fan, then finishing the job with a hobby knife. Begin by drilling a small pilot hole at the center of the fan, then use a series of larger bits to drill bigger diameter holes while leaving the outer ring of the fan intact. Once the center of the fan has been removed, an X-ACTO #18 chisel blade

can be used to remove the outer ring by placing it flat along the roof then cutting through the ring. To insure precision work without gouging the roof, cut though one side of the ring until you reach the center. Then move to the opposite side and cut through it until the two cuts meet, allowing the ring to be removed from the roof.

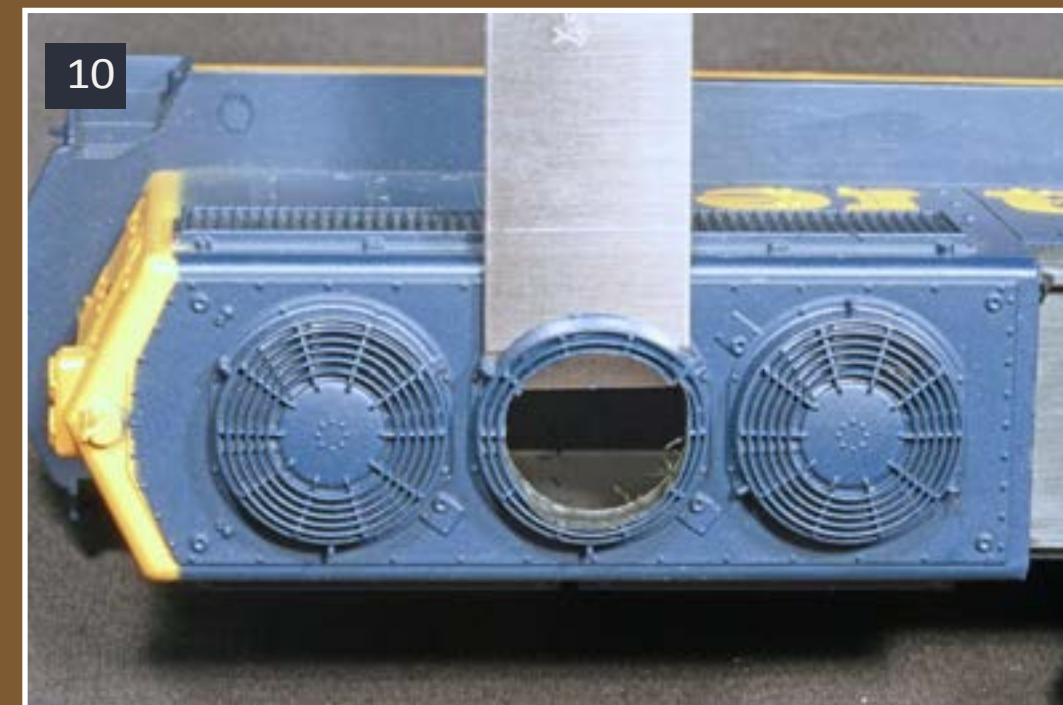

STEP 3: Removing the Center Fan *Continued ...*

Now we can clean up any imperfections in the cuts with a series of fine grit sandpapers. Cut a small length of 800 grit sandpaper and fold it into a small square to fit the area between the fans. Use it to sand the fan mounting base smooth with the roof. One trick that can be used when sanding is to use the paint on the shell as a guide to insure even and level sanding. When sanding a removed part on a flat surface such as the roof, sand only the removed part. Once you've begun sanding into the paint of the roof, the entire area should be level.



With the center fan removed, we can now strip the shell of its factory paint and lettering. There are several plastic-compatible paint removers on the market such as Scalecoat II Wash Away, or 90% isopropyl alcohol. After choosing a paint remover, dab a bit on a hidden surface of the model such as the underside of the shell to insure it is compatible with the model you are using.

After you've determined that your paint remover is compatible, immerse the shell for 30-45 minutes, then check the progress of the chemical agent. Paint removal is not an exact science. The time it takes the stripping agent to separate the paint from the shell will vary with the thickness and color of the paint applied at the factory. Remove the shell from the paint stripper and run your finger across the surface to see if the paint has begun to lift from the shell. If the paint does not separate easily, place the shell back into the stripper and let it sit, checking on it every 30 minutes.

Once the paint has begun to separate from the model shell's surface, use a toothbrush to remove the paint from the shell. This allows you to reach into crevices such as step wells and grillwork. Once the paint has been removed, rinse the shell in soapy water, using a toothbrush to remove all of the stripping agent. Let the shell dry overnight.

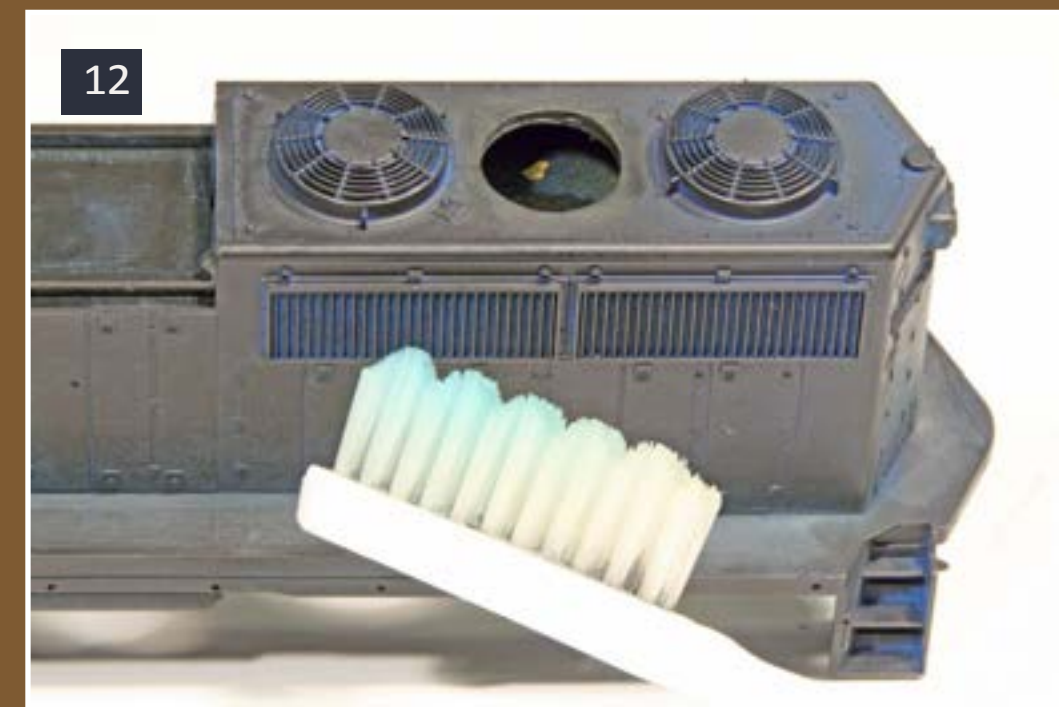

STEP 3: Removing the Center Fan *Continued ...*

Now we can begin changing the bare GP50 shell into the Norfolk Southern model by 'plating over' the center radiator fan. The prototype used a thin steel plate to cover the missing fan and we will do the same using .005 plain styrene sheet. Due to the flexibility of the thin styrene it is necessary to fill the hole left by the missing fan, preventing the styrene plate from drooping into the hole or showing the outline of the removed fan.

Cut a piece of .030 styrene sheet to fit inside of the hood, then tape it in place using masking tape. Using a sharp pencil, trace the diameter of the hole onto the styrene, then remove it and cut the circle from the styrene sheet creating a 'plug' for the hole. Using a gap-filling CA adhesive, cement the plug in place, first tacking one end, then pressing the plug upward from the inside of the shell and tacking the opposite end. Once you are confident the plug is flush with the roof surface, it can be firmly cemented in place from inside the shell by running a bead of cement around the edge of the plug.

Once the plug is in place, the joint between the hood and plug can be smoothed out using putty and sandpaper. This makes sure the joint will not be visible through the thin styrene required for the square plate. Apply a small amount of putty to a scrap piece of styrene, then dip a #17 blade into the putty and apply it sparingly around the edge of the plug. Spread it across the joint using the flat chisel blade. Once dry, lightly sand the joint until there is an even transition between the factory roof and styrene plug, leaving a flat surface for the styrene plate.

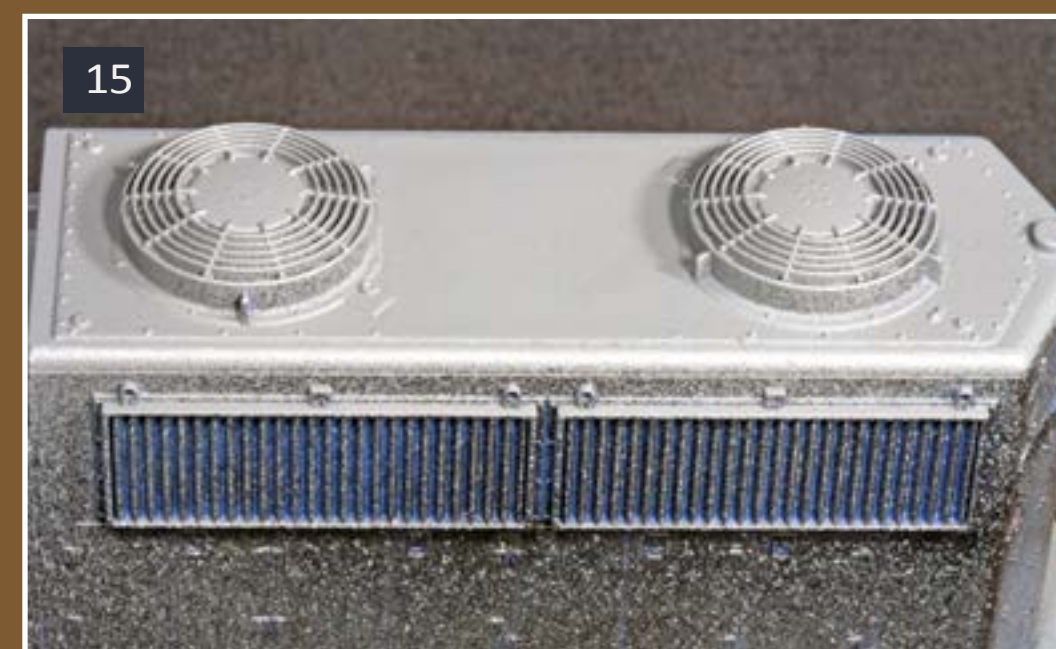

STEP 3: Removing the Center Fan *Continued ...*

The final step is to add the thin plate covering the missing fan. Cut a square of .005 styrene sheet to a 48" x 48" square, the diameter of the missing radiator fan. Spread a thin layer of CA across the underside of the square. Then place it onto the roof using tweezers. Press one side down, then move along the length of the square to insure there is no air trapped beneath it which will cause it to bubble or lift.

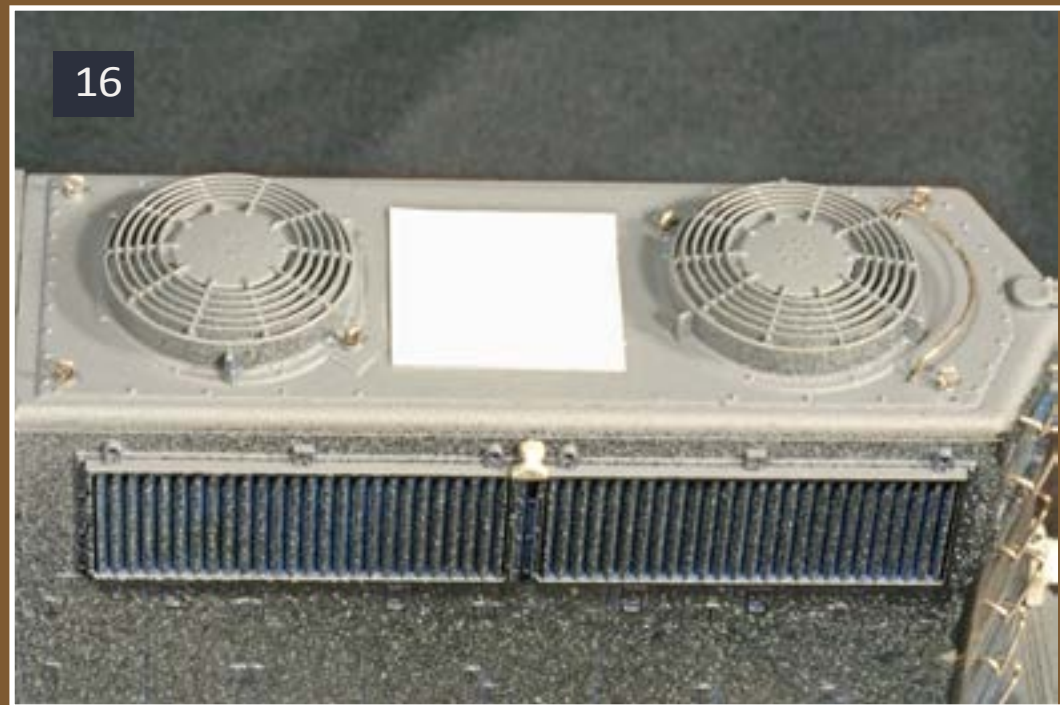

STEP 4: Dynamic Brake Insert

With the rear portion of the roof complete, we can move to the center, focusing on the dynamic brake insert. As part of the rebuilding process, the single exhaust hatch was converted to an air filter housing, and new dual exhaust stacks were added to the roof. Make these modifications by cutting through the exhaust hatch with a #18 chisel blade, removing a portion of both the exhaust stack and raised housing.

Fill the area with putty, filling in the remaining portion of the exhaust stack while rebuilding the rear edge of the housing. Once the putty dries, the top and rear edges can be sanded smooth, and the riveted plate located along the outer edges of the housing can be removed with the #18 chisel blade. Remove the vent at the rear of the dynamic brake blister, then cement two Detail Associates #2402 EMD Non-Turbo Exhaust Stacks in place, one on each side of the dynamic brake fan.



STEP 4: Dynamic Brake Insert *Continued ...*

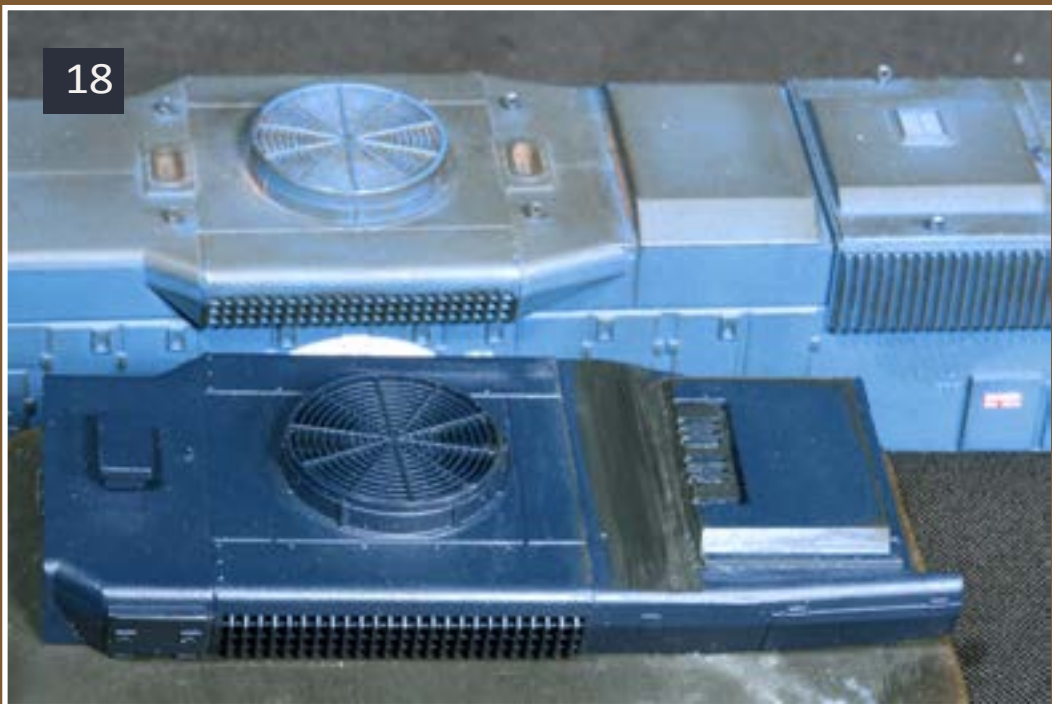

STEP 5: Central Horn

The last addition to the dynamic brake blister is a horn. To enhance crew safety, horns are now commonly located near the center of the locomotive rather than atop the cab and the GP38-3 horn follows this practice. Aftermarket horns are available as either brass or white metal castings in a variety of configurations. I chose Details West #343 casting of a Nathan K5LA23 style horn common to Norfolk Southern locomotives, mounting it adjacent to the rear exhaust stack. Completing the roof of the long-hood are lift rings added using Detail Associates #2206 eye bolts in #80 holes drilled into each of the mounting dimples, and a grab bar or grab iron at the rear of the roof.



STEP 6: Cab Detail

Moving further forward on the locomotive, we reach the cab. Fill the hole used to mount the Athearn horn. Cement the Athearn horn in place on the cab, then cut it off flush with the cab roof using a #17 chisel blade. Once removed a little putty and sanding will leave a smooth roof surface without a trace that the horn was ever mounted there.



Several other notable details on the cab roof include an air conditioner, an End-Of-Train antenna, and two Sinclair antennas, added when the traditional firecracker style antennas of the Southern were removed with the old high short-hood. The air conditioner on the top of the roof blocks the traditional mounting location for radio antennas, and the large Sinclair antennas are installed on the sloping portions of the cab roof, one on each side of the cab.

Adding the Sinclair antennas on the sloping roof seems simple enough using Detail Associates #1803 Sinclair antennas, but getting an even placement on both sides may be tricky. Locate the point you wish to drill the hole for the mounting stem of the antenna casting, then stretch a piece of blue painters tape across the roof and down each of the sloped portions. This will give you a guide line to drill the holes for the Sinclair antennas.

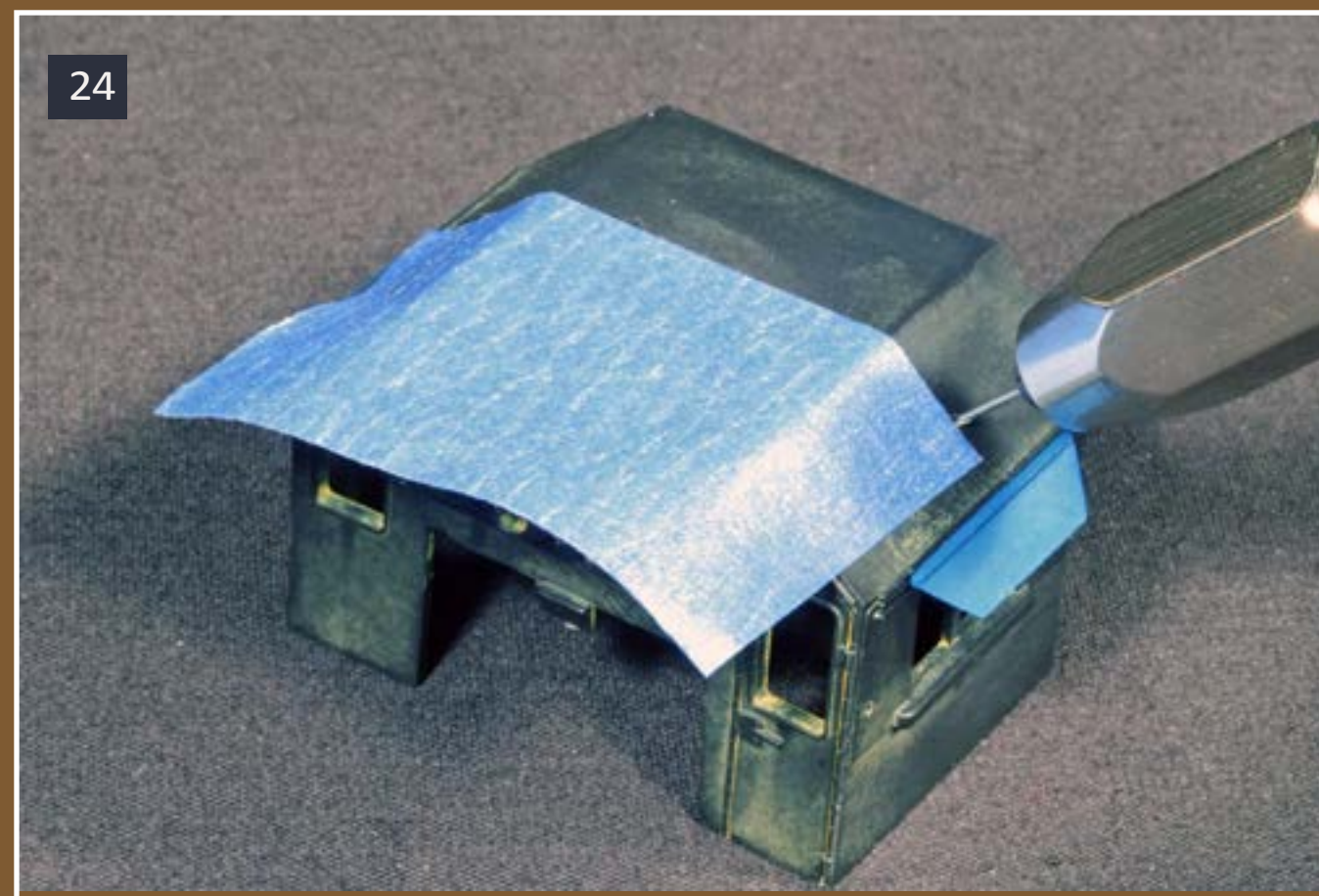

STEP 6: Cab Detail *Continued ...*

Once the Sinclair antennas are in place, cab and sunshades can be added to each side, located above the windows. Sunshades are available from a variety of manufacturers in both plastic and brass. One consideration for this part is the use the locomotive will get. If the model will be used on an operating layout, or will be handled frequently, a brass casting with mounting pins is recommended over the plastic style that can be easily broken off.

A third antenna, used for the End of Train device, is located in the front above the engineer's side numberboard. This small antenna can be added using a Details West #275 EOT antenna casting. Drill a hole and glue in place. The final addition to the roof is the air conditioner, a retrofit that is becoming standard on rebuilt locomotives. While the exact style of air conditioner used on the GP38-3 is unavailable, Detail Associates has a #2309 air conditioner which can be painted white and added after the locomotive has been painted.

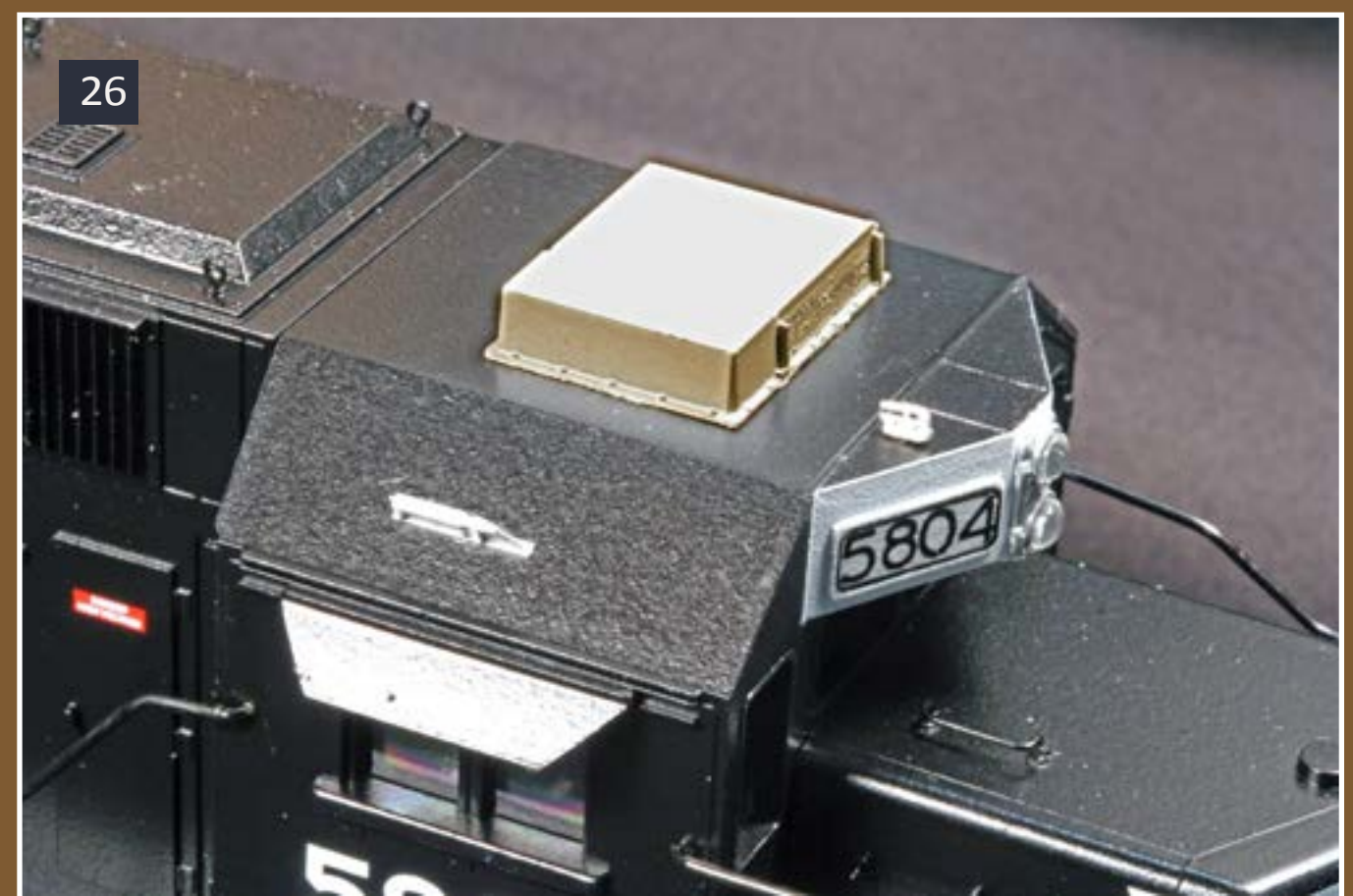

STEP 7: Hood Sides and Ends

With the roof details complete, we can focus on the sides and ends of the hoods. Classification lights are not needed on most modern locomotives because of changes in operating rules. Removing class lights from the Athearn shell requires carving them off flush with the hood surface, then filing the remnants flat with the hood surface.

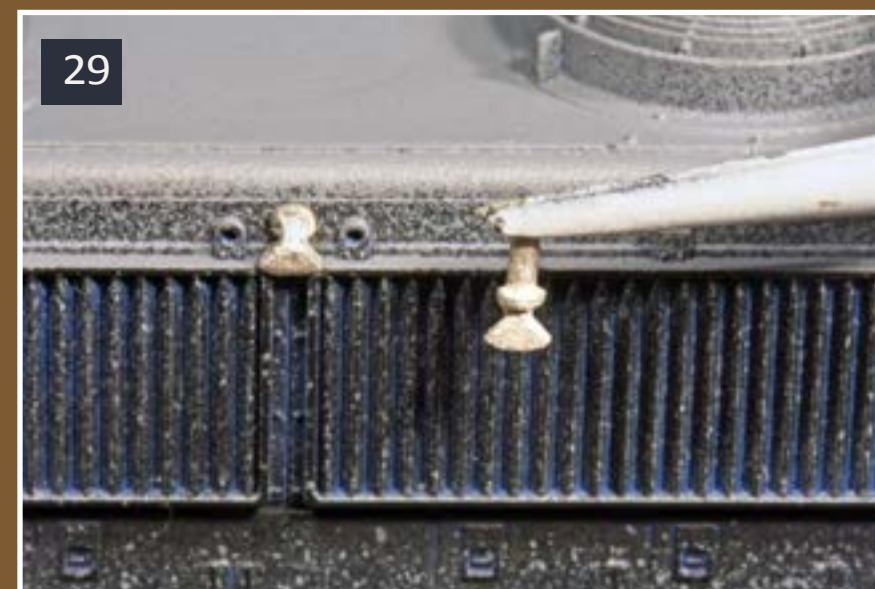

Whether a structure, locomotive, or freight car, the details of a model can often tell a story, and the GP38-3 is no exception. One detail of the long-hood are walkway lights indicating that this locomotive was once owned by the Southern Railway. These unique details can be added by kitbashing Details West #172 Engine and Caboose Step Light castings. By holding the soft white-metal casting with needlenose pliers, the mounting stem can easily be bent at a right angle, leaving a mounting stem that can be inserted into holes drilled in the side of the long-hood and dynamic brake blister.

STEP 7: Hood Sides and Ends *Continued...*

At the ends of each hood, Detail Associates #2202 drop grab irons can be installed in #80 holes drilled at each of the mounting dimples, completing the hood detailing. Whenever detailing a model, one consideration is whether details should be permanently fixed prior to painting the model. In the case of the Norfolk Southern scheme, a large graphic occupies a portion of both hood ends, and grab irons would interfere with adding the decals for the graphics. In areas such as these, detail parts should be left removable and permanently fixed only after the decal work is complete.



STEP 7: Hood Sides and Ends *Continued...*

FRA-mandated ditch lights have been added to the deck at each end of the locomotive. Details West #228 ditch light castings may be cored out to accept a micro bulb, then installed into holes drilled into the walkway deck to accept the mounting stems of the castings. Spacing the ditch lights evenly can be a problem, especially given the angular anticlimber which forms the ends. To help insure an even mount for both castings, draw a grid in pencil across the walkways to provide guidelines to drill the holes. Once the holes are drilled, the grid can be removed by gently erasing it.

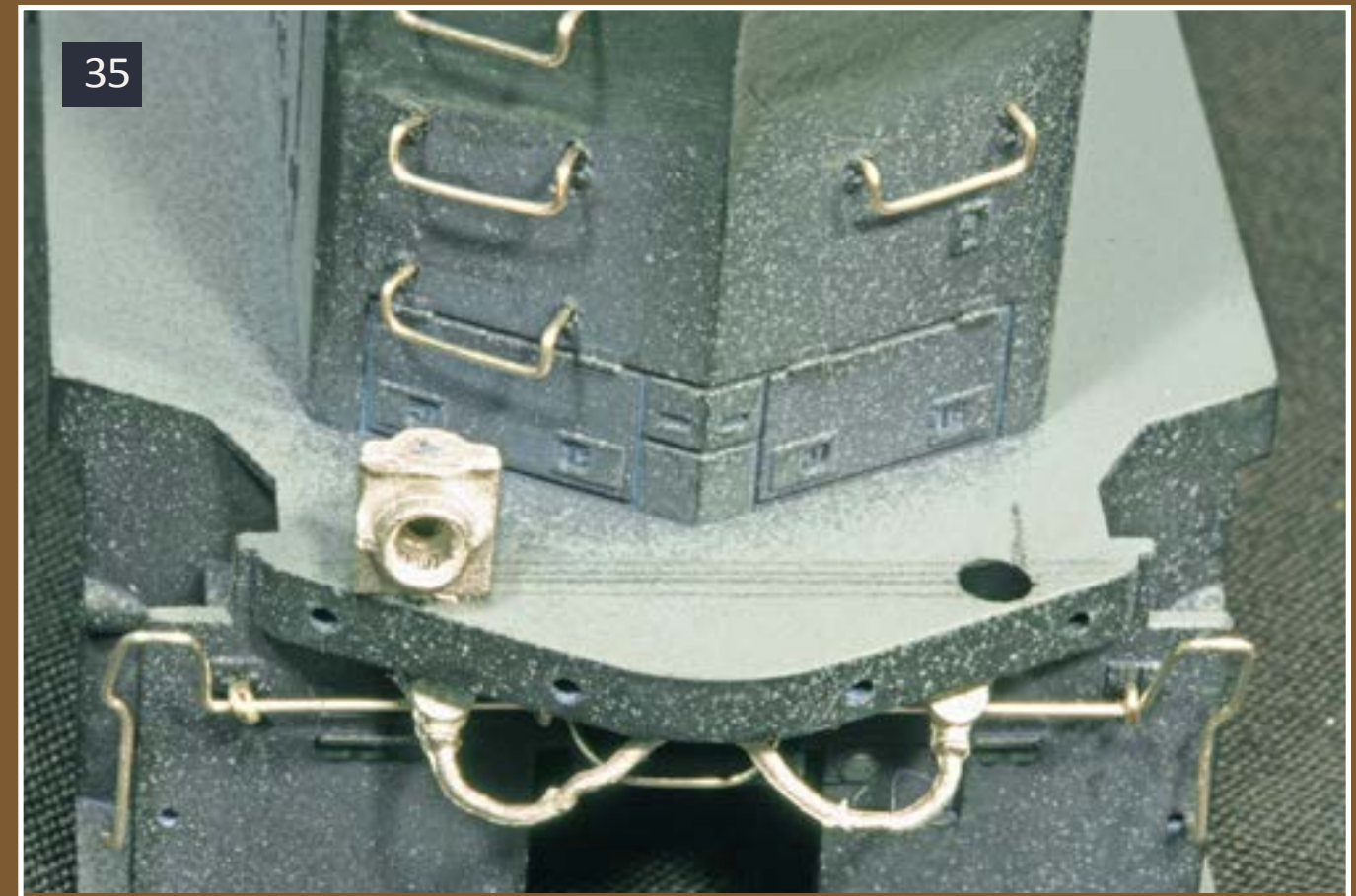

STEP 7: Hood Sides and Ends *Continued...*

Both pilots can be detailed using various commercial detail parts. While the amount of detail applied to any given model is a matter of individual preference, several standard details including cut levers, trainline air hoses, MU hoses, MU cables, and a snowplow will transform the barren pilots.

Begin by carving off the molded cut lever mounts and adding a Detail Associates #2212 coupler cut lever. Hold it in place with #2206 eye bolts. Once the cut lever is in place, a Details West #236 MU electrical cable and add it to holes drilled into the pilot to represent the red cable held in place by a chain below the anticlimber. Finally, add either individual MU cables or a one piece 'cluster,' followed by a snowplow on the front of the locomotive. Once again consider paint, decal and assembly needs, as you may find that permanently affixing the snowplow gets in the way of painting or adding stanchions and handrails.



38



37

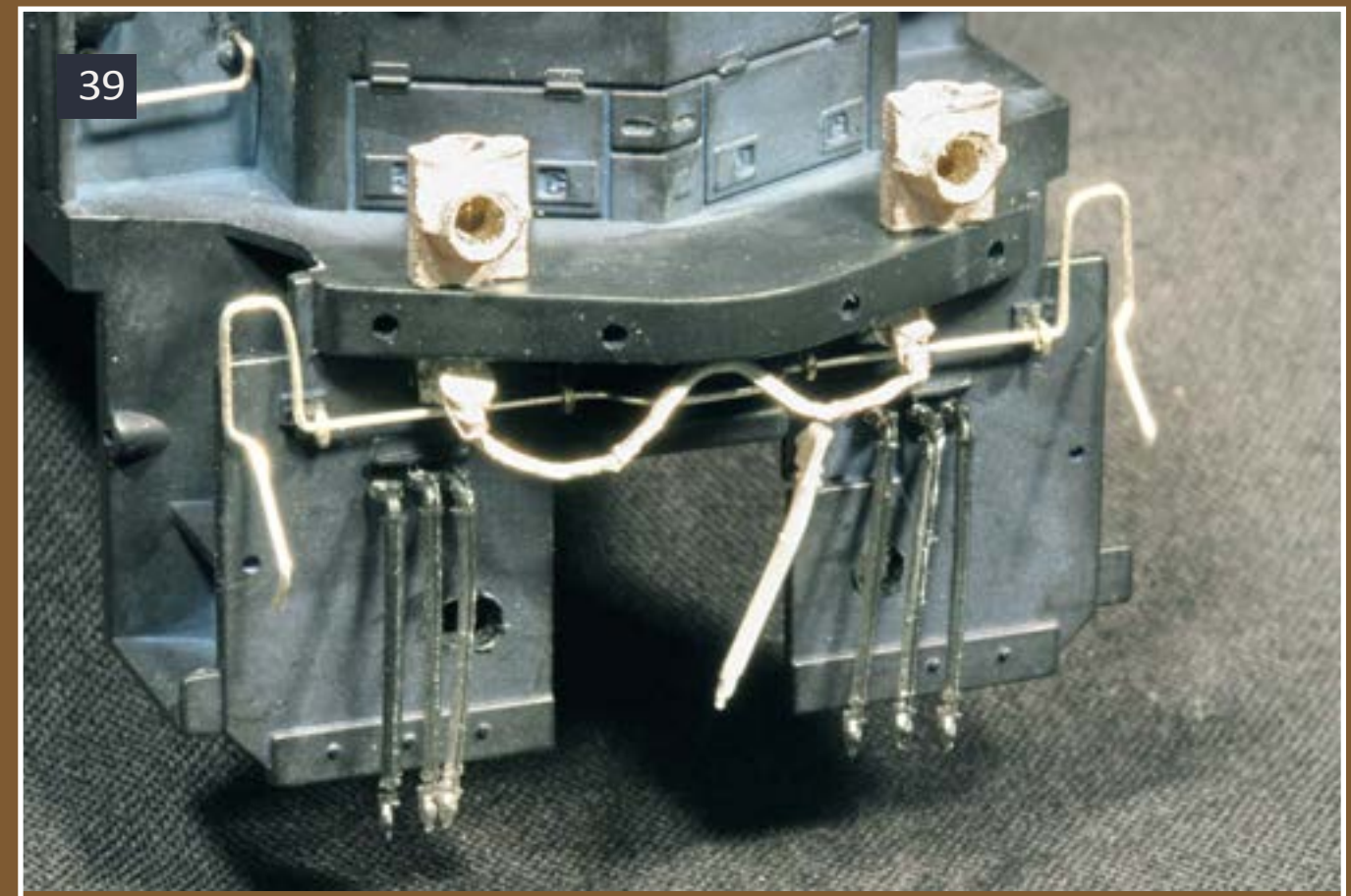

39

STEP 8: Airbrushing

Now it's off to the paint shop where the locomotive can be airbrushed black. After drying, the numberboard portion of the cab can be masked and airbrushed white. The shell and frame can then be reassembled and sprayed with Testor's Glosscote to prepare the surface for decals.

Lettering a rebuilt locomotive will often require decals from several sources to obtain the correct graphics, as many of the commercially available sets are designed for locomotives painted as manufactured. The NS GP38-3 is no exception, using both Microscale #87-1225 and 87-1182 sets to obtain the full

spectrum of lettering applied by the Norfolk Southern. In addition to the graphics identifying the locomotive as belonging to the Norfolk Southern, a variety of informational and safety markings are applied to the carbody. These can be taken from Microscale set #87-527, a GE/EMD data set. Completing the graphics are numberboards at the front and rear, that use Shellscale set #124 designed specifically for current era repainted locomotives of the Norfolk Southern.



STEP 8: Missing Details

To complete the locomotive, just add and paint the handrails, and add any remaining detail parts, such as grab irons, snowplow and air conditioner, which were left off during painting. As this project has shown, constructing a home-road rebuilt locomotive is not the impossible task we may think it to be. It only requires careful observation of our prototype, and basic modeling skills to add a unique class of power to our model rosters!

42



NEW for August!

HO AND N-SCALE NEW RELEASES



87-1376 & 60-1376
Southern Pacific Station Signs, Signal Lettering, Right of Way Signage

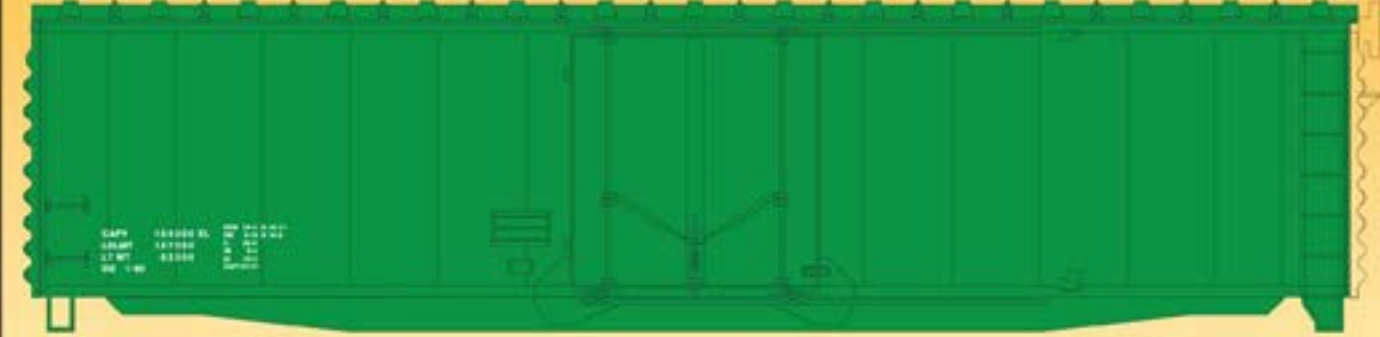

87-1377 & 60-1377
Burlington Northern 40' and 50' Boxcar Dimensional Data



87-1378 & 60-1378
Missouri Pacific and Texas & Pacific Express Boxcars



87-1379 & 60-1379
Western Pacific 4600 and 4650 ACF Centerflow Hoppers, Early and Late schemes

Subscribe to our AUG. newsletter!



Check out the featured model



microscale.com

MADE IN THE USA

ADVERTISEMENT

click here



Rusty Stumps

Scale Models

WE ONLY SELL WHAT WE MANUFACTURE

DETAILS

IN HO, O, S & N SCALES

LASER CUT SHINGLES, DOORS & WINDOWS, FENCES, SIDING, CRATES. Also RESIN and WHITE METAL DETAILING CASTINGS.

CRAFTSMAN KITS

IN HO, O & S SCALES

CHECK IT ALL OUT AT WWW.RUSTYSTUMPS.COM

Send \$3.50 for Catalog - Specify Scale
RUSTY STUMPS SCALE MODELS
 6785 Cherry Blossom W. Dr., Fishers IN 46038
 Phone (317) 595-9489



43

ADVERTISEMENT

RailPro™

NEW TECHNOLOGY



Click here to watch our videos!



For more information visit our Internet site:
www.RingEngineering.com



Presently residing in Ohio, Matt and his wife Debie share the hobby, modeling the area he grew up in: north-central New Jersey.

Their "Conrail New Jersey Division" layout has been featured in *Great Model Railroads*, *Rail Model Journal*, and in the Allen Keller *Great Model Railroads* DVD series. Matt has had articles in *Railroad Model Craftsman*, *RailModel Journal*, *Scale Rails* and *Model Railroader*, as well as online at railroad.net.

M.R. (Matt) Snell has been a model railroader and railfan for 30 years. His interest in railroading grew while growing up in New Jersey surrounded by freight and passenger rail lines.



A "Right Clamp"™ Mini Project

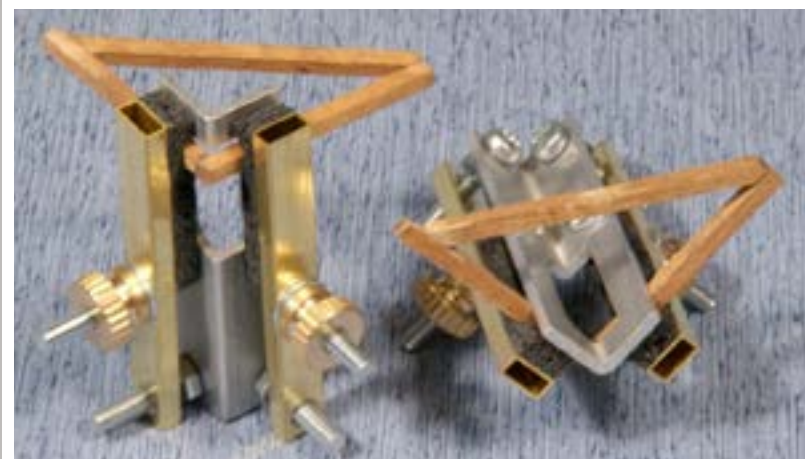

AC-2-2 "Mini Right Clamp"™ used for gluing Bulkhead Frames.



AC-1-1 "Original Right Clamp"™ used for Bulkhead Assembly.

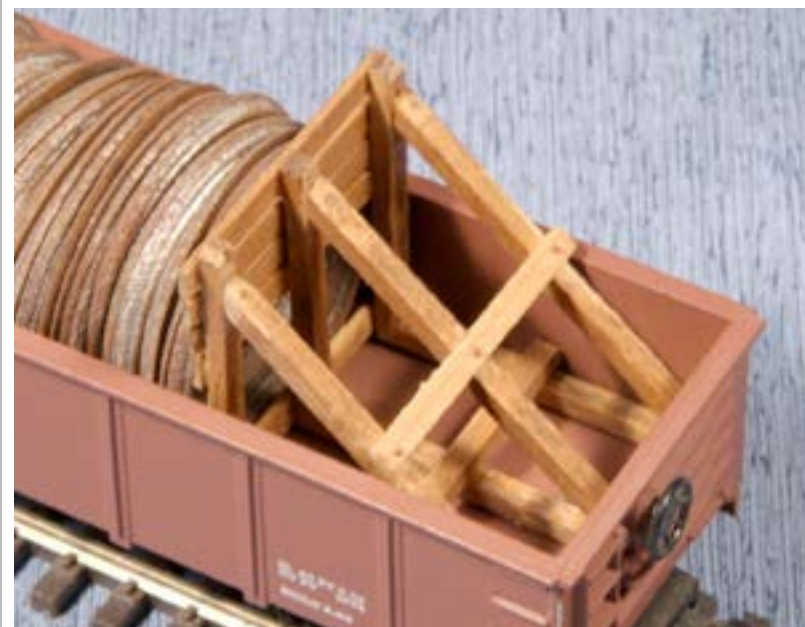

Assembled Bulkhead in gondola with load of ring castings.

Right and Splice Clamp –Tools for Modelers

See all our products at:

www.coffmaneng.com

Coffman Graphic Solutions Co.

1500 River Circle, Richmond, KY 40475-7907

Phone: 859-527-0476, Fax: 859-527-0485

TRAINPLAYER
ARMCHAIR MODEL RAILROADING

NEW VERSION 5.0 --- MODULAR RAILROADING!

Snap together a string of modules and test drive it before the show!
Most full-featured model railroad simulator on the market -- live track, scenery,
huge gallery of rolling stock, ops, thousands of layouts ready to run! Free demo.

WWW.TRAINPLAYER.COM

Have you started your MRH Contest entry yet?

Click here to learn more ...



Short Hill & Western
Craftsman Series Model Railroad Products

DUNPHY'S ICE
August 2012 Special

For August 2012 Only **\$59.95**
Enter Coupon Code : MRH100D At Checkout

Check Out A Snippet Of A Day At Dunphy's On
Our YouTube Channel



www.shorthillwestern.com

Modeling the CP Sudbury Division of the 1970s

How one innovative club manages to model the near-contemporary Canadian Pacific so well

1



Chris VanderHeide

1: Returning to Sudbury from Little Current, Train no. 74 (lead by GP35 5025 and an RS10) pulls into the siding at Nairn to make way for a westbound train lead by C424 4235 and an RS18 still in maroon and grey.

– by Jurgen Kleylein

Photos by the author except where credited otherwise

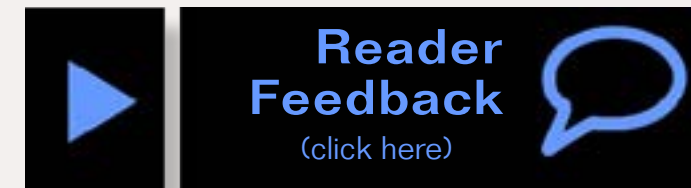

When the Canadian Pacific Railway began its march across Canada, it eventually arrived at the south rim of the basin which would be named Sudbury.

The CPR selected this location as the junction for a branchline to Sault Ste. Marie to the west, while the mainline continued northwest around the north shore of Lake Superior. While blasting through the rocks the builders discovered copper ore near Copper Cliff – and the rest, as they say, is history.

By 1970 the city of Sudbury had become the nickel capital of the world, as well as producing abundant copper, iron, zinc, silver and gold and other minerals. CP Rail by then moved trainloads of nickel-copper-ferrous ore from scattered mines around the rim of the basin to the huge INCO smelter and Falconbridge Ltd. refinery.

The junction at Sudbury increased in importance when the CPR built a “Toronto branch” which joined the mainline just east of the Sudbury yard. The Toronto route began to

eclipse the Montreal mainline in traffic volume. Numerous other spur and branch lines also radiated out from Sudbury Yard serving lumber mills, quarries, and even a couple of lake ports.

The station at Clarabelle 2 miles down the Nickel Sub was said to bill more tonnage than any other station on the CP system.

Sudbury had become one busy place.

Deciding to model the Sudbury

In 1989 a group of model railroaders who were regulars in operating sessions at John Brown's layout in Waterloo, Ontario decided the area needed a permanent club layout.

This wasn't just post-session beer talk: the club actually started collecting dues and wrote a constitution. The Waterloo Region Model Railway Club was born.

We eventually found a new home in a warehouse near the Kitchener VIA station. With a clean slate, we could do anything we wanted in the new space. As mostly prototype modellers, we wanted to avoid the typical generic or fictional prototype club approach.

Since CP was popular among the members, we chose that prototype. And after considering dozens of possible locations to model, we selected Sudbury.

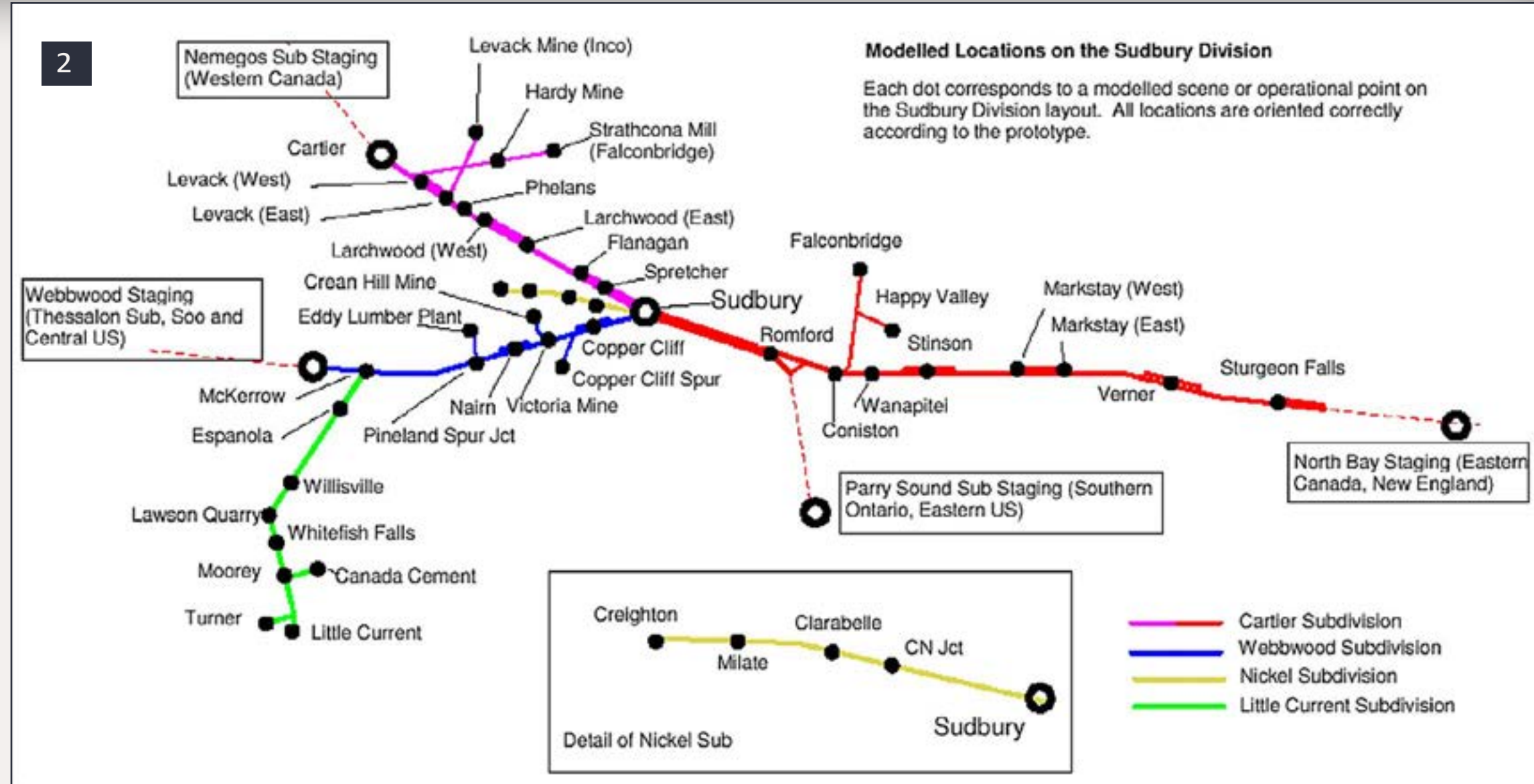

2: The Sudbury Division and all its feeder routes, as modeled by the Waterloo Region Model Railway club.

A year later we had the mainline up and running on an innovative multi-level layout with over 600 feet of main – our “Cartier Subdivision” layout. We pioneered a few run-lengthening techniques including multiple use helices, and built a first attempt at Sudbury yard.

We had our club layout taking shape, but we weren't crazy about the building. It used old wood construction inside, so we had worries about how safe the place was. We started looking elsewhere for a new home.

Bill, one of our members, had a friend who lived in the country with a 2000

square foot Quonset hut where he raised chinchillas.

He planned to get out of the chinchilla business and was seeking an alternate use for his “barn”. Bill organized a visit to the building so we could look it over.

The first time we saw the place, it housed 700 chinchillas, all in individual cages. The building had good insulation, running water, a bathroom, a hot water heater and 100 amps of power.

Our only question was a simple one: “When can we move in?”

Less than 2 years after starting the Cartier Sub we tore it down and moved an amazing amount of stuff salvaged from the first layout to the new building outside of Maryhill.

Modeling the Sudbury Division, take 2

With 2000 square feet and 14 feet of headroom, we elected to try something outlandish.

We could have built a decent 2 level layout on the main floor and then built a club room/dispatch office on a second floor above. But one of our

members mused about what would happen if we built a helix up to the second floor.

A 20-turn helix to get through the ceiling sounded nuts. But what if we went up a step at a time? By nesting the walkways between the walls of the lower levels we could more than double the effective size of the layout, and more smaller helices would stretch the run enormously.

A quick calculation resulted in 20 miles of mainline, plus room for almost all of the branches and spur lines of all the routes out of Sudbury (2, previous page).

Without leaving out anything important, we could build all the routes served out of Sudbury yard in all directions, and still have room to do an outstanding reproduction of Sudbury itself! For example, we modeled Sudbury yard as 20 tracks wide and 20 feet long, which is two-thirds the length of the prototype (3).

We made the neighboring shops and New Yard area about the same size as well. We represent about 80 miles of the Cartier Sub mainline using the 20 scale miles we have in our space. Using a 4:1 ratio fast clock allows us to operate with prototype schedules. All of the industries and traffic on the layout are authentic for Sudbury in the 1970's.

At least, that's the plan. We're 12 years into the construction and only have the Webbwood Sub and part of the Cartier Sub running. Right now we're expanding the mainlines east and west out of Sudbury up to the second floor into a temporary east-west staging yard.

We've already got Webbwood staging and a temporary Little Current Sub staging yard up there, while we've located the Toronto/Parry Sound Sub staging on the lowest level of the main floor.

Though we're focusing on the heavy construction and trackwork, we do work on scenery when time allows. You can see some of the layout photos here in this article. Also check out our online gallery at www.wrmrc.ca/models.html.



3: Shortly after midnight on the clock, Peter Korschefsky (left) switches a cut of hoppers in Sudbury yard, while President Bob Kelly (right) works on getting the Pulp Train turned to run down the Webbwood Sub.



4: As Bob and Phil Trudel (left) pull out with the westbound Pulp Train, Peter (right rear) waits his turn to use the yard lead. Meanwhile, Yardmaster Chris VanderHeide (far right) is on the radio to the dispatcher.

In the fall of 2011, we fired the Sudbury Division up for another season of operations after a summer of working on the layout. We documented the first session of the season on video (5).

For the first session of the new season, operations were stellar. We had only one unit with stalling problems: the west yard switcher.

We're not sure what this loco's problem was, since that was supposed to be the better unit of the two switchers. My switcher (6) on the other hand, ran almost flawlessly.

I went over the east end of the yard with cleaning pads once to make sure all the rails were clean. Everything ran fine after that, even over dead frogs.

The trains running out of and through Sudbury ran well except for one Geep on the Nairn Turn which seemed to be having speed table problems. That should have been noticed and fixed before the session, but you can't catch everything.

Still, it was a very smooth session, and we're hoping for more such operating sessions this season.

Working on the layout

Summer is work season at the Sudbury Division.

We operate the layout from September to April each year and then shut down in the spring.



5: Railfan the Sudbury division of the Canadian Pacific Railroad in August of 1975! See the Waterloo club's layout come alive in this video taken at the first op session of the season in the fall of 2011.



6: Two trains pass on the double track in Sudbury Yard as Jurgen's yard engine (far left) earns its keep shoving some cars into track 2.

After that we use the second Saturday of each month as an all-day work session instead of our operating day. This past Saturday (July 14, 2012) was one of those work sessions.

Each summer we like to set a goal so that we know where we need to concentrate our efforts. This year we decided to get more of the Cartier Sub mainline operational. The project involves about 200 feet of track east of Romford to the siding at Stinson and extending the western end of track to a temporary reverse loop at Sprecher (7).

By also putting in a temporary loop at Stinson we hope to run trains continuously on our mainline for this October's open house, which will cut down on the log jams of traffic trying to get onto the Webbwood Sub from Sudbury during shows.

This also adds capacity for regular operations, which will free up some room in the Toronto staging yard, which has been over capacity for a couple years. If we could just get the upper level of Toronto staging into service, that would not be an issue! All in good time.

Let's visit a work session

The Sudbury Division has a good crew of modelers. We have several members who can lead or take on projects without needing a lot of supervision. In a club like ours where we intend everything to produce a cohesive whole, having seasoned, motivated members can be a real bonus. We can have a bunch of projects on the go at the same time which all eventually tie in together.

Having a number of such members also allows us to spread the work sites around the building. We all know what happens when too many people work on the same thing or in the same small area. It gets too crowded and people often start gabbing instead of getting things done.

Continues on article page 104 ...

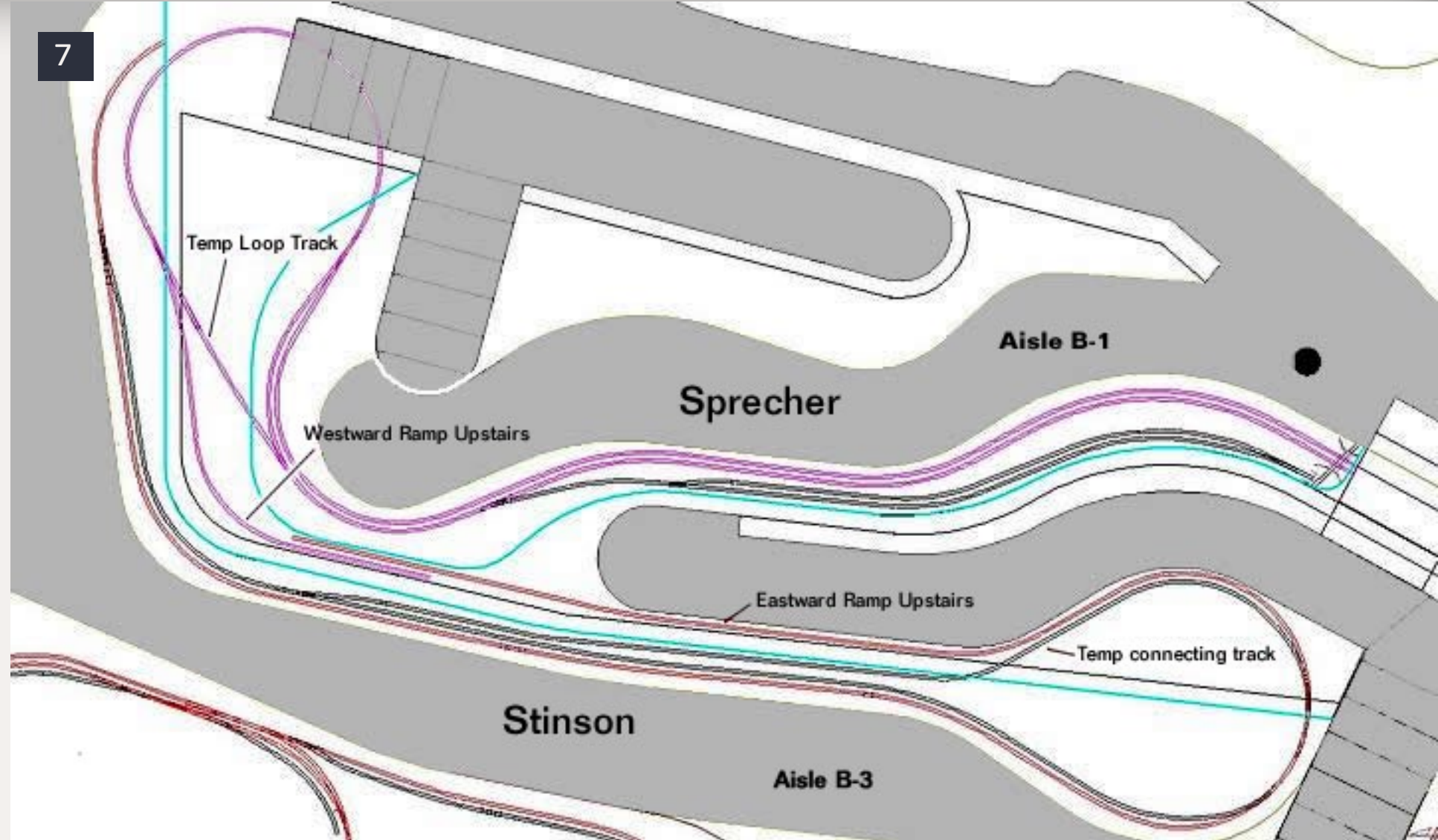

7: Here's the plan for temporary end loops at Sprecher and Stinson (level 2 on the layout plan).



8: Justin inspects some of the shelving at Sprecher. We need to finish some work on a staging yard on the lower level here so we can continue with the upper deck.

Sudbury Division Track Plan - page 1 of 6

The Sudbury division fits into a 40x50 foot quonset hut. The plan takes 6 different levels to present since it's being built in 2000 square feet of space in a building with 14 feet of headroom.

Level zero presents staging, and level 1 begins the main plan. See the quonset hut cutaway drawing on page 5 of the track plan for an idea of how the different levels work.

The layout plan includes about 20 scale miles of mainline, plus room for almost all of the branches and spur lines of the routes out of Sudbury.

The guiding principle of the design is that when a train leaves a scene at one location, it will never reappear more than a few feet from where it left, and never in a different aisle, except when it changes floor levels, and then it just reappears at the top or bottom of the flight of stairs adjacent to where it disappeared. The different track levels in each scene join through a hidden helix between each scene. The layout incorporates over a dozen of such helices.

To keep things easier to follow, the plan shows very little of the hidden trackage. The full plan with all trackage in 3rd-Planit has over 50 layers!

The trackage in each scene connects to trackage in another area – just match up the letter references: AA to AA for example. Each letter reference includes a notation as to the level where the next scene is located.

Editorial Note: We've compressed each track plan drawing to fit onto our page, but each plan drawing has more detail you can study by zooming in to 200% and scrolling around. We've also included PDF versions of these plans as part of our bonus downloads this issue.

Zoom in to see the track plan details.

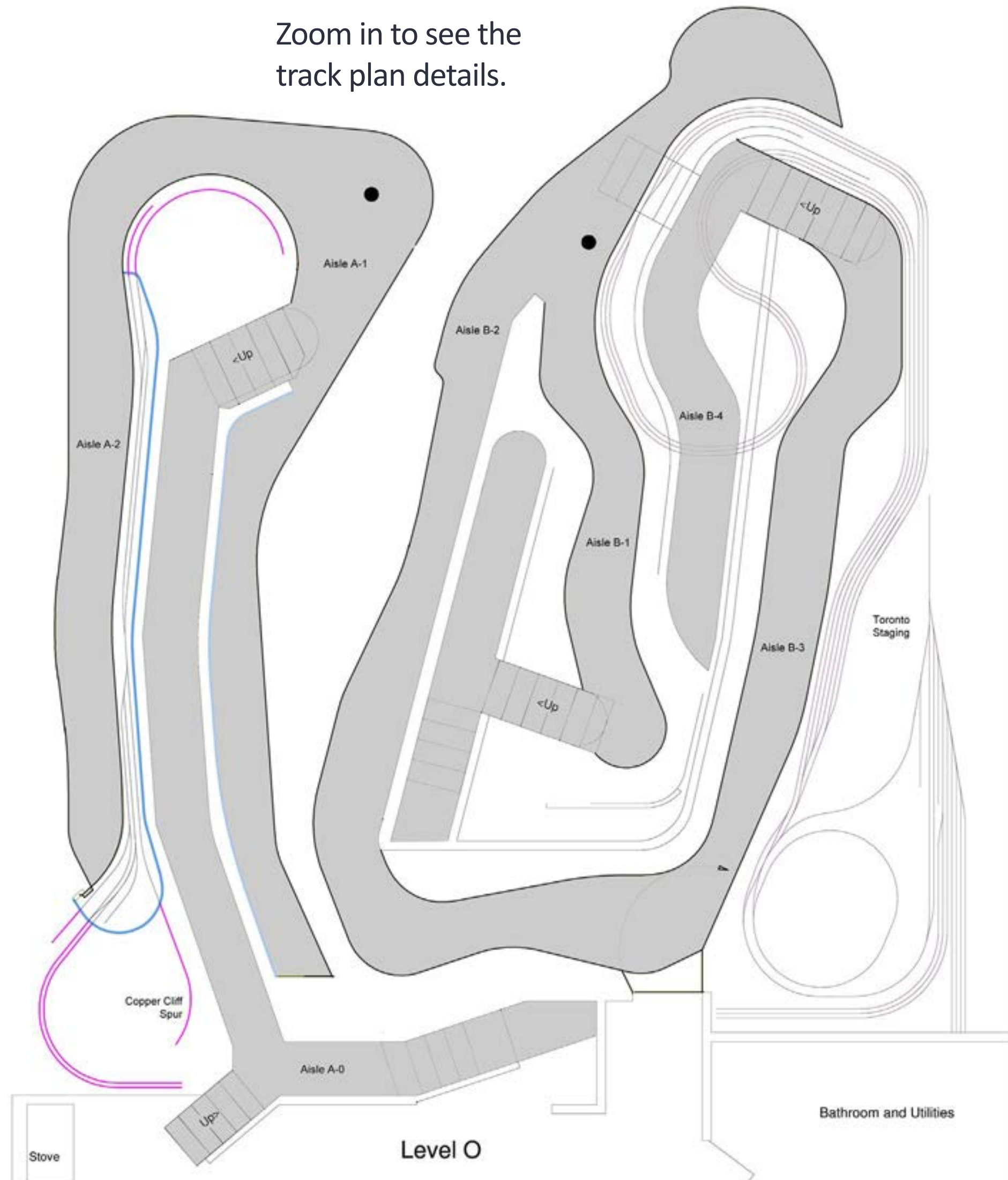

Sudbury Division Track Plan - page 2 of 6

You can find a lot more information about the Waterloo Club and the Sudbury Division on the internet. The club has a very nice website, and some of the club members also frequently post on the MRH website.

Waterloo Club website links

Home page: www.wrmrc.ca

Layout plans: www.wrmrc.ca/divmap.html

Photo gallery ...

Construction: www.wrmrc.ca/construction.html

Finished layout/models: www.wrmrc.ca/models.html

Operations: www.wrmrc.ca/operationsgallery.html

Prototype reference: www.wrmrc.ca/proto.html

Video gallery ...

YouTube channel: www.youtube.com/wrmrc

Jurgen's blog links (MRH website)

Blog home: mrhmag.com/blog/jurgenk

Sudbury Division blog series:

- 1: [Tales from the Basin](#)
- 2: [Tales from the Basin, part 2](#)
- 3: [Return to the Basin](#)
- 4: [Tales from the Basin 3: Back in the cab](#)
- 5: [Monday movie night in the Basin](#)
- 6: [Working in the Basin](#)

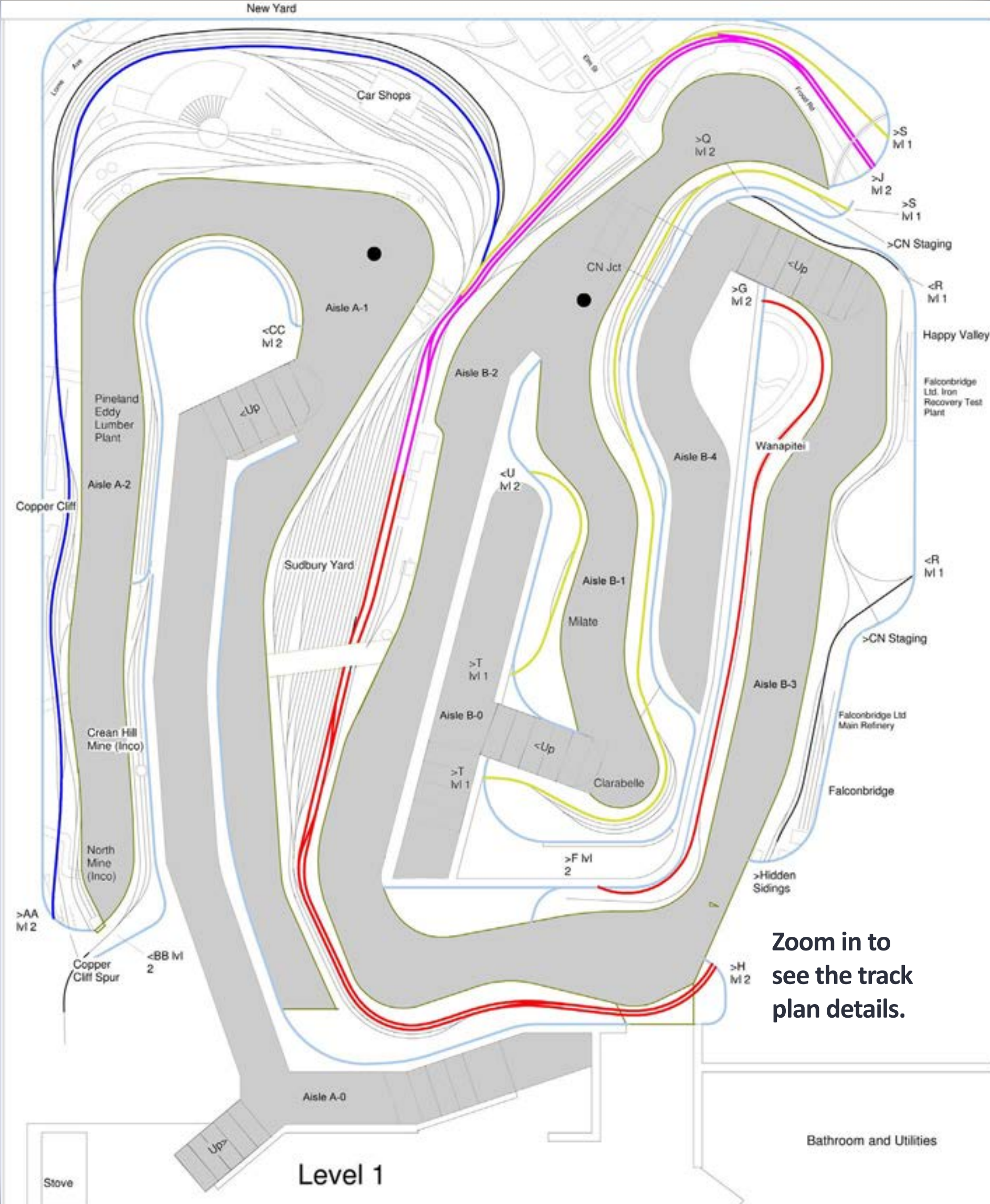

Zoom in to see the track plan details.

Sudbury Division Track Plan - page 3 of 6

About the Waterloo Region Club by Ted Kocyla

A small group of modellers within the tri-cities of Kitchener-Waterloo, Cambridge and surrounding area formed the Waterloo Region Model Railway Club in 1989. This small pocket within south-western Ontario has been a hotbed of model railroading activity, and has contained more than its share of master modelers and fine home layouts.

However, in the late 1980s, the area did not possess a permanent layout-based club, and had not done so for over two decades. Stranger still, several communities surrounding K-W had well established clubs with layouts. Some of these had much smaller population centres to draw members from. The WRMRC felt it was high time for a club layout in the Waterloo Region.

This group initially formed the club as an assemblage of modelers who regularly operated a large basement home layout in the city of Waterloo. During one of the usual gripe sessions about not having a large club-sized layout to run on, the layout owner quipped "why don't we start a club and fund a new layout?"

That night, the WRMRC was born. The club continued to operate on the owners pike, but we started collecting monthly dues for funding a new home and club layout. Since 1996, the club has been in its third (and hopefully final) location, inside a specially-built quonset hut near the small town of Maryhill, Ontario.

From the outset, the WRMRC wanted to be very different from many of the other clubs in south-western Ontario, or in much of Canada for that matter. We've been inspired by the La Mesa Model Railroad Club at the San Diego Model Railroad Museum in San Diego, CA, famous for modeling the SP / Santa Fe crossing of the Tehachapi mountains.

Continued on the next page ...

Lower level
benchwork

Zoom in to see the
track plan details.

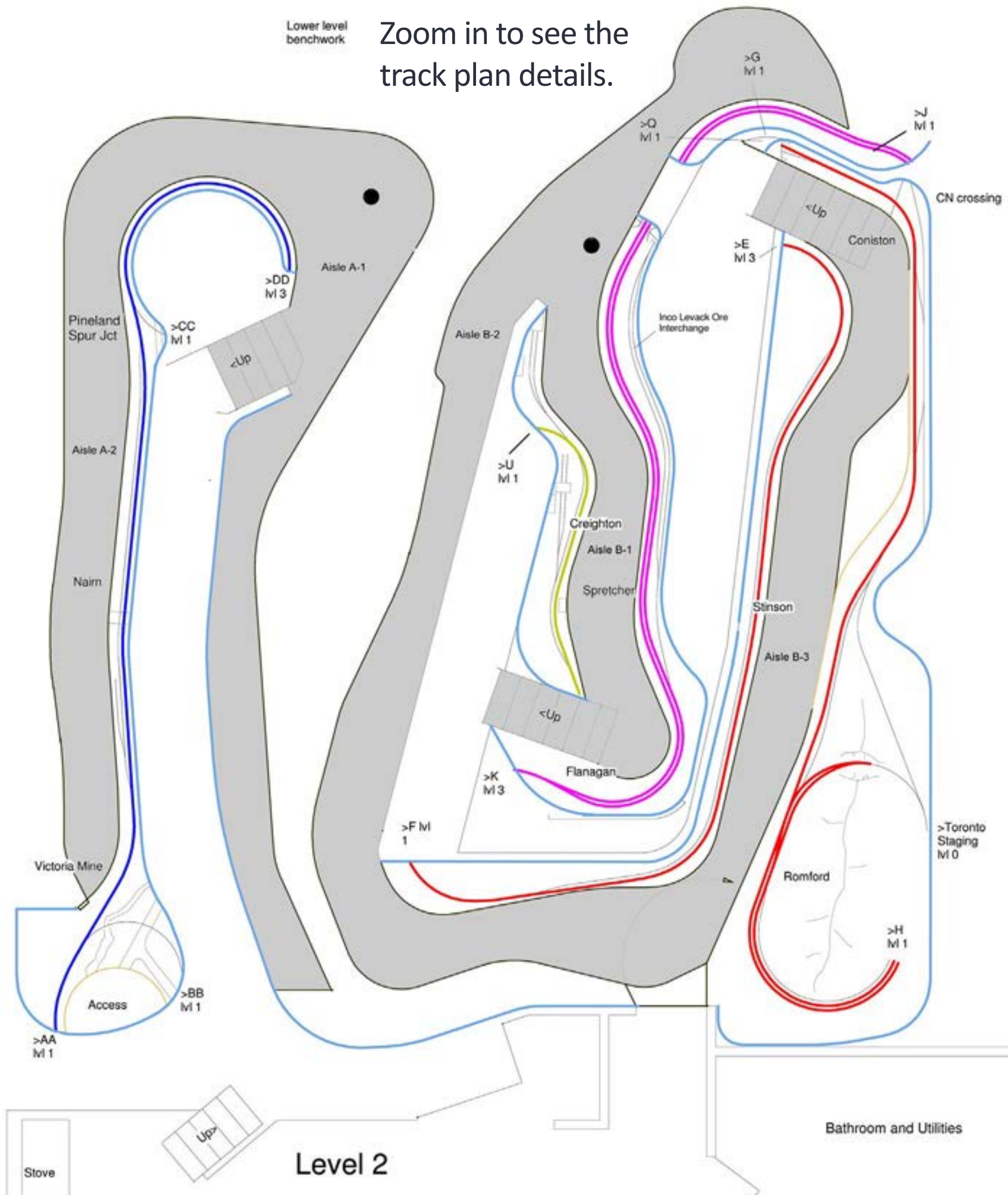

Sudbury Division Track Plan – page 4 of 6

All the WRMRC members like prototype modeling, and all wanted the club layout to follow a specific railway line, just as La Mesa was doing. Most clubs feature a fictional home road with allowances for operation by other real railways, or they operate a collection of real railways operating a fictional line.

We chose to model only one railway, in a particular area at a specific period of time. This less common approach isn't as popular with most railway clubs. We suspected we would not attract as many modelers once we limited the railway, place, and time, but modeling a specific prototype does have benefits.

First of all, many members witnessed other groups self-destruct due to conflicting interests. A few knew of modellers who vowed never to join clubs again due to these conflicts. By choosing a specific prototype, no one individual or internal group could determine what the WRMRC will or will not model, because the prototype railway has already dictated how it must be done.

To quote a sinister, yet strangely accurate phrase from George Orwell, "freedom is slavery." The decision to model a prototype freed us from a lot of undesirable politics, and united us towards a common goal.

We ultimately chose to model the CP Rail Sudbury Division during the 1970s. Common questions asked of our club usually consist of:

Why Sudbury? Why CP Rail? Why not the CN? Why the 70s? Aren't steam-to-diesel and modern day more popular eras with modelers?

We chose the Canadian Pacific since it enjoyed an unusually strong following in Waterloo Region, and most members modeled it already. The home layout we ran on when the WRMRC was founded modeled CP's Parry Sound Sub. At the time, the CPR had more reference material than any other Canadian railway.

We selected the 70s because it was recent history and easily researched (remember, this was 1989). It also satisfied "classic" CPR modelers who like maroon and gray plus it allowed modeling the modern day CP Rail (this was 1989, remember). The 70s satisfied both camps.

The other option was the ever popular steam-to-diesel transition era. If we were to have a prototype 50s era layout, we would need accurate steam engines: i.e., lots of costly scratch-building and brass models. The 1970s won the vote easily.

Continued on the next page ...

Zoom in to see the track plan details.

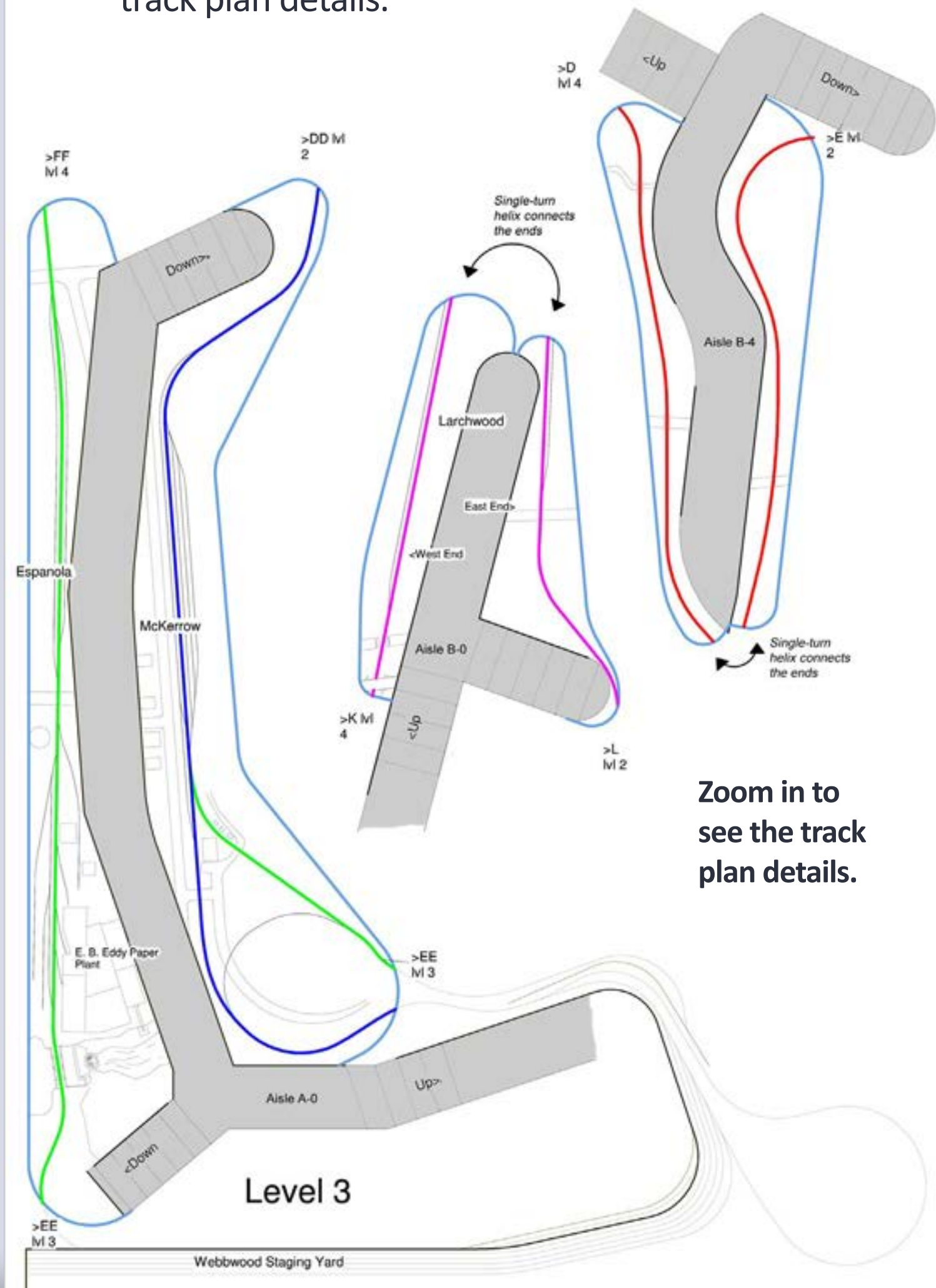

Zoom in to see the track plan details.

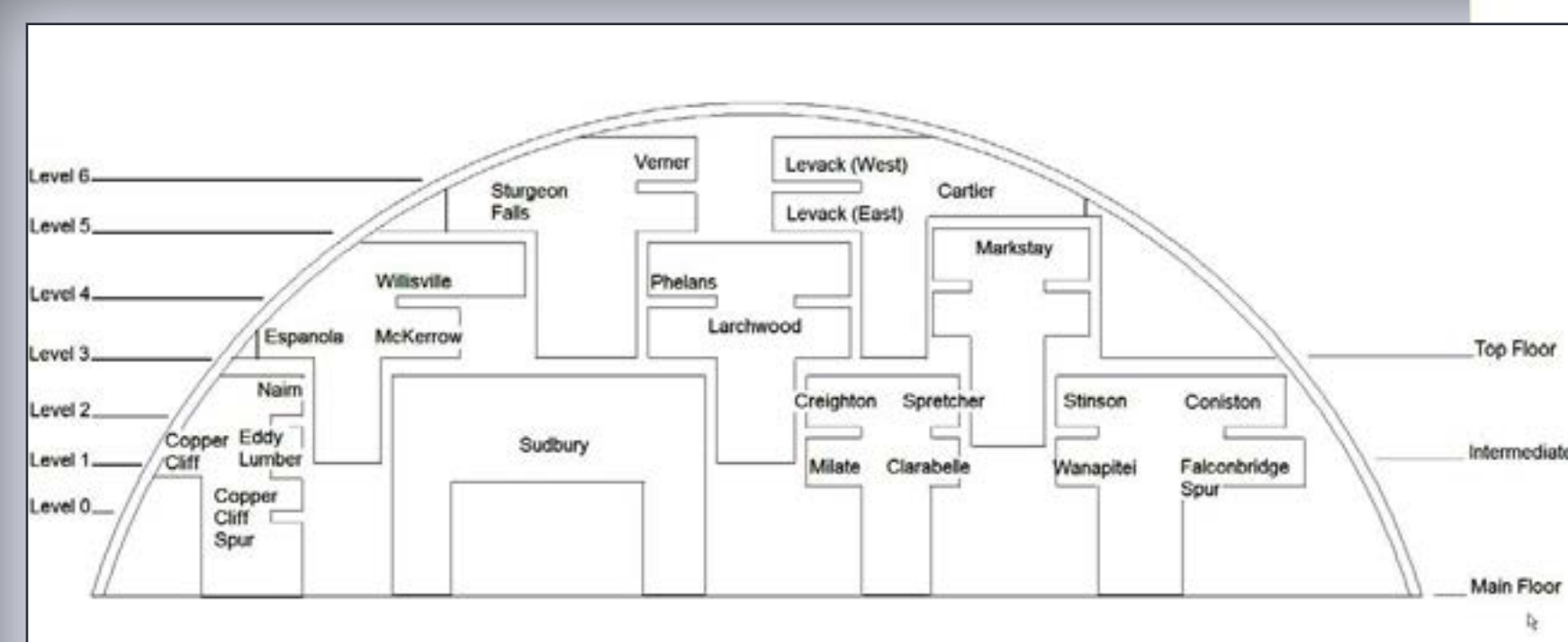

The quonset hut cutaway of the track plan is shown above. You can use this as a key of sorts to locate the different track plan levels presented here.

Sudbury Division Track Plan – page 5 of 6

Finally, why did modelers in southern Ontario model the province's near-north? Referring to our inspiration, the La Mesa club in San Diego – they model Tehachapi, a four hour drive away (the Sudbury happens to be a four and half hour drive from our club location). We ruled out the local area quickly, as the area is flat and heavily agricultural. It's hard to hide track going into a wall when it's supposed to be in the middle of a field. So the north it was.

We studied the CPR subdivisions and soon discovered the Sudbury. It had everything a we could want: mainline transcontinental time-freights, lowly manifests, heavy industry with switching, local turn jobs, mining and logging trains, local passenger service, and was the only place in Canada where CPR's flagship, "The Canadian," stopped and switched. It also has a small yard (the CPR thinks it's small) that's very busy.

Additionally the topography along the Cartier Subdivision changes completely every thirty miles. From flat farmland outside North Bay, to rugged rocky forests in Markstay, to earth-scorched lunar landscapes in the Sudbury basin to very rugged hilly scenes in Levack and Cartier. All the forests and rock cuts along the way made hiding those ugly holes in the walls between scenes easy.

While we work to complete our large layout project, we also promote the trend toward prototype railroad modeling. No matter what, we hope we inspire everyone to model to the best of their abilities, regardless if the models are highly detailed brass or simple tinplate. Challenge yourself to take your modeling to higher levels, just as the members of the WRMRC continually challenge themselves. ■

Zoom in to see the track plan details.

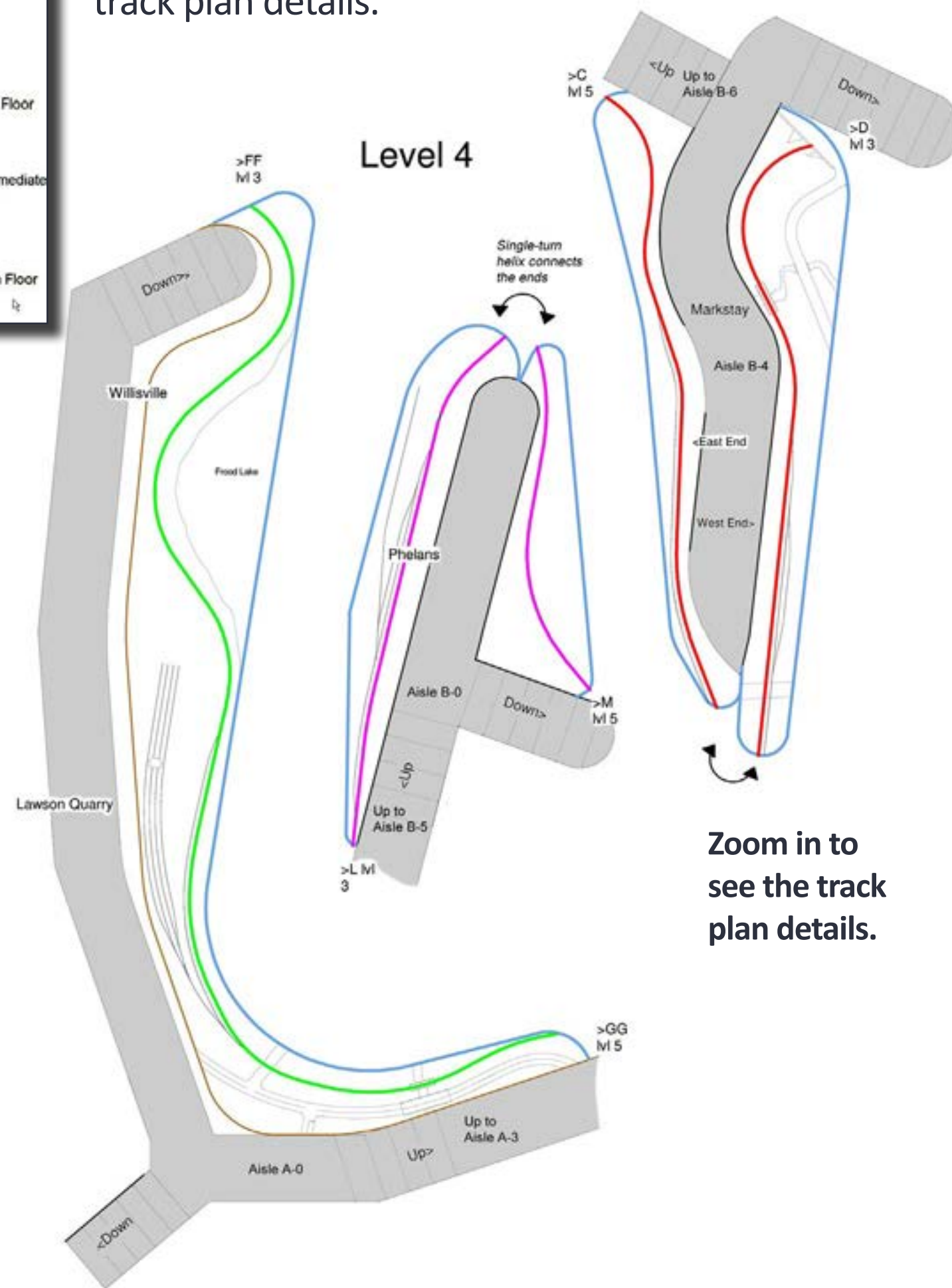

Zoom in to see the track plan details.

Sudbury Division Track Plan - page 6 of 6

Layout Statistics

Era: 1970-1979

Locale: Northern Ontario

Style: Prototypical re-creation of select parts from CP Rail's Sudbury Division, including the Cartier, Webbwood, Little Current and Nickel subs.

Scale: HO

Trackplan: Point to Point, 6 level multi deck on 2 stories

Building size: 2000 square foot; structure is 40x50 ft quonset hut

Min. radius: Mainlines 30" radius, Secondary (Webbwood Sub) 28" radius, Branchlines and Spurs 24" radius

Max. grade: 1.5% (mainline)

Track: Handlaid code 83, 70 and 55 in visible areas, code 100 flex track in hidden areas.

Turnouts: Minimum No. 6, mostly scratchbuilt with some Fast Tracks jig built in a few places, using Caboose Industries N scale ground throws or Tortoises.

Control: DCC - NCE radio and tethered throttles.

Operation: Dispatcher control using MBS clearances via FRS radios; car movements using car cards and waybills.

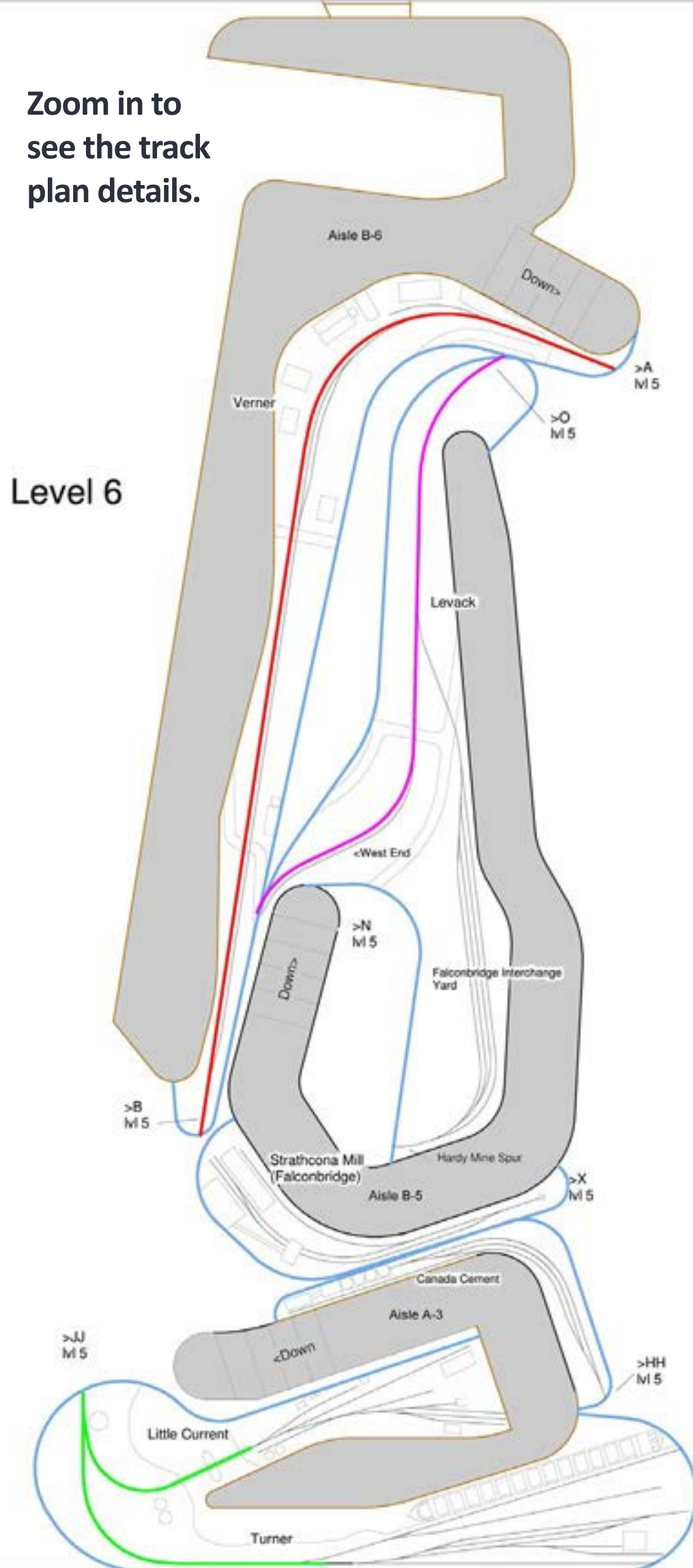
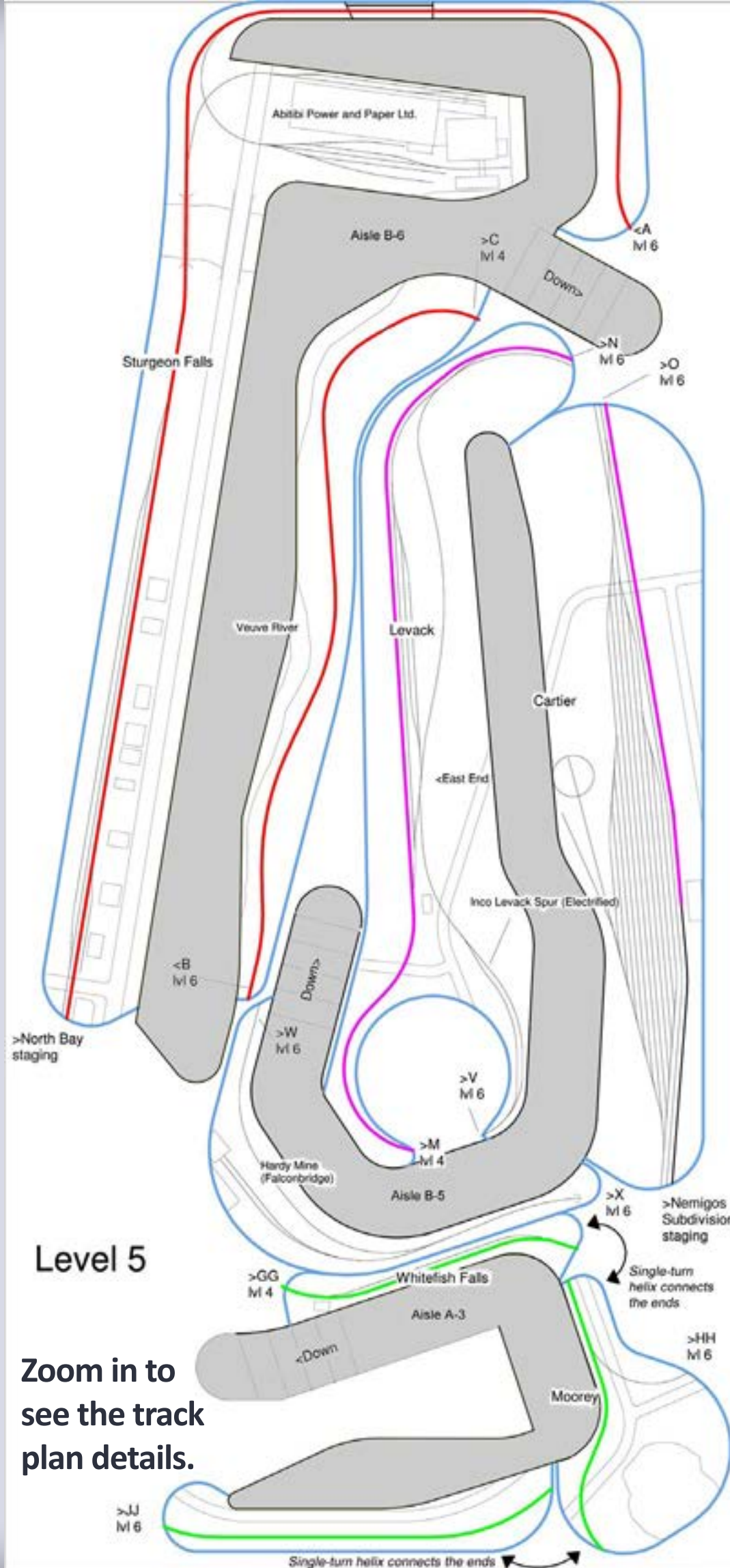

... Continued from article page 97

We had eight members out, which isn't bad from a membership of 20 or so. Some people travelled over 50 miles to make it to the work session. Justin (8) was the only member of our regular splining crew out, so he took charge of continuing the work on western mainline, while Don (9) and I helped him with various parts of the job. We added some splines, planed the roadbed and installed some backdrop at Sprecher.

The shelf at Sprecher can't be extended further until we get the throat for the Inco staging yard at Clarabelle on the lower level installed. This has been some real work since part of the throat will be visible from some angles, so we handlaid it (with some help from some Fast Tracks turnouts) – plus we have to scenic it partially.

We're building it at the workbench because access is difficult where it will be located. We've completed most of the track, but we still need to wire it, prepare the Tortoise mounts, set up the detector locations, and ballast the thing – all before it gets put in!

After I finished helping Justin, I worked on my pet project: getting the deep scenery at Wanapitei finished. This scene is over two feet deep and we will be building a second deck over this area once the scene is done (11).

Since it will be difficult to access after the upper deck is in, we need to get the areas furthest away from the edge (especially the river and backdrop) finished before the upper shelf goes in. The upper shelf supports the east end of Stinson and that's one of our goal projects for the summer. This means getting my area finished is a priority.

While some members work on the core projects, we had others working in still additional areas (it's a big layout).

Steven's completing the trackwork at the west end of the New Yard and shop area at Sudbury, along the Webbwood branch. Almost a dozen turnouts are involved, and they will all be handlaid. Steven is a newer member, but has



9: Don chisels away a bit of excess plywood in preparation for installing a section of backdrop behind Sprecher.



10: Chris B set up an area on the second floor to comfortably work on the Inco staging yard throat. There's only one track left to spike in place, plus some tuning on the Fast Tracks turnouts.

done hand laying in the past, so after brushing up his skills, he's making good progress on this complex project (12).

Wiring can be an endless task on a large club layout, and we find ours to be no exception. We want a feeder on every piece of rail to ensure reliable pickup. Phil has become our track wiring expert and has been working his way down the Webbwood Subdivision this summer, upgrading the wiring to our present standards.

Phil's made it to the second helix at Pineland (13), and has been improving its wiring. We salvaged the Pineland helix from our previous location over 15 years ago; we've made our standards for wiring quite a bit more stringent these days.

We're giving scenery more attention lately. We started the scenery at the rear of the Romford scene before the wye section was installed because access would be difficult later if we didn't do this.

Since then, we've done nothing much on it. Now because of our mainline extension (which began at Romford) we are back doing more at Romford. Chris V decided to give the area some attention this session (14). He's one of our more distant members, having travelled 2 hours from Sarnia.

With all the work aimed at expanding and improving the layout, we also continually need more rolling stock. Ted's been concentrating on decaling and weathering rolling stock lately, and has over 30 new cars to his credit this summer alone. So far Ted's delivered mostly CP 40 foot boxcars (15, 16, 17). We're still quite a ways from having the 200 or so CP 40-footers needed for the finished layout.

We're doing all this effort (at least partly) to add more trains to our operations. We want to add Potash and Grain extras to our sessions. Naturally, these trains need potash and grain cars, so bought cars in bulk from North American Railcar Corp (Pacific Western) because they make models of Hawker-Siddeley cylindrical hoppers.

Continued on article page 107 ...

11



11: Scenery starts to take shape at Wanapitei. We need to get the river banks roughed in, the river surface completed, and the backdrop scene painted before we can build the deck above. A modified Central Valley truss bridge will be used for the river crossing.

12



12: Steven is elbow-deep (or maybe hip-deep) in trackwork at the west end of the Sudbury shops area.

13



13: Phil solders new feeders into the Pineland helix.

14



14: Chris V puts down styrofoam blocks to support new scenery at the Romford rock cut. While most insist on blue or pink styrofoam, we find white beadboard works fine, especially since we had tons of it donated to the club.

15

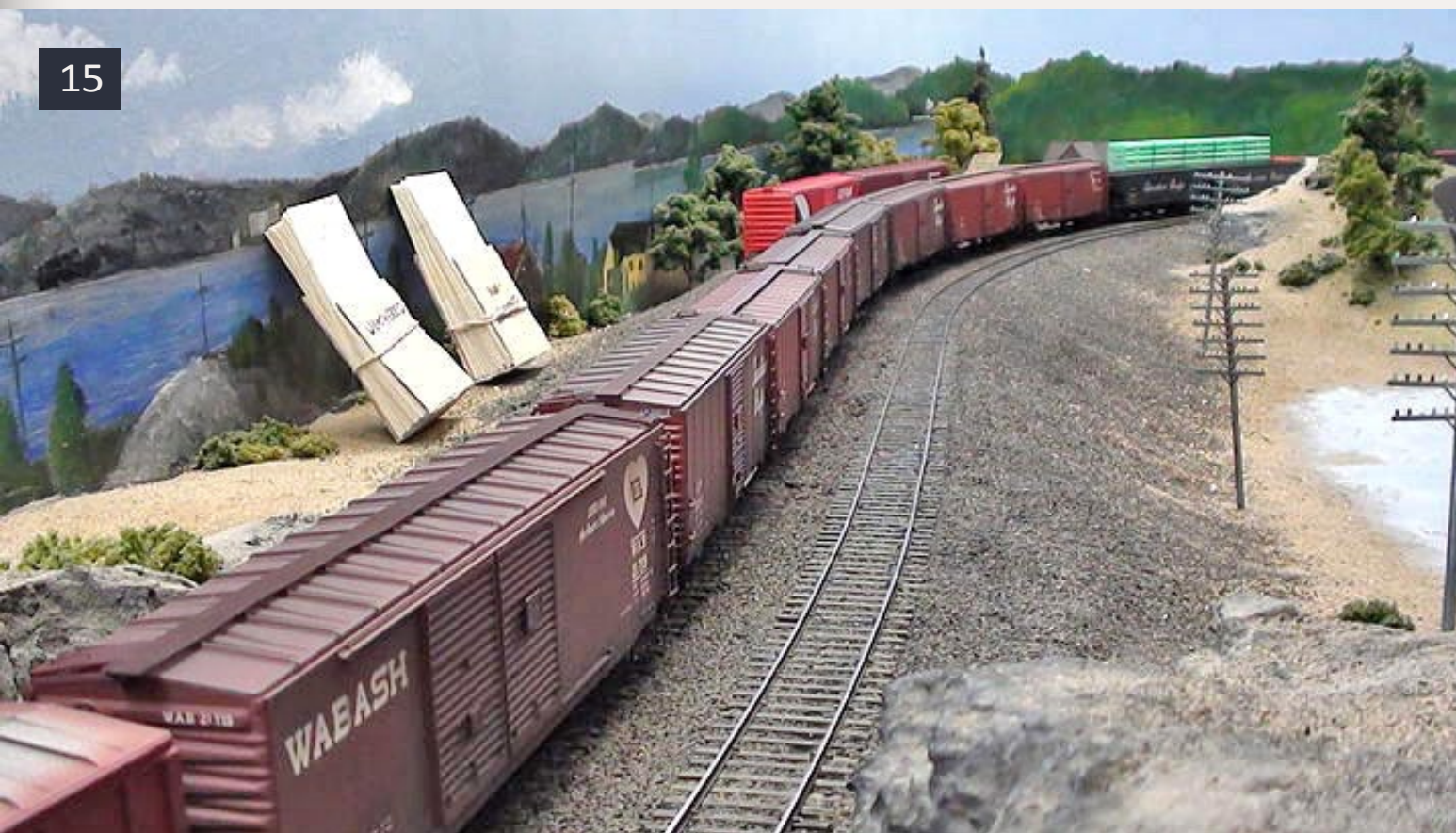

15: A long string of newly-weathered cars standing on the main near Sudbury. We're adding mostly CP cars for now since we need over 70 percent of the traffic to be CP rolling stock. We also add a few appropriate foreign cars like the Wabash 50 footer in the foreground. The Wabash car, lacking consolidated stencils and having a roofwalk, represents a car from the early 70s.

16



16: Finished weathered cars stand in front of a track full of cars awaiting weathering. ExactRail makes the long gondolas, we've backdated them with modifications so they represent 1970s prototypes.

... Continued from article page 105

Combining these cars with our existing fleet of Intermountain NSC cylindrical hoppers will allow us to put together some authentic unit trains to run in the coming winter months (18).

We still have a lot of work to do before our October open house, but we're making good progress. We've achieved success with similar deadlines in the past. Other projects include:

- Preparing Sudbury Yard for switching the Rapido Canadian when it arrives later in 2012
- Finishing Copper Cliff and Victoria Mine so we can put the Crean Hill mine run into service

There's lots of work, but it brings lots of reward. We're seeing the Sudbury Division's reality coming ever closer to our vision.

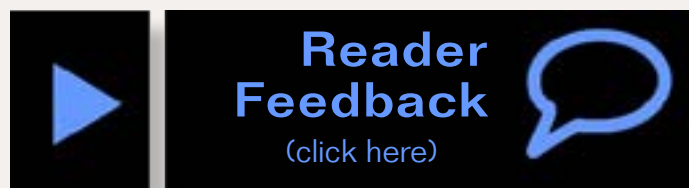

17: Here's where the magic happens. In this photo we see Ted dirtying up a couple of Fox Valley Soo Line 50 footers. White Soo Line cars just beg for weathering before going into service. Ted usually does the decal work at home, but does the weathering in the club's spray booth. By the way, we found that red letterboard in the background trackside, having fallen off a CP bulkhead flatcar. It's nice to know the prototype has problems with details falling off their cars too.



18: Three tracks full of cylindrical hoppers await weathering before they can enter unit train service. Each of the cars is owned by a club member, with some members buying as many as three each. Spreading out the cost over the entire membership makes building realistic and accurate trains like these affordable.

Scratchbuilding a Steam Loco in Styrene, Part 3



Techniques for getting exactly the loco you need using styrene ...

– Kenneth Rickman
Photos by the author

In parts 1 and 2 of this series, Ken introduced you to the prototype for this steam loco, the process of building a steam loco boiler out of styrene, adding details to the boiler, and improving the stock chassis to

perform better plus be more like the prototype loco he's trying to follow. Here in Part 3, Ken focuses on the front of the locomotive and getting it just right. In this part, Ken also provides side comments on installing the DCC decoder.

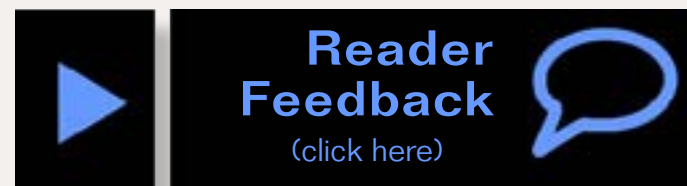

Ken Rickman started with a Lionel train set under the Christmas tree at two years old, and has always been fascinated by steam locomotives. Ken models primarily in HO, although he's dabbled in N, O, On30, and Fn3, as well as HOn3.

Ken's currently modeling and researching the Danville & Western Ry., a Southern-owned Virginia short line.

Ken is 32 years old and works as an engineer for Norfolk Southern. He has been with the NS for 14 years, starting as a conductor and graduating to engineer in 2005.

Ken's wife Cindy is a constant support as he spends time on research and modeling projects. His other hobbies include cooking, woodworking, and photography.

STEP 23: Making Pilot Beam and Deck

Having the deck and pilot beam attached to the cylinders can make construction simpler in many cases. By itself, the deck can be somewhat weak and difficult to attach the frame. There are often steps and hand rails which attach to both the deck and cylinders or steam pipes, and which are difficult to attach to only one or the other. Since all the associated parts are usually the same color, there is no real reason not to make the whole thing as a single piece.

Start with a "T" of .040" styrene. Cut a rectangle of .040" styrene a scale 9'-4" X 6'-5". This forms the base of the cylinder saddle and the front of the frame. At one edge, mark out a rectangle a scale 9'-4" X 34" for the cylinder saddle. In the center and perpendicular to the first rectangle, mark a rectangle a scale 3'-6" X 6'-5". Be sure to mark the centerlines of these as well. Cut away the two corners that are not within either of these rectangles. Drill a hole through where the two centerlines cross.

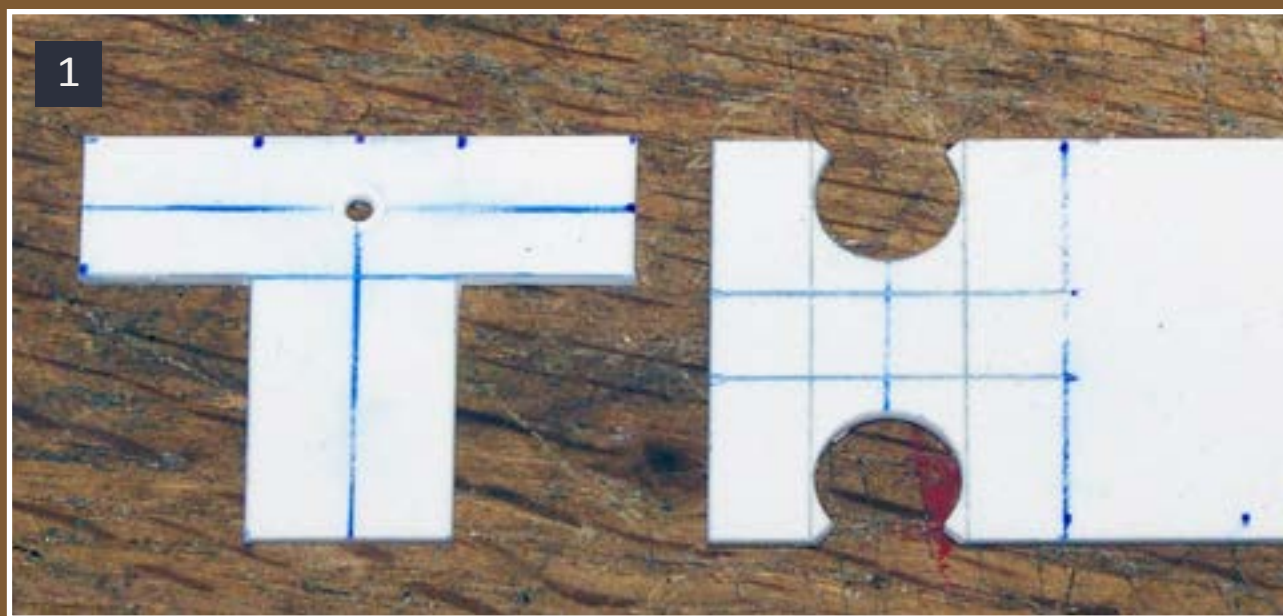

1: The "T" will form the cylinder saddle and the pilot beam, tying them together neatly and rigidly. The piece on the right will provide the bits to connect the cylinders to the saddle. By cutting them like this, it is easy to ensure that the curve is exactly the right radius and location, and the pieces are easier to handle for the extra material around them.

STEP 24: Making Pilot Beam and Deck

For the cylinders, cut two lengths of 11/32" tube a scale 44" long. Using dividers, cut four circles out of .015" styrene, just a hair larger than the cylinders. For the back ends, the center point of the dividers will mark the exact center for the piston rod.

At the front, be careful not to punch through, and the dot left behind will represent the nut which holds the cover on. Glue the caps to the cylinders, being careful to get them centered.

When the glue dries completely, file the overhang off of the cylinder caps, so that you cannot see or feel a joint. They shouldn't need any putty, if you were careful when you cut the cylinders to begin with. If they do, putty them and let the putty dry before sanding it down and continuing. Use sandpaper to round over the edges a little, keeping the radius consistent all the way around on all four caps.



2: The vertical pieces should in theory continue across the saddle, but they have to be separated to fit over the IHC chassis. The cylinder caps are in place here, but have not been sanded smooth yet.

3: It's good to test the fit frequently as you work. A quick swipe with some sandpaper and this will be ready to go.

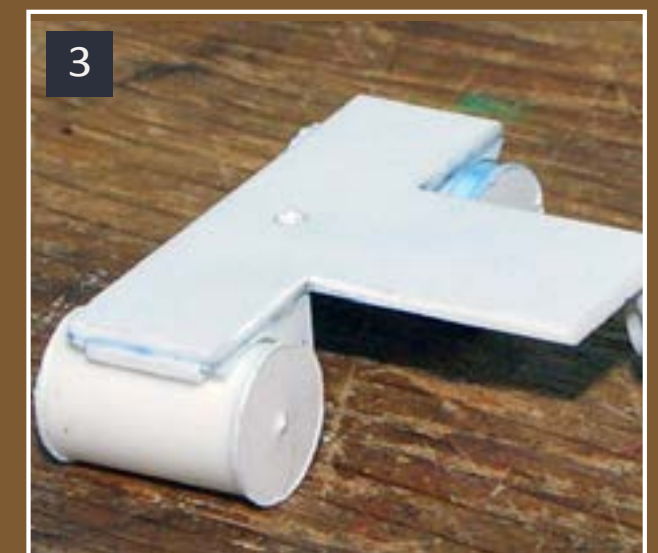

STEP 25: Mounting the Cylinders to the Deck

To make the lower portion of the saddle, cut two 11/32" holes in another piece of .040" styrene, spaced a scale 7'-2" apart. Sand the holes until they just fit an 11/32" styrene tube. Scribe two parallel lines that almost touch the edges of the holes, and a third between them through the centers of the holes.

Cut the ends to give a length of a scale 9'-4", centered on the holes, then cut the two halves apart. Remove the middle scale 3'-6" of each half, and glue the resulting pieces to the bottom of the "T".

Glue a filler piece between the outside ends, and another to keep the inner ends square. Bevel the outside edge slightly, forming the undercut outer edge of the valve seats. Lightly sand the curve slightly if needed to get a good fit on the cylinders.

Putty and sand the seams as needed to make it look like a single cast piece. Double check the fit of the cylinders in the saddle, and glue them into place centered front to back. There should be no gap in the joint, because it is very difficult to fill and sand it down afterward.



4: I puttied and sanded the base before gluing the cylinders in place. Here I'm starting the saddle itself. It is a lot easier to clean up the joints before gluing the sub-assemblies together.



Southern Digital

Specializing in DCC Since 1992

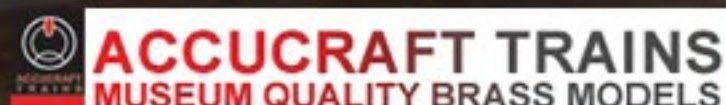

DigiFrame Kit



ADVERTISEMENT

20% Discount
on most items!

www.sodigi.com
(770) 929-1888

(Photo from our N-Scale layout)

STEP 26: Building Up the Saddle

On a piece of .040" styrene, mark out a strip a scale 3'-0" wide, and divide it into two scale 5'-3" sections. Mark the center of the line between the sections. Set your dividers to a scale 42" and scribe two arcs, using the center mark you just made. This lays out the front and back of the saddle.

To make the sides, cut two rectangles a scale 26" X 23". Glue these pieces into a box, with the sides between the front and back. It is helpful to work on a sheet of glass to keep things flat. Make sure everything is square. When the glue dries, sand and putty the seams. Glue the saddle to the base, centered left to right and with the back flush with the edge of the base.

To form the top of the saddle, cut a piece of .020" styrene a scale 38" X 52", and heat form it around a piece of 1/2" PVC pipe, with a .040" spacer. Punch a row of rivets along the short edges. Sand the top of the saddle box until it fits the curve perfectly, then glue the cap in place. Center it front to back and left to right. When the glue dries, drill a hole in the center for the mounting screw.

Punch a row of rivets into a piece of .015" styrene, about a scale 6" apart. You'll want 25 or so total. Cut along either side of that row to make a strip

around a scale 3" wide, and cut that strip into quarters. Glue two pieces back to back, keeping the rivets on either side in line with each other.

When the glue is dry, cut the two pieces to length and glue them to the front and back of the saddle. The front should fit snugly between the top of the base and the bottom of the flange, while the rear should go all the way to the bottom of the base. They should not project beyond the flange, so trim them as necessary to make them fit properly.

Cut two lengths of .040" styrene a scale 9" wide by a scale 48" long, and taper the last scale 15" to a point. Glue these on either side of the saddle to represent the frame rails which rise over the saddle casting.

If the new saddle is not exactly the same size as the original on the chassis, you'll need to shim it a little to make it fit snugly. A couple squares of .030" styrene on the back, just behind the frame rails, will keep it from sliding too far back. Make sure the holes in the frame and saddle line up.

Add shims to the underside of the saddle where it meets the frame, to keep it perfectly centered left to right as well.



5: Another test fit. I found out that my saddle was too low, and I had to cut it away from the base and add a spacer beneath it, which you can just see in the photo.

STEP 27: Making the Steam Chests

To make the steam chests, build a pair of boxes a scale 26" X 33", a scale 15" tall. The tops are .040" styrene rectangles a scale 27" X 34" with the edges rounded over. The goal is to have the tops the same width as the base, with the boxes about 1/2" smaller all around.

Sand the boxes smooth, don't round the corners, and glue the assemblies to the base.

To model the economy piston valves on a superheated engine, cut two circles of .010" styrene about a scale 14" in diameter, and emboss a circle of rivets around the outside. Glue these to the front of each steam chest, centered horizontally and vertically.



6: The steam chests are simple boxes with overhanging lids. You can also see the false upper frame members on either side of the saddle.



7: The brass rings simulate the rolled lip on the prototype's cylinder caps. At this point, it's a fairly accurate model of an original K class slide valve saddle.

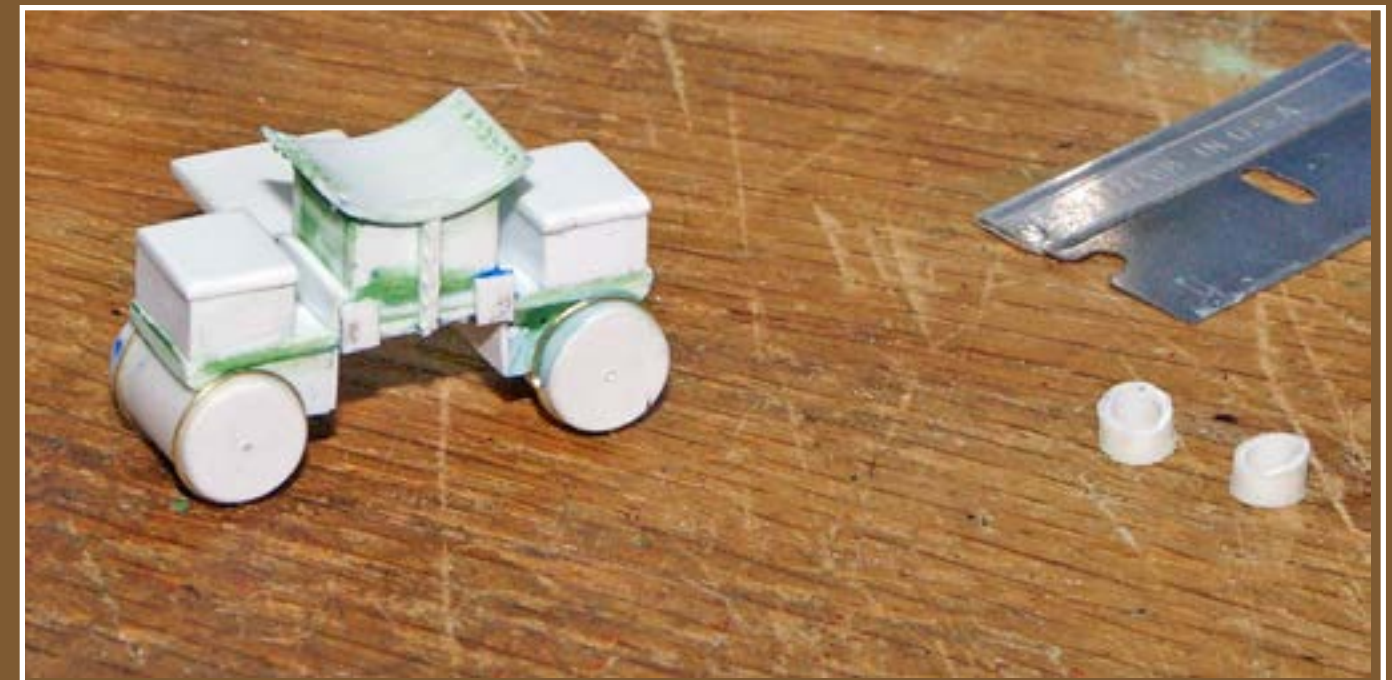

8: The little squares behind the saddle are spacers, to make it fit in the right location on the IHC frame.

STEP 28: Making the Dry Pipes

The steam pipe is made from 3/32" styrene tube. There is a short (about a scale 9") vertical segment which is centered on the top of each chest, and an angled piece which runs from that to the smokebox, a few inches below the center line.

With the boiler assembled on the chassis and cylinders, the live steam pipes can be finished. They should fit tightly against the smokebox, and are glued to the stubs already in place on the valve chests.



9: The dry pipes are made to fit, and require a little testing to get right. It helps to have the boiler finished so that you can fit them to the smokebox. The piston valve access covers are just circles of styrene glued in place.

STEP 29: Making the Running Board Steps

Make the lower running boards from .020" styrene, a scale 16" wide and long enough to extend from the front of each boiler running board to the rivet seam on the smokebox. Measure each side, as they may not be the same. File out notches for the steam pipes, taking care to get a close fit.

Cut four steps from .005" brass, a scale 16" wide, about a scale 12" tall, and with scale 6" legs bent in a 'Z' shape. Glue two to the bottom of each running board, one up and one down. Glue the running boards to the steam pipes so that the upper step just touches the bottom of the boiler running board.



10: With the dry pipes done, the lower running board steps can be added. They just sit beneath the running boards on the boiler, but if carefully made the joint will not be visible on the finished model. The pilot beam and deck are in place in the photo as well. By building up the beam in layers, it is easy to get the casting pattern in the end.

STEP 30: Building Up the Pilot Beam, Deck, and Draft Gear

The pilot beam is built up out of several pieces, to simulate the open ended steel box on the prototype. Cut three strips of .040" styrene, a scale 12" wide and a scale 10'-0" long. On one, file notches in the corners so that there is a thin stub left on the center of each end. Glue the three strips together, with the notched one in the middle. With the laminated strips oriented vertically, glue a .030" strip to the bottom, and .015" strips to the front and back. Using a file and sandpaper, round over the ends of the beam until they're half circles.

Make the deck by cutting a piece of .020" styrene, a scale 3'-0" X 10'-0", and glue it to the top of the beam. Round over the front corners to match the rest of the beam. Glue the beam and deck to the pilot and cylinders, then build up the back side behind the beam with .060" styrene to form the coupler mounting pad. Cut a notch in the center of the beam, a scale 6" up from the bottom and a scale 21" wide. This is for the coupler pocket, so double check the height using a gauge and the width based on your preferred couplers.

From the underside, drill two holes in the deck right behind the beam and to either side of the front frame extension. These will be enlarged later to pass the braces on the smokebox. With a larger drill (something in the 1/8" range, but exact size doesn't matter), make the poling pockets in the front and back corners of the beam by drilling dimples at 45 degrees to the beam.

While there are couplers designed for steam locomotive pilots, they are scarce and expensive, and generally not functional. The Accumate Proto:HO coupler from Accurail has a scale width box which can be made to resemble a beam-mounted coupler pocket. Kadee #5 and others can be used, but they are too wide, and will require adjustments. The Accumate box needs to be mounted upside down in order to work in this situation (the coupler will still work properly). Begin by removing all the detail from the bottom of the box, except for the lip at the front edge. Also, remove the "wings" on either side. You may choose to shorten the box, if it interferes with your chassis or pilot truck. Glue the box to the pad you made behind the beam, leaving about a scale 9" protruding in front of the beam. This should put the front mounting hole just far enough back in the beam to hold a screw securely.



11: The underside of the pilot deck has a pad for mounting the coupler, since I chose to use a regular coupler modified to resemble those on a steam locomotive pilot.



12: Aside from being a way to test the fit of various parts, putting everything together can be a way to keep yourself inspired. It's starting to look like a locomotive!

STEP 30: Building Up the Pilot Beam, Deck, and Draft Gear *Continued ...*

To make the Accumate draft gear box look like the coupler pocket casting, cut a rectangle of .020" styrene, a scale 30" X 18". Emboss two rivets in each short side, and two more across one long side. Cut out a piece a scale 21" X 12" to allow the plate to fit over the coupler box, and glue it into place on the box and the front beam. Cut six triangles of .015" styrene, made by cutting scale 9" squares and cutting them in half diagonally. Glue two to each side at the top and bottom of the box, and the last two to the top, roughly dividing the box into thirds. Glue a couple scraps of .040" styrene to the bottom of the beam on either side of the coupler box, to brace the back of the plate where it extends below the beam.

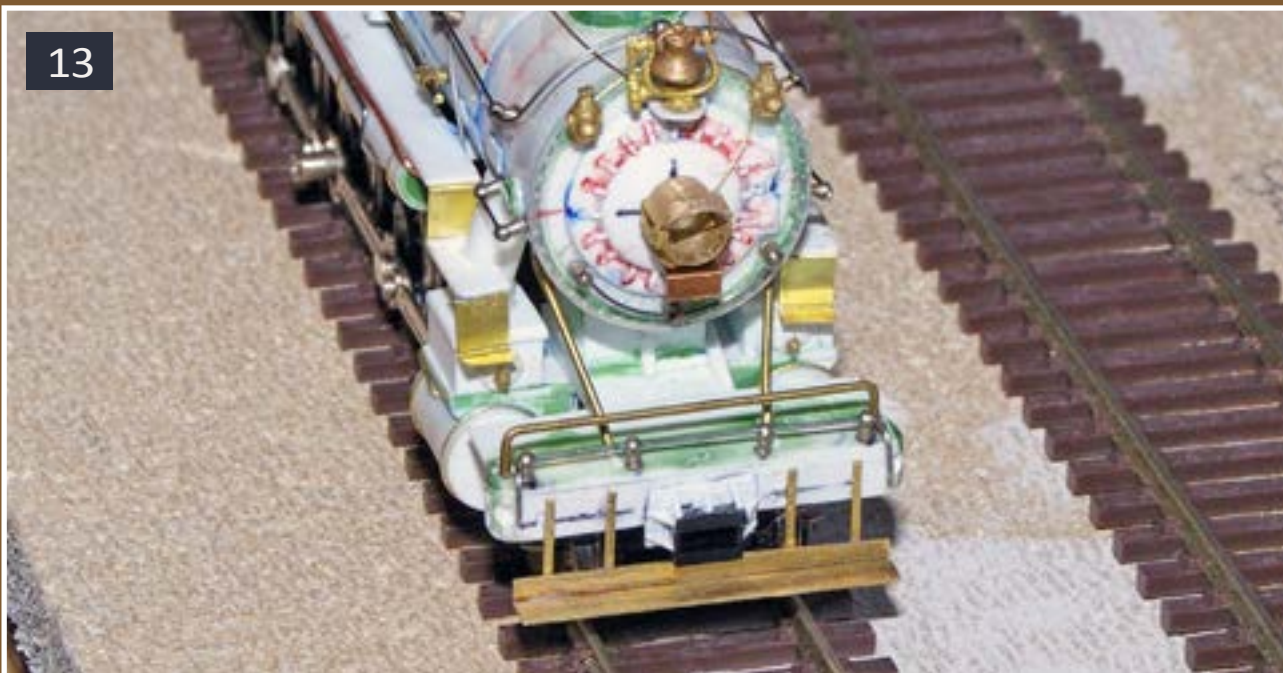

13: With the coupler "casting" built up and the foot boards, cut lever and hand rails in place, the pilot is pretty well finished.

Power Pick-Up Truck

Use to get power from the track for sound decoders, lights, cameras and more! Design provides dependable contact on slightly uneven and moderately dirty track!

ADVERTISEMENT

All Wheel Electrical Pick-Up

Four Bushing Design



33 or 36 Inch Wheels

Four Wheel Independent Suspension

- HO Scale
- RailPro, DCC and Analog Compatible
- Machined and Blackened Wheels
- Prototypically Accurate Exponential Curve in Wheel Face
- Low Rolling Friction for Electrical Pick-Up



ADVERTISEMENT



Tired of old structures on your modern layout?

We can help!



SUMMIT USA

Click Here for more details...
www.summit-customcuts.com



STEP 31: Making the Crossheads and Main Rods

The dimensions of the crossheads will affect the length of the main rods and the construction of the guides and guide support, so they need to be made next. Cut 2 rectangles of .040" styrene, roughly a scale 12" X 15". Drill a large hole close to one end and centered across the short dimension, then cut from the corners into center of the hole. This forms the clearance for the small end of the main rod inside the crosshead. The pieces should sort of resemble the plastic clips used on bread bags. Next, glue a square piece of .010" styrene to each side of each piece, making a block with a pocket in one end and a channel on opposite sides. Drill a small hole for the wrist pin completely through both faces, ideally centered in the larger hole inside.

With a round file, or sandpaper around a round form, file a curve into the back (pocket) side of the crosshead. This is purely cosmetic, so the exact shape is not critical. In the front (solid) portion, cut a notch with rounded ends. The easiest way is to drill three small holes and carefully join them with a knife and files. This notch will hold the "nut" which, on the prototype, attaches the end of the piston rod. To make the piston rod, find a section of brass or steel rod roughly a scale 4" diameter. I found some small finish nails which were perfect. Steel rusts, and will need oil or wax, but it has the advantage of looking a lot like steel, and it's hard to keep paint on a sliding surface like this. Drill a hole in the front center of each crosshead and glue the rods in place, leaving them long for now. Slide a short section of styrene tube over the end of the rod, against the crosshead, and glue a brass or styrene nut (snip the corners of a square scrap) into the notch.

Temporarily assemble your chassis with at least the main driver and cylinders in place. Measure the distance from the center of the crank pin to the cylinders with the crank pin fully forward. Subtract from that measurement the length of your crosshead, from the wrist pin hole to the front of the sleeve over the rod. The resulting dimension is the maximum length of the main rod, so subtract a scale 3" or so for clearance to find the final length of the main rods.

Cut a piece of 3/32" square brass tube longer than the final length of the rod, and then carefully cut the tube in half lengthwise. You should have two pieces of "C" channel. If you cut too close to one side or the other and removed the flutes at the top or bottom, cut another piece. Cut two pieces of 1/4" X 1/16" brass strip 3/16" long. Solder the channels and strips to .005" brass sheet to form the rods and big ends, then cut each rod out and file the edges until the sheet is not visible. File the fluted side of the rod

until it is an even thickness along its length. Drill a hole for the crank pin in the center of the big end. Drill the wrist pin hole in the small end at the distance you determined above. Cut away the excess length and round the small end of the rod over. Check to see that it fits easily in the crosshead - if not, file it down slightly until it does, but take care not to file away the flutes. Solder some washers, scraps of brass, or a short piece of tube to the back of the big end, to serve as a spacer. It should be slightly thicker than the crank pin heads with washers, and is there to provide clearance behind the main rod. Drill, file, or ream the hole until it is a smooth running fit on the crank pin.



14: The crossheads and rods are built up in layers. Here you can see one of each finished along with some of the pieces that went into it.

STEP 31: Making the Crossheads and Main Rods *Continued ...*

The wrist pins are short 00-90 hex head bolts and washers, carefully glued from the outside using epoxy or CA. Slide the rod into the crosshead, then insert the bolts and glue them in place, being careful not to get any glue on the rod itself. You could use nuts on the back side, making the wrist pins removable, but that increases the thickness and requires everything to be wider in order to avoid hitting the rods, wheels, or crank pins. When the glue is cured, file the back of the crossheads flat, and file down about half the thickness of the bolt head.

You could dress up the big ends of the rods with bolts, wedges, grease cups, etc, but I chose not to on my model. Soldering would disturb the assembly, drilling could twist the rod apart, and making little tiny pieces stay put would be a challenge. If you want them, I would recommend using lengths of styrene rod glued to the back of the rod and protruding from the top and bottom to simulate the bolts and wedges.



15: The main rods needed spacers to keep them from hitting the crank pin screws on the other drivers. I also chose to glue the wrist pins in place, rather than making them removable.

STEP 32: Making the Crosshead Guides

The crosshead guide bars are made from code 83 nickel silver rail. Cut the head off of a scale 5-6" of rail. Dress the cut surface with a file, then color it with a marker so that you don't accidentally put it against the crossheads. Any roughness will chew up the plastic crossheads, so it is best to keep the cut edge toward the outside. Cut four bars a little longer than the length of the crossheads plus the throw of the crank pins, which should put the back ends between the #1 and #2 drivers. File one end of each bar into a pin, which will later be inserted into a hole in the cylinder.

File the end of another piece of rail with a slight back bevel, so that the head of the rail becomes a very blunt chisel. Using this, scrape out the top and bottom of each crosshead so that it rides smoothly on the head of the rail. Sand or file the "lips" down, as they only need to protrude enough to keep the crosshead from sliding sideways off the bars.



16: New crossheads, rods, and guides! The rear support is flimsy until everything is soldered together. Then it gets pretty sturdy.

STEP 33: Making the Crosshead Guide Support

Make the rear guide support out of .010" brass sheet, using the photos and your model dimensions to determine the exact size and shape. It is critical that the guide bars are parallel to each other and to the frame, and also that they are level. The crossheads should be spaced just wide enough to clear the crank pins when the drivers move fully to either side of the frame, and that measurement will depend heavily on your choice of chassis and the parts that you have made so far. Tape the guide bars to a piece of wood which is the same thickness as the crossheads to hold them parallel, and solder them to the support.

Mark the locations for the guide bars on the back of the cylinders. They will be outside of the centerlines, because the cylinders are spaced prototypically, but the wheels are wider than prototypical. Drill holes for the guide bars, and a larger hole for the piston rod. Make the piston rod hole larger than the rod itself. Dry fit the cylinders to the guide bars on the chassis, and if everything lines up neatly, use epoxy (not CA) to glue the bars into the cylinders. To strengthen the entire assembly, cut a strip of .005" brass wide enough to fit on top of the chassis and long enough to go from the front of the cylinders to just behind the crosshead guide support. Drill holes in the appropriate locations for the bolt through the smokebox and the screw in the rear support, then solder it to the support and glue it to the cylinder saddle. Mount the rear support to the chassis with a small screw through the tab in the center.

The crossheads should slip in from the back, and slide smoothly all the way up to the cylinders. Carefully file and carve the crossheads until they run smoothly on each side. Since you are fitting each one independently, they will no longer be the same, so mark them as left and right. Cut the piston rod to length, so that it is just a little short of hitting the front cylinder wall when the crosshead is all the way forward. Once everything is running smoothly, cut small diamonds of .010" styrene, and drill holes for the piston rods in the centers. Slip a diamond over the rod, and slide the rod into the cylinder. Slide the crosshead almost against the cylinder, and glue the diamond in place on the cylinder. If your rods are parallel to the top and bottoms of the crossheads, they will now run smoothly in the diamond packing gland on the cylinder wall.



17: With everything assembled, it becomes quite rigid. You can see that the crosshead guides are not centered on the cylinders – a compromise required because of the wider than scale wheels we use. It doesn't show on the finished model, and is actually a fairly common compromise.

STEP 34: Simulating Stephenson Valve Gear

Stephenson valve gear has few parts visible from the outside. There is a shaft which runs across the frame, and rocker arms on each end of the shaft. The ends of the arms attach to the valve rods, which pass through the crosshead guide support and into the steam chests. You could model the individual pieces, but a reasonable representation can be made out of a single piece of brass wire, bent to represent the shaft, arms, and valve rods. Solder the shaft to the .005" brass on top of the frame, and glue the valve rods to the steam chests.

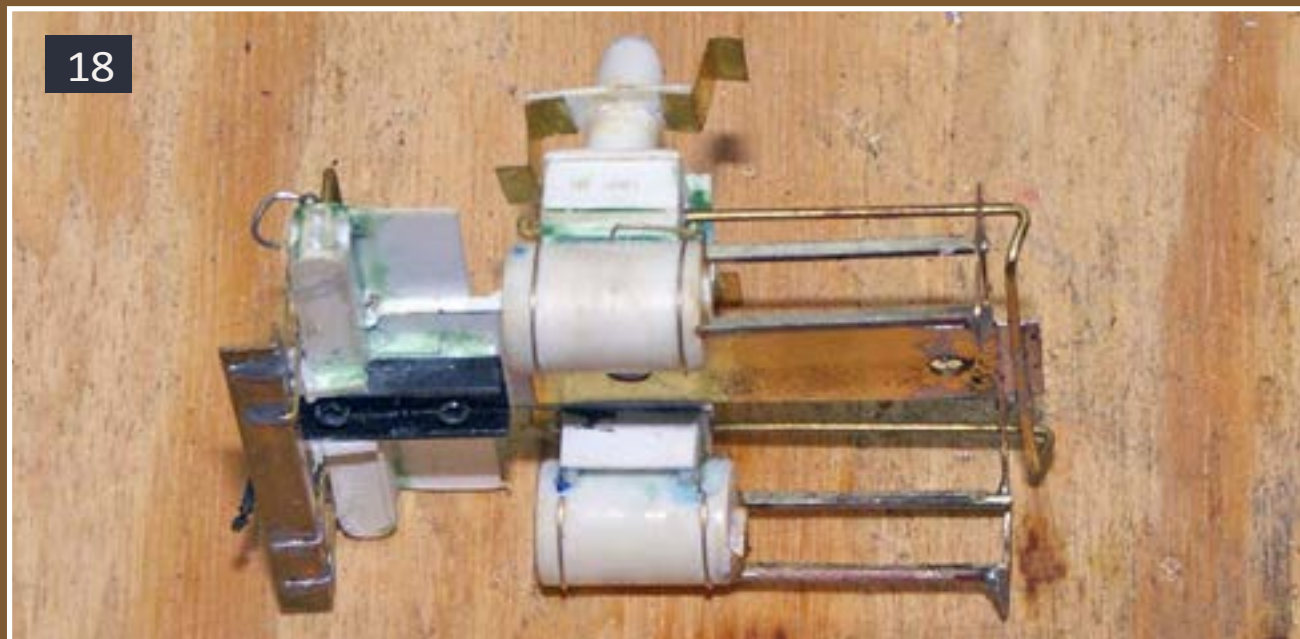

18: I used simple brass rod to simulate the Stephenson valve gear. You can also see there's room under there for a regular coupler box. Notice the styrene shims I added to keep the saddle from moving sideways on the frame.

Decoder Install sidebar continues on next page.

STEP 35: Making the Foot Boards and Final Pilot Deck Details

To make the foot boards, start with a length of 3/16" square brass tubing. Using a fine saw, cut off one side, and then cut the resulting 'U' channel in half. Cut the two 'L' shaped pieces off, a scale 9'-0" long, and clean them up with a file. The tender will need a foot board as well, and it's easier to make them both at the same time. Make eight legs from .010" X .030" brass strip. They should be extended 'L' shapes, with the long leg a scale 2'-6" long and the short leg about a scale 6" or so. Solder these to the back/bottom of the foot boards, a scale 9" and 27" in from each end. If you like, you can emboss two rivets in each leg, a scale 3" and a scale 9" from the top. Glue the foot boards to the beam so that the boards are level and about a scale 8" above the railhead.

The hand rail and cut lever on the deck are pretty basic, being made up out of brass wire and handrail stanchions. While adding detail to the deck, cut four short lengths of .010" X .020" strip. Two are glued to the deck, running forward from the holes where the smokebox braces pass through, and two are glued running back from the holes where the hand rail is glued in place. The air line, modeled with brass wire, passes over the right side of the saddle and across the deck, with the hose hanging to the right (not left, as is usual) of the coupler. The cylinder cap rims are simulated with rings of brass wire, and the drain cock control rods are simply lengths of wire glued in place at the bottom of the cylinders.

In the final part, we'll cover building the cab, tender, and painting the loco.

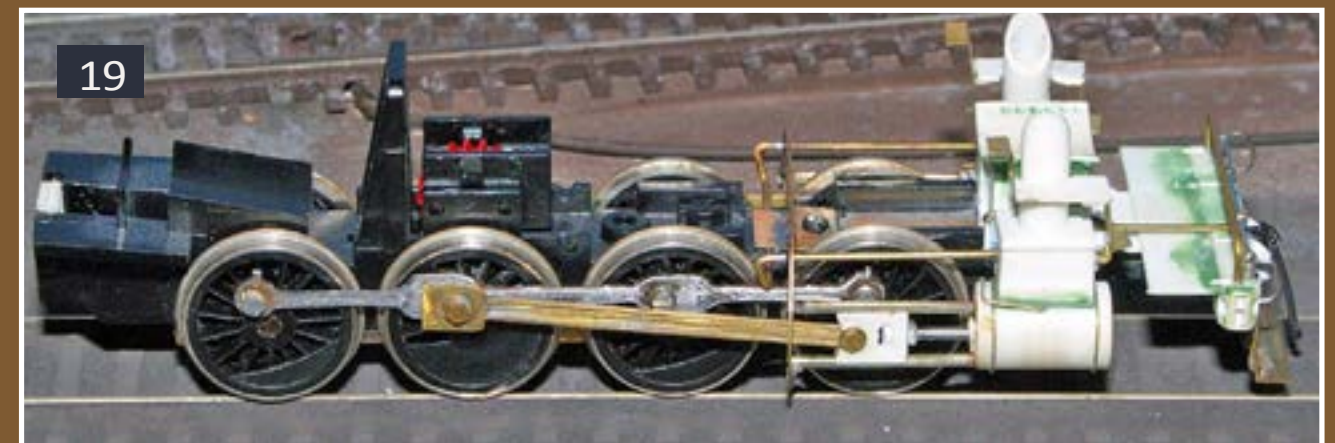

19: Here's the finished product. With the motor removed, this should roll around smoothly. I coupled it to another engine and moved it all around the layout, fine tuning things until the drivers rolled smoothly everywhere they went.

STEAM LOCOMOTIVE DECODER INSTALLATION

I decided to install a Soundtraxx Tsunami medium steam decoder in this steam model, because after all that work, I wanted it to sound good.

In order to get as much as possible out of the limited space in the tender, I made an enclosure that completely filled the tank, and put the decoder inside the enclosure. The high bass speaker I used was too tall to sit vertically and fire through the front opening in the tender (nothing like proper planning, right?) so I had to mount it on an angle.

The top of the enclosure is tapered, in order to more easily hide it beneath the coal load.

I used a standard 8-pin connector between the engine and tender because they are easy to get and small enough to be hidden easily. I followed standard NMRA wiring so that if I ever get the connector on upside down, I won't damage anything.

In retrospect, the wires are so short that I would have to connect the entire tender upside down to get the wiring wrong. Because of the design of the enclosure, the wires have to come out right at the front, and the enclosure is

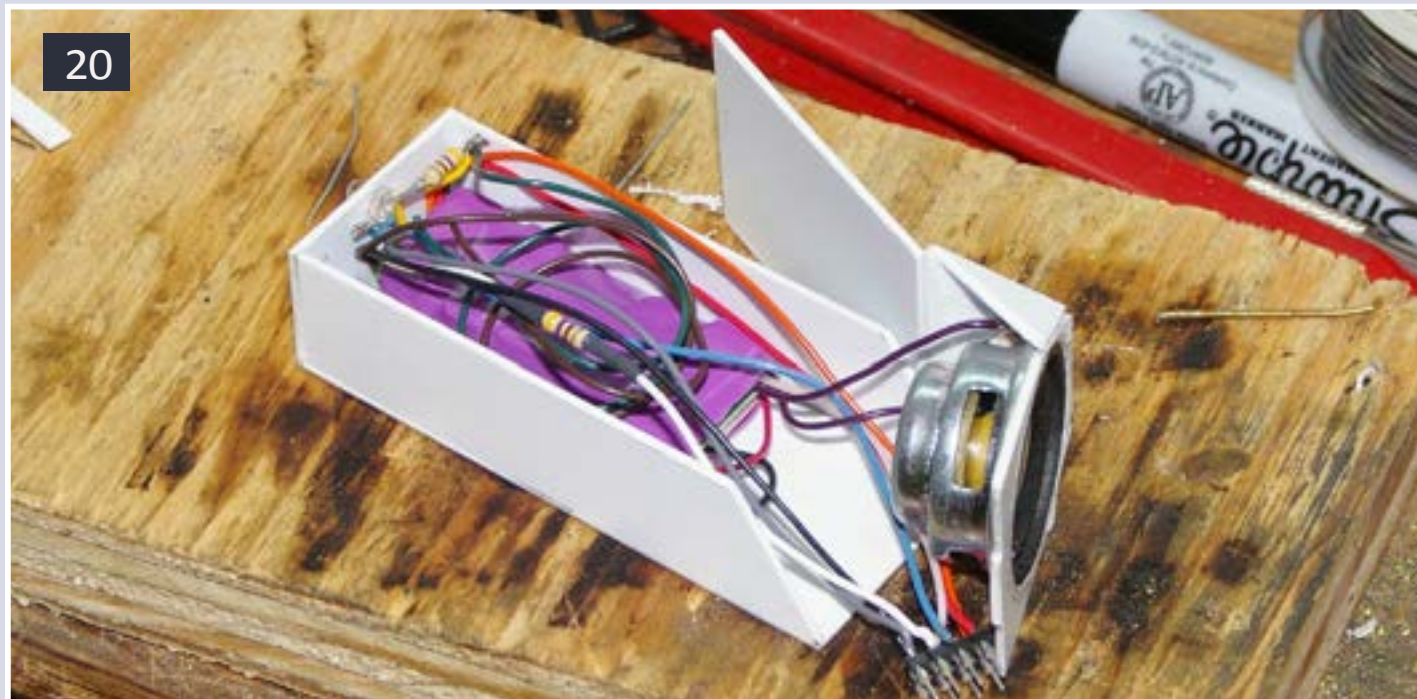

20: A mini Tsunami would have given me a little more room, but this was manageable. The rear LED headlight is glued into the enclosure as well. I left the enclosure split in half like this until I was certain that everything was working properly. It's impossible to get to when the enclosure is closed.



21: The channels on the sides give room for the wires to fit between the enclosure and tender tank. The line across the top marks the rear of the coal bunker. Nothing could go behind that line, or the tank would not fit over it.



22: I wired the 8-pin plug upside down for some reason, so the red and black wires have to cross. The copper pads will provide plenty of area to solder the truck wires to.

glued up around everything. I made it in halves, and glued it up after the wiring was properly tested.

Because of the tight space inside the tender, I carved channels in the sides of the enclosure for the wires coming off the trucks. I taped these into the channels for final assembly.

I glued a piece of copper clad board on top of the enclosure to make it easy to connect the truck wires to the rest of the wiring, and later disconnect them if needed. I also had to remove the rear corner of the enclosure to fit around the rear tank mounting, and that hole was sealed with Scotch® tape.

I puttied the seams around the enclosure to make sure they were air-tight, and then got a little carried away with making everything as neat as possible. Then I painted the chrome center of the speaker cone and the white styrene enclosure flat black, to make them less obvious through the rather large hole in the tender.

Since I had not painted the tender yet, I decided to make a brass cover for the enclosure and solder it into the tender tank. It was just cut and folded to fit neatly over the enclosure, without bothering to much about perfection.

Styrene, or even paper would have worked as well, and could have been put in after the decoder was installed. Of course, if I had used a smaller speaker,



Figure 23: I made the enclosure just as large as I could. In order to fit around the rear tank mount, I notched the bottom and used tape to cover the hole.



Figure 24: I was having fun with brass at this point, so I made a cover for the enclosure. It's far from perfect, but it won't show, and it was a quick and easy thing to make and solder into place.

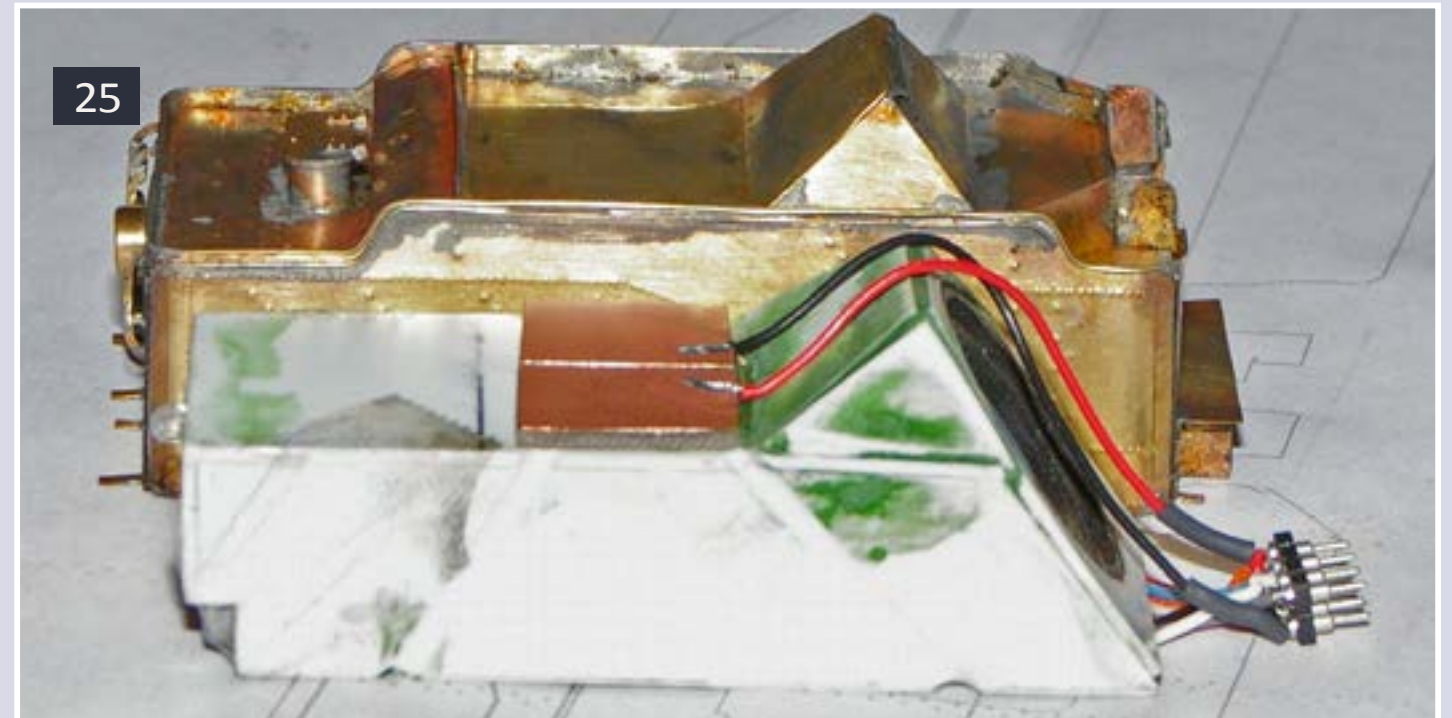

Figure 25: This should give some idea of just how tight the fit is. There is almost no wasted volume inside the tender.

or a power only decoder, I could have used a simple flat sheet for the bottom of the coal load.

The last step in any decoder installation is of course programming. I found fairly quickly that I could not program a Tsunami with the programming track on my Digitrax Zephyr.

Doing some research on line, I found that I could set Option Switch 07 on the Zephyr to "t", which would allow me to program the engine on the main line at full power. Be very careful when doing this, because you can let the magic smoke out of the decoder very quickly if it is not installed properly, and of course all engines on the layout will be reprogrammed.

I was careful to test the engine at address 03 first, and of course to remove all other engines from the layout. With the address set, I could do the rest of the programming on the main in ops mode, with switch 07 set back to "c" and the rest of the engines back on the layout. ■



 **Reader Feedback**
(click here) 



Figure 26: I painted everything flat black to hide it inside the finished model. Only the front face needs paint, of course.



Yankee Dabbler.Com
(727) 457-9227

HO **DCC**
Click to see specials in these categories
All Scales

Authorized dealer for:

OVERLAND MODELS, INC.	EXACTRAIL	NCE The Power of DCC	YD Yankee Dabbler.Com
Digitrax	Bar Mills SCALE MODEL WORKS	SOUNDTRAXX	PECO
WALTHERS	RE RING ENGINEERING	TCS	RailMaster Hobbies
INTERMOUNTAIN RAILWAY CO.	Kadee The Coupler People®	Bowser	BEV-BEL

Atlas • Bachmann • AccuRail

ADVERTISEMENT

RailPro
HOT!



Click to see our
August Specials
(while supplies last)

- Digitrax
- SoundTraxx
- Kadee
- NCE
- And more!

Click now and save!



**Everyone who has their
AUX-BOX, raise their hand!**

**"Taking model railroad control
to the next level ..."**



So what's an AUX-BOX?



click to find out ...

www.auxboxdcc.com

ADVERTISEMENTS



Structures
of simple
elegance ...



Made in
the USA

**ALPINE
- DIVISION
SCALE
MODELS**

**Click to
Learn
more...
alpinemodels.com**



Exceptional
Model Product

Exceptional
Products - past,
present, or future

Model Railroad
Hobbyist magazine™



PRODUCT SHOWCASE

Intermountain: Santa Fe class Rr32 reefer

→ [Visit intermountain-railway.com](http://www.intermountain-railway.com)



In 1996, [InterMountain Railway](http://www.intermountain-railway.com) introduced a series of HO scale SFRD refrigerator cars that have since been released in a range of authentic Santa Fe schemes. Number 31902 represents a USRA car rebuilt by Santa Fe as a class Rr32 and decorated in the Super Chief slogan that became prevalent in the late 1940s. The opposite side of the car displays a Ship & Travel message. Initially, InterMountain's highly acclaimed SFRD reefers were marketed exclusively by Longs Drug Store, which had assisted in funding the tooling for the series.



Exceptional
Model Product

Exceptional
Products - past,
present, or future

Model Railroad
Hobbyist magazine™



PRODUCT SHOWCASE

Athearn: Amtrak EMD F59PHI loco

→ [Visit horizonhobbytrains.com](http://horizonhobbytrains.com)

(Athearn)

[Athearn](#) introduced its **N scale** rendition of Electro-Motive Division F59PHI passenger locomotive in 2002. Since then Athearn has made several upgrades to the original ready-to-run model including redesigning the truck sideframes with greater detail and the introduction of factory installed SoundTraxx™ DCC sound decoder. During the past ten years Athearn has offered the contemporary diesel in a variety of liveries including the Amtrak/West paint scheme seen here on number 451.



Exceptional
Model Product

Exceptional
Products - past,
present, or future

Model Railroad
Hobbyist magazine™



Reader
Feedback
(click here)



PRODUCT SHOWCASE

Pacific Fast Mail:

Santa Fe 1950 class 2-8-0 consolidation steam loco

(Blast from the past ...)

PFM's Santa Fe 1950 class 2-8-0 Consolidation was the all-time best selling brass model ever produced. At a time when typical production runs of handcrafted brass locomotives from Japan were in the 50 to 250 range, Pacific Fast Mail imported a total of 8,448 of the well-proportioned **HO scale** locomotive. Introduced in 1956 at list price of \$39.50, the retail price had climbed to \$175.00 by 1975, the last year PFM imported the model. Built in Japan by United/Atlas Industries, the model is a fine example of the state of the locomotive-building art more than half a century ago.

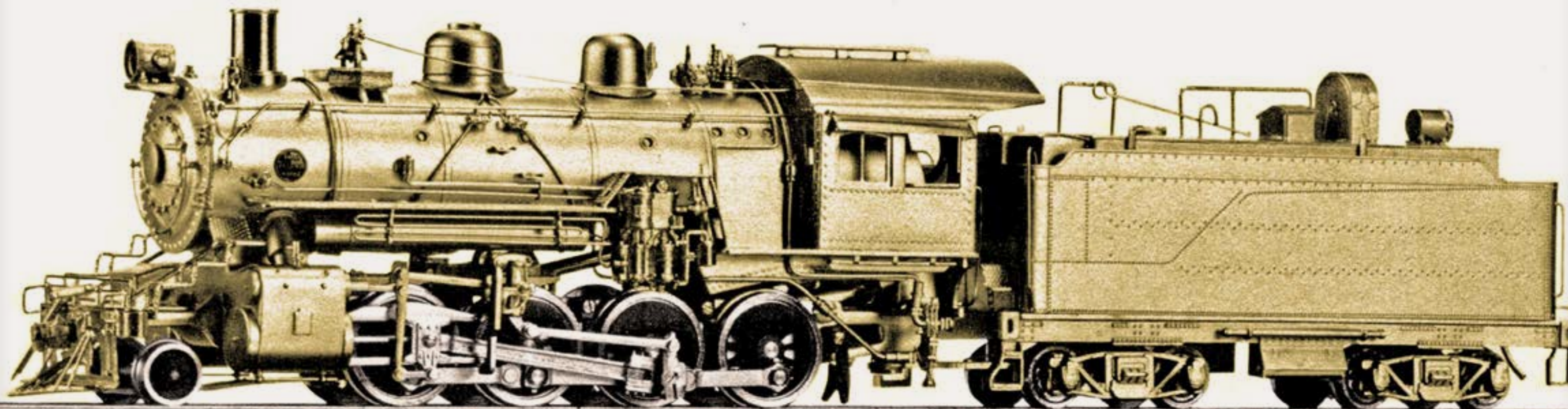



About our News & Events Assistant Editor



Jeff Shultz has been modeling off and on since age 8. Jeff's background is Internet support and system administration, so he spends a fair amount of time on model railroading forums. Jeff also is the "face" of MRH, and often the "guy behind the mike" for MRH's National Train Show videos.

MRH News Desk: The Latest Model Railroad News, Products, and Events

August 2012

By the time you read this, the **2012 National Train Show** in Grand Rapids will be finished. Please visit MRH's online-forums for our coverage of the show and for product announcements – Athearn plans to announce something on Friday morning and many manufacturers use the show to announce new product,

Atlas O (atlasrr.com) has notified its customers of an error in their N&W Hy-Cube boxcar model #8633 & #9633. The paint color for this scheme was brown instead of black. Atlas is supporting the cancellation of reservations and returns to the dealer for models already purchased. Atlas plans to produce the brown N&W car in the future. On a positive note, since since there were fewer than 50 models of this car made in 2- and 3-rail, Atlas notes that it's an instant collector's item ...

Centerline Products (centerline-products.com) will discontinue their current N scale die-cast rail cleaners and replace them with aluminum rail cleaners. Centerline said their supplier of zinc die-cast bodies had outsourced production to China, with an accompanying loss of quality standards. Due to the high cost of setting up production with a new supplier, Centerline opted instead to manufacture the bodies from aluminum and bring their production in-house. Pricing changes and item numbers for the new aluminum products are not yet determined ...

Ragg's... to Riches? (raggstoriches.biz) are downsizing their business due to several simultaneous life-changing events. As a result of this, owner Joe Foss has decided to close the business, but the timetable for doing so is uncertain. The company plans to take orders through the end of September, but some kits are expected to be canceled before then, as their stock of third-party components runs out. They will attend the National Narrow Gauge Convention in Seattle in September (seattle2012.com) and

will be selling products and taking orders there. For details please go to raggstoriches.biz/#UPCOMING ...

The Scale Card (thescalecard.com) website is announcing that they will be closing their doors on December 31, 2012. As their online shopping cart was hacked, they are now using a printable form that is available on the website. Credit card orders have not been accepted since July 2012 ...

S Helper Service (stacktalk.com) has sold their production assets to MTH (mthtrains.com), with the final move from Sanda Kan to MTH's factory occurring on May 17. MTH will begin production of S scale items in 2013. S Helper Service will continue to sell products through their website above ...

Sunshine Model Kits (sunshinekits.com) has announced its intention to downsize the company by simplifying its product line. They intend to reduce the number of new kits introduced to three kits per year on a limited-run basis after 2013. They will also begin liquidating older kits, beginning with their earliest releases and working forward. The first to be eliminated are kits #1 – 19 on their product list. The entire announcement can be found at sunshinekits.com/sunimages/thesun2012.pdf ...

OBITUARIES:

Micro-Trains has confirmed the passing of their founder, **Keith Edwards**, of natural causes on July 26, 2012 at the age of 91. The Co-Founder, with his twin brother Dale, of Kadee Quality Products, Keith founded Micro-Trains in 1990 to concentrate on N & Z scale products. He retired in 2000 ...

Bruce Herrick, Achievement Program Chairman for the NMRA Blue Ridge at-large Division passed away July 11, 2012 as a result of injuries he sustained in an automobile accident two days earlier. Herrick was the John F. Hendon Professor of Economics, Emeritus, at Washington and Lee University and had many other interests ranging from motorcycles to music. Services were held July 17, 2012 in Lexington, Virginia ...

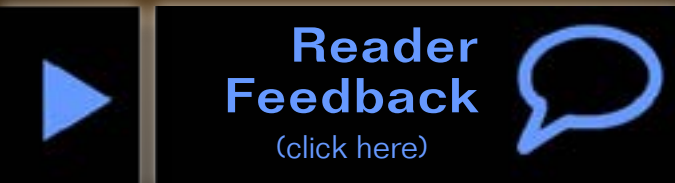

Bill Roy, owner of **McKenzie Iron & Steel Co.** of Eugene, Oregon, passed away as a result of complications from esophageal cancer on June 14th, 2012. He was 71. McKenzie Iron & Steel produced 1:48 scale models, machinery kits and figures. As a result, the company is ceasing business, and anyone with a pending order that had already been charged is asked to contact them for a refund, using the Contact Us link on their website at mckenzieironandsteel.com. Services were held June 23, 2012 in Eugene ...

Now let's take a look at what's new this month.

NEW PRODUCTS FOR ALL SCALES

Azatrax (azatrax.com) has announced its new Pickle Fork RR controller. It controls 3 different trains using DC power back and forth on a single point-to-point layout. The controller manages a turnout at each end of the track, allowing up to three trains to be run across the main track. It requires train detectors and slow motion switch machines, which are available separately. MSRP \$32.50.

Backdrop Junction (backdropjunction.com) has several new backdrops. Three of the new backgrounds are part of their Farms and Fields section and four of them are part of the Hills and Mountains section. See their website for pricing and sizing information.

Grandt Line (grandtline.com) has a valve handle assortment and .010" clear plastic 4.5" x 6" sheets suitable for window glazing. MSRP is \$3.30 for two sets of valve handles or 2 sheets of clear plastic.

Micro-Mark (micromark.com) is now selling a static grass rake (micromark.com/static-grass-rake,10589.html) to be used in removing tangles from static grass after it dries. The other side contains a brush to fluff-up grass and remove debris. Regularly priced at \$6.95, the rake is currently on sale at \$5.50.

Also on sale at Micro-Mark is a 265-piece accessory set for rotary tools. Complete with a case that includes a carrying handle and hang-up slots, this tool set includes sanders, grinders, drill bits, buffers, diamond bits, brushes and cut-off wheels designed to fit any rotary tool with a 1/8" collet or chuck. Valued at \$239.80, its currently priced at \$59.95. micromark.com/265-piece-accessory-set-for-rotary-tools,10591.html.

Monster Model Works (monstermodelworks.com) has introduced a laser-cutting service at \$5 per 12" x 4" project sheet. Provide them with drawings in a suitable digital format (see the website for a list) and Monster will do the cutting. Monster can also digitize drawings for a service charge of \$35/hr, with a minimum charge of one hour.

Also from Monster Model Works is a package of four six-inch "Clean Brick Corners", which allow you to make outside brick corners on buildings nearly invisible. Designed for use with Monster's 1/8"-thick brick sheets, they are available for N, HO, S, and O scale. Each package is \$4.99.

Monster has also released a series of brick column/pier/chimney products for N, HO, S, and O scales, with three sizes of Old Brick (1/4", 1/8", 3/16"), 2 of Clean Brick (1/4", 1/8") and one Assorted Old Brick which contains one of each of the Old Brick sizes. Each package, except the assortment, contains 2 6" pieces and retails for \$4.99. The Assorted Old Brick package contains 3 pieces and retails for \$5.99.

Morning Sun Books (morningsunbooks.com) has announced upcoming releases through November 15th, 2012.

July 1 -- "Anthracite Railroads & Mining In Color Volume 2" by Chuck Yungkurth; "Trackside on the Union Pacific 1960-1982 with Emery Gulash" by Timothy Morris.

August 1 -- "Leigh Valley-6 In Color" by Mike Bednar; "Long Island Rail Road In Color Vol. 4: The Photography of William J. Brennan" by Arthur J. Erdman.

September 1 -- "Hudson & Manhattan Railroad In Color" by Robert J. Yanosey; "Santa Fe: The Final Years In Color Volume 1: Chicago to Belen, Raton and Denver 1980-1996" by Jerry A. Pinkepank.

October 1 -- "Frisco In Color Volume 2" by Greg Stout; "Industrial Railroading In Color Volume 1" by Stephen M. Timko; "Buffalo, Rochester & Pittsburgh In Color Vol. 4: Partners & Connections" by Mike Zollitsch.

November 1 -- "Conrail In Color Volume 2: 1980-1989" by Jeremy F. Plant; "Trackside on the Santa Fe In Oklahoma 1957-1973 with Frank Tribbey" by Daryl McGee; "Southern Railway In Color Volume 3" by Kurt Reisweber.

November 15t -- "Penn Central Power (25th Anniversary Edition Reprint)" by Robert J. Yanosey; "Appalachian Coal Mines and Railroads In Color Vol. 1: Kentucky -- The Color Photography of Everett N. Young" by Stephen M. Timko;

“Trackside around Southeastern Pennsylvania 1965-1975” with John P. Stroup and William Tilden by John P. Stroup.

All books are \$59.95 + postage. Upcoming releases can be reserved on the Morning Sun website.

Signature Press (signaturepress.com) has released “Union Pacific in the Los Angeles Basin” by Jeff S. Asay. A history of the Union Pacific from its arrival in Los Angeles in 1901 through its cooperation and competition with the Southern Pacific, Pacific Electric and Santa Fe railroads. The book covers the century between 1901 and 2000 and carries an MSRP of \$80.00.

Tam Valley Depot (tamvalleydepot.com) has introduced the QuadLN – a programmable servo drivers and Loconet decoder. It contains four servo drives, 2- or 3-position servo control, eight programmable I/O lines, positional feedback, programmable routes, and is fully integrated with JMRI. A switching power supply can use anything from 5 to 24V DC. MSRP is \$59.95 for 1-2, \$53.95 for 3-9, and \$47.96 for 10 or more.

A companion part, the Remote Aligner for Quad LN, is used with the QuadLN to align servos. Only one is needed, no matter how many QuadLN’s you have. Comes with a 10’ cable so the user can stand next to the turnout when aligning a servo. It is priced at \$12.00.

LARGE SCALE PRODUCT NEWS

Grandt Line (grandtline.com) has released three new doors in 1/2” (1:24) scale. The first is a five-panel double door with frame, the second is a four-panel Victorian double door with frame, and the last is a set of four-panel double doors with frame. All retail for \$8.25 per set.

QSI Solutions (qsisolutions.com) has is now selling 3.5CFM miniature fans for use in cooling decoders in S, O, G and some wide-body HO scale locomotives. The fans are 30mm x 30mm x 6mm (1.18” x 1.18” x 0.24”) in size and come with 5.3” 28 gauge power leads. The fans use 5 volt DC power and 0.120 Amps at 0.6 watts. They retail for \$9.95 each.

O SCALE PRODUCT NEWS

American Models (americanmodels.com) has introduced a 4-8-4 Northern model based on the AT&SF 2900 series. The limited-production model features a diecast boiler, frame, wheel centers, pilot, cab trucks, tender and tender trucks. Equipped with a five-pole motor, headlight, smoke and synchronized sound, all 16 tender wheels are flanged and equipped for electrical pick-up. The models are compatible with American Flyer 20” radius track. Available lettered for Santa Fe as well as CB&Q, C&O, Cotton Belt, Lackawana, Leigh Valley, Milwaukee, Rock Island, Southern Pacific, Western Maryland, and unlettered, the models have an MSRP of \$429.95 (scale or hi-rail DC), \$459.95 (AC limited sound) and \$499.95 (AC full sound).

The Aspen Modeling Company (theaspenmodelingcompany.com) added a wash stand (MSRP \$5.00) and farrier (MSRP \$11.00) to their line of O scale figures, animals and detail parts.

Atlas O (atlaso.com) has new road numbers and paint schemes for their RS-1 locomotive model in 2- and 3-rail. Each road name is available in two road numbers except for the NYSW Bicentennial scheme. New road numbers are available for Great Northern, Pennsylvania, and Santa Fe. New paint schemes are Gulf Mobile & Ohio, Long Island, Minneapolis & St. Louis, and NYSW Bicentennial. All locomotives retail for \$479.00. Estimated delivery is 1st quarter 2013.

Atlas O is also releasing new paint schemes on their pulpwood flat car. Available in both 2- and 3-rail versions, the car is a model of of a General Steel Castings V-Deck design of the 1950s. New paint schemes include Illinois Central Gulf (orange/black), Santa Fe (brown/white), Seaboard Coast Line (black/yellow), Southern Pacific (brown/white), and Western Maryland (brown/white). With an estimated delivery date of 4th quarter 2012, MSRP for the 3-rail version is \$57.95. MSRP for the 2-rail version is \$62.95.

New from B.T.S. (btsrr.com) is the GN 24’ Berne Depot. The prototype for this kit was built in Berne, Washington around 1910, and was in use until 1967. The depot included a waiting room/office, as well as living quarters for the station master. The overall footprint, including a scale 16’x70’ gravel platform is a scale 70’x47’. MSRP for the O scale version is \$139.95.



Previously available in HO, B.T.S. has released the McCabe Sand House in O scale. The kit includes a drying house, sand bin, and tower, including the framework connecting the drying house to the tower. The drying house and sand bin have a scale footprint of 17' x 37' with the tower designed to sit between two servicing tracks. MSRP for the O scale kit is \$119.95.

Clever Models LLC (clevermodels.squarespace.com) has added two new On30 cardstock kits to their Freebies section: the flatcar that forms the basis for many of their other kits, and a shorty "Cabeese." As with all of their kits, you print out the provided PDF on cardstock and add your own trucks and couplers.

New from **Grandt Line** (grandtline.com) in 1/4" scale are two building kits and an assortment of detail parts. The first kit is #3413, Cliff's Streetcar Diner. Listed as an intermediate or advanced kit, it is based on an 1870s streetcar. Finished size is 5" x 7" with an MSRP of \$38.95. The second kit is #3414, Granny's Goodies Bake Shop. Listed as an intermediate level kit, it is based on the old-town buildings in St. Charles, MO. Interior furnishings are included and the roof and front wall of the building can be left loose for more interior details. With a finished size of 4" x 6" it is \$38.95.

The new detail parts include iron head/footboards for \$3.30, a post-mounted street clock for \$4.00, a parking meter – 8 for \$3.50, Station or house door w/ frame – 2 for \$3.30, Residence door w/oval window and frame – 2 for \$3.30, double open-scrollwork doors with frame for \$3.30, and refrigerator car ladders, 2 sets for \$3.75.

Mullet River Model Works (mulletrivermodelworks.com) is showing partial assembly photos of a "first-cutting" for an L&N caboose. Also shown were the wax patterns for the bolsters, which will be investment-cast in brass. Anticipated release dates for the kit were not specified.

Protocraft (protocraft.com) is now selling Modified 1937 AAR 10'-6" IH boxcar models in brass. Built by BooRim Precision in Korea, the model will come in 15 different versions as used by 25 different railroads. Modifications to the standard 1937 AAR car include 4"-6" greater inside height and 5/5 dreadnought

ends with the improved "W" corners. The cars come unpainted with a light clearcoat that can function as a primer. All trucks are interchangeable, and are available in O scale or Proto:48. All versions are priced at \$297.00 ea.

Sidetrack Laser (sidetracklaser.com) has released the Sodaville Country Store, an O scale background building. Buildings of this type do not have a finished back, and are meant to be placed against a backdrop. The kit features laser-cut building components, doors, windows, Berkshire Valley and Grandt Line cast detail parts, and both corrugated metal and peel-and-stick roofing. The building's basic footprint is 6" x 8" depending on the location of the gas pump and exterior sign. It is \$62.95 MSRP.

SMR Trains (smrtrains.com) has announced a pre-Civil War era locomotive, the Western & Atlantic's locomotive "Yonah". Built in 1849 by Rogers, Ketchum & Grosvenor, the locomotive was involved in the pursuit of the General during the famous Andrews raid. Available for both 2- and 3-rail modelers, it features all-brass construction and is pre-order priced at \$1499.95 for both versions, with a regular price of \$1699.95. Additionally, the NY&Harlem locomotive "Amenia" will be produced in limited quantities.

Southern Car & Foundry (southerncarandfoundry.com) has released a Santa Fe Bx12 Extended Height Boxcar. It is priced at \$135.00.

Vector Cut (vectorcut.com) has released a set of four weather-vanes in O scale. Cut from red .007" plastic film, they are easy to paint and assemble. The weather-vanes are each topped with a silhouette – a sperm whale, a rooster, a horse, and a 4-4-0 locomotive. The price is \$12.50 for the set.

Weaver Models (weavermodels.com) in conjunction with MNP has announced ready-to-run custom track cleaning cars, individually built per customer's choice in body style and livery. The cleaning mechanism features dual high-torque geared motors and two constantly-spinning adjustable pressure-sensitive disks with peel-and-stick pads for easy change-out. Each track cleaning car is priced at \$184.95 plus shipping.

S SCALE PRODUCT NEWS

Ragg's... to Riches? (raggstoriches.biz) will begin shipping the new S scale Mancos Depot kit the week of July 22, 2012. The depot was in Mancos, Colo.

on the Rio Grande Southern. The structure measures 8" x 19 1/2" with the platform, 6 1/4" x 17" without the platform. Available at the Ragg's... to Riches? website, it is priced at \$239. See the announcement regarding Ragg's... to Riches? closing at the beginning of the Old Yardmaster News.

HO PRODUCT NEWS

5th Avenue Car Shops (5thavenuecarshops.com) has released two custom steel plug-door refrigerator cars, one lettered for Burlington Refrigerator Express (BREX) and the other for National Car Company. Both feature a July 1952 built date. The BREX model includes a new herald from October 1952. 3 additional overlay numbers are available for both models. The retail price of each car is \$16.00.

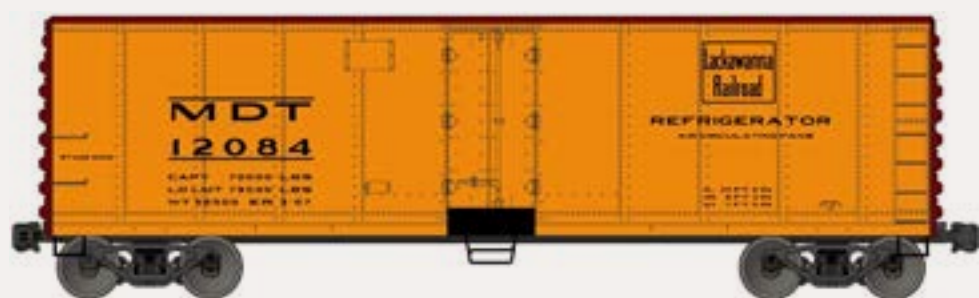

Accurail (accurail.com) is offering their 40' swing-door steel reefer kit lettered for Lakawanna (MDT) at an MSRP of \$15.98. Also

new for August is a limited-run two-car set of 40' PS-1 steel boxcars lettered for Northern Pacific with "Route of the Vista-Dome North Coast Limited" at an MSRP of \$28.98. Another limited-run 40' PS-1 set includes three Union Pacific "Be Specific – ship UNION PACIFIC" boxcars for \$42.98.

Also from Accurail: Detroit Toledo & Ironton 70-ton offset triple-hopper in black with a color "We have the CONNECTIONS" logo for \$14.98 and 55-Ton USRA hoppers in Norfolk Southern, with a three-number set for \$39.98 and a single number (randomly chosen from the three packs) for \$13.98 retail.



Modern modelers may be interested in Accurail's 50' exterior-post boxcar model lettered for the Toledo Peoria and Western, for \$14.98.

AL&W Lines (alwlines.com) has released several new structures in their collection of Southern Pacific in Oregon laser kits. In HO, SP24 is a large extended tool shed and SP25 is a small extended tool/motor shed. Each retails for \$25. Also in



HO scale are SP concrete phone booths in both the pre-1939 style with a wooden door and overhanging cap and the post-1939 style with a metal door and flush cap with lift eyes. Each is available in limited quantities for \$15/pair.

Anvil Mountain Models (anvilmountainmodels.com) is currently shipping "The Mikado," a laser kit of a saloon and bordello on Blair St. in Silverton, Colo. The prototype was built in 1893 with an addition in 1925. Between 1934 and its destruction by fire in 1954, it was used as a bakery. With a footprint of 3.25"x4", the kit retails at \$59.95.

Anvil Mountain has also announced two additional kits that will be available this fall. Goble's Building Materials will be a large laser-cut kit with the base model measuring 8.5" x 12". Three-inch-deep extension kits can be added to it – three extension kits are required to achieve a prototypical depth of 21". The building was located across from the Silverton Northern depot between the 1880s and 1940s. The price for the base kit is estimated to be \$149.95, with the optional extension kits selling for \$24.95.



Also from Anvil Mountain, The Yankee Girl Mine kit replicates a mining head frame between Ouray and Silverton, Colorado on the Silverton Railway. The kit will include the hoist house and head frame and has an estimated retail price of \$89.95. The Yankee Girl Mine and Goble's Building Materials pilot models will be on display at that National Narrow Gauge Convention in Seattle from Sept. 12-15, 2012

Athearn's (athearn.com) July announcements include the Genesis GP7/9 in several versions and paint schemes. The passenger GP9 in SP Black Widow comes in four sequential road numbers, the Reading Company GP7 has four non-sequential road numbers, as does the Chessie System GP9 – two in B&O, two in C&O. There will be a Western Pacific GP9 in a post-1970 scheme with road number-specific details on its four locomotives. MSRP on non-sound units is \$189.98, sound unit MSRP is \$289.98.

Also announced in July are Genesis F7A/F7B/F3A locomotives for Lackawanna & Western. The F7's are set up as freight units while the F3A's are detailed as passenger units that were also used in freight service. The single F7A, road number 635A, is MSRP \$169 without sound, \$269.98 with Tsunami sound.. F7A #632A and F7B #632B are sold as a set, as are F3A's #805A and 805C. Non-sound sets retail for \$309.98 with the Tsunami sound units retail for \$489.98.

July is an all-Genesis month, with three road numbers of the GP15-1 in Burlington Northern. Tsunami sound MSRP is \$289.98, non-sound MSRP is \$189.98. The Genesis SD70M-2 was also announced in EMD Demo paint with road numbers #74, #75, and #76. MSRP for the non-sound version is \$199.98, Tsunami sound is \$299.98.

Orders for all of the announced products are due by August 17, 2012 for an estimated March 2013 delivery.

Atlas (atlasrr.com) is releasing new paint schemes for both the high- and low-nose versions of its Master Series U30B Phase 2 locomotive. The low nose comes undecorated (with and without a nose light and with AAR trucks), four road numbers of BN and Chessie, three road numbers of Milwaukee Road and Frisco, and one in the Frisco "XR Series" scheme that includes a dual low nose headlight. The high-nose version comes in three road numbers for N de M and four Norfolk & Western road numbers. The Master Silver series models retail for \$189.00 and the Master Gold Series models with QSI sound retail for \$299.00. Delivery is expected in 1st quarter 2013.

Atlas is also releasing single-window and paired-window heavyweight coaches in new paint schemes. With an estimated delivery of 4th quarter 2012, the single-window coach will be available in three numbers for Delaware & Hudson, New Haven Hunter, New York Central, Southern, and Spokane Portland & Seattle. The paired-window coaches are coming in three numbers for Canadian National, Chesapeake & Ohio, and Milwaukee Road. MSRP for the standard models is \$64.95 and undecorated is \$54.95.

In freight cars, Atlas is releasing the Trainman 50'6" ACF boxcar in new paint schemes, with two road numbers each for Laurinburg & Southern, Ontario Northland, Terminal Rwy Alabama State Docks, and Union Pacific, as well as new road numbers in Canadian National, KCS, and Rail Box. Anticipated delivery is 4th quarter 2012, with an MSRP of \$19.95. Undecorated MSRP is \$15.95.

In scenery, Atlas is releasing hand-crafted LED streetlights. Utilizing quick-fit bases, several light styles are available, including a clock light for \$25.99, ball light for \$24.99, park light for \$24.99, street light for \$24.99, two highway lights for 25.99, and a curved light for \$24.99. Delivery is expected in 4th quarter 2012.

Auscision Models (auscisionmodels.com.au) of Australia announced an early-August availability for their three-bay AHGX grain hopper. A ready-to-run model equipped with 36-in metal wheels and scale-size metal knuckle couplers, the models are sold in 4 packs with an MSRP of AU \$239.95.

Bachmann Trains (bachmanntrains.com) will release ready-to-roll 1860-1880 passenger coaches and combines in HO scale. The unlettered cars will be produced in red and yellow with blackend-metal wheels, non-magnetic axles, and body-mounted couplers. Part of Bachmann's "Silver Series", they will have an MSRP of \$23.50.



Blair Line (blairline.com) has released the limited-edition laser-cut Walnut Grove Depot. Limited to 200 kits, it features pagoda-style flared roof eaves and a bay window. It has a footprint of 3.3" x 5.5" and retails for \$69.95.

At the 2012 National Train Show, **BLMA** (blmamodels.com) announced a modern triple-track signal bridge in HO scale for a spring 2013 delivery. Fully assembled and lighted, it includes six operating modern block signal heads. Price TBA.

Branchline Trains (branchline-trains.com) has available Cobleskill Coal, a new building in their Laser-Art Structures line. Based on a well-known coal company in Cobleskill, NY, it has a footprint of 12"x5"x7.5" and a MSRP of \$179.98.

B.T.S. (btsrr.com) has released the first kit in its Encore Series, the Hyde Pulp Mill. Consisting of eight buildings, a riverside dock and a storage tank, the overall footprint of the mill is a scale 180'x95' and is serviced by two tracks. MSRP is \$439.95.

New from B.T.S is the GN 24' Berne Depot. The prototype for this kit was built in Berne, Washington around 1910 and was in use until 1967. The depot included a waiting room/office as well as living quarters for the station master. The overall footprint, including a scale 16'x70' gravel platform is a scale 70'x47'. MSRP for the HO scale version is \$79.95.

B.T.S. has also introduced a 30' truss-rod tank car as part of their HO scale Expansion Series. This 5,000 gallon car is representative of one built in the 1870-80s. The kit consists of laser-cut wood components, a urethane tank, and brass and plastic detail parts. Trucks, couplers and decals are not included. MSRP is \$39.95.

Builders In Scale/CC Crow (cccrow.com) has in stock his new model of the Northern Pacific Hotel, based on a structure in Easton, WA at the base of Stampede Pass. Step-by-step instructions with full size drawings and templates are included. With a footprint of 5 1/4" x 9" in HO scale, the MSRP is \$165.00.

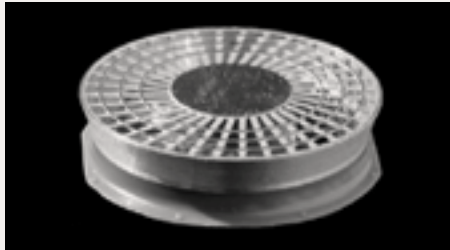

Cannon & Company (cannonandco.net) has released a new thinwall 48-inch flared radiator fan. A distinctive feature of the EMD GP20, it also appeared on other models. Utilizing the same fan base and motor hub as other Canon 48 inch radiator fans, the RF-1708 48-inch fan features a precision-machined flared shroud and multilayer photo-etched grill. MSRP is \$12.50 a pair.

Centerline Products (centerline-products.com) has announced the availability of the HO-3 Rail cleaner. Made of brass and equipped with Kadee #502 trucks and couplers, it is assembled and ready for use. MSRP is unchanged from the HO-2 at \$90.00.

New from **City Classics** (cityclassics.biz) are their Kit 115 "The Main Street Cafe" and Kit 116 "South Side Salon." Both kits feature a footprint of 4.25"L x 3.125"W x 3.375"H and are representative of buildings that started appearing in the 1930s, with brightly-colored storefronts made of glass, plastic or metal. MSRP for each kit is \$27.98.

Clever Models LLC (clevermodels.squarespace.com) added two HOn30 card-stock kits to their Freebies section: the flatcar that forms the basis for many of their other kits, and a shorty "Cabeese." As with all of their kits, you print out the provided PDF on card stock and add your own trucks and couplers.



Concept Models (con-sys.com) has released the PRR 470245 "Queen Mary" depressed center flatcar. Designed to carry a 500,000-pound load, the flatcar consisted of a depressed center section that rode on two bolster sections, each with two 4-axle trucks (trucks and couplers not included). The kit consists of resin castings and includes coupler mounts that will fit most commonly used couplers. The kit is priced at \$69.99.

Digital Fox (digitalfox.com) is shipping their customized "Conditionaire Insulated Covered Hopper" lettered for Burlington Northern, in six road numbers. The model is based on an Accurail 4600 cu. ft. covered hopper kit that has a special coating applied prior to painting and lettering. Retail price is \$19.98. Also available are Wisconsin & Southern 50' exterior post boxcars, which include optional pre-printed Amway placards that some cars in this series were equipped with. MSRP is \$15.99 each.

Division Point (divisionpoint.com) is taking reservations for CB&Q early Budd stainless steel cars, as used on the Exposition Flyer, the Advance Flyer, and the California Zephyr. The cars will be available in a three-car set (#4700 52-seat chair car "Silver Chariot", #191 48-seat dining car "Silver Inn", #302 dining-parlor-observation car "Silver Hours"), and as single cars – 52-seat chair cars #4701 "Silver Trail" and #4702 "Silver Spring"; 48-seat dining cars #190 "Silver Pheasant" and #192 "Silver Spoon"; dining-parlor-observation cars #300 "Silver Star" and #303 "Silver Fountain"; and vista-dome chair cars #4714 "Silver Dome" (built from #4714 "Silver Alchemy") and #4709 "Silver Castle" (built from #4709 chair car). Prices were not announced.

FOS Scale Models (foslited.com) has recently released three new structure kits, starting with a set of two phone booths in the classic "Superman Changes Here" style. The kit features laser-cut resin board parts, laser cut window acetate, cast metal pay phone and a color sign sheet. MSRP is \$7.95.

Next from FOS is Three Fingered Freddy's Fireworks, a typical roadside fireworks stand. It features a large rooftop billboard with a laser-cut lettering, a parking lot billboard, laser-cut walls, Tichy windows, metal details and color signs. The overall footprint of the kit is 3" x 6.75" and it retails for \$44.95.

Caravan Machine Tool is the third of FOS's offerings, a medium-size machine shop capable of both repair and sales of power and shop tools. It features a large lathe and drill press from Crow River Products, as well as a rooftop dust collector, assorted junk details, two loading docks assorted signage and both rolled, and corrugated roofing. Available now, it is priced at \$149.95.

Fox Valley (foxvalleymodels.com) has arranged with Intermountain a special "Appalachian Lines" production run of GE ES44AC GEVOs. These locomotives will be decorated for both the Allegheny Midland and the Virginian & Ohio. Both road names will have two paint schemes (normal and "Flag") available, with two road numbers per scheme. The locomotives are DC only - no sound



options will be available on this run. MSRP is \$179.95 for each locomotive, with reservations due by August 24, 2012 for a first quarter 2013 delivery.

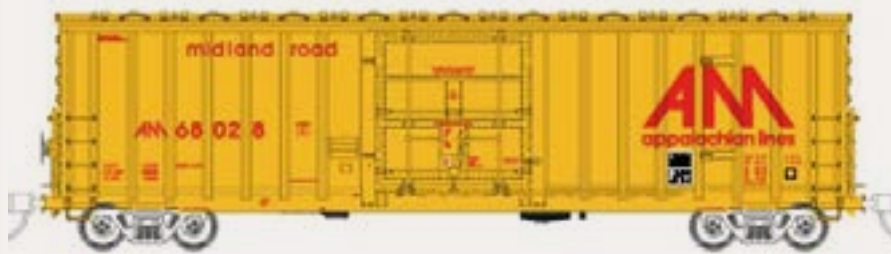

Along with the GEVOs, Fox Valley is also releasing their seven-post boxcar in Allegheny Midland and Virginian & Ohio paint schemes. With two road

numbers available for each railroad, the models are priced at \$30.95, with the same reservation and delivery schedule as the GEVOs.

GC Laser (gclaser.com) has five new laser-cut structures in HO scale. The first is the milk house, the 3rd release in the Elfering Farm Series. With a footprint of 2 9/16" x 1 15/16" x 1 5/8", it is priced at \$10.99. The second structure is the Ridgeway Office Building. Its footprint is 9 1/2" x 6 3/4" x 4 1/4" with a price of \$64.99. The third structure is a small factory guard house. Its MSRP is \$19.99 with a footprint of 2 11/16" x 3 5/8" x 3 1/8". Fourth is a building called "Board-Up #1," Its footprint is 2 5/8" x 1 7/8" x 1 5/8" and is priced at \$17.99. The last building is the fourth release in the Elfering Farm Series, the well house. Its footprint is 2 5/8" x 1 7/8" x 1 5/8" with an MSRP of \$14.99. All buildings feature laser-cut and etched-materials construction.

Grandt Line (grandtline.com) has two new detail parts in HO scale, an older gas pump (#5314) and a double door with frame and transom. Each comes in a package of two and retails for \$3.30.



Hi-Tech Details (hitechdetails.com) has introduced modern trash and recycle cans. The familiar "toters" bins with the fake-spoke wheels in back are pro-

tototypical for many American neighborhoods since the 1980s. They come in five colors – black, olive, green, blue, and brown. MSRP is \$5.95 for a package of six in one color.

InterMountain (intermountain-railway.com) has announced the 1937 AAR 40' boxcar in eight paint schemes – C&O, UP/OWR&N, Texas & Pacific, B&M (White Minute Man), ATSF BX-27, Pere Marquette, Wabash/NJI&I, and ACL. Each scheme is available in six road numbers. HO list price is \$29.95. Reservations are due by August 31st for a February/March availability.



Also available from InterMountain is a new run of their plywood panel boxcars, available in four Great Northern paint schemes (original, Scotchlite, Vermillion Red, and Mineral Red) with six

road numbers each. List price is \$29.95. Reservations are due by August 31 for February/March availability.

Kadee (kadee.com) has announced for August two PS-1 50' boxcars, one with a 10' door lettered for DHNY with their colorful "I <heart> NY" scheme with an MSRP of \$40.95 and another with 15' double doors lettered for WP in an as-built 1960's scheme, and an MSRP of \$34.95.



Due in September are a Milwaukee Road 50' PS-1 boxcar with 9' doors and a build date of 1961 and a PRR PS-2 two-bay covered hopper with a build date of 1955. The PS-1 retails for \$35.95 and the PS-2 is priced at \$41.95.

In October there are three products on the schedule, a 40' boxcar with a 7' door decorated in Monon's "Factory New Boxcar Red." It features a build date of 1953 and an MSRP of \$36.95. The second model of the month is a GN PS-2 covered hopper with a build date of 1958 and an MSRP of \$43.95. The third model for October is the 2012 Kadee Christmas Car, with an MSRP of \$38.95. This Kadee Collector's Car must be pre-ordered.

In other news from Kadee, #7052, a C&EI 50-ton AAR standard open-bay hopper has been delayed due to a material supply delay. It will be rescheduled when the materials become available.



Laser Modeling 3 (laser-modeling3.com) has introduced the Sodus Point Welding Compound, the prototype of which serviced the Pennsylvania RR. Featuring a welding car with three outbuildings, a photo gallery on the Laser Modeling 3 website contains 272 photos showing the kit at various stages of construction as well as the prototype. It is priced at \$160.00 + S&H.

Lunde Studios (lundestudios.com) has released the first kit in its "Plus Series," which features separate pre-colored windows and doors, and resin tab-and-slot construction. The Monroe Corp. is a corner structure with a recessed corner entry, pre-colored awnings, building sign casting, and clear window glazing. This 4-story building kit measures 7" x 3.75" x 6.38" and is priced at \$59.95.

Also new from Lunde Studios is their "Quick Flats" series of HO building flat wall panels. Each package contains either two 3-story ground-level wall panels with roof and cornice details, or four 2-story upper wall panels. All packages include optional 1"-deep side panels, window glazing, "gluing squares" to assist in window gluing, and instructions. Ground-level packages retail for between \$19.95 and \$23.95 and the upper "window-wall" packages retail for \$19.95 each.

Miniatronics (miniatronics.com) has introduced both single- and double-ended flashing arrows in HO scale, appropriate for mounting on highway department trucks and trailers. Both kits come with a 3VDC transformer and 10' of 30 gauge wire, with the single-ended arrow kit including five arrows and the double ended arrow kit containing four arrows. Both sell for \$30.95.

Model Rectifier Corp. (MRC) (modelrectifier.com) has announced several new drop-in sound decoders for HO scale diesel locomotives, as well as two universal decoders for light and heavy steam locomotives. All the drop-in decoders feature one prime-mover sound, 16-bit "Brilliance" sound, 16 volume levels, programming on the main, advanced consisting, 1.5 amp capacity, four horns, two bells, 28 functions, custom speed tables and adjustable back-EMF. The steam decoders feature two fully-synchronized chuff types – articulated and non-articulated, 1 amp capacity, two whistles, as well as the other features on the diesel decoders as appropriate. Diesel prime movers announced include the Alco 244, Alco 539T, EMD 645, EMD 710, EMD 567, and EMD 645E. All retail for \$67.98.

Monroe Models (monroemodels.us) is offering a new line of HO scale unpainted, lead-free, cast metal detail product sets under the name "Mini-Tales." Their first offerings include "Back Yard Junk;" "Loading Dock Junk;" "Chimneys, Vents and Lights;" "Modern Luggage Set;" and a "Vintage Luggage Set." All sets have an MSRP of \$8.99.

Monster Model Works (monstermodelworks.com) has a new security bar set, suitable for doors or windows. Six different sets using three different designs that will cover 51 different windows and doors currently sold today are available. MSRP is \$7.99 for a package of eight security bars.



New from **Nick & Nora Designs** (nicka-ndnoradesigns.com) is a Southern Railway Combination Depot. Assembled from Southern Railway Engineering drawings for the Ridgecrest, NC depot it has a footprint of 3.5" x 8.25" and an MSRP of \$85 plus S&H.



Osborne Model Kits (osbornemodel-kits.com) has released a craftsman kit of an HO scale DHC-2 Beaver, known for its rough-field and floatplane capabilities around the world. The basswood kit is assembled by sandwiching the pieces of the airplane together on alignment pins, and sanding to round-off the edges. Peel-and-stick decals are included. Price for the kit is \$14.99.

Other aircraft, such as the P-51D Mustang, Supermarine Spitfire IX, and the Cessna 172 are also available.

Precision Scale Co. (precisionscaleco.com) has announced the HO 1942 Morning and Afternoon Hiawatha Cars in HO scale brass for delivery in 2013. Built by Boo-Rim Precision Co., Inc., the cars will be sold in nine-car Morning and Afternoon sets, with additional cars for both trains available separately. One car, the Morning Hiawatha Beavertail Observation car, will be available as it appeared after upgrading in 1948, with a rear cowling enclosure as used on the Midwest and Chippewa Hiawathas.

Also announced for 2013 from Precision Scale is the Mich-Cal Lumber Co. No.2 and 16-ton Shay in HO scale. The 16-ton Shay has a tee boiler and both models will be available in a "painted black and graphite" scheme, as well as a non-painted version. Reservations for both the Hiawathas and the Shays are being taken at Precision Scale dealers now.

Rail Scale Miniatures (railscaleminiatures.com) is shipping Delwins Boat and Net Storage, an HO Scale craftsman kit consisting of five major structures with an overall footprint of 24" x 28." Limited to 300 kits, it sells for CDN\$320.

Ring Engineering (ringengineering.com) has introduced a lighted End-of-Train device mounted on a Kadee #119 Shelf Coupler. Available with either 33- or 36-inch wheels and with a gray or yellow case, it retails for \$39.95.

Rusty Stumps (rustystumps.com) has announced the imminent arrival of the Fall Creek Mercantile Store, similar to the sold-out Mercantile Store Kit (aka Silver Plume Store). The new kit will include an interior wall and some additional features. Anticipated to ship at the end of August, the price is not specified. Instructions for requesting notification when it is in stock are on the Rusty Stumps website. It has a 2" x 3 1/2" footprint.

Sea Port Model Works (seaportmodelworks.com) has released several new HO scale boats. They include a 30' sloop/sailboat with molded-in bulwarks, skylight, lazarette, hatch cover and deck planking. Stock for the wood mast and boom is included. The model is priced at \$16.95 and measures 4" x 1-1/4". A larger kit, a 53' coastal passenger steam ferry, is a waterline hull model utilizing several resin castings, etched brass ladders and railings and pewter detail parts. At 7-1/4" x 2-1/8" it is priced at \$89.95.

Sound & Northwestern LLC (snwlines.com) has released the Great Northern Standard 12'x34' Portable Depot. A multimedia laser-cut kit represents a type

of station that was built in large numbers and then shipped to the towns it would occupy. The kit includes an optional bay window and positionable window sashes. Its footprint is 4.7" x 1.95" x 2" and it sells for \$40.00.



Tangent (tangentscalemodels.com) is releasing eight new paint schemes on its PS-2CD 4740 Covered Hopper. They are Chessie System B&O in blue & yellow w/ blue trucks and six road numbers, Conrail in former EL gray Conrail and EL car number stencil with three road numbers, Illinois Central IC "Original Orange 1969" orange/black with 12 road numbers, Canadian National IC (CN) "Website" oxide red scheme with "Service With Safety" lettering, 1969 details in three road numbers, TLCX "Allied Mills" white & black with three road numbers, and Burlington Northern, as built 1970 "Cascade Green" with 6 road numbers. Also available are two undecorated assembled models in primer gray, both 1967-68 and 1970 production. All models are priced at \$42.95 ea.

Tangent also announced the availability of 10 new Bethlehem Quad Hoppers with coal load. New paint schemes announced included six road numbers each of Clinchfield original paint H-8 Class, CSX original paint, and Illinois Central Gulf's "1982 Simplified Scheme", three road numbers each of Detroit, Toledo and Ironton original paint and Wisconsin Central "Former Clinchfield" paint with WC yellow paintouts. Previously released schemes with new road numbers include Bessemer & Lake Erie original paint black (six road numbers), Clinchfield original paint FH19 Class (12 road numbers), Illinois Central Gulf "Centralia Quad" (six road numbers), Louisville & Nashville original paint black (three road numbers), Union Pacific "Original H-100-16" (12 road numbers). All but UP also have an unnumbered version with decals available separately. An Undecorated Primer Gray RTR car is also available. MSRP is \$32.95 each with discount "mix and match" pricing for six, 12, 24, 36 and 48 models.

The N Scale Architect (thenarch.com) has announced the HO scale Modern Brick Wall Panel System. The base system kit will include a 10" x 16" photo-etched brass sheet with over 100 multi-layered windows, doors, & fans; a brick 10" x 12" styrene sheet with window and door panels, columns and rows, a 10" x 15" x 3/32" TaskBoard sheet with laser-cut window & door openings, columns, rows, and roof cornice assembly; a second 10" x 15" x 3/32" TaskBoard sheet for wall supports, roofs, loading docks, and other applications; a glazing sheet and full-color instructions with tips, ideas, and reference photos. Limited-time pre-order price is \$79.95.

Tichy Train Group (tichytraingroup.com) has released several HO scale Window, Door and Structure part assortment sets. Part # 8221, priced at \$35.00, contains samples of all structure parts from #8001 to 8218. 470 total parts, 43 different parts catalog sheets. Part #8220, for \$40.00, contains samples of all doors from #8001 to 8218. 76 total doors of 36 different types with precut glazing. #8219, priced at \$60.00, contains samples of all windows from #8001 to 8218. 290 total windows of 86 different types, all precut glazing. Part #8222, priced at \$120.00, is a combination of #8221, 8220, and 8219. All parts are injection molded in gray styrene.

Also announced were three add-on kits: brick wall sheets (two sheets, \$19.95); laser-cut window, door & cornice sheets (two sheets, \$35.95); and etched brass window, door & fan sheet (one brass sheet, one taskboard sheet, one glazing sheet, \$49.95). Some of the items may be sold as "Web Only Specials" off their website. N Scale Architect expects to also release the Wall Panel System in O and N scales in the near future.



True Line Trains (truelinetrains.ca) has announced the Canadian Pacific 'Minibox' steel boxcar, which will be available in both CP and British Columbia Railway. This model depicts a boxcar that Canadian Pacific Railroad received 7,500 of between 1929 and 1931. Some of them were still in use

in MoW service through at least 1993. BCOL used ex-CP cars in MoW service. Anticipated to be released in five Canadian Pacific schemes and one British Columbia Railway Scheme, they carry a MSRP of \$44.99.

Vector Cut (vectorcut.com) has released a set of four weathervanes in HO scale. Cut from red .007" plastic film, they are easy to paint and assemble. The weathervanes are each topped with a silhouette – a sperm whale, a rooster, a horse, and a 4-4-0 locomotive. The price is \$11.50 for the set.

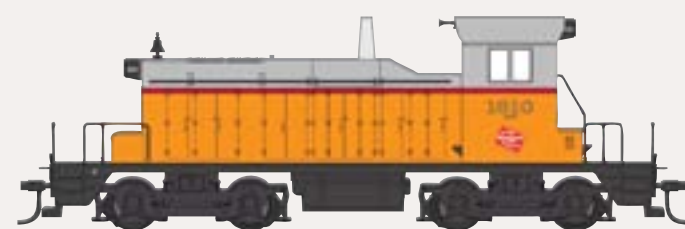

Walthers Mainline (walthers.com) has announced an EMD SW1 locomotive. Featuring an all-new drive mechanism, it will be released in Boston & Maine (2 road numbers), Milwaukee Road (two road numbers), Southern RR (two road numbers), and Southern Pacific (two

road numbers). MSRP is \$99.98, and pre-orders are being taken until August 31, 2012. Expected delivery is March 2013.

Walthers Scenemaster has announced four new figure sets: carhops – four figures with two full and one empty tray; a set of eight drive-in patrons, a set of eight modern railroad workers, and a set of seven vintage railroad workers. All sets retail for \$14.98. They are expected to be available in August & September 2012.

Walthers Cornerstone announced two structure kits in July, both with late-August 2012 expected availability. The Antiques Barn has authentic wood siding and a metal roof & ventilators. Featuring a positionable side door, it includes decals and signs depicting it as an antique store. Donnie's Drive-In is an octagonal design drive-in restaurant first seen in the 50's, complete with a detailed interior with tables, chairs, counter and seats. Both kits retail for \$39.98.

N SCALE PRODUCT NEWS

AL&W Lines (alwlines.com) has released models of the SP concrete phone booth in N scale, both the pre-1939 style with a wooden door and overhanging cap and the post-1939 style with a metal door and flush cap with lift eyes. Each are available in limited quantities for \$15/pair.



Atlas (atlasrr.com) announced they will release their N scale SD60 locomotive in six new paint schemes, and new

road numbers for previously released schemes. With an anticipated delivery date of 1st quarter 2013, schemes include CEFX and Panama Canal Railways in two road numbers, and CSX YN-3, Indiana Railroad, Norfolk Southern, and Union Pacific with three road numbers each. Previous schemes with new road numbers include Soo Line and Canadian Pacific with three numbers each and Oakway Leasing and Susquehanna with two numbers each. Standard MSRP is \$129.95 and Decoder equipped MSRP is \$169.95.

Atlas is releasing a new model of an ACF 89' 4" flat car that features two different hitch styles, container pedestals, and the correct jack pads, depending on the model year. With an estimated delivery date of 4th quarter 2012, the car will be released in two undecorated (mid/end hitches, triple hitches) styles as well as four road numbers each for the Erie Western, Providence & Worcester, Florida East Coast, and Trailer Train in the mid/end hitch style and four road

numbers for TTX Company in the triple hitch style. Standard MSRP is \$24.95 with the undecorated models priced at \$19.95.

In the **Trainman** line, Atlas is introducing new paint schemes for their 40' plug door box car model. With an estimated delivery date of 1st quarter 2013, the model features two road numbers each of Dairy Shippers Despatch, American Colloid – Bicentennial, Jersey Central, Northern Pacific, Canadian National, and Chicago & Northwestern. Undecorated cars will also be available. Standard MSRP is \$14.95 with the undecorated models priced at \$11.95.

In scenery, Atlas is releasing hand-crafted LED streetlights. Utilizing quick-fit bases, several light styles are available, including a clock light for \$26.99, ball light for \$25.99, two park lights for \$25.99, street light for \$25.99, highway light for 26.99, and two curved lights for \$25.99. Delivery is expected in 4th quarter 2012.



Bachmann Trains (bachmanntrains.com) is shipping #6 turnouts in N-scale E-Z Track. Electrically-gapped for operation on with DCC, the turnouts are equipped for remote operation via AC accessory power. MSRP for each turnout is \$52.00.

Blair Line (blairline.com) has released the limited-edition laser-cut Walnut Grove Depot. Limited to 200 kits, it features pagoda style flared roof eaves and a bay window. It has a footprint of 1.8" x 3" and retails for \$39.95. See HO Section for photo.

BLMA (blmamodels.com) has introduced both large and small plastic jewel boxes intended to replace those lost or damaged over the years. Made of injection-molded clear plastic, both the large and small boxes retail for \$1.25 each.



Bluford Shops (bluford-shops.com) is showing test shots of their N scale transfer and short bay window caboose models. Models to be released include transfer cabooses with and without running boards, long and short roof

transfer cabooses, and short bay window cabooses. Roadnames to be produced include MKT, NYC, RI, Southern, PC, CGW, Monon, GB&W, ICG, N&W, Chessie B&O, C&EI, EL, AMTK, GN, GTW, CR, IHB, KCS, MP, UP, SP, UP-MOW, L&N, CRR, and INRD. Pre-orders are still available for some of these models. All of the caboose models have an announced retail price of \$36.95 except for the SP #1 which will be \$38.95.

Bluford Shops is also releasing 86' double-plug door boxcars lettered for the Rio Grande and Detroit & Toledo Shore line. Each road name will have 3 road numbers, to be sold as a single car for \$29.85 and a two-pack for \$59.70.



ExactRail (exactrail.com) has announced an all-new P-S 50' waffle-side boxcar in N scale. Manufactured by Pullman-Standard for the Southern Railway, the 70-ton, 5277 cu ft capacity cars became a Southern

Rwy signature item. Equipped with Micro-Trains #1015 couplers and 33" wheels on ExactRail's Barber 70 ton S-2 Trucks, the cars are available from the ExactRail website in six road numbers for \$22.95 each.



Fox Valley (foxvalleymodels.com) closes out their NS Heritage Series ES44AC GEVO models with the Interstate, Norfolk Southern

(original) and Monongahela railroads. These models feature high headlights with a notch in the nose, Hi-Ad trucks, directional headlights, illuminated ditch lights, cut levers and MU hoses. Fox Valley's GEVOs are DCC-ready and can be converted to DCC by removing the roof panel and plugging in a Digitrax DZ1251N or TCS EUN651 decoder (not included). Delivery is planned for the first quarter of 2013 at an MSRP of \$130. Reservations are due by August 24th.

Fox Valley will release a limited edition set of all 10 Heritage GEVO locomotives in a presentation box this fall. It includes Conrail, Norfolk & Western, Southern, Leigh Valley, Central of Georgia, Interstate, Nickel Plate Road, Norfolk Southern (original), Pennsylvania, and Monongahela. MSRP for the set is \$1000.

InterMountain (intermountain-railway.com) has announced the 1937 AAR 40' boxcar in eight paint schemes – C&O, UP/OWR&N, Texas & Pacific, B&M (white Minute Man), ATSF BX-27, Pere Marquette, Wabash/NJI&I, and ACL. Each scheme is available in six road numbers. N scale list price is \$21.95 Reservations are due by August 31st for a February/March availability.

Also announced from InterMountain are the Centralia Car Shops 2-1-1 observation-buffet lounge. The model features wire grab irons, interior details and



lighting, and Micro-Trains trucks and couplers. List priced at \$49.95, the paint schemes announced are: NYC – 20th

Century Limited (two names), NYC – post war 1946 (two names), B&O – National Limited (2 names), Southern Pacific – Lark (one number), Southern Pacific – Sunset (two numbers), GN – Empire Builder (two names), PRR – Fleet of Modernism (two names), PRR – Tuscan 3-Stripe (two names), IC – Panama Limited (one name), NP – Loewy (two numbers), NP – Pine Tree (two names), and UP (two numbers). Reservations are due by August 31 for February/March availability.



Kato (katousa.com) has new commuter versions of its F40PH locomotive with new body shell tooling – to include an over-the-cab air conditioner and illuminated ditch lights.

Still using the DCC friendly mechanism of previous Amtrak F40PH models, the commuter version is designed to be combined with Kato’s new release Nippon Sharyo Gallery Bi-Level cars. The commuter version of the F40PH is being produced in Caltrain (two numbers), Metrolink (one number) and Virginia Railway Express (two numbers) and retails for \$115.

The aforementioned bi-level gallery cars are being released in three-car book-case sets that include space for two additional cars and two locomotives, either the F40PH or MP36H. The three cars included consist of two coaches and a cab coach. Available for Chicago Metra and Virginia Railway Express, the sets retail for \$100. In addition, a Chicago Metra bi-level coach and a Chicago Metra bi-level cab-coach are available separately for \$30 and \$40, respectively.

Micro-Trains (micro-trains.com) has added a three-pack of Union Pacific passenger coaches and a Wisconsin & Southern three bay covered hopper to its collection of weathered N scale cars. The passenger coach 3-pack retails for \$89.95 and the W&S covered hopper has an MSRP of \$29.95.



New releases for July include UP/MP 50’ rib side boxcars in N scale. Both lettered for MP, one is painted in Armour yellow with an aluminum roof and the other

is in MP brown. The prototypes are 5090 cu. ft. and are rated for 220,000lbs. gross capacity. MSRP for the cars is \$23.45 (yellow) and \$22.15 (brown).



Also new for July are Gunderson well cars lettered for Canadian Pacific. Available in two road numbers, their MSRP is \$29.75.

Other Micro-Trains releases include a Pennsylvania X-54 40’ insulated boxcar at an MSRP of \$19.30, a Canadian National 50’ standard boxcar with wood crate load for \$24.25, a 36’ wood-sheathed ice reefer lettered for Morrell Refrigerator Line at \$26.95, a BNSF PS-2CD 4427 cu. ft. covered hopper for \$27.75, a Western Paving and Construction Co. 43’ Ortner rapid-discharge open hopper at \$24.40, a CNW 40’ outside-braced boxcar with “Route of the 400” slogan for \$21.85, a 40’ despatch stock car in GN Vermilion Red with Great Northern lettering in white and Norfolk & Western brown for \$17.90 ea., a closed autorack 3-pack for \$124.95, the Waterfront Hotel for \$24.95, and a two-pack generator load for \$9.95.

S&R Models (srmodeltrains.com) has announced a pewter metal kit to convert the Walthers N scale SIECO pulpwood car to a modern log car. Available direct from S&R Models or select dealers for \$7.50 MSRP.

Trainworx, distributed by Intermountain (intermountain-railway.com) has announced Pullman-Standard 85’ flat cars lettered for Rock Island and two Western Pacific styles, a yellow-lettered one with trailer jacks and a white-lettered one with container anchors. Available in six numbers for each style, the cars retail for \$29.95 each.

Companions to the flatcars, Trainworx also has 40’ trailers in a variety of styles and names. Trailer styles include a smooth-sided drop-floor trailer lettered for Western Pacific and two Rock Island styles, a corrugated side trailer lettered for Navajo, Rock Island, PIE, and Western Pacific, a rib-side trailer in two APL schemes and a corrugated-side trailer with a refrigerator unit mounted underneath lettered for Alpha Beta grocery stores.

MSRP is \$15.95 to \$17.95 each with three road numbers available per style. Pre-orders for the Trainworx products are due August 31st for delivery during the Fall of 2012.



Voltscooter Electronics (voltscooter.com) is now shipping a capacitor-equipped constant lighting board designed for N scale passenger cars. A drop-in replacement for

Walther's N scale cars, the board can also be installed on cars with or without pickups and can be shortened for use in 60' cars.

Wheels of Time (wheelsotime.com) has announced a new run of N scale Piggy-Packers, with pre-orders due August 7th and an ETA of late-fall 2012. The Piggy-Packer model boom can be raised and lowered to the desired position. The bottom pick is adjustable and can hold a trailer. It includes rubber tires and is decorated according to the prototype railroads. MSRP is \$59.99.

Z SCALE PRODUCT NEWS



Full Throttle (wdwfullthrottle.com) has introduced several new paint schemes for their 33-foot two-bay hoppers, including the Chessie "Moonshine" in four road numbers on the rib-side hoppers, and two road numbers for Mopac on the offset-side hoppers. All models feature Full Throttle's own trucks, metal wheels, and knuckle couplers. Both models come in two-packs and retail for \$42.00.



InterMountain (intermountain-railway.com) has announced cylindrical covered hoppers with round hatches in for delivery in February/March 2013. Equipped with AZL trucks and couplers, the

cars will be available in 10 paint schemes of six road numbers each. There are five CN schemes (Continent, Rainbow, Wet Noodle, Environmental, and Canadian National), two CP schemes (Script and Multi-Mark), as well as Potash – Logo, UNPX-Alcan-Chemical Products, and Roberval Sanguenay. Reservations are due by August 31st.

InterMountain has also announced their second car project in Z scale, the 57' R-70-20 mechanical refrigerator car in both open- and full-roof versions. More information will be forthcoming, with a possible release later in 2012.



Great Lakes Models (greatlakesmodels.com) has released two etched brass road detail sets – storm sewer grates and manhole covers. Based on designs common to the Midwest and eastern United States, the grates come in a package of six for \$2.25 and the manholes in a package of eight for \$2.95.

NEW DECALS, SIGNS, AND FINISHING PRODUCTS

Protocraft (protocraft48.com) has released many new scale decals sets, produced for Protocraft by Microscale, in 1:48, 1:64, and 1:87 scales recently, including sets for GATX single, four, and six dome tank cars leased to Gibson Wine, and sets for reefers and boxcars from the '30s to the '50s. Check out their website for availability and pricing.

Jerry Glow (home.comcast.net/~jerryglow) recently released a set of 50's-era Illinois Central ice reefer decals in HO. Suitable for use on a modified Intermountain kit (such as their 41199) or Stan Rydarowitz (sunshinekits.com/stanpage.html) has a modified kit with replacement sides.

Dan Kohlberg has released two sets of HO/N scale Illinois Central decals. Both the ICG-56 Illinois Central 50' combination door PS-1 boxcar 1967+ and the ICG-57 Illinois Central 50' single door PS-1 boxcar 1968+ are \$7.00 and can be found at his website at home.mindspring.com/~paducah.

Microscale (microscale.com) has released the following decal sets:

87-1355 & 60-1366 – Chicago Northwestern Yellow Scheme including Brown Scheme GATC boxcars

87-1372 & 60-1372 – NRE GenSet and Conventional Diesel Demonstrator paint scheme, includes GenSet DATA

87-1373 & 60-1373 Burlington Northern Passenger and Business Car Names

87-1375 & 60-1375 BN GATC Airslide Hoppers includes lettering for 2600, 3500, 4180

Highball Graphics (highballgraphics.com) has several new sets of freight car decals available:

St. Johnsbury & Lamoille County Early Boxcars in HO (F-305)

CP Rail 27' Bottom Dump Ore Cars in HO (F-304) and N (FN-304)

Reading 50' ACF Boxcars in HO (F-301), N (FN-301), and O (IMO-063)

Reading 40' ACF Boxcars in HO (F-302), N (FN-302), and O (IMO-067)

Pittsburgh & Lake Erie 50' Boxcars built by NYC Despatch Shops in HO (F-303), N (FN-303), and O (IMO-099)

Mid-West Farmers CO-OP Pink Covered Hopper letter sets in HO (F-COOP-1B) and N (FN-COOP-1B) Other colors are available on request.

All decals are MSRP \$7.00 (HO), \$6.00 (N), and \$14.00 (O).

Highball Graphics also has new locomotive decals available for the Dakota Minnesota & Eastern and Iowa Chicago & Eastern hood units in HO and N. For DM&E, set L-245 (HO)/LN-245 (N) is the basic set for the locomotives, with L-245a (HO) and LN-245a (N) being a companion set that covers all the unit names and numbers. Similarly, for the IC&E, sets L-246(HO) and LN-246(N) are the basic set for the locomotives with L-246a(HO) and LN-246a(N) being the unit names and numbers. L-245/L-246 are \$8.50 ea, LN-245/LN-246 are \$7.50 ea, L-245a is \$15.00, LN-245a is \$12.50, L-246a is \$30.00 and LN-246a is \$25.00.

San Juan Decals (sanjuandecals.com) has released On3 Oahu Railway & Land decal sets, one for passenger cars (coaches only), two for freight cars (pre- and post-1920), and one for steam locomotives (post-1916). All sets are \$8.95, except the post-1920 freight car set which is \$9.95. More sets are planned. Go to sanjuandecals.com/oahu.html for further details and information.

Timberline Scenery (timberlinescenery.com) has released a new set of water-based paints developed for use on plastic, wood, plaster and other surfaces. The paint may be brushed or sprayed on, and when cut with water can make a transparent wash. Single one-oz. bottles are \$3.49 with the complete nine-color kit available for \$29.99. The colors are red, green, purple, orange, blue, yellow, black, brown, and white.

Tru-Color Paint (trucolorpaint.com) will release new colors throughout 2013 with the introduction of two railroad specific colors each month (three in

December), as well as continuing their line of railroad specific boxcar browns and reds at the rate of two a month. All products are available in 1 oz. (\$4.99) and 2 oz. (\$8.95) bottles. 16 oz. bottles of any color can be provided via special order. Suggested retail prices will remain the same through the first half of 2013. For a full list of forthcoming colors and more details, visit trucolorpaint.com/index.php?p=1_19_Announcement.

DISCLAIMER

The opinions expressed in this column are those of the writer and do not necessarily reflect the opinion of *Model Railroad Hobbyist* or its sponsors. Every effort is made to provide our readers with accurate and responsible news and information, however, neither *Model Railroad Hobbyist* or the writer of this column can be held responsible for any inaccuracies or typographical errors that may inadvertently appear in this column.

The Get the Latest Model Railroading News, Tips, Reviews & Opinions

SCOTTY MASON

S H O W
The Original Model Railroad Podcast

-Monthly Interviews

- Modeler's Spotlight: Top Modeler's Talk
- Narrow Gauge Modeling w/Chris Lane
- Contemporary Modeling w/ Mike Rose

-More Product Announcements & Reviews

 Our feed has changed! To get the latest shows, Please search Scotty Mason and subscribe to the new feed!

www.TheModelRailroadPodcast.com

Scott Mason Jimmy Simmons Mike Rose Joe Duckworth



**A
D
V
E
R
T
I
S
E
M
E
N
T**



Send us your product announcements

If you are a hobby manufacturer with a product announcement, just [click here](#) and submit your announcement to us.

Our web site and free magazine reach continues to grow, so get on board with this new media train that's hard to stop!

 **Reader Feedback** 
(click here)



Selected Events

August 2012

COLORADO, PUEBLO, August 11-12, Colorado Rail Fair featuring clinics, operating layouts, sales tables, manufacturers displays, and more, at Occhiato Center, Colorado State University. Sponsored by Pueblo Model Railroad Association and Arkansas Valley Division NMRA RMR.

Special rates available at Clarion Inn, 4001 N. Elizabeth St. Info from John Denny at 719-547-7990.

GEORGIA, NORCROSS (Atlanta), August 11, 43rd Atlanta Train Show, North Atlanta Trade Center. Info at gserr.com/shows.htm.

NEW JERSEY, CHERRY HILL, August 30 - September 2. 2012 Steel Mill Modeler's Meet. Crowne Plaza Hotel, 2349 West Marlton Pike. Conference registration is \$99.00 and includes the Saturday evening "Mill Hunkie Banquet" served buffet style. Additional information at: peachcreekshops.com/2012steelmeet.php.

NEW JERSEY, EDISON, August 11-12, Greenberg's Train & Toy Show, New Jersey Expo Center. Info at greenbergshows.com.

OHIO, NILES, August 19, Niles 30TH Annual Train Show, McMenamy's Banquet Center. Info at gserr.com/shows.htm.

PENNSYLVANIA, EVERETT, August 25-26, 8th Annual "N-Scale Weekend" Model Train Show. Saturday 10am – 5pm, Sunday 9am – 3pm. ProCare "SPORTSPLEX" 125 Willow Grove Drive. Admission \$4, children under 12 free with adult.

PENNSYLVANIA, LEESPORT, August 10-12, Greater Reading Narrow Gauge Meet. With operating displays, dealers, clinics, and demonstrations. Leesport Farmers Market Banquet Hall, Arlington Drive. Info at nateslightironhobbies.com/narrowgaugemeet.htm.

September 2012

CALIFORNIA, COSTA MESA, September 8-9, The Great Train Expo, Orange County Fairgrounds. Info at trainexpoinc.com.

CALIFORNIA, OXNARD, September 6-9, NMRA Pacific Southwest Region "Ventura Flyer" 2012 Convention featuring clinics, prototype tours, layout tours, swap meet, and hobo auction. Scheduled banquet speaker is Michael Gross. Courtyard Marriott, 600 East Esplande Drive. Info at psrnmra.org.

CALIFORNIA SAN JOSE, September 15-16, The Great Train Expo, Santa Clara County Fairgrounds. Info at trainexpoinc.com.

COLORADO, COLORADO SPRINGS, September 14-15, TrainExpoCO, swap meet, operating layouts, clinics, manufacturers presentations. Financial Services Expo Center, 3650 N. Nevada. Info at tecoshow.org.

COLORADO, PUEBLO, September 7-9, RockyOp 2012 – a fun filled weekend of operating sessions on a variety of excellent operating layouts in the Colorado Springs & Pueblo West metro area. Registration deadline: August 15. More info: home.comcast.net/~rockyop/even/index.htm.

NEW YORK, LIVERPOOL (Syracuse area), September 6-9, Empire Junction '12, NMRA Northeastern Region Fall 2012 Convention, Holiday Inn Hotel & Convention Centre on Electronics Parkway.

NEBRASKA, NORTH PLATTE, September 14-16, Rail Fest 2012, multiple events including tour UP challenger 3977, DD40, and dozens of railcars at Cody Park, model train expo, tour of diesel shops, car repair facility, and Bailey Yard that process 150 trains and 10,000 railcars each day. Details at nprailfest.com.

TEXAS, TEMPLE, September 15-16, 30th Annual Temple Model Train Show sponsored by Central Texas Area Model Railroaders. Frank Mayborn Convention Center. Info at centramod.com/show2012.htm.

WASHINGTON, BELLEVUE, September 12-15, 32nd National Narrow Gauge Convention, with 50 clinics, 35 layout tours, and 80 plus vendors. Meydenbauer Convention Center. For info visit seattle2012.com.

WASHINGTON, LA CONNER, Sept 8-9, 18th Annual North West Logging Modelers Convention, antique engines, logging equipment displays, donkey hunt, Snag boat tour, model contest, vendor tables, and logging fan camaraderie. Contest info at sites.google.com/site/nwlmconvention. Additional info from Loyd Lehrer at lloydlehrer@gmail.com or phone 310-951-9097.

CANADA, ONTARIO, September 30, 10am – 6pm. 8th Annual: Muskoka & Simcoe County Model Railroad Layout Tour. Locations: Alliston, Tottenham, Beeton, Stroud, Barrie, Craighurst, Orillia, Severn Bridge, Gravenhurst, Springwater, Waubaushene, Bracebridge & Huntsville. Admission \$5 (includes door-prizes, proceeds to charity). 20+ layouts from N to G and Live Steam. More information at nfr-nmra.org.

FUTURE 2012

COLORADO, COLORADO SPRINGS, December 15-16, TrainExpoCO, swap meet, operating layouts, clinics, manufacturers presentations. Financial Services Expo Center, 3650 N. Nevada. Info at tecoshow.org.

ILLINOIS, NAPERVILLE, October 18-20, 19th Annual RPM-Naperville Conference with blue ribbon panel of speakers including Jack Burgess, Paul Dolkos, Stephen Funaro, Glenn Guerra, Dick Harley, Richard Hendrickson, Bob Hundman, Tony Koester, Martin Lofton, Brain Marsh, Scott Mason, Lance Mindheim, Pierre Oliver, Frank Peacock, Mike Rose, Stan Rydarowicz, Bill Schaumburg, Andy Sperandeo, Mont Switzer, Tony Thompson, Bill Welch, and more. Hosted by Joe D'Elia at Naperville Marriott Conference Hotel. Info at railroadprototypemodelers.com.

INDIANA, DANVILLE, November 17, 10am to 4pm. Central Indiana Division of the NMRA Presents: the Danville, Indiana Train Show and Swap Meet. At the Hendricks County 4H Fairgrounds, Contact jpancini@indy.rr.com or see cid.railfan.net for more information.

MARYLAND, TIMONIUM, October 27-28, Great Scale Model Train Show with more than 350 vendor tables. Hosted by Howard Zane in Exhibition Building, Maryland State Fairgrounds. Info at gsmts.com.

NORTH CAROLINA, BREVARD, October 12-13, Narrow Trak 12. Annual narrow gauge and logging mini-convention with model displays, operating modules, seminars, and popular-vote model contest. Speakers include Matt Bumgarner, Jerry Ledford, and Tom Yorke. Transylvania County Recreation Center, 1078 Ecusta Road. Send inquiries to narrowtrak@mac.com.

NORTH CAROLINA, FLETCHER, October 13-14, Autumn Rails 2012, Expo Building, Western North Carolina Agricultural Center. Set-up: 9am-5pm Friday, 7:30am – 10am Saturday. Show hours: 10am – 5pm Saturday, 12pm – 4pm Sunday. Table rental contact: hmp3@blueridge.net or call 828-685-2726.

OHIO, CLEVELAND, October 11-14, iHobby Expo, annual hobby industry trade show, IX Center.

OKLAHOMA, TULSA, October 19-20, Oklahoma Narrow Gauge Meet. Clinics include Bob Hyman on 20.3 scale outdoor RGS layout, and Chuck Lind on logging and sawmills, plus op sessions. Progressive meet in private homes requires RSVP as early as possible. Info at okng.org or e-mail Ken Ehlers at: ehlerskd@hotmail.com.

PENNSYLVANIA, STRASBURG/LANCASTER, October 11-13, Fine Scale Model Railroader Expo, with manufacturers displays, clinics, dioramas, display

layouts including Muskrat Ramble On30 layout, plus others activities at the Strasburg Railroad, and The Pennsylvania State Railroad Museum (PSRM). HQ at Lancaster Host Hotel & Conference Center, Strasburg, with special awards dinner at PSRM. Info at modelrailroadexpo.com.

SOUTH CAROLINA, MYRTLE BEACH, October 13-14, Grand Strand Model Railroaders 3rd Annual Model Train Show, at Lakewood Conference Center, 5837 S. Kings Hwy. Info at isfans.com/gsmrrc.

UTAH, SALT LAKE CITY, October 26-28, NMRA Wasatch Division hosts Wasatch Rails 2012. Grand Building, Promontory Hall, Utah State Fair Park. Info at nmrawasatch.org/html/events.html.

VIRGINIA, SUFFOLK, October 18-21, 2012 NMRA Mid-Eastern Region Convention at Hilton Garden Inn. Guest speaker Jim McClellan former vice president of Norfolk Southern. Info at mer.nmra.org/MERConv/MERConv.html.

VIRGINIA, WINCHESTER, November 10, 9am – 2pm. Winchester Model Railroad Club Train Show and Sale. Friendship Fire Hall, North Pleasant Valley Road. Adults 4pm, children under 12 free with adult. Club Layout, 430 N. Cameron St., is open during the show. More information at wmrrc.org or 540-665-9898.

WASHINGTON, SEATTLE, October 13, Rails By The Bay 2012, Pacific Northwest Railroad Prototype Modelers meet. Info at northwestrpm.com/RPM_Meet.html.

FUTURE 2013

AUSTRALIA, MELBOURNE, April 12-14, 2013, 13th National Australian N Scale Convention, Rydges Bell City Event Centre, Preston, Melbourne. Info at convention2013.nscale.org.au or send email to nscale2013@bigpond.com.

CALIFORNIA, PASADENA, August 28-31, 2013, 33rd National Narrow Gauge Convention. Hilton Hotel, 199 S. Los Robles St. Info at 33rdnngc.com. Send inquiries to Jeff Smith at jeff@railmasterhobbies.com.

GEORGIA, ATLANTA, July 14-20, 2013, National Model Railroad Annual Convention and National Train Show.

MINNESOTA, BLOOMINGTON, April 25-28, 2013, 28th Annual Sn3 Symposium. Ramada Mall of America Hotel. Info at Sn3-2013.com.

NEW MEXICO, ALBUQUERQUE, June 6-9, 2013, Rails Along the Rio Grande, NMRA Rocky Mountain Region, Rio Grande Division 6, convention with clinics, layout tours, train show, OpSig sessions, UPRR and BNSF modelers showcase night, and banquet. Marriott Pyramid North. Info at rarg2013.org. ■



Grand Rails: The 2012 National Train Show

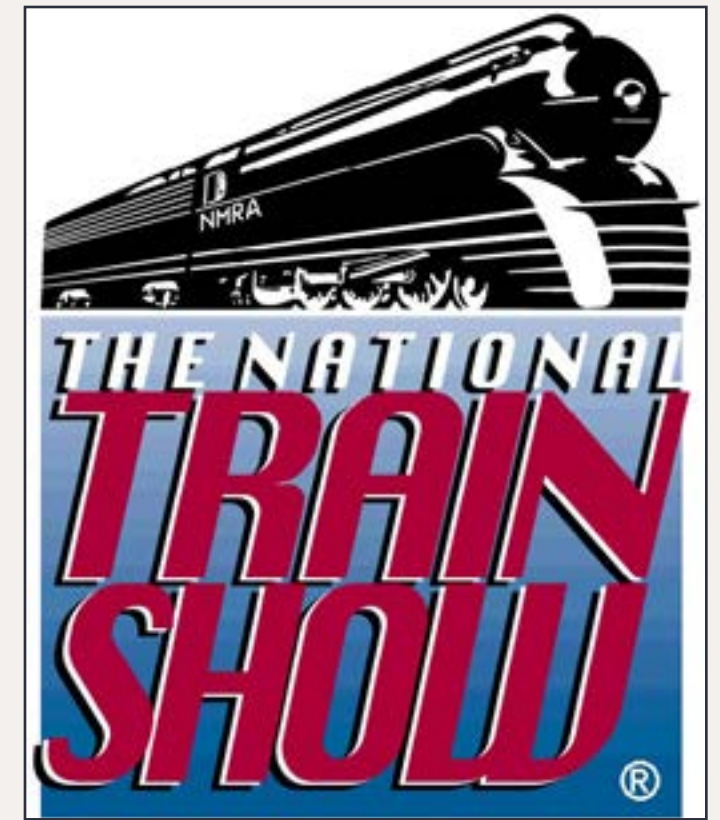

An MRH Exclusive Report from Grand Rapids



Model Railroad Hobbyist attended the 2012 NMRA National Convention in Grand Rapids, Michigan this summer from July 30 - August 5.

We took lots of photos and had a booth at the National Train Show which ran Friday to Sunday.

Here's our exclusive report of what we saw and learned from vendors and saw on the National Train Show floor. The [subscriber bonus downloads](#) this issue has even more! You can also find more MRH Grand Rails coverage on the MRH website and on our Facebook page. See the sidebar: *More Grand Rails Coverage* for links.



1: New Atlas N Scale F89 flat car with intermodal hitches. Pre-production model.

2: Close up end view of the same flat car, showing the container pedestals and brake lever. See: atlasrr.com.

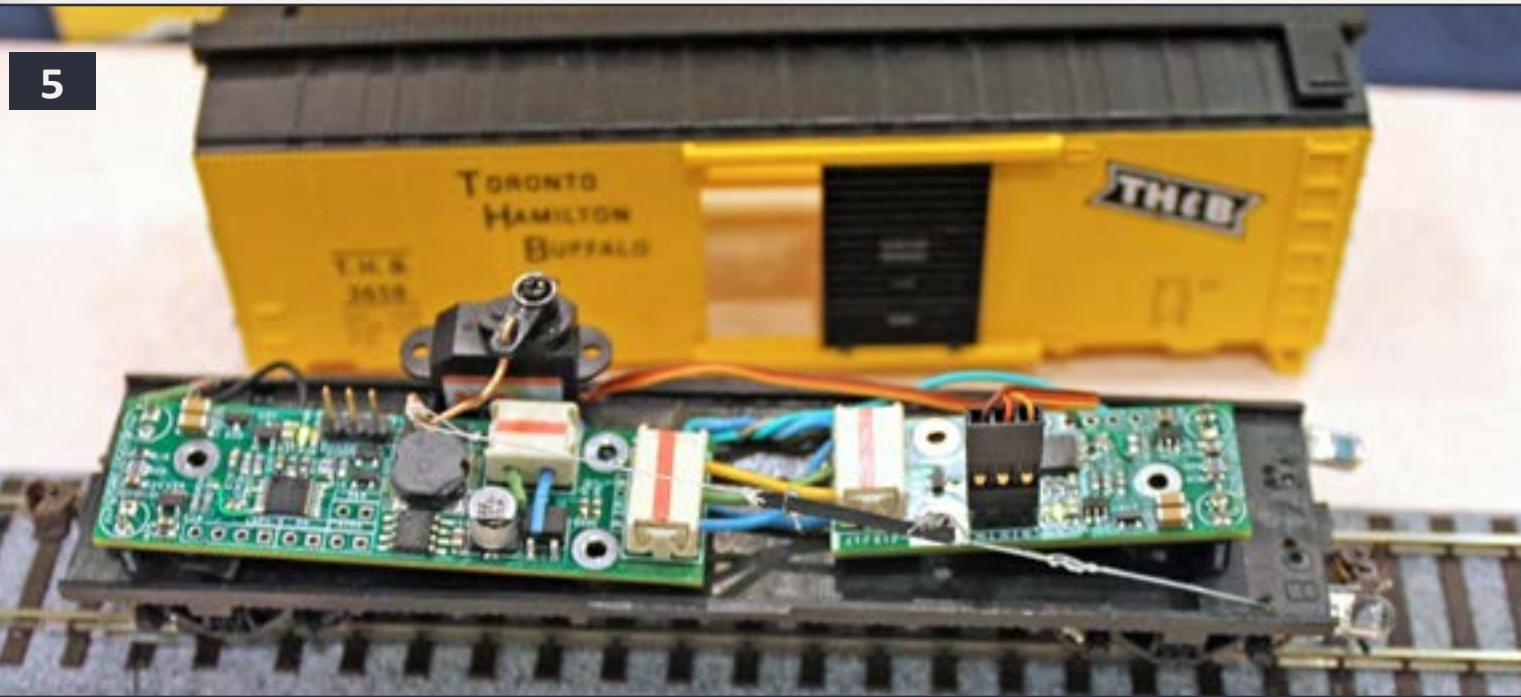

- 3: Traincat HO scale adjustable Wilson automobile ramp in brass (traincat2.com).
- 4: NCE DCC Twin command station. all scales, \$159.95
- 5: LaserActive uncoupling system for HO scale (unionvilledepot.com/laseractivesystem.php).
- 6: Athearn HO Scale 57' FGE Reefer (modernized). BNSF 79972 with truck-style reefer unit.
- 7: Athearn HO Scale 57' FGE Reefer (original). FGMR 12824 "Solid Cold" with genset reefer unit.
- 8: Athearn HO Scale 57' modernized FGE Reefer ARMN 912057, "Union Pacific Chilled Express" with truck-style reefer unit. See: athearn.com.

9



12



10



13



11



9: Athearn HO Scale 57' FGE Reefer (original). BNFE 11702 "Western Fruit Express" with genset reefer unit.

10: Exclusive MRH-Athearn product announcements video. See: athearn.com.

11: Kato HO Scale Pullman-Standard Bi-Level commuter car, Chicago Metra.

12: Kato HO Scale "Commuter" F40PH locomotive in Chicgo Metra paint scheme, engineer's side.

13: Kato HO Scale "Commuter" F40PH locomotive in Chicgo Metra paint scheme, fireman's side.

See: katousa.com.

14



17



15



18



16



14: Athearn HO Scale 57' modernized FGE Reefer ARMN 912057, "Union Pacific Chilled Express" close-up shot of truck-style reefer unit.

See: athearn.com.

15: Kato N Scale MP36PH in Chicago Metra #416.

16: Kato N Scale MP36PH – topside details.

17: Kato N Pullman-Standard Bi-level Cab Car in Chicago Metra.

18: Kato N Pullman-Standard Bi-level Cab Car end detail.

See: katousa.com.

19



22



23



20



24



21

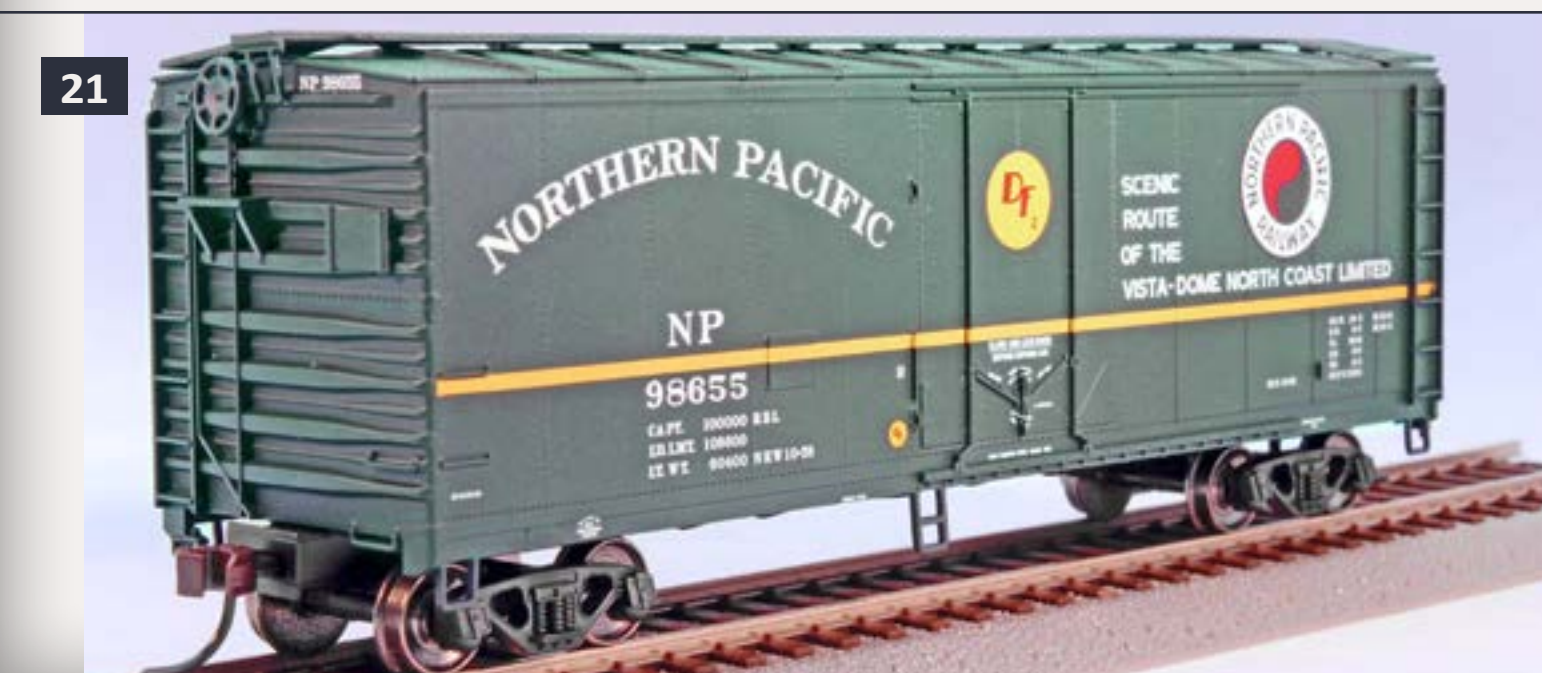

- 19: Walthers HO scale Cornerstone "Import Motors" kit. See: walthers.com.
 20: Atlas HO scale 40' Plug Door Box Car, PRR 19103.
 21: Atlas HO scale 40' Plug Door Box Car, Northern Pacific 98655.
 22: Atlas HO scale FMC 5077 Single Door Railbox 17756 – 3rd Qtr 2012.
 23: Atlas HO scale FMC 5077 Single Door Port Huron & Detroit – 3rd Qtr 2012.
 24: John's Custom Model Trains, John Drozdak, HO scale Rock Island Transfer Caboose

25



28

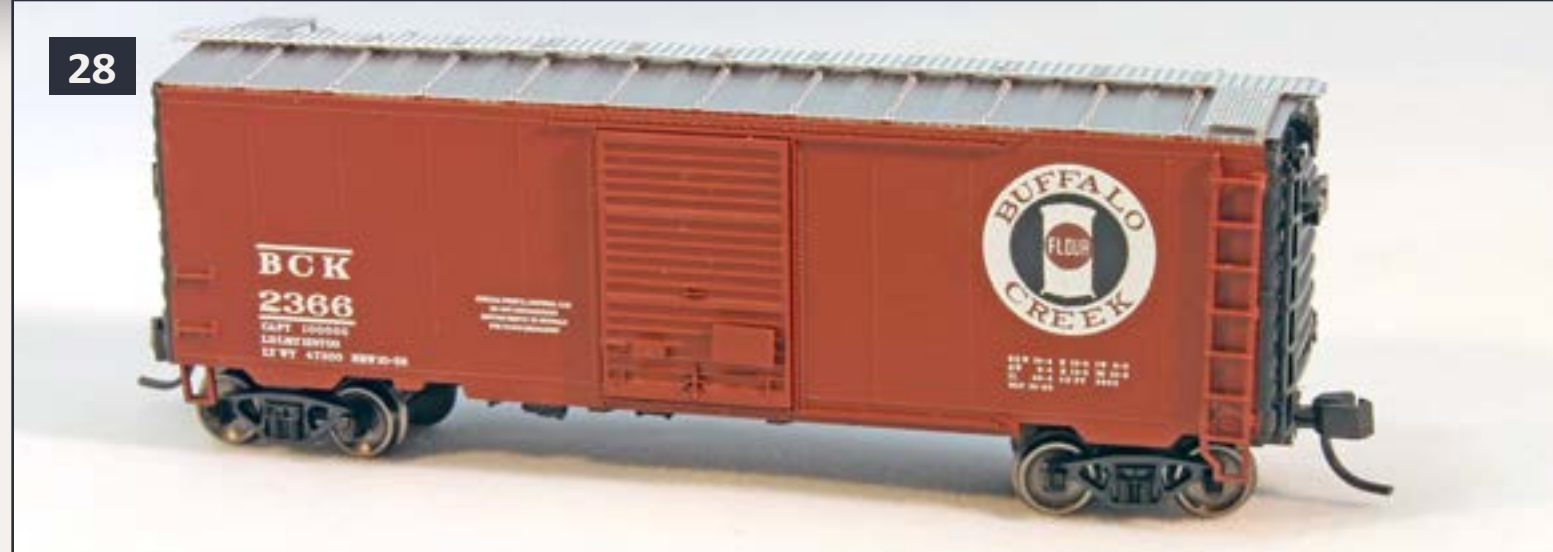

26



29

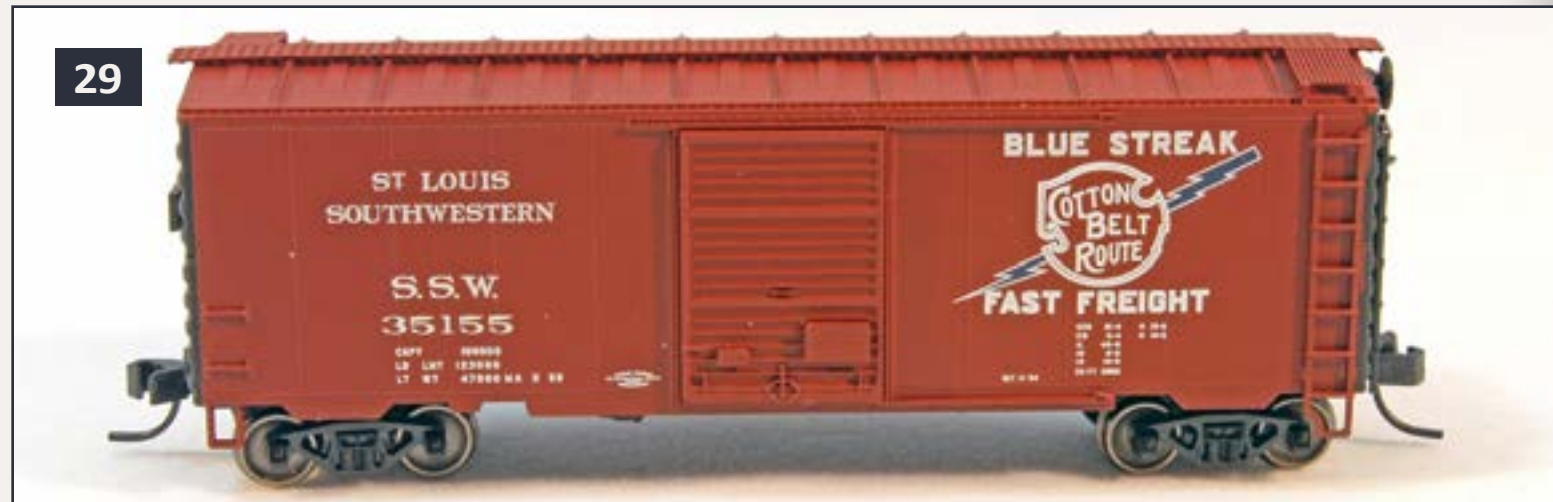

30



27



29: John's Custom Model Trains, HO scale Grand Trunk Western Transfer Caboose.

26: John's Custom Model Trains, HO scale Nickel Plate/N&W WWII "boxcar" war emergency caboose.

27: Atlas N scale 40' PS-1 Box Car, Rutland 151. Pre-production model, available 3rd Qtr 2012.

28: Atlas N scale 40' PS-1 Box Car, Buffalo Creek, BCK 2366. Pre-production model, available 3rd Qtr 2012.

29: Atlas N scale 40' PS-1 Box Car, St. Louis Southwestern SSW 35155 "Blue Streak Fast Freight" Pre-production model, available 3rd Qtr 2012.

30: Walthers HO scale 85' Pullman-Standard 10-6 Sleeper Plan 4167, Pere Marquette. Dec 2012 delivery, MSRP \$69.98 Pre-production model.

31



32



33



34



35



36



31: Walthers HO scale 85' Pullman-Standard Diner Coach, Pere Marquette. Dec 2012 delivery, MSRP \$69.98 Pre-production model. See: walthers.com.

32: Walthers HO scale 85' Pullman-Standard Lunch Counter Lounge, Pere Marquette. Dec 2012 delivery, MSRP \$69.98 Pre-production model.

33: MTH O scale Crocodile Electric Engine with Proto-Sound 2.0. Available Sept 2012, MSRP \$899.95.

34: MTH O scale 50' PS-1 Boxcar w/Pullman-Standard Door. Pre-production sample (mthtrains.com)

35: Joe Fugate with the Walthers scale comparison display

36: All scale, Caboose Industries 199R Remote Spring. 12" length, for use on any non-sprung Caboose Industries turnout control (cabooseind.com).

37



40



38

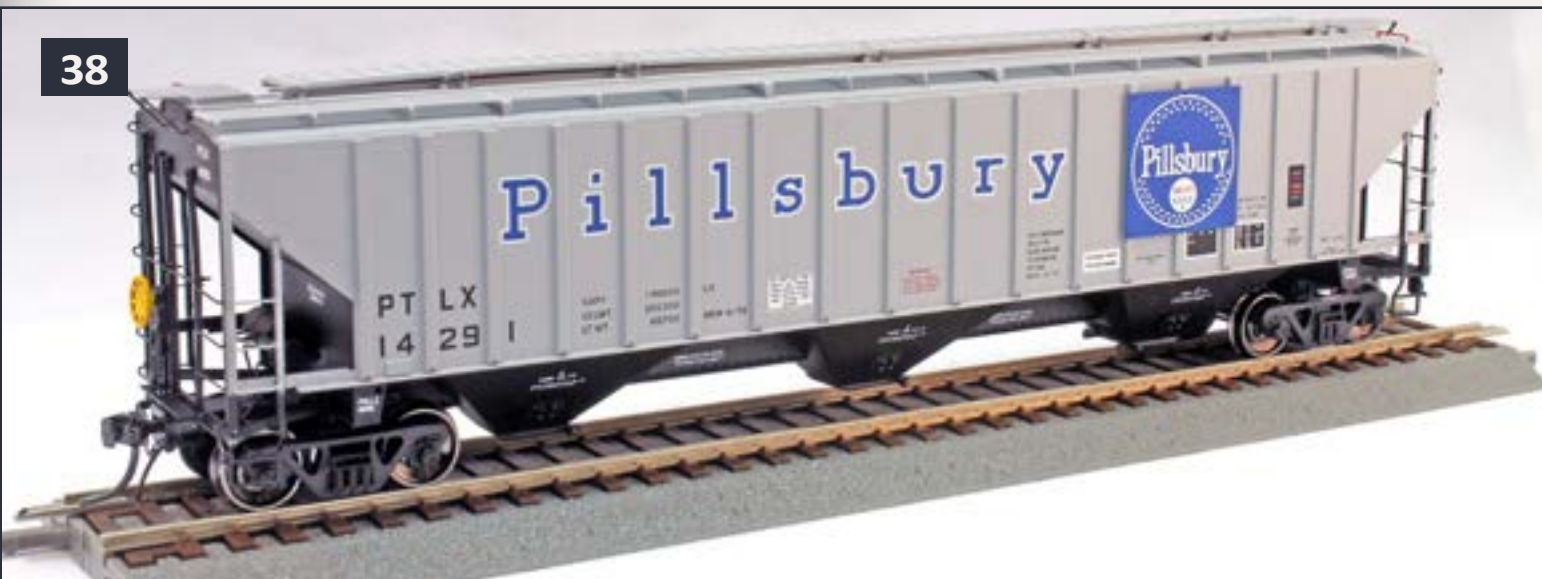

41



39

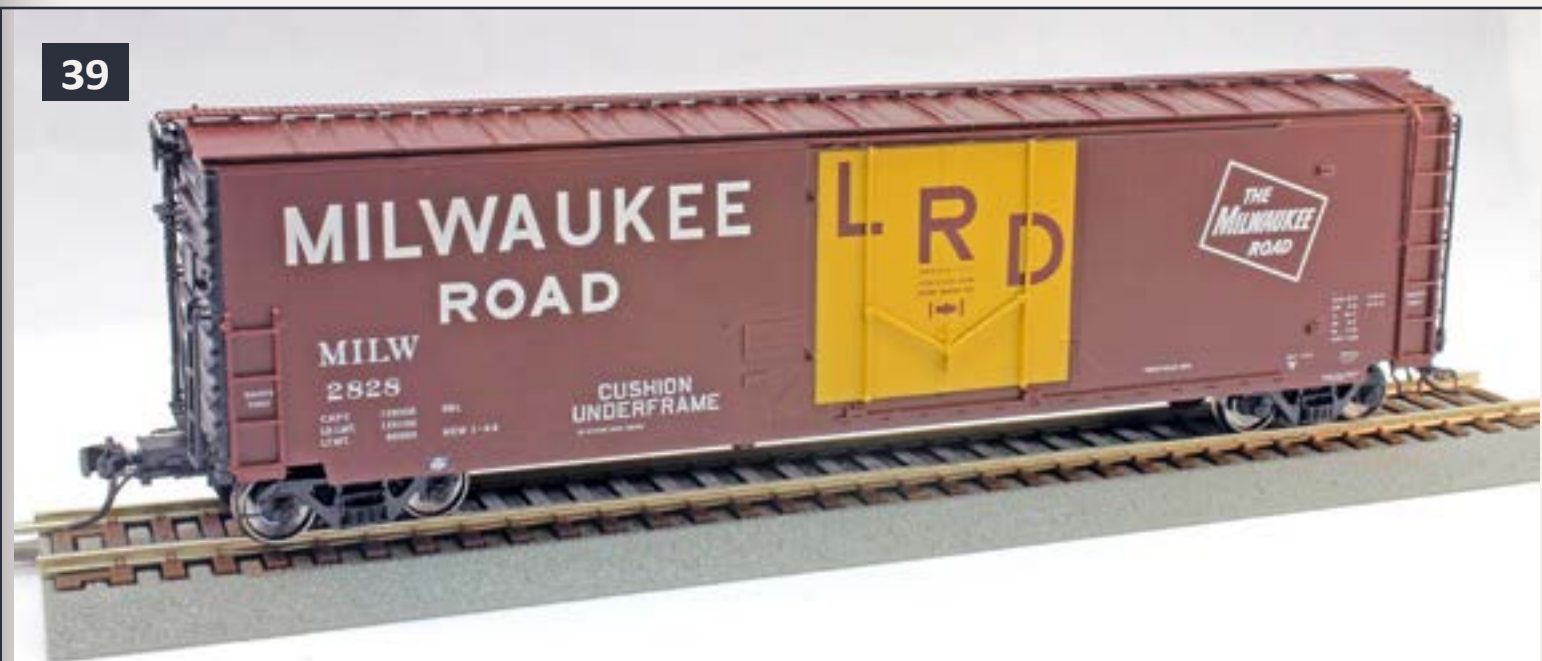

42



37: Tangent HO scale Bethlehem-Design Quad Hopper, CSX 350176 MSRP \$32.95 (tangentscalemodels.com).

38: Tangent HO scale PS-2CD 4750 Covered Hopper, Pillsbury PTLX 14291, MSRP \$42.95.

39: Moloco HO scale General American 50" RBL 10'6" offset door/wide rods, RTR. Milwaukee Road MILW 2828 (molocotrains.com).

40: Moloco HO scale General American 50" RBL 10'6" offset door/wide rods, RTR, Wabash WAB 783623.

41: Woodland Scenics, HO scale, Tidy Track powered wheel cleaner (woodlandscenics.com).

42: Des Plaines Hobbies 40' MOD Boxcar, C&EI "Route of the Dixie Flagler" (desplainseshobbies.com).

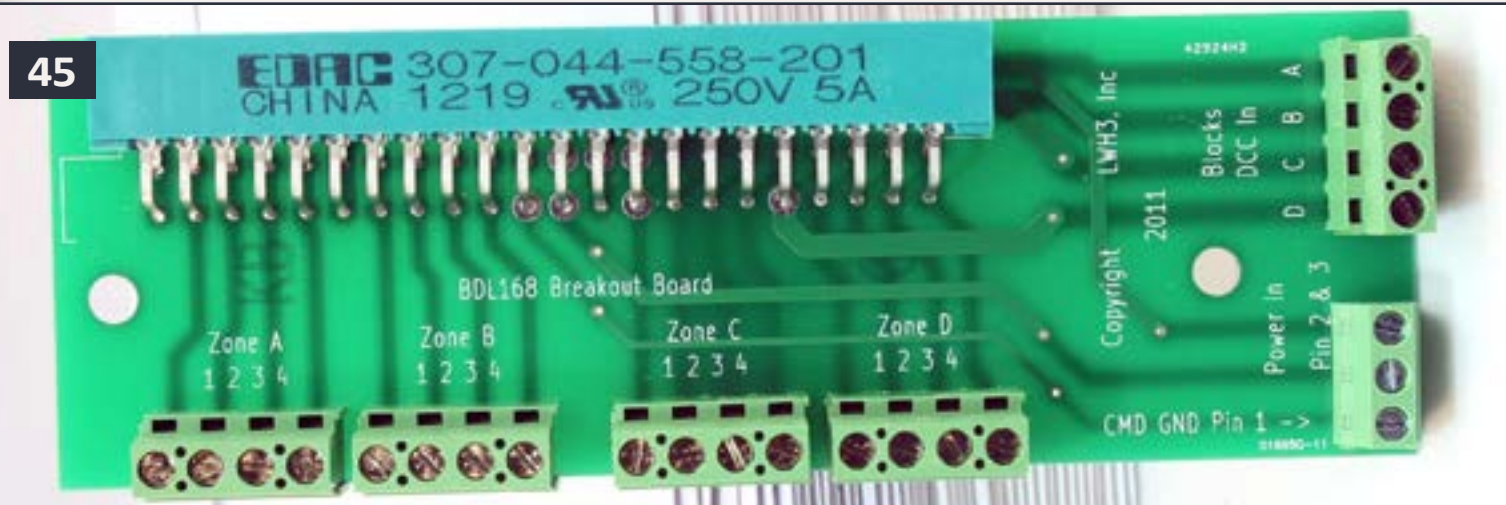
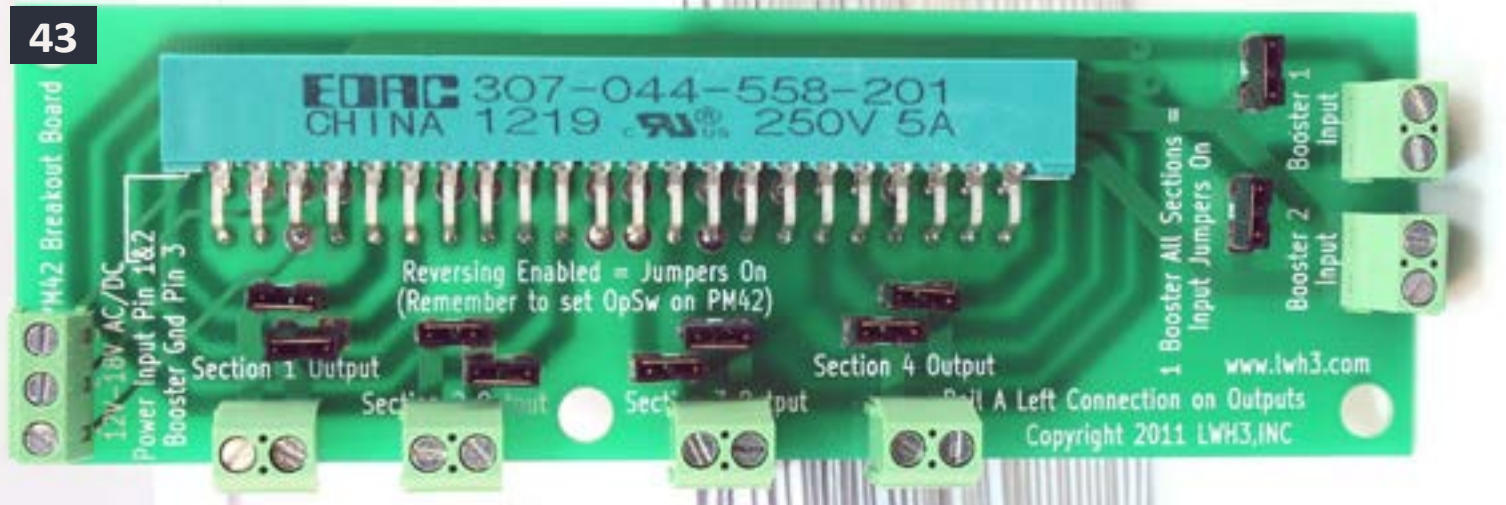

43: Rick Lull, multi-scale, PM42 Breakout, MSRP \$35.00.
 44: Rick Lull, multi-scale, SE8C Breakout, MSRP \$38.00.
 45: Rick Lull, multi-scale, BDL168 Breakout, MSRP \$35.
 46: Rick Lull, multi-scale, BDL168 Breakout (small), MSRP \$30.
 47: Funaro & Camerlengo, HO scale, PRR G28 Gondola, Pennsylvania 343679 (fanckits.com).
 48: Funaro & Camerlengo, HO scale, PRR G29 Gondola, Pennsylvania 357934.
 49: Funaro & Camerlengo HO scale, New Haven 36' rebuilt boxcar, NH 72150.
 Funaro & Camerlengo HO scale, New Haven 36' rebuilt boxcar, NH 72150.

50



51



52



53



54



50: ExactRail HO scale, Trenton-Built bulkhead flatcar, pre-production model.

51: ExactRail HO scale, 63' Thrall "Opera Window" Centerbeam pre-production model, MSRP \$46.95.

52: Rail Scale Miniatures, HO scale, Dome Gas craftsman model kit – dusk shot (railscaleminiatures.com).

53: Alpine Scale Models Division, HO scale, Cathy's Furniture Factory (corrugated matboard). MSRP \$29.99.

54: Alpine Scale Models Division, HO scale, Millard's & Sons (corrugated matboard). \$15.99 (alpinemodels.com).

55



58



56



59

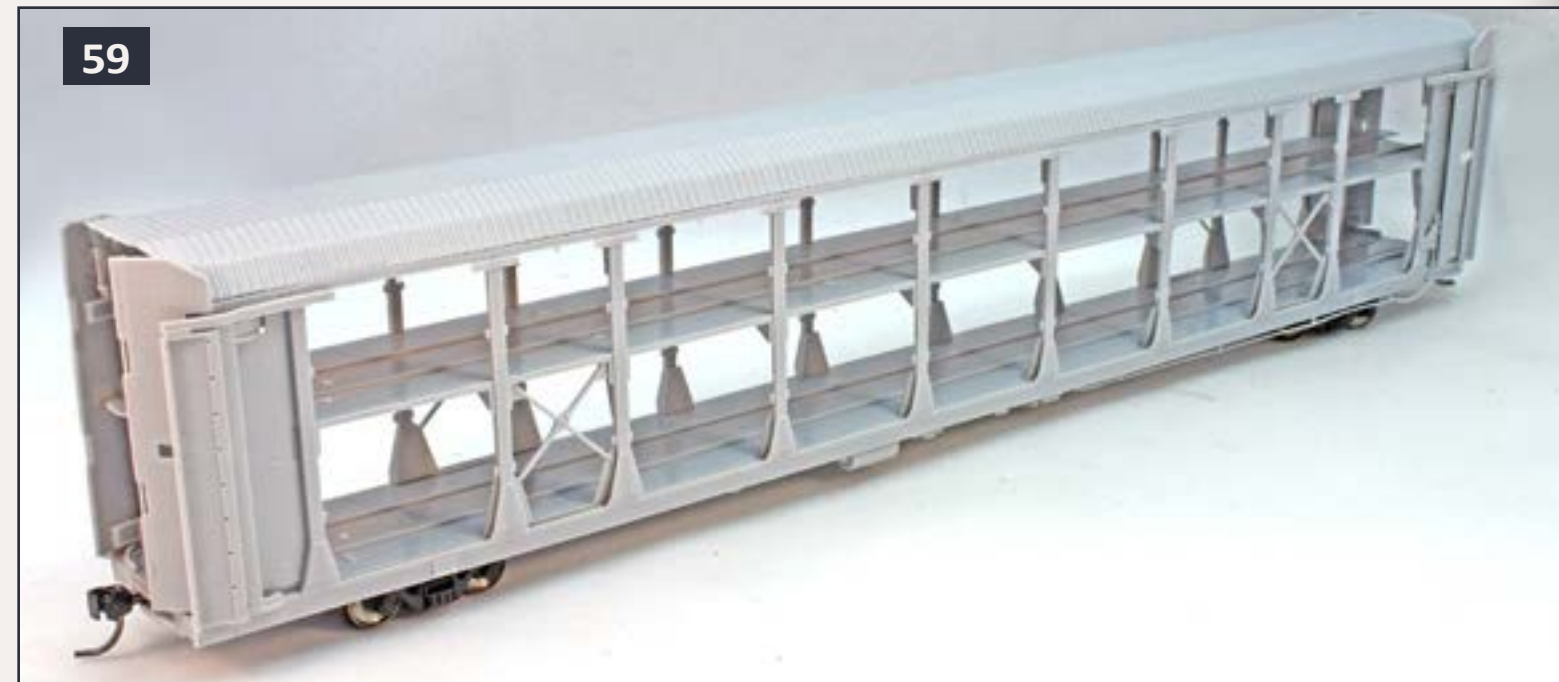

57



60



- 55: Bachmann 52'6" flatcar with 35' piggyback trailer – pre-production model.
 56: Bachmann HO scale Alco S2 Diesel Switcher (DCC Sound Value Equipped) MSRP \$195.00 Shipping Sept. 2012.
 57: Bachmann N scale Alco S4 Diesel Locomotive (DCC Equipped) \$129.00.

- 58: Bachmann N Scale Alco 2-6-0 Steam Locomotive \$179.00.
 59: Intermountain HO scale bi-level Auto Rack, test shot.
 60: Intermountain HO scale bi-level AutoRack, Burlington Northern. The doors on these units open and close.

61

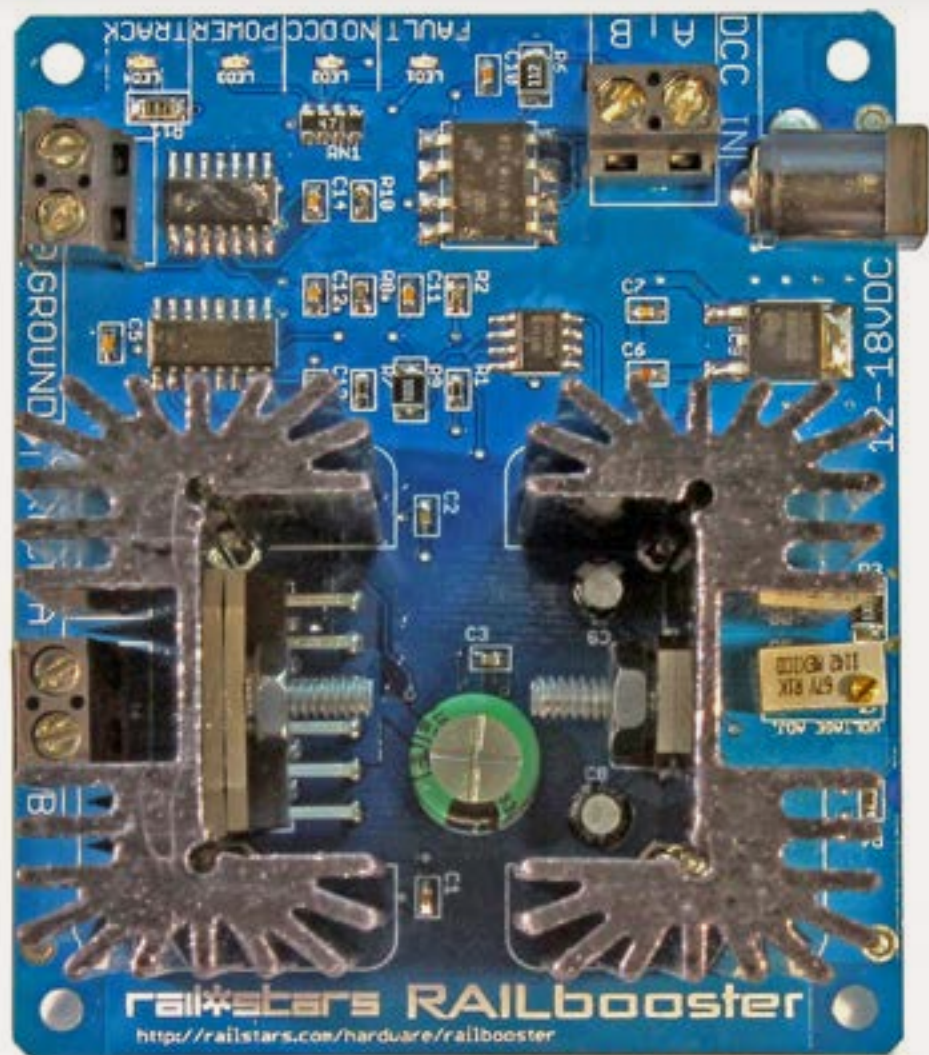

63



62



64



61: Rail*Stars multi-scale Railbooster 3 Amp DCC Booster.. 80: Railmaster D1425-8 speaker, \$12.50 (railstars.com/hardware/railbooster).

62: Railmaster D1425-8 speaker, \$12.50 (railmasterhobbies.com).

63: Railstars 70W Universal AC Adapter. For use with the Railbooster, it also comes with plugs that make it a good backup transformer for many laptops. MSRP \$25.

64: Atlas HO scale – Test shots of the updated RS-3 hood with both air and water cooled turbo exhaust stacks..

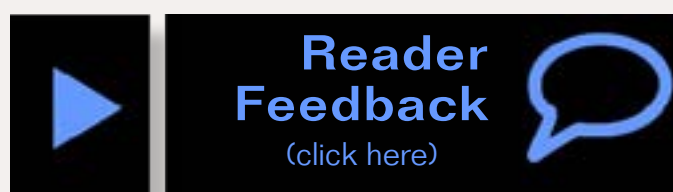

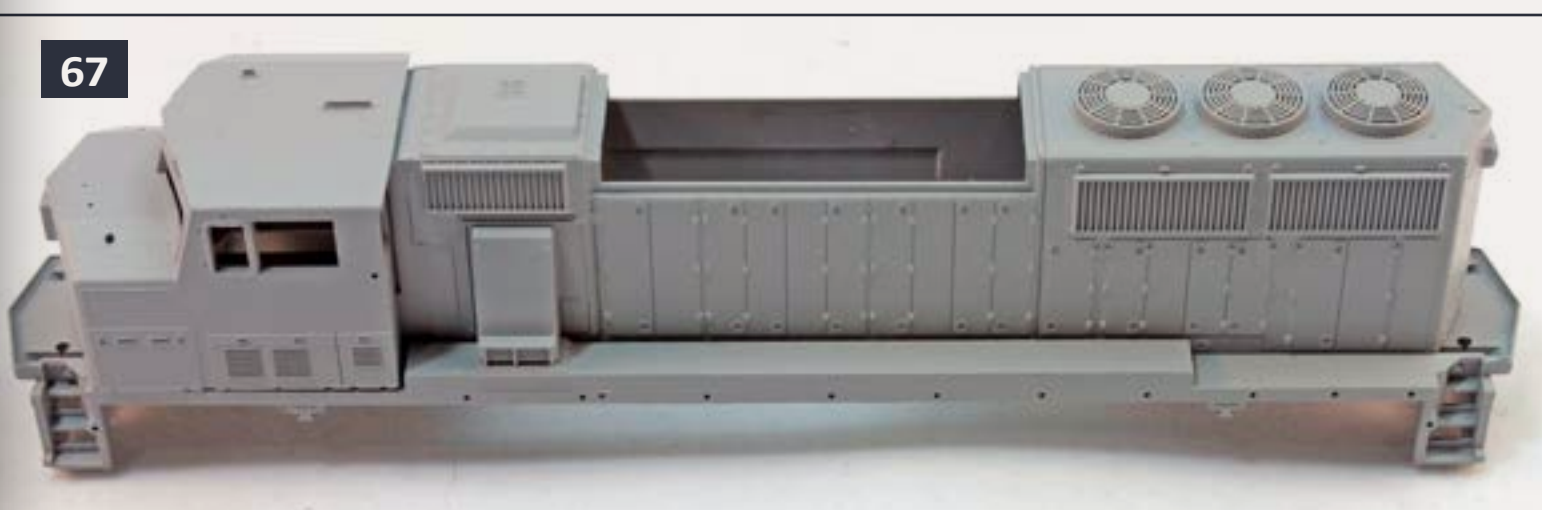
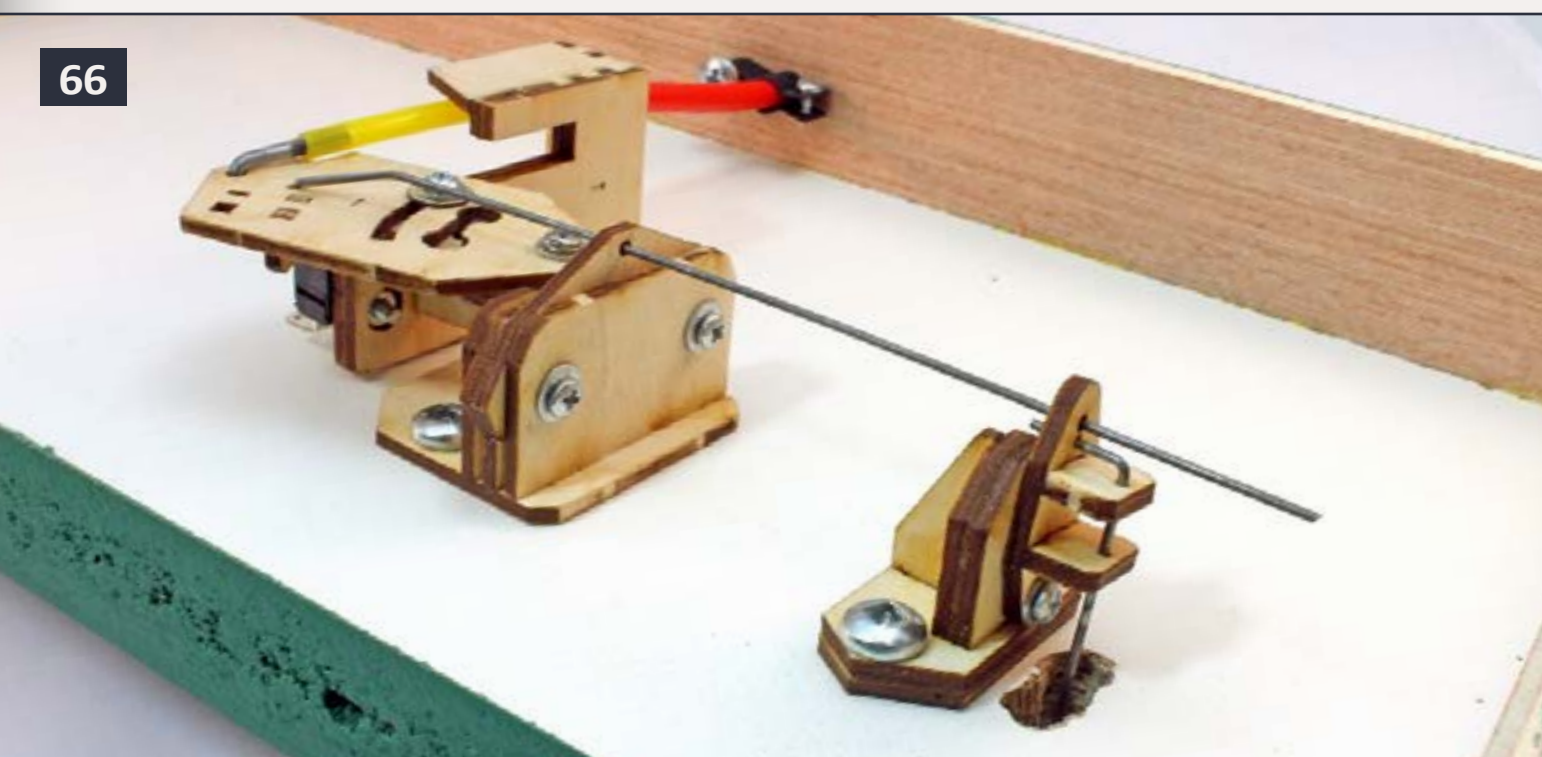
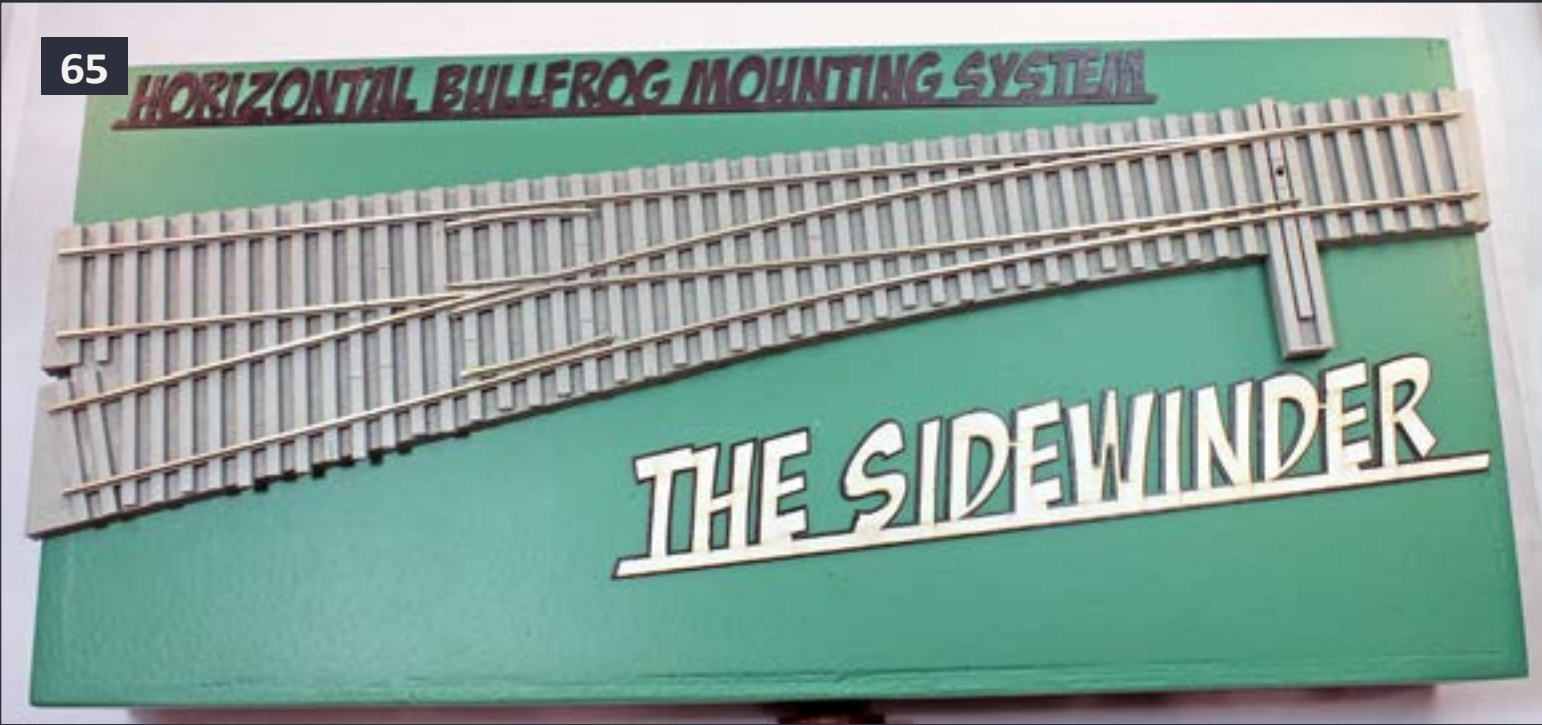

65-66: FastTracks "Sidewinder" horizontal Bullfrog mounting system.
 67: Fox Valley Models N scale GP60M pre-production test shot.



68: NJ International HO scale SA Type Target Signals.
 69: NJ International S scale B&O Color Position Signal.
 70: NJ International HO scale LED lit-RR crossing sign and Upper-Quadrant Wig-Wag.



71



74



72



75



73



76

71: MTH Booth at NTS.
72-74: Holland Modular Railroad Club.
75-76: Peninsular Modular Railroad Club.



77



80



78



81



79



82

77: Capital Area Railway Society.
78: Wisconsin & Michigan Model RR Club.
79-81: Michigan Lego Train Club.
82: Southeastern Michigan S Gaugers.

[▶ Reader Feedback \(click here\) ◀](#)



83



84



86



85



87

83: Panoramic Shot of the National Train Show from Above just after opening on Sunday morning.
84: Southeastern Michigan S Gaugers – First place Module by group.
85-86: Mister Dave's Golden-Blackhawk & Central City – a recurring Z scale display layout at the National Train Show.
87: Miami Valley Modular Railway of Dayton, Ohio.



88



91



89



92



90



88: Miami Valley Modular Railway – Thomas chases the Broadway Limited.

89: Cincinnati Northern Model Railroad Club.

90: Grand River Valley Railroad Club.

91: Ohio Valley Sipping & Switching Society.

92: MidweZt HaulerZ – Z scale modular.

 **Reader Feedback**
(click here) 

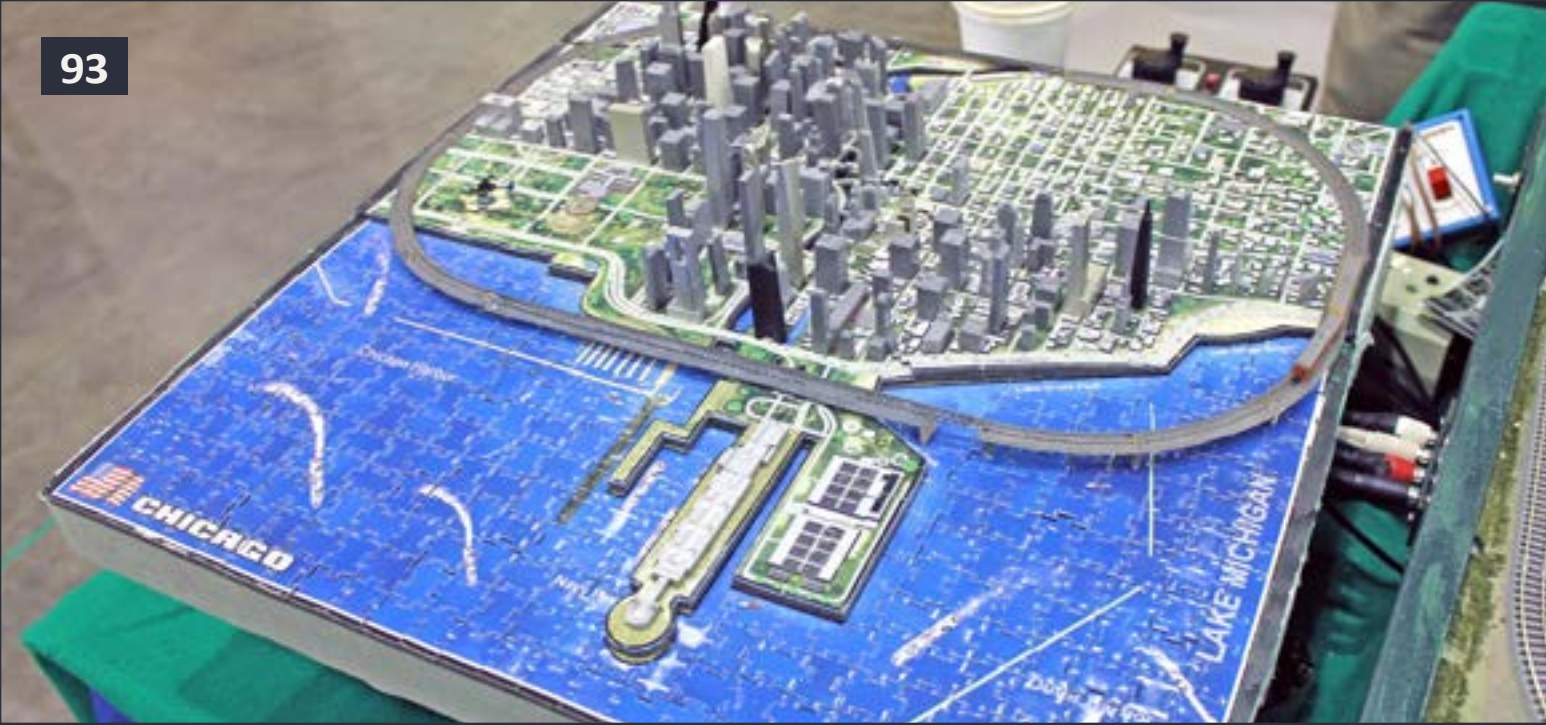

93



96



94

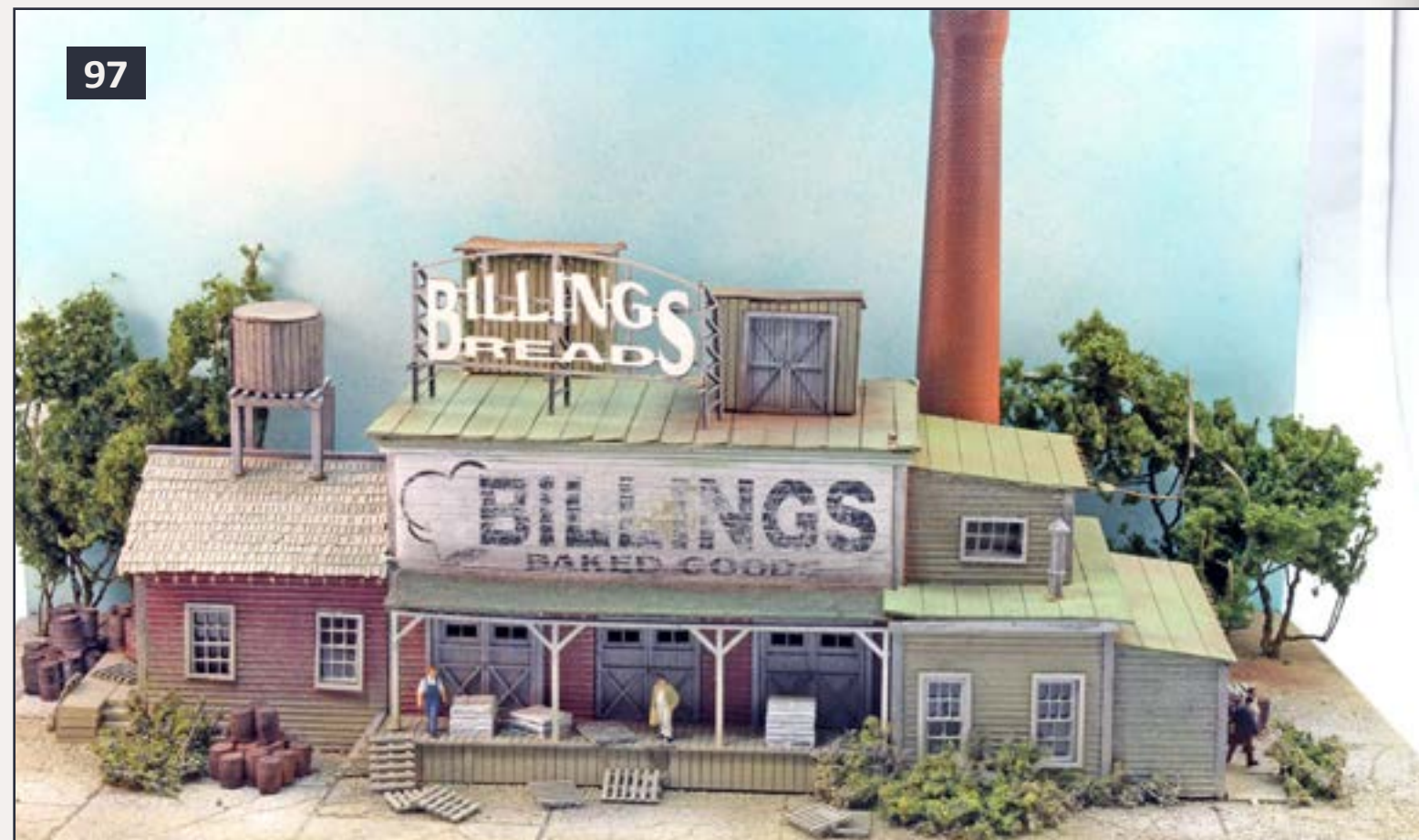

97



95

- 93: An operating T scale layout (1:450) - half the size of Z!
- 94: Independent Hirailers Midwest Division.
- 95: Division 4, Mid-Central Region.
- 96: Laser Modeling 3 HO scale "Gillmeister Co." anthracite coal dealership.
- 97: Bar Mills N scale "Billings Baked Goods".

REVERSE RUNNING: Making the right model railroading choices

Stepping outside the box with a contrary view



matter more than others based on my hobby likes and dislikes. Given that none of us has unlimited time to do the hobby, choosing where to put more of my focus has been helpful.

If you like operations

as I do, then reliable performance is critical. Rough-running equipment and frequent derailments rob me of my greatest pleasure in the hobby.

I've learned that I need to make the choice to focus on good trackwork. I must choose to devote the time to doing it well and become something of an expert at trackwork.

By the way, you know what an expert is, right? They're the ones who've made more stupid mistakes than the rest of us!

The road to becoming an expert reminds me of what I used to tell my kids: Good judgement comes by experience, and experience comes from poor judgement!

If you're smart, it doesn't all have to be your own poor judgement, though. Choose to heed advice and let as much of that poor judgement as possible be the other guy's poor judgement!

Anyway, back to getting reliable track. Today's good quality flex track makes getting reliable track easier because you need not concern yourself much with getting the proper distance between the rails – that happens more or less automatically.

It's also easier now to handlay and get consistent results, thanks to the new jig systems you can get from Fast Tracks, the Proto:87 Stores, and others.

One thing I've also learned in my 45 years is to pay attention to where derailments happen. I've found 99% of them happen at turnouts and similar special trackwork like crossings. In short, any place where two rails cross, look out!

Since we're talking about how to make better choices, choose to become an expert at smooth operating turnouts. You'll thank yourself later for making this choice.

The [NMRA S-3 track standards](#) provides the specs for good operating turnouts, and you need to check all turnouts to make sure they meet these guidelines.

The frog area tends to be where most problems happen, but the points can also be a source of derailments if it's not built well. I not only use my trusty NMRA gauge (I'm in HO), I also keep a micrometer handy.

Commercial turnouts, with their mass production variances, tend to be slightly out of spec with S-3.

The only "commercial" turnouts completely in-spec are the Fast Tracks and Proto:87 stores turnout systems (which includes the Central Valley turnout tie strips).

Proto:87 Stores promotes the Central Valley turnout tie strips, and the NMRA is on record as saying the CVT strips comply with the S-3 specs. In both of these commercial jig systems, you need to build the turnout yourself.

For me the point is: I choose to do what I must to get the best-performing turnouts possible. Reliable operation matters most to me, and since 99% of derailments happen at turnouts, I have elected to get really good at building jig-made turnouts that are spot on the S-3 spec.

So I'll say it again – for reliable operation, I've found the thing I must choose to focus on is turnouts. Get really good at ultra-reliable turnouts on your layout and running trains will become more fun than ever!

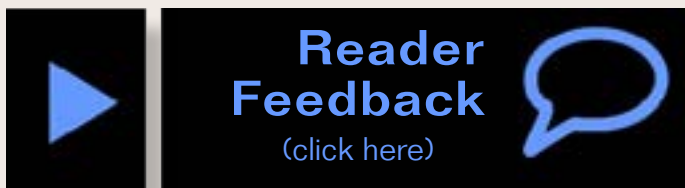

— by *Joe Fugate*

I got into the model railroading hobby in the summer of 1967 with the purchase of an issue of *Model Railroader* magazine. After 45 years in the hobby, I would hope I've learned at least a couple of things.

One of the things I've learned is that some parts of the hobby don't matter as much as others, depending on your goals. For me, building the models, while fun, is not the ultimate goal. My ultimate pleasure comes from running the trains. In other words, I'm an operator first, and a modeler second.

With my 45 years in the hobby, I learned to choose what things

Clickable Advertiser Index	Page
Accu-Lites	26
Alpine	123
Andover Junction	72
Backdrop Junction	50
BLMA	3
Bullfrog Snot	50
Clever Models	51
Coffman	92
DCC by Design	51
Dig Com Designs	17
Digitrax	30
ESU	15
ExactRail	4
Fifer Hobby Supply	29
Great Decals	51
Horizon Hobbies	9
Iwata-Medea	12
Litchfield Station	33
Logic Rail Technologies	50
Micro-Mark	50
Microscale	89
Model Railroad Benchwork	50
Modular Railroading	51
Model Trains Video	69
Monster Modelworks	11
M.T.H.	22
Nano-Oil.com	18
NCE	5
New York Central System	68

Clickable Advertiser Index	Page
North American Railcar	36
Ohkwari Sales	51
O Scale Resource	13
RailMaster Hobbies	27
Rapido	7
Reynauld's Euro Imports, Inc.	13
Ring Engineering (1)	90
Ring Engineering (2)	115
Rslaserkits	44
Rti	51
Rulers of the World	51
Rusty Stumps	90
San Juan Car Company	50
SBS4DCC	50
Scenic Express	25
Short Hill and Western	92
Southern Digital	110
Summit	115
TAM Valley Depot	23
The Amherst Railway Society	10
The Scotty Mason Show	141
The Proto:87 Store	51
Tony's Train Exchange	49
Trainplayer	92
Train Tek	123
True Line Trains	52
True Scene Modeling	51
Yankee Dabber	122

Clickable Topic Index	Page
Carrying Cases – Comme-N-Tary	31
DCC - DCC Impulses	20
Editorial – Publisher's Editorial	8
Editorial – Reverse Running	162
Electronics – A CTC-style Control Panel	70
Grand Rails– The 2012 National Train Show	144
Locos– Modeling a Modern Rebuild	73
Locos– Scratchbuilding a Steam Loco Prt 3	108
Layout – CP Sudbury Division	93
News – August MRH Showcase	124
News – August Newsletter	127
News – August Events	142
Q and A – MRH Questions, Answers, and Tips	16
Rolling Stock – Bring a wrecking crane to life	53
Scenery – My Modular Adventure	37
<hr/>	
Other – Cover	1
Other – Index	163
Other – MRH Sponsors	2
Other – Table of Contents	6
Other – Staff Notes	11
Other – Hobby Marketplace	50
Other – Derailments	164



For the love of model trains

Coming in September 2012 MRH

- Modeling a Frisco GP40
- Mike Confalone builds a quarry scene!
- Recession-proof modeling
- Great Western layout streamlined ops
- Building a steam loco finale

... and lots more!

Derailments, humor,
and Dashboard on next
page ►

Deraillments

humor (allegedly)



... there really is a prototype for eeverything!

“Rail travel at high speeds is not possible because passengers, unable to breathe, would die of asphyxia.”

Dionysius Lardner (1842-1914)
US journalist, short-story writer

If you're the first to [submit a bit of good humor](#) and we use it, it's worth \$10!



**Reader
Feedback**
(click here)



Can't remember what MRH back issue that article was in?

Have you checked the online index?

Click here to learn more ...

[Printer-Friendly Version](#)

[Download PDF Version](#)

When talking to hobby vendors, please remember to mention MRH.