

Model Railroad Hobbyist magazine™

Price:
Forever Free
STANDARD
Edition

December 2012



- Era-setting trials and tribulations
- Classic track cleaning slider
- Fill a hole in the layout
- Layout disaster? Be prepared!

*... and lots more,
inside!*

Tom Patterson builds a coal loader



Front Cover: Tom Patterson enjoys switching hopper cars into his new coal loader industry on his Chesapeake, Wheeling and Erie layout. Tom describes how he researched and built this backwoods coal loader, starting in this issue.

ISSN 2152-7423

Editorial Staff

Joe D. Fugate, Publisher and Editor

Columnists

Richard Bale, News and events
 John Drye, N scale
 Les Halmos, Modular railroading
 Bruce Petrarca, DCC

Special Correspondents

Joe Brugger, Questions and answers
 Jeff Shultz, First looks
 Charlie Comstock, Contributing editor

Production

Patty Fugate, pasteup and layout
 Joe Brugger, copy editing
 Mike Dodd, copy editing

Technical Assistants

Jeff Shultz
 Jimmy Simmons

Advertising

Les Halmos, Account Manager
 Daniel Nava, Advertising Assistant

Published for the glory of God.

 click to learn more about this sponsor	 NEW SPONSOR! click to learn more about this sponsor	 click to learn more about this sponsor	 click to learn more about this sponsor	 click to learn more about this sponsor	 click to learn more about this sponsor	 click to learn more about this sponsor
 NEW SPONSOR! click to learn more about this sponsor	 click to learn more about this sponsor	 click to learn more about this sponsor	 click to learn more about this sponsor	 click to learn more about this sponsor	 click to learn more about this sponsor	 click to learn more about this sponsor
 NEW SPONSOR! click to learn more about this sponsor	 click to learn more about this sponsor	 click to learn more about this sponsor	 click to learn more about this sponsor	 click to learn more about this sponsor	 click to learn more about this sponsor	 click to learn more about this sponsor
 NEW SPONSOR!	 NEW SPONSOR!	 click to learn more about this sponsor	 click to learn more about this sponsor	 click to learn more about this sponsor	 NEW SPONSOR!	 NEW SPONSOR!
 NEW SPONSOR!	 click to learn more about this sponsor	 click to learn more about this sponsor	 click to learn more about this sponsor	 NEW SPONSOR!	 click to learn more about this sponsor	 click to learn more about this sponsor
 click to learn more about this sponsor	 click to learn more about this sponsor	 click to learn more about this sponsor	 click to learn more about this sponsor	 click to learn more about this sponsor	 click to learn more about this sponsor	 click to learn more about this sponsor
 click to learn more about this sponsor						

*Remember to tell our sponsors:
 "MRH sent me!"*

Want your logo on this page? Click to find out how....

64,000+ audience as of Jan 2012.
 Click [here!](#)

Need something? See our Hobby Marketplace!

HOBBY MARKETPLACE ads are economical and effective. Click [HERE](#) to learn more.

SMOOTH TUBS FOR ALL!

New TOP GON Variation in 24 Numbers



Norfolk Southern TOP GON®

HO & N

Photo by Joe Shaw

This is our **fourth** run of the ultra-popular, Norfolk Southern TopGon Coal Car. This run features a new variation with a formed, **smooth tub design**. Order all 24 numbers today through your favorite dealer or direct.

N scale \$22.95 #10085-10108 Norfolk Southern

HO scale \$32.95 #50085-50108 Norfolk Southern

RESERVE BY JANUARY 15
DELIVERY 4TH QUARTER, 2013

SEE MORE ONLINE AT ***BLMAmodels.com***



2008 2010 2011

2012



2012 RECAP

18 released products. 98 paint schemes. 585 road numbers



HO ALL-NEW!
 P-S 5344 Box Car



HO N ALL-NEW!
 Thrall 2743 Gondola



HO ALL-NEW!
 Deck Plate Girder Bridges



HO ALL-NEW!
 Berwick 7327 Box Car



HO N
 Trinity 64' TRINCool Reefer



N
 Trinity 50' Hy-Cube Box Car



N ALL-NEW!
 Evans USRE 5277 Box Car (Early)



N ALL-NEW!
 P-S 50' Waffle Box Car



N ALL-NEW!
 Gunderson 6269 High-Cube Box Car



HO N
 PS-2CD 4427 Covered Hopper

INTRODUCING

100% MADE IN THE USA

▶ The most accurate
WHEEL SETS

Raw Brass, Nickel Silver
 & Blackened Brass



accurately contoured exterior
 & interior wheel face

precision milled tapered axle

EMD GP60 DIESEL HO SCALE



New Schemes

PROTO 2000® In Stock

Soundtraxx® Tsunami® Sound & DCC \$299.98 | Standard DC \$199.98



PROTO FASTFACTS™

As computer technology advanced in the 1980s, EMD took a major step forward with the introduction of the new GP60. Directly behind the cab, a trio of onboard microprocessors regulated and ran various systems, replacing complex wiring circuits and relays. Coaxing 3,800 horsepower from its 16-cylinder 710G3A prime mover, the four-axle GP60 was well suited for fast freight service and was often seen on the point of priority trains when new. While the GP60 proved the advantages of computer control, potential buyers were more interested in six-axle power, and EMD focused its development efforts on the bigger units. For now, the GP60 may be the last in a long line of geeeps.

- Limited Edition - One Time Run of These Roadnumbers!
- Road-Specific Detailing
- 14:1 Helical Gears for Smooth, Quiet Performance
- Kit-Ready Ditch Lights w/Clear Lenses
- Five-Pole Skew-Wound High-Torque High-Efficiency Can Motor
- Low Speed Under 3 Scale MPH
- LED Constant & Directional Headlights
- Metal Grab Irons & Lift Rings
- Available With Factory-Installed Tsunami® Sound for DCC or DC Operation
- Proto MAX™ Metal Knuckle Couplers

BNSF

Detailed to match units in service from the late 1990s to the present with:



- Nose Mounted Headlights
- Short Fuel Tank
- Short Blower Sill Duct
- Left Side Long Hood Sill Handrails without Safety Plate
- Cab Roof-Mounted Air Conditioner
- Cab Roof-Mounted Ground Plane w/Small Sinclair Antenna
- Long Hood Roof-Mounted Ground Plane w/Large Sinclair Antenna
- Raised Leslie S-3L Horn
- Round Vent on Right Side of Short Hood
- Lever-Style Hand Brake

920-41800 #8734 Tsunami Sound & DCC
920-41801 #8735 Tsunami Sound & DCC
920-48800 #8721 Standard DC
920-48801 #8738 Standard DC

DRGW[†]

Detailed to match units in service from the mid-1990s to the early 2000s with:



- Cab Mounted Headlights
- Long Fuel Tank
- Long Blower Sill Duct
- Left Side Long Hood Sill Handrails w/Safety Plate
- Cab Roof-Mounted Air Conditioner
- Cab Roof-Mounted Ground Plane w/Small Sinclair Antenna
- Long Hood Roof-Mounted Ground Plane w/Large Sinclair Antenna
- Raised Leslie S-3L Horn
- Oval Cab Vent
- Wheel-Style Hand Brake

920-41802 #3155 Tsunami Sound & DCC
920-41803 #3156 Tsunami Sound & DCC
920-48802 #3154 Standard DC
920-48803 #3155 Standard DC

NS

Detailed to match units in service from the mid-2000s to the present with:



- Cab Mounted Headlights
- Long Fuel Tank
- Short Blower Sill Duct
- Left Side Long Hood Sill Handrails without Safety Plate
- Cab Roof-Mounted Air Conditioner
- 2 Large Cab Roof-Mounted Sinclair Antennas
- Nathan K5LA-R24 Horn
- Round Vent on Right Side of Short Hood
- Oval Cab Vent
- Recessed Wheel-Style Hand Brake

920-41804 #7131 Tsunami Sound & DCC
920-41805 #7138 Tsunami Sound & DCC
920-48804 #7131 Standard DC
920-48805 #7138 Standard DC

UP[†]

Detailed to match units in service from the late 2000s to the present with:



- Cab Mounted Headlights
- Long Fuel Tank
- Long Blower Sill Duct
- Left Side Long Hood Sill Handrails w/Safety Plate
- Roof-Mounted Air Conditioner
- Cab Roof-Mounted Ground Plane w/Small Sinclair Antenna
- Long Hood Roof-Mounted Ground Plane w/Large Sinclair Antenna
- Raised Leslie S-3L Horn
- Wheel-Style Hand Brake

920-41806 #1955 Tsunami Sound & DCC
920-41807 #1964 Tsunami Sound & DCC
920-48806 #1946 Standard DC
920-48807 #2000 Standard DC

Undecorated

920-48808 Standard DC

For the latest locomotive news, sign up for Walther's E-Newsletters at www.walthers.com/signup, or visit your local hobby shop. To find a shop near you, call 1-800-487-2467 or visit walthers.com.

Availability and prices shown were accurate at time of printing, for updates visit walthers.com. Some details and colors may vary. † Union Pacific licensed product. ©2012 Wm. K. Walther's, Inc.

WALTHERS

80 YEARS

Main Features



60 Classic track-cleaner

Make a track cleaning slider car
by Joe Brugger

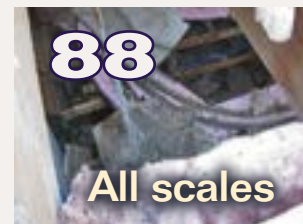

88 Slow orders

Preparing for disaster, just in case
by Bruce and Linda Petrarca



64 Modeling a coal loader, part 1

Build this small backwoods coal tippie
by Tom Patterson



95 Streamlined movie theater, part 2

Build a theater with animated marquee
by Isaac Herrera

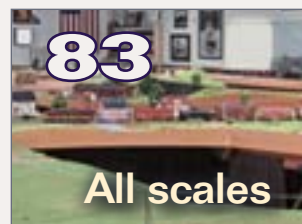

83 Fill a hole in the layout

Build a light-weight sceney lift out
by Ray and Renee Grosser



113 December Model Railroading News

MRH News and events

by Richard Bale and Jeff Shultz

Columns

23 Peninsula construction!

Up the Creek
by Charlie Comstock

30 Basic electronics for DCC

DCC Impulses
by Bruce Petrarca

41 Eras and implications

Getting Real
by Mike Rose

51 Model RR artist Mike Budde

What's neat this week
by Ken Patterson

132 Make only new mistakes?

Reverse Running
by Joe Fugate

16 Subscriber-only extras

Bonus downloads

Other Features

9 Model railroad blogs

Publisher's musings *by Joe Fugate*

57 Hobby Marketplace

Vendor ads

11 MRH Staff Notes

Not changing too fast, New MRH photo feature...

134 Derailments

Humor?

18 MRH Q - A - T

Questions, Answers and Tips



Great products. Exceptional service. Serious fun.™

Find products from over 100 model railroad companies at HorizonHobbyTrains.com. All the brands you love—Athearn®, Lionel, Bachmann and more—are right there. You'll also enjoy:

- Same-day shipping
- Our deal-filled Savings Station
- eGift certificates

Everything we sell is backed by the best customer service and support available. Our service center team is standing by to help you get the most from whatever you buy. At HorizonHobbyTrains.com, we take having fun very seriously.

Visit HorizonHobbyTrains.com. Exclusively Trains.



©2012 Horizon Hobby, Inc. All rights reserved. Athearn, Serious fun and the Horizon Hobby logo are trademarks or registered marks of Horizon Hobby, Inc. All other trademarks, service marks and logos are property of their respective owners. 36139

GREAT PRODUCTS



EXCEPTIONAL SERVICE



SERIOUS FUN



Containerterminal

ALOU CENTRAL

Two B...



About the Publisher



Joe Fugate is the featured expert in many [Model-Trains-Video.com](#) videos, and he's also the founder and publisher of **Model Railroad Hobbyist Magazine**.

To learn more about Joe, [click here](#).

PUBLISHER'S EDITORIAL: Model railroad blogs

Musings from MRH's founder



I continue to be amazed at the volume of model railroading information available on the Internet these days. It's significant and it's increasing daily!

True, not all web content can be called high quality. Getting published on the web has a pretty low barrier. Still, you can find some great model railroading info on the web today.

Not only do we have a dozen or more popular model railroading forums on the web (most free, a few not), there are also tons of model train videos on YouTube, and several model railroaders maintain blogs.

If you're not that web-savvy, you may be asking, "so what's a blog?"

Blog is techy buzzword short for weblog: a public personal diary or journal on the web. It's like having your own personal bully pulpit on the web where you can do show and tell to your heart's content.

So, you may be asking, how's a blog different from a forum?

I like to use an real-world analogy to help distinguish a blog from a forum.

You can think of a forum like you're at the club some night and there's a bull session discussion going on in the lounge. No one person controls the conversation, and any number of topics may get discussed over the course of the evening. That's a forum.

A blog's more like attending a lecture, where one person has the floor, and it's their meeting. They can talk about anything they want, but a blog generally tends toward personal notes and experiences. It's like the lecturer talking mainly about themselves and sharing their own experiences. That's a blog.

Most blogs allow people to comment on the blogger's posts, which starts to blur the distinction somewhat between a forum and a blog. But with a blog, the blog owner has absolute say over what gets posted and what's discussed, unlike a forum where all participants carry equal weight (or at least they should).

There are a number of great model railroading blogs on the web, and of course some of them live right on our very own MRH website!

To find the MRH blogs, just go to [mrhmag.com](#) and click [Blogs](#) on the right hand menu. Up comes a summary page with recent blog entries. You can also see a list of recent blog

titles under **Recent Blog Posts**, also on the right about halfway down.

Some others who have their blogs hosted elsewhere also frequent the MRH website, so you'll want to check them out too.

One such MRH forum regular, Tom Patterson (author of this issue's cover story), has a blog he maintains on Blogspot for his [Chesapeake, Wheeling and Erie Railroad](#).

You owe it to yourself to visit Tom's blog. If you like his layout and want more, there's a wealth of information on his blog, including many photos.

I think back to the days before the web when I'd read an interesting article by some modeler in the paper magazines. I'd get just enough to make me hungry, and then the article ended.

Now thanks to the Internet and accomplished modelers like Tom taking time to host a blog, we can all enjoy getting our fill of information!

As if that's not enough, remember the comment button on Tom's article. If you have a question or a comment, please post it. Chances are Tom will answer you within the next 24 hours. It doesn't get much better than that, guys!

Now, **NOTHING** stands between DC railroaders and **ALL ONBOARD SOUNDS!**

Nothing short of a miracle

If you're like other DC railroaders, you probably have a collection of DC locos. And while you'd love to have onboard sound, you're not ready to add sound decoders to all your locos and switch to DCC. With Tech 6 Sound Controller 6.0, you don't have to switch. Buy a sound equipped loco or two, and Tech 6 will access all their onboard sounds... and it'll run your other locos as well.

Control up to six locos

This powerful 6 amp unit, with versatile walk-around, can control one standard DC loco or six fully functional sound decoder equipped locos at one time. Best of all, Tech 6 allows you to enjoy all the sound advantages that until now were only available to the DCC crowd.

Experience the full range of onboard sounds

You're no longer limited to simple chuffs, or awkwardly flipping the direction switch to activate a bell or whistle. With this advanced DC train control, enjoy as many of the 28 NMRA functions (all sounds and lights) as your sound decoder equipped loco has to offer. Call them up with the touch of a button.

Tech 6 Sound Controller 6.0 ... complete with handheld, console, power supply and a huge 6 amp reservoir of power. (#0001201)



Also available, Tech 6 Sound Controller 2.0 (#0001200), a 2 amp unit. (NOT PICTURED)



M O D E L R E C T I F I E R C O R P O R A T I O N
80 Newfield Ave. ■ Edison, New Jersey 08837 ■ Phone: 732 225 6360 www.modelrectifier.com

TECHNOLOGY. PERFECTED.

Model railroads Plastic model kits Battery chargers Radio control helicopters, planes, cars & boats Slot Cars Scenery Die cast

Notes from the

MRH STAFF

Not changing too fast, New MRH photo feature...

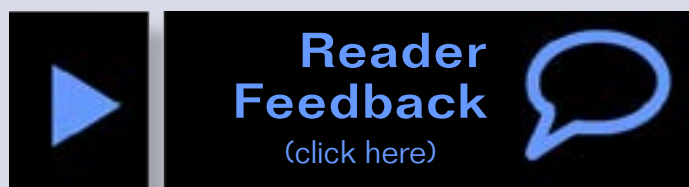

Not changing too fast

We're just a month away from the roll-out of the new Gen2 format. Originally, we also wanted to start the process of sunsetting the PDF format in favor of an HTML5 format instead.

As we thought about it more, we decided to not change too much too fast. We now feel it's better to stay with the PDF file type for now, but to simply make the HTML5 version available as an option later in the year.

It's true the HTML5 format will have the most features, such as the highest quality images and the most animations.

We'll probably earmark the Embedded Edition PDF to sunset first because it's pushing the PDF paradigm to the limits and we get the most support problems from the Embedded Edition.

Once you agree the HTML5 version is superior to the old PDF Embedded Edition, that's when we'll sunset the

Embedded Edition. We'll probably keep doing the PDF Standard Edition for quite a while yet, until almost no one reads the PDF version any longer.

One of the beauties of going to HTML5 is it's just HTML, which means it will display in any modern web browser.

This change will also allow us to put MRH on the Amazon Kindle store and on the Apple iBooks store.

The \$500 starter layout contest

Well, the \$500 starter layout contest is over as of November 30th. We've received a lot of entries, so next we'll be judging them and announcing the winners in January, as well as publishing the winning entry.

Stay tuned – we're expecting some very clever and insightful layout designs to have come out of this. We're also hoping these designs provide some novel, affordable ways for hobby newcomers to get started!



Click to explore the **free** apps, tools and utilities of My Railroad.

OUR MY RAILROAD
APPS + TOOLS
ARE THE SAME PRICE
AS THIS MAGAZINE.



New MRH monthly photo feature

In our January magazine, we're introducing a new monthly photo feature we're calling, "Yes, it's a model."

If you visit the MRH website much, you should have noticed the "Yes, it's a model" banners on the website.

For these banners, we select some of the best modeling photos posted on our website. The modeling (and the photography) needs to live up to the claim of being a model, but looking otherwise.

The new monthly photo feature photos need to be above-average photos and modeling. We won't make things so narrow that the models need to represent actual prototypes, but they need to look like they could.

The way you submit your photo to this new photo feature is by posting in on our website. We'll pull from the best photos posted on our website, and

work with you to get a version of the photo that's enough megapixels to publish well in the magazine.

Even though the photo may have been posted on our website already, we may enhance things by getting other angles

Your rating: (5 votes) **November 2012 MRH Ratings**

The five top-rated articles in the [November 2012](#) issue of MRH are:

- **4.8** Shelf layout project in N scale
- **4.6** EasyTrees - mass producing great looking trees
- **4.6** Allagash gets a quarry, p3
- **4.5** Getting Real - A new depot
- **4.4** DCC Impulses - Getting an installation done
- Issue overall: **4.7**

Please rate the articles!

Click the reader feedback button on each article and select the star rating you think each article deserves. **Thank you!**

and we'll also get more details for the photo caption in the magazine.

Out of the almost 70,000 readers who visit our website, a little more than 6,000 of you frequent the forums. That means 90% of our readers never see the modeling topics, photos, and blogs our readers post at mrhmag.com/recent-posts.

By doing this photo feature, drawn exclusively from our website, all the rest of you can see some of the best that's getting posted to the MRH website.

On the right is the first spread from this new feature. This gives you some idea what it's going to look like in the new Gen2 format.

We're excited to see this new magazine feature, and we hope you'll agree that some awesome modeling is being done out there!

Calling John Frantz

John Frantz, please contact us! You sent us an article we want to publish

Yes, it's a model

Model Railroad Hobbyist's monthly photo album

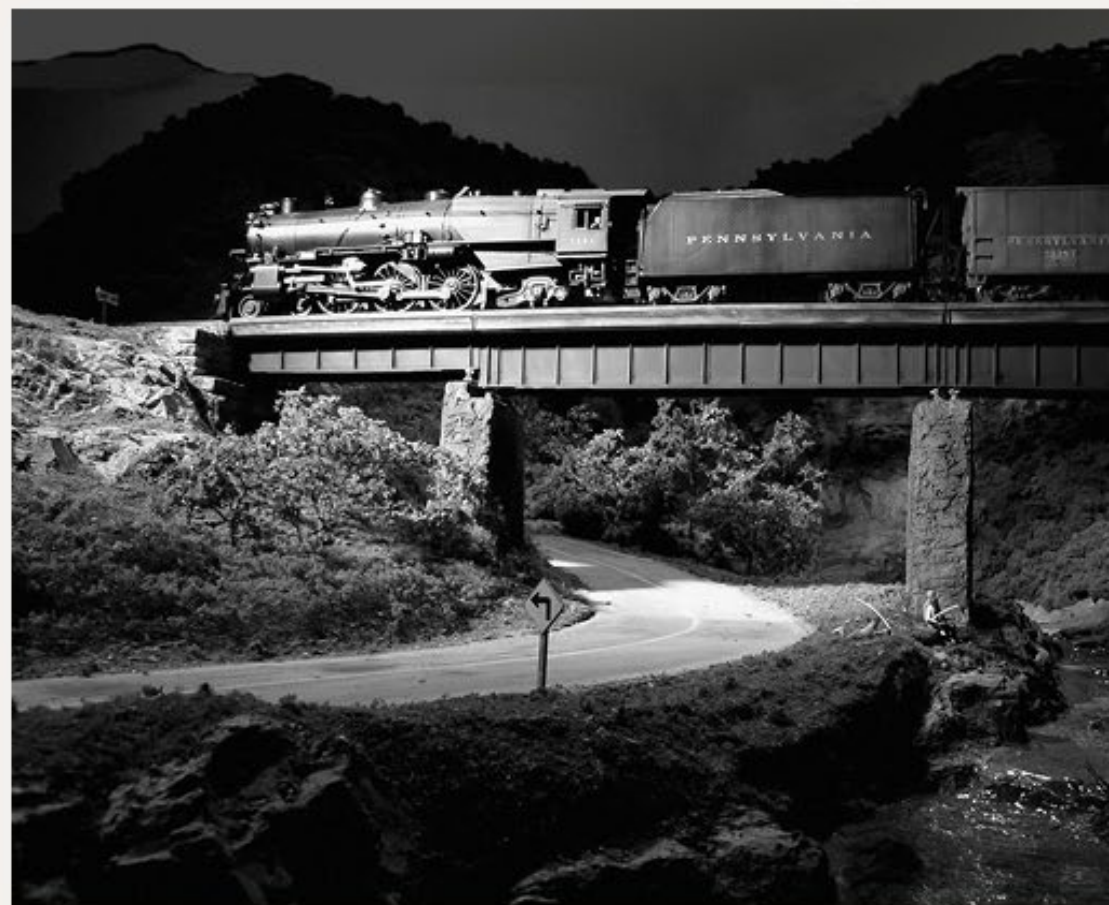

Shades of O. Winston Link's prototype night black and white flash photography, we found this model photo by Jay Herr of his HO layout really jumped out at us. Jay posted this photo on MRH's *Weekend Photo Fun* thread recently, and he told us he was "just experimenting" with interesting photographic lighting. Jay had never seen O. Winston's photos, but we think Jay's modeling and photography capture this look superbly for a model. Very nicely done, Jay, and we look forward to seeing more of your layout!



Kevin Packard writes, "This car started out as Walther's 50' Airslide. I was inspired after seeing Tom Zanck's incredible Proto:87 airslide build and used many of his tricks and techniques on this. I completely redid the details on this car, replacing cast-on detail with separate detail all around the car. I traded the stock trucks with semi-scale Athearn Genesis trucks. Finally, I painted and decalled the model.

"I *always* work from a prototype picture when weathering. Even if it isn't an exact copy of the car, looking at prototype pictures is the *only* way to ensure that your weathering patterns are realistic. [We heartily agree. – MRH]

"Good places to look for pictures are rrpicturearchives.net, locophotos.com, railcarphotos.com, and railpictures.net. There are many other websites that have a bank of prototype pictures including websites like protomodeler.com and theweatheringshop.com.

MRH-Jan 2013

Yes, it's a model - 1



contents



index

Here's a spread from our new *Yes, it's a model* photo feature in the January issue. You can see it's the new 2-up Gen2 format, which looks a lot like the current landscape format. The 1-up format works well on smartphones and mini-tablets. To navigate pages/spreads you just tap or click the right edge for next or the left edge for previous.

and it has no contact info in the document! We need your phone number and your email, please!

If you're not John Frantz but you've been thinking of sending us an article, please, please, *please* include your contact information in every text file you submit.

There's no guarantee your article submission form or email won't get separated from your submission. If you care to get paid, you need to make it easy for us to find you!

Has your email changed?

We regularly get emails from subscribers who have a new email address, and they ask us to change their email. Did you know you don't need us to change it, and can change it yourself?

Here's how you can quickly change your own email:

1. Log into the MRH website. If you don't remember your login, see our website login help:

mrhmag.com/login_help

2. Click My account on the right.
3. Click the Edit tab.
4. Change your email address.
5. Tap or click the Save button.

Done! Your email address has been updated and any emails we send you will now go to the new address.

While you're in your account, also check the notifications tab. Sometimes if your email bounces our system turns notifications off in order to prevent more bounces.

If you're ever wondering how to do something on our website like this, do check the help menu. We try to document the answers to frequently asked questions, and many of these tasks you can do yourself by following the steps in a help entry.

For example, the steps for changing your email or user name are here:

mrhmag.com/help/update-email-username

We try to make our site as easy and self-service as possible for you to use!

Building a magazine

We thought it might be interesting to tell you how we build an issue of MRH. From the emails we receive and the posts on the MRH website, it's clear some of you think that because



**Your Local
Online
HO & N
Scale Hobby
Shops**
575-523-9743
fiferhobby.com
fiferhobbyho.com

HO, N, Z AND O-SCALE PREMIUM LASER STRUCTURES
RSM precision cut laser structures offer a level of realism rarely seen in Model Railroad structures.

Learn why we're different



THE GRASSELLI TOWER

The Grasselli Tower guards the junction between the IHB, EJ&E, and B&OCT in East Chicago, Indiana.

\$69.95 RSM #871001 HO Scale Laser Cut Grasselli Tower
\$94.95 RSM #601001 N Scale Laser Cut Grasselli Tower

\$59.95 RSM #201001 Z Scale Laser Cut Grasselli Tower
\$94.95 RSM #451001 O Scale Laser Cut Grasselli Tower

THE CASTLE CAR WASH

The "Castle" Car Wash is a famous Route 66 landmark in Chicago, Illinois.



\$69.95 RSM #871002 HO Scale Laser Cut Castle Car Wash
\$59.95 RSM #201002 Z Scale Laser Cut Castle Car Wash
\$94.95 RSM #601002 N Scale Laser Cut Castle Car Wash
\$94.95 RSM #451002 O Scale Laser Cut Castle Car Wash

Dealer Pricing Available

Toll Free 1-888-762-6872

REYNAULD'S
FULL STEAM AHEAD SINCE 1904
EURO IMPORTS, INC.

122 N. Main Street
Elburn, IL. 60119
www.reynaulds.com/rsm.aspx
info@reynaulds.com
facebook.com/ReynauldsEuroImports



we're all digital, that somehow makes putting the magazine together easier.

The work needed to actually construct the magazine is about the same as a paper magazine, and because of our digital nature, it's harder in some ways than building a paper magazine.

So here's the basic process we follow.

First, we plan an issue, usually 3-6 months at a time. First thing we do is determine the cover story.

Next, we determine what columns we expect to be in the issue, so we know how much space we have for articles.

Then we look through our article backlog and schedule articles for

specific issues, with an eye toward balancing the content. We don't want all caboose articles, for example, nor do we want everything to be all the same scale, or era, if possible.

About 2 months out, we finalize an issue's content, and we build the cover. This allows us to put the next issue's cover into the issue we're currently building.

About 6 weeks out, we start initial pasteup on an issue, and at about 4 weeks out, we kick pasteup into high gear.

At about 3 weeks out, we're heavy into the copy editing cycle, with articles going to authors and copy editors for

correction. Also at this time we're collecting ad copy for the issue.

At 2 weeks out, the news column arrives, and we paste it up. Because of all the photos in the news, it's one of the more involved columns to paste up.

Ideally, at about 10 days out, we start placing ads. We try to place ads that share space with content next to content that's somewhat topical. We can't always do that, especially if the ad copy is late, but we try!

Also at about this time, we begin pushing an assembled draft version of the issue to the staff for review. At this stage, we're looking for the silly typos and mistakes. There's often many hours

of corrections that come back at this stage because of the fresh eyes getting to see the entire issue in context.

As we come down to the last few days, things get hectic because we need to move content around to make space for any late-coming ads (who wants to turn away income?) and we need to start making sure all the links work.

You may not realize it, but each issue of MRH has at least 500 links in it, either between pages or to external websites.

Someone has to enter all those links and someone has to click on every last link to make sure it works. That's a lot of clicking, folks! The paper mags don't have to worry about this.

ADVERTISEMENT

Watch our website for our monthly specials!

Free Shipping on all US WEB orders over \$100.



ACCU-LITES, inc
Your DCC Center!

CLICK TO LEARN MORE:



<http://www.acculites.com>

New ACCU-LITES exclusive!

Tortoise SNAPS 8-position block wiring quick connect socket



Authorized Dealer for: Digitrax, NCE, Soundtraxx, TCS and others.



Structures of simple elegance ...

Made in the USA

**ALPINE
— DIVISION
— SCALE
— MODELS**

**Click to
Learn
more... 
alpinemodels.com**

ADVERTISEMENT

Oh yes, and somewhere in here we need to edit and render all the videos and click-n-spin animations. Again, the paper mags don't need to concern themselves with this extra media stuff.

Around this time, we need to build all the comment pages, we need to build the issue home page and the download wizard page, along with making the legacy download pages.

And we're still not done!

We also need to make sure the previous issue can be reached through the back issues page, and we need to build a new home page for the next issue.

Oh, and did we remember to do the bonus downloads? We need to put those together.

Once the master pasteup gets a clean bill of health including that all links work, then we create the Embedded Edition with the media included in the PDF. We also need to edit all internal page links for the online edition.

Plus we must build the black and white Printer-Friendly edition and the full color eReader edition.

Once we have everything built, then we upload the different PDF versions to the primary and mirror sites, along with the online edition to Issuu.com, our web edition host.

If we can get all this done soon enough, we like to do what we call a "quiet release" to the MRH website, so the issue only shows up in the Recent Posts list. This way, we get a few hundred of our most ardent subscribers to check out the issue and let us know if we missed anything (it happens).

And hopefully, on Sunday evening we update the MRH website so all the current issue links point to the new issue, and we update the home page with the new issue feature story images.

Then we build and send out an email blast telling you all to come-and-get-it!

Phew! Another issue behind us and on to the next one ...

In this issue

Tom Patterson's cover story describes building a coal loader for his Chesapeake, Wheeling and Erie layout. This is part one, with the next issue covering the truck ramp and how Tom assembled all the pieces into the final scene on his layout.

Ray and Renee Grosser describe how they filled a hole in their layout using lightweight foam sheeting. They describe the process and point out some fast techniques like using hot glue to assemble things. The resulting lift out looks much better than just a hole, and it's easy to lift out because it's so light.

Model Railroad Hobbyist magazine™

HAVING FUN WITH TRAINS

YES, subscribing MATTERS!

(even though it's free)

It helps MRH get more advertisers

Click here to subscribe!

December 2012 Bonus Extras!

Available to subscribers!

DVD and HD quality versions of the videos in this issue, plus:

- SketchUp versions of the Coal Loader drawings

Click here to access



MRH staffer Joe Brugger's one evening project describes the classic "Masonite hardboard" track cleaning slider. These little gems make a great one-evening project and will help keep your track clean in the process!



Bruce and Linda Petrarca next cover the topic of family and layout disasters and how to properly prepare for such an event. We all hope we never have to face this situation, but it's always prudent to plan ahead and not just stick your head in the sand. Bruce and Linda take this hard but important subject head on and provide many helpful recommendations on how to be ready, just in case.

Isaac Herrera finishes his movie theater build this issue by showing us how he did the animated lights. Very cool!

As for columns, we have a full set this time from Charlie Comstock, Bruce Petrarca, Ken Patterson, and this issue's prototype modeling columnist, Mike Rose.

There's also the November news, *Questions, Answers and Tips*, and some editorials, completing our 34th issue to date. This is also the last of the "Gen1" format, since as of January, we're moving to the new Gen2 format.

Enjoy the December MRH, and have a merry Christmas season. See you again next year, with a fresh look!

 **Reader Feedback**
(click here) 

iwata

by ANEST IWATA

Just Rolling By...

Make It REAL With Iwata Climb Aboard!



Visit...
www.iwata-medea.com
To Check Out Our Full Product Line!

*Models By... Alan Houtz,
North American Prototype Modelers*

A
D
V
E
R
T
I
S
E
M
E
N
T



The Amherst Railway Society Railroad Hobby Show

Our 2013 Show will be

January 26 & 27, 2013

Save the dates!

About The Show

Every year late in January or early in February, the Amherst Railway Society holds its Railroad Hobby Show at the Eastern States Exposition Fairgrounds (The home of The Big E) in West Springfield Massachusetts. More than 25,000 railfans and public attended the Show each of the past three years.

The event features real life railroads and scale model railroads, historical societies, travel agencies, art shows, flea market dealers, importers, manufacturers and photographers. You have to see it to believe it!



Click to learn more ...



MRH

Questions, Answers and Tips

 **Reader
Feedback**
(click here)



QUESTIONS AND ANSWERS

Q. Does anybody know what happened to the micro/small layouts for model railroaders website? I can't seem to get to it. I hope it has not disappeared.

A. The Small/Micro Layout site is still available. Head to carendt.us where a small team of volunteers and regular contributors are keeping things alive, with the occasional "Scrapbook" appearing as submissions and available time allow. Some mirror sites of the original carendt.com website are still active. Try carendt_backup.gully.org.

Should that fail, you can find the scrapbook and gallery at carendt.com/scrapbook/linkindex/index.html.

The site's creator, Carl Arendt, specialized in the impossibly small layout designed to fit in areas as small as pizza pans and ironing boards. Many prototype ideas are discussed, like the ferry terminals at carendt.us/scrapbook/page97/index.html. Many classic compact layout designs were also presented and talked about. Most of the layout plans on the site are firmly grounded in reality and many are designed to operate. Others were simpler vignettes.

Arendt, who had retired after a long career with Westinghouse, died in March 2011. His site is being maintained and occasionally updated by friends and supporters. The site includes sections on the "Small Layout Scrapbook" "Small Layout Articles," and the "Micro Layout Design

Gallery." He and his friends presented designs in scales from N to G scales. Maybe even Z.

The site has an international following, with features like "Bichou's Yard" based on European themes. See it at at carendt.us/scrapbook/page96a/index.html#bichou.

He published three softcover books, "52 Micro Layouts You Can Build", "Creating Micro Layouts", and "Carl Arendt's Small Layout Scrapbook" which can be found occasionally on Amazon or alibris.com.

– Prof. Klyzlr, Jim Dixon, Graham Line

Q. Finishing up a scratchbuilt caboose, I decided to pre-paint and gloss-finish to make it easier to apply decals to the end walls before installing railings, ladders and a brake stand. I should have waited and just used care reaching inside the end platforms, because in the process of drilling the tiny holes for the grab irons and installing a deck walk, I left an embossed fingerprint on a cupola corner. Should I sand with 2000 grit or finer and refinish, or just re-spray gloss over it? Would that option melt the print away?

– Ironhand 13

A. You will not be able to cover the print; there will be just enough texture there to show through any reasonable thickness of finish. Your options are to leave it, attempt to conceal it with weathering, or try to carefully remove the print.

Given that a 1:1 thumbprint doesn't resemble any weathering pattern

ever seen on a railroad car, your best option is removal. If the only work you have done on the car is a coat of paint, the option for a first-quality finish is probably to strip the paint from the car and start over with a fresh coat.

In the alternative, rubbing the affected area with a cotton swab dipped in paint stripper might work, but you will then need to blend in new paint to repair the area. The "fix" could end up being more conspicuous than a thumbprint.

If stripping the paint doesn't seem practical, try scraping the ridges very gently with the point of a knife blade or sanding tools. A flat-ended chisel blade might knock down the ridges if used very carefully, but it could knock off details like rivets and could easily gouge the finish.

Detail sanding sticks like those sold by nws1.com or micromark.com work well in small areas. Look at micromark.com/micro-sanding-wand-set,7760.html and nws1.com/uploads/cat_chap1_TOOLS-web_9-20.pdf for detail sanding tools. The products can also be found in hobby stores catering to railroad and plastic modelers. Micro-Mark sells a package of all of the "sanding twigs" you will ever need at micromark.com/sanding-twigs-bulk-pack-of-approx-300,9336.html.

It's easy to make your own sanding tools with Popsicle sticks or wood scraps, sandpaper and contact

cement, and you can make a tool with the exact size, shape and grit you need.

– Ken Rickman, MRH

Q. I purchased an HO Jaeger lumber car load kit a while ago and the wraps for the blocks have me stumped! I have tried just about every fold this, fold that with no luck. I would appreciate any input from those who might have worked with this kit before.

A. Welcome to the origami aspect of model railroading. Jaeger’s kits for loads require care in construction but

build into very attractive and accurate models.

A Google search found an NMRA clinic handout on detailing centerbeam flat loads (and empties): b-n-ferrco.com/tipsdocuments/centerbeam_2012.pdf.

You will need a sharp X-acto knife or the equivalent to start cutting all of the wrappers along the thick lines. A metal straightedge is essential for this and the following steps. After the wrappers are cut to size, take the straightedge and fold up the two long sides. Drag the back of

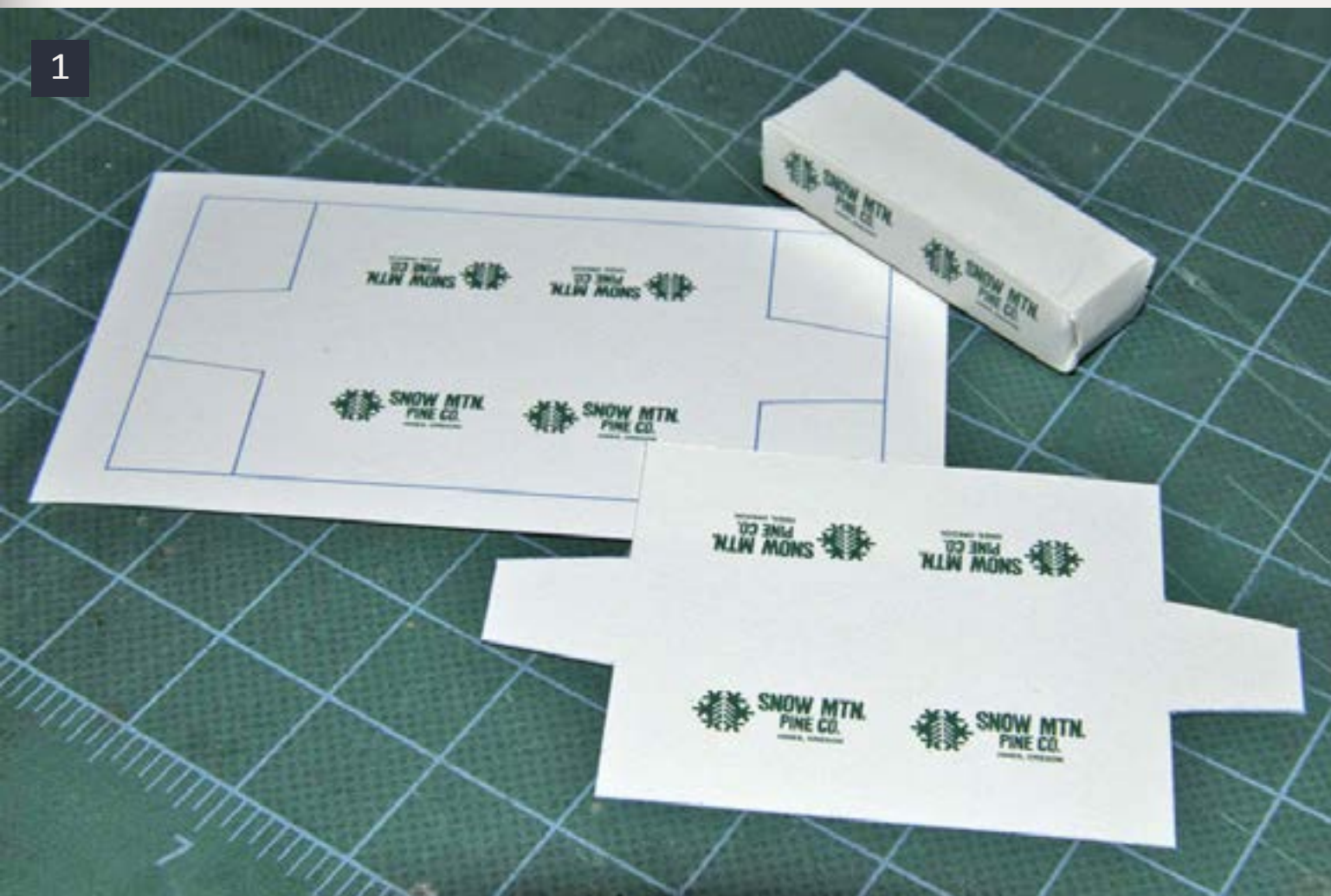

1: Trim the printed lumber wrappers along the marked lines to start the assembly process.



2: With a straightedge, fold up the edges on the long side of the lumber block, then fold in the ends before wrapping the long ‘tail’ of the wrapper and taping it to the bottom.

a screwdriver blade or the flat of a thumbnail along the folded edge to get a well-defined crease.

Place the wooden block in the center of the folds. Smearing in a tiny dot of white glue can help, but don’t get any glue on your fingers. The glue will hold the paper in place and allow you to make the final folds on the short sides. Fold the ends up like a wrapped gift. You may find it helps to trim the ends a little shorter.

Use a good quality clear tape like Scotch Matte Finish Magic Tape (in

the green plaid dispenser) to hold down each folded end. Cheap tape will turn yellow, harden, and ‘let go’ very quickly. The most tedious part of building these loads is the repeated cutting and folding. Stop when you’re tired.

Mainline Modeler magazine took a good look at centerbeam flatcars in its May 2006 issue, and Railmodel Journal published good survey articles on centerbeams in January 1996 and April 1998. Google “centerbeam flatcar images” or “flatcar images” for prototype photos to



3: This Jaeger centerbeam load was assembled and glued into a solid block about 20 years ago, for use on a Front Range car.

replicate the different banding patterns on the loads.

The complete line of Jaeger loads can be found at walthers.com/exec/search?manu=347&split=30&start=60.

– Ken Stroebel, Bill Brillinger

Q. Several folks have mentioned that they drill a 1/2" diameter hole for the actuating wire between the Tortoise machine and the switch throw bar. Why such a large hole? The Tortoise instructions indicate a 1/4" hole for this purpose. That is what I used in the past and it seemed to work fine. The wire shouldn't have to arc more than the distance of the point throw, so what am I missing here? What is the benefit of the larger hole? Seems to me that large hole would just make it harder to put ground cover or ballast near the ties/throw bar.

– Jack Shall

A. The half-inch hole is useful when the combination of roadbed and sub roadbed gets pretty thick. Think of

3/16" cork on top of 1/2" Homasote on top of 3/4" plywood. Or, atop 1" Masonite spline strips. Or, atop 2" of foam insulation board. The hole needs to be wide enough to keep the vertical throw wire from hitting the sides and stopping. If a 1/4" hole is precisely located, it might be possible to flare out the bottom of the hole in an inverted funnel to add clearance.

Several regular MRH Forum readers responded to this question with good observations and recommendations:

"I think the half inch is recommended in case your positioning is off (if you drill the hole before installing the turnout) or if you are sloppy making the hole and there are slivers of wood sticking out. In either case a larger hole will make it more likely to work.

"The thickness of the material and how much flex is necessary in your wire has a bearing, too, in that deeper materials or more resistant throw bars mean the wire has to be bent farther, and if it hits the side of the hole, it won't work."

– Jurgen Kleylein

"We use a twist saw bit in a Dremel tool to make an oblong slot to make sure our holes are big enough. Earlier on we used the 1/2" hole, too and in some cases it was necessary. I don't know who is using a huge 1/2" hole, but as you say, how can you keep ballast from falling through the hole? I use a 1/4" hole as well, and could get by with a smaller hole.

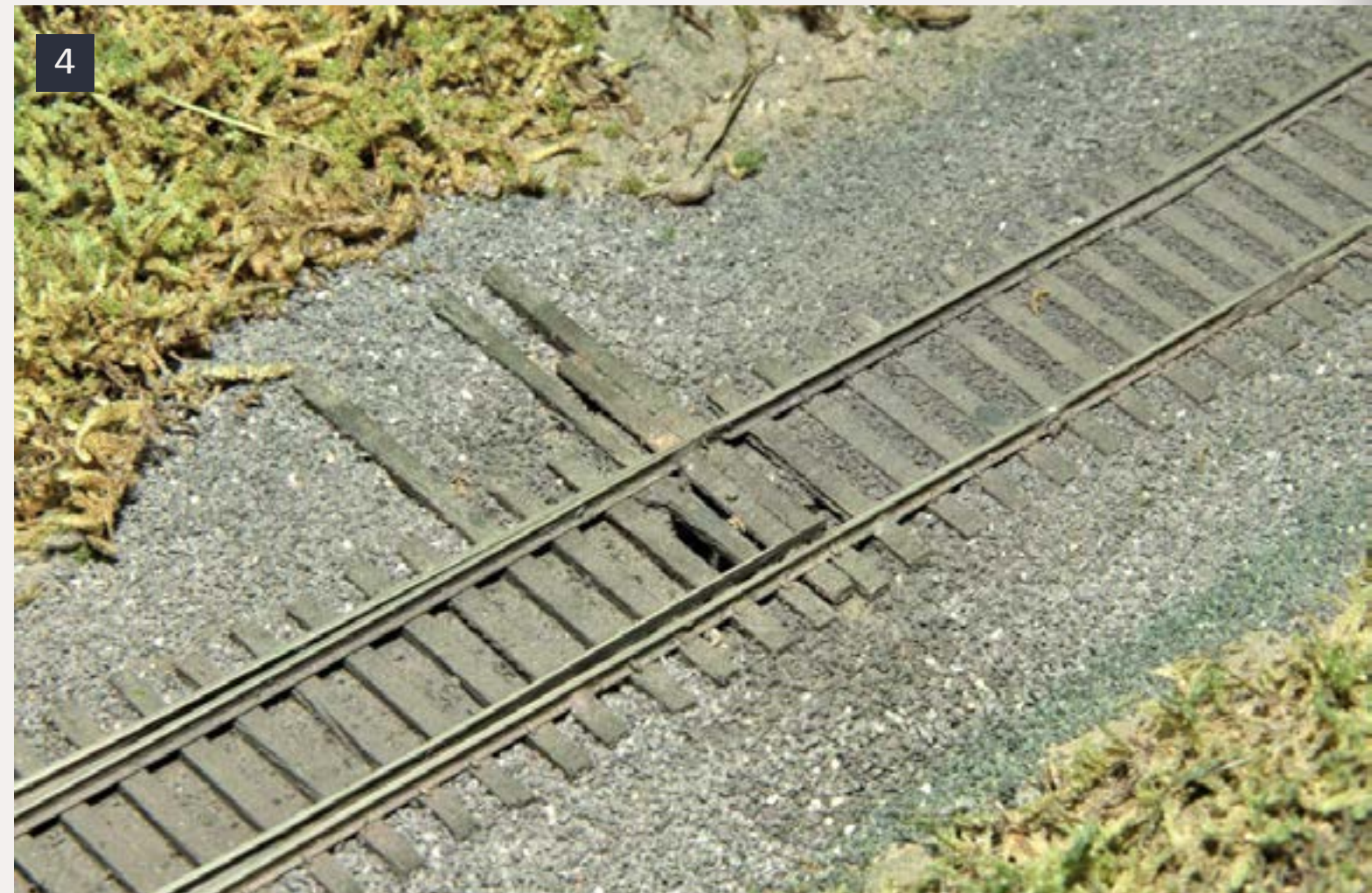

4: Ties and ballast conceal most of a 1/2" throw rod hole for a Tortoise switch machine. Taping off part of the hole can keep scenery from dribbling through.

"In N scale, which I model, the throw bar only moves about 1/8" inch anyway, so a quarter gives it plenty of clearance. I guess some folks want some slop to play with perhaps, if they are not completely sure of the turnout's final position? I agree, a 1/2" hole is completely unnecessary. Keep on doing what you're doing!"

– Russell Kingery

"I use a 1/2" hole, as the hole is drilled before the track is laid. I form a slot by gluing pieces of card stock under the switch to cover up most of the hole and give me a surface

for ballast. A color that matches the roadbed will help disguise the hole."

– Terry Roberts

Azbaja skips Circuitron's recommendations for a hole centered beneath the head switch rod (many modelers call this a 'throw bar') and installs a vertical rod in a 1/16" hole to control a link alongside:

"For years now I have been using a bell crank set-up on my turnouts. I drill a small pilot hole and run a brass tube down the hole as a bushing for the piano wire I use.

"I can set my turnouts and then at a later date I can run the pilot holes for the bell cranks. If at a later date I do not like the location of the turnout, I can move it and fill in the small 1/16" hole with a dab of putty."

Read the thread at mrhmag.com/node/8721 and watch the YouTube videos.

Go to unitracrail.com/pdfs2007/Turnout_Components_Section.pdf for a diagram naming all of the parts of a switch.

to that size, marking the car or engine type on the block of wood.

After laying my wooden train pieces end to end, I can easily see if a switch is in the correct position and if a spur is too long or too short. This came in handy when I was building some industry sidings, as I was able to line the car up with the correct building door or other feature and see that I had enough room to actually spot my car in the correct position.

— Ken Stroebel



GET \$25 PER TIP

We pay \$25 USD for each tip we publish. [Send your modeling tips to Model Railroad Hobbyist](#) and we'll get payment to you upon acceptance.

If you include any photos with your tip, we pay a bonus of \$10 per photo we use with the tip. ■



TIPS

Mockups to test sidings

For any layout, but especially a small layout where space is tight, how you design your layout's passing sidings, industry sidings and yard tracks can be critical. You don't want to end up being short when switching cars and finding that you just don't quite fit into the allotted space.

My system is fairly easy and cheap. It involves cutting pieces of scrap wood to the actual size of rolling stock and engines that I'll be using. For my layout, I found that I had extra 1 by 1-inch stock after cutting benchwork legs. I carefully measure cars and engines from coupling to coupling, and then cut my stock



con-cor.com
888-255-7826

Super Sale
on HO & N Items
Up to 75% Off

Choose from
more than
200 items!

www.con-cor.com/sitemap.htm



HO 1935
Reading Crusader Set

- Steam Loco + 5 Car Set
- Pre-Order Save 20%
- Optional Sound

Set of 5 cars only, (no steam loco) will also be available for diesel era Reading fans.
www.con-cor.com/Partners/GHB.html

HO & N Passenger Cars



Start at our Site Map to see the Variety Available.
www.con-cor.com/AdPortal22.html

HO MU mP54 Cars
2nd Run
New Road Numbers



Powered & Non-Powered
See the online video
www.con-cor.com/HO-Powered-mP54.html

HO New Haven Comet
Optional Sound Available \$459.98 3-car set



In Stock Now! **Video online!!**
www.con-cor.com/Comet.html

ADVERTISEMENT

STARTER STRUCTURES

We've Got You Started...

An all Basswood Kit!, No Plaster or Resin!

FROM
MONSTER
model & laserworks

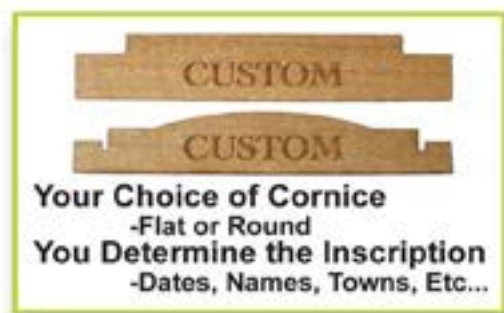

*Personalize The Name Of Your Building,
Create A Business That Fits Your Needs.*

On Sale Now



HO SCALE

Bowser

EXECUTIVE LINE

New Product Announcements!!



HO New Orleans Streetcar

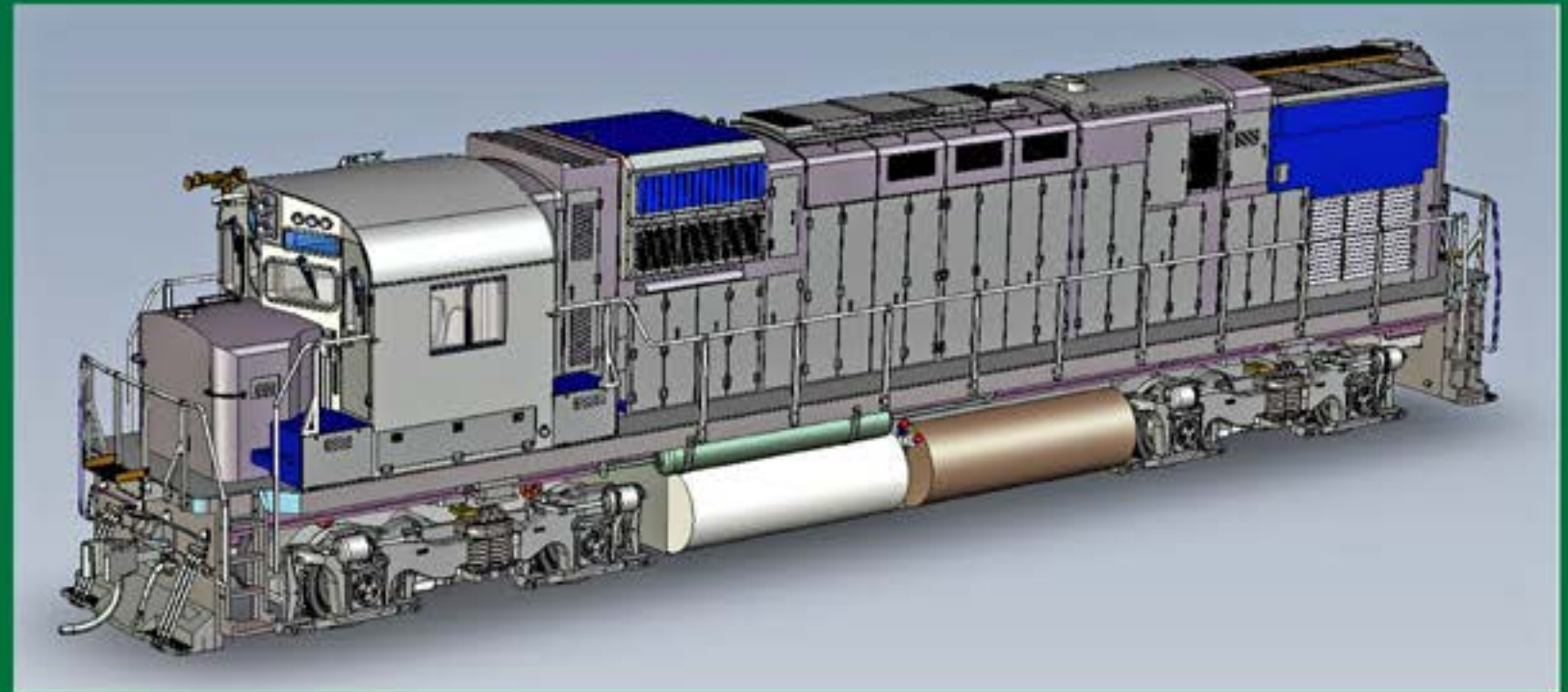

HO C430 Locomotive

Click here for more information and to sign up for our email newsletter to get the latest news about these and other great Bowser products



HO 450 Covered Hopper Car

UP THE CREEK: Peninsula Construction!

A regular report on the construction of a 1950s-something layout

Wiring a junction between reversing loops using relays wiring...

About our
layouts
columnist



Charlie Comstock is a MRH contributing editor.

Arrgh! Everything seems to take longer and have more problems these days. The benefit of a day job is income, but they expect you to show up regularly and stay there all day long. Progress in the layout room suffered over the last several weeks while I was working longer hours, and it didn't help I needed to cancel three work nights.

Despite that, progress on the BC&SJ continues. I'm happy to report that at long last trains can negotiate each route in and out of the junction at the top of the helix – no small feat when you realize that this junction connects two back-to-back reversing loops.

Relay race

I guess I'm an ornery cuss. Instead of using auto-reverse units, I wanted to wire it the old-fashioned way using a few relays. Relays have the advantage of being less expensive (if you shop carefully for them) and they don't depend on wheels shorting a mispolarized gap creating a small wheel-pitting arc to initiate the polarity reversal. And because I designed and built it, if it fails I can fix it (in theory any way – at the rate my "huh" factor is increasing this may no longer be true in another few years).

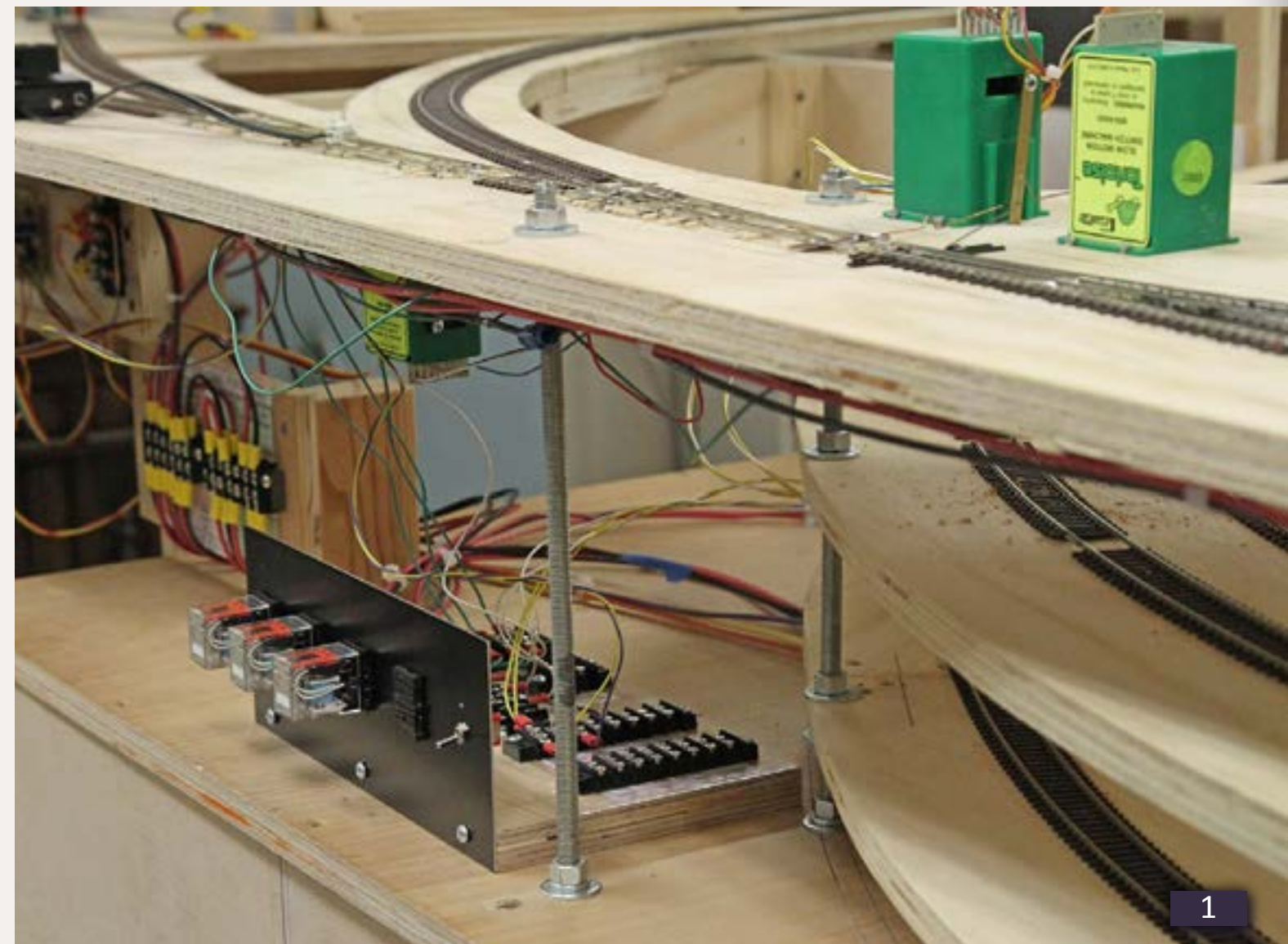

1. The relay panel for the helix junction, installed next to the helix. This circuit flips track power polarity for the two reversible areas: the helix junction and the helix (and main staging it leads to)

2. The circuit uses three 4PDT relays, one for each turnout in the helix junction. A fourth relay auto-stops trains at the top of the helix.

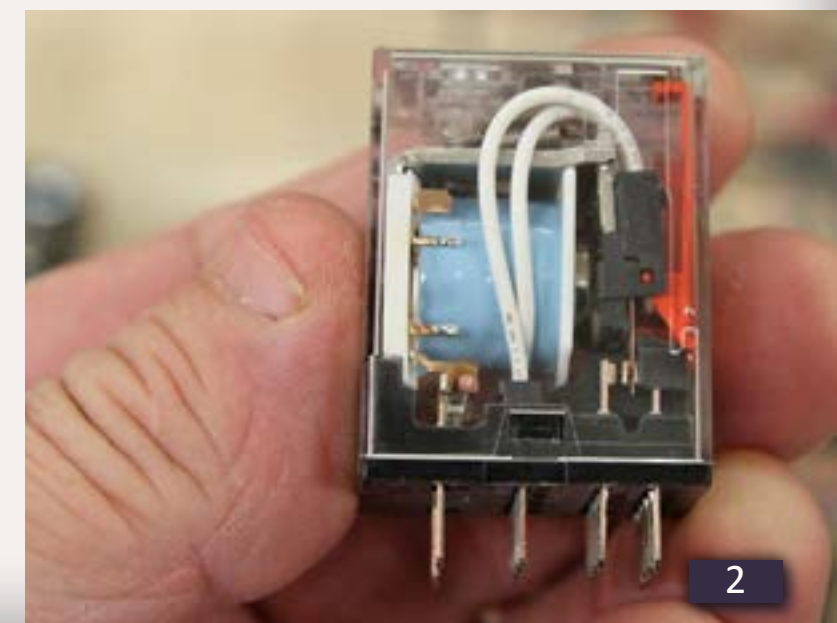



3. I bought a piece of .060" aluminum at my local Ace Hardware, smeared it with black magic marker where the four relay cut-outs would go, then scribed the relay socket outlines and marked the panel mounting holes.



4. I used a center punch and a small hammer to make dimples where I'd be drilling holes. The dimples keep a drill bit from wandering, letting you bore holes more precisely. I used a small bit, just larger than the #6 screws I was using to mount the panel and a 3/8" bit to start the holes for relay sockets.



5. ALWAYS clamp sheet metal securely before drilling holes in it. Drill bits tend to grab the piece, whip it around, and may send it flying. If you dislike the sight of blood, especially your own, clamp securely. 3/8" holes started the relay socket cutouts.

Because the junction is at the top of the double-track helix between the main deck and staging, I wanted to add an automatic stop feature. When a train is nearly to the top of the up track, a sensor will detect it and turn off power to a block on the uphill track. This allows the staging manager to launch a train uphill and then go do something else. When the train stops at the top of the helix, the staging manager can throw a toggle switch to restore track power, allowing the train to pull out into the open where a road crew takes over.

Making a relay panel

There are a number of ways to mount relays, ranging from the quick and dirty (hot gluing them under the road-bed – not recommended) to sockets with screw terminals (usually expensive). I elected to use panel mount sockets with solder lugs – they're cheap and easy.

I needed to make a panel to hold the sockets (and a switch and a couple of LEDs). I used .060" aluminum for mine. Carefully lay out where all the components will go, scribing hole outlines or hole center lines. Machinists use a blue dye to make the scribe marks stand out. I couldn't find mine after not using it for 25 years so I made do with a black magic marker (3).

I drilled holes and used a nibbler to chew away the cutouts for the relay panel-mount sockets. A coat of black
Continued on page 26.

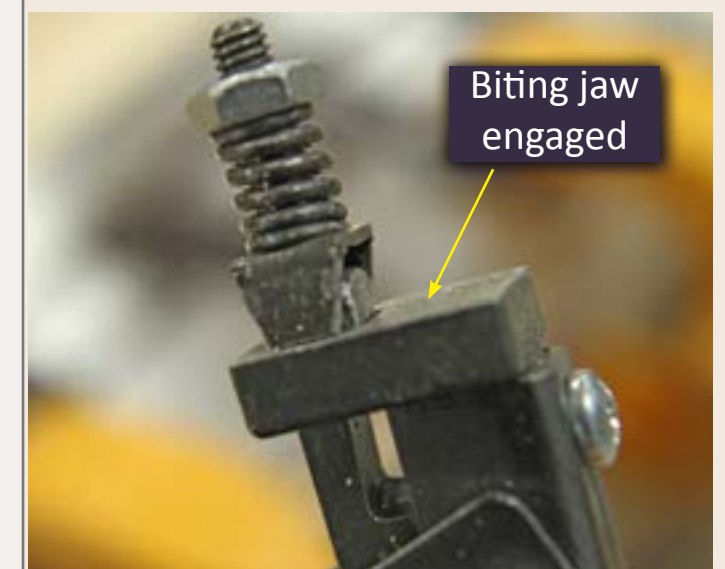
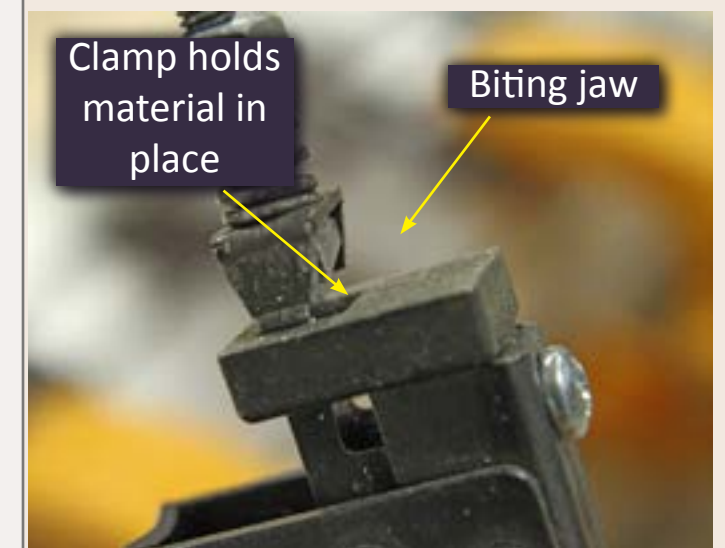

A nibbler is a hand tool used to "chew out" (or nibble) a small hole (from a drill) to make it bigger. The tip is inserted in the hole, the jaw is moved to the edge of the hole, and the tool's handle is squeezed to take a bite. Repeat until your cut out is done.

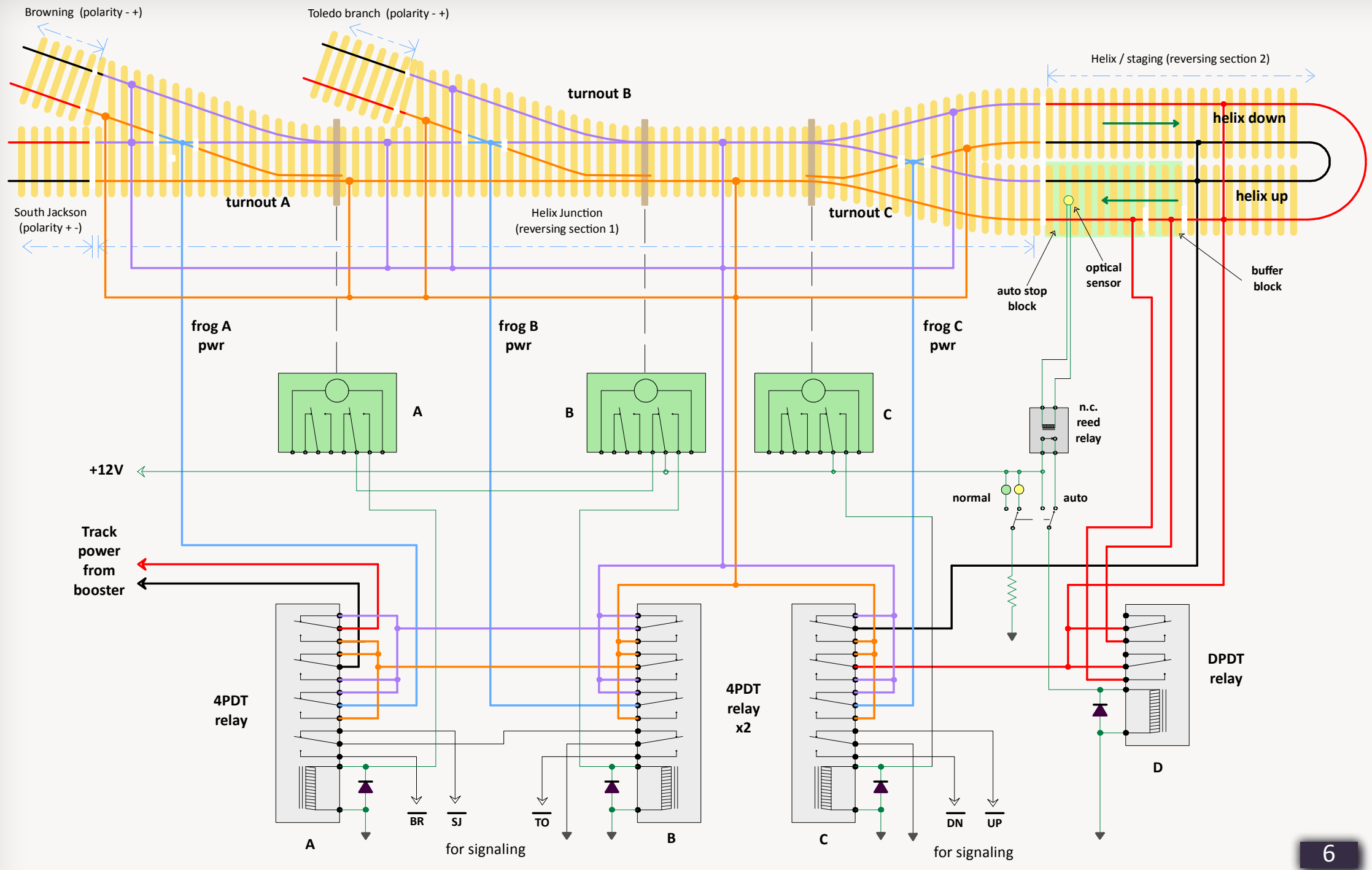

6

6. Schematic of my double reversing helix junction wiring.
 7a,7b. A panel mount socket for a DPDT relay. Note the tangs on the side of the socket. Once pushed through the cutout in the panel, they snap out and hold the socket in place.

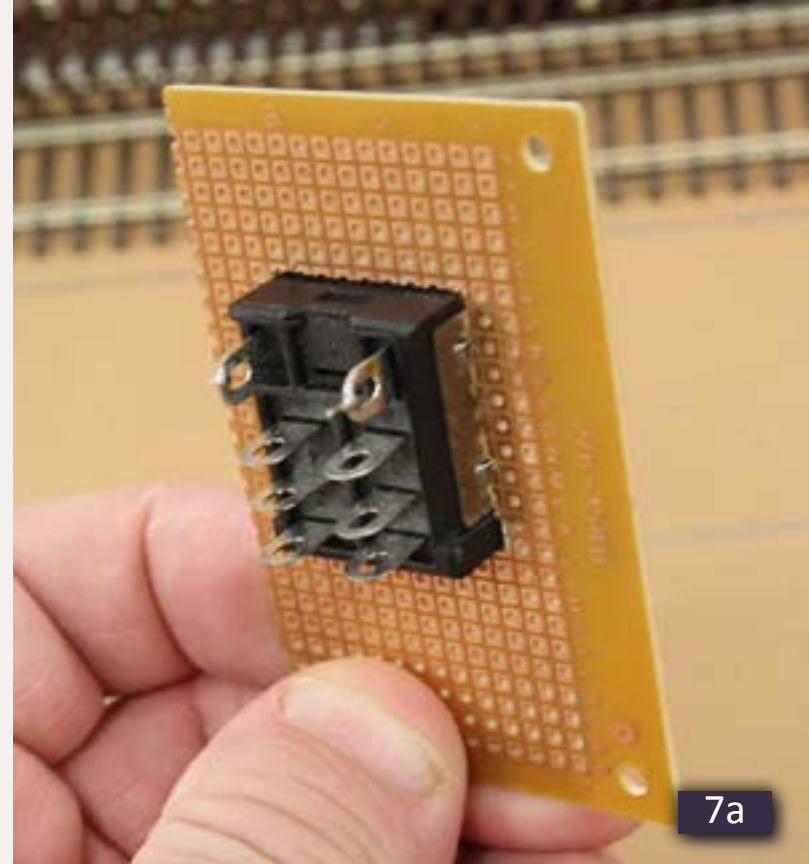

7a

How it works!

The track is divided into three areas. From left to right:

- The outside world: South Jackson, Browning and the Toledo branch. Browning and the Toledo branch are opposite polarity (represented by the black and red rails) from South Jackson.
- The helix junction block which includes the three turnouts.
- The helix and main staging. This block is another reverse loop.

The South Jackson, Browning, and the Toledo branch are fixed polarity blocks. The power for their rails doesn't flip.

The helix junction is a reversing block. Its track power must be reversed if turnout A is lined for Browning or turnout B is lined for the Toledo branch. If both A and B are lined for South Jackson polarity is not reversed.

The other area is the helix and main staging which are a reverse loop with reversing polarity. Track polarity for this area depends on the position of turnout C. When turnout C is lined for the up track, the polarity matches the helix junction. When C is lined for the down track relay C reverses the power relative to the helix junction.

The big problem setting the helix junction track polarity is the need for two reverse sections. Note that

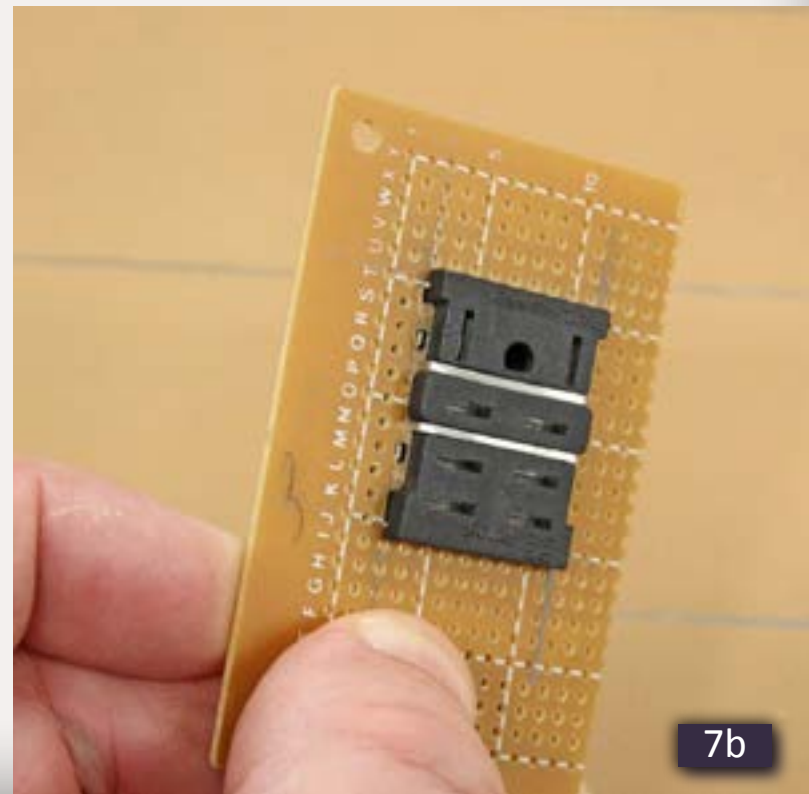

7b

How it works! (cont'd)

both relays A and B are configured to reverse polarity. When either turnout A or turnout B but not both A and B are thrown, the helix junction track power is reversed (matching Browning or the Toledo branch polarity). But if both A and B are thrown the helix junction polarity is reversed twice setting it to unreversed.

So, when relay B is activated (reversing) because turnout B is lined for the Toledo branch, relay A must NOT be activated or the helix power is double reversed, causing a polarity mismatch between main track power and the helix junction.

What about turnout A? If turnout B is lined for the Toledo branch it doesn't matter how turnout A is set, from a track routing point of view. So there are two solutions to the A or B, but no A and B problem:

- Wire the control circuitry for turnouts A and B so they can't both be lined for their diverging routes at the same time.
- Run the power for relay A through a set of turnout B's contacts so when B is set A can't be set. This is shown in the schematic on the previous page.

The helix and main staging power is taken from the helix junction block (which gets its power from the booster) and is either reversed or not reversed depending on whether

turnout (and relay) C are active (the down track) or inactive (the up track).

What about the other wiring? I haven't wired the auto-stop feature yet so it may change. Here's what I'm planning.

There will be an optical sensor near the top of the helix up track in a block long enough for the longest normal train.

The optical sensor can't handle much current so it is used to drive a normally closed (N.C.) low power reed relay. When a locomotive arrives at the top of the helix it causes the reed relay to activate and open its contacts.

The DPDT toggle switch has two positions: normal and auto.

In the normal position relay D is energized directly from the +12VDC line causing relay D to activate and connect power to both the motive power cutout block at the top of the helix up track and a buffer block next to it on the up track. The buffer prevents trains coming from behind from connecting power to the stop block.

In the auto position, if the optical sensor registers no train present the relay remains powered. When a train arrives, power to relay D is interrupted and track power is taken away from the train, stopping it.

When the DPDT toggle switch is returned to normal, the train resumes operation.

Continued from page 24.

spray paint finished the panel and I screwed it to a piece of plywood to hold it in place (1).

Wiring the relays

The wiring may seem a little complicated but refer to the schematic and I'll try to explain how it all works.

8. Barrier strips for connecting track and signalling wiring to the relay panel. The labels for the barrier strips are easily seen in the inset photo (8a).

9. The rats nest behind the relay panel starting to take shape. Working methodically is important.

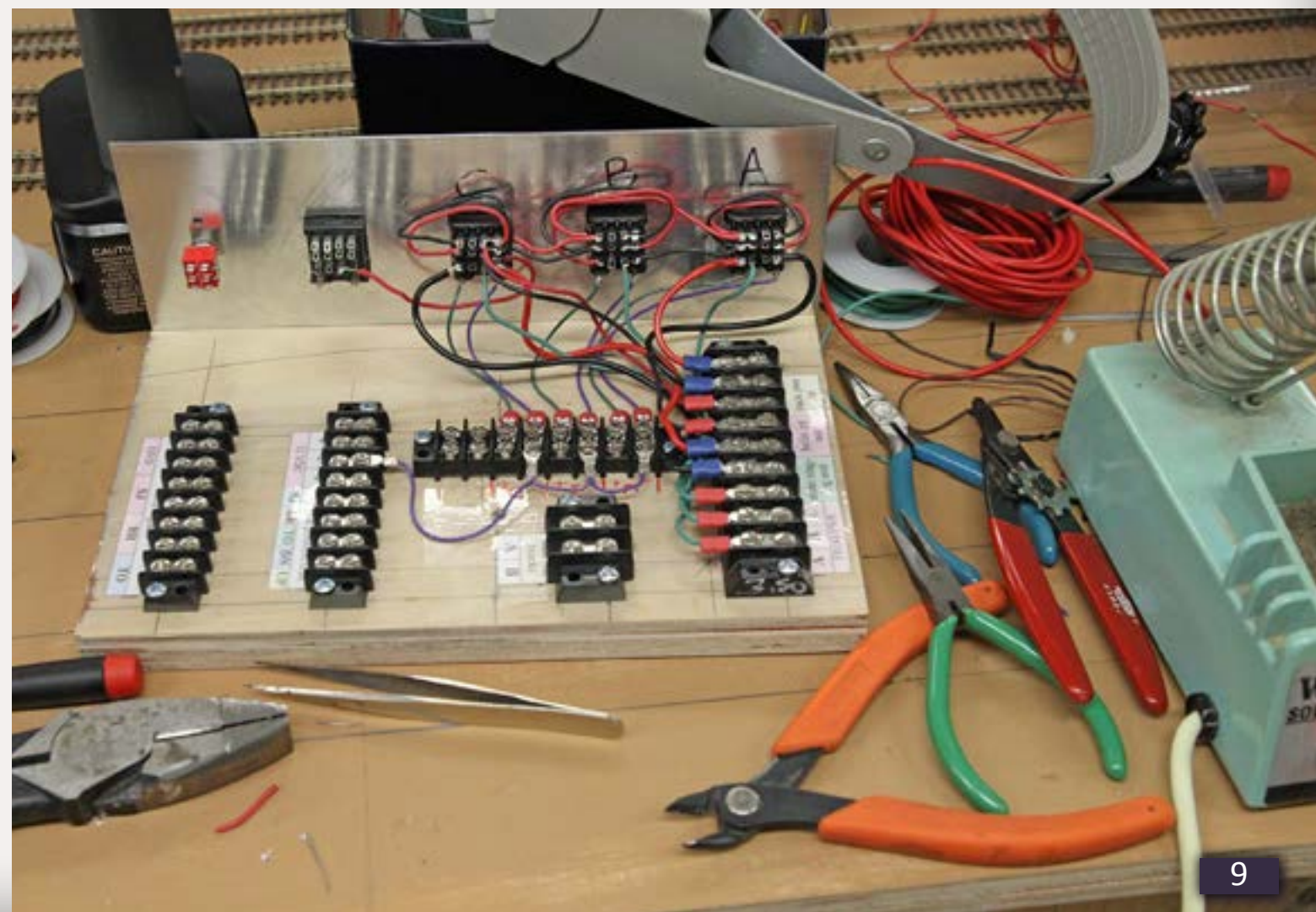

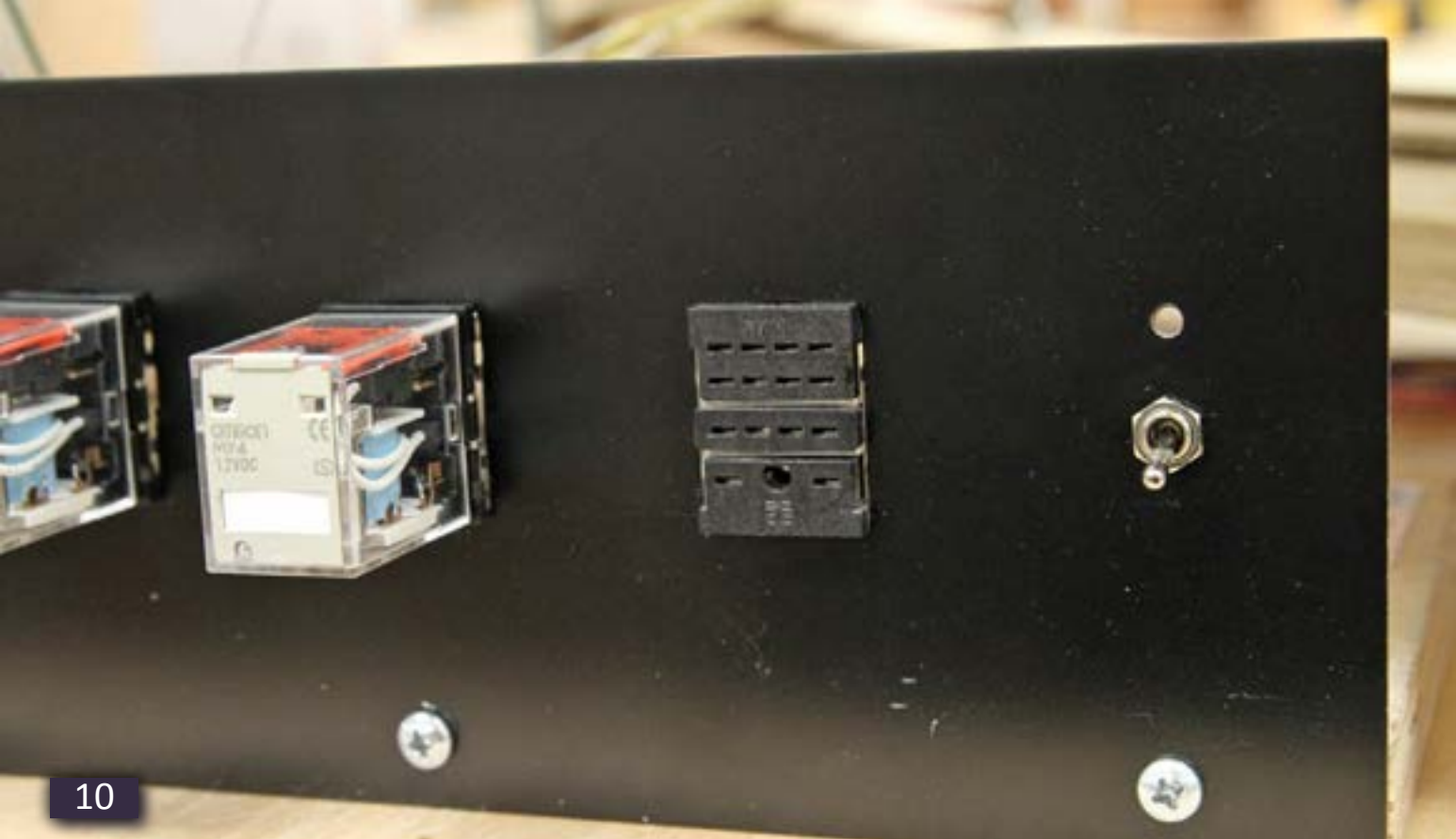

10

10. The panel with empty and filled relay sockets.

There are three turnouts at the helix junction. Each turnout is controlled by a Tortoise and each Tortoise has a 4PDT (four pole double throw) relay attached to it – the DPDT contacts of a Tortoise are too meager for this kind of wiring. The turnouts, Tortoises, and relays are labeled A, B, and C on the schematic (and on the layout).

A fourth relay will be used to implement the auto-stop feature but I've not yet built this part of the circuit.

Connections

I use barrier strips to connect the on-layout wiring to the relay panel. Each barrier strip is labeled so five years from now I'll still be able to figure out which wires go where.

I use smaller (#6 screw) barrier strips for signal wiring and larger (#8 screw) barrier strips for track power wiring.

The solder tails on the back of the relay sockets are too small to permit connecting the 12 gauge stranded wiring I use for track power to the them. Because they are very short the higher resistance isn't a problem, I use 16 and 18 gauge wire between the barrier strips and the relays.

Color coding will keep you from going crazy trying to remember which wire is which. All the track power wiring on the relays is either black or red. I also use yellow for +12VDC, purple for ground, and orange for -12VDC wiring and other colors for signals.

All the relays are protected by a reversed polarity diode. When a relay is powered by a DC voltage a magnetic field builds up around their coils. When the power to the relay is abruptly removed, the magnetic field collapses and induces a high voltage spike of the

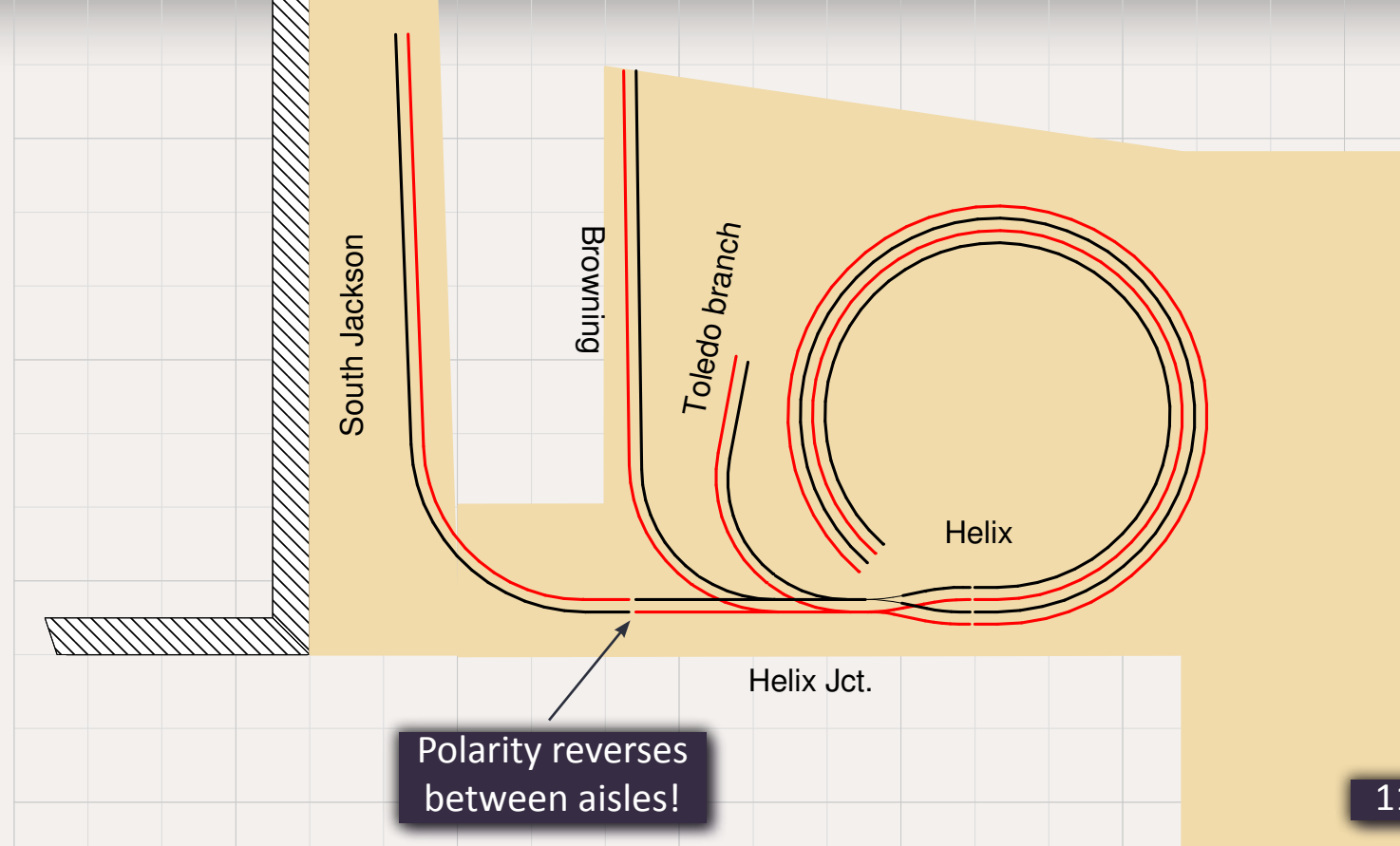

11

11. Oops. I forgot that the aisle side wire in South Jackson was the away-from-the-aisle in the helix junction! Bad dog!

opposite polarity. The reverse polarity diode short circuits this spike, protecting any voltage sensitive components attached to the circuit.

Oops...

With the relay panel wired and connected to the layout wiring it was time to give it all a try. It was a work night and three good train buddies were there to watch and cheer (or jeer) me on.

After a thorough inspection I turned on the +12VDC power. No smoke – a good thing. I used the turnout control panel to line the turnouts for different routes and the relays clacked away following the turnout alignments.

I turned on the DCC booster power supplies and the RRampmeters read a 12 volt output from each booster with

slight current draw. In another part of the layout, some sound locomotives woke up with their usual clamor. Good so far.

I tried running a pair of RS2s up the helix and through the junction. They made it over the gaps separating the helix junction block from the helix track but then something shorted out. A bit of quick trouble shooting revealed I'd wired the turnout C frog with the opposite polarity of what should have been there. I disconnected turnout C frog power and tried again. The locos now sailed through turnouts C and B but the turnout A frog power was also backward. Rats...

After disconnecting the power from turnout A's frog the locos ran back and forth on the track from South Jackson to helix up and down tracks.

Until now the Toledo branch had been connected to the helix junction block. I gapped both rails, separating the two blocks and dug up some clip leads to apply power to the Toledo branch track. I lined turnout B for the Toledo branch and the RS2s headed in that direction. As soon as they touched the new Toledo branch block track power shorted out. Hard.

A careful inspection failed to uncover the reason for the short. Everything looked right. So we sat down with the schematic thinking there must be something wrong there. But after 30 minutes we couldn't see the problem. The "helpers" left me sitting in the train room feeling defeated.

12. I reverse the power wires (red to black and black to red) leading to the relay panel to solve my aisle polarity short circuit problem. The crude panel operates turnouts A, B, and C until I make something snazzier.

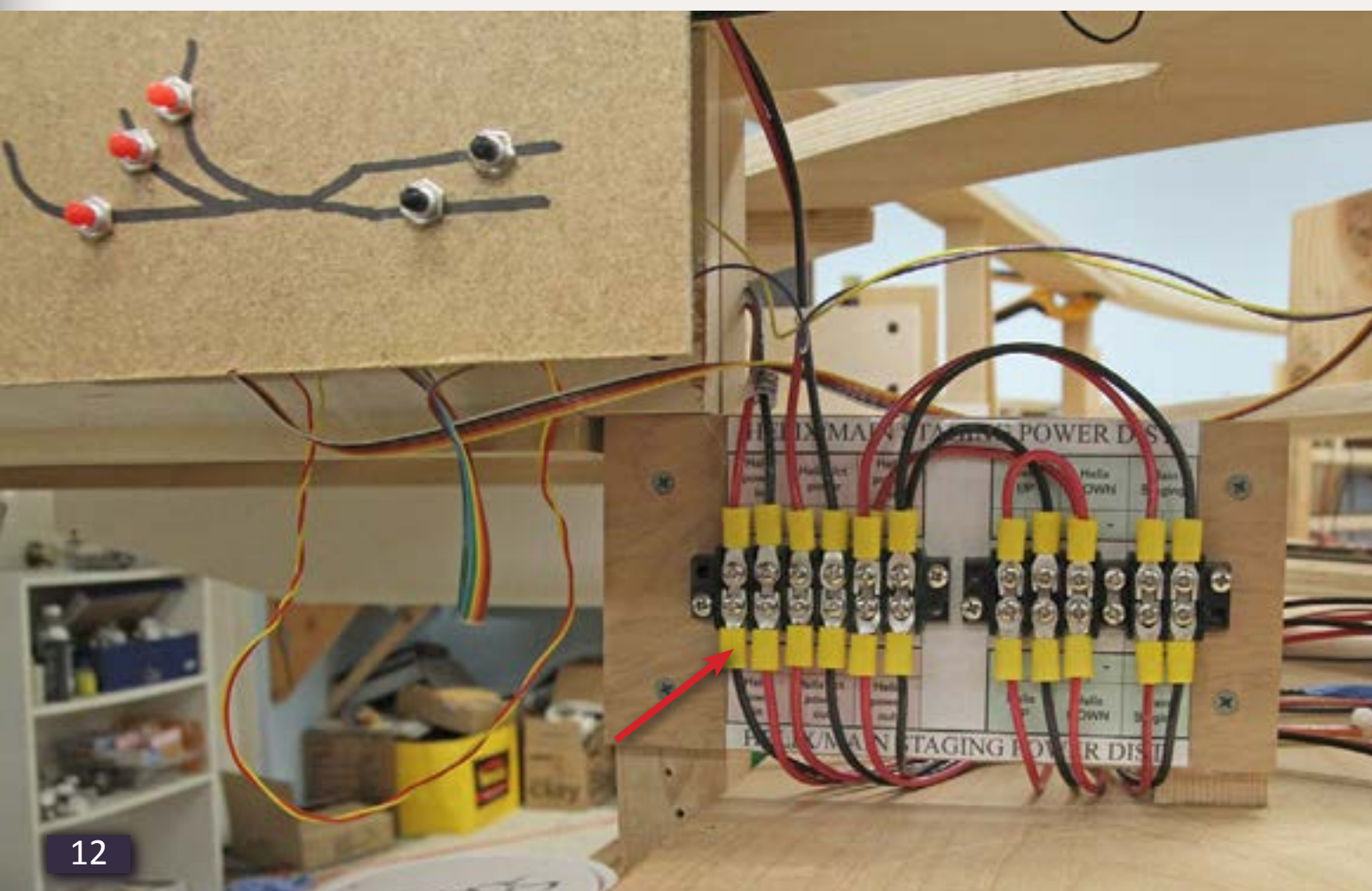

I found it!

I didn't get a rematch with my wiring until three days later. I pulled out the relay panel and thoroughly checked everything. Aside from the polarity reversed frogs there was NOTHING wrong with the way the relays were wired! The schematic appeared to be correct and the wiring appeared to be correct. But the short circuit remained. Now what?

I was staring at turnout B in the layout room when the source of the problem came to me. I'd managed to create an aisle polarity violation. If you're wondering what the heck that is take a look at figure 11.

You may recall I use red and black for track power busses and feeders with the red wire powering the rail closest to the aisle and black for the other.

That's what I did with the helix junction. Big oops! When the track leaves South Jackson heading for the helix red next to the aisle is correct polarity. But once it gets to the helix junction it's a different aisle and the black wire should be next to the aisle. I'd forgotten this. The entire helix junction block was polarity reversed from what it should have been.

Hey easy to fix! I quickly reversed the black and red power inputs to the relay panel. No more problems right?

Nope. I'd gotten fancy and used my Fluke DMM (digital multi-meter) to measure voltages and verify polarity.

The first check was good. But the next showed voltage across a gap where the should not have been any. Argh! This shouldn't be possible! Back to the schematic and more head scratching.

Finally I noticed turnout C (at the top of the helix) was lined for the up track. But a loco had been left straddling the gap between the down track and turnout C. No wonder there was power in unexpected places! I removed the loco and the problem disappeared.

Another test run through the junction worked perfectly with the loco sailing through the turnouts on all routes.

If I'd just run the locos to test the relay panel instead of using the DMM

I would've noticed the problem right away and saved a half hour of hair pulling. Oh well, at least the relays are working now!

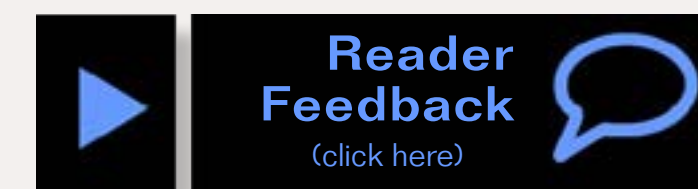

A clipping from the

South Jackson Gazette

Railroad Sponsors Relay Race!

The local population in South Jackson has been getting their exercise lately. Said an unnamed patron at the Bear Creek Grill, "We heard the railroad was having a relay race, so naturally we all want to participate."

BC&SJ general manager, Charlie Comstock, shook his head at the news. "All we did was mention we're using relays in the control system for the junction where the ends of the universe meet. I guess they didn't understand."

Horace Fithers was a holdout. "I'm afraid all them women-folk here 'bouts would pass out from the shock of it if they saw me in running shorts," he explained. "Anyhow why'd they want to be a bunch of racists?"

It's unclear whether the locals may put on their own race when they find out the railroad has passed the buck (er... baton) on this purported event ☒

* Enjoy the Gazette? Read more at bcsjrr.com

From Train Set To Club

NCE Covers ALL Your DCC Needs



DCC Twin

2 trains - power supply - Optional Cabs -
Perfect for Train Sets

Power Cab

6 trains - power supply -
Great way to start DCC on your railroad -
Optional Cabs available

Smart Booster 3a

6 trains - Four Optional Cabs

PH Pro

Many trains -
5 Amps of power for Z, N, HO, S Scales -
Optional Cabs

PH Pro R

PH Pro with Wireless Operation

PH10

10 Amps of power for
O and G Scale layouts

PH10 R

PH10 with Wireless Operation



NCE Corporation builds products in Upstate New York - Right here in the U.S.A
We build our products to the NMRA Standards and Recommended Practices where applicable

585.265.0230
9am-4pm EST.
www.ncedcc.com

NCE

The Power of DCC

Call or Email
for FREE Brochure
support@ncecorporation.com





About our DCC columnist



Bruce Petrarca is a well-known expert on all things DCC.

DCC Impulses: Basic Electronics for DCC Going Beyond the Basics

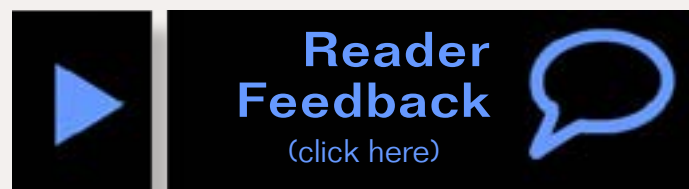

Understanding a few concepts helps remove mystery ...

Last month's column was on the light and breezy side, so it is time to get back to some meat and potatoes.

In addition to dealing with DCC items, this column will also be a basic primer on electronics for everyday use.

I have been teaching electronics in various formats since my senior year in college (1969), when I taught a freshman electronics laboratory wherein the students explored the theory of radio receivers and built themselves a transistor radio in the process.

The goal here is to make it simple. Yes, there are more exacting and complex ways to say what I'm going to say, but the underlying theory is accurate.

Water analogy

It is hard to see electrons running around inside wires. If you get them to jump and make a spark, you can see them. However, since we really want to keep them inside the wires

and other electronic components, let's look at them another way.

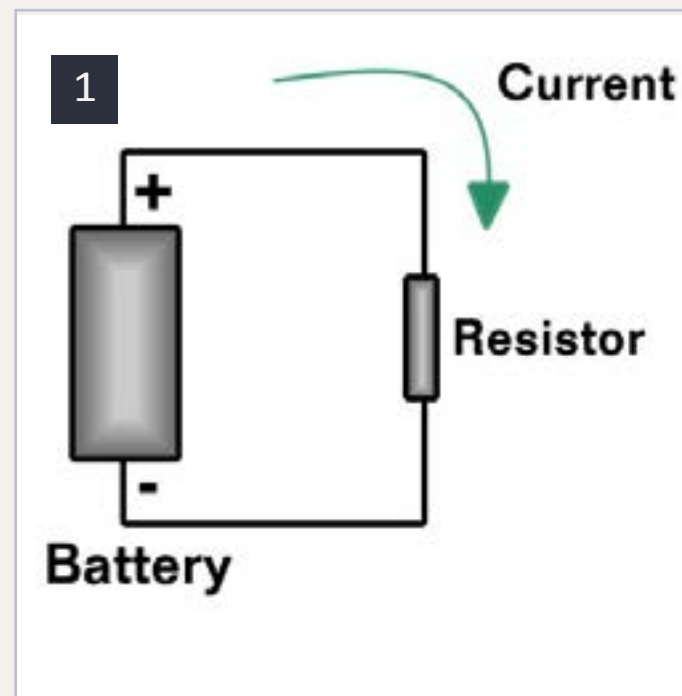

1: Electrical flow.

Folks seem to understand water flowing better, so I'll use a lot of water analogies, to help your understanding.



2: Water flow.

Do you relate to 2 better than 1? Most folks do.

I will talk about current flowing from the positive terminal of a battery toward the negative terminal. I know that this is contrary to semiconductor theory, but it is easier for the layman to understand.

Yes, I live in the U. S. A. and will refer to units commonly understood here. I'm not going to complicate things by adding scientific or other units. Sorry.

DC vs. AC vs. DCC

For the purpose of this column, there are three types of electricity, named by the way current flows in a circuit.

D. C. (DC or Direct Current) is what comes from a battery. It flows in one direction only (1).

A. C. (AC or Alternating Current) is what is supplied to your house and is usually a sinusoidal waveform. It goes back and forth in polarity. Forget the big words, it looks like figure 3 (next page). For power mains, the frequency is most commonly 60 or 50 cycles per second (Hertz).

DCC uses a train of pulses to carry the data. So, it acts a bit like AC and a bit like DC (4 next page).

Some folks refer to it as AC, because it has a frequency associated with it, but it is really different than power line AC and requires different tools to

measure it. When you look at it on an oscilloscope, you see something like figure 4.

The highest frequency for DCC (the narrowest pulses in 4) is about 9,000 cycles per second or 150 times as fast as the power mains.

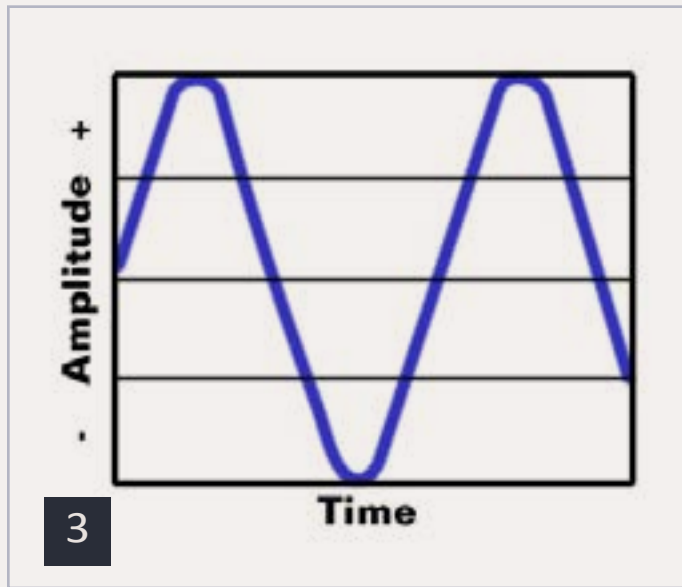

3: AC sinusoidal waveform.

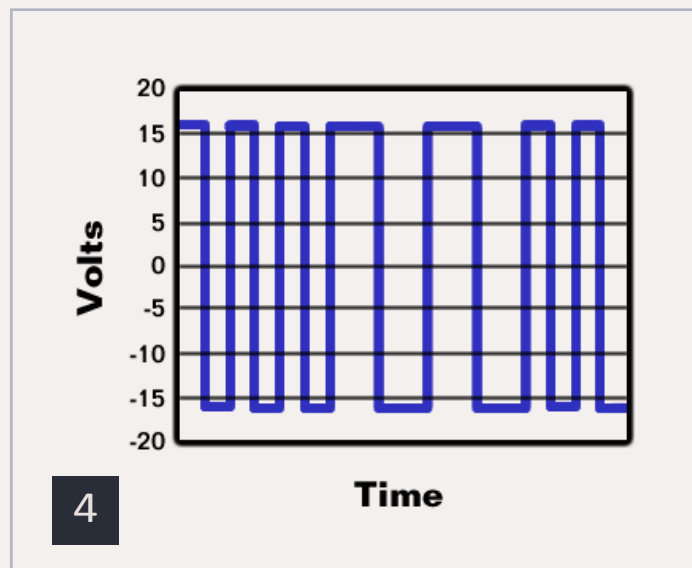

4: DCC waveform set at 16 track volts.

Voltage

The force pushing electrons around is called electromotive force (EMF).

Since it is measured in volts, it is commonly referred to as voltage.

Water pressure is the force that pushes water molecules through a pipe and is measured in pounds per square inch (PSI).

Current

The number of electrons flowing per second is the current flow. It is commonly measured in amps, which is a whole lot of electrons per second. A common unit in model railroading is the milliamp, which is 0.001 amp or 1/1000 amp.

Water flow is frequently measured in gallons per minute. A gallon is a whole lot of water molecules. See the relationship?

If you move one gallon per minute of water at 5 PSI, doubling the pressure to 10 PSI will give you two gallons per minute.

If you have 1 amp flowing in a circuit with 5 volts applied, doubling the voltage (pressure) to 10 volts will cause 2 amps to flow.

There is one more thing to think about relative to current. The total current in a given connection will be zero. That is, the current flowing into a connection will equal the current flowing out.

In figure 5 there is 1 amp flowing in (positive) from the left to the point and $\frac{1}{4}$ amp flowing out (negative) to the right and $\frac{3}{4}$ flowing out (negative) downward. The total current is zero: $+1 - \frac{1}{4} - \frac{3}{4} = 0$.

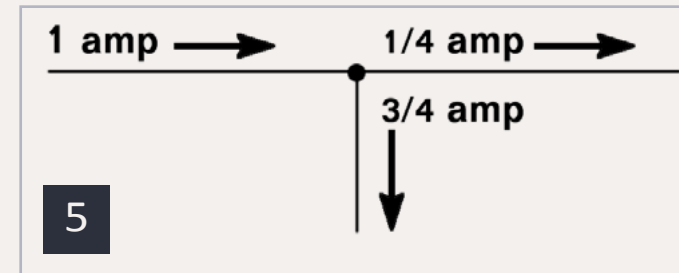

5: Current flow in a connection.

Power

The power being used is the product of the voltage and the current. It is most frequently measured in watts.

If you apply 10 volts and $\frac{1}{2}$ amp flows, then you are dissipating 5 watts ($10 \times \frac{1}{2} = 5$).

Yes, this is correct for DC. While it is not totally correct for AC or DCC, it will be close enough for our needs.

So, let's consider a 5 amp DCC system with 15 volts on the track. The power that the system can supply is 75 watts ($5 \times 15 = 75$). Consider how hot a 75-watt bulb gets. Some of the energy being consumed by the bulb is being converted to light, so not all of the 75 watts becomes heat. Without effective short-circuit protection, this is the kind of heat that can be put into the wheel of a car that is shorting on a DCC layout.

Shorts

The word "short" is probably the most misused in electronics. Folks tend to call any malfunction a short. That is not true.

A "short" occurs when something that should be receiving electricity has been bridged or otherwise connected across.

When a wire breaks, that is an "open," not a "short."

As previously discussed, when a wheel bridges between the tracks, that is a short.

When main power (either your house mains or your track) is shorted, lots of current is drawn and, hopefully, a circuit breaker opens to relieve the short.

With some of the basics established, let's turn our attention to electronic components.

Resistors

Resistors are components designed to limit the current flow through a section of a circuit.

Okay, what does that mean?

Back to the water analogy. If you think about a dam on a river, it keeps the water from flowing down the canyon where it is built (6).

Normally, we allow some water to run through generators and exit the dam. There is resistance to the flow limiting the amount of water coming through the powerhouse and out. The height of the dam determines the pressure (voltage) driving through the resistance of the piping and generators.



6

6: Hoover Dam stores a lot of energy on the Colorado River.

If you connect a wire directly across a battery, you get a lot of current flow and energy (heat). Similarly, if you break the dam, you get a lot of energy in the form of flowing water.

Bringing this down to a more reasonable level, think of plumbing in your house. Copper tubing that is 3/4 inch in diameter has slightly more than twice the cross sectional area that 1/2 inch tubing has. Thus, the larger tubing has less resistance, allowing more water to flow for the same pressure – less resistance means more current for the same voltage.

Electrical resistance is measured in ohms (Ω). The components used to add resistance to the circuit are called resistors and sized by the amount of power (watts) that they can dissipate.

Resistors in the DCC world are frequently valued in thousands of ohms, called kilohms ($k\Omega$).

Ohm's Law

Ohm's Law dictates the relationship between voltage, current, resistance and power.

One amp will flow when one volt is connected across a one-ohm resistor and there will be one watt of power dissipated as heat in the resistor.

The formulas are:

$$E = I \times R \text{ (volts = amps} \times \text{ohms)}$$

$$P = E \times I \text{ (watts = volts} \times \text{amps)}$$

Rearranging these formulas gives us:

$$I = E / R = 1 \text{ volt} / 1 \text{ ohm} = 1 \text{ amp}$$

$$P = E \times I = 1 \text{ volt} \times 1 \text{ amp} = 1 \text{ watt}$$

Scaling this by 1000, one milliamp will flow when 1 volt is applied to 1 kilohms.

$$I = E / R = 1 \text{ volt} / 1 \text{ kilohms}$$

$$= 1 \text{ milliamp}$$

Capacitors

Okay now things can get complicated. I'll try to keep it simple.

A capacitor is simply two parallel plates with a dielectric (insulating) material in between them. Oh, boy, that sounds complicated. But it's not.

ADVERTISEMENT

HOLIDAY STOCKING STUFFER SALE

LET THEM KNOW ABOUT THE DECODER
INSTALLATION SUPPLIES YOU REALLY WANT!



CALL US AT 1-888-339-8724 or CLICK TO LEARN MORE 

Remember to
click on ads!
The more you
click the more
you help MRH
stay free ...

Figure 7 shows a simple capacitor. Just two conductive plates held parallel to each other with wires connected to them surrounded by air.

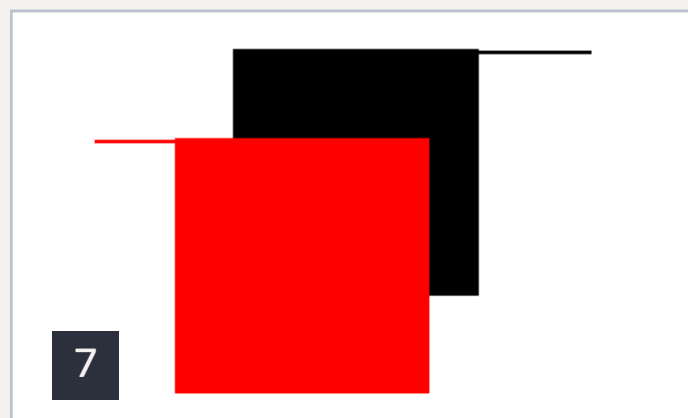

7: Parallel plate capacitor.

There are lots of dielectric materials used: air, ceramic, Mylar, electrolyte, mica. The most common capacitor used in model railroading is

electrolytic, using a chemical solution for the dielectric material (8). This allows fairly large value capacitors to be of reasonable size.

Capacitors are rated in farads, although a farad is a really big number. The most common range for capacitors we use is between 0.1 and 10,000 microfarads (μF - millionths of a farad). There are some “super caps” that range from 0.1 to 1.0 farads, but they typically are only rated at 3 to 5 volts.

Capacitors have voltage ratings. Higher voltage ratings make for physically larger capacitors, which are more expensive. This is the reason for selecting adequate voltage ratings for safe operation (10% to 20% above

what you expect the capacitor to see) without going overboard.

The standard electrolytic capacitor has polarity markings that must be observed when connecting them (8).

Electrolytic capacitors that are connected backwards or run over voltage tend to boil the electrolyte inside the capacitor. Steam locomotive engineers know what happens when you boil something in a closed container. BOOM!

Okay, that’s what they are and how to connect them, but what do they do? They store charge. “Ask a simple question and get a dumb answer,” I hear you cry.



8: Capacitors: top: electrolytic – 2,200 μF at 25 volts bottom: ceramic – 0.1 μF at 50 volts

Let’s try the water analogy again. Think of a rain barrel. It collects water off the roof when it rains, so that you can have a constant supply of water, even on sunny days. Similarly, a capacitor turns pulsating DC into constant, or filtered, DC. Storing when there is excess and releasing when there is need. You will frequently hear them called “filter capacitors”.

ADVERTISEMENT



Southern Digital

Specializing in DCC Since 1992



DigiFrame Kit



20% Discount on most items!

WWW.sodigi.com (770) 929-1888

(Photo from our N-Scale layout)

Okay let's look at some DCC applications for capacitors:

- Keep-alive – These capacitors allow your loco to run when the power drops out. They are usually polarized electrolytic units; 100 to 10,000 μF ; frequently rated 25 or 35 volts (8).
- Radio Frequency Interference (RFI) suppression – The capacitors are the ones seen on the circuit boards from Bachmann to control the RFI when a decoder is not installed. They are frequently 0.1 μF with a voltage rating over 25 volts (8).
- Speaker isolation – A capacitor is used to couple the sound to the speaker from an amplifier. Many early sound decoders (SoundTraxx

DSD and DSX series, for example) had this component external to the decoder for ease of installation. 33 μF at 16 volts was a frequent value in this use. Many of these use a special style of electrolytic that isn't polarized, hence they don't have polarity markings and it doesn't matter which way they are connected.

- Super caps can be used to make anti flicker circuits for LEDs that will let them run for many minutes without track power.

Diodes

Another component that has lots of uses in DCC is the diode. Basically, it allows current to flow in one direction only, like a water check valve. Most of

the uses in model railroading are for what are known as rectifier diodes – designed to control amps of current at 50 or more volts.

A common example is the 1N4001 series of diodes. The 1N4001 is rated at 1 amp of current flow with a (reverse) voltage of 50 volts. Feel safe substituting other diodes in the series from the 1N4002 through the 1N4007. They have the same current rating, but with increasing voltage ratings up to 1000 volts.

The direction of flow in a diode is noted by the band on the body. Figure 9 shows a photo of a diode and a circuit diagram. The photo of the diode and the circuit diagram are same polarity. If the battery were reversed, no current would flow.

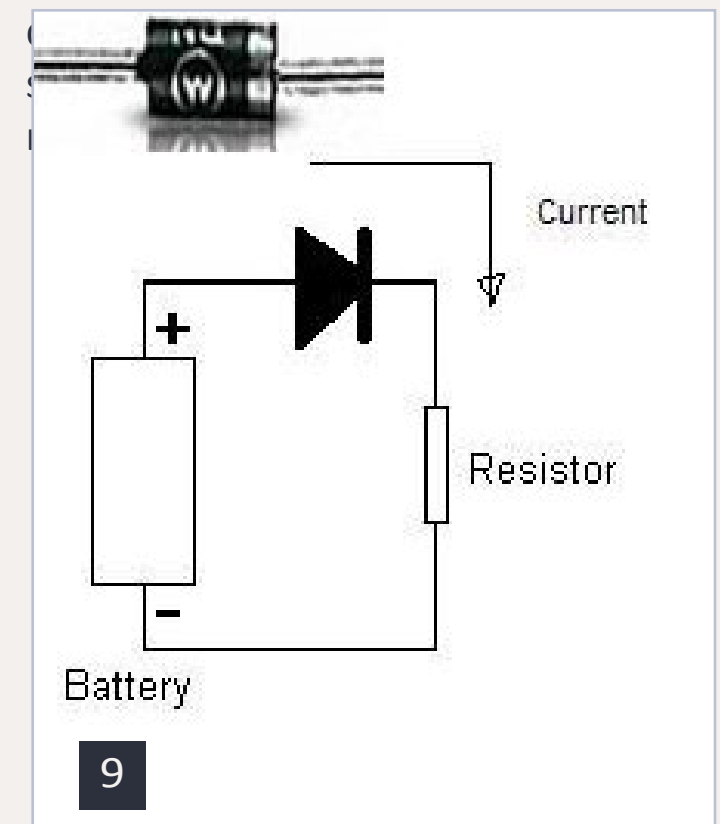

9: Diode circuit diagram with photo of diode.

ADVERTISEMENT

NEW FROM ACCURAIL **MADE IN THE USA**
EASY TO ASSEMBLE HO SCALE KITS

Join the Accurail Mailing List for the latest announcements & upcoming releases



Maine Central 40' Wood Stock Car



Norfolk Southern USA Hopper 3-Number Set

Also available as singles



American Refrigerator Transit 40' Steel Reefer

Visit Accurail at Trainfest in Milwaukee November 10th & 11th for these and other special run kits

WSOR, Soo Line, Milw, and KGBW special run cars available only at Trainfest



Lackawanna 40' Steel Reefer



Limited Run Union Pacific 3-Number Set 40' PS-1 Steel Box Cars



Toledo Peoria & Western 50' Box Car

PLEASE SEE YOUR HOBBY DEALER FIRST OR CALL 630-365-1173 FOR DIRECT ORDERS - ACCURAIL INC. PO BOX 278 ELBURN, IL 60119

Another use for diodes is to provide a consistent low voltage. Think back to the check valve used in plumbing. When you install one, the pressure downstream from it is a bit lower than it is upstream. In fact, if you measured across the check valve, you would see a pressure drop across the check valve.

Diodes, such as the 1N4001, mentioned earlier, drop about 0.6 to 0.7 volts when they are conducting. So, if you put two of them in series and drive current through them, you will get 1.2 to 1.4 volts across them. This is a perfect voltage to illuminate 1.5 volt bulbs. I cover this on my web site (mrdccu.com/curriculum/Lighting/1.5Volt.htm).

A specialized diode is the Light Emitting Diode (LED). I covered these useful critters in my March 2012 column (model-railroad-hobbyist.com/magazine/mrh-2012-03-mar/dcc_impulses). So I won't go into them here.

Wire

Wire is to electronics like pipe to plumbing. The larger the diameter, the more current can flow. However, unlike pipe, if you try to force too much current through wire, it gets hot. Hot enough to melt the insulation and then even enough to melt the wire.

Stranded wire is more flexible than the same gauge of solid wire.

Wiring of your layout was the subject of my December 2011 column (model-railroad-hobbyist.com/magazine/mrh-2011-12-dec/dcc_impulses).

Motors

Where would model railroading be without motors? Okay, let's talk a bit about them.

Analysis of the different styles of motors used in model railroading could consume an entire article or two, so I'm just going to hit some of the important issues.

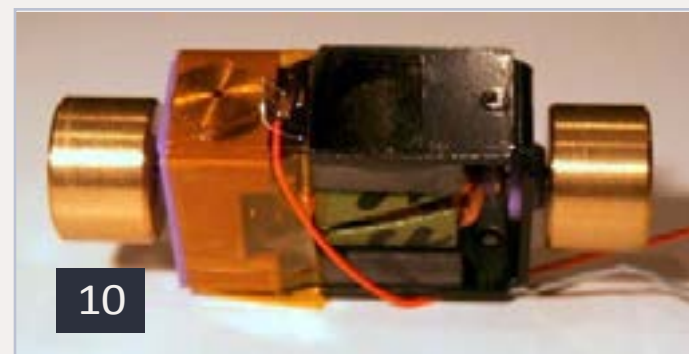

10: Motor from an HO Atlas S-1 locomotive.

Motors convert electrical power into rotating energy. They can go the other way, converting rotating energy to voltage, also called a generator. When they are being driven as a motor, they generate a voltage in the opposite direction of the voltage being applied to them. This reverse voltage is known as "back electromotive force", abbreviated as BEMF. Some DCC decoders use this BEMF to keep the motor moving at very low speeds. Now, you know what that set of letters refers to.

RailPro™
NEW TECHNOLOGY



Click here to watch our videos!



For more information visit our Internet site:
www.RingEngineering.com

ADVERTISEMENT

Interested in O Scale?

THE

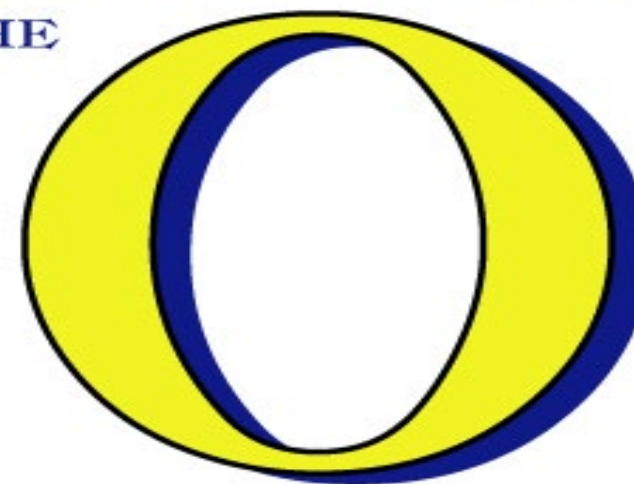

SCALE

RESOURCE®

www.oscaleresource.com

Listings of O Scale manufacturers, dealers, and suppliers.

The basic resistance of a motor determines its stall or starting current. The voltage being applied will cause a current to flow per Ohm's Law.

If your decoder supplies 15 volts and the motor resistance is 7.5 ohms, the initial current pulses will be 2 amps ($I=E/R=15/7.5=2$). Once the motor gets moving, the BEMF generated will reduce the current flowing. Frequently, the current when running freely will be 1/10 to 1/4 of the stall current.

I discussed stall current as part of the process for decoder selection in my January 2012 column (model-railroad-hobbyist.com/magazine/mrh-2012-01-jan/dcc_impulses).

Heat

Heat is a byproduct of most electronic activities. Solid-state components (transistors, integrated circuits, diodes, etc.) are most sensitive to it. Heat damage is usually permanent and not recoverable.

Decoder manufacturers, for the most part, design decoders to shut down before they get too hot and damage themselves. That wasn't always the case. Overheating can damage many of the early decoders.

This is why I recommend folks think about heat removal as part of their decoder installation design. You can read more about this in my February 2012 column (model-railroad-hobbyist.com/magazine/mrh-2012-02-feb/dcc_impulses). Also, check out this

month's sidebar, "From Mr. DCC's workbench" on page 39, where I discuss a new epoxy I've been using to help dissipate heat.

Measurements

The go-to piece of electronic test equipment for the model railroader has become the digital multimeter (11). For less than \$10, you can measure voltage, current and resistance.



11

11: Digital Multimeter – photo courtesy of Litchfield Station.

My word of caution here is that they are designed to measure DC voltage, current and resistance. They convert AC to DC and measure the result. They are calibrated to read the (RMS) value of sine wave AC (3) applied to them. The waveforms in figures 3 and 4, show that there is a different

Introducing the New

SwitchWright™



A
D
V
E
R
T
I
S
E
M
E
N
T



A simple to install and operate, under the table, compact switch machine.

Flexible controls - plug-in one or more fascia controllers (shown above), use a toggle switch and/or DCC.

Speed easily set from slow to fast.

Slave units for crossovers!

Built-in DPDT Relay for frog power and signals.

Based on an RC servo the SwitchWright is only 1.5" tall and 2" wide with a 3" wire.

Learn more at

www.TamValleyDepot.com



amount of energy in one waveform than there is in the other. What this means is that multimeters are inaccurate when measuring DCC voltage and are not equipped to measure DCC current directly.

Yes, you can put them on the AC voltage scale and get some relative measurements on DCC track. For example, if you measure 13 volts on one stretch of track and 14 volts elsewhere, you have a good indication that the one section does have more voltage. But the absolute values of 13 and 14 and 1 are suspect.

An oscilloscope, a piece of sophisticated electronic test equipment, will

measure DCC voltage. An oscilloscope cannot easily read DCC current.

In my May 2012 column, I discussed the RRampmeter (model-railroad-hobbyist.com/magazine/mrh-2012-05-may/dcc_impulses). It is the most cost effective way to measure DCC voltage and current, in my opinion.

A misuse of terminology

Folks often incorrectly refer to the decoders installed into locos as “chips” and the process of installing the decoder as “chipping”.

Chips are the electronic devices (integrated circuits, resistors, etc.) that make up the decoder; they are not the entire decoder.

Referring to a decoder as a “chip” is like calling the motor for your car a “carburetor”.

Until next month

Hopefully, I have cleared up some confusion for many folks. If so, please click on the Reader Feedback link and rate this column “awesome”. Feel free to join in the conversation this likely to be unfolding there.

I wish you green boards until next month!

A Sidebar continues on page 39

 **Reader Feedback**
(click here)

ADVERTISEMENT

Get Better Sound from your Locomotives

Can't get good sound from your sound decoder? Give our speakers a test drive with your ears.

We offer high quality speakers to enhance your model railroad experience

Dealer inquiries welcomed



RAILMASTER HOBBIES
9815 WALNUT ST #106
BELLFLOWER, CA 90706
562-867-5627
WWW.RAILMASTERHOBBIES.COM
SALES@RAILMASTERHOBBIES.COM

Bass Reflex Speakers



High Bass Speakers



When it comes to speakers we have high quality speakers to fit many different applications. We are also a full line hobby shop. Need anything? We are an authorized dealer for Soundtraxx, Digitrax, Athearn, Walthers and many others. We provide quality speakers for your DCC sound systems and quality service.

Limited time from TrueLine Trains ...

Click only if you want to know more!



BI-CENTENNIAL. BECAUSE AGE IS A THING OF BEAUTY. AVAILABLE AT BETTER STOCKED WALTHERS DEALERS \$39.99* for a really limited time. TLT 999002 GTW BI-CENTENNIAL CABOOSE



CP EXPRESS BOX CARS!
WITH AND WITHOUT AN
ACTION RED STIPE!

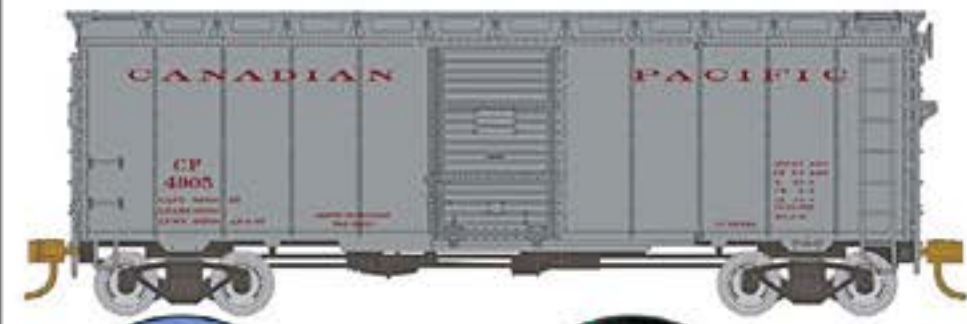
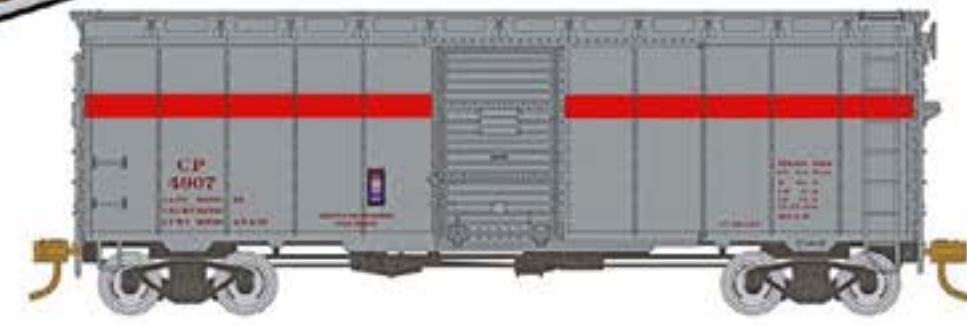

LIMITED PRODUCTION
(and we mean limited)
AND ONE RUN ONLY!
DON'T MISS YOUR CHANCE TO
REALLY COMPLETE YOUR CANADIAN!



For More Info, Please Call (905) 738 - 6556

True Line Trains Exclusively distributed in Canada by Canadian Hobbycraft Limited 445 Edgeley Blvd, Unit #1, Concord, Ontario L4G 4K1

From Mr. DCC's workbench – Arctic Alumina™ Thermal Adhesive

I've recommended on my web site, and in prior columns, the use of caulk to attach decoders to metal parts. This allows heat to flow from the decoder into the metal and keeps the decoder cooler.

Since the SoundTraxx Micro Tsunami (TSU-750 series) is very sensitive to overheating, it frequently needs such assistance.

Caulk is not a very good thermal conductor, but it works and it allows the decoder to be removed without damage.

Recently, I've found a new best friend for these installations. I stumbled upon Arctic Alumina™ Thermal Adhesive (arcticsilver.com/arctic_alumina_thermal_adhesive.htm). It is a 5-minute epoxy that is filled with ceramic particles. That makes it thermally conductive, but electrically insulating. Perfect for the need.

It comes in a set of two tubes. The epoxy and the hardener are mixed

in equal parts and applied similarly to most two part epoxies. It is bright white.

I purchased a set of tubes through Amazon for about \$6 with free shipping. This was only a few dollars more than I pay for JB Quick Weld, also a 5-minute epoxy.

I used it for installing Micro Tsunamis in Atlas S-1 style locos. Folks may remember that, to provide reliable operation, these locos need a brass heat sink built up on the front of the frame and then the decoder attached to the heat sink.

I report full success. The installation was easier and less expensive than prior times when I used silver epoxy. The silver epoxy is electrically conductive and, therefore, troublesome to use.

I had a need to remove a decoder after the epoxy had set. I was able to pop it off the brass plate without damage. ■

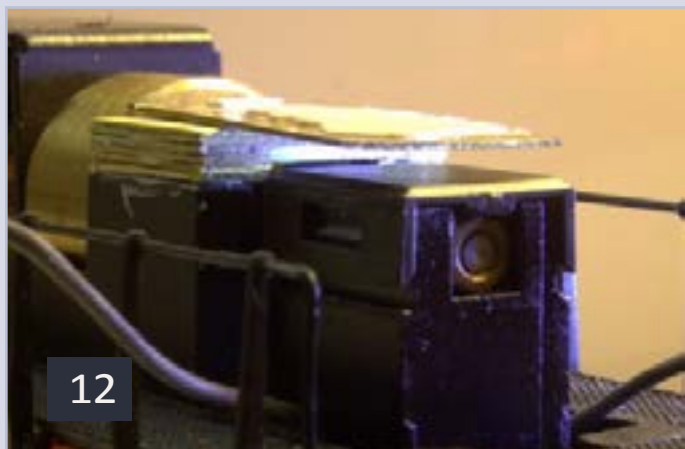

12: Detail of the heat sink build up on the front of an HO Atlas S-1 frame using Arctic Alumina™.



13: The same Atlas S-1 with the decoder installed and partially wired – blue tape holds the headlight wires out of the way.



- Digitrax
- SoundTraxx
- Kadee
- NCE
- And more!



RailPro

HOT!



Click to see our

December Specials

(while supplies last)



Click to see specials in these categories

HO

DCC

All Scales

Authorized dealer for:



ATLAS • BACHMANN • ACCURAIL

ADVERTISEMENT

Enjoy Great Operation with **Digitrax**



\$455.00 MSRP

Super Chief Xtra



\$225.00 MSRP

Zephyr Xtra



LocoNet
Is The Digitrax Difference

- Run Trains
- Sound
- Feedback
- DC Control
- Computer Control
- Lighting
- Turnouts
- Signaling
- Transponding
- Block Detection

Free Digitrax Toolbox App!
Easy to use tools to enhance your Digitrax experience!

For iPhone/iPad and Android

Download now @
[www.digitrax.com!](http://www.digitrax.com)

About this issue's prototype modeling columnist



Mike Rose has over 70 published articles in the hobby magazines, as well as contributed photos and essays to a number of prototype and modeling books. Mike's a regular on the Prototype Modeling Meet circuit, giving clinics on a variety of model railroading topics.

Mike's also the owner of Mike Rose Hobbies (mrhobby.com).

Photos and illustrations by the author unless otherwise credited.

GETTING REAL: Eras and Implications Adventures in Prototype Modeling

How zeroing in on an era is both liberating and limiting ...



Prototype modelers are usually very concerned and in tune with their era. Eras are important in so many ways. For example, I had always cut myself a lot of slack in defining my era until the past year or so. This is because, as a Conrail modeler, I found at least three distinctly different eras of Conrail very interesting (and also because I had models from the entire span of Conrail!). I had gotten around it by telling myself and my friends that I'd have "early Conrail night" sometimes and run mostly patched former predecessor road units. I even began to assemble certain consists, as shown in figure 1.

I had previously acquired the nifty ex-Jim Six locomotive shown in Figure 2, which he kitbashed to capture a former PRSL GP38 in Penn Central livery. This loco made it into Conrail, so I was either going to patch out the PC and do a hasty Conrail re-stencil, or paint it into the first Conrail blue scheme (2 next page).

Several other predecessor road locos were purchased by me with an eye towards doing patch jobs on them, and included LV U-23Bs and RS-3s, RDG GP-35s and SD-45-2s, a CNJ SD-40, and several other RS-3s that would be converted to "Dewitt

Rebuilds", or RS3m as PC and Conrail referred to them. Most have since departed in various locomotive purges over time, as anyone who subscribes to the various model railroading For Sale lists can attest (3 next page)!



1: The above unit (CR 1793) was either purchased from or traded for with my modeling buddy Dennis Lippert who did an excellent job on the locomotive. I think it was the open nose door that grabbed me. And it looks very good, particularly in light of the fact that it hit the floor at least twice, and possibly three times prior to my owning it. I think it's safer with me! The ability to mix Conrail and PC locos was initially very attractive to me.

The fact is that I realized this year that I needed to put a stake in the ground with my era, since the entire functionality of my new peninsula depended on it. Construction of my big Procter & Gamble manufacturing plant in Mehoopany, PA, discussed in my last Getting Real column, prodded me into doing a lot of prototype research. The research produced, among other things, the harsh reality that this plant stopped shipping by rail in the mid-1980s. If I were to operate

it as a major industry, with all of the trackage that entailed, and all of the incoming and outbound loads, it only made sense to set the layout era to coincide with the point in time when they were still shipping by rail.

That's the background. Now that I knew my railroad needed to be a mid-80s railroad at the latest, that meant all of my 90s power was out of the question for this. To me there's nothing that screams "fake" more than



2: Ex-PRSL PC 7906, done by Jim Six with an Atlas GP38 as a starting point, that I acquired from him a few years ago. Note the extended cab face where the windshield is. This was a special order feature designed to permit more crew members to travel in the cab in lieu of a caboose.



3: CR 6664 (former EL SD45-2) is an otherwise stock Athearn unit, which seems to be missing a horn and front handrail! It's also missing much-needed weathering since this paint scheme would have been in service for several years before EL was absorbed into Conrail. I simply "painted out" the EL markings with Microscale trim film of the appropriate color, and applied early CR markings from another Microscale set. Shown idling at Mehoopany, PA.

seeing a Dash-9 consisted with an RS-3 on the same railroad! I personally only like to combine models that would have co-existed in real life. I started to do a lot more research on the various Conrail models and when they arrived and departed on the timeline. It forced me to make some hard decisions on what was important to me, what I could live without, and also what I had to acquire.

To make it a bit easier for me to understand, I listed the models in a spreadsheet format so it would be easy to see what was out of bounds and what was "right" for my era. It

even produced a few surprises (4 next page)!

In the first blue column of the tables starting on the next page, I chose to highlight the models that were era-appropriate for the mid 1980s, and also which were good for the 1990s as well. At the time I prepared it, I was still on the fence about back-dating. Clearly anything in the green and amber columns was out of the question.

In the happy surprises department, it now looked like I could have some coveted SD45 engines and even a

Text continues on page 44.

Conrail Rosters and Retirements By Year

4

Model	Number Range	Total Units 1980	QTY 1982	QTY 1986	QTY 1991	Date retired
MT-4	1000-1023	24	24	24	24	
MT-6	1100-1128	29	29	29	29	
GP15-1	1600-1699	100	100	100	100	
B-23-7	1900-2023	124	124	117	117	
C-430	2048-2059	12	7			
C-420	2074	1	0			
GP20	2100-2112	13	13			
GP30	2168-2249	82	82	64	0	4/1/1991
GP35	2250-2399	219	172	77	45	
U25B	2500-2685	168	138			
U23B	2700-2798	99	99	97	0	4/1/1991
B-23-7	2800-2816	17	17	17	17	
U28B	2822-2823	2	2			
U30B	2830-2889	57	56			
U33B	2890-2970	80	79			
U36B	2971-2974	4	4	4	0	4/1/1991
GP40	3000-3274	253	230	71	0	4/1/1991
GP40-2	3275-3403	129	128	128	127	
GP35	3620-3692	73	0	43	21	
GP9B	3800-3839	37	3			
B36-7	5000-5059	0	0	60	58	
B40-8	5060-5089	0	0	0	30	
FL9	5000-5028	17	17			
FL9	5030-5059	27	27			
C425	5060-5087	22	0			
GP8	5400-5462	49	49	48	0	4/1/1991
RS3	5500-5520	5	5			
GP7	5600-5999	238	147			
C39-8	6000-6021	0	0	0	22	
C40-8	6025-6049	0	0	0	25	
C40-8W	6050-6149	0	0	0	100	
SD35	6000-6051	52	52			
SD45	6066-6239	173	164	49	0	8/1/1986
SD40	6240-6357	115	113	110	85	
SD40-2	6358-6524	167	165	165	165	
C30-7A	6550-6599	0	0	50	50	
C30-7	6600-6609	10	10	10	5	
C32-8	6610-6619	0	0	10	10	
C36-7	6620-6644	0	0	25	25	
SD45-2	6654-6666	13	13	13	13	
SDP-45	6667-6699	33	33			

Model	Number Range	Total Units 1980	QTY 1982	QTY 1986	QTY 1991	Date retired
SD50	6700-6834	0	0	105	135	
U23C	6700-6718	19	19	18	18	
C628	6736-6747	3	0			
C630	6753-6777	16	2			
C636	6781-6794	12	6			
U25C	6800-6819	20	18			
U28C	6820-6834	15	15			
U30C	6835-6844	10	10			
SD60	6840-6867	0	0	0	28	
U33C	6845-6883	39	39			
U36C	6884-6896	13	13	13	0	12/1/1987
SD9	6900-6924	25	25			
SD38	6925-6959	35	35	35	35	
SD7	6998-6999	2	2			
GP9	7000-7483	346	204	112	0	9/1/1990
GP18	7496-7499	4	4			
GP9	7500-7508	4	0			
GP10	7513-7597	76	76	75	75	
RS11	7604	1	0			
RS11m	7644	1	0			
RS11	7651-7652	2	0			
GP38	7656-7939	281	279	148	148	
GP38-2	7940-8231	340	336	336	235	
SW1	8400-8599	88	21			
SW8	8600-8627	28	38	35	0	4/1/1991
SW900	8628-8663	31	45	8	5	
SW8	8664-8700	37	0			
SW900	8701-8721	21	0	19	10	
SW7, 9	8836-9001	159	121	105	16	
SW9m	9008	1	6			
SW7, 9	9009-9150	99	124			
NW2m	9151-9194	44	31	0	0	8/1/1986
NW2	9200-9296	95	55	26	0	8/1/1986
SW1200m	9301-9311	6	3	0	0	4/1/1990
SW1200	9315-9382	68	68	64	51	
SW1001	9400-9424	25	25	25	25	
SW1500	9500-9620	121	121	116	116	
MP15	9621-9630	10	10	10	0	12/1/1989
RS3m	9903-9999	96	94	0	0	

Text continued from page 42.

few models of U-boats. SD50s were fine too. They were not only a major locomotive for Conrail, but I had several of them already. C32-8 and C39-8 were another surprise as being right for that time- frame, although in reality their arrivals coincided with massive retirements of models like

SD45s. Looking at the numbers, you can see that the C40-8s of both types stomped all over that SD45 number block, meaning they were gone at that time.

However, SD60s and most Dash-8s were out, and I had plenty of those too. Most have since been sold off. Unhappily my beloved RS-3s and RS-3m locos

5: The picture shows two of my three recently prepared SD45s (CR6091 & 6149) holding at the bridge over Mehoopany Creek, with completed basic detailing and very light weathering. Later the weathering will be tailored to particular prototype examples specific to each road number. Some of the detailing already reflects that, such as making sure these were the correct numbers to have three strap as opposed to newer, two strap cab signal boxes. The placement of cab vents and road numbers also reflects variations in particular prototype road numbers.



5

ADVERTISEMENT

THE ROCK ISLAND MODELER

U25B GP35

MODELING

2nd Generation Diesels

By JOE SCHOLAR
MODEL PHOTOGRAPHY BY JOE SCHOLAR

Learn More

Notes: Note that this Data Sheet contains revisions up to 1971. Drawn by Terry Caruthers, and checked by Harold Olson & J. Dennis Coleman.

By December 1968 additional girders over the radiator openings had been installed on the 234. The truck's roller bearing assemblies had been updated too. Notice how Joe has opened the cab windows on his model of the 223 to provide the HO scale crew with plenty of rock on. There was no air conditioning on these second locomotives.

1965 hovers below the cab on the engineer's side, and a Detail Associates No. 157 antenna, and a Detail West No. 175 three climate fans to the roof. Detail Associates No. 1508 MLI

Both U25Bs were repowered with GM motors to improve performance. A Stainless Treaded DCC decoder was installed in both, which I believe accurately captures the stereotypical "chugging" of U-boats.

Both units were spray painted with Popsell Primer and then top coated with a 50-50 mixture of Scalecoat Caboose Red and Scalecoat

After taking delivery of the first 25 U25Bs, the Rock Island turned to EMD for their next 2nd generation power. All of Rock Island's GP35s

Chew
REMEMBER THE ROCK
magazine

Run through power?
2nd hand units?
Leased power?
It's your railroad!

would have no place here, nor would any Alcos, at least on Conrail. But after speaking about this in some detail with other modelers, and thinking about it some after the fact, I concluded that two or three ex-Conrail RS3m rebuilds would look great in their old paint but hastily re-stenciled for my short line! It would also reinforce the connection with the "parent" railroad, in this case Conrail. I call that having my cake and eating it too.

I noted that I could have bought MP15s, which I'd passed on when they were newly available, since in my newly defined era they were still on the railroad. And I saw no way to incorporate two SD35s that I already

owned, except perhaps for them also to become property of my short line.

I found myself studying this document at length and planning my operational rosters. I was also heavily influenced by other op sessions I'd attended, particularly at Mike Confalone's Allagash Railway. It became clear that there was a real advantage to having multiples of similar models that were rugged and dependable operating locomotives. This is of course much more realistic than one or two each of a wide variety of models.

I decided that my roster would consist of the following:

A nice trio of Conrail SD45s.

Fortunately I had several Kato undec models "in stock" and proceeded to get back in touch with painting and decalling, something I'd always enjoyed in the past. Katos are easy to work on, and after doing chassis work that included using my milling machine to make room for Railmaster speakers, I soon had them operational with Tsunami decoders. Scalecoat II CR Blue was used throughout (5).

I also decided that at least a **quartet of Kato SD40s** would compliment and intermix nicely with the SD45s. Another quartet of **Athearn SD40-2s** would consist nicely with several **Athearn SD50s** I had already

purchased in Conrail factory paint. An occasional SD45-2 or perhaps a C39-8 or C30-7 would be thrown into the mix for interest, but the above four models would comprise the backbone of the six-axle road power (6 next page).

There would also need to be lots of four axle power. GP38s and GP40s/40-2s based on the reliable Atlas models would be the backbone of the fleet, and I have at least four or five of each model prepared and ready to run. I also acquired a quartet of Proto 2000 GP38-2s and found that they ran really well and were easier to install larger speakers in, once I figured out what weight material to mill

ADVERTISEMENT

New Innovation

LUBRICATION FOR THE NEW MILLENNIUM...

NANO-OIL.COM 
Nano Technology Lubricants

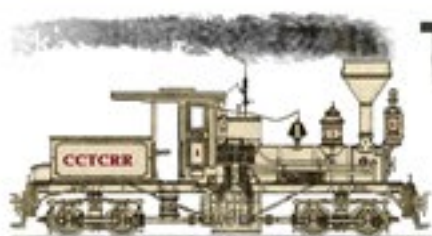

THE SHAY FIXER

VISIT US AT...

SHAYFIXER.COM



Specializing in brass Pacific Fast Mail / United geared locomotives

"I use only the finest quality lubricants such as Nano-Oil ..."
-The Shay Fixer



StClaire

Made in U.S.A



**DRAMATICALLY
REDUCES LOCO
AMP DRAW ...**

**For more details
click here**



off. Those were gutted and completely re-wired with Tsunamis, Railmaster DSM-8 speakers and real light bulbs. Future projects include a trio of GP35s and a trio of GP30s that will be Proto 2000 shells on milled Kato GP35 chassis (7).

Right now I'm working on GE four axle power, which requires a slightly different mindset. I had squirreled away two Atlas U23Bs that Brian Banna had begun, and as such they have highly detailed fuel tanks, milled chassis and an even higher degree of dis-assembly! Truly a kit in the strictest sense of the word, "some assembly required" doesn't begin to describe starting

with one of my friend Brian's work in process locos (8)!

So that I didn't bog down there, in addition to the two "super U-Boats" I'll construct from Brian's units, I'm also completing a stock Atlas numbered U23B and I have just numbered another un-numbered unit. Those will be placed into service with the "super" ones at some point, in part for me to test out a theory on what level of detailing is appropriate for a layout model. As I get older, and my eyes age, the level of detail that I added to locomotives and rolling stock before I had an operational layout no longer makes as much sense to me, particularly given the fact that

6



6: Conrail SD45 6163 and SD40 6318 are in between set-outs on the passing siding at Mehoopany, PA. The big Procter & Gamble plant looms in the distance. Behind the locos GP38 8227 lurks in West Yard.



HO GG-1 Electrics

Arriving This October At Your Local M.T.H. Authorized Retailer

Available In EIGHT Different Paint Schemes!



80-2149-1 Pennsylvania GG-1 Electric with Proto-Sound 3.0

Featuring:

- Sound-equipped versions with built-in DCC decoder
- 2 Cab Figures
- LED lighting
- Powerful 5-pole 12-volt DC motor
- Available In 8 Different Paint Schemes
- 28 DCC Functions*
- Kadee® Couplers
- Remotely Operated HO Scale Proto-Couplers
- RP-25 Metal Wheels Mounted on Metal Axles
- Lighted Cab Interior
- Illuminated Number Boards
- Lighted Marker Lamps
- Locomotive Speed Control in Scale MPH Increments
- Operates On Code 70, 83 & 100 Rail Curves

* Proto-Sound 3.0 Equipped Models Only



See why
M.T.H. HO Locomotives
Do More



©2012 M.T.H. Electric Trains

ADVERTISEMENT

these units will be handled by many others, and that I need a large quantity of them. Rather than an extensive detailing project for each loco, I'm adding details that individualize

the engines and that stand out the most to me, and then getting them into service as soon as possible. Later, as time and interest permits, they'll eventually receive more detailing and weathering attention on a random

7



7: CR 7966 (GP38-2) and CR 7883 (GP38) on a local at Skinner's Eddy, PA.

8



8: Brian Banna's chassis modifications include permanently mounting the fuel tank to the chassis after removing the cast-on air tanks, and drilling holes in the bottom to permit access to the motor mounting screws. He applied new ends and fuel gauges to the tank, and milled the frame rails. Most of this is similar to changes I made on my U18B that was featured in Model Railroad Hobbyist in July 2010.

Rslaserkits



← Jacks Cabin Water Tower

Now in O and HO scales soon in N

10% off and **FREE** Shipping (US) on all call in and faxed orders for December

Randolph Depot →

Now in O, HO and N scale Z soon

The perfect Station for your layout that can be used in any era from the 1800's to today



← Derelict Passenger Car

By request now available in HO scale
Why cut up a nice car or kit when you can have it already done for you.



MOW car →

Now in On30, HO, HOn3, N and Z scales



Look for our new On30 Pickle car soon

Custom Laser Cutting and design
Dealers welcome



click here

5145 Gaffin Rd. SE • Salem, OR 97317 (503) 371-4290 • Fax: (503) 585-0850

E-mail: Sales@rslaserkits.com Web site: www.rslaserkits.com



ADVERTISEMENT

basis. But even now, I can see that the more heavily detailed and weathered units coexist nicely with these newer models on the layout (9 next page).

Another quartet of Atlas's beautiful Conrail B23-7s are under construction at this time as well. Since I've standardized on Tsunami decoders and Railmaster speakers, even the factory-sounded ones are being modified

with the same setup used in the U23s. It was also necessary to selectively repaint the Quality units I'd purchased, since Conrail's Quality scheme arrived after my era. To my chagrin, I also realized I had to remove the white frame stripe and white number boards from a handful of other locomotives, but it's not my top priority at this time for sure!

9



9: Stock Atlas U23B shown with Railmaster DSM-8 speaker installed at the rear. Note that the radiator hatch has largely been hollowed out, and the shell mounting areas have also been removed. The body has been glued to the walkways and the shell-to-frame mounting tabs have also been excised. This makes removal and re-installation of the body much easier. The radiator piece will simply be glued in place. We've found that we prefer the sound from a sealed carbody like this, since model speakers tend to contain too many high frequencies as compared to low frequencies. Having the speaker either face down or into a sealed area makes for a more realistic sound to the ears of our operating group.

10



10: CR U23B 2751 is mated to one of Neil Schofield's beautifully weathered B23-7s on an empty ballast extra at Skinner's Eddy. U23s and B23-7s were often freely intermixed on Conrail in this era and were commonly seen on ballast trains, along with locals and other service commonly assigned also to EMD GP38s. It was not uncommon to see them added to consists of higher horsepower locomotives to bump up the horsepower a bit on heavy road freights. This U23 is a lot cleaner than Neil's loco, but that won't be the case for long. The grills have been painted weathered black, as well as the trucks and underframe. Exhaust soot has been added to the roof, but this is otherwise a stock Atlas model.

END OF TRAIN DEVICE

FLASH CIRCUIT UNDER TRUCK

TRACK POWERED

BRIGHT RED FLASHING LIGHT!



READY TO RUN!

Installs in minutes with no freight car modification required!

RE RING ENGINEERING

Patented Technology - US Patent 7,549,609

Does not affect Load!

↓ Car without Load ↓

↓ Car with Load ↓



For video and more click here!

ADVERTISEMENT

And that's what's happening with eras and locomotives. Don't even get me started on freight cars! That analysis has yet to be done, and is sure to produce some interesting additions and subtractions. The ideal time to do that is when I start preparing waybills for operation, which has not yet begun.

Goals

I've been asked many times "so what's your next step?" and it's a very good question. By definition it's always the right question if you hope to make steady progress. Working back from the larger goal of "I want to have an op session", it means that I want to be done with making a mess in the new area of the layout room. That includes completing the scenery in the town of Meshoppen, which is on the other side of the peninsula from Mehoopany. Here's a sneak peek at progress there (11):

I also need to complete a ballast quarry operation with the help of Mike Confalone. We've found that taking turns working on each others' layouts has really helped us move beyond bottlenecks and it leverages each person's area of interest and capability. I just wish he wasn't two hours away. After that it's time to do the whole waybill and freight car pool project, and concurrently implement and learn Decoder Pro to really tweak all of those locomotive consists. So much to do, so little time! But that's what makes it such a great hobby.

Stay Real, until next time.



11: BUAL drifts past Meshoppen on the way to pick up and set out cars at Mehoopany, just around the river bend. Scenery has progressed in Meshoppen to the point that it was time to begin construction on Kintner Milling (foam core mock-up shown top left). Roads are largely in place, one of the houses has most of its greenery, and all that remains are driveways, sidewalks, lawns and a few details, in addition to the elevator. Most of the structures in the scene were built by Rich Cobb, one of the main reasons I'm this far along. Kintner Milling's design and construction will have a feature article all to itself down the road in 2013.

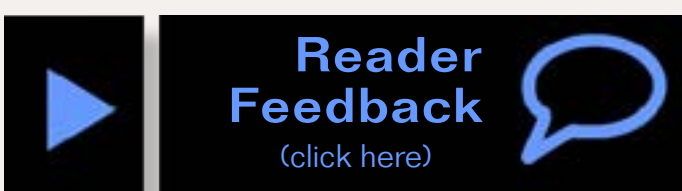

ADVERTISEMENT

Click here 

★ THIS IS THE MODEL TRAIN WEBSITE YOUR WIFE DOESN'T WANT YOU TO KNOW ABOUT



SO REAL... You'll Think You're There!

LokSound Select - 3 SIZES, ENDLESS POSSIBILITIES

**INDUSTRY LEADING MOTOR CONTROL
4 OR 8 Ohm SPEAKERS!**

- Multiples Bell types
- Multiple Brake squeals
- 4 or 6 Output functions depending on the style
- Up to 4 Primer Movers or Steam Sounds on EACH decoder
- 16 Very Playable LOUD Horns or Whistles depending on Profile
- All Changeable by using ONE CV! No Programmers or Boosters needed!*

**Small Size
BIG POWER! 1.1 Amp!
LokSound Select
"4 AUX"**



\$99.99

NEW 2011

LOKSOUND SELECT

Only Available From ESU LLC (USA)

**ONE SIZE FITS ALL!
LokSound Select "DIRECT"**



\$109.99

**6 Outputs!
LED Resistance
Built In!**

NEW 2011

LOKSOUND SELECT

Only Available From ESU LLC (USA)

**Tiny Size,
HUGE Versatility!
LokSound Select
"MICRO"**



\$99.99

NEW 2011

LOKSOUND SELECT

Only Available From ESU LLC (USA)

*ESU LokProgrammer needed to "Replace" Sound and for Firmware updates, not for normal editing

www.LokSound.com • 477 Knopp Drive Muncy, PA • 570-649-5048

Now on Facebook!





About our columnist



Ken Patterson has been published many times in *Model Railroader*, *Railroad Model Craftsman*, and other model train publications. His backyard, on a bluff above the Mississippi River provides an ideal background for his commercial photography.

What's Neat This Week: Model Railroad Artist Mike Budde Photo Presentation of Ken Patterson's Ongoing Experiences

Modeler Mike Budde does some great miniature reproductions of auto racks ...

Mike Budde first came to my attention in the early '90s when *Rail Model Journal* (RMJ) had a freight car weathering contest. Mike won the contest with a very realistically weathered Rock Island cylindrical hopper.

RMJ Editor Bob Schleicher mentioned to me on the phone that his first place winner was from my town: St. Louis. Schleicher decided to be coy; said he wasn't going to tell me who it was! Eventually, after I promised Schleicher a few articles, he did relinquish the

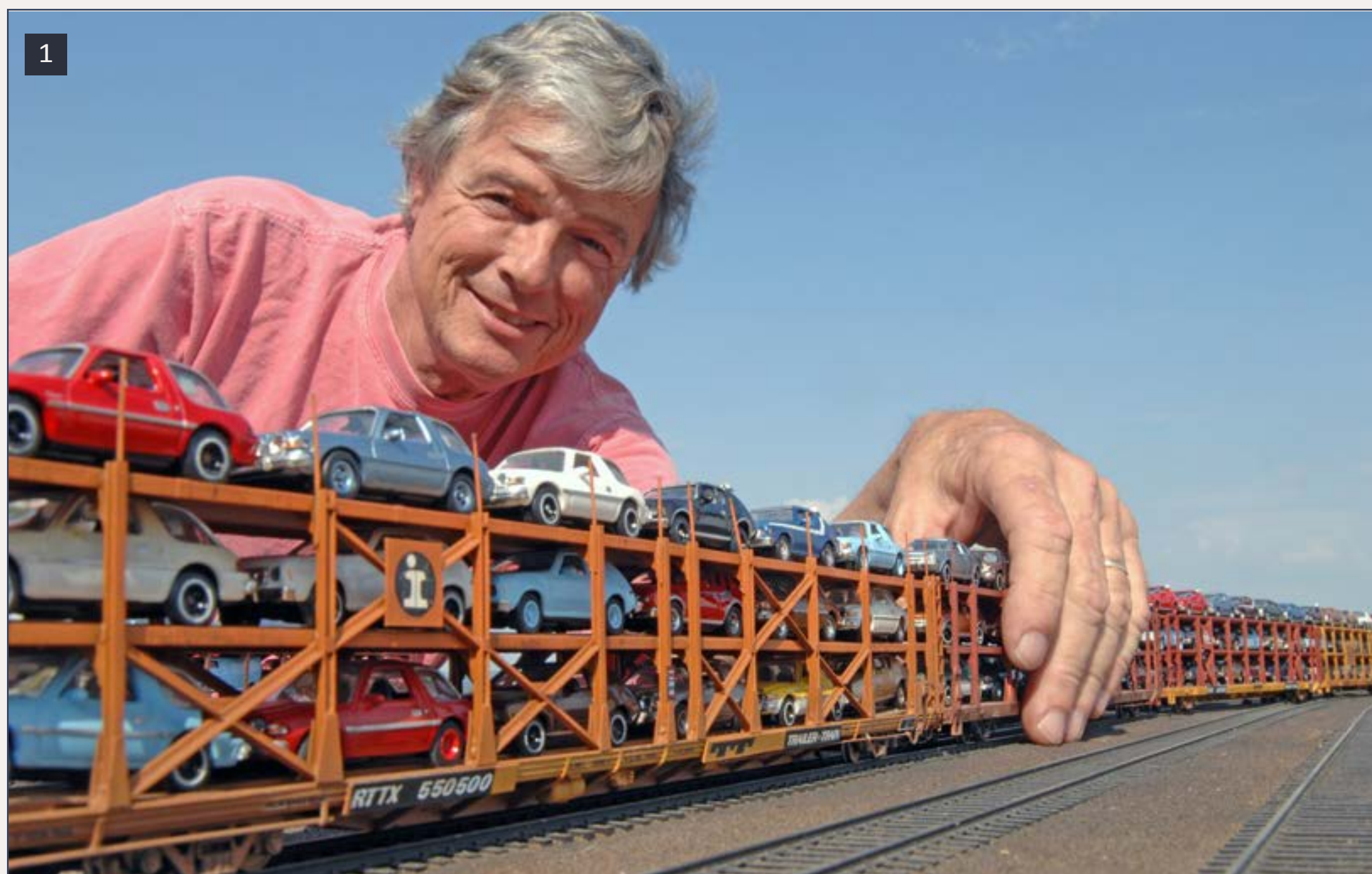

1: Mike Budde displays some of his carefully detailed and weathered IC auto racks.

 **Reader Feedback** 
(click here)

contest winner's name: Mike Budde. Mike was a lone wolf modeler who wasn't known in any of the local modeling circles. His weathering techniques were done by hand and self-taught, motivated by the need to get the most realistic looking equipment possible.

During a visit to our club's modular layout, The Midwest Valley Modelers, Mike displayed an array of auto racks and 89-foot auto parts cars, realistically weathered with oils like none I had ever seen.

That's when I learned to appreciate the art of oil paint weathering – and that you can glue an auto rack car scratch-built from wood together with Elmer's white glue, and it will hold!

2: There's nothing like combining outdoor diorama photograph techniques with great modeling like that of Mike Budde. Mike's autoracks look pretty nice, don't you think?

3: This black CP tri-level represents a Whitehead & Kales rack on a Canadian-built National Steel Car Company flat. This flat, reporting marks CP Rail #550135, is a modified Walthers car with scratchbuilt racks. Mike achieved the protective screen effect with Plano Roof walk sheet material. Mike loaded the rack with various HO Fords, complete with window stickers!



Around that time Mike started writing articles for the hobby press, and he now has about 10 articles to his credit. I'm inviting Mike to write a few articles for MRH, so that we can all benefit from his insightful modeling techniques (If you'd like to encourage Mike to write articles for MRH, click on the comments button on this column to post your thoughts).

So, without further ado, enjoy these examples of Mike's outstanding work on the following pages.

Pictures continue on next pages.

Please
mention
MRH
when
contacting
hobby
vendors.

4



6



5



4: Mike decorated TTBX 942344 in MKT Green by altering a Walthers bi-level kit. Mike replaced the stock side screens with Plano Model Products etched metal side screens. Adding these screens required Mike to open the ends and the areas between the side posts, along with the need to add an upper deck.

5: Mike's model of Missouri Pacific TTKX 801341 is a completely scratchbuilt representation of a Whitehead & Kales auto rack, mounted on a Pullman-Standard low-level flat. Mike made the side panels from Evergreen siding material. Mike used prototype photos as reference, and duplicated the prototype's weathering and look, right down to the actual graffiti on the prototype!

6: To model this wrecked auto rack full of Ford vans, Mike started with an Accurail auto rack. Mike formed the torn and damaged areas with aluminum foil. Very effective!

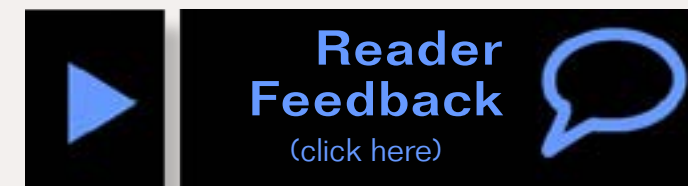



7: Mike Budde is a real scratchbuilder, as we can see here with Mike working on this 1:25 scale auto rack model. This is a Whitehead and Kales "Stack Pack" auto rack, mounted on a Bethlehem Steel Car Co. F-89GH flatcar, with a build date 10-1964.

This model is completely scratchbuilt, started in 1977 and completed in 2011. The only commercial parts Mike used were couplers, nut bolt & washer castings, and Erector Set wheels turned on a drill. Mike made the flatcar and truck side frames from wood. Mike finished the

flatcar part of the model in 1982, and it features working end-of-car cushioning. Mike built the upper rack from styrene. Mike built the 1/25th scale 1969 Chevelle models from AMT, kitbashed into the 7 different body styles available in 1969 from GM.

Mike reproduced in resin many of the parts he scratchbuilt for the project, including gussets and brake shoes on the flat. Resin parts Mike made for the Chevilles include flat hoods, open wheels, bench seats, headrests and steering columns.

Video on next page.



Play video

ADVERTISEMENT



Rusty Stumps
Scale Models

WE ONLY SELL WHAT WE MANUFACTURE

DETAILS IN HO, O, S & N SCALES
LASER CUT SHINGLES, DOORS & WINDOWS,
FENCES, SIDING, CRATES. Also RESIN and
WHITE METAL DETAILING CASTINGS.

CRAFTSMAN KITS
IN HO, O & S SCALES

CHECK IT ALL OUT AT
WWW.RUSTYSTUMPS.COM

Send \$3.50 for Catalog - Specify Scale
RUSTY STUMPS SCALE MODELS
6785 Cherry Blossom W. Dr., Fishers IN 46038
Phone (317) 595-9489



ADVERTISEMENT

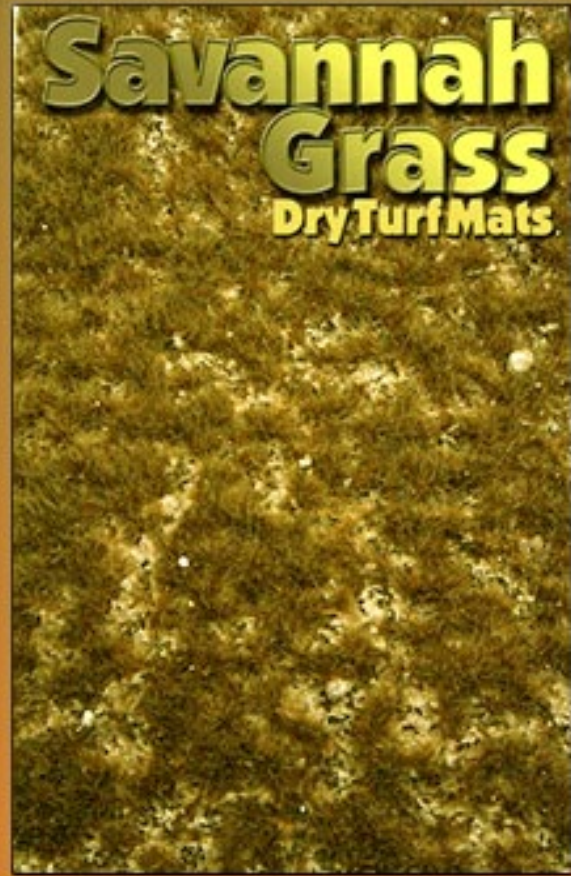

Click for more - lots more!





Whip Your Flextrack Into Shape!

With Fast Tracks *SweepSticks*

Available now for all popular scales in straight and curved sweeps with a large selection of radiuses.



Order online now at:

www.fast-tracks.net/sweepsticks

STREAMLINED BACKSHOP SERVICES

DCC Decoders Galore!

[Elektronik](#) [TCS](#) [SOUNDTRAXX](#) [Digital](#) [DCC](#)
[Digitrax](#) [NCE](#) [ESU](#) [MRC](#) [QSI](#) [Zimo](#)

www.SBS4DCC.com

Looking for a signaling solution or fast clocks? Look no further!

LOGIC RAIL™ TECHNOLOGIES "Sophisticated Model Railroad Electronics"

Please visit our website and online store!

21175 Tomball Pkwy Phone: (281)251-5813
 Suite 287 <http://www.logicrailtech.com>
 Houston, TX 77070 info@logicrailtech.com

True Scene™ Modeling

NEW FusionFiber™

Dependable Quality. Easier than Plaster!

SATISFACTION GUARANTEED!

www.truescene.com or 716-523-7305

Goes on easy

All Scales
All Brands

Recommended installation tool

SNOT = SAND

99% Know It Works!

Make a Tire or Retire

Green Grip from a Jar

WWW.BULLFROGSNOT.COM

Affordable custom and modular benchwork.

BenchWork.com

ON3 - ON30

Click to visit ...

WWW.SANJUANCARCO.COM

Backdrop Junction

Your stop for Model Railroad Backdrops

backdropjunction.com

N, HO, O Scales • Custom Orders

WESTERFIELD GOLDEN AGE LINE
MODELS, L.L.C.

Available Again

#3200 Series H21 / H21A
More RI Stock Versions Soon

westerfieldmodels.com

HOBBY MARKET-PLACE ads are economical and effective.

Click HERE to learn more.

Great Decals!

is now selling decals produced by *After Hours Graphics* for Midwestern railroads. Roads offered include C&O, Cincinnati Union Terminal, Conrail, CSX, DT&I, Great Miami, Indiana and Ohio, Interstate, NKP, Norfolk and Western, Pere Marquette, Southern, Transkentucky, and private labels Dow and Owensboro Grain.

For the complete list, see:

[www.greatdecals.com/
AfterHours/AfterHoursList.html](http://www.greatdecals.com/AfterHours/AfterHoursList.html)

Great Decals!
P. O. Box 994, Herndon, VA 20172

RULERS of the WORLD

Scale Rulers \$4 each
Over 150 scales!

Metric or Imperial

www.rulers-of-the-world.com

Your Text Ad

Could be here for a remarkably
affordable price!

[mrhmag.com/advertise with us](http://mrhmag.com/advertise_with_us)

The Proto:87 Stores

21st Century, Model Railroad
Miniature Engineering for
everyone. Actually making
your model track and control
systems look and work the way
the Prototype does. All without
needing craftsman skills, or
crawling under your layout.

www.proto87.com



Railroad Art-Prints,
Caps, Jackets,
Shirts and More ...
Jackets starting
at \$79.95

www.jelsma.com

1-904-221-3513 • Jacksonville, FL.

Your ad could be
here and reach
up to 65,000.

Click to find out how.

Please
mention
MRH
when
contacting
hobby
vendors.

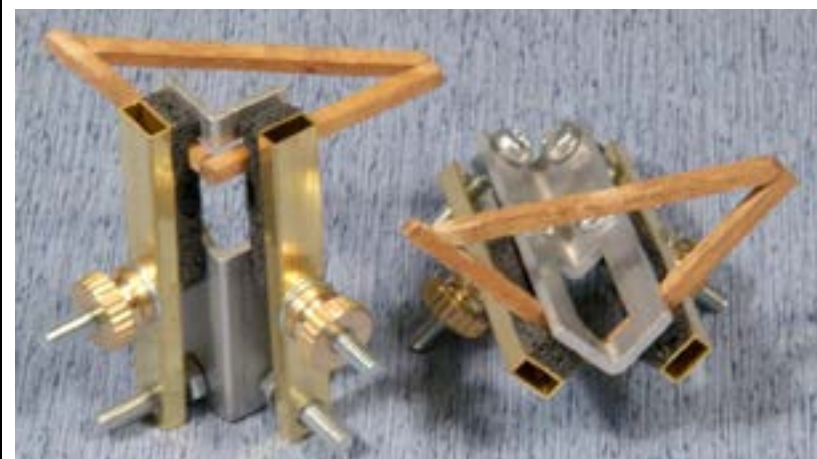

AC-2-2 "Mini Right Clamp"™ used for gluing Bulkhead Frames.



AC-1-1 "Original Right Clamp"™ used for Bulkhead Assembly.



Assembled Bulkhead in gondola with load of ring castings.

Right and Splice Clamp –Tools for Modelers

See all our products at:

www.coffmaneng.com

Coffman Graphic Solutions Co.

1500 River Circle, Richmond, KY 40475-7907

Phone: 859-527-0476, Fax: 859-527-0485



We Carry Over **39**
Major Suppliers So
Your DCC Needs
Are *Always* Covered!



www.Mr-DCC.com

623-298-7355

1-(888)-395-3976

ADVERTISEMENT

THIS IS
THE
MODEL
TRAIN
WEBSITE
YOUR WIFE
DOESN'T
WANT YOU
TO KNOW
ABOUT

THE CAR SHOP





to the rolling resistance of a train but are best handled near the head end. Many people use them in special track cleaning trains in combination with cleaner cars that dispense alcohol or lacquer thinner, and they are also ideal for clean-as-you-go maintenance in regular trains.

Here's how we built a couple:

Classic track-cleaner

Make "car sledding" useful ...

- by Joe Brugger
Photos by the author

 **Reader Feedback**
(click here) 

But dust is everywhere (except Intel's computer chip fabricating factories) and eventually it's going to settle on the model railroad.

One good way to maintain that critical contact patch between wheels and rails is the long-popular 'sled,' a piece of Masonite dragged along beneath a freight car. With beveled ends and a floating suspension, the Masonite pad skates along the top of the rail, polishing the surface and picking up assorted bits of crud.

Sleds are easy to make and easy to use. Built properly they don't add a lot

Even in a weather-tight air-conditioned room, it can be hard to keep track clean. Polishing routines work and some people use an ultra-thin film of clipper oil.



1: Masonite blank: Cut a rectangle of 1/8" hardboard to the width of the car body, and about 3/4" shorter than the distance between the flanges on the inner wheel sets. Use a file or medium-grade sandpaper to round off the ends and edges of the sled to keep it from catching on irregular track work. Some commercial sleds are narrower but can hang up on the rail in a tight curve. These sleds will work well down to about an 18" radius.

2: Mounting posts: Mark the center line, then locate mounting points for a couple of machine screws. Check the sled pad against the underframe to find the best place for the posts. Mount the rough side down. Machine screws are epoxied to the mounting points. The screws need to be narrow enough to fit up inside the car's center sill, and short enough to easily clear the roof.



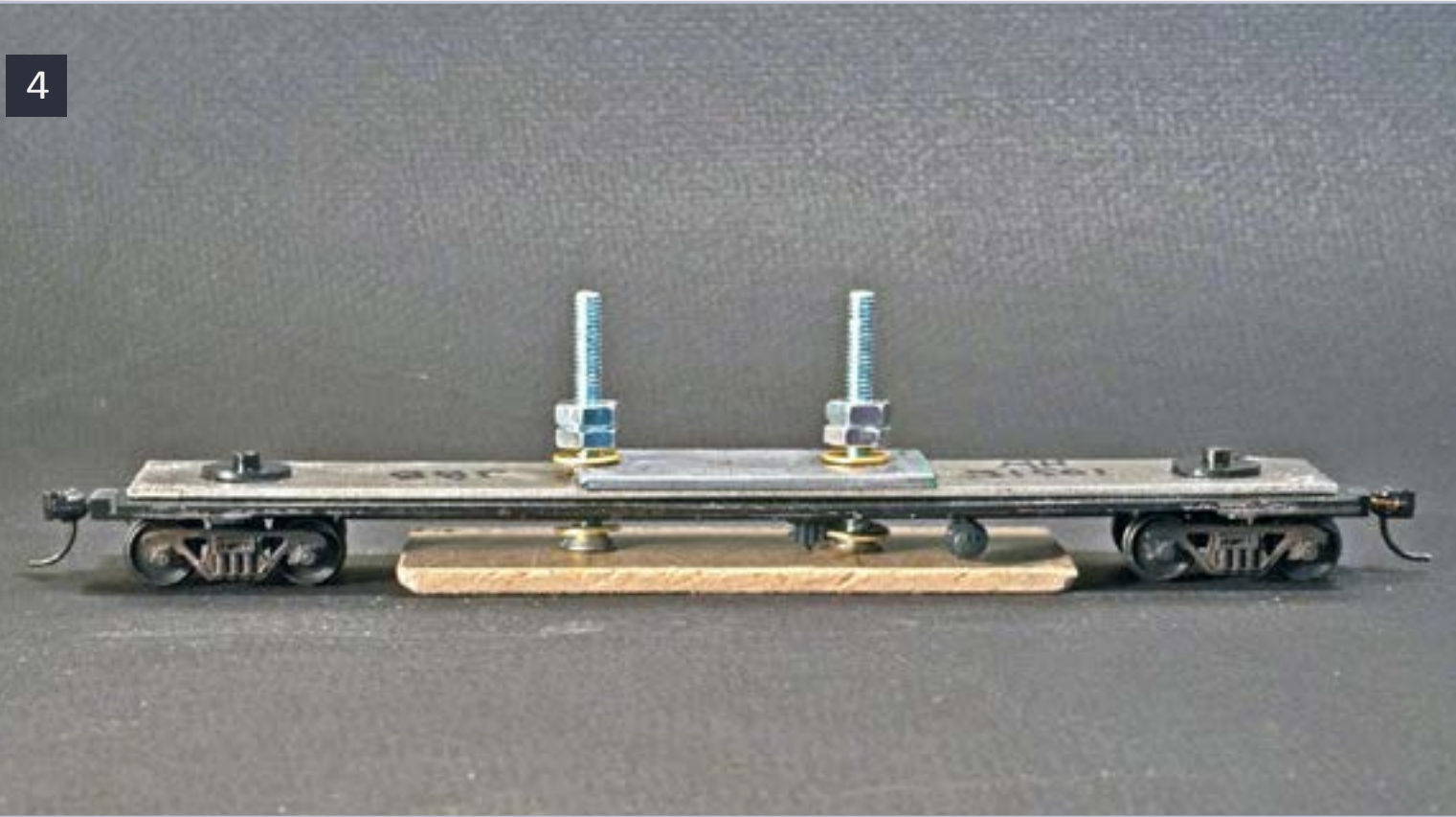
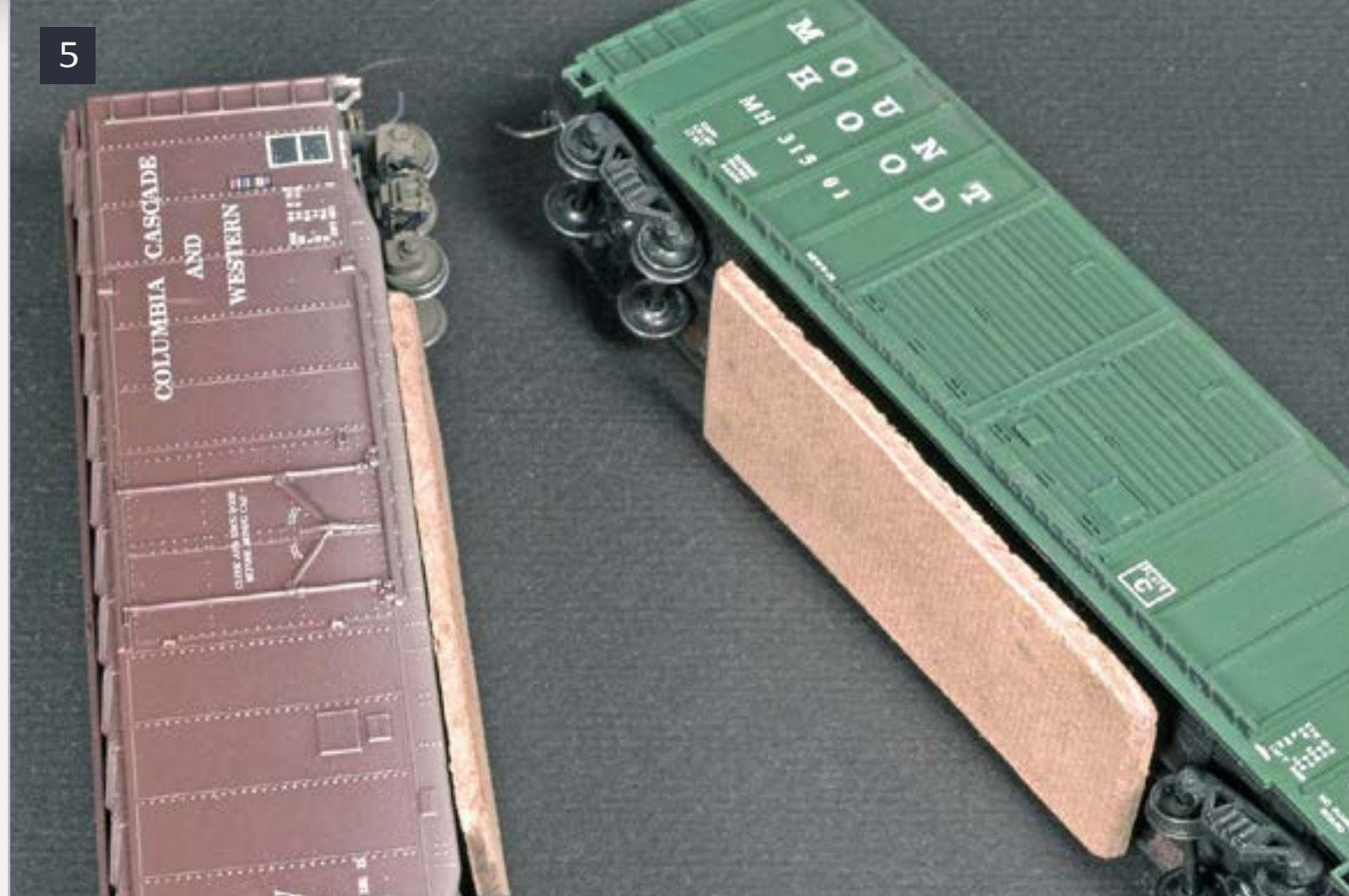
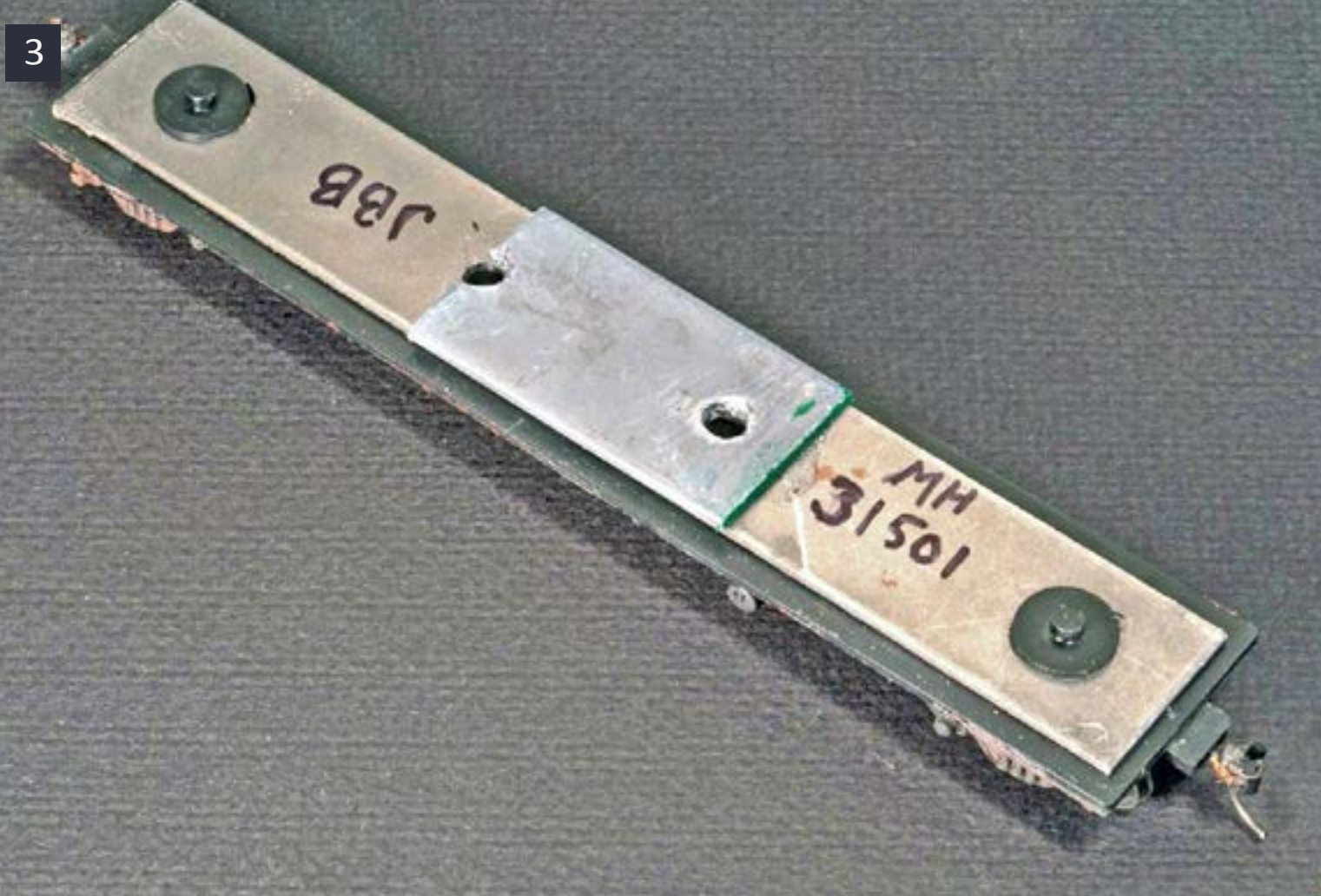

3: Underframe: Clamp the underframe in a vise, mark a center line and transfer the mounting point positions. Use a center punch to mark the holes to keep the drill from wandering. The drill should be slightly larger than the diameter of the machine screws so the pads will be able to float freely. On this Model Die Casting car, under-car details didn't interfere. On a similar Athearn car, the center section of the underframe was cut away and discarded to allow the sled to move around.

4: Assembly: Place a washer on each mounting post, then slide the underframe down onto the sled. Add another washer up top, and then run two nuts down each screw to secure it. The washers help to keep the sled from hanging up. Jam the nuts so they lock together, allowing 1/8" or so of clearance to let the sled move freely. The hardware provides enough weight to allow good cleaning action without adding excessive drag.

5: All together: Here's how they look. Be sure the sled corners are rounded off, and they don't interfere with the wheels. Because of the added rolling resistance, cleaning sleds should be in the first few cars behind the motive power to avoid string line accidents.

Reader Feedback
 (click here) 

6

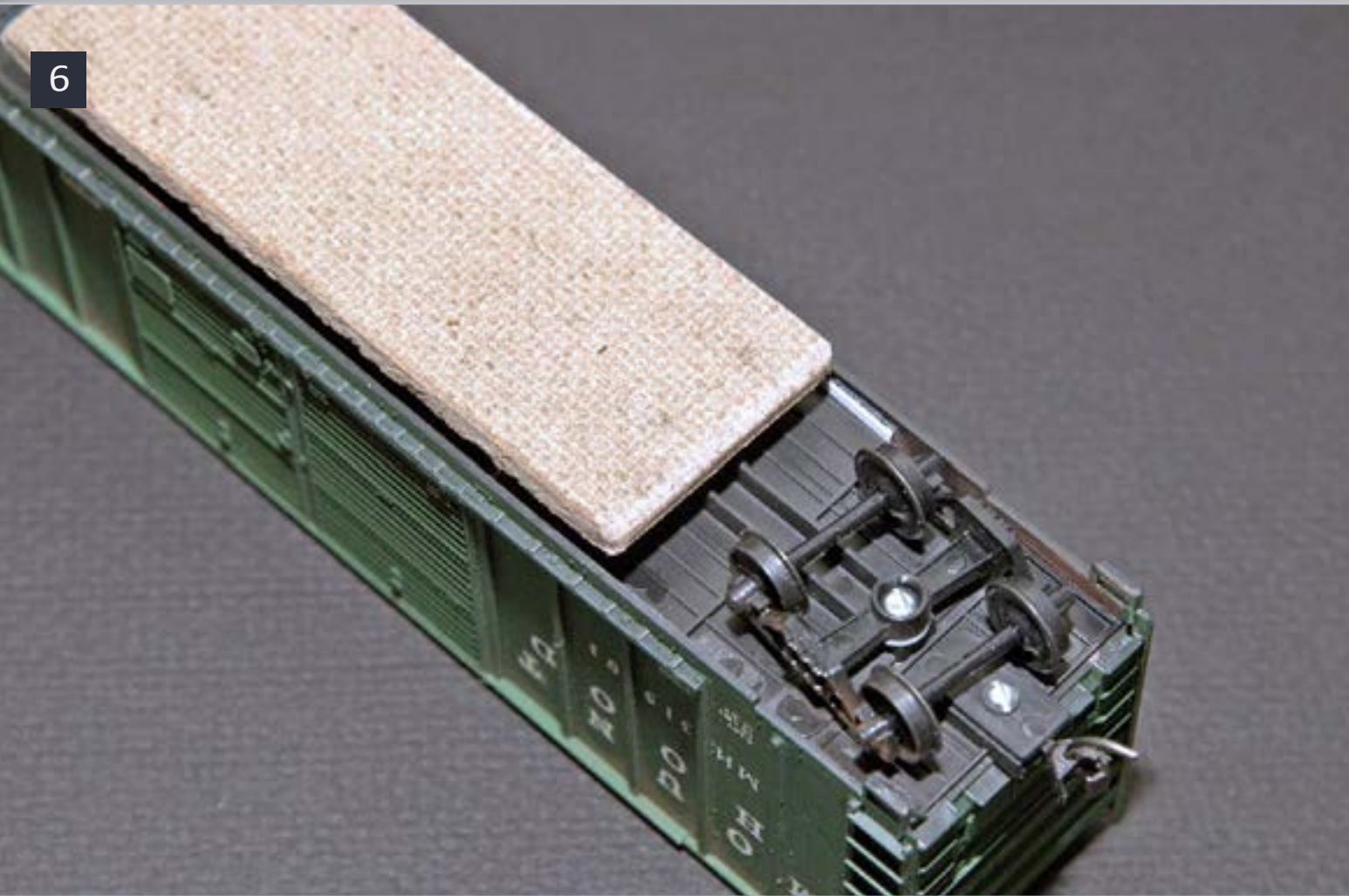

7



6: **Body shell retainers:** The extra weight of the sled will overpower retaining clips on shake-together freight car kits. Gluing thin strips of plastic (visible between the sled and the wheels) helps to hold the underframe into the body. The car body can still be removed if necessary.

7: **All finished:** There's not a lot of point in disguising a hunk of Masonite dragging along underneath a freight car, but a spray of matte black paint on the top and sides will make them less obtrusive. DO NOT paint the surface that rubs on the rails. Accumulated dirt can be cleaned off the sled with a light sanding. ✓

NEW for DECEMBER!

HO & N Scale

MC-5017, 60-5017
(BLACK)
MC-6018, 60-5018
(WHITE)
Pullman Standard
Covered Hopper
Data 4000-4750cuft

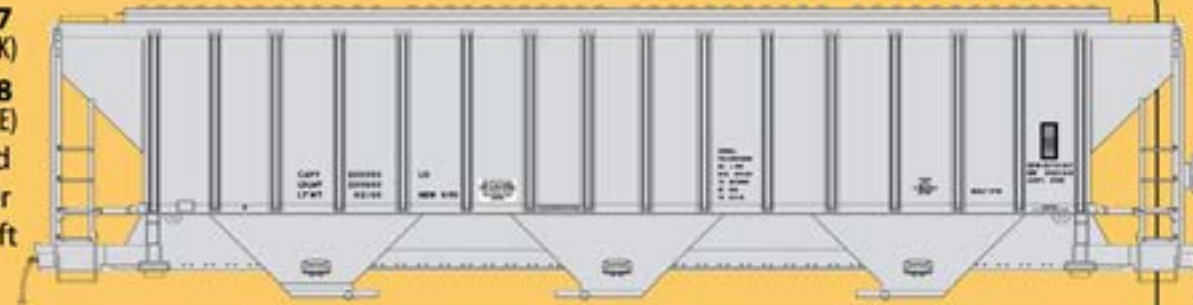

87-219 & 60-219
Cotton Belt
Common Standard
Heralds and Lettering
40' and 50' Boxcars
Use with 87-1369 for
more lettering
options

87-251 & 60-251
Burlington Northern
Common Standard
Heralds and Lettering
for 40' and 50'
Post-BN Merger Boxcars
Use with 87-1377 for
more lettering options



87-272 & 60-272
Western Pacific
Modernized Feather
Herald for PC&F
and FMC double door
boxcars

ADVERTISEMENT

NOVEMBER NEW RELEASES

[click here](#)



87-1387 & 60-1387
Seaboard Coast Line and Family Lines
Covered Hoppers (Includes L&N Family Lines
repainted ACF Centerflow)

[click here](#)



87-1389 & 60-1389
Pacer Stacktrain 53' Container and
MAXI IV 3 Unit Well Cars

[click here](#)



87-1388 & 60-1388
Great Northern Wood Boxcars
(Includes Sidefacing Goat) Circa 1928-1953

[click here](#)



87-1390 & 60-1390
Southern Pacific and Cotton Belt Cement Hoppers
(Includes Repaints, and "ghosted" faded style lettering)



microscale.com

MADE IN THE USA

Micro-Mark[®]

THE SMALL TOOL SPECIALISTS

Berkeley Heights, New Jersey 07922

Your source for hard-to-find
mini tools and model building
supplies at low prices!

15% OFF Any Order!



**In the
Spotlight!**

To receive discount, place your order online at
www.micromark.com/BA30

or call 1-800-225-1066 and mention Promo Code BA30

**The Topside
Creeper[™]
Safely
Extends Your
Reach...
Reduces Back,
Leg and
Knee Stress**



#83876

**FREE
CATALOG!**
with any
order

15% discount offer ends 12/31/12.
Pre-order items excluded from
this offer. Cannot be combined
with any other offer.



Modeling a Coal Loader • Part 1



– **Tom Patterson**
Photos by the author

Tom Patterson describes in step-by-step fashion how he built this small coal tipple. Follow along with Tom to see how he did it ...

When I first saw a picture of the small truck loader next to Haysi tunnel on the Clinchfield Railroad many years ago, I knew that I would eventually build a similar structure for my layout. Structures such as this were once common throughout the coal fields of Appalachia and could be found along

the right-of-way of most of the coal hauling railroads in the region. Once I decided to add a small tipple to the spur at Big Chimney, West Virginia on my Chesapeake, Wheeling and Erie Railroad, it was easy to choose which one to model.

I have collected several photos of the Atomic tipple at Berta Junction over

the years along with photos of similar tipples. The real impetus to get started on this project occurred when I purchased Bob Helm's book titled

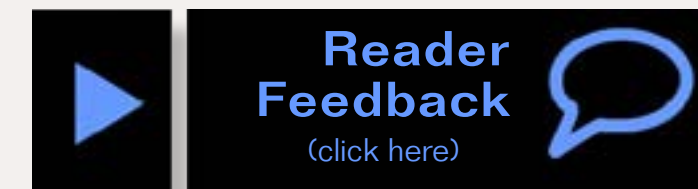

“The Clinchfield Railroad in the Coal Fields.” There are several photos of the Atomic tipple taken by preeminent coal field photographer Everett N. Young that are included in the book. There are also many other color photos of tipples on the Clinchfield in the book. I highly recommend it to anyone interested in coal hauling railroads and tipples. A book is due out in November from Morning Sun Books titled *“Appalachian Coal Mines and Railroads in Color Vol. 1: Kentucky-the Color Photography of Everett N. Young”* by Stephen M. Timko featuring many photos of tipples in eastern Kentucky.

While I don’t have plans for the actual structure and never saw it in person, I used the photos I do have to estimate sizes and develop a plan for constructing the tipple.

I also used an article titled “A coal loader for the Roakandee Mountain RR” by Richard Knapp that appeared in the February 1983 edition of Model Railroader magazine. The article detailed the construction of a small truck dump tipple that stood on the Clinchfield at Bartlick, Virginia. This article provided the basic dimensions of the large conveyor and the breaker and apron. So with this background, let’s get started on construction.



1: The photo above, taken by Everett Young, shows the tipple on July 29, 1978 as Clinchfield No. 26, southbound from Elkhorn City, exits Haysi Tunnel at Berta Junction. The tipple had a different roof configuration at the end in earlier shots that I’ve seen, but its appearance at this point in time was what I wanted to capture in the model.

STEP 1: Mock Up the Structure



2: Blocks of wood are placed in site to mock up the loader.

In order to get an idea of the size and placement of the tippie, I gathered some wood blocks from my box of blocks (see sidebar next month on "Box of Blocks") and mocked up the ramp, loading bin, breaker and conveyors. The tippie needs to be able to serve 3-4 hopper cars, and I wanted to make sure there would be enough room on the spur for the hopper cars to be shoved past the loading point.

Empty hopper cars were typically spotted so that once loaded, they could be rolled past the tippie using only gravity and the car's brakes. In some places winches or front end loaders were also used to move the cars. Using the blocks for the mock-up helped me make sure there would be adequate space on the spur for spotting the hopper cars in a more prototypical manner.

STEP 2: The Conveyor Supports

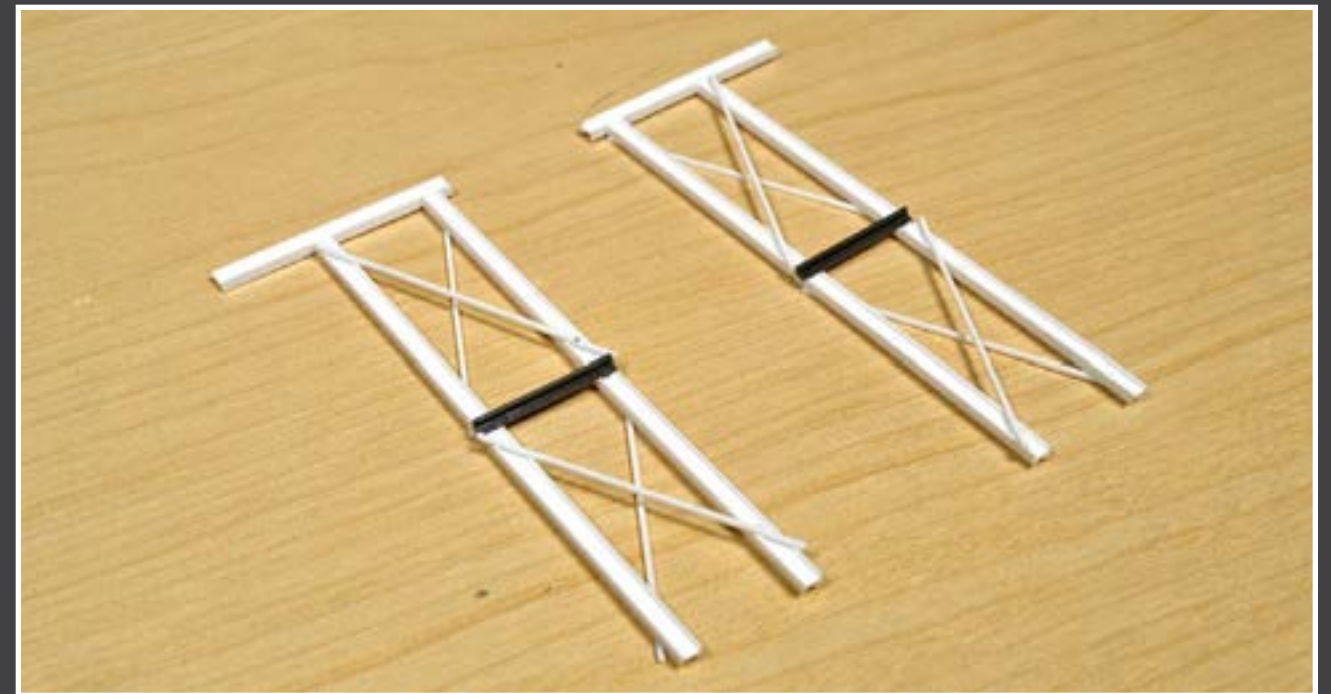

3: Left and right side of conveyor support structure.

Start construction with the end of the conveyor that sits adjacent to the spur. The end is a small, square structure made from I-beams and angle iron, and the conveyor rests on one side of it. There is also a small, short conveyor located on top of this structure that moves the coal from the end of the conveyor to the center of the spur where the coal is dropped into waiting hopper cars.

Start by cutting two 18' lengths of .080 I-beam and a 7 1/2' length of I-beam. Mark a scale 6" from the end of the 7 1/2' piece and glue one of the 18' lengths of I-beam here, with the edge of the I-beam flush with the 6" mark. Next, measure 4 1/4' along the top piece of I-beam and glue the second piece of 18' I-beam here.

The distance between the outer edges of the 18' I-beams should be 4 1/4'. For the lateral brace about mid-way up the 18' I-beams, cut a 4 1/4' piece of 1/16" Plastruct angle. Measure up 9' from the bottom of the 18' I-beams, file the flanges flat so that the piece of angle will lie flush against the entire surface of the I-beam, and glue the angle in place.

I use Testor's Liquid Cement when gluing styrene pieces to Plastruct pieces and Ambroid Pro Weld when gluing Plastruct pieces to other Plastruct pieces.

STEP 2: The Conveyor Supports *Continued ...*

For the cross bracing, I cut pieces of Evergreen HO scale 2 x2 and glued them in place. It's apparent from the photos of this tippie that the cross braces were tack-welded in place with little concern for accurate placement. As is often the case with structures like this in the coal fields, the objective was to get the facility operational – not to make it pretty.

Repeat these steps for the other half of the structure.

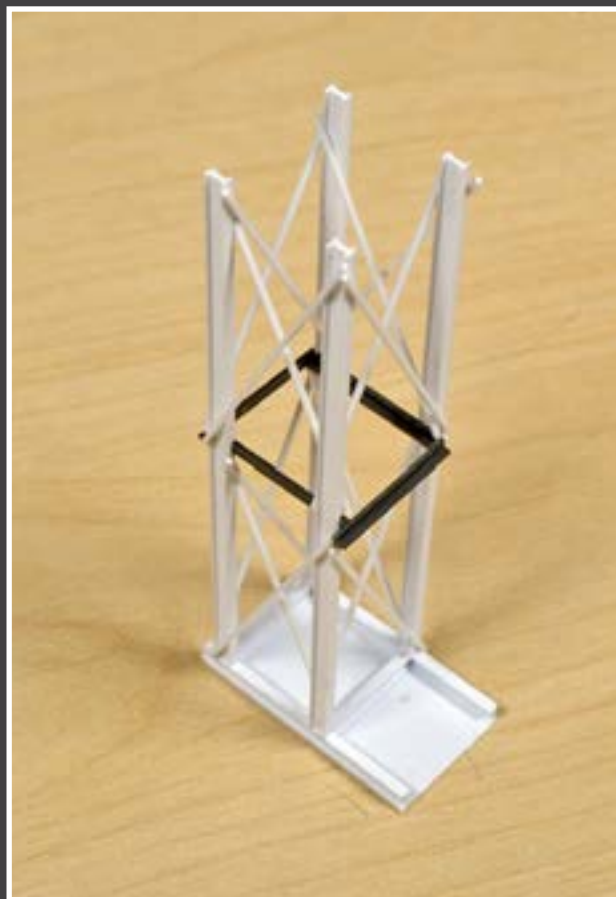

4: A piece of sheet styrene forms the top of this structure.

Next, cut a piece of .010 sheet styrene to measure a scale 7'6" x 4'3". This will represent the plate steel that is welded to the tops of the two sides made in the previous step. Attach each of the side structures to the piece of styrene as shown here (4).

Cut two small pieces of .080 I-beam to fit between the two sides and glue them in place so that they line up with the I-beams on the sides. For the horizontal side braces, cut two pieces of Plastruct 1/16" channel to a length of 4'3" and glue them to the outside of the I-beams at the same level as the inside cross braces.

To finish this step, cut pieces of scale 2" x 2" to complete the x-bracing on the front and back of the structure. Set the tower aside for now.

STEP 3: The Basic Conveyor Frame



5: A plate glass base helps to keep the I-beams perfectly flat.

Now we'll start construction of the main conveyor.

Begin by cutting two pieces of Evergreen .080 I-beam a scale 60' long. As you can see in the photo above, I'm working on a piece of glass in order to have a perfectly flat surface. In order to keep the two I-beams a scale 2' apart, I cut 4 short pieces of 6" x 6" styrene and glued them together to use as spacers. Make two of these or find something else to use as a spacer.

Place the two I-beams beside each other, insert your spacer and place a scale rule against the outside of one of the I-beams as in the photo. I used two small blocks to keep the I-beams snug against the spacers. Next, cut 11 pieces of Plastruct 1/16" channel to a scale 6'9". Place the first channel at the end and allow it to stick out a scale 9" past the end of the I-beam as shown in the photo here (5).

STEP 3: The Basic Conveyor Frame *Continued ...*



Once the glue on the channel applied above is dry, measure down a scale 6' and repeat the process. As you can see from this photo (6), I have placed a long scale ruler along the I-beam and the short scale rule on top of it. Make a light pencil mark on the I-beam every 6' and use the small scale rule to measure the 9" inch distance from the end of the channel to the side of the I-beam.

Move the blocks and the spacers down the I-beams to install the rest of the channels (6).

6: Using scale rulers in this way, helps to get exact measurements.

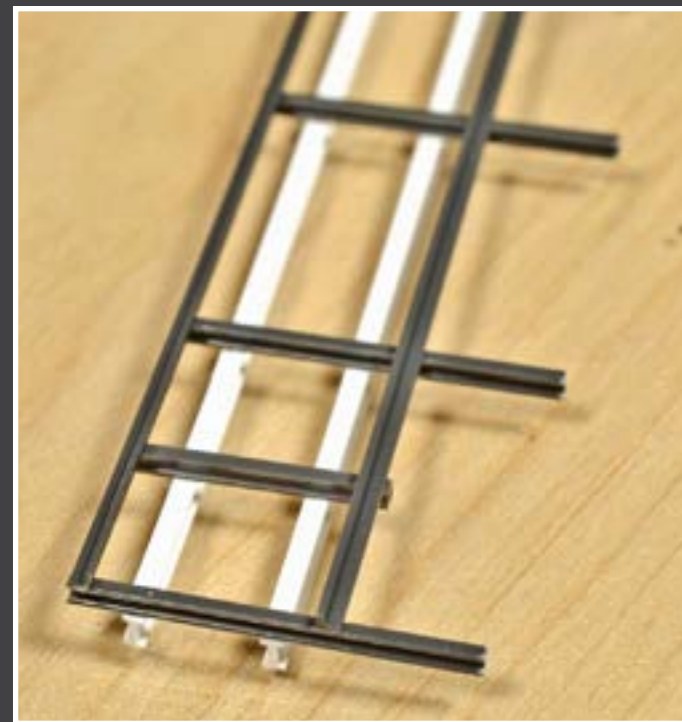

Cut 2 pieces of Plastruct 1/16" angle to a scale 60' length. Glue the first piece to the end of the channels that extend 9' from the I-beams. Next, measure a scale 9" from the outside of the other I-beam and glue the second piece of angle in place, making sure that the outside edge of the angle lines up with the 9" mark.

NOTE: Be sure the bottom leg of the angles face outward as in the photo here (7). Use this angle later to install the braces for the bottom rollers of the conveyor.

7: Glue the Plastruct angles to the channels.

at one end. This piece of channel will be used later to support some of the motor mechanisms.

Cut a length of 1/16" channel to a length of 4'3" and glue it halfway between the two longer channels

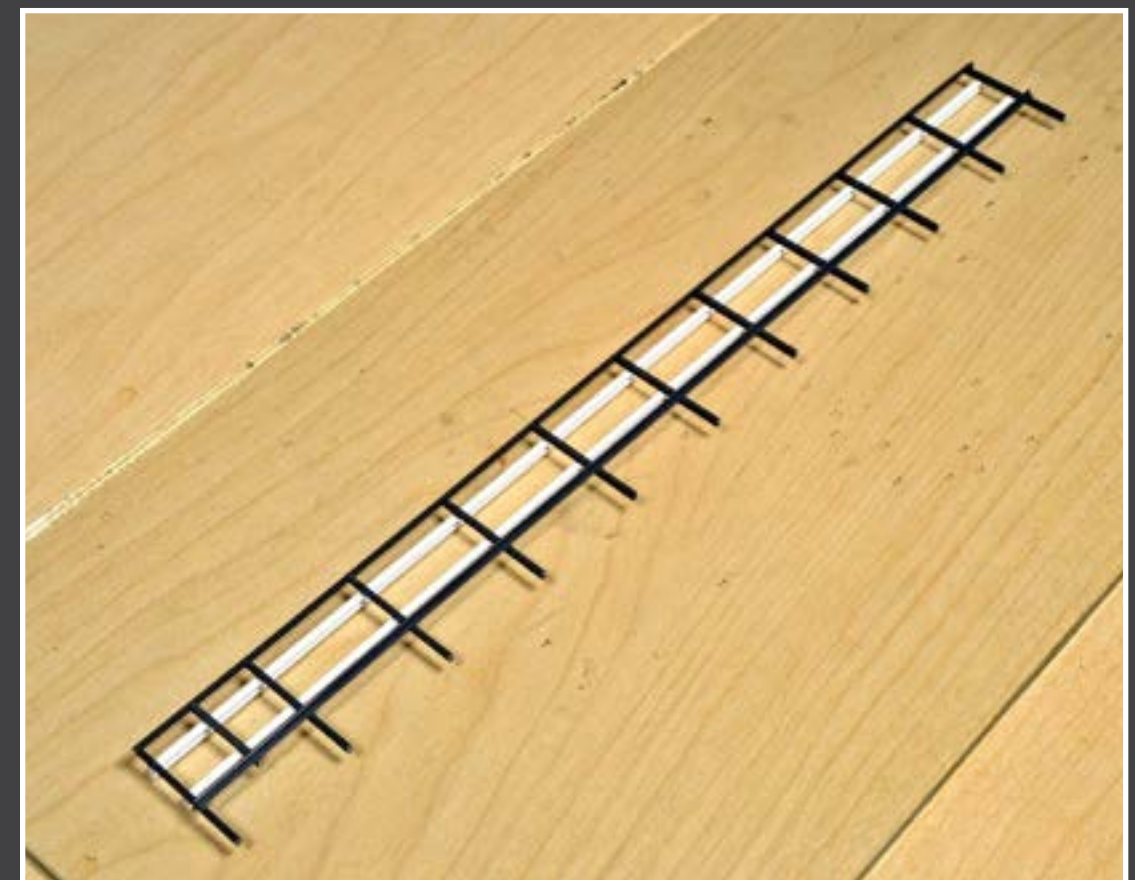

8: The completed main conveyor.

The photo here (8) shows the completed main conveyor at this point. The next step is to work on the rollers at the end of the conveyor (8).

STEP 4: Finish Conveyor Frame and Support Bents

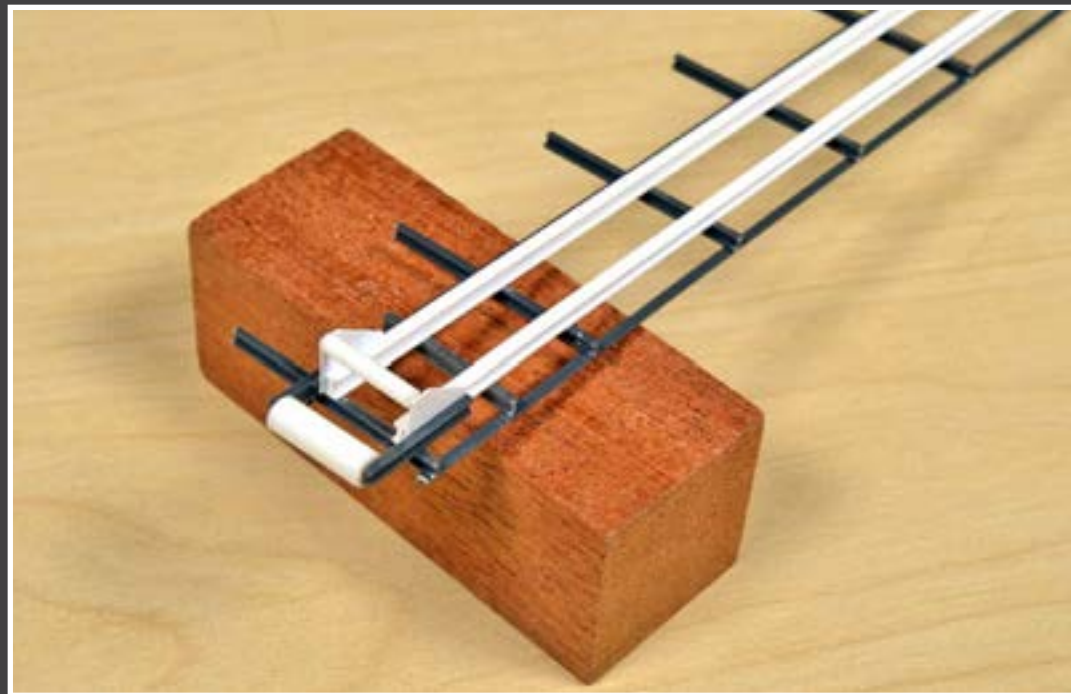

9: End plate and roller assembly.

For the two plates at the end of the conveyor that hold the last small roller, cut 2 pieces of .010 styrene to measure 2' x 1 1/2'. Next, make a mark on the short side of each piece to match the width of the .080 I-beam and cut off the corner to match the shape in the photo above. See the conveyor bracket top end drawing in diagram 1 (see page ??) for the bracket dimensions.

Glue these pieces on either side of the .080 I-beam making sure that the angle is away from the end of the conveyor. Cut 2 pieces of 1/16" channel to a length of 3'6" and glue them to the .010 plates so that 1 1/2' stick out past the end of the conveyor.

For the roller, cut a piece of 1/16" diameter styrene rod to a length of 4'3" inches and glue it to the top of the side plates as shown in the photo. For the large roller at the end, cut a length of 1/8" styrene tube to a length of 4'3" and glue it between the 2 pieces of 1/16" channel (9).



10: Add the bents that hold up the conveyor.

At this point, make the bents that hold up the conveyor in order to avoid handling the conveyor once additional detail is added. Begin by cutting 2 pieces of .080 I-beam to a length of 1'6". These will be used to hold the end of the conveyor on the tower.

Stand the tower up on a flat surface and glue the first piece of I-beam vertically at the corner of the platform at the top of the tower – see the photo here (10). Next, measure the inside distance between the 2 pieces of angle that run the length of the conveyor.

The I-beams are going to support the conveyor on the bottom of the last piece of 1/16" channel. Use the measurement from between the 2 angles to mark the distance on the platform from the first small piece of vertical I-beam. Now glue the second piece in place.

Note in the photo here (10) that the second piece of vertical I-beam is set in from the edge of the platform. This creates a slight angle between the platform and the conveyor and allows the bottom of the conveyor to move away from the track (10).

Diagrams of the Conveyor bracket and and the Breaker bin ...

Conveyor bracket - bottom end

Drawing 1

Conveyor bracket - top end

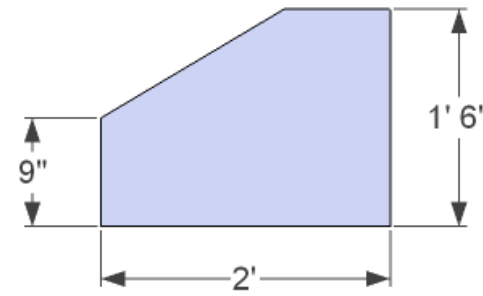
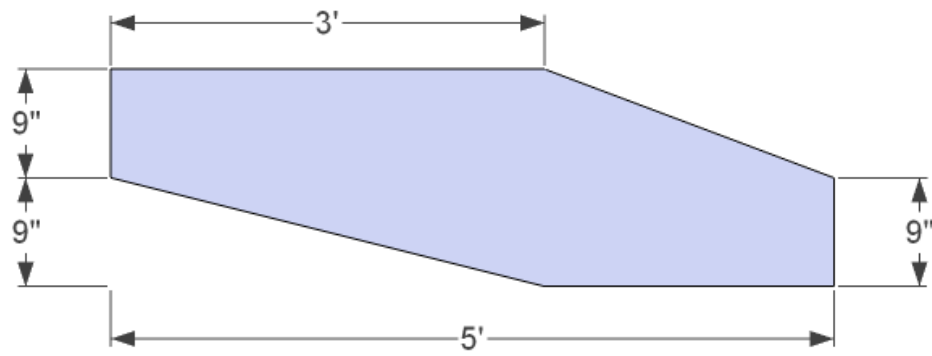

Drawing 2

Breaker

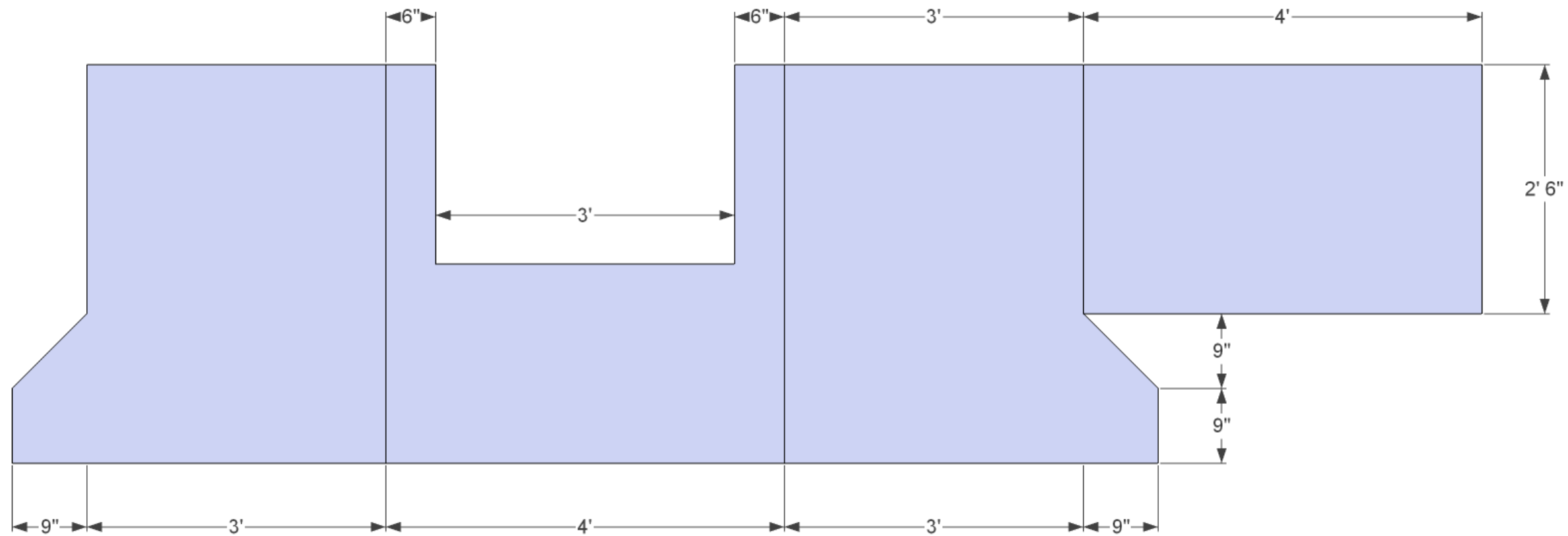

STEP 4: Finish Conveyor Frame and Support Bents *Continued ...*

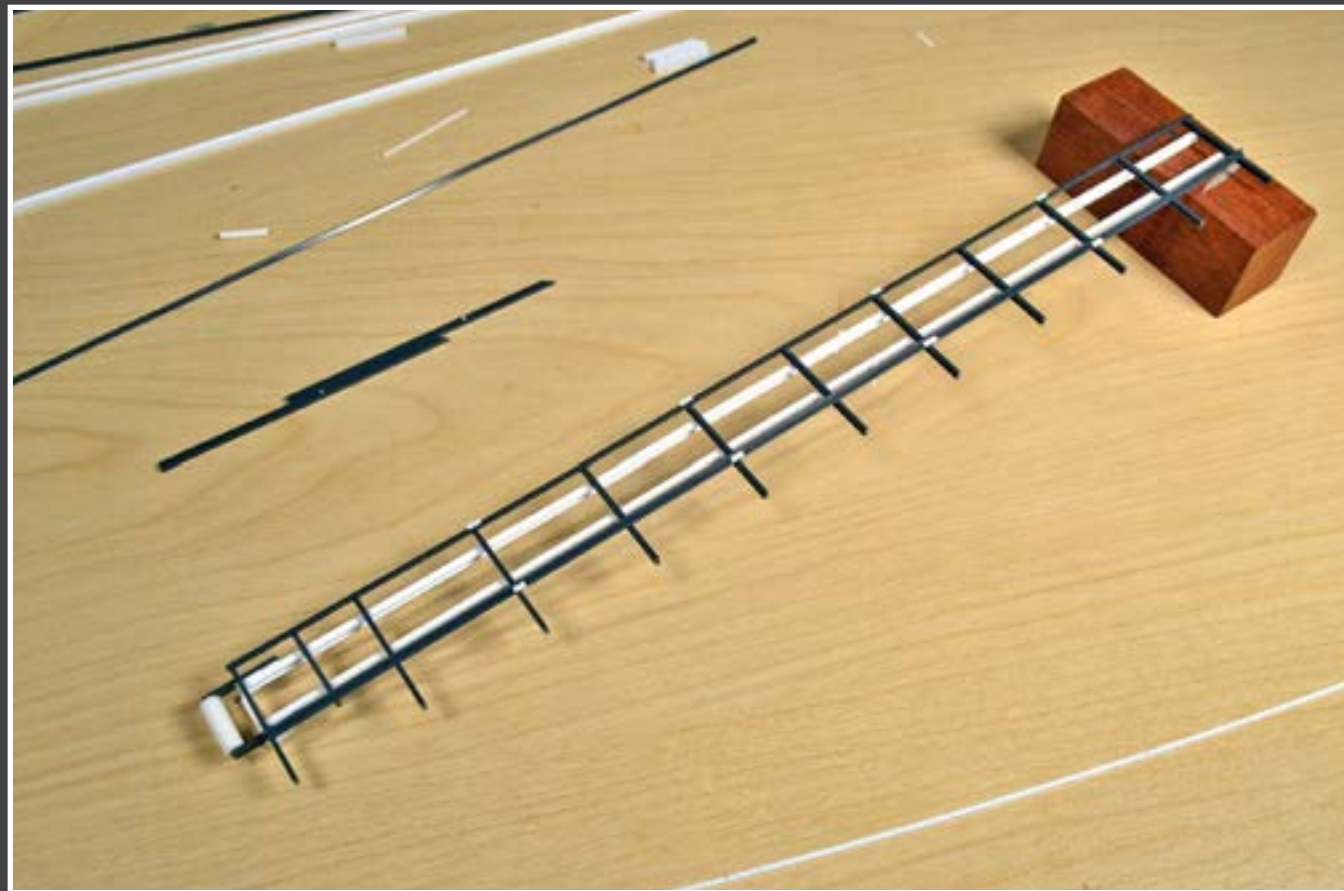

11: Add small pieces of styrene to the bottom of the angles.

Prior to construction of the bents, add a small piece of scale 2 x 3 styrene to the bottom of the angles where the support bents will be located. See the photo here (11) for the location of the 8 pieces of styrene. This provides a little more of a base for the tops of the bents. The belt frame will simply rest against the bottom of the angle once the conveyor gets installed on the layout.



12: The four support bents.

The four support bents are constructed from 1/16" channel, 3/64" angle and scale 2 x 2's. Start the largest of the bents by cutting two 15 1/2' pieces of 1/16" channel. Next, cut two lengths of 3/64" angle to a scale length of 4'3".

The length of these pieces of angle should match the width between the angles on the bottom of the conveyor. Glue the angles at 7' and 14' from the bottom, leaving 1 1/2' at the top for the conveyor belt to move through. Next, add the cross bracing by cutting pieces of 2 x 2 and gluing them in place. For the next bent, cut two 11 3/4' pieces of 1/16" channel and one 4'3" piece of 3/64" angle. Glue the angle a scale 3' from the top.

Add cross bracing by cutting and gluing pieces of scale 2 x 2. The next bent is made from two lengths of 1/16" channel cut to a length of 7 3/4' and one 4'3" piece of 3/64" angle. Glue the piece of angle 3' from the top. For the last bent, cut two pieces of 1/16" channel to a length of 4' and once piece of 1/16" channel to a length of 4'3". Glue the 4'3" piece of channel 2 1/2' from the top of the upright channel pieces (12).

The completed bents are shown in photo 12. Once the glue has dried, set the bents aside for now.

STEP 5: Conveyor Rollers



13: Construction of the rollers.

Now back to the conveyor. For the rollers on the top of the conveyor that will support the conveyor belt, I used pieces of scale 2 x 3 for the side supports and 1/16" diameter styrene rod for the rollers. Begin by cutting 40 pieces of scale 2 x 3 to a length of 1 1/2' scale feet. I used a Northwest Scale Models Chopper for this as it speeds up the process and insures that all of the pieces are the same length.

Set the conveyor on edge as shown in the photo above and glue the support pieces against the outside of the I-beams at each intersection of the angles on the bottom of conveyor and half way between the two angles. You should have a scale 3' between each of the supports. This appears to be extremely tedious but it actually goes very quickly (13).

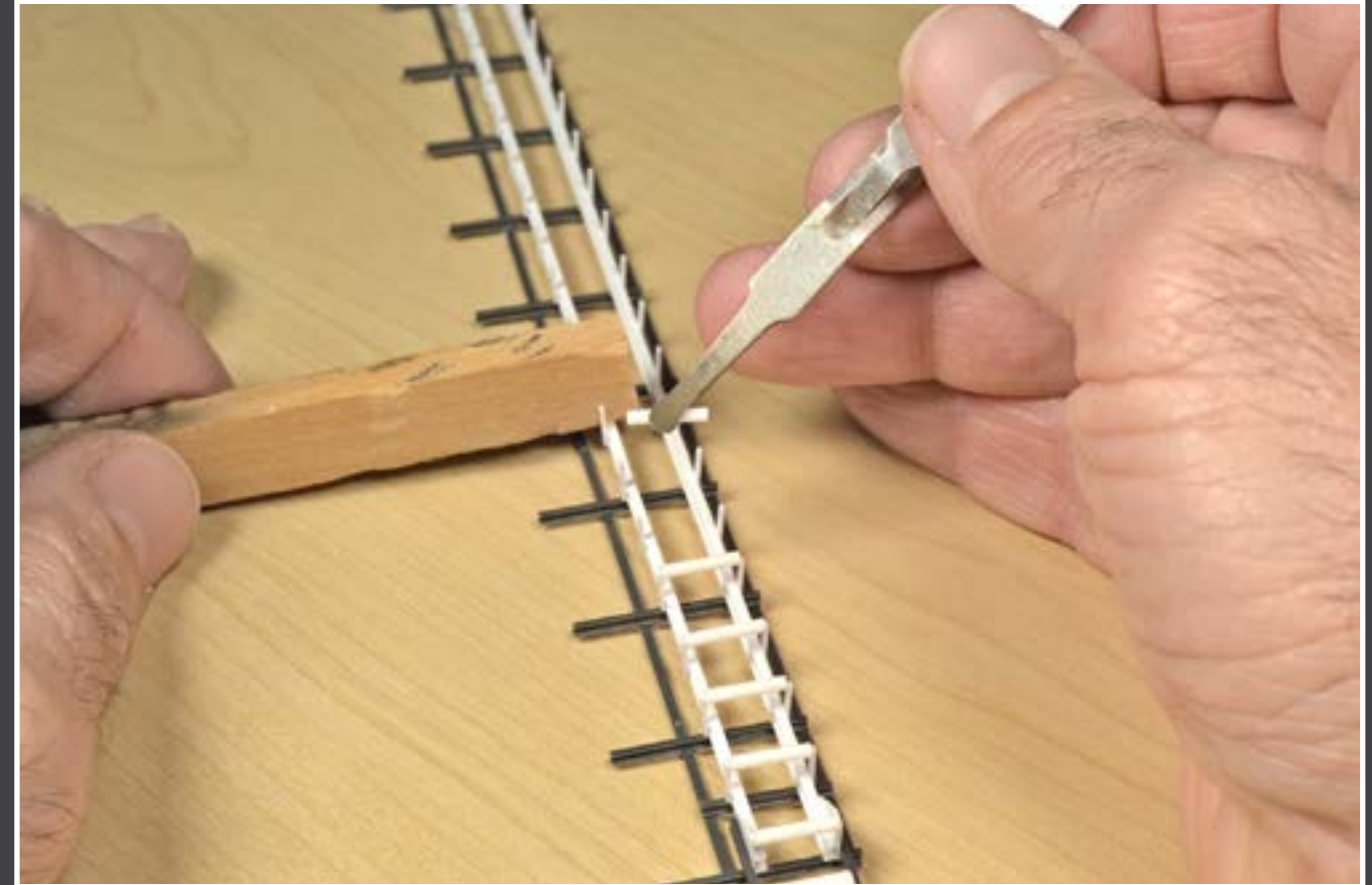

14: Adding the rollers.

After the top roller supports have been added, cut 20 pieces of 1/16" diameter styrene to a length that is slightly greater than the width between the supports. There was some slight variation in the width of the .80 base girders over the length of the conveyor, and cutting the rollers slightly wider allows filing each to fit.

Press the rollers in between the supports and touch each end with a small amount of MEK as in the photo here (14). Note in the photo how using a small piece of wood inserted in between the supports holds the conveyor frame in place.

STEP 5: Conveyor Rollers *Continued ...*

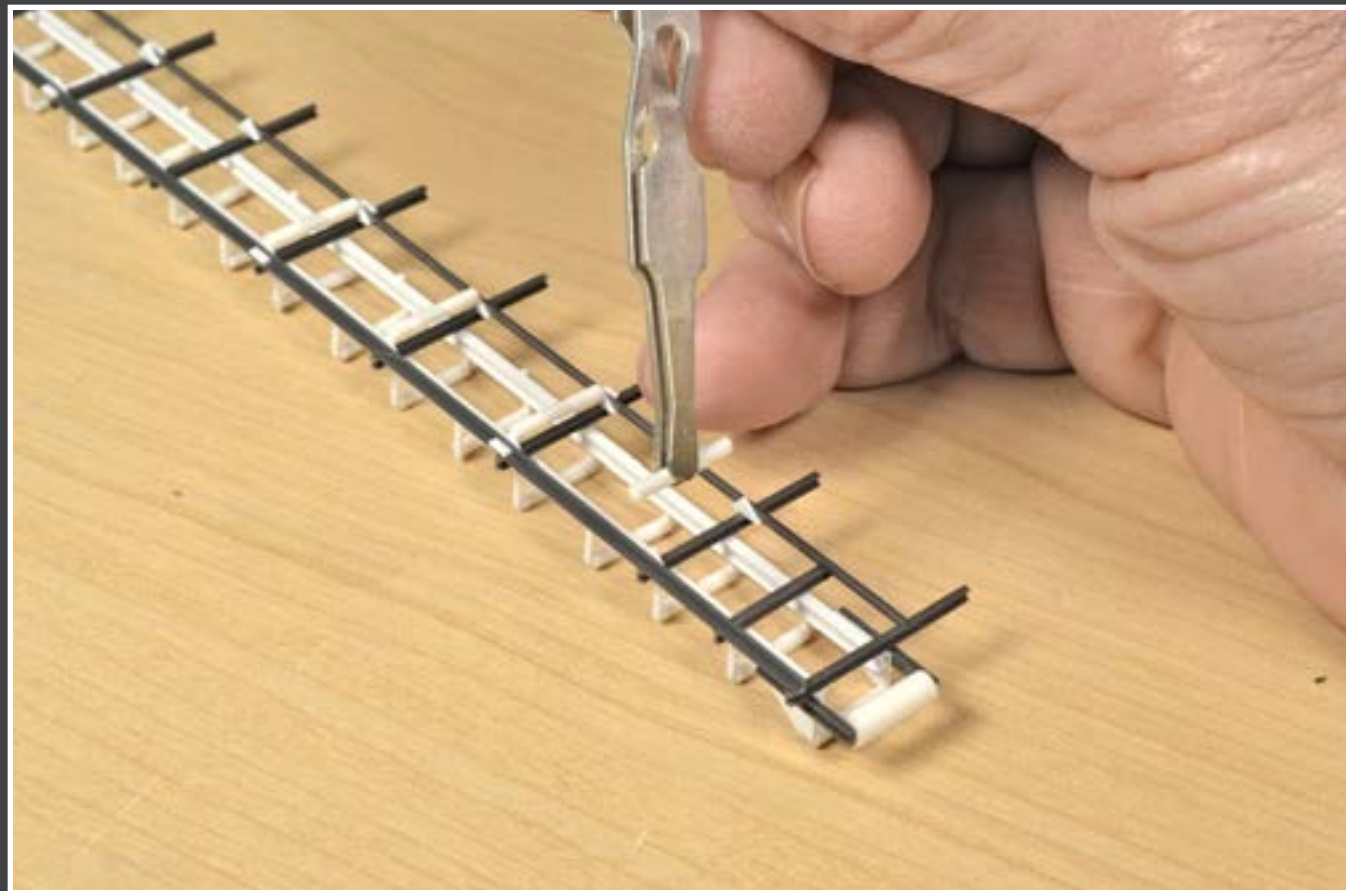

15: Installing the bottom braces and rollers.

The rollers on the bottom of the conveyor are spaced further apart than the top rollers as the belt isn't carrying any load. Begin by cutting 9 pieces of scale 2 x 10' to a length of 10 scale inches. This produces a small square that then is cut diagonally to make triangular braces for the bottom rollers.

Install the bottom braces on the inside of the 1/16" angle at each location where the 3/32" channel crosses starting at the second angle from the bottom of the conveyor. Do not place any braces on the angles at either the end of the conveyor. The photo here (15) shows placing the last roller toward the end of the conveyor that will rest on the small tower.

Once all the bottom braces are in place, measure the distance between the braces, cut 9 pieces of 1/16" styrene rod to this measured length between the braces, and glue the rollers in place (15).

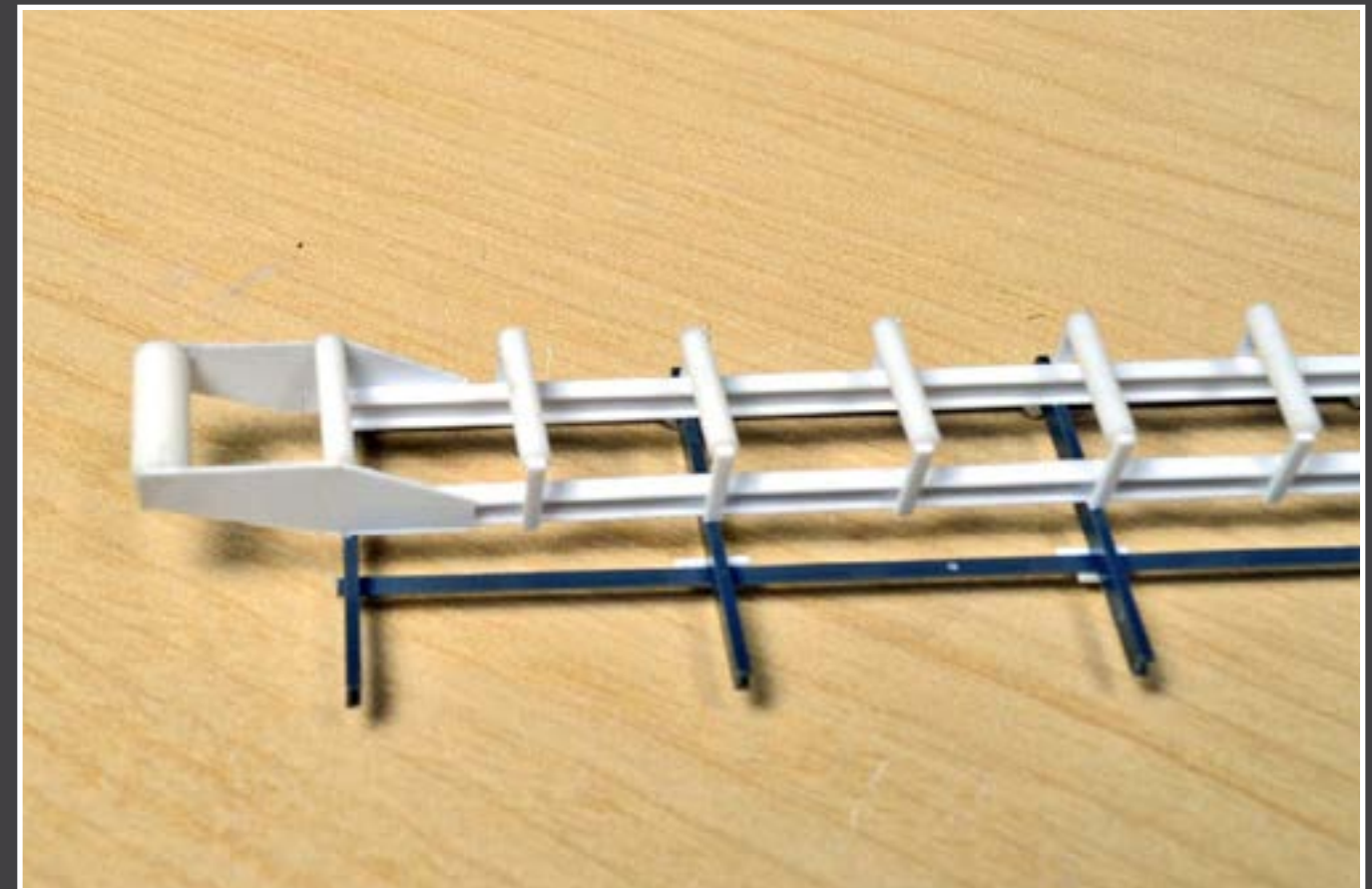

16: Conveyor ends and roller.

To finish the other end of the conveyor, two plates are needed to support the last two rollers. Cut two pieces of .010 styrene a scale 5' x 1 1/2' and trim them to match the dimensions of the drawing of the conveyor bracket- bottom on Drawing 1.

Install the plates on the outside of the I-beams so that 3' feet extends beyond the end of the conveyor. Cut a piece of 1/16" styrene rod and glue it in place a scale 3' from the end of the plates. Next, cut a piece of 1/8" styrene tube to the width between the plates and glue it at the end of the plates as shown in the photo here (16).

STEP 6: The Conveyor Walkway and Roof Supports

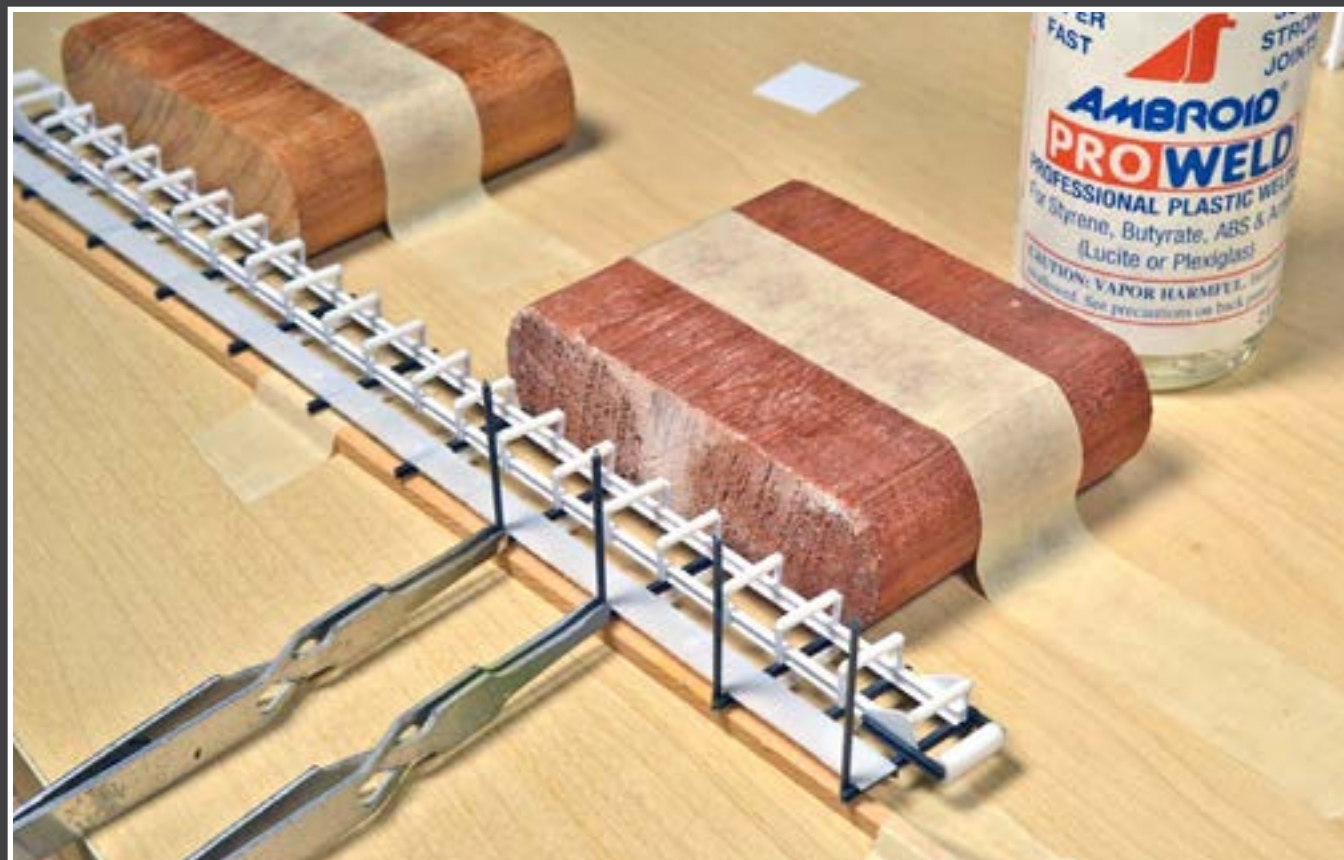

17: Adding a walkway.

Once the top and bottom rollers are in place, add a walkway along one side using two sections of Cal-Scale styrene roof walks. The outer edge of the roof walk needs to sit back far enough from the edge of the bottom cross channels to allow space for the 1/16" angle vertical roof supports. See the spacing in the photo here (17).

Once the walkway is complete, begin adding vertical supports for the roof that will cover the conveyor. Cut pieces of 1/16" angle to a length of a scale 7' and attach them to the channels so that the bottom of the angle is flush with the bottom of the channel. Making a jig for this process out of wood pieces can be helpful, the jig can be seen in the photo (17). Tape two wood blocks to the work surface with drafting tape and then use a scrap piece of basswood to fit flush under the channels.

Tape this piece to the work surface positioned so as to provide a rest for the bottom of the angles. Place the vertical angles on the opposite side of the conveyor so that their outer edge is flush with the outside edge of the cross channel.



18: Connecting the Conveyor Roof Supports..

To connect the two vertical angles, measure the distance between the angles and cut a piece of scale 2 x 6 to length. Turn the conveyor upside down, dab some glue on either end and slide the piece of 2 x 6 into place. Turning the conveyor upside down to install the cross braces will insure that all of the braces will be at the same height when the conveyor is turned right side up.

Once all of the top lateral braces are in place, make the walkway railing from .012 brass wire. Cut the wire to the length of the conveyor and glue it to the inside of the vertical supports next to the walkway approximately 3' up from the top of the walkway.

At this point, paint the small tower, the bents and the conveyor. Use Floquil Roof Brown and add Floquil Boxcar Red until you get a rust color that looks similar to the color of the conveyor in photos 19 and 20 (next page).

STEP 7: The Conveyor Belt



19: Adding the conveyor belt to the three top rollers.

Once the paint on the conveyor had dried for several days, I added the conveyor belt. Start by cutting a strip of .005 clear styrene 2'3" wide by the length of a full sheet. Sand the top and bottom surface with 320 grit sand paper making sure that all of the surface area is scuffed. This allows the bottom of the belt to appear to be the same color as the top and thus save the additional step of painting the bottom of the belt.

Start by gluing the belt flat across the first three rollers at the top of the conveyor. Next, use a small block to hold the belt down against the end roller as shown in the photo above. Let the glue dry thoroughly before moving to the next step (19).



20: Continuing to bend the belt around the rollers.

The next step is to move the belt under the conveyor as shown here (20). Apply a small amount of glue to end roller and allow it to dry completely. The idea is to glue small areas of the belt to the end roller in order to get the belt to "bend" around the end roller.

Now take the loose section of the belt and gently slide it between the bottom rollers. Take care not to break the belt at the end roller. Once the belt is snug against the end roller, glue the belt to the bottom rollers. I inserted a small paint brush handle midway between two of the bottom rollers in order to get a slight sag in the belt.

Repeat this process until the belt reaches the end of the conveyor. Next, cut another piece of .005 styrene 2'3" in width and long enough to stretch from the top of the roller at the bottom end of the conveyor to the section of belt glued previously on top up near the upper end.

Glue this piece in place and paint the outer surface of the belt with a grimy black color. Set this assembly aside for now (20).

STEP 8: The Small Conveyor and Breaker Assembly

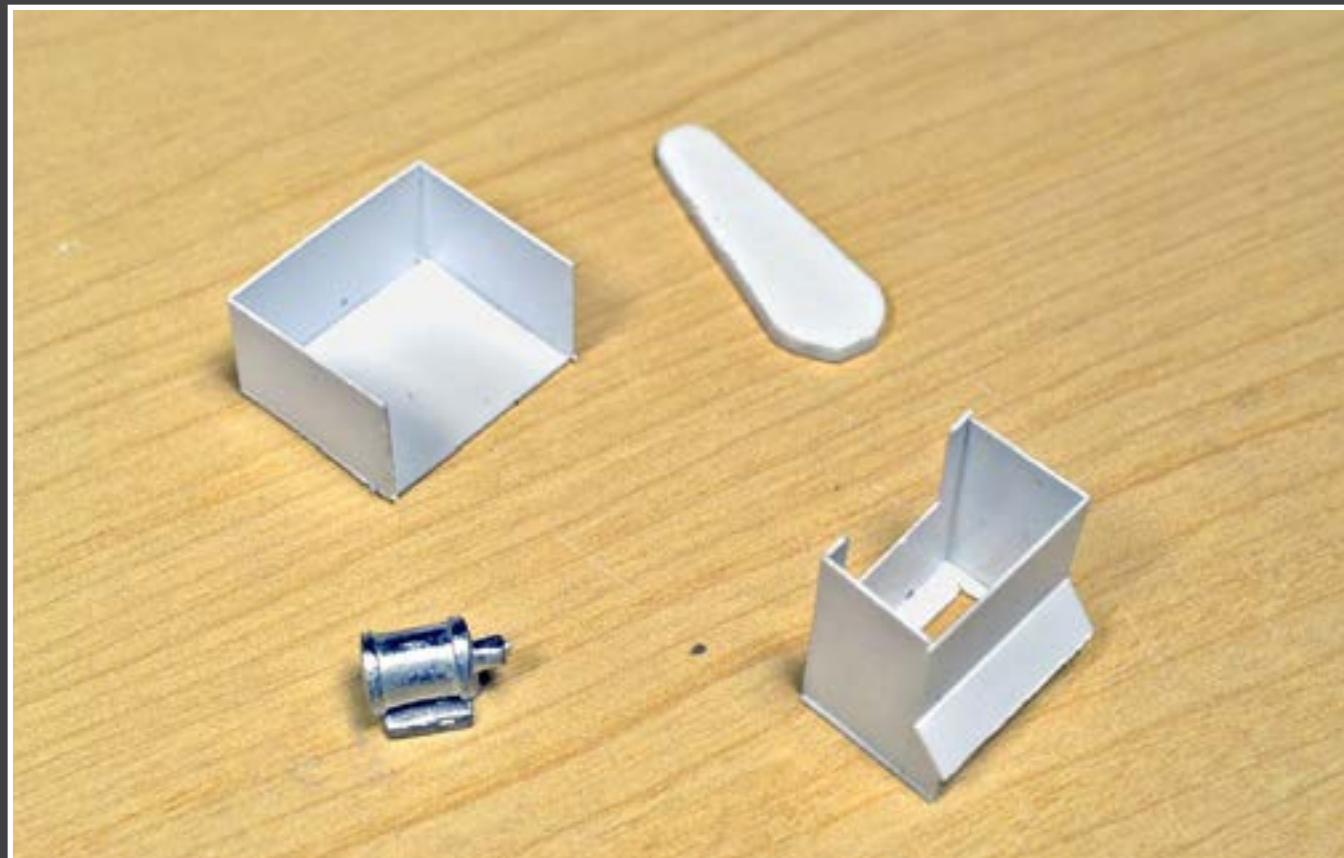

21: Constructing the breaker assembly.

The next step is to construct the small conveyor and breaker between the receiving bin and the large conveyor. Start by constructing the breaker and the breaker apron. I used the basic shapes of the breaker and breaker apron that Richard Knapp included in his article and constructed both pieces from .010 sheet styrene. The dimensions are shown in Drawings 2 and 3.

I added a base to the breaker in order to make construction easier, but removed most of it after the sides were glued in place. Use an Xacto knife with a small chisel blade and gently tap it with a small hammer around the sides to remove the base. File a piece of .060 sheet styrene in the shape of a drive belt cover. I used a small brake cylinder to represent the motor for the breaker.

The photo (21) shows the breaker, the breaker apron, the drive belt cover and the motor.



22: Constructing the small conveyor.

For the small conveyor, start by cutting a piece of .060 styrene to a scale 13' long by 2 1/2' wide. Cut two pieces of .010 styrene a scale 15' long by 2 1/2' wide and glue them to each side of the piece of .060 styrene so that 1' extends beyond either end. Next, cut 4 pieces of scale 1 x 6 to a length of 4 scale feet.

Glue these to the inside of the .010 styrene so that a scale 1' extends beyond the end of the .010 styrene as shown in Photo 22 (a). Cut 2 pieces of 1/8" diameter rod to a length of 2 1/2' feet and glue them in between the 1 x 6's for the end rollers.

To complete this conveyor, cut a length of .050 a scale 2 1/2' wide by the length between the two rollers and glue it in place. The photo (22) shows the completed small conveyor (22).

STEP 8: The Small Conveyor and Breaker Assembly *Continued ...*

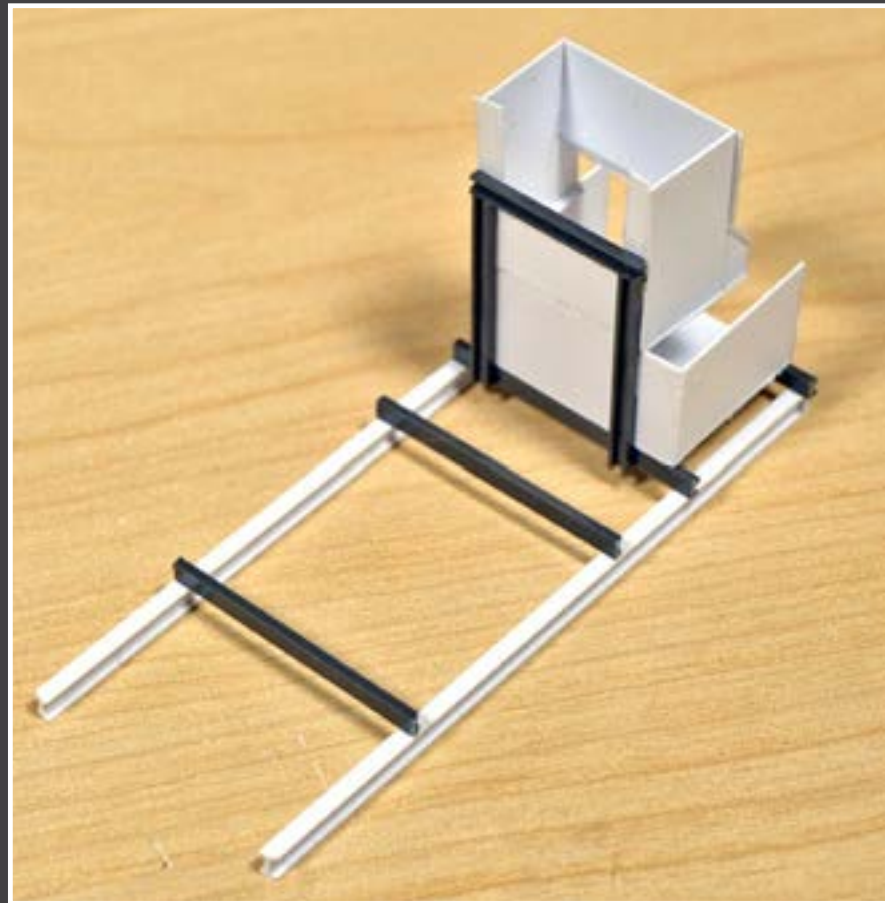

23: The framework that holds the small conveyor and breaker,

With the breaker assembly and the small conveyor complete, next turn to the framework that will hold these components. Begin by cutting two pieces of .080 I-beam to a scale 16'. Next, cut 4 pieces of 1/16" channel to a scale 6' in length. Place the two I-beam pieces 6' apart and glue one the channel pieces crosswise at the end of the beams.

Measure the distance from the front to the back of the breaker and glue another piece of 6' channel so that it will support the back of the breaker. See photo 23. Glue the breaker to the top of the breaker apron and glue this assembly to the top of the first two cross channels. Now measure a scale 6' and 12' from the channel at the end of the I-beams and glue the last two channels at these locations.

The vertical supports for the roof section will rest against these cross pieces. To support the small conveyor at the back of the breaker, measure and cut three pieces of 1/16" channel and glue them to the back of the breaker as shown in the photo (23).

Diagrams for the Breaker Apron and Receiving Bin

Drawing 3.

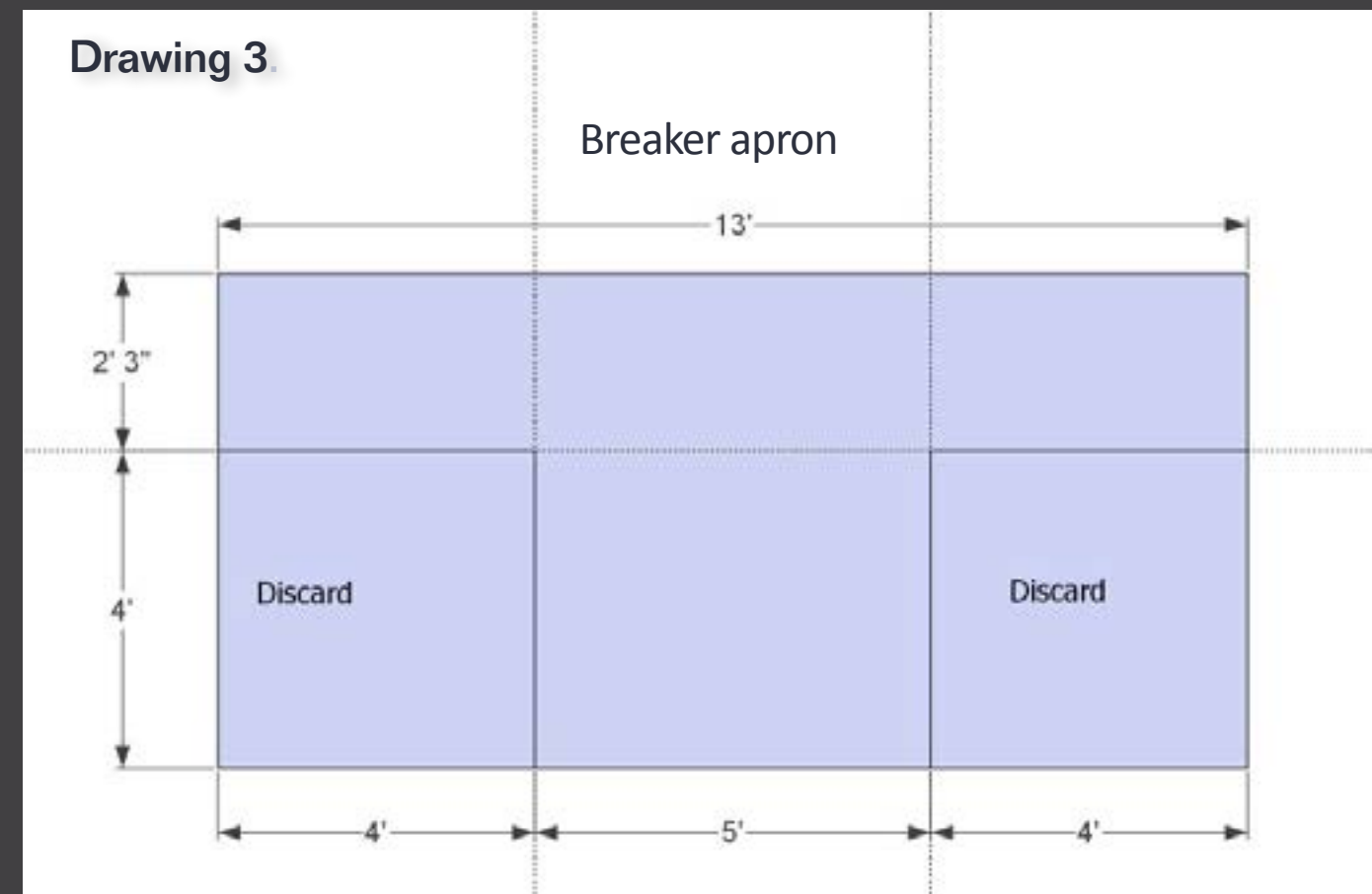

Drawing 4.

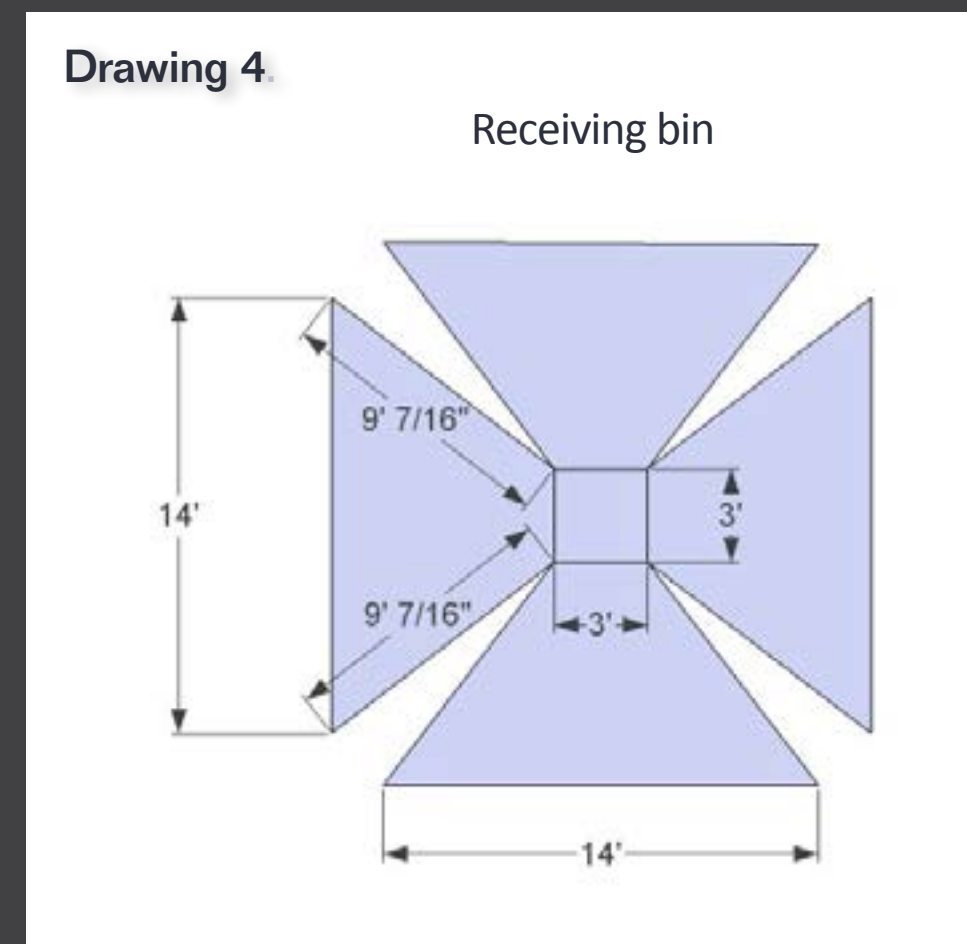

STEP 8: The Small Conveyor and Breaker Assembly *Continued ...*

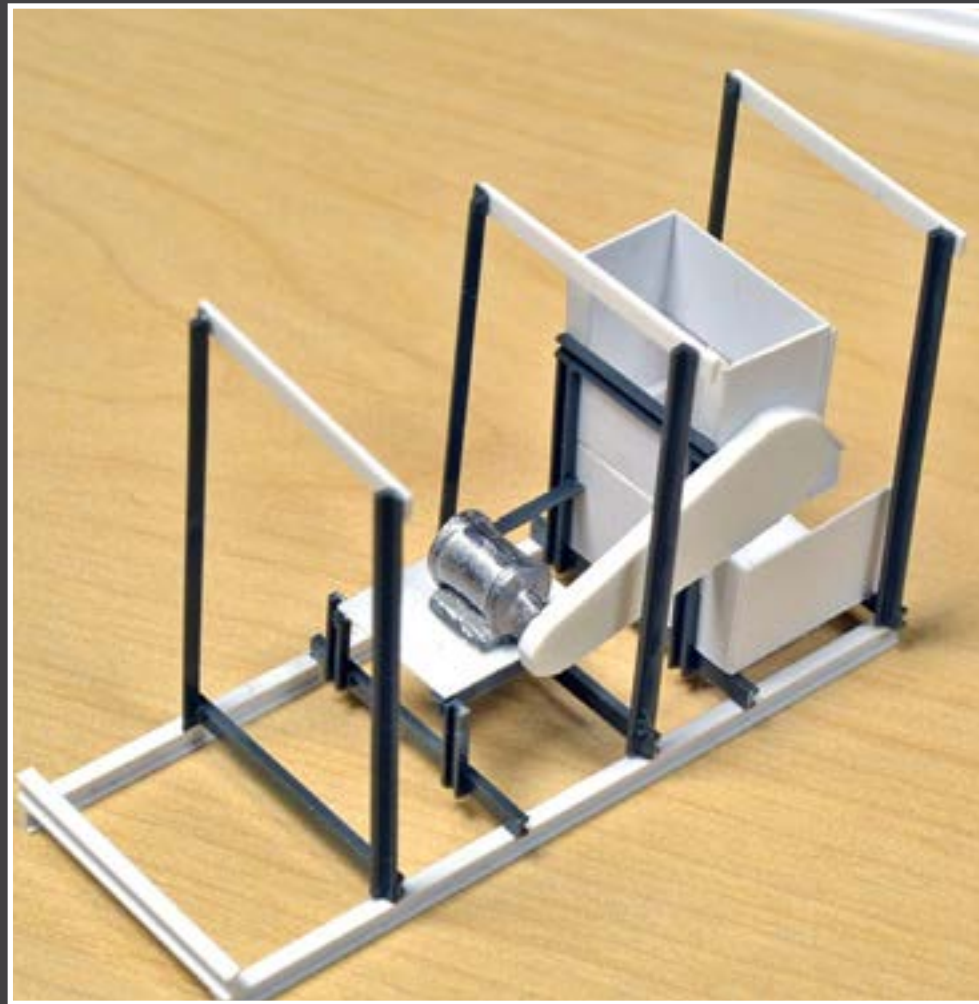

24a-b: The finished motor assembly, both sides.

The last step is to glue the .010 base plate in place and glue the motor to it. Positioning the motor and cutting the support pieces takes a bit of trial and effort, but the results are worth it.

To finish up this step, cut a piece of .080 I-beam and glue it across the two base I-beams at the opposite end of the breaker. This will serve as the support for the lower end of the conveyor. For the roof supports, cut 6 pieces of 3/64" angle to a scale 9' and glue them in place as shown in the photo (24).

When these have dried, flip the assembly over and glue a piece of scale 2 x 6 between each set of supports in the same manner you did in for the main conveyor.

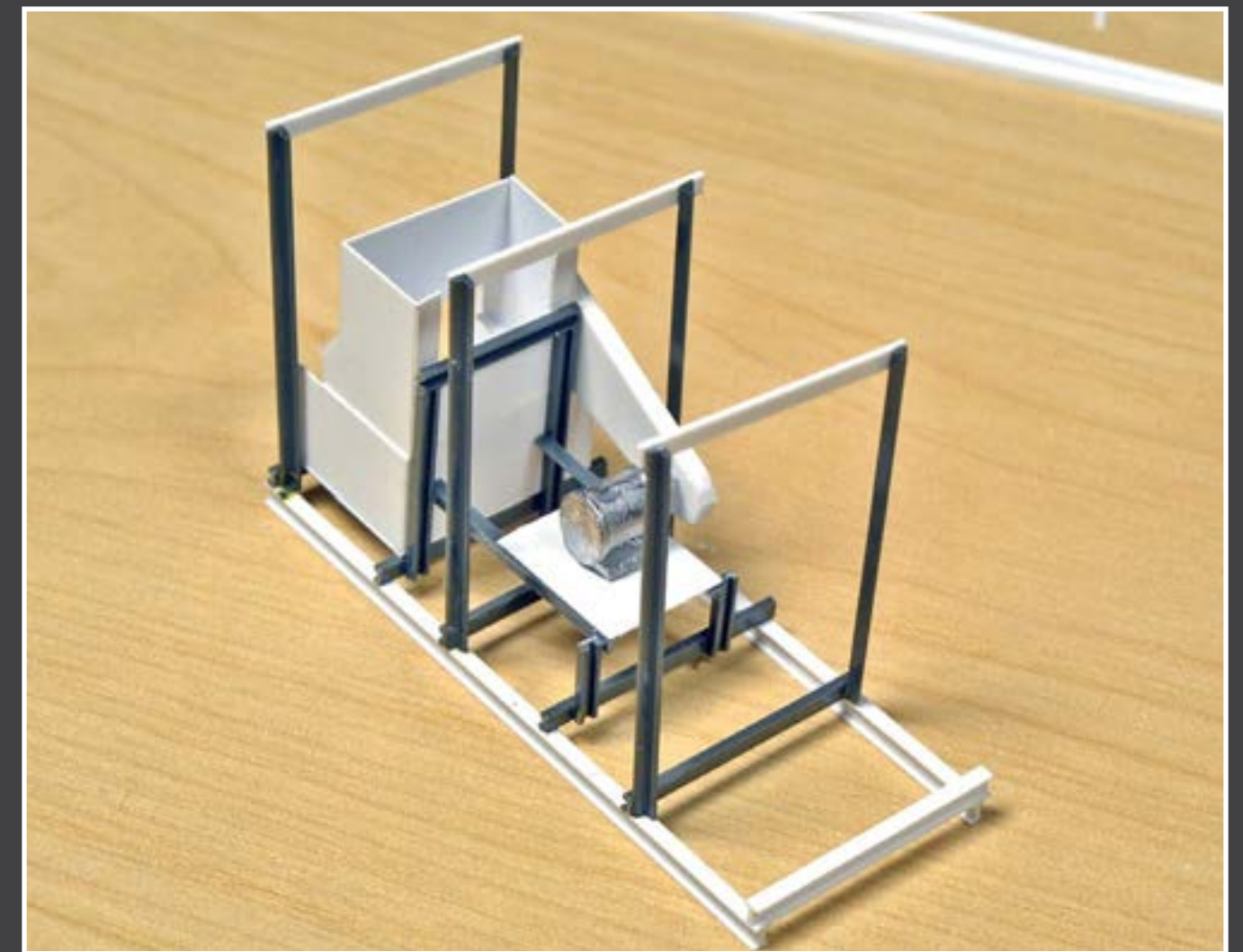

For the motor assembly, begin by gluing the drive belt cover to the side of the breaker. Place the small conveyor in position while doing this to insure that you will have enough room under the conveyor for the motor. The photo (24) shows the placement of the drive belt cover.

For the base of the motor, cut a piece of .010 styrene to a length long enough to support whatever you are using for the motor and to a width equal to the distance between the inside edges of the vertical channels on the back of the breaker. Study the photos for this sequence of construction.

Next, cut a piece of 1/16" channel to a length of 6' and glue it in position where the edge of the base plate for the motor will sit. Cut two small pieces of 1/16" channel to the height of the motor base plate and glue them vertically to the channel you just installed. Measure the distance from the vertical channels to the back of the breaker and cut two pieces of 3/64" channel to this length. Glue these pieces to the inside of the channel on the back of the breaker and the two small vertical channels.

STEP 8: The Small Conveyor and Breaker Assembly *Continued ...*

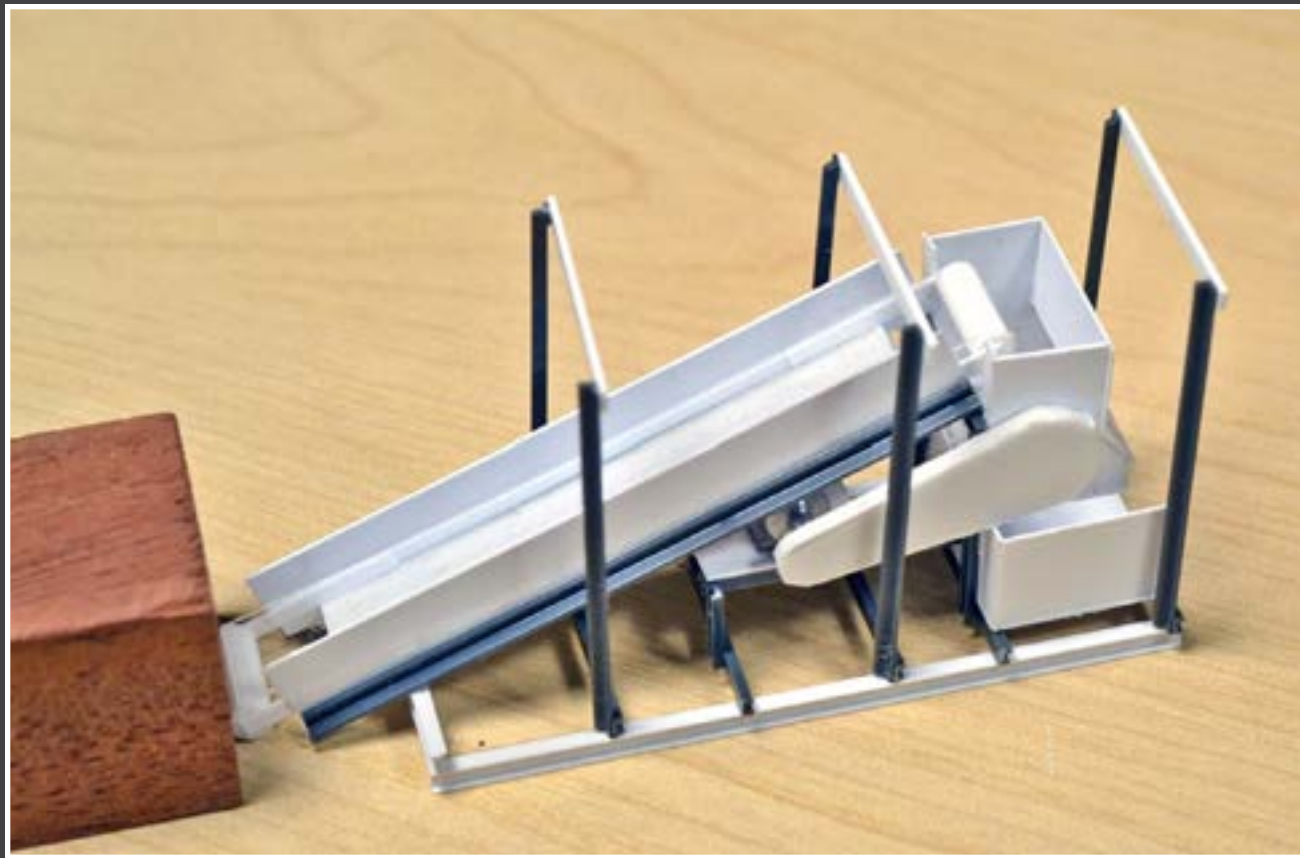

25: The complete small conveyor and breaker assembly.

The completed small conveyor and breaker assembly is shown in the photo here (25). The small conveyor has not been glued in place yet and is being held in position by the wood block to the left of the assembly.

At this point paint the breaker assembly and the small conveyor the same rust color as the main conveyor. We will paint the conveyor belt black, glue the conveyor in place and add the roof later.

For now, set this assembly aside (25).

STEP 9: Receiving Bin

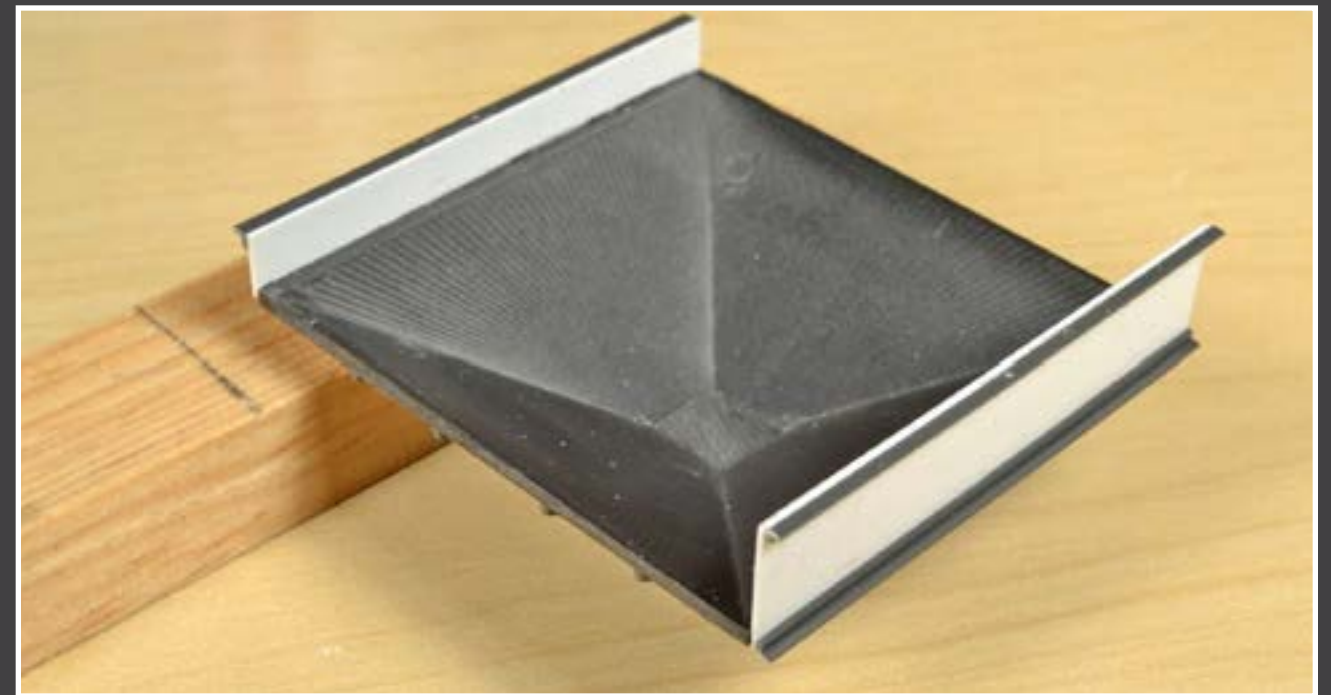

26: Constructing the receiving bin.

To construct the receiving bin, I cheated a bit – I cut one section from the bottom of the three bin hopper that comes with the Walther's New River Mining kit to use for the base. For those of you who wish to scratch build this piece, the dimensions are shown in Drawing 4.

To make sure the sides of the bin are the correct length, start with the front and back side. For the front piece, cut a piece of .020 sheet styrene to a height of 1 1/2 scale feet and a length equal to the width of base of the bin and glue it in place. Cut a piece of 1/16" angle to the width of the bin and glue it across the top of the front piece. This serves as a wheel stop for trucks backing up to the bin.

For the back side, cut a piece of .020 sheet styrene to height of 3' and a length equal to the width of the base and glue it in place. Cut two pieces of 3/64" angle and glue them flush with the top and the bottom of the back piece as shown in the photo here (26).

STEP 9: Receiving Bin *Continued ...*

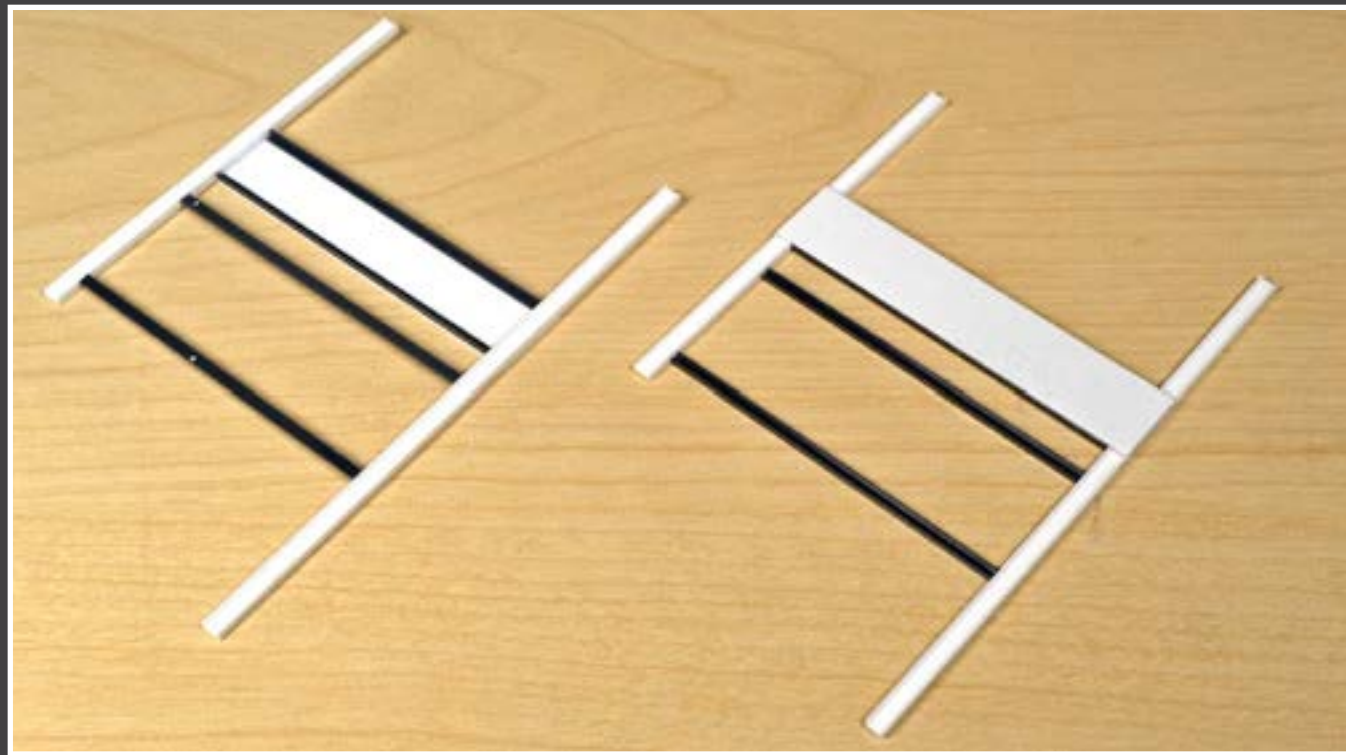

27: Receiving bin framework.

For the sides of the receiving bin, begin by cutting two pieces of .080 I-beam to a length of 18' and two pieces to a length of 24'. These will serve as the support columns for the four corners of the bin. Next, measure the distance from the outer edge of the angle on the back side to the outer edge of the angle on the front side. Cut two pieces of .020 sheet styrene to this length. Be sure to measure both sides as there might be a slight difference in the two. Adjust the length of the side pieces accordingly.

To construct the side piece, glue the 18' section of I-beam flush with the edge of the piece of .020 styrene so that 8' is above the top edge. This will leave you with 7' below the bottom of the side piece. Next, glue the 24' piece of I-beam flush with the other edge of the side so that 14' is above the top edge and 7' is below the bottom edge of the side. Cut two pieces of 3/64 angle to fit between the I-beams on the top and bottom of the side and glue them so that they are flush with the top and bottom edges.

Now turn the side piece over and cut two pieces of 1/16" channel to fit between the two I-beams. Measure up 1 1/2' and 7' on the vertical I-beams and glue them in place as shown in the photo here (27). Once the sides are complete, glue them to the bottom of the bin.



28: Cutting an angle at the top of each vertical I-beam.

Once the sides are installed, lay the receiving bin on its side and cut an angle at the top of each of the vertical I-beams as shown in the photo here (28). I used a piece of paper as a straight edge in order to make sure that both angles lined up. Next, cut two pieces of .080 I-beam so that 1 1/2' extend past the edge of the vertical I-beams.

In the photo here (28), these pieces have already been installed.

STEP 9: Receiving Bin *Continued ...*



29: Constructing the roof rafters above the receiving bin.

Cut 5 pieces of scale 2 x 8 [or 2 x 6] for the roof rafters to length that is 2' longer than the distance between the outside edges of the .080 I-beams. Glue them in place so that 1' extends past the edge of the .080 I-beam on either side as shown in the photo above.

At this point, paint the receiving bin the same rust color as the other structures and set it aside. We'll come back to add the corrugated roof and sides and later (29).

Construction of this coal loader concludes in the next issue with the building of the truck unloading ramp along with final construction and placement of the loader onto the layout. See you in January!



Tom Patterson got his start in model railroading with a Lionel train set at Christmas back in the '60s. That train set eventually became part of his first layout. Tom reentered model railroading in the late '70s and has been working on his current layout, the HO scale Chesapeake, Wheeling and Erie Railroad, a free-lanced coal hauler set in West Virginia, for almost 20 years.

Tom and his wife have two grown children and live in Cincinnati, Ohio. They enjoy hiking, biking, reading and spending time with their family, which includes two rescue mutts and a large number of salt water fish.

BILL OF MATERIALS

Evergreen Scale Models

evergreenscalemodels.com

.060 I-beam, item#271

.080 I-beam, item#272

HO scale 2 x 2, item #8202

HO scale 2 x 3, item #8203

HO scale 2 x 6, item #8206

HO scale 2 x 10, item #8210

HO scale 1 x 6, item #8106

.062 diameter round rod, item #222

1/8" diameter styrene tube, item #224

.010 sheet styrene, item #9010

.005 clear sheet styrene, item #9005

Plastruct (Walthers part number)

walthers.com

1/16" ABS channel, item #570-90041

1/16" ABS angle, item #570-90002

3/64" ABS angle, item #570-90001

Bowser Cal Scale

bowser-trains.com

Styrene roof walk, item #190-491

Detail Associates

walthers.com/exec/manuinfo/229/Detail_Associates.html

.012 brass wire, item #229-2504

Kappler Mill & Lumber Company

HO scale strip wood

kapplerusa.com/y2k/kp-main.htm

12" x 12", item #KP1193-HOP12

4" x 10", item #KP1155-HOP12

2" x 4", item #KP1120-HOP12

2" x 6", item #KP1122-HOP12

4" x 4", item #KP1149-HOP12

4" x 12", item #KP1156-HOP12

Campbell Scale Models

(Walthers part number)

walthers.com

aluminum siding, item #200-801

Testor's liquid cement

Ambroid Pro Weld liquid cement ■

20 Yrs of DCC Experience



The Big E Railroad Hobby Show

W. Springfield MA. Jan 26-27, 2013

- Sound Demos
- Show Specials
- Decoders Installed

Happy Holidays



DCC Sale

Sale Effective Dec 10, 2012-Jan 10, 2013

DIGITRAX

STARTER SETS	LIST	SALE
Zephyr X	225.00	159.95
S. Emp. Builder X	355.00	264.95
Super Chief 5AX	455.00	374.95
Super Chief 8AX	475.00	364.95
Radio S. E. Builder XD	575.00	455.95
Radio S. Chief 5A XD	665.00	495.95
Radio S. Chief 8A XD	685.00	510.95
THROTTLES		
DT402	185.00	144.95
DT402R	250.00	189.95

NCE CORP

STARTER SET	LIST	SALE
PowerCab	199.95	155.95
Power Pro	529.95	412.95
Power Pro 10	649.95	506.95
Power Pro-R	699.95	545.95
Power Pro 10-R	849.95	662.95
THROTTLES		
Cab-04PR	179.95	139.95
Cab-04P	89.95	71.95
Pro Cab	159.95	124.95
Pro Cab-R	249.95	194.95

LENZ

STARTER SETS	LIST	SALE
SET-90	442.95	289.95
SET-100	497.50	319.95
THROTTLES		
LH90 Cab	162.50	119.95
LH100 Prog Cab	247.50	199.95

MRC

Prodigy Adv 2 Wireless	629.98	369.99
Prodigy Adv W'less Cab	209.98	129.99
Prodigy Advance 2	439.98	269.95
Advanced 2 Cab	125.98	79.99

All Soundtraxx and
QSI Titans in Stock



Pinewood Plaza, 57 River Rd, Suite 1023
Essex Junction, VT 05452
info@TonysTrains.com • fax 802-878-5550

- * FIRST in DCC Sales & Support
- * Installations and Loco Work
- * Club Demos & Discounts
- * We Guarantee Your Satisfaction

800-978-3472

INFO, QUESTIONS, CATALOGUE

TonysTrains.com



<http://www.tonystains.com/specials/specials.htm>

Filling a Hole in the Layout

– by Ray and Renee Grosser

Photos by the authors



1: Here's the hole we want to fill!

Tips for building a scenery liftout that's so lightweight it makes lifting out a breeze ...

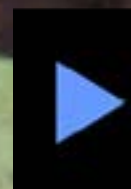

Reader Feedback
(click here)



Every layout that is built similar to ours will have some holes in the 'dog bone' sections on the ends. We find it's hard to get the true feel of a real railroad's expanse with those obvious holes in the loop ends.

We decided to make some removable fillers in the ends of the layout to increase scenery real estate. We also like the feel of the Soo Line's plains expanse in Minnesota where we grew up, so we began looking for a good way to fill these holes, yet not make it look like a lift out.

Our desired filler material has to be light and easily removed for access to the track and to also work for adding scenic details, such as a farm

scene, for example. We chose to put some 1X4 pieces across the inside of the opening and then layer on some 2-inch Styrofoam with the topography contours carved into the top surface. This worked well on previous layouts as a scenery foundation, and after making a few of these lightweight fillers, we have concluded that no layout benchwork hole need go unfilled!

Some of our insights we used on this project we learned from "Lost" Bob Lawson of Danville, KY and Cincinnati, OH. He has two well-detailed HO layouts and he uses this same method we will describe here to make the dioramas that he fits into his scenery.



2: Starting the process of filling the hole using some 1x4 pieces.



3: Adding notches into the plywood frame to hold the 1x4 support stringers.

I would expect this method could also be used with more mountainous terrain by sandwich gluing layers of Styrofoam board on top of one another. However, since our layout models a Granger line, we only have small hills we will be making.

Building the foundation

Since the inside edge of the loop on our layout was semi-finished with a fascia board that I did not really want to remove, I attached 2-1/2 inch strips of 5/8 inch plywood with drywall screws to the fascia which drew the plywood up tight to it.

To locate and install the stringers I cut some pieces of 1X 4 inch lumber to span the hole from side to side. I marked where I wanted the stringers then removed the plywood edging and took them to the circular saw to cut the straight line for the depth of the 1X4 notches. I finished cutting out the notches with a saber saw, then reinstalled the edging and dropped in the stringers.

Scenery board

This section of our layout must be lightweight and removable, so we chose some 2-inch masonry Styrofoam insulation from the local concrete block and masonry supply

place. This is a perfect material for what we are attempting to do, as the plains of Minnesota can be very low rolling hills. I find these terrain undulations easy to make in the top surface of the Styrofoam with a rotary grinder using a flexible sanding disc. I can get these sanding disks at Lowe's, Home Depot, and a host of other places – and they fit on a right angle grinder just like a sanding disc.

NOTE: Do not use the rotary grinder method in the train room. Take the board outside, downwind from the house and other outbuildings to grind off the larger areas. Then with that rough work complete, set the board in place and touch it up with a Surform planing tool (also available at Lowe's and others).

The glue I have been using lately for scenery work is easy to use and the best stuff I have found anywhere. It's called LocTite Power Grab white glue. I've found I can use it to stick anything to Styrofoam. I use it to secure our Masonite road foundations as well as gluing multiple layers of Styrofoam board together for making higher hills. The stuff is great and easy to use with a caulking gun.

Once I have finished grinding the topography to the level I want, I install the section in place and touch up any high/low areas with the Surform plane.

I made a paved roadway using tempered Masonite from Lowe's and Power Grab glued it onto the



5: Using the sanding disk to rough-carve terrain undulations into Styrofoam board.



4: Cutting the 2" Styrofoam to fit the hole.



6: LocTite Power Grab white glue available in a caulking gun tube.

Styrofoam. I prefer using 1/8-inch tempered Masonite intended for shower enclosures for my paved roads. This material is white on one side and plain on the other.

I cut the paved road sections on our circular saw to 5-1/2 inches wide (22 feet wide for the older roads we measured) and I then sand the top outer edges to form a crown in the center. This is not as noticeable in HO, but in O scale you can really see it. Only the concrete highways built in the 50s were relatively flat, otherwise, all paved roads are crowned in the center. More modern concrete highways also now have a crown.

Once the roadway cures and won't move, I bring the ditch line and

edge up flush using Sculptamold. I like Sculptamold because it's much tougher than plaster and easier to shape because it stays workable longer than ordinary Plaster of Paris.

I also glued 1/8-inch Masonite to the edges of the Styrofoam to protect it and to give the edges a little more rigidity. I installed the bottom edges flush with the bottom of the foam. I grind top edges down with the rotary grinder— again out in the barn, as it can get messy. As an end result, I get pieces with reasonably close fitting edges and just a hint of a joint between them. In the grand scheme of things, I find the joints to be preferred over an abyss in the middle of the layout.



7: The Styrofoam sheet glued to the 1x4's with Power Grab, ready for the final shaping.



8: The filler piece in place, with roads and grass to match the surrounding scenery.



9: Another view of the final scenicked filler in place, with a dirt road and a paved road added.

For grass, I'm using 6mm static grass from Silflor and Noch, and a Noch GrassMaster to apply it. While it's more expensive than ordinary ground cover, I find the results to be far and away superior to anything else I have tried. It is not always tall as I'd like, but 6mm gives me the feel of plains grass in the spring.

I completely filled in the hole, because I wanted to display some Minnesota farm and grazing lands as well as some of my wife Renee's magnificent scratchbuilt buildings and houses. As we continue working on the layout, we will continue to fill this area with buildings and details.

The new section is nearly 12 feet across but we made the panels on the inside removable to be able to access the middle when needed.

I built the 3-inch scale riding railroad on the original non-removable table while I built the barn and roadway over the blue Styrofoam fill sections.

We are extremely pleased with the end results of our filled-in area. It gives us a much greater sense of the Minnesota plains we know and remember.



10: Here's the finished scene, with the entire hole filled in with the Styrofoam lift out. The joints are not too noticeable, and it looks a whole lot better than before with the open access hole!



11: Another view of the finished dogbone end, with the center Styrofoam access hatch in place. If you know what you're looking for, you can find the access hatch seams, but I consider the insert, seams and all, to the look of an empty access hole.

Ray Grosser MMR 362 has been model railroading since his first train in 1948. Renee Grosser started scratchbuilding her structures in 1992 first in HO and then in O scale. She scratch built all but a few of the structures on the O scale Nostalgia Trip railroad and this layout is just a display pedestal for her work.



Slow Orders

Dangerous Track Ahead!

– by Bruce and Linda Petrarca
Photos by the author unless otherwise noted

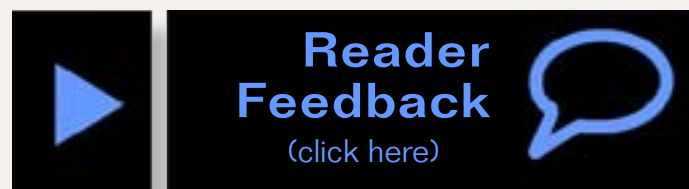

Prepare now for smoother running in the future ...

Model railroading is consumed with what to build and how to build it. The press presents a myriad of articles about the what-and-how of modeling.

We researched and wrote this article to help you protect the time and money you have invested in your trains.

Linda attended a clinic at the NMRA national convention in Anaheim in 2008 entitled “Estate Planning for Model Railroaders”. It wasn’t about 401(k)s or IRAs. She came away from that clinic with a desire to share with the community how to keep dangerous tracks ahead from derailing your finances. The following are experiences



1: Peter’s house on fire, this photo by a neighbor – photo courtesy of Peter Herron.

that Linda gathered from folks who wanted to help you avoid pitfalls.

Fire

In 2010, the most recent year covered by the U. S. Fire Administration statistics, 362,100 home fires occurred. These fires caused 2,555 deaths, 13,275 injuries and losses totaling over \$6.5 billion. See: usfa.fema.gov.

But most of us still believe disaster will strike elsewhere.

“It still breaks my heart to see this picture (1)”, says MRH subscriber Peter Herron, the victim of a 2009 fire that consumed not only his house but also his model railroad located in his basement.

Peter relates his story: “I was having a new roof installed on my house and having it painted as well. I spoke to the workers in the morning and my fiancée and I left for our camp on a lake 84 miles north in the Adirondacks.

“At about 6:45 PM, a friend called telling me my house was on fire and

the firemen were worried that I was trapped in the burning building. She finally convinced me that this was not a joke, and that she had assured the firemen that I was indeed absent from the structure.

“Lauri, my fiancée, grabbed my bag and we rushed home.

“By the time we arrived, the fire was almost extinguished. Good thing she brought that bag. It contained my entire wardrobe: 2 T-shirts, 1 pair of white socks and a pair of jeans!”

The cause was never officially determined but it is suspected a cigarette ended up in a tinder dry planter outside that was right next to the house on the back deck and it smoldered

until the plastic container caught fire and then caught the house.

Peter, now retired, was formerly a multi-line adjuster for two insurance companies and handled many, many homeowner’s insurance claims including fire.

Peter had his expertise in insurance claims, good documentation of his layout and well thought-out insurance coverage. It still took almost 3 months to come to an agreement in compensation for his loss.

When you see Peter’s layout damaged and exposed to the elements (2), the extent of his loss is overwhelming.



2: After the fire – a view of Peter’s layout from outside the house – photo courtesy of Peter Herron.

Water

Although it is easy to imagine what damage a fire could do to your railroad, think about water. It can spell disaster, too.

Water can get into your layout many ways: snow collapsing the roof over an upstairs layout; winds tearing a roof off and exposing your layout to rain; plumbing leaks inundating lower floors.

Restoration expert Chris Callaway, a model railroader and the franchise owner of Steamatic of Phoenix (steamatic.com), states that the most frequent sources of plumbing leaks are:

- Burst washing machine hoses (usually the hot water line).
- Plastic water softener lines or broken plastic parts.
- water supply lines to icemakers and toilet tanks.
- Plastic nuts holding the supply line onto the bottom of toilet tanks.

Chris’ company handles disaster clean up ranging from the overflow of a washing machine to total structure loss.

Chris was the clean-up guy when a flood claimed the layout of a modeler here in the Phoenix area. Richard Newkirk went away for about two weeks. He had been having a problem

with the supply line to the toilet in his master bath on the second floor of his house. He shut off the valve at the toilet. When he returned, he was greeted with a blast of humidity. The toilet had flooded the bathroom and master bedroom. The water dropped into the main floor, where it was an inch deep in the kitchen.

60% of the basement ceiling fell in onto his layout, which was 2 inches-deep in water (3 next page).

Richard pointed out that the shut off valves for toilets and sinks only last 1 to 2 years with the hard water in our area. After that they may not shutoff completely. Check with folks in your area.

You might discuss with your insurance agent the possible need for federal flood insurance, too.

Earthquake

Earthquakes can have an effect on your layout ranging from moving a few buildings to complete destruction.

There is not a place in the world that is totally immune to earthquakes. However, there are places, like Alaska, where low level quakes occur daily and larger ones are known.

You have no control over whether an earthquake will occur. You can make sure you have are prepared if one happens and damages your layout.

Estate planning

It is a rare situation where both spouses are equally involved in model railroading. If your spouse isn't as involved as you are, it is unkind to

leave her (or him) with a sizeable asset without information.

Much of the work that we have discussed for an insurance claim will also prepare data for your spouse to



3: The water damage at Richard Newkirk's layout – photo courtesy Richard Newkirk.

handle your layout after you have moved on to that big roundhouse beyond. Consider these real-life examples:

- Jack Miller, of Jack's Trains in Glendale AZ, told us about a widow who couldn't bear to go into the layout room for months after her husband passed.
- Another widow, who is a real train buff, couldn't bring herself to sell her husband's N-scale collection for several years after his sudden death.
- When we owned Litchfield station, we had dealings with several widows. Perhaps the most poignant example came from the wife of a good customer. He ordered frequently and had a lot of Blackstone cars and locomotives on order with us. One day, she called us, after having received our eMail informing him that we were shipping some Blackstone cars that had just come in. She told us that he had died suddenly in the prior week.
- Another story was about the widow, having been told for years that her husband "wasn't spending much" on his O-scale brass locos, gave a dozen or more to the grandchildren to play with in the sandbox.

One of the best suggestions we've gotten is to designate a friend or a

club to be the coordinator of the distribution for your spouse. Make sure that the designee and your spouse know full well what you expect. Written instructions help.

If you are actively buying items that are on advanced order, make sure your spouse and designee both know where the list of outstanding orders is.

If you don't know someone or a club well enough to be comfortable with them assuming this responsibility, you may want to interview local train stores and find someone who purchases estates. If you find one that you are happy with, get a card from them and make certain that your spouse knows about them and that the card is in your estate data.

Preparation

While you cannot prevent a disaster, you can make it easier to recover with a bit of planning and preparation. Hopefully this information will accomplish two purposes:

- Help each of you to consider seriously the possibility that something disastrous could happen to your railroad.
- Point out to you some of the tools available to create the necessary data to assist if something happens.

Insurance

What kind of insurance do you have? Folks frequently think about property protection.

Chris says: "Insurance coverage is usually overlooked by model railroaders. Some underwriters classify the equipment as 'collections' with a cap of \$10K just like jewelry.

"My opinion is that a railroad that is attached to the house needs specific coverage via a rider on the insurance policy. The engines, cars and other things including tools may need specific coverage too. This simple precaution can avoid a lot of heartache and grief."

Peter points out that the bench-work may be considered part of the cost of the dwelling. His point of view in sorting out coverage is: "Turn the house upside down. What falls is contents, what doesn't fall is structure."

Richard didn't have a rider or separate policy on his layout, but he had increased his contents coverage to provide for the layout. It took the work of a local modeler and a respected shop in Pasadena, CA to put together the presentation for the insurance company. In the end, Richard received compensation to have his layout restored by a professional builder.

Both Peter and Richard had an easier time collecting on their railroads than they did on their structures. Apparently there are variations between policies and, perhaps, state to state.

However, frequently the benchwork and such has not been included in the valuation of the structure for insurance purposes. If you have made a significant investment (time and money) into a layout attached to the house, a discussion with your agent is indicated. Make sure that it is covered.

Bob Libbey, the PSR Secretary, pointed out that NMRA members might want to look at the NMRA layout insurance. The PebbleCreek Club that Bruce belongs to uses this insurance to cover it all: the layout, club owned structures and rolling stock, and members' rolling stock on loan to the club. See: nmra.org/national/insurance/model_collection_insurance.html.

What about liability issues? You may wish to discuss your railroad guests with your insurance agent along the way and make sure you are adequately covered in the event of an issue with them.

Layout planning

Think of the layout you have or are planning. If a person collapsed in your railroad room, how would you or the firemen get them out of there?

Likewise, if there were a fire, how would people get out? Are there enough of the correct fire extinguishers to assist in their exit?

In the event of a fire or medical emergency, that extra track work you squeezed in may come back to you as a liability for the death or injury of a fellow model railroader.

Extinguishers and alarms

Fire extinguishers provide a small amount of protection: enough, perhaps, to put out a very small fire or to provide a safe pathway out of a bigger one.

Do not expect to extinguish even a small fire by yourself, that's the fire department's job.

A prudent modeler has one or two extinguishers strategically placed around his layout. Remember, you may be dealing with a fire that involves wood & paper, liquids and electrical wiring, so an ABC rated unit is worthy of consideration. For more information on extinguishers, see: fire-extinguisher101.com.

Our home has smoke detectors wired together. If one senses smoke, all go off. If you have such a system, you may consider a smoke detector that is compatible with your existing system for installation in the layout room (and workshop, if it is a separate room). That way, a fire in the unattended area would create a general alarm.

First aid kit

While it is slightly off topic, you may want to consider a basic first aid kit for your layout. Locating it with the fire extinguisher is frequently



4: Fire extinguisher installed near the door at the Pebble Creek club layout.

reasonable and provides a single location to go to in an emergency. A phone located there, too, could prove helpful in a time of need.

Plumbing

One other area of preparation is to get the plastic out of your plumbing world. If you review your toilets, laundry, ice makers, etc. with Chris' list in hand, I'm sure you will find some inexpensive places to increase the safety of your home.

Inventory

Our insurance agent says, "It is the insured's responsibility to prove the value of lost or damaged property."

The best way to establish what is on your layout is to keep a record of what goes into it. If you make the list as you are building, it is a minor issue.

Going back and documenting what you have done previously is a much bigger chore.

Consider also, keeping a log of hours spent working on the layout or the structures or the rolling stock. This can help justify the replacement cost.

There are several ways of documenting the items and costs.

The traditional way is some form of a ledger with manual entries.

Bruce uses a spreadsheet (5) as both a database for rolling stock (owned and needed) and a running record of costs and items. A sample Excel spreadsheet is on Bruce's site: (mrdccu.com/XLS/Inventory.xls). Use this spreadsheet as a starting point. Add whatever data columns you desire.

One advantage of spreadsheets in general is that you can hide columns of data. Perhaps you don't want the total value of your investment readily available. However, in a time of need, the column could be "unhidden" for use.

"There is an app for that", too. Several apps available for smart phones and tablets are designed to keep inventory of your model railroad holdings. Check to make sure that they have places for date acquired, cost, modifications (like adding a DCC decoder), total cost, etc. It would be nice if there were a field for your choice of disposal in the event you are no longer with us: say a club or friend who would want a certain piece. Also, think of how the data will be backed

up before you use an app to document your investment.

Photos

One of the best ways to document your layout (or your entire home, for that matter) is with photos, either still or video.

Peter even had "in progress" photos, which helped the adjuster understand the scope of the layout in terms of the level of effort that went into it and its size (7). It wasn't just a piece of plywood with a couple of tracks glued down and running a loco and two cars!

Peter pointed out one shortcoming of most photo sets: folks don't think to open the drawers and photograph what's in there, too! Without that data, it is almost impossible to be properly compensated.

	A	B	C	D	E	F	G	H	I	J	K	L	M	N	O	P	
1																	
2																	
3		Purchased	Type	Road	Rpt #	Manufacturer	DCC	Condition	Paint	Coupler	Lights	Paid	Upgrades	Total	Hours	Comments	Where - return to
4	2/17/2009	RS-1	Santa Fe	2397	Atlas	Tsunami	New	Blue/Yellow	Kadee	2 x 5 mm LED	\$ 85	\$ 90	\$ 175	4.6	Fred did DCC	At the club	
5	5/15/2005	Mikado	Grand Trunk	21	Ath Gen	TCS T-1	New	all Black	Kadee	Stock	\$ 90	\$ 25	\$ 115	1.2	Add sound next	Roundhouse	
6																	
7																	
8																	
9																	
10																	
11																	

5: Excel Spreadsheet screen shot.

Storing data

Okay, you've got the records and photos. If you leave them in your home, they may be lost. Consider a major fire, like Peter's, what happened to paper in his office or data on his computer? Here's where an off-site data storage plan becomes important. You want the data preserved, but available for easy update as things change. Some choices:

- store the data with another family member. There is the possibility that they would be lost when you most need them. In our extended family, there were two families who lost homes in the Colorado wildfires in 2012 on the same day. And they were about 100 miles apart.

- store them in your desk at work.
- store them in an off-site storage unit.
- if you have all the data in a computer file format, consider some form of "cloud" storage. This allows easy access and quick updating.

We don't recommend storing several copies different places. Updating is a nightmare. If you need the data and there are several inconsistent sets, it may be difficult to determine which is the most recent and accurate. A man with three watches is confused as to what time it really is.

Evacuation plan

Safety experts frequently recommend that you have a home evacuation plan and practice it repeatedly.



6: Before the flood at Richard Newkirk's layout – photo courtesy Richard Newkirk



7: Peter's layout in progress – photo courtesy of Peter Herron

What else should I do?

Okay, now that you have your insurance reviewed, evacuation plan practiced, safety devices in place, plumbing updated and inventory data safely stored, it is easy to think you are done.

Not so fast. Let's look at what you may want to include as an ongoing part of your railroad operations.

Briefing

When you have guests in for an operating session, do you brief them on where the emergency equipment is, where the phone is and how they fit into the evacuation plan? You should.

Also, are you in the room every minute of an operating session or an open house? You might consider designating someone at each session to call 911 and assist in an evacuation in the event you are absent or incapacitated.

Keep up to date

Periodically, you need to review things to assure that all is fresh and current, including:

- Your data
- Your insurance coverage
- Your designated estate agent
- Your evacuation plan
- First aid kit contents
- Fire extinguisher charge

Recovery

Okay, now let's look at what happens after the fire or flood or earthquake.

Your insurance agent and any restoration agent should work together with you to help you bring your data to the attention of the adjuster.

If you haven't prepared, you may be in the position Peter was, gathering records from auction sites where he had made purchases, documenting costs and current prices.

The adjuster may want experts to evaluate the claim for validity. They may even seek a second opinion.

Everyone we talked to told us that folks generally wished that they had more data, not less, after a disaster.

In deciding what data to keep, think about convincing a non-modeler of the level of work and cost that went into scratchbuilding a box car which looks to him like something purchased at a flea market for a buck.

Who will rebuild it?

This is a significant question after a major loss.

With proper documentation and insurance, you may receive compensation for a professional layout builder to do all or part of the reconstruction.

After his loss, Peter sent a letter to several professional builders asking for a quote for rebuilding his layout. While he chose to do the work

himself, he had the quotes to work with the adjuster in the process of making things right financially.

This is just a quick brush over the top of these topics. Our goal was to start some thought processes and to point out some places for you to look.

We have talked to or emailed many folks in preparing this article: Peter shared many of his strategies; additional insurance agents commented; Chris weighed in; store owners, several widows and a few modelers shared their stories and safety program representatives were happy to add their advice.

We hope that this will motivate you to slow down now and take a few

precautions so that you can highball the rest of the way.

If you like this article, please vote for it by clicking the link below. That blog page will, in all probability, include a bunch of folks telling their stories and voicing their opinions. Join in!

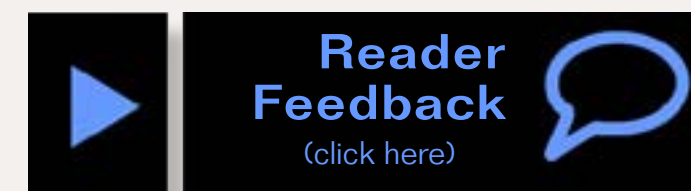

8: The briefing before an operating session at the Pebble Creek Model Railroad Club.

Remember to click on ads! The more you click the more you help MRH stay free ...

Building a Streamlined Movie Theater Part 2

– by *Isaac Herrera*
Photos by the author

We continue with building the animated marquee on this golden era movie theater project ...



In our last installment we had our basic movie house facade partially constructed and it should be looking good by now... but of course, we still have that big gap out in front.

Here is where we take out little structure project and give it that extra bit of "Oomph".

It's now on to building the all-important sign and marquee. Our animated lighting is a simple affair featuring blinking lights on top of the marquee and a sequential light on the sign (see

the video – I made the video look like it was shot with a vintage home movie camera).

Believe me, adding the animated lighting was not as hard as it seems.

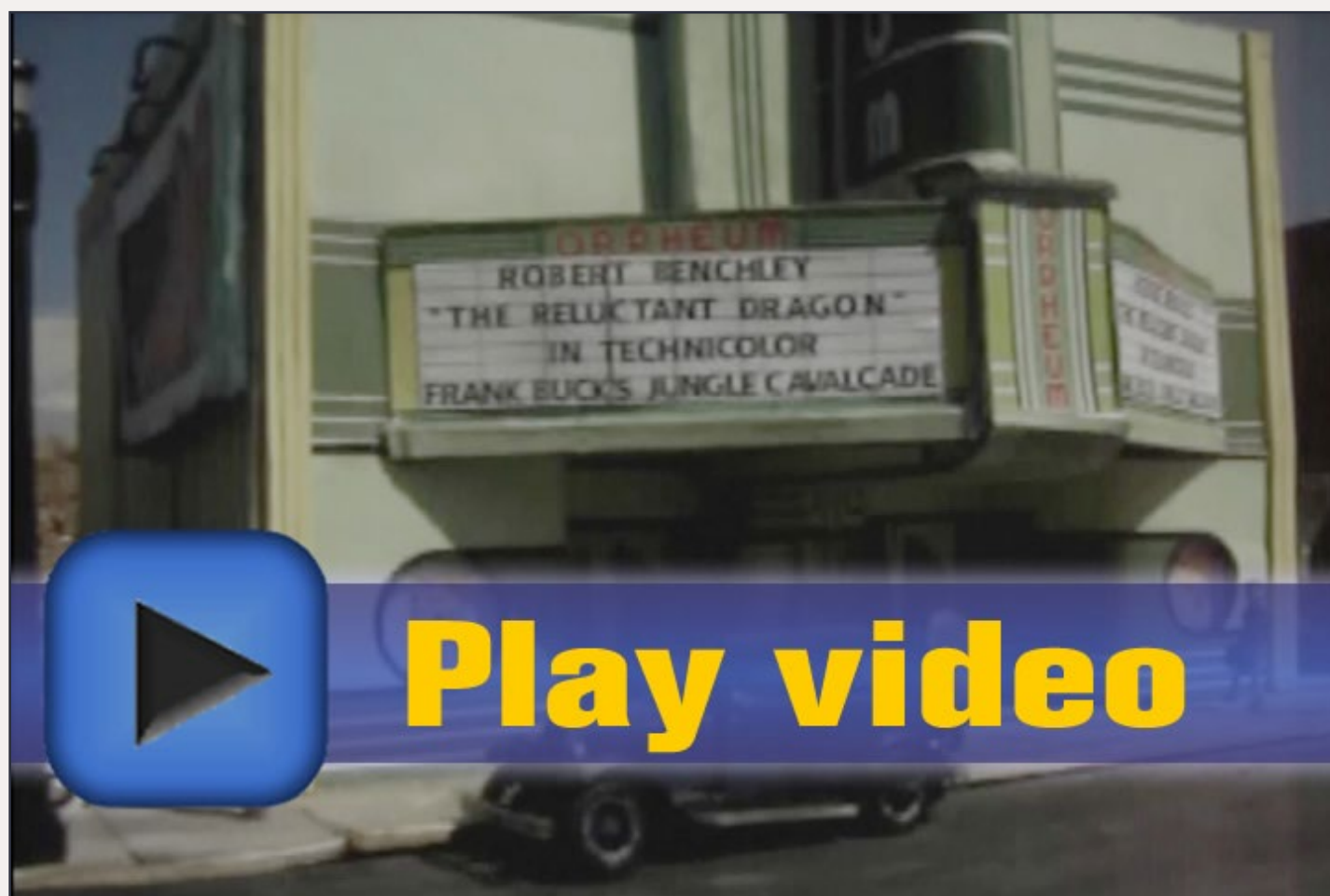
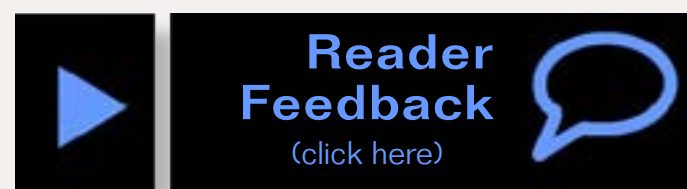

STEP 13: Marquee Faces

Before starting on building the marquee proper, we'll prepare the illuminated portions, front, left and center. These come in two parts- The first part is an all-black ink "matte" on acetate that will block out light where we don't want it. The other part is the full color exterior, where we have our movie title* and the theater name at the center. It's important to print these on ordinary bond paper to let the light shine through. Set these aside and brace yourself, for the next part is rather fiddly.

*For my version I wanted to be able to change shows, so I left that area blank.

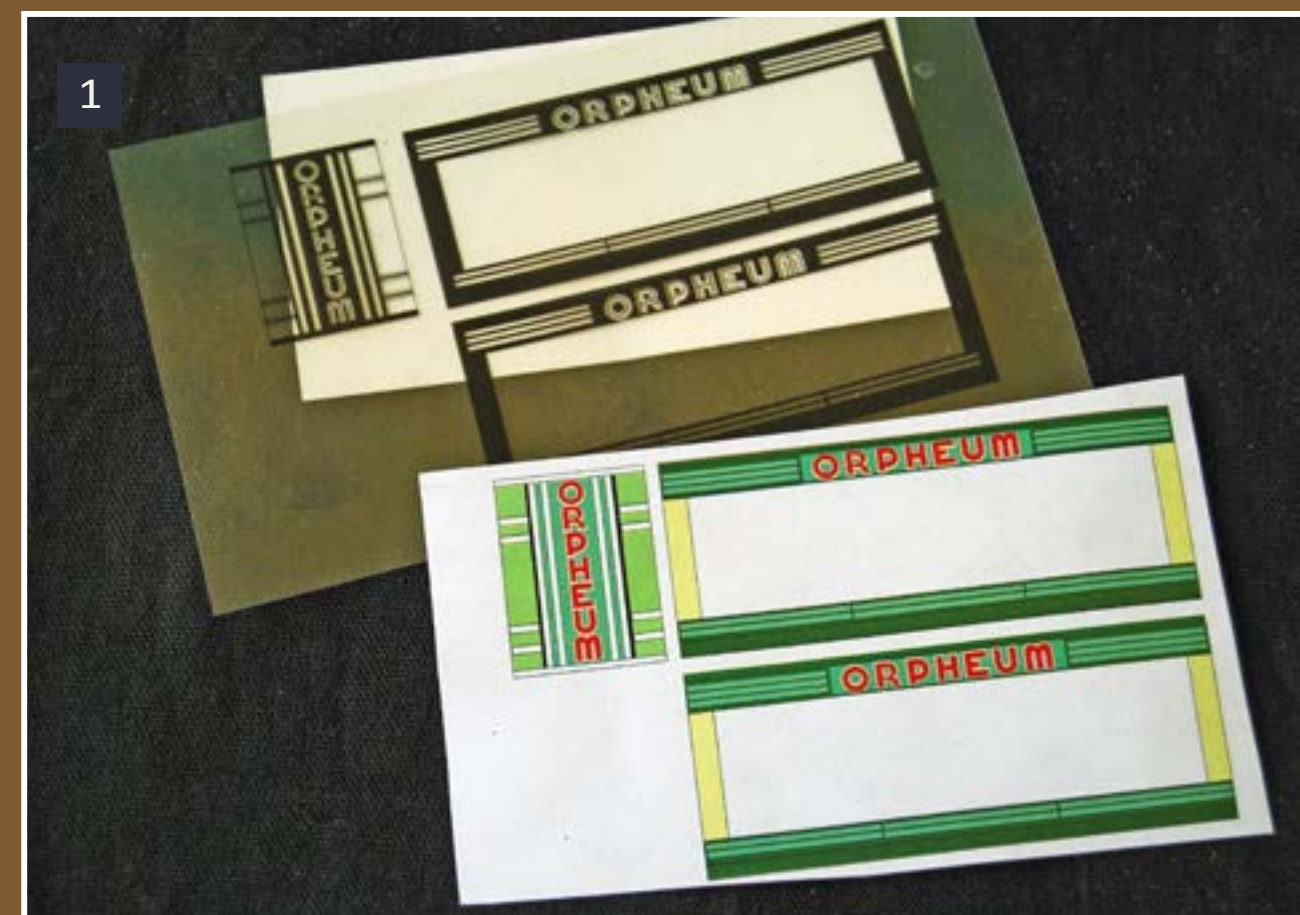

1: The two parts.

STEP 14: Marquee

The marquee is designed to be assembled and then simply inserting the LEDs when it's done. Start by cutting out the patterns on thin cardboard (2). Notice that there is an interior and an exterior pattern for the bottom part of the marquee. The interior part is a guide to cut out slits to simulate fluorescent tubes, so paste this one first and then cut out the slits. The round holes can be done with an ordinary paper punch. Now, paste the exterior part, making sure the white lines are aligned with the slits (3). Having taken care of that, we can now assemble the marquee structure as shown in figure 4.



2: The parts laid out.

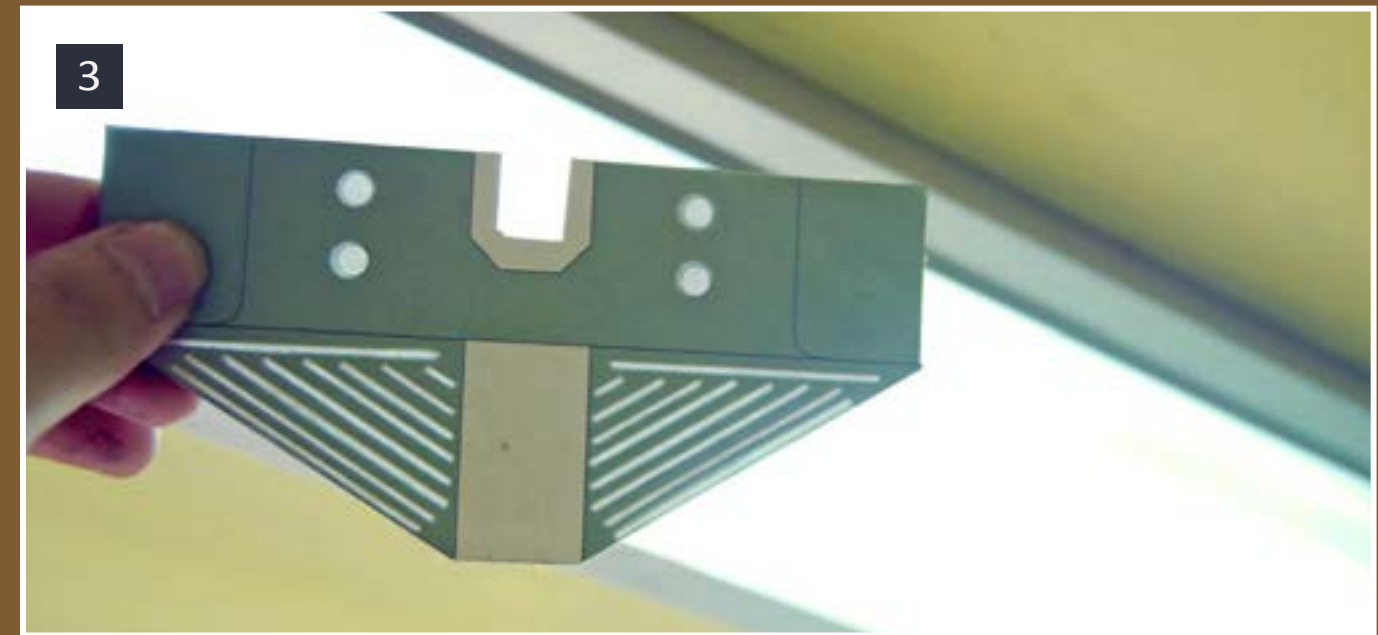

3: The bottom.

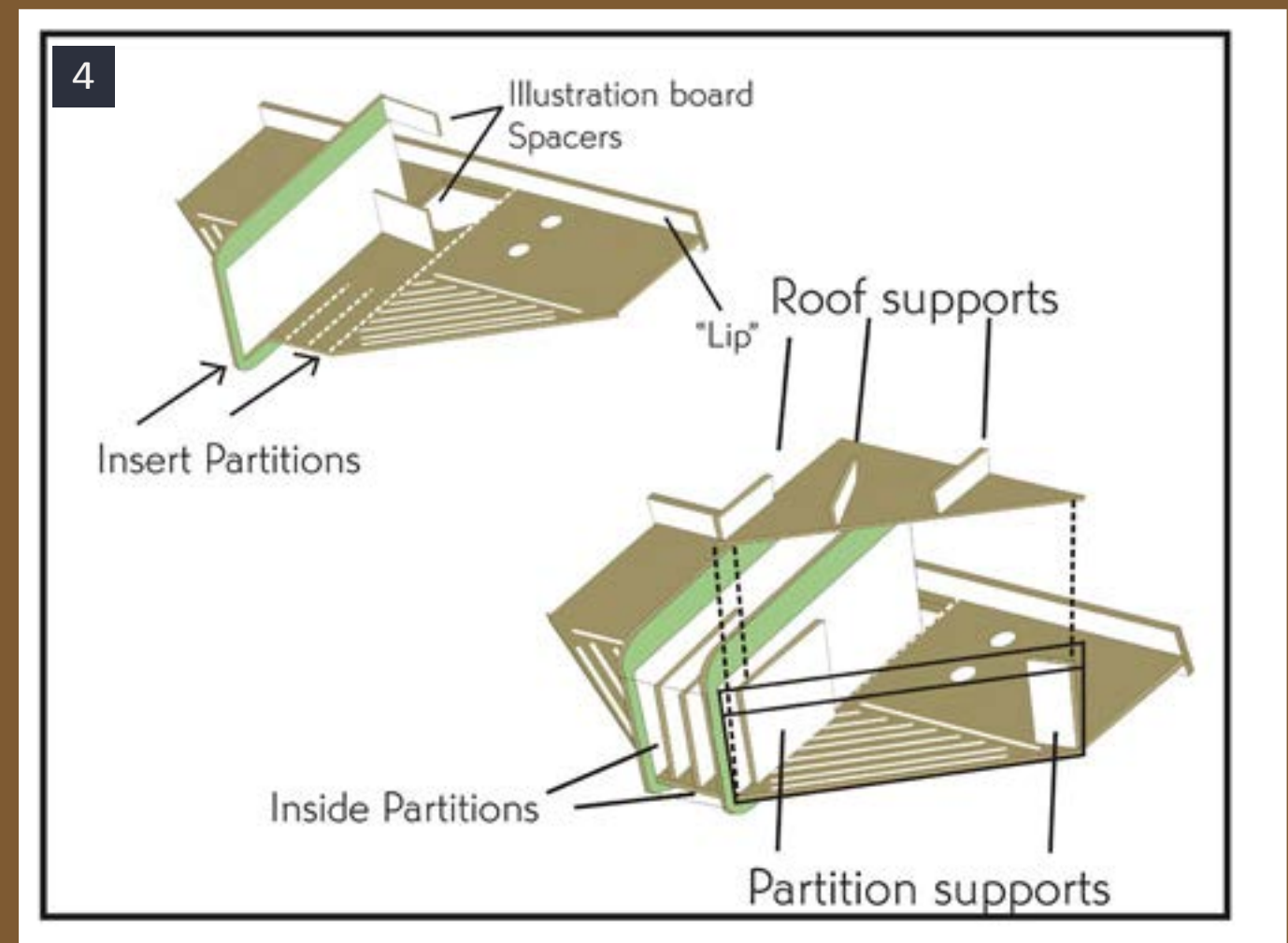

4: How it all goes together.

STEP 14: Marquee *Continued ...*

The middle part also has two partitions inside to separate the flashing lights (5). Getting those aligned with the outer covering was a bit of a pain, and when everything was done I had one of those “why didn’t I think of that?” moments – so you might want to add some spacers on top to keep everything in place. To help keep the whole assembly in place, the rear has a lip that fits behind the entrance wall.

As with the middle segment, the marquee has two levels to separate the flashing lights on top, from the constant lights as shown in the illustration. First add the supports, and then the second level, making sure it’s perfectly straight. On top of that we have two partitions on each side for the flashing lights. Having built the structure, it’s time to add the faces. Use glue sparingly so it doesn’t spill into the illuminated areas, or it’ll show.

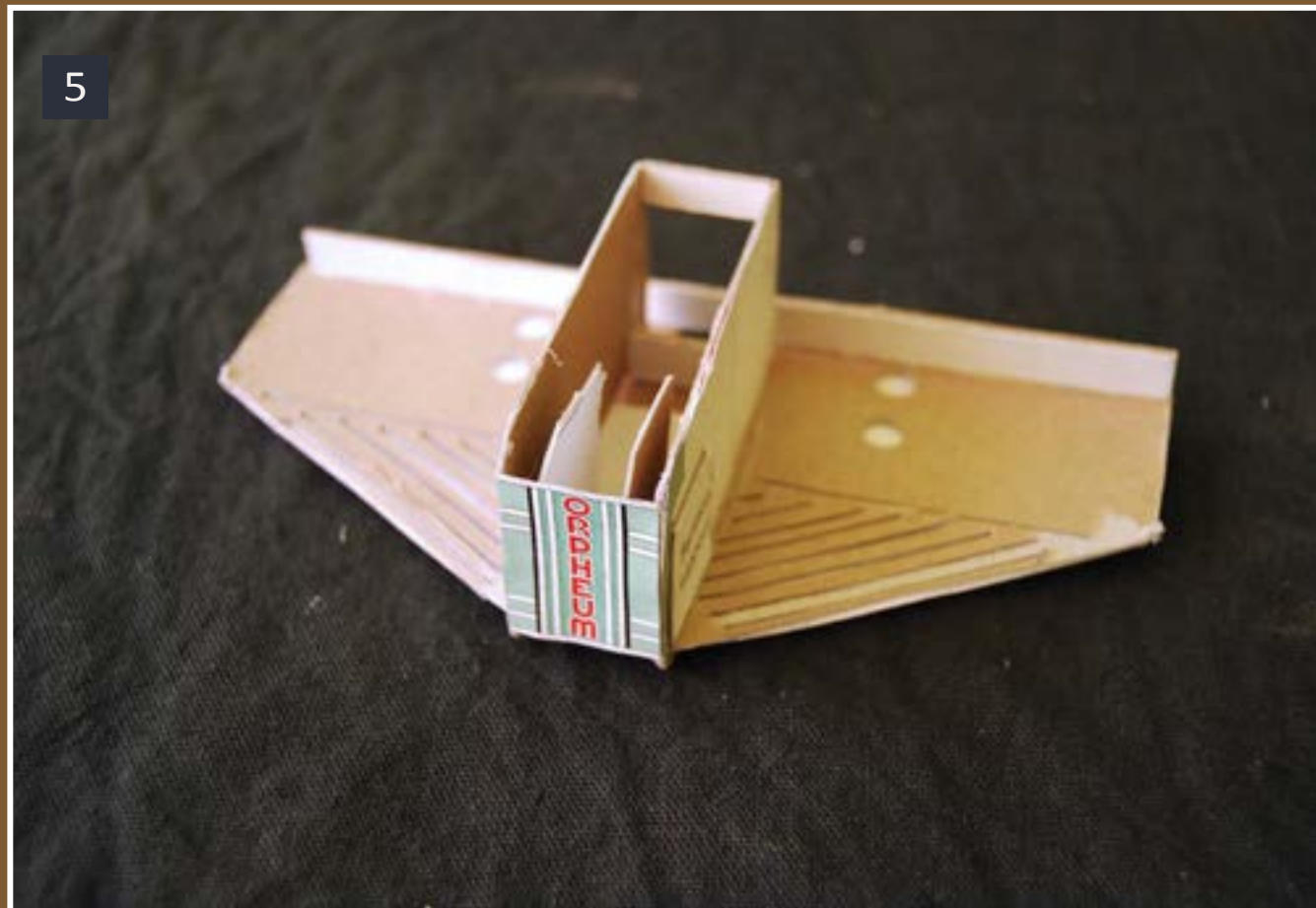

5: Middle partitions.

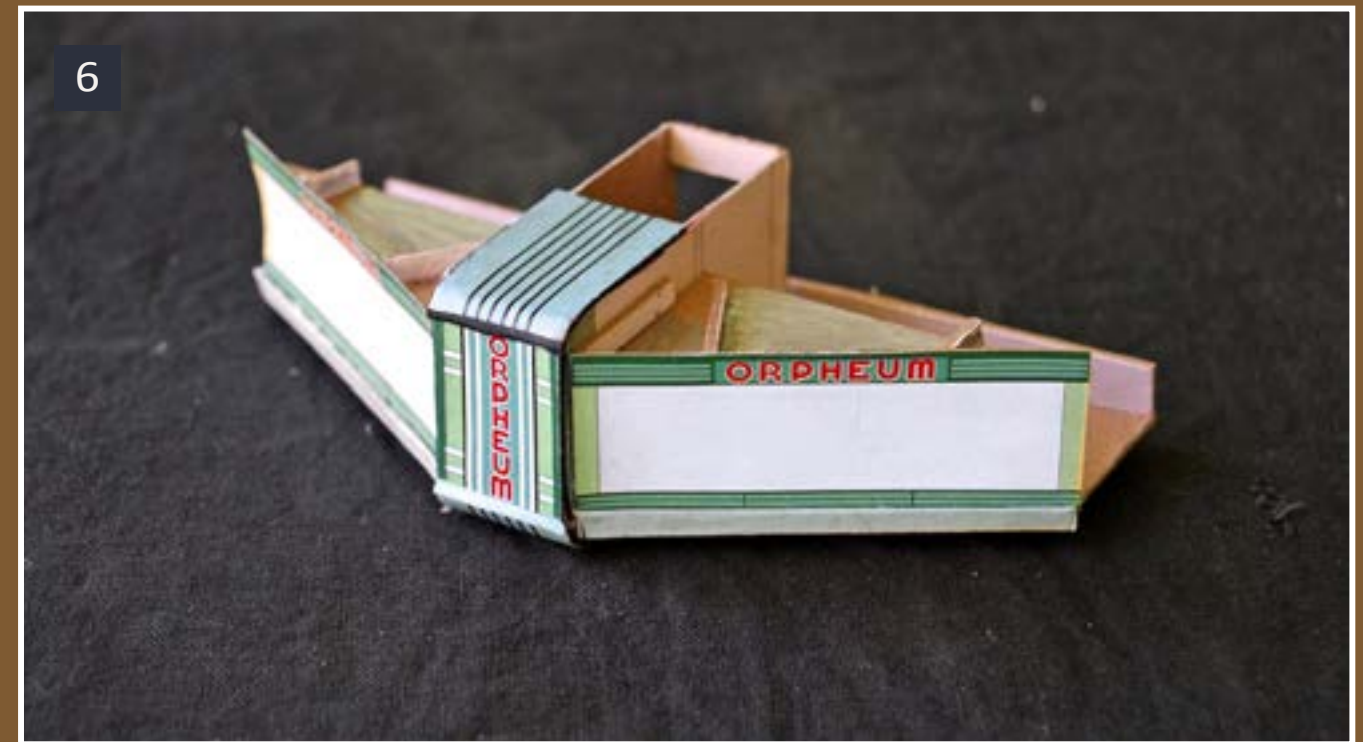

6: The finished superstructure (front).



7: The finished superstructure (rear).

STEP 14: Marquee *Continued ...*

To finish off our big marquee, we'll wrap it with this decorative roof piece and a thin ridge, as shown in figure 8. This must be done with thin cardboard so it can be easily bent around the curves. The rear end of the lower piece must wrap around the top of the box office as shown. To hold it all together, add an L-shaped part to the bottom, as shown in the illustration. To cover up the seams, add paper strips as shown.

With that in place, cover up the tops and sides as shown and our marquee is finished.

I should note, a printing error in mine left blank areas on the sides of the center piece, so I covered them with a pair of fin pieces. These are not part of the printable parts.

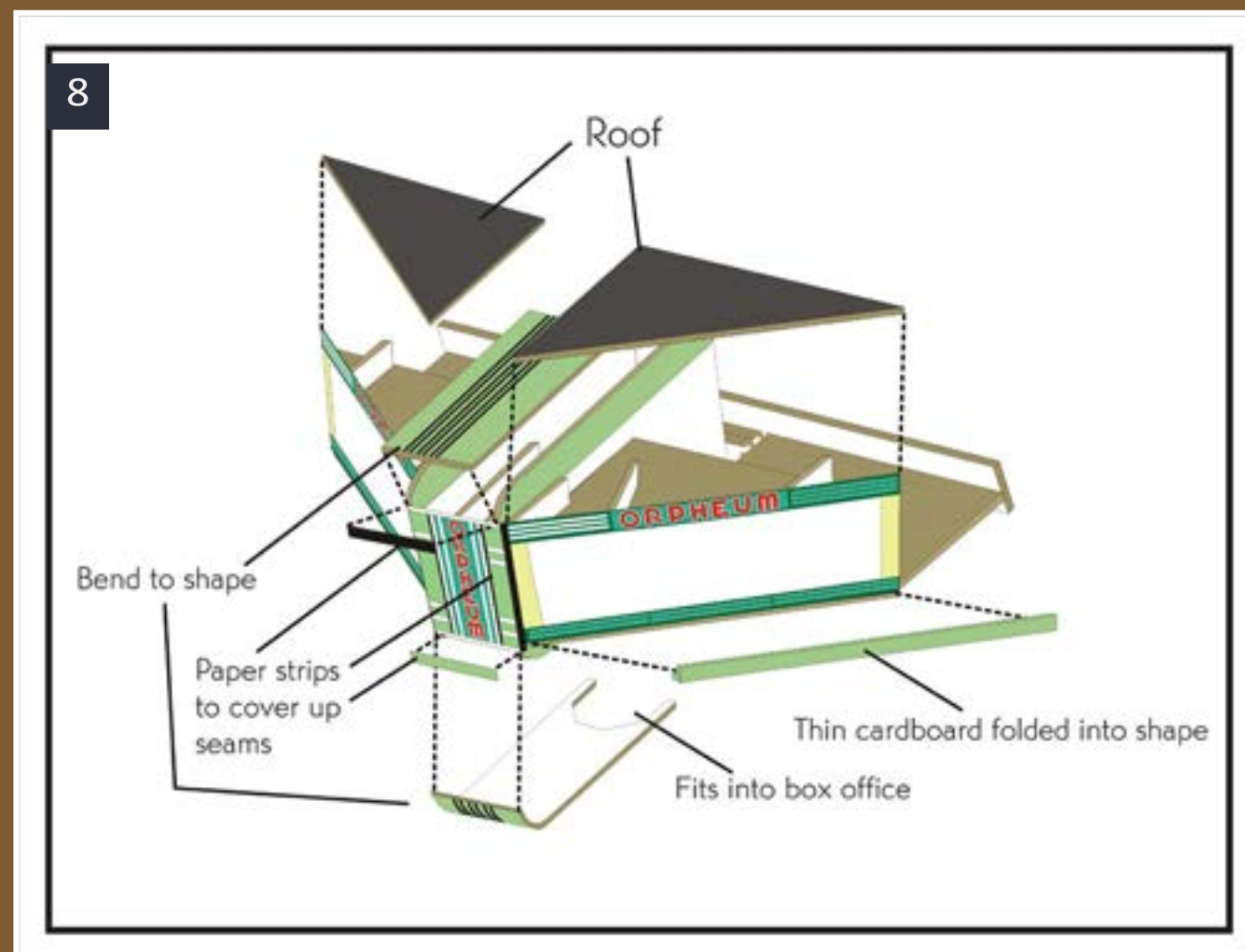

8: Finishing.

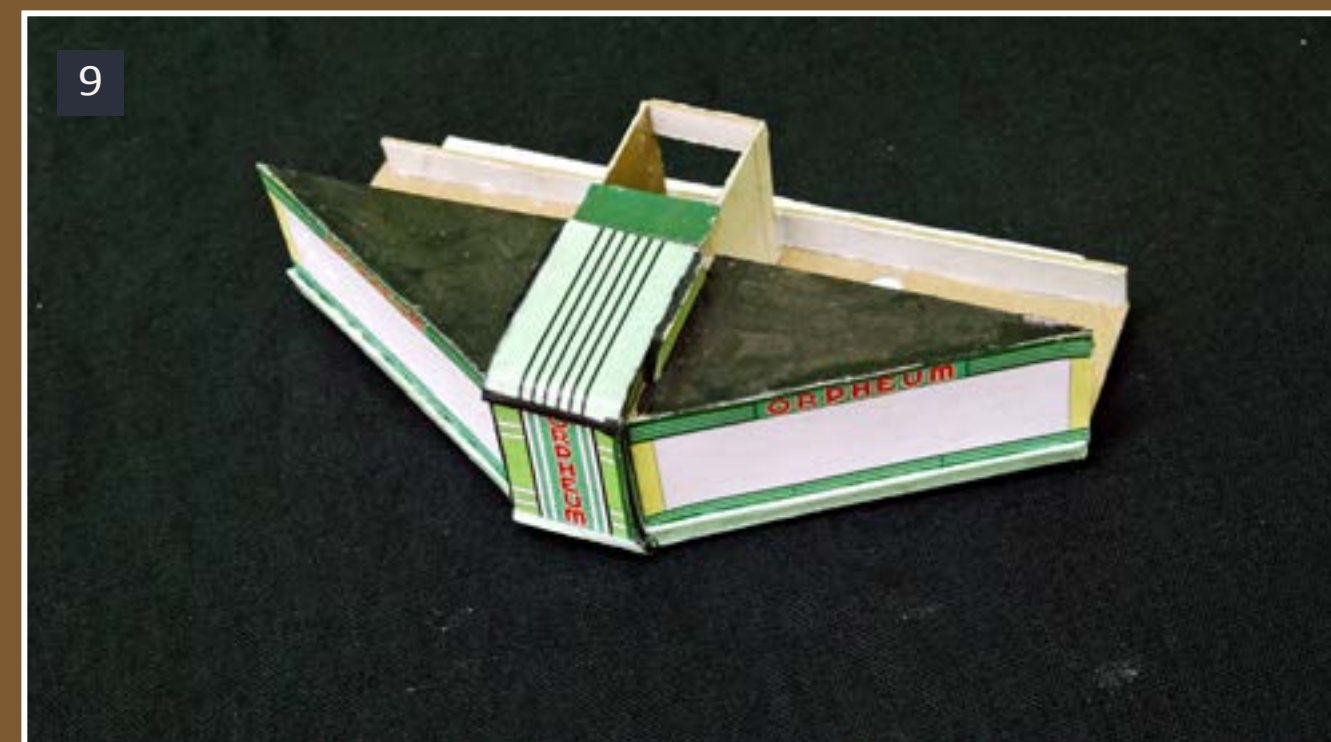

9: Finished marquee.

STEP 15: The Sign

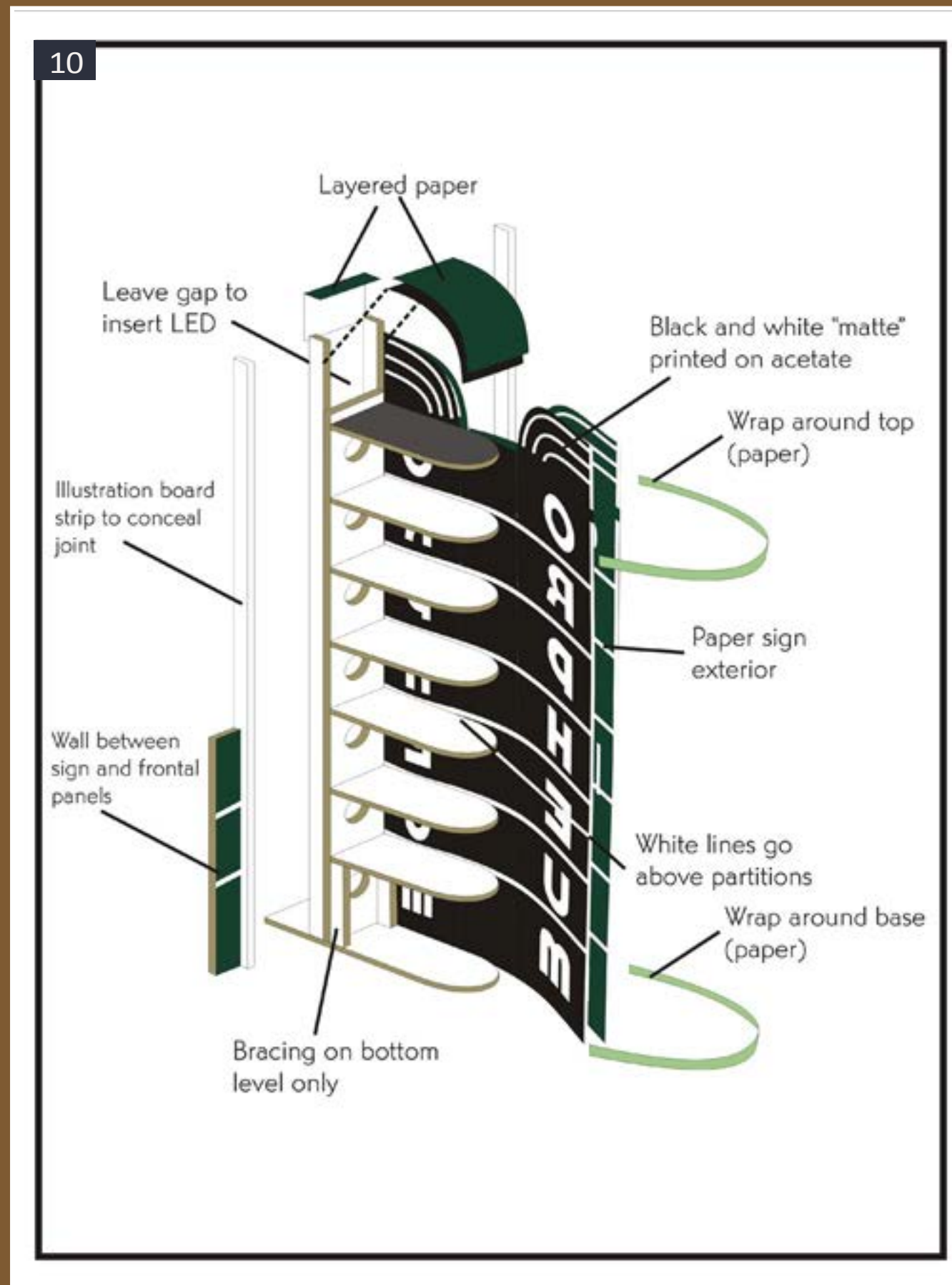

10: Sign construction.

Now comes that most distinguished part of a classic theater – the Big Sign (fig. 10). The curved shape makes for a slightly tricky build, so be patient. Start by building the frame on illustration board, as shown in figure 11.

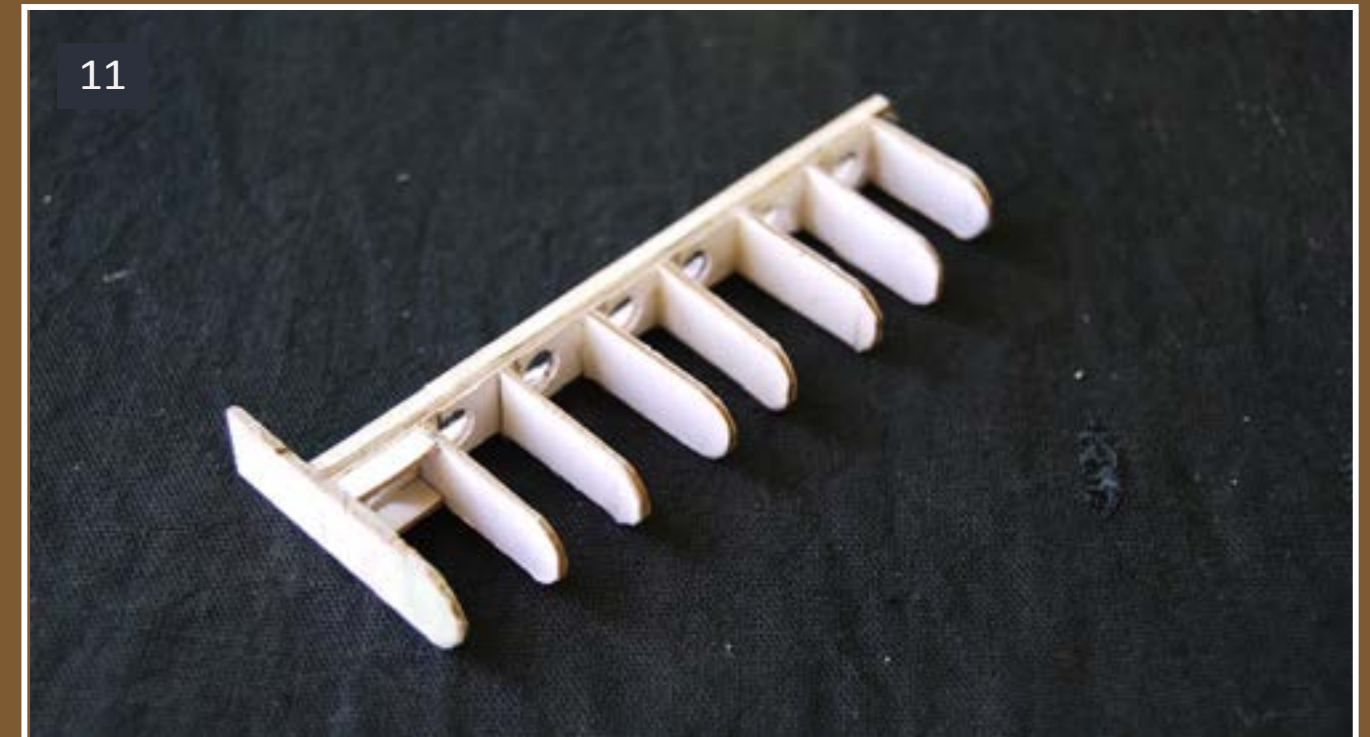

11: The Skeleton – Only the bottom level has bracing, as it would block light on the other levels.

STEP 15: The Sign *Continued* ...

Make sure it's solid, as acetate can get pretty unwieldy. As with the marquee, the sign exterior is made up of a black and white matte on acetate and an external bond paper covering, and they must be properly aligned. Before anything else, bend the sign around the frame for test fitting, and to give it some curvature. Depending on the quality of the print, you may encounter cracks on the black areas of the acetate, but that's taken care of with a marker. Now, glue one side to the frame, with the white lines just above the spacers and let it dry completely (12).

Now fold and glue the other side of the sign – you will need to keep it in place with clothespins. (It took me three tries, as the acetate kept popping off even when the glue was thoroughly set!). The top is two layers of paper wrapped around the sides, and it also had a tendency to pop out of shape! To seal it all in place, add strips of illustration board to the rear and wrap colored paper at the back on the top. Also, to fill out the gap on the theater façade, we'll add two narrow walls to the sides. When the material decided to stay in place, I shined a small flashlight through the holes to make sure

everything was aligned and that there were no light leaks (and to get a taste of things to come!).

In order to conceal the wires and to give the sign some extra heft we'll make this small "box" (fig. 14). It's a pretty simple affair, as it's only illustration board cut and assembled into shape with the appropriate wallpaper. This will be glued in place at the very end.



12: Half glued sign



13: The finished sign.



14: Box – the horizontal white lines line up with those on the sign

STEP 16: Frontal Panels

To seal it all together and to add some dimension to the façade, the sign is flanked by two raised panels that curve over to the roof (fig 15). Sides are cut in illustration board, while the fronts are made with thin card so it curves easily. Note that the pictures show that the center piece is separate – the patterns included here have it all as a single piece.



15: The parts.



16: A single panel.



17: The finished piece.

STEP 17: Roof

A structure this big requires a bit of extra work on the roof, as a single slab of card won't do. The roof comes in two separate parts (18) – the short front piece, which is permanently attached to hold the sign in place and to keep the walls at the proper width, and the longer rear, which is removable to access the interior. The front portion has a baffle to prevent light leaks, while the rear portion is braced to prevent warping. At this point, glue the front portion of the roof. This may make the installation of the marquee and the sign a bit tricky, but it's necessary so the façade has the proper width so everything fits together properly. Finally, I painted it flat black for a tarred finish. You can also draw in tarpaper lines or add a thin layer of gravel.



18: The roof parts.

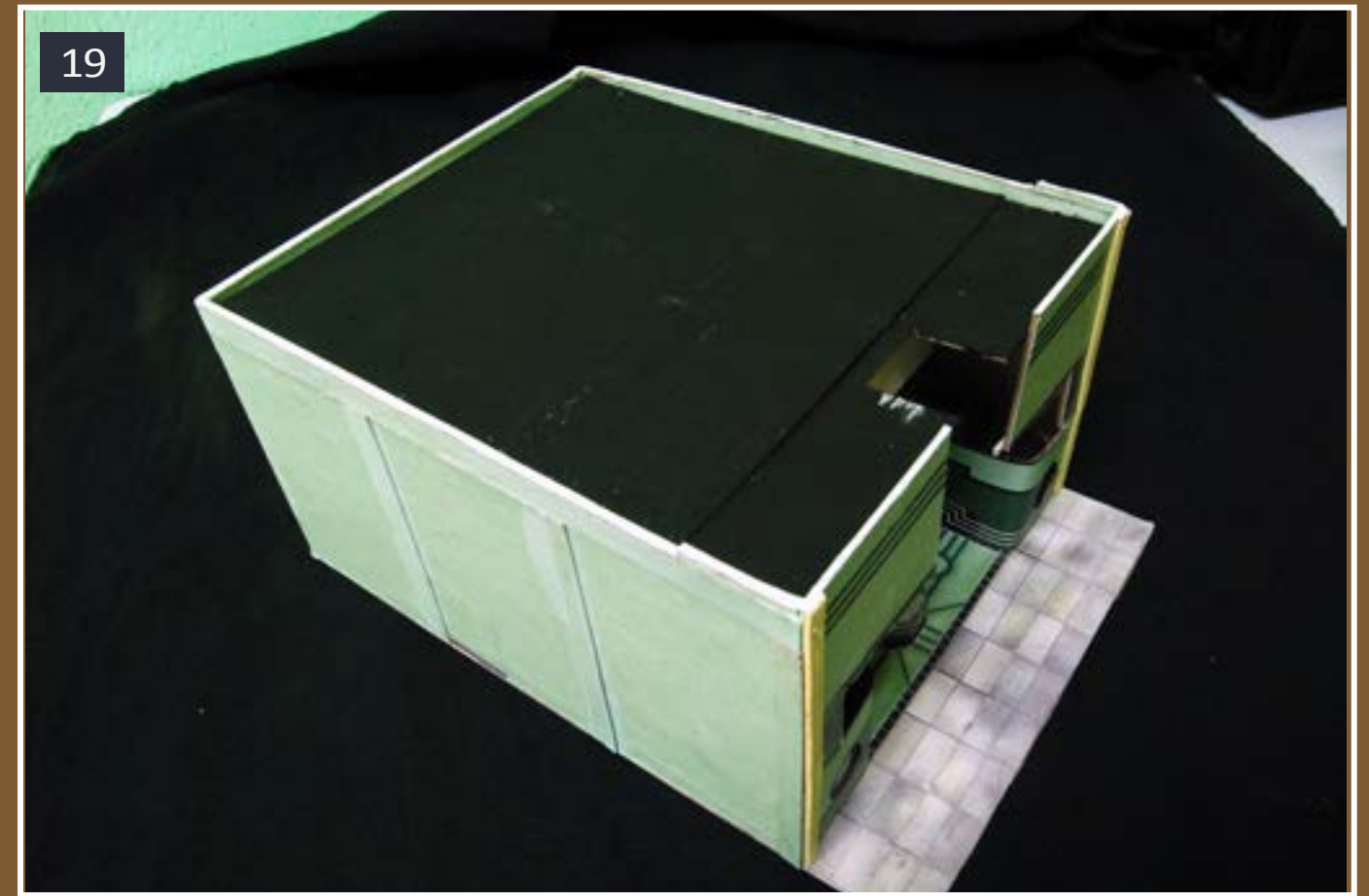

19: Mounted roof.

STEP 18: Test Fitting

Before moving on to the lighting and final assembly, we have to make sure everything fits together neatly. At this point I discovered that very slight mistakes resulted in gaps, while other parts didn't quite drop into place as expected. Some slight trimming was necessary around the marquee area, while the front panels needed some decorative trim at the bottom to cover up a narrow gap.

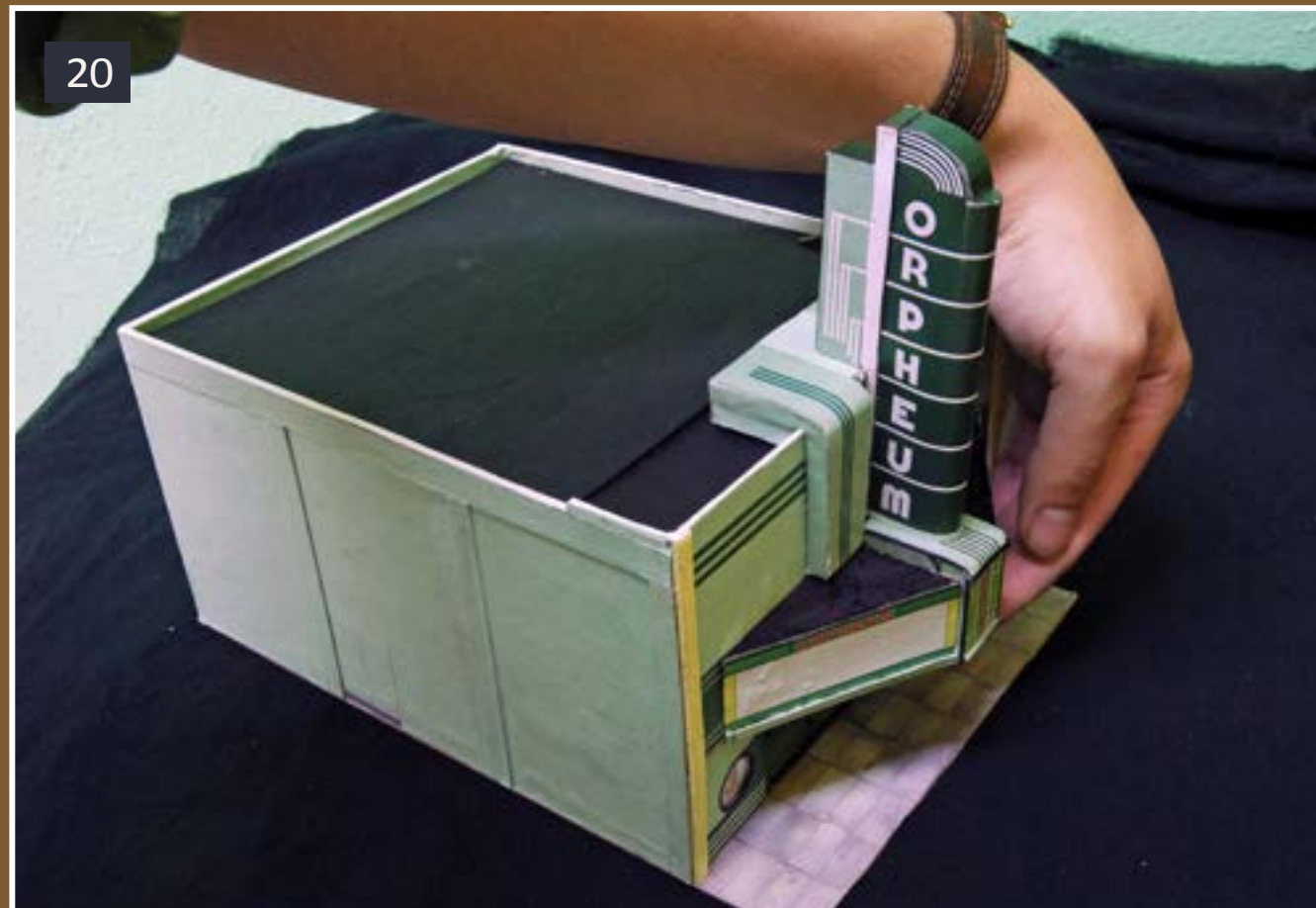

20: Fitting the marquee.

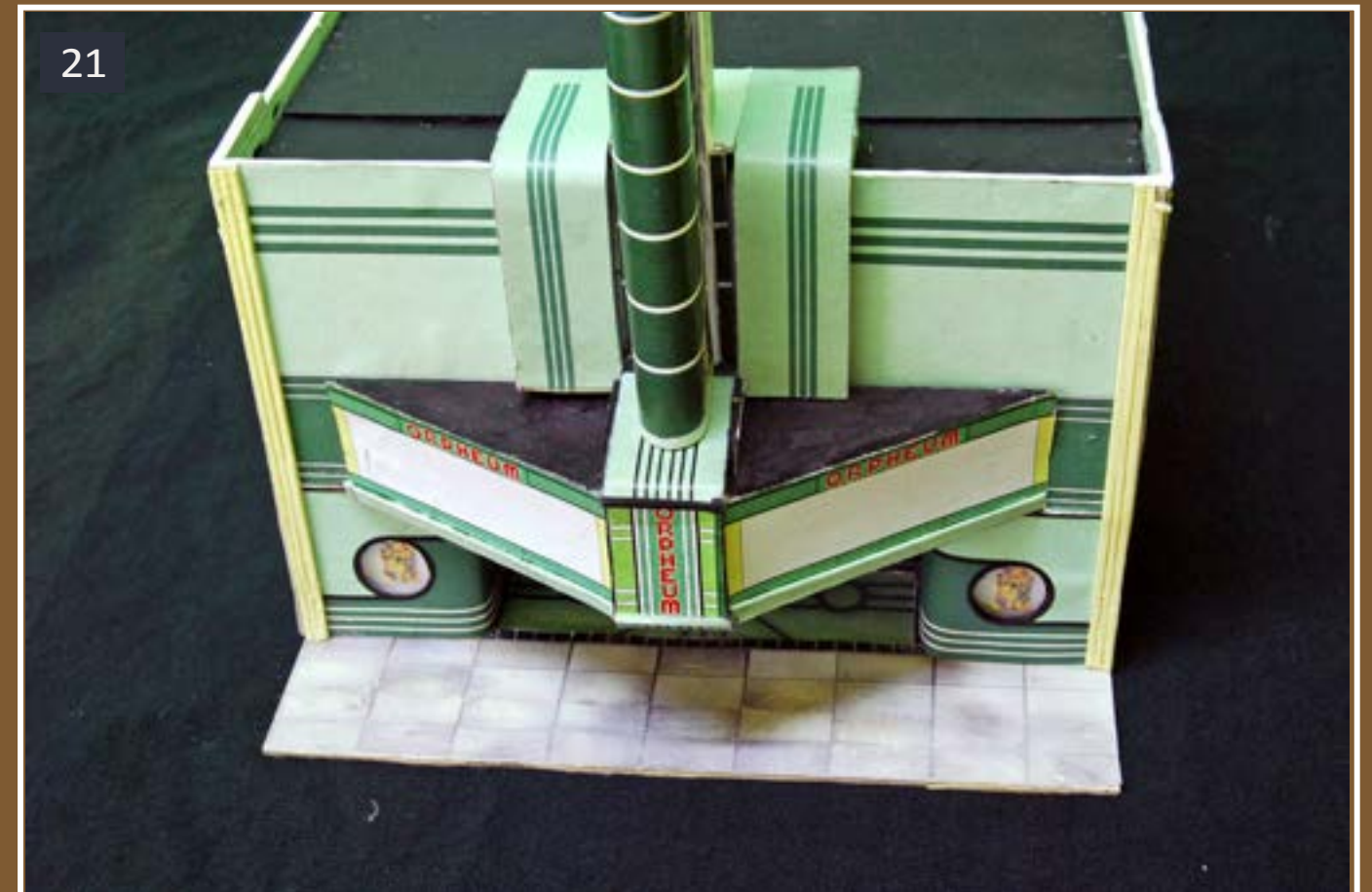

21: Fitting everything else.

STEP 19: Let there be light!

This is it. The moment you've all feared and/or eagerly awaited. The theater uses 3 separate circuits – one for constant lighting, and two flashers (22) for the sign and marquee. The simplest one is the constant light circuit, which illuminates the interior and the lower portion of the marquee. Rather than using juice from the layout's power supply, I prefer to use batteries. This simplifies wiring, makes structures self-contained and if something fails, you don't have to scurry under the layout to fix it (although it helps to have a switch hooked up in your control panel). Should you choose to connect the lighting to your layout's power supply, it's important to add resistors of the appropriate value or the whole thing will turn to toast.

The constant lighting circuit is a string of 7 ultra-bright white LEDs wired in parallel and powered by a 3v lithium coin cell. This will illuminate the interiors and the lower portion of the marquee. Usually I give white

LEDs a touch of yellow to represent incandescent lights, but since this is an ultra-modern late 30's facility, the bluish glow of brand-new fluorescents is just about right. This circuit also had one light at the top of the sign. Late in the construction, I added an extra LED to illuminate a wall mounted billboard.

Here we have the flasher circuit (23). To simplify matters I decided to add the blinking "neon" only on the top of the marquee. The circuit was adapted from a two-led blinker found online, and it consists of two transistors, two capacitors, four resistors, 6 LEDs and is powered by a 9v battery. You can change the flashing rate by changing the value of the resistors – the smaller the value, the faster the flash. I did a fair bit of experimenting on a solderless breadboard before figuring out a decent flashing rate.

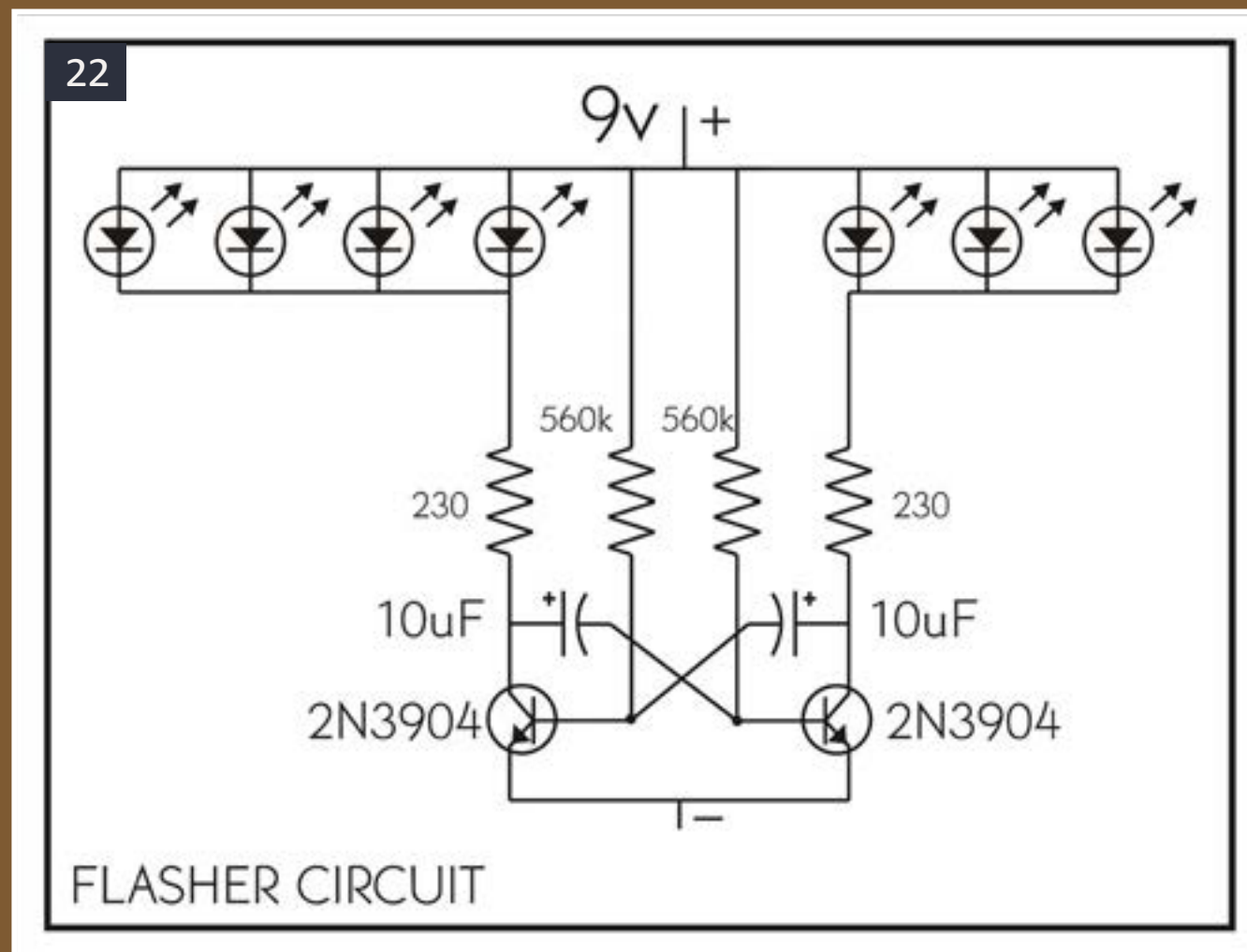

22: The flasher circuit.



23: Testing the circuit.

STEP 19: Let there be light! *Continued ...*

The circuit is mounted on a breadboard and tucked away behind the interior. This same circuit was used for the sign, making a simple but effective chase effect. It's a good idea to make the sign circuit as flat as possible, because later we'll be slipping it through the narrow opening at the front.

When installing lights in the marquee, make sure to arrange them in a way where you don't end up with conspicuous points of light, as we want a nice even light all over. Also be careful when inserting the lights into the sign- at one point during assembly, the covering almost popped off! When you're done fitting the lights on the sign, attach the box that goes behind it. Because of the tight quarters, it's a good idea to insulate all of the joints and leads, as they may touch and short out the circuit.

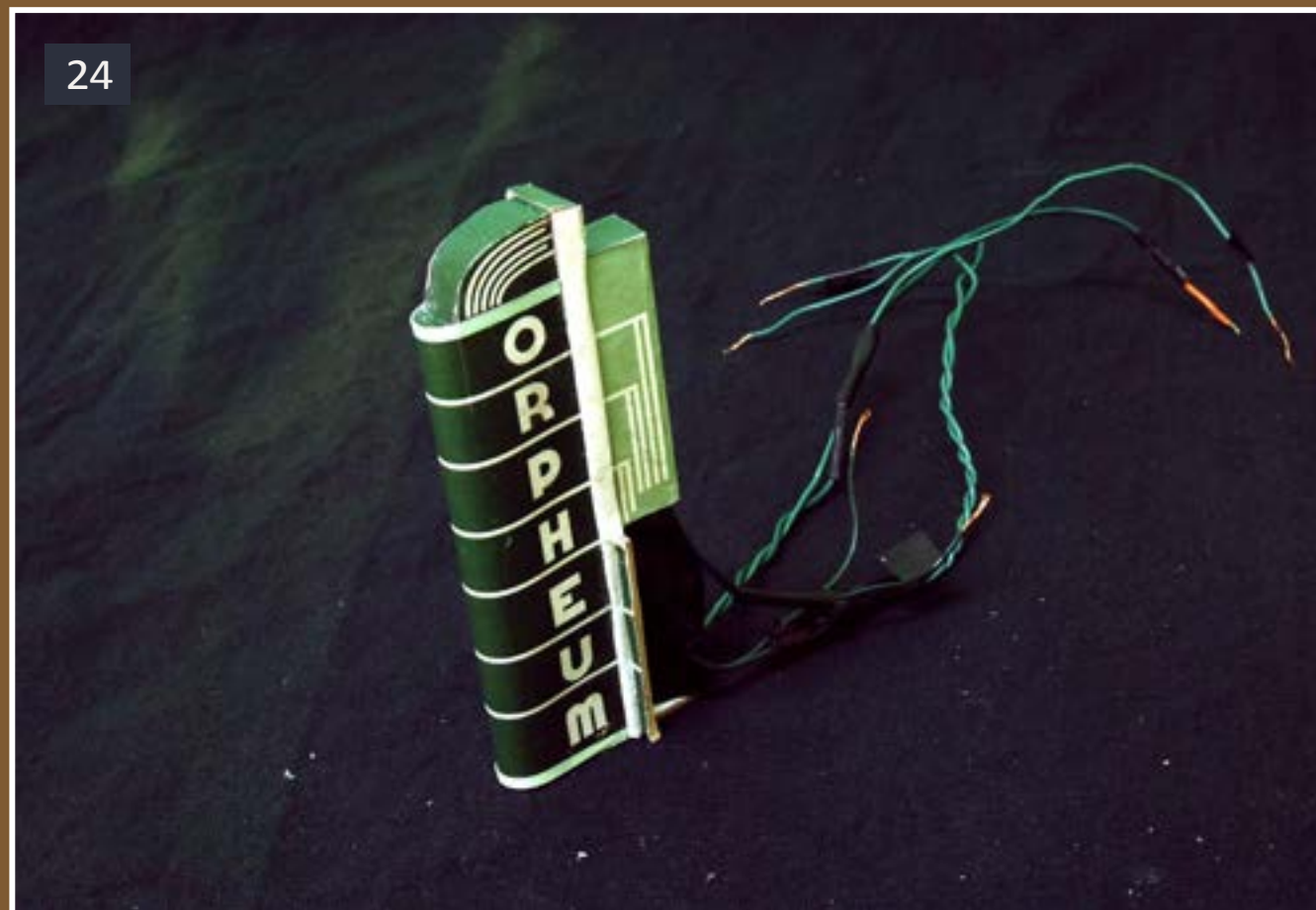

24: Circuit installed in sign.

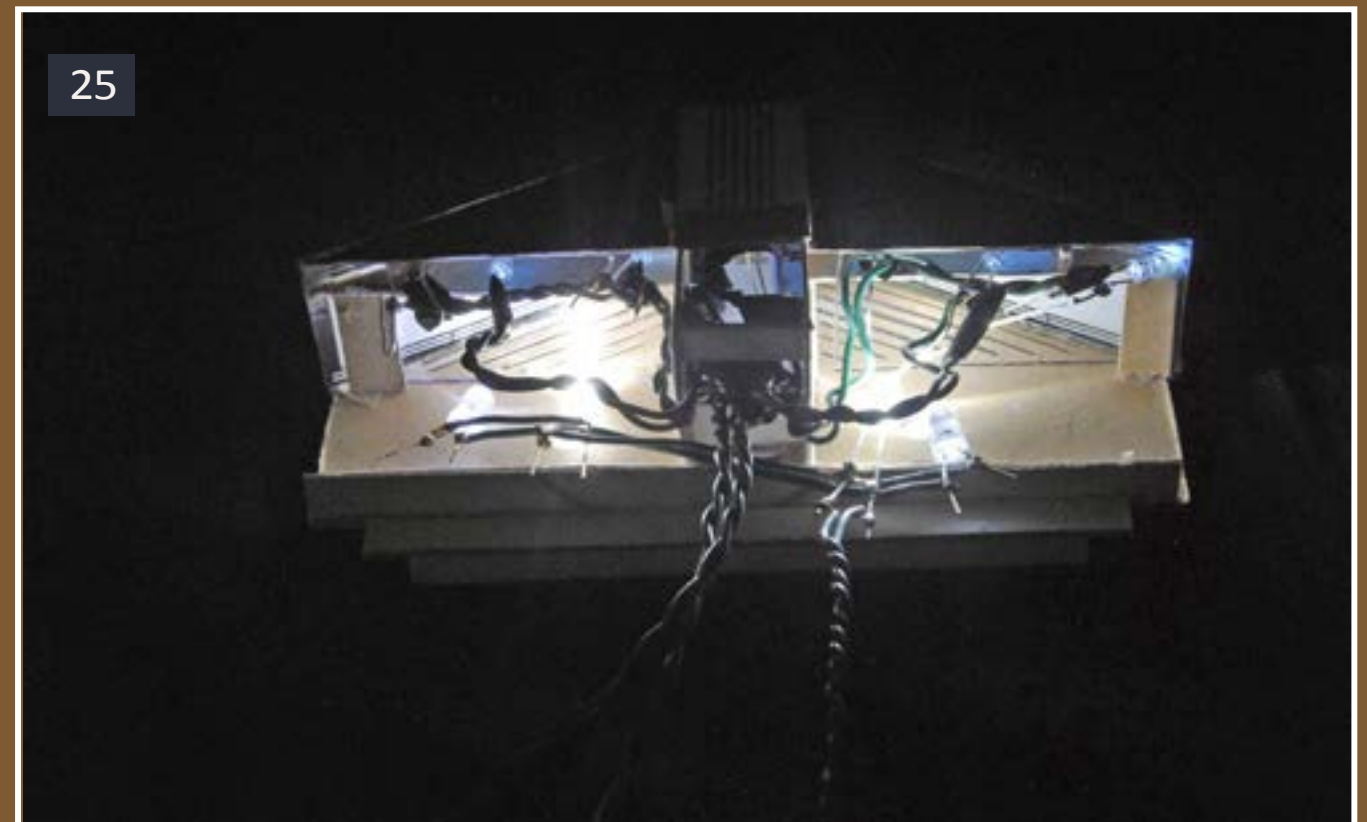

25-26: Marquee lights in place (front and rear(=)).

STEP 19: Let there be light! *Continued ...*

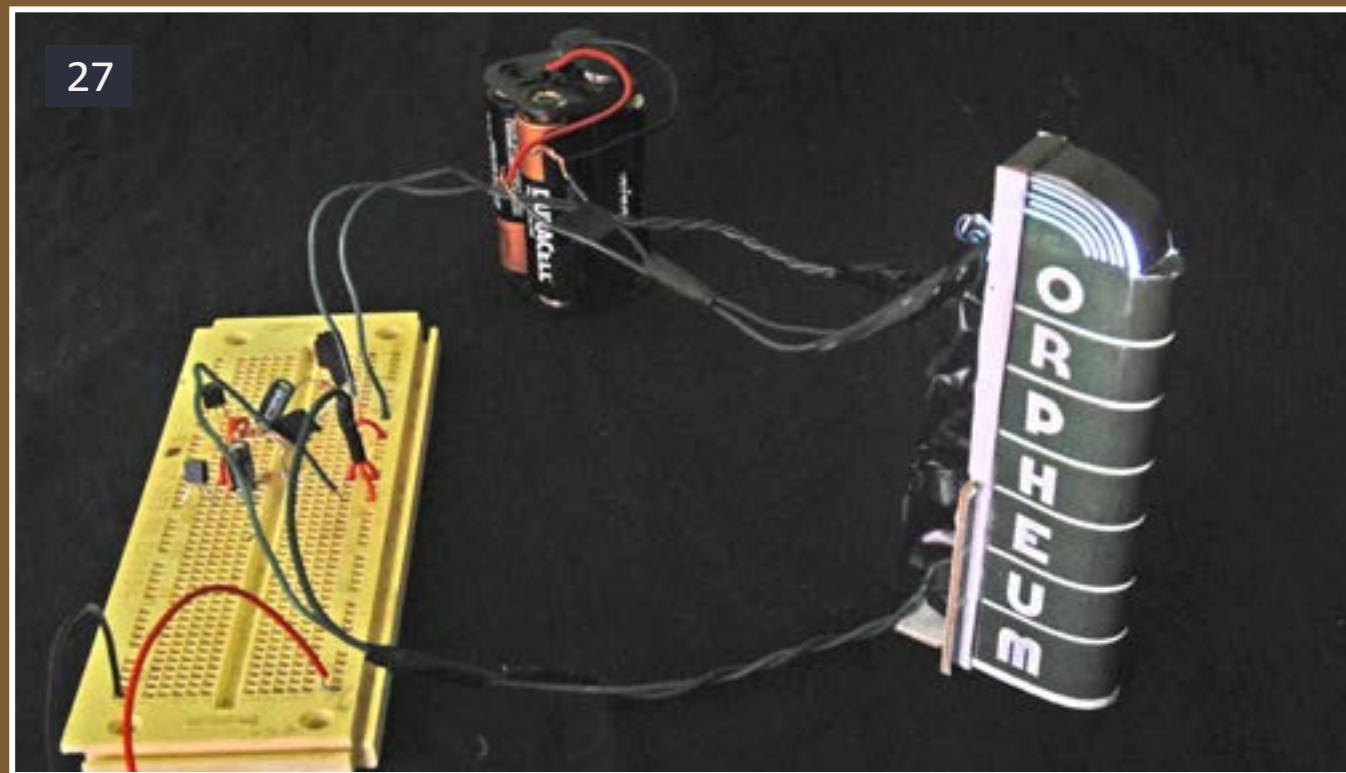

27

27: Lit up sign.

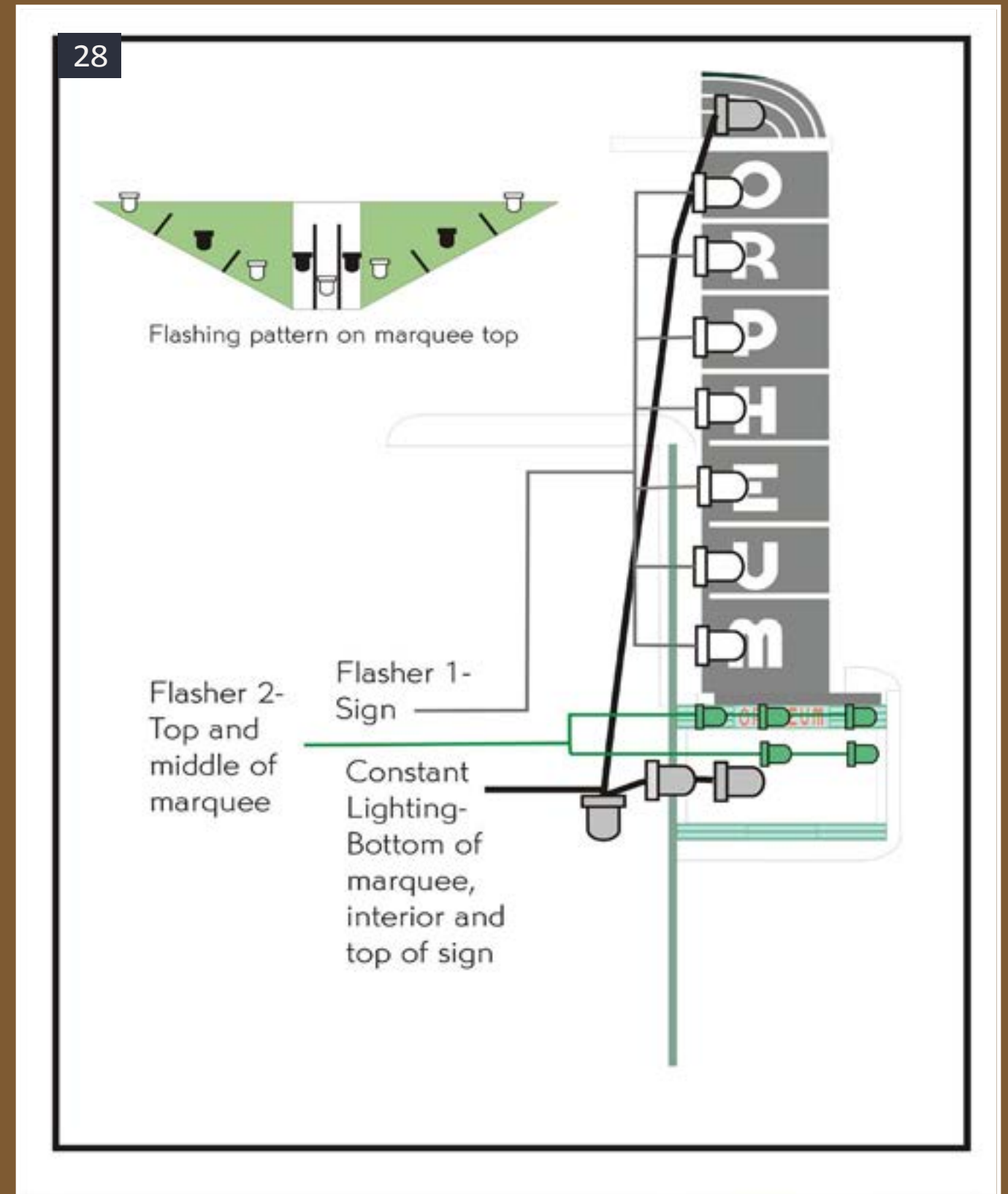

28

28: Position of the different circuits.

Get the Latest Model Railroading News, Tips, Reviews & Opinions

The SCOTTY MASON SHOW

S H O W
The Original Model Railroad Podcast

-Monthly Interviews

- Modeler's Spotlight: Top Modeler's Talk
- Narrow Gauge Modeling w/Chris Lane
- Contemporary Modeling w/ Mike Rose

-More Product Announcements & Reviews

Our feed has changed! To get the latest shows, Please search Scotty Mason and subscribe to the new feed!

www.TheModelRailroadPodcast.com

Scott Mason Jimmy Simmons Mike Rose Joe Duckworth

ADVERTISEMENT

STEP 20: Final Assembly

With all the electrical assemblies in working order, it's now time to put it all together. First, slip the sign into place, adding glue on all the points where it rests. You may have to press it in place for a moment to prevent any gaps. Also, since the outer edges are mostly paper, you must be careful not to warp them. Glue or tape the circuit board behind the interior wall. Next comes the sign. Carefully slip the circuit board through the gap in the wall, and glue the base of the sign on the top of the marquee. Finally, add the front panels, making sure they sit well on the roof and on the marquee. Pop in the removable roof, and there we have it! But it ain't over yet.



29

29: The fully assembled theater.

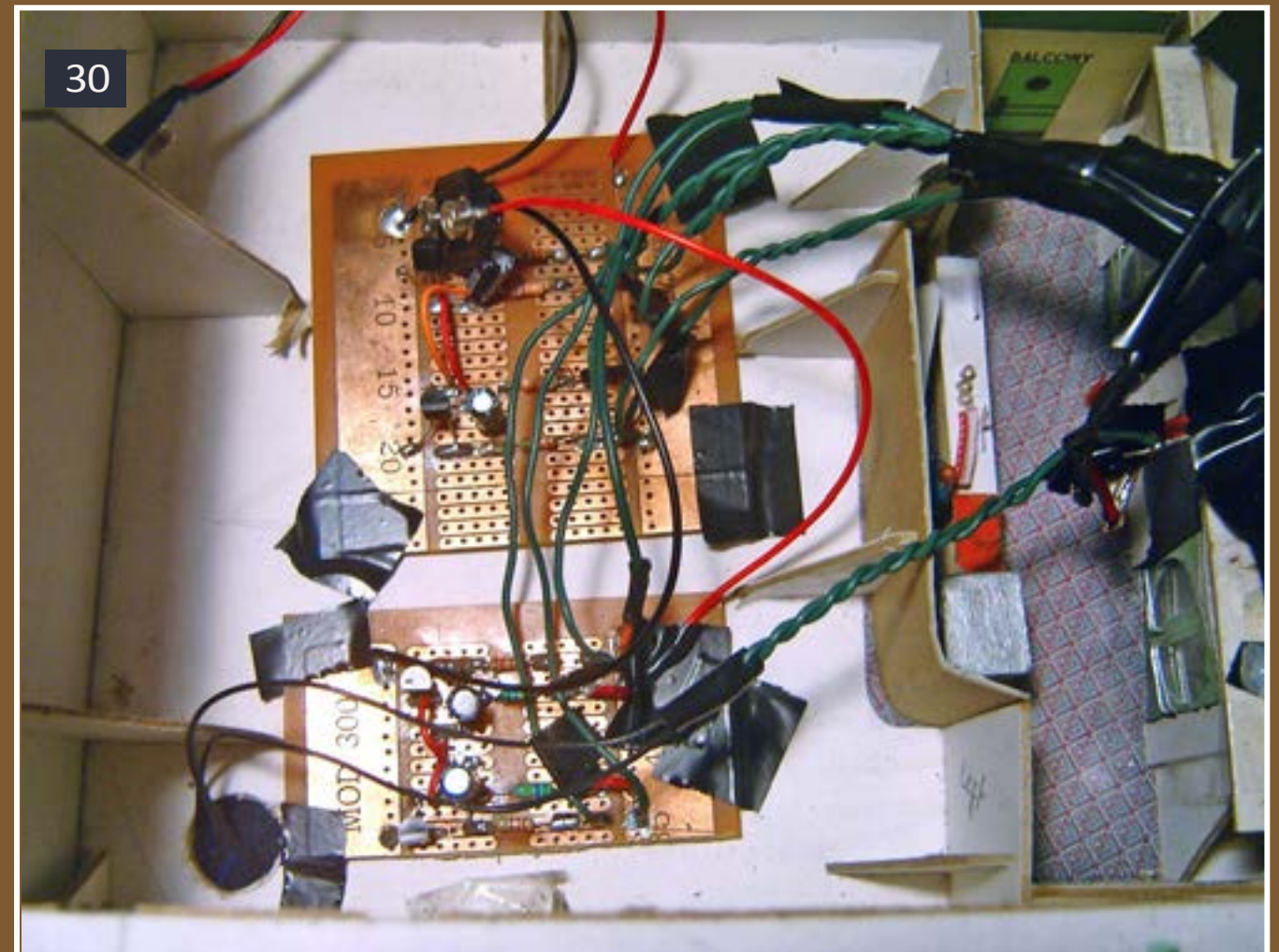

30: The circuits in place – 'tain't gonna win any beauty contests, but they do the job.

STEP 21: Details, Details, Details

By now we have a swell looking structure ready to plant on your downtown scene. But there's no need to stop now. There are several other little details you can add to give the model that extra bit of "oomph". Seeing how this theater was built in the era of highly flammable nitrate film, a fire escape was a must, so I made one using bits and pieces I found in the scrap box (including a picket fence!) (31). As I mentioned in the wiring step, I later decided that one of the sides looked rather bare, so I built a wall mounted billboard with lights. It's a pretty simple addition, consisting of a 95x47 millimeter piece of illustration board, with a cardboard and paper frame (32).

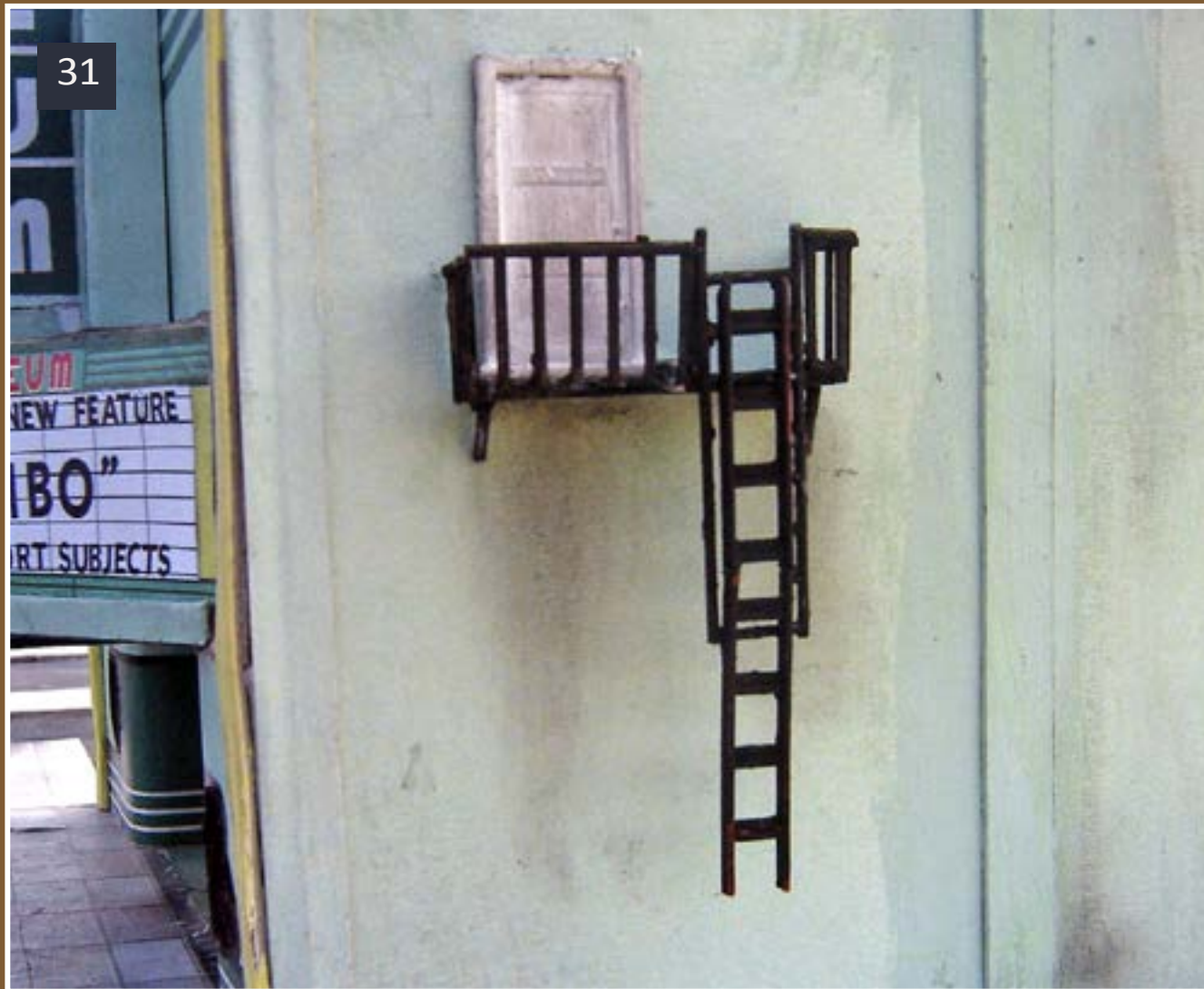

31: Fire escape.

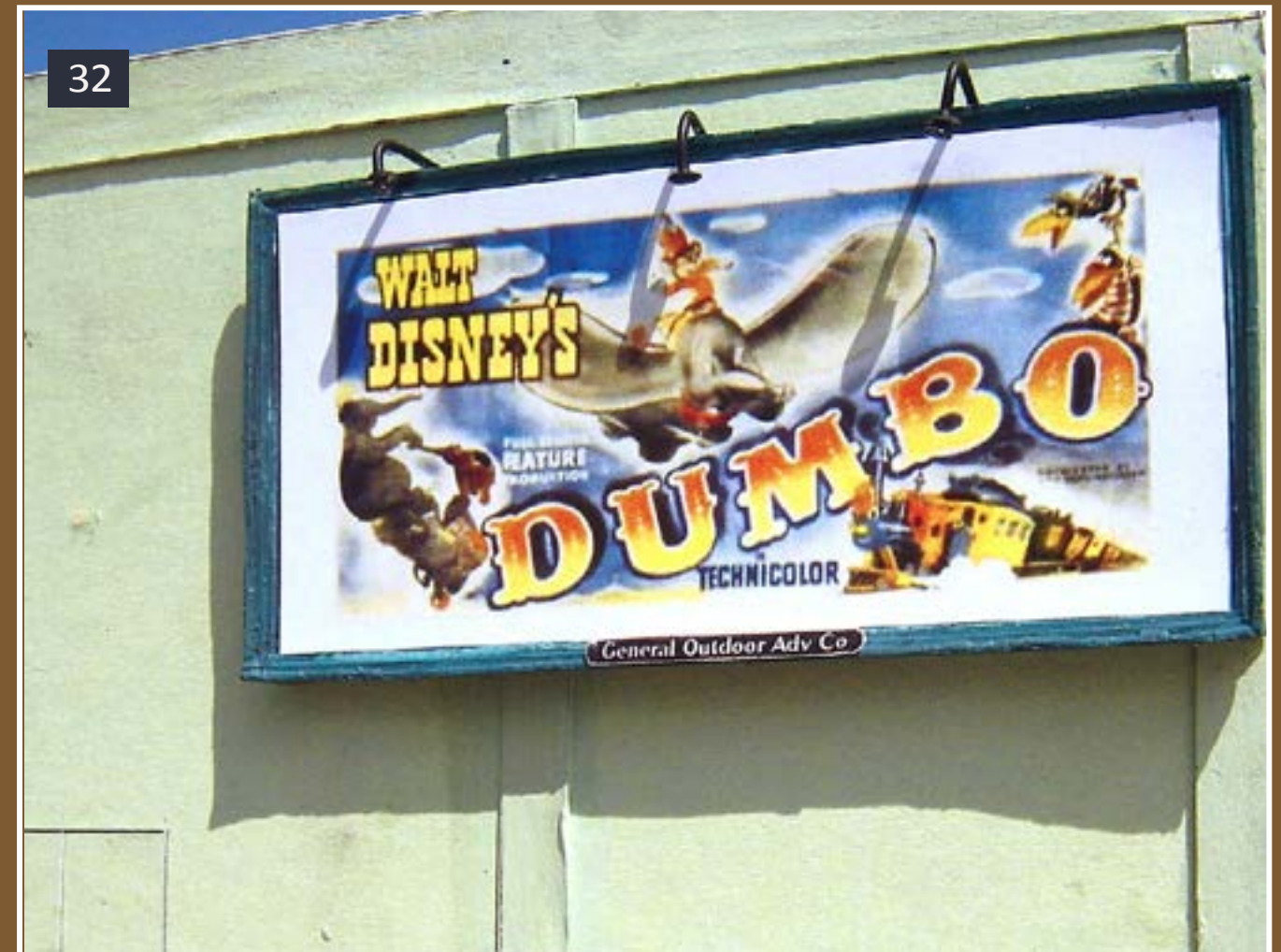

32: Billboard in place.

STEP 21: Details, Details, Details *Continued ...*

The lamps are fiber optic strands bent to shape, and attached to a LED behind the wall (although you might want to use one for each lamp... when everything was glued in place, I found out that using only one makes for some pretty dim lights!). The roof also requires at least a few vents or stacks. I added a pair I found in the scrapbox – one near the front where the projection area would be, and another at the rear. Also built from scraps were the electrical meters and hookups, located at the back. And finally, despite being meant to represent a new structure, I added some weathering to the sides using pastel chalks (34).



33: Electric hookup.



34: Weathering.

And this is where we wrap up our build. It took quite a bit of time and experimenting to arrive to the final design, but I must say it was time well spent. This just comes to show that you can cook up some very interesting things when working on a shoestring budget.

Please see the 3D click-n-spin if you want to study the finished structure from any side.

Since this is made up of printed parts, kitbashing is a simple matter of fiddling around on an image editor, so this little project has quite a bit of possibilities. Hope you enjoyed it!

Click-n-spin on next page.

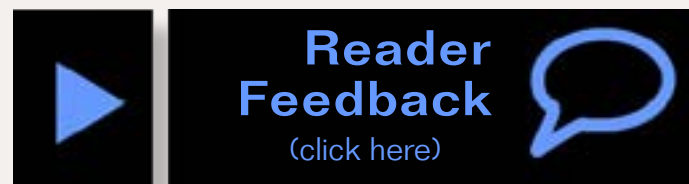

Isaac Herrera is 25, and currently works as a prop builder and illustrator. He has been active in the hobby since the age of 10.

In addition to model railroading, his hobbies include photography, animation, vintage clothes and 8mm movies.



**When talking
to hobby
vendors,
please
remember to
mention MRH.**

A MESSAGE ABOUT THE HISTORY AND PHILOSOPHY OF THE PROTO:87 STORES

A little before 1995, a tiny, very fine scale oriented, group of North American, HO scale modelers, wanted to model overall far more to scale realistically, and especially by finally using actually accurate to scale, HO wheels and track. And so they got together and the US Proto:87 SIG was born. But back then, there were none of the truly scale sized, yet strong and reliable, track components we would need, and no commercial manufacturer was willing to risk stepping up. So, while still finishing a career of running R&D and Engineering for several successful hi-tech companies, and most importantly, unashamedly selfishly wanting so many of those parts for myself, I volunteered to act as the parts maker, as my own hobby contribution. My challenge was to overcome the many difficulties, so that we could then all share the resulting parts and that started the Proto:87 Stores, as an independently funded, SIG member service.

The Original Stores Goal was to use every possible hi-tech design idea and lots of thoughtful innovation to obtain or make the basic missing pieces we needed, yet do so economically in just small quantities, without having to make huge investments in little used machinery and high volume tooling. And for all our sakes, to keep the overall costs of "modeling to actually look like the real thing", much the same as regular HO, or hopefully even less.

What was quickly discovered, once the first parts were made, was that most of the specialized Proto:87 track components, are either the same as or only very slightly different from, those needed for extra-realistic HO. And so the fledgling Stores steadily attracted the attention of many regular HO modelers as well. And their interest helped fund the development of even more new ideas for uniquely extra realistic modeling solutions, including now some asked for parts in N and even Z scale. And so the Stores became financially self-supporting for continuing its manufacturing and sales.

Now getting close to 20 years later, the current "Stores" has grown dramatically beyond its initial expectations, providing a wide range of often amazing seeming, as well as mostly home grown and unique, parts to thousands and thousands of like minded modelers, all over the World. However, we are committed to providing just those products and parts that meet our original goals of providing the most exceptional, but economic and practical, true to scale realism, with absolutely dependable performance and close to everlasting reliability, but with the least possible technical compromises. That means that we do not diverge from our purpose by attempting to be either a general "on-line hobby shop" or an "overnight discount warehouse", nor would we supply or resell unrelated or less realistic items, merely for the profit that they might make.

Because the ideal full product range is still a few more years away from completion, working on my own layout is still a lower and delayed priority, and the "Stores" is still a one-man, hobby within a hobby, operation. All the extensive design work is still performed gratis in my own time and there are occasional other local volunteers, who have the same interests, and help with manufacturing and shipping. But in order to meet the increasing quantity demands, we sub-contract many operations to my past professional industrial source contacts, while using several home built, production dedicated, CNC Machines as "robots" to provide low-cost "labor" for parts that need some aspect of machining.

Most of our parts requests come from picky modelers who have heard of the Stores from the growing group of our existing happy users. However, I would like newer or less experienced modelers to at least hear about us, and sooner, just in case they would like to have the choice of going in our particular direction earlier in their plans. And MRH magazine is wonderful new way of making that connection available at no cost to those modelers.

So if you haven't heard of us before, but might like to see your wonderfully detailed models running on matching equally realistic detailed track, then please check us out anytime when you have a few minutes to spare. As well as our model turnouts that look and work exactly like their prototype, and much lower cost fixtures to build them, we have switch machines and a track wiring system that may save you having to crawl under your baseboards ever again. And our original street track system is almost exact scale, yet works with out of the box RTR vehicles. And far more is yet to come . . .

Andy Reichert



Click on the image above and spin it to see a full 3D “animation” of this model.

About our News & Events Editor



Richard Bale writes our news column under the byline of *The Old Yardmaster*. He has been writing about the model railroad trade for various hobby publications since the 1960s.

[Click here](#) to learn more about Richard.

MRH News Desk: The Latest Model Railroad News, Products, and Events

December 2012

Trainfest 2012

Last month's Trainfest event in Wisconsin set a new record for attendance with a total of 25,569 visitors, exhibitors and volunteers. Billed as America's largest operating model railroad show under one roof, this year's event also hosted 8,326 kids who participated in a special youth oriented program. Activities included special displays, clinics, demonstrations, and nearly 70 operating railroads from Z to G scale. More than 100 manufacturers and hobby dealers presented the latest in equipment and supplies. The annual event was held on November 10-11, in West Allis, Wisconsin. Trainfest is a non-profit organization sponsored by the Wisconsin Southeastern Division of NMRA. Trainfest 2013 will be held November 9-10, 2013 ...



Another Unique Paint Scheme From NS

Norfolk Southern SD60E locomotive number 6920 received a special paint job that honors the Nations' Veterans and members of all branches of the armed services. Twenty-six NS employees used 66 gallons of primer and paint to complete the one-of-a-kind red, white, blue, (and black) paint scheme. To see how workers at the railroad's Altoona Shop applied the special paint go to youtube.com/watch?v=2eAk2rWjGrE. Overland Models has already announced plans to produce a brass version of NS 6920 (see page122) ...

Athearn Production Resumes

Athearn has resumed production of some models affected by the CML factory closure in China earlier this year (see page 103, February 2012 MRH). Items resuming production are in Athearn's ready-to- roll, Roundhouse, and N scale

product lines. Athearn said it's SD40 locomotive is being discontinued and will be re-introduced in the future after modifications have been made to the tooling for that model ...



More Veteran Tributes

In a tribute to America's Armed Forces and Veterans, San Diego's North County Transit District wrapped one of it's bi-level Coaster commuter cars with a massive color photo of

U.S. servicemen and women. Officials said the special car will operate on the Coaster system for the next year ...

25th RPC Released

Congratulations to Ed Hawkins and Pat Wider of RP CYC Publishing, Chesterfield, Missouri, on the release of their 25th edition of Railway Prototype Cyclopedia. Since their initial volume was published in July 1997, their exhaustively researched, fact-laden articles have become must-reads for prototype modelers everywhere. For additional information visit rpcycpub.com ...

InterMountain Names New CEO

InterMountain Railway Company has named Ron Angstead its new president and CEO. Ron was formerly employed by InterMountain from 1990 through 2001. Ron's father, Frank Angstead, who has been president and CEO since 1997, will now serve as executive vice president and CFO concentrating on financial matters. Doug Dolloff has been named senior vice president and will continue to focus on production. Three new vice presidents have also been named including Larry Leicht, who will be responsible for product development, Bill McClung, sales, and Richard Frazier, marketing and customer service. InterMountain produces HO, N, and Z scale products including locomotives and rolling stock.



The Colorado-based firm distributes its own product line as well as products of several other model railroad manufacturers. InterMountain was founded in 1988 and expects to surpass \$4 million in sales this year ...

25th Anniversary for ESM

Eastern Seaboard Models is celebrating its 25th anniversary. We send our hearty congratulations to founder Brian Bussey and the ESM team that has been creating outstanding N scale models since 1987 ...

Leo Campbell 1927-2012



Leo A. Campbell, founder of Campbell Scale Models (CSM), passed away November 1, 2012 at his home in Grand Junction, Colorado. Campbell, who was 85, had suffered from multiple hip surgeries during the past several years. Campbell was a painting contractor working at Disneyland in 1960 when he met the late Tom Ayres who offered marketing advice and financial assistance to Leo. The enterprise began with three wood kits produced in the garage of Campbell's home in Tustin, California. By the mid-1970s CSM was shipping more than 3,000

HO scale kits per month. At one time the company employed more than 40 people. In 1991 Leo relocated his company to Durango, Colorado. He retired in 2004 and sold CSM to Duncan Campbell (no relation) who moved the operation to Oregon.

A tireless supporter of the hobby, Campbell helped establish the Western Model Railroad Manufacturers Association and served as its president for two terms. Campbell's promotional efforts were recognized on several occasions by the National Model Railroad Association. He was the recipient of the NMRA Presidents Award in 1975, the NMRA's Distinguished Service Award in 1984, and the NMRA Pioneers Award in 2010. The Hobby Manufacturers Association named Campbell to their Industry Hall of Fame in 1996. Leo Campbell was born in Michigan in 1927 and grew up in the state of Washington. He is survived by his wife Ruth, four children, and eight grandchildren. Campbell served in the U.S. Marine Corps during World War II. A graveside service with full military honors was held November 16, at the Western Colorado Veterans Memorial Cemetery in Grand Junction ...

Bob Karig 1946-2012

Lt. Col. Martin Robert Karig, III (U.S. Army, retired), died suddenly on November 2, 2012, while attending a military alumni reunion in San Antonio, Texas.

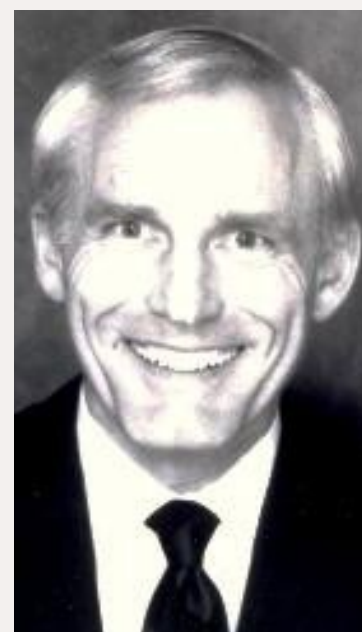

After retiring, Bob moved to Lancaster, Penn., where he volunteered as a researcher and docent at the Railroad Museum of Pennsylvania in Strasburg. He also volunteered for the Ontario & Western Railways in Middletown, NY, Landis Valley Museum in Lancaster and Habitat for Humanity.

Bob was an enthusiastic modeler and participated in various prototype modeling events. He was also an accomplished author, having published two books that dealt with the history of freight car technology: *"Hard Coal and Coal Dust,"* and *"Coal Cars: The First Three Hundred Years."* He was currently working on a third book, *"From West Shore to Coal Fields,"* which traces the business

histories of the New York, West Shore & Buffalo and the New York, Ontario & Western Railways. A native of Middletown, NY, Bob held a bachelor's degree in history and political science from Alfred University, a master's degree in business administration from Georgetown University, and had studied international business at Oxford University.

Bob was a career officer who served two combat tours in Vietnam as a helicopter pilot, before retiring from active military duty in 1989. Among his medals and citations were the Distinguished Flying Cross, Legion of Merit, Bronze Star, Meritorious Service Medal and two Air Medals, one awarded for valor. Bob worked in the Pentagon while in the army and then as a civilian for the University of Maryland and also served on a consortium for Lockheed Martin. Interment with full military honors will be held January 30, 2013 at Arlington National Cemetery ...

Now for a look at some new model railroad products...

NEW PRODUCTS FOR ALL SCALES



Among Kalmbach's (kalmbachstore.com) newest books is Tony Koester's *"How to Kitbash Structures,"* in which the author explores ideas for working with commercial kits and how to alter them to meet your own needs. In an early chapter Koester urges hobbyists to ignore the label on a box. *"If during a visit to a local hobby shop or while perusing a catalog we see a kit labeled as a cement plant, it may never occur to us that there is actually a soybean processing plant hiding inside the box"*. Rather than being a how to build it book, this is a how to think book. It's full

of ideas for newcomers and experienced modelers. The 8.25" x 10.75" 94-page, soft-cover book is available from hobby stores or direct from the publisher for \$21.95.

O SCALE PRODUCT NEWS



Morgan Hill Models (morganhill-models.com) has introduced a kit for an On30 scale 20' flat car with logging bunks. The kit is composed of a cast resin frame, cast white metal bunks, chain, and basswood deck boards. Trucks and couplers are not included.

The kit is priced at \$24.95 each, or \$69.95 for a pack of three.

Scale Model Masterpieces (debenllc.com) has released an O scale kit for Rio Grande La Jara Water Tank. If the model looks familiar, it's because it was originally offered by the legendary Thomas A. Yorke as an HO kit. The hollow tank is cast in LabStone. The bents and platform are cast in a light grey driftwood color. Additional components include wood, nut-bolt-washers castings, a spout assembly, and detailed instructions. The kit is available at \$87.89. Model builder (and company owner) Richard E. 'Ben' Bendever, finished the HO and O scale models shown in the photo with Doctor Ben's weathering stains, as described in the kit instructions.



The kit is available at \$87.89. Model builder (and company owner) Richard E. 'Ben' Bendever, finished the HO and O scale models shown in the photo with Doctor Ben's weathering stains, as described in the kit instructions.



A British firm operating under the name **Track-Pass** (trackpass.net/id57.html) has released four new O scale cast metal figures. The locomotive engineer, above right, aka Boiler Wash Bill, is a two-part figure specifically designed to fit in Bachmann's On30 Shay.

The other figures are, from the left, Sweet Caroline, Frisco Pete, and Depot Dan. There are

currently no dealers in North America, however the figures are available on eBay under the name Railfolk. Additional information is available at the Track-Pass website.

HO SCALE PRODUCT NEWS



Accurail (accurail.com) is preparing new tooling for a Pullman Standard 4750 cu ft triple-bay covered hopper. No word yet on the retail cost but it is expected to be in keeping with Accurail's generally modest prices. Availability will be in 2013. Initial road names being considered for the HO scale kit include Santa Fe, BN, BNSF, C&NW, D&RGW, Union Pacific, CSX, Soo Line, Farmers Co-op, Southern Railway, Rock Island, and Canadian Pacific. Kits lettered with data only will be available with bodies painted white, light gray, and mineral red. An undecorated kit will also be offered.

Meanwhile, Accurail has announced availability this winter on the following new HO scale kits. All prices shown are manufacturer's suggested retail.

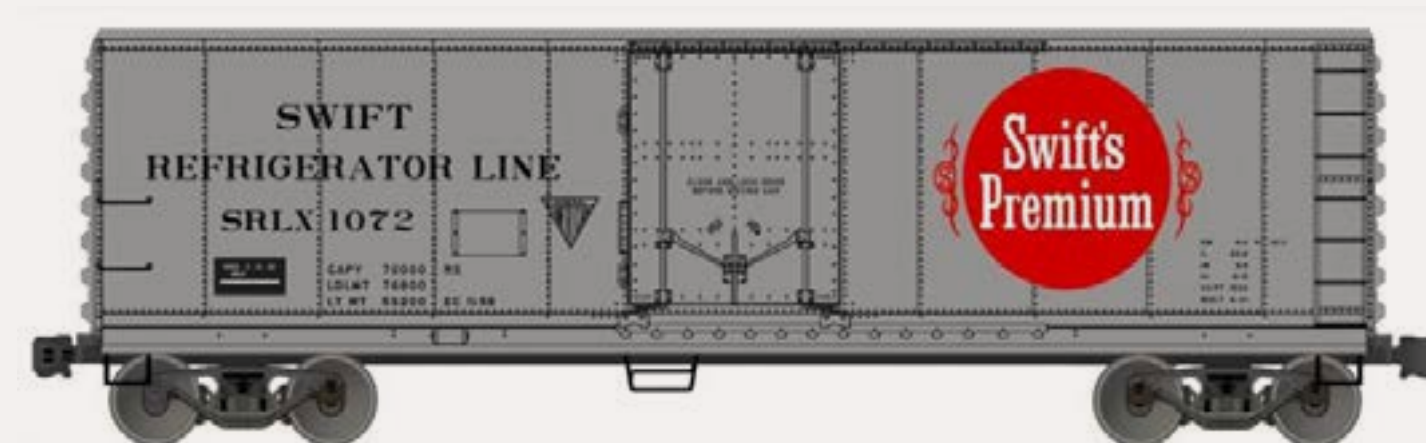

Swift Refrigerator Line-SRLX 40' aluminum body reefer with plug-door (item 8512) at \$15.98



Two-car set of Northern Pacific 40' steel boxcars (single door and combo door) at \$29.98.



Denver & Rio Grande Western 40' single-sheathed 6-panel wood boxcar (item 70082) at \$15.98.

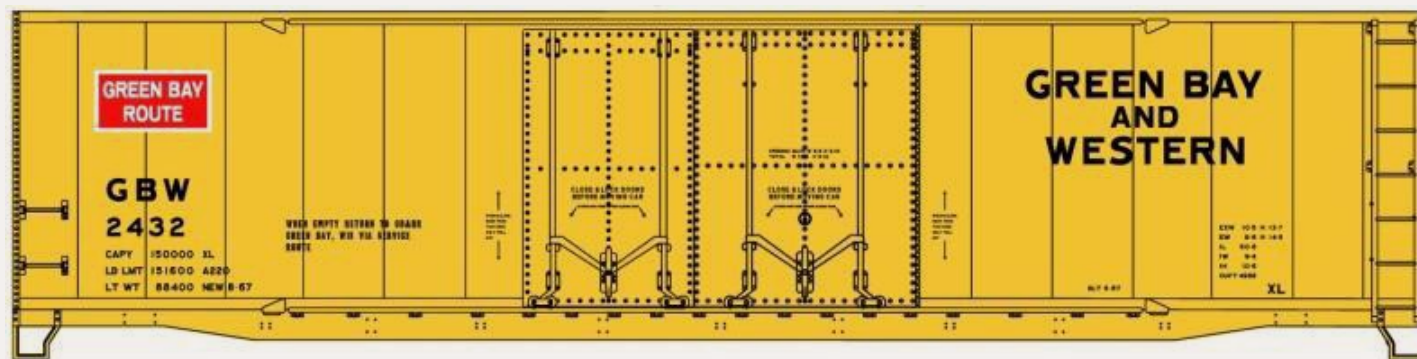

Green Bay & Western 50' double plug-door steel boxcar (item 5412) at \$15.98.

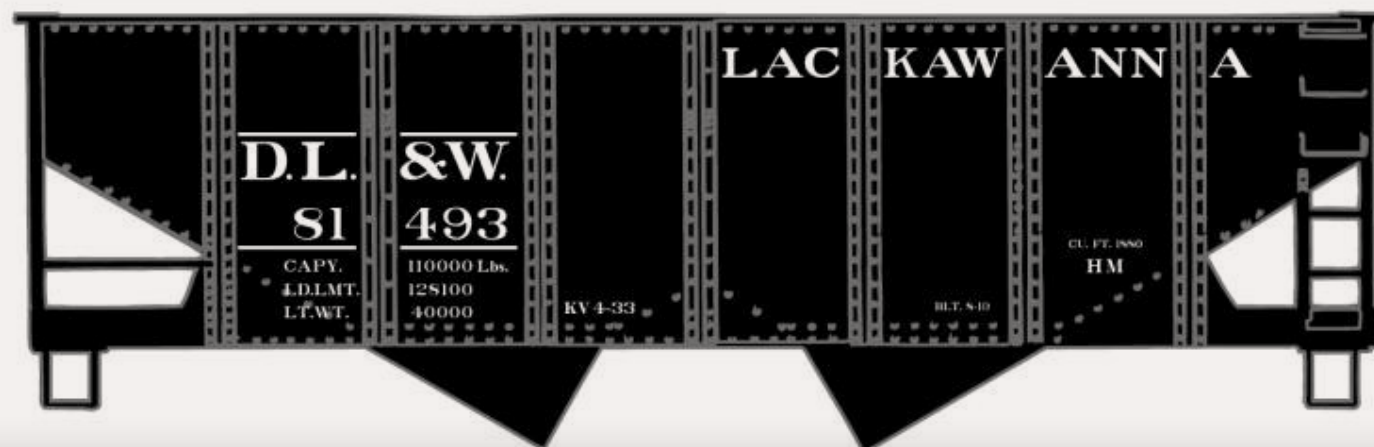

DL&W-Lackawanna 55-ton USRA twin-hopper car (item 25032 lower-left column) at \$14.98.



Three-pack of Santa Fe triple-bay ACF covered hopper cars at \$49.98.

Additional new models coming from Accurail over the next 30-60 days include Canadian Pacific 40' swing-door steel refrigerator car (item 8312) with mineral red body and white graphics at \$15.98; Northern Pacific 50' plug-door aluminum body boxcar with black, white, and red graphics at \$15.98; Northern Pacific 89' partially

enclosed bi-level Auto Rack (item 9411) at \$22.98; Rock Island 40' wood refrigerator car (item 4844) at \$16.98, three-pack of Rutland 41' AAR gondolas (item 37484) at \$45.98; and Detroit, Toledo & Ironton 70-ton offset-side triple-hopper car (item 7544) at \$14.98. Also 55-ton wood-side USRA war emergency hopper cars at \$14.98 each decorated for Delaware & Hudson (item 2720), Monon (item 27131), and Chesapeake & Ohio (item 27131).

Athearn Division of Horizon Hobby (athearn.com) used the occasion of Trainfest to introduce a comprehensive new catalog. It can be viewed on line at the link above.

Athearn has completed the first release of its all-new Genesis series HO scale GP38-2 locomotive. The ready-to-run models are available for CN, MP, SP, and Southern. Each version features numerous road-specific details.



Athearn's Canadian National GP38-2 represent an early Phase Ib version with several distinctive Canadian features including front and rear low plows with white "V" stripe, uncoupling levers, ribbed anticlimber, operating lampshade-style ditch lights, short blower housing, snow shields over air intakes, vertical rear headlights, and a Canadian safety cab.

shields over air intakes, vertical rear headlights, and a Canadian safety cab.

Additional details include square air filter box and chicken wire radiator grilles; bell mounted between the number boards; triangular cluster of red, white and green class lights; Sinclair ice skate antenna; sunshades; early inertial air intake grilles; curved radiator fan grab iron; Salem air filter; Nathan K3 horn mounted to the rear of the engine compartment roof; 2600-gallon fuel tank; and Bloomberg-M trucks.



Athearn's Missouri Pacific GP38-2 is a Phase Ib2 version of the locomotive. MP road specific details include side-mounted bell, and extra jacking pads added at the ends of the frame by the step wells. Parts are included to allow modelers to add MoPac's four-stack "free-flow" exhaust system, and spark arrestors.

Additional features include 81" nose with ratchet brake, front snowplow, early-type uncoupling levers, front and rear drop steps, firecracker antenna, riveted cab side, sunshades, mirror/wind wings, dash-2 ribbed blower housing, curved radiator fan grab iron, Leslie 3-chime horn, 2600-gallon fuel tank, and Bloomberg-M trucks with speed recorder.



Southern Railway's GP38-2s are Phase I locomotives with split radiators resulting in wider spacing of the radiator fans, oil-bath air filters, and chicken-wire radiator grilles.

Athearn's Genesis model has several distinctive Southern features for the road's long-hood-forward operation

including a high nose, bell mounted on the end of the long hood, cab interior with single control stand facing long hood forward, and switcher style steps with the upper steps recessed to allow a crewman to stand on the bottom step. Additional details include MU boxes at front and rear, two Nathan P-5 horns, riveted side cab, sun visor, firecracker antenna, standard Dash-2 ribbed blower housing, intermediate inertial air intake grilles, raised exhaust stacks, dynamic brake, curved radiator grab irons, Salem air filters, 2600-gallon fuel tank, and Bloomberg-M trucks with speed recorder.

Southern Pacific GP38-2s with the road's Bloody Nose paint scheme represents Phase IIc1 locomotives delivered in 1980. Athearn's model represents late production prototypes with an 88" nose with brake wheel, corrugated



radiator grilles and notched step wells to allow for easier access to the uncoupling lever. They also have FRA-mandated noise-reduction equipment with 48" Q-fans on the radiators and shotgun stacks that did not extend above

the hood roof, SP-style walkway toolbox extension at the end of the blower duct, SP jack pads, SP light package with Gyalight cab headlights, SP-style rear headlights, and stenciled homeport designation on the cab. Additional details on the SP model include a large snowplow, square anticlimber, cab with welded side plates, L-shaped window on the engineer's side, Nathan P3 horn with staggered chimes, ground plane whip antenna and conduit, air conditioner, oval cab vent, sunshades, late inertial air intake grilles, and extended range dynamic brakes. Other features include angled radiator grab iron, frame-mounted bell, 3600-gallon fuel tank, no rear number boards, and Bloomberg-M trucks with speed recorder.

Each GP38-2 road name is available in four road numbers. Locomotives without sound will be DCC-ready using Quick Plug™ technology. They have an MSRP of \$179.98. Sound-equipped GP38-2s have SoundTraxx® Tsunami® DCC decoders and have an MSRP of \$279.98. The next GP38-2 releases will be for Burlington Northern, Milwaukee Road, Norfolk Southern with a high hood, and Rock Island in Bankruptcy Blue. We'll have complete details next month.



At Trainfest, Athearn showed samples of its Genesis series of General Electric ES44AC GEVO locomotives. Some key components of this HO scale ready-to-run model will be produced from reworked Tower 55 tooling purchased in

2008 from Overland Models. The initial ES44AC release will be for Union Pacific, BNSF, and Canadian Pacific. The models are scheduled to arrive in June 2013. Features common to models in this release include the nose door on the left side, dynamic brake intakes with fans visible inside, two closely spaced dynamic brake vents with undercut panels above, X-panels on the electrical cabinet with a capacitor box on the walkway just behind it, side grab irons on the long hood, flush-mounted top radiator grilles and radiator compartment doors. Additional features, unless noted otherwise, include a low front headlight, large antenna

dome, GPS dome, Nathan K5HL horn, hand brake panel grille, flush heat exchanger housing, top radiator grilles, 5000- gallon fuel tank, and trucks with separately applied piping.

The BNSF ES44AC models represent locomotives GE delivered to BNSF between October 2005 and July 2006. They will be decorated in the Heritage III Swoosh paint scheme and will include distinctive BNSF details such as four-window cab side windows, nose-mounted headlights, and cab mounted number boards. Additional prototype road details include a short front plow, nose door window, sunshades, Salem air filter, and Hi-Adhesion trucks.



Athearn's Canadian Pacific ES44AC comes with GE steerable trucks, nose-mounted headlights, and number boards. Additional details include a tall front plow, dual trainline hoses, additional MU stand at front and rear, nose

door window, nose door grab iron, three-side windows in cab, desktop control stand, no sunshades, Sinclair antenna, prime air filter, low rear sand filler, high vertical rear headlights, and long hood end access door.



UP was the first railroad to receive test ES44ACs in early 2003. Athearn's UP ES44AC models in this release represent locomotives GE delivered to UP in 2006. Decorated in UP's "Building America" paint scheme,

road specific details include a tall front plow, bolt-on front sander door, low front headlight, high number boards, three-side windows in cab, modernized AAR control stand, dual cab side blue flag brackets, sunshades, prime air filter, electronic parking brake, high vertical rear headlights, low rear sand filler, and Hi-Adhesion trucks.

Each of the four ES44AC railroad names will be available in four different road numbers. ES44AC models without sound will be DCC-ready using Quick Plug™ technology. They will have an MSRP of \$199.98. Sound-equipped models come with SoundTraxx® Tsunami® DCC decoders and have an MSRP of \$299.98.



Athearn's most recent production schedule indicates Genesis series GP9 diesels decorated for Texas & Pacific and New York Central will arrive in June 2013. DC versions of the HO scale models will have an MSRP of \$189.98. DCC/sound versions list at \$289.98.



Also coming in June are 57' mechanical reefers both with and without on-board sound at \$44.98 and \$79.98 respectively. The Genesis series HO scale cars will include an as-delivered version with a gen-set visible through the see-through ends,

and a modernized car with a trailer-style refrigeration unit. Paint schemes will be for FGE/FGCX, FGE/FGMR (solid cold), and BN/BNFE.



Athearn HO scale ready-to-run models coming in June include 34' 50-ton, two-bay, offset-side hopper cars with removable cast-resin coal

loads for B&O, Canadian Pacific, Illinois Central, and Rock Island. The hoppers will have an MSRP of \$19.98 each or \$119.98 for a six-pack.



Athearn's June vehicle schedule includes HO scale yard tractors decorated for Canadian Cartage and Canadian National, as well as reruns for BNSF, CSX, and Union Pacific.

BLMA (blmamodels.com) showed this pre-production sample of its HO scale PTTX F89-J flat car at Trainfest. Some minor details may change on the production version which is scheduled to arrive in early 2013. BLMA chief Craig Martyn noted that the steel risers and wood cross beams will come in a separate bag.



This will aid modelers installing a load other than BLMAs. The prototype F89-J cars were created in the 1990s when the Trailer Train Company refitted a fleet of 1960-era F89-J flats with wood crossbeams to transport pipe and other over-size or over weight bulk loads. Designated PTTX, the cars received additional modifications such as side-mounted brake controls. BLMA will replicate the prototype by modifying its own F89 models with new tooling for the deck braces and brake rigging. The HO scale ready-to-run F89-J's will feature Kadee™ #156 couplers and 70-ton trucks with 33" metal wheels. Ten road numbers will be available at \$39.95 each.



BLMA is now selling individual ThermoKing refrigeration units. These are the same upgrade units added to prototype equipment such as BLMA's own 64' Trinity modern reefer cars. HO scale ThermoKing units are priced at \$7.45 each.

Bluford Shops (bluford-shops.com) entry into HO scale will be with five ready-to-run transfer cabooses including a short-body, bay-window caboose, and a short bay-window MoPac style caboose. Three additional styles of transfer cabooses -- long roof, short roof, and with running boards -- will also be available. Delivery will be sometime in 2013 with pricing tentatively set at \$49.95 each. Undecorated models of each type will also be available.

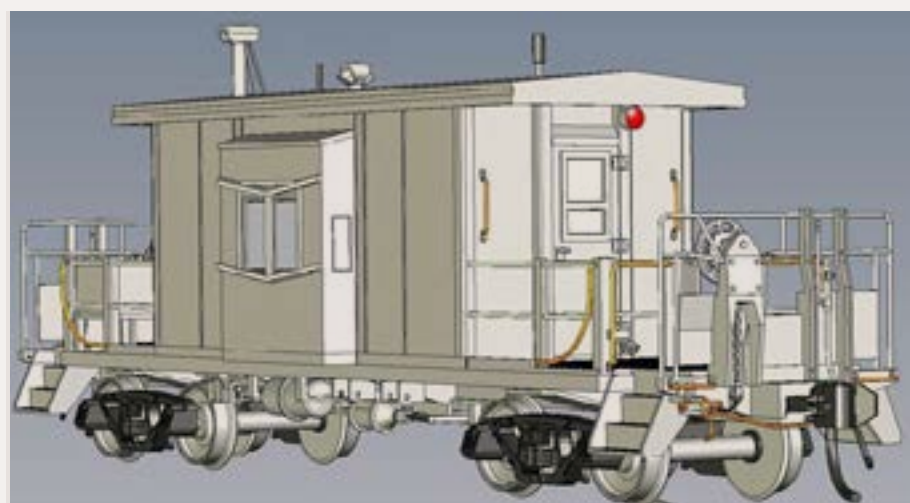

The ready-to-run cabooses will have wire grab irons and uncoupling levers, Kadee #5 couplers, and stairway light fixtures. Variation in marker light placement will be prototype-appropriate per the road name being modeled. The first HO scale release will be a short bay-window

car decorated for Missouri Pacific and Union Pacific. An MP version with a long roof decorated in MOW green will also be in the first release. Coming in the

future are short-body bay-window cars with a long roof decorated in Family Lines colors with L&N, Clinchfield, and Seaboard System reporting marks. A patched Family Lines caboose with Indiana Rail Road markings will also be offered.



Southern Pacific's number 1 will be offered in Daylight-inspired colors. SP evaluated the MoPac design but shortened the roof. Only one car was built. It entered system-wide service when SP was experimenting with orange, red, and gray paint schemes. SP number 1 retained the paint job throughout its service life. Its final assignment was on SP's fire suppression train. Bluford's HO scale version will be come with coil-spring roller-bearing trucks.



Boreal Trains of Rimouski, Quebec, has contracted with Rapido to produce a limited run of HO scale FP9A diesel locomotives decorated in VIA's experimental Grey Ghost scheme. The locomotive will be equipped with DC/DCC Sound at \$329.95 CAD with delivery expected in mid-2013. For additional information on the Grey Ghost prototype as well as the HO scale project including details on reserving a model, contact Denis Côté at didomcote@hotmail.com or visit rapido-trains.com/fp9_special1.html.

Bowser (bowser-trains.com) showed computer drawings of an ALCo C430 diesel at Trainfest. ALCo's 3000 hp four-axle Century series prototype will be replicated in Bowser's up-scale Executive Line of ready-to-run HO scale models. Road names in the first release will be New York Central, Penn Central, Conrail (blue), Conrail (black) CR Reading (patch), Reading, Seaboard Coast Line, Louisville & Nashville, Susquehanna, Susquehanna (late scheme), Western New York & Pennsylvania (red), Western New York & Pennsylvania (black),

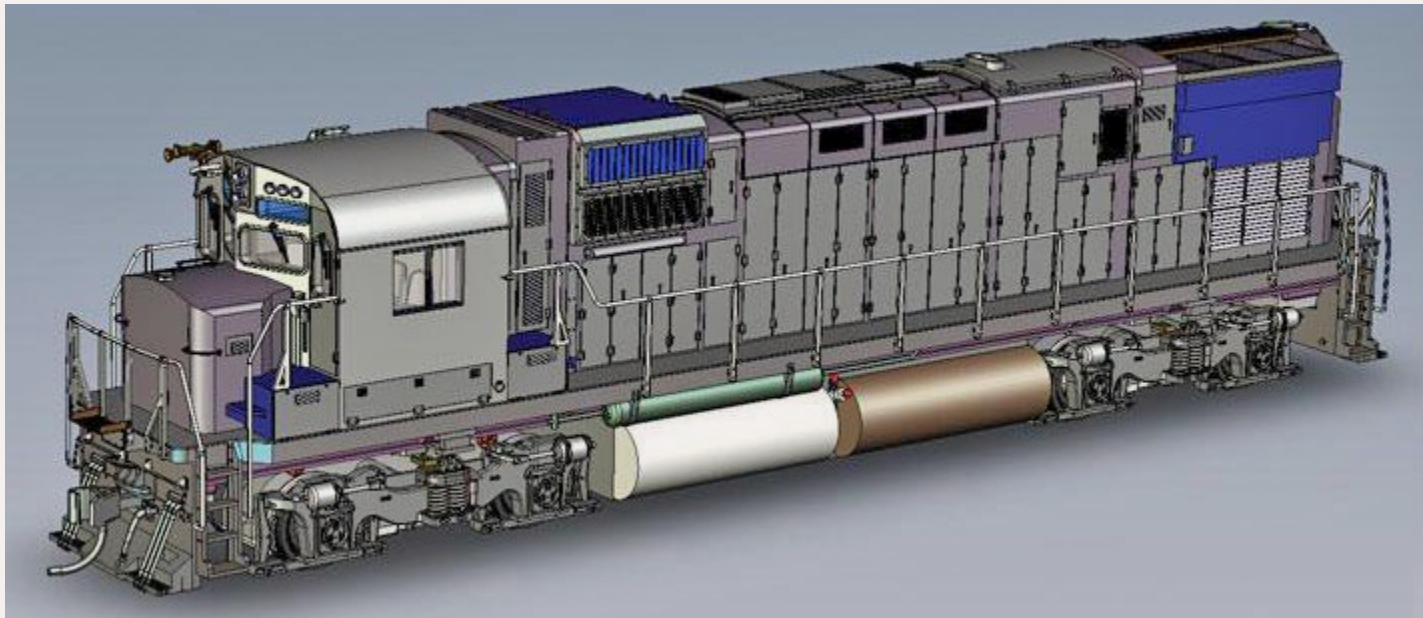

Morristown & Erie, Green Bay & Western, Green Bay & Western (grey stripe), and ALCo demonstrator. The Executive Line model will feature Bowser's usual attention to detail including separately-applied grab irons, can motor with flywheel, and directional lighting with golden-white LEDs. Two different fuel tanks and, two air intakes. Hi-Adhesion or AAR 'B' trucks with blackened metal wheels will be applied per prototype road practice. The models come with Kadee® couplers. Bowser currently estimates delivery will be in the Fall of 2013. Analog (DC) versions of the C430 with an NMRA plug for an aftermarket DCC decoder will have an MSRP of \$199.95. DCC/sound versions featuring LokSound Select Dual -Mode decoder (for operation on DC or DCC) will have an MSRP of \$299.95.

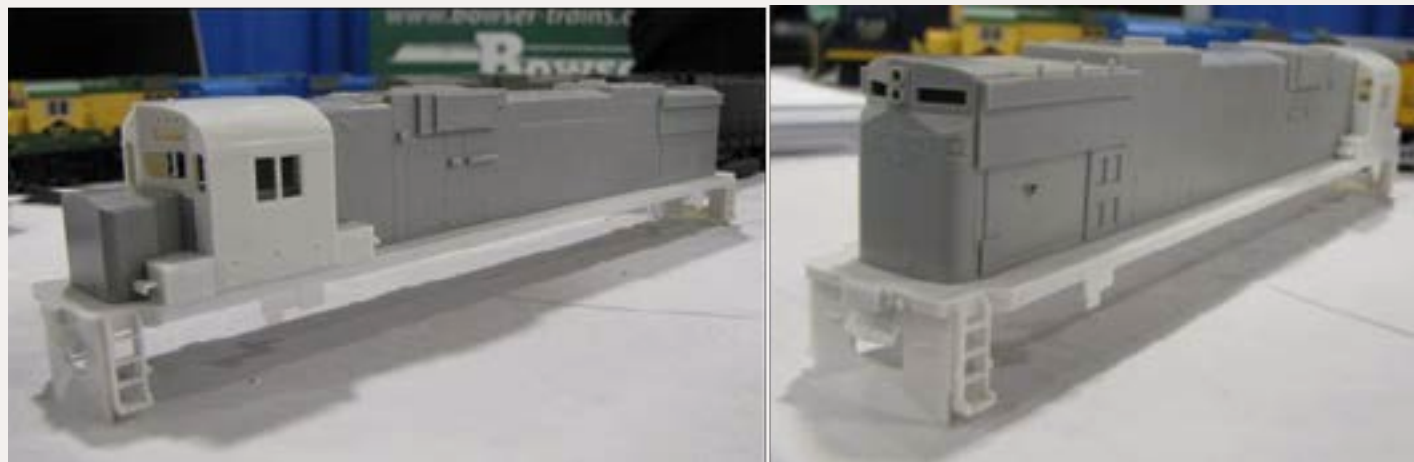

Bowser also showed these test shots from the new tooling for an ALCo Century C636 coming next summer. The current selection of road names are ALCo demo, MK-Leasing (ex demo), Illinois Central, BN, SP&S, SP&S/BN, Penn Central, and Delaware & Lackawanna. The Executive Line HO scale model will be available in a DC analog version with and NMRA plug for an aftermarket decoder (not included) at \$199.95. A DCC/Sound version will be priced at \$299.95.



Bowser is preparing tooling for Pennsylvania Railroad's well-known class H30 covered hopper car. Introduced in the 1930s, the 39' 6" triple-bay 10-hatch prototype was designed to haul cement with a rated capacity of 1973 cu ft. An upgraded version, classified H30a, with welded rather than cast bolsters, survived long enough to see service on the Penn Central and Conrail. Norfolk & Western owned a hopper, class HC-1, similar to the H30a. Pricing and availability dates are pending.

Also under development at Bowser is a HO scale New Orleans streetcar with an injection molded plastic body. Features of the Executive Line car include window glass, operating roof poles, and operating headlight. The model will use Bowser's recently-introduced 4' 10" wheelbase power truck with can-motor drive and flywheel. Pricing and availability dates are pending.

Concept Models (conceptmodels@con-sys.com) is selling an HO scale kit for a PRR well-car for carrying large, heavy loads. The kit consists of resin castings, styrene parts, load, decals, and photo illustrated instructions. Hand grabs, ladders, trucks, couplers, and related detailing parts are not included. The kit is priced at \$39.99. An optional short wheel-base truck side frame kit is available at \$9.99.

ExactRail (exactrail.com) is nearing completion of an HO scale ready-to-run version of Southern Pacific's class G-100-22 steel gondola. Built by Thrall, the 65'-6" 100-ton prototype with Dreadnaught ends numbered 340525-340624 were delivered to SP in early 1974. ExactRail's Platinum line model will have grab irons, wire rib side and top chord tie downs, wire lever carriers and uncoupling bars, 100-ton ASF 'Ride Control' trucks with Exact Rail's blackened brass wheelsets, and Kadee® #58 couplers. ExactRail said the model will be entirely produced in it's Orem, Utah facility. A release date is targeted for late this month. Pricing had not be announced at press time.

Fox Valley Models (foxvalleymodels.com) is getting ready to cut tooling for Milwaukee Road transfer cabooses. The prototypes were built in the railroad's own shops using underframes recycled from retired steam tenders. The molded plastic models will have etched metal and formed wire detail parts. Delivery is expected during the third quarter of 2013. Pricing on the HO scale ready-to-run model will be \$65.95 each. Sales and distribution of Fox Valley Models are handled by InterMountain Railway (intermountain-railway.com). Additional information is available at either of the above websites.



At Trainfest, **InterMountain Railway** (intermountain-railway.com) revealed it has completed research on developing an HO scale Paducah GP10 diesel locomotive and will soon begin preparing tooling for the project. Although InterMountain has identified some two dozen suitable road names, the Trainfest announcement invited modelers to send emails with (intermountain@intermountain-railway.com) suggestions for their favorite roads. The HO scale model will be offered in both DC and DCC with SoundTraxx™ Tsunami™ Sound. Pricing and arrival dates are pending. Because GP10s were rebuilt (at IC/ICG's shops in Paducah, Kentucky) from a variety of GP7s, GP9s and GP18s, InterMountain will have both opportunities -- and challenges -- in dealing with the endless variations seen in GP10s.

Cabs, window positions, noses, filters, fans, turbo housings, MU hookups, number boards, and lights, frequently vary from one GP10 to the next. Specific details on the initial release should be available next spring.

InterMountain is booking reservations for an early May delivery of FT locomotives in A-B sets. Four numbers each will be available for Lackawanna, Western Pacific (green and orange), Southern (green), NYO&W, Milwaukee Road (gray), St Louis & Southwest (gray), Lehigh Valley, and Atlantic Coast Line (black). Non-sound models have an MSRP of \$219.95 and come with a factory installed DCC decoder capable of operating on either DC or DCC. Sound units have an MSRP of \$359.95 and come with a SoundTraxx® Tsunami® sound decoder.



InterMountain has scheduled another run of its U18B diesel locomotive. Arrival is expected in June or July. The HO scale ready-to-run model comes with wire grab irons and uncoupling bars, and Kadee® couplers. Cab styles and trucks (either Bloomberg or GE) are appropriate to the road name. Grilles, radiator sections, and sun shades are etched metal. New road names on this release are LMX and Peabody Coal-Lynnville. Names being rerun are Maine Central, Seaboard Coast Line, Ferrocarriles Nacionales de Mexico, Seaboard System, Pickens, and CSX. The model will be available DCC-ready with an NMRA compatible plug at an MSRP of \$159.95, or with SoundTraxx® Tsunami® sound installed at \$229.95.



InterMountain plans to deliver HO scale class R-40-23 refrigerator cars next summer. The ready-to-run model will be available decorated for PFE (SP and UP red, white, and blue double herald), PFE (black and white double herald), PFE (modern Gothic), MDT, Armour, Libby's, NP (Mainstreet), and AGAR. The model has an MSRP of \$32.95 and comes with etched metal running boards, metal wheelsets, and Kadee® couplers.

Also coming from InterMountain next summer are HO scale post-war 10' inside height boxcars. Six road numbers each will be available for KCS, Clinchfield Railroad, New York Central, Erie Lackawanna, N de M (Ferro Tienda), Penn Central, Southern Pacific (sans serif), and C&O. The ready-to-run models will have etched metal running boards, metal wheelsets, and Kadee® couplers. Final pricing is pending.

Kadee (kadee.com) is developing a new HO scale car. That is about all we can report at this time since Kadee is keeping mum about body types and release dates. Kadee also revealed that their long-range plans call for making their trucks available with semi-scale code 88 wheel treads, but again, no dates. As soon as we learn more we'll pass it along to MRH readers.



Meanwhile, Kadee is getting ready to release an ATSF covered hopper in factory-new boxcar red with an MSRP of \$42.95. It should be ready in February along with a N&W 40' PS-1 boxcar with an 8' door. Originally built in 1956, the N&W boxcar was shopped in 1980 and given a black paint job. It will be priced at \$33.95. Both of the HO scale ready-to-run cars come with Kadee's new HGC trucks.

handcrafted brass model will feature operating lights, ditch lights on both ends, Kadee #58 scale couplers, and a Canon EN22 can-motor with dual flywheels. The DC model will be fitted with a DCC plug for those who wish to install an aftermarket decoder of their choice. Overland dealers are now booking reservations for the ready-to-run model (OMI #AA-6920) with delivery expected in 2014. Final pricing is yet to be determined but a tentative MSRP is expected to be around \$1,075.00. Information about other locomotives and paint schemes being considered for this production run is available at the above website.



Rapido (rapidotrains.com) has partnered with VIA Rail Canada to produce VIA's Skyline Dome-Lounge-Coffee Shop, a car that has been in transcontinental service since Canada's national passenger railway was formed in 1978. Rapido has created new tooling to reflect the interior changes VIA made to the car in 1982. Three different car numbers will be produced and a "Canada" logo and flag decals will be included in the box for modelers wishing to replicate HEP cars. The models are priced at \$105 CAD each and are available exclusively from VIA Rail Canada. Availability is expected late this month. To order visit souvenirs.viarail.ca/index.cfm?page=categoryItemsList&categoryID=6&parentID=0. Buyers outside Canada are asked to first send an email inquiry to VIA at feedback@souvenirs.viarail.ca. For additional technical information about the model and prototype visit Rapido at rapidotrains.com/canadianvia3.html.

Norfolk Southern photo by Casey Thomason



Overland Models Incorporated (overlandmodels.com) will import an HO scale version of Norfolk Southern SD60E locomotive number 6920 decorated in the unique red, white, and blue (plus black) paint scheme honoring our nation's veterans. In addition to Overland's usual attention to prototype-specific detail, the



Roundhouse Division of Horizon Hobby (athearn.com) will release its Harriman-style arch-roof passenger equipment decorated for Rio Grande, Erie Lackawanna, and Western Pacific, plus a MOW version in plain gray paint. Body types include RPO, baggage (EL above), combine (D&RGW above), coach, diner,

and an open-end observation car. Upgrades from the original Model Die Cast version include window glazing, separate grab irons, magnet roof, McHenry knuckle couplers, 33" machined metal wheels, and improved decorating and lettering. The cars are scheduled to arrive in June with an MSRP of \$39.98 each.



Spring Mills Depot (springmillsdepot.com) showed preproduction samples of their wagon-top cabooses at Trainfest. Availability is expected later this month. The HO scale ready-to-run models have an MSRP of \$59.95.

An undecorated kit will be

offered at \$49.95. Features include wire grabs, metal wheels, separately applied door tracks, Kadee® couplers, and added weight so they can be used in pusher service. Four versions of the distinctive cars will be produced including B&O class I-12 from the 1941-1945 era (shown above) with period-specific details including a slack adjuster, wood running boards, C-style corner grabs, wood window sash, a lantern, and an early style smoke jack. A B&O class I-12 from the 1955-1962 era will have a newer-style smoke jack, peep lights rather than lanterns, an oil fill pipe, and J-type corner grabs. B&O cars decorated in blue paint and assigned to pool service during the 1965-1969 period will have metal running boards, a toilet vent on the roof, J-type corner grabs, peep lights, a modern smoke jack, oil fill pipe, Stimsonite reflectors, red rear safety light, and sealed windows with anti-vandal screens.



A Chessie B&O class C-18 version of the caboose from the 1973-1983 era is similarly equipped with the addition of a toilet tank. Some of the era-specific details come in a separate parts bag which can be optionally installed by

the modeler. Also available is an undecorated kit with parts to build any version of the I-12 caboose. A unique feature of the caboose are B&O's home-built trucks with protruding leaf springs which Spring Mills has tooled specifically for this car. The trucks are included in the kit and will eventually be available separately.



True Line Trains (trueline-trains.ca) will produce an HO scale version of the commemorative caboose Grand Trunk Western decorated in 1976 to honor America's 200th Birthday. The ready-to-run model of GTW's Bicentennial caboose is priced at \$44.99, however, orders booked before December 10, 2012, will be at the early-bird price of \$39.99. The one-time only production run is scheduled for early next year.



Walthers (walthers.com) has scheduled release this month of its WalthersProto™ series Union Pacific City Observation Dome Lounge cars. The prototype 85' cars were built

for UP by ACF. Features of the HO scale ready-to-run cars include unique ends, train-specific tail signs as seen on UP's city service trains, factory installed grab irons, tinted windows. The cars are priced at \$79.98 each or \$89.98 each with DCC LED interior lighting. Tail signs include Challenger, City of St. Louis, City of Los Angeles, and City of Portland. Due to the extended length of the cars a minimum radius of 24" is suggested for reliable operation.

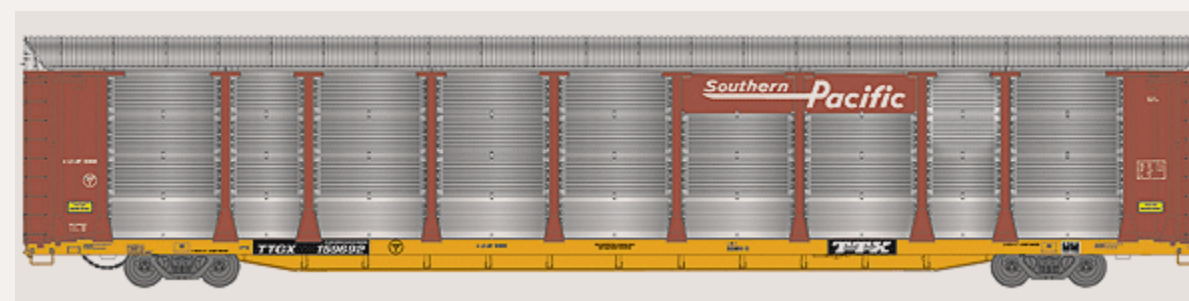

Also due this month are WalthersProto™ 89' Thrall Bi-Level Auto Carriers with new car numbers. Road names are BNSF rack on a TTGX flat, SP rack on a TTX flat (above), CN rack on a TTX flat, and UP rack on a TTX flat. The HO scale ready-to-run models have an MSRP of \$44.98 each. Grab irons, ladders, and brake equipment details are all separately applied.



WalthersMainline™ 70' Cryogenic refrigerator cars in new paint schemes and numbers are also due to be released this month. Road

names will be GATX-Articar (above), CAGX-Lamb Weston, FURX- Lamb Weston/ Inland Valley, and JRSX Simplot. The cars have an MSRP of \$24.95.



A nine-story Apartment Building is the newest item from Walthers Cornerstone™ line of HO scale structure kits. The brick and stone building is molded in three colors of plastic and comes with decals that simulate chiseled Art Nouveau detailing. The assembled building has a footprint of 8.125" x 5.187" and is 12.687" high. The kit has an MSRP of \$46.98.



NEW PRODUCTS FOR N SCALE

BLMA (blmamodels.com) is now selling individual ThermoKing refrigeration units. These are the same upgrade units added to prototype equipment such as BLMA's own 64' Trinity modern reefer cars. N scale ThermoKing units are priced at two for \$10.95.

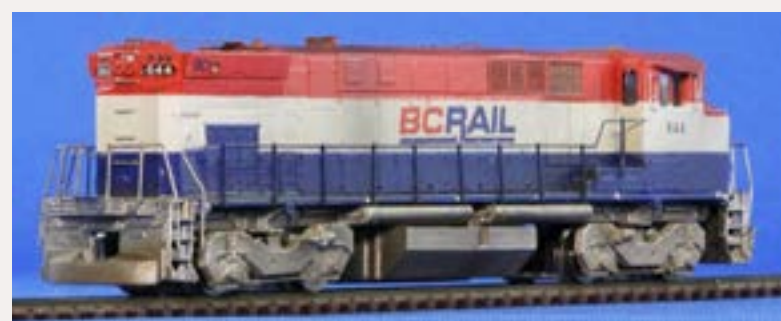

and B conversions are available.

Briggs Models (briggsmodels.ca) is selling a kit to convert an Atlas B30-7 to an accurate representation of the MLW M-420 as operated by Canadian National and British Columbia Railway. Both A



The resin parts include ZWT truck side frames, fuel tanks (three versions), pilot/step assemblies, rebuilt steps (BCR), CN pilots, frame strips with air tanks, battery boxes, bell and bracket, light housings, roof inserts for dynamic brake and non-dynamic brake versions, radiators (original and rebuilt versions), and a jig for drilling ditch lights. There are alternate

parts for the dynamic brakes, radiator, and steps. The etched-metal parts include alternate car body panels, uncoupling levers, grab irons, brake wheel, number boards, numerous cab details, radiator walkways, and handrail stanchions. Also phosphor bronze wire for the handrails, laser-cut window glass inserts, and flexible wire for the chassis modifications. The kit includes information on how to download comprehensive instructions for completing the conversion, which requires the modeler to make some modifications to the Atlas donor chassis (not included). The MLW M-420 conversion kit is available at the above website for \$100.00 CAD, plus shipping. Correct horns and plows are not included but are available from Miniatures By Eric (miniaturesbyeric.com).

Fox Valley Models (foxvalleymodels.com) is getting ready to prepare tooling for Milwaukee Road transfer cabooses. The prototypes were built in the railroad's own shops using underframes recycled from retired steam tenders. The molded plastic models will have etched metal and formed wire detail parts. Delivery is expected during the third quarter of 2013. Pricing on the N scale ready-to-run model will be \$38.95 each. Sales and distribution of Fox Valley Models are handled by InterMountain Railway (intermountain-railway.com). Additional information is available at either of the above websites.



InterMountain Railway (intermountain-railway.com) will deliver N scale class R-40-23 refrigerator cars next summer. The ready-to-run model

will be available decorated for PFE (SP and UP red, white, and blue double

herald), PFE (black and white double herald), PFE (modern Gothic), MDT, Armour (HO model shown), Libby's, NP (Mainstreet), and AGAR. The model has an MSRP of \$21.95 and comes with Micro-Trains® trucks and couplers.

InterMountain is booking reservations for an early May delivery of FT locomotives in A-B sets. Four numbers each will be available for Lackawanna, Western Pacific (green and orange), Southern (green), NYO&W, Milwaukee Road (gray), St Louis & Southwest (gray), Lehigh Valley, and Atlantic Coast Line (black). The N scale ready-to-run locomotive sets have an MSRP of \$199.95.



KatoUSA (katousa.com) showed their new CB&Q Silver Streak train set at Trainfest. The N scale model represents Burlington's non-articulated edition of the train that was powered by "Silver Bullet", the specially-built EMD E5A. The short-distance luxury train operated in the 1940s between Kansas City and Lincoln, Nebraska with stops at Omaha and St. Joseph. See page 111

of the October issue of MRH for additional details about Kato's Silver Streak train set. Also available now is the 3rd release of Kato's California Zephyr. The 11-car train set of Budd-built cars includes baggage, three dome coaches, dome buffet-lounge, diner, three 10-6 sleepers, a 16-section sleeper, and a dome observation car. Item 106-055B is priced at \$280. It is also available with factory installed interior lighting at \$445.



Kato has released an N scale EMD NW2 diesel switcher with new road numbers each for Burlington Northern, Northern Pacific, and Union Pacific. The N scale model is available

at \$115 for DC operation or \$155 with factory installed DCC.



New road numbers have been announced by Kato for its MPI and MP36PH Chicago Metra #426 and Virginian Railway Express #V52 at \$120 DC and \$160 with factory installed DCC.



Also available this Holiday Season is Kato's N scale Santa Fe Super Chief Starter Set. The set includes an EMD F7A #300 diesel locomotive, 4-4-2 sleeper Royal Court, Diner #601, observation car Vista Valley, plus an oval of track, grade crossing and rerailling track, rerailling ramp tool, and a power pack. The MSRP is \$280.00.



The initial release for the new N scale car is decorated for Wabash with the road's familiar flag herald. The car is available now for \$22.10.

Micro-Trains (micro-trains.com) has completed new tooling for a Greenville 60' double plug-door boxcar with a short 41'3"

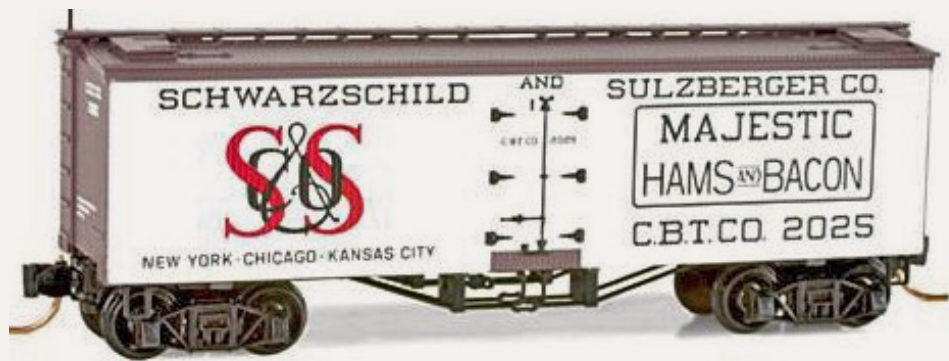

Micro-Trains continues to expand its Meat Packer series; adding this month a 36' wood truss-rod reefer decorated for CBTCO-Schwarzschild & Sulzberger "Majestic Hams & Bacon."

The ready-to-run N scale model is available now at \$26.95.



Micro-Trains 2012 Christmas car features Micro-Mouse on an N scale 40' Hy-Cube boxcar. Each side of the car has a different seasonal message. It is available now at \$27.55. Additional N scale ready-to-run cars currently available from Micro-Trains include a 40' boxcar with a colorful Happy Hanukkah message at \$22.70, an Erie Lackawanna 50' boxcar with a freight load at \$20.85, a 50' Baltimore & Ohio flat car with a covered load at \$18.75, a 50' BC Rail rib-side boxcar with both plug and sliding doors at \$26.55, a Smithsonian Civil War Series car depicting the "Battle of Hampton Roads" on a modern box car at \$24.95, and a 40' Northern Pacific boxcar featuring a "Scenic Route of the Vista-Dome North Coast Limited" slogan at \$24.30.



The Milwaukee Southeastern N Scale Model Railroad Club (mnse.org) is raising money to support the club through the sale of a special 3-pack of Milwaukee Road 50' rib-side boxcars. The N scale limited run models were produced for the club by Fox Valley Models. They come with body-mounted Micro-Trains™ couplers and Fox Valley metal wheelsets. The 3-pack sells for \$50.00 plus \$7.00 shipping via USPS Priority Mail. International customers are asked to contact Keith Schmidt at kschmidt626@hotmail.com before

ordering. The club is located in the Milwaukee suburb of Cudahy, Wisconsin. It was founded in 1986 and is the only N scale club in the Milwaukee area with a permanent home layout.

Red Caboose is preparing an N scale 62' insulated boxcar with a 10' 6" door for delivery this summer. Road names include Santa Fe (Shock Control), BNSF, Western Pacific, Progressive Rail (blue), and Union Pacific. The production run will include cars with 12' doors decorated for Burlington Northern (small logo), and Missouri Pacific. InterMountain Railway is responsible for marketing Red Caboose products. For additional information visit intermountain-railway.com.

Trainworx will deliver N scale quad-hopper cars next summer decorated for CSX, CSXT, Southern (black), Southern (Tuscan red), Union Pacific (black with yellow end), and Union Pacific (three-color herald with yellow end). The ready-to-run cars will be priced at \$24.95 each. InterMountain Railway is responsible for marketing Trainworx products. For additional information visit intermountain-railway.com.

NEW PRODUCTS FOR Z SCALE



Full Throttle (wdwfullthrottle.com) is offering a pair of Z scale 70-ton triple-bay offset-side hopper cars decorated for Illinois Central (black) and Illinois Central Gulf (orange). The open-top cars come with a coal load. The cars were custom produced for Full Throttle by Bowser Manufacturing. They have Bowser's Bettendorf-type roller bearing

trucks with blackened metal wheels. Two road numbers are available for each car. Set #1 contains ICG 67235 and IC 82265, set #2 contains ICG 67242 and IC 82272. Each set comes in a clear plastic stackable case. The 2-packs have an MSRP of \$44.00 each.

NEW DECALS, SIGNS, AND FINISHING PRODUCTS

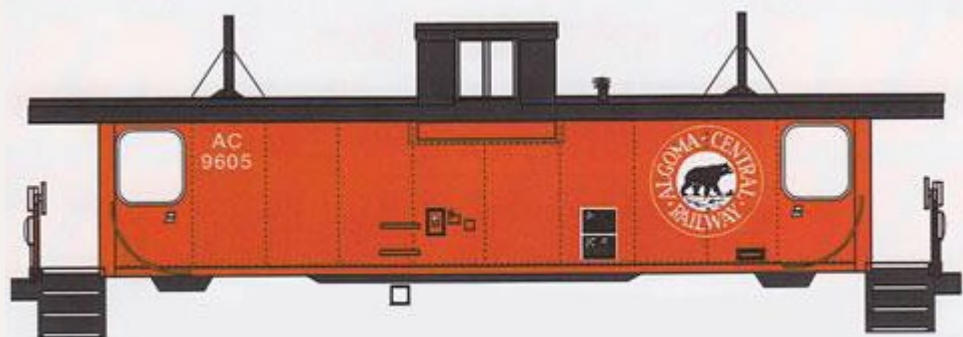

Highball Graphics (highballgraphics.com) has released HO and N scale lettering sets for Algonoma Central Railway. Decals for a caboose in CN red/orange with

a black roof is available for HO (item F-306) at \$7.00, and N scale (item FN-306) at \$6.00. Algonoma Central early passenger cars with Bear Tracks scheme plus lettering for ex-CZ "Sprit of Superior" dome car are available for HO (item P-125) at \$12.00, and N scale (item PN-125) at \$10.00. Algonoma Central modern passenger cars with multi-colored stripes and the Bear at each end for HO (item P-126) at \$8.00, and N scale (item PN-126) at \$7.00.



New decal sets now available from **Microscale Industries** (microscale.com) Southern Pacific/Cotton Belt (SSW) cement hoppers including repaints and "Ghosted" faded style lettering; Seaboard Coast Line, and Louisville & Nashville Family Lines repainted 4600 ACF Centerflow and 4750 PS covered hopper cars; Great Northern Railway 40' wood boxcars circa 1928 thru post-1953 with side-facing goat; and PACER Stack Train Maxi IV-53' containers and 3-unit well cars. The above lettering sets are available in HO scale at \$7.00 each, and in N scale at \$5.75 each. Additional information is available at the above website.

New decals currently on the drawing board at Microscale and expected to be released soon include Pullman Standard covered hopper car data in black and white, Western Pacific modern FMC and PC&F double-door boxcars, and general lettering sets for BN and Cotton Belt boxcars.

San Juan Decals (sanjuandecals.com) has two new O scale sets of generic lettering for Consolidation locomotives with Railroad Roman lettering and

numbers (item #O-CONS), and Shay/Climax/Heisler logging locomotives with both Gothic and Railroad Roman letters and numbers (item #O-SHAY). There is enough material in each set to decorate several locomotives. Names such as Westside Lumber and Ferrocarril Mexicano are in each set along with other familiar roads, plus extra letters for private named models. The two new lettering sets are priced at \$8.95 each.

DISCLAIMER

The opinions expressed in this column are those of the writer and do not necessarily reflect the opinion of *Model Railroad Hobbyist* or its sponsors. Every effort is made to provide our readers with accurate and responsible news and information, however, neither *Model Railroad Hobbyist* or the writer of this column can be held responsible for any inaccuracies or typographical errors that may inadvertently appear in this column.



Send us your product announcements

If you are a hobby manufacturer with a product announcement, just [click here](#) and submit your announcement to us.

Our web site and free magazine reach continues to grow, so get on board with this new media train that's hard to stop!

Briefly noted at press time...

... Until December 20, 2012, **Kato USA** is selling kits for various Budd passenger cars at \$12.99 each. The N scale kits include a decorated corrugated body, trucks, diaphragm parts, and knuckle couplers. The kits are guaranteed to have all parts necessary to complete a car. Some bodies may have minor scratches or blemishes that require touch up. They are being sold as is without exchange or return privileges. Car types are baggage, RPO, dome, coach, and a 10-6 sleeper. Road names include Burlington, Santa Fe, Southern, Wabash, Canadian Pacific and Pennsylvania, but not all road

names are available for each car type. The kits are in limited supply and are available only through Kato's Parts Department at http://www.katousa.com/Zcart/index.php?main_page=index&cPath=148.

... **Atlas** (atlasrr.com) will deliver a new NRE Genset II locomotive in the second quarter of next year. The HO scale Trainman® series model will feature a newly-tooled body with a noticeably shorter hood due to the cab being positioned farther forward on the frame. The DC model will have an NMRA plug to accept

Text continues on page 129



RSM is bringing this rare gem to you in the new Diamond Series! These will be a very limited number of small designs that will be available in both HO & O Scale. They will be just as rare as a diamond itself. Our first Diamond kit will be Dome Oil Co., Takoma Park, in Maryland in 1921. A gritty diorama of the Petroleum Age. A tanker car would arrive to fill the underground fuel storage tanks while sitting from high above on a wooden trestle, and the vehicles would then be refueled with a gravity fuel pump.

Initially, little more than a shack near a pump on a dirt lot. Bring yourself back to the time of when early stations provided basic services, such as lubrication and tire repair, sold oil and batteries. The building-type, which has become the cultural icon of the automobile age, is undoubtedly the gasoline (gas) station.

HO version, \$95.00 cdn. Available in winter of 2012 - O Scale kit early 2013

Click for more ...

LED Lights, Figures, Landscaping and Vehicles not Included



Unit 24 - 24185 106B Ave. Maple Ridge, B.C. Canada V2W 0C4 • 1-604-466-9750 • rsminiatures@telus.net • www.railscaleminiatures.com

Briefly noted at press time *continued...*

an after-market DCC decoder (not supplied). The MSRP will be \$144.95. Road names on the initial release will be available with two numbers each for Belt Railway of Chicago, BNSF, Canadian Pacific, CSX, Indiana Harbor Belt, and NRE Demonstrator. An undecorated model will also be available.

Tangent Scale Models

(tangentscalemodels.com) is now selling an all-new HO scale model of a General Steel Casting 60' flat car. The ready-to-run model replicates a prototype developed by GSC in 1956 with a one-piece cast steel frame. Many of the prototypes remain in service today. The models are available decorated for ATSF, IC, MP, PRR, SSW, and Wabash at \$32.95 each. Undecorated versions are available both with and without oval hole cutouts in the car side.

BLMA (blmamodels.com) has announced plans for a Norfolk Southern class G-85R/G98R smooth-tub coal gondola. The NS TopGon will be available in 24 numbers. HO scale versions will be priced at \$32.95 each. N scale at \$22.95. Reservations close January 15 with delivery expected in the fourth quarter of 2013. ■



Selected Events

December 2012

COLORADO, COLORADO SPRINGS, December 15-16, Train Expo Colorado, includes sales tables, operating layouts, clinics, and manufacturers presentations. At

Financial Services Expo Center, 3650 N. Nevada. Info at tecoshow.org.

KANSAS, OVERLAND PARK (Kansas City area), December 29-30, Great Train Expo. Overland Park International Trade Center, 6800 West 115th Street. Info at greattrainexpo.com.

MICHIGAN, NOVI, December 8-9, Great Train Expo, at Suburban Collection Showplace, 46100 Grand River. Info at greattrainexpo.com.

NEW JERSEY, BROOKLAWN, December 8, and 15, Gateway Model Railroad Open House, with operating steam and diesel model railway. Event at 100 E. Browning Road. Details available from Nicky Caccavo at 215-514-6591 or email chicolini@juno.com.

OREGON, PORTLAND, December 8-9, Great Train Expo, at Portland Expo Center, 2060 N. Marine Drive. Info at greattrainexpo.com.

WASHINGTON, PUYALLUP (Tacoma area), December 15-16, Great Train Expo, at Puyallup Fair & Events Center, 110 9th Avenue SW. Info at greattrainexpo.com.

January 2013

CALIFORNIA, SANTA CLARA, January 24-26, O Scale West and S West Annual Meet. Hyatt Regency Hotel, 5101 Great American Parkway. Info at oscalewest.com.

FLORIDA, COCOA BEACH, January 10-12, Prototype Rails/Cocoa Beach 2013. Major RPM meet hosted annually by Mike Brock. To preregister send \$35 check payable to "Prototype Rails" to Marty Megregian, 480 Gails Way, Merritt Island, FL 32953. Event at Hilton Hotel, 1550 N.

Atlantic Ave. (Highway A1). For hotel reservations call 800-526-2609 or 321-799-0003. Refer to Prototype Rails for reduced rate. For info visit prototypetrails.com.

MASSACHUSETTS, WEST SPRINGFIELD, January 26-27, Amherst Railroad Hobby Show, sponsored by Amherst Railway Society. Major event attracting 25,000 or more people annually with operating layouts, clinics, and up to 250 vendor tables. Participants include manufacturers, publishers, importers, and historical societies. Eastern States Exposition Fairgrounds. Info at railroadhobbyshow.com/abouttheshow.php.

MISSOURI, ST. LOUIS, January 12-13, World's Greatest Hobby on Tour, featuring manufacturers displays, operating displays, interactive activities, and workshops presented in a family-oriented atmosphere. America's Center. Attendee and exhibitor info at wghshow.com.

PENNSYLVANIA, FORT WASHINGTON, January 5-6, 19-20, and February 9-10. Final Open House of 38-year old GATSME layout, a historically driven organization that has built an outstanding HO scale operating layout in the Old Fort Washington Elementary School. The club has lost its lease and the layout will be torn down after the final operating session on February 10, 2013. Visit gatsme.org for additional information including history of the club and the old school building.

PENNSYLVANIA, YORK, January 5-6, Annual Open House, hosted by Miniature Railroad Club of York, Saturdays 3 to 8 PM, Sundays 1 to 5 PM. Event at 381Wheatfield Street. Donation at door. Info at mrrcy.com or call 717.458.2932.

TEXAS, FORT WORTH, January 5-6, World's Greatest Hobby on Tour, featuring manufacturers displays, operating displays, interactive activities, and workshops presented in a family-oriented atmosphere. Will Rogers Memorial Center. Attendee and exhibitor info at wghshow.com.

FUTURE 2013

AUSTRALIA, MELBOURNE, March 29-31, 2013, 11th Annual Australian Narrow Gauge Convention, at Carwatha College, Noble Park North. Info at cngg.org.au/index.html.

AUSTRALIA, MELBOURNE, April 12-14, 2013, 13th National Australian N Scale Convention, at Rydges Bell City Event Centre, Preston. Info at convention2013.nscale.org.au or send email to nscale2013@bigpond.com.

CANADA, ALBERTA, CALGARY, April 20-21, 2013, Supertrain, with live demonstrations, clinics, and manufacturers displays. Subway Soccer Centre, 7000-48 Street SE. For fees and hours visit supertrain.ca.

CANADA, ONTARIO, MISSISSAUGA, April 26-28, 2013, Streetsville Junction, NFR-NMRA Regional Convention, with clinics, self-guided layout tours, and a special Canadian manufactures show Friday evening. Awards Sunday morning at Hobo breakfast. Four Points Sheraton Hotel, 2501 Argentia Road. Call 905-858-2424 for hotel reservations. For info visit streetsvillejunction.com.

CALIFORNIA, BAKERSFIELD, March 9-10, 2013, Annual Model Train Show & Swap Meet, with 100 dealer tables, operating model train displays, and hourly door prizes. Sponsored by Golden Empire Historical & Modeling Society Model Train Club. At Kern County Fairgrounds, 1142 South 'P' Street. Hours and fee information at gehams.net.

CALIFORNIA, PASADENA, August 28-31, 2013, 33rd National Narrow Gauge Convention. Hilton Hotel, 199 S. Los Robles St. Info at 33rdnngc.com.

CALIFORNIA, SACRAMENTO, February 23-24, 2013, World's Greatest Hobby on Tour, featuring manufacturers displays, operating layouts, interactive activities, and workshops presented in a family-oriented atmosphere. Event at Cal-Expo. Attendee and exhibitor info at wghshow.com.

CALIFORNIA, SAN DIEGO, February 9-10, 2013, World's Greatest Hobby on Tour, featuring manufacturers displays, operating displays, interactive activities, and workshops presented in a family-oriented atmosphere. Event at Del Mar Fairgrounds, 2260 Jimmy Durante Blvd. Attendee and exhibitor info at wghshow.com.

COLORADO, LONGMONT, December 8-9, 2013, Annual Train Show, sponsored by Boulder Model Railroad Club, with operating layouts, prize winning models, vendor tables, and a layout raffle, plus opportunities to meet and chat with railroad modelers from the area. Boulder County Fairgrounds. Info at boulder-modelrailroadclub.org.

GEORGIA, ATLANTA, July 14-20, 2013, National Model Railroad Annual Convention. At Cobb Galleria Centre with convention HQ at adjacent Renaissance Waverly Hotel. Info at nmra2013.org.

GEORGIA, ATLANTA, July 19-21, National Train Show, in conjunction with annual NMRA convention. At Cobb Galleria Centre, 2 Galleria Parkway. Info at nmra2013.org.

GEORGIA, PINE MOUNTAIN, February 1-3, 2013, Southern Rails (formerly Narrow Gauge Railway Day). Family oriented event with clinics, contests, vendors and 'down south' fun, at Callaway Gardens. Info at southernrails.org.

GEORGIA, PORT WENTWORTH (Savannah area), April 4-6, 2013, 13th Annual Savannah RPM at Port Wentworth Community Center located on Appleby Road. Program follows the usual RPM format with clinics, model displays, vendors, historical societies, and brotherhood. Information from Bob Harpe at rharpe@comcast.net or Denis Blake at dblake7@columbus.rr.com. Send \$20.00 for weekend registration to Robert Harpe, 313 Paradise Drive, Savannah, GA 31406.

INDIANA, INDIANAPOLIS, May 2-5, 2013, Mile Post 50, annual convention of NMRA Central Indiana Division, with layout tours, operating layouts, op sessions, clinics, and contests. Banquet speaker is Thomas Hoback, president/CEO of Indiana Railroad Company. Marriott Indianapolis East, 7202 East 21st Street. Phone 317-352-1231 for reservations. Additional information including registration form available at cid.railfan.net.

ILLINOIS, LOMBARD, March 15-17, 2013, Chicago O Scale Meet, at Westin Lombard Yorktown Center. Info at marchmeet.net.

ILLINIOS, NAPERVILLE, October 17-19, 2013, 20th Annual RPM Conference hosted by Joe D'Elia. For pending details and probable change in venue visit railroadprototypemodelers.org.

MARYLAND, TIMONIUM, February 2-3, 2013, Great Scale Model Train Show. One of the nation's largest shows with more than 800 vendor tables. Hosted by Howard Zane at Cow Palace, Maryland State Fairgrounds. Information at gsmts.com.

MASSACHUSETTS, PEABODY, March 9, 2013, Annual Spring TRAINing Show, sponsored by NMRA Hub Division, Northeastern Region, with operating trains, vendor tables, and clinics ranging from fundamental to advanced including special clinic by Paul Dolkos. Holiday Inn, 1 Newbury Street. Info at hubdiv.org.

MINNESOTA, BLOOMINGTON, April 25-28, 2013, 28th Annual Sn3 Symposium. Ramada Mall of America Hotel. Info at Sn3-2013.com.

NEW MEXICO, ALBUQUERQUE, June 6-9, 2013, Rails Along the Rio Grande, NMRA Rocky Mountain Region, Rio Grande Division 6, convention with clinics, layout tours, train show, OpSig sessions, UPRR and BNSF modelers showcase night, and banquet. Marriott Pyramid North. Info at rarg2013.org.

NEW YORK, STATEN ISLAND, February 2-3, 2013, Winter Meet, sponsored by NMRA Garden State Division, Northeastern Region. At St Margaret Mary's Presentation Hall, 1126 Olympia Blvd. Subject to reschedule due to Hurricane Sandy. Visit nergsd.com for the latest info.

OHIO, MIAMISBURG (Dayton area), May 15-18, 2013, Operation Dayton 2013, NMRA-MCR convention with clinics, model contests, layout tours, railfanning, and more. Wyndham Gardens Hotel. Info at MCR2013convention.com.

TEXAS, HOUSTON, February 16, 2013, Greater Houston Train Show, features 20,000sq ft of operating layouts, instructive classes, model and photo contests, train videos, and vendors. Also tours of local home layouts. At Stafford Center, 10505 Cash Road at Murphy Road. Hosted by San Jacinto Model Railroad Club. Info at sanjac.leoslair.com/resources/2013-Public-Flyer.pdf.

WEST VIRGINIA, CHARLESTON, February 9-10, 2013, 8th Annual Train Show, sponsored by Kanawha Valley Railroad Association, at Clubhouse in Coonskin Park. Details available from Joe at (304) 539-6721, or email at horte@suddenlink.net.

WISCONSIN, WEST ALLIS (Milwaukee area), November 9-10, 2013. Trainfest 2013, sponsored by Wisconsin Southeastern Division of NMRA. For info visit trainfest.com. ■

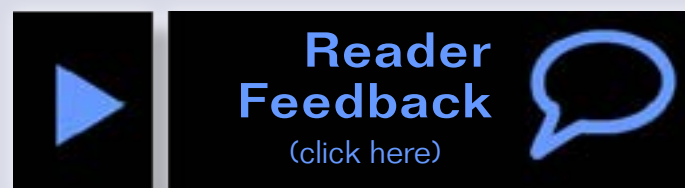

Mike Confalone does it again!

Scenery techniques that go outside the box - you won't find many of these methods illustrated on step-by-step video any where else ...

~~\$29.95~~
DVD

Holiday special!

\$14.95

\$12.99
Instant
download

Level:
Intermediate/Advanced

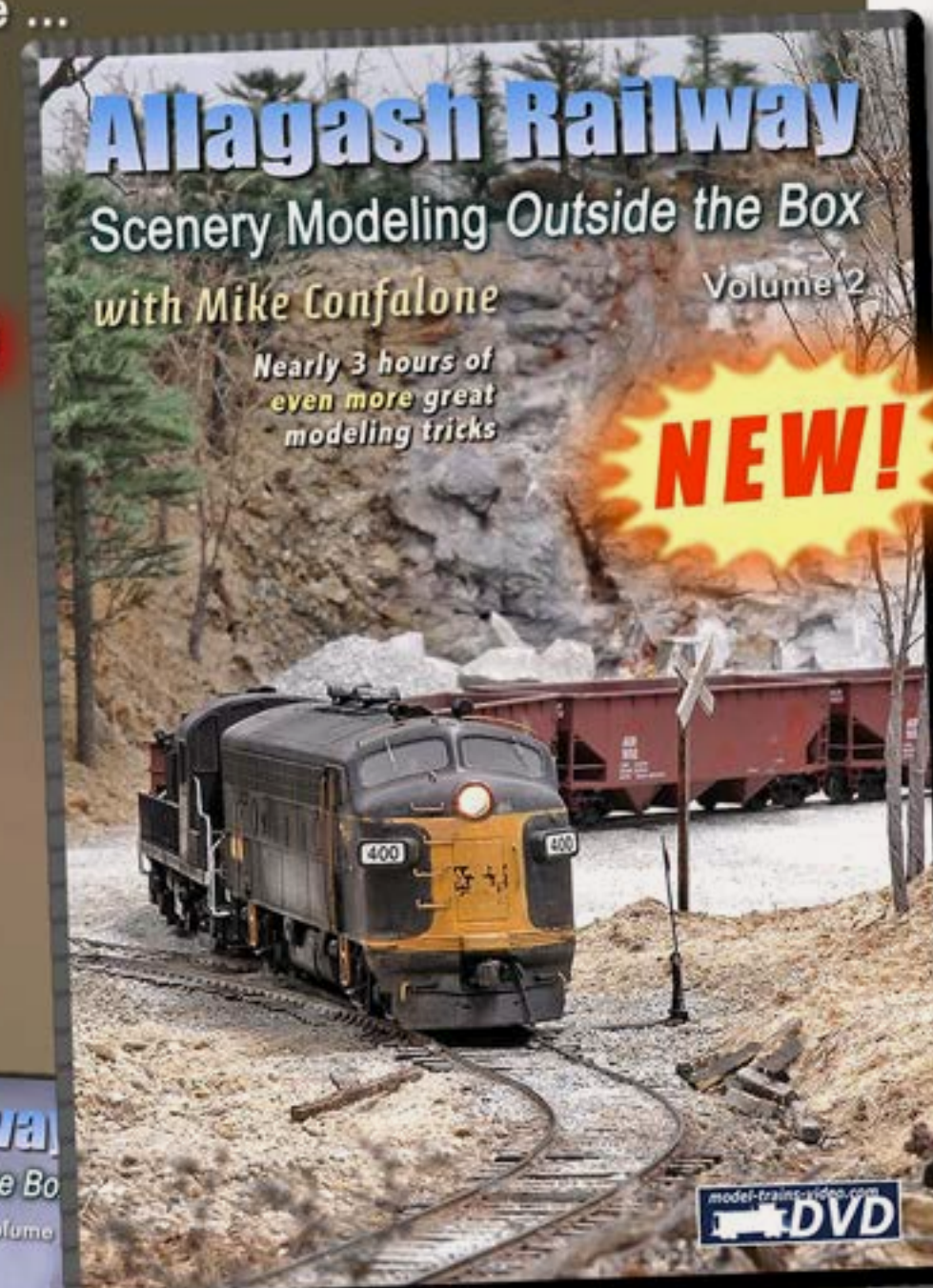

Get both!

Vol 1 + Vol 2 ...

~~\$40~~ Holiday special!

\$20

\$18 Instant
downloads

REVERSE RUNNING: Make only new mistakes?

Stepping outside the box with a contrary view



This reminds me of a saying I used to tell my kids: Good judgement comes from experience – and experience comes from poor judgement!

As I told my kids, the key is that poor judgement (that experience) doesn't have to be your own poor judgement. If you're

smart (I would tell them) you need to pay attention to good advice and heed it. Borrow from the other guy's experience!

In this season when a lot of new people enter the hobby, this "make only new mistakes" advice is great advice indeed.

Most newcomers can't wait to start a layout. To that, I say, "hold your horses there, fella!" Take some time to learn more about this hobby before you just launch out into unknown territory. Others have charted these waters before you, so why not take a map and a compass along?

While getting some basic books is always a good option, that need not be your only approach to learn more about the hobby before you fill your space with track.

There are a number of other good options that can also be a lot of fun.

Connect up with some of the other hobbyists in your area or online and get yourself invited to see some layouts. Even better, go run some trains on these layouts.

Talk to the other modelers who've been down this road ahead of you, and ask questions. Hear their stories of what they did wrong and what they did right.

Don't start off immediately building your room-filling layout. Try a module or a diorama. Lay some track, get a starter DCC set and run a few trains. Build a few structures and kit-bash a couple pieces of rolling stock. Make some scenery.

In other words, get some experience in the hobby. Remember, experience comes from poor judgement – in other words, making mistakes – some of your own and some you avoid yourself by heeding the advice of others.

But *do not* let analysis paralysis set in. Get started small, make some mistakes, ask lots of questions, visit some layouts, run trains, and read as much as you can get your hands on.

And have fun doing it! Don't get all worked up about trying to build your

ultimate layout until you get to the point you're ready to make mostly new mistakes.

And make them you will, but it's not the end of the world when that does happen. As the owner of a large basement home layout myself, ask me how I know. I've been in the hobby for 46 years now, and I'm still making mistakes. Fortunately, they're mostly new mistakes now (I said, mostly).

When you do make one of these "new mistakes", stop and assess the situation. Generally these new mistakes are not so onerous they can't be corrected. I find if I'm willing to take out something I'm not happy with and redo it, I'll do better next time and I'm much more content as a result.

The pain of redoing it pales in comparison to the ongoing joy of knowing I did a much better job the second time around.

I figure if I don't redo it, then I'll have to live with the sinking feeling from now on every time I look at it. Redoing it is short-term pain for long-term gain!

Resolve this new year to put yourself on the road to having better judgement and therefore "more experience." You should find yourself making fewer of the same old mistakes everyone makes!

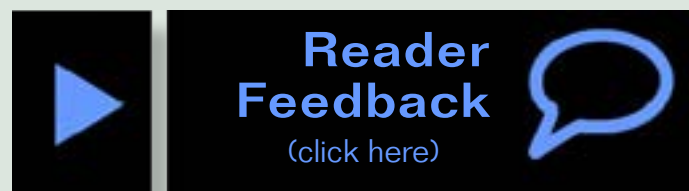

— by Joe Fugate

The Layout Design Special Interest Group has a motto: "make only new mistakes." In this season of New Year's resolutions, perhaps this would be a good one to make?

Let's consider what this motto means so we can determine how to apply it to our model railroading pursuits.

First, if we're going to only make new mistakes, then we need to know what mistakes have already been made, so we don't repeat them, right?

Clickable Advertiser Index	Page
Accu-Lites	14
Accurail	34
Alpine Division Scale Models	15
Amherst Railway Society	17
Andover Junction	44
Backdrop Junction	57
BLMA	3
Bowser	22
Bullfrog Snot	57
Coffman	59
Con-Cor	21
Dallas Model Works	11
Digitrax	40
ESU	50
ExactRail	4
Fast Tracks	56
Fifer Hobby Supply	13
Great Decals	58
Horizon Hobbies	7
Iwata-Medea	16
Jelsma	58
Litchfield Station	59
Logic Rail Technologies	57
Micro-Mark	63
Microscale	62
Model Railroad Benchwork	57
Model Rectifier	10
Model Trains Video	131
Monster Modelworks	21
M.T.H.	46

Clickable Advertiser Index	Page
Nano-Oil	45
NCE	29
North American Rail Car (1)	49
North American Rail Car (2)	59
O Scale Resource	35
Proto:87 Store (1)	58
Proto:87 Store (2)	111
RailMaster Hobbies	37
Rail Scale Miniatures	128
Rapido	8
Reynald's Euro Imports	13
Ring Engineering (1)	35
Ring Engineering (2)	48
RSlaser	47
Rulers of the World	58
Rusty Stumps	55
San Juan Car Company	57
SBS4DCC	57
Scenic Express	55
Scotty Mason Show	107
Southern Digital	33
TAM Valley Depot	36
Tony's Train Exchange	82
TrainTek	32
True Line Trains	38
True Scene Modeling	57
Walthers	5
Westerfield Models	57
Yankee Dabbler	39

Clickable Topic Index	Page
DCC Impulses – Basic Electronics for DCC ...	30
Editorial – Publisher's Editorial	9
Editorial – Reverse Running	132
Getting Real – Eras and Implications	41
Layout – Filling a Hole	83
News – December Newsletter	113
News – December Events	129
Other – Slow Orders	88
Q and A – MRH Questions, Answers, and Tips ...	18
Structures – Modeling a Coal Loader Part 1 ...	64
Structures – Modeling a Movie Theater Part 2 ...	95
Up the Creek – Peninsula Construction!	23
The Car Shop – Classic Track-cleaner	60
What's Neat This Week – Mike Budde	51
<hr/>	
Other – Bonus Extras	16
Other – Cover	1
Other – Derailments	134
Other – Hobby Marketplace	57
Other – Index	133
Other – MRH Sponsors	2
Other – Staff Notes	11
Other – Table of Contents	6

**First issue in new
Gen2 format!**

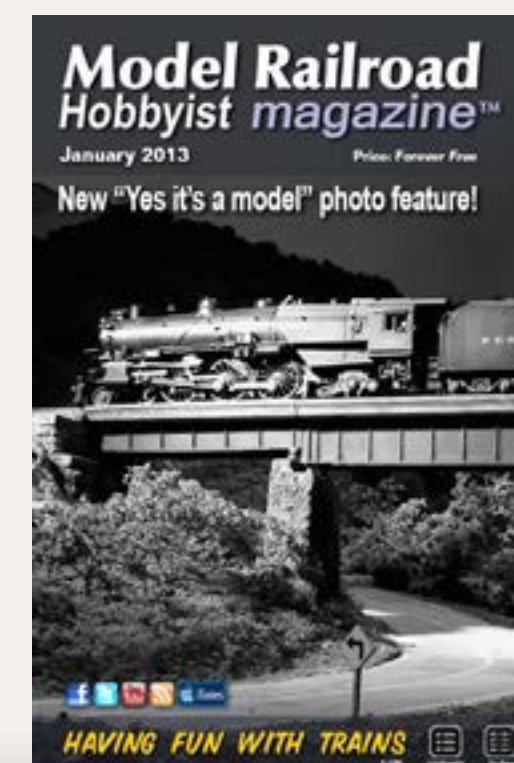

**Derailments, humor, and
document options on
next page ▶**

For the love of model trains

Coming in January 2012 MRH

- New monthly photo gallery feature!
- Master Modeler's workshop, in-depth
- Aisle lift-out bridge
- Kitbash a Conrail caboose
- Starter layout for \$500 - contest winner
- ...and lots more!

Deraillments

humor (allegedly)



His "relaxing" hobby...

While working as a mall Santa, I had many children ask for electric trains. "If you get a train," I would tell each one, "you know you need to share. Would you let your dad run the train a little?"

The usual answer was a quick yes, but after I asked one boy this question, he became very quiet. Trying to move the conversation along, I asked what else he would like Santa to bring him. He promptly replied, "Another train."

If you're the first to [submit a bit of good humor](#) and we use it, it's worth \$10!



**Reader
Feedback**
(click here)



Can't remember what MRH back issue that article was in?

Have you checked the online index?

[Click here to learn more ...](#)

[Printer-Friendly Version](#)

[Download PDF Version](#)

When talking to hobby vendors, please remember to mention MRH.