

Sound keep-alive • Makin' smoke • \$500 starter layout

# Model Railroad Hobbyist magazine™

March 2013

Price: Forever Free



**Superdetailing  
20T wood  
coal cars in N**



Click here for the  
landscape version

**HAVING FUN WITH TRAINS**



Standard edition - Portrait

download

contents

index

# BLMA MODELS

HO&N

TROPICANA REEFER

*Food  
-a-  
licious!*

Stand-In 64' Reefer in 24 Numbers

CLICK HERE TO SEE MORE



MRH-Mar 2013



# Model Railroad Hobbyist magazine™

**Front Cover:** M.C. Fujiwara continues to do some great modeling, as you can see from his cover photo for March. We're also thrilled this is N scale, because we don't get many N scale submissions. N scale or not, M.C.'s cover story this issue should spark useful modeling ideas in any scale.

**ISSN 2152-7423**

## Editorial Staff

Joe D. Fugate, Publisher and Editor  
Don Hanley, Assistant Editor

## Production

Patty Fugate, pasteup and layout  
Joe Brugger, copy editing  
Mike Dodd, copy editing

## Technical Assistants

Jeff Shultz  
Jimmy Simmons

## Advertising

Les Halmos, Account Manager  
Daniel Nava, Advertising Assistant

Published for the glory of God. [What's this?](#)



## Columnists

Richard Bale, News and events  
Jeff Shultz, News and events  
Les Halmos, Modular railroading  
Ken Patterson, Reporter at large  
Bruce Petrarca, DCC

## Special Correspondents

Joe Brugger, Questions & answers  
Charlie Comstock, Contributing editor

Issue password: March2013





click to learn more about this sponsor



click to learn more about this sponsor

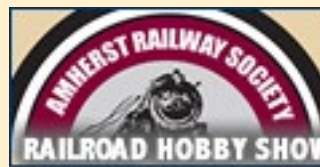

click to learn more about this sponsor



click to learn more about this sponsor



click to learn more about this sponsor



**NEW SPONSOR!**



click to learn more about this sponsor



click to learn more about this sponsor



click to learn more about this sponsor



click to learn more about this sponsor



click to learn more about this sponsor



click to learn more about this sponsor



click to learn more about this sponsor



click to learn more about this sponsor



click to learn more about this sponsor



click to learn more about this sponsor



click to learn more about this sponsor



**NEW SPONSOR!**



click to learn more about this sponsor



click to learn more about this sponsor



click to learn more about this sponsor



click to learn more about this sponsor



click to learn more about this sponsor



click to learn more about this sponsor



click to learn more about this sponsor



click to learn more about this sponsor



click to learn more about this sponsor



click to learn more about this sponsor



click to learn more about this sponsor



click to learn more about this sponsor



click to learn more about this sponsor



click to learn more about this sponsor



click to learn more about this sponsor



click to learn more about this sponsor



click to learn more about this sponsor



click to learn more about this sponsor





**NEW SPONSOR!**



click to learn more about this sponsor

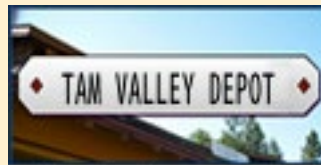

click to learn more about this sponsor



click to learn more about this sponsor



click to learn more about this sponsor



click to learn more about this sponsor



click to learn more about this sponsor



click to learn more about this sponsor

Want your logo on this page? Click to find out how....

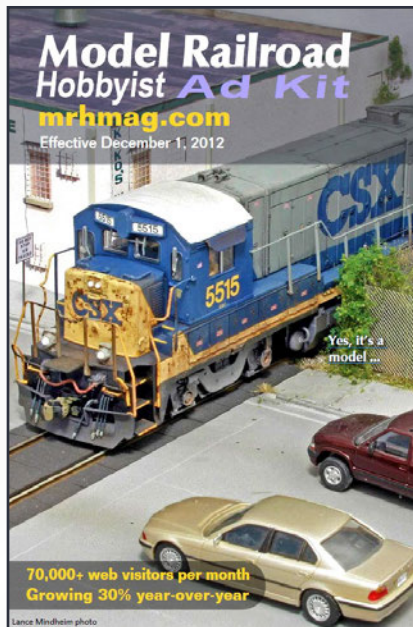

**90,000+ unique device views / month as of February 2012.**

**Tell me more**



**Looking for something? Check our Hobby Marketplace!**

**Take me there**



# Table of Contents - 1

## Main Features

*Click title  
to view*

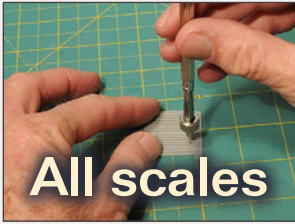

### Tool Shed: Pin vises

The essential tool for drilling holes

*by Jack Burgess*



### RLW's Nn3 20-ton coal cars

Super-detailing and modifying for std gauge

*by M. C. Fujiwara*



### Yes, it's a model

MRH's fabulous modeling photo feature

*Compiled by the MRH staff*



### Makin' smoke

Getting locos and other things to smoke

*by David Salsbery*

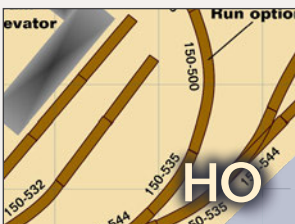

### Western Expansion Central

Starter layout for under \$500 - First place winner

*by Doug Forbes*

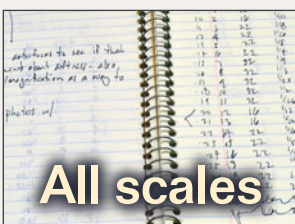

### Writing for MRH

Submitting an article to MRH can be fun

*by Tom Patterson*

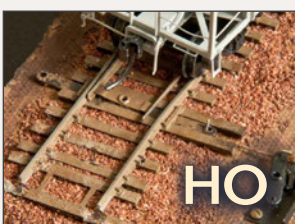

### Bitter Creek ground throw

*by Joe Brugger*



### Feb News

*by Richard Bale  
& Jeff Shultz*



## Table of Contents - 2

# Other Features

*Click title  
to view*

[Mastermind group?](#)

**Assistant Editor commentary**  
*by Don Hanley*

[MRH Staff Notes](#)

**MRH pays for articles ...**  
*by the MRH staff*

[MRH Q - A - T](#)

**Questions, Answers, and Tips**  
*compiled by Joe Brugger*

[Hobby Marketplace](#)

**Vendor ads**

[Derailments](#)

**Humor?**

# Columns

[Running trains again!](#)

**Up the Creek**  
*by Charlie Comstock*

[Stayin' alive](#)

**DCC Impulses**  
*by Bruce Petrarca*

[Course correction](#)

**Getting Real**  
*by Marty McGuirk*

[Gary Christensen's railcars](#)

**What's neat this week**  
*by Ken Patterson*

[My hobby has been ruined!](#)

**Reverse Running**  
*by Dave Kilborn*

**Subscriber-only extras** (*subscribers click here to access*)



**NEW!**

**High Performance  
Resistance Soldering Unit  
at an Affordable Price!**



**Click *HERE* for more info  
and Special Introductory Price!**

**Micro-Mark®**







# Becoming part of a mastermind group

Do you have one?



**Assistant Editor commentary**  
by *Don Hanley*



**A**re you a part of a mastermind group? In Napoleon Hill's book "Think and Grow Rich" he discusses having a mastermind group to help you build your wealth. While MRH is not about building wealth, the principal is still the same: we benefit most when we connect with others more than superficially.

So how does this look in model railroading? I see it as three to five like-minded modelers who get together and share. But if you stop at just the surface level, you miss out on the real benefits.

To transform into a mastermind group, you need to go deeper to learn from and teach each other. For example, I may be good at building models and detailing them, but my electrical skills are somewhat lacking.

Someone in my mastermind group that's good at the electrical side of model railroading then is beneficial. That modeler can help me avoid electrical pitfalls as I work on my layout.

I, on the other hand, can help another with model building techniques that can improve their skills on their projects. And so it goes. We each have areas where we excel in the hobby and areas where we do not.



# Bowser

## EXECUTIVE LINE

### HO C-430 Locomotive

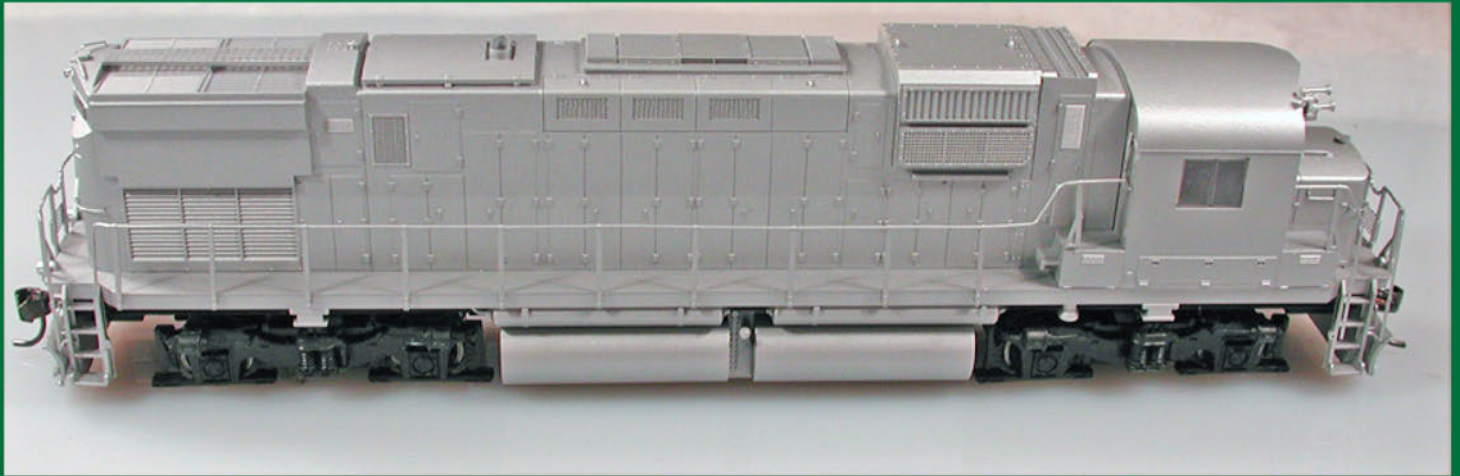

Production Sample Pictures  
[Click here to see more](#)

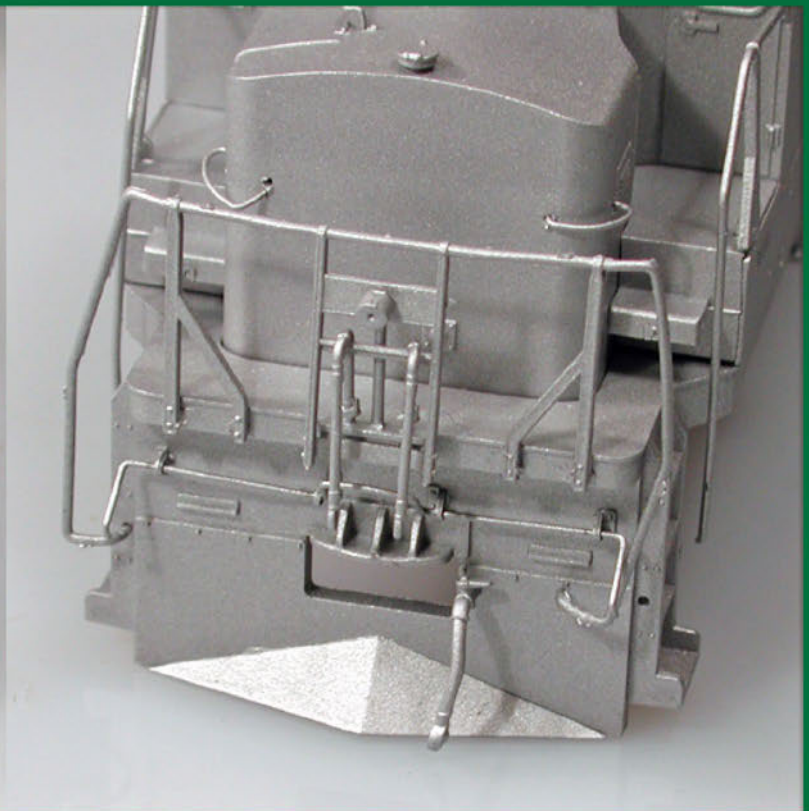
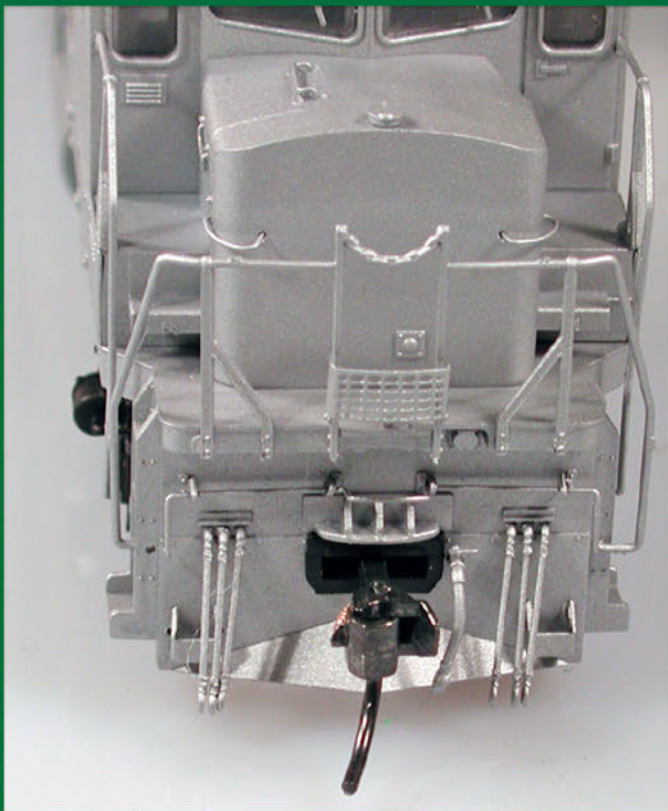

One important aspect of a mastermind group worth mentioning: you must be willing to have others in your group critique and challenge your modeling. While it's not always comfortable, this is a vital part of the mastermind process. Remember critiquing is not criticizing.

Be willing to put your ego in check and listen. As one who has had my modeling critiqued, it's not always pleasant. However, when I've taken it to heart, my modeling has benefited greatly.

Having a mastermind group does not mean you exclude other modelers from your circle. Your mastermind group are those in your circle you influence and who influence you most. In a larger club you can have several groups going on at the same time. Group members can and do change over time.

So how do you build a mastermind group? You need to develop friendships first. Once you have developed friendships, take the next step and ask them to critique your work,

**NEW for MARCH**  
 87-361, 60-361  
 Rock Island - Early GP and F Unit Diesels and Stripes



87-1398, 60-1398  
 Chesapeake & Ohio (C&O)  
 Passenger Cars - Extra Striping, Numbers, Logos

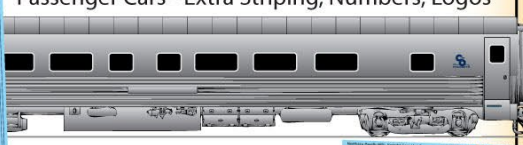

87-1399 & 60-1399  
 Northern Pacific (NP)

Stock Cars, Flat Cars  
 Wood Chip Gondolas



87-1400 & 60-1400  
 Chicago Great Western (CGW) Insulated Boxcars

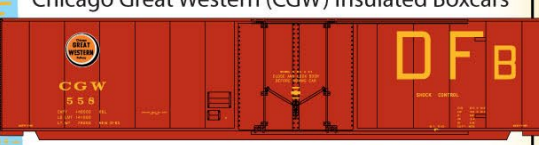

87-1401 & 60-1401  
 Southern Pacific (SP) Speed, Station, DTC Block Signs

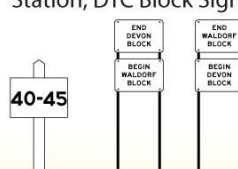

87-1402 & 60-1402  
 Union Pacific (UP) SD70ACe & ES44AC Diesels, New Flag



87-1403 & 60-1403  
 Chicago Great Western (CGW) Passenger Cars



87-1404 & 60-1404  
 KYLE Railway (YW, OPE, POVA)  
 40' and 50' Per Diem Boxcars



Microscale Decals® [microscale.com](http://microscale.com) MADE IN THE USA



or ask for help on a particular modeling problem that you have. And offer to help them in something you're especially good at.

Over time you will naturally develop a mastermind group using this approach, and it won't be forced.

I have discovered that being involved with different model railroad-ing mastermind groups has improved my modeling skills as well as the techniques that I use. More importantly, as my confidence has grown, so has my willingness to help and teach others.

So what is stopping you from developing a mastermind group and helping others become better modelers, as well as yourself?



*Advertisement*

**Click Here**

**FIFER HOBBY SUPPLY LLC**

**Your Local Online**

**HO & N Scale Hobby Shops**

**575-523-9743 • fiferhobby.com • fiferhobbyho.com**

MRH-Mar 2013





# HO GP-35 Diesels

Arriving This November At Your Local M.T.H. Authorized Retailer



80-2178-1 Santa Fe GP-35 Diesel with Proto-Sound 3.0

### Choose From:

- Sound-equipped versions with built-in DCC decoder
- DCC-ready versions awaiting your preferred decoder

### Featuring:

- 2 Cab Figures
- LED lighting
- Powerful 5-pole 12-volt DC motor
- Available In 8 Different Roadnames
- 28 DCC Functions\*
- Kadee® Couplers
- Remotely Operated HO Scale Proto-Couplers\*
- RP-25 Metal Wheels Mounted on Metal Axles
- Lighted Cab Interior
- Illuminated Number Boards
- Lighted Marker Lamps
- Locomotive Speed Control in Scale MPH Increments\*
- Operates On Code 70, 83 & 100 Rail Curves

\* Proto-Sound 3.0 Equipped Models Only



New York Central GP-35 Diesel available with Proto-Sound 3.0, Proto-Sound 3E+ or DCC-Ready

Union Pacific GP-35 Diesel available with Proto-Sound 3.0, Proto-Sound 3E+ or DCC-Ready

Pennsylvania GP-35 Diesel available with Proto-Sound 3.0, Proto-Sound 3E+ or DCC-Ready

Baltimore & Ohio GP-35 Diesel available with Proto-Sound 3.0, Proto-Sound 3E+ or DCC-Ready

Southern Pacific GP-35 Diesel available with Proto-Sound 3.0, Proto-Sound 3E+ or DCC-Ready

Norfolk & Western GP-35 Diesel available with Proto-Sound 3.0, Proto-Sound 3E+ or DCC-Ready

Erie Lackawanna GP-35 Diesel available with Proto-Sound 3.0, Proto-Sound 3E+ or DCC-Ready

See why  
**M.T.H. HO Locomotives**  
**Do More**



HO TRAINS THAT DO MORE  
[www.mthHOtrains.com](http://www.mthHOtrains.com)

Follow Us Online!



©2013 M.T.H. Electric Trains



# PRAIRIE SHADOWS

MODEL RAILWAY Co.

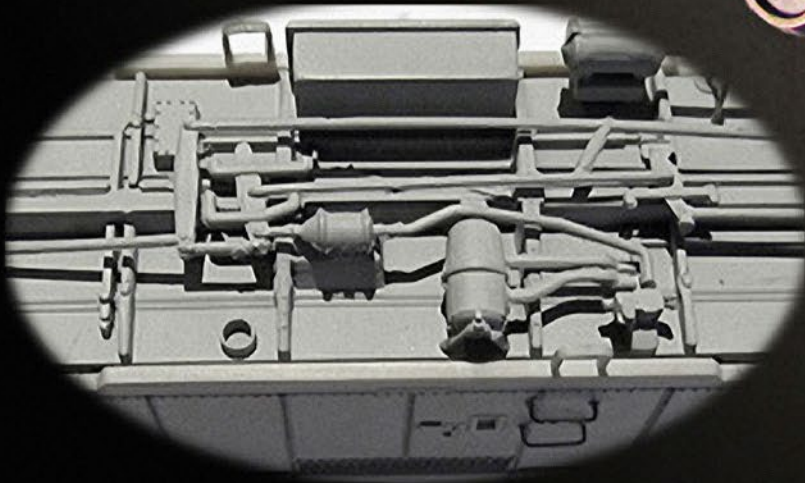
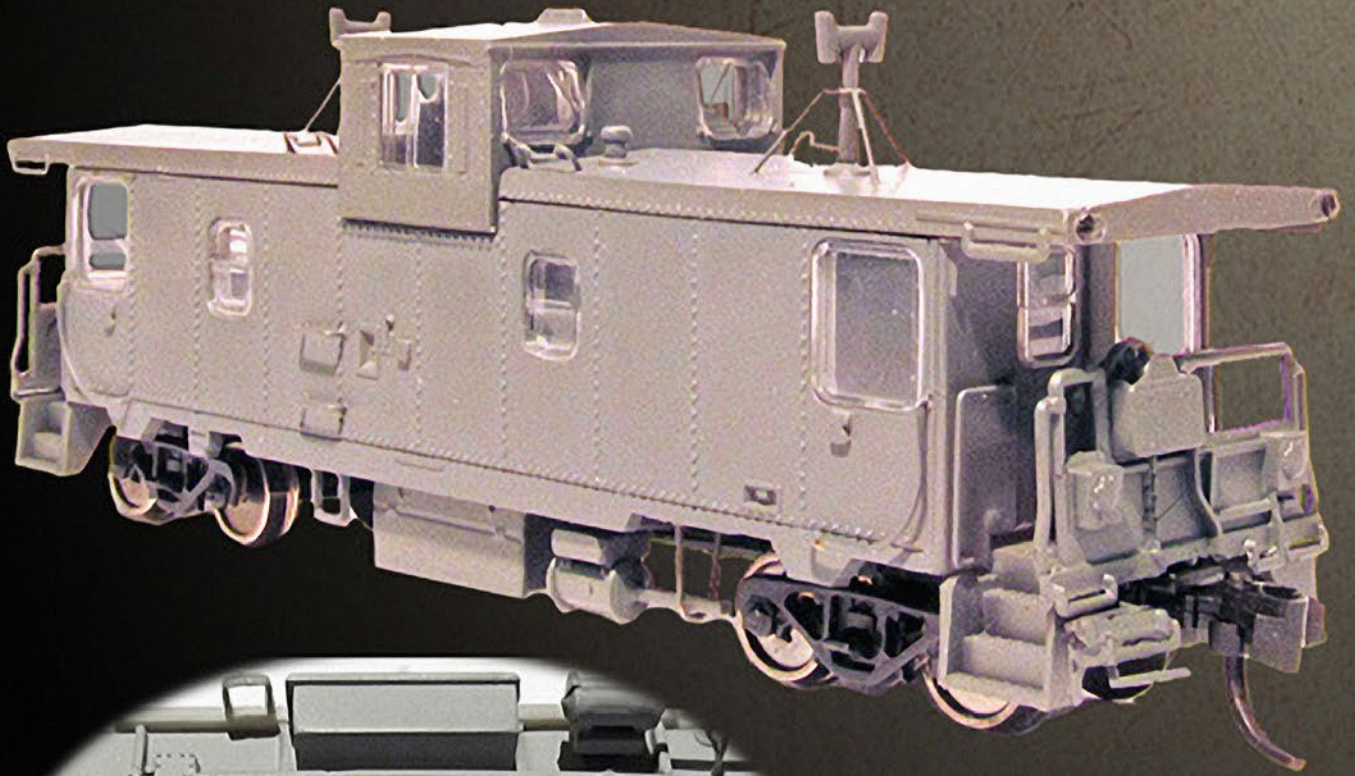

## EXCLUSIVE N SCALE MODELS!

In Association With



MRH-Mar 2013



Email



Phone



contents



index

# EXCLUSIVE N SCALE MODELS!

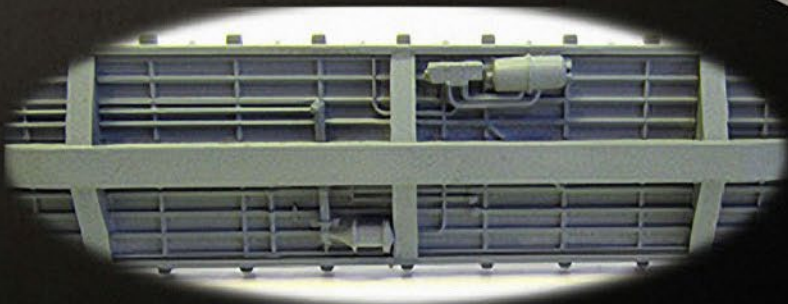
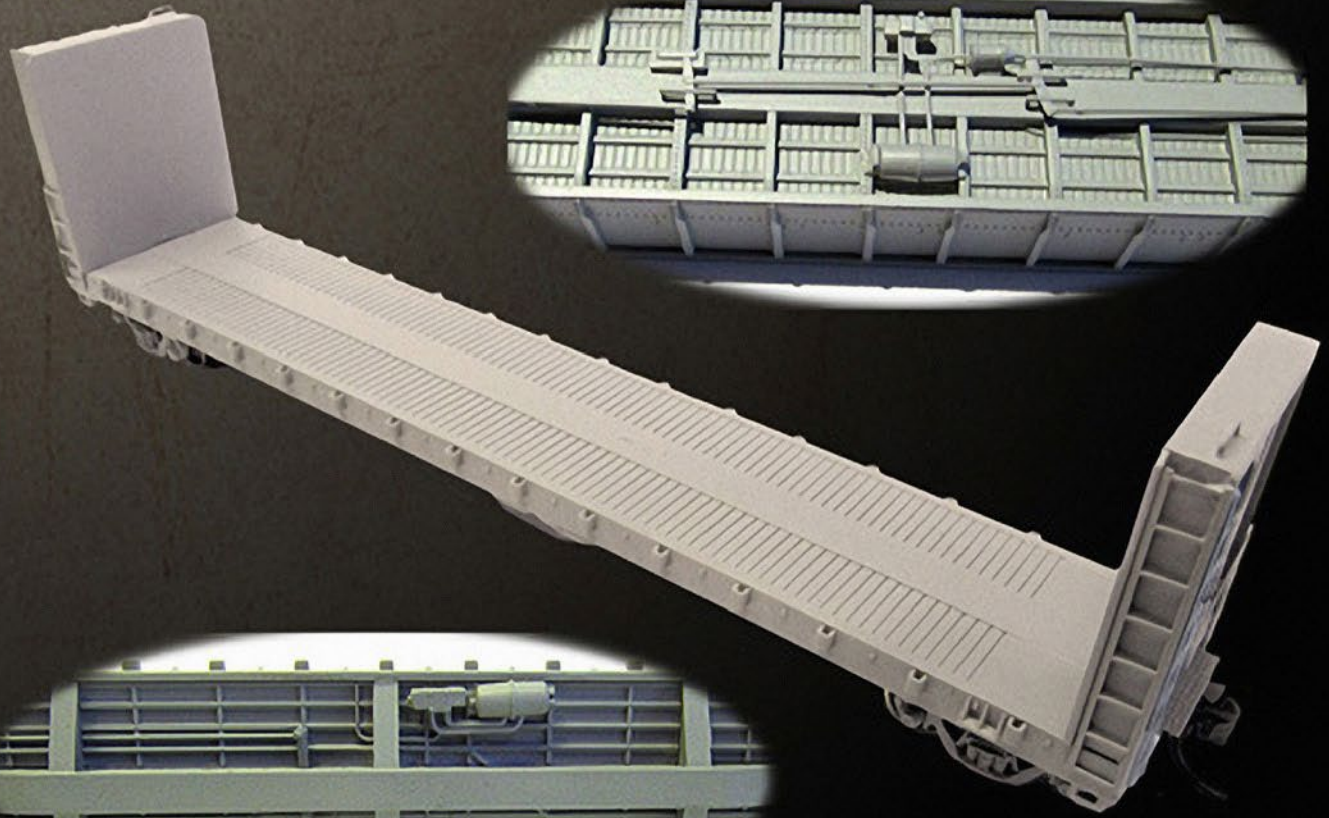

# PRAIRIE SHADOWS

MODEL RAILWAY Co.



Email



Phone



contents



index

# Notes from the MRH STAFF

MRH pays for articles, Extreme Diesel Weathering DVD coming ...



## Remember, MRH pays for articles!

Every so often we run into someone who is surprised to find out we pay for articles, so we thought it's probably about time to remind everyone once again that we do pay for articles! In fact, we've written a few checks for 4 digits in US dollars to some authors – now that will give the old hobby budget a shot in the arm!

That said, we don't want to give you the idea everyone will walk away with that kind of payment, but it can happen if you do a nice in-depth article for us with over 100 photos.

The kinds of articles we're looking for fall into three basic categories: short quick projects (1-2 pages), medium-sized pieces (3-6 pages), and large in-depth works (7-20+ pages). Anything over about 10 pages we'll generally split into a multi-part article across more than one issue.

**Short quick projects (1-2 pages):** We typically run these as a one-evening project. An article in this category generally has 250-400 words, and 4-10 photos with captions of 2-3 sentences each. We pay about \$100 - \$150 USD for a short article like this.







# February 2012 MRH Ratings

The five top-rated articles in the [February 2012](#) issue of MRH are:

- 4.7 DCC Impulses - Anatomy of a decoder
  - 4.4 What's neat - Weathering artist Butch Eyler
  - 4.4 Yes, it's a model
  - 4.4 Reverse Running - What are you waiting for? GO!
  - 4.3 Up the Creek - Peninsula construction, the first train
- Issue overall: 4.6

***Please rate the articles!***

Click the reader feedback button on each article and select the star rating you think each article deserves. ***Thank you!***

*Advertisement*



## NEW CONCRETE BLOCK SHEETS

**WHAT WILL YOU BUILD?**

## NEW CONCRETE BLOCK STARTER FOUNDATION KITS



All Basswood!, No Plaster or Resin!

**MONSTER**  
model & laserworks

[www.monstermodelworks.com](http://www.monstermodelworks.com)



Email



Phone



contents



index

**Medium-sized pieces (3-6 pages):** A medium-sized article generally isn't as detailed as a step-by-step. Most often the article describes the general process used, and highlights a few key techniques with photos and/or diagrams. This kind of article typically has 500-2000 words and 6-20 photos or diagrams with captions of 2-3 sentences each. We typically pay about \$150 - \$300 USD for a medium-sized article like this. If you include special media like a video or a click-n-spin photo series, we pay extra for that.

**Large in-depth works (7-20+ pages):** Most often, our larger articles follow a step-by-step format, but any in-depth treatment is possible here. An article in this category generally has 1000-5000 words or more, and 20-60+ photos with captions of 2-3 sentences each. We typically pay \$400 - \$1400 USD or more for these in-depth articles. Almost always, we like to get extra media with this category of article, which ups the payment even more.

Most layout tour articles fall into the large category. If you're of a mind to do a layout tour article for us, make sure you follow our interview format. Also, we like to get a video with layout tours, so readers can see the layout and meet the owner or club leaders.

If you do happen to get a cover photo, we pay \$100 for that.

To help you better know how to submit articles to us, we're running an article in this issue that goes into some detail about how to create and submit an article to MRH. Tom Patterson, who has made the cover a couple times now, tells you about his experiences doing his first article for MRH.

Finally, make sure and check our author submission guidelines ([mrhmag.com/submission-guidelines](http://mrhmag.com/submission-guidelines)) and our new author style guide ([mrhmag.com/authors/mrh-style-tips](http://mrhmag.com/authors/mrh-style-tips)). The style guide



makes your life simpler by answering such nagging questions as: do you write box car, or boxcar?

## **It's the photos that make or break submissions**

While we're on the subject of article submissions, let's add a very important note. Photos, not text, make or break an article with us. You will note Tom's article deals a lot with the photo side of his article-building effort.

We have budding authors who try to send us text samples to see if we'd be interested in an article, and we respond: *send us some photos with captions, please.*

The reason for this is simple: if you can write at all coherently, we have copy editors who can make you sound good. But if you can't take a decent photo, then all bets are off. Photoshopping bad photos gives you one consistent result: Photoshopped photos that look bad. Unfortunately, there's not much you can do to change that.

Good visuals matter most with us. If you can take a good photo that's well lit, well-focused, and well-composed, then you rise to the top quickly. If you study our article ratings, you will notice the articles with the best-looking images tend to be in the top 5 every issue. The articles with B-grade photos (and we do run a few of those when the ideas merit it) tend to get lower ratings in the reader feedback.

## **Sending MRH really large files**

Files of 10 MB or larger size may give you problems if you try to post it to our site as an attachment or if you try to send it to us as an article. What do we recommend to solve this problem?

Dropbox is one good option, or the latest new kid on the block for "internet cloud storage" is Google Drive.



contents



index

Google Drive allows you to have up to 5 GB of free space (Dropbox only provides 2 GB of free space). With this space you can upload large files and then you can provide a share link for people to access the large file.

Google Drive is optimized to work with larger files, in contrast to our website which is optimized for serving fairly compact web pages, rather than really large files. There are advantages to using free cloud storage services, as they do large file sharing very well.

Here's a how-to video on Google Drive ...



Once you put your large file on Google Drive (or on Dropbox), then just include a link to it in your MRH forum post or include the link to it in your article submission comments.

## **Coming: Extreme Diesel Weathering DVD**

If you recall any of Mike Confalone's excellent Allagash Railway scenery articles we published last year, we've got a treat in store for you this spring. Mike's doing a new DVD video for us he's calling: *Extreme Diesel Weathering - No airbrush required.*



To give you a taste of what he's going to cover, Mike created this thread on the MRH website:

[mrhmag.com/node/12126](http://mrhmag.com/node/12126)

Mike's included a lot of photos in this thread illustrating what he's going to show, so if you are at all interested in the subject of diesel weathering, you should check out this thread.

Above, you can see one of the before and after photos from this thread – all done without an airbrush, remember!

## March 2013

# Bonus Extras!

*Available to subscribers!*

**DVD and HD quality versions of the videos in this issue, plus:**

- **Scalable PDF version of the Bear Creek & South Jackson track plan**

**Click here to access**



contents



index

## Last issue's editorial ...

Last issue's Publisher editorial asked you if you feel MRH should lead by the hand or if we should just point the way. The comment thread to this editorial made a lot of good points, but a favorite is this post by MRH subscriber sdbanjo:

"There are a wide variety of modeling skills out there, running the gamut from newbies who have just purchased a basic starter set and aren't sure how to move past a circle of track on the floor to the old timers who have layouts I continue to marvel at and envy. I think the main print magazines have settled into roles by which one is aimed at the more advanced modeler and the other is more basics.

"Each has their place, but MRH is in a unique position of having the ability to appeal to not just one or the other but the whole spectrum of modelers. I am not a rank beginner nor am I a wizened expert. I have a lot to learn but am comfortable with the basics.

"With MRH I always learn something new and am never bored. Combining a magazine format with the content and forums of the web site, I could see producing articles that are pointing the way, but with helping hands available a click away if someone wants to know more.

"It's tough for print magazines to be 'all things to all people' because you need to find a target audience and not alienate - and in hobbies, someone is always unhappy about something. MRH is something special, something that has come at the right time and the right place fusing technology and a hobby that all of us care about. "

Well said, sb.



By definition, special interest magazines are passion-based publications - or at least they should be if they're well done.

We see MRH's role being mostly pointing the way, with some leading by the hand where it makes sense to do so. It's also good to remind all our readers that if you're just reading the magazine, you're only getting half the picture. The quality of our comment thread posts and website posts often rival the magazine content.

It's also true we see our articles as living documents, thanks to the comment thread that goes with each article. We encourage the authors to drop by the comment thread and to post answers to questions, and to post further insights to expand on their article.

Readers, likewise can post their own experiences and insights, making the combination of the magazine article

## Craftsman Kits and Details

Featured HO Scale Kit, \$59.95



HO & N Scale Laser Cut  
Model Kits & Details



Secure on-line ordering

[www.interactionhobbies.com](http://www.interactionhobbies.com)

INTER-ACTION  
Enterprises

E-mail: [sales@inter-action.ca](mailto:sales@inter-action.ca)  
Phone: (888) 850-1742



**When talking  
to hobby  
vendors,  
please  
remember  
to mention  
MRH.**



contents



index

plus its comment thread into something a static print magazine can't begin to match.

We like the idea that the comment thread can be a good place to bring the newbies along on the more advanced topics.

This all said, we do have some parts of our magazine where we take more time to lead by the hand. For instance, our MRH QAT column takes a more tutorial tone on many topics. And Bruce Petrarca takes the time to explain the mysteries of DCC to our readers.

We also publish an occasional article that deals with some basic techniques, like a recent article we did on simple freight car weathering by Dirk Reynolds.

So thanks for the feedback. It appears most of you feel we're doing it about right – mostly pointing the way, with some leading by the hand now and then, depending on the topic. It's also a great point that you, our readers, can also assist with any leading by the hand needed to bring the newbies along.

That's a team effort we feel is hard to beat!

## **How to save an article**

Some of our readers like to not save the entire issue of MRH on their system, but save only the articles of interest. This is especially true for those who don't have a great Internet connection and who go to the library to use their web connection to access MRH.

We get questions from readers on how to save individual article more easily. The answer depends on what kind of computer you're using to access MRH.

[... On to next page of text →](#)







Installing DCC sound just **NOT** your thing?

Trust Traintek for sales and installation of sound decoders from these fine vendors!



**RailPro**™

*"Taking model railroad control to the next level ..."*



**traintekllc.com**

Click here for more details...



"Traintek **was** the way to go!"



[← back to previous page of text ...](#)

The best solution is to download and then print out just the pages you want to a new PDF file.

On the Mac using Mac Preview you can do this by selecting the Save as PDF option.

Here's a link that shows you how:

[mrhmag.com/url/mac-preview-pdf-print](http://mrhmag.com/url/mac-preview-pdf-print)

For Windows, here's a good option (not free, however) ...

[mrhmag.com/url/windows-print-as-pdf](http://mrhmag.com/url/windows-print-as-pdf)

If you want a less powerful print as PDF option for Windows that's free, then Google, "CutePDF".

However, we must point out that those of us who have been in the hobby for decades now find that our interests have changed. We'd like to suggest the wiser approach is to just store the entire magazine and use [Rod's Index](#) to search for articles of interest.

Given that disk space is so cheap these days (1 terabyte for less than \$100 USD now), you can store 10,000 full issues of the embedded edition of MRH in that much space. At 12 issues per year, that's over 800 years of MRH!

Make sure you're not being penny-wise and pound foolish. It's annoying to find your interests have changed and you didn't elect to save off that one article you could really use now ...

By the way, starting with this issue, if you do need to remove the issue password, we publish it on our staff masthead page.

[... On to next page of text →](#)



# March Specials

*(while supplies last)*

Click here  
for more  
info ...

**HOT!**



YD



Yankee Dabbler.Com

## ST. PATRICK'S

## DAY

- Digitrax
- SoundTraxx
- Kadee
- NCE
- And more!

HO

DCC

All Scales

Remember  
You can click  
on the Email  
or Phone  
buttons to  
contact a  
sponsoring  
advertiser!

And tell them  
“Thanks for  
sponsoring  
MRH!”



Email



Phone



contents



index

## What's in this issue ...

Coming your way in the March issue we have ...

**Pin vises:** Jack Burgess shows us some handy pin vise insights. Get more out of this small but vital tool, thanks to Jack's advice.

**Modeling turn-of-the-century wood 20T coal cars:** M.C Fujiwara has fun with some turn-of-the-century modeling. MC's always good for clever modeling methods. M.C. models in N scale but his methods can inspire similar techniques in other scales.

**Yes, it's a model:** Our new photo feature presents some amazing modeling this issue. You have to see it to believe it.

**Makin' smoke:** We like these clever smoke methods from N scale modeler Dave Salsbery. They work for larger scales too!

**Another \$500 starter design challenge layout:** Doug Forbes presents his approach for doing a \$500 starter layout in HO via his "Western Expansion" plan.

**Writing for MRH:** Two-time MRH author Tom Patterson gives you a blow-by-blow account of getting an article published in MRH. Our hope is this account will encourage more of you to submit an article to us for publication!

**Our regular columns:** *Getting Real* columnist Marty McGuirk discusses his SNE layout reboot, showing how you can start over without completely starting over. Charlie Comstock shares the first op session after his peninsula construction project started, and Bruce Petrarca shows some very useful sound decoder keep-alive techniques. Ken Patterson presents Gary Christensen's wonderful modeling.

Have a great read this month! ■

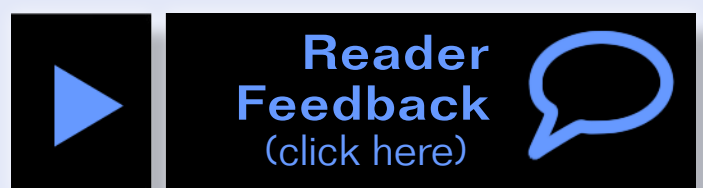

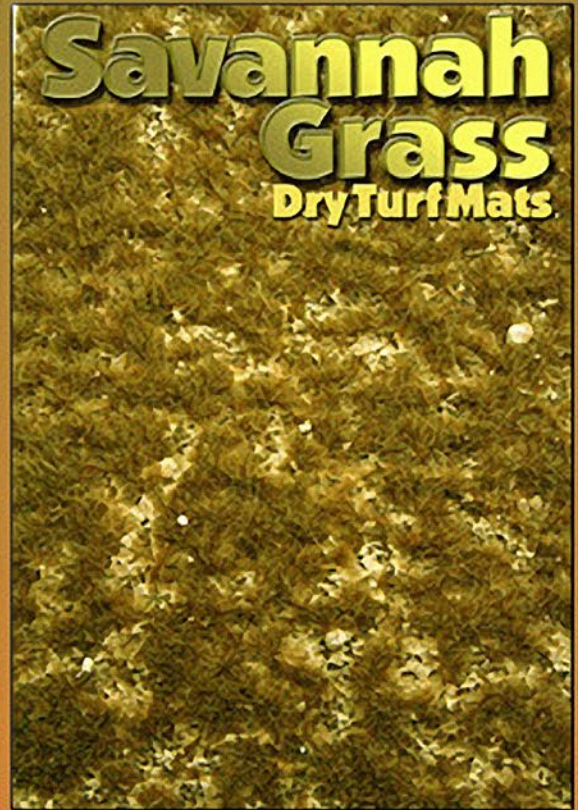
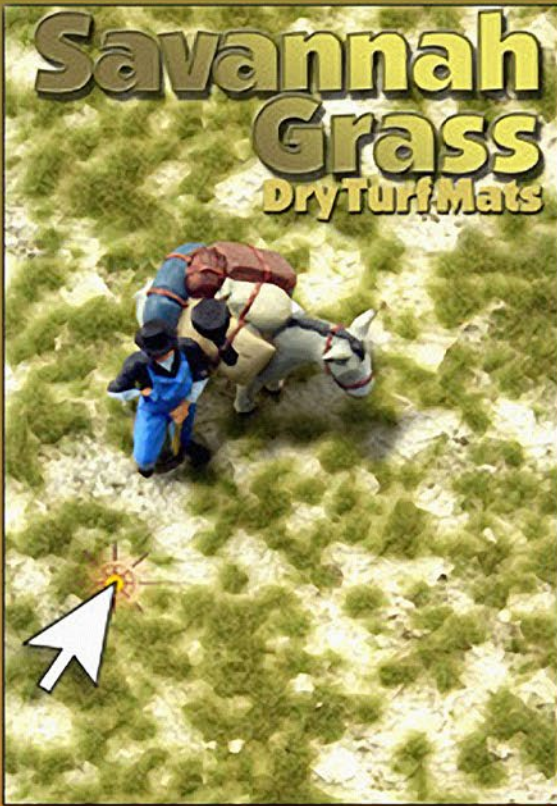

**Click for more - lots more!**

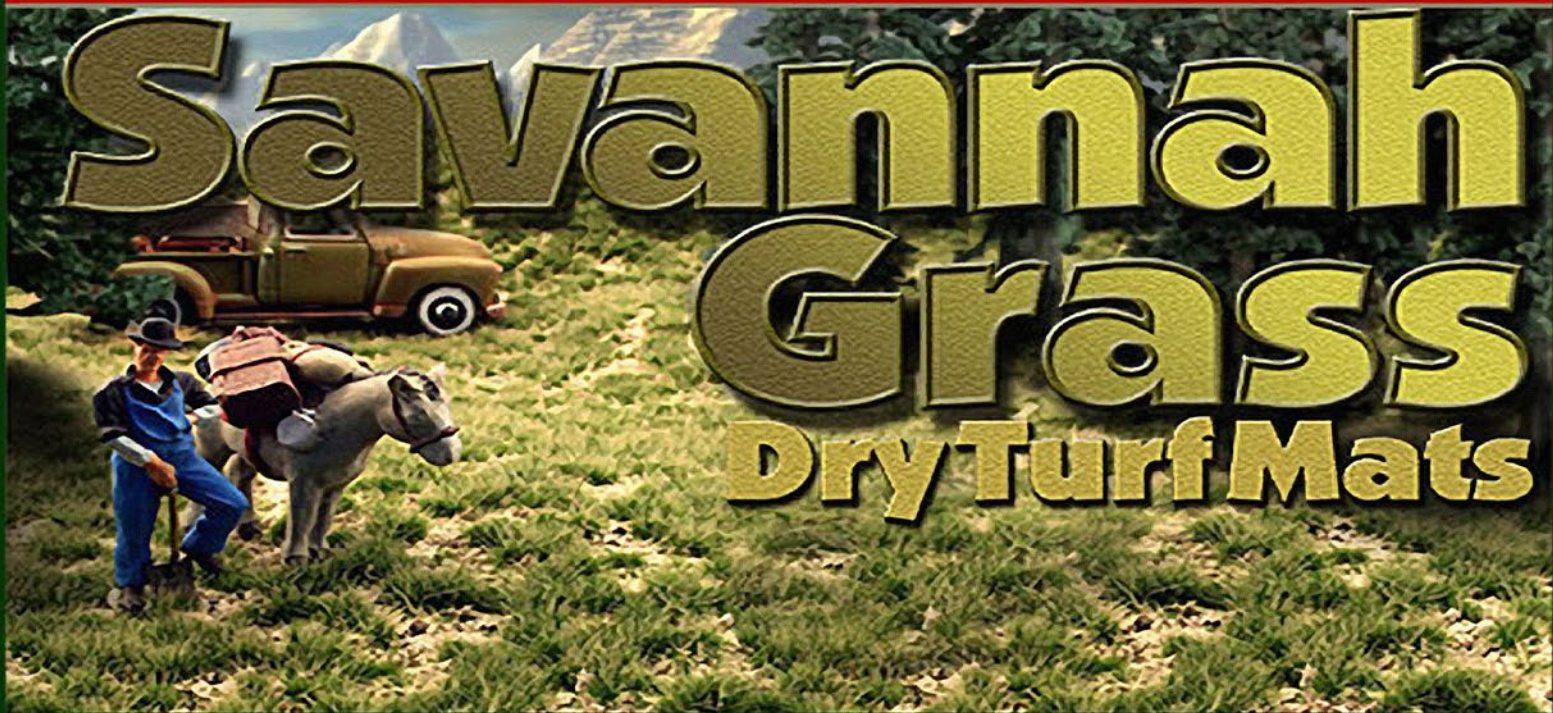

# QSI Breaks the Sound Barrier with Its' New, Exclusive Emulation Technology! (ET™)

**QSI's, Break-Through, Emulation Technology  
(ET™)**

**Makes You the Engineer with Real Time**

The new QST Titan's **ET** software is the first **DC/DCC** sound unit to put you in the engineer's seat to emulate a multitude of real locomotive bi-directional operational characteristics.

**ET** is not a mindless decoder simply responding to one way commands with no meaningful action-reaction interplay with the locomotive.

With **ET**, except for scale, you are the real engineer and responsible in a prototypical manner for your locomotive operating in the real world in real time!





Check out just a few  
of **ET's**  
break-through  
features!



- Decoder controls locomotive motor like a real traction motor!
- RPM governor for motor specific, prototypical, motor acceleration, overshoot and undershoot.
- Real Time Notch Control: No annoying stair stepping between notches, RPM moves seamlessly from any notch to any notch, just like the prototype. <sup>TM</sup>
- True Exponential RPM decay
- Full Dual Prime Mover Sounds. Multi Level Control of Prime Mover sounds

**Click here for  
more features ...**



# MRH

## Questions, Answers and Tips

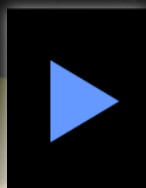

**Reader  
Feedback**  
(click here)



### QUESTIONS AND ANSWERS

#### Light bulb for short protection

**Q.** I have set up a test area to work out the wiring for your 1156 bulb short management system. I believe that you use EasyDCC as I do. However, I was unable to duplicate the results that you showed on the video. I never saw the 1156 bulb light up. Are there any common errors that rookies make, or can you provide hints that might help me debug my test setup?

– Dan Foltz

**A.** This idea may be less practical than it used to be, depending on what DCC system you are using. EasyDCC and Lenz have made their systems' response time to short circuits too fast for the bulbs to work, which is unfortunate. Taillights in automobiles are moving away from incandescent bulbs to LEDs. This means the 1156 auto taillight bulbs will get more scarce over time, and more expensive.







1: Automotive taillight bulbs, wired in series in a power block feed, indicate short circuits without tripping breakers in some – not all – DCC systems.

My EasyDCC installation used older Lenz boosters that reacted slowly enough to short circuits for the bulbs to work great. You need a booster that reacts at about 250 milliseconds or longer. Anything faster and the booster wins, not the bulb.

NCE boosters and Digitrax systems still work great with the bulbs. Digitrax systems have a firmware OPs switch that controls short response time, and if you set it to half a second (500 milliseconds) the bulbs work great. Lenz systems are too fast, except for their oldest LV100 boosters. The EasyDCC boosters are the other way: the older EasyDCC booster cards don't work.

See my two-minute video about using 1156s for short management at [model-trains-video.com/assets/video/shortMgmt2\\_bbhi.swf](http://model-trains-video.com/assets/video/shortMgmt2_bbhi.swf).

– Joe Fugate

Why are we talking about taillights? What's an 1156? An 1156 is a 12 volt incandescent automobile bulb. It generates light by heating a wire filament.



contents



index

Shorts are easy to come by with metal wheels running on 2-rail DC layouts, particularly at turnouts. Usually a short is caused by an operator running against an incorrectly set of points or turnout. Other causes are the back of a wheel touching an opposite-polarity closure rail, wheel sets that are out of gauge, or track that's out of gauge. Metal pilots and plows mounted too close to the rails are another cause.

When there is a short circuit, the DCC system's internal breaker will shut down power to the whole layout. While a single operator can just remove the problem, it is very annoying when there are several operators and the whole layout shuts down. Sound-equipped locomotives will go through their start-up routines when they lose, and then regain, power. Very annoying.

Eliminate the issue by setting up power districts. There are three basic methods:

- Add boosters to the original power supply. These are the most expensive option, and most power supplies can run several trains at a time. This will not eliminate shorts, but a short in one district won't shut down trains in others.
- Install circuit breakers for each district. These are cheaper than boosters.
- Install 1156 automotive lamps wired in series for isolated train blocks.

The two-buck 1156 automotive brake lamps will restrict the current to 2.0 amps when there is a short. Excess current heats the filament and lights the bulb – warning of a problem – but the breaker does not cut out. Operation on the other train blocks is not affected. You still need to do something about the short, but you get a warning and the short doesn't pull the whole system down.

For more information, see: [4dpnr.org/articles/DCC\\_Wiring.pdf](http://4dpnr.org/articles/DCC_Wiring.pdf)



**2:** Hardware store spray primer is fine for use on scale models when it can be fogged on in one or two light coats, just enough to cover the part.

**3.** Metal primer creates a strong bond between paint and metal parts to reduce chipping and flaking. Many cast metal parts need careful cleaning with files and sandpaper.

for “Tricks with auto lamps.”

Threads: [mrhmag.com/node/2660](https://mrhmag.com/node/2660).

Video: [model-trains-video.com/assets/video/shortMgmt2\\_bbhi.swf](https://model-trains-video.com/assets/video/shortMgmt2_bbhi.swf).

**Q.** I am working on a kit that has metal parts, and the directions say to prime parts before painting. What kind of primer is safe for this adventure?

– Theron

**A.** Priming is Step 2. Step 1 is cleaning up the metal pieces to get rid of flash and casting lines. Military modelers often rinse parts in diluted vinegar to etch the metal surface a bit. Or, give them a good clean in lukewarm water and dishwashing liquid to clean away oils and stray metal.

When the parts are dry, Krylon's Indoor/Outdoor (2) is a pretty



contents



index

good primer and won't break the bank. It comes in five colors. We like Krylon because it covers in a thin coat and comes with a good spray nozzle.

Testors 2782 Super Fine Gray Lacquer Primer is also good. Read the labels or website and look for a primer that is intended for metal. Scalecoat I paints are formulated to be used without a primer on wood and metal.

You need to mist on just enough primer to cover the surfaces and then let it dry hard -- probably one or two days. The idea of a primer is to create a surface to which paint will adhere, and not flake or chip (3). Once the primer has set up, you can paint with your favorite acrylics or enamels.

A couple of items in hobby stores sound like they would work as primers, but read the labels carefully. Model Master Gray Sandable Lacquer Primer can build up quickly and obscure fine details. Floquil and PollyScale lines include paints named 'Gray Primer' and 'Zinc Chromate Primer' but these are paints formulated to replicate the look of 1:1 primer. There's a link below that takes you to Testors' primers for metal.

– MRH

Read more at: [krylon.com/products/indooroutdoor\\_primer](http://krylon.com/products/indooroutdoor_primer).

Scalecoat: [weavermodels.com/page12.html](http://weavermodels.com/page12.html).

Testors: [testors.com/search?q=metal+primer&x=0&y=0](http://testors.com/search?q=metal+primer&x=0&y=0).

**Q. Trying to renumber some new Walthers cars and man is their paint tough! Tried the eraser, tried the eraser w/ alcohol, and even tried Joe's Decal Remover and didn't even smudge the numbers.**

**Q. I need to replace the color Union Pacific logos on several Pacific Fruit Express reefers, made by InterMountain, with the black and white logo, to update them to late 1953. I also need to re-number and change other lettering.**

**I keep reading online that many modelers use various methods for removing printed lettering on cars but with varying degrees of success.**

**A.** Joe's Decal Remover can remove InterMountain's lettering without damaging paint. How to remove lettering is among the Top 3 in questions on model railroad message boards. There are dozens of answers because there are dozens of paint and lettering combinations among the manufacturers. Walthers and Kato lettering are particularly tough. The only universal solution is blasting with baking soda or fine aluminum oxide, but that takes special equipment and some careful handling.

Because there are so many variables, you should test any solution on a scrap model or in an easily concealed spot. Some lettering can be scraped away with a knife blade, or with a fiberglass or brass pencil. But it is very difficult to avoid damaging the paint finish this way.

Liquids can be applied with a damp, but not wet, cotton swab. Do not let your remover solution remain on the finish long enough for it to migrate into the paint. Go slowly until you find a workable method.

An alternative method is to daub alcohol or decal solvent on the lettering, let it sit for a minute, and then gently scrape it with a piece of stiff styrene – .040 should work.

Here's a rundown of new and old solutions. Start at the top and work your way down:

**Isopropyl alcohol:** 91% alcohol from the drug store works with the cotton swab method and can be diluted. Products labeled “rubbing alcohol” can contain oils that can leave a residue.

**Microsol:** This is a decal solvent and can work on stubborn lettering, using a pencil eraser or cotton swab. Walthers Solvaset is similar. Both can be thinned with water if they work too quickly.



contents



index

**Chameleon Paint Stripper:** Chameleon is biodegradable and reusable, and safe for most plastics. When you are done with the stripper, run the model in water to clean it up. For lettering removal, dampen a cotton swab and lightly rub the lettering. The product is sold as a liquid and a gel but can be hard to find.

**Citrus cleaners, Simple Green:** Fast Orange and similar brands work, but can take a while and some companies' lettering is completely unaffected.

**Acetone:** It works very well at taking stamped graphics off of glossy enameled surfaces. Thin it with water and experiment. Find it at the hardware and paint store, or in the cosmetics aisle packaged as fingernail polish remover.

**Brake fluid:** Brake fluid was a favorite for stripping metal and plastic, but it has changed in composition over the years. Most varieties leave a messy residue. Some eat plastic and dissolve adhesives. Old-style brake fluid was a mixture of denatured alcohol and light oils to lubricate brake system parts.

And here are the links:

“Joe's Decal Remover” at [joesmodeltrains.com/Paint%20and%20Decal%20Remover.htm](http://joesmodeltrains.com/Paint%20and%20Decal%20Remover.htm).

For scale models, we DO NOT RECOMMEND [youtube.com/watch?v=scF0GUJPGo0](https://www.youtube.com/watch?v=scF0GUJPGo0).

– MRH



# TIPS

## Insulating lighting resistors

A recent article on installing DCC in a locomotive said you will need to insulate lighting resistors in the shell. My method not only accomplishes that, but affixes them to the shell itself. I use a Permatex Blue RTV Silicone, used for making automotive gaskets. “RTV” means “room temperature vulcanizing,” which means the product cures without additional heat or special treatment. Being a gasket product it is made to withstand high heat for a long period of time.

I have used this method for going on 25 years without experiencing an overheating issue and have used the product to install circuit boards on the inside of shells or to the chassis. I have had as many as four resistors in one hood section without heat issues. Blue RTV is also great for securing and insulating metal or brass light tubes and securing can

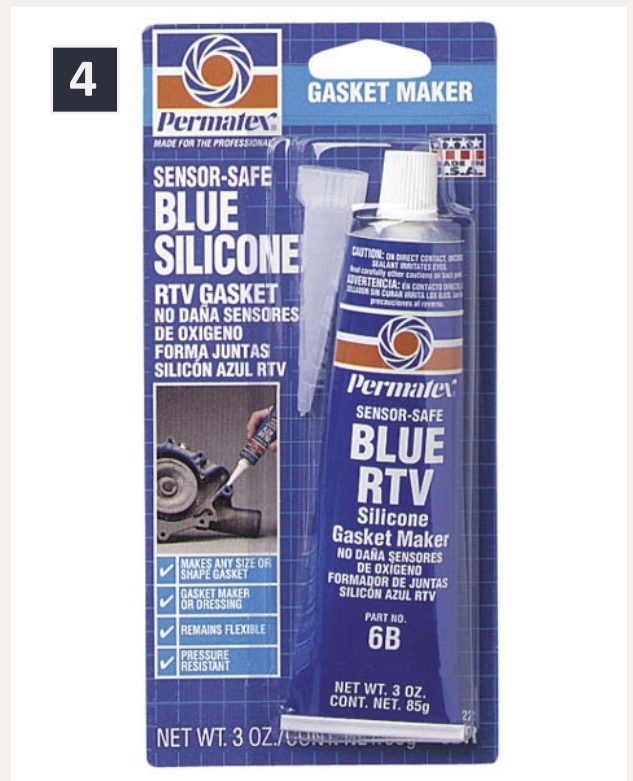

**4: Permatex Blue RTV Silicone, a gasket product made to withstand high heat for a long period of time, can be used to install and insulate lighting resistors in locomotives.**



contents



index

motors to chassis. Anytime there is a potential heat issue I would use this product.

This can be purchased at any auto parts store and most large retailers who sell auto parts. Being a gasket product it is made to withstand high heat for a long period of time..

– Andy Hauser

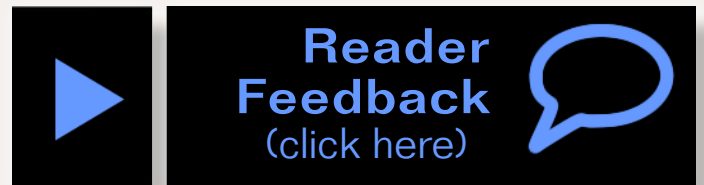

## GET \$25 PER TIP

We pay \$25 USD for each tip we publish.

[Send your modeling tips to Model Railroad Hobbyist](#) and we'll get payment to you upon acceptance.

Just think, for only a few minutes effort, you could fund your next piece of rolling stock – or even pay for an entire train if you send in several tips and we publish them!

If you include any photos with your tip, we pay a bonus of \$10 per photo we use with the tip. ■



**New  
Innovation**



# Nano Technology Lubricants

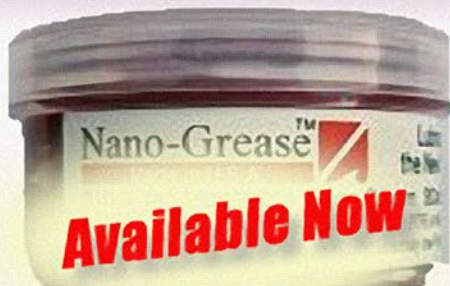
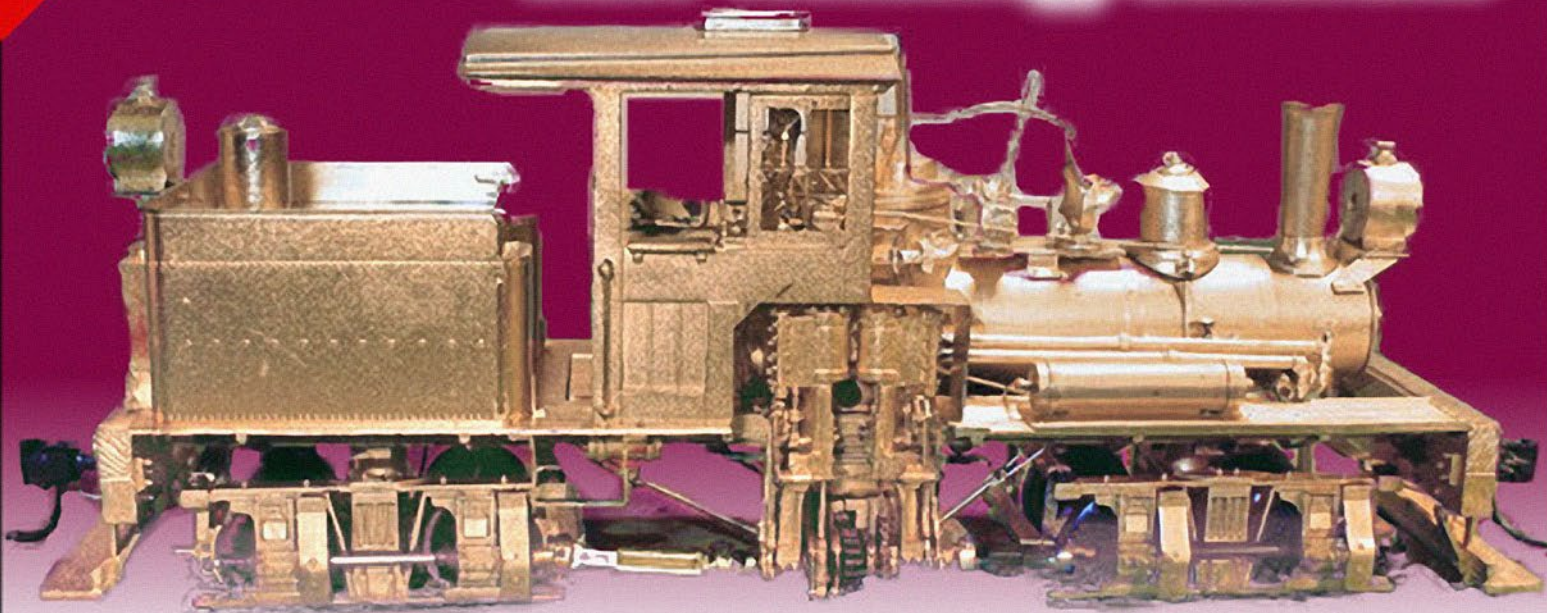

**Nano-Grease**

"I was skeptical, but my experiments show significant improvement with Nano Oil ... why not lube it with the best?"

- Bruce Petrarca, MRH DCC columnist

**THE SHAY FIXER** 

VISIT US AT...  
**SHAYFIXER.COM** 

*Specializing in brass Pacific Fast Mail / United geared locomotives*

**For more details  
click here ...**



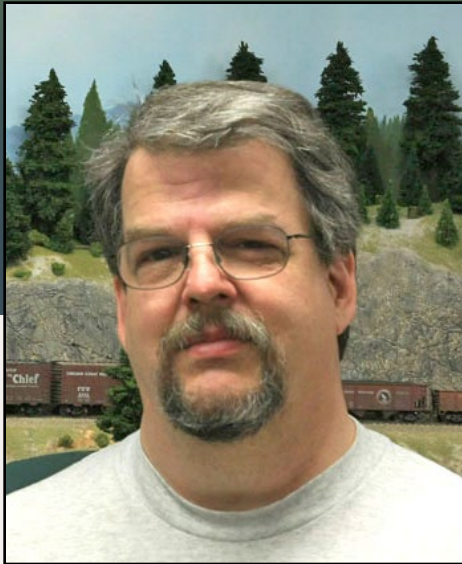

## Peninsula construction!

A regular report on the construction of a 1950s-something layout

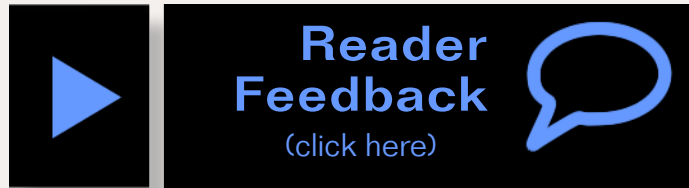

### Up the Creek column

by Charlie Comstock

## The Bear Creek and South Jackson is running again!

**A**ugust 13, 2011 was the date of the most recent BC&SJ op session. That is, it was until now. With the completion (well near-completion – the turntable is still inoperable) of the new, improved, and hopefully final South Jackson yard, the railroad was again ready to run on February 9th. A crew call yielded 13 eager operators and around 7:30 p.m. the first trains made their way out of staging and onto the layout proper. Amazingly, things worked pretty well, especially considering the layout had been idle for 1-1/2 years since the previous session.

Because there was a considerable amount of tested but untried track in South Jackson and the main staging area, I elected to keep things on the simple side. The track schematic hadn't changed – the railroad got longer, so we re-ran the previous train lineup. Instead of a fast clock, dispatcher, radio headsets, and TWC (track warrant control), we used mother-may-I dispatching to launch trains, and smoke signals to prevent unfortunate incidents on the mainline (cornfield meets).

[... On to next page of text →](#)



**A clipping from the**

# **South Jackson Gazette**

## **BC&SJ Trains Resume Operation!**

Last weekend, locals gathered at the South Jackson Grill where Gastonary Delyte was dishing up hors d'oeuvres and Horace Fithers was talking up a storm about the resumption of operations on the BC&SJ railroad.

Said Horace, "It were almost like the trains never stopped running! All the new tracks worked purty near perfect like and the older parts of the railroad just kept rolling along liken they never stopped. I was so happy, my heart like to burst!"

Others were quick to agree and even quicker to line up for the free drinks provided by the railroad.

BC&SJ Superintendent of Nearly Everything, Charlie Comstock, promised operations would continue and be expanding shortly once more terra-firma was



Train crews and trackside giants working together to expedite a train swapping blocks at the new South Jackson yard, a sight long missing from the BC&SJ that brought smiles to the faces of local railfans.

constructed and the railroad laid tracks on it.

This reporter is confident the good times (and trains) will continue to roll on the tracks of the Bear Creek. ✨

\* Enjoy the Gazette? Read more at [bcsjrr.com](http://bcsjrr.com)



contents



index



**1: South Jackson yard 14 days before the Feb 9th op session, with the track gang on break. Not quite the Messy Flats & Stuff Everywhere but not ready for ops either.**

**2: The track gang and the operations department made a Herculean effort to get all critical trackage installed. Here is the pre-session South Jackson with cars staged and ready to go.**



**3: In comparison, here's the previous scrap box version of South Jackson (prior to connecting to the helix). The newer version is definitely more elegant, and features an additional siding for passenger trains while they make depot stops. The new turntable is not yet operational.**

[← back to previous page of text ...](#)

## **Good stuff and problems**

We ran all 15 of the trains called for on train line up M, with only a few issues. These included:

- The yard lead for new South Jackson is shorter than the old yard and it took Brandon, one of my experienced yard masters, a bit of time to get used to it.
- Somehow I missed some black residue on one of the yard tracks, presumably left by the black tape used to package Micro Engineering flex track. This caused locos to stall.





**4: The previous yard with yardmaster Norm (black shirt) and train crew Joe B. (left) joking about something. The grain elevator in this photo is replaced by a turntable in the new South Jackson yard.**

- One of my Walthers GN heavyweight passenger cars had some trouble with a turnout in the new staging area. These cars have historically been a bit stiff and need good trackwork.
- The Oakhill Turn crew reported the wye at Oakhill didn't run as smoothly as it should. This is old track that should be working fine – I'll need to take a serious look at it before the next session.

Things that worked out great:

- The vast (compared to previous staging) space in main staging (5 and 6) on the lower deck of the peninsula at the bottom of the helix will greatly increase the layout's ability to handle more trains. And the new staging area is only half built! I don't want to think about the amount of flextrack there...



**5: The main staging area after the layout was prepared for operation. This area currently represents Pocatello and the east end of the railroad. The tracks in this area are so long it only took two tracks to hold the trains that often required four tracks in the previous Pocatello (Siskiyou staging was pressed into use as Pocatello before the peninsula was constructed). The longest track here can hold more than 60 40' freight cars.**

- The turnout control panel for lower deck staging was intuitive enough that nobody had too much trouble figuring out how to get trains in and out of the desired track.
- The separate depot (passenger) track in South Jackson really helped with multi-train meets. It also meant that two trains could meet there while a passenger train was making a station stop at the depot. Score one for the good guys!
- The new turnouts in South Jackson performed flawlessly!
- Amazingly enough after 1-1/2 years of construction, even though I didn't vacuum the track, a single pass of my Masonite slider car got the track clean enough that most



contents



index



**6: This view of main staging may give a better idea of its size. There are nine tracks here and there will be 10 more on the other side of the peninsula's spine. Tony Koester says you should determine the number of staging tracks needed by estimating how many you need, then doubling that number and adding one. We hope the BC&SJ will have enough.**

trains ran without issue. There were a couple of hold-out locos, though, which needed their wheels cleaned before they behaved themselves, but that's been the case forever.

We had a pretty good time running the trains and nearly all the brownies were eaten – an important consideration so I wouldn't be finishing that job myself after the session ended.

## **What's next?**

Finishing the main (lower deck) staging areas is high priority. It's not that the extra capacity is needed yet – there's plenty of space already (5 and 6). But I want to get those tracks and turnouts

[... On to next page of text →](#)





**7: This photo is one of the rarest of the rare. The busiest man in Woodburn, Oregon, MRH publisher Joe Fugate (black shirt) is holding the throttle of the Bear Creek Hauler East, one of the first trains out on the layout. Joe loves to operate, but the magazine production schedule all too often keeps him glued to his computer. Joe and I live about 50 minutes from each other.**

**The BC&SJ is a south-facing layout. That is, whenever you're standing in front of it you're facing south. Which means east and west are reversed from standard map directions – east is left, not right, and west is right, not left. The station plates on the fascia all have East and West nomenclature to help crews keep track of which way is which.**



contents



index



**4: Yardmaster Brandon at the beginning of the session. This is the first time the new yard is being used as a yard. Luckily, its design is similar to its scrap-box predecessor, making it a bit easier for him to get the hang of it. One thing missing is a tray for dealing with car cards. I'll need to provide that before the next op session.**

**The industries at this end of South Jackson are all new, too, adding additional unfamiliarity. On the positive side, the cabooses track is almost right under the yardmaster's nose instead of being around the corner, and there is a reasonably long runaround track adjacent to the cabooses track. Once the turntable (in the corner beyond Brandon) goes into operation, locos won't need to cross the main to travel between their trains and the South Jackson engine service area.**

# RailPro™

## NEW TECHNOLOGY



Click here to watch our videos!

### New Products

- Accessory Module
- Auto Reverse Module
- New Sounds and more!

For more information visit our Internet site: [www.RingEngineering.com](http://www.RingEngineering.com)



Structures of simple elegance ...

Made in the USA

## ALPINE - DIVISION SCALE MODELS

# Click to Learn more...

[alpinemodels.com](http://alpinemodels.com)





**9: Joe Fugate is intent on bringing train BCHE safely down the 2.8% grade from Oakhill toward Tunnel 3. Behind Joe is the very first piece of the main deck roadbed on the peninsula.**

**10. Jim B. (left) is the Redland local switch crew tonight. Jim M. (middle) and Mike B. (right) are the Deschutes Hauler East crew. They'll shortly be bringing their train out of Deschutes staging (lower deck beyond them) into Redland for a block swap before proceeding to Pocatello.**



**11: The two Bear Creek Haulers, east and west, are meeting at South Jackson. David H. (between Joe and Brandon) has just brought BCHW into the yard after ascending the helix (off to the right) from Pocatello (in main staging).**

**Strangely, BCHW went from the main to the siding (under the yellow roofed car) then back to the main again – a bit curious, perhaps a result of this being the first meet in this yard during an op session.**

**Joe F., in the background, appears to be checking his car cards.**



contents



index



**12: The Deschutes Hauler has arrived in Redland where it's working with the Redland local switch crew to swap blocks of cars.**

**This train has strict blocking requirements. It should arrive in Redland with the shorts (cars that will be handed to the Redland switch crew) in the middle of the train and the Pocatello (terminating station) cars at the end of the train.**

**When it departs, all cars to be dropped at South Jackson (its next stop) should be at the head of the train but with cars for South Jackson, Mill Bend, Oakhill, and Salem blocked together. Pocatello cars remain at the rear of the train.**

**Redland has over 45 car spots, so it has its own switcher.**



13



14

**13: Paul M. (a work crew regular) runs the Oak Hill Turn above Baynes Valley on his way to switch out Oak Hill.**

**14: John B. is the crew for the Deschutes Express west. This train first runs east on the Deschutes branch, then reverses direction at Mill Bend before heading west through Oakhill to Salem. John is preparing to change DSXE's direction in Mill Bend.**



contents



index



**15:** Although the scenery looks suspiciously like plywood and the milling complex in the rear is held together with blue painters tape and clothespins, once you get into operating you hardly notice these shortcomings.

Yardmaster Brandon seems intent on the rack of car cards. The rack has a box for each track in the yard, making it easy to find the paperwork for each car.

I use car cards with 4-cycle waybills. Each car has a car card. Each car card has a pocket. Waybills are inserted in the pocket specifying the destination for that car. Between op sessions I "turn" the waybill to its next destination. Crews look at the visible destination on the waybill and switch the car accordingly.

Look at [s145079212.onlinehome.us/rr/operations/ccwb.html](http://s145079212.onlinehome.us/rr/operations/ccwb.html) for more information.





**16: The Deschutes Hauler East nears the junction between the Deschutes branch and the mainline. I find a branchline that generates and consumes trains adds greatly to the fun of an op session. Eventually the BC&SJ will have three such branchlines.**

**The main deck of the peninsula behind Jim M. is slowly beginning to take shape. But there won't be much progress there until the lower deck staging area has all track and turnouts installed and thoroughly tested. It's much easier to fix lower deck track before it gets covered over!**



contents



index



**17: John B. brings the Deschutes Express East off the steep 2.8% grade and into Oakhill on the main before proceeding to Salem.**

**He'll be passing the Oakhill Turn, which is already at work in Oakhill. Normally, the OHT does all its work using the siding and wye track but staying off the main in Oakhill, so the DSXE should be able to run by without a problem.**

# Rslaserkits

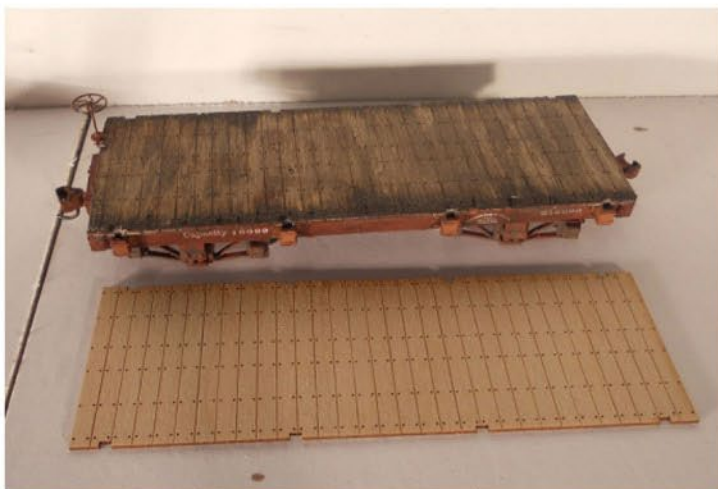

New wood decks  
for the new On30'  
Bachmann 18 ft  
freight cars



click here



Pre production photo  
Final kit to have more  
parts then shown.

## Fugate Farm Supply

One of the new kits released at the Amherst Show

Custom Laser Cutting and design

**Dealers welcome**



5145 Gaffin Rd. SE • Salem, OR 9317

(503) 371-4290

• Fax: (503) 585-0850

E-mail: [Sales@rslaserkits.com](mailto:Sales@rslaserkits.com)

Web site: [www.rslaserkits.com](http://www.rslaserkits.com)





**18: Paul (in the pop-up) and Theron (red shirt) are the crew of the Oakhill Turn. Switching Oakhill is a bit challenging because there are leading and trailing point spurs but no runaround track, only a wye.**

**The OHT arrives from the east (left) and needs to return in that direction. A skilled crew will quickly switch the Oakhill log loading, team track, and gravel quarry, but an unskilled crew is likely to be anything but quick!**

**Check [www.s145079212.onlinehome.us/rr/operations/switching\\_oakhill/index.htm](http://www.s145079212.onlinehome.us/rr/operations/switching_oakhill/index.htm) to learn how to switch Oakhill like a pro.**



Today brings another challenge. Because a real dispatcher is absent and the Superintendent of Nearly Everything was a bit busy and distracted, train BCHW (behind the Black Widow F3 AB set) is in Oakhill on the main. However the BCXE, the Bear Creek Express East, has left Salem and is on the way to Oakhill arriving from the right. Oakhill is the only place they can meet but with the OHT in town space on the sidings is at a premium. Oops...



contents



index



**19: While angst abounds in Oakhill due to the impending facedown, the rest of the railroad keeps running. Joe Fugate brings train BCHE into the main staging area A on track 7 after completing his run. Good job, Joe!**



**20: After train BCHW made it past Deschutes Junction on its way to a date with destiny up in Oakhill, the lowly Deschutes Hauler East, which was waiting on the branchline for traffic to clear, made the run into South Jackson. It is swapping blocks with the yard before proceeding to Pocatello (in main staging).**

**Amazingly, Brandon, Mike, and Jim actually appear to be having fun with trains.**



contents



index

## A "Right Clamp"™ Mini Project

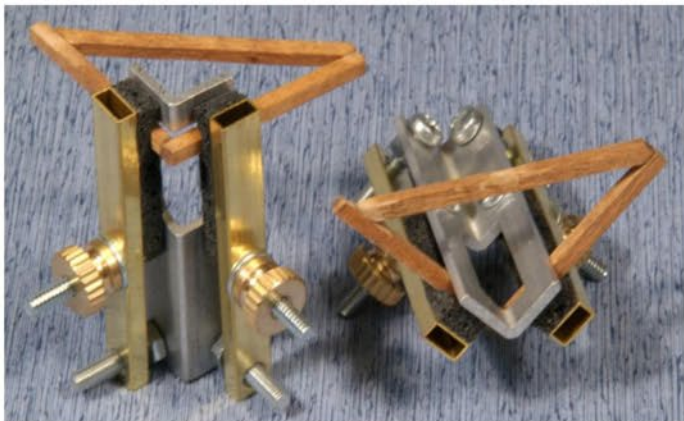

AC-2-2 "Mini Right Clamp"™ used for gluing Bulkhead Frames.

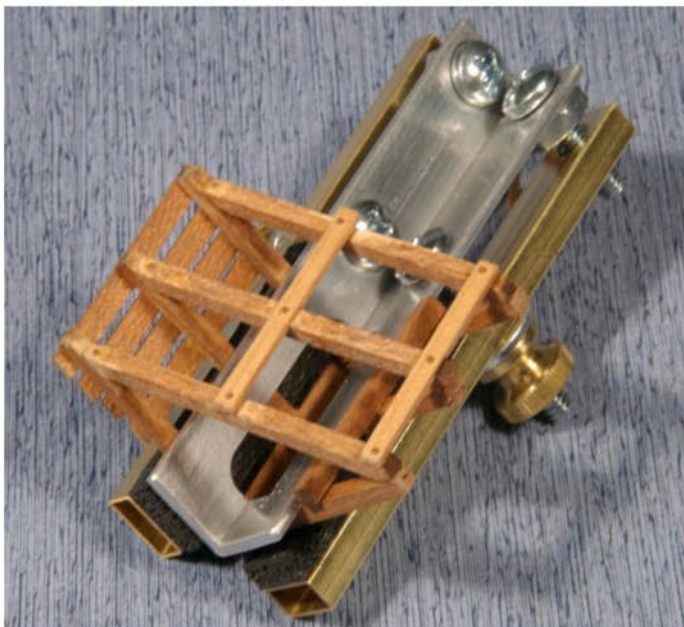

AC-1-1 "Original Right Clamp"™ used for Bulkhead Assembly.



Assembled Bulkhead in gondola with load of ring castings.

### Right and Splice Clamp –Tools for Modelers

See all our products at:



[www.coffmaneng.com](http://www.coffmaneng.com)

**Coffman Graphic Solutions Co.**

1500 River Circle, Richmond, KY 40475-7907

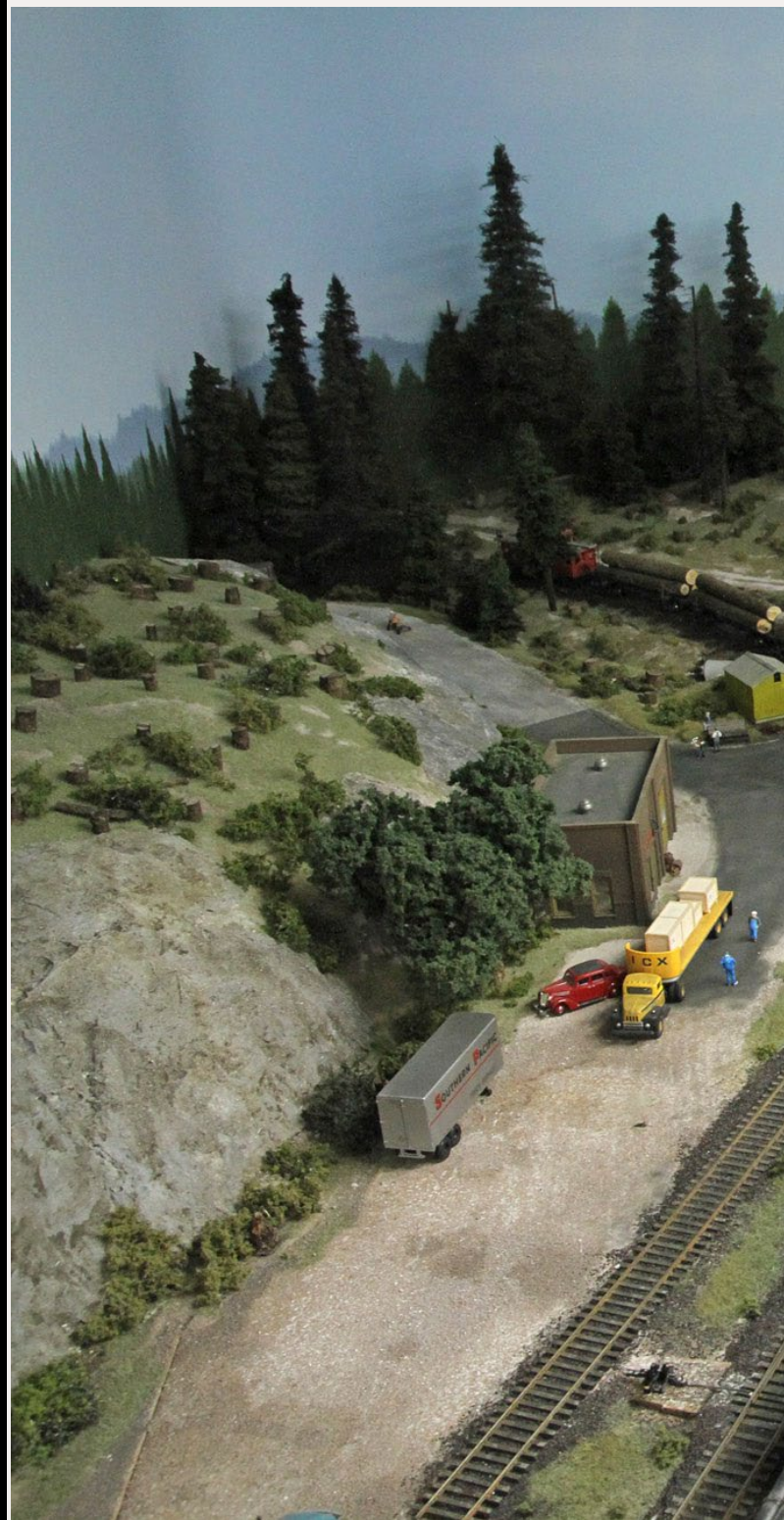
Phone: 859-527-0476, Fax: 859-527-0485



 **Reader Feedback**   
(click here)



Email



Phone



contents



index





**21: A three-way meet at Oakhill! The Oakhill Turn managed to fit itself onto the wye and spur tracks, clearing the main and siding. The Bear Creek Express East (led by the bumble-bee RS2 locos) is taking the siding, while the Bear Creek Hauler West is on the main.**

**Except that the Express, being higher priority, ideally should have been on the main. Job well done, guys!**



**22: Another oops! Train SAHW has stalled on the 2.8% grade between Mill Bend and Oakhill. Each train crew receives a train sheet for their train. This lists the destination, stops along the way, blocking order of cars, special instructions, and the speed limits and maximum length for the train.**

The deck of car cards and waybills for each train includes cards for the locos. These cards specify the maximum number of cars this loco can safely move up the ruling 2.8% grade between Mill Bend and Oakhill. This is often less, sometimes significantly so, than the maximum train length given on the train sheet.

The train and yard crews are supposed to check the motive power's pulling power to ensure their train hits the grade with sufficient power. If there isn't enough get up and go, a helper needs to be called.

Unfortunately the green crew of the Salem Hauler West didn't notice their single cab forward wouldn't have the oomph to get 26 cars up the grade without a helper.



**23:** The obvious solution was to run a helper up behind the stalled SAHW, but the GN passenger extra "borrowing" the BC&SJ tracks occupied the main in Mill Bend, where the helper needed to run around the SAHW's caboose. BC&SJ rules dictate no pushing on an occupied car so the helper crew had to wait.

Jerry S. is running the throttle on the passenger train. The two BLI E7A units on point are making their first appearance in a BC&SJ op session. Once it scuttled off down the Deschutes branch, the 2-10-2 helper could go again.

The two boxcars to the right on the main are the rear of the Salem Hauler West where it stalled on the grade.





# Rusty Stumps

Scale Models

WE ONLY SELL WHAT WE MANUFACTURE

## DETAILS

IN HO, O, S & N SCALES

LASER CUT SHINGLES, DOORS & WINDOWS, FENCES, SIDING, CRATES. Also RESIN and WHITE METAL DETAILING CASTINGS.

## CRAFTSMAN KITS

IN HO, O & S SCALES

CHECK IT ALL OUT AT

[WWW.RUSTYSTUMPS.COM](http://WWW.RUSTYSTUMPS.COM)

Send \$3.50 for Catalog - Specify Scale

### RUSTY STUMPS SCALE MODELS

6785 Cherry Blossom W. Dr., Fishers IN 46038

Phone (317) 595-9489



## Interested in O Scale?

THE

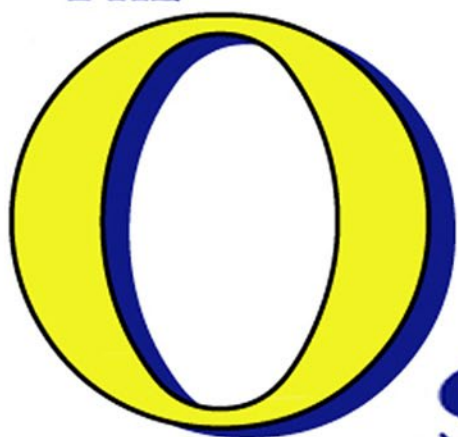

# SCALE

# RESOURCE<sup>®</sup>

[www.oscaleresource.com](http://www.oscaleresource.com)

Listings of O Scale manufacturers, dealers, and suppliers.



contents



index



**24: The helper crew ran their 2-10-2 around the hack in Mill Bend before coupling to the rear of SAHW.**

**25: The Salem Hauler is long! The helper is next to Paul while the lead unit is up along Roberts Creek next to Joe Fugate in the distance. Long trains with helpers are fun!**





**26: Made it! The cab forward leading train SAHW hits level track in Oakhill. The helper will cut off and return to South Jackson when traffic permits.**

**I only run helpers when they are needed. I also prefer to use a second crew to man the helper. The coordination and skill required between head end and rear end crews to safely move heavy trains adds extra fun!**



The BC&SJ will be one of the layouts open for the [2015 Portland Daylight Express](#).

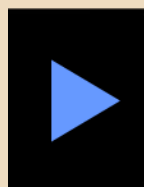

**Reader  
Feedback**  
(click here)



[← back to previous page of text ...](#)

installed and thoroughly tested before they're covered by the main level track work on the peninsula. The main level plans include:

- Bear Creek yard – the main yard on the layout. This yard will dwarf South Jackson and will have house track, depot track, main, two arrival/departure tracks, eight class tracks, a thoroughfare track, a separate empty car yard, ice platform for reefers, and a massive engine service facility. I anticipate needing a yardmaster, two switch crews, and a motive power hostler in Bear Creek.
- Junction City – a switching area including industrial spurs.
- Albany Junction – a town on the Toledo branchline.
- Browning – an agricultural center town area.

Other high-priority tasks are getting the South Jackson turntable installed and operating, and working on the main level of the peninsula. Somewhere in there a full height backdrop needs installation, too.

Wahoo! I can't wait, but there's one heck of a lot of work to be done before the Bear Creek has its golden spike ceremony and we get to start full operations.

[Click here to download the BC&SJ trackplan.](#)

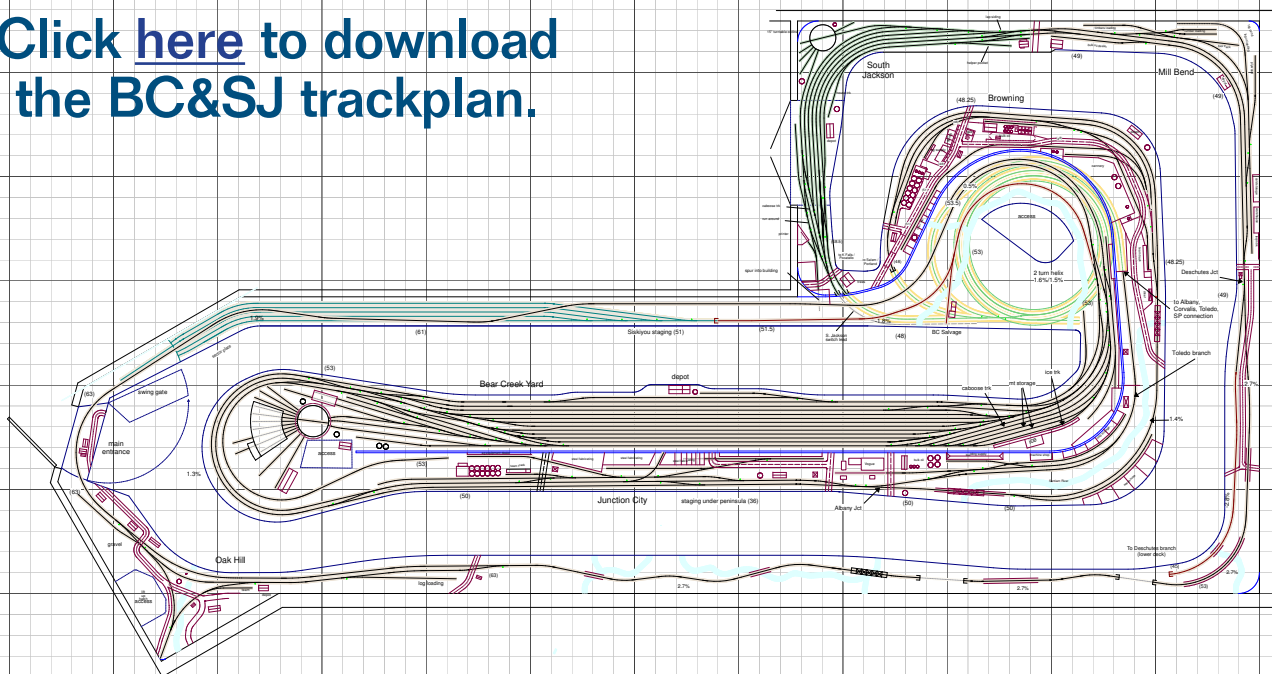

contents



index



# EXACTRAIL<sup>®</sup>

The Next Generation of Model Railroading



**LEARN MORE** 





# SERIOUS FUN™



**GREAT PRODUCTS**



**EXCEPTIONAL SERVICE**



## Great products. Exceptional service. Serious fun.™

Find products from over 100 model railroad companies at [HorizonHobbyTrains.com](http://HorizonHobbyTrains.com). All the brands you love—Athearn®, Lionel, Bachmann and more—are right there. You'll also enjoy:

- Same-day shipping
- Our deal-filled Savings Station
- eGift certificates

Everything we sell is backed by the best customer service and support available. Our service center team is standing by to help you get the most from whatever you buy. At [HorizonHobbyTrains.com](http://HorizonHobbyTrains.com), we take having fun very seriously.

Visit [HorizonHobbyTrains.com](http://HorizonHobbyTrains.com). Exclusively Trains.



# HORIZON™

HOBBY TRAINS.COM

©2012 Horizon Hobby, Inc. All rights reserved. Athearn, Serious fun and the Horizon Hobby logo are trademarks or registered marks of Horizon Hobby, Inc. All other trademarks, service marks and logos are property of their respective owners. 36139

**Click to learn more ...**



# Enjoy Great Operation ...



**\$455.00 MSRP**

## Super Chief Xtra



**LoCoNet**

**Is The Digitrax Difference**

- Run Trains
- Sound
- Feedback
- DC Control
- Computer Control
- Lighting
- Turnouts
- Signaling
- Transponding
- Block Detection



...With **Digitrax**



**\$225.00 MSRP**  
**Zephyr Xtra**

***Free Digitrax Toolbox App!***  
*Easy to use tools to enhance your  
Digitrax experience!*

***For iPhone/iPad and Android***

**Download now @  
[www.digitrax.com!](http://www.digitrax.com)**





## Stayin' Alive

Reduce dirty track woes

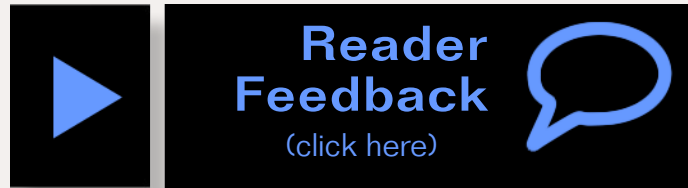

### DCC Impulses column

by Bruce Petrarca

## Keep minor track power disruptions from stopping your loco ...

**D**CC users have long been aware of the need for good continuity between the loco and the rails. Having the control signal and the motive power supplied together makes the track connection doubly important.

As I discussed last month, Lenz came up with a way to enhance the reliability of the DCC signal being received through dirty track. To my knowledge, no other manufacturer has adopted the Lenz Uninterruptible Signal Processing technology.

Ok, so let's look at the other side: keeping the loco moving. What keeps the loco moving down the track without applied power is stored energy. The most direct method to store energy is a flywheel. Once the flywheel is moving, inertia keeps it moving. A loco with a flywheel will run over "bad" spots that will stall a loco without a flywheel. This is, by

the way, the only energy storage option available for DC operation. You don't want a huge flywheel, even if you could fit one in the locomotive, as you would have a hard time stopping it when you want to.

## **What causes power dropouts?**

The most frequently discussed cause is dirty track or wheels. But this is not the only reason for loss of power.

You can't build a turnout without isolating the track somewhere or you will have a rail-to-rail short. These breaks can range from a few thousandths of an inch up to several inches. No matter how big or small the breaks, they are a dead spot. Some turnouts provide a way to connect most of the frog to external power, which can be switched, depending upon the direction of the turnout. While powering the frog will restore much of the lost electrical contact, there will still be an insulated area at each end of the frog.



**1: Insulated frog turnout – Atlas HO Code 83 #8**  
frog is insulated between the two black bands.  
Copper ring nearest the camera is provided to electrify the frog.



contents



index

Variations in track height can pick wheels off the track and disrupt power, as can out-of-gauge wheels or track.

The problem is enhanced if your loco doesn't have all-wheel power pickup. Sometimes the wire to a truck breaks, leaving those wheels not connected to the decoder. Some locomotives are designed with only a few wheels picking up power: for example, brass steamers, where the loco usually picks up from the right rail and the tender from the left.

## What about opposite rail pickup?

Personally, I recommend adding pickups to locos that are not designed for all-wheel pickup. Nothing beats having all the wheels bringing power to you. However, even then disruptions will happen.

Figure 2 shows what I did with an O-scale brass steamer to pick power off the drivers. The axles pick up off the right rail and keep the frame at the right-rail voltage. I installed a printed circuit board that was insulated from the frame of the loco and added phosphor bronze pickup wires to rub on the tires of the drivers. The tires were in contact with the rail, but were insulated from the rest of the wheel.

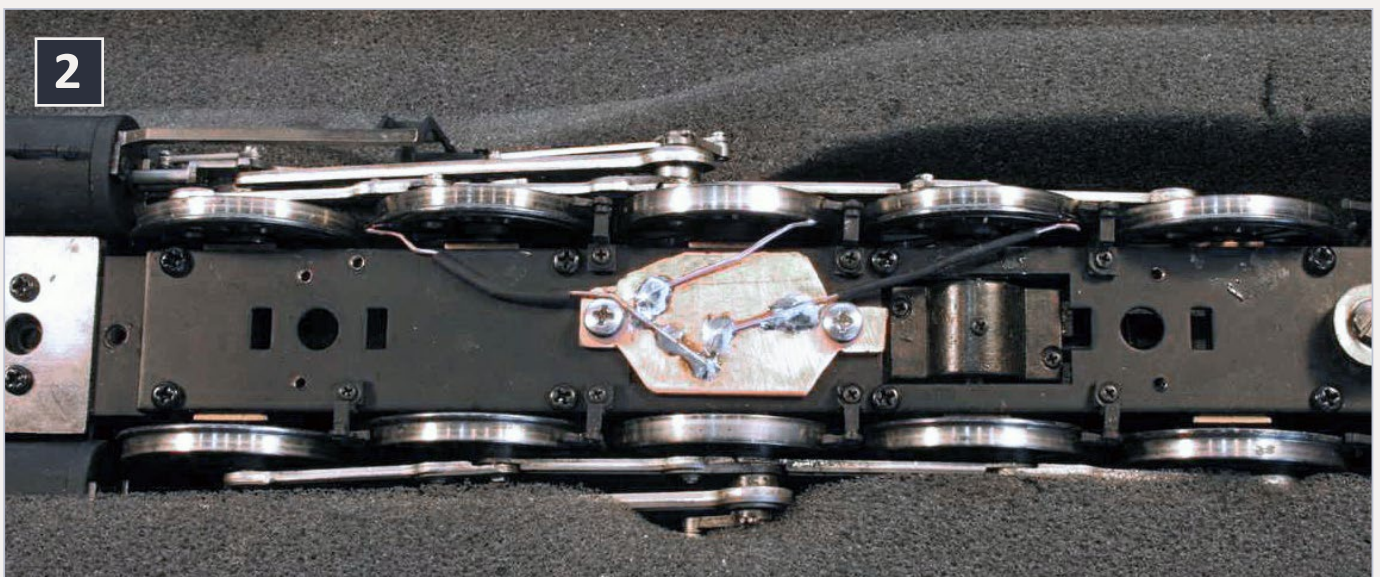

**2: Opposite rail track pickup added to an O-scale locomotive.**

As you can see, I didn't try to pick up off all five drivers, but just the middle three. The tender originally picked up off the left rail only. Similar wipers were added there to pick up off the right rail, too. These additions were enough to keep the loco running smoothly without adding any energy storage.

Enhancing the contact points on your loco is always a good thing, in my mind. Once the loco itself is as good as it can be, then it is time to look at onboard energy storage.

## **Evolution of decoders and NMRA recommended practices**

Before sound, decoders had pretty simple power supplies. There was a bridge rectifier to make the DCC waveform into DC and a small filter capacitor to smooth the DC out and, perhaps, a small capacitor to suppress the spikes coming from the DCC waveform. Energy storage was left to the flywheel, just like in the DC world.

Then along came sound decoders. Early versions had a bit more storage in the decoder to keep the sound processor running when the track voltage varied a bit, but nothing fancy.

Manufacturers began to realize that, when the processor ran out of power, the result was not realistic. While the flywheel kept the loco moving, a diesel, for example, might go through the start-up sequence while running down the track. UGH!

The manufacturers responded by added slightly larger storage capacitors to their sound decoders. SoundTraxx, for example, even provided a way for modelers to add a capacitor to their venerable DSX series of sound-only decoders ([mrdccu.com/curriculum/soundtraxx/dsx.htm](http://mrdccu.com/curriculum/soundtraxx/dsx.htm)).

Even the few hundred microfarads ( $\mu\text{F}$ ) that were used early on exceeded the NMRA recommended practices for the programming track. A change to RP-9.2.3 in 2006 relieved some



contents



index

of the programming track issues and created a new market in Programming Track Boosters ([mrdccu.com/curriculum/ptb.htm](http://mrdccu.com/curriculum/ptb.htm)) to interface older command stations with decoders that meet the new RP.

Some boosters see the increased in-rush current drawn by the larger capacitors in the sound decoders as a short and shut down, sometimes refusing to restart until the loco is removed. The use of circuit breakers designed for sound locos, such as the PSx series, can frequently fix this.

But modelers continue to demand smoother operation. So, let's look at how to get additional energy storage in your locos. Like other things in life, there is no single answer that fits all and changes have consequences.

## **Do I need special decoders?**

The basic answer is “no”. However there are some issues.

To add any form of electronic energy storage, you need access to both the decoder positive and negative leads. Positive is easy, as it will be the function common. This is the blue lead, assuming the decoder meets NMRA Recommended Practices in color selection.

Most non-sound (and even some sound) decoders don't bring out the power supply negative lead, as I discussed last month ([mrhmag.com/magazine/mrh-2013-02-feb/di\\_anatomy-of-a-decoder](http://mrhmag.com/magazine/mrh-2013-02-feb/di_anatomy-of-a-decoder)). If you are intent upon adding electronic energy storage to one of these decoders, you will need to bring out that negative lead yourself. Please understand that these modifications will void your warranty. Marcus Ammann has a wonderful page on his web site dedicated to finding the negative lead ([members.optusnet.com.au/mainnorth/alive.htm](http://members.optusnet.com.au/mainnorth/alive.htm)). The negative lead is shown in green in figure 4.

[... On to next page of text →](#)





# PARAGON

S E R I E S



PRR T1  
AS DELIVERED, HO

All  
TOOLING  
New

## THE MUST-HAVE MODEL OF 2013

for the pure Pennsy steam collector arrives **MARCH 29. PREORDER NOW!**

**CLICK HERE**

for your FREE  
2013 PRODUCT  
GUIDE!

NOW AVAILABLE! | GET YOUR COPY TODAY!



SIGN UP TO  
**WIN!**

You could win the diecast N&W Y6b  
in HO scale when it arrives this spring.  
Simply enter your email address to enter!

**Enter to Win!**

BROADWAY LIMITED IMPORTS



# Get Better Sound from your Locomotives

Can't get a good sound from your sound decoder?  
Give our speakers a test drive with your ears.



**RAILMASTER HOBBIES**  
**9815 WALNUT ST #106**  
**BELLFLOWER, CA 90706**

Bass Reflex  
Speakers



High Bass  
Speakers



When it comes to speakers we have high quality speakers to fit many different applications. We are also a full line hobby shop. Need anything? We are an authorized dealer for Soundtraxx, Digitrax, Athearn, Walthers and many others. We provide quality speakers for your DCC sound systems and quality service.

**Click here for  
the *sound* answer ...**



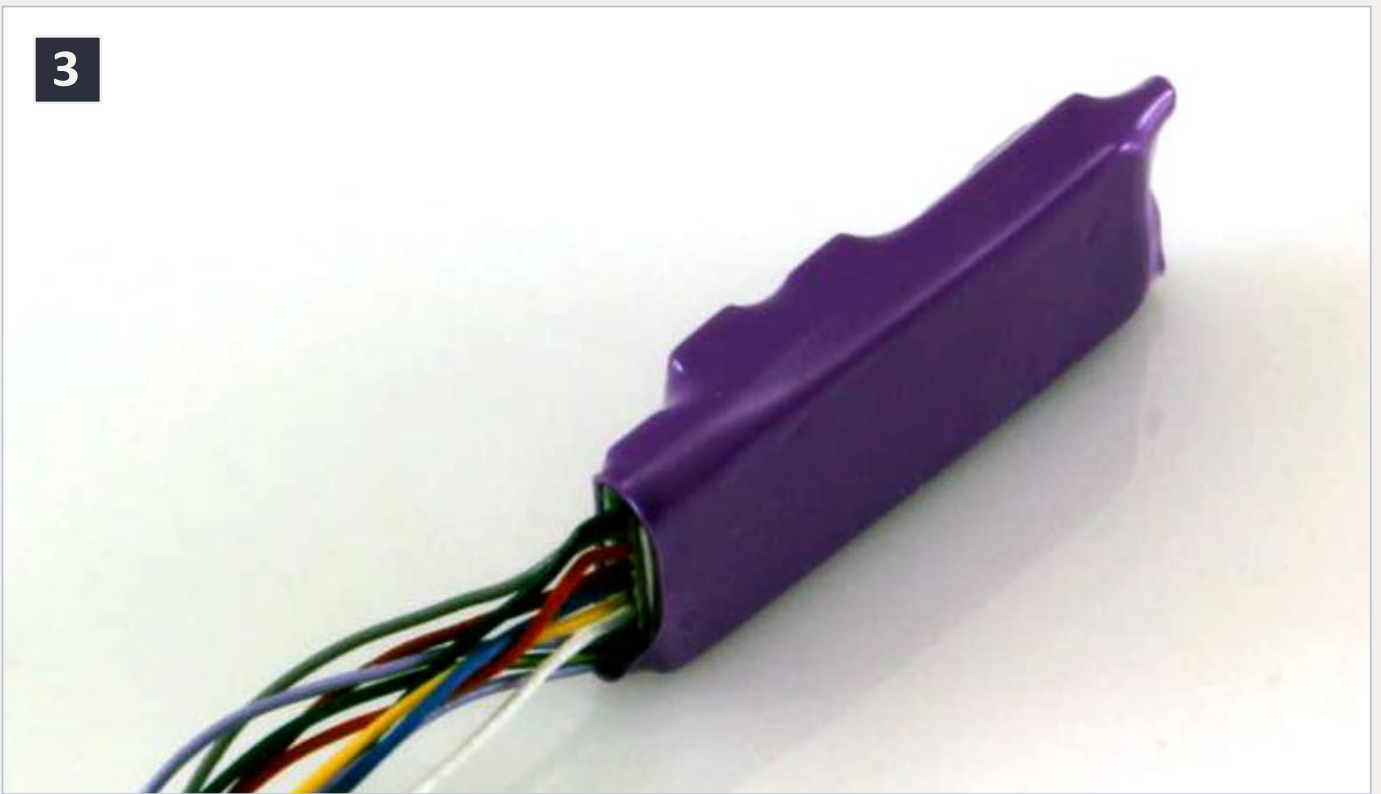

### 3: Decoder with internal heat sink - SoundTraxx Micro Tsunami TSU-750.

[← back to previous page of text ...](#)

I'll have some recommendations for connections to specific decoders later in this column.

A decoder with an internal heat sink will have a very flat side as shown in figure 3. Removing the heat shrink from these decoders will dislodge the heat sink. Once the heat sink is loose, it is beyond the scope of most modelers to get it back well enough to prevent damage to the decoder. I recommend against opening decoders like this. Fortunately, many decoders of this ilk already have the negative lead brought out.

## Kinds of energy storage

Since most modern models have just about maxed out on flywheel storage, there is probably little to gain here. However, if your model doesn't have a flywheel or two, I'd recommend adding one or two, if possible. Test the resulting loco before looking at electronic energy storage.



# Capacitors

Frequently I hear: “Well, if 220  $\mu\text{F}$  comes with my decoder, why not add another 10,000  $\mu\text{F}$ ? I’ve got the room.”

This approach is effective and inexpensive. I recommend the circuit in figure 4. It is slightly more complicated than just adding a big capacitor in parallel with the existing ones. It adds a resistor and diode to the mix. Why? The resistor limits the inrush current, reducing the load on the DCC system. The diode bypasses the resistor when the track voltage drops so the capacitor can supply power to the decoder.

Here’s how to select the components for figure 4.

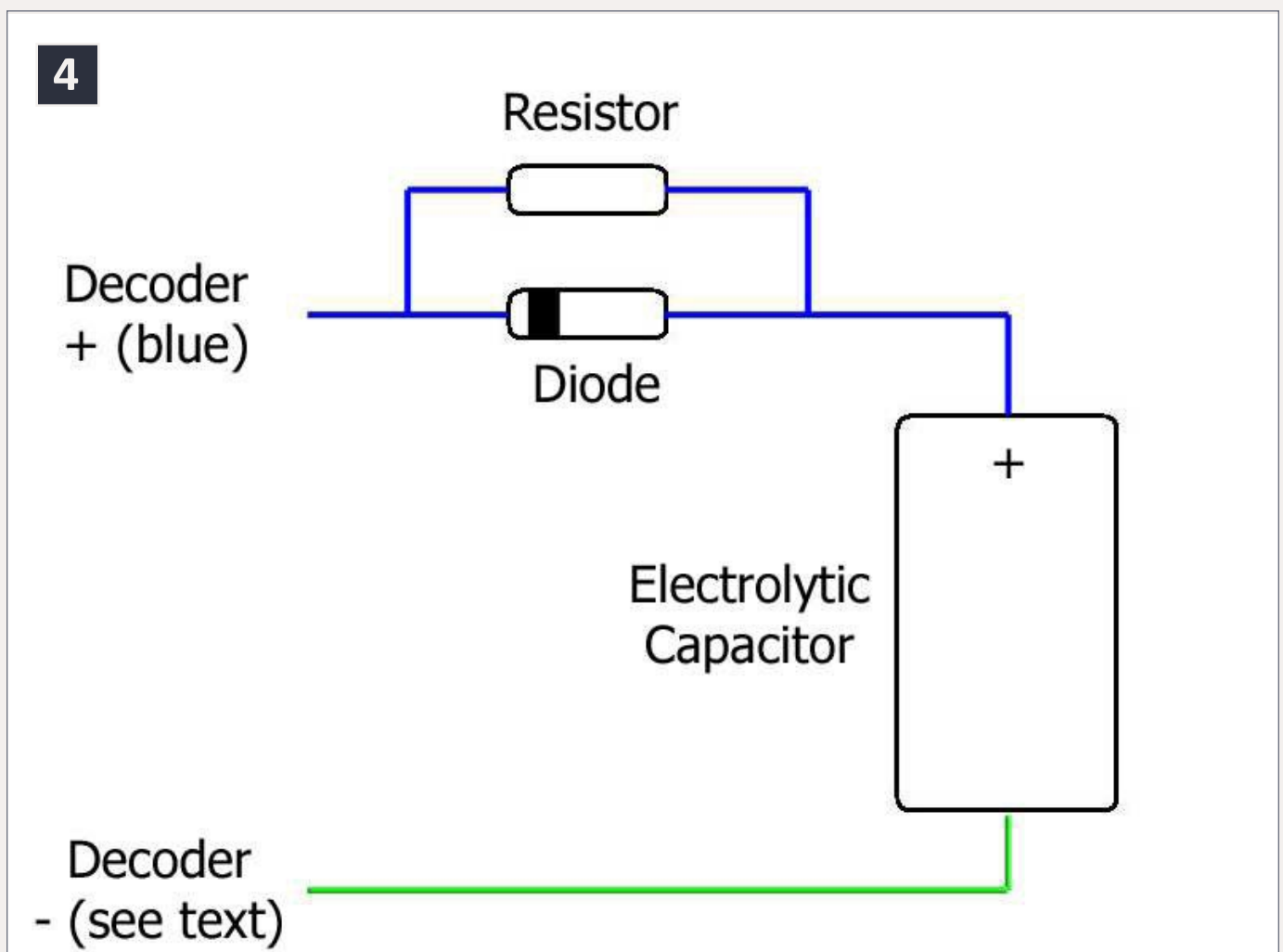

**4: Circuit to add more capacitance to any decoder**  
**See text for component values and connections.**

NMRA DCC standards allow track voltage as high as 27 volts for scales larger than N and 24 volts for N scale decoders. Thus, the capacitor should have a working voltage of 35 volts or higher to fully comply with the standards, especially for O and G scales. I find that most folks run their smaller scale track voltage in the teens and can get by with 25-volt capacitors. Size and cost both go up with working voltage. There is a compromise.

The “capacity” of the capacitor is measured in microfarads ( $\mu\text{F}$ ). The more microfarads, the more energy stored. I usually find 2200  $\mu\text{F}$  to 4700  $\mu\text{F}$  the most useful range.

If you need, say 1000  $\mu\text{F}$ , and a capacitor that size won't fit into your space, look at several smaller capacitors. In this case, two 470  $\mu\text{F}$  capacitors wired in parallel will give you about 1000  $\mu\text{F}$  and may have a more manageable form factor. Be sure that you keep the polarity consistent (wire all the + leads together and all the – leads together). Insulate your connections.

The resistor should be  $\frac{1}{2}$  watt with the value determined by the size of capacitor.

Capacitor Value	Associated Resistor Value
Up to 2200 $\mu\text{F}$	100 ohms
Up to 4700 $\mu\text{F}$	220 ohms
Up to 10,000 $\mu\text{F}$	470 ohms

The diode should have a working current rating equal to or larger than the decoder's current rating. Its voltage rating should be 30 volts or higher. For common 1-amp decoders,



contents



index

the 1N4001 diode is just fine. Frequently I order 1N4001 diodes and actually get 1N4005 or some such. Don't worry. The 1N4001 is rated at 100 volts. As the last number gets larger, so does the voltage rating. Overkill here doesn't cost either in money or size.

If you need more than 10,000  $\mu\text{F}$ , I recommend the Keep-Alive™ from TCS instead of larger electrolytic capacitors.

## Keep-Alive™ from TCS

Train Control Systems recently introduced two Keep-Alive™ modules that store way more energy than the simple circuit from figure 4.

They claim that the KA1 (about \$25) will keep an HO-scale locomotive at speed step 10 (out of 128) running for 2 to 5 seconds with the headlight lit. Under the same conditions,

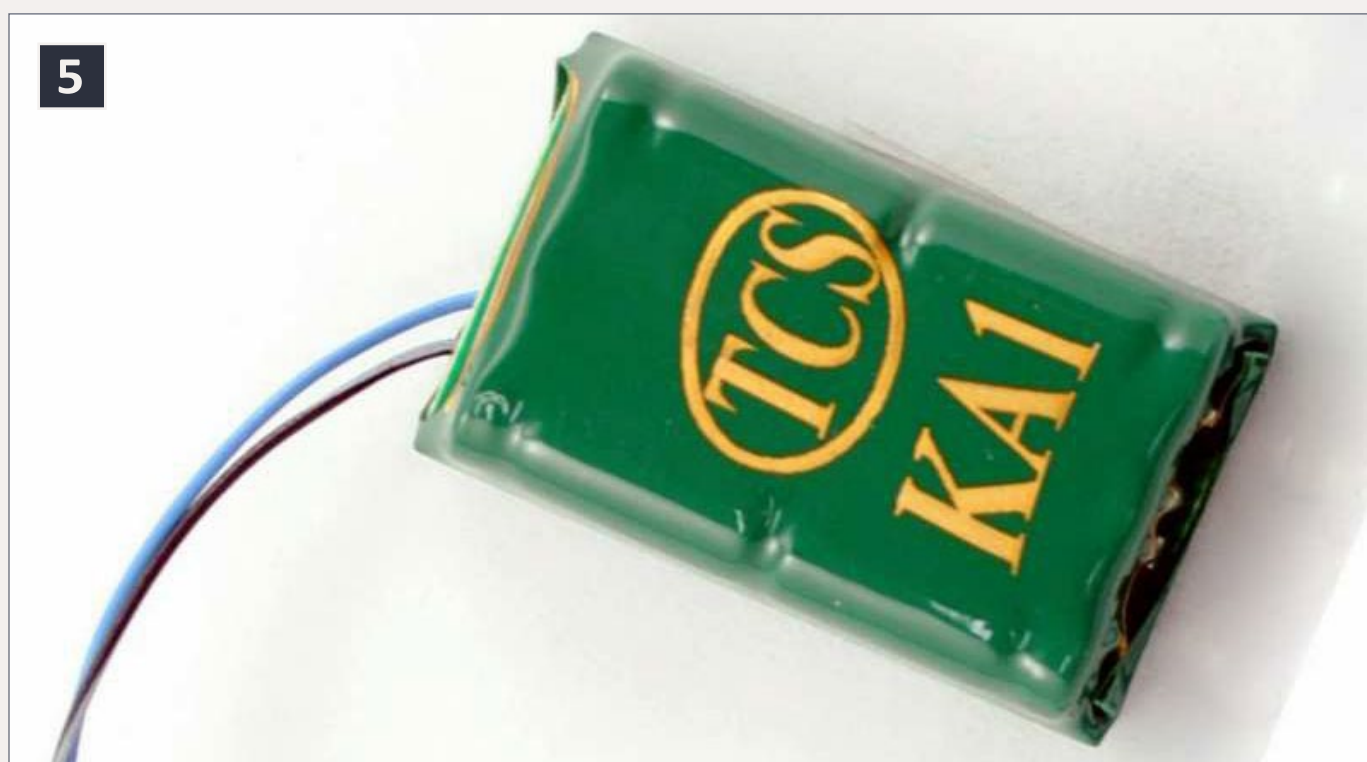

**5: KA1 Keep-Alive™ Module, about the size of typical HO-scale decoders. Photo courtesy Train Control Systems.**



**Playback problems? [Click to try a different version.](#)**

**6: Keep-Alive™ video: A TCS KA2 module in an HO loco with a SoundTraxx Tsunami decoder – running on the PCMRC layout.**

they suggest that the KA2 (about \$40) will keep going for 6 to 15 seconds. That would indicate that the KA2 has three times the energy storage. My rough testing seems to bear these numbers out.

So, I decided to test them out on our most finicky locomotive at the PebbleCreek Model Railroad Club ([pcmrc.org](http://pcmrc.org)). This loco is a Proto 2000 RS27 that originally had a QSI decoder. It was changed out for a Tsunami about 5 years ago. We had tried to use the RS-27 in our large Hammond, IN, yard, but it continuously stumbled on the Atlas code 83 #6 turnouts. The addition of a Tam Valley Depot Hex Frog Juicer to power the frogs helped, but didn't eliminate stalling.

For this test, I disconnected the power input to the Hex Frog Juicer board, giving totally dead frogs. The video in figure 6 starts with the loco stalled on a turnout and only responding



after a couple of nudges. I took the loco home and removed the shell. I then disconnected the SoundTraxx external capacitor and connected a KA2 to the capacitor black (power supply negative) wire and the blue (power supply positive) decoder connections. I taped the KA2 down on the loco with double sided tape for a quick check. I let the loco rest on powered track for a few minutes to assure that the KA2 was charged up. The second segment of the video shows the loco running smoothly through the yard ladder. After resting a bit more to assure a full charge, I shot the third segment of the video where I removed the running loco from powered track and set it on plastic running beside the track. It ran about a full loco length on plastic – no power applied. When the charge in the KA2 was depleted, the loco stopped gracefully and the sound quit. Nothing dramatic.

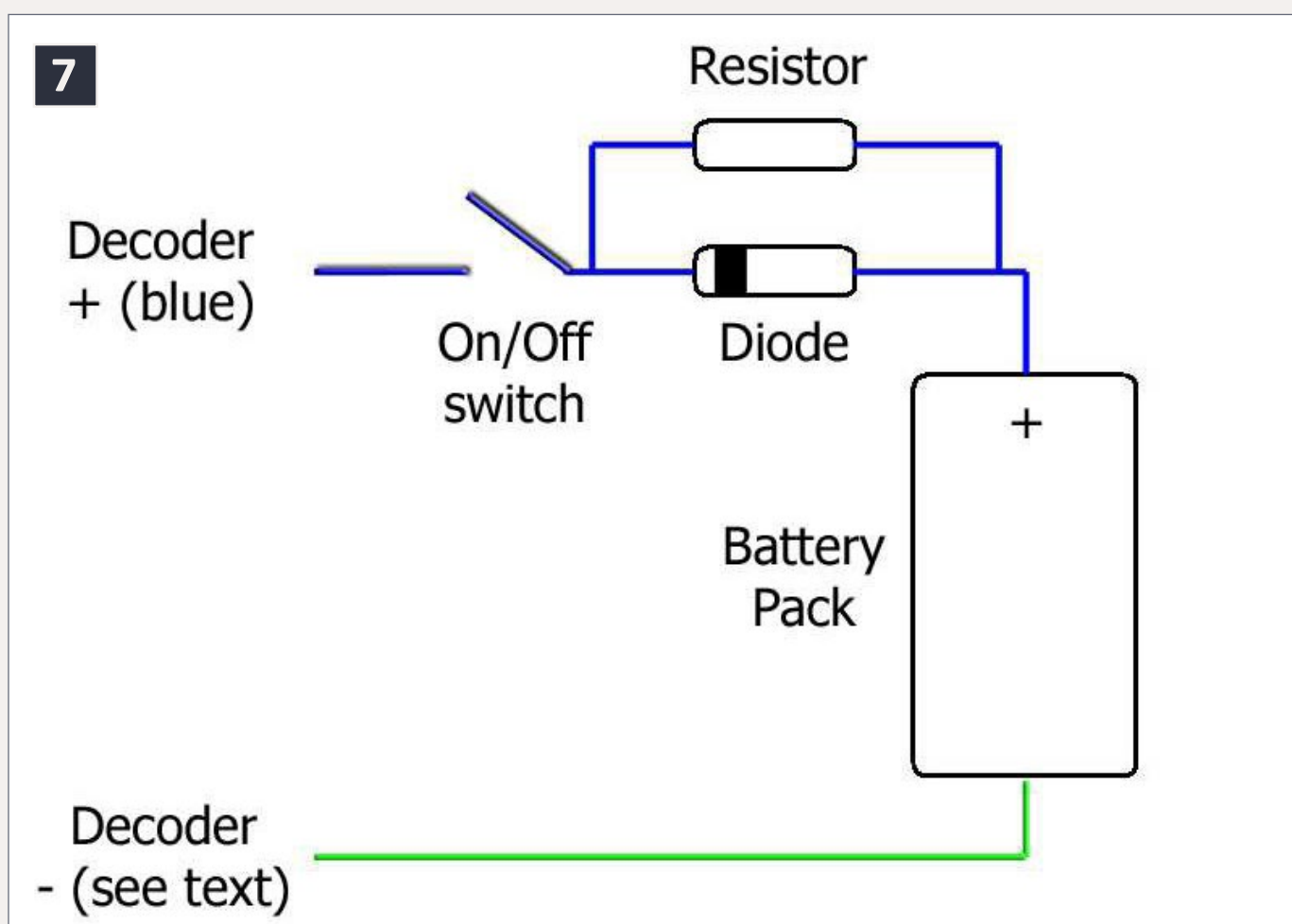

**7: Hybrid Drive Circuit diagram. Connect it just as you would a capacitor.**



The TCS literature tells the installer to set CV182 = 2 on TCS decoders. I called TCS and talked with JD about that. TCS has a “stop on DC” mode enabled by default. That is, if a TCS decoder sees no DCC waveform, but has power to run, it assumes that it is on a DC section and will stop. Well, that’s exactly what it will see with track power dropout and a KA module connected. Setting CV182 will override that condition for TCS decoders. JD confirmed that KA modules have been used on almost every sort of decoder with no ill effects. CV changes were only needed on decoders made by TCS.

There have been reports of the KA2 units taking so long to charge up (several minutes) that they would prevent the decoder to which they were attached from being programmed on the programming track. Either program on the main (remember, no read back on the main) or disconnect one wire of the KA unit when programming. I have had no problems reading from, or writing to the RS27 shown in the video with the KA2 connected with my PowerCab.

What’s in one of these modules? The heart is a bunch of Super Caps, as I discussed in my December 2012 column ([mrhmag.com/magazine/mrh-2012-12-dec/di\\_basic-electronics-for-dcc](http://mrhmag.com/magazine/mrh-2012-12-dec/di_basic-electronics-for-dcc)). They are low voltage, requiring about five to make up DCC track voltage. The module also has the necessary electronics to prevent over-voltage from damaging the capacitors. They will not stand being hooked up backwards, so be watchful with your wire colors.

Multiple KA modules can be connected in parallel for even greater storage capacity.

The only caveat I’ve seen is most important to large-scale users. Although they will stand any input voltage allowable in the NMRA standard, their output voltage when supplying power to the decoder will be about 14 volts, maximum. So, if you are using a KA on a layout with the track voltage set for



contents



index

18 volts, there may be a noticeable reduction in speed and light level when track power is interrupted.

I'll be trying the KA2 on my Fn3 locomotives on the brass-tracked Rocky Mountain Pacific ([mrdccu.com/layouts/RMP.htm](http://mrdccu.com/layouts/RMP.htm)). I'll report back later.

Thanks to Jack of Litchfield Station for the Keep-Alive™ modules for this column.

## Hybrid drive

Stan Ames, one of the founders of the NMRA DCC committee, pioneered a hybrid of track power and batteries to keep the locos running on his Fn3 layout many years ago.

This technique is most useful in garden railroading where there is enough room for a pack of AA or so rechargeable batteries and the on/off switch.

You will notice that it looks very much like the capacitor circuit, except that there is an on/off switch. Since batteries will hold more energy than even the Keep-Alive™ module, the switch is needed to prevent unneeded discharge of the batteries. It can be mounted in the bottom of the loco. Just throw the switch and run your loco on track DCC power. When you are done, switch the battery pack off. If you forget and leave it on, there will be a long charge-up time before you will have full energy storage the next time.

Stan also has a circuit, using a relay and a transistor to automate the turn-off. This way, no external switch is needed.

Hybrid drive allows the loco to run on track with a lot more dropouts than even the KA modules. It also allows you to add more cells to the battery to match higher track voltages. Since

[... On to next page of text →](#)

# From Train Set To Club

## NCE Covers ALL Your DCC Needs



**NEW**

### DCC Twin

Includes power supply - Use Optional Cabs  
- Perfect for Train Sets -

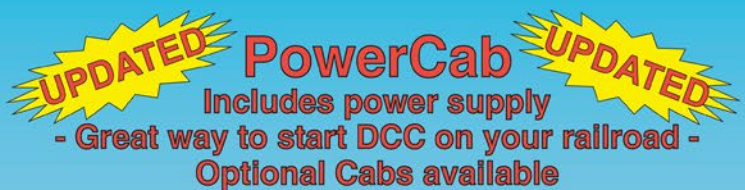

**UPDATED**

### PowerCab

**UPDATED**

Includes power supply  
- Great way to start DCC on your railroad -  
Optional Cabs available

### SB5 Smart Booster

**NEW**

5 Amps - Six Optional Cabs  
Includes Power Supply

### PH Pro

- 5 Amps of power for Z, N, HO, S Scales -  
Optional Cabs

### PH Pro R

- 5 Amps of power for Z, N, HO, S Scales -  
Optional Cabs  
Wireless Operation

### PH10

10 Amps of power for  
O and G Scale layouts

### PH10 R

PH10 with Wireless Operation



585.265.0230  
9am-4pm EST.  
[www.ncedcc.com](http://www.ncedcc.com)



Call or Email  
for FREE Brochure  
[support@ncecorporation.com](mailto:support@ncecorporation.com)



Look for these **NEW NCE PRODUCTS** at your local dealer



PB5 - New version 5 Amp Booster  
Includes power supply

UTP-CAT5 Panel  
Use common CAT5 cable  
to hook up your Cab Bus



NCE Corporation builds products in Upstate New York - Right here in the U.S.A  
We build our products to the NMRA Standards and Recommended Practices where applicable



# SOUNDTRAXX

STATE OF THE ART MODEL RAILROADING  
SOUND SINCE 1990

**NEW!**

**TSU-AT1000 Cummins  
QSK19C x3 for NRE  
GenSet Locomotives!**

**Tsunami**®



**Click to listen!**

For lots more, visit our website at ...

**SoundTraxx.com**

**Read  
our  
blog**



[← back to previous page of text ...](#)

this technique is aimed at a very limited audience, rather than spend more time here, I refer you to Stan's web site ([tttrains.com/dcc/hybriddrive](http://tttrains.com/dcc/hybriddrive)).

## Can you overdo it?

Just like the overly large flywheel would store so much energy that controlling the loco could be problematic, you can have too much on-board electronic storage.

Capacitors will run a loco without applied power for a second or so. Keep-Alive™ modules will work for several seconds. Hybrid drive can run for minutes.

If your loco derails, you will have no DCC signal getting to the decoder. So hitting emergency stop or dialing the speed to zero won't make any changes in the loco's speed.

Consider how far you want the loco to run without power and select your energy storage accordingly.

If you, or your guests, frequently run locos on the ground, you may want to go the low end of energy storage, at least to start. That way, even though you may still have a stumble or two, you won't drag a complete train across the layout on the ground.

## Where do I connect to my decoder?

Due to some variations in internal decoder design, you cannot get consistent results by connecting an energy storage system in parallel with an external capacitor. Here is where to hook them up on various decoders.

Many open-board decoders today are marked as to power supply positive and negative. Use these contacts, if available. Just



contents



index

connect the positive of the energy storage system to the plus terminal (labeled things like V+ or +14V) and the negative terminal to the minus terminal (labeled things like V- or GND or the ground symbol). I suggest testing with a voltmeter before you connect your module. Look for correct polarity and a voltage a couple of volts below your selected track voltage.

For SoundTraxx wrapped Tsunamis:

- TSU-1000 –connect the positive from the energy storage system to the blue wire, and connect the negative to the capacitor black wire, not the black track wire. If you connect the system where the external capacitor was connected, you will only store energy for the processor and amplifier.
- TSU-750 – Connect the energy storage system to the blue and yellow/green wires, just as the instructions show for the external capacitor.

For TCS decoders – observe the color code – TCS is consistent throughout their product line. If the decoder has a black/white stripe lead, that is your power supply negative. If the decoder doesn't have a black/white stripe lead, there is no power supply negative brought out. I don't recommend digging into the decoder to find the negative. But that's your choice.

Digitrax sound decoders – just connect the energy storage in place of the external capacitor.

I know this list isn't comprehensive, but it should lead you in the direction you need to go. When in doubt, dig out the voltmeter and test.

Until next month, I hope that you have green boards. If you liked this article, please click on the Reader Feedback icon and rate it awesome. While you are there, join in the discussion of this column. Thank you. 

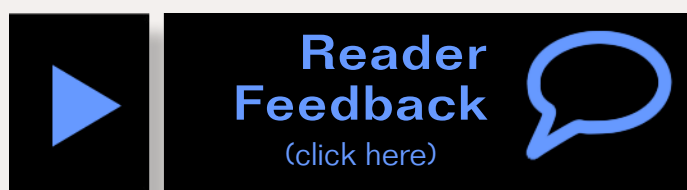

**Can't remember  
what issue of MRH  
that article is in?**

**Have you checked  
the online index?**

**Click here to learn  
more ...**

*Advertisement*



**A well  
juiced  
frog is a  
happy  
frog**

**Click here to keep your  
trains rolling with our  
Frog Juicers...**

***TamValleyDepot.com***

**Please use  
the email  
and phone  
buttons on  
ads to contact  
advertisers,  
and please  
mention MRH.**



contents



index

# From Mr. DCC's workbench

## – The best DCC tester

I recommended this to a customer. After he used it, he eMailed me, “That’s the best DCC tester I’ve ever seen.” So, I had to share it with my readers.

It doesn’t come from a hobby store.

Look at your auto parts store or online for an “automotive 12 volt tester”. The one my customer bought was about \$3 from Harbor Freight, as shown in the photo. I’ve even found them at “dollar” stores.

They are the cat’s pajamas for sorting out dead frogs and track wiring errors. Clip to one track and probe the opposite track for power.



Checking out power district or auto-reverse section wiring? Just clip to one rail at the district boundary and probe the two rails on the other side of the boundary. It will light when you have opposite polarity between the two sections.

Want a quick check of a function output on a decoder? Clip this between the blue lead and the white (or whatever function you are testing) lead. ■



# Railroad Explorer Magazine

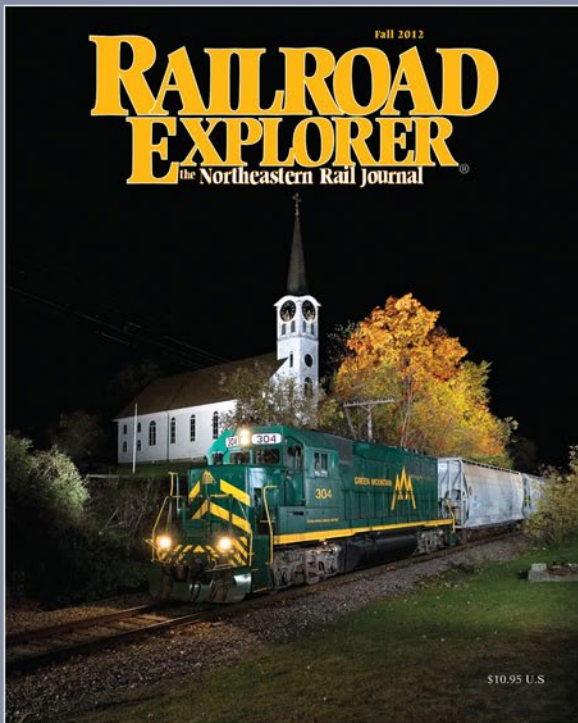

- Three, all-color issues per year.
- Exciting feature stories, spectacular photos.
- Best-in-class photo reproduction.
- Printed on heavy, glossy paper.
- Zero advertising. All content.
- Winter, Spring/Summer and Fall editions.

## Issue 36 - Fall 2012

### On sale now

# Subscribe Today!

[www.railroadexplorer.com](http://www.railroadexplorer.com)



# END OF TRAIN DEVICE



**Bright Red Flashing Light!**

Installs in minutes with no freight car modification required!

**RE RING**  
ENGINEERING

Patented Technology - US Patent 7,549,609

**Does not affect Load!**

↓ Car without Load ↓

↓ Car with Load ↓



For video and more click here!





# Southern Digital

Specializing in DCC Since 1992



**20% Discount  
on most Items!**



## DCC Conversions & Service

### WWW.SODITI.COM

(770) 929-1888

*(Photo's are from our N-Scale layout)*



contents



index



# Course Correction

A place to build realistic models



## Getting Real column

by Marty McGuirk

### How I ditched the upper deck and learned to love my layout again ...

**H**ave you ever gotten started on a project, at work or on the modeling bench, only to realize the results just aren't going to meet your expectations? That's a little bit like the way my HO scale home layout, which has the somewhat grandiose (but descriptive) moniker of "The Winooski Subdivision of the Central Vermont Railway" has come to be. It's certainly been a journey, somewhat painful at times, but the results are, at long last, meeting my expectations.

The railroad as it sits in our basement at this moment is considerably different than the one I spent hours sketching while waiting for our home to be built. Perhaps I rushed into the building process too soon – (I remember "sketching" the outline of the benchwork with a stick in the dirt before the basement floor was poured!) Make no mistake about, building a large home layout is an involved, costly, and sometimes overwhelming project and should not be entered into lightly.

When we moved into this house in 2008 long-distance moves and career changes meant it had been several years since I'd had a large home layout. Over the years, I've witnessed several of the hobby's premier practitioners, many of them friends of mine, complete their highly successful "lifetime" layouts only to tear them down and start building anew. Their stories are exciting and I follow their progress in the press and on the web, still awestruck that they've razed their old-and-famous pikes, only to start over..

Those are the good news success stories. Less heralded are stories about stillborn layouts, layouts that are torn out before they reach any form of "completion." This is my story. My layout was designed to get as long a mainline as possible into the space.



**1: A Central Vermont N-5-a class 2-8-0 (converted from a Bachmann 2-8-0) leads a Canadian National C-Liner across the bridge at Williams Creek on the author's HO scale CV Winooski Subdivision.**

Ninety percent of the layout was double-deck, a construction approach that dominates the layout design press these days. My story is about how, two years into the project, it became all too clear that I'd created not only a great layout for someone else but a monster that wasn't working for me. The story is about frustration, indecision, and soul-searching, and ultimately the course needed to bring about a happy ending.

## **The space**

All discussions of layouts must start with a discussion of the space – after all, we can choose any theme we'd like, but ultimately the walls of the layout room determine, more than anything other factor, the basics about the layout.

Although not the biggest model railroad I've ever seen, this layout is certainly the largest I've ever attempted, occupying a 16 x 45 foot area along one side of our finished basement. And "finished" is the key word – the room has sheetrock walls, recessed lighting, and wall-to-wall carpeting. I was even able to leave one side of the basement as the designated "crew lounge" area.

After years of dreaming and planning, this at last was going to be my "dream layout." Ah, the dream layout, – you know the one I'm talking about – the layout all model railroaders know we have in us, a memorable "tour de force" – a true masterpiece of the model railroading art – albeit in our own eyes.

## **Shifting focus**

Back in Model Railroad Planning 2000, my friend, well-known British layout designer Iain Rice and I relayed the story of how my prototype-freelanced Southern New England Railway had come to be. I built a second SNE layout when we moved from Wisconsin to Colorado. When we moved to Virginia I saw no



contents



index

reason I shouldn't continue with my prototype-freelanced railroad. SNE #3 was a small switching layout along two walls in the basement of a rented townhouse. And, once we started building a new house I looked forward to SNE #4 – which I felt would be the ultimate version of the theme.

I've covered the "whys" of the SNE in other articles, so I won't belabor them here. Suffice to say, one of the things that appealed to me about the SNE concept was it gave me a chance to "fix" a few things that I found unappealing with the southern half of the prototype Central Vermont Railway (my favorite railroad). Some of the issues I felt needed fixing included increased passenger traffic (the CV's southern division didn't have much, if any, and I wanted some), interesting station buildings, and greater traffic density, since that's what all the "experts" told us back then – you have to run lots of trains in a session lest your operators get bored and never return.

On a practical level, the SNE allowed me to use inexpensive off-the-shelf plastic steam locomotives to create a workable fleet for the layout without the need to obtain hard to find and pricey imported brass CV-specific steam engines (that I couldn't afford at the time, even if I could have found them!)

## Getting Started

We moved into the house in June 2008, and I found myself with a wonderful layout room, and a considerable number of landscaping and other "new house" chores. So I didn't start construction until December 2008. The layout's footprint looked like Figure 2.

The long peninsula in the center of the room, and the section of the layout along the wall to the right side of the drawing were double deck in an effort to get as much mainline run as

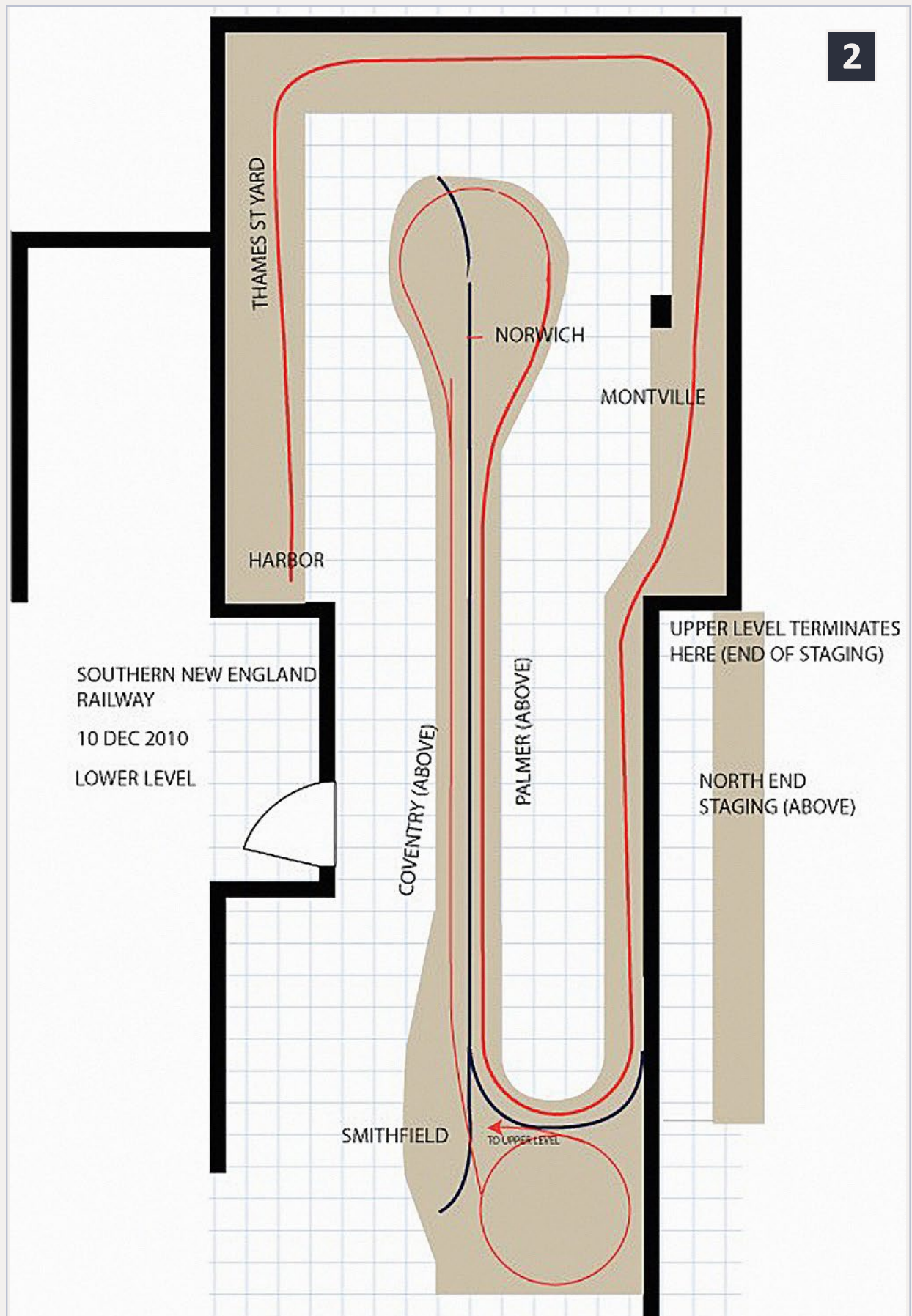

**2: Original layout footprint.** The details of the track are not shown here. Studying this drawing, with the “after” drawing will reveal several of the issues the author had with the layout configuration as outlined in the text.



possible into the space. Plans called for adding a second deck around the remainder of the layout, but it was never built.

By mid-summer 2009 I'd built the benchwork, including a helix, and laid and wired the vast majority of the track. The result was a layout with a mainline length slightly more than five scale miles. By February 2010 I was ready to put the layout through an early test "open house" session. This was the first time I'd had more than three or four people in the layout room at one time actually running the trains. I relayed the story of that "Sea Trial" session, as we called it, in the May/June 2010 issue of MRH .

Mechanically, "SNE 4.0" operated fine, with only a few small, easily corrected glitches. But during that test session and on several occasions over the next few months when more than a couple of people were in the layout room at once, more serious issues with the design reared their ugly head, and I grew increasingly uncomfortable with my creation.

My wife could tell something was wrong since suddenly I wasn't spending every waking hour in the basement. I wrote off this lack of activity to some sort of modeling funk brought on by a big push to get the layout ready for that first test run. But it became apparent to everyone, including me, that this was no mere case of model railroading blahs. With input from good friends and lots of soul searching I put everything – scale, gauge, and prototype, on the table.

In retrospect, I'd say the layout had gotten away from me. I'd succeeded in getting a plenty long mainline into the space, but it otherwise it was too big, too complicated, and, perhaps most importantly, too wrong, for me. I suppose I could have continued with the current layout just to be bull-headed (one





friend joked my headstone could feature the epitaph “Here lies a model railroader who stuck with it”) but what would be the point of spending time, effort, and money to build a layout that I didn’t find truly satisfying?

## **Prototype CV or Freelanced SNE?**

There’s no better fuel for the model railroad Internet to erupt into an all-out flame war than the “prototype vs. freelance debate.” Suffice to say the prototype freelancing concept works, and I certainly enjoyed it. It made it possible for me to model a steam-era railroad on a fairly limited budget. I simply wanted to do something a little more prototype specific this time around.

---

**“A prototype-based layout, especially on a relatively seldom-modeled road like the CV, will be a one-of-a-kind unique creation.”**

---

I will add one cautionary note for any of those freelancers who are still reading. A prototype-based layout, especially on a relatively seldom-modeled road like the CV, will be a one-of-a-kind unique creation. However, with the quantity, and quality of product available today you run a real risk with any type of “freelancing.”

When faced with a large layout to populate with everything from rolling stock to structures, I fell into the trap of purchasing commercial products that look “close,” or were “good enough for now” – even if they really look nothing like their full-sized New England counterparts. The risk is the resulting layout soon looks like another version of everyone else’s.

Not this time. Focus is my new watchword. If it isn’t appropriate for the time and place I’m modeling on the chopping block



contents



index

it goes. Through this process I've learned a lot about the resale value of model railroad items. It's an expensive lesson, one I'm continuing to learn as I rent tables at train shows and upload no longer appropriate items to sites like eBay.

## **Traffic flow and other considerations**

One option I seriously considered was replacing the freelanced SNE with a prototype CV layout without changing the layout itself. The SNE was close enough to the CV's southern division that I could have simply changed the town names and gradually replaced the kit structures and the like with scratchbuilt prototype models.

About this time I stumbled across the Rapido Osgood Bradley "American Flyer" style coaches in the hobby shop. I knew that, aside from excursion service in the late steam era on the CV's southern division in Massachusetts and Connecticut, these cars were limited to the CV's northern division. But these models were, in a word, stunning. I couldn't help myself so I purchased a pair of B&M and New Haven cars. I figured if nothing else I could run them in a model of the CV's Ambassador on my layout (I have the requisite brass 4-8-2). The Ambassador never ran on CV rails south of Massachusetts, mind you, but I figured I could run it on the layout, you know, when no one was looking.

The fact that the CV's 4-8-2s couldn't negotiate my 26" minimum mainline radius curves – fine for the CV southern division inspired SNE – didn't stop me daydreaming about watching the Ambassador, in its full HO scale glory, rounding the bend.

Then there was the CV 700-series 2-10-4s. Although the smallest of the wheel arrangement built, there was no denying they were cool looking beasts – with their Elesco feedwater

heaters and impressive trailing truck frames. A number of years ago Division Point imported a beautiful brass model of these engines. And my lovely wife presented me with one as a surprise gift (it covered Christmas, Anniversary, Father's Day and Birthday in one package . . .) But like the 4-8-2s it couldn't handle the curves on the layout, so other than running it back and forth on the straight track, it sat in the display case.

The Rapido Osgood Bradley cars and the 2-10-4 pushed me over the edge. But both of these really didn't belong on the southern end of the railroad. That was the first big revelation – acknowledge that what I really wanted to do was (finally) return to my roots and model the Central Vermont Railway's northern division in Vermont. The compelling question became: How many changes would it require to the layout, and would the resulting plan be compelling enough to stomach the thought of taking what may be a major step backwards?

*The* Get the Latest Model Railroading News, Tips, Reviews & Opinions  
**SCOTTY MASON**  
S H O W  
*The Original Model Railroad Podcast*

**-Monthly Interviews**

- Modeler's Spotlight: Top Modeler's Talk
- Narrow Gauge Modeling w/Chris Lane
- Contemporary Modeling w/ Mike Rose

**-More Product Announcements & Reviews**

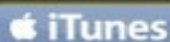

**Our feed has changed! To get the latest shows, Please search Scotty Mason and subscribe to the new feed!**

[www.TheModelRailroadPodcast.com](http://www.TheModelRailroadPodcast.com)

*Scotty Mason*

*Jimmy Simmons*

*Mike Rose*

*Joe Duckworth*



contents



index

First, I didn't care for the looks of the double deck layout, so any redesign would likely remove the upper deck portion of the layout. Other issues were defined as the curve radius, the "people" traffic flow, perhaps best described as the layout "footprint;" the helix, and the layout height.

It was obvious shifting focus to the CV's northern division was going to strain on the existing layout's infrastructure to the breaking point. In order to fit a turnback curve at the end of a peninsula into the space and retain a decent aisle width the curve radius ended up at 28". That was fine for the Bachmann plastic 2-8-0s that made up the core of the SNE fleet, but my brass CV Consols had some issues with that curve. And the bigger steamers were no match for it at all. While passenger equipment could negotiate those curves, it looked awful doing it, especially when viewed from outside the curve. I considered widening the lobe end of the peninsula to increase the main-line radius but found the room stood firmly in the way.

In addition to the curve radius issues, the people space in the layout was simply not working. Somehow, I'd ended with a railroad that would require 8-10 operators to crew correctly . . . but the space was so limited for them to move around that I doubt any more than six people would fit in the space – and that would hardly be "comfortable" for any of them.

At the heart of the problem was a combination of long narrow aisles that dead ended by the north end staging yard.

Look at the diagram of the "before" layout and you can see every operator – no matter if they were running a north or south bound train, had to transit the entire "stub ended" narrow (32") aisle. In the meantime, crews working towns in that aisle would be relatively stationary. And the peninsula and

the post created a narrow pinch spot and operators would pin crews into the dead end aisle like a cork in a bottle (3).

One solution that presented itself early on was simply limiting the number of operators during a session. This would, of course, ease crowding but does nothing to solve the issues with the deck heights or other ergonomic concerns.

An even bigger issue was the helix. Although multi-deck layouts are never pretty to look at, for a number of reasons I'd ended up with the ugliest and most model railroad element – a helix – smack dab in the entry to the layout area.

---

**“One solution that presented itself early on was simply limiting the number of operators during a session.”**

---

The helix had the same minimum 28” radius curve, but since a curved track on a constant grade creates a lot more friction than the equivalent grade on straight track, those steam engines that could handle the curve were limited to 8-12 cars. Again, not a really big issue for the freelanced SNE, but such short trains hardly befitted the northern division.

## **The final nail in the coffin?**

While all this thinking was going on in the back of my mind I tried, and failed, to fix some of these problems without tearing the layout completely down. The problem, to use a military analogy, was simple – I was trying to fix a strategic problem – the way the layout fit the space – with tactical solutions (3).

I started by leaving the larger locomotives – which I really liked – in the display case. I also determined to limit the number of



contents



index

operators to the bare minimum, and then take whatever steps I could to improve the yard area and the layout's "front door."

The solution I came up with is shown in Fig 5. It was a slight improvement, but the area I describe as the "front door" to the layout didn't capture the verdant Vermont countryside I wanted to depict. That labyrinth of benchwork and track really bothered me. It wasn't long after reframing the helix that I knew no amount of "rebuilding" was going to get me where I wanted to go.

Although I wasn't quite sure what the answer was I knew the SNE layout wasn't it, so I spent New Year's weekend 2011 with a crowbar and cordless drill in hand. By the time I'd finished SNE 4.0 was nothing more than stacks of wood, boxes



**3: Marty felt the weakest point from an appearance standpoint of the double deck layout was this view of the helix from the bottom of the stairs.**



**4: Diagram shows the planned changes: Boxing in the helix with an extended fascia and adding a branchline on top, essentially covering the top of the helix with scenery.**

of screws and salvaged flextrack, some open grid benchwork around the walls, and the grid benchwork for the bottom deck of the peninsula. I have to admit there was a “What did I just do?” moment (Fig. 5). And I seriously considered completely emptying out the basement and putting in a pool table. But cooler heads prevailed.

## **Redesigning the layout**

Once I decided there had to be a better way, the primary focus shifted to correcting the shortfalls with the first version of the layout and, more importantly, to avoid the introduction of any new problems in the process!



contents



index

Before I started drawing a track plan, I decided on some basic assumptions:

- Single level
- Minimize the number of turnback curves in the space
- Model a couple of recognizable CV locations as Layout Design Elements (LDEs)
- “Comfortable” aisle widths
- No grades
- Simple, open, accessible staging



**5: “YIKES! What the #\$% did I just do?!!!!”** is the thought that goes through any layout owner’s mind when demolition begins. Oh well, there’s no turning back now. It took less than an afternoon to clear most of the old layout out down to the open grid lower deck benchwork.



The initial sketch of the new footprint is shown in Figure 6.

Everyone who has seen the “before” and “after” versions of the layout agrees the current arrangement represents a significant improvement. As you tell from the track plan, which is still very much a work in progress, there’s lots of room for filling in the details.

## **A new layout**

I also looked upon this as a chance to radically improve the traffic flow in the aisles. So, although it was painful to make that first saw cut on the helix and upper deck, once it was gone I could immediately tell I’d made the right choice.

In an effort to reuse as much of the existing wood as possible, I removed the helix but simply slid the base grid frame away from the wall to form the basic benchwork for the new lobe end of the peninsula (Fig. 7).

Hopes of keeping some of the old layout’s lower deck track in place were soon proved more problematic than they were worth and in the process of rebuilding we’ve raised the track height 5” or so. On a multi-level layout 45” seemed fine for the lower level – on a single deck layout that just seemed a little too low.

The flow is much improved – both for the trains and more importantly the operators. Road crews pick up their trains at the north end staging yard by walking around the end of the peninsula, follow their trains through the first aisle, back around the end of the peninsula, and follow their trains through the longer aisle up into White River Junction – and into the south end staging yard. Once the train is tied up in south end staging they are at the other “end” of the layout in the utility room.



contents



index

South  
Staging

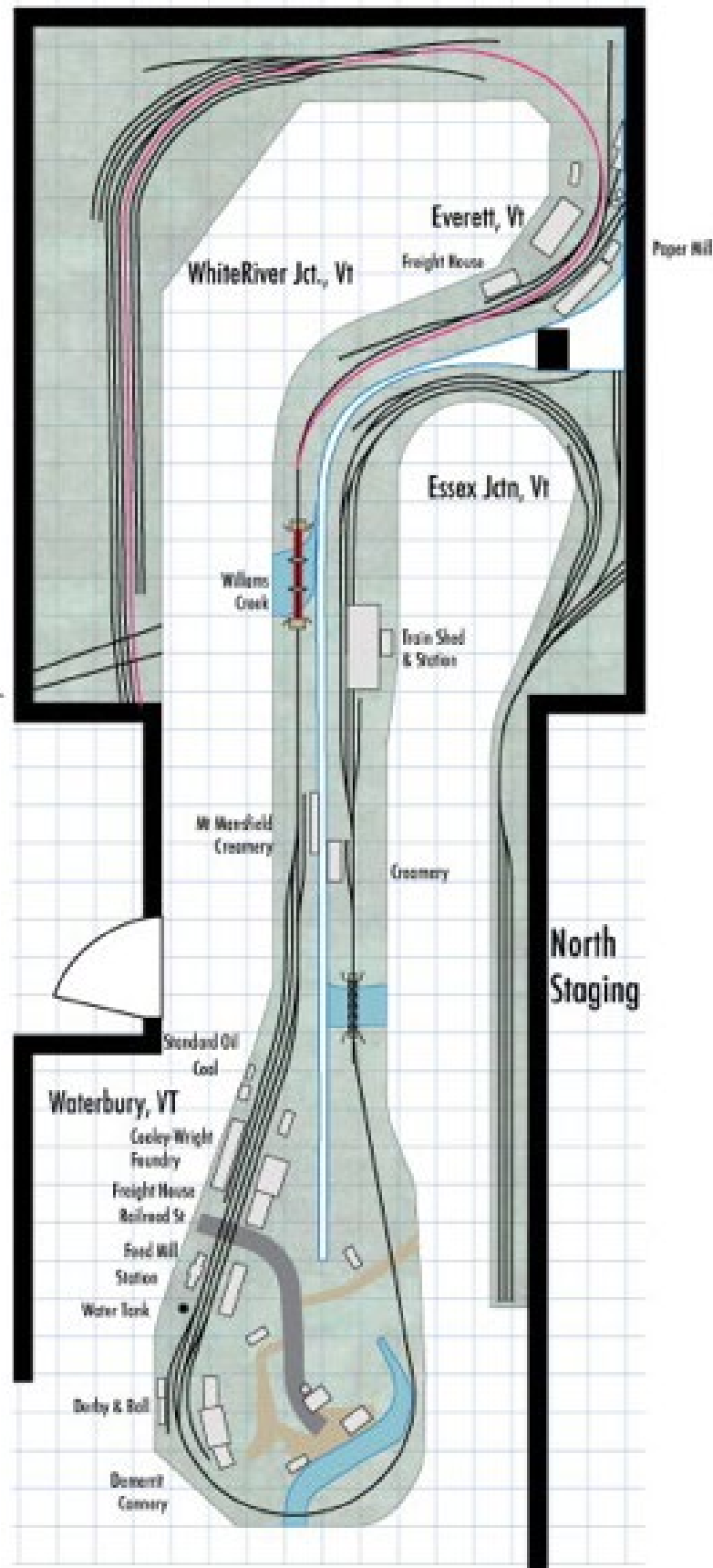

North  
Staging

**6: The revised layout trackplan. NOTE: The details of the White River Junction yard area are not shown on this drawing.**

I first got interested in modeling the CV in the steam era from a single Phil Hastings photo of Waterbury, Vt., that appeared as a two-page spread in Bob Jones's series of books on the railroad. Although there's nothing really special or unique about the scene, that may be the main reason I've always found it so appealing. In any event, it's a scene I've long wanted to model and decided to include as the new "front door" on the layout.

An early suggestion I got from a number of folks was to have the track drop downgrade enough beyond Essex Junction to pass below White River Junction on a lower level staging yard. First of all, I'm afraid it would take an act of Congress to place staging yards below the scenicked level since it would require two things I've come to loath in model railroading – grades, and hidden track. (well, I can live with grades – but hidden



**7: Don't dwell on the mess or the demolition. IF you're going to make significant changes it's best to handle the demo quickly – so you can get to the exciting phase of rebuilding sooner.**



contents



index

track – no way!). I'm modeling the CV's climb over the Green Mountains – but I'm planning on doing it without any grades at all. They play havoc with tractive effort, can cause operational issues with vertical transitions, and can even cause issues with structures and industries (with spurs on grades). I've concluded that in most cases grades are simply more trouble than they're worth.

And the simplicity of visible, open, staging is extremely appealing to me.



**8: It's been a little more than two years since the extensive rebuilding started. There's still a long way to go, but at long last parts of the CV Winooski Sub are looking less like a construction zone and more like a railroad.**

It's been about three years since the "Sea Trial" session, and about two years since I pressed the "reset" button. I'm pleased to report considerable progress has been made at putting things back together. All the benchwork, trackwork, and wiring, with the exception of the south end staging yard, is in place. And, with the trains running again, I'm planning on hosting a "Sea Trial" session in the next few weeks. And, in a few places I even managed to rough in some scenery (Fig. 8)

So that's the story of the somewhat painful journey of how I ended up with a layout that's right for me, and how I changed course midstream to produce a layout that's a perfect fit. I think the layout now offers a wide variety of wonderful modeling projects based on a favorite prototype, can provide a lot of fun for as many as six people, but still be operable by one or two folks as mood, and availability, indicates.

## Then and now

The following photos show the layout in its double-deck 2008-2010 configuration compared with a photo taken from the same location as the layout appeared during the tracklaying phase in early 2013. 

*[More photos on the next pages ...](#)*

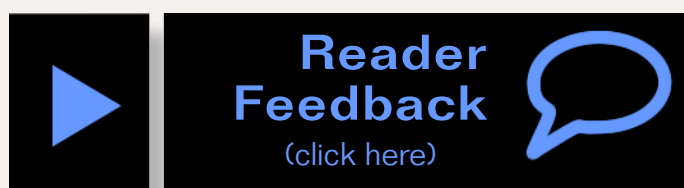

contents



index



**9: Before:** North end staging is on the upper deck to the right. The photo was taken standing in the “dead end” aisle with the helix behind the photographer.



**10: After:** “Essex Junction” aisle viewed from the end of the peninsula. That’s the north-end staging yard on the right.



**11: Before: The main aisle. Lobe end of the peninsula is straight ahead and to the right. Yard area on left.**

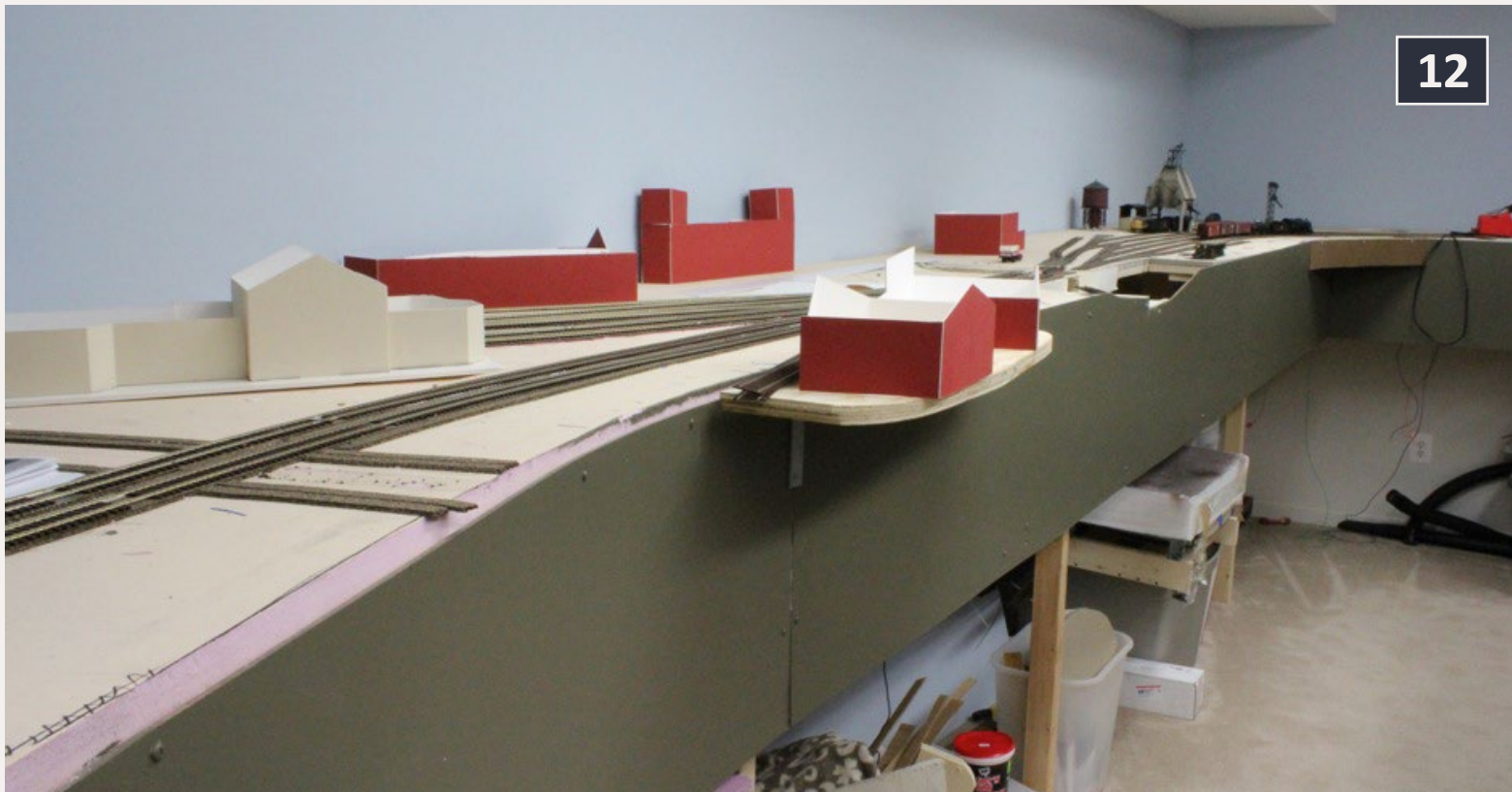

**12: Although the buildings are all mockups in this picture, the scene has all the key elements of the prototype White River Junction.**



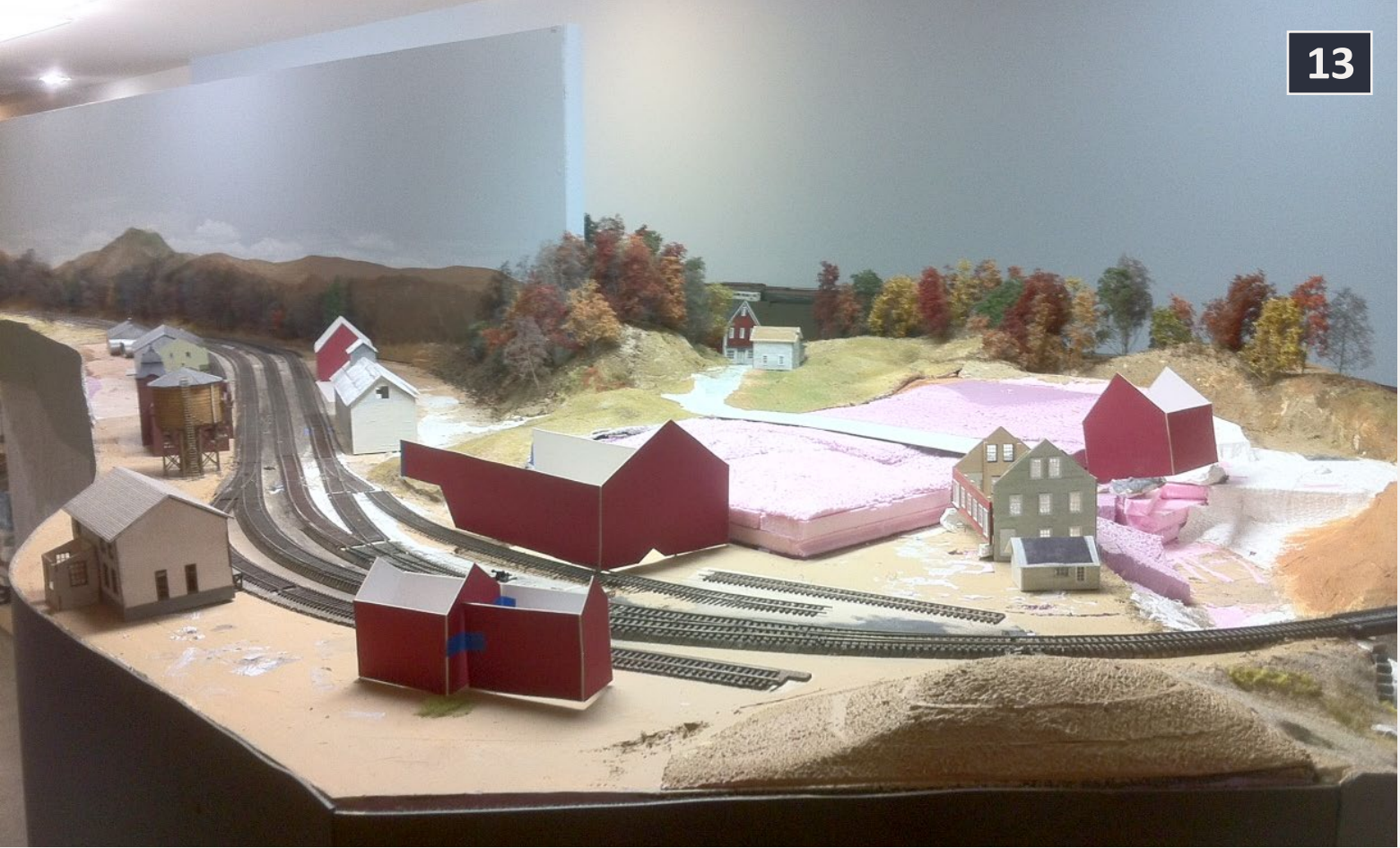

13: The "modern art" sculpture appearance of the original layout (see Fig. 3) has been replaced with this (under construction) panorama of rural New England.

Advertisement

Free Shipping on all US WEB orders over \$100.



New ACCU-LITES exclusive!



Tortoise SNAPS 8-position block wiring quick connect socket

Watch our website for our monthly specials!

CLICK TO LEARN MORE:

<http://www.acculites.com>





## After thoughts ...



**14: Note for those building multi-deck layouts. The under-cabinet lights used to illuminate the lower deck worked pretty well.**

Some people have misinterpreted the changes I've made to the layout as some sort of vendetta against multi-level railroads. Nothing could be further from the truth. Sure, perhaps I'm bucking a trend by going from a multi-deck layout to a single-deck layout, but if my layout goals were different I might have been perfectly happy with the multi-level railroad. Building, and rebuilding has, after all, set me back about three years. On the pragmatic side there were some things I learned in building the multi-deck layout configuration that may prove helpful to those planning to build a multi-deck layout.

## After thoughts *Continued* ...

### Lower deck lighting

The lighting on the lower deck, visible in some of the “before” pictures, actually worked out very well. I used linkable under-cabinet fixtures. I ended up with two different brands – Lights of America (Wally World) and GE (Home Depot). They are not interchangeable. But both brands worked fine, didn’t intrude on the “sky space” of the lower level, and I plan to re-use these lights to illuminate some of the dark pockets on the single-deck layout.

### Layout height

I planned to use step stools or some raised platforms to make it easier for operators to reach the upper level. But I had some real concerns about this as well. I had someone take a header off a one-step step stool years ago (not a modeler, a plumber installing some pipes). Luckily I was home, heard his step ladder fall over and came downstairs to find blood on the wall and floor and this poor fellow wondering where, and who, he was. I called 911 and he ended up in the hospital for more than a month – if I hadn't been around he likely would have passed out and I would have found him in a coma – or worse. That experience has really stuck with me and I was always hesitant about using step stools, etc ... to build and operate the upper deck.

Let's face it, a lot of model railroaders I know could benefit from some time in a step class, but I didn't want to risk someone taking a header. More likely one of the more – uh – “robust” members of the crew would need to give themselves a boost up the step and might take a large chunk of the layout down as they hoisted themselves up.



Although it's impossible to have an ideal height for both decks, I felt the upper level ended up just a little too high. I set the lower level between 45" and 48" as it seemed like a nice height for the lower level yards. At some point I decided the upper level needed to be 16"-18" above the lower, which put the track at 61"-64" – which always seemed a little too high for most folks to see/operate without a step or raised platform. The narrow aisles (32") meant building a permanent step would interfere with standing near the lower deck.

Laying the track and painting the backdrop I also got sick of going up and down the step ladder to work on it - and a few times caught myself reaching just a little too far. I never fell, but I "forgot" I was on the step a couple of times. The takeaway is you can easily get away with less than 16" of separation between decks – 12"-14" seems like a reasonable separation provided the decks are kept relatively shallow.

And try to avoid having to use step stools or short ladders, or even platforms. But, if you must use them try to limit their use to isolated "pocket aisles" away from the main aisle and make them true platforms and not steps. A low "toe guard" is also suggested. – MM ■

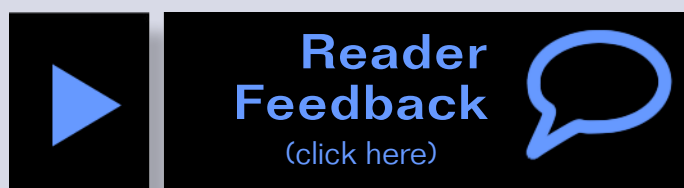

contents



index

# iwata

by ANEST IWATA

## *Just Rolling By...*

## Make It **REAL** With Iwata *Climb Aboard!*



**Eclipse  
HP - CS**

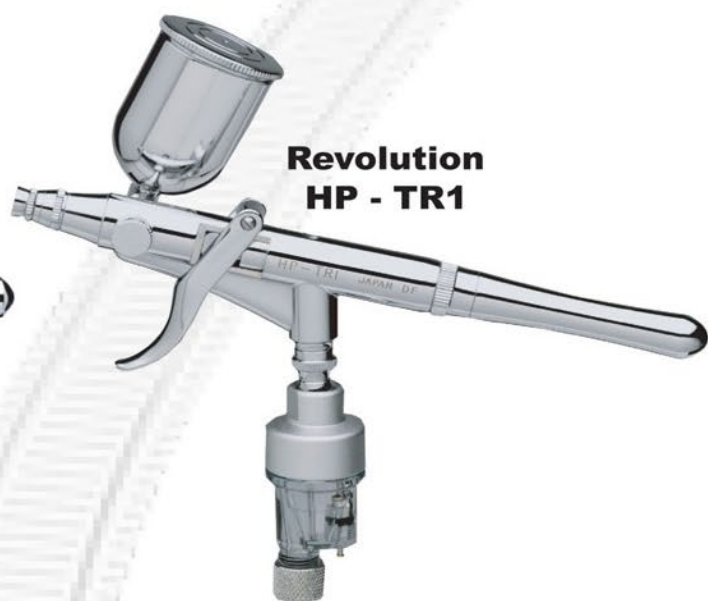

**Revolution  
HP - TR1**

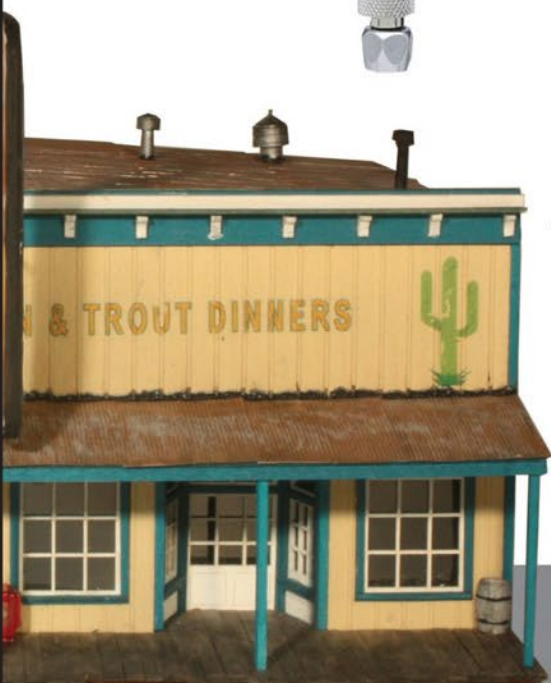

**Visit...**  
**[www.iwata-medea.com](http://www.iwata-medea.com)**  
**To Check Out Our  
Full Product Line!**

*Models By... Alan Houtz,  
North American Prototype Modelers*





# Gary Christensen, Weathering and Graffiti Artist

Photos and video of superb models

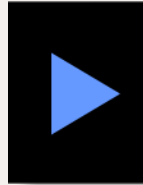

**Reader  
Feedback**  
(click here)



**What's neat this week column**  
by *Ken Patterson*

1



**1: Gary positions his auto racks on a bridge scene during the outdoor photo shoot in July.**



## “What’s neat this week” features the artistic talents of Gary Christensen, of Coos Bay, Oregon ...

**G**ary is known for his prototypical looking graffiti, masterful weathering and realistic dioramas. I had the privilege of meeting him at the St Louis Railroad Prototype Modelers Meet this past summer. During his visit to St Louis, Gary agreed to come by my studio and let me do an afternoon photo shoot featuring some of his models for this issue of Model Railroad Hobbyist magazine.

Gary has been in the hobby for 20 years, but in 2005, the Internet gave him new direction in the field of graffiti and weathering as art. He made many new friends on the Model Trains Weathered forum, including Jeremy St. Peter who

[... On to next page of text →](#)



**Playback problems?** [Click to try a different version.](#)

# NEW FROM ACCURAIL



## EASY TO ASSEMBLE HO SCALE KITS

Join the Accurail Mailing List for the latest announcements & upcoming releases



Rock Island Offset Twin Hopper



Northern Pacific 89' Auto Rack



Santa Fe ACF Hoppers  
3-Car Set



Pennsylvania USRA Hopper  
3-Car Set

Singles also available



D&RGW  
40' Wood Boxcar



Louisville & Nashville  
50' Steel Boxcar



GB&W  
50' Dbl. PlugDoor Steel Boxcar



Baltimore & Ohio  
40' Wood Reefer

PLEASE SEE YOUR LOCAL HOBBY DEALER  
OR CALL 603-965-1173 FOR DIRECT ORDERS



contents



index

[← back to previous page of text ...](#)

moderates TheWeatheringShop.com. It was the influence of these friendships that drove him to become the weathering expert he is today.

The following photos with captions and video tell you more about Gary and his work.

3







**3-4:** This 53-foot gondola started life as an Athearn model. The car was sprayed with a flat almond shade of enamel paint. Depth shadowing was achieved in recessed areas with gray pastel powders. Scratches, dings and scrapes were done with sienna and black acrylic paints. He also uses oils. Added details include Sergent Scale “E” couplers, Hi-Tech air hoses, and hand-fabricated pin lifters. The load is made with scrap plastic from the work bench scrap box, strategically positioned and glued in place.



contents



index



**6: Gary applied a heavy rust treatment to this Walthers 89-foot auto rack. The hand-painted color transition was achieved using acrylic paint mixed to match the prototype color of the car. The panels were weathered using orange oxide oil paint with pastel powders mixed in. The finish is sealed with Dullcote. The car has Kadee #5s, Hi-Tech air hoses, and hand-bent coupler lift bars.**



**7: His CSX rack was faded using acrylic paint, pastel powders and oil paint, all sealed with Dullcote. It took hours to hand paint the graffiti with acrylic paint, using several colors, and prototype photos as reference. Scale couplers, air hoses, and coupler lift bars round out the end details.**



contents



index



**8:** This model is an eye catcher. Starting with an Atlas 47-foot ACF Centerflow, Gary used the side of the car like a canvas to replicate by hand the famous Ichabod graffiti, girl and all. Before the graffiti the car received 5 layers of a mocha brown acrylic paint. The car was then sealed with Dullcote before the acrylic graffiti was applied. Gary spent 20 hours hand-painting this car.

Scale couplers from Sergent, Hi-Tech air hoses, and hand bent coupler lift bars and linkage complete the details on this car.

**9:** This car started out as an Athearn Genesis PCF double plug door insulated boxcar in Cotton Belt livery. Gary tells the story: "I had been introduced to a prototype flick that was captured by Butch Eyer of this very same car. I decided to keep with the theme of reproducing a series of freight cars that were hit with graffiti by Ichabod, with a woman's portrait as the focal point."

"I soaked the car in a mild citrus solvent to strip the factory Athearn paint and Cotton Belt lettering. I then shot the car with an enamel paint called periwinkle blue. From there ... I set the car with Golden West Service decals from the Microscale sheet



of GWS freight cars. I then misted the car with Dullcote, and being that the prototype car was relatively new, there wasn't needed much in the way of weathering. The entire ICH tag and portrait of the unknown woman ... was all hand painted freehand ... pretty much a close match to the prototype."

"I constructed a diorama to present this model. I wanted to address a scene behind a warehouse with a reflective puddle of water that would display the model in the foreground in reverse. Thought it might be an interesting effect. I used a sheet of masked Plexiglass imbedded into the press board base to represent the water. I then added all the scenery around to incorporate the standing water puddle into the fixed scene."

"All in all ... this wasn't a very time-consuming project in creating the diorama scene. The model absorbed approximately 20 hours (in segmented sessions) to complete."



**Reader  
Feedback**  
(click here)



contents



index

# MRH HOBBY MARKETPLACE - 1

**REAL  
CEDAR  
TRUNKS**  
Click Here!

Don't settle for lifeless signals!  
We've got signaling circuits!



**LOGIC RAIL™**  
TECHNOLOGIES

"Sophisticated  
Model Railroad  
Electronics"

Please visit our website and online store!

21175 Tomball Pkwy  
Suite 287  
Houston, TX 77070

Phone: (281)251-5813  
<http://www.logicrailtech.com>  
info@logicrailtech.com

**W** GOLDEN AGE LINE  
**WESTERFIELD**  
MODELS, LLC

Available Feb 15



**R. I. Stock Car**  
**Two New Versions**  
[westerfieldmodels.com](http://westerfieldmodels.com)

click here!

Goes on easy

All Scales  
All Brands

Make a Tire or Retire



Recommended installation tool

SNOT = SAND



99% Know It Works!

**Green Grip from a Jar**  
[WWW.BULLFROGSNOT.COM](http://WWW.BULLFROGSNOT.COM)

AMERICA'S NUMBER ONE  
RAILROAD PRINT SOURCE

**Jelsma**  
Graphics

...America's Railroad Embroiderer

Railroad Art-Prints,  
Caps, Jackets,  
Shirts and More ...  
Jackets starting  
at \$79.95

[www.jelsma.com](http://www.jelsma.com)  
1-904-221-3513 • Jacksonville, FL.

**True Scene™ Modeling**

**NEW FusionFiber™**

Dependable Quality. Easier than Plaster!

**SATISFACTION GUARANTEED!**

[www.truescene.com](http://www.truescene.com) or 716-523-7305

**On3 Waynesburg and**

**Washington  
Passenger Car Kits**

Click here for more info ...

**Minimalist Model Railroad**

New Approach to  
Model Railroad Design

Click here to learn more...

[minimalistmodelrailroad.com](http://minimalistmodelrailroad.com)



# MRH HOBBY MARKETPLACE - 2

Affordable custom and modular benchwork.

MODEL RAILROAD

**BenchWork**.com

## ON3 - ON30



Click to visit ...

[WWW.SANJUANCARCO.COM](http://WWW.SANJUANCARCO.COM)

## Backdrop Junction

Your stop for  
Model Railroad Backdrops



 [click here to visit our website  
backdropjunction.com](http://backdropjunction.com)  
N, HO, O Scales • Custom Orders

## Introducing . .



You won't **believe**  
everything this model  
RR software can do ...

Show me  
(click here)

StansTrains.com



CLICK  
HERE

**DISCOUNT COUPON CODE: MRH-1302**  
**The Age of Steam & Steel**  
RAILROADS 1832-1949 5-DL DVD-ROMs



# MRH HOBBY MARKETPLACE - 3

## STREAMLINED BACKSHOP SERVICES

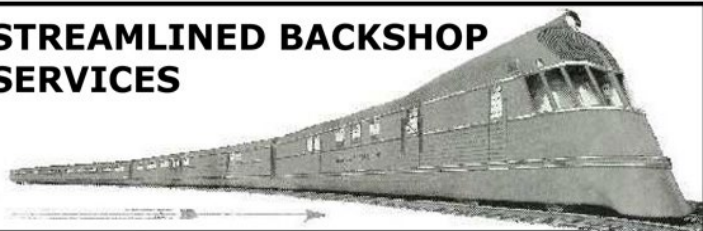

Featuring the  
Model Railroad Technologies  
**ACCUTRACK** Scale Speedometer ...



... **SPEED** has met it's **MATCH** !



[www.SBS4DCC.com](http://www.SBS4DCC.com)

## Great Decals!

is now selling decals produced by *After Hours Graphics* for Midwestern railroads. Roads offered include C&O, Cincinnati Union Terminal, Conrail, CSX, DT&I, Great Miami, Indiana and Ohio, Interstate, NKP, Norfolk and Western, Pere Marquette, Southern, Transkentucky, and private labels Dow and Owensboro Grain.

For the complete list, see:

[www.greatdecals.com/  
AfterHours/AfterHoursList.  
html](http://www.greatdecals.com/AfterHours/AfterHoursList.html)

Great Decals!

P. O. Box 994, Herndon, VA 20172

## RULERS-of-the-WORLD

Scale Rulers \$4 each  
Over **150** scales!

Metric or Imperial

[www.rulers-of-the-world.com](http://www.rulers-of-the-world.com)

## Your Text Ad

Could be here for a remarkably  
affordable price!

[mrhmag.com/advertise\\_with\\_us](http://mrhmag.com/advertise_with_us)

## The Proto:87 Stores

21st Century, Model Railroad  
Miniature Engineering for  
everyone. Actually making  
your model track and control  
systems look and work the way  
the Prototype does. All without  
needing craftsman skills, or  
crawling under your layout.

[www.proto87.com](http://www.proto87.com)

Get your ad here ... click to find out how.







NORTH AMERICAN RAILCAR CORPORATION  
ПОСЛІДНІ ПІДПИСАНИЙ КОМПАНІЙНИЙ

New  
Innovation



# NARCorp High Performance MagnaLock Brake Lines

CLICK HERE FOR  
**Video Clip**

 See the YouTube video!



**NARCorp High Performance  
MagnaLock Brake Lines**

are sold exclusively by

***Pacific Western Rail Systems***





## Pin Vises

Pin vises are an essential tool for drilling holes with small drill bits ...

by Jack Burgess



**P**in vises are fairly basic tools in our hobby. Although the name “pin vise” suggests that they are a “vise” designed to hold “pins”, they actually hold very small drill bits to let you drill the numerous small holes so common when building freight cars and sometimes even structures. We typically use drill bits down to No. 80, 0.0135” in diameter and you need to have a pin vise to hold such small drills. I’ve had several pin vises over the years.

My first pin vise was an X-Acto model. It had a rounded wood ball head which was intended to let you cradle the ball head in the palm of your hand to apply pressure on the drill bit when drilling. This type of pin vise is still available from Mascot. However, the ball feature should only be used with larger drill bits (larger than a No. 50). With smaller drill bits, it is too easy to apply too much pressure and break the drill bit with this type of pin vise. You would also rarely need to apply force on the drill bit except when drilling metal.

From the X-Acto pin vise, I graduated to a General Tools Swivel Head pin vise, a readily available pin vise. This pin vise has two



double-ended, reversible collets which are stored in the body of the pin vise. This provides four different sized collets in a single tool. This lets you use it with drill bits ranging from a No. 80 to an 1/8”.

While the four collets in a single pin vise is an advantage, the design also has a downside. One collet has the largest collet on one end and the smallest one on the opposite end. This means that as you switch from a small drill bit to one a little larger, you must unscrew the collar, remove the collet, and then remove the swivel head and retrieve the larger collet, and then swap out the two collets. Many times it seems that you disassemble the tool and select a particular collet only to find a minute later that it is either too large or too small for the drill bit you need.



**1:** Here are two General Tools Swivel Head pin vises. The one on the right has been disassembled to show the collar, body, and swivel head (center) as well as the two double-ended collets (top).



contents



index

Obviously, one solution for this frustration is to purchase four of these pin vises and have each one set up for each of the different collets. I actually did this but I still don't use these pin vises that often. That is because I have realized over the years that many pin vises are too large for the tiny drill bits we typically use.

I think that a pin vise should have a mass as small as possible since a heavier pin vise makes it much easier to break a small drill bit. A lightweight pin vise can be used with a light touch.

For years now, I have been using the Secure Grip Sliding pin vise (Item No. MT1079) from Model Expo ([modelexpo-online.com](http://modelexpo-online.com)). This one pin vise works with drill bits from No. 80 to slightly larger than a No. 61. The sliding collar works well and small drill bits center easily in the tool. But, most important to me, the light weight of the pin vise doesn't overpower the drill bit, thus making it easy to use very small drill bits without the threat of breaking them due to excessive side pressure on the drill bit.

## Drill Bit Holders

Of course, a pin vise needs a selection of small drill bits in the range of 61-80. While one can obviously buy just the drills needed for a particular project, I have long had an entire selection of drill bits ranging from 61-80 (together with another set in the range of 1 to 60 for other projects).

Regardless of how you buy small drill bits, you need an easy way to store them so that you can easily find the one that you need. There are a couple of choices for storing small drill bits in the range 61-80—all of these choices require that you purchase an entire set of 61-80 drill bits in order to get the case.

2



**2: This is the Secure Grip Sliding pin vise with a small drill bit in place. The collar is slid toward the top of the tool to close the collet which is part of the body of the tool. When using very small drill bits, this collar can be slid part of the way up to only partially close the collet, making it easy to center the drill bit.**

One choice is the circular case sold under the name Rogers Drill Bit Set and available through Micro-Mark ([micromark.com](http://micromark.com)) and others. These cost about \$33 each, which includes the 20 drill bits. I started using one of these several decades ago (probably marketed back then by X-Acto) since it was the only collection of 61-80 drill bits available then. But one annoyance with this case was that, with my large fingers, I could easily grab more than one drill bit at a time when trying to remove a single drill bit. Once a drill bit was accidentally broken (not a infrequent occurrence, especially with those in the range of 77-80), it was easy to pick up a drill bit next to an open hole and then set it back down in the wrong hole after using it.



contents



index

Right now I'm using a plastic index case for 61-80 drill bits which are sold by Micro-Mark, ModelExpo, and others. These consist of a slotted tray with a sliding cover. They typically cost about \$5 less than the circular cases, and I think they work much better. The drill bits are held in slots by size and the sliding cover lets you expose one drill bit at a time to remove it. When new, the sliding cover tends to stay in place when you set the case down, allowing you to put the used drill bit back in the correct slot after use.

While the smaller drill bits can seem intimidating to use due to their size, they are actually reasonably flexible and, as long as you are careful and don't apply too much downward pressure while drilling, can last a reasonably long time if you are vigilant. But regardless of how careful you are, you will end up breaking some of them. When building freight cars (such as resin kits), the drill bits most often used tend to be the smallest drill bits which are the ones most likely to break. Many years ago,



**3: A Rogers Drill bit set. The size of each drill bit in inches is next to the drill bit number.**

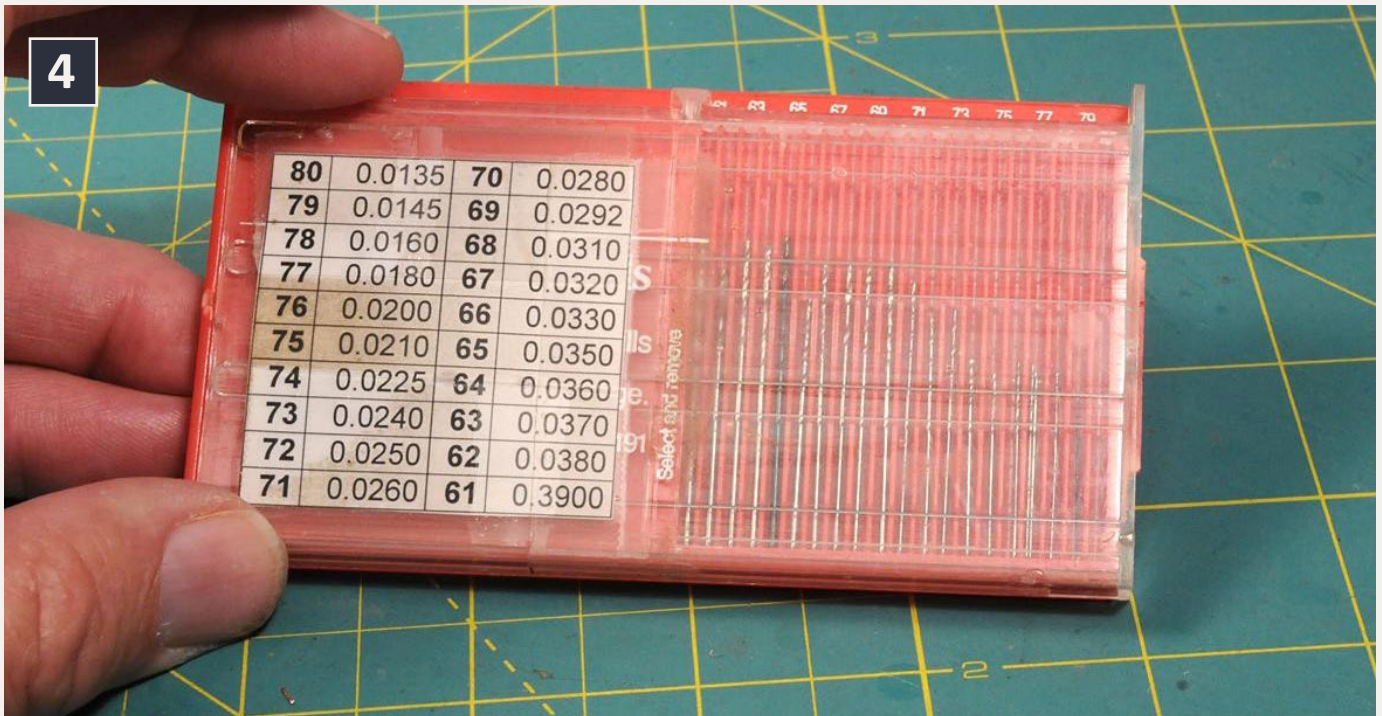

**4: This is the sliding tray type of drill bit case that I use. I don't refer to drill bit numbers except when ordering them. Instead I select a drill bit by the size of hole I want to drill. So I worked up the small chart which I taped to the sliding cover.**

if I broke my only No. 80 drill bit, I'd substitute a larger No. 79. It might result in a sloppy fit for a grab iron but at least it got the job done. However, kit grab irons are usually formed from .012" brass wire and so even a No. 80 is larger than needed. So, using a No. 79 in lieu of a No. 80 isn't an equivalent solution.

To deal with such expected issues, I finally invested in a stock of extra drill bits in every size from 61 through 80. I purchased mine online from Drill Bit City ([drillcity.stores.yahoo.net](http://drillcity.stores.yahoo.net)). They sell 6-piece packs of new HSS Drill Bits in sizes ranging from 80 to 61 and larger. (Small wire drill bits are under the link for "High Speed Tools". For example, item DBC-22180 is for a package of 6 new No. 80 drill bits.) There are other suppliers although you need to recognize that some outlets sell cheap drill bits which aren't properly sharpened—although they



contents



index

might work fine with styrene and maybe resin, they will not drill holes in metal such as brass. ✓

*Disclaimer – I love good tools and don't hesitate to invest in them.*



**5: This is my stock of spare drill bits. I found the miniature zipper storage bags at Michaels craft store.**

**Please use email and phone buttons on ads to contact advertisers, and please mention MRH.**



6



**6:** To use a pin vise, hold it vertically between your thumb and fingers. Your “index” finger can rest on top of the pin vise to keep it vertical. With small drill bits and materials such as wood, styrene, and resin castings, the weight of the pin vise will generally be enough downward pressure. Otherwise, you can apply just a very light downward pressure with your index finger. Twist the pin vise with your thumb and fingers while holding the work piece with your opposite hand. Too much downward pressure will result in broken drill bits when using those smaller than a No. 77 or so.



**Reader  
Feedback**  
(click here)



contents



index



## RLW's Nn3 20-ton Coal Cars: Super-detailing & modifying for standard gauge

– M.C. Fujiwara  
Photos by the author



**Detailing tips and tricks for early 1900s-era rolling stock ...**

**F**or those of us modeling the Turn of the Century/early 1900s, rolling stock selection is slowly growing: in addition to Roundhouse's "Old Timer" series and MTL's 36' reefers and boxcars, Republic Locomotive Works (RLW) of Cathlamet, Washington has recently developed a line of pre-1900s cars. The RLW line includes ventilated boxcars, house cars, cabin cars, stock cars, flatcars, and, filling a void that had long remained empty, wooden 20-ton coal/ore hopper cars.

While all these kits are produced with Nn3 running in mind, their non-standard middling size make them easily adapted to standard gauge N scale, which is what I did.

Designed by Chris Schmuck, (well-known as Chris333 on the forums), RLW offers these laser-cut thin-birch plywood 20-ton Coal/Ore car kits in packs of two or six, minus trucks and couplers. For Nn3 running, RLW recommends MTL 961 Nn3 Diamond Archbar trucks and MTL 905 body-mount Nn3/Z couplers. To adapt for N, I used the MTL 1015 archbar trucks (more on installation later), and kept the MTL 905 couplers for more prototypical appearance, though true rivet counters should fabricate link-and-pin hardware.

The kit comes with very useful instructions, and it behooves one to take their suggestions seriously, especially in regard to allowing the thin side braces to dry overnight, as they will pop off if one becomes too hasty and attempts trimming off the sprue too quickly.

While all the pieces are still attached to the wood sheets, I paint the body pieces Polly Scale Boxcar Red and the undercarriage Polly Scale Grimy Black, both slightly thinned with water to allow the wood grain to show through. Given the thinness of the birch plywood sheets, I sandwich them between wax paper & weights to prevent curling or warping while drying.

I find that assembling two cars takes about an hour to get to the point where the side braces are attached and you must wait a day for the white glue to dry. Mounting trucks and couplers, adding details, weight and loads, and weathering takes about another hour. While waiting for the braces to dry, I prep the details by removing flash, painting, and then trimming them from their sprues. The kit comes with the brass wire and brake wheels (installed on one end of each car), and, while the cars look great as is, I decided to add Grandt Line HO 1" NBW details, eight on each side, and one Grandt Line O 1" square NBW on each side center to simulate the drop rod at the bottom of the



contents



index

car. I painted all NBW heads PollyScale Grimy Black, cut off the bolts and then attached only the head details to the car sides with the same wood glue I used for the rest of the car. While you can use brass wire, I used Gold Medal Model's hand grabs, which I painted Floquil Grimy Black while still on the sprue. The pre-drilled indentations are just slightly wider than the GMM hand grabs, but a slight spreading of the brass makes for a flush fit. Attach with CA: Use a toothpick dipped in Floquil Grimy Black to touch up any paint on the hand grabs, NBW details, or brake wheel.

The bolsters are designed for MTL 961 Nn3 trucks, and so, using a small drill bit on my Dremel, I ream out the bolster holes to accommodate the slightly thicker MTL 1015 Archbar truck pins:



**2. I attached the nut-bolt-washer head details to the car sides with the same wood glue I used for the rest of the car.**

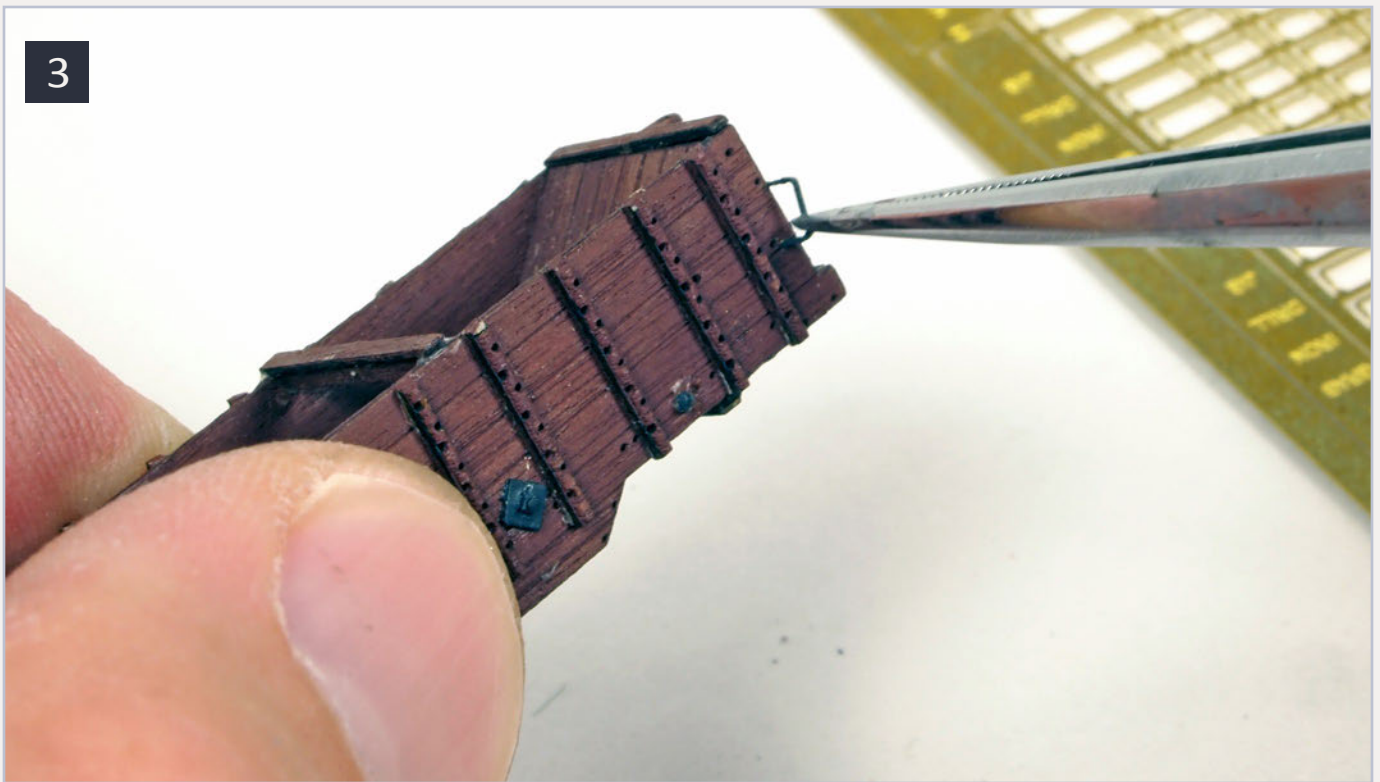

**3. I installed Gold Medal Model hand grabs in the cars with some superglue applied to them.**

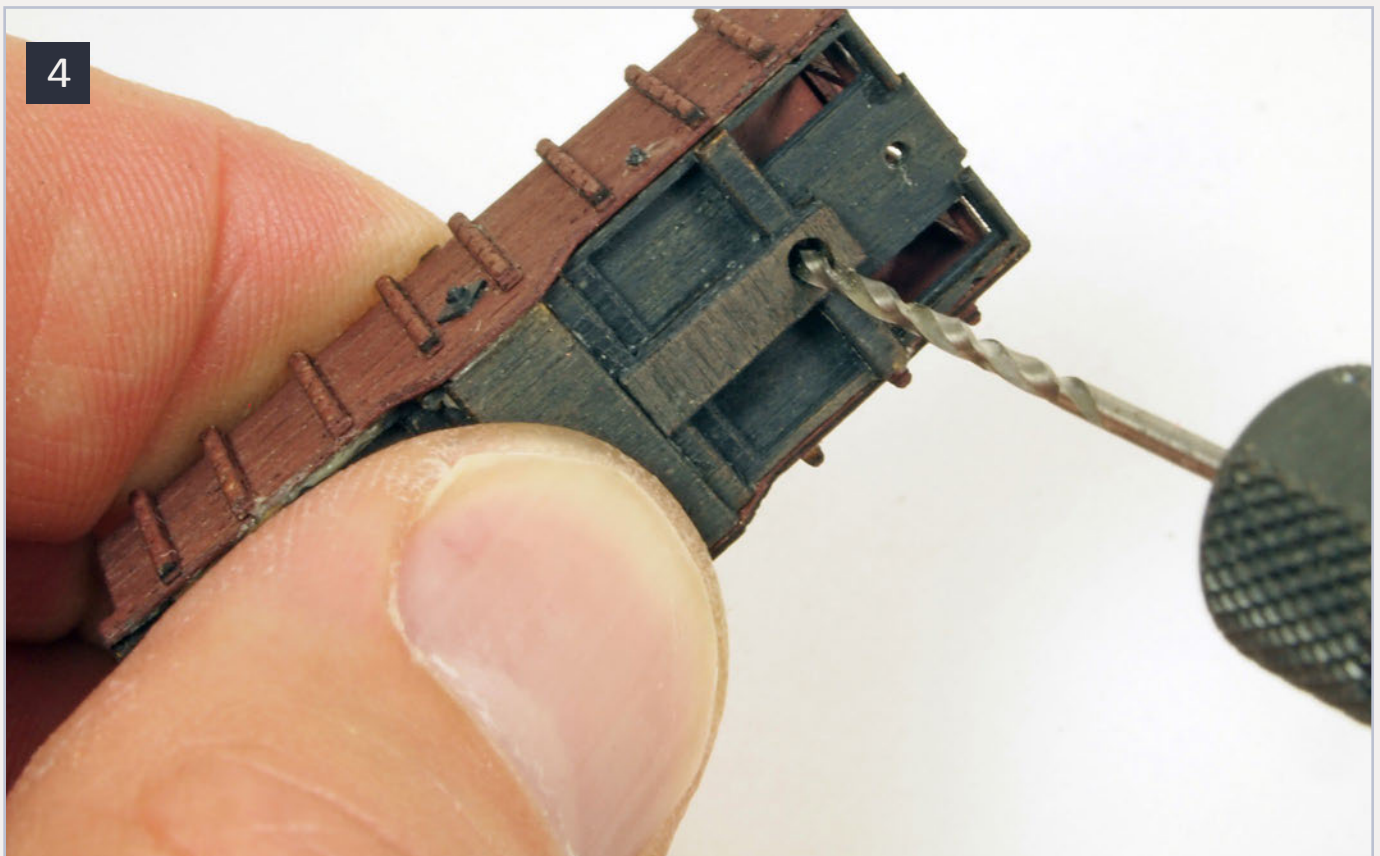

**4. I reamed out the the truck bolster holes using a drill bit in my Dremel to accommodate the truck pins.**



contents



index

While reaming, proceed slowly and evenly around the hole, occasionally testing the bolster pin for a good fit.

Be careful: while the four layers of birch ply sandwiched together provide a solid base for the car, applying too much pressure on the bolster pin while attempting to fit an insufficiently reamed hole may result in slight damage to the frame.

A testament to the quality of material and design: even after the above show of strength / learning experience, I repaired the floor and sides with wood glue and now the damaged car is near indistinguishable from the previous five successful builds.

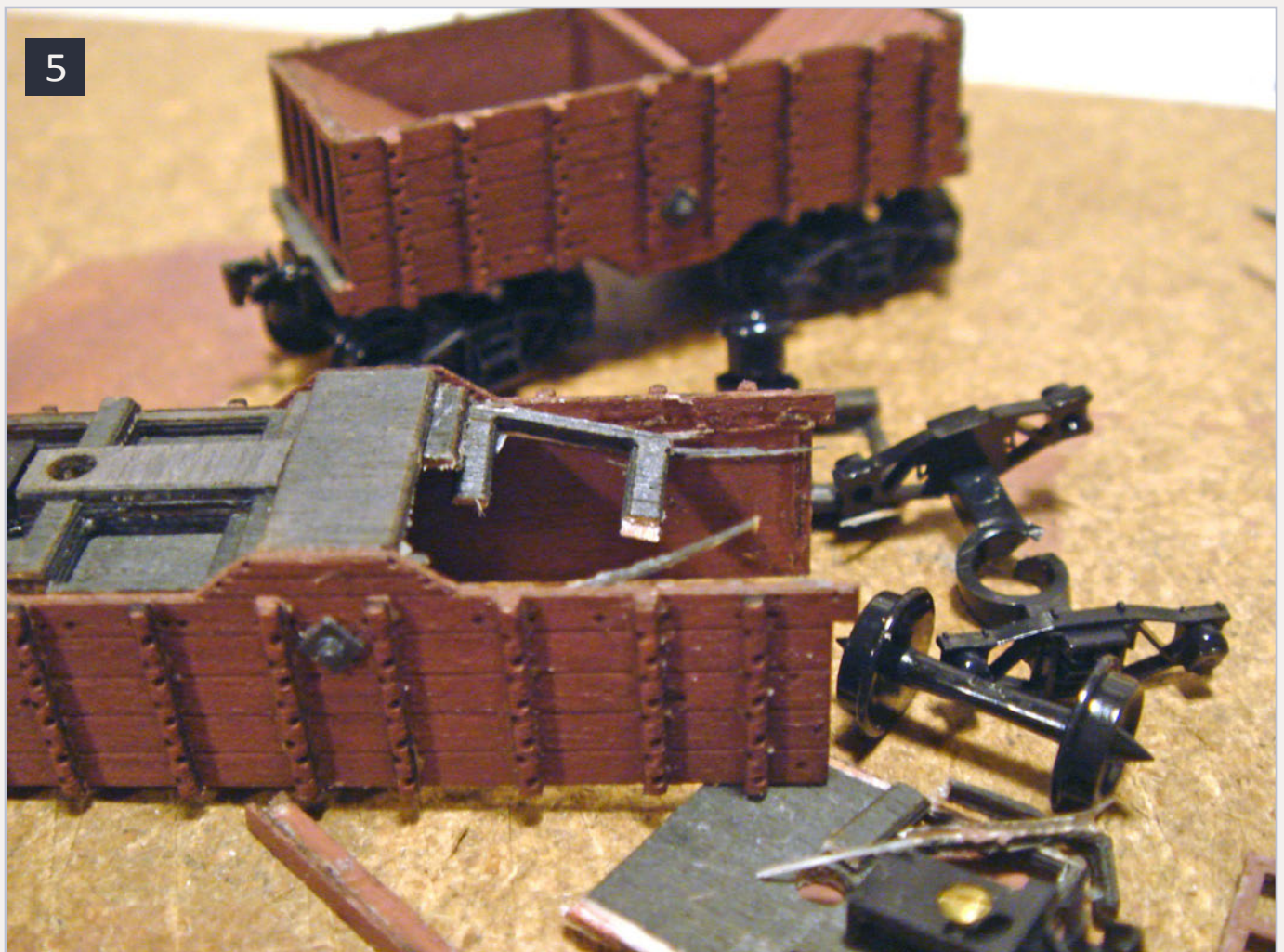

**5. Be careful that you don't press the bolster pins in too hard or you will damage the car like I did here. Fortunately, using wood glue I repaired the damage.**

6

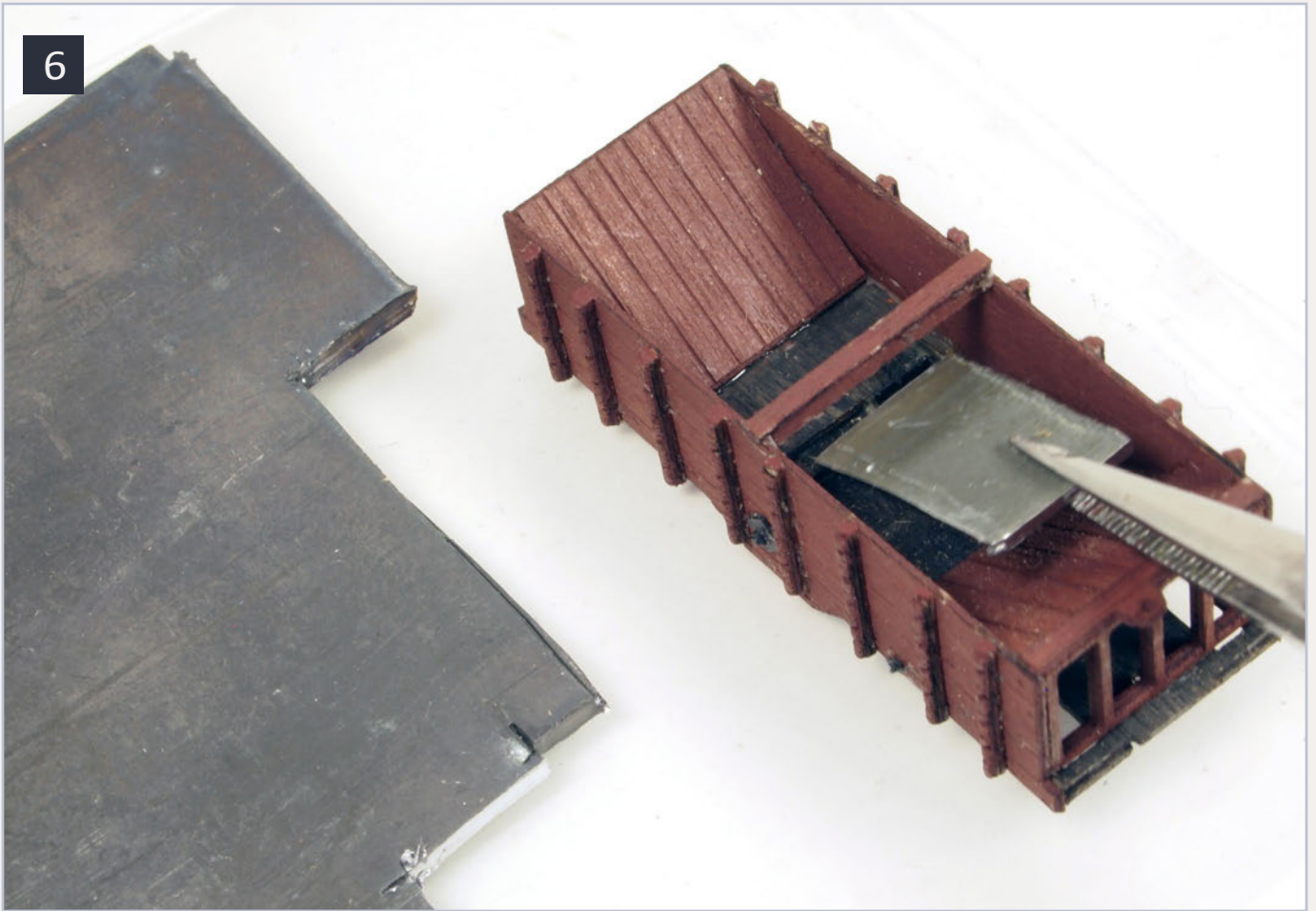

## 6. I added a couple cut rectangles of lead sheet to the bottom of the car for added weight.

The frames have holes pre-drilled for the MTL 905 coupler screws, making mounting them a simple task (though still go easy on the applied force!).

With the first two cars I built, I attached three rectangles of 1/8" lead weight with CA to the bottom of each car. This proved a little too heavy, and in the other four I added only two rectangles each. Brush the lead tops and car sides with white glue, then spoon in coal (I use Timberline Scenery's Fine Coal) to create the load. I use an eyedropper to carefully apply a few drops of 70% isopropyl alcohol to wet the coal, then one or two drops of diluted white glue to fix the load, taking care not to over-saturate and soak the wood of the car itself.

[... On to next page of text →](#)



contents



index

## It just keeps getting better ...

When I wrote this article a year and a half ago, I used the Archbar trucks available from Micro Trains. Since that time, many fine modelers have created late 1800's / early 1900's trucks and details using 3-D printing.

I recently received sets of wood beam and Allen / "California" style archbars trucks from Panamint Models (Eric Cox) for some ventilated boxcars I was working on. The trucks have great detail and, while a bit fragile, they run and look great.

I tried out a pair of the Allen archbars on one of the 20-ton coal cars and liked the look.

The trucks come from Shapeways and require careful cleaning to remove any grease or residue left over from the 3-D printing process. I spray painted mine Floquil Grimy Black then applied NeoLube to the journal boxes and other "metal" parts.

A quick dusting of weathering powder helped to age the trucks. NeoLube also stains the couplers, cutting the plastic shine, and keeps the action smooth.

Modeling early steam keeps getting easier. Several models have been released recently which fit this era:

- The new Atlas 4-4-0
- Bachmann's 2-6-0
- MicroTrains' Civil War-era rolling stock
- MicroTrains' wood beam truck bulk packs
- CG N Scale's ventilated boxcars, stagecoaches, and steam donkey crane
- Panamint's pre-1900 variety of trucks and link-and-pin couplers

Looks like 2013 is shaping up to be a very exciting year for early steam in N scale! ■







**7. The Micro Trains archbars are on the two cars to the left, while the Panamint Allen archbars are on the car on the right. Panamint also makes Fox trucks, both standard and short versions, which would probably fit the smaller Nn3 20-ton cars even better as well as look more prototypically accurate.**

[... Sidebar continues on the next page →](#)



contents



index

## It just keeps getting better *Continued ...*



8. I love the look of Chris Schmuck's 20-ton coal cars, as they instantly time warp almost any layout back to the 1890s and early 1900s.



**9. While my daughter and I built our Alameda-Belt-in-a-Box shelf switching layout to be set in the years immediately after WWII (see the article in MRH Nov 2012), just by replacing the rolling stock with the 20-ton cars, ventilated boxcars, and one of Atlas' new 4-4-0's – we've created something that a young Jack London might have seen while he was clam digging on the marshy peninsula.**



[← back to previous page of text ...](#)

The kits come with scribed interior details, but I wanted cars with full loads. As the cars track a bit light, adding a coal load also allows the insertion of a few rectangles of lead weight:

Brush some grimy/soot weathering powder on the sides, inside walls and rim to create the dirty state these cars were in for their working lives. A few rust highlights on the NBW details reflect the constant battering these cars took, not only by the job, but by the elements as well. If anything, my cars are too clean, and need a bit more battering to truly play the part.



10

**10. On the author's Mt. Coffin & Columbia River layout, set in the early 1900's in the Pacific Northwest, a Ten-Wheeler spots a pair of 20-ton coal cars on a scratch-built coal unloading dock.**

Chris Schmucks' photos on the RLW website show the couplers painted the same red-oxide as the cars. I left mine black, but cut the trip pins short and used powders to weather the coupler and box. To create a hint of metal under the soot and wear of the trucks, I spray Scalecoat Graphite onto a plastic food-container lid and then paint the springs and metal bands with a fine brush, over which I weather with rust and soot powders. (Note: NeoLube works very well to stain and weather both trucks and couplers without sticking them shut like paint! -- MCF)

As each pair is a two-evening project, you'll have a great cut of six 20-ton coal cars by the end of the week. Fun to build and detail, these hoppers make for an eyebrow-raising, era-evoking element of any Turn-of-the-Century layout.

[... Sidebar continues on the next page →](#)



M.C. Fujiwara is a writer and editor, as well as the model railroad layout designer of Yardgoat Layout Designs ([yardgoatlayoutdesign.com](http://yardgoatlayoutdesign.com)). He lives in his native San Francisco Bay Area with his wife and two children, who enjoy helping their dad build his N-scale layout projects by making trees, painting rocks, and running trains.



contents



index

# The Mt. Coffin & Columbia River

The layout in the cover photo is my Mt. Coffin & Columbia River, a 23"x41" N-scale design based on the cannery industry along the Columbia River of Oregon in the early 1900s.

This layout started as a "chunk" from an old layout. The dimensions are based on this old chunk that screamed "don't throw me out!".

As someone who has moved about once a year for the past 12 years, I'm very much into small, portable layouts.

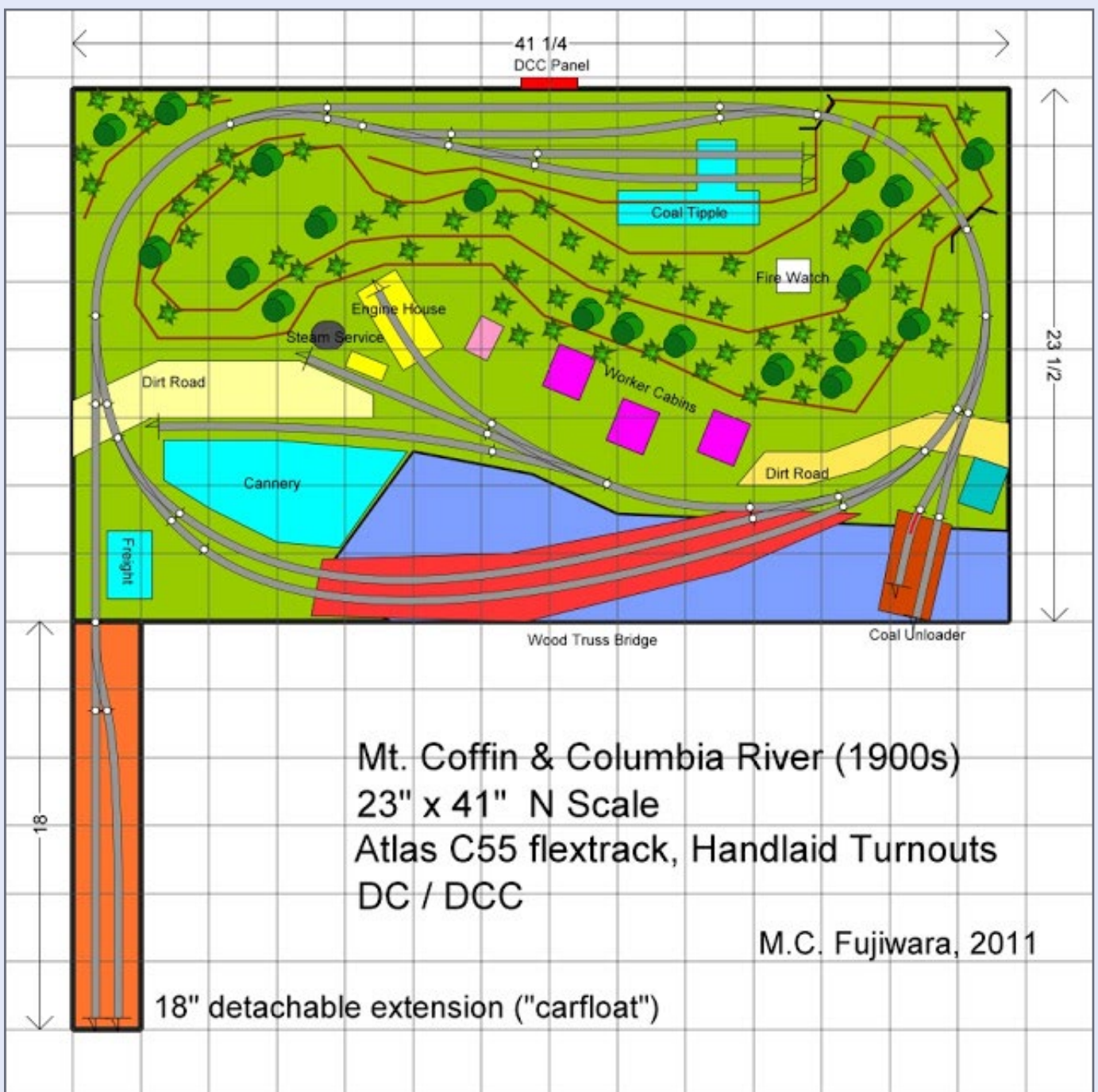

I chose the Columbia River (Oregon) between Portland and Astoria because my grandparents lived around there from the 1930s on, and I really like the feel of the water and greenery of the area. I backed up the era to the early 1900s because I like steam and wood.

I do have a specific future layout in mind, and so I thought this "chainsaw layout" would allow me to develop certain skills: handlaying curved and three-way turnouts, scratch building structures such as mines, canneries, wooden truss bridges, and ore unloading docks, building different kinds of trees, and so on.

It's funny how these temporary layouts soon become a time- and skill-sink all their own! This layout that was supposed to be done in a couple of months took over a year and a half to get somewhere near "good enough".



**11. Here's the final layout, just before it was dismantled. It served its purpose well as a test bed for learning various techniques.**



contents



index

## The Mt. Coffin & Columbia River *Continued ...*

The inspiration for this layout was some period scenes along the Columbia River in Oregon. Although freelanced, I wanted to have some Columbia River signature scenes in there like this cannery (12).

I also wanted to get the steep, conifer-covered slopes and the rock tunnels that are common along the Columbia River (13).

On the wall in front of my workbench I posted up these and many other photos of the Columbia River for easy reference while working. One of the most satisfying moments was when I showed photos of the half-finished layout to my 92-year-old Grandmother and, without me telling her where I was modeling, she said, “Oh, that’s the

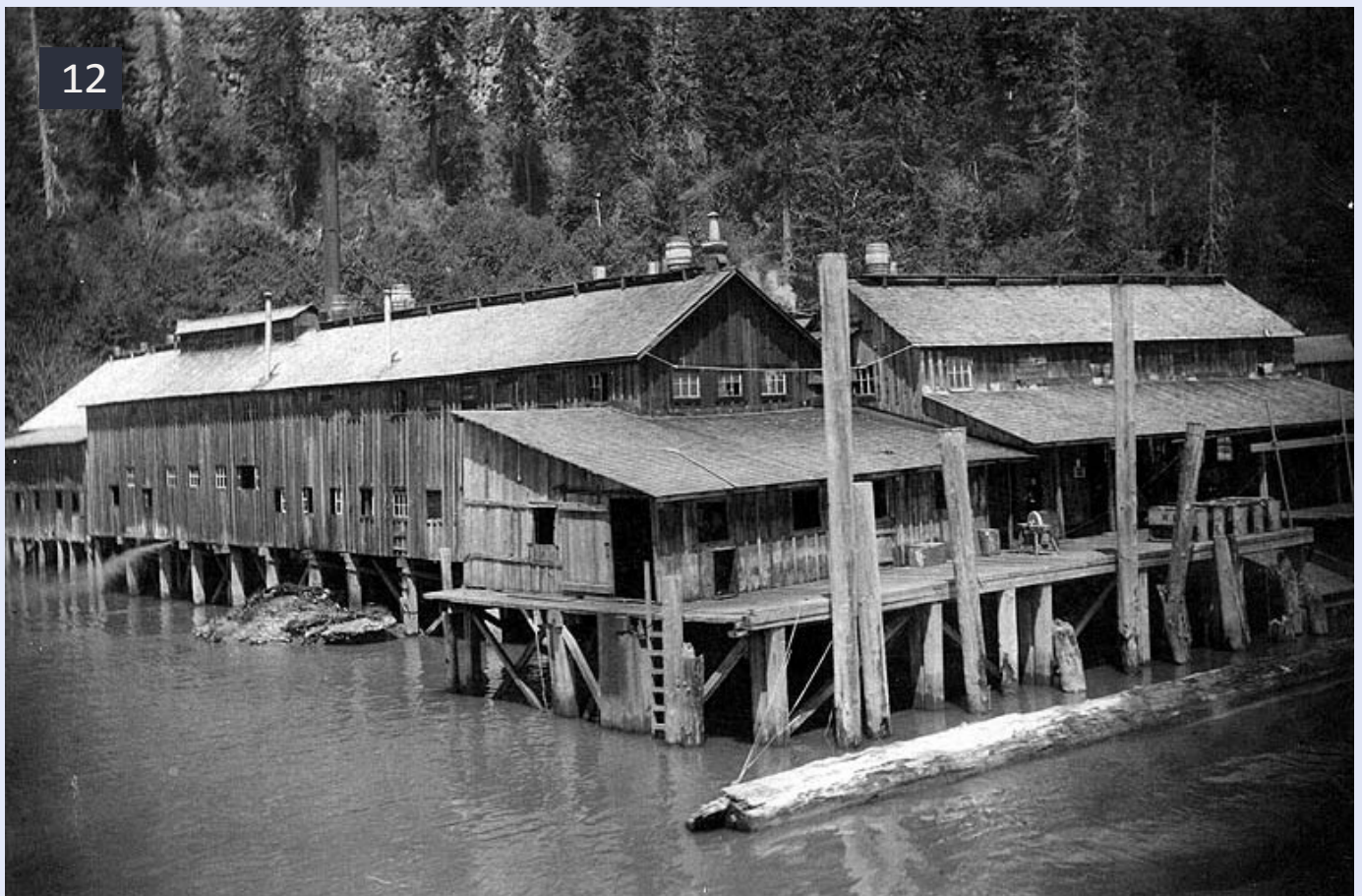

**12. Here's a turn-of-the-century early 1900s cannery along the Columbia River in Oregon. This is the feel I wanted to capture with this layout (University of Washington Digital Collection).**



Columbia River, isn't it!" That's when I knew I was doing something right!

Part of the challenge I gave myself on this layout was "nothing under the layout". So even though there are some wood supports under this one, I told myself nothing goes under the ply support, to mimic the real shelf conditions: all wiring and power block/lighting toggles are all in the fascia and in channels in the foam (14).

Since I was planning to use DCC for this layout, I created a space for the NCE DCC panel in the middle of the mine side of the layout, mainly because that was the only area that had room for the electronics. While the riverfront scene is the "front" side of this

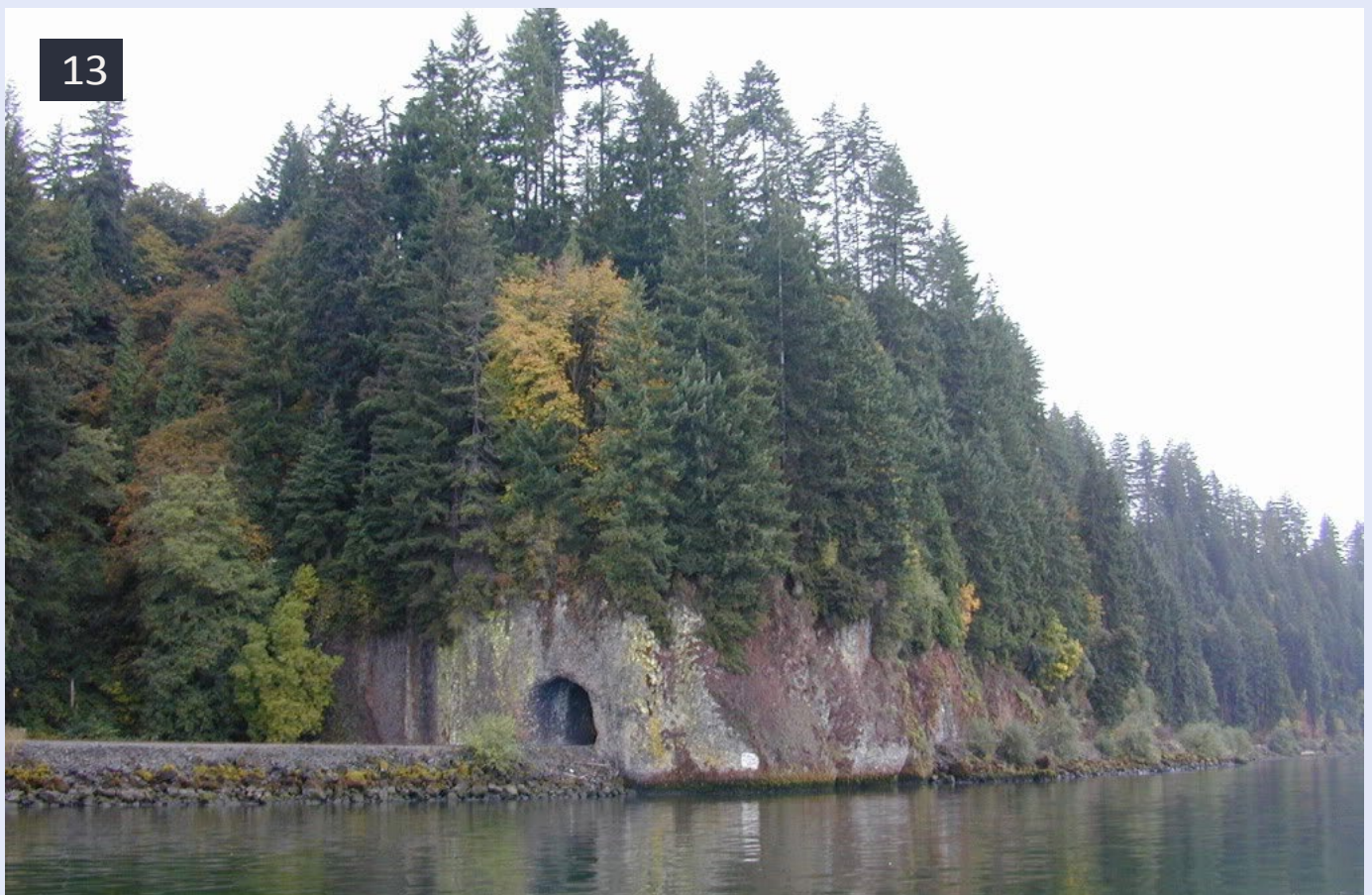

**13. One of the signature scenes along Oregon's Columbia River that I wanted to capture with this layout. Looks like we're going to need a lot of fir trees (Photo by Jim Nieland: [panoramio.com/photo/4373679](https://panoramio.com/photo/4373679)).**



contents



index

## The Mt. Coffin & Columbia River *Continued ...*

coffee-table-top layout, the only area available for a DCC panel—the far left—was needed for the detachable staging (that never got built).

I tried Great Stuff to foam the mountains together: but I would not use Great Stuff again. Caulk, though it takes longer, is easier (after drying) to work with. Great Stuff is more airy and it files/shapes quite a bit differently from the foam.

I used cork roadbed on this layout for the main with the rest of the track attached with caulk directly to the foam. The compact layout design forced me to learn how to hand lay both multiple-turnout fixtures (largest had 4 consecutive curved turnouts all built as one unit)



**14. Photo of the layout under construction, with the wiring tucked in a channel cut in the foam that will go behind the fascia (not installed in this photo). Looks like we need a couple hundred more fir trees!**



## 15. Close-up shot of the layout, with the large out-of-scale "catapult" turnout ground throws very apparent in the scene.

as well as a 3-way turnout. The sharp curves and short locos necessitated powering the frogs which I did by installing slide switches on styrene sections secured under—and actuated by—the throw bar.

One challenge was the N-scale ground throws: they're a bit big, and the camera makes them seem even bigger. I call them my "catapults".

I really wish Caboose Industries would make some real N-scale ground throws (their "N Scale Ground throws" are still too big for HO), but they don't. Darn physics.

So it's a trade-off: I and my kids really like flipping them with our fingers, and I can ignore the hugeness, but they sure do look enormous in photo close-ups. As I get more and more into more "realistic" looking layouts, and especially photography (a very recent interest), I'm becoming more and more aware of those scaling issues and totally appreciate getting called out on them.



## The Mt. Coffin & Columbia River *Continued ...*

And the next layout I build, I'll be using low-profile slide switches as both turnout control and frog-power router following Steve Lohr's article on "Easy Slide Switch Turnout Control" in N Scale Railroading (Jan/Feb 2011) [Writer's note: Recently I've been using Fast Tracks' Bullfrog turnout machines on my Free-moN modules and like them very much, though they do require about 2 ½" of space under the baseboard]

I ballasted the "mainline" with cinders, then poured some tinted Magic Water into the river area. I added Mod Podge Gloss on top to create more slow-moving river ripple effects. Mod Podge is



**16.** "Boating Railfan" shot made by placing the camera on the water. Even a small N scale layout can look large when shot from interesting angles!

inexpensive and looks great when it first cures. However, I've noticed over time that the Mod Podge both attracts and traps dust and debris, so next time I'll try WS Water Effects or some Matte Medium to create the rolling water.

I built up the harbor area with a basswood retaining wall, as well as scratchbuilt a small ore/coal unloading dock.

For scenicking the gorge (a mini "Bellina Drop" viewblock separating the waterfront from the mine), I used plaster rock molds, paint, dirt, ground foam, chopped moss and a lot of pine trees.

---

**“My Big Jug O' Stain (BJOS) is a large glass spaghetti sauce jar in which I keep my weathering/staining solution. I make this solution from 70% isopropyl alcohol, India Ink, and Woodland Scenics 'Earth Colors'... ”**

---

I made the trees using Ace twine fiber between Michael's floral wire twirled in a drill, spray painted grimy black, and then hairsprayed and sprinkled on Woodland Scenics "conifer" ground foam. You can still see the twisted trunks, but I need 300+, so only the outer trees near the layout edges got real trunks in the end. Trees on a ridge are a great partial viewblock: they raise the scenic divider (in this case a mountain ridge) up an additional 4-6 inches, yet the spaces between branches and trunks allow the eye to monitor train movement on the other side.

My Big Jug O' Stain (BJOS) is a large glass spaghetti sauce jar in which I keep my weathering/staining solution. I make this solution from 70% isopropyl alcohol, India ink, and Woodland Scenics "Earth Colors" Black, Burnt Sienna, Burnt Umber, maybe some slate grey, probably some PollyScale grimy black, and a little more India ink. It's more or less whatever looks right.



contents



index

## The Mt. Coffin & Columbia River *Continued ...*

I throw the basswood strips in there to stain them when I build bridges or am making us some replacement ties. I dip a brush in there and paint the sides of cars and styrene buildings to weather them (with various levels of success). I dip a paper towel in there and blot the cedar shingles to color them before applying to the roof.

I've had the same jar for at least two years. When it starts to get low, or weak, I throw in more alcohol and whatever else I think it needs. Usually more India ink and some kind of brown color. It's a little like Pappy's moonshine: not exactly sure what the recipe is, but when you start to go blind it's done!

On a whim I realized I could rest the camera on the water to get the shot in figure 16.

I haven't been able to find any NBW details in N-scale, so I use Grandt Line HO-scale 1-1/2" NBW for the small ones and Grandt Line O-scale 1" square NBW for the larger square ones. It pays to poke around in other scales' bins! I used the combination to detail the bridge, the coal unloading dock and the 20-ton coal cars from RLW.

In all cases I paint the heads first (usually grimy black), use a knife to cut off the heads and then apply to the structure with the same wood glue I use to build the building.

The HO bolt heads are so small and round that I lose 10%-25% just by having them fly out of the tweezers as I go to apply them.

I just wish there were realistic N-scale rivets out there! (Archer now makes N scale rivets, just Google "Archer N scale rivets". - MRH)

This layout has been definitely worth it in terms of skill-building. I've learned:

- Handlaying your own turnouts is both extremely satisfying as well as layout-design liberating: no longer are you at the mercy of manufacturers' frog sizes or turnout lengths!

- Do your trackwork right the first time and make it perfect so everything and their mothers can run on it.
- Power your frogs!
- Don't spend all that time scratchbuilding structures and creating nice scenery and then use catapult-sized ground throws.
- Did I mention have great trackwork and powered frogs?

Maybe all this layout needed to really finish it off was some seagulls and salmon? That, and I would have had to go back and redo all the trackwork to get it perfect (ah, the price of learning). In January I was having lunch with layout design guru Byron Henderson at the Bay Area LD/OPS SIG Weekend event, and, while we were discussing the importance of “letting go,” he put it pretty succinctly: “Keep the lessons, lose the layout.”

Which is a pretty good lesson in itself to keep, along with all the scratch-built structures, trees and many, many photos and videos of the layout before it goes to its own trash can Mt. Coffin.

There's always another layout!

For more ...

For more on the Mt. Coffin & Columbia River, including lots of construction details, see M.C. Fujiwara's blog entries on the MRH website:

Part 1: [mrhmag.com/node/5556](http://mrhmag.com/node/5556).

Part 2: [mrhmag.com/node/6483](http://mrhmag.com/node/6483). ■



contents



index

# Yes, it's a model

**Model Railroad Hobbyist's  
monthly photo album**



**1: David Plummer posted this modern-era BNSF photo on the MRH website recently. David says of this photo:**

“These two former Santa Fe locos are Overland models that I weathered to represent their present-day look on the BNSF. My weathering techniques include: paint and chinks applied with brush, airbrush and washes. I feel weathering has been the most creative hobby advancement in recent years. I shot this on the Houston Society of Model Engineers layout.”







**2: Rolling the clock back about 60 years, we have this photo of the Santa Fe from the middle of the previous century. Crandell Overton, who posted this photo, says:**

“On the fictional Seneca Falls Subdivision, this Santa Fe 4-8-4 the head-end power slows to a stop while taking late-day commuters to their various destinations. The Seneca Sub is somewhere west of the Great Plains (perhaps in the Dakotas). As the sparse vegetation suggests, rain generally doesn't fall a lot this far out from the Rockies. In recent years, due to the heavier trains and motive power, the yard tracks constantly undergo repairs. A homebuilt water column looms in the foreground.

“This image is actually a composite of at least six stacked images in order to derive the sharp depth-of-field you see. The steam and smoke effects were hand-drawn with the cloning brush in Sagelight™ Image Editor.”



contents



index



**3: Bill Beverly, a member of the Slim Gauge Guild club, originally took these photos in color, but we made them B&W because we thought the period look made them even more classy. Bill says:**

“The engine in the top scene is an Sn3 K-28 pulling a freight cars assembled, painted and weathered from kits. The scratch-built trestle follows a prototype that existed on the Rio Grande Southern that ran from Ridgway to Durango Colorado.

“The engine in the lower scene is an Sn3 K-27. The K-27 is rolling through the big trees area of the S-scale layout where there's a lot of logging. If you'd like to see more, the club will be open at the National Narrow Gauge Convention in Pasadena, CA this August.”



**4: Michael Tolich's SP locos caught our eye and we asked about them. Michael responded:**

“Cotton Belt SD40T-2 8325 and SD45T-2 9387 lead a run through freight over my Pacific Western as they head for the Southern Pacific connection at Oakdale. Here they're passing Tri-State Milling in Green River.

“Loco 8325 is an earlier Athearn Blue Box unit I detailed, painted and weathered some years ago, while 9387 is a later version Athearn tunnel motor which I weathered.

“My Pacific Western is a fictional bridge line and my first real effort at a layout in years. It has been good to get my models out of storage and see them operating. I am enjoying working with the many new scenery products and models on the market these days. But I think the best thing about getting back into model railroading has been re-connecting with old friends and making new ones.”

We heartily agree, Michael. It's the people in the hobby and sharing with them that makes it particularly fun.



contents



index



**5: Jerry Krueger posted this photo of his weathered Rio Grande covered hopper on a recent Weekend Photo Fun thread. Jerry perfectly captured the look of a hard-working in service car.**

Jerry says, "This is an Atlas O scale single bay Airslide covered hopper. It has been weathered using a combination of artists oil paints and weathering powders. I airbrushed it with 'mud' along the underside to bring out the details, then applied a light wash of weathered black as a final coat to blend the weathering and to tone down the weathering contrast on the stark light gray car.

"I typically model in HO scale, but I saw some O scale rolling stock that I like, so decided I wanted to try my hand at some O scale for a change of pace."

We think your change of pace shows excellent work there, Jerry. Nice job, and show us some of your HO modeling too!



**6 and 7: It's hard to have enough superlatives to describe the realism of the modeling in these two photos. This is what you get when you combine the expertise of a half-dozen accomplished modelers with a skilled photographer: an amazing team effort!**

Just as an interesting co-incidence, the gondola in the upper photo is the work of Gary Christensen, the modeler Ken Patterson features in this month's *What's neat this week* column. Small world!

Jürg Rüedi purchased these models from a number of modelers, and he also had his friend Stefan Foerg do the scenery on these modules. Jürg took the photos. To see these photos in jumbo size, check out the next couple of pages ...



contents



index



**6: When we first saw this image, we had to do a double-take. The grass and vegetation all look totally natural, and the station wagon fine detail does not shout “HO model” like most model automobiles do. As if this wasn't enough, the railcars and the loco look absolutely superb. The detailing, the weathering and the graffiti (we're sorry to say) all look spot on.**

Jürg Rüedi purchased the CP Engine from Rodney Walker, and he got the two railcars from Gary Christensen. The diorama was built by Stefan Foerg, and the automobile in front is a resin model from NEO Models. For a complete thread showing step-by-step photos of Stefan building scenery, see this thread on the MRH website:

[mrhmag.com/node/12298](http://mrhmag.com/node/12298)



This isn't all ... go to the next page for more from Jürg Rüedi →



contents



index



**6: This is the first of Jürg's images we saw posted on the MRH website and it's a dandy. From the reflection in the water to the composition, lighting, and depth of field, it's an excellent quality model photo, clearly a standard-setter for *Yes, it's a model*.**

Jürg Rüedi says, "This picture shows a BC Rail Car from Gary Christensen and an engine from Jim Rinker. The diorama is about the size of a laptop computer and was built by my German friend, Stefan Foerg."





Jürg admits his own modeling isn't up to this level, but it's easy to see his photographic skill is first rate, and his eye for excellent modeling is second to none. There's also something to be said for a model railroader who knows how to collect the work of many modelers together to get a superb, top-notch whole. Jürg Rüedi clearly knows how to do that, and using his photography skill to show off the work of these modelers allows the rest of us to appreciate what's possible in this hobby if we work together!



contents



index



Here's Stefan Foerg (left) and Jürg Rüedi (right) when Jürg went to Germany (4 hours drive from Switzerland) to pick up some modules Stefan had built for him.

We're trying to convince Stefan to write some articles for MRH!

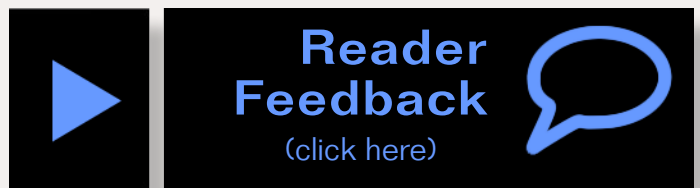

## Get your photo here!

Our *Yes, it's a model* monthly photo feature presents some of the most inspiring modeling and photos from the MRH website. If you'd like to get *your modeling* in our photo feature, just start posting your photos on the MRH website, especially in the [Weekend Photo Fun thread](#) created each weekend.

Many of the photos posted show HO modeling, but we'd like to encourage modelers in other scales to post on the MRH website as well. We don't want this to just be an HO photo feature!

For info on how to post photos to our website, [see this help how-to](#). You need to be an MRH subscriber to post photos to our website, and becoming a subscriber is free, [just fill out this form here](#).



# **iBachrus** inc

**RUNNING ON QUALITY**

## **MODEL TRAIN RUNNING STANDS**

The complete Locomotive Running Stand that will support your locomotive AND the tender.

And it's modular, so locomotive size is limitless.

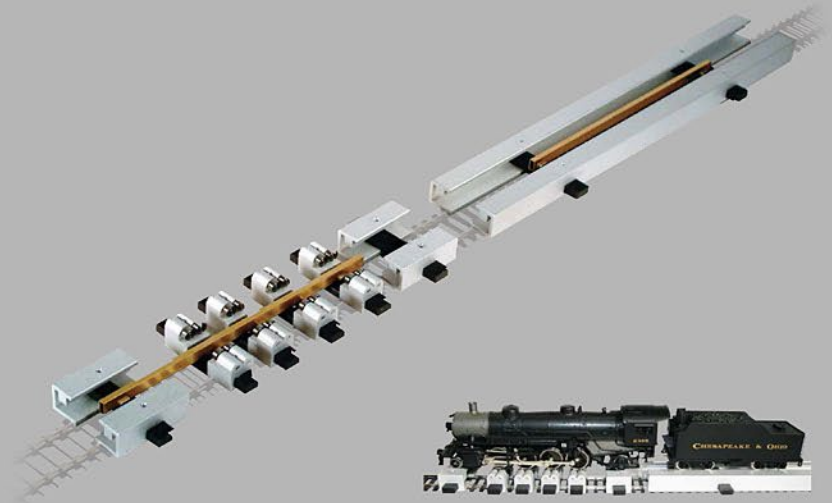

## **MODEL TRAIN SPEEDOMETER**

Measure the real-time speed of your locomotive while on the running stands.

Decoder Pro version also available.



## **MODEL TRAIN WHEEL CLEANER**

The easy way to scrub your wheels clean – just add a motor.



[Click here to learn more](#)





# Makin' Smoke

– By David Salsbery  
Photos by the author



How to get locomotives, buildings and other things on the layout to smoke ...

**I** run steam locomotives on my N Scale Stevens Pass layout, but the lack of smoke and steam from the locos seems unrealistic, especially those with sound.

Photos in various magazines with smoke or steam appear to have been Photoshop-enhanced to add the effects. While this is nice for photos, it didn't solve my desire to have the smoke come from the locomotives while running on the layout.



So I stopped and asked myself, “Could I come up with a way to create the effects of smoke and steam coming from my locos running on the layout?”

After some experimenting, here’s the technique I developed.

## Getting smoke in my steam locos

To create the smoke for my N scale steamers, I use Q-tips swabs as the starting point. I cut the swab stick in half; this gives me two chances for each swab, one for each end.

I tease out the cotton using a dental pick; a round toothpick also works, and I pick at the cotton little by little. I aim to tease it out into a thin, airy texture that will look like smoke or steam (2).

I like to leave as little cotton as possible attached to the shaft of the swab when I am done. It took me a little practice to get some good enough to be classified as keepers. Those that didn’t turn out to my liking were used for smaller projects that I will share with you a little later.



**1. Typical locomotive without smoke.**



contents



index

Once I have finished teasing out the cotton of the swab (3), it's decision time. If they are being used for steam release, I don't paint them – I declare them done. For these, all I need to do is attach them to the locomotive or some other equipment's steam vent.

To make smoke rather than steam, I poke the swab shaft into a base of cardboard or foam. I prefer to do spray painting outside with a rattle can of Krylon or Rustoleum dark gray primer – I find it makes a nice dark smoky color (4).

I have also found the cotton tends to blow around a little while I am spraying it, which makes it harder to control the paint application. To keep this from happening, I hold the cotton down with a skewer or a tooth pick.



**2. The beginning of the teasing process.**

**3. The finished look of the teased swab end.**



#### **4. The teased Q-tips swab painted dark gray and ready to install in a locomotive.**

To create the effect of smoke going over the boiler of a locomotive, I stand the cardboard/foam base holding the teased swab up so that the smoke hangs down at a 90° angle while it is drying. If I want the smoke to go straight up, I hang the cardboard/foam base upside down.

The paint holds the cotton to shape once it has dried. After the paint has dried, for variety I sometimes tease the smoke out a little more to create a multi color look (6).

After the paint has dried, I cut off the excess swab shaft to prepare it for mounting in a locomotive. For maximum clearance, I cut the shaft as short as possible. I found that the swab shaft fits quite nicely into many of my locomotive smoke stacks (5).





## 5. The smoke has been added to one of my locomotives.

On some of my locomotives, the fit is a little loose so I add a dab of Walthers Goo or CA cement to hold it in place. On other locomotives, the opening in the stack is too small.

Where the stack is too small, I cut the swab staff at an angle and force the tip into the hole, then add some glue to secure the smoke.

## Adding smoke around the layout

That's about it for making smoke for locomotives, but why stop there?

I haven't seen smoke modeled very often on layouts. There are chimneys on homes, stations, factories, as well as other things that vent smoke or steam. Being pleased with the results for my locomotives, I moved on to some of my structures.



6

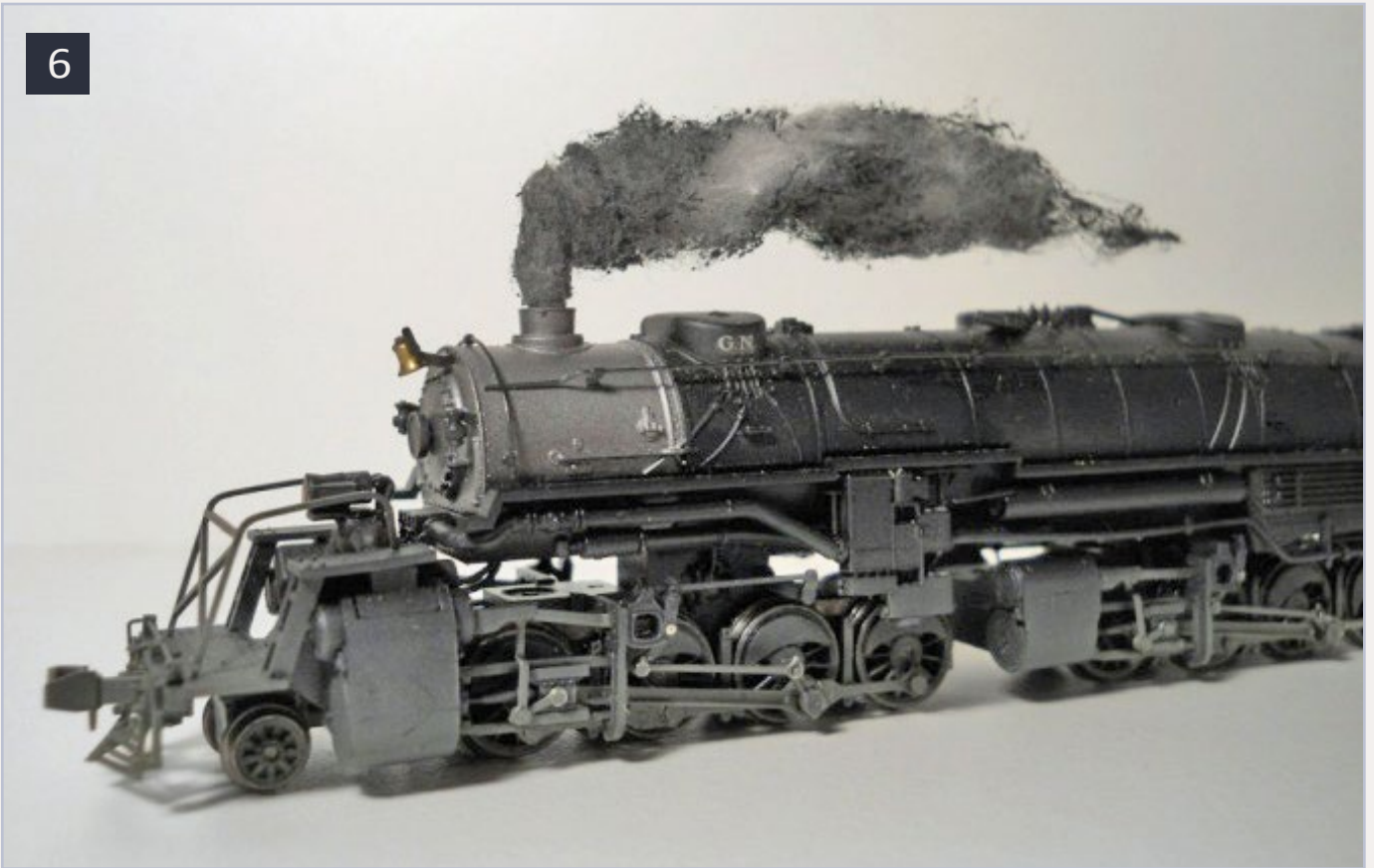

## 6. This smoke has had additional teasing done after painting.

I decided to add smoke to a Scenic Depot on my layout. I began by drilling a 1/16" hole in the large chimney. I then folded a strand of thin wire to trap a piece of cotton that I had pulled away from a swab with my fingers. I teased the cotton in the same manner as I had done for the locomotives (7).

## 7. The cotton is trapped in-between the wire ready to be teased.

7



contents



index

Once I was happy with the appearance, I painted it lightly with an all-purpose gray primer, which is a lighter color than the gray used on the locomotives. I am careful not to spray too solid of a color onto the smoke (8).

When I am done painting, I hang the painted smoke upside down to dry. This creates the effect of the smoke rising up from the chimney. Once it was dry I clipped off most of the wire and glue it into the hole that I had drilled into the chimney.

For the smaller smoke stacks I use only a tiny bit of cotton, but the procedure is the same. For these, I tease only a little bit of the cotton on the swab before painting, or I leave them unpainted, depending on their use (9).

Some items may not have a hole in which to mount the smoke, or may require a hole too small to be practical. The small pipes of rolling stock or vehicles generally fall into the category.

When I run into these situations, I add a very small amount of CA cement to the end of the pipe with a sharp toothpick. I let it set for a second or two before touching the swab cotton on the pipe, and then holding it there until the CA cement sets up.

## **8. The teased cotton with a light coat of the light gray primer.**





## 9. The depot with smoke added. It adds a nice touch.

When the cement is set, I pull the swab away, leaving just a whisp of cotton smoke. This is how I added the smoke on the smaller chimney of the Scenic Depot (9) and on some of my vehicles (11).

I have a lumber mill with a boiler house on my layout. Unfortunately, without the boilers being fired, the lumber mill won't saw any logs, which leads to no lumber being shipped. So time for some smoke in those boiler stacks!

For the industrial smoke stacks of the boilerhouse, I used the same process as the station smoke.

I made this smoke flowing in an upward direction, and I used the lighter gray color like the Scenic Depot. After making the



10



**10. A truck without any smoke.**

11



**6. The same truck with smoke added. I use the same procedures on the truck that I use on the small chimney of the Scenic Depot.**

12



**12. The boiler house without smoke venting from the stacks.**

13



**13. The boiler house is fired with smoke coming from the stacks. Sure hope the EPA isn't looking!**

*Text continued on next page ...*



contents



index

smoke and gluing it into the smoke stacks, I teased the separate smoke plumes a little more and merged them together. By doing this I am able to create the suggestion of the wind blowing them together.

There are many opportunities to model smoke and steam on your layout (14,15), from just a wisp to bellowing out like the place is on fire. I have received many compliments about the smoke that I added to the models on my layout.

Give this technique a try and see how you can use it to add life to locos and your layout!



A Portland, Oregon native, David's been modeling trains since he was 12.

David got more serious in the '90s when he discovered N scale. After building some small layouts, David discovered modular and club railroading. His current Stevens Pass oNetrak layout models the Great Northern.

David owns his own painting contracting business.

14



14. I made the smoke for my heavy crane the same way as the industrial smoke. The shaft of the swab fits perfectly into the stack, so I did not glue it in place.

15



15. For my steam winch at a logging area on the layout, I wanted to suggest some steam leaks around the edges for a little extra detail. I used the same procedures I use on the small smoke stacks except no paint.



contents



index

# THE WESTERN EXPANSION CENTRAL

A starter layout you can build for under \$500

– By Doug Forbes

First place winner of the MRH \$500 starter layout design challenge contest ...



1. While the layout here starts as a Plywood Pacific, it need not stay that way. This photo by Chet Zaiko shows what it could look like with some scenery applied,

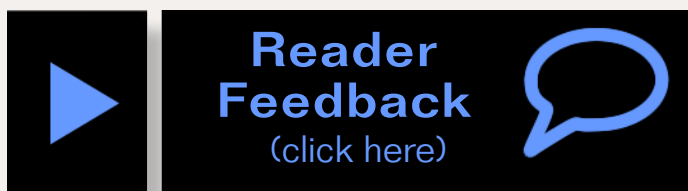

**W**hen I read about the MRH competition to spend 500 bucks, I thought about what I would do if I were to start over with nothing but 500 dollars.

As I thought about what I would want in my beginning layout, four criteria came to mind. First, I would want a continuous run so I could sit back and enjoy watching my trains run. Second, I



would want some operating potential so I could “play” or simulate operations with my trains. Third, a main line of 22” radius would be nice to run some longer equipment and have it look less toylike. Finally, I would want the layout to be expandable, so that I could easily add on and continue to use this original layout. No chain saw need apply here.

What I have come up with I call the Western Expansion Central which takes into account these four design criteria. It provides for a continuous mainline run in a 4 x 6 foot setting with a 22” radius mainline. There is also a short passing siding with a two track spur that allows for shipments to/from an elevator and team track allowing for operating potential. The wye off of the mainline is also 22” radius and allows for further expansions using 2 x 4 foot dominos at a later date by adding on to the end of the table. These dominos could proceed around the walls of the room, run out into a peninsula with a yard or another town, etc. At this point, the siding at the top right, siding A, will be an interchange/staging track, and the siding at the bottom right will be an industry.

I have chosen to set the theme of this layout somewhere in the Midwest as a modern-day shortline grain-hauling railroad. In the grain transportation network, the railroads in the Midwest haul grain to barge terminal load-out facilities. These facilities could be located on the coast, i.e., New Orleans, or at a river facility, such as St. Louis, Missouri, on the Mississippi River. The sequence begins with the local farmer taking his crop to the local elevator. The elevator would then load out the grain into covered hoppers for shipment to a bakery, ethanol plant, or if the grain was to be exported, then a river or costal barge terminal facility. This layout represents a modern fictional Midwestern town with a Class II regional railroad. While not



contents



index



them on the spur in front of the elevator. After attaching the caboose to the end of the train, the train runs around the loop several times at which point it arrives at the barge terminal load out facility. There it drops the loaded hoppers and then runs light (just engine and caboose) back to the mainline spur and parks for the night.

The operating possibilities can easily be expanded as more time and money allow for the purchase of more cars. The rear interchange/staging track could be used to spot more hopper cars destined for other locations as well as supplying box-cars or loaded flat cars for the team track located next to the

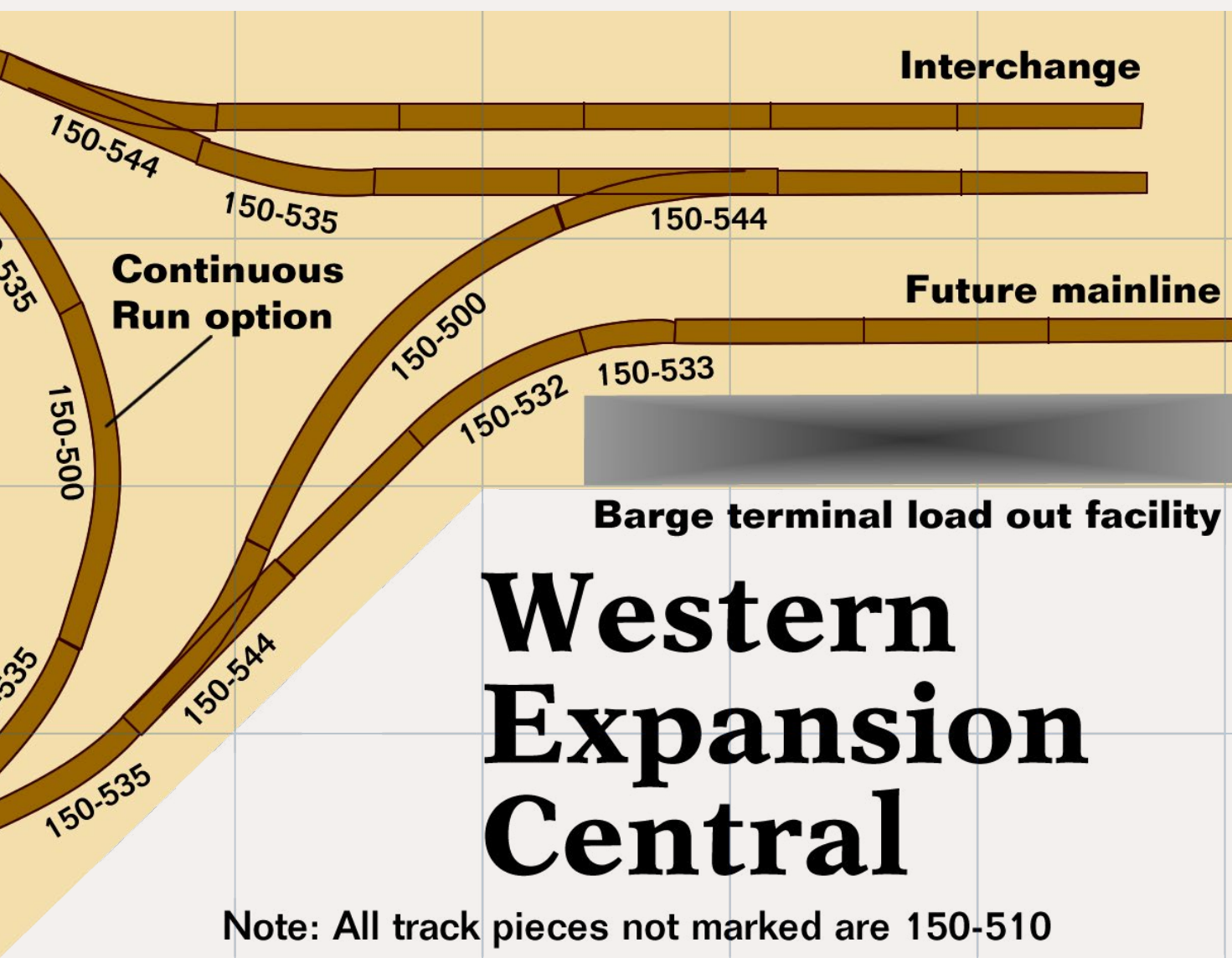

contents



index



## Local Lumber Store, RP Lumber, Illinois

Number	Description	per (\$)	Total (\$)
1	Sheet of 7/16" OSB particle board	\$13.69	\$13.69
9	1" x 4" x 8' pine boards	\$2.96	\$26.64
1	1" x 4" x 10' pine board	\$3.70	\$3.70
1	Box of dry wall screws	\$2.00	\$2.00
1	Bottle of wood glue	\$2.00	\$2.00
	Total		\$48.03

The odd shaped piece will need to be flipped around up side down to make the extension off of the end. Build a frame using the diagram in figure 4 to go underneath it as shown using 1" by 4"s. For the legs, cut five of the 1x4" 8 footers in half and glue and screw them together to form an ell to make the legs resulting in a table height of ~48 inches.

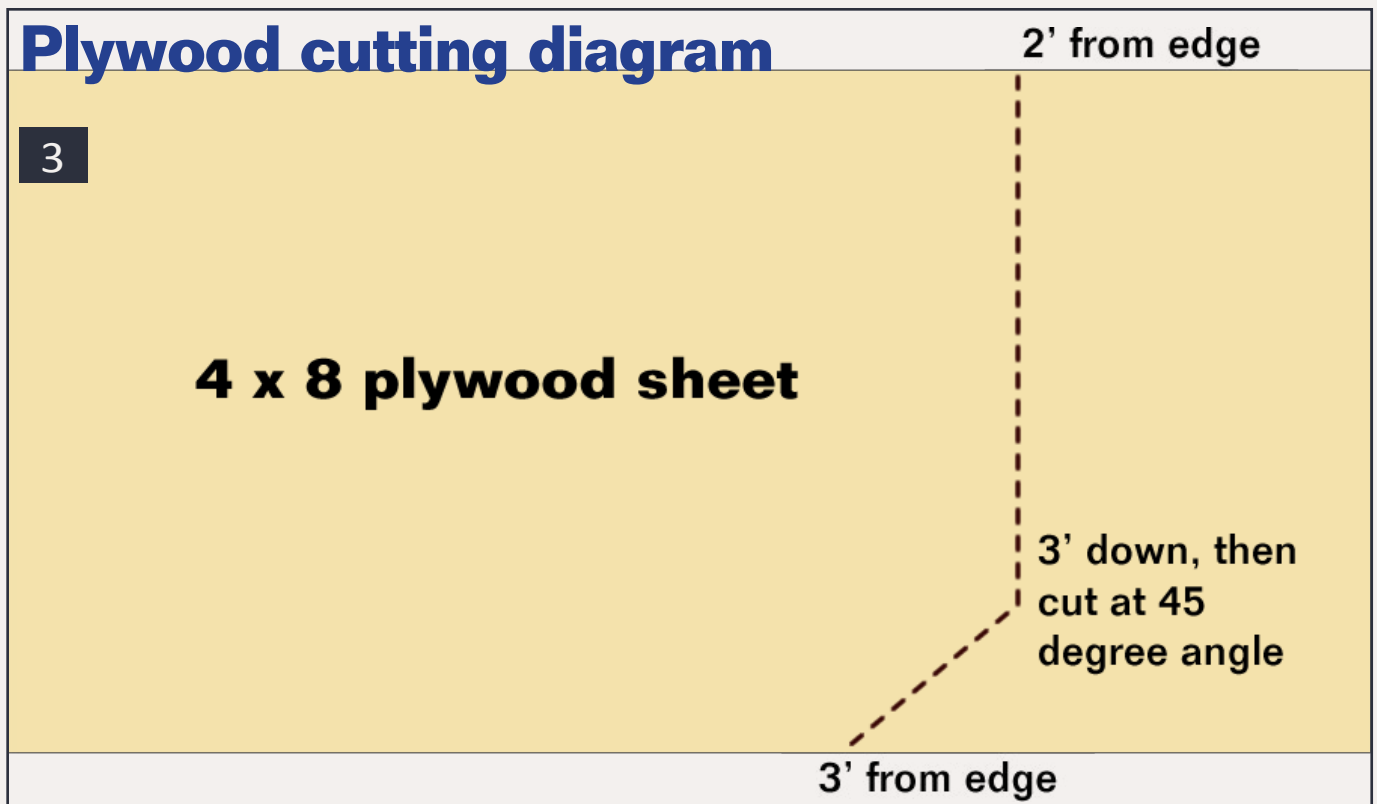

**3. To build the table, cut the plywood as shown.**



contents



index

I have designed the layout using Atlas Right Track software. The track components can be laid out with the centerlines marked, the cork roadbed laid out, and the track glued down on top of the cork. The only gaps needed at this point are double gaps on both tracks off of the wye as it's a reversing section. The DPDT switch will then be used to flip the polarity as this creates a reversing section on the layout. The turnouts will be controlled by installing the Caboose Industries ground throws. The throttle can then be connected to the track to provide power.

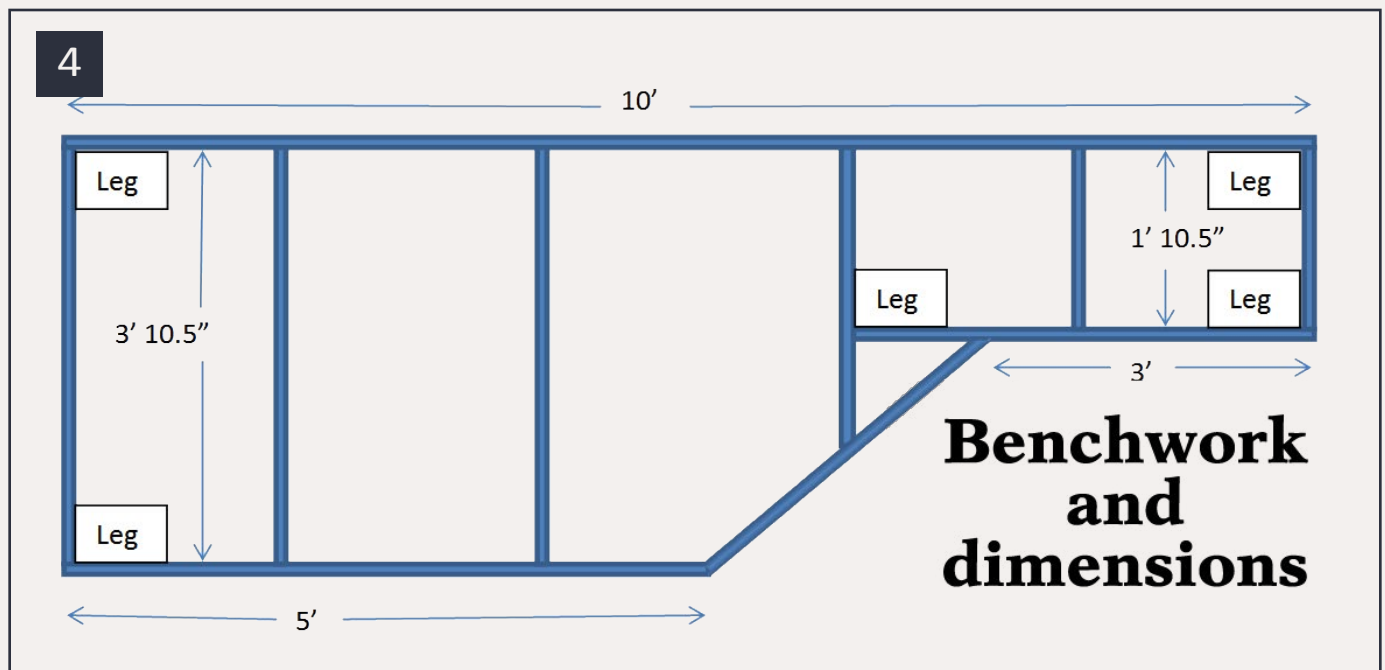

#### 4. Build the frame.

## \$500 Starter Layout Contest Rules

Here are the rules for the \$500 Starter Layout Challenge Contest we ran from August to November of 2012.

- You have a \$500 total budget.
- Assume basic tools: hammer, saw, drill, screwdriver, scissors, single-edged razor blades, soldering iron.

BLUE RIDGE HOBBIES Prices			Code 83 track	
Nbr	Item nbr	Description	per (\$)	Total (\$)
2	150-500	flex track	\$4.64	\$9.28
20	150-510	9" Straight	\$0.96	\$19.20
1	150-532	Full Section 18" Radius pkg. 6	\$5.67	\$5.67
1	150-533	1/2 section 18" radius (4 pcs./pkg. - 1 Element req'd)	\$3.09	\$3.09
3	150-535	22" Radius (6 pcs/pkg. - 16 Elements required)	\$5.67	\$17.01
3	150-542	Snap Switch left - manual	\$10.96	\$32.88
1	150-543	Snap Switch right - manual	\$10.96	\$10.96
4	150-544	22" Radius Snap Switch left - manual	\$11.33	\$45.32
1	150-545	22" Radius Snap Switch right - manual	\$11.33	\$11.33
SUB Total Not including shipping				\$154.74

Other Components, Blue Ridge Hobbies prices				
Nbr	Item nbr	Description	per (\$)	Total (\$)
1	500-200	Throttle - MRC	\$56.72	\$56.72
2	472-3015	Midwest Cork Roadbed, box of 5, 36"	\$6.64	\$13.28
2	97-5202	Caboose Industries Ground Throw, pkg. 5	\$11.12	\$22.24
		Wire – hookup wire from Wal-Mart	\$4.00	\$4.00
1	475-3610002	Miniatronics DPDT toggle (reversing sec.)	\$6.04	\$6.04
6		Railroad Cars – hoppers	\$15.00	\$90.00
1		caboose	\$15.00	\$15.00
		Total		\$207.28

- Assume advanced tools like a table saw, router, or lathe are NOT available.
- Must design an operating layout or module (continuous running optional).
- Include a shopping list not exceeding \$500 - must cover benchwork, road bed, track, wiring, control system, rolling stock, locos, structures, and scenery.
- Common items listed on the web like eBay or Yahoo train yard sale okay.
- Thinking outside the box encouraged.



contents



index

<b>Scenery</b>				
<b>Nbr</b>	<b>Item nbr</b>	<b>Description</b>	<b>per (\$)</b>	<b>Total (\$)</b>
1	Wal-Mart	Brown paint	\$10.00	\$10.00
		Rail tie brown spray paint	\$3.00	\$3.00
1	933-3036	Farmers Cooperative Rural Grain Elevator	\$26.39	\$26.39
		Ballast		
		Ground Foam		
		Trees		
		City buildings		
		Barge load out facility		
		<b>Total</b>		<b>\$39.39</b>

<b>Total costs</b>	
<b>Category</b>	<b>Cost</b>
Construction Materials	\$48.03
Track	\$154.74
Engine	\$50.00
Other Materials	\$207.28
Scenery	\$39.39
<b>Grand total</b>	<b>\$499.44</b>

## Conclusions

This layout fits the goals of the competition. This is what I would do were I to start over with just 500 bucks. This provides operating interest, and a wide range of modeling opportunities. It also has a lot of room for details to be added. A critic might argue that the layout isn't finished with scenic elements. I would counter with the following arguments. First, the



operating potential should outweigh the visual appearance as it provides true enjoyment, not just something that is pleasing to the eye. Secondly, if someone wanted a more finished layout, they could simplify the track arrangement by not purchasing some of the track such as the turnout for the interchange/siding as well as the turnout to double-track the elevator.

By not purchasing these two turnouts and associated track, \$30 would be freed up to purchase scenic elements such as trees, ground foam, a road through town, or a store for the downtown. These turnouts could then be added at a later date as more money and time allow providing more operating interest. Were I to start over again, this is exactly what I would spend my 500 bucks on.



Doug got started in the hobby when he and his twin brother and received a Bachmann Power House train set for Christmas in the 6th grade – and it's grown from there. Doug models the original main line of the Illinois Central from Centralia to Decatur in the late 1950s in HO scale. Doug has also built several G scale cars from the plans in *Garden Railways*.

Outside of the hobby, Doug teaches science at a rural high school in southern Illinois. His wife, Christy, is a nurse practitioner and they have three children: Abby is 10, Anna is 7, and Isaac is 4.



contents



index

# Writing for MRH

– Tom Patterson  
Photos by the author

## Submitting an article to MRH can be rewarding and fun

1. I submitted the picture of the bridge above to verify depth of field and acceptable exposure levels.

**T**here are frequently questions on the MRH forum about submit-

ting an article to Model Railroad Hobbyist Magazine.

I thought it might be helpful to see the process from the perspective of someone who recently put together an article. This was my first attempt at writing an article for publication in anything, and I had very little experience at taking digital photographs.



So let me walk through what was involved in getting an article on modifying a Central Valley bridge published in the November 2011 issue of MRH.

## GETTING READY

The first step was to determine whether or not MRH would have any interest in the article I had in mind. I sent the e-mail below by clicking on the "Have an article idea" drop-down on the Authors heading at the top of the MRH home page. In my inquiry, I made sure to provide some background information on the project along with a brief description of what the article would include. This isn't cast in stone, and changes and or modifications can be made as the article progress.



Joe/Charlie-

I'm getting ready to modify a Central Valley Pratt truss bridge and wondered if this would be of interest as a short how-to article. I built the bridge shortly after the kit came out in the late 1980s and installed it on my first layout. I subsequently learned that this specific design wouldn't be appropriate for a main line coal-hauler set in the mid-'70's and I've been looking for ways to modify it ever since. I recently came across a photo of an SP train on a bridge at Winchester, OR on the CarrTracks website and the inspiration hit. It also struck me that this is the same bridge that Joe modeled on his Siskiyou line. I then checked the MRH website and found the discussion regarding the CV bridge, links to photos of Joe's bridge, and potential modifications to make it appear to be a heavier duty bridge. In any event, here's the article outline:

1) Brief history of the bridge and the kit



contents



index

- 2) Description of the existing structure and reasons for changes
- 3) Planned modifications (removal of the diagonal braces and portals, replacement with B-B girders and styrene, using the new Micro Engineering decals to represent rivets, etc.)
- 4) Photos of the modifications
- 5) Painting and weathering with artist's acrylics, brushes and cosmetic sponges
- 6) Conclusions: don't be afraid to re-do something that's already finished, applying new techniques to old models, etc.

I've uploaded a photo of the existing bridge in my MRH folder- it is dsc\_0027. I assume you have access to this folder- if not, let me know and I'll e-mail you a copy. Let me know if this would be of interest.

Regards,

Tom Patterson

Good news! The folks at MRH are interested in my article. At this point I printed and reviewed all of the article submission material I could find on the MRH website.

I made a list of what would be needed, i.e. bill of materials, listing of photo captions, etc. and set up folders on my computer for the project.

I went back and reviewed a number of previous construction articles in MRH with an eye toward how the article was put together. I also realized that I was going to need to spend some time with my new digital camera in order to be able to submit photos that would be acceptable.

I decided to send the e-mail below to Charlie Comstock along with a test photo, and ask for a little feedback.



Charlie-

I look forward to working with you guys, too. Along those lines, and since this is my first railroad article rodeo, would you please check the attached photo and make it sure it meets all of your criteria? I've started the article and now need to take photos. I don't want to get through the project and find out the photos won't work.

I reviewed the photo submission criteria and, being somewhat new to DSLRs, was confused by several comments. Here's what I have been shooting, and I've used these settings for the photos I've posted so far on MRH:

Camera: Nikon D3100 14.2 megapixels

Lens: Nikkor 18-55mm

Image size: 2304x1536 (small setting)

Image quality: basic (compression ratio of 1:16) - this is the lowest quality setting on the camera. If I move it up one step to Normal, the file size is slightly in excess of 1.0M. Any higher setting, like RAW, and the files get huge.

F-stop: smallest possible for the lens and available light - generally f/29-f/36.

White balance: set to cool white fluorescent which matches the lighting in the layout room.

Shutter speeds: shooting 3-4 exposures, usually starting at the optimal exposure in the indicator and then stepping up in over-exposures. The lighter exposures seem to give a better representation of the colors and add some depth to the photos.



contents



index

For the detail photos, I'll be shooting against a white back-drop using 2 incandescent reflector spots.

Please let me know if I need to make any changes. I plan to send you a wide variety of angles and exposures for each of the photos so that you can choose the ones that work best.

Regards,  
Tom

Charlie Comstock, who has forgotten more about photography than I'll ever know, responded to my initial e-mail request for some guidance with a long e-mail outlining tips and techniques for white balance, depth of field, composition, etc. The information was extremely helpful and I began to think that I just might be able to pull this off.

At this point I visited Charlie's website to review his tutorial on model railroad photography ([s145079212.onlinehome.us/rr/howto/photography/index.html](http://s145079212.onlinehome.us/rr/howto/photography/index.html)). I also visited numerous other digital photography websites and began taking pictures of the layout and some test construction pictures.

Armed with just enough knowledge to wear out a good camera, I started taking pictures. In order to make sure that what I was shooting would be acceptable, I responded to Charlie's helpful e-mail with the e-mail below along with several shots.

Charlie-



Well, I spent a bit of the weekend taking pictures, taking notes and reading up on some the technical aspects of digital photography. I also read and re-read the information you sent

[... On to next page of text →](#)

## Polishing Your Article

Drafting your article is only the first step, its important to write in a clearly and with good grammer so readers don't have to read a sentence 2 or 3 times to understand what

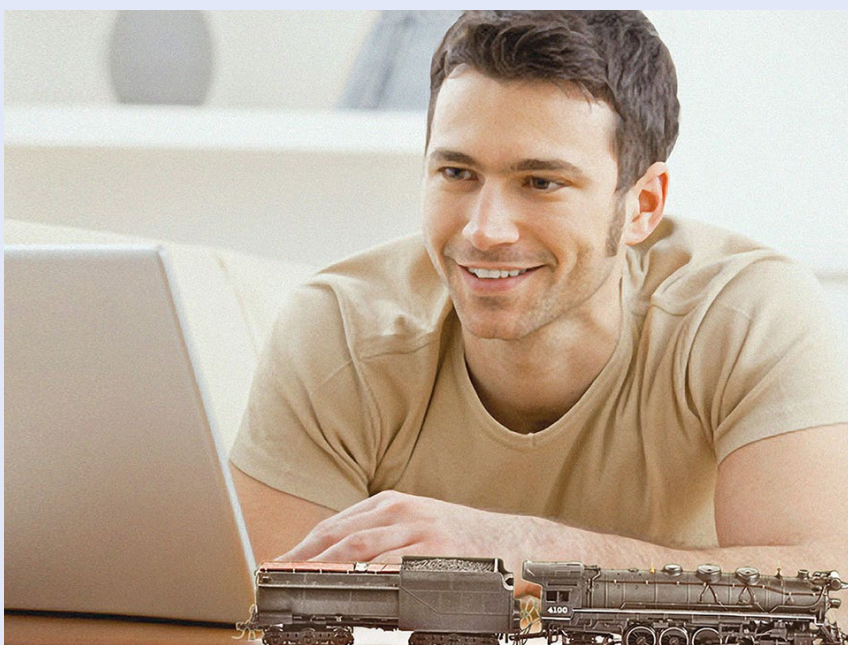

your saying, furthermore you need to use accurate modeling terms and brand names.

*Wait a minute!*

That first paragraph is so poorly-written it's hard to believe you read it in *Model Railroad Hobbyist*. Let's try again:

Drafting your article is only the first step. Write clearly and use good grammar. Someone shouldn't need to read a sentence two or three times to understand what you're saying. Always use accurate modeling terms and brand names.

There. That's better. See the difference? The first paragraph:

- wasn't proofread (“...write in a clearly...” and “grammer”)
- is one long sentence instead of several short ones
- contains word usage errors (“its” should be “it’s” and “your” should be “you’re”)
- contains a style error (“2 or 3” should be “two or three”)

It is important that your submission is clear, easy to read, grammatically correct, and follows MRH style guidelines.

Where do you start?



contents



index

First, write in a conversational tone, to avoid sounding like an encyclopedia.

Next, read the MRH Style Guide:

[mrhmag.com/authors/mrh-style-tips](http://mrhmag.com/authors/mrh-style-tips)

This short document sets forth basic writing guidelines and advice for grammar and spelling. It includes common modeling and railroad terms, plus product and manufacturer names.

The guide shows how to include Web links and Internet terms in your article.

In this age of 24x7 instant communication, it is easy to be misled about grammar. If you read a dozen Web pages that say, “The company released it’s newest model,” it is tempting to think that all those people must be right, and “it’s” always (or never) has an apostrophe. Not true. See the style guide.

Give yourself some credit! You once knew proper grammar and how to spell. Read the style guide to refresh your memory and improve your writing. Pay particular attention to commas in a series, apostrophes, and how to write numbers.

There’s more to writing than grammar and spelling. Model railroaders are a knowledgeable bunch. You gain credibility when you use correct railroad terms, names, and abbreviations. Even seemingly minor errors like “SD-40-2,” instead of the correct “SD40-2,” or “back head” instead of “backhead” are sure to catch people’s attention.

Each error is a “bump” that slows reading and comprehension. As the style guide says, make life easy for readers. *No bumps, please.*

Refer to the MRH Style Guide to see how MRH wants you to use certain terms. One example is “boxcar,” not “box car.” But use “flat car” instead of “flatcar.” These styles might seem like nit-





picking, but consistency helps MRH maintain its high standards and good reputation.

Spell and punctuate company and brand names according to the guide. Most of these are the shown as the companies actually use them, but sometimes MRH wants a variation that is easier to read. One example is X-ACTO, the hobby knife company. It is spelled with all capital letters and a hyphen, but MRH uses “X-Acto” because it doesn’t SHOUT at you.

If you run across a brand name that isn’t in the style guide, write it the way the company does, and MRH editors will decide if it is OK.

Likewise, if you are an expert on a topic and know that a word or phrase should be used differently than the style guide shows, drop a note to the editor and tell him. An example might be a Pullman passenger car. The guide says to use “Pullman Standard,” but that company didn’t exist until 1934. So, if you’re writing about a 1928 observation car, “Pullman” is the correct company name. Kudos to you for knowing that! Tell MRH.

What happens if you don’t quite follow the style guide? MRH has copy editors who go over all of the articles and correct errors.

But if the article is difficult to read and contains many errors, the editors will balk. Correcting errors at the last minute is difficult and time-consuming.

As an author, you are the manufacturer, and MRH is the customer. If you deliver a sloppy product, MRH might send it back and ask you to fix it, or you might get paid less because MRH needs to clean it up. Or worse yet, MRH may simply reject it. As the customer, we are under no obligation to purchase a product (your article) was slapped together.

Spend the time and make the effort to deliver a well-written article. It will benefit everyone. ■



contents



index

[← back to previous page of text ...](#)

below. Attached are six more test images, all of which were re-sized to 2,000 x 1,333 using Microsoft Office Picture manager. I also set the image quality to Fine (compression ratio 1:4).

The two photos of the existing bridge were shot at f/22, shutter speed 1.6, white balance set to fluorescent- cool white and DSC\_0023 was shot with manual focus and DSC\_0026 was shot with auto focus. I can't see the difference in the two, but perhaps you can. These files are slightly in excess of 1.0M, but I assume that's o.k.- correct?

The four close-up shots were taken at f/16, shutter speed of 1/13 and 1/10, and manual focus with the white balance set to incandescent. I'm using two reflective spot lights with 150 watt bulbs with a sheet of white styrene as the backdrop.

I was surprised how far from the recommended shutter speed I had to go to make the background appear white. The photos started to wash out at any shutter speed slower than 1/8.

Please let me know your thoughts on the photos. If the pictures of the existing bridge are good enough, I'll get started on construction. If there are some changes needed to the close-ups (I'll use a new #17 blade for the construction photos), let me know.

Thanks again for your help.

Tom

The photos that I submitted are shown in Photos 1, 2, and 3. I wanted to include photos of the bridge in place on the layout so that I could make sure the depth of field was good enough. I also included several close-up photos in order to make sure

that I had the right settings for these shots as there were going to be a number of them included with the article.

Shortly after submitting these photos I received the e-mail below from Charlie.



Tom,

That's a pretty decent job on the photos.

The only thing I'd do for the 'finished' bridge photos would be to shoot a train on the bridge for use as a lead photo for the article.

The construction photos look pretty decent. The white balance appears OK. On the shot with the X-Acto chisel blade you might consider stopping down a bit further to increase depth of field since the bridge is oriented running away from the camera.

However, with the chisel in decent focus and it being the main point of interest of the photo  $f/32$  might not be required. In fact, having all the bridge in focus (even  $f/32$  probably wouldn't do that) might detract from the point of interest. If you want to give it a try ( $f/22$  if you don't have  $f/32$ ) you might go ahead just to see the difference in depth of field between  $f/16$  and  $f/32$  and how you react.

The existing bridge photos are pretty nice too. I'd suggest maybe seeing how badly depth of field decreases if you shoot at  $f/16$  and  $f/11$  – the camera may be far enough away from the scene so depth of field would be maintained. One thing I would suggest is the camera is a bit tipped side to side. This is most evident in the vertical truss members of the bridge which aren't perfectly vertical in the photo. This is NOT a big deal as it is easily corrected in Photoshop, but with the composition, exposure and white balance of these shots being pretty good,



contents



index

2



3



**2-3. Close-up pictures were taken to verify exposures and to make sure that shadows were eliminated as much as possible.**

not having to crop and rotate is a little time saver that makes editors smile (we're a lazy bunch). Not that I'd frown at receiving these photos – you've done a good job.

All the photos seem slightly soft, but a bit of unsharp mask in Photoshop should cure that. If your camera has live view and you can magnify the 'viewfinder' image on the back of the camera, setting focus that way is the most trustworthy. My Canon 40D, which is otherwise a really nice camera, has the thru-the-lens viewfinder ever so slightly out of whack as is the autofocus. Live view lets me shoot noticeably sharper photos.

Overall I'd say A- on the photos!

Cheers,  
Charlie Comstock

While I was pleased with the grade I received, I told Charlie that I believed there was a little incentive baked into it. At this point I made an outline of the various steps that would take place in the construction process and noted where I thought photos would be appropriate.

I also started taking photos- and more photos, and more photos, and... Did I mention that I didn't have much experience with digital photography?

I got a spiral-bound notebook and each time I took a set of photos, I recorded the specifics of each individual shot: see Photo 4.

Across the top of each page I made heading for photo number, f-stop, shutter speed and focus. After taking a round of photos, I would load them into the computer for review. I made notes about photos that worked and ones that didn't, and kept taking shots until I got the photos I wanted for a specific step in the construction process.



contents



index

I kept folders for each of the photos on the computer and decided to come back later to pick out the ones for submission (more on this later).

Along the way I made many mistakes, such as forgetting to change the white balance from incandescent to fluorescent. But I was now on the path to be able to produce photographs that could be used for the article.

## WRITING THE ARTICLE

Now that I was comfortable with taking pictures, it was time to actually write the article. I went back and reviewed the article submission guidelines again with an eye toward the hints and

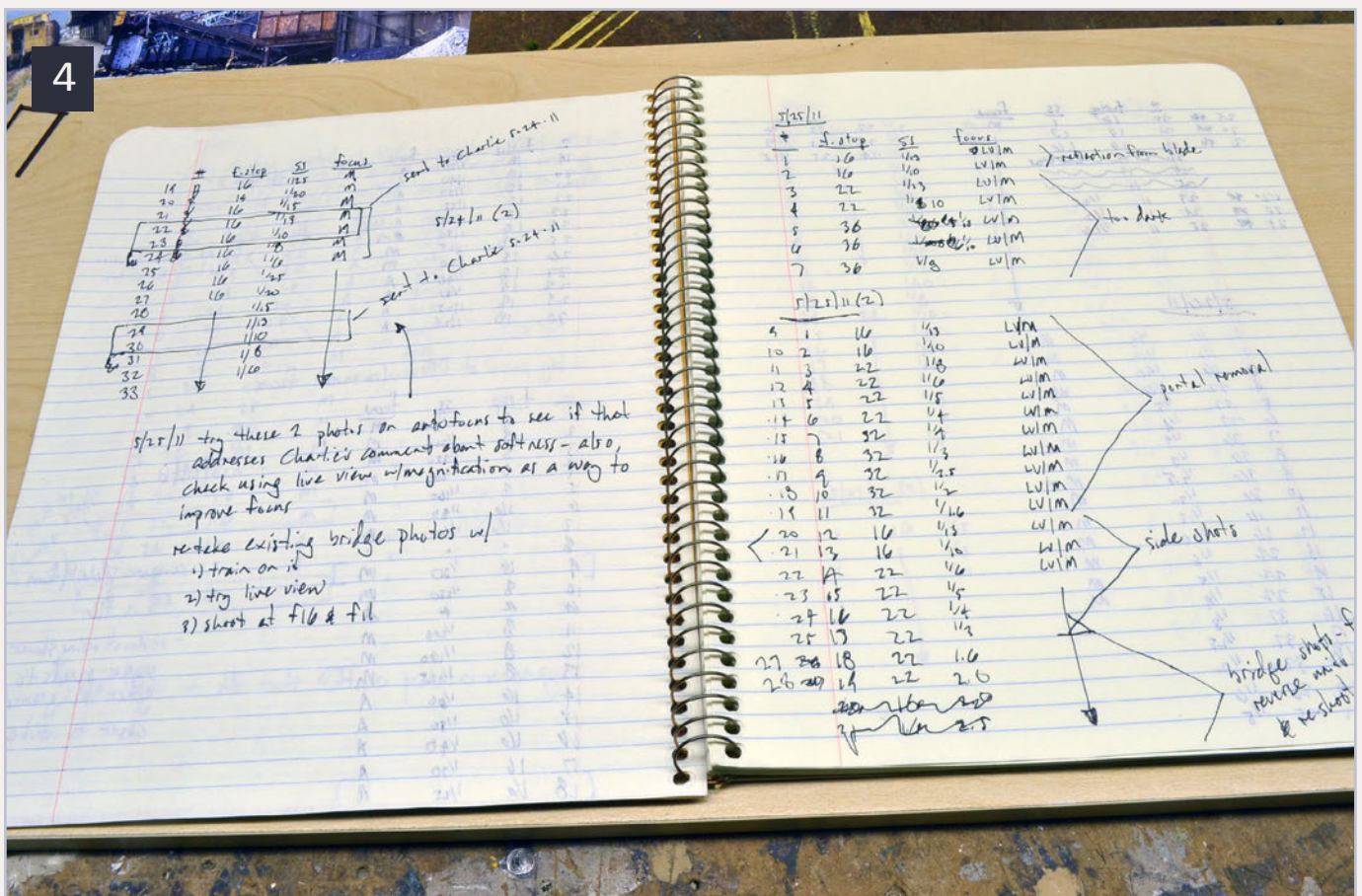

4. One useful tool is the notebook I used to record different aperture, focus and exposure levels. This step was instrumental in gaining experience as to what settings would work under various conditions.

tips about composition. The two most important tips were “Present your subject simply and directly in plain English” and “Use active writing, such as ‘Paint the wall white’.” My writing tends to be passive and somewhat verbose, so I had to keep this in mind throughout the writing phase.

Referring to the outline of the various construction steps that I made earlier, I broke the article up into four pieces: 1) Background Information; 2) Girder modification; 3) New portals; and, 4) Painting and weathering.

Next, I reviewed the photographs in each of the folders (A quick note – do not put the photos in separate folders when submitting them. Simply list them as "Photo 1(a), Photo 1(b) for different exposures of the same shot). I picked several bracketed exposures for each step and then wrote about



Tom Patterson got his start in model railroading with a Lionel train set at Christmas back in the ‘60s. That train set eventually became part of his first layout. Tom reentered model railroading in the late ‘70s and has been working on his current layout, the HO scale Chesapeake, Wheeling and Erie

Railroad, a free-lanced coal hauler set in West Virginia, for almost 20 years.

Tom and his wife have two grown children and live in Cincinnati, Ohio. They enjoy hiking, biking, reading and spending time with their family, which includes two rescue mutts and a large number of salt water fish.



contents



index

what was involved in this particular part of construction. This process gets pretty quick once you get the hang of it.

If you are going to take the pictures and complete the project prior to writing the article, it's important to make sure you have all the necessary pictures. While doing subsequent construction articles, I have found it easier to take the pictures and document each step as I go rather than waiting until the project is finished.

---

**“When the manuscript was finished, I printed it out and left it alone for a day or two. I inevitably make changes when I go back through and edit the document.”**

---

When the manuscript was finished, I printed it out and left it alone for a day or two. For me, this helps to clear my head and get away from the process of pounding out detailed explanations of the work involved. I inevitably make changes when I go back through and edit the document. This step is critical in making sure that your article is as crisp and concise as possible. And a trip through the grammar and spell check is a requirement.

## **SUBMITTING THE ARTICLE**

Once the article was finished, I put together the bill of materials and prepared captions for each of the photos. I printed these out and reviewed them in detail while looking at the photos for each step.

Then I checked the “Organizing Your Submission” information on the MRH website to be sure that my article would meet all of the requirements. I put the article and bill of materials, both of which were Word documents, into a



new folder on my computer and then added a folder titled “Assets.” In this folder I placed all of the photographs to be submitted with the article.

In order to get a large file submitted to MRH electronically, it has to be compressed into a zip file. I followed the link on the MRH website to Zipcreator ([zipcreator.com](http://zipcreator.com)) and made a zip file of the folder with all of the material for the article. Once the zip file was created, I submitted it by clicking on the "Submit an Article" drop-down on under the Authors heading on the MRH banner.

It’s important to check your file size, as each submission is limited to 64 MB. If your submission is larger than this, break it into two separate files and label them with “Article XYZ-Submission 1” and “Article XYZ- Submission 2” so that the folks at MRH know there are two parts. So with the article finally finished and submitted, I patiently await a response.

Good news arrives! MRH is going to use the article. But not so fast – the bad news (but actually really good news) is that Joe and Charlie want to use it for a cover article. So it's back to the basement to take more photos.

---

**“So with the article finally finished and submitted, I patiently await a response. Good news arrives! MRH is going to use the article.”**

---

About this time I learned about Helicon Focus, a computer program that allows you to combine multiple photos at different focal ranges in order to get incredible depth of field. I found a free focus stack application by the name of CombineZM ([pcworld.com/downloads/file/fid,84627-order,4/description.html](http://pcworld.com/downloads/file/fid,84627-order,4/description.html)) and start taking more photos.



contents



index

---

**“All of this took place over the span of about two months. It was an extremely gratifying project, and it was very rewarding to see my work published in MRH.”**

---

After submitting a number of new photos using the CombineZM software, we finally have winner!

All of this took place over the span of about two months. It was an extremely gratifying project, and it was very rewarding to see my work published in MRH. It was a bit more work than I anticipated, but I wanted to make every effort possible to insure that the article had a good chance of getting published.

So give it a shot. The folks at MRH couldn't be any more helpful or easy to work with. And we all benefit from sharing our experiences and ideas with others.





Everyone wants DCC,  
luckily we carry 39  
major DCC suppliers

*including:*



[www.Mr-DCC.com](http://www.Mr-DCC.com)

623-298-7355

1-(888)-395-3976



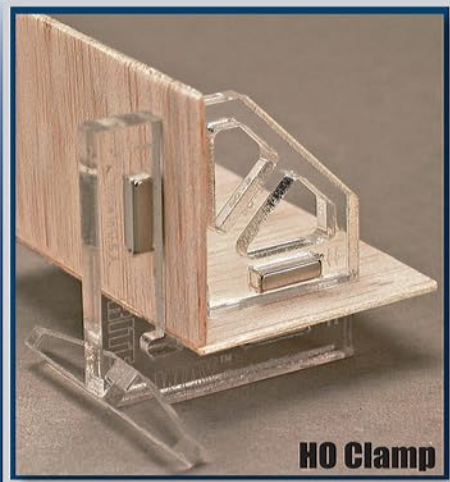

# RITE-WAY™

## Clamping Systems



See video!



# HO, N & Z Scale 90° Clamps Now Available!

Your "Third Hand" for gluing together your projects

- 21st Century Clamping Technologies
- Made of clear acrylic for easy viewing of your parts during assembly
- Simple loading of materials by using the included stabilizing base
- Easy & fast way of assembling parts at a 90 degree angle
- Auto adjust for material thickness
- No "Twisting Action" like found in C-Clamps
- Access windows for applying adhesives
- Approximately 14 lbs of magnetic force
- Removable stabilizer base
- Positive stop for perfect edge alignment
- The ultimate tool for building laser structures, scratch built projects & more
- Great for working with bass wood, balsa wood, styrene, plastic & most other hobby materials

**\$24.95** Per pair  
Introductory Price

Dealer Pricing Available

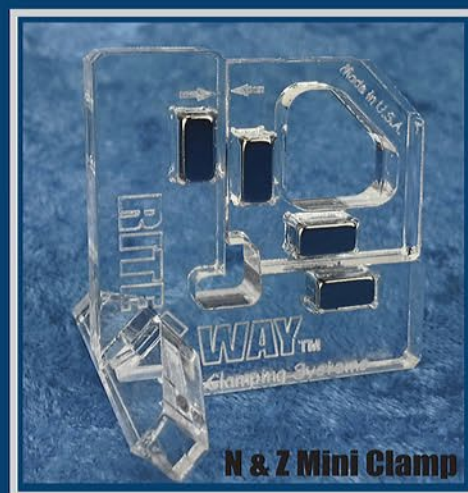

**Click for more ...**

Toll Free: 1-888-762-6872



41W245 Prairie View Lane  
Elburn, Illinois 60119 USA  
www.roco.com  
rocousa@roco.com





# Bitter Creek ground throw

Low profile, positive action ...

by Joe Brugger



**1: Installing Bitter Creek's low-profile ground throw requires bending a wire throw link and drilling holes for two screws. Instructions are provided in each package of two throws.**

**W**hat goes around, comes around, in model railroad-ing. It's always fun to rediscover a product that solves a thorny problem, and doesn't cost an arm and a leg.



Here's the highly abbreviated history: These manual ground throws were originally developed in the early '60s or so by Fred Baumgarten, owner of Baumgarten's Hobby Shop in Santa Barbara CA and were part of his Ribbonrail line of products. The Ribbonrail line was later picked up by another manufacturer, but the ground throws soon went out of production and were sold to another entity who did little with the product.

“Soon after I started Bitter Creek Models, Lee Nicholas ([ucwrr.com](http://ucwrr.com)) convinced me that I should try to bring these units back out on the market,” said company owner Jeff Stone. “I finally located the original tooling and stamping dies and purchased the project from the owner. They are now back in production and available again.”

The B-4001 compact manual ground throw ([bittercreekmodels.com/page11.html](http://bittercreekmodels.com/page11.html)) is an all-metal unit made up of a base-plate, bellcrank, spring, throw lever and attaching rivets. The base and bellcrank are stamped out of sheet steel and the throw lever is stamped from brass sheet. There is no provision for electrical power routing. All parts are made in the USA, with the stampings done by a company in Clearfield UT. Stone finishes forming the basic stampings, then assembles the ground throws, paints them, and packages them at his shop in Afton WY. One pair sells for \$9.95. The package includes two ground throws, formed linkage wires, four mounting screws, and an instruction sheet.

The maximum points throw of the unit is approximately 3/8". In addition to use with HO turnouts, they have been successfully used with O and N scale turnouts. The over-center design and spring provide sufficient tension on the bellcrank to keep the switch points tight against the stock rails, with the solid positive contact between the rail segments solving a lot of

power routing problems caused by loose point contact. The unit has a very low profile and can be mounted up close to the turnout but not interfere with locomotive footboards or car steps. The low profile allows them to be blended into the surrounding scenery, and they can be set up for either right- or left-hand operation.

The all-metal ground throw is a very durable unit and will withstand many years of operation without failure. Nicholas has had some of his from a previous manufacturer in service for over 30 years and they are still going strong. Three finally did fail; two wore out the lever rivet and one broke a spring. Stone repaired all three and now they are back in service.

The Bitter Creek Models product line also includes cast white metal detail parts and HO and HO<sub>n3</sub> freight car and passenger trucks of interest to modelers of the 1860 to 1910 era. Many of the detail parts have a heritage that dates back to the days of Red Ball and Binkley craftsman kits. "I am in the process of bringing out a line of car kits, again for the early rail era modeler as well as adding new trucks and detail parts to the line," Stone said.

For more information, click [bittercreekmodels.com](http://bittercreekmodels.com), or email at [BitterCreekModels@silverstar.com](mailto:BitterCreekModels@silverstar.com). Their mailing address and phone number is:

### **Bitter Creek Models**

PO Box 1601

Afton, WY

**307-886-0703** 

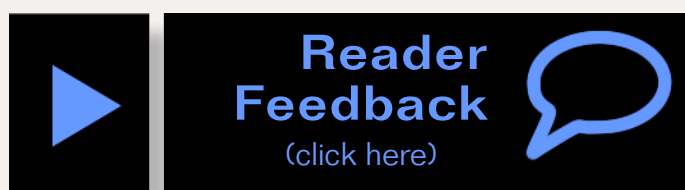

contents



index

VOLUME I

VOLUME II

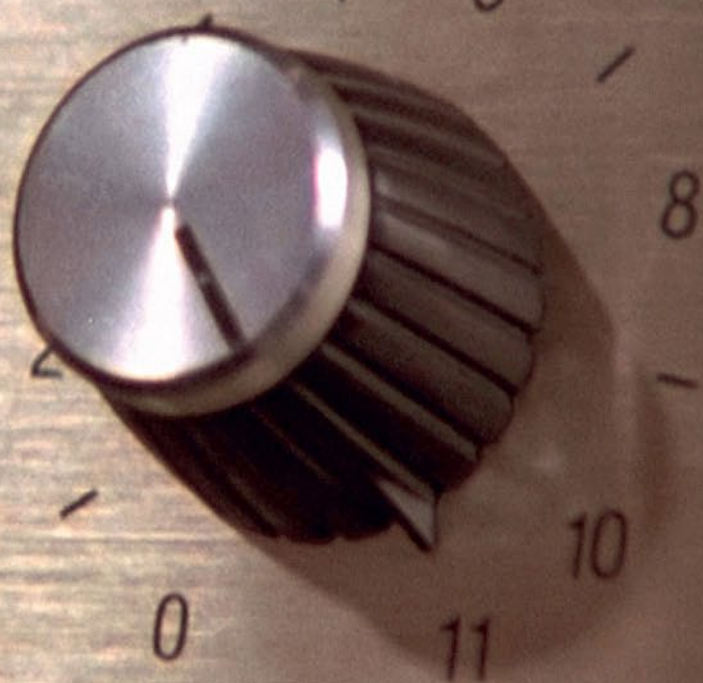
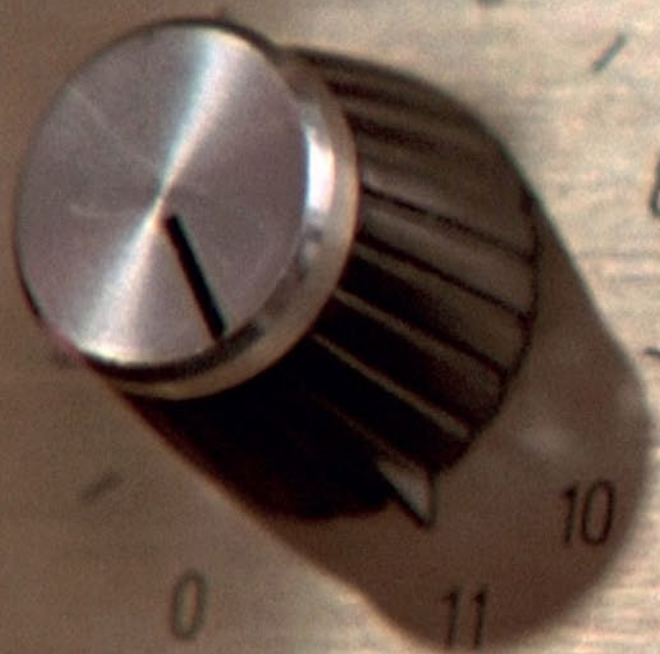

**WE SHOULD HAVE STOPPED AT 10.**

**Thanks Nigel. Really.**

Don't get the cultural reference?  
ask Randy, it was his idea.

Yep. That's right. Canadian National steel reefers in the 1961 'Wet Noodle Scheme' are Aluminum #10, not Gray #11. We goofed. We'll be replacing them, although it could be a little while. You'll need to contact the dealer where you picked up your reefer for details.

**CALL, FAX OR EMAIL YOUR INQUIRIES TO:**

tel: (905) 738 - 6556 or (800) 465 - 6100

fax: (905) 738 - 6329 or (888) 236 - 4629

email: [randy@truelinetrains.ca](mailto:randy@truelinetrains.ca)

Find us on line [facebook.com/truelinetrains](https://www.facebook.com/truelinetrains)

**CAN-CAR**  
MODEL DISTRIBUTORS



Ottawa  
**TRAINEXPO**  
d'Ottawa

Come visit us as this upcoming show:

May 4 & 5, 2013







*The Old  
Yardmaster*



**Reader  
Feedback**  
(click here)



**Mar 2013:**

## **The latest model railroad products, news & events**

*by Richard Bale and Jeff Shultz*

### **2016 NMRA Convention**

Indianapolis will be selected as the site for the 2016 NMRA annual convention and National Train Show. The dates are July 3-10, 2016. No additional details have been released. Other future dates include Atlanta, Georgia, July 17-20, 2013; Cleveland, Ohio, July 13-19, 2014; and Portland, Oregon, August 23-30, 2015 ...

### **Diet Pepsi Photos Sought**

Jim Abbot of Highball Graphics is seeking photos of the VIA Diet Pepsi F40PH-2 No. 6400 that made a promotional tour of Canada in 1990. Abbot said he specifically needs photos of the engineer's side of No. 6400, both sides of the steam heater car, and any other cars in the trains. If you have suitable photos please contact Jim at [jsabbott@roadrunner.com](mailto:jsabbott@roadrunner.com) ...

### **California Roadbed**

Owner Richard Jayne reports that he is working as fast as possible to clear the backlog of orders for Homasote® roadbed that



piled up during his illness last year. California Roadbed can ship most N and O scale items from stock but HO products continue to be back ordered. Jayne is still not able to put in a full 40 hour week and asks that modelers be patient as he is preparing roadbed and filling orders as quickly as possible ...

## **Smoky Mountain Exits HO Scale**

Jim King, owner of Smoky Mountain Model Works has sold the patterns, instructions, and production rights to his HO scale SAL B7 to Gary Wright of WrightTrak Models [wrighttrak.com](http://wrighttrak.com). The transaction ends King's 18-year involvement in manufacturing HO scale resin kits. The company will focus on expanding its industrial customer base and continue production of S scale models. See WrightTrak report in HO section for additional information on the SAL kit ...

## **Help Wanted**

Horizon Hobby of Champaign, Illinois, currently has career opportunities for several positions including product support personnel, graphic designers, and electrical engineers. For details visit [www7.ultirecruit.com/HOR1005/JobBoard/ListJobs.aspx?VT=ExtCan](http://www7.ultirecruit.com/HOR1005/JobBoard/ListJobs.aspx?VT=ExtCan) ...

## **Minnesota Steam Up**

After a four year hiatus, Milwaukee Road 4-8-4 No. 261 will be at the point of an excursion train from Minneapolis to Duluth on May 11-12, 2013. The event will mark the first public operation of the steam locomotive since 2008. The route will utilize BNSF's ex-Great Northern Railway Hinckley Subdivision, which saw its last regular passenger service in 1985. For complete details of the trip, as well as a history of No. 261, visit [261.com](http://261.com) ...

## **Bob Bird**

Robert Edward Bird died on January 4, 2013 at the age of 85. A life-long model train hobbyist, Bob's scratchbuilt models were

frequent award winners in the NMRA's Northeast Region contests. He won the Baldwin Trophy for best in show on several occasions. Bob earned the Gold Award for best in show at the NMRA Valley Forge national convention in 1993. His models also appeared in various hobby publications including Model Railroader magazine. A native of Jersey City, Bob worked as a tower man for P.A.T.H. Railroad. In 1985 he received the Port Authority of New York and New Jersey's Distinguished Service Medal. He served in the U.S. Navy during World War II. Bob Bird is survived by his wife Lillian, four children, nine grandchildren, and a great-granddaughter ...

Here's a look at some of the latest new model railroad products.

## NEW PRODUCTS FOR ALL SCALES



**Morning Sun Books** ([morningsunbooks.com](http://morningsunbooks.com)) has released three new full-color hardback books for March including “*Erie Lackawanna in Color, Volume 8: New York Division.*” Authored by Robert J. Yanosey, the book covers the EL's New York Division with its tangle of heavy suburban commuter lines and freight routes. Photographers Al Holtz and Bill Rosenberg document the workings of the busy division from New York City to the Delaware River.



contents



index

Also new is *“Pittsburgh Trolleys In Color, Volume 1”* by Ed Ridolph. During the 1960s the Steel City was a virtual museum of operating trolley cars of every type. A variety of photographers have contributed their work that captures the essence of the era when central Pittsburgh was still the heart of a bustling city.

*“Steel Mills Railroads in Color, Volume 4”* presents a continuing look at the role of railroads in the steelmaking process. Author Stephen M. Timko takes readers on a pictorial journey from the iron ore mines, through iron and steel production, transportation of finished products, and the ultimate recycling processes. The three publications mentioned are available from the above web site at \$59.95 each.

---

## O SCALE PRODUCTS



**Atlas O ([atlaso.com](http://atlaso.com))** has released a 62' bulkhead flat car in its Trainman® series. The O scale ready-to-run model features individual side stake pockets and simulated tie-loops. Road

names include Canadian Pacific (black), TTX-Trailer Train (yellow), Illinois Central (black), Union Pacific (tuscan), and BNSF (above). Undecorated models are also available. Three-rail versions have an MSRP of \$46.95. Two-rail models list at \$49.95.

Atlas is quoting a third quarter release date for O scale models of both extended vision cupola and standard cupola cabooses.



Extended vision models will be decorated for Maine Central, Santa Fe,

and D&RGW (above). Caboose with standard cupolas will be available for Great Northern, Norfolk Southern, Northern Pacific, and Norfolk Western. Both cupola types will also be available undecorated. Three-rail versions have an MSRP of \$79.95. Two-rail models list at \$89.95.

Also coming in the third quarter is a Trainman® series 52' flat car with a pipe load that includes deck tie-downs. Atlas based this O scale model on a general service flat car built by the Canadian Pacific in the early 1950s. Road names on this production run will include CNW, Conrail, Rio Grande, Norfolk & Western, and undecorated. Three-rail versions have an MSRP of \$49.95. Two-rail models list at \$59.95.

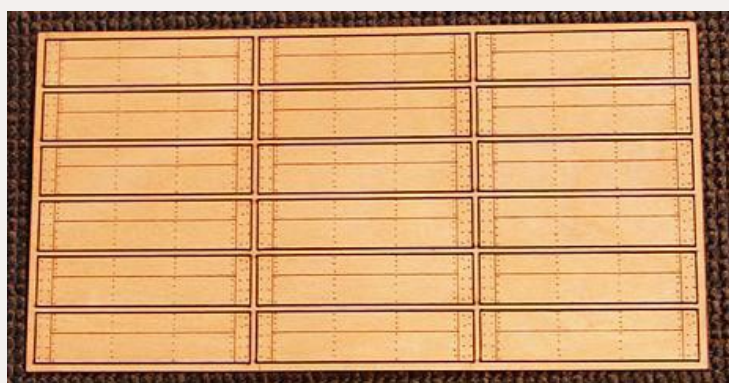

### Great Lakes Models ([greatlakesmodels.com](http://greatlakesmodels.com))

is selling O scale grain panels for grain-hauling boxcars. The panels were temporarily secured to the inside of open-door

boxcars to facilitate loading. The panels were often used when boxcars were pressed into service hauling coal and



contents



index

powdered dolomite limestone. The laser-cut wood doors are detailed on both sides. A sheet of 18 panels sells for \$14.96.

---



**Morgan Hill Models** ([morganhillmodels.com](http://morganhillmodels.com)) has introduced a small sand house (drying shed) and fenced bin suitable for a small engine service facility. Assembly features board-by-board construction over laser-cut wall framing. Weathered tar paper, a bag of sand, and details shown (except figure) are included. The O/On30 kit sells for \$39.95.

---

## HO SCALE PRODUCT NEWS



**Accurail Inc.** ([accurail.com](http://accurail.com)) has released six new HO

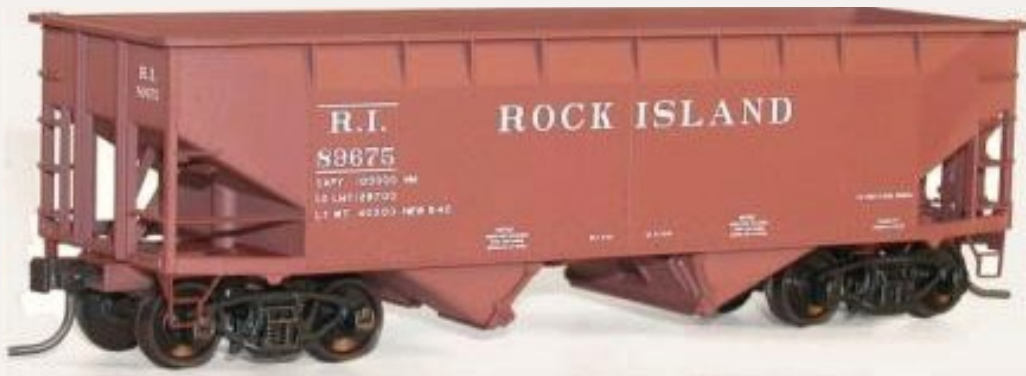

scale freight car kits including the 89' Northern Pacific partially-

enclosed auto rack carrier shown. The car has an MSRP of \$23.95.

Also new are kits for a Baltimore & Ohio 40' wood refrigerator car at \$16.98, a Rock Island 50-ton offset-side two-bay hopper car (above), an L&N 50' sliding door steel boxcar, Green Bay & Western 50' double plug door steel boxcar, and a D&RGW 40' single-sheathed wood boxcar (below).



Unless noted otherwise, the Accurail kits mentioned above have an MSRP of \$15.98 each.



**Atlas Model Railroad Company** ([atlasrr.com](http://atlasrr.com)) is

scheduled to release a steel express refrigerator car during the third quarter of 2013. Atlas acquired the tooling for this



contents



index

car from Branchline which based the model on a group of 550 welded prototypes built by American Car & Foundry in 1947. Five hundred were delivered to Railway Express Agency with the remaining 50 going to Atlantic Coast Line. Collapsible ice bunkers allowed the cars to handle both refrigerated loads and dry LTL parcels.

The Atlas' HO scale version adheres to the prototype with an arched roof, 3/3 Improved Dreadnaught ends, and high-speed four-wheel passenger-type trucks. Additional features include a detailed underframe; separate uncoupling levers; steam, air, and signal hoses; metal wheelsets, and AccuMate® knuckle couplers. Three numbers each will be available for six schemes including REA - 1947 (as delivered with silver body, bold green stripes with red edging, and green ends, above), and REA - early 1950s (repaint with dark green body and gold lettering).



Also REA – mid 1950s (repaint with dark green body,

gold lettering, and red and white herald, above), and REA - 1960s (light green body, white italic lettering, red and white herald).

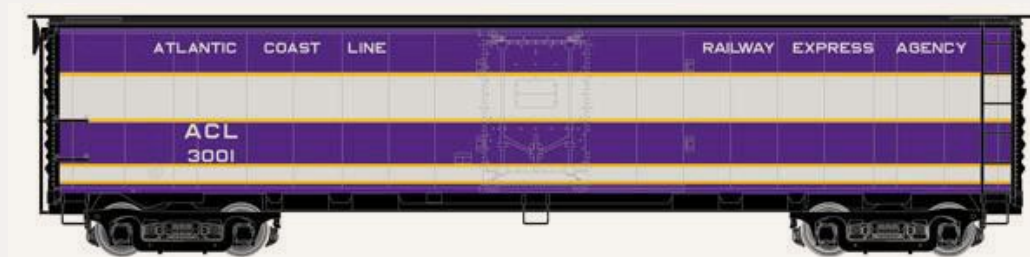

Atlantic Coast Line schemes include ACL - 1947 (as

delivered with purple and silver sides, gold stripes, black roof and ends, above), ACL – 1960s (repaint with green body and aluminum roof, silver lettering). The ready-to-run model has an MSRP of \$35.95. An undecorated version will list at \$29.95.





Atlas plans to begin delivering an upgraded version of its HO scale

ALCo S-2 diesel locomotive in the fourth quarter of this year. The hood, cab, and truck frames have been retooled, and the die-cast chassis has been modified to accommodate optional DCC sound. A special feature is optional horizontal or vertical radiator shutters. Additional details include directional LED lighting, scale handrails, separately applied grab irons, uncoupling levers, and air hoses. Road names will be Boston & Maine, Canadian Pacific, Erie Lackawanna, Great Northern, Pennsylvania, Susquehanna, and ATSF (above). Standard DC models have an MSRP of \$149.95. Decoder equipped units list at \$259.95.

---

**Blackstone Models** new 2013 product catalog is now available online. The 26-page, full-color catalog showcases the companies HOn3 scale locomotives, rolling stock, and accessories. In addition to the usual product illustrations, close-up images of the models fine details are provided. The listings include helpful historical information about the prototypes. The catalog is available online at [blackstonemodels.com](http://blackstonemodels.com). Hard copies can be requested free-of-charge from [sales@soundtraxx.com](mailto:sales@soundtraxx.com).

---

**Blair Line** ([blairline.com](http://blairline.com)) has released a craftsman kit for Walnut Grove Depot that features a pagoda-style roof with flared eaves. Construction details include laser-cut floor, sub-roof, interior and exterior walls, with tab-and-slot connections.



contents



index



Additional items include laser-cut peel-n-stick doors, windows, window glazing, and roofing material. Peel-n-stick trim comes in one piece for each

side of the structure and the bay windows which simplifies the application of the detailed trim work. A chimney and signage are included. The assembled model has a footprint of 3.30" x 5.50". The HO scale kit is priced at \$69.95. The model is based on a prototype structure that served the Frisco (St. Louis-San Francisco Railway) in Walnut Grove, Missouri.

---



**Bowser ([bowser-trains.com](http://bowser-trains.com))** has released pre-production photos of its ALCo Century series C430 diesel (left) scheduled for delivery this fall. The company also announced that an undecorated version of the HO scale locomotive with Hi Ad trucks will be included in the initial production run. The model

will have an MSRP of \$199.95 and will be offered as a standard DC only model without sound.

Additional road names for the Executive Series ready-to-run model include New York Central, Penn Central, Reading,

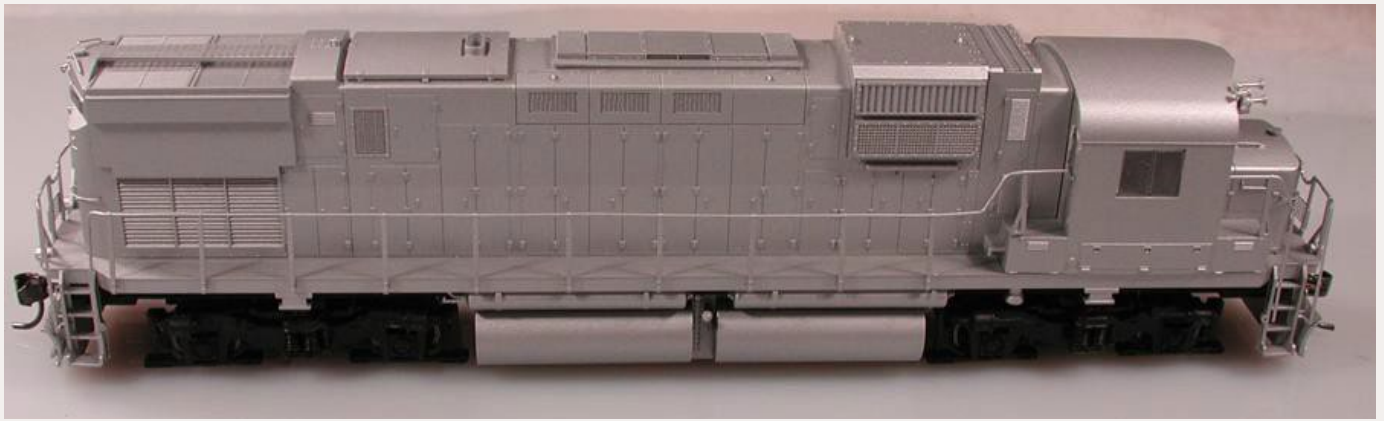

Seaboard Coast Line, Louisville & Nashville, CR Reading (patch), Western New York & Pennsylvania (red), Western New York & Pennsylvania (black), Morristown & Erie, Green Bay & Western, Green Bay & Western (grey stripe), Susquehanna (early scheme), Susquehanna (late scheme), ALCo demonstrator, and Conrail (black scheme). The models mentioned above will come with Hi Ad trucks. A model decorated in Conrail's blue scheme will have AAR type B trucks. In addition to the \$199.95 standard DC version, DCC equipped locomotives with LokSound Select Dual-Mode decoder (for operation on DC or DCC) will be available at \$299.95 MSRP.

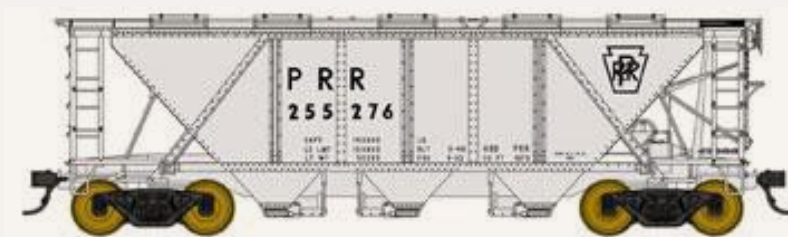

Bowser has released additional information about its new PRR class H30 triple-bay covered hopper

car. Six PRR decorating schemes for class H30 car include plain, circle, and shadow keystone (above) heralds on gray cars. Cars painted red oxide will have a circle keystone and a plain keystone with a black "S". The plain keystone will also be applied to a car with a yellow body. Two of the 1973 cu ft triple-bay 10-hatch cement hauler will be available in Penn Central green (one for interchange and one designated for MOW service). Gray cars decorated for Norfolk & Western and Conrail will complete the run. Delivery of the newly-tooled HO scale model will be this fall at an MSRP of \$29.95.



contents



index



**Broadway Limited ([broadway-limited.com](http://broadway-limited.com))** is selling an HO scale version of Norfolk & Western's class J 4-8-4 steam locomotive. The ready-to-run model replicates the highly-regarded prototypes built between 1941 and 1950 in Roanoke at the railroad's East End Shops. BLI's production run offers different versions of the locomotive with variations in the side rods, style of tender deck, and bell position. The model comes equipped with Paragon2 Sound for DC and DCC operation at an MSRP of \$399.99 each. Visit the above web site for additional options available.



Broadway Limited has scheduled an April release date for a series of HO scale EMD E6, E8, and E9 diesel locomotives. Both A

and B units will be included in the run. E6 models will be available for ATSF (warbonnet), Baltimore & Ohio, Florida East

Coast, Illinois Central, Kansas City Southern, Union Pacific, and Milwaukee Road (above). E8 units will be available for ATSF (warbonnet), CB&Q (stainless steel scheme), NYC, PRR, and EMD Demo. A Union Pacific E9 is also in the mix. Models with BLI's Paragon2 Sound/DC/DCC have an MSRP of \$349.99 each. B units will be available in both powered and dummy versions. Visit the above website for more details.



BLI has set a May release date for a series of HO scale Trackmobile rail car movers. The powered heavy die-cast model comes with a Kadee® No. 56 coupler at the rear. DC versions are priced at \$79.99 MSRP. Units equipped with an NCE DCC decoder

have an MSRP of \$109.99. Models in MOW yellow will be available for BNSF, CN, NH, NS, UP, CP (above) and unlettered. Additional road names include FEC (blue), Milwaukee Road (orange and black), and PRR (Brunswick green).



**City Classics ([cityclassics.biz](http://cityclassics.biz))** has introduced a family of HO scale window awnings that can be adapted to most commercial structure models. The one-piece injection molded awnings come in five widths: 3/8" (.375"), 7/16" (.4375"), 1/2" (.5"), 5/8" (.625"),



contents



index

and 3/4" (.75"). The awnings have an MSRP of \$9.98 for a package of 12.

---



**Classic Metal Works** ([classicmetalworks.com](http://classicmetalworks.com)) has released its highly-anticipated Scenicruiser Greyhound bus. The HO scale version of the GMC 1954-era inter-city bus is available with unique

numbers and destination signs for New York City, Chicago, Los Angeles, and St. Louis. An unmarked version is also available. Additional details include separately applied side mirrors and dual windshield wipers. The MSRP is \$27.50.



Also coming this month are HO scale models of a 1950 Plymouth four-door sedan. Visit the above web site for additional details.

---

**ExactRail** ([exactrail.com](http://exactrail.com)) has completed another release of its HO scale Magor 4750 cu ft three-bay covered hopper car. The HO scale model replicates the aluminum prototype Magor

introduced in 1966. Features of ExactRail's ready-to-run Platinum series model include Kadee #58 couplers, wire grab irons, wire uncoupling levers, separately applied air hoses, an etched-metal Morton brake platform, and ASF 100-ton Ride Control® trucks with ExactRail's machined 36" wheel sets.

Decorating schemes include Pennsylvania, Western Pacific, Burlington Northern (name spelled out and large bold BN initials), Burlington Northern (small BN), Seaboard Air Line, and Conrail (above left in the late grey paint). Six numbers are available for each of the cars mentioned above. The Conrail car shown above right in the as-built red scheme will be available in three numbers. Just one number is available for a Cargill car in unique patch paint. ExactRail's 4750 is available direct at \$46.95 each.



**HO Fox Valley Models'** 2013 production schedule includes HO scale class M-53 wagon-top boxcars decorated for three well-known model railroads: Tony Koester's Allegheny Midland; W. Allen McClelland's Virginia & Ohio; and the

Cumberland Valley System built by brothers Bill and Wayne Reid. M-53s decorated for real roads will include B&O 1955-1962 billboard scheme with Youngstown doors, and a B&O C-16 dark green express car with flat steel doors. All versions of



contents



index

the ready-to-run models will have an MSRP of \$30.95. In other news, Fox Valley reports that a Silverside gondola built from Southern Railway blueprints will be released later this year. InterMountain Railway is responsible for marketing Fox Valley products. For additional information visit [intermountain-railway.com](http://intermountain-railway.com).

---



**Imperial Hobby Productions** ([ihphobby.tripod.com](http://ihphobby.tripod.com)) has released photos of a preproduction sample of its SEPTA (Southeastern Pennsylvania Transportation Authority) single-end LRV (Light Rail

Vehicle) currently under development in China. The 50' prototype cars were delivered to SEPTA in 1981-82 by Japan's Kawasaki Heavy Industries. The new cars replaced the oldest of the PCC trolleys then still in service. IHP's injection molded plastic model will eventually be available in three paint schemes. The first release, scheduled for Fall 2013, will be decorated for the commemorative run of car #9000 in its original 1982 livery. Later schemes will include the 1987-1997 design (see prototype photo above), and finally the current all-white scheme with a fade-away stripe above the windows and logos on the ends.





Although scaled 1:87 for HO, the car will be marketed as a non-powered souvenir display model with 5' 2.5" gauge wheel sets to match the broad gauge SEPTA prototype. The model will

be available only through the SEPTA Transit Gift Shop ([septa.org/store](http://septa.org/store)). The possibility of a future powered conversion kit for HO scale is under consideration by IHP as a separate project.



Many of the traction models offered by IHP in the past have been made of cast resin components. The company plans to transition gradually from resin casting to plastic. The Kawasaki LRV represents IHP's initial injection-molded plastic model.

---



contents



index



InterMountain Railway ([intermountain-railway.com](http://intermountain-railway.com)) is taking reservations for GE's Evolution series ES44AC diesel locomotive in four new decorating schemes.

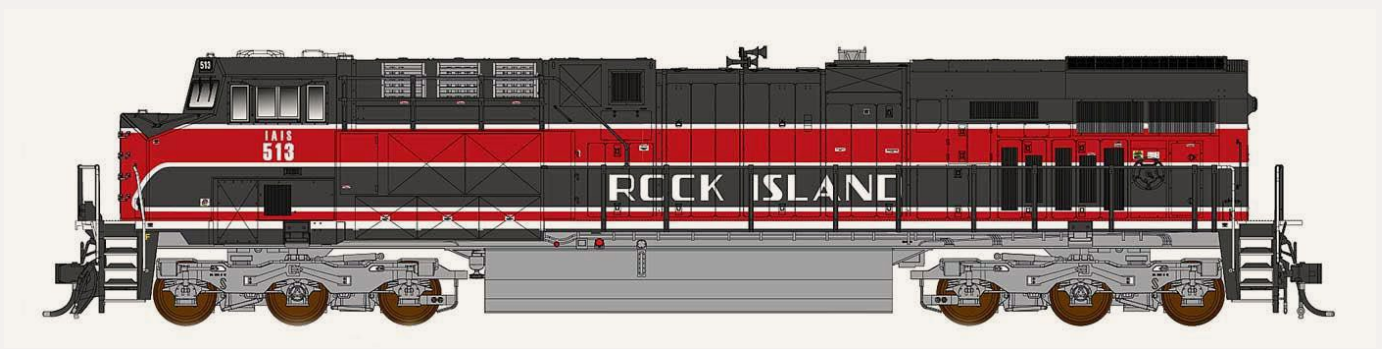

Road names applied to the HO scale ready-to-run model will be Norfolk Southern, CSX, Iowa, and IAIS/Rock Island. Delivery is planned for September/October of this year. Standard DC versions will have an MSRP of \$189.95. DCC models with sound will list at \$279.95.



Coming this fall is a new release of IRC's 1958 cu ft two-bay covered hopper cars

equipped with an etched-metal roofwalk, wire grab irons, and Kadee couplers. Road names on cars with open sides will be

Union Pacific, NC&STL, New Haven, CNW, Boston & Maine, and ILDX-General Electric.



Closed side versions will be available for P&WV and Rock Island. The MSRP is \$37.95.



Also due in September/October is a rerun of Inter-Mountain's 19,600 gallon tank car riding

on trucks with 36" metal wheels. The MSRP is \$37.95. Road names applied to black tanks include ADMX-ADM Corn Processing, ADMX-ADM (new logo design), STSX-Staley, STSX-Tate & Lyle, CRGX-Cargill, CCLX-Corn Products International, and TILX.



A car decorated for ARSX-Domino Sugar (photo) will be available on a white tank.



contents



index



Next month  
**Kadee Quality  
Products  
Company**  
([kadee.com](http://kadee.com))  
will release a

40' PS-1 boxcar decorated for Chicago North Western (above). The HO scale model is based on a prototype built in 1958 with tab side-sills, and an 8' six-panel Pullman Standard door. The ready-to-run car has an MSRP of \$35.95. An identical car will be released in May decorated for Union Pacific with yellow lettering and a "Be Specific, Ship Union Pacific" slogan. The UP model has an MSRP of \$34.95.



Also due from  
Kadee in May is  
a Richmond,  
Fredericksburg  
& Potomac 40'  
PS-1 boxcar  
equipped with

6' Youngstown doors (above). The MSRP will be \$33.95. Built in 1952, Kadee's HO scale version is decorated as repainted in 1963 in boxcar red with a "Linking the North and South" slogan and map.

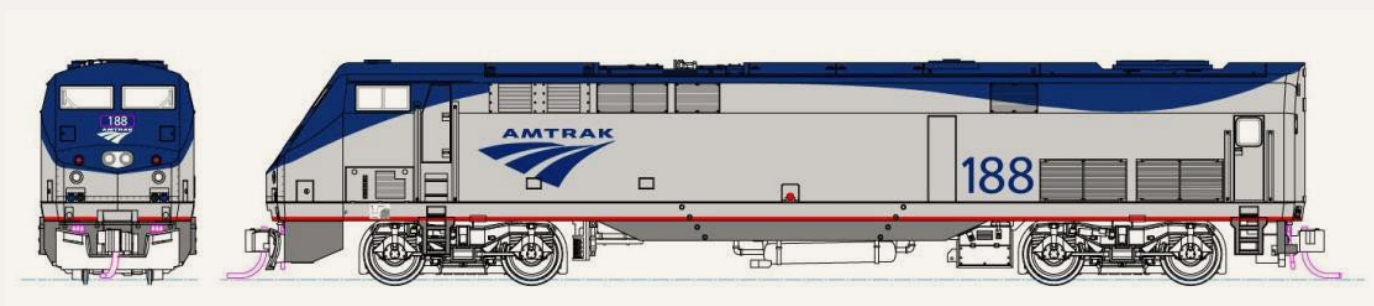

In May, **Kato** ([katousa.com](http://katousa.com)) plans to release an HO scale P42 locomotive equipped with a unique new drive system that places all of the mechanical components, including a coreless motor, in each power trucks. Kato says the new design provides interior space for additional weight and larger speaker housings. The elimination of mechanical linkage and drive shafts increases the ability of the new power trucks to swivel and will permit the P42 to operate on curves with a radius as tight as 370mm (approximately 14.75"). The P42s will be decorated in Amtrak's Phase Vb scheme (above) in three different road numbers.

This new model has two motors and does not have a DCC-ready adapter plug. Details and pricing are tentative, but Kato is offering DCC and sound equipped versions in its Kobo Line with custom DCC and sound options installed in the US. Kato is working with ESU Loksound and Soundtraxx Tsunami to develop suitable decoders for the new two-motor drive system.

Standard analog DC versions will be priced in the range of \$185.00 to \$195.00. Units with ESU Loksound DCC are targeted at \$305.00 to \$315.00. P42s with custom Soundtraxx® Tsunami™ sound and DCC decoder installations are expected to



contents



index

be in the range of \$315.00 to \$325.00 each. Sound equipped locomotives will have dual speakers.

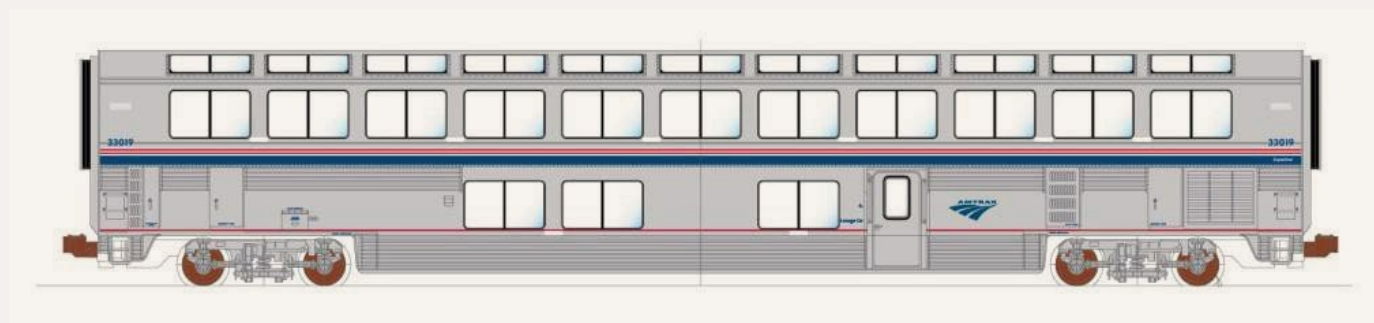

Also coming from Kato in May are HO scale Amtrak phase IVb cars decorated in the current paint and logo scheme. Car types will be a coach, diner, lounge, and sleeper. Final pricing will be in the range of \$80.00 to \$90.00. Features include metal wheels with rotating bearing caps, clear plastic windows, and detailed interiors. An interior lighting kit for the lower level of the lounge car (item 958048) is available at \$8.00. An interior lighting kit for the other bi-level cars (item 7-504) is priced at \$24.00. A tail light kit (item 958046) to add marker lights to Superliners or material handling cars is priced at \$8.50. All prices mentioned are MSRP (manufacturers suggested retail price).



**North American Railcar Corporation**, a division of Pacific Western Rail Systems, has assumed responsibility for marketing the HO scale self-coupling brake/air hoses initially developed by Fairway Park Models. Although the magnetic hoses were engineered for use with NARC equipment, indications are they work equally well on rolling stock and locomotives from other manufacturers. The HO scale hoses sell for \$24.98 for ten pair.

Installation instructions are available at:  
[pwrs.ca/view\\_product.php?ProductID=213983](http://pwrs.ca/view_product.php?ProductID=213983).  
For additional information visit:  
[pwrs.ca/announcements/view.php?ID=7440](http://pwrs.ca/announcements/view.php?ID=7440).

---



The Illini Chapter of the Professional Car Society is selling HO scale kits decorated for Nash Motors and Kissel Motor Car Company. Both are fantasy schemes being promoted as

fund raisers for the organization that is dedicated to the restoration and preservation of vintage funeral cars, ambulances, and limousines. The double-sheathed wood boxcars were produced by Accurail with Dreadnaught ends, National wood doors, and a vertical brake shaft. The kits sell for \$19.50 each, plus \$5.35 shipping for any number of cars ordered. Checks can be made payable and mailed to Illini Chapter PCS, 918 W. Colfax St., Palatine, IL 60067, or online PayPal payments can be sent to [superior1980@yahoo.com](mailto:superior1980@yahoo.com).

---



contents



index



**Railroad Kits**  
([railroadkits.com](http://railroadkits.com)) has released two new HO scale craftsman structure kits including Liam Thomas Craftsman Furniture complex. The main

structure features laser-cut basswood walls and detailed plaster chimney and dock cast from masters created by Russ Green. The shed uses board-by-board construction over laser-cut mat board framing. Numerous cast metal details are included along with templates and diagrams to aid assembly. The model lists at \$99.00. The diorama shown above is approximately 12" x 15.5".



Also new is Gleason Garage which is based on a structure that once stood in Jamaica, Vermont. Construction is similar to the Liam Thomas kit. The HO scale kit

is priced at \$70.00. The scene shown above is approximately 10" x 14.5".





This fall, **Red Caboose** is scheduled to release an HO scale ready-to-run model of a 10,000 gallon type 103W welded tank car. The ready-to-run model will be equipped with 33" metal wheelsets and Kadee couplers. In addition to the Phillips car shown above, road names will include UTLX, SHPX, Sinclair, Conoco, and UTOX-Standard Oil (below).



Road names will be available in six numbers at an MSRP of \$34.95 each. InterMountain Railway is responsible for marketing Red Caboose products. For additional information, including reservations, visit [intermountain-railway.com](http://intermountain-railway.com).



contents



index



The South Shore Model Railway Club ([ssmrc.org](http://ssmrc.org)) is raising funds through the sale of two versions of a 40' Southern New England boxcar produced by Kadee. The prototype, known as the Titanic Railroad, owned by the Grand Trunk Railway of Montreal, was conceived as a connection between the Central of Vermont at Palmer and the Port of Providence, Rhode Island. The enthusiasm and funding for the planned railroad went down with the Titanic when the Grand Trunk's president, Charles M. Hayes, went down with the ship.



The HO scale ready-to-run models are fictitious schemes that might have been but never were. The box herald and maple leaf versions are available at \$34.95 each. Shipping is \$5.25 for one car and \$1.50 for each additional car.



Here's a preview look at a 50' 70-ton newsprint boxcar being developed by **True Lines Trains** ([truelinetrains.ca](http://truelinetrains.ca)). Almost 3,600 of the prototype cars were built by National Steel Car Company beginning in 1967. Full details on the HO scale model, including pricing and availability dates, are pending.

---



**Walthers** ([walthers.com](http://walthers.com)) will release another round of its General Electric U28/30B diesel locomotive with new road

names in July. Great Northern and Milwaukee Road will be available as Phase 2 U28B locomotives. The U30B version will be available decorated for Seaboard (above) and New York Central. Each road name will be available in two engine numbers. The HO scale ready-to-run Proto™ series model comes with constant and directional LED headlights, metal grab irons and lift rings, and



contents



index

14:1 ratio helical gears. Road specific details on this release (not available on previous production runs) include individual wind deflectors and sunshades. Standard DC models will have an MSRP of \$199.98. Locomotives equipped with Tsunami® Sound and DCC decoders will list at \$299.98 each.



Walthers plans to release a re-run of its Proto™ series 46' 70-ton USRA steel gondola this month. New road numbers will be available for Reading (black), New York Central (boxcar red), PRR (Tuscan red with shadow keystone herald), and Pittsburgh & Lake Erie with NYC football herald (above). The HO scale ready-to-run model has an MSRP of \$29.98.



Walthers has scheduled an April delivery date for a rerun of its ALCo RS2 1500 hp locomotive. The ready-to-run model features constant and directional lights, and helical cut gears at a ratio of 14:1. Road names will be Ontario Northland (green, white band, and yellow stripes), Rock Island (red with gray stripes), Union Pacific (Armour yellow), and Lehigh Valley (above). The HO scale

Mainline™ series model operates on standard DC and has an MSRP of \$124.98.

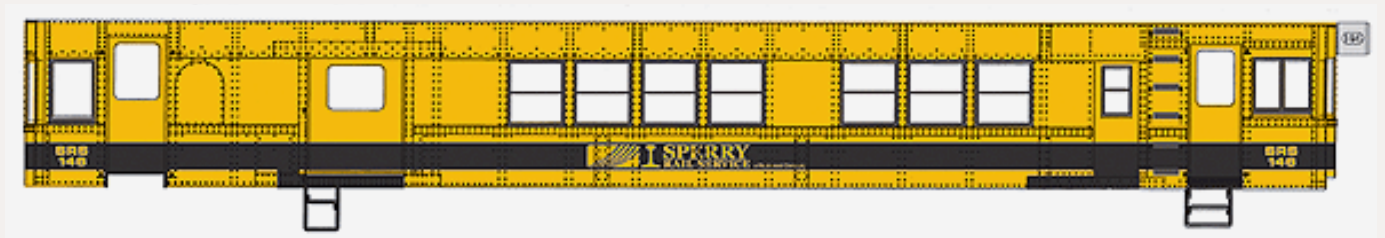

Also due from Walthers in April are four versions of a Sperry Rail Service car. Decorating schemes will include 1960s-1980s, 1980s-2003, circa 2005, and 2008-2011 (above). The self-propelled HO scale model operates on standard DC and has an MSRP of \$119.98.



Walthers is booking dealer reservations now for August delivery of a Mainline™ series 40' X-29 boxcar. Features include a vertical brake shaft, 3-panel Superior doors, 2-panel flat steel ends, and 33" metal wheelsets. Road names are New York Central, Chicago Great Western (1950s Tuscan scheme), Nickel Plate Road (Tuscan red), and Baltimore & Ohio (boxcar red with capitol herald). The HO scale ready-to-run model will have an MSRP of \$21.98.



contents



index



**Westerfield Models** ([westerfieldmodels.com](http://westerfieldmodels.com)) has introduced HO scale resin kits for two versions of a Rock Island single-deck stock car. Between 1944 and 1950, the prototypes were rebuilt from thirty-year old class B-2 boxcars. AB brakes were installed during the rebuild. In some cases the stock cars retained the original Murphy XLA roofs (Westerfield kit 12102, above). Stock cars converted from B-2s with deteriorated metal roofs were given single-board wood roofs (Westerfield kit 12013). The stock car kits are priced at \$37.00 each, plus shipping.



Other kits recently reissued by Westerfield include B&O class W-1 hopper car, modernized (kit 3151); PRR class H21/H21A hopper car, original (kit 3201, above); PRR class H21A

hopper car, original with PRR keystone (kit 3202); PRR H21A hopper car, sawtooth hopper (kit 3251); and PRR H21A hopper car, sawtooth hopper, modernized (kit 3252). All hopper kits mentioned are \$33.00 each plus shipping. Westerfield kits are HO scale unpainted urethane castings plus custom decals. Assembly instructions, a thorough history of the prototype, and proprietary decals covering the life of the car are included in each kit. Trucks and couplers are not included. Visit the above web site for ordering information.

---



**WrightTRAK** ([wrighttrak.com](http://wrighttrak.com)) is selling an HO scale kit for a Seaboard 40' class B7 boxcar with a turtleback roof. The kit was formerly available from Smoky Mountain Model Works (SMMW). The craftsman-style kit consists of a one-piece resin body, resin underframe, Tichy details parts, trucks and assembly instructions. Also included is a special 1941-era decal prepared by Greg Komar that includes a "Through the Heart of the South" herald and "Silver Meteor" slogan. The kit comes with trucks but without couplers. The kit (item SAL-05B7) is priced at \$49.00. Visit the above website for ordering instructions. Special decals (item 87-DEC-009) with a 56" diameter



contents



index

"Railroad" herald (1947 to 1960s) and 1950s/60s reweigh initials/dates is available for \$4.00.

Gary Wright of WrightTRAK is considering issuing a one-piece cast resin body kit for an HO scale Southern wood caboose formerly available from SMMW as a flat resin kit. Modelers are asked to express their level of interest in a one-piece body kit by contacting Gary through the above web site.

---

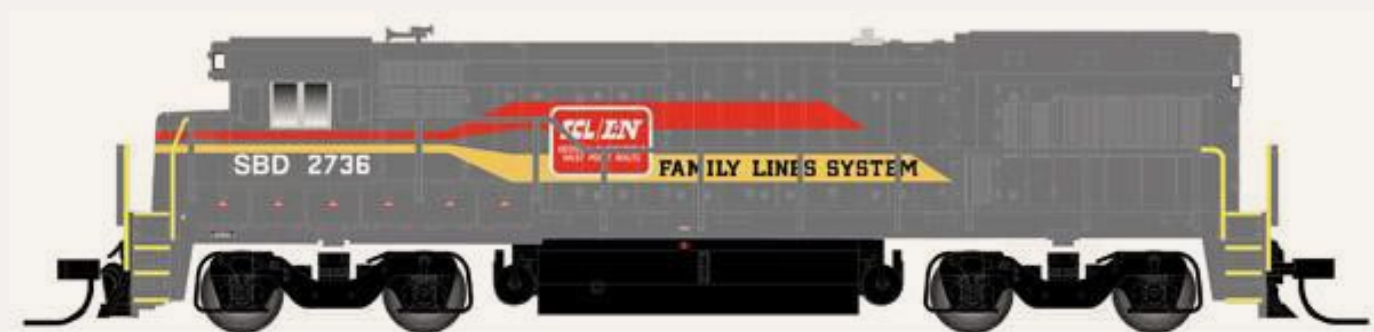

## N SCALE PRODUCT NEWS

Atlas Model Railroad Company ([atlasrr.com](http://atlasrr.com)) has scheduled the next release of its N scale U23B locomotive for the fourth quarter of this year. Both standard DC and DCC equipped versions of the ready-to-run model will be available. New decorating schemes will be released for SBD-Family Lines (above) and PRL-Penn Eastern Rail Lines (blue body with yellow railings).

Previously released roadnames with new numbers include Chessie System (vermillion and yellow), Delaware & Hudson (blue over grey with yellow stripe), Lehigh Valley (zebra nose, red body with yellow lettering and stripe), Western Pacific (dark green body with orange nose and lettering), and Santa Fe (above). Undecorated versions will be available with a choice of AAR-B or FB-2 trucks. DC-ready models will have an MSRP of





\$119.95. Locomotives equipped with an NCE decoder will list at \$154.95.

Atlas has set a third quarter release date for a group of N scale 40' wood refrigerator cars that are based on a prototype built by Pullman for the Northern Refrigerator Car Company in 1930. Decorating schemes on the ready-to-run reefers include



Erie (above), NWX-Horvitz Brothers, and ART-Mexene Chile Products (below).



contents



index

Also URTX-Phenix Cheese, SLRX-St. Louis Refrigerator Car Company (white sides), and URTX- Nucoa Best Foods (below).

In addition to their colorful sides, the reefers feature vertical brake shafts, wood running boards, working ice hatches, and Bettendorf-style 40-ton solid-bearing trucks. The ready-to-run cars have an MSRP of \$24.95 each. An undecorated model lists for \$13.95.



Atlas has scheduled a second production run of its N scale Trainman® series 5250 cu ft hopper car for release in the third quarter of 2013.

Three numbers each will be available for Atlantic & Western; BFGX (blue body); Continental Polymers; Gulf (above); Eastman Chemical; General America; Lifeline Foods; Monsanto; Elgin, Joliet & Eastern; and Borg Warner (below).



Elgin, Joliet & Eastern; and Borg Warner (below).

The ready-to-run four-bay covered hopper cars have an MSRP of \$16.95. Undecorated versions will have a list price of \$12.95.

---

**Blair Line** ([blairline.com](http://blairline.com)) has released a craftsman kit for Walnut Grove Depot, a structure that features a pagoda-style roof with flared eaves. Construction details include laser-cut floor, sub-roof, interior and exterior walls, with tab-and-slot connections.

Additional items include laser-cut peel-n-stick doors, windows, window glazing, and roofing material. Peel-n-stick trim comes in one piece for each side of the structure and the bay windows which simplifies the application of the detailed trim work. A chimney and signage are included. The N scale kit sells for \$39.95 and when assembled has a footprint of 1.80" x 3.0". The model is based on a prototype structure that served the Frisco (St. Louis-San Francisco Railway) in Walnut Grove, Missouri.

---



**Eastern Seaboard Models ([esmc.com](http://esmc.com))** has scheduled an April/May release date for its Magor/PC&F 40' boxcars decorated in the distinctive BAR State of Maine paint scheme. Both 1950 and 1969 (above) versions will be offered. The ready-to-run N scale model will also be available decorated for Penn Central, Canadian Pacific (with heater, below), and for OKEX (no running boards or heater). Other injection molded plastic models currently under development include a class G36 gondola, a C&O class F-9 well car, and a class X65 boxcar that will initially be decorated for New York Central and Pittsburgh & Lake Erie.

ESM's Made in America series of cast resin Keyser Valley kits include a Lackawanna caboose in the original body version,



contents



index

as well as Erie Lackawanna and Conrail versions on a modified Spartan body. A cast resin New Haven 8600 series coach with etched-metal detail parts is currently under development. Visit the above web site for pricing and ordering instructions.

---

**N scale Fox Valley Models** 2013 production schedule includes class M-53 wagon top boxcars decorated for three well-known model railroads: Tony Koester's Allegheny Midland , W. Allen McClelland's Virginia & Ohio, and the Cumberland Valley System built by the Reid brothers, Bill and Wayne. M-53s decorated for real roads will include B&O 1955-1962 billboard scheme with Youngstown doors, and a B&O C-16 dark green express car with a flat steel door. The ready-to-run N scale models will have an MSRP of \$19.95.

Additional N scale items on Fox Valley's production schedule include three body styles of a B&O Canstock car, three-bay class H-30 hopper cars, and Milwaukee Road rib-side cabooses with oil tanks and modernized end ladders with splash guards. Paint schemes on the caboose will include MOW and St. Maries River. Currently under development for release later this year is a Silverside gondola built from Southern Railway blueprints. InterMountain Railway is responsible for marketing Fox Valley products. For more information visit [intermountain-railway.com](http://intermountain-railway.com).

---

**Kato's** ([katousa.com](http://katousa.com)) March schedule includes reruns of its N scale SD40-2 diesel locomotive decorated for Chicago North Western and Union Pacific, as well as new paint schemes for Wisconsin & Southern (above), and Pan Am Railroad. All road names are available in two numbers. The standard DC models have an MSRP of \$118.00 each.

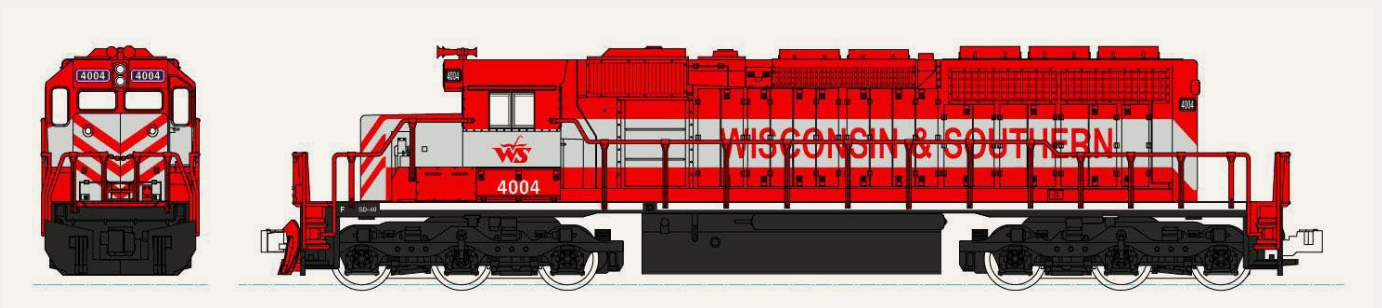

Over the next three months Kato plans to release its Gunderson Maxi 1 well cars in three different road names. Each sales item will consist of five well-cars and ten 40' containers.



The March release will be for DTTX cars with Maersk containers. BNSF (swoosh scheme) cars with MOL containers (above) will be released in April. AOK well-cars with Hanjin containers are due for release in May. Each road name will be available in two different number sets. The MSRP is \$150.00 per set.

---

**Trainworx** ([train-worx.com](http://train-worx.com)) has released road names for the fall production run of its N scale 52'6" corrugated gondolas. Features of the ready-to-run model include separate brake wheel and stand, etched-metal grab irons, ladders, footboards, sill steps, tow rings, retaining valve release linkage, and 100-ton trucks with Fox Valley metal wheelsets. Road names will be Santa Fe, Conrail, and Penn Central in a choice of 12 numbers at \$28.95 each. Cars decorated for Great Northern and Union Pacific will also come in 12 numbers at \$26.95 each. Six numbers will be available for Burlington Northern and Northern Pacific cars at \$26.95 each. Pre orders are due March 31 for delivery this fall.

---



contents



index

# NEW DECALS, SIGNS AND FINISHING PRODUCTS

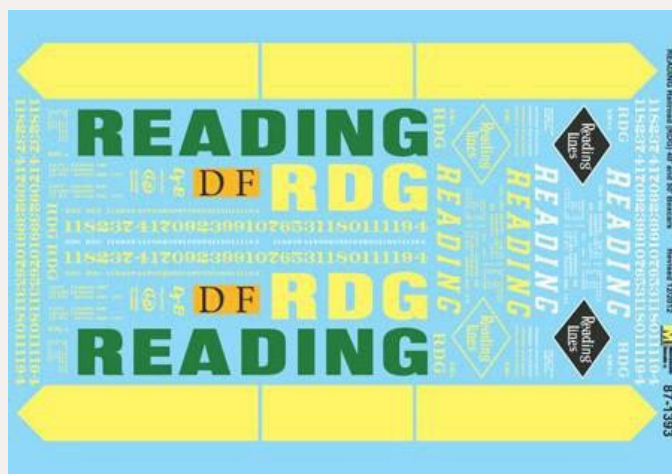
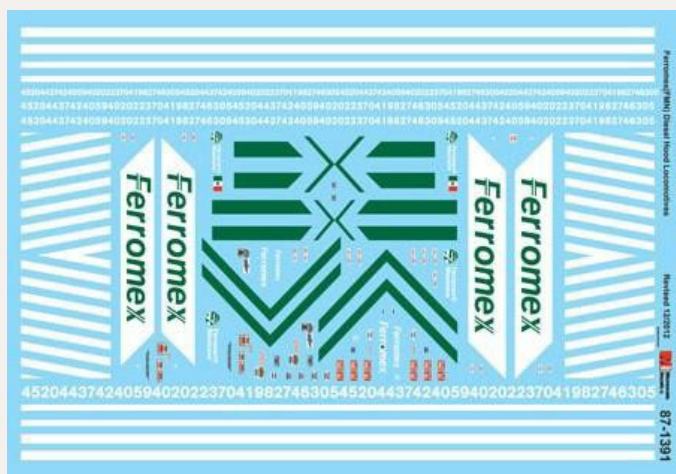

**Microscale Industries** ([microscale.com](http://microscale.com)) has released four new sets of HO and N scale decals. They include FMN-Ferromex for diesel hood locomotives (above left); L&N-Louisville & Nashville ACF Centerflow, GATC 4160 Airslide, PS 2600, and Magor 4750 covered hopper cars; C&O-Chesapeake & Ohio lightweight streamlined passenger cars; and RDG-Reading 40' and 50' boxcars (above right). HO scale sets are priced at \$7.00 each. N scale sets are \$5.75 each.

Decal sets expected to be announced soon include Rock Island first generation diesels, NP wood chip gondolas, CGW insulated boxcars (for the MOLOCO kit), UP SD70ACe and ES44AC diesels, CGW passenger cars, and KYLE Railways boxcars.

---

**T2 Decals** is selling an 8.5" x 11" decal sheet of pre-weathered graffiti for \$17.99. For purchasing details contact Todd Thornberry at [Thorn142002@hotmail.com](mailto:Thorn142002@hotmail.com).

---



**Highball Graphics** is selling Ontario Northland decals for small hood units and road switchers in blue and yellow chevron scheme (item L-260, above). Also pulpwood racks in four schemes (item F-310), and 53' mill gondolas in blue and yellow chevron scheme (item F-311, below).



The sets are available for N and HO scale. Visit [highballgraphics.com](http://highballgraphics.com) for pricing and ordering information.

**Mount Vernon Shops** ([mountvernonthops.com](http://mountvernonthops.com)) has several new lettering sets including HO and N scale decals for PRR E44 and E44a electric locomotives for all schemes through 1968 (item E44); PRR class F33 flat cars with enough material to letter two cars including system-wide reweight and repack locations (item F33); Penn Central ex-PRR 65' class G26, G26a, G33, G33a, G33b, and G37 mill gondolas including data for two cars and appropriate shop codes, COTS stencils, and wheel inspection dots (item PCP65). Also black and white Conrail locomotive patches (item CRP), decals covering all classes of Conrail cabooses (item CRC), and Maryland & Pennsylvania diesel locomotives in 1969-1992 yellow and black scheme including



contents



index

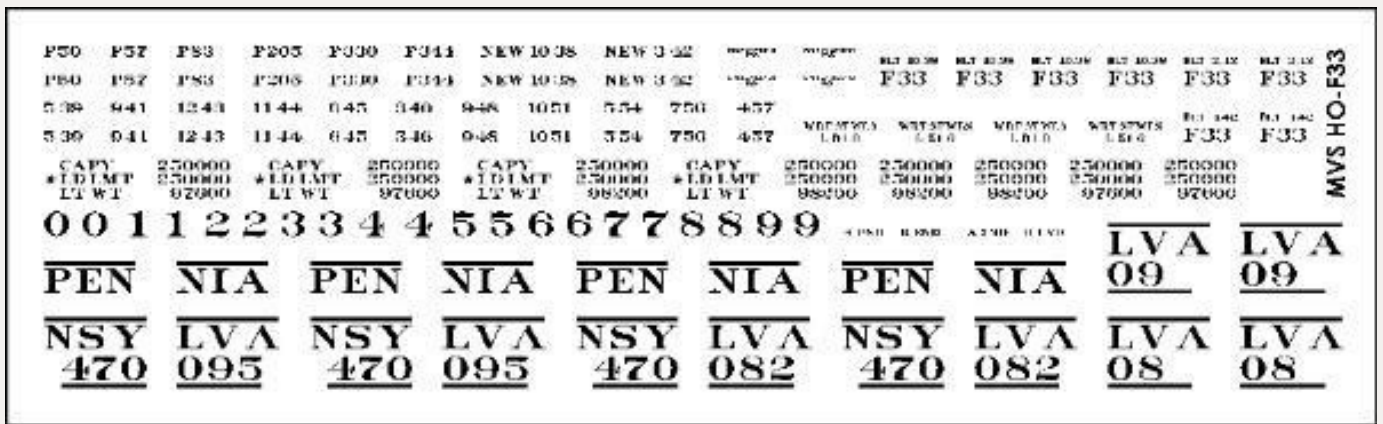

**Note: Actual decal has white lettering.**

all known lettering variations (item MPAL). Visit the above web site for additional prototype information and to verify pricing and availability in HO or N scale.

**San Juan Decals ([sanjuandecals.com](http://sanjuandecals.com))** is now selling decals for large scale (1:20.3, 15mm, Fn3) D&RGW locomotives. The lettering set has sufficient material to decorate up to three locomotives including decals for one of each class of locomotive as well as lettering for one Flying Rio Grande style, and both early and late Moffat heralds.



## DISCLAIMER ..

The opinions expressed in this column are those of the writer and do not necessarily reflect the opinion of Model Railroad Hobbyist or its sponsors. Every effort is made to provide our readers with accurate and responsible news and information, however, neither Model Railroad Hobbyist or the writer of this column can be held responsible for any inaccuracies or typographical errors that may inadvertently appear in this column.





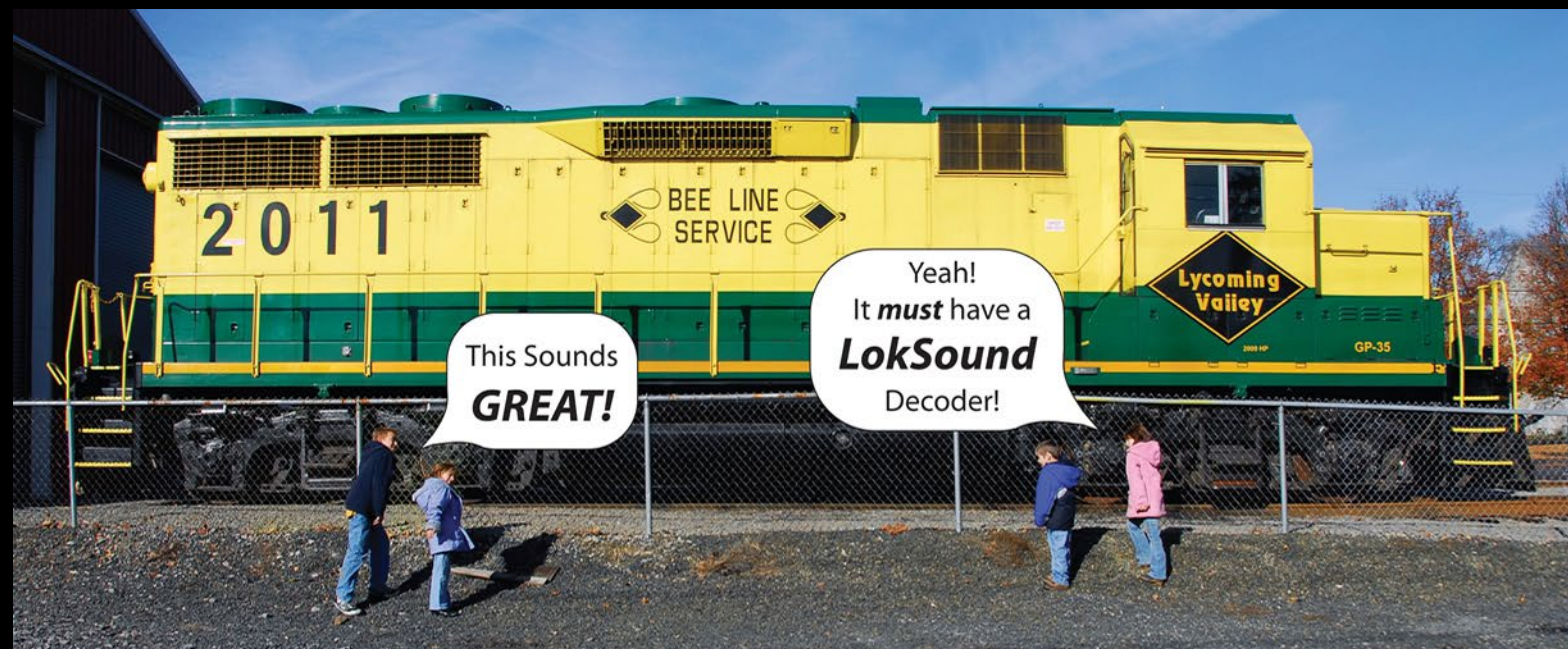

**SO REAL...You'll Think You're There!**

**LokSound Select · 3 SIZES, ENDLESS POSSIBILITIES!**

**INDUSTRY LEADING  
MOTOR CONTROL**

- Multiple Bell types
- Multiple Brake squeals

**4 OR 8 Ohm  
SPEAKERS!**

- 4 or 6 Output functions depending on the style
- Up to 4 Prime Movers or Steam Sounds on EACH decoder
- 16 Very Playable, LOUD Horns or Whistles depending on Profile
- All Changeable by using ONE CV! No Programmers or Boosters needed!\*

**Small Size  
BIG POWER! 1.1Amp!  
LokSound Select  
"4 AUX"**



**\$99.99**

**NEW 2011**

**LOKSOUND  
SELECT**

Only Available From  
ESU LLC (USA)



- Great NEW Size 1.18" x 0.61"
- Versatile DCC & DC "Dual Mode" decoder!
- 8 channel sound system!
- FOUR lighting outputs and a 1.1A motor controller
- Available with ALL Current LokSound Select Sound Profiles
- Use 4, 8, or 16 Ohm Speakers

**ONE SIZE FITS ALL!  
LokSound Select "DIRECT"**



**\$109.99**

**6 Outputs!  
LED Resistance  
Built In!**

**NEW 2011**

**LOKSOUND  
SELECT**

Only Available From  
ESU LLC (USA)



- Easy Drop in Design
- Versatile DCC & DC "Dual Mode" decoder!
- 8 channel sound system!
- SIX lighting outputs ALL with built in resistors for LEDs
- Available with ALL Current Diesel Sound Profiles
- Use 4, 8, or 16 Ohm Speakers

**Tiny Size,  
HUGE Versatility!  
LokSound Select  
"MICRO"**



**\$99.99**

**NEW 2011**

**LOKSOUND  
SELECT**

Only Available From  
ESU LLC (USA)



- Great NEW size ONLY 0.98" x .417"
- Versatile DCC & DC "Dual Mode" decoder!
- 8 channel sound system!
- FOUR lighting outputs and a .75A motor controller!
- Standard 8-pin NEM 652 plug included
- Available with ALL Current LokSound Select Sound Profiles
- Use 4, 8, or 16 Ohm Speakers!

\* ESU LokProgrammer needed to "Replace" Sound and for Firmware updates, not for normal editing

[www.LokSound.com](http://www.LokSound.com) • 477 Knopp Drive Muncy, PA • 570-649-5048

Now on facebook!





## Send us your product announcements

If you are a hobby manufacturer with a product announcement, just [click here](#) and submit your announcement to us. Our web site and free magazine reach continues to grow, so get on board with this new media train that's hard to stop!

### Briefly noted at press time...

... On February 27, 2013, Korea-Brass Company Ltd., an OEM supplier of hybrid plastic, brass and die cast models for several brand names including Broadway Limited, announced that it will enter the North American market with its own line of models. Company executive, Scott Wendt, said one of the reasons for developing their own brand was to support their manufacturing operation in the event of a slowdown from any of their current American clients.

The new direct brand will be identified as KBM Line, with the introductory item being an HO scale General Electric U25C diesel locomotive. Availability is planned for early 2014. The announcement said the ready-to-run locomotive will be available in multiple prototype road names with separately applied details and a high-quality sound system. KBM has set a target price of \$290.00 to \$350.00 for a model with DCC and sound. A standard DC version without sound is expected to be priced at about \$190.00.

The Korean enterprise was established in 1984 as a producer of detailed lost wax castings. It later expanded into producing complete models and in 1999 changed its name to Korea-Brass Company, Ltd. The company is headquartered in Hagye Technotown, Seoul, Korea. Additional information is expected to be posted soon at [korea-brass.com](http://korea-brass.com). ■



# Sound decoder installation video

By MRH DCC Columnist,  
Bruce Petrarca

*90 minutes, step-by-step*

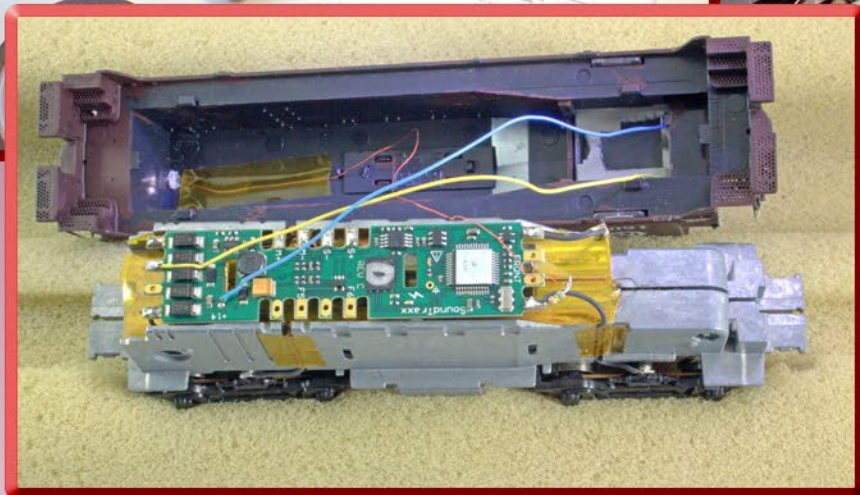
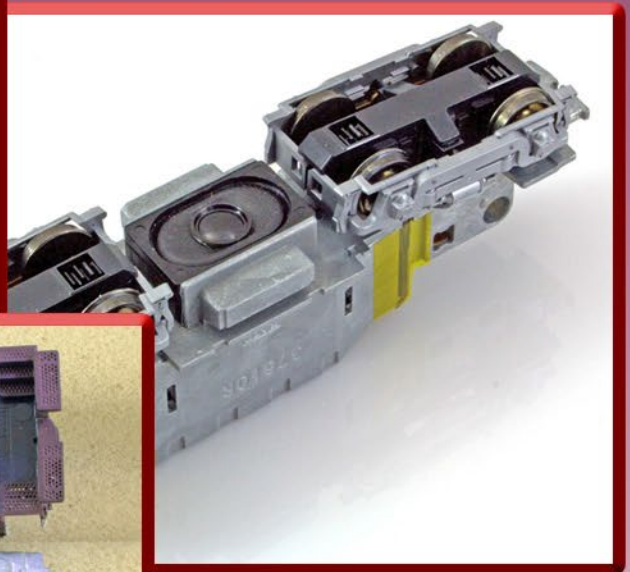

***Available for immediate download!***

**\$4.99 STD**  
**\$5.99 HD**

**Learn more...**



## Selected Events



### March 2013

**AUSTRALIA, CANBERRA**, March 23-24, Model Railway Expo, at University of Canberra High School, Baldwin Drive, Kaleen, Australian Capital Territory. Info at [canberra-model-railway-club.webs.com](http://canberra-model-railway-club.webs.com) or contact Andrew Lund at [cmrcexpo@gmail.com](mailto:cmrcexpo@gmail.com).

**AUSTRALIA, MELBOURNE**, March 29-31, 11th Annual Australian Narrow Gauge Convention featuring displays, seminars, and vendor displays. Special layout tours April 1 to Bill Black's Sn3 DRGW, Peter Sutton's HOn3 Los Pinos and Toltec, and Rod Warren's On30 Lost Creek layout. Info at [cngg.org.au/html/latest\\_news.html](http://cngg.org.au/html/latest_news.html).

**CANADA, ONTARIO, TORONTO**, March 16, Annual Railway Prototype Modellers Meet, with clinics on auto frame cars, detailing prototype track work, and realistic freight car weathering. Also show- and-tell program and an open forum on prototype modeling. Humber College, North Campus, Building B, rooms B201& B202. Free parking. For details including fees contact Brian Gauer at [bdgauer@rogers.com](mailto:bdgauer@rogers.com).

**CALIFORNIA, BAKERSFIELD**, March 9-10, Annual Model Train Show & Swap Meet, with dealer tables, operating model train displays and hourly door prizes. Sponsored by Golden Empire Historical & Modeling Society Model Train Club. Kern County Fairgrounds, 1142 South 'P' Street. Hours and fee information at [gehams.net](http://gehams.net).

**CALIFORNIA, BAKERSFIELD-TEHACHAPI**, March 8-10. Tour (self-guided) of 25 home layouts in Bakersfield, Lake Isabella, Tehachapi, and the High Desert area, sponsored by Model Railroads of Southern California. Layout descriptions and a tour



map available on request from Bob Chaparro at [chiefbobbb@verizon.net](mailto:chiefbobbb@verizon.net).

**CALIFORNIA, STOCKTON**, March 9, Winterail 2013, 35th Anniversary multi-media event featuring railroad photography from well-know photographers, plus vendor tables. Scottish Rite Masonic Center, 33 West Alpine Avenue.

**GEORGIA, ATLANTA**, March 9-10, The Great Train Expo, Cobb Galleria Center. Info at [greattrainexpo.com](http://greattrainexpo.com).

**ILLINOIS, LOMBARD**, March 15-17, Chicago O Scale (2-rail) Meet. Lombard Yorktown Center, 70 Yorktown Center Road. Info at [marchmeet.net](http://marchmeet.net).

**KANSAS, WICHITA**, March 16-17, The Great Train Expo, Century II Center. Info at [greattrainexpo.com](http://greattrainexpo.com).

**MASSACHUSETTS, PEABODY**, March 9, Annual Spring TRAINing Show, sponsored by NMRA Hub Division, Northeastern Region, with operating trains, vendor tables, and clinics ranging from fundamental to advanced including special clinic by Paul Dolkos. Holiday Inn, 1 Newbury Street. Info at [hubdiv.org](http://hubdiv.org).

**MICHIGAN, MOUNT PLEASANT**, March 24, 33rd Annual Mid-Michigan Model Train Show, with operating layouts, door prizes and more than 200 vendor tables, at Finch Fieldhouse, Central Michigan University. Free parking. Info from John Thompson at [redwings48618@yahoo.com](mailto:redwings48618@yahoo.com) or Dan Foltz at [midmichiganmodeltainsow@gmail.com](mailto:midmichiganmodeltainsow@gmail.com).

**MICHIGAN, TAYLOR**, March 10, Railroad Memorabilia & All-Scale Model Train Show, sponsored by Bluewater NRHS and Society of N-Scalers, at Taylor Town Trade Center. Info at [bluewaternrhs.com](http://bluewaternrhs.com).

**MISSOURI, JOPLIN**, March 30, Model Train Show at Joplin Museum Complex, 504 Schifferdecker Avenue. Info from Fred Miller at [fredmiller@engineer.com](mailto:fredmiller@engineer.com).



contents



index

**MISSOURI, SPRINGFIELD**, March 16, 35th Annual OMRA Train Show & Swap Meet with vendor tables and operating layouts from Z to G scale and tin plate. Also home layout tours and clinics on the History of the Ft. Leonard Wood Branch, Model Railroading 101, and Weathering with PanPastels. Remington's Community Event Center, 1655 West Republic Road. Info from Ron Williams at [rwilliams3129@gmail.com](mailto:rwilliams3129@gmail.com).

**OHIO, GREENFORD**, March 21-23, 21st Annual Midwest Narrow Gauge Show hosted by Gary Kohler at Greenford Space Center (formerly South Range Middle School), West South Range Road (Route 165). Featuring clinics, vendor tables, model contests, layout tours, and narrow gauge camaraderie.

Additional info at [maine2footquarterly.com/midwest.htm](http://maine2footquarterly.com/midwest.htm).

**OHIO, KIRTLAND**, March 16-17, Railfest 2013, hosted by NMRA MCR Division 5, at Lakeland Community College near SR306 and I-90. Info at [railfest.org](http://railfest.org).

**OKLAHOMA, TULSA**, March 22-24, 4th Annual Layout Design and Operations Weekend, hosted by NMRA Indian Nations Division. Speakers include Mike Porter, Barry Karlberg, Jim Senese, Robert Bornfleth, Steve Newton, and Marc Montray. Op sessions on local layouts Friday and Saturday evening plus Sunday morning. Info at [picturetrail.com/salomon](http://picturetrail.com/salomon).

**OREGON, PORTLAND**, March 9, Willamette Model Railroad Club Swap Meet with vendors featuring model railroad equipment, railroad memorabilia, books, photos, and more. Kliever Memorial Armory, 10000 NE 33rd Drive. Free parking. Request fee info at [wmrswapmeet@yahoo.com](mailto:wmrswapmeet@yahoo.com).

**OREGON, PORTLAND**, April 20th, 2nd Division PNR Spring Meet. Located at the Columbia Gorge Model Railroad club, it will feature clinics by Tony Thompson, Rod Spangler, and Richard Hendrickson. Layout tours in the afternoon followed by Operating Sessions



(reservation only) on the Bear Creek & South Jackson and the Columbia Cascade & Western in the evening. More information at [2dpnr.org](http://2dpnr.org).

**PENNSYLVANIA, GREENBURG (PITTSBURGH area)**, March 22-23, RPM-East, usual learning and sharing of prototype and model railroad information, display room, and vendor exhibits. Speakers include Jim Dalberg, Jeff English, Fred Lagno, Jim Panza, Bill Schaumburg, Stan Rydarowicz, Mont Switzer, John Teichmoeller, and Tony Thompson. Phone 724-836-6060 for hotel reservations at Ramada Inn (formerly the Sheraton Four Points). Event info available at [hansmanns.org/rpm\\_east/index.htm](http://hansmanns.org/rpm_east/index.htm).

**VERMONT, ESSEX JUNCTION**, March 16, Vermont Rails, at Champlain Valley Expo, hosted by Northwestern Vermont Model Railroad Association. Info at [nwwrailroad.org](http://nwwrailroad.org).

## April 2013

**AUSTRALIA, MELBOURNE**, April 12-14, 13th National Australian N Scale Convention, at Rydges Bell City Event Centre, Preston. Info at [convention2013.nscale.org.au](http://convention2013.nscale.org.au) or send email to [nscale2013@bigpond.com](mailto:nscale2013@bigpond.com).

**CANADA, ALBERTA, CALGARY**, April 20-21, SuperTrain, with live demonstrations, clinics, and manufacturers displays. Subway Soccer Centre, 7000-48 Street SE. For fees and hours visit [supertrain.ca](http://supertrain.ca).

**CANADA, ONTARIO, MISSISSAUGA**, April 26-28, Streetsville Junction, NFR-NMRA Regional Convention layout tours and clinics presented by Chris Lyon, Graham Macdonald, Pierre Oliver, Dave Patterson, John Spring, and Paul Taylor. Special Canadian manufactures show Friday evening. Awards Sunday morning at Hobo breakfast. Four Points Sheraton Hotel, 2501



contents



index

Argentia Road. Call 905-858-2424 for hotel reservations.  
Details at [streetsvillejunction.com](http://streetsvillejunction.com).

**CANADA, ONTARIO, SCHOMBERG (Toronto area)**, April 13,  
8th Annual Ontario Narrow Gauge Show. Co-sponsored by  
the Narrow Gauge Madness Gang, Fast Tracks, and Mt. Albert  
Scale Lumber. Schomberg Community Hall. Info at [narrow-gaugemadness.com](http://narrow-gaugemadness.com).

**CALIFORNIA, DUBLIN**, April 3-7, NMRA Iron Horse Express  
PCR Convention, Holiday Inn, 6680 Regional St. Info at  
[pcrnmra.org/conv2013](http://pcrnmra.org/conv2013).

**CALIFORNIA, LOS ANGELES**, April 6-7, April 9, and April  
13-14, Annual Spring Open House of Sierra Pacific Lines at  
Pasadena Model Railroad Club, one of the largest HO scale-  
operating model railroads in the world covering almost 5,000  
square feet. At 5458 Alhambra Ave. Info at [pmrrc.org](http://pmrrc.org).

**CALIFORNIA, SAN BERNARDINO**, April 13, Western Prototype  
Modelers Meet, with model displays, manufacturer exhib-  
its, vendor tables, raffle prizes. Clinics featuring Don DeLay,  
Michael Gross, Tom Bacarella, and Gary Robinson -- plus live  
BNSF mainline railfanning. At Amtrak/Santa Fe Depot (and  
museum), 1170 West 3rd Street. Info at [railroadprototype-modelers.com](http://railroadprototype-modelers.com)  
Vendors contact Joe D'Elia at [ppw-aline@att.net](mailto:ppw-aline@att.net)  
or phone 760 -721-3393.

**GEORGIA, PORT WENTWORTH (Savannah area)**, April 4-6,  
13th Annual Savannah RPM. Usual prototype modelers for-  
mat with clinics, model displays, vendors, historical societ-  
ies, and brotherhood. Port Wentworth Community Center on  
Appleby Road. Info from Bob Harpe at [Rharpe@comcast.net](mailto:Rharpe@comcast.net)  
or Denis Blake at [dblake7@columbus.rr.com](mailto:dblake7@columbus.rr.com).





**ILLINOIS, WATSEKA**, April 20, Annual Meeting of Chicago & Eastern Illinois Historical Society includes swap meet, model displays, photography, and railfanning at Woodlawn Junction. Info from Dave Forbes at [altamontc\\_ei@yahoo.com](mailto:altamontc_ei@yahoo.com).

**INDIANA, MIDDLEBURY**, April 19-20, NMRA Michiana Division 2013 Education and Training Conference (formerly GLMRS Symposium), includes Friday evening banquet. Info at [michiana-nmra.org](http://michiana-nmra.org).

**MARYLAND, TIMONIUM**, April 13-14, Great Scale Model Train Show. One of the nation's largest shows with more than 800 vendor tables. Hosted by Howard Zane at Cow Palace, Maryland State Fairgrounds. Info at [gsmts.com](http://gsmts.com).

**MINNESOTA, BLOOMINGTON**, April 25-28, 28th Annual Sn3 Symposium. Info at [Sn3-2013.com](http://Sn3-2013.com). At Ramada Mall of America Hotel. Call 952-854-3411 for reservations. Use code CGSN33 for convention rate.

**OHIO, MARION**, April 25-27, Central Ohio RPM Meet, at Marion Union Station. Request details from Denis Blake at [dblake7@columbus.rr.com](mailto:dblake7@columbus.rr.com).

**TEXAS, NEW BRAUNFELS**, April 6-7, Model Railroad Jamboree. Show at Civic Center 375 S. Castell Avenue and nearby Museum at railroad tracks and San Antonio Street. Request info from Jim Edmonson at [jedmonson@satx.rr.com](mailto:jedmonson@satx.rr.com).

## Future 2013

**AUSTRALIA, NSW, ALBURY**, May 25-26, Annual Model Railway Show, hosted by Murray Railway Modellers. Featuring trader tables, model railway displays from various



contents



index

regions of Australia in N, HO and O scales, and special Thomas the Tank Engine display. Mirambeena Community Centre, 19 Martha Mews, Lavington. Info at [murrayrailway-modellers.com](http://murrayrailway-modellers.com).

**CANADA, ONTARIO, OTTAWA**, May 4-5, Ottawa Train Expo, with operating trains, displays, and railroad exhibits. Carleton University Field House. Details at [ottawatrainexpo.com](http://ottawatrainexpo.com).

**NEW ZEALAND, DUNEDIN**, May 11-12, Dunedin Model Train Show sponsored by the American Modular Group, at Forbury Park, 146 Victoria Road. Features include more than a dozen operating layouts including two Sn3, and five New Zealand Railways layouts, plus operating Thomas and Friends layout for kids. Additional details at [dunedinmodeltrainshow@vodafone.co.nz](mailto:dunedinmodeltrainshow@vodafone.co.nz).

**CALIFORNIA, LONG BEACH AREA**, May 18, Tour (self-guided) of home layouts in the Long Beach and South Bay area, sponsored by Model Railroads of Southern California. Layout descriptions and a tour map are available on request from Bob Chaparro at [chiefbobbb@verizon.net](mailto:chiefbobbb@verizon.net).

**CALIFORNIA, PASADENA**, August 28-31, 33rd National Narrow Gauge Convention. Details at [33rdnngc.com](http://33rdnngc.com). HQ at Hilton Hotel, 199 S. Los Robles Avenue. Volunteer clinicians please contact Carl Heimberger at [clinics@33rdnngc.com](mailto:clinics@33rdnngc.com).

**CALIFORNIA, RICHMOND**, June 22, San Francisco Bay Area Prototype Modelers Meet, Hosted by BAPM. St. David School, 871 Sonoma Street. Info at [bayareaprototypemodelers.net](http://bayareaprototypemodelers.net).

**COLORADO, LONGMONT**, December 8-9, Annual Train Show, sponsored by Boulder Model Railroad Club, with operating layouts, prize winning models, vendor tables, and layout



raffle. Boulder County Fairgrounds. Info at [bouldermodelrailroadclub.org](http://bouldermodelrailroadclub.org).

**CONNECTICUT, COLLINSVILLE**, May 31 – June 1, New England/Northeast Prototype Modelers Meet. Info from Dave Owens at [daowens@gmail.com](mailto:daowens@gmail.com), or [neprototypemeet.com](http://neprototypemeet.com).

**GEORGIA, ATLANTA**, July 14-20, NMRA Annual Convention. Cobb Galleria Centre with convention HQ at adjacent Renaissance Waverly Hotel. Info at [nmra2013.org](http://nmra2013.org).

**GEORGIA, ATLANTA**, July 18-20, National Train Show, in conjunction with annual NMRA Convention. Cobb Galleria Centre, 2 Galleria Parkway. Info at [nmra2013.org](http://nmra2013.org).

**IDAHO, BOISE**, June 26-30, Snake River Special, NMRA Pacific Northwest Region 2013 Convention. Info at [pnr.nmra.org/3div/2013.html](http://pnr.nmra.org/3div/2013.html).

**ILLINOIS, COLLINSVILLE (Metro St. Louis)**, August 2-3, St. Louis RPM, at Gateway Convention Center. Info from John Golden at [golden1014@yahoo.com](mailto:golden1014@yahoo.com).

**ILLINOIS, LISLE (formerly at Naperville)**, October 17-19, 20th Annual RPM-Naperville Conference featuring prototype models, manufacturers displays, vendor tables, raffle prizes, and clinics with usual blue ribbon panel of speakers. Friends of the Freight Car dinner Thursday. Event hosted by Joe D'Elia. Info at [railroadprotypemodelers.com/naper\\_meet.htm](http://railroadprotypemodelers.com/naper_meet.htm). At Wyndham Lisle Hotel (new venue), 3000 Warrenville Road, Lisle. Call 630-505-1000 for hotel reservations.

**INDIANA, INDIANAPOLIS**, May 2-5, Mile Post 50, Annual Convention of NMRA Central Indiana Division. Banquet speaker is Thomas Hoback, president/CEO of Indiana Railroad Company. Event info at [cid.railfan.net](http://cid.railfan.net). Marriott Indianapolis



contents



index

East, 7202 East 21st Street. For hotel reservations call 317-352-1231.

**KANSAS, OLATHE**, June 13-16, NMRA Mid-Continent Region 2013 Convention. Info at [mcor-nmra.org](http://mcor-nmra.org).

**MARYLAND, TIMONIUM**, June 22-23, Great Scale Model Train Show. One of the nation's largest shows with more than 800 vendor tables. Hosted by Howard Zane at Cow Palace, Maryland State Fairgrounds. Information at [gsmts.com](http://gsmts.com).

**MASSACHUSETTS, PITTSFIELD**, November 7-9, Fine Scale Model Railroader Expo. Billed as "the only show dedicated to the art of scale model structure building," with model displays, vendor exhibits, and a layout tour of Dick Elwell's Hoosac Valley Lines. All-star list of clinician/speakers include Jon Addison, Michael Duggan, Dave Frary, Brett Gallant, Ken Hamilton, Bernard Kempenski, Marty McGuirk, Bob Mitchell, Dave Revelia, and Bill Sartore. Expo info at [modelrailroad-expo.com](http://modelrailroad-expo.com). Event at Berkshire Crown Plaza Hotel, One West Street. Call 413-499-2000 for hotel reservations.

**NEW MEXICO, ALBUQUERQUE**, June 6-9, Rails Along the Rio Grande, NMRA Rocky Mountain Region, Rio Grande Division 6 Convention, at Marriott Pyramid North. Info at [rarg2013.org](http://rarg2013.org).

**OHIO, CINCINNATI**, June 5-9, National Garden Railway Convention. Info at [ngrc2013.com](http://ngrc2013.com).

**OHIO, DAYTON**, May 15-18, Operations Dayton 2013, NMRA Mid-Central Region Convention at Wyndham Gardens Hotel. For hotel reservations call 937-434-8030. Convention info at [mcr2013convention.com](http://mcr2013convention.com).

**OHIO, HILLIARD**, May 18-19, 5th Annual N-Scale Weekend, sponsored by Central Ohio NTrak. Info at [centralohiontrak.org](http://centralohiontrak.org).



**OREGON, PORTLAND**, June 28-30, West Coast 2013 Garden Railway Regional Meet, hosted by Rose City Garden Railway Society. Info at [rcgrs.com](http://rcgrs.com).

**PENNSYLVANIA, PHILADELPHIA**, May 3-4, 21st National Model Trolley Meet, hosted by East Penn Traction Club at Greater Philadelphia Expo Center, 1601 Egypt Road, Phoenixville, PA 19460. Info at [eastpenn.org/meet.html](http://eastpenn.org/meet.html). Vendors contact Charles Long, 227 Locust Rd, Ft. Washington, PA 19034-1425.

**TEXAS, IRVING**, May 29 - June 2, Lone Star Express, 2013 NMRA Lone Star Region Convention at Sheraton DFW Hotel. Call 800-345-5251 for reservations request 2013 Lone Star Region rate.

**WISCONSIN, MILWAUKEE**, June 26-30 National N Scale Convention. Info at [nationalnscaleconvention.com](http://nationalnscaleconvention.com).

**WISCONSIN, WEST ALLIS (Milwaukee area)**, November 9-10, Trainfest 2013, hosted by Wisconsin Southeastern Division of NMRA.

## Future

**FLORIDA, COCOA BEACH**, January 9-11, 2014, Cocoa Beach RPM meet.

**OHIO, CLEVELAND**, July 13-19, 2014, NMRA National Convention and National Train Show.

**OREGON, PORTLAND**, August 23-30, 2015 NMRA National Convention and National Train Show.

**INDIANA, INDIANAPOLIS**, July 3-10, 2016 NMRA National Convention and National Train Show. ■



contents



index

# My hobby has been ruined!

## Reverse Running: Stepping outside the box with a contrary view

by Dave Kilborn

**M**RH and the greater community in the MRH forums have ruined my hobby. It used to be a fun hobby. I'd go to the hobby shop, see something that looked cool and buy it. I would joyfully take it home, plop it on my diorama or small layout, whichever I had at the time, and run it around and around. It was a nice past time that provided me some semblance of stress relief.

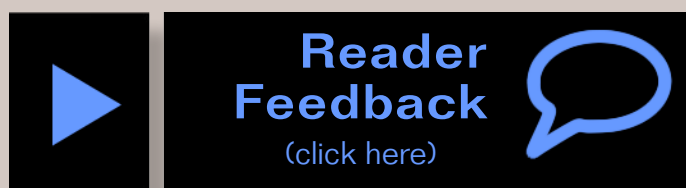

Enjoying my hobby, I came across Joe Fugate's Siskiyou Line website in 2008. I loved scenery but had only made a small attempt at it on a diorama once. Joe's video series looked like something I would enjoy and was reasonably priced, so I bought it. I tried out several of the techniques and enjoyed this next step. Joe also discussed his new ezine that he planned to produce, which I was fully supportive of. I'm a visual learner and the thought of videos and more pictures available through an ezine would benefit me more. I eagerly awaited the magazine and joined the MRH forums months before MRH released its first issue.

The MRH forums were modest at first, but friendly and helpful. There were many good tips, as well as a number of posters that

provided updates of their work. Many of those original people still frequent the forums today. As MRH moved from a quarterly to bi-monthly to monthly publication, the forums grew and more people were finding what a great resource the MRH website is, not just the publication. Unfortunately, this was where it all went terribly wrong for my hobby.

The more I learned from the forums and MRH itself, whether it was in the questions I asked, articles I read or just reading other peoples' questions or comments, the more I realized where my layout lacked. Where once I saw a great CP loco with the Action Red and Multimark, I began to see a loco with the incorrect headlight, bell and horn placement. Where once I saw some nice double stack cars, I now saw cars that didn't fit my chosen era.

In fact, after my recent switch back to HO, I pulled out a few locos I had stored and instead of seeing the nicely detailed, smooth running locos, I now saw a foobie and three others that needed a number of modifications to bring them up to standards. In fact, I sold the foobie and one of the other locos, and bought two newer offerings that were much closer to standard. The other two await a promised article on detailing them from a MRH member.

I also used to enjoy “designing” track plans that would fit in my desired space. My main requirements in those designs years ago was trying to get the longest mainline run, have a tunnel, at least a couple bridges and a couple passing sidings to run two trains opposite directions.

Now I have to figure out ways to make the layout a plausible depiction of a real railroad, including operational plans and determining what rolling stock and locos I will need to meet these objectives. Now I have to really work hard at getting a good plan.

Thanks, MRH. Look at how you've ruined my hobby! 



contents



index

# Clickable advertiser index

[Accu-Lites](#)

[Accurail](#)

[Alpine Division Scale Models](#)

[Bachrus](#)

[Backdrop Junction](#)

[BLMA](#)

[Bowser](#)

[Broadway Limited](#)

[Bullfrog Snot](#)

[Coastmans Scenic](#)

[Coffman](#)

[Digitrax \(2 page spread\)](#)

[ExactRail](#)

[ESU](#)

[Fifer Hobby Supply](#)

[Great Decals](#)

[Horizon Hobbies](#)

[Interaction-Enterprises](#)

[Iwata-Medea](#)

[Jelsma](#)

[Knucklepin \(Passenger cars\)](#)

[Litchfield Station](#)

[Logic Rail Technologies](#)

[Microscale](#)

[MicroMark](#)

[Minimalist Model Railroad](#)

[Model Railroad Benchwork](#)

[Model Trains Video](#)

[Monster Modelworks](#)

[M.T.H.](#)

[Mullet River \(O scale\)](#)

[Nano-Oil](#)

[North American Railcar](#)

[NCE](#)

[Olin's Depot](#)

[Portland Daylight Express](#)

[Proto:87 Store](#)

[RailMaster Hobbies](#)

[Railroad Explorer](#)

[Rapido \(2 page spread\)](#)

[Reynauld's Euro Imports](#)

[Ring Engineering \(1\)](#)

[Ring Engineering \(2\)](#)

[RSlaserKits](#)

[Rulers-of-the-World](#)

[Rusty Stumps](#)

[San Juan Car Company](#)

[SBS4DCC](#)

[Scenic Express](#)

[Scotty Mason Show](#)

[SoundTraxx](#)

[Southern Digital](#)

[Stans Trains](#)

[TAM Valley Depot](#)

[The Curio and Whatnot Shop](#)

[Tony's Trains \(2 page spread\)](#)

[TrainTek](#)

[True Line Trains](#)

[True Scene Modeling](#)

[Westerfield Models](#)

[Yankee Dabbler](#)





# Clickable topic index

[DCC Impulses – Anatomy of a DCC Decoder](#)

[Editorial – Assistant Editor](#)

[Editorial – Reverse Running](#)

[First Look – Bitter Creek Ground Throw](#)

[Getting Real – Course Correction](#)

[Layout – The Western Expansion Central](#)

[News – March Newsletter](#)

[News – March Events](#)

[Q and A – MRH Questions, Answers, and Tips](#)

[Rolling Stock – RLW's Nn3 20-ton Coal Cars](#)

[Scenery – Makin' Smoke](#)

[The Tool Shed – Pin Vises](#)

[Yes It's a Model – MRH Monthly Photo Album](#)

[What's Neat This Week – Gary Christensen Graffiti Artist](#)

[Up the Creek – Peninsula Construction!](#)

---

[Other – Bonus Extras](#)

[Other – Cover](#)

[Other – Derailments](#)

[Other – Hobby Marketplace](#)

[Other – Index](#)

[Other – MRH Sponsors](#)

[Other – Staff Notes](#)

[Other – Table of Contents](#)

[Other – Writing for MRH](#)

# Derailments

humor (allegedly)



He ain't talkin'... git the rotary plow!

If you're the first to [submit a bit of good humor](#) and we use it, it's worth \$25!



**Reader  
Feedback**  
(click here)



# For the love of model trains

## Coming in April

- Modeling Erie boxcars from the 1950s
- Building a laser kit, step-by-step
- LEDs for loco lighting
- Tool shed: Third hand
- Another \$500 starter layout contest winner
- ...and lots more!

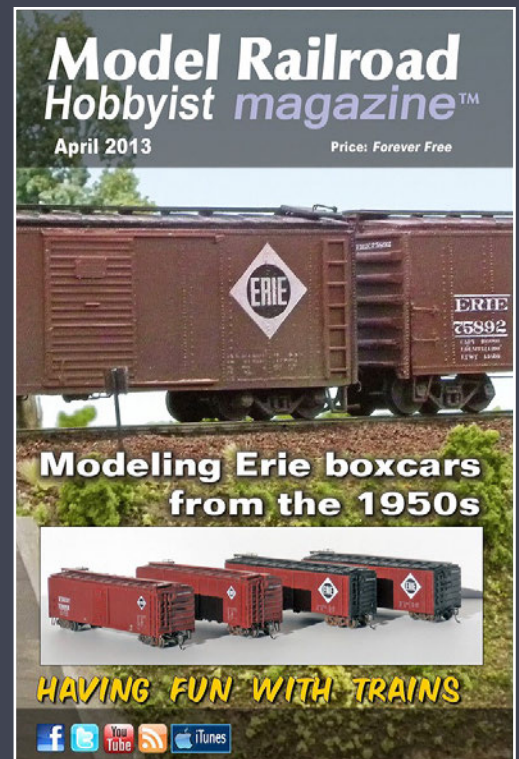

## ~~More Derailments humor ...~~

A man traveling by train asks the conductor what time the train stops at Victoria. "Sir, we don't stop at Victoria," the conductor said. "But I *must* get off there!" he insisted.

"Well, I might be able to get the engineer to slow down the train a little. Then I can dangle you out the door and lower you onto the platform."

"Will that work?"

"It's worth a try."

As they approached the platform, the train slows from 50 MPH. The conductor hangs the man in mid-air out the door. The man starts running in mid-air. "Run faster! Faster!" He lowers the man and the man's feet touch the platform. His shoes start to smoke! His heel comes off! He's running at 30 MPH. He made it! The other passengers stare in amazement. As the last car goes by, a hand grabs the man by the shirt collar and lifts him right back onto the train!

As he's helped back on the train, the gent who picked him up says, "Man you're lucky I was here to help! This train doesn't even STOP in Victoria!"

Coming next issue



contents



index