

Freight car trucks • Small layouts • Backdrop coving

Model Railroad Hobbyist magazine™

May 2013

Price: Forever Free

Mike Rose models
Kintner Milling
in Meshoppen,
Pennsylvania



Click here for the
landscape version



HAVING FUN WITH TRAINS



Standard edition - Portrait



download



contents



index

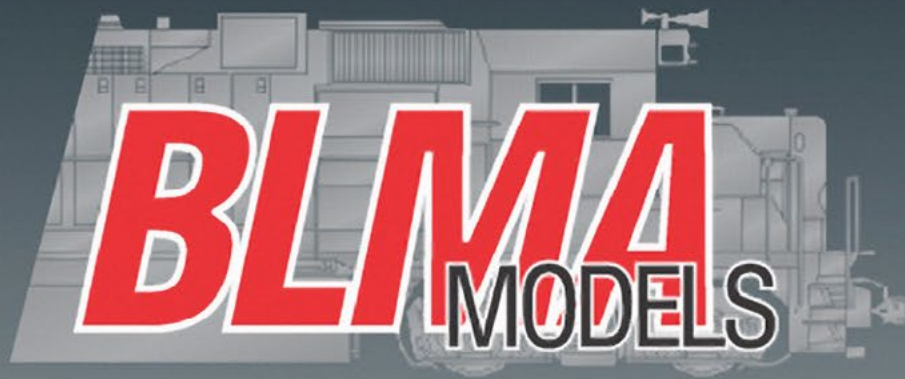

GET YOUR JTTX!

ACF F89-J 89' Flat Car - JTTX

CLICK HERE TO SEE MORE



Model Railroad Hobbyist magazine™

Front Cover: Mike Rose tells us of his journey of discovery, and building the Kitner Milling located in Mehoopany, PA. Follow along as Mike shows us how he developed and built this beautiful scene from beginning to end on his layout.

ISSN 2152-7423

Editorial Staff

Joe D. Fugate, Publisher and Editor
Don Hanley, Assistant Editor

Production

Patty Fugate, pasteup and layout
Joe Brugger, copy editing
Mike Dodd, copy editing

Technical Assistants

Jeff Shultz
Jimmy Simmons

Advertising

Les Halmos, Account Manager
Daniel Nava, Advertising Assistant
Jean-François Delisle, Marketing Assistant

Published for the glory of God. [What's this?](#)



Columnists

Richard Bale, News and events
Jeff Shultz, News and events
Les Halmos, Modular railroading
Ken Patterson, Reporter at large
Bruce Petrarca, DCC

Special Correspondents

Joe Brugger, Questions & answers
Charlie Comstock, Contributing editor

Issue password: May2013

Cover and MRH masthead



contents



index



click to learn more about this sponsor



click to learn more about this sponsor



click to learn more about this sponsor



click to learn more about this sponsor



NEW SPONSOR!



click to learn more about this sponsor



click to learn more about this sponsor



NEW SPONSOR!



click to learn more about this sponsor



click to learn more about this sponsor



click to learn more about this sponsor



NEW SPONSOR!



click to learn more about this sponsor



click to learn more about this sponsor



click to learn more about this sponsor



click to learn more about this sponsor



click to learn more about this sponsor



click to learn more about this sponsor



click to learn more about this sponsor



NEW SPONSOR!



click to learn more about this sponsor



click to learn more about this sponsor

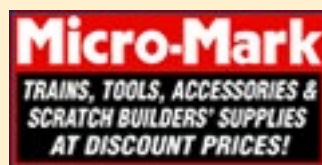

click to learn more about this sponsor



click to learn more about this sponsor



click to learn more about this sponsor



click to learn more about this sponsor



click to learn more about this sponsor



click to learn more about this sponsor



click to learn more about this sponsor



click to learn more about this sponsor



click to learn more about this sponsor

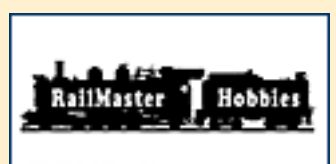

click to learn more about this sponsor



click to learn more about this sponsor



click to learn more about this sponsor



click to learn more about this sponsor



click to learn more about this sponsor





click to learn more about this sponsor



click to learn more about this sponsor



NEW SPONSOR!



click to learn more about this sponsor



click to learn more about this sponsor



click to learn more about this sponsor



click to learn more about this sponsor



click to learn more about this sponsor



click to learn more about this sponsor



click to learn more about this sponsor

Want your logo on this page? Click to find out how....

90,000+ unique device views per month...

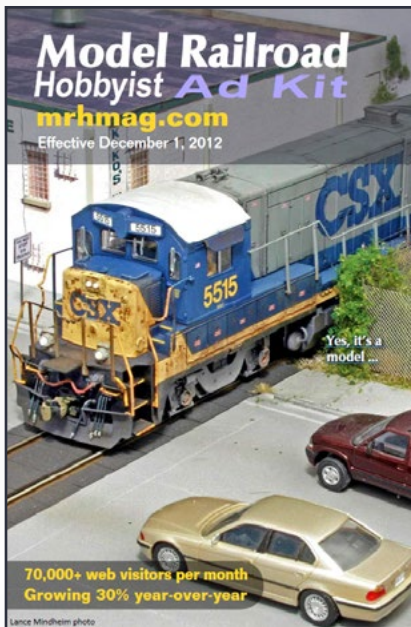

Tell me more



Looking for something? Check our Hobby Marketplace!

Take me there



Main Features

*Click title
to view*



Tool Shed: Stripwood staining fixture

Make staining stripwood in bulk easier

by Richard E. Napper



Freight trucks, 1900-1960

From archbar to roller bearing designs

by Richard H. Hendrickson

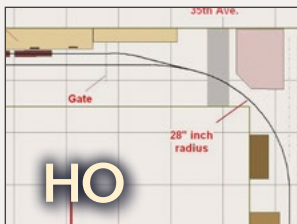

One-turnout layout

How much layout do you need?

by Lance Mindheim



Yes, it's a model

MRH's great modeling photo feature

Compiled by the MRH staff

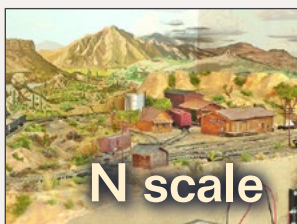

N scale 2' x 4' layout for \$500

Second place design contest winner

by Michael Brown



Erie Railroad boxcars of the '50s, part 2

Mass-production scratchbuilding techniques

by Don Hanley



May Model Railroading News

MRH news and events

by Richard Bale and Jeff Shultz

Table of Contents - 2

Other Features

*Click title
to view*

The next level in sound

Publisher's commentary
by Joe Fugate

MRH Staff Notes

Calling all authors ...
by the MRH staff

MRH Q - A - T

Questions, Answers, and Tips
compiled by Joe Brugger

Hobby Marketplace

Vendor ads

Derailments

Humor?

Columns

Bending the Sky

Up the Creek
by Charlie Comstock

Using Ohm's Law

DCC Impulses
by Bruce Petrarca

Kitner Milling

Getting Real
by Mike Rose

What's Ken up to?

What's neat this week
by Ken Patterson

The one module challenge

Reverse Running
by Joe Fugate

Subscriber-only extras (*subscribers click here to access*)





EXACTRAIL®

The Next Generation of Model Railroading



NEW AT EXACTRAIL

P-S 5344 BOX CAR



COMING SOON

5 NEW PAINT SCHEMES & KIT

[LEARN MORE](#)





The next level in sound realism?

The new hobby frontier



Publisher's Musings editorial

by Joe Fugate

For some time now, loco sound has become a regular expectation on HO and larger layouts, and loco sound is even are found on a few N scale layouts. Recently, SoundTraxx released their SurroundTraxx product, which allows you to put the speakers under the layout and have the sound follow the train around.

One of the big problems with loco sound, especially in HO and N, is the tiny speakers and their inability to transmit the deep bass rumble that's common with full-sized locomotives. SurroundTraxx addresses that problem to a degree by having the sound follow the train around, using much larger speakers mounted under the layout. For N scale, especially, this makes decent loco sound practical.

Being a computer guy, I have to ask why we need to stop with just loco sound? With programmable sound decoders from folks like LokSound/ESU, why not put a sound decoder in the caboose that has train sounds?

The caboose decoder could be consisted with the loco decoders and be programmed so when the train starts out, there's a train



SERIOUS FUN



GREAT PRODUCTS



KATO



EXCEPTIONAL SERVICE



Great products. Exceptional service. Serious fun.™

Find products from over 100 model railroad companies at HorizonHobbyTrains.com. All the brands you love—Athearn®, Lionel, Bachmann and more—are right there. You'll also enjoy:

- Same-day shipping
- Our deal-filled Savings Station
- eGift certificates

Everything we sell is backed by the best customer service and support available. Our service center team is standing by to help you get the most from whatever you buy. At HorizonHobbyTrains.com, we take having fun very seriously.

Visit HorizonHobbyTrains.com. Exclusively Trains.



HORIZON™

HOBBY TRAINS.COM

©2012 Horizon Hobby, Inc. All rights reserved. Athearn, Serious fun and the Horizon Hobby logo are trademarks or registered marks of Horizon Hobby, Inc. All other trademarks, service marks and logos are property of their respective owners. 36139

Click to learn more ...



rumble that's typical when the cars start to roll. Then continue to play car rumble along with car creaking, and some wheel and track noise. You could even program in some random flange squeal. When the train slows to stop, again, more car rumble as the cars bunch up to a stop.

It seems to me this would be rather easy to do and would add a lot to the fun of running a train. When dubbing sounds into a model train video, just adding in the loco sounds makes the video feel kind of flat. Adding in the train sounds really brings a model video alive (for an example of this see our [Hot Trains video](#), which has dubbed in train sounds as well as loco sounds). It should be no different when running a model in person.

The other thing I have often wondered about was if you could program some wireless headphones to take the sound decoder feed and get more

Click to see our

May Specials

(while supplies last)

- **Digitrax**
- **SoundTraxx**
- **Kadee**
- **NCE**
- **And more!**



HOT!

Click Here
For More
Info ...

HO

DCC

All Scales

*Click to see specials
in these categories*

YD



Yankee Dabbler.Com



realistic, rich-sounding loco and train sounds without the complexities of "follow the train" circuitry around the layout.

Lance Mindheim has developed a working prototype for a this very thing. See Lance's blog: lancemindheim.com/blog.htm ... Lance has three blog posts on his wireless headphones experiment.

Lance's focus is the sound as heard in the cab of the locomotive, so adding other train sounds in the headphone feed is not a big requirement. If you're sitting in the cab of a locomotive, sounds from the engine will completely overpower any other noises.

Lance found the result was quite satisfying and the technology requirements aren't that complex.

So why not take this to the next level? Use a multi-channel headphones-with-microphone arrangement to allow switching back and forth between train sounds and talking with the dispatcher. For two person crews, give a headset to the engineer and the conductor/switchman.

For the engineer, having the loco and train sounds blasting in your ears makes hand signals with the conductor/switchman more necessary – how's that for realism?

Now, if you can add in the train sounds decoder I mentioned earlier with the loco sounds and a multi-channel headset with a microphone, then we could be really on to something! Without searching too hard, the MRH staff was able to find an 8-channel system that included a headset with a microphone.

So here is the challenge – is anyone willing to explore these ideas and push us to the next level in model train sound realism?

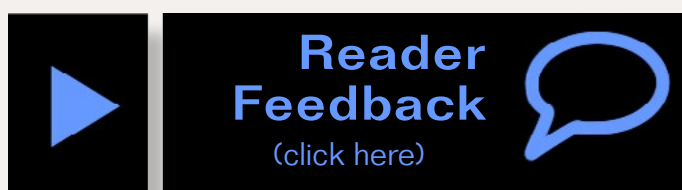

**New
Innovation**



Nano Technology Lubricants

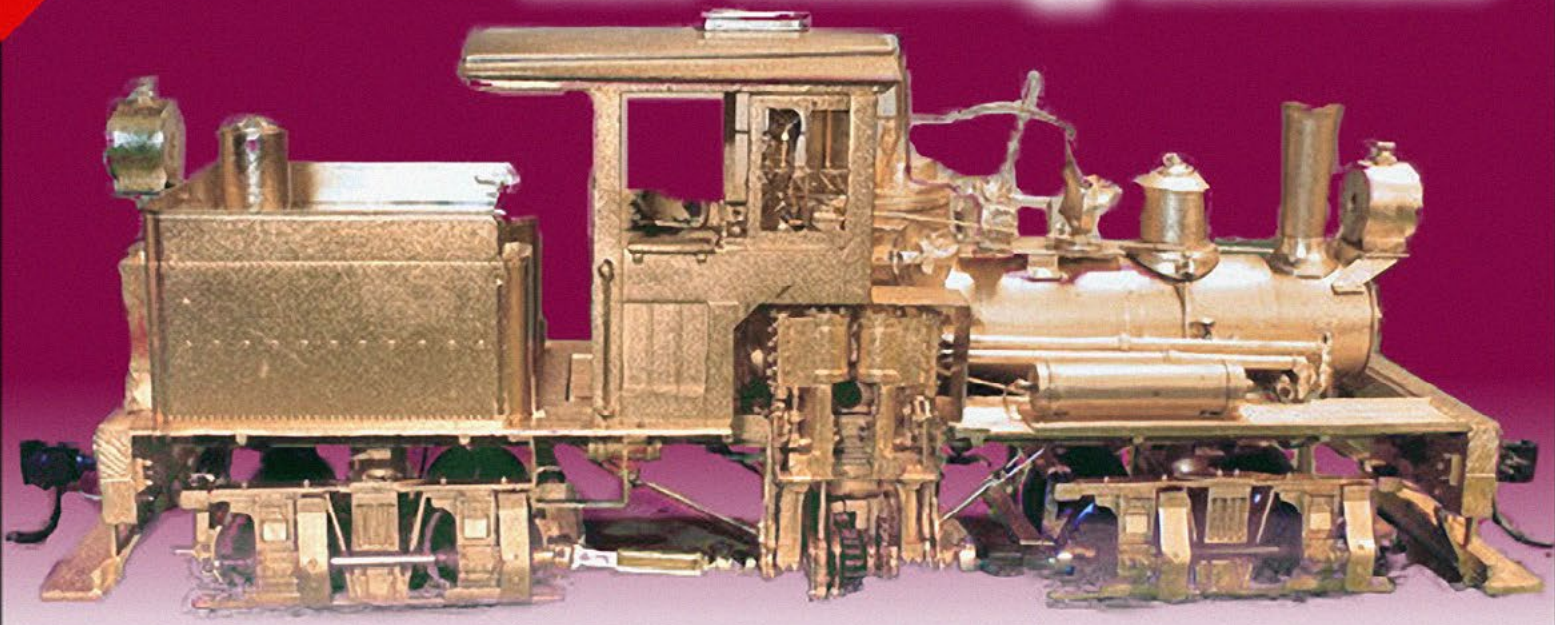

"I was skeptical, but my experiments show significant improvement with Nano Oil ... why not lube it with the best?"

- Bruce Petrarca, MRH DCC columnist

Nano-Grease

THE SHAY FIXER 

VISIT US AT...
SHAYFIXER.COM 

Specializing in brass Pacific Fast Mail / United geared locomotives

**For more details
click here ...**



The Best-detailed HO Passenger Cars Ever!

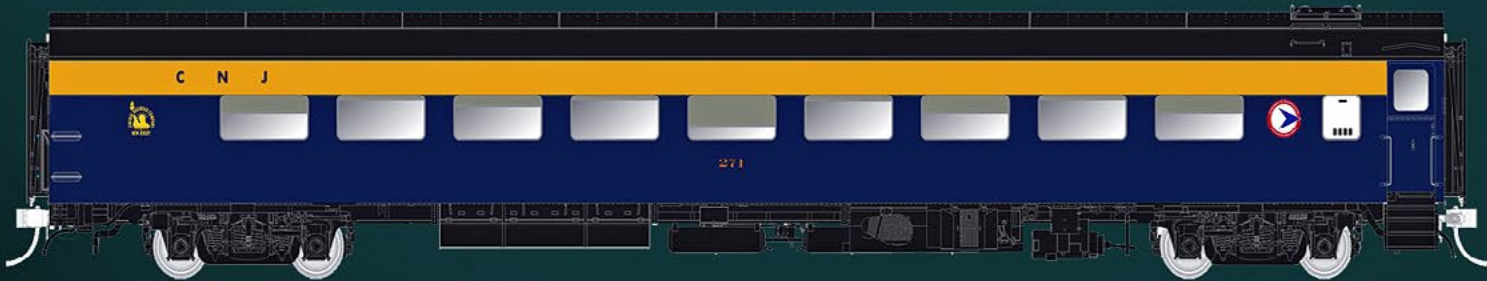
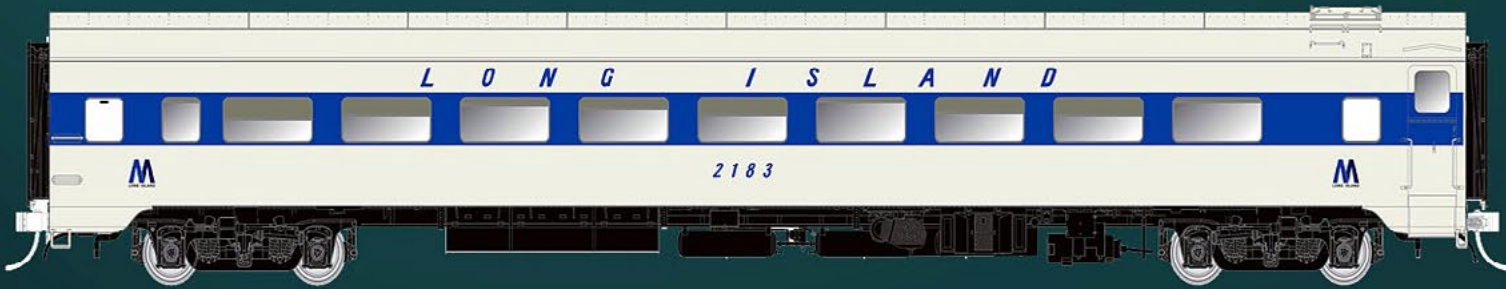

Now back and better than ever!



**New Road Names!
New Car Numbers!**



Email



Phone



contents



index

Notes from the MRH STAFF

Calling all authors, MRH \$500 contest #2 ...



Calling all authors

We are on a continual lookout for articles. The magazine only works when we have articles submitted to publish, and the greater the selection, the better for you the reader. What are some of the topics that are of interest to us?

Structures:

- How you used a standard kit from Atlas, DPM, Walthers, or any other manufacturer and modified it so that its heritage is not readily noticeable?
- Scratchbuilding a specific structure or selective compression of a structure.
- Detailing and weathering of a structure.
- Signs on buildings and billboards, along with animation of signs.

Rolling stock:

- Upgrading an old Athearn or Accurail kit with detail parts.
- Using an existing kit that is close to a specific prototype and modifying it to match the prototype.
- Building fleet cars for your layout, that is, “generic” cars.





April 2012 MRH Ratings

The five top-rated articles in the [April 2012](#) issue of MRH are:

- 4.6 DCC Impulses - The myth of DCC ready
- 4.6 Yes, it's a model
- 4.3 Getting Real - Modeling signature freight cars
- 4.3 Coal and sulphur operations in the Alberta foothills
- 4.3 Reverse Running - Planning to destroy your layout

- Issue overall: 4.4

Please rate the articles!

Click the reader feedback button on each article and select the star rating you think each article deserves. ***Thank you!***

Advertisement

**Free Shipping on all US WEB
orders over \$100.**



**New ACCU-LITES
exclusive!**

**Tortoise SNAPS
8-position block
wiring quick
connect socket**



**Watch our
website for our
monthly specials!**

CLICK TO LEARN MORE:

<http://www.acculites.com>



- Weathering, upgrading and developing a standard for your rolling stock.

Locomotives:

- Loco kitbash to model a specific locomotive or unique features to a specific railroad
- Tuning up your locomotive to improve its performance
- Lighting, decoder, and sound installation
- Detailing of the trucks and body to improve the appearance of your locomotive

Track:

- Lineside and support structures for the railroad
- Track details. Yes, the track is a model.
- Bridges, from small culverts to the large three-span through truss.
- Building turnouts, diamonds, highway crossings with gates, and signals.

So, here are more than 16 topics to get the creative juices going. There are many more possibilities.

What are we looking for in an article?

We need a clear and concise manuscript describing the project. Don't be vague. Read it aloud, to yourself. If it doesn't make sense to you, don't assume that we will understand what you intended.

Advertisement

**OUR MEMBERS GET
ALL THE GIRLS.**

TEENY-TINY GIRLS, BUT GIRLS ALL THE SAME.



Click to see more



Email Phone

MRH is a graphic-driven magazine, so we need lots of photos to choose from. Make sure that your subject is well lit when you photograph it. Also make sure that the subject is in focus. While a lot can be done with photo editing programs to correct minor problems, out of focus photos are impossible to fix.

Finally, remember you are interviewing for a job or selling a product by sending us an article. You want to put your best foot forward, so don't cut corners when putting your article together. Provide good captions for each photo and follow our submission guideline mrhmag.com/submission-guidelines so you don't make more work for us. If you make our job easier, then you may become a favorite author we turn to for more than a few articles.

Remember, we pay for articles, so if you've ever wondered how your hobby could help pay its own way, here's your chance.

Advertisement



Click Here

FIFER HOBBY SUPPLY LLC

Your Local Online HO & N Scale Hobby Shops

575-523-9743 • fiferhobby.com • fiferhobbyho.com



To our readers

The following post is a hats-off and congratulation to everyone who participates on the MRH website forum (model-railroad-hobbyist.com/forum).

“Thanks for all your input and encouragement, I've submitted questions in other forums before (other than RR'ing) and never gotten the kind of response I've gotten here. I've been a long-time model railroad enthusiast but never had the time to dig in, this will be my first. I'm sure there'll be bumps, failures and successes, but I guess that's what it's all about, it's not the arrival, it's the getting there. So I think I've found a home and lots of friends. Thank you all once again.” ... Rob

This post says a lot about you, our readers, and you should be proud. Your participation and willingness to take the time to help others is what makes MRH so great. From the staff, we would like to say thank you and keep on doing a great job.

MRH \$500 layout contest #2

It's that time again. Getting started in the hobby with \$500. What would you do – how far can you get on \$500? You don't actually need to spend the money, but we won't stop you if you want to. With this issue of MRH, we're kicking off our contest: Help a hobby newcomer get started right in the hobby of model railroading in an affordable way.

The contest has few rules. You can spend only \$500 and you need to get an operating layout as a result.

You can assume basic tools like a hammer, saw, drill, pliers, screwdrivers, hobby knife, motor tool, and a soldering iron. But not much more.



You can't assume fancier tools that a typical newcomer might not have, like a table saw, router, lathe, and so on.

Do not include the cost of tools. Just stick with common tools most have access to (a jigsaw, motor tool, and a soldering iron are okay).

The \$500 will need to cover benchwork, roadbed, track, wiring, control system, rolling stock, locos, structures, and scenery.

Used items from common online sources like eBay or the Yahoo yard sale lists are okay, as long as the items often appear frequently as something for sale. Rare or hard-to-find items don't work.

You can use any scale from Z to G, because we don't want to put any limits on your approach.

Your submission needs to include an itemized list, expected cost, and sources. Also include a drawing of the layout plan and a write-up of your rationale and approach.

May 2013

Bonus Extras!

Available to subscribers!

DVD and HD quality versions of the videos in this issue, plus:

- **Universal modeling sizes and dimensions chart**

[Click here to access](#)



contents



index

We want to encourage contest entrants to think outside the box, which is why we're not putting a lot of constraints on this contest. The *MRH* staff will judge the entries and select the winners.

The deadline for the contest entries is November 30th, 2013 (post-marked or submitted to us online by midnight Pacific time on that date). We will announce the winners in the January issue of *MRH* and publish the winners later in the year.

What criteria will the judges use to select the winners?

We will be looking for the most creative use of the \$500. For example, who says the benchwork even needs to be wood? Or that the structures need to be fancy kits?

We'd like your entry to have good future expansion potential. Don't just make a super-cheap one-off that you can't expand or do more with. This is to get someone started with \$500, not to show them how to invest in a dead-end hobby!

You also don't need to spend the full \$500 - doing more with less will play a big part in selecting the winners. That said, those able to do the most with the full \$500 will also be a factor.

We'd like to show that getting into the hobby doesn't have to be expensive.

January, when the first of the winning entries will be published, is when a lot of newcomers will be entering the hobby, so here's your chance to help them get started without a huge outlay

Calling Norman Woollons

Norman, where are you? We have been receiving your article queries. When we attempt to respond to your queries, your spam filters prevent our response from coming through to you.



Combo Right Clamp™

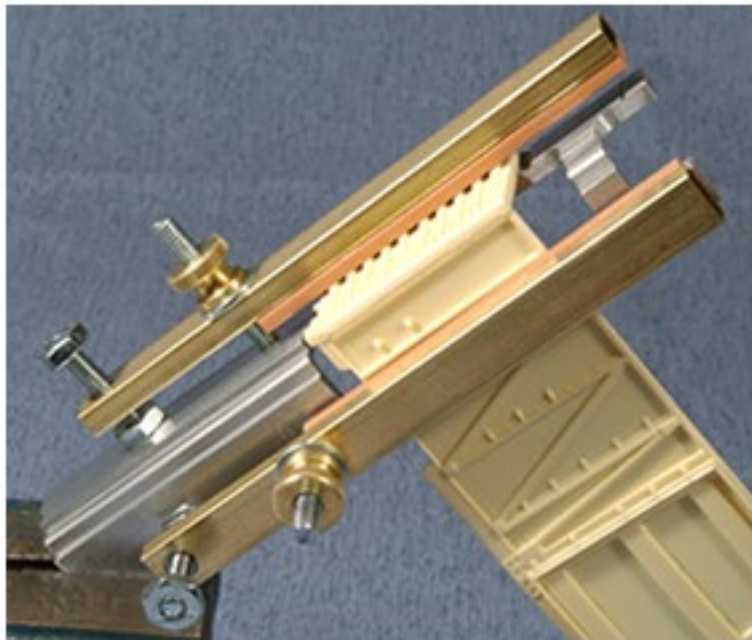

Combo Right Clamp™
with cast resin boxcar

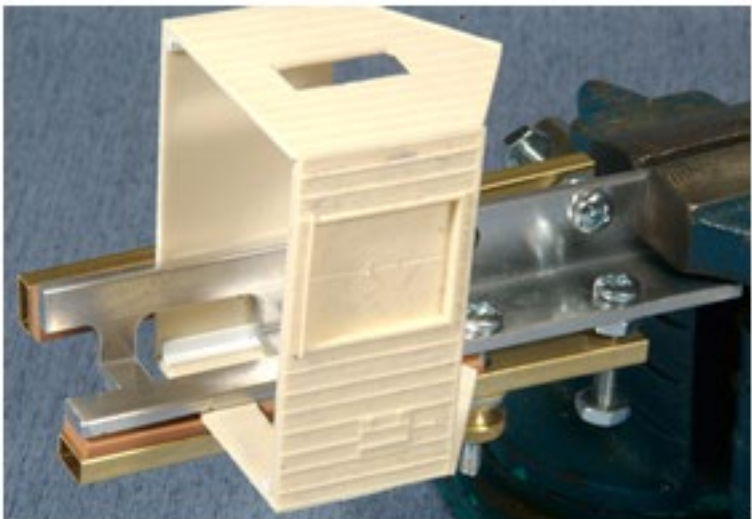

Combo Right Clamp™
with Wolf Design Pump House

[Click here for
all our products ...](#)

Tools for Modelers

Coffman Graphic Solutions Co.
1500 River Circle, Richmond,
KY 40475-7907

Please make sure that **model-railroad-hobbyist.com** and **mrhmag.com** are marked as safe senders.

Also please provide us a phone number or alternative email address so that we're guaranteed we can contact you.

This is also a good reminder to anyone else who sends us an article for consideration or queries regarding your submission. Include your phone number along with an alternate email address if you have one.

A blast from the past

We went out to the *MRH* forum and took a look at some of the early posts. There are over 9500 posts to date so you have plenty of reading material between issues. More importantly, a good number of these posts may be a helpful reference resource for you.

Questions that you have may have been answered, so put some keywords in the search and see what you can find.



contents



index

Also try Google – for instance, if you want to find what may have been posted on the *MRH* website about couplers, type "*MRH* couplers" into Google. You will get over 300 pages on the *MRH* website.

Here are some past threads we chose.

Looking for the ideal *MRH* reading device in 2008 (iPad wasn't invented until 2010).

mrhmag.com/node/38

Show us your high-contrast photography (long before our popular Weekend Photo Fun thread came on the scene).

mrhmag.com/node/135

Do you think model track is expensive? Then check this thread:

mrhmag.com/node/148

What methods can you use for shaping pink foam?

mrhmag.com/node/199

What options exist for powering turnout throws?

mrhmag.com/node/295

Pros and cons of prototype modeling:

mrhmag.com/node/150

Are dummy locomotives a good idea?

mrhmag.com/node/511

So what do you tell a guy who's new to the hobby?

mrhmag.com/node/172

The essential artistry of layout design, by Marty McGuirk:

mrhmag.com/node/196

[... On to next page of text →](#)

Bowser

EXECUTIVE LINE

New Product Announcements!!

HO Baldwin S-12 Switcher

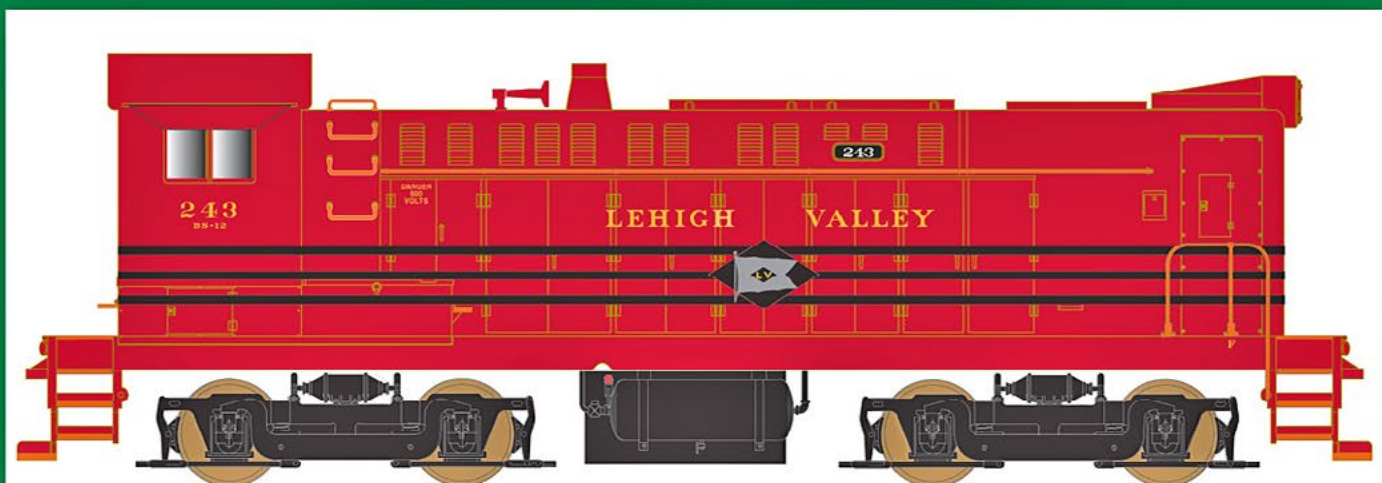

HO 3 & 5 Unit Spine Cars



HO H21a Hopper Cars

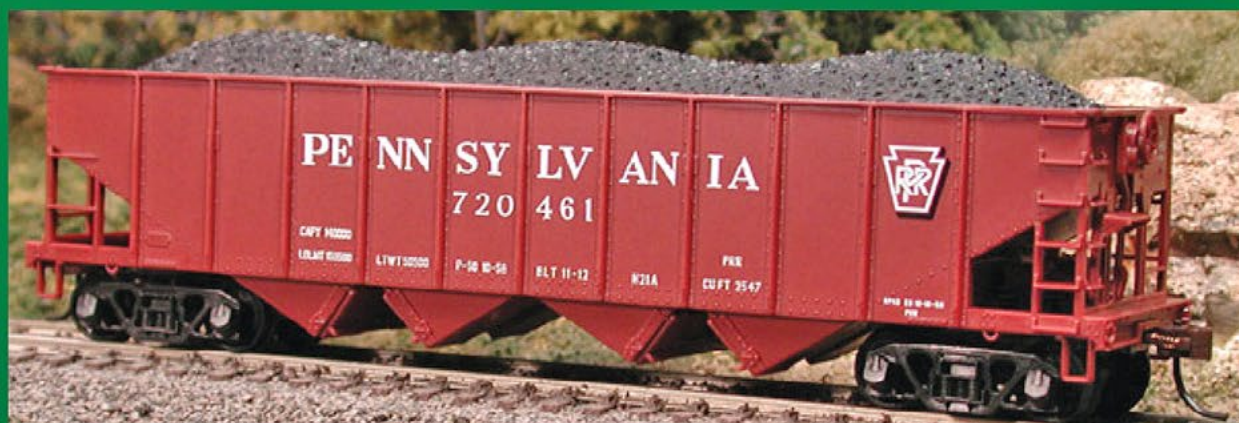

[Click here for more information](#)



Email



Phone



contents



index

[← back to previous page of text ...](#)

Track-cleaning consists ...

mrhmag.com/node/146

In this issue ...

In the manifest for the May issue we have ...

Third hand: Richard Napper shows us his nifty staining fixture

Freight trucks from 1900-1960: Richard Hendrickson shares with us the definitive history of the development of the freight truck. Learn what worked and didn't work for the prototype.

One-turnout layout: Lance Mindheim presents a layout with one turnout that has the potential to provide great operating challenges as well as great modeling possibilities

[... On to next page of text →](#)

Advertisement



WE ONLY SELL WHAT WE MANUFACTURE

DETAILS IN HO, O, S & N SCALES
LASER CUT SHINGLES, DOORS & WINDOWS, FENCES, SIDING, CRATES. Also RESIN and WHITE METAL DETAILING CASTINGS.

CRAFTSMAN KITS
IN HO, O & S SCALES

CHECK IT ALL OUT AT
WWW.RUSTYSTUMPS.COM

Send \$3.50 for Catalog - Specify Scale

RUSTY STUMPS SCALE MODELS

6785 Cherry Blossom W. Dr., Fishers IN 46038

Phone (317) 595-9489

MRH-May 2013





A well juiced frog is a happy frog

Click here to keep your trains rolling with our Frog Juicers...

TamValleyDepot.com



Lasercut structures. Highway, storefront and billboard signs. Graffiti, details and more...



HO/N Yard/Hiway Cafe kit



WHAT'S NEW?



Our 20th year!

Blair Line



When talking to hobby vendors, please remember to mention MRH.



contents



index

[← back to previous page of text ...](#)

Yes, it's a model: Our continued series of great modeling and photography has a decidedly international flare this month. Enjoy some of the great modeling work from around the world.

\$500 layout contest 2nd place: Michael Brown's 2nd place winning entry in our contest is presented this month. Michael has a neat 2' x 4' layout that you won't want to miss.

Erie Railroad boxcars, part 2: *MRH* assistant editor Don Hanley continues his in-depth step-by-step on how to produce Erie boxcars from the 1950s that are not commercially available. Don's techniques can be adapted to many other railcar modeling projects as well.

Our regular columns: "Up the Creek" columnist Charlie Comstock is back to show us how to bend the sky. "Getting Real" columnist Mike Rose takes us through the steps from prototype discovery to building a scene on his layout. Bruce Petrarca explains how to use Ohm's law, and Ken Patterson takes us on a photo tour of some of some models that he's recently photographed.

Have a fun read! ■

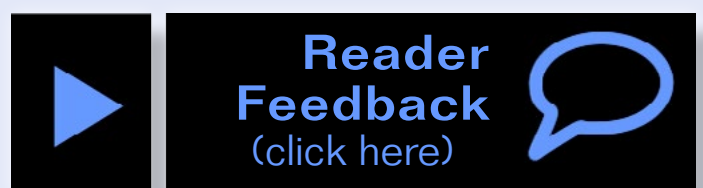

iwata

by ANEST IWATA

Just Rolling By...

Make It **REAL** With Iwata *Climb Aboard!*



**Eclipse
HP - CS**

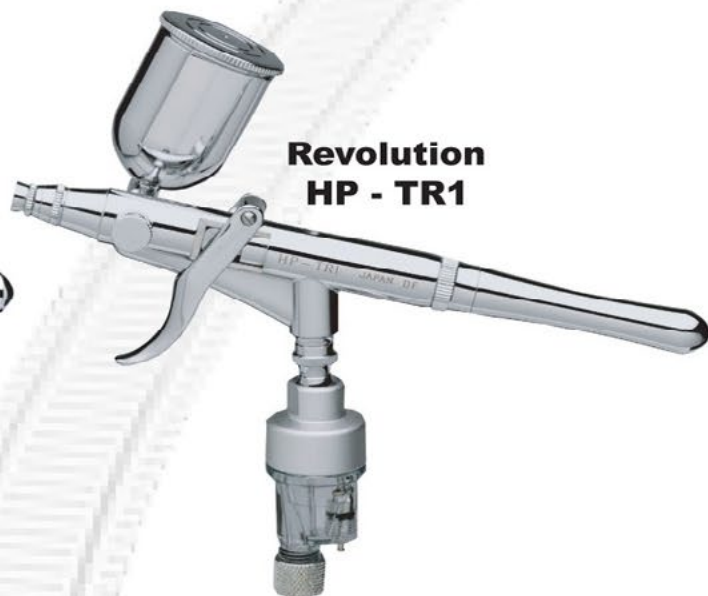

**Revolution
HP - TR1**



Visit... www.iwata-medea.com

To Check Out Our Full Product Line!

*Models By... Alan Houtz,
North American Prototype Modelers*



Enjoy Great Operation ...



\$455.00 MSRP

Super Chief Xtra



LoCoNet

Is The Digitrax Difference

- Run Trains
- Sound
- Feedback
- DC Control
- Computer Control
- Lighting
- Turnouts
- Signaling
- Transponding
- Block Detection



...With **Digitrax**



\$225.00 MSRP
Zephyr Xtra

Free Digitrax Toolbox App!
*Easy to use tools to enhance your
Digitrax experience!*

For iPhone/iPad and Android

**Download now @
[www.digitrax.com!](http://www.digitrax.com)**



MRH

Questions, Answers and Tips

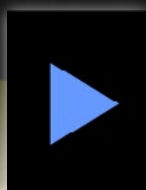

Reader
Feedback
(click here)



QUESTIONS AND ANSWERS

Making a dirt road

Q. I am redoing some scenery on my layout and am looking for suggestions on dirt roads. I have been thinking about using very fine sifted sand, stepping up to a medium coarse sand for the center and the edges of the road, and then coarse sand for the very edges. Anyone have any other suggestion?

A. Study photos or take a field trip to nail down how dirt roads look in the area you're modeling. Look for color, texture, width, weeds, grading, ditching, and so on. After you look at the pictures, check track ballast as a size comparison and find some fine sand at different sizes smaller.

The photo (1) shows a dirt road crafted by Harold Minky, who shares a detailed how-to at pacificcoastairlinerr.com/scenery/clods. His basic materials are latex paint, a texturing compound,

white glue and water. The most sophisticated tool involved is a spoon. Harold mixed the paint texture additive with his road-colored latex, let it set up, and then spooned the crumbly mixture onto the layout.

Paver sand can be sifted into several grades, and is available at home improvement and garden stores. In some areas it's called "sharp sand."

An option is lightweight spackle, which has some body and sticks well to wood and painted surfaces. Spackle can be shaped to



1. Latex paint mixed with texture compound is the basis for Harold Minky's rural dirt road, churned by horses' hoofs. Harold Minky photo.



contents



index

build up a crown in the road, or gouged for potholes. Fine sand can be sifted into it, then fixed in place with white glue and water. Grass tufts from Silflor or Woodland Scenics can add a green or weedy strip down the center of a two-wheel track.

Charlie Comstock has posted an excellent feature on making dirt roads at s145079212.onlinehome.us/rr/howto/roads/index.shtml and a Model Trains Video download is available for sale at model-trains-video.com/MTV-0006.php.

You'll find a useful eight-page article called "Zip Texturing Resurrected," in the September-October 2010 issue of Model Railroad Hobbyist at mrhmag.com/magazine/mrh-2010-SepOct.

– MRH

Design a paint scheme

Q. I am looking for a computer program that I can use to design the paint scheme for my new road. I would prefer a free one, but if that is not possible I am willing to buy, at a reasonable cost, a program that will help.

– Glenn Patterson

A. We located one site with drawings at trainiax.net/mes-caleloco.php, and copies of The Railroad Paint Shop at [web.archive.org/web/20050216090641/](http://web.archive.org/web/20050216090641/paintshop.railfan.net/), paintshop.railfan.net/.

Lots of general graphics apps are out there. Just Google "graphic drawing app" and the first couple of pages are full of choices.

One program to consider is Corel Painter Lite, at \$69 retail. It would be more than adequate for doing lettering and filling in outlines.

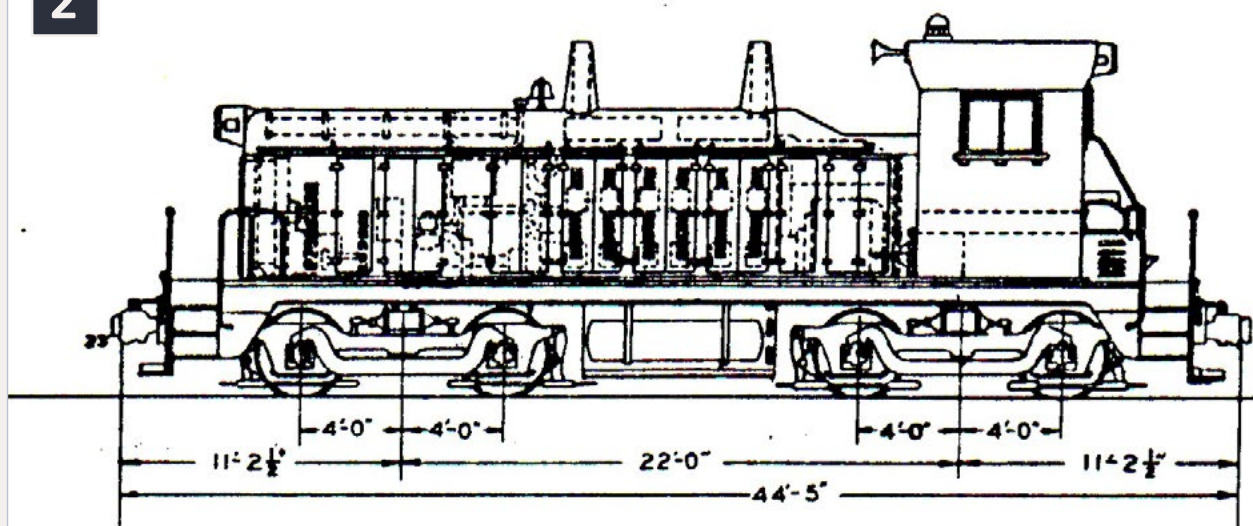
2

2. This EMD SW9 is scanned from old railroad shop diagrams. A simple painting program can be used to design a custom paint scheme – or you can print the diagram and work with acrylics or colored pencils.

See the PC World review at pcworld.com/article/2024551/review-painter-lite-offers-many-of-corel-painter-s-features-for-a-fraction-of-the-cost.html.

You didn't mention what engines you have in mind, but if you Google “diesel locomotive diagrams” quite a few drawings come up. For personal use, these could be copied into a paint program, with the lettering plan and paint scheme added on separate layers. Loco outlines (2) can also be scanned from railroad shop manuals.

In the recent past, there was a site with many good engine diagrams at trainweb.org/tomfassett/grfx/dieselgrfx.html, but it seems to be inactive.

– MRH

Track joiners

Q. In the middle of building my layout, I have run out of Atlas Code 83 track connectors and they are nowhere to be found.



contents



index

How can I continue construction without waiting for the track joiner pipeline to refill?

A. You can carry on with a flat file and a source of Micro Engineering 26-083 Code 83 joiners. ME rail has a thinner base, web and rail head than Atlas track, but the joiners can be adapted. Walthers 948-841 Code 83 joiners are available.

With the flat file, cut a slight angle on the bottom of the base and both sides. This will allow the smaller ME joiners to be pushed on the rail. It takes some extra work, particularly when installing switches, but gives a snug joint. You may decide that you prefer the look of the smaller part. To save yourself some time, file or grind a small screwdriver's tip so it will slide into the skinny ME joiners and spread them out enough to slip onto the fatter Atlas rail. You may get lucky and find a screwdriver that works without modification.

– MRH

Blue flags

Q. Can you explain blue flag rules for freight yards? Who can place and remove a blue flag?

A. That would be Rule 26 in the General Code of Operating Rules, my collection of Union Pacific rulebooks, the Uniform Code of Operating Rules, and in Steve Karas' and R.S. Hanmer's made-for-model railroaders *Condensed Code of Operating Rules*.

Here's what the 1968 Uniform Code says:

Blue signal. – A blue signal displayed at one or both ends of an engine, car or train, indicates that workmen are on or about it; when thus protected it must not be coupled to or moved. Each class of workmen will display the blue signals and only those same workmen are authorized to remove them. Other equipment must not be placed on the same track so as to intercept the view of the blue signals, without first notifying the workmen.



3. A “blue flag” can be a signboard, cloth flag, or a light, but it is always used to protect workers on railroad equipment.

When emergency repair work is to be done under or about cars in a train and a blue signal is not available, the engine men will be notified and protection must be given those engaged in making repairs.

The GCOR, at least the 1989 edition, goes into more detail and defines when the signal is to be applied. The signal must be placed when workers are on, under or between equipment and subject to personal injury if the equipment is moved. However, train and yard crews are excluded, *“except when assigned to perform such work on railroad rolling equipment that is not part of the train or yard movement they are handling or will handle.”*

The GCOR goes on to say: *“NOTE: Servicing does not include supplying cabooses, engines or passenger cars with items such as ice, drinking water, tools, sanitary supplies, stationery or flagging equipment.”*



contents



index

Blue signals (3) can take several forms. Many engine terminals have blue electric lights permanently installed along tracks where engines are serviced. Depending on the era, it can also be a blue lantern hung on the equipment, or a cloth flag or metal panel.

When a blue signal is placed to protect workers and equipment not on a main track, it continues, *“switches providing direct access must be lined against movement to that track, secured by an effective locking device and a blue signal must be placed at or near such switch. Facing point crossover switch must be lined against a crossover movement and secured by an effective locking device.”*

Sub-sections set out rules for positioning derail devices, and for securing remote control switches.

Lettering on flags and panels can vary according to the situation. Most have some variation on “STOP: Men at Work,” but they might also have a plain “STOP,” “STOP – Tank Car Connected,” “Occupied Camp Car” or something else. The rules are the same for all.

– MRH



TIPS

Soldering iron cleaner

How do you clean up flux and other stuff that tends to get into switch-making jigs?

4

4. Hakko's coiled wire cleaning sponge for soldering iron tips minimizes heat loss and allows one-hand operation.

Tim Warris of Fast Tracks uses a metal-bristle brush to keep the soldering iron tip clean. My background is in electronics soldering, and I've used a wide variety of tip-cleaning techniques, starting with the Weller sponge/water combo.

Eventually I ran across the Hakko (4) tip cleaner "metal sponge." The metal of the tip cleaner captures dirt and flux, keeping it out of the work area, and in general is neater. You simply plunge the tip of the iron into the coils of the cleaner, and out comes a clean tip which you can then tin, and get back to work. It has the advantage of one-hand operation, so you're less likely to burn yourself by accidentally touching the iron. The Hakko cleaning system is fairly inexpensive, too.

One source is Amazon.com: <http://amzn.com/B000PDQORU>.

– John "Steck" Stoecker

Instruction sheets

I use car cards and waybills for operations. I have color-coded blocking for my trains and provide the yards/stations with blocking sheets so the operators know where the cars go in the trains. I had been putting them flat on the fascia,



contents



index

but you had to step back to see them. Fastening the sheets to the fascia with tape or rubber cement made them difficult to update or change.

I looked at putting them in clear document holders attached to the backdrop but that seemed unaesthetic. I then thought about hinging them to the fascia by removing the backbone and rings from a small 3-ring binder and attaching it to the fascia, then putting a laminated sheet or plastic document cover on the rings.

At that point the light bulb went on. I realized that I could just attach a plastic 3-ring document cover (5) to the fascia. That would allow the user to lift up the sheet to read it more easily, but let it lie flat against the fascia. Changes are easy – just slip

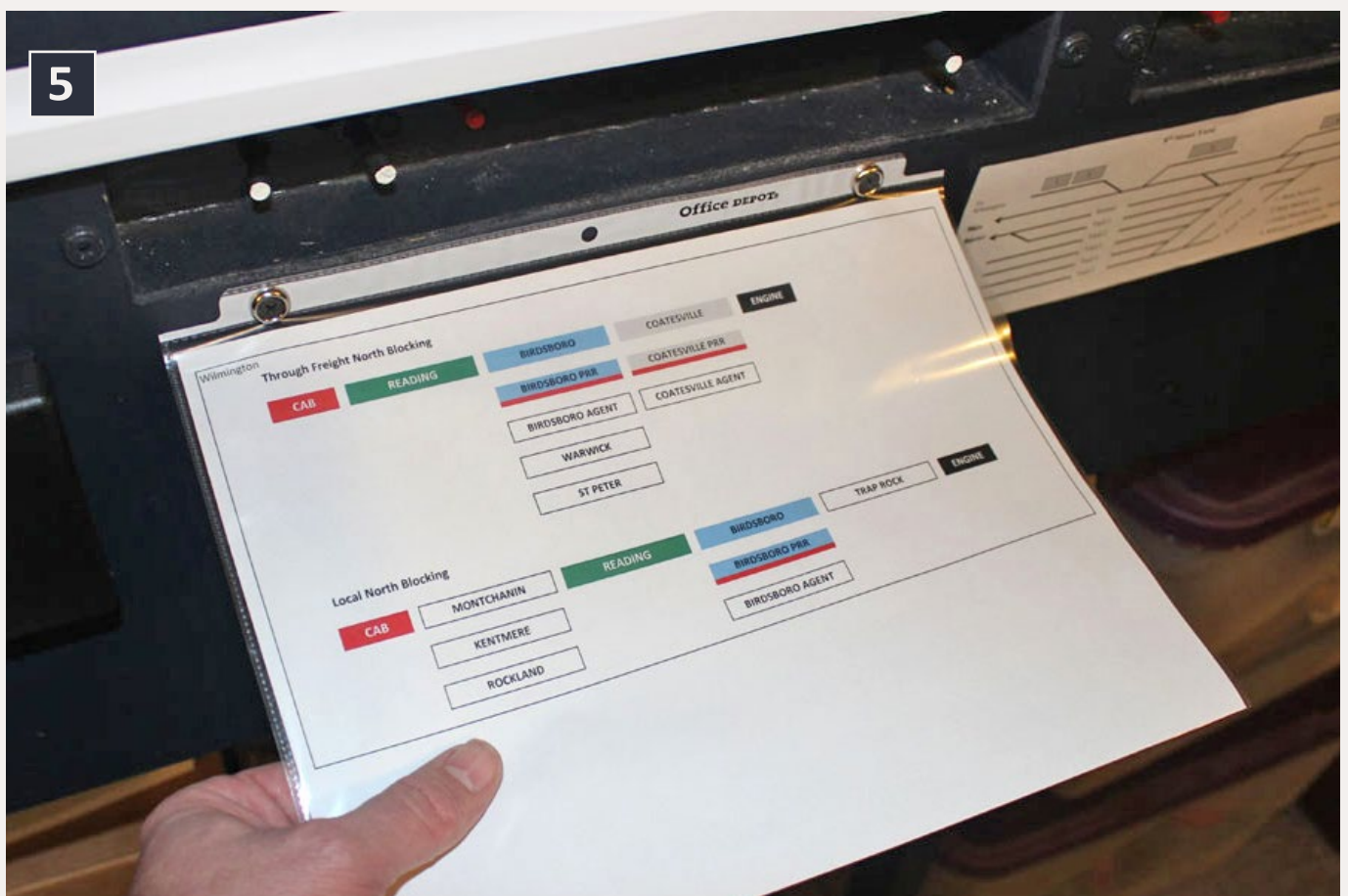

5. The blocking diagram in its clear cover lies flat against the fascia when not in use and can be lifted for easy reading. Dave Husman photo.

the sheet out of the cover. Two finish washers, two 3/4" bugle head screws and a plastic document cover (total cost less than 50 cents) and I have a blocking sheet.

– Dave Husman

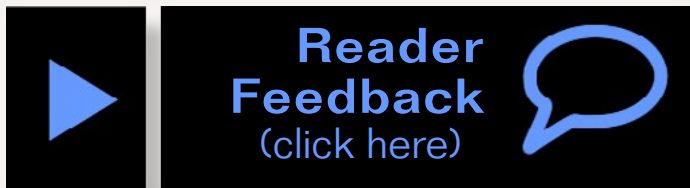

GET \$25 PER TIP

We pay \$25 USD for each tip we publish.

[Send your modeling tips to Model Railroad Hobbyist](#) and we'll get payment to you upon acceptance.

Just think, for only a few minutes effort, you could fund your next piece of rolling stock – or even pay for an entire train if you send in several tips and we publish them!

If you include any photos with your tip, we pay a bonus of \$10 per photo we use with the tip. ■



contents



index



Bending the sky!

A regular report on the construction of a 1950s-something layout

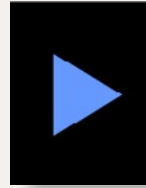

**Reader
Feedback**
(click here)



Up the Creek column

by *Charlie Comstock*

Coving backdrop corners with styrene ...

There are very few 90-degree corners in nature, especially in the sky. That being the case, I determined some time ago to make the corners in the backdrop behind my current Bear Creek and South Jackson disappear.

As far as I know coving is the easiest way to make a corner in the sky vanish or at least greatly reduce its obnoxiousness. There are many ways to do this. I prefer pushing pieces of sheet styrene into the corner, then building up a lip of drywall mud or spackle along each vertical edge to hold the styrene in place, and to feather the edges into the backdrop.

White styrene is available in 4'x8' sheets in various thicknesses. It flexes nicely, takes paint well, and although it can be spendy when purchased from a plastic retailer, I found a local plastics wholesaler who was willing to sell me sheets for a very reasonable price.

Styrene does have a serious drawback. It can't be glued to anything other than more styrene or other similar plastics. Its natural oiliness prevents construction adhesive, ACC, and epoxy





1: The corner in the backdrop behind South Jackson yard prior to coving it.

from getting a solid grip on it. My technique fixes the sheets in place mechanically. In addition, it allows the curved portion of the coved corner to float freely. When the walls expand or contract the styrene flexes with the walls.

The coving process gets a bit messy so it's best done before detailed scenery is installed.

[... On to next page of text →](#)



contents



index

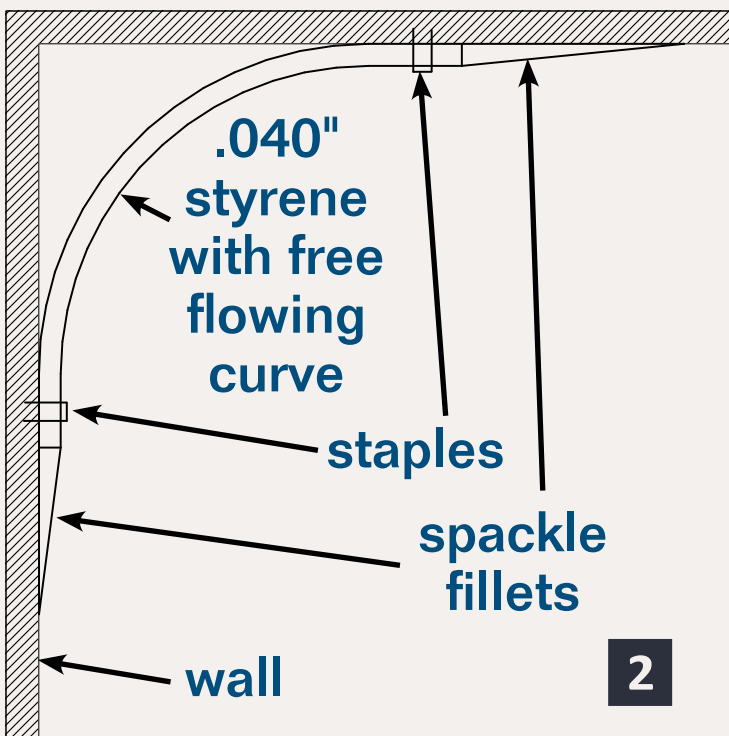

2: Here's a top view of a coved backdrop with .040" styrene sheet shoved into the corner and held in place with staples and spackle.

The flat areas adjacent to the coving allow the coving to flex without cracking the seam between the spackle and styrene.

3: A piece of .040" sheet styrene about 15" x 48". The edges should be trimmed neatly so a good mechanical joint will be possible between the styrene coving and the spackle fillets.





4: Test fitting the styrene in the corner.

The sheet needs to be slightly shorter than the corner it will be filling, otherwise getting it in place will be difficult.

I usually leave the gap at the top where it will be less noticeable. If the joint between the bottom of the styrene and the benchwork will be hidden by scenery, a bottom gap is good, too.

[← back to previous page of text ...](#)

I used .060" sheet styrene for my first attempt at coving a back-drop corner on my current layout. Styrene this thick doesn't like extremely tight curvature but worked OK for the 10" radius in the Canyon Creek corner. The corner in Oakhill required a much tighter radius, approximately 3", so I switched to .040" styrene which is much easier to bend. I was concerned the thinner sheets wouldn't have enough edge thickness for the spackle to hold it in place, but this hasn't proved to be a problem.

While the .060" styrene seemed to work well at first, over the seven years it's been in place small cracks have developed in the seam between the styrene and spackle (24) while no cracks have are visible in the corners where I used .040" styrene. I'm guessing

[... On to next page of text →](#)



contents



index



5: I continued test fitting the styrene sheet by shoving it into the backdrop corner. After a couple of trimmings it fit well and was ready to staple in place.

6: My trusty staple gun.

7: And its staples.

8: I shoved the styrene into the corner and had at it with the staple gun. This holds the styrene in place until I can add the spackle fillets that will really hold it in position.

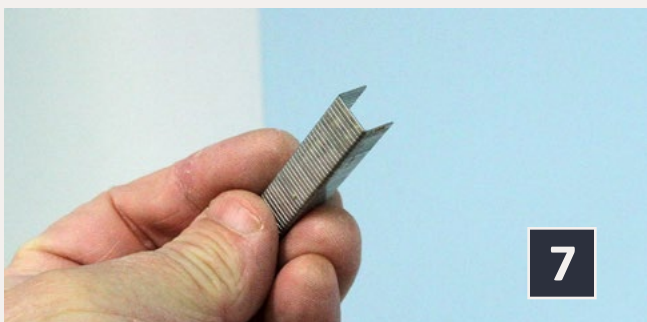



9: Hurrah! I managed to wrassle the styrene coving into place and get it stapled.

10: A close up of the staples. I don't drive them completely home. Once the spackle fillets are added I'll cut their heads off. This is easier if the head isn't up against the styrene.

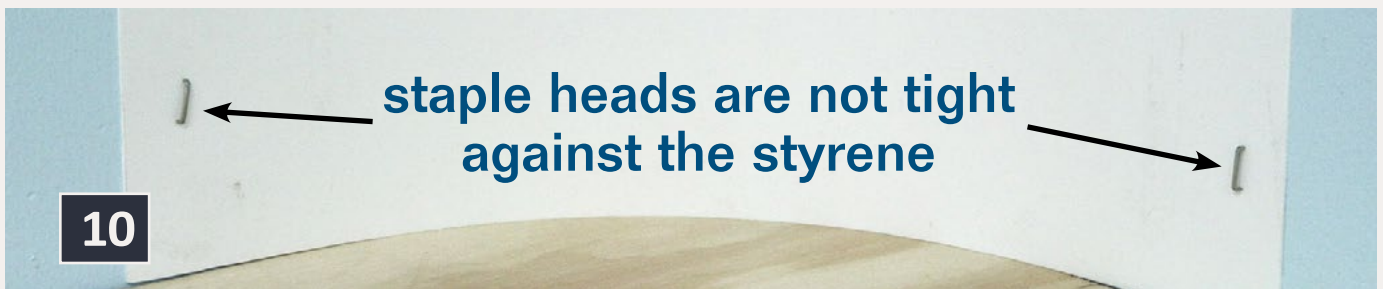

[**← back to previous page of text ...**](#)

the extra stiffness of the thicker stock prevented it from following the walls as they settled and shifted over the years.

Remember all the times wise heads told you, "Keep the reach from aisle to the backdrop under 30" or you'll be sorry?" Well, let's just say I let the depth of the South Jackson benchwork in this corner get slightly out of control. Standing on a chair and leaning over trying to staple the styrene to the backdrop while simultaneously keeping it bowed to the correct curvature turned out to be an ordeal. I should know better than this by now!

How did I get started using styrene for coving? Years ago I bought a bunch of .060" styrene to use for backdrops. I cut it to size and glued it to 2x4 studs to hold it in place. It looked good and I even used a heat gun to set a 2" radius curve at the end of the stud

[**... On to next page of text →**](#)



contents



index



11

11: Pretty much any kind of spackle will work for building up fillets next to the styrene coving.

12a, 12b: I use a fairly stiff 6" knife to spread and smooth it.

13: The first layer of spackle is applied. It takes a number of applications before the fillets are smooth and even.



12a



12b



13



14: I use diagonal nippers to remove staple heads.

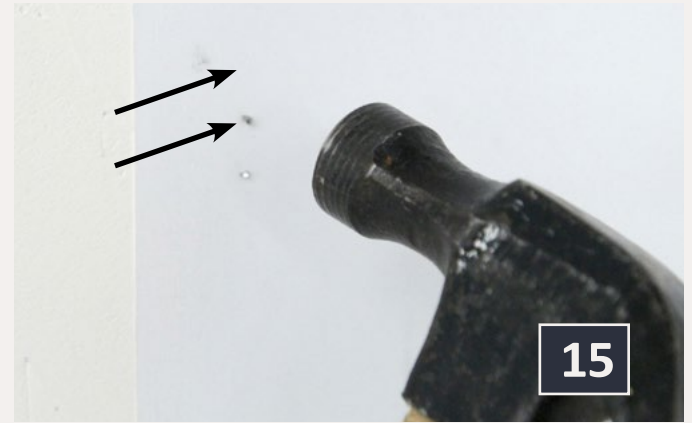

15: With the staple heads removed, a small hammer sets the staple shanks flush with the surface of the styrene.

16: The staple shanks after being seated with the hammer.

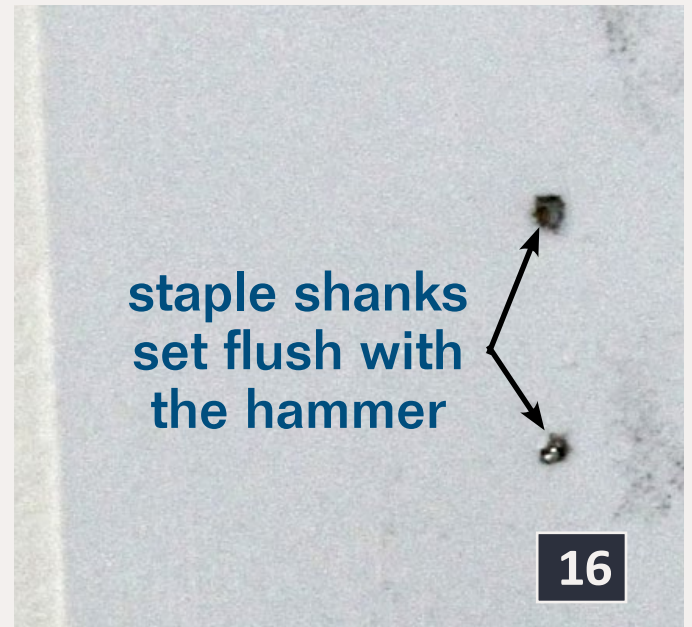

[← back to previous page of text ...](#)

wall. Then, a couple of months later, I noticed that all the glue joints had broken loose!

It seemed Latex Liquid Nails wasn't up to the task. I tried solvent based Liquid Nails, polyurethane construction adhesive, ACC, and epoxy. None made a secure wood to styrene bond. Eventually I gave up using glue to attach the styrene backdrop panels and resorted to #4 flat head wood screws. These worked OK until I tore down the layout for a move two years later. The current layout's perimeter backdrops are the room's walls. I don't yet know what I'll use for the peninsula's backdrop, perhaps Masonite.

A result of all this was a supply of .060" sheet styrene that I'd intended for use in backdrops. This gave me the idea to use it for coved corners. I resisted using glue when it came to mounting



contents



index

the styrene because I had lost my faith in glue joints. Instead, I thought shoving the styrene in the corner and letting its natural springiness work against fillets (berms) to hold it in place mechanically would make a durable joint.

Spackle was the first thing I thought of to make the fillets and it worked well, but something was needed hold the coving in place until the spackle hardened. Staples solved that problem.



17: Once the spackle dries and the staple shanks are set flush with the coving surface, it's time to sand the spackle smooth. I use a long particle board sanding block wrapped with a sheet of 80 grit sandpaper.

18: Sanding spackle makes LOTS of dust. I vacuum it up while I'm sanding to avoid having it accumulate. Work slowly to avoid putting lots of dust into the air where it floats around and lands on everything nearby.

I also worried about cracks along the joint between the backdrop and the styrene. Cracks are appropriate in roads but not in the sky. I made curved formers for the previous layout. Even without glue failures these had proven to be a pain. I cut the formers from 3/4" plywood using a band saw and found it nearly impossible to make them uniform and install them in perfect alignment.

For the coved corners on my current layout I elected to skip the formers and depend on the styrene to form a natural curve when compressed between the fillets (berms). I also hoped that letting the styrene float in the corners would compensate for any settling, or expansion and contraction of the walls due to changes in temperature or humidity.

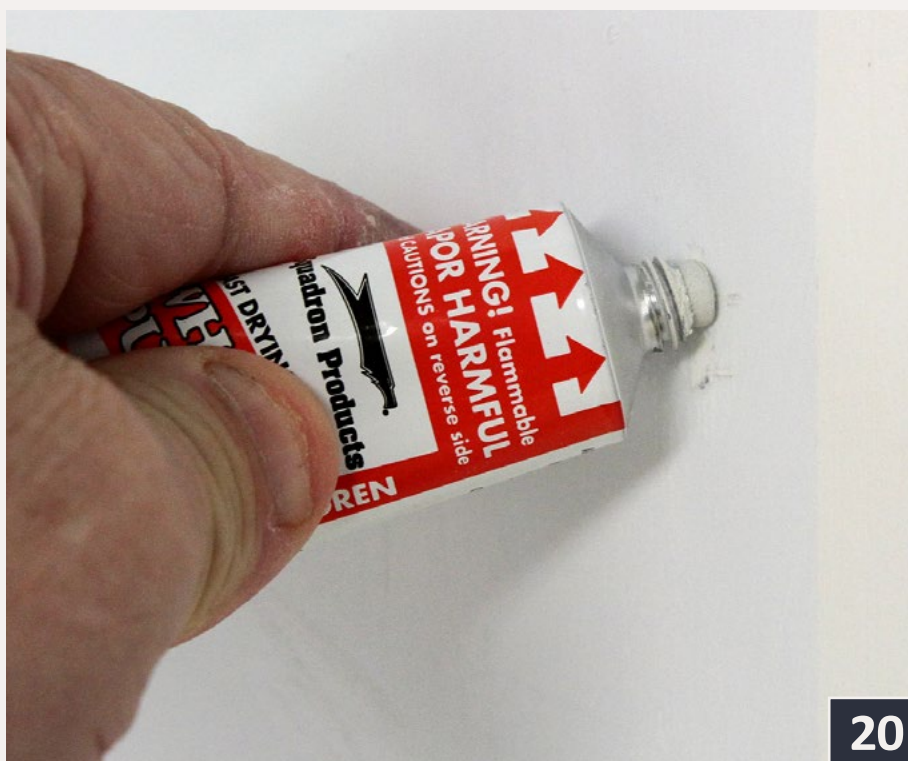

19: Cutting the staples' shanks and setting them flush doesn't result in a perfectly smooth surface. I use Squadron White putty to fill dents or cuts in the surface of the styrene.

20: I squeeze a small dab of putty on each staple shank and smooth it with a 1" putty knife. This stuff releases nasty vapors, so use lots of ventilation.



contents



index

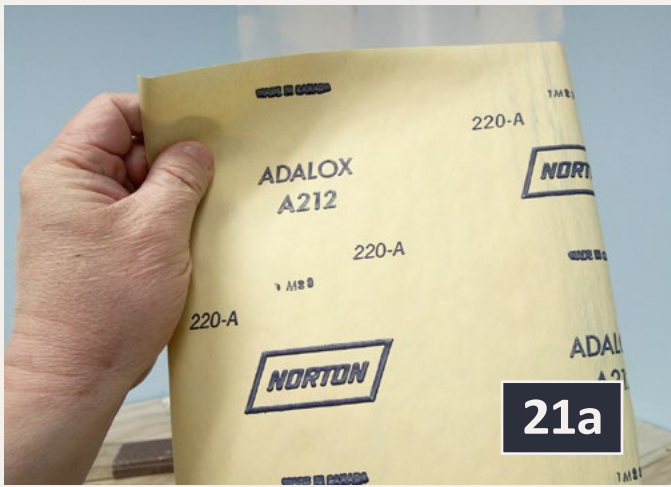

21a, 21b: Once the Squadron White putty set, I used some 220 grit sandpaper wrapped around a small block of wood to sand the area around the staples smooth.



Some staple shanks still protrude slightly above the coving surface even after setting them flush. Careful sanding with the 220 grit sanding block brought them down to a smooth and flush surface.

I cut the styrene wider than needed for the coving so that there is about 1-1/2" laying flat against the backdrop (2), and drove the staples in this flat area. Even with their heads removed, the staple shanks help keep the flat area of the styrene coving tight against the wall, and help to prevent unsightly cracks in the sky.

Styrene coving installation milestones

- Cut the styrene sheet and test fit it in the corner.
- Shove the coving into the corner and staple it in place.
- Build up a fillet of drywall spackle next to the styrene to hold the styrene in place and provide a smooth transition from the styrene to the backdrop. Let dry.
- Remove the heads of the staples and set the shanks flush with the styrene's surface.
- Sand the spackle fillet.



22: Once the staples were smooth and flush with the surface of the styrene, I applied several more layers of spackle to the fillets, sanding after each layer dried.

Once the fillets were smooth and flush, I used a brush to paint the coving with my sky blue latex house paint. Here the paint is close to dry where the spackle absorbed it, but the paint on the styrene is still quite wet. The fan helps shorten the paint drying time. It takes at least two coats of paint to color the coving evenly.

- Apply Squadron White putty to the staple shank holes, let dry, then sand smooth.
- Apply additional layers of spackle to the fillets as needed, sanding smooth after each layer dries. Shining a light close to the backdrop but off to the side will reveal any remaining dimples or divots.

[... On to next page of text →](#)



contents



index



23: South Jackson with its newly covered backdrop.

A clipping from the

South Jackson Gazette

Crime wave in South Jackson?

Police in South Jackson are complaining that the new sky, while nice to look at, is making it harder for them to do their job.

Said Horace Fithers, "Seems like the local flat-foots are claimin' it's gonna get a sight harder to corner crooks now

that they've lost another corner here in South Jackson."

Railroad bigwig Charlie Comstock expressed hope the problem would be less serious than stated. ❀

* Enjoy the Gazette? Read more at

bcsjrr.com

NEW FROM ACCURAIL



EASY TO ASSEMBLE HO SCALE KITS



Penn Central Insulated 40' Steel Box Car



Southern Pacific 3-Car Set



Central New Jersey 40' Steel Reefer



Also available as singles



Southern Railway Double Door 40' Steel Box Car



Norfolk & Western 50' Steel Combo Door Box Car

Illinois Central 50' Steel Insulated Plug Door Box Car



PLEASE SEE YOUR LOCAL HOBBY DEALER OR CALL 603-965-1173 FOR DIRECT ORDERS
ACCURAIL INC. PO BOX 278 ELBURN, IL 60119



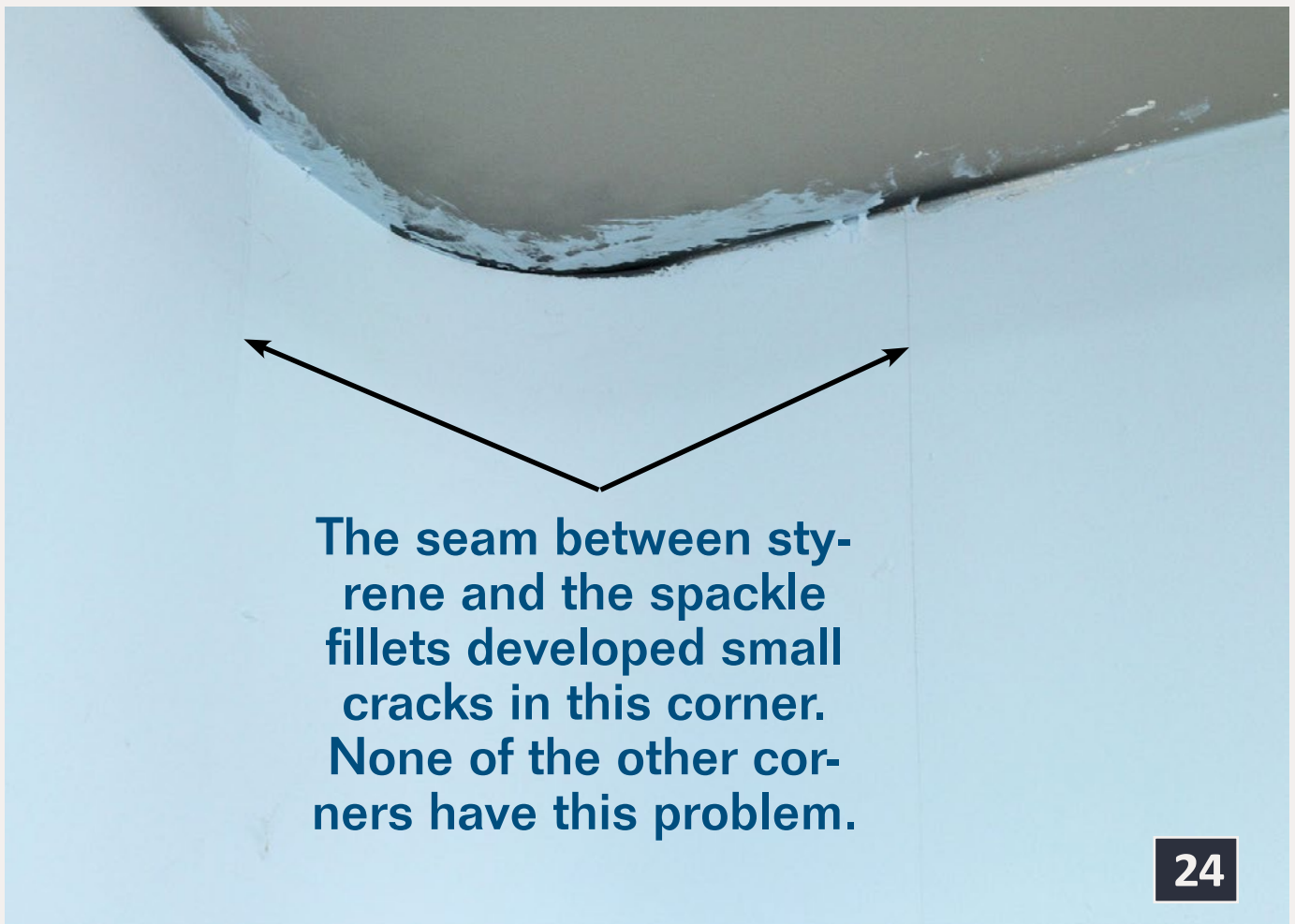

24: The corner behind Canyon Creek. Note the cracks near the ceiling between fillets and styrene, probably a result of using stiff .060" styrene. You have to be looking for the cracks to see them in person.

[**← back to previous page of text ...**](#)

- Paint the coved area with at least two coats of sky paint.

There are now six styrene coved corners on my layout. So far, only the one made with .060" styrene has any cracking. They work very well at making the corners in the backdrops less obvious in person and the corners often vanish in a well-lit photograph.

I think the effort required is well worth the results.

Pictures continue on the following 2 pages ...

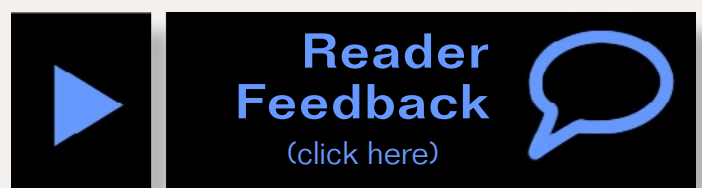

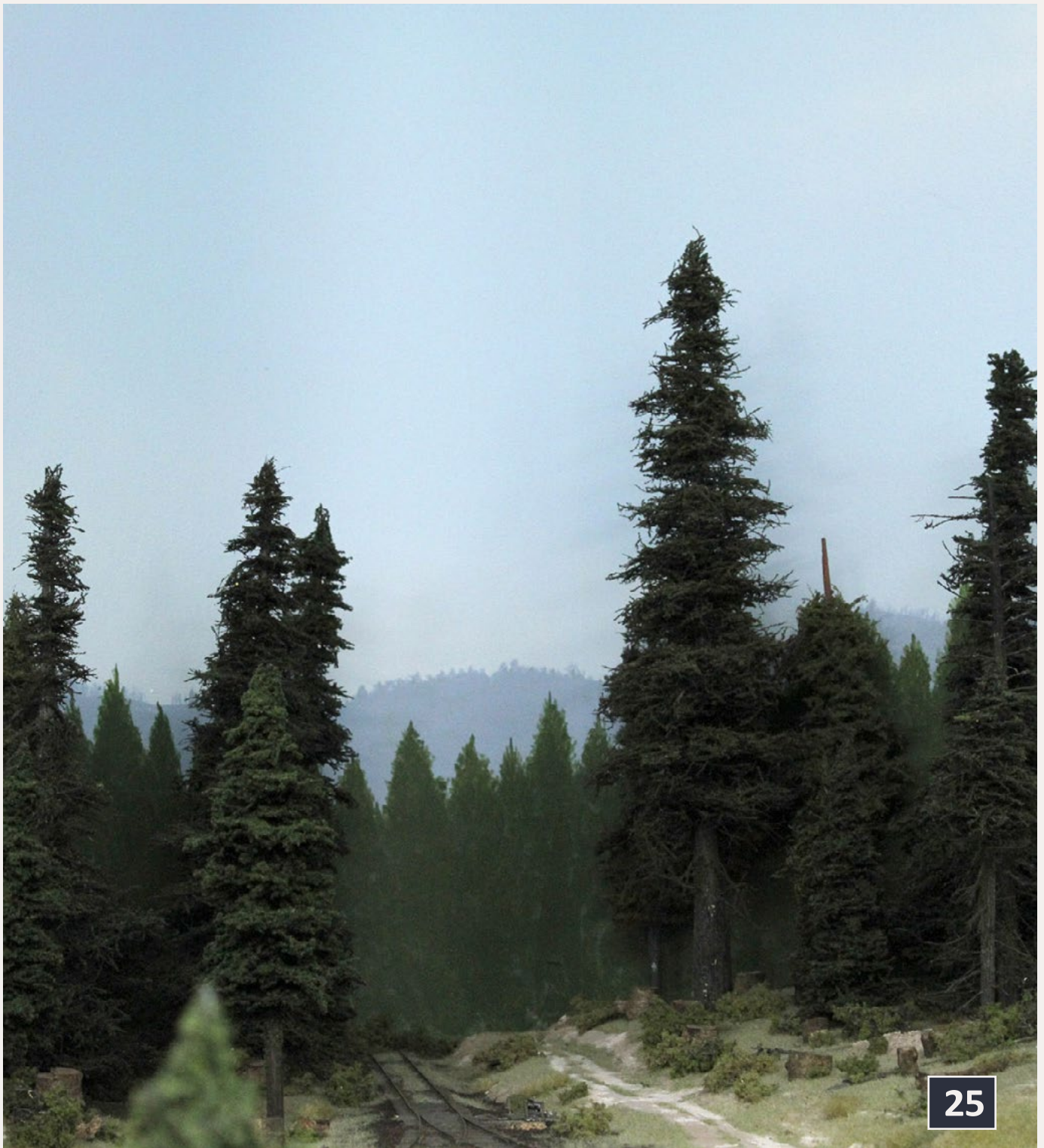

25: The coved corner behind the Oakhill wye uses .040" styrene. The tight, 3" radius coving at the end of the track is effective at hiding the corner.



contents



index



26: The coved corner in Mill Bend uses .040" styrene. This coving has a radius of about 6". It's relatively easy to see the corner in this photo, but when scenery around the log pond is finished it will be harder. The amorphous clouds on the backdrop do a good job hiding the change in perspective as the backdrop traverses the corner.



Visit Our Website
www.Mr-DCC.com

**National
Train Day
is May 11th!**

Our DCC
products
are a
GREAT
way to...

Celebrate

www.Mr-DCC.com

623-298-7355

1-(888)-395-3976





Using Ohm's Law

Looking at what's on that little board



DCC Impulses column

by Bruce Petrarca

Let's go from theory to circuit, step by step ...

After my March 2013 Staying' Alive column (mrhmag.com/magazine/mrh-2013-03-mar/di_staying-alive), I got an e-mail from a fellow model railroader about adding a battery to his camera car to keep the video from dropping out with track power disruptions. He provided me with a complicated circuit with two adjustable voltage regulators and a bunch of capacitors and resistors.

I took on designing a simple module to charge the battery and power the camera using DCC track power. The battery will take over running the camera when track power is interrupted. There are lots of needs in DCC model railroading for such a circuit. They can provide power for coach lights or other lighting details, on-board sound modules, etc. That's why I decided on making it a column.

Building such a device is a simple project, once you have a design. So, I broke the circuit down into functional blocks and designed each block, using Ohm's Law. A walk through



the design may help folks unravel some of the "mystery" of electronics.

Functional blocks

There are three functions that this circuit needs to perform, as shown in figure 1.

- Power supply
- Camera power
- Battery charger

So, let's look at each function by itself and understand how to select each component.

Power supply

This will turn the track DCC into a DC voltage. The DC voltage will be slightly less than what the track DCC voltage is set to. The schematic is shown in figure 2.

The heart of this function is the bridge rectifier – the four diodes near the middle of figure 2. It stacks all of the positive DCC pulses on one side and all the negative ones on the other side. It can come as a module with four terminals on it

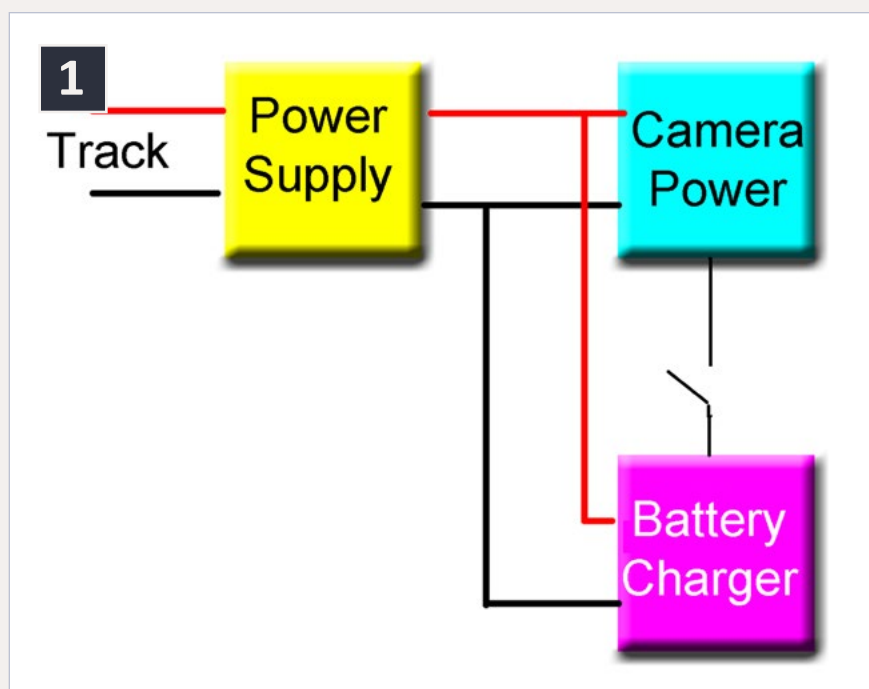

1: Block diagram.



contents



index

(2 inputs, one + and one - output) or can be made from four discrete diodes. Generally, I recommend the module, for small size and ease of construction (3).

Rectifiers have two primary specifications, voltage and current.

The rated voltage is properly known as Peak Inverse (reverse) Voltage (PIV) and is the maximum voltage that the rectifier is designed to withstand backwards across the diode. Back to my water analogy from my December 2012 (mrhmag.com/magazine/mrh-2012-12-dec/di_basic-electronics-for-dcc) Basic Electronics column. PIV is the maximum pressure that the check valve will withstand when the water is trying to flow against the closed valve.

Rectifiers are usually rated at 50 volts or higher. Since this exceeds the maximum DCC voltage, most any will work just fine, voltage wise.

The sum of all the current drawn through the rectifier should be less than the rating on the rectifier. One amp is about the minimum current rating for a rectifier and works in the vast majority of DCC uses. In the case of this circuit, there will be

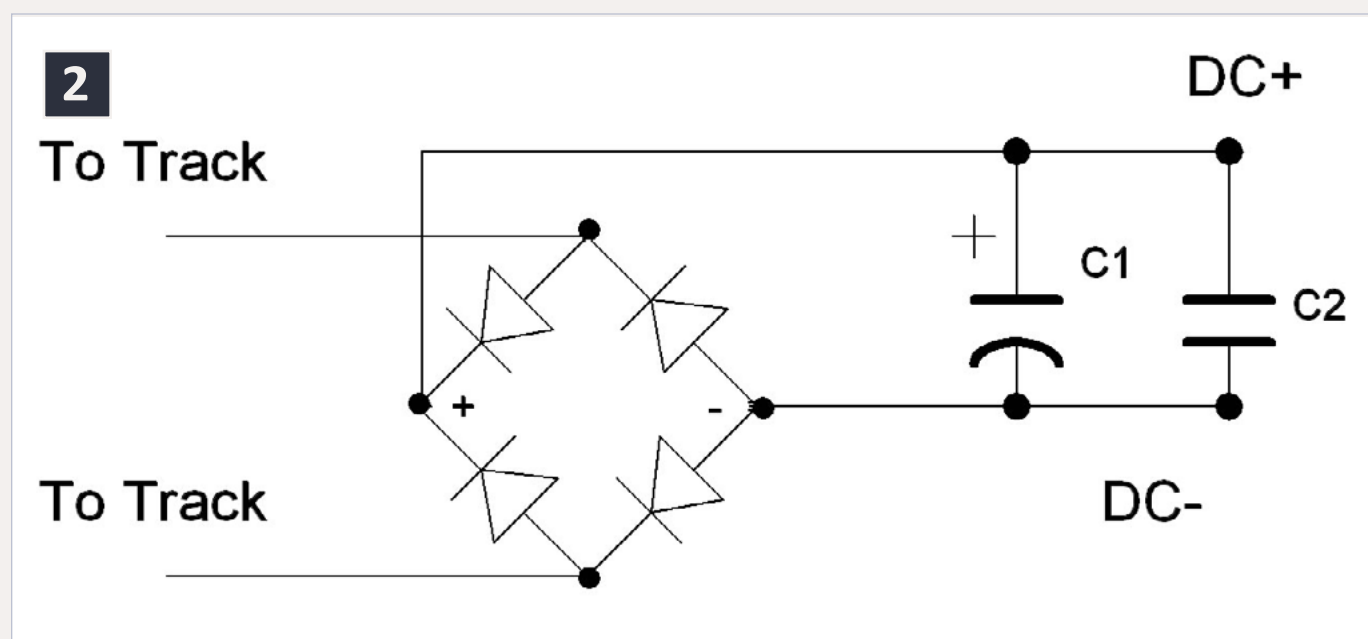

2: Power supply schematic.



3: Bridge rectifier module vs. discrete diodes.

about $\frac{1}{8}$ amp being drawn through the rectifier, so a 1-amp unit will be fine.

There are two capacitors in this circuit.

The filter capacitor (C1) is an electrolytic (polarized) unit. Its function is to store the pulses passed by the rectifier. It makes DC out of the pulses of DCC that have been directed by the bridge rectifier. $10\ \mu\text{F}$ is enough to smooth out the pulses. A 25-volt rating will work with all DCC track voltages up to 20 volts. If you are in garden railroading or using track voltages up to the 27-volt DCC maximum, use a 35-volt capacitor for safe operation.

The other capacitor (C2) is there to remove any spikes left due to asymmetry in the DCC signal. This should be a small mica or ceramic capacitor. The electrolytic capacitor doesn't filter these small spikes, so the addition of a spike suppressor capacitor in parallel will help you have clean DC for sensitive electronics like the camera. A frequent value is $0.1\ \mu\text{F}$ at 50 volts. This could be anywhere from $0.01\ \mu\text{F}$ to $0.5\ \mu\text{F}$, as long as the rated voltage is above 35 volts.

Figure 5 shows the oscilloscope display reading the DCC signal being applied to the power supply whose circuit is in figure 2.



Note that the oscilloscope reads the peak-to-peak DCC voltage as 14.65 volts. When this photo was taken, the output voltage was measured at 13.57 volts DC. This is why I use a 1-volt difference between DCC track voltage and DC output voltage as a “rule of thumb”.

Okay, now we have a DC power supply (very much like what is in a DCC decoder). While that is necessary, it doesn't do what we came here for. Let's get on with designing the circuits that do what we really want.

Camera Power

I'm going to assume a DCC track voltage of 15 volts throughout this example. As you saw above, the DC power supply will put out about one volt less than the DCC input. I'm going to use 14.3 volts in my calculations. First, let's supply power to the camera.

In order to design this circuit, we need to know how much voltage and current the camera needs. Since it was designed to

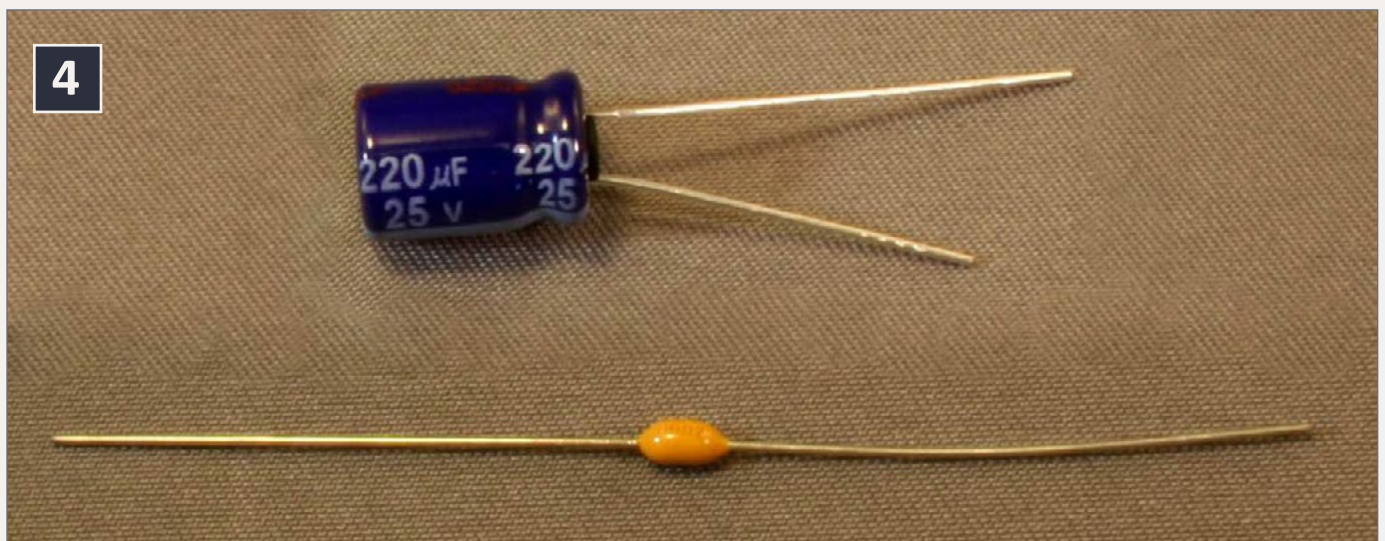

4: Capacitors used in this circuit: electrolytic (top) and ceramic (bottom). The electrolytic capacitor shown is a much larger value than what this circuit needs.

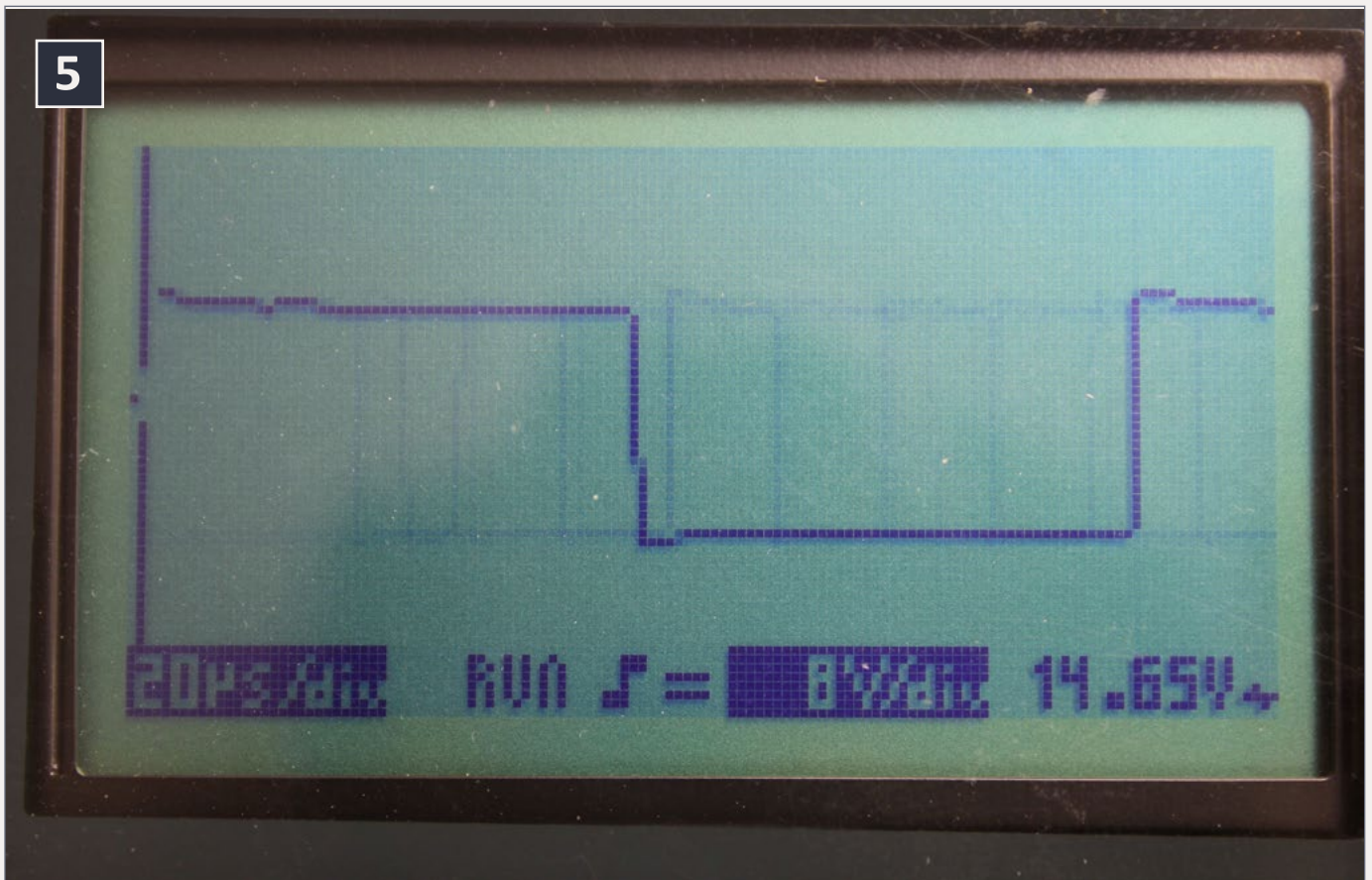

5: DCC input waveform to power supply – 14.65 volts “track voltage”.

use a 9-volt battery, the quickest way to get this data is to connect it to one. The camera owner connected a conventional battery through an RRAmpmeter to the battery. He read 8.6 volts at 0.12 amps.

We’ll use those numbers to figure out what value of resistor (R1) to use to connect the camera to our power supply. The purpose of this resistor is to drop the voltage down to what the camera wants when the camera is drawing its operating current.

First, we figure out how much voltage we need to drop across the resistor. The camera seems happy at 8.6 volts and the power supply will deliver 14.3 volts. Thus, the resistor needs to drop 5.7 volts (14.3 volts – 8.6 volts).



Ohm's law is $R = E / I$ (Resistance in ohms = Volts / Amps). Let's plug in what we know: 5.7 volts and 0.12 amps.

$$R1 = E / I = 5.7 / 0.12 = 47.5 \text{ ohms}$$

You can't go to the store and buy a 47.5-ohm resistor. Resistors come in standard values and 47 ohms is the closest value. It will result in a slightly larger voltage for the camera, but well within normal design parameters.

Resistors are also rated in watts (how much power they will dissipate). Let's see how much power (in watts) will be being put into the resistor.

Another formula is $P = E \times I$ (Power in watts = Volts x Amps). If we plug our numbers in, we get:

$$P = E \times I = 5.7 \times 0.12 = 0.684 \text{ watts}$$

Okay, if we put 0.684 watts into the resistor, it must be rated to handle at least that amount. A standard value larger than 0.684 is 1 watt.

Warning: this is quite a bit of power and the resistor will get warm – not hot. Make sure that it is located so that it won't touch plastic items: a shell or plastic tape.

[... On to next page of text →](#)

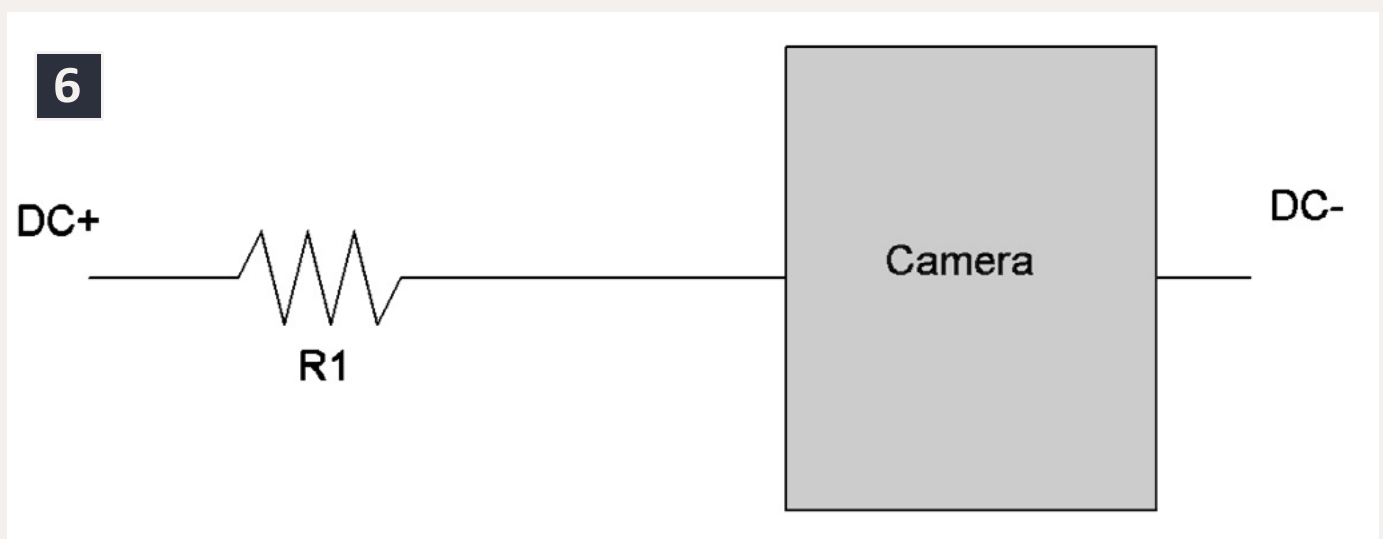

6: Camera power supply circuit diagram.

Get Better Sound from your Locomotives

Can't get a good sound from your sound decoder?
Give our speakers a test drive with your ears.



RAILMASTER HOBBIES
9815 WALNUT ST #106
BELLFLOWER, CA 90706

Bass Reflex
Speakers



High Bass
Speakers



When it comes to speakers we have high quality speakers to fit many different applications. We are also a full line hobby shop. Need anything? We are an authorized dealer for Soundtraxx, Digitrax, Athearn, Walther's and many others. We provide quality speakers for your DCC sound systems and quality service.

**Click here for
the *sound* answer ...**



Email



Phone



contents



index

[← back to previous page of text ...](#)

Next we need to build a battery charger.

Battery charger

To safely charge the battery, we need to know how much voltage we must drop between the DC power supply and the battery and what current we can safely run through the battery for extended periods of time.

The camera owner selected a PowerEx 9.6 volt NiMH battery with a capacity rating of 230 mAH. This means that the battery will supply 9.6 volts when fully charged and will deliver 230 mA (0.23 Amps) for an hour. Thus, a fully charged battery will run the camera for almost two hours ($0.23 / 0.12 = 1.92$).

These sorts of batteries will accept a charge current of 0.1 C forever without damage. Okay, what's C? Not the speed of light, as in the theory of relativity. C stands for the Capacity of the battery. So, a 230-mAH battery will stand 23 mA (0.023 Amps) or less of charge current on an ongoing basis. So, we design the circuit to supply this current to the battery.

There is a diode between the DC power supply and the resistor connected to the battery. This is a check valve to keep the battery voltage from feeding back into the power supply. As I said

[... On to next page of text →](#)

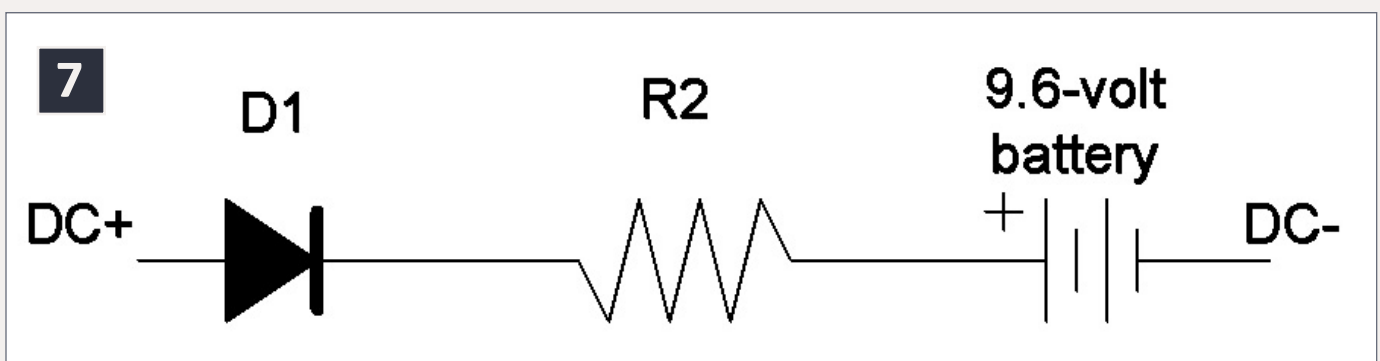

7: Battery charger circuit diagram.



Southern Digital

Specializing in DCC Since 1992



20% Discount
on most items!



DCC Conversions & Service

WWW.SODIGI.COM

(770) 929-1888

(Photo's are from our N-Scale layout)



[← back to previous page of text ...](#)

before, this diode will drop 0.7 volts, so that reduces the voltage across the resistor.

Let's calculate the voltage across the resistor. The DC supply provides 14.3 volts. The battery charges to 9.6 volts and the diode will drop 0.7 volts. So, the voltage across the resistor when the battery is fully charged, but under load, will be:

$$14.3 \text{ volts} - 0.7 \text{ volts} - 9.6 \text{ volts} = 4 \text{ volts}$$

Now that we know the voltage and current, we can calculate the resistance and power:

$$R2 = E / I = 4 / 0.023 = 173 \text{ ohms}$$

$$P = E \times I = 4 \times 0.023 = 0.1 \text{ watts}$$

A standard resistor close to this is 180 ohms rated at least $\frac{1}{8}$ watt ($\frac{1}{4}$ watt is very common). The slightly larger resistor will reduce the on-going charge current, which is safer for the battery.

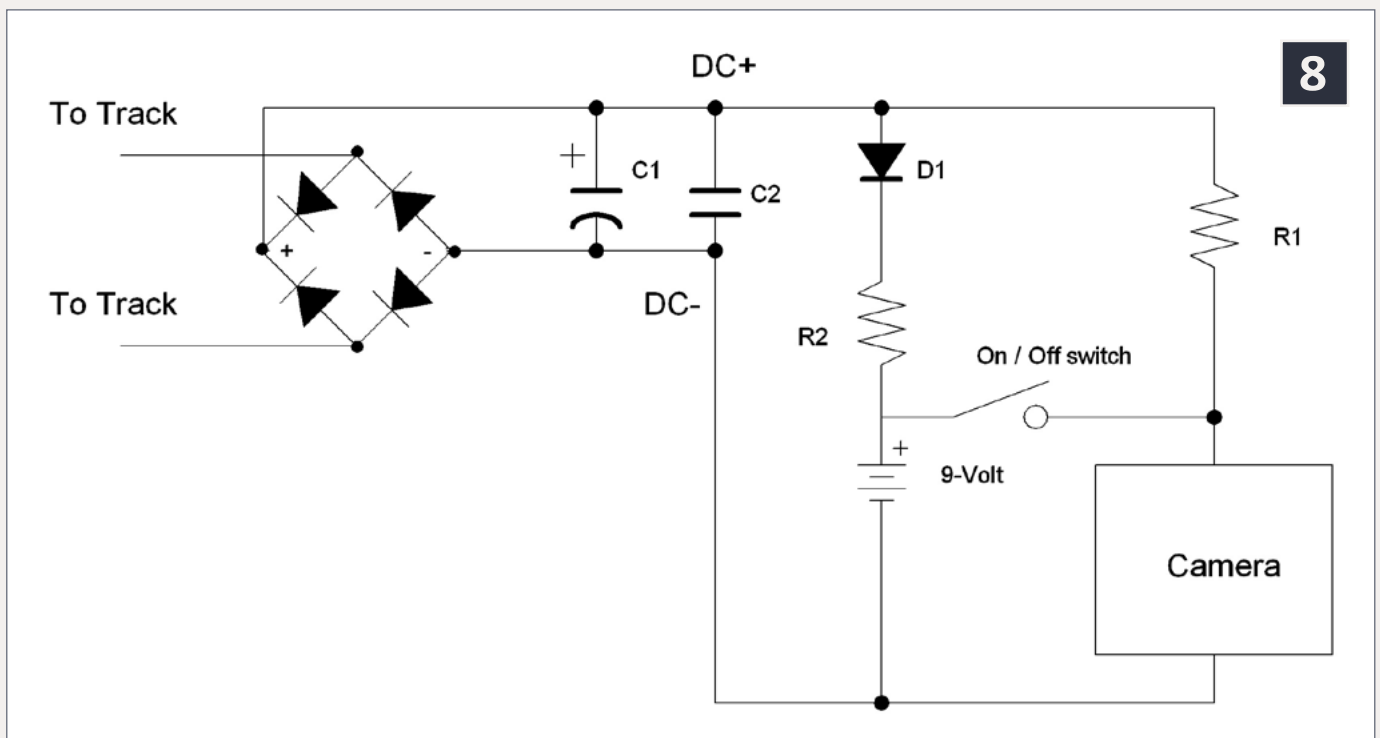

8: Complete circuit diagram.

A very common diode for this circuit is the 1N4001, rated at 1 amp and 50 volts. The 1N400x series are all rated at 1 amp, with the last number increasing with higher voltage ratings. Thus, a higher rating, such as 1N4007 will work just fine.

Bringing it all together

Okay, we now have each module designed. We need a switch to disconnect the battery from the camera, to keep the camera from discharging the battery when no track voltage is present. Bringing this all together, we get the complete circuit diagram.

If you liked this column, please click on the Reader Feedback link here and rate it awesome. Please join in the conversation that invariably develops there about the topics presented in the column. Share your experiences. Thanks.

Until next month, I wish you green boards. 

[... Sidebar continues here →](#)

Advertisement

END OF TRAIN DEVICE

FLASH CIRCUIT
UNDER TRUCK

TRACK
POWERED



READY TO RUN!

**Bright Red
Flashing Light!**

Installs in minutes
with no freight car
modification required!

RE RING
ENGINEERING

Patented Technology - US Patent 7,549,609

Does not affect Load!

↓ Car without Load ↓

↓ Car with Load ↓



For video
and more
click here!



Email



Phone



contents



index



SO REAL...You'll Think You're There!

LokSound Select · 3 SIZES, ENDLESS POSSIBILITIES!

**INDUSTRY LEADING
MOTOR CONTROL**

- Multiple Bell types
- Multiple Brake squeals

**4 OR 8 Ohm
SPEAKERS!**

- 4 or 6 Output functions depending on the style
- Up to 4 Prime Movers or Steam Sounds on EACH decoder
- 16 Very Playable, LOUD Horns or Whistles depending on Profile
- All Changeable by using ONE CV! No Programmers or Boosters needed!*

Small Size
BIG POWER! 1.1Amp!
LokSound Select
"4 AUX"



\$99.99



**LOKSOUND
SELECT**

Only Available From
ESU LLC (USA) 

ONE SIZE FITS ALL!
LokSound Select **"DIRECT"**



6 Outputs!
**LED Resistance
Built In!**

\$109.99



**LOKSOUND
SELECT**

Only Available From
ESU LLC (USA) 

Tiny Size,
HUGE Versatility!
LokSound Select
"MICRO"



\$99.99



**LOKSOUND
SELECT**

Only Available From
ESU LLC (USA) 



www.LokSound.com Now on facebook!



477 Knopp Drive - Muncy, PA - 570-649-5048



From Mr. DCC's workbench – Another DCC Tester

In a recent post, my friend Marcus Aumann talked about using a dome light bulb for HO track testing. It is designed for 13.8 volt auto systems and the contacts are just perfect to pick up HO (or On30) track (9).

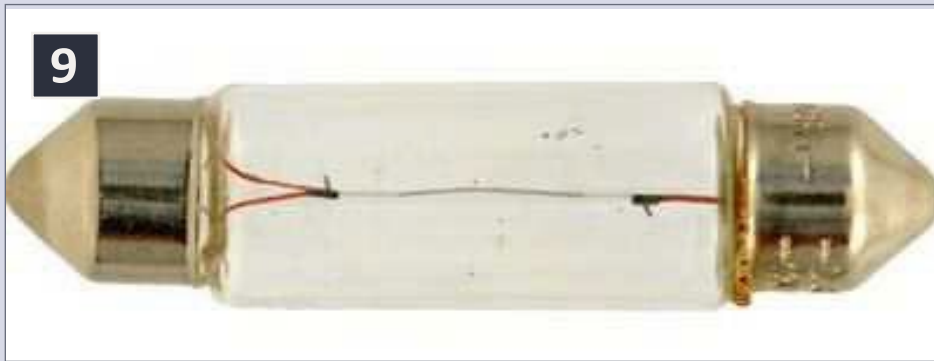

I thought about this for a bit. I see good and bad things with this approach.

It draws about one amp, which can be good or

9: Dome light bulb.

bad, depending upon what sort of testing you are doing. If you are looking to verify voltage on the rails, it is a bit much. If you are looking to see that the system can handle the load of a locomotive, it is beneficial.

The current it draws makes it get hot quickly: burned fingers.

So, I looked online and found the LED replacement bulbs. They don't draw a lot of current, but stay cool. They are intrinsically more rugged than a filament bulb. And, I found a package of 10 on eBay for \$9.99 with free postage.

Anybody want to buy a few LED bulbs? I have about 8 more than I'll probably ever use!

Sidebar continued on next page ...

From Mr. DCC's workbench – Another DCC Tester *Continued* ...



10: LED dome light testing HO track plus one off track for comparison.

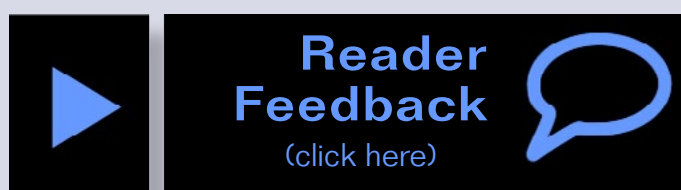

HO GP-35 Diesels



Now Arriving At Your Local M.T.H. Authorized Retailer



80-2164-1 New York Central GP-35 Diesel with Proto-Sound 3.0

Choose From:

- Sound-equipped versions with built-in DCC decoder
- DCC-ready versions awaiting your preferred decoder

Featuring:

- 2 Cab Figures
- LED lighting
- Powerful 5-pole 12-volt DC motor
- Available In 8 Different Roadnames*
- 28 DCC Functions*
- Kadee® Couplers
- Remotely Operated HO Scale Proto-Couplers*
- RP-25 Metal Wheels Mounted on Metal Axles
- Lighted Cab Interior
- Illuminated Number Boards
- Lighted Marker Lamps
- Locomotive Speed Control in Scale MPH Increments*
- Operates On Code 70, 83 & 100 Rail Curves

** Proto-Sound 3.0 Equipped Models Only*



Santa Fe GP-35 Diesel available with Proto-Sound 3.0, Proto-Sound 3E+ or DCC-Ready
Union Pacific GP-35 Diesel available with Proto-Sound 3.0, Proto-Sound 3E+ or DCC-Ready
Pennsylvania GP-35 Diesel available with Proto-Sound 3.0, Proto-Sound 3E+ or DCC-Ready
Baltimore & Ohio GP-35 Diesel available with Proto-Sound 3.0, Proto-Sound 3E+ or DCC-Ready
Southern Pacific GP-35 Diesel available with Proto-Sound 3.0, Proto-Sound 3E+ or DCC-Ready
Norfolk & Western GP-35 Diesel available with Proto-Sound 3.0, Proto-Sound 3E+ or DCC-Ready
Erie Lackawanna GP-35 Diesel available with Proto-Sound 3.0, Proto-Sound 3E+ or DCC-Ready

See why
M.T.H. HO Locomotives
Do More



HO TRAINS THAT DO MORE
www.mthHOtrains.com



From Train Set To Club

NCE Covers ALL Your DCC Needs



NEW

DCC Twin

Includes power supply - Use Optional Cabs
- Perfect for Train Sets -

UPDATED PowerCab UPDATED
Includes power supply
- Great way to start DCC on your railroad -
Optional Cabs available

SB5 Smart Booster
5 Amps - Six Optional Cabs
Includes Power Supply

NEW

PH Pro
- 5 Amps of power for Z, N, HO, S Scales -
Optional Cabs

PH Pro R
- 5 Amps of power for Z, N, HO, S Scales -
Optional Cabs
Wireless Operation



PH10
10 Amps of power for
O and G Scale layouts

PH10 R
PH10 with Wireless Operation

585.265.0230
9am-4pm EST.
www.ncedcc.com



Call or Email
for FREE Brochure
support@ncecorporation.com



Look for these **NEW NCE PRODUCTS** at your local dealer

 PB5 - New version 5 Amp Booster Includes power supply	 UTP-CAT5 Panel Use common CAT5 cable to hook up your Cab Bus
---	---

NCE Corporation builds products in Upstate New York - Right here in the U.S.A
We build our products to the NMRA Standards and Recommended Practices where applicable





Kintner Milling

Developing a signature scene



Getting Real column

by Mike Rose

How stumbling upon an interesting prototype allowed me to focus on an entire region ...

Way back in 2003 I was wandering around Pennsylvania, a state that I found endlessly fascinating to railfan in. I loved the combination of heavy main-line action, interesting regionals, and abundant shortlines that seemed to be everywhere! It was during one trip that I headed into an area of Pennsylvania that I had not yet explored. My goal was to follow the tracks from Pittston up to Sayre and then come home by continuing to Waverly, New York and heading east along the Southern Tier.

At the time I didn't realize that I was following the line I would decide to base my model railroad on: the former Lehigh Valley "Snake Path" (later part of Conrail's Philadelphia Division) that followed the beautiful valley of the Susquehanna River almost the entire way. I quickly realized that the steep, wooded hillsides and relatively sharp mainline curves leant themselves



ideally to a model railroad, and more time was spent exploring the various towns along the former LV mainline.

Eventually I happened upon the town of Mehoopany, which on the map seemed to have a large industry and yard, and found the big Procter & Gamble plant that I would eventually model and base my new peninsula on. Continuing north from there, and quite by accident, I found a very photogenic grain mill called Kintner Milling in Meshoppen, the very next town up from Mehoopany.



1: Here is my first view of Kintner Milling. Note that it was now being used as an antiques dealer. The photo angle taken from the street gives a view that does not yet indicate all of the proportions of the building, but I had not quite realized that yet. Other than the green antiques sign, the building was mostly unchanged from

its days as a working, railroad-served industry.

Remaining work includes determining the best way to build and apply the chutes, but I think I have some thinwall brass channel that may do the job. I'll likely cut slices into the siding and foam core, and simply insert the channel. I also need to add one more piping detail to the rear of the structure, and of course paint the grain bin.



2: In the above photo you can see part of the elevator on the left, and the retail store end of the operation. I eventually decided to omit this structure when I modeled the complex.



contents



index

3



3: The rear of the structure had this interesting building with a great deal of modeling appeal. To its left is the concrete pit the grain was dumped into, and the pipes above were used to get grain to and from the elevator itself. Note the delicate iron work used to support the pipes, an important modeling aspect. Track to this complex came up a fairly steep hill from the tracks along the river, and at one time there was another spur that no doubt aided in shifting loads and empties once the local got out there. Noted railroad author Mike Bednar explained to me that this mill was served with a local out of Mehoopany, using the plant switcher, which was generally a GP38.

4



4: The rear view shows the overall elevator height, details such as doors, a fan, windows and louvers, plus the general layout of the facility.

I took as many detail photos as I could, and filed this trip away for future reference until I was able to return in 2006. By then very little had changed except that my interest in the structure was increasing and I realized I needed more photos.



contents



index



5: When you are scratchbuilding something like this, detail photos such as this (showing a close up of the siding, a patch job, the old sliding door, and the loading chutes) are invaluable.



6: Here you can see the concrete that was part of the loading pit, now filled-in. It also looks like a truck dock has been built where rail cars once stood.



contents



index

7



7: The above view would prove to be very helpful to show the side details and closer views of the rear and its piping.

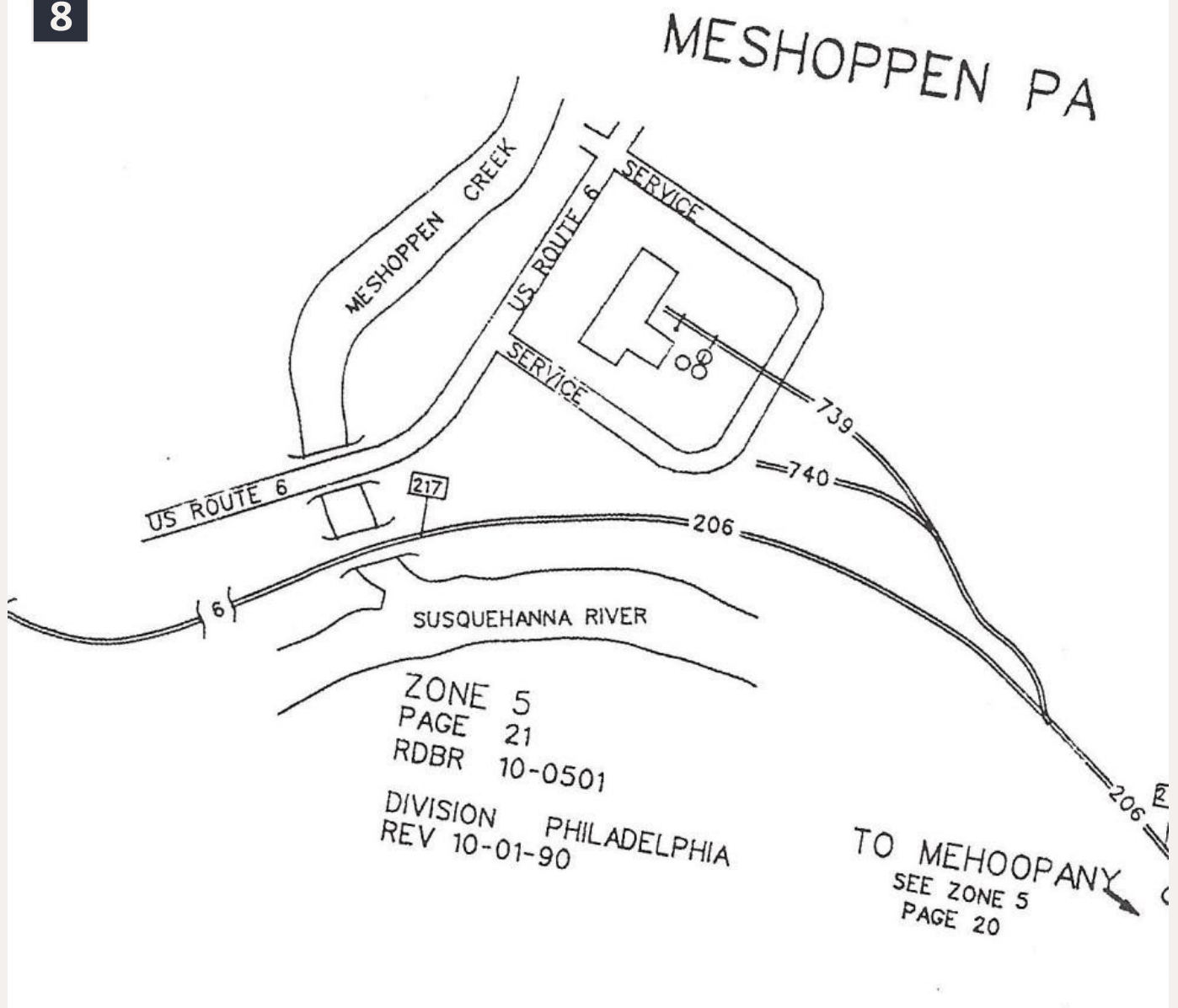

8: The above map is from official Conrail ZTS (Zone, Track, Spot) maps showing the track arrangement at Kintner Milling in Meshoppen. On the layout, I reversed the location of the two tracks, with 740 being to the right of 739, since the mill is hard against the backdrop scenic divider.



9

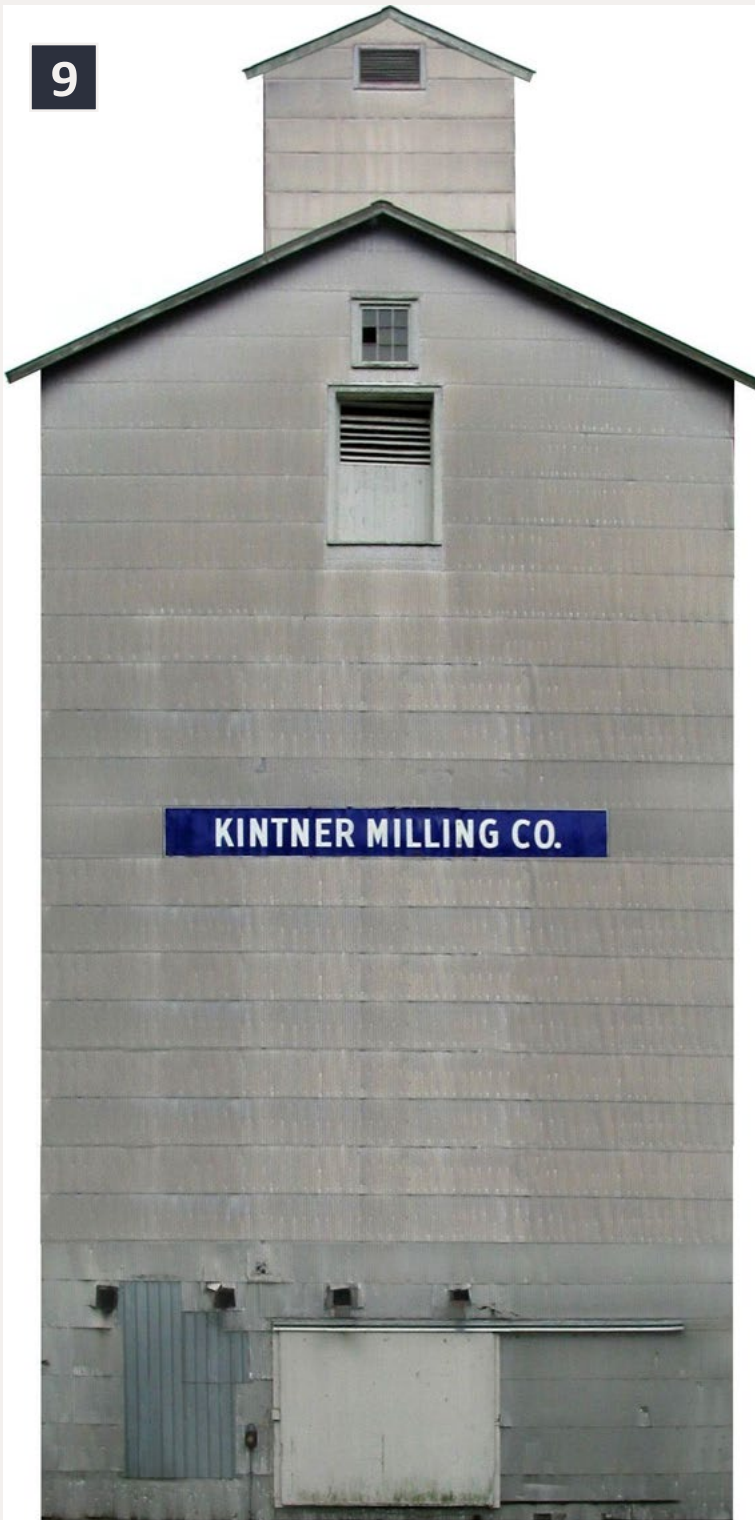

9: So what have we here? This is the result of my friend Jim Six using Photoshop to "de-parallax" the photo and to remove all traces of the antiques sign. Another friend, Neil Schofield, used Autocad to help me print the image to what we believed was HO scale. The image came out so well that I began to think that doing the building with photo sides would be the best way to model it.

Unfortunately, the images of the side of the elevator were too skewed to be useful, and I began to con-

sider alternatives. Eventually I decided that a combination of standard modeling materials and parts of the scaled image could be combined for a convincing look. A quick-and-dirty mock-up was made out of cheap foam core painted silver and the photo above stuck to the front of it. That mock-up was kicked around and moved for years until actual construction of the town of Meshoppen was started.



10

10: In this picture, the mock-up is being used to help visualize the eventual proportions of the town itself.



11

11: Here we see that there is literally nothing behind the front of the mock-up! Note the “input-output” building already constructed for me by modeler Rich Cobb. Later you’ll see how this was blended properly into the scene.



contents



index

12



12: Even at this relatively late stage of constructing the town, you can see I'm still using the mock-up. This is despite the arrival of all of the other buildings in town that Rich Cobb built for me. Clearly it was time to get moving on the actual Kintner Milling.

13



13: My first task was to get comfortable with the site layout and dimensions. Here you see that I've marked the grain bin, the dumping pit (the wood you see is the lauan plywood roadbed ready for track) along with an excavated area for the "input-output" building, and the footprint of the elevator to be built.



contents



index

14



14: The excavation was necessary to position the building at the proper height, relative to the tracks and elevator. Note that the track is in position and ties removed where the pit excavation will soon begin.

15



15: Here the pit has been fully excavated and is ready for an application of “concrete.” Note how the luan has been notched for girders that will support the tieless rails over the pit.



contents



index

16



16: With the girders in place, you can see how a covered hopper would be positioned for dumping, one bay at a time. While there was no evidence of a device to move the car, most small facilities either had some kind of cable-operated capstan to pull the car, or a bucket loader or similar tractor would be pressed into service, sometimes with its own attached coupler.

17



17: Actual construction of the final model has officially begun. I used leftover Gatorfoam board from the Procter & Gamble project to build the main elevator structure. It allowed me to use my table saw for accurate cuts and a hot glue gun for quick assembly. This top view shows the overall footprint of the building.



contents



index

18



18: The old and the new: having the model full depth gives the elevator a much heftier look than the mock-up I'd become used to.



19: From the rear you can see how the end of the track nestles into the crook of the elevator, just like the prototype.



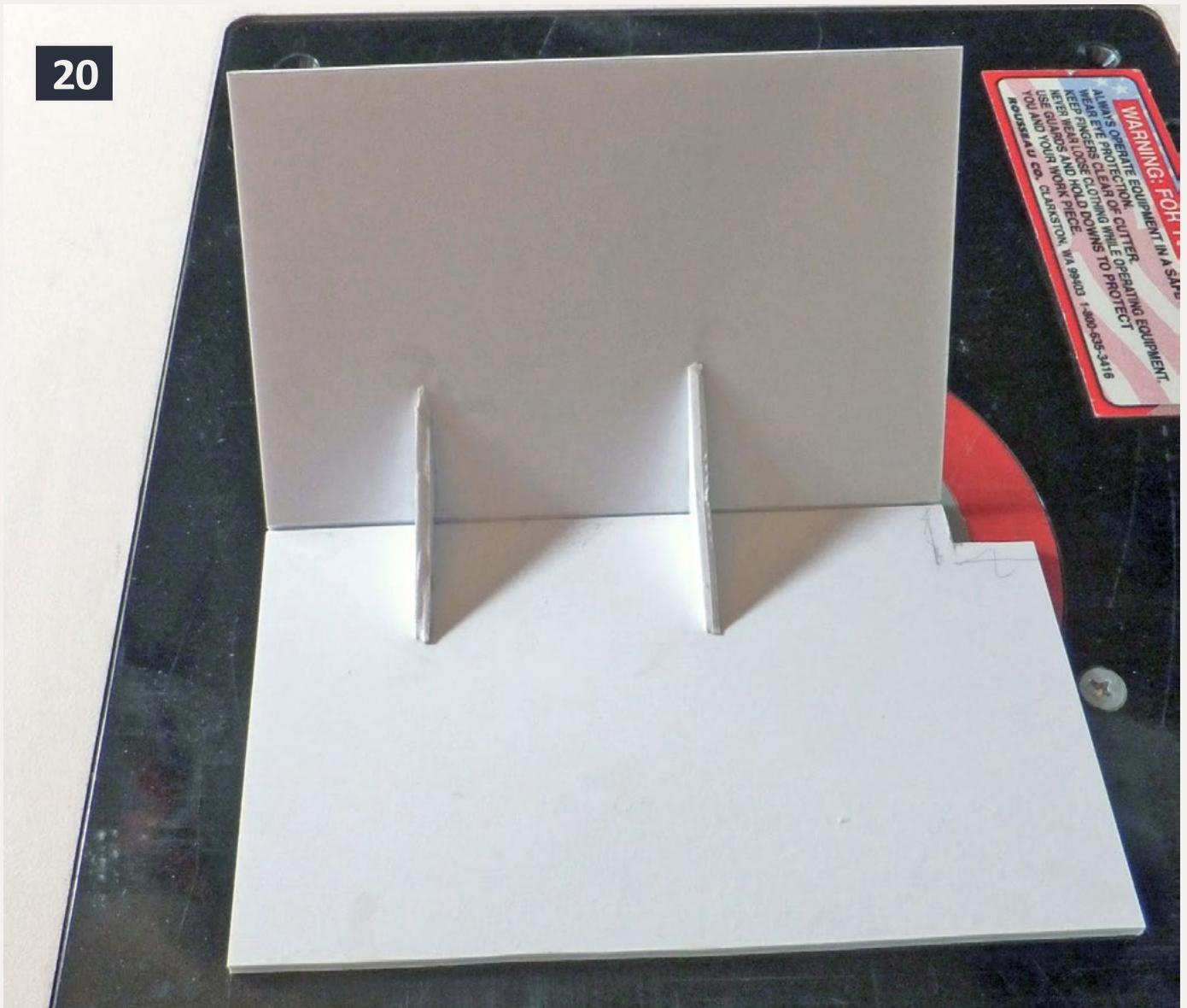

20: I chose to build the roof out of thick styrene for ease of construction, reinforcement, and because it offered a thinner profile than the 1/4" thick Gatorfoam board.



21: I had decided from the start that I wanted to use metal siding on the building and I needed to draw a lot of alignment lines for the various courses. The wooden jig I built allowed me to easily draw the lines on all sides, and they even met satisfactorily at the last one as I worked my way around the building.

22

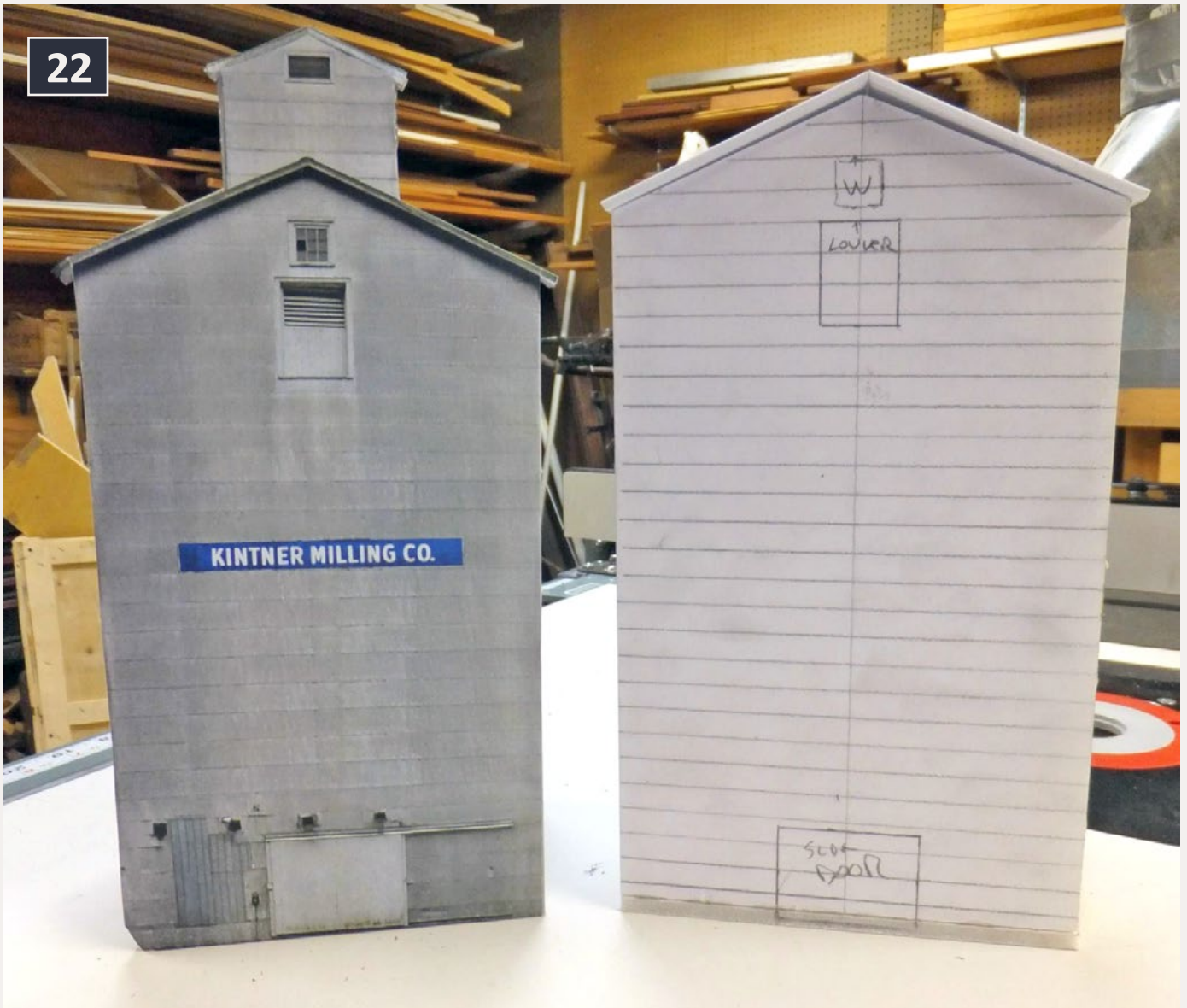

22: In this shot, you can see how I'm planning the locations of the windows and doors. Note how the actual building was constructed a bit taller to better match the proportions of the town's other structures.

23

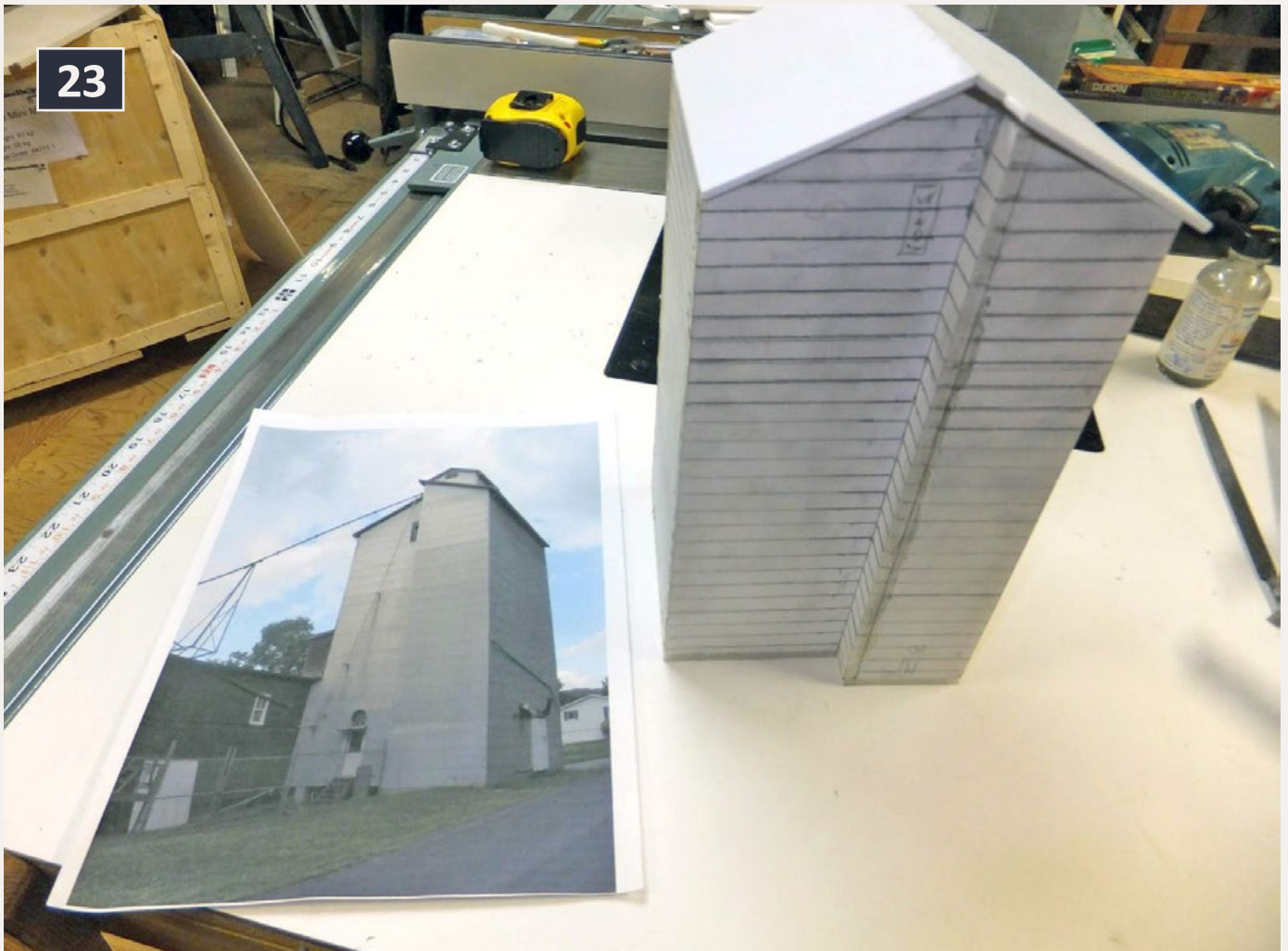

23: I refer constantly to prototype photos to be sure I maintain the look and feel I need to capture. Just having the lines on the building is a huge improvement over bare white sides, helping me to visualize it better with siding.



contents



index

24



24: For a building like this you need a lot of siding! Friend Scott Mason had given me a quantity of Northeastern corrugated siding, and it seemed like just the right thing to use. I made up a jig, using a hacksaw blade which just happened to be the right dimension, to allow for consistent cutting of the siding. I made multiple passes with new, sharp X-Acto blades to get clean cuts.

25



25: While all this was going on, I continued to work on the town itself. After “pouring” the town’s concrete sidewalks, I used leftover material to apply concrete to the sides of the pit. The materials used were light-weight spackle, mixed with a combination of Bragdon Enterprises powders until it looked right to me.



contents



index

26



26: Even though the mill is still under construction, I continued improving the site with dirt and grass, and constructed a grain bin resembling the prototype from a pair of Rixx N scale grain bins. Another piece of the thick styrene was used for a concrete base for the bin.



27: This close-up of the bin shows how I used a Walthers etched-brass ladder, some Plastruct styrene tubing, and some aluminum wire to replicate the ladders and piping for the bin. It will eventually get an overall coat of silver paint.





28: This view shows the structure with a significant amount of the initial siding applied. Sharp eyes will note that it's now covered with Campbell corrugated siding, as the Northeastern siding just looked too coarse for this application. Yes, I methodically removed all of the original siding to apply the new! Double-stick tape was the adhesive used.



29: This view shows the siding all in place, ready for weathering. Also note that the roof material is in place and painted the same color as the prototype, judged from aerial photos. On the roof, the Northeastern material looked just right!



30



30: How *not* to do it: what's wrong with this picture? It shows how I did my usual Dullcote of the siding, then used alcohol to fade the Dullcote. While the look of it was actually pretty good, I hadn't counted on the alcohol completely dissolving the adhesive of the tape holding the siding in place! To say that I was not pleased is an understatement. This building sat for several days while I was in denial about the whole thing. Eventually I removed all of the siding and started over from scratch.



31: This is more like it! After again consulting with Scott Mason, I decided to spray paint all the Campbell siding primer gray, let it dry for a day, then baked it in a low heat oven for half an hour to further solidify the coating. Dullcote and alcohol fading were applied to the sheets, and only then did I cut them into strips for application. This is the right way to do it. Live and learn! While I'm accomplished with many materials, it was actually my first time using a lot of this metal siding material.





32: This astounding photo, graciously provided by Wayne Sittner, was taken in my modeling era and actually shows the mill in use with a Conrail H-54 covered hopper spotted there. This is the only photo I had that showed the mill at this time, and also showed the grain bin.

33

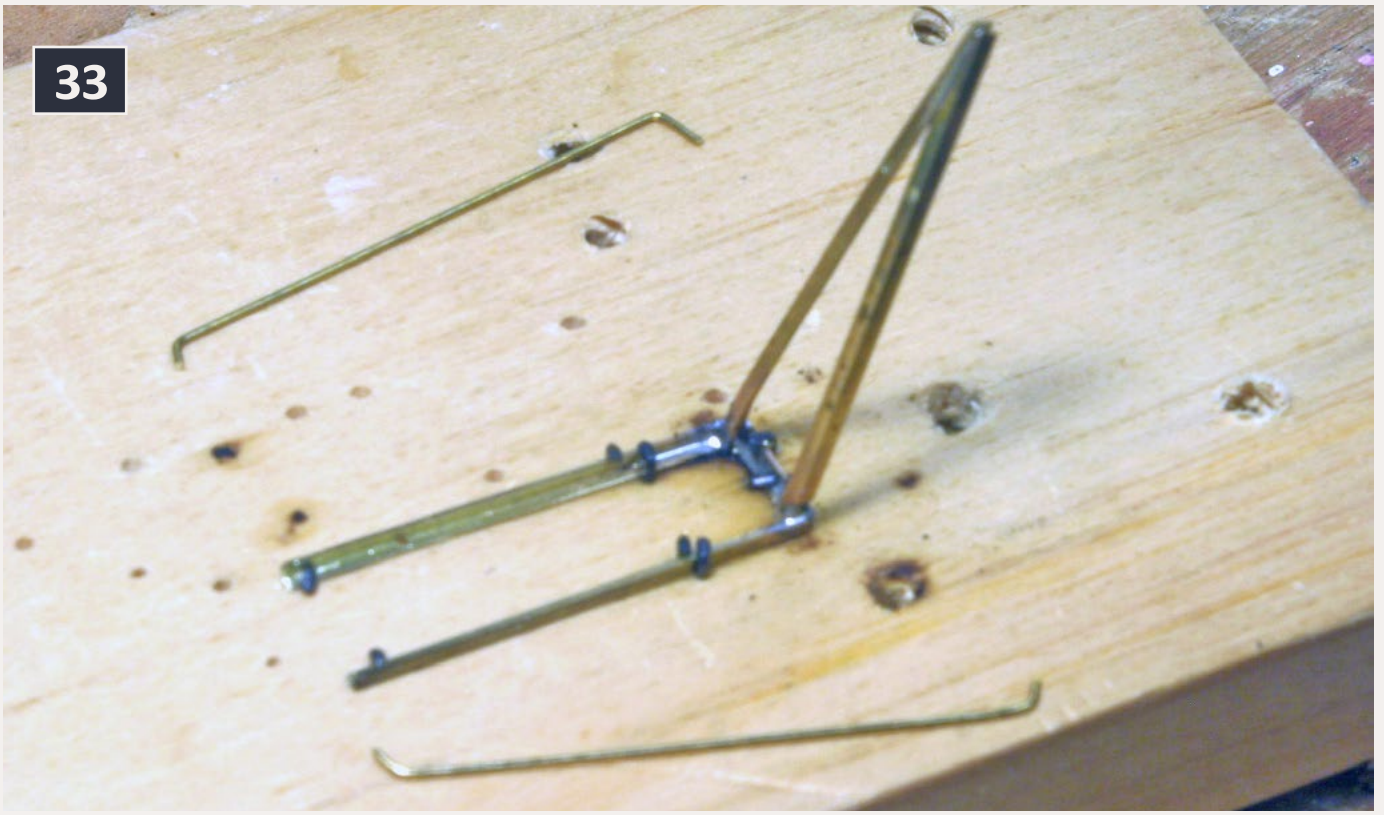

33: It was time to construct the angle iron bracing for the piping that connects the elevator with the input-output building in back of the elevator. Here I'm soldering brass angle and combining .015 brass rod for the tension bracing.



Playback problems? [Click to try a different version.](#)



contents



index

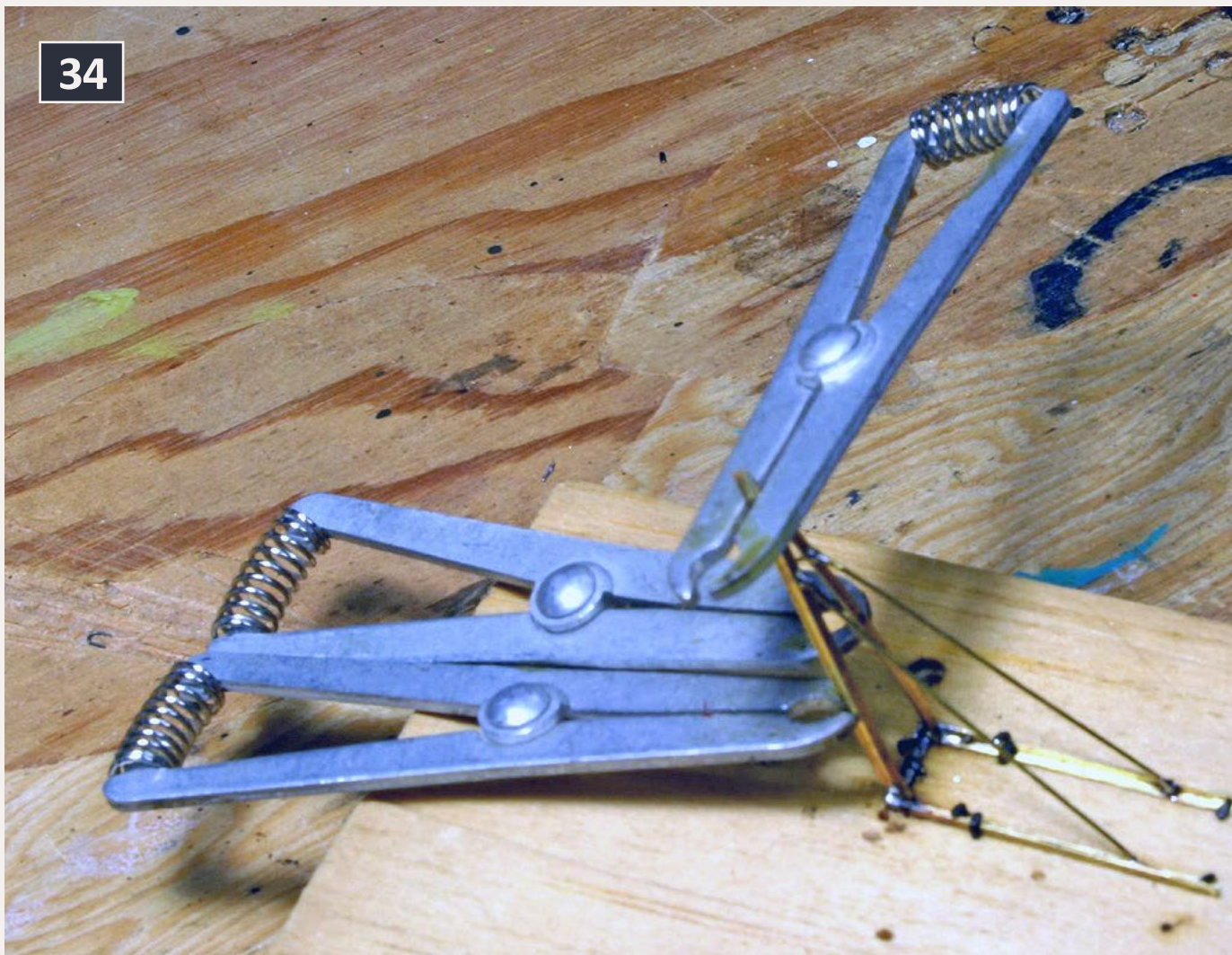

34: Heat sinks are very useful to make sure you're not unsoldering something else while soldering more pieces.

Advertisement

Craftsman Kits and Details

Featured HO Scale Kit, \$29.95*



*Partiers not included

Party Houseboat

HO & N Scale Laser Cut
Model Kits & Details



PayPal

Secure on-line ordering

www.interactionhobbies.com

INTER-ACTION
Enterprises

E-mail: sales@inter-action.ca
Phone: (888) 850-1742



Email



Phone

35



35: The almost-finished product: the angle bracing is on top of the input-output building, and .020 brass rod has been used to fabricate the main piping it supports. This view also clearly shows the mixture of techniques used to construct the mill. The upper louver and window on the cupola are photos, the upper window on the elevator is real, with the Gatorfoam cut out to accommodate it, and the recess painted black. The same thing was done for the lower “people” door, which would later receive a photo circular fan above it. The sliding door is a photo of the real wooden one, glued to thin styrene.

Article continues on the following page ...

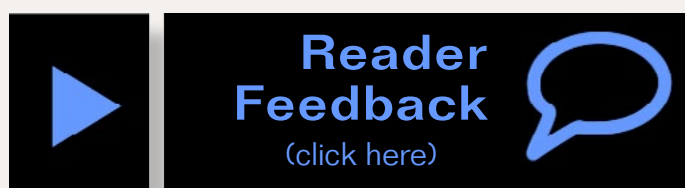

36



36: In this front view, a strip of the Northeastern siding has been cut and applied above each sliding door as a track, and the Kintner sign is now applied. It too was glued to thin styrene and applied to the building front with double-stick tape.

Remaining work includes determining the best way to build and apply the chutes, but I think I have some thinwall brass channel that may do the job. I'll likely cut slices into the siding and foam core, and simply insert the channel. I also need to add one more piping detail to the rear of the structure, and of course paint the grain bin. My goal is to have the entire complex, along with a small diorama board, ready to display at the New England Prototype Modeler Meet in Collinsville, CT. on May 31st. and June 1st.

See the following site: neprototypemeet.com/Welcome.html.

Until then, Stay Real! 

Rslaserkits



Jacks Cabin Water Tower

Now in O and HO scales soon in N

Due to price increases
We will be increasing our
Pricing on June 1
Our first ever increase

On30 -On3 Pickle car



Derelict Passenger Car

By request now available in HO scale
Why cut up a nice car or kit when you
can have it already done for you.

MOW car

Now in On30, HO, HOn3, N and Z scales



click here

Custom Laser Cutting and design
Dealers welcome



5145 Gaffin Rd. SE • Salem, OR 9317 (503) 371-4290 • Fax: (503) 585-0850

E-mail: Sales@rslaserkits.com Web site: www.rslaserkits.com



New Tsunami[®]

Cummins QSK19C x3
for NRE GenSet
Locomotives

Hear the Sound Sample

See it on YouTube

SOUNDTRAXX[®]

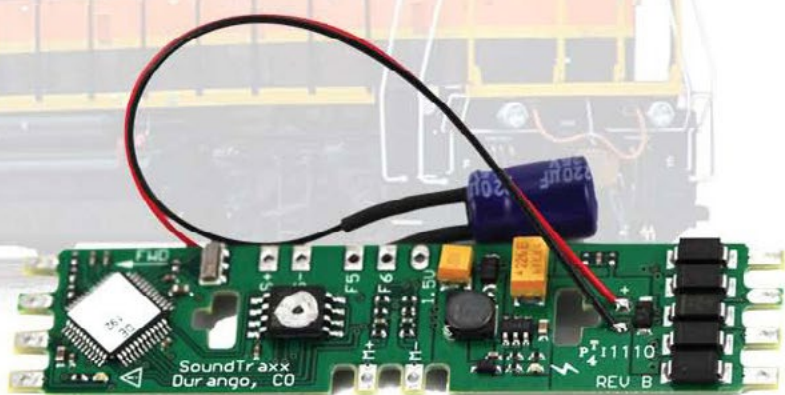

For easy installation instructions see our **Application Note**, or for other products visit www.soundtraxx.com



New Large Scale Loco Plugs!

We have developed a source for reasonably priced reliable quality connector options to use in large scale "G" and "O" locomotive installations. These connectors will support 10 Amp loads. Each kit comes with an easy to install low profile locking male/female plug pair with 10" pig tails in varying color codes. There are 4 different pin configuration options.

P/N	# of Pins	Desc	W" X H" X L"	\$ MSRP	\$ TTX
ahdgoconn2	2	2 Pin, Large Scale Locomotive Plugs	0.31 X 0.30" X .92"	\$4.80	\$4.08
ahdgoconn3	3	3 Pin, Large Scale Locomotive Plugs	0.41 X 0.30" X .92"	\$5.20	\$4.42
ahdgoconn4	4	4 Pin, Large Scale Locomotive Plugs	0.51" X 0.30" X .92"	\$7.40	\$6.29
ahdgoconn6	6	6 Pin, Large Scale Locomotive Plugs	0.71" X 0.30" X .92"	\$8.80	\$7.48



800-978-3472
www.tonystrains.com





What has Ken Patterson been up to?

Photos and video of superb models



What's neat this week column

by Ken Patterson

Joe Fugate asked that I do a What's Neat This Week on Ken Patterson and what I've been up to.

You've got to figure I have five different ads running each month for Bachmann with photos in the various scale magazines, N, HO, ON30, O 3 rail and 1:20.3 F scale. Add to that a What's Neat video and story each month, plus I am producing how-to videos to sell on my web site, you could say I'm swamped.

I've spent the past year learning video editing, and am working aggressively to produce true-to-life video that matches the standards I set for myself in still photography. The learning curve has been pretty fast, as you can visually see the difference from the first Mike Budde video in November compared to the one running this month.

It was the Butch Eyer shoot where I filmed a few outdoor run-bys in sunlight for the first time. This shoot turned into an exercise in switching, complete with coupler clash. Nice, but it was missing real sunlight in the modeled scenes. In the upcoming Dave Davis and Joe Steimann "What's neat this week," model run-bys are all shot outdoors. DCC with



radio makes it all possible, as you can operate the train and the camera at the same time during filming. This month's Video has 34 video files, 30 text files, two music tracks, and two sound effects, for a total of 66 files, compared to the November Mike Budde video of only three files total.

I am working on the idea of an outdoor HO railroad loop with straight and curved lift-out sections to change the scenes from HO to On30 with the same track. On the back loop, adjacent tracks in O scale 3-rail and N scale would be in place to match up with front dioramas. This would enable me to drop in scenes in various scales and be able to



1

1: Snow shot video clip still. This is a photo of a video clip of a Milwaukee Road passenger train running through a diorama covered with a little patching plaster for snow. The lights are lit with DCC. On the video the train runs past with computer generated snow falling at a rate of 18,000 flakes per second. It looks fantastic and very believable.

NEW for MAY

87-1406, 60-1406

Plywood Texture, New Weathered and Grain Only

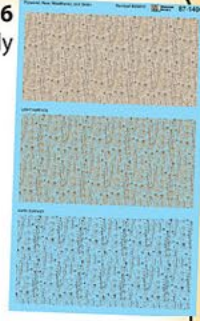

87-1407, 60-1407

GE Solar Panel Texture

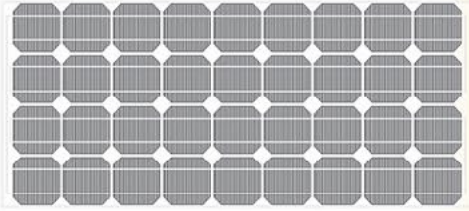
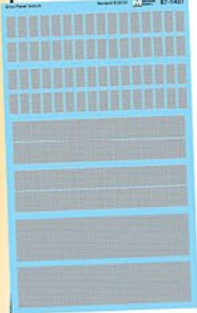

87-1414 & 60-1414

Northwestern Pacific (NWP) GP9, Past Operators, Wood Boxcars, Wood Caboose, and MOW equip.



87-1415 & 60-1415

Pan Am Railways, Locomotives and Boxcars



87-1416 & 60-1416

Missouri Pacific (MP) & Missouri Illinois (MI) boxcars



87-1417 & 60-1417

Texas Mexican Railway (TM) Locomotives, Boxcars, and Caboose



Microscale Decals

microscale.com

MADE IN THE USA

capture quality sunlit video. I smell professional, model railroad manufacturer product trade show videos here.

In this month's video presentation I exhibit another neat trick – computer-generated snow in HO scale. There are plenty of summer runbys with steam and diesels and a little snow-plowing in F scale towards the end, plus a Skype chat with Joe Fugate about putting this piece together.

Follow along with the still photos and captions, and watch the video as I show "What's Neat This Week".



contents



index



2: This is the new N scale Missouri Pacific caboose from Bluford Shops. You can't really tell from this photo what scale the model is. Code 55 Micro Engineering track and the railroad worker help to complete this scene. I can't wait to see the HO scale caboose they have announced as I watch the prices of brass Mo-Pac cabooses decline on eBay from the \$200+ price range down to \$150 or so in the past three months.



3: This is the just-released Broadway Limited Pennsylvania I1 decapod, or as I call it, the SD40-2 of the Pennsy steam fleet. I've got some realistic outdoor run-bys of these steam locomotives running with short and long tenders. This model features great detail, looks, and sound, with a smoking unit that blows smoke with each chuff. Usually I would write this off as a gimmick to spit oil all over the locomotive, but this is not the case. The unit performed flawlessly, and looked very interesting on video with two locomotives double-heading freight.





4: This is the out-take for the Bachmann 2013 catalog cover and my 110th cover in the model press to date. This Williams 3-rail GP30 has all-new tooling, and raises the bar in the Williams line.



5: Classic Metal Works has introduced this wonderful-looking Greyhound bus which I chose to shoot with the Aero Train as the backdrop. I left the mirrors and wipers off in this photo, as I plan to disassemble the model and fill it with the battery and electronics necessary to give it radio remote steering and power. "I'm going to drive this bus."

Advertisement



MONSTER
model & laser works

**CUT THEM IN SECTIONS TO
MAKE YOUR OWN PATTERN**

**NEW
JOINTED
CONCRETE
SHEETS**

Cracked Concrete & Plain Concrete



www.monstermodelworks.com

WHAT WILL YOU BUILD?





6: With an increase in fuel efficiency and power, the ES44 packs 4400 horsepower into a 12-cylinder engine with power to spare. The Intermountain model captures the feel and sound of this beast well in the video presentation. The model photo is completely in focus, with beautiful clouds, “that’s the luck,” and this Bachmann railroad worker that looks totally natural in any modern photo.



7: This is a photo of the Bachmann B&O EM1 in all its glory, weathered and looking natural in this photo. I weathered two of these locomotives and documented the six step process on video with brushed on oils and extensive airbrush use. You can get your DVD Video copy for \$19.95 at kenpatterson.com.



contents



index



8: In this photo, you see a few Amtrak E8s from Walthers. With their line of plated passenger cars in the 1973-75 era, I thought I would get the models while they are available, to model a nice Amtrak consist. I've got a lot of work to do to finish this train so I really could not shoot any video of this consist until it is finished this summer.



Playback problems? [Click to try a different version.](#)



9: It snowed a lot this past February in St Louis. It took a lot of plowing to keep the garden railroad running. Here you see me shooting some very cold runbys to include in this month's video feature. The models are 1:20.3 F scale running on track power of around 18 volts with no conductivity problems from the wet conditions.

 **Reader Feedback** 
(click here)



contents



index

MRH HOBBY MARKETPLACE - 1

STREAMLINED BACKSHOP SERVICES

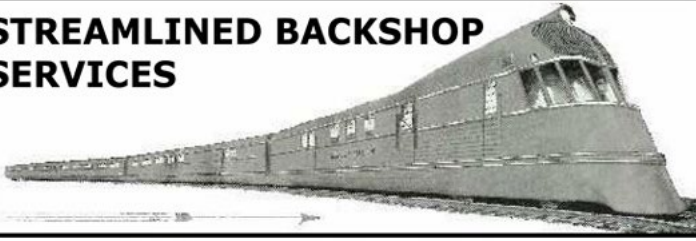

MAKE 'EM ALL HEAVY WEIGHTS



www.SBS4DCC.com

True Scene™ Modeling

NEW FusionFiber™

Dependable Quality. Easier than Plaster!

SATISFACTION GUARANTEED!

www.truescene.com or 716-523-7305

Don't settle for lifeless signals!

We've got signaling circuits!



LOGIC RAIL™ TECHNOLOGIES

"Sophisticated Model Railroad Electronics"



Please visit our website and online store!

21175 Tomball Pkwy
Suite 287
Houston, TX 77070

Phone: (281)251-5813
<http://www.logicrailtech.com>
info@logicrailtech.com

On3 Waynesburg and

Washington Passenger Car Kits

Click here for more info ...

Affordable custom and modular benchwork.

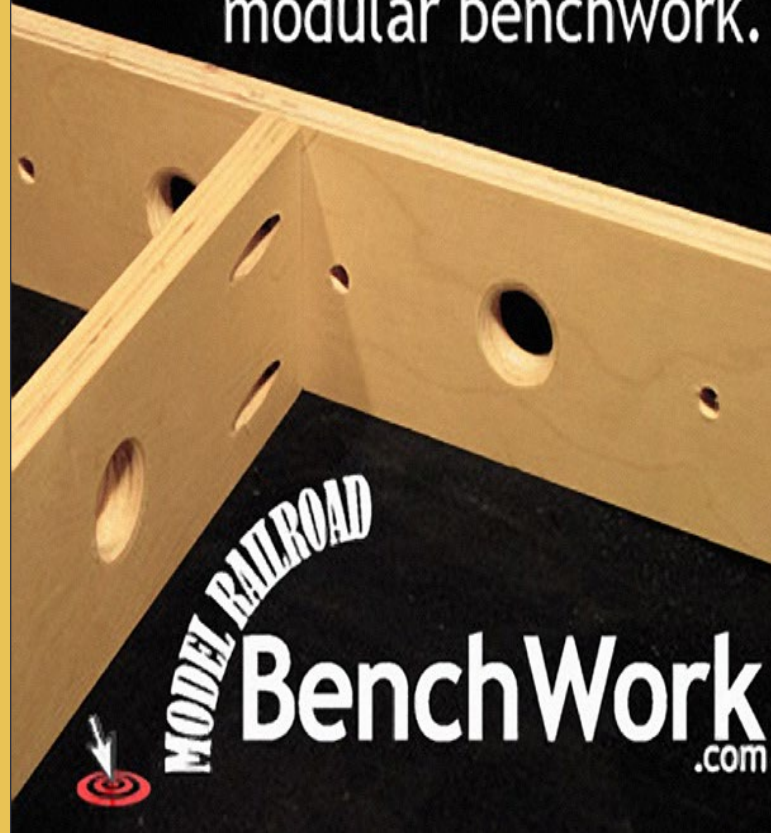

MODEL RAILROAD

BenchWork.com

CLEVER models LLC

Cardstock models & building materials

CLICK HERE

PayLoadz PayPal





An exciting new development is coming from Model Railroad Hobbyist this fall ...

Watch for it!

ON3 - ON30



Click to visit ...

WWW.SANJUANCARCO.COM



MRH HOBBY MARKETPLACE - 3

Backdrop Junction

Your stop for
Model Railroad Backdrops



click here to visit our website
backdropjunction.com
N, HO, O Scales • Custom Orders



Now Available



R. I. Stk Car - 3 Versions
Also Avail: PSC Ore Car
westerfieldmodels.com

**REAL
CEDAR
TRUNKS**
Click Here!

Coastmans

click here!

Recommended installation tool

Goes on easy

All Scales

All Brands

Make a Tire or Retire

Green Grip from a Jar

WWW.BULLFROGSNOT.COM

SNOT = SAND

99% Know It Works!



Railroad Art-Prints,
Caps, Jackets,
Shirts and More ...
Jackets starting
at \$79.95

www.jelsma.com

1-904-221-3513 • Jacksonville, FL.

Minimalist Model Railroading

New Approach to
Model Railroad Design

Click here to learn more...

minimalistmodelrailroad.com



**HOBBY
MARKETPLACE**
ads are
economical
and effective.
Click HERE to learn
more.

Great Decals!

is now selling decals produced by *After Hours Graphics* for Midwestern railroads. Roads offered include C&O, Cincinnati Union Terminal, Conrail, CSX, DT&I, Great Miami, Indiana and Ohio, Interstate, NKP, Norfolk and Western, Pere Marquette, Southern, Transkentucky, and private labels Dow and Owensboro Grain.

For the complete list, see:

[www.greatdecals.com/
AfterHours/AfterHoursList.
html](http://www.greatdecals.com/AfterHours/AfterHoursList.html)

Great Decals!

P. O. Box 994, Herndon, VA 20172

RULERS-of-the-WORLD

Scale Rulers \$4 each

Over **150** scales!

Metric or Imperial

www.rulers-of-the-world.com

Your Text Ad

Could be here for a remarkably
affordable price!

mrhmag.com/advertise_with_us

We've added REALISM to
Hand-Laid Track.

And made it Table-Top Easy for
Everyone

The Proto:87 Stores

Accurate and Correctly Detailed
Trackwork, your Back and even
your Digital Camera will Love.

www.proto87.com

Get your ad in the marketplace ... click to find out how.



contents



index



**NEW SIDEFAMES!
NEW MOTOR!
NEW SOUND!
NEW COUPLER!
NEW LIGHTS!
NEW FEATURES!
NEW 21 AND 8
PIN DC BOARD!**

**AVAILABLE IN
NYC, MILW, PRR**

**THE ALMOST ALL
NEW 4 AXLE US
C-LINER FROM
TRUE LINE TRAINS.**



YOU'LL BE WOWED TOO!



True Line Trains® is exclusively distributed in Canada by Canadian Hobbycraft Ltd. 445 - 1 Edgeley Blvd, Concord, Ontario L4K 4G1

For the latest information look us up on line at www.truelinetrains.com

SOUNDS PROVIDED BY ESU / LOKSOUND



The True Line Trains® logo and all Intellectual property are the property of Hobbycraft Canada Ltd.



MRH-May 2013



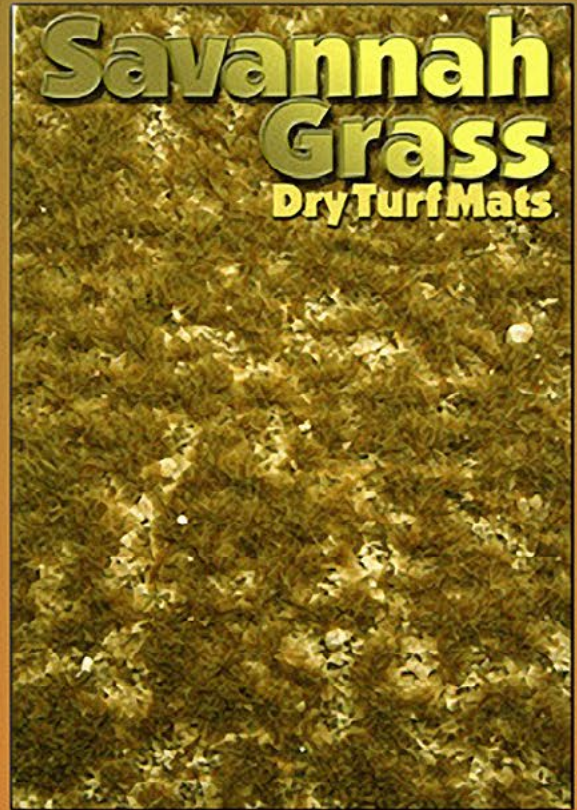
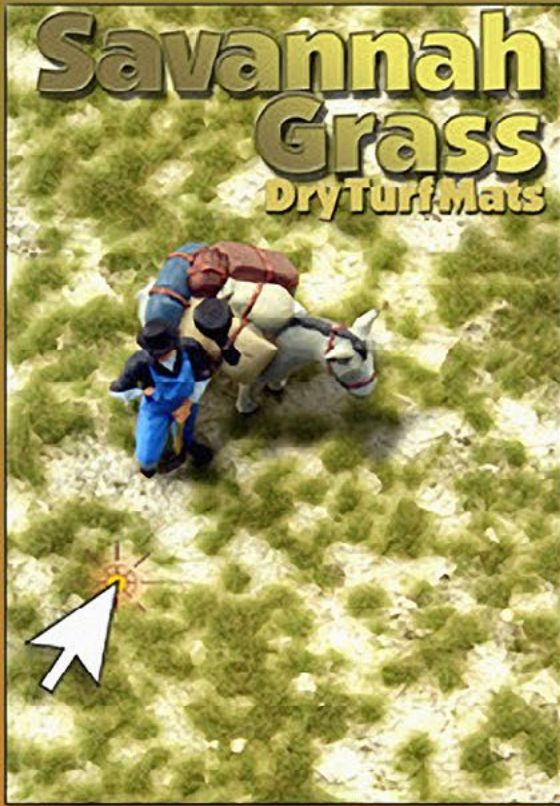

Click for more - lots more!

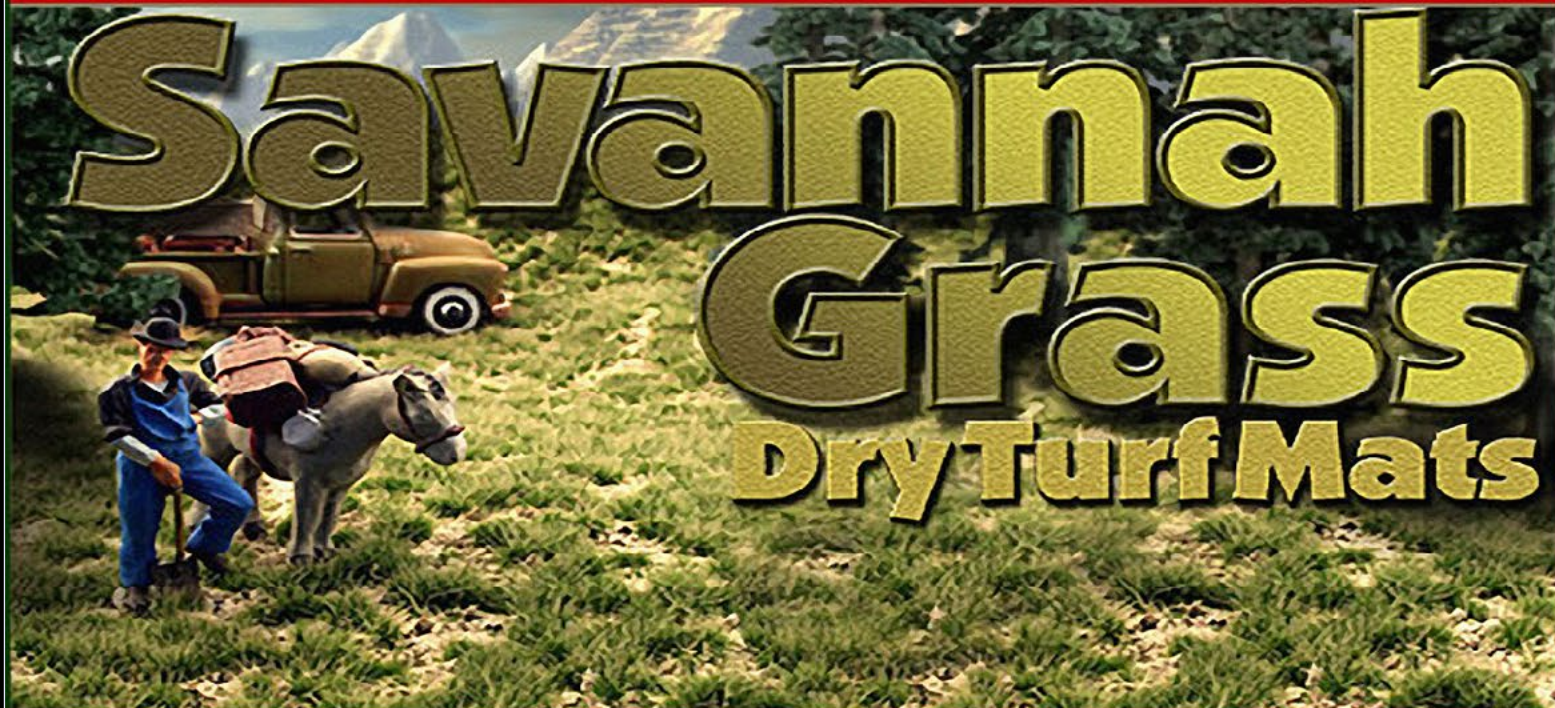



Build a Wood Staining Fixture

Make staining stripwood super-easy with this fixture ...

by *Richard E. Napper*

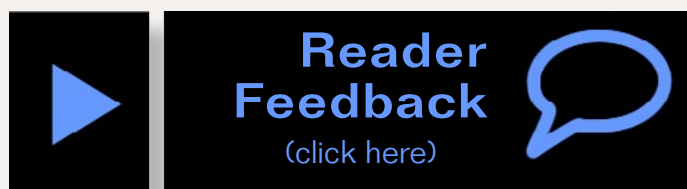

Like many of you, I buy scale wood in long strips. I could use the old rag-soaked-in-stain method to stain the wood, but it seemed to me there ought to be a better way.

After giving the problem a little thought, I constructed for myself a wood staining fixture to make it easy to apply stain to long stripwood.

I cut a 40" long piece of 2" PVC pipe down the middle on a table saw, using a cutting fence, and glued on two pipe end caps. By making the fixture 40" long, stripwood pieces up to 3' in length fit easily into it.

I drilled a hole in one end cap and inserted a short ¼" diameter brass tube, so I could return the staining solution to the bottle when I was finished with a staining project.

I super-glued two square pieces of brass under one end cap keep the fixture level and upright.



1: Here's the stripwood staining fixture, made out of a 40" long piece of 2" PVC pipe. Note the ¼" brass tube on the end to allow draining the stain back into the bottle, and the two ¼" square brass pieces super-glued to the end cap so the fixture doesn't roll around.

To use this fixture, I put the wood strips in the pipe trough, add the stain of choice, let it absorb, and then place the wet wood on a window screen to dry. After cutting the wood to length, I use a brush and the staining solution to stain any raw ends.

So that's the fixture. I find a staining job goes much faster with this fixture than with the old staining cloth method, especially when I have a lot of wood I want to stain!

Continued on the next page ...



contents



index



2: Here's the other end of the fixture. It has a few strips of wood in it, ready for me to pour in the stain. I much prefer this fixture to using a cloth-wipe stain. For big staining jobs, this fixture makes things go much faster.





Installing DCC sound just **NOT** your thing?

Trust Traintek for sales and installation of sound decoders from these fine vendors!



RailPro™

"Taking model railroad control to the next level ..."



traintekllc.com

Click here for more details...



"Traintek **was** the way to go!"



Freight Car Trucks 1900-1960

– Richard H. Hendrickson
Model Photos by the author

From Arch Bars to Roller Bearings ...



Reader
Feedback
[\(click here\)](#)



Many years ago, those who modeled in HO scale had few choices when it came to freight car trucks, and it was all most modelers (or model manufacturers) could do to recognize the differences between arch bar, Andrews, "Bettendorf," and roller bearing trucks. The situation today is much different. Prototype research has revealed a wide variety of different truck designs, and model manufacturers have produced HO scale representations of many of them. We're now able to put the correct trucks under almost any HO scale freight car – if we know what the correct trucks are and who makes them in HO scale. Many modelers, however, still know little



about either prototype or model trucks, so they just find the subject confusing. What follows is an attempt to impart more information and reduce the confusion.

To keep things from getting totally out of hand, I've given only a sketchy account of truck development before 1900, since very few modelers focus on railroading in the 19th century. I've also stopped short of discussing roller bearing trucks, apart from some very early experiments, because they are of no interest to steam and transition era modelers like me and also because I know relatively little about them; that's a subject for someone else (any volunteers?).

Some truck basics

Almost all of the trucks described below had solid brass or bronze journal bearings, also known as plain bearings. Note that plain bearings should not be called "friction" bearings, a term coined by roller bearing manufacturers to imply (falsely) that roller bearings had no friction. Though not used in the prototype railway engineering literature, the term has, unfortunately, been picked up and employed by some modelers and model manufacturers. More on this later.

Unlike roller bearings, which are lubricated and sealed, plain bearings were open at the bottom and were crudely lubricated by oil wicked up onto the bottom of the axle journal by cotton waste packing. This packing required periodic replacement, and oil had to be added to the cellars at the bottom of the journal boxes frequently – typically every time a car stopped at a major freight yard or junction point.

Without getting overly technical, a word about truck capacities. The vast majority of freight cars built in the first half of the



contents



index

20th century were of 40, 50, or 70 tons nominal capacity, and most of what follows will be devoted to trucks of those capacities. Truck capacity was stated in terms of how much weight a pair of trucks would support. Thus a single "50-ton" truck was designed to carry only 25 tons, with the other half of the 50 tons resting on the truck at the opposite end of the car. Capacity was determined by the size of the journals, as follows:

40 tons nominal capacity, 5" X 9" journals, load limit 136000 lbs.

50 tons nominal capacity, 5-1/2" X 10" journals, load limit 169000 lbs.

70 tons nominal capacity, 6" X 11" journals, load limit 210000 lbs.

Nominal capacities were intended to indicate approximately how much weight could be loaded into or on the car, so load limits were more than half again higher than nominal capacities to account for the empty weight of the car itself.

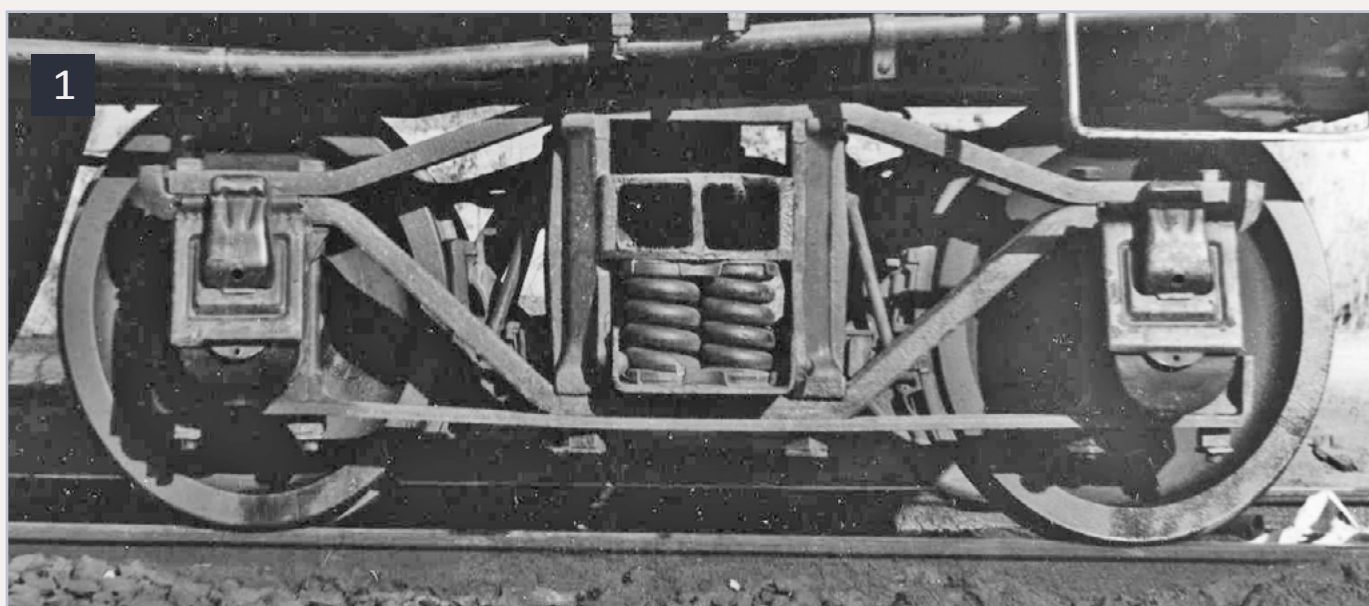

1: A turn-of-the-century arch bar truck with straight lower chords, cast steel bolster, and steel channel spring plank. The vertical columns on either side of the bolster were also steel castings.

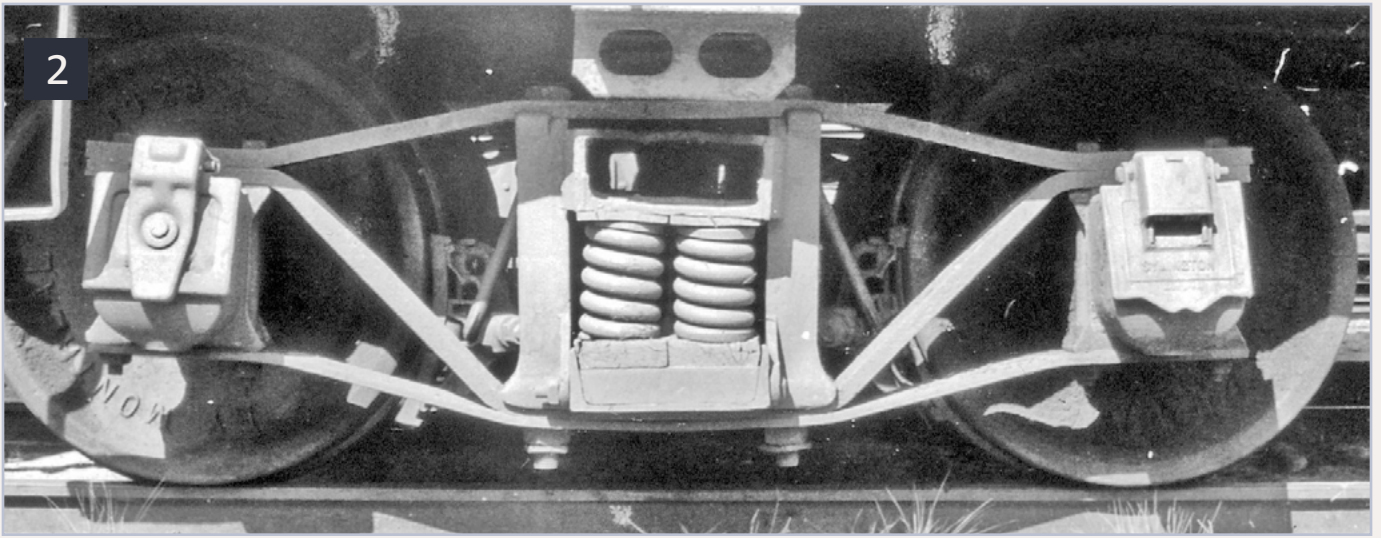

2: This typical early 20th century arch bar truck had symmetrical top and bottom chords, cast steel bolster and columns, and a steel channel spring plank with oak spring seats.

Arch bar trucks

The first arch bar trucks began to appear in the 1860s. Originally the side frames were made of iron bars bolted together, and bolsters and spring planks were wood. The arch bar design was adopted almost universally in the years that followed, with improvements that included iron and (later) steel bolsters and spring planks, steel side frame bars, and longer wheelbases. The arch bar truck had a number of advantages over other freight car truck designs. It was simple and inexpensive to make, and it rode and tracked well. Moreover, as freight cars became larger and heavier, the arch bar truck's load-carrying capacity could be increased simply by making the component parts larger. [For more information on the evolution of trucks in the nineteenth century, see John H. White, Jr.'s *The American Railroad Freight Car*, Johns Hopkins University Press, Baltimore, 1993.]



There was one drawback to the arch bar design, however. Because it was assembled entirely with bolts and nuts, vibration could loosen the nuts, and constant working of the truck could enlarge the bolt holes until the truck would become out of alignment or, in the worst case, come completely apart. This shortcoming was becoming increasingly problematic by the turn of the century, owing in part to the dramatic increase in car size and capacity that followed the universal adoption of air brakes and knuckle couplers. The tendency of arch bar trucks to shake themselves apart could be overcome with periodic maintenance, but cars that ran in interchange might not be returned to their owners for months or even years at a time, and when off-line, their trucks seldom received any attention apart from journal oiling.

As a result, though the venerable arch bar design remained the de facto standard (1 and 2), late nineteenth and early twentieth

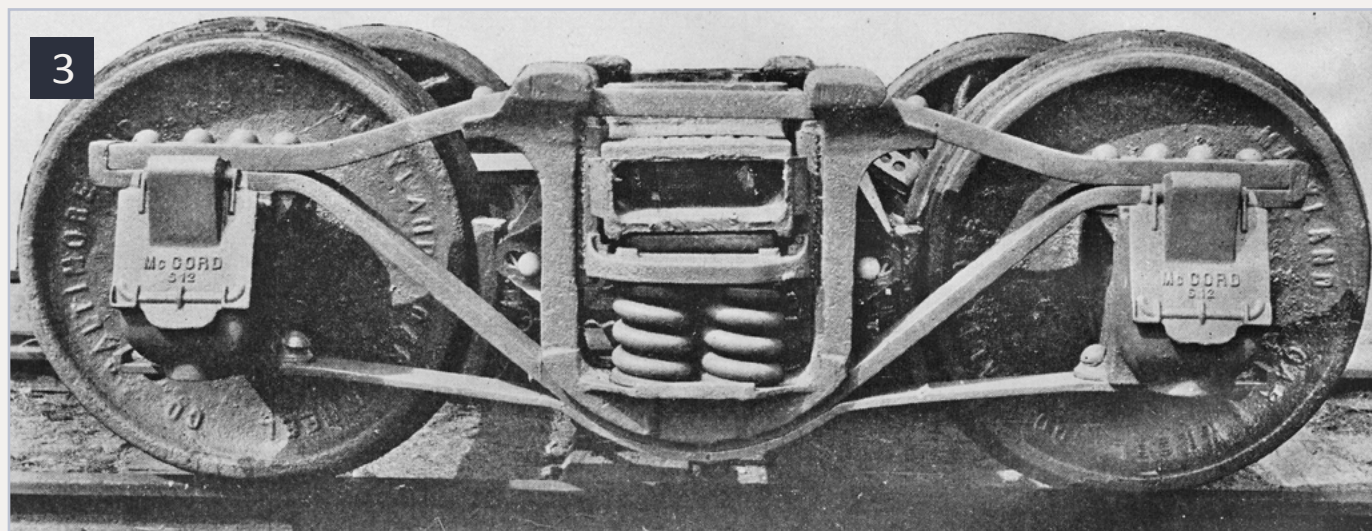

3: John J. Tatum, head of the Baltimore & Ohio car department and a prolific innovator, designed this improved arch bar truck in the early 1920s when arch bars had fallen out of favor with most other railroads. The spring seat and columns were a one-piece steel casting and Barber lateral motion rollers were located between the springs and the bolster.

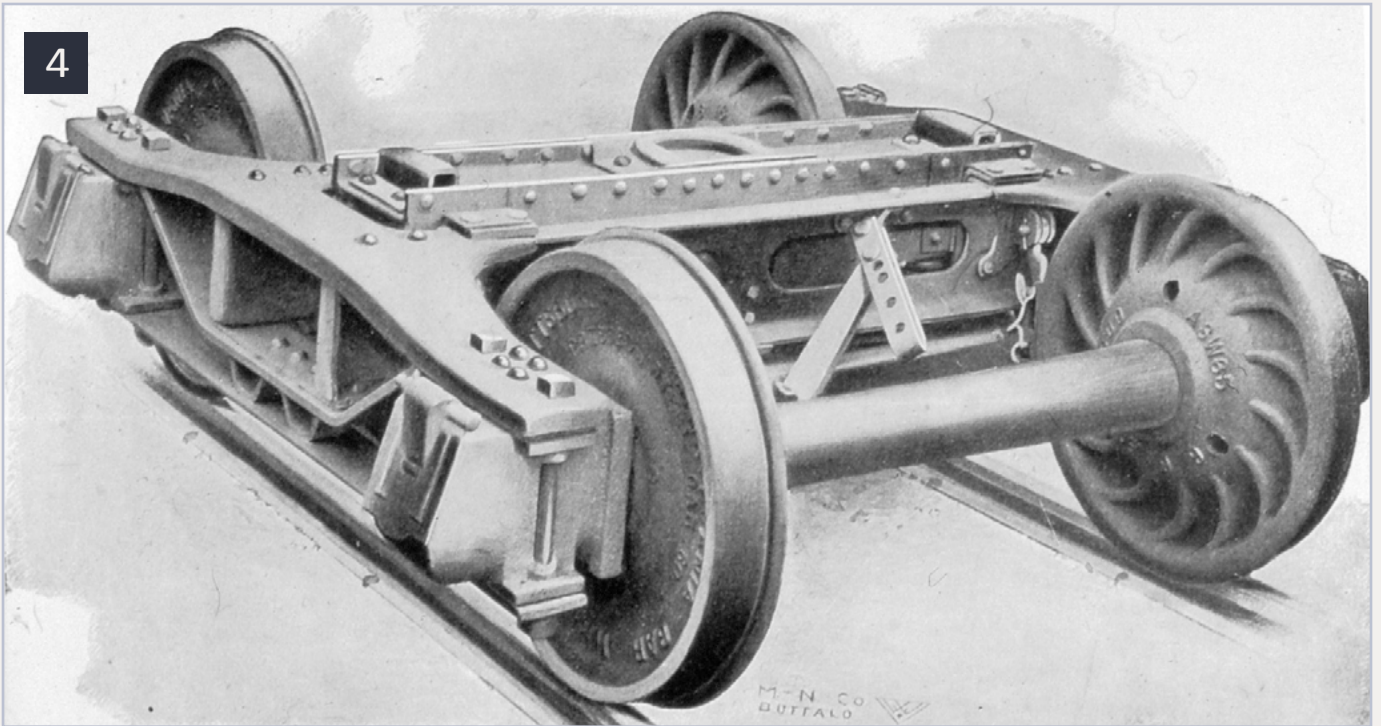

4: The Pressed Steel Car Co. designed this pressed steel version of the arch bar truck design. It was assembled with rivets instead of bolts except for the bolts that held the journal boxes in place.

century freight car truck development was devoted largely to finding better alternatives, and a variety of designs employing pressed steel or cast steel side frames and bolsters began to replace arch bars. Some railway mechanical engineers remained reluctant to abandon the arch bar truck, and efforts to improve it continued until the mid-1920s (3). In fact, the Baltimore & Ohio was still taking delivery of new steel sheathed boxcars with arch bar trucks as late as 1928. By that time, however, arch bar trucks were a lost cause. The Association of American Railroads banned them from interchange in 1940, though they continued to be used under company service cars that did not go off-line at least as late as the 1970s.

Pressed steel trucks

Toward the end of the 19th century, making freight car parts from pressed steel became both practical and economical,



and several truck manufacturers introduced trucks whose side frames and bolsters were made of pressed steel parts riveted together. Some of these were merely variations on the arch bar design in which pressed steel replaced steel bars (4). Others had one-piece pressed steel side frames with the journal boxes sliding in vertical pedestal jaws and coil springs above the boxes. The most widely used of these was the Fox truck, made by the Pressed Steel Car Co. (5).

Trucks with one-piece pressed steel side frames eliminated the bolts-and-nuts assembly of arch bar side frames but, after some years in service, they began to develop other problems that proved to be inherent in the pedestal-jaw design. Unless the wearing surfaces of the pedestal jaws and journal boxes received regular lubrication, which seldom happened, rapid wear resulted. The journal boxes could then become

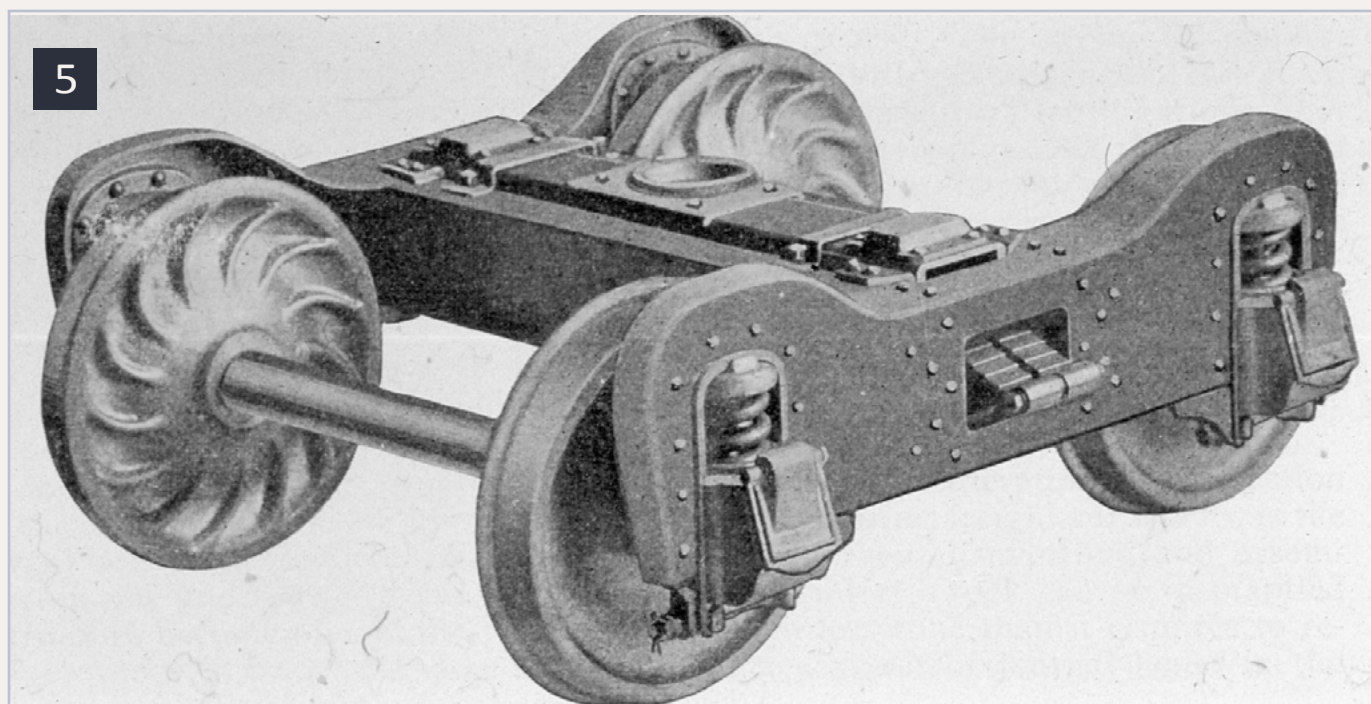

5: A Fox truck made by the Pressed Steel Car Co. Many Fox trucks had springs only above the journal boxes, but this one also had leaf springs between the bolster and side frames. The downfall of these trucks was the tendency of the journal boxes to stick and jam in the vertical pedestal jaws.

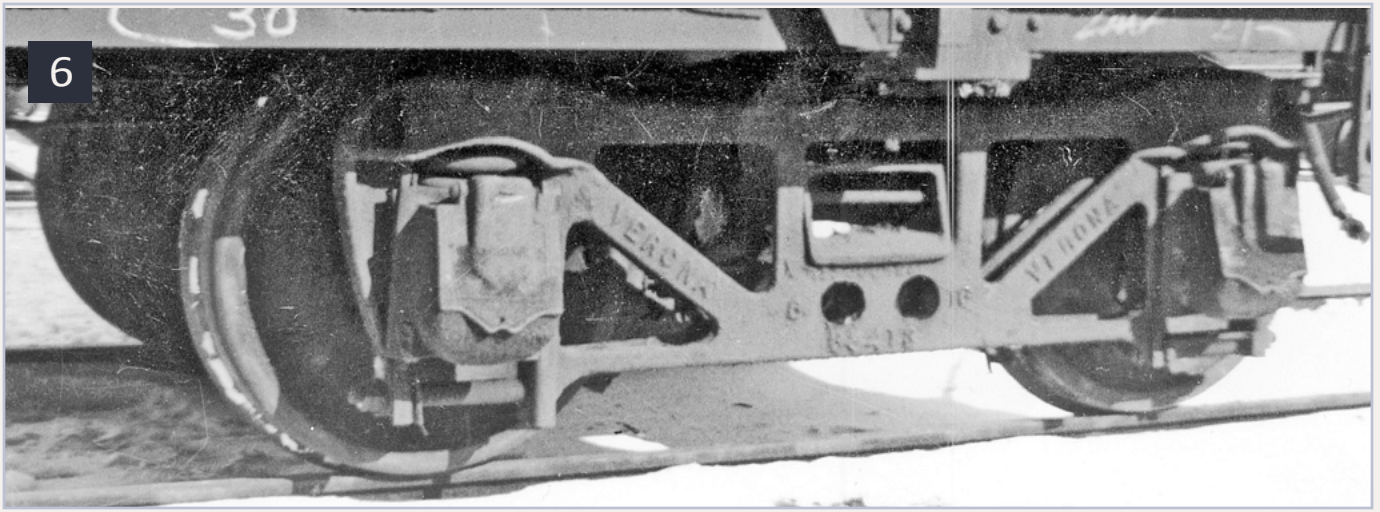

6. Similar in concept to the Fox pressed steel truck but made of steel castings was the Verona truck made by the Standard Steel Car Co. It suffered from the same problems that afflicted pressed steel pedestal jaw trucks.

misaligned and stick or jam in the pedestal jaws, thus seriously affecting the truck's riding and tracking qualities. For this reason, the popularity of pressed steel trucks was short-lived.

Cast steel trucks with separate journal boxes

As with pressed steel construction, complex steel castings became more readily available and less costly in the closing years of the 19th century, leading to the development of truck designs employing cast steel side frames and bolsters. One of these was the Verona truck, produced by the Standard Steel Car Co. (6). Like the Fox truck, the Verona truck had vertical pedestal jaws with the springs located above sliding journal boxes, and thus it suffered from the same problems as the Fox and other pressed steel trucks of similar design. Though Verona trucks were used briefly and in limited quantities by some northeastern railroads, they were not widely adopted.

Much more successful was the Andrews truck, which was widely accepted and progressively improved. Andrews trucks had separate journal boxes bolted into cast steel side frames



contents



index

with retainer bars at the bottom to hold them in alignment. One advantage of this arrangement was that Andrews side frames could be applied to existing arch bar trucks using the original bolsters, journal boxes, and wheelsets – a significant economy for car owners.

The earliest Andrews trucks had L-section side frames and sloping one-piece journal box retainer bars (7). These were soon followed by T-section castings and short journal box retainers bolted to lugs cast onto the side frames (8). Next came U-section side frames (9 and 10). Later U-section versions of the Andrews truck, made in 40-, 50- and 70-ton versions, were applied to all of the 100,000 freight cars built for the United States Railway Administration during World War I (11). The Andrews design continued to be widely used through the mid-1920s, and lasted on some cars in revenue service through the 1960s.

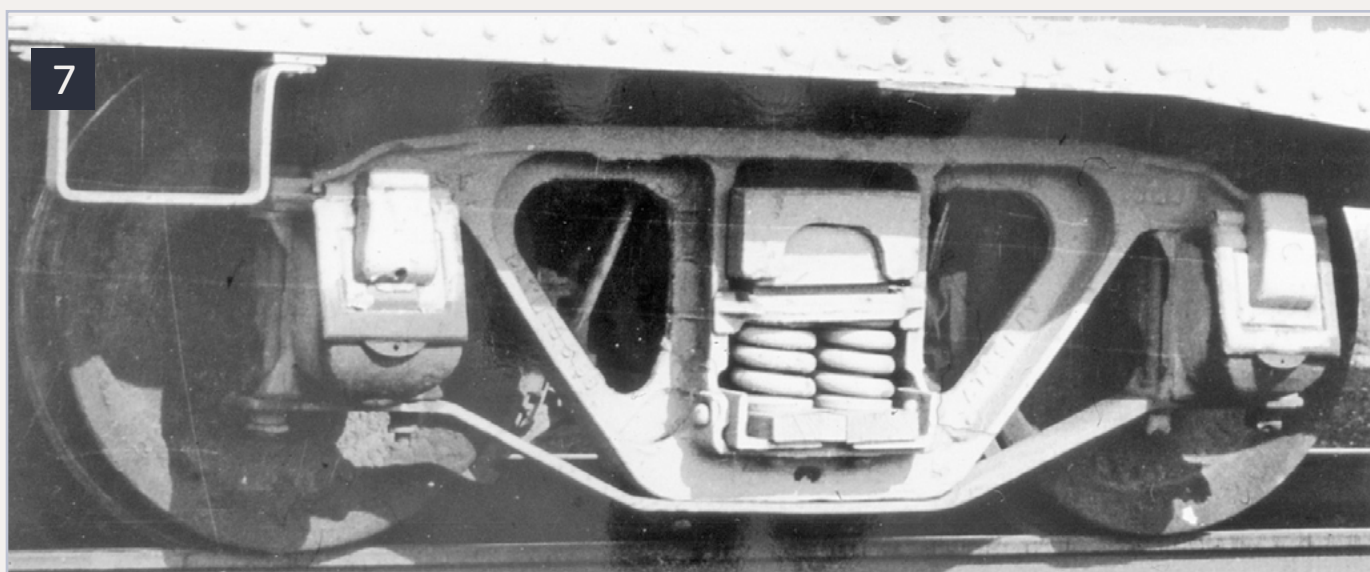

7: The earliest Andrews trucks had L-section side frames and sloping one-piece journal box retainer bars. Many car owners favored the Andrews design because the cast steel side frames could be applied to existing arch bar trucks, re-using the existing journal boxes, wheelsets, and bolsters. Note the oak lower spring seats, often used on early 20th century trucks.

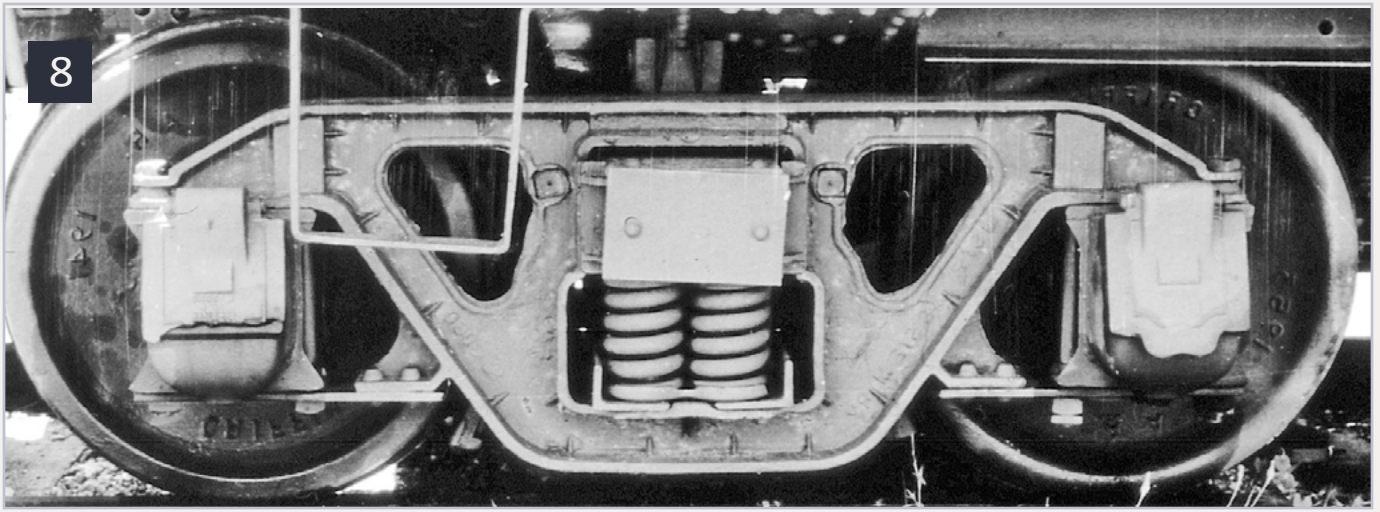

8: A T-section Andrews truck. By this time, the journal box retainer bars were shorter and bolted to bosses cast onto the side frame, rather than to the bottom of the side frame. The plate on the end of the bolster was a later addition.

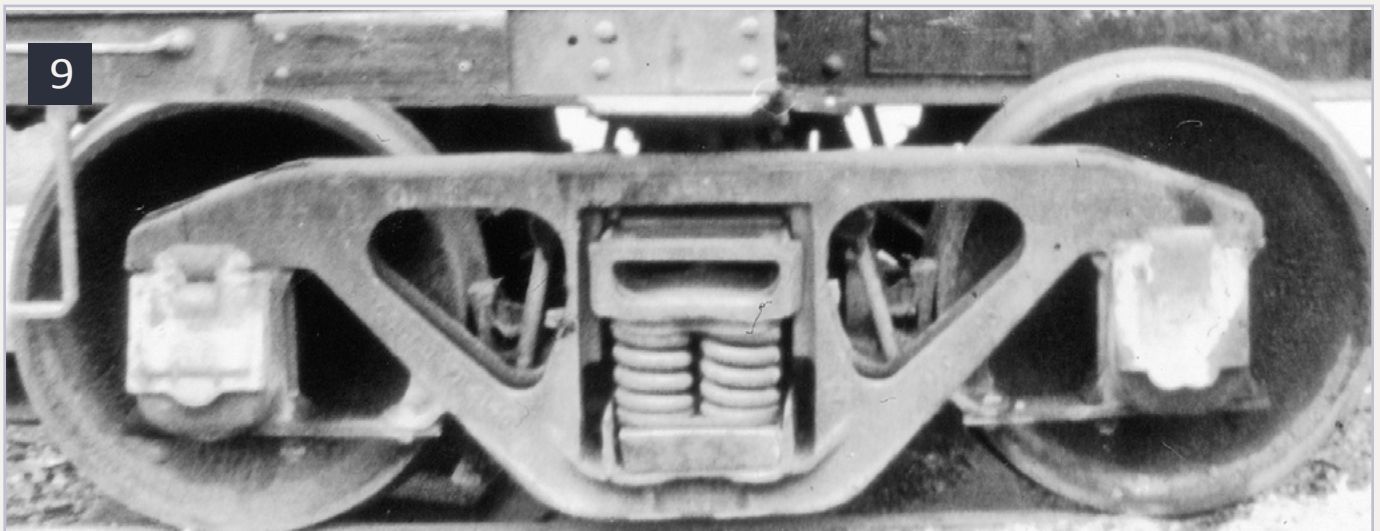

9: The Andrews design progressed to U-section side frames, as shown in this example. Again, note the oak shim between the springs and spring plank.



contents



index

Another major design using cast steel side frames with separate journal boxes was the Vulcan truck, developed by American Steel Foundries. Vulcan side frames had pedestal jaws into which the journal boxes were bolted.

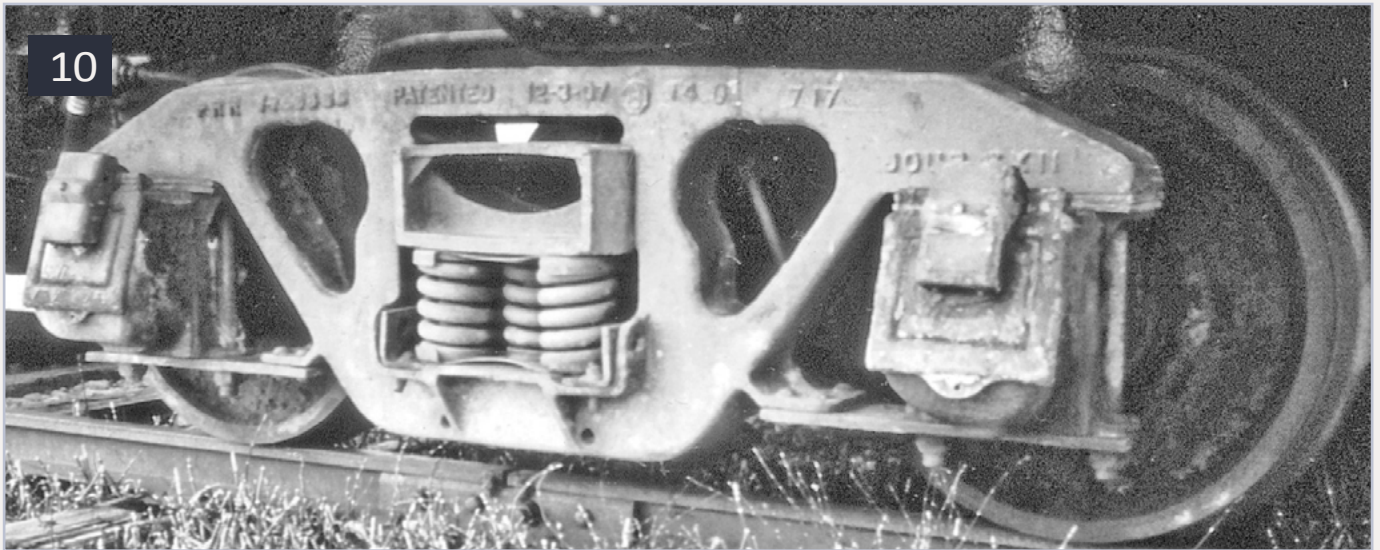

10: The Crown truck was a heavy duty 70-ton version of the Andrews design used in the teens by the Pennsylvania Railroad on gondolas, hoppers, and flat cars.

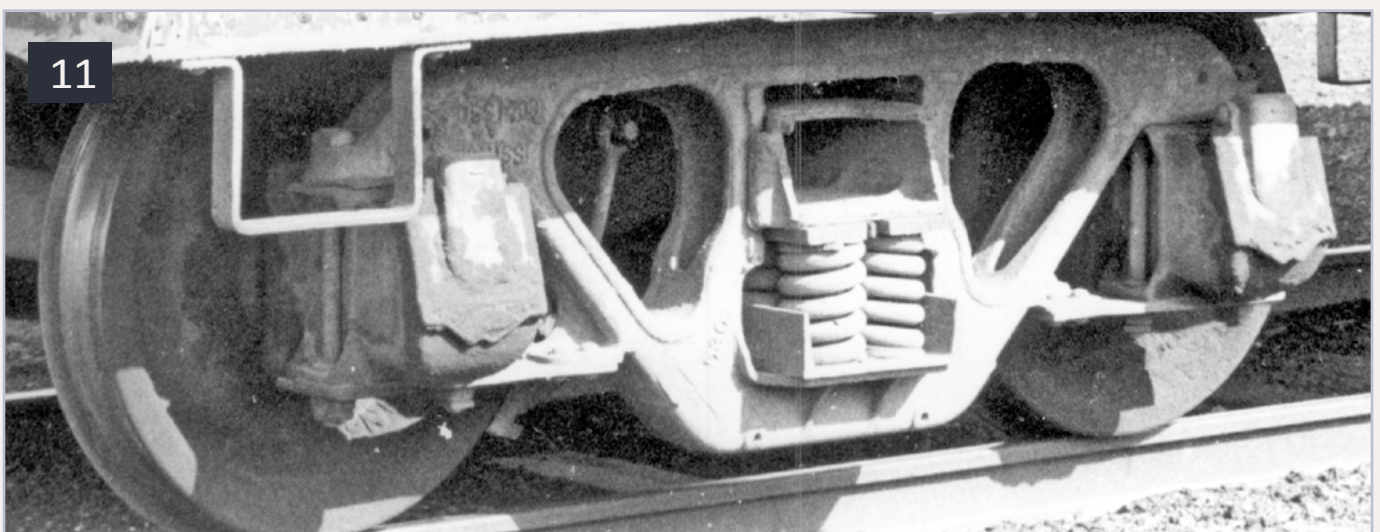

11: During and after World War I, the United States Railway Administration built 100,000 cars to overcome the nation's shortage of modern freight cars, and all of them were equipped with U-section Andrews trucks of 40-, 50-, or 70-ton capacity. This is a 50-ton USRA Andrews truck.

As with Andrews trucks, early Vulcans had L-section side frames (12) but later ones employed stronger U-section side frames (13).

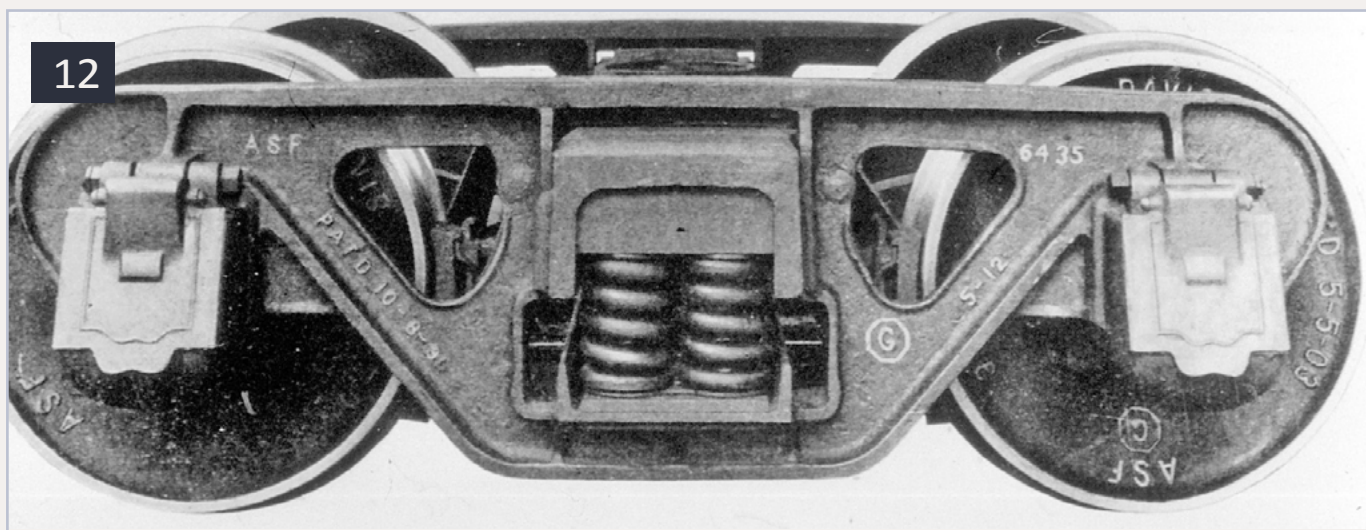

12: Vulcan trucks had separate journal boxes, like Andrews trucks, but in the Vulcan design the boxes fit into pedestal jaws and were secured in place by transverse bolts at the top. This is a T-section Vulcan truck.

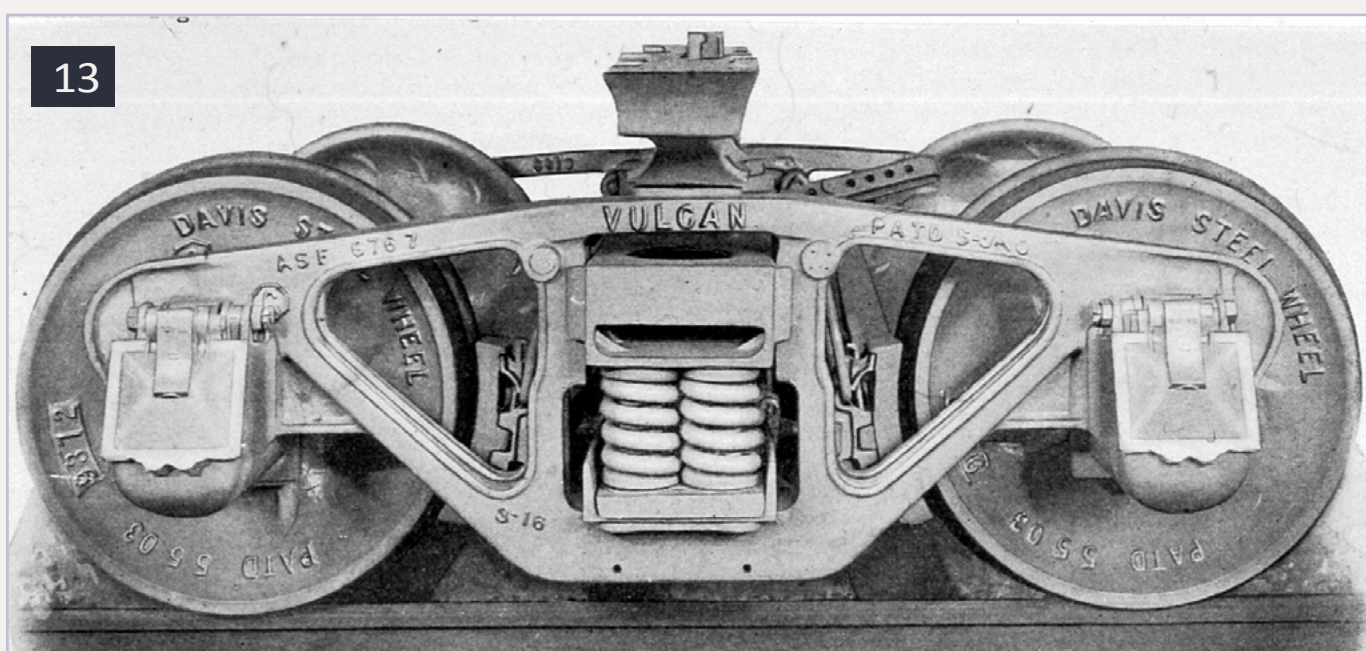

13: A later U-section version of the Vulcan design. The bolts that held the journal boxes in place are visible behind the journal box lid springs.



contents



index

Cast steel trucks with integral journal boxes

The ultimate development of cast steel truck side frames was to incorporate the journal boxes as an integral part of the side frame casting. This was first accomplished in the Bettendorf T-section truck, developed and patented by Bettendorf Steel Axle Co. The T-section chords of these side frames were arranged as equilateral triangles (14 and 15). The Bettendorf truck was strong, relatively light, and immune to the journal boxes becoming loose and misaligned, and it quickly became

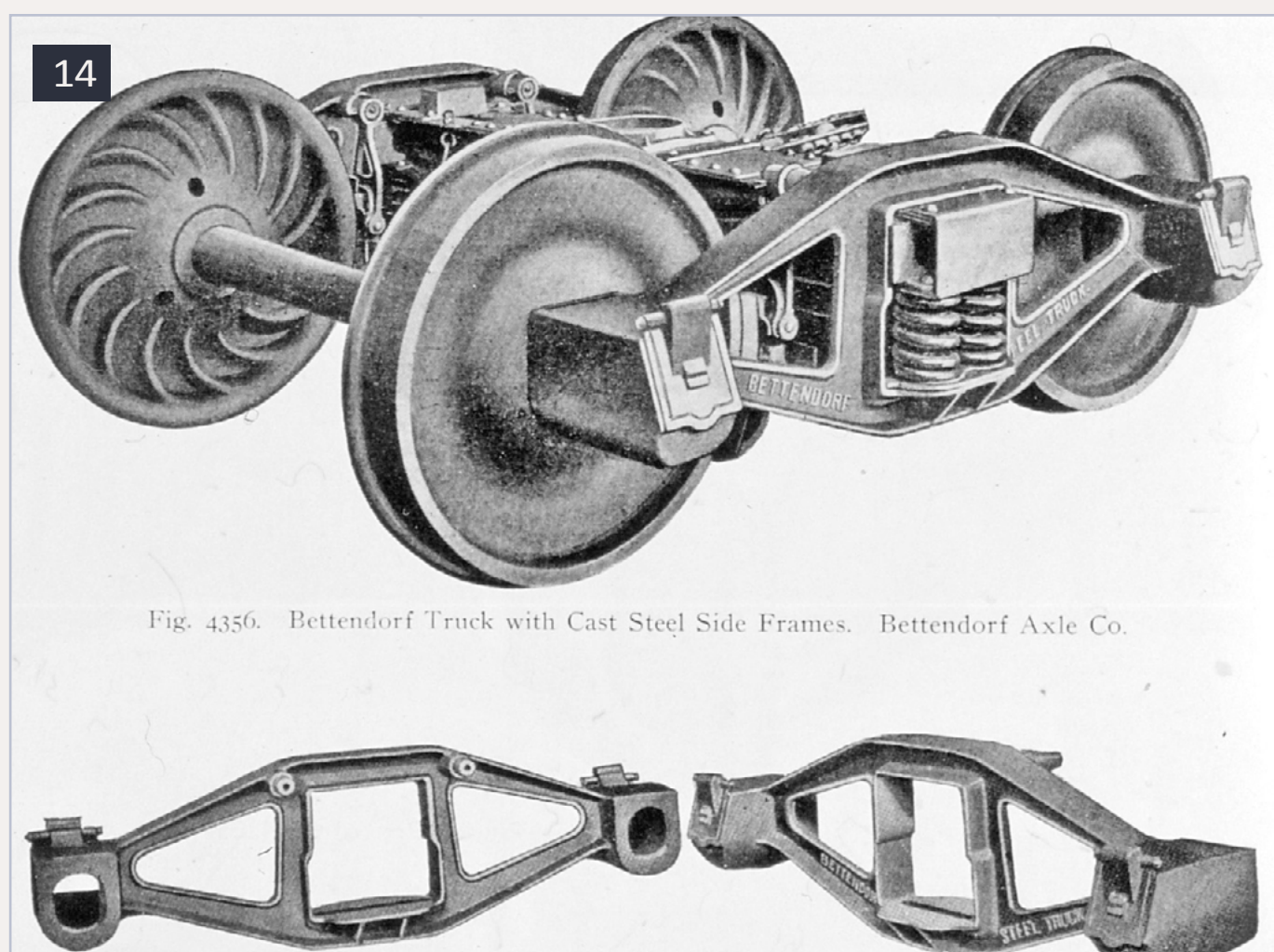
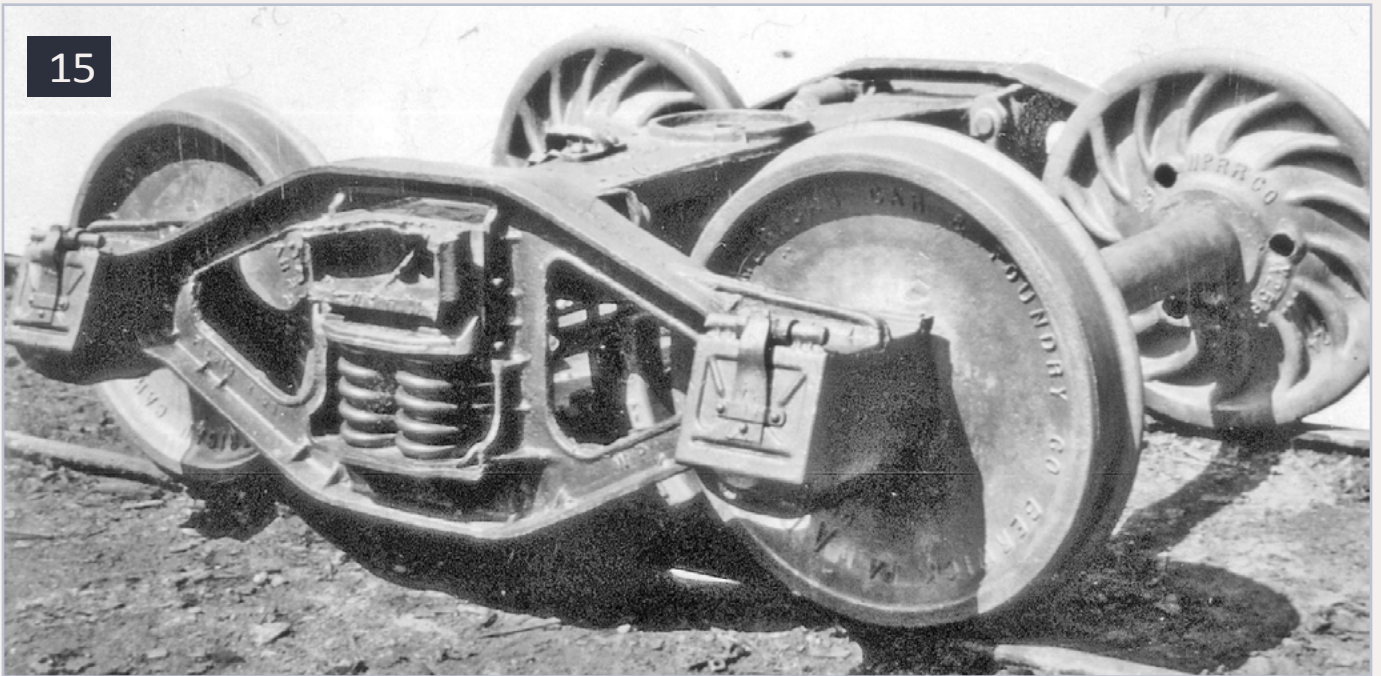

Fig. 4356. Bettendorf Truck with Cast Steel Side Frames. Bettendorf Axle Co.

14: The casting of the journal boxes as integral parts of the Bettendorf T-section side frames is seen clearly here. This arrangement eliminated problems with journal boxes working loose and becoming misaligned but required the truck to be dismantled whenever a wheelset was changed.



15: A later, improved version of the Bettendorf T-section truck. Note the stiffening ribs above the journal boxes and between the flange and web of the T-section side frame.

popular with some railroads and private car owners. What discouraged more widespread adoption was the fact that replacing a wheelset required the entire truck to be dismantled, rather than just jacking up the frame and removing the journal box bolts, as on Andrews and Vulcan trucks.

On lighter cars, Bettendorf T-section trucks gave good service, but when loaded more heavily, as on 50 ton boxcars, the side frames were prone to cracking where stresses were highest at the lower corners of the spring box. This weakness was cured by casting the side frames with U-section chords, a change that Bettendorf adopted around 1920, foreshadowing the universal adoption of U-section cast steel side frames in the years that followed. (16). Eventually, in 1956, the AAR banned all trucks with L- or T-section side frames from interchange.

ARA "Standard" trucks

One of the trucks that adopted the Bettendorf concept of integrally-cast journal boxes with U-section side frames was



the Pennsylvania Railroad's 2DF8 truck. The American Railway Association adopted what was essentially the Pennsylvania design as its Type Y truck (17). (There was also a similar Type W truck which, like the Vulcan truck, had separate bolted-in journal boxes, but it was little used.) Equally important, the ARA established revised standard specifications for freight car trucks, including such key dimensions as wheelbase, center plate height, and side bearing height.

It was soon found that the Type Y trucks were prone to cracking at the lower corners of the spring box, so the Type Y side frame design was short-lived except on the Pennsylvania Railroad, which continued to employ 2DF8-style trucks until the late 1930s. However, other truck manufacturers quickly developed alternative side frame designs of varying configurations which reduced the cracking problem. All had integral

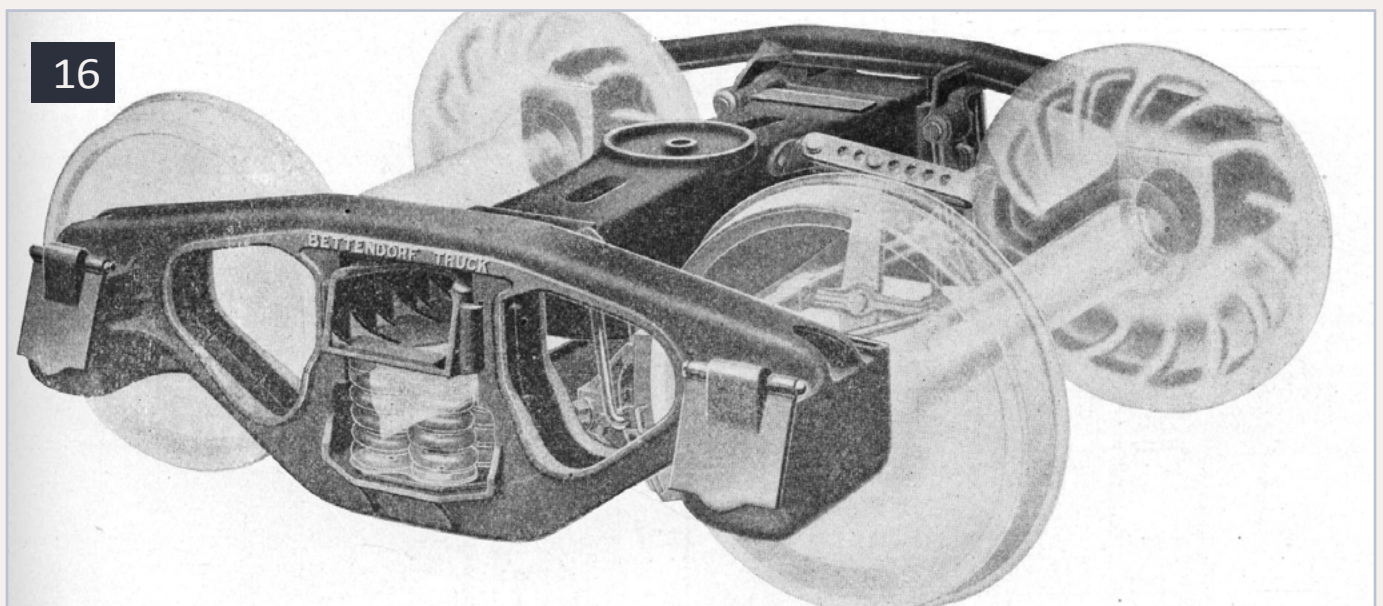

16: Following the end of World War I, Bettendorf redesigned its integral journal box truck to incorporate U section rather than T-section side frames, and this was the forerunner of many similar trucks in the 1920s conforming to ARA specifications.

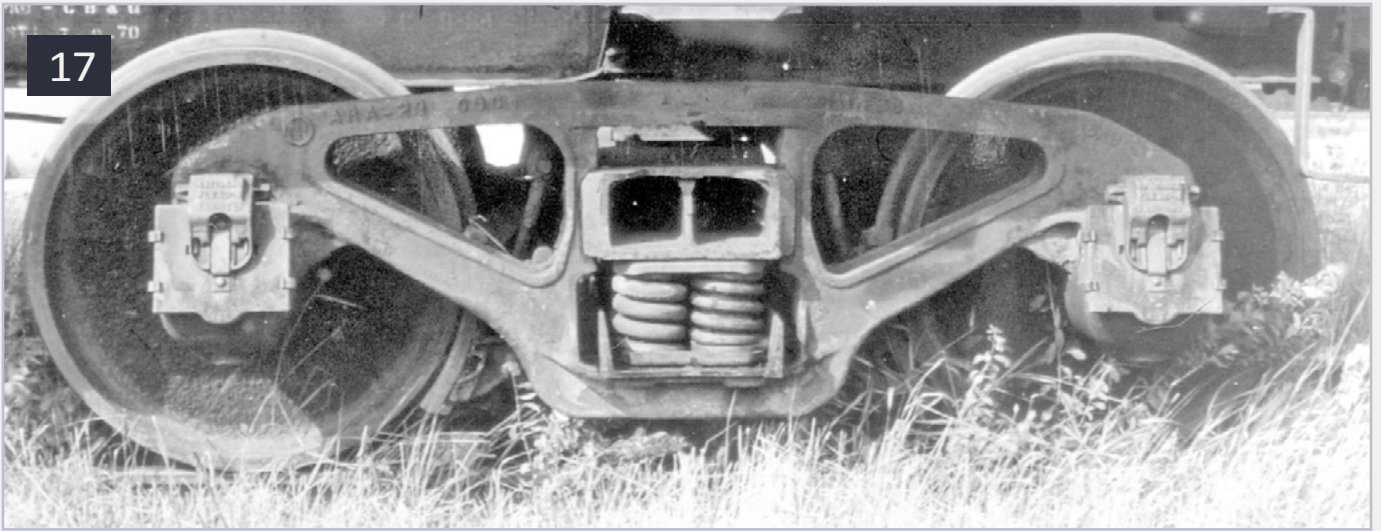

17: The ARA Type Y truck was an integral journal box truck developed from the Pennsylvania Railroad's 2DF8 truck, which it closely resembled. Its popularity was short-lived, owing to side frame cracks at the lower corners of the spring box, though the Pennsy continued to produce the 2DF8 and variants for many years.

journal boxes, U section side frames, and shallow U-section steel spring planks, and all conformed with ARA standard specifications (18 through 25). It is therefore useful to consider these trucks as ARA "Standard" trucks, as long as it is understood that – apart from the Type Y – none were ever designated as standard designs by the ARA.

In 1934, when the American Railway Association was reorganized into the Association of American Railroads, the ARA standard truck specifications became AAR standards. With some modifications, the AAR standards have continued in effect to the present day.

Efforts to improve riding qualities

In the first two decades of the 20th century, the size, weight, and tractive effort of locomotives increased dramatically. Initially most railroads emphasized using this increased power



18

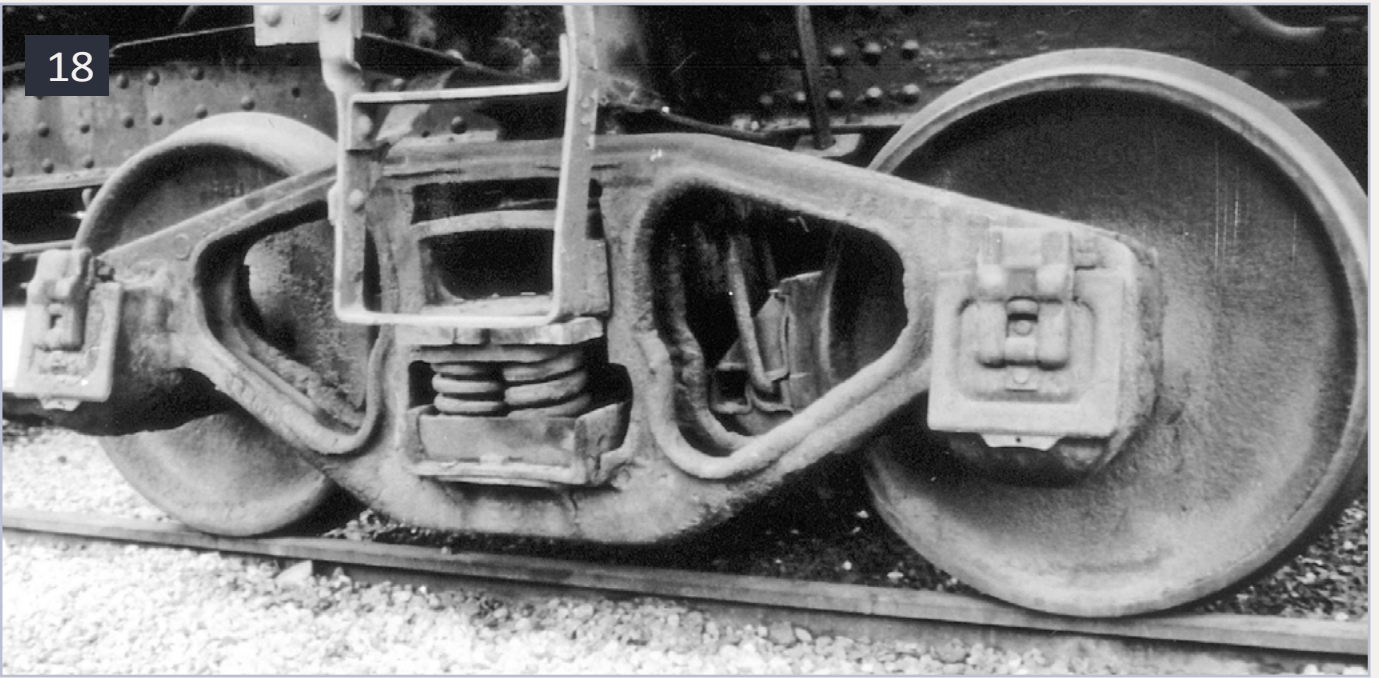

19

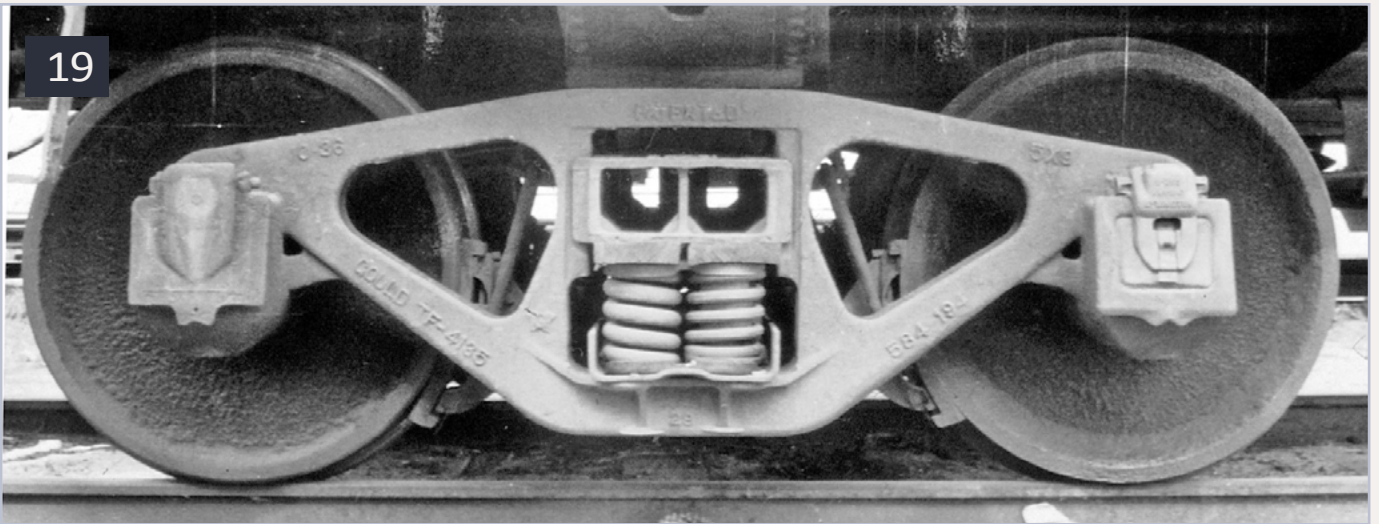

20



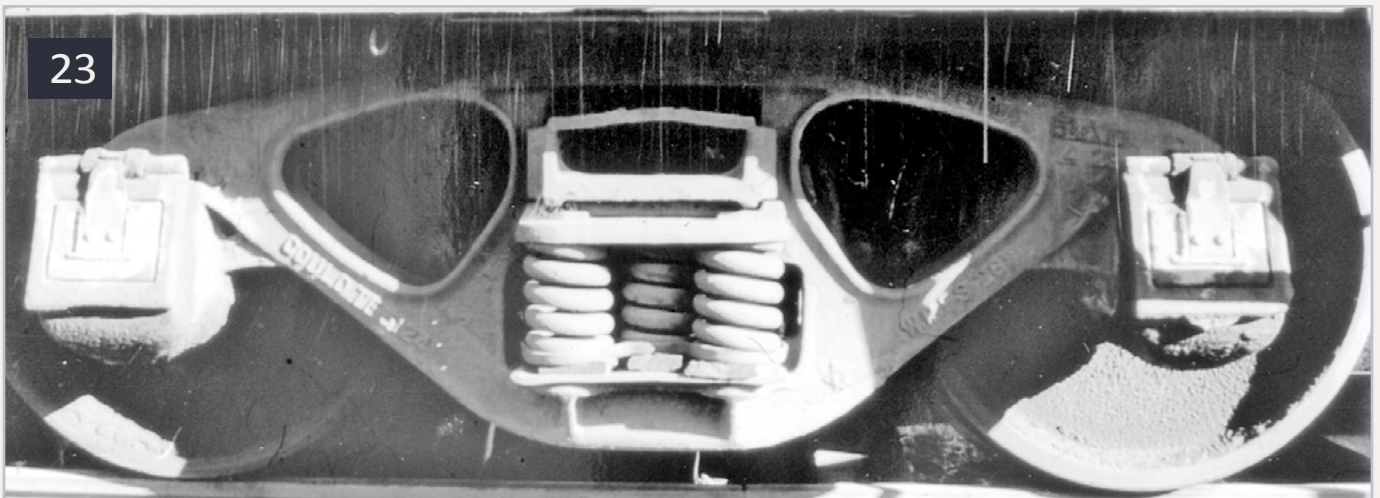
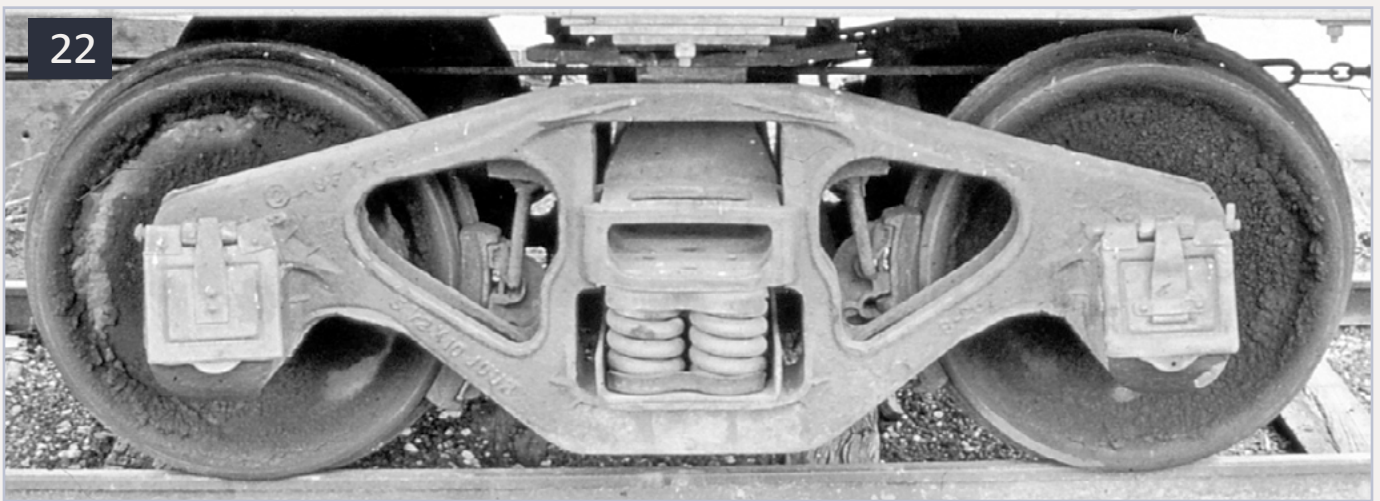
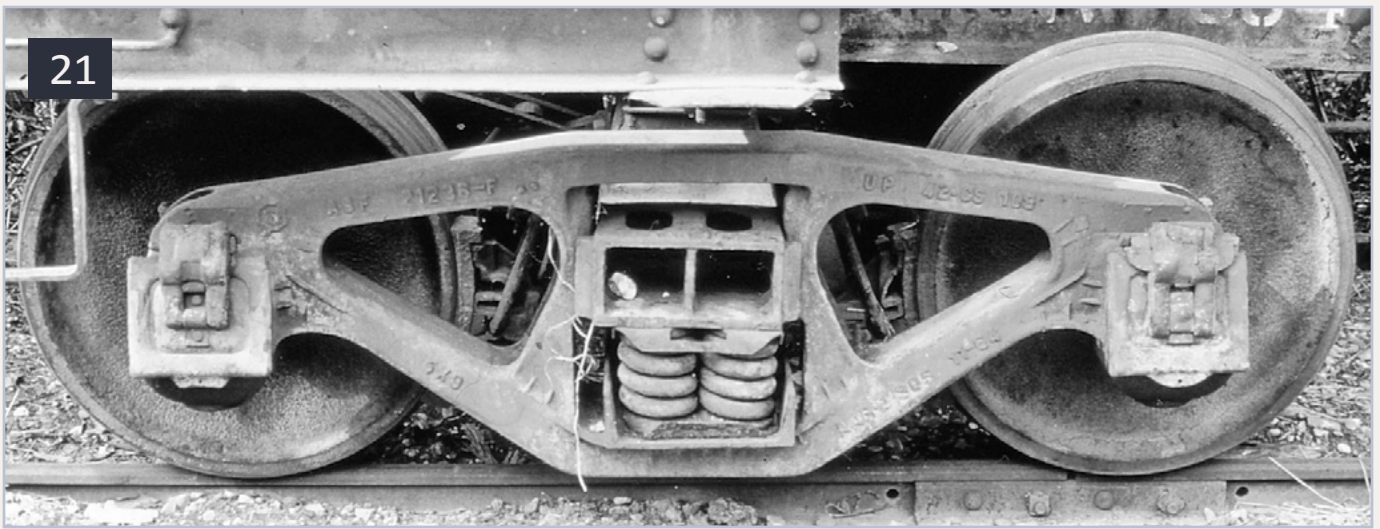

18-23: Take a look at the variety of side frame configurations on these ARA "standard" trucks. All are 40- or 50-ton cast steel U-section trucks with spring planks, but apart from that they vary all over the map. The truck in Figure 23 had Barber Lateral Motion devices between bolster and springs.



contents



index

to haul longer and heavier trains at relatively low speeds. After World War I, however, this "drag freight" philosophy began to change as shippers demanded faster service. As the speed of freight trains increased, it was found that most freight car trucks were unequal to the task. Truck springs that cushioned loaded cars provided a harsh ride when the car was empty, and vice-versa. In addition, experiments showed that the 39' spacing of rail joints set up harmonic oscillations in trucks at certain speeds which were so severe that, in extreme cases, the wheels were actually being lifted up off the track.

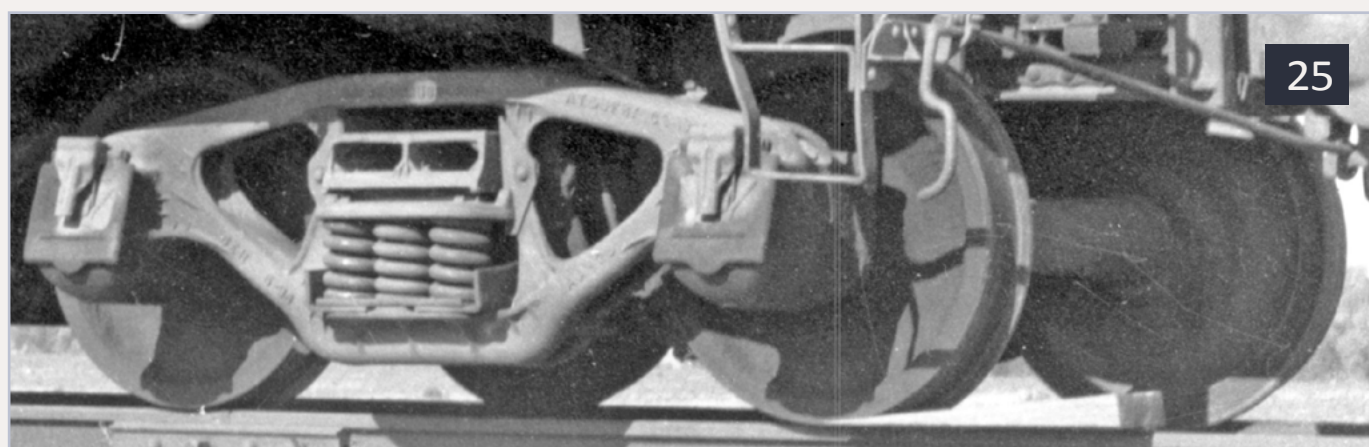

24-25: Two slightly different versions of the ARA 70-ton truck with 5'8" wheelbase, one by Symington and the other by American Steel Foundries. The ASF truck had Barber Lateral Motion devices.

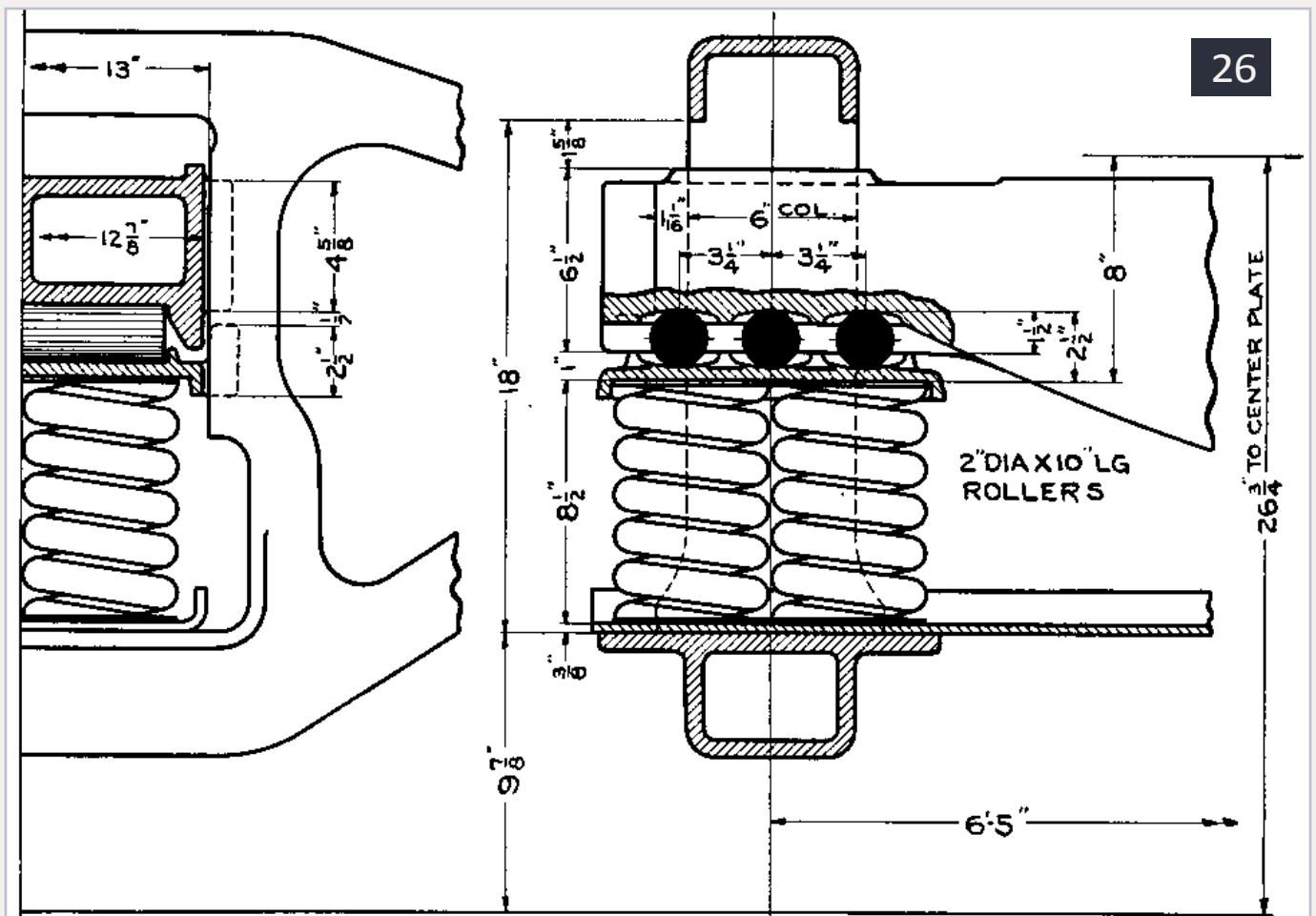

26: This cross section drawing reveals how the self-centering rollers in the Barber Lateral Motion device made limited sideways motion between the side frame and bolster possible.

A variety of measures were taken to address these problems. Truck spring stiffness and spring rates were modified. A number of different trucks designed to improve riding qualities began to appear, and these efforts continued through the 1930s and into the post-World-War-II period. Friction snubbers were also developed which could replace one spring on each side of existing trucks and provide some improvement in riding qualities at modest cost.

Barber lateral motion devices

As the cushioning effect of lateral motion in trucks had long been recognized as desirable, the Standard Car Truck Co.



offered the Barber Lateral Motion Device, which could be fitted to almost any type of freight car truck. This consisted of self-centering rollers between the bolster and the top of the spring package (26). Many trucks made in the 1920s through 1940s incorporated this device (3, 23, 25, 28, and 40).

Dalman trucks

The Dalman Two-Level truck, introduced ca.1922, was an ARA standard design with the bolster and side frames modified to accommodate more, and softer, springs. Owing to its improved riding qualities, it was widely adopted during the 1920s on all types of freight cars (27 and 28). Later, a One-Level version of the Dalman design was introduced in which the outer springs of the spring package were at the same level as the other springs, rather than being offset vertically (29). The Dalman One Level truck was equally-popular for a brief period in the



27: This 50-ton Dalman Two Level truck offered improved riding qualities by providing more and softer springs. There were six pairs of springs on each side with the spring seats for the outer pairs slightly offset vertically, hence the Two Level designation.

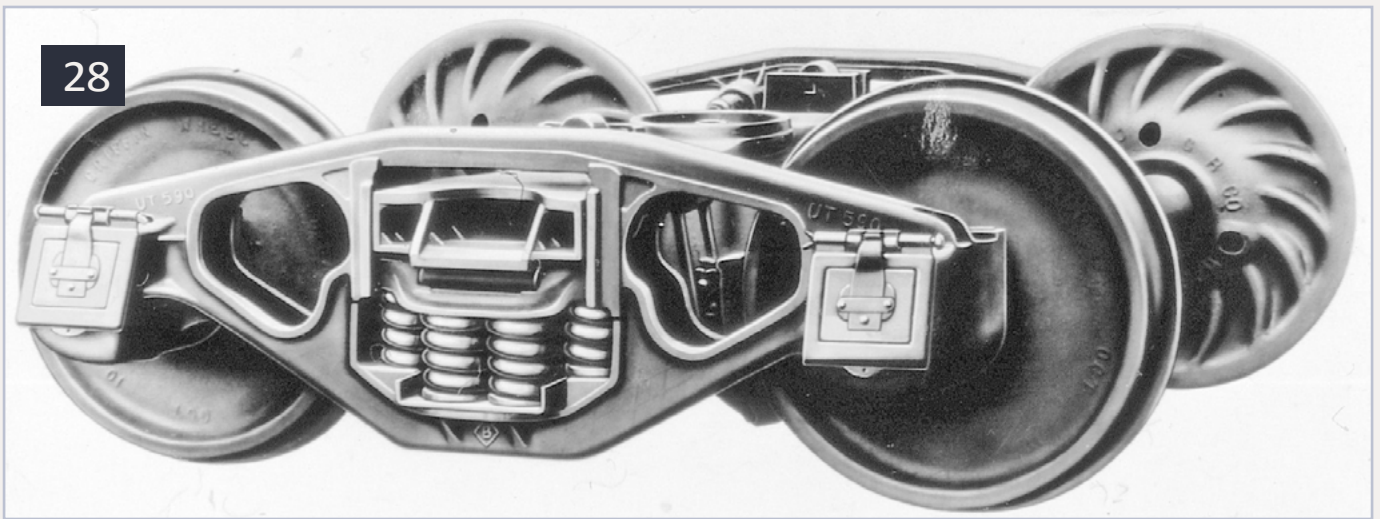

28: Clearly visible on this version of the Dalman Two Level truck are the seats and rollers of the Barber Lateral Motion device between the bolster and springs.

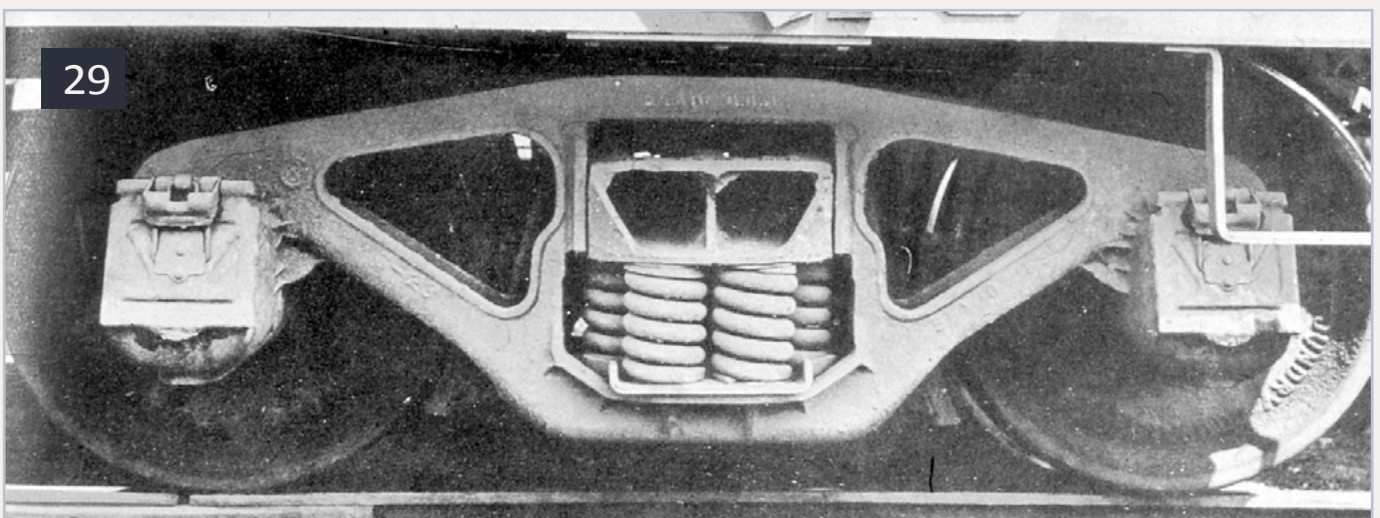

29: The Dalman One Level truck worked exactly like the Two Level Dalman, but the spring seats were all at the same level instead of being "stepped."

late 1920s and early 1930s. The Dalman arrangement was even applied to Andrews trucks; cars of a few railroads, notably the Great Northern and Seaboard Air Line, were equipped with Dalman-Andrews trucks in the 1920s (30).



contents



index

After-market friction snubbers

In the late 1920s after-market snubbers began to appear which employed various friction devices to reduce uncontrolled shocks and harmonic oscillation. All of these were designed to replace one spring on each side of an existing truck. All of the major railway equipment manufacturers eventually had their own patented snubbers (30 and 31), and these became increasingly popular in the 1930s through 1950s as an economical way to improve the riding qualities of trucks that were already in service, rather than replacing them with entirely new trucks.

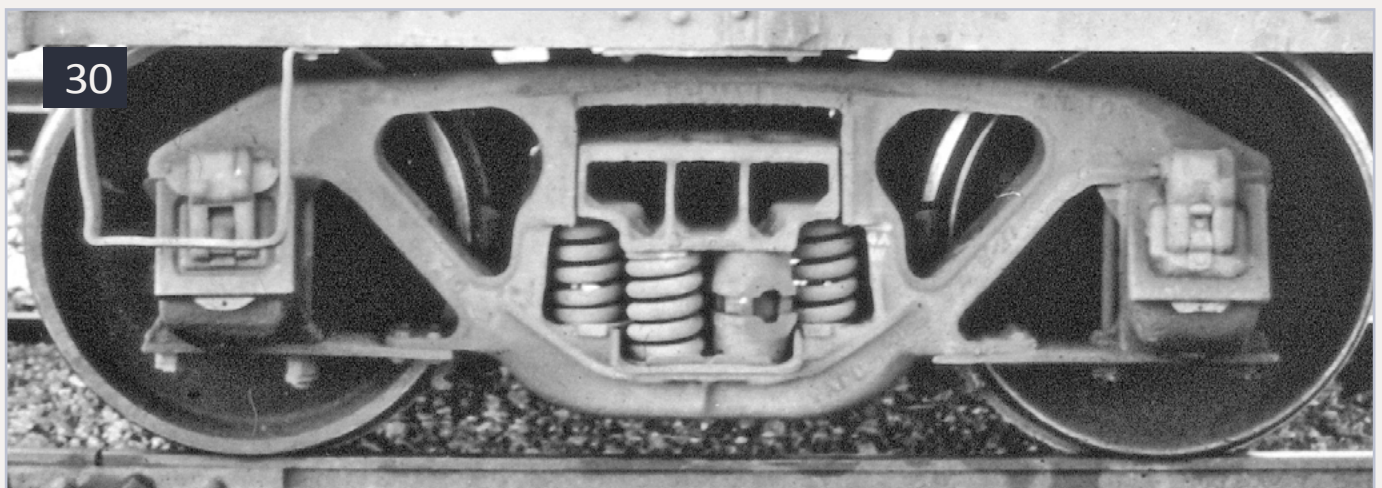

30: The Dalman Two Level design was adapted to the Andrews truck, as shown here. Note that when this truck was photographed after World War II, one spring on each side had been replaced by an ASF Simplex friction snubber.

31a-31f: It seemed as if every railway equipment manufacturer developed its own design of friction snubber spring replacement to dampen unwanted movement and harmonic oscillation. Here are, in alphabetical order, the ASF Simplex, Cardwell Type A, Frost #360, Holland A-6-A, Miner C2XB, and Symington SBS.

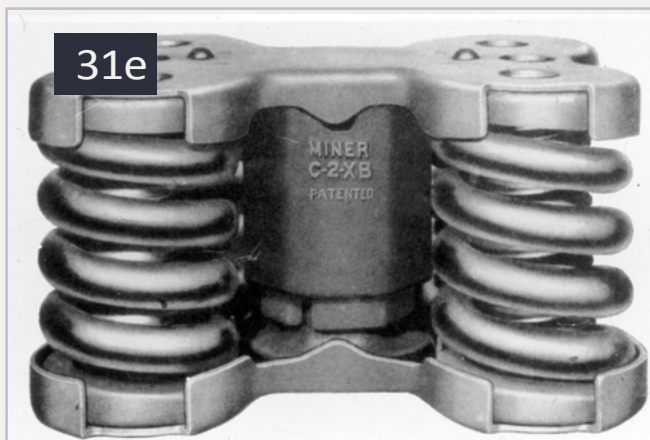
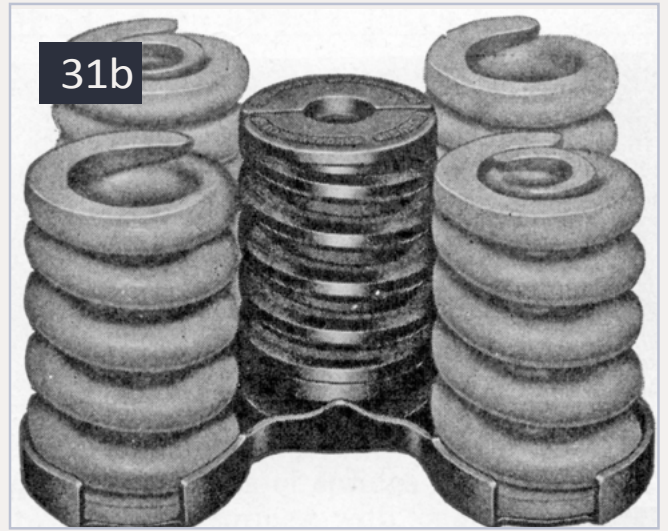

contents



index

Taylor Flexible trucks

Developed ca.1930 by the Flexible Truck Co. of Reading, PA, the Taylor truck allowed each side frame to rotate freely around the bolster and spring package (32). This arrangement turned out to be more impressive in theory than in practice, as conventional trucks already provided enough flexibility to negotiate even very uneven track. The only major railroad to adopt Taylor Flexible trucks was the Reading; apparently the Taylor brothers were well enough connected with Reading mechanical officials that several batches of new cars for the Reading were ordered in the late 1920s and early 1930s with Taylor trucks. The Flexible Truck Co. soon disappeared, however, one of many victims of the Great Depression.

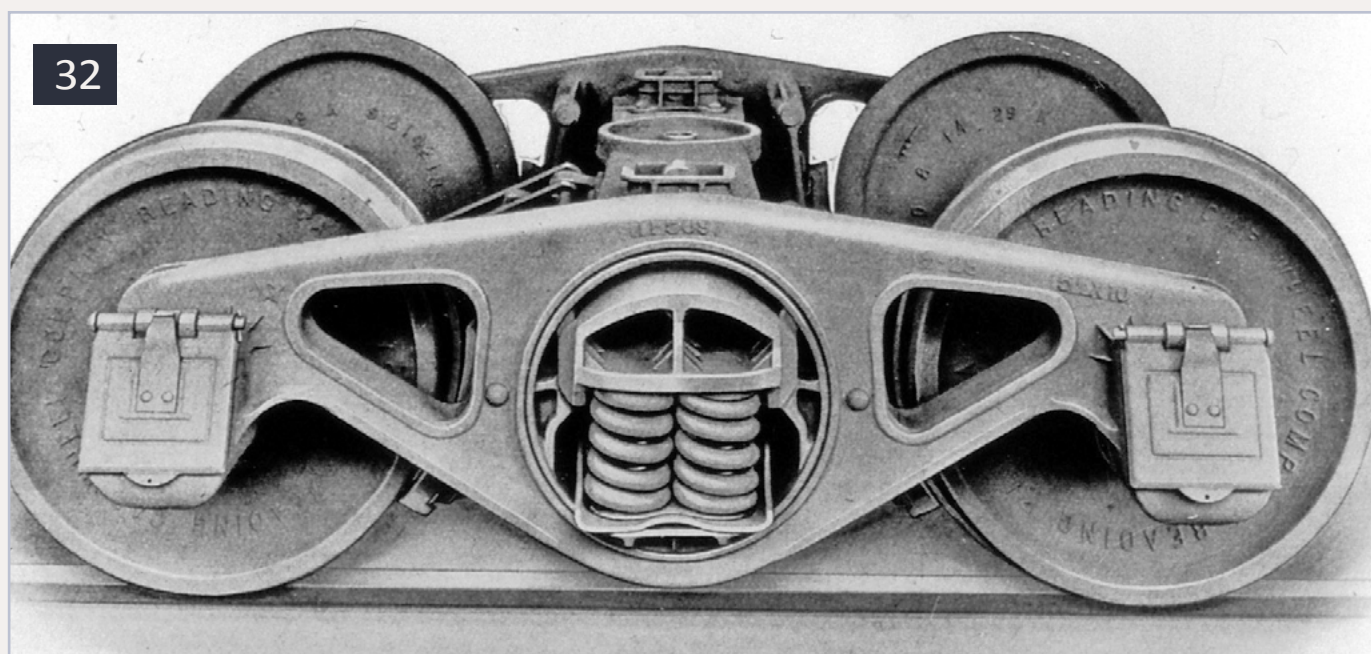

32: In the Taylor Flexible truck, the side frames were free to rotate around the bolster, springs, and spring plank. This novel idea offered little advantage in practice, however, so Taylor trucks were employed only briefly and only by the Reading railroad.

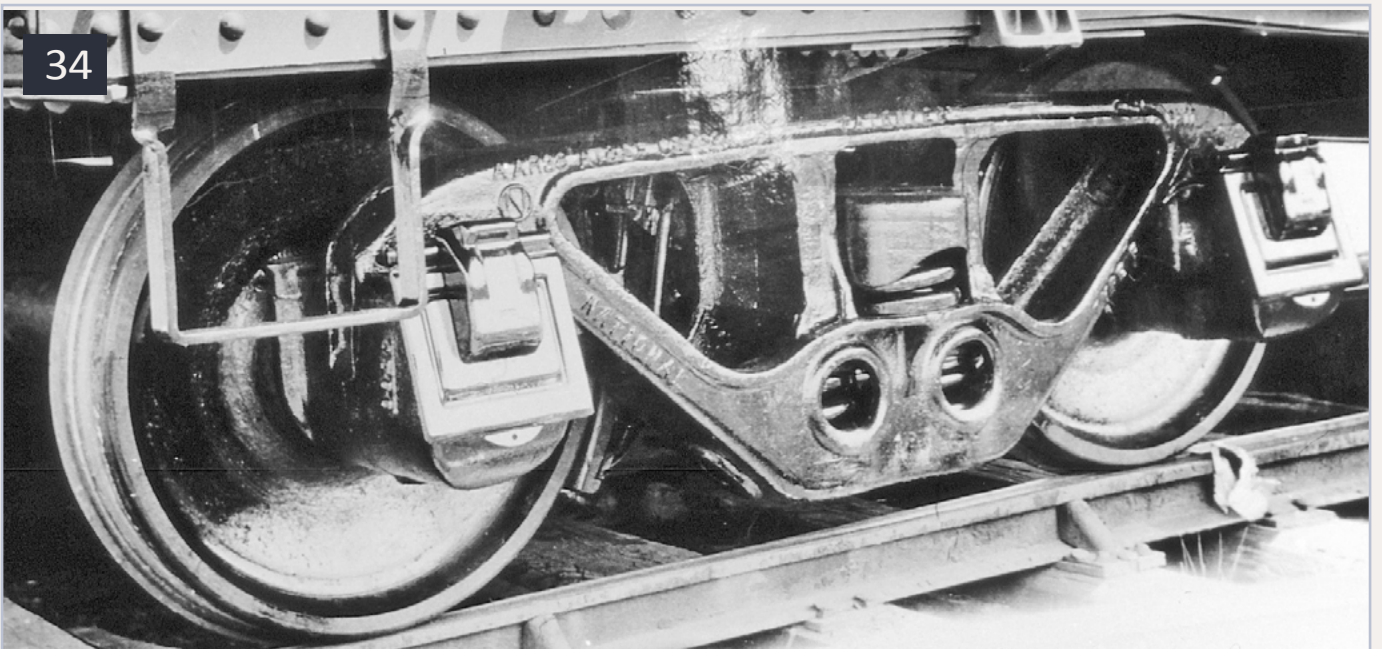
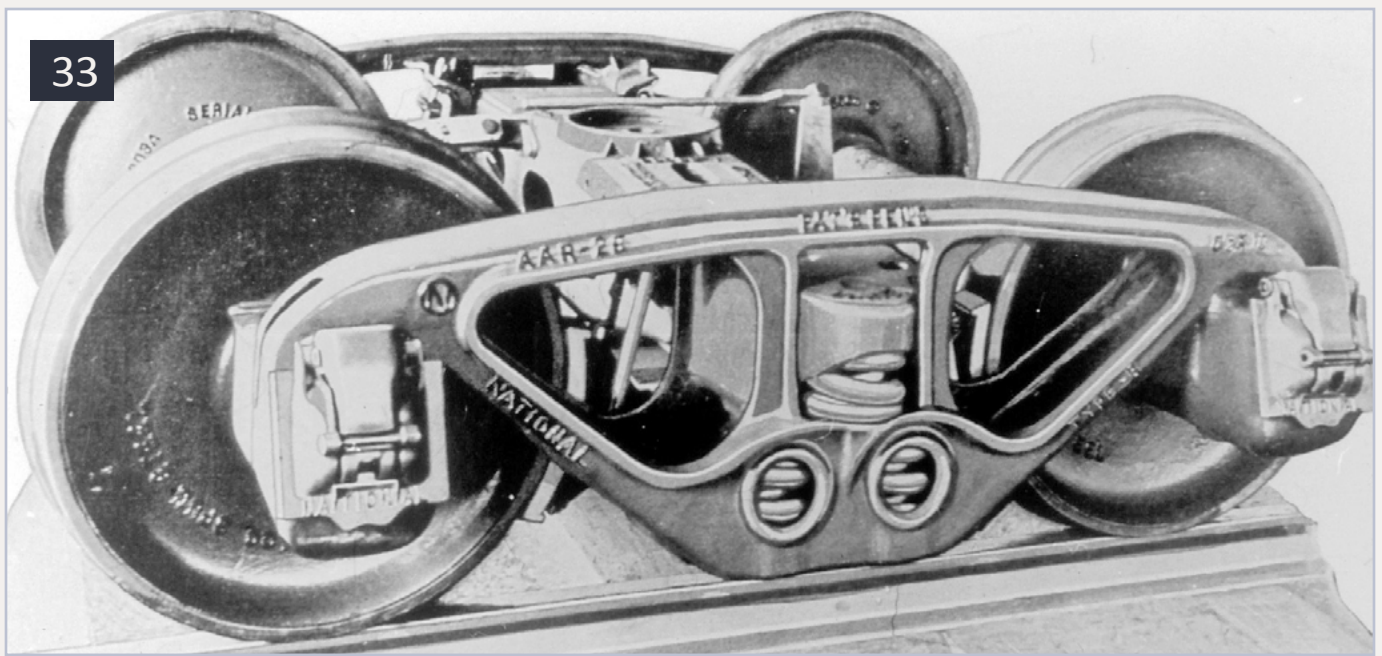

33-34: 50-ton and 70-ton versions of the National B-1 truck, a unique self-aligning truck which first eliminated the heavy steel spring plank. National B-1s were widely used by many railroads from the early 1930s through the early 1950s.

National B-1 trucks

A much more successful innovation was the National Type B-1 truck, introduced in 1931 by the National Malleable and Steel Castings Co. (33 and 34). The bolster and side frames of



contents



index

this truck interlocked so that the truck was self-aligning; no spring plank was required, resulting in a significant reduction of unsprung weight. Though distinctive in appearance, the National B-1 truck conformed in all respects to ARA/AAR specifications. Competitive in price and performance, it was widely adopted by many railroads in the 1930s and 1940s until it was rendered obsolete by trucks with built-in friction snubbers such as the Barber S-2 and ASF A-3 (see below).

Coil-elliptic trucks

Several truck manufacturers, notably Gould and Buckeye, began in the late 1920s to offer ARA/AAR standard trucks with a combination of coil and elliptic springs (35). The Pennsylvania Railroad also applied coil-elliptic spring packages to many of its later ARA type trucks (36). The advantage of this arrangement was that elliptical leaf springs had inherent friction between



35: An ARA truck with a combination of coil and elliptical leaf springs. Motion dampening was provided by the inherent friction of the leaves in the spring. Note that this particular truck had double-truss side frames, with the lower chords boxed-in, but was not self-aligning and still employed a spring plank.

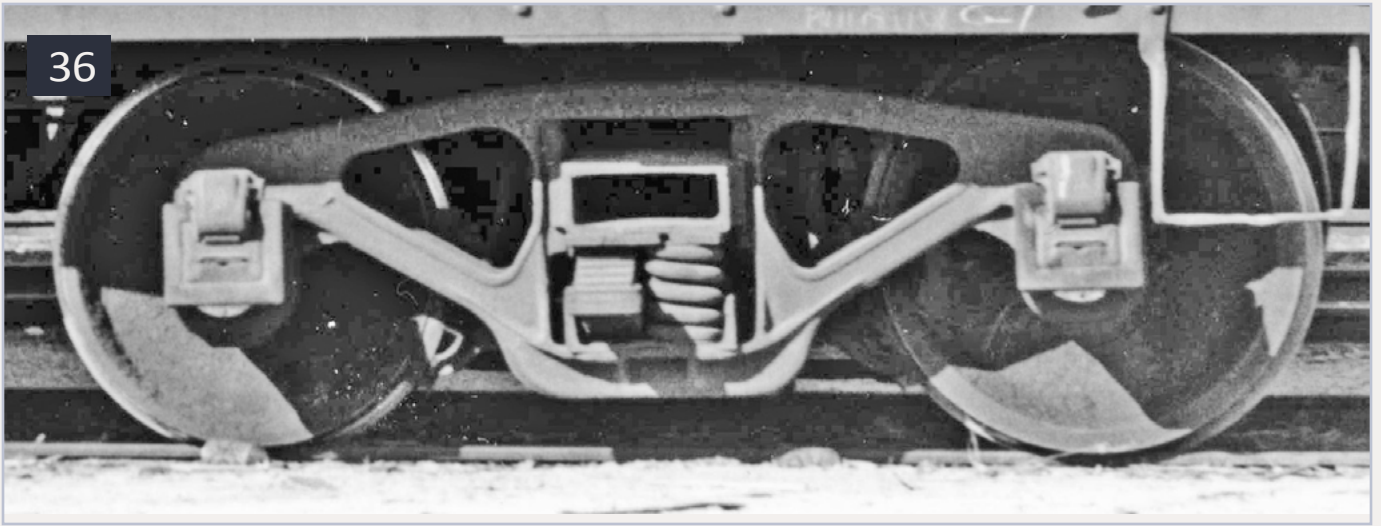

36: Applied to a car built in 1936, this Pennsylvania Railroad truck with coil and elliptical springs was a direct descendant of the ca. 1920 2DF8 design, which the Pennsy continued to use long after other railroads (and the ARA itself) had abandoned it because its side frames tended to crack.

the leaves so that they tended to act as snubbers and damp out excessive jolts and oscillation.

AAR Self-Aligning Spring-Plankless trucks

The need for further research and development in the design of freight car trucks continued into the early 1930s, but owing to the effects of the economic depression, individual truck manufacturers lacked the capital to pursue it on their own. This led to formation of a consortium of truck manufacturers under the Four Wheel Railway Truck Agreement. All of those who participated in that agreement contributed to the research, and all were able to employ the resulting improvements without paying royalties.

The outcome of this initiative was the Self-Aligning Spring-Plankless Double Truss truck, whose innovations combined to



improve performance, increase strength, and reduce weight. Self-alignment was accomplished by attaching the bolster to the side frames with interlocking, precisely-machined joints, thus eliminating the need for the spring plank (37). The double truss eliminated side frame cracking problems by boxing in the lower chords and extending a rib down the tops of the chords into the spring box (38 and 39). In the mid-1930s and '40s Self-Aligning Spring-Plankless Double Truss trucks replaced earlier truck designs on many new freight cars, despite their somewhat increased cost.

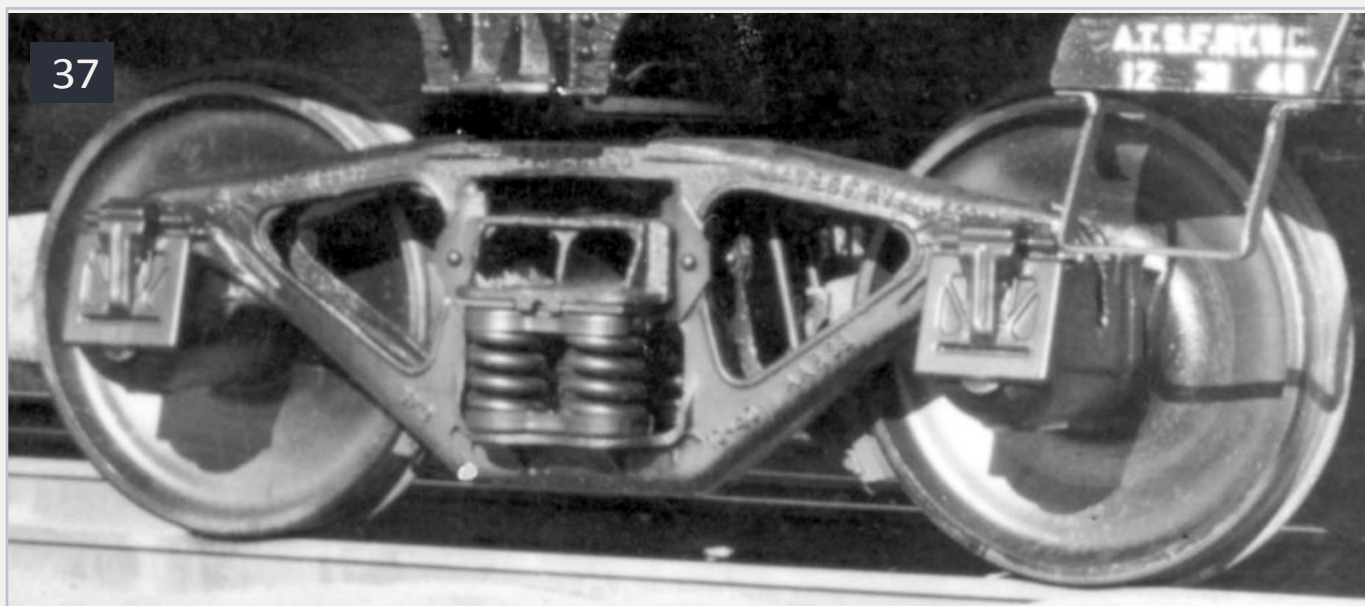

37: Made by American Steel Foundries in the 1930s, this truck was self-aligning and spring-plankless but did not have double-truss side frames; the lower chords had open u-sections and were not boxed in. Note the replaceable wear plates between the bolster and side frame.

38: A 50-ton self-aligning spring-plankless double-truss truck, employing all the features developed by the consortium of truck manufacturers under the four-wheel Railway Truck Agreement. The arrangement of five spring clusters with one in the center was an

38

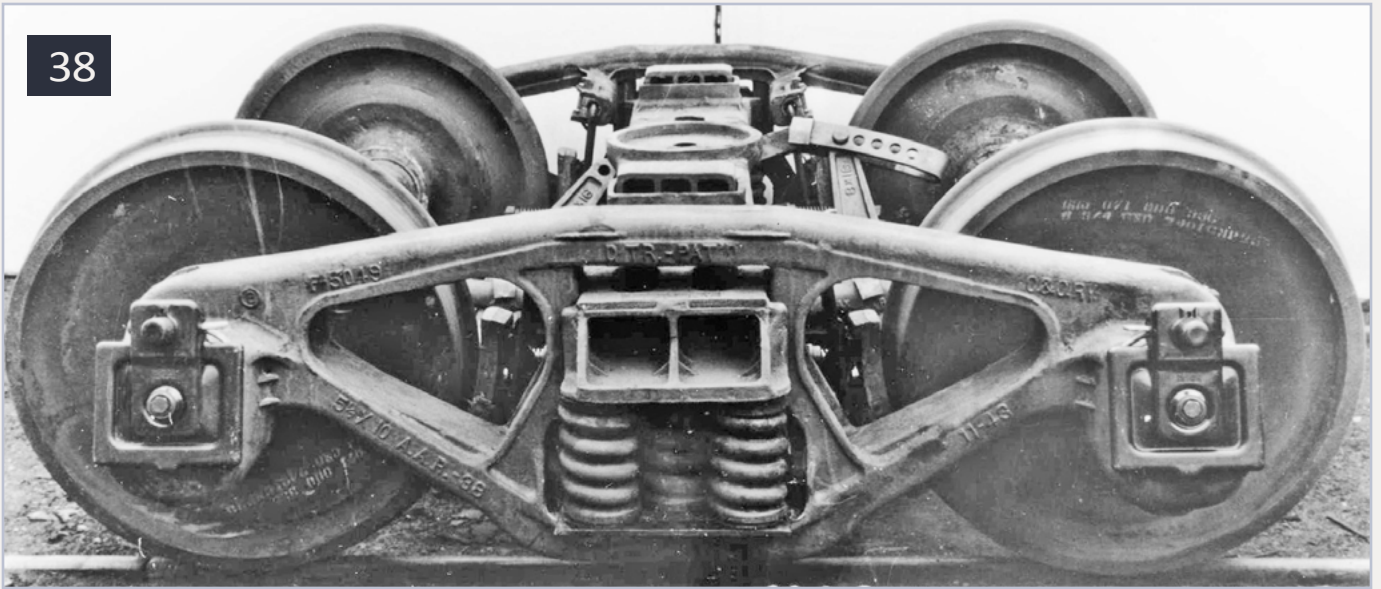

39

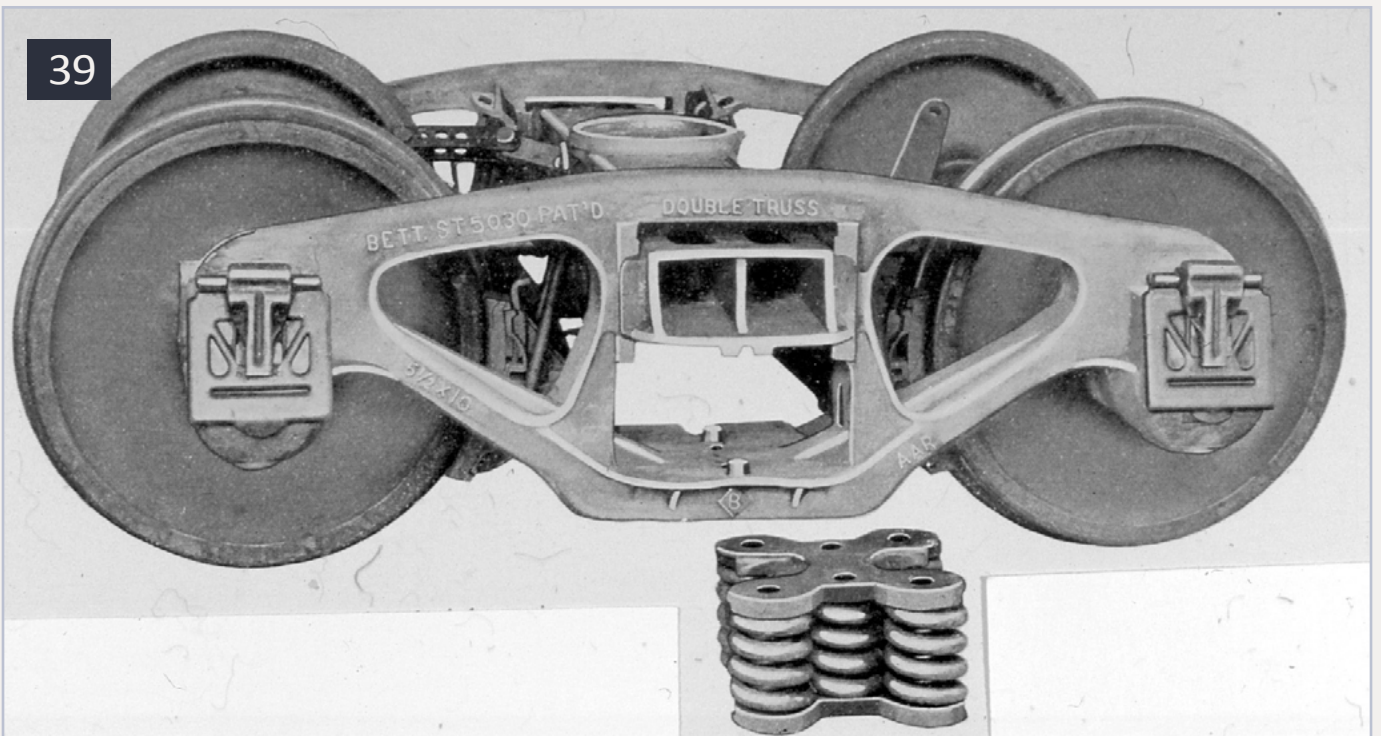

alternative to the equally-common four-spring clusters on 40- and 50-ton trucks.

39: The double-truss side frame design, with the ribs extending into the spring box, is clearly visible in this view with the spring package removed. Note also the absence of a spring plank. In the spring package, the inner springs are barely visible inside the outer ones; few modelers seem aware that truck springs had both inner and outer coils.



contents



index

Barber stabilized trucks

With the example of after-market friction snubbers before them, all of the major truck manufacturers began to explore the design of trucks with built-in snubbers. The first such truck to reach the market was the Standard Car Truck Co.'s Barber Stabilized S-1, which appeared in the early 1930s (40). It had a spring plank and was not self-aligning, but it incorporated spring-loaded triangular steel wedges between the bolster and side frames which snubbed out excessive motion and harmonic oscillation. It rapidly demonstrated superior riding qualities and doubtless would have been more widely adopted if the depression had not severely reduced the production of new freight cars.

By the late 1930s, an improved version of the Barber Stabilized truck, the Barber S-2, was introduced. At first it also had a

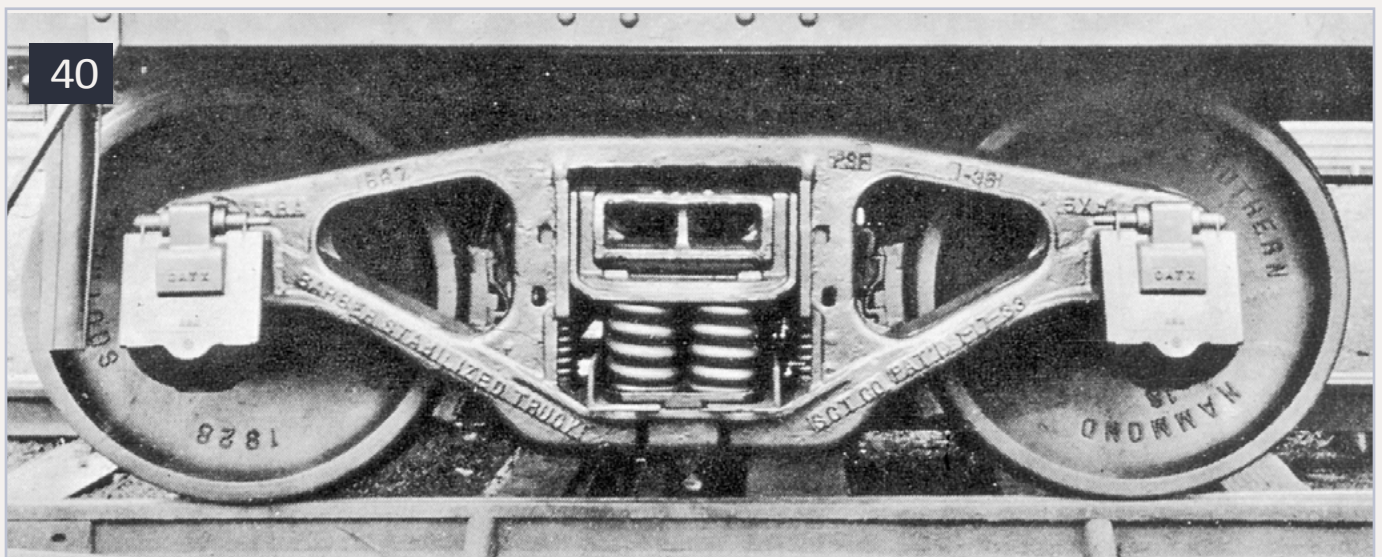

40: An early '30s Barber Stabilized S-1 truck with spring-loaded friction wedges between the bolster and side frame; note the small springs just visible at the edges of the spring box which applied pressure to the wedges. This truck had a spring plank as well as Barber lateral motion devices.

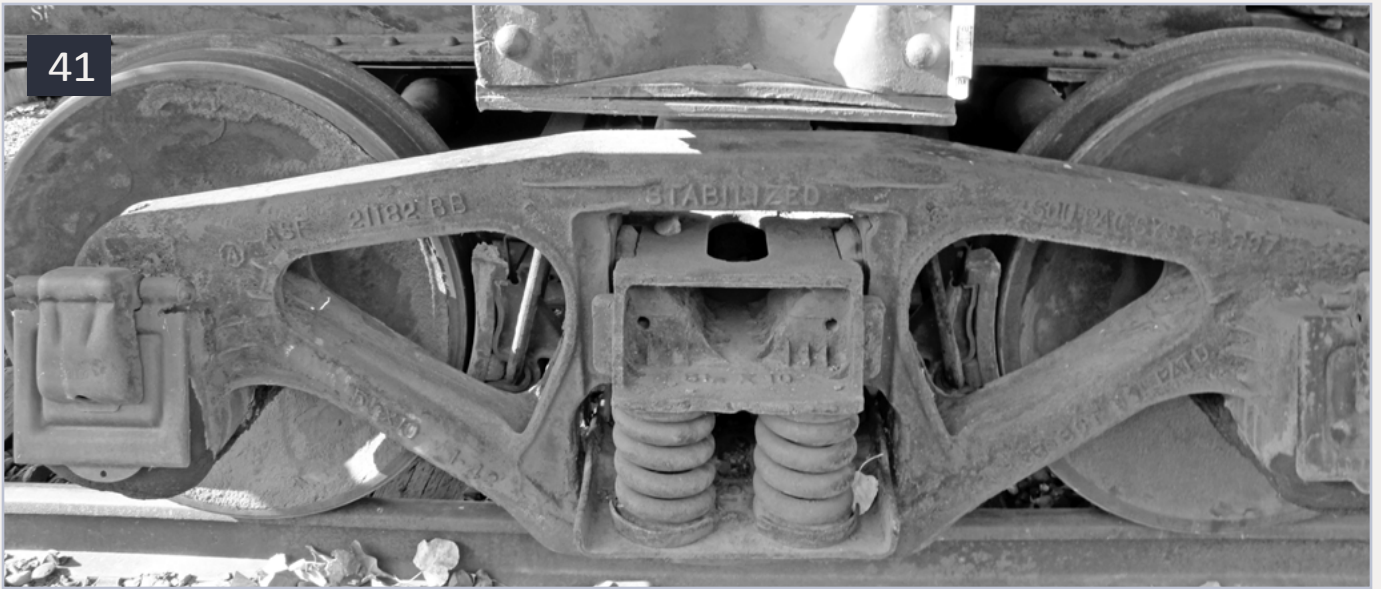

41: A later S-2 version of the Barber Stabilized truck, still with a spring plank. The small springs bearing on the friction wedges had been moved in so they were behind the front row of main truck springs; note the wedge pockets inside the bolster and the tops of the wedges that are just visible between the bolster and side frame.

spring plank (41), but a self-aligning spring-plankless S-2 quickly followed (42), as well as the 70 ton Barber S-3 (43). The S-2 was so successful that it was licensed to other truck manufacturers and, following World War II, became one of the two most widely-used freight car trucks, the other being the ASF A-3 (below). The Barber S-2 design was easily modified for roller bearings, and as a roller bearing truck, it remains in production today.

ASF A-3 Ride Control trucks

American Steel Foundries developed the ASF A-3 Ride Control truck in the early 1940s, but before it could be placed on the market World War II broke out, and the federal government



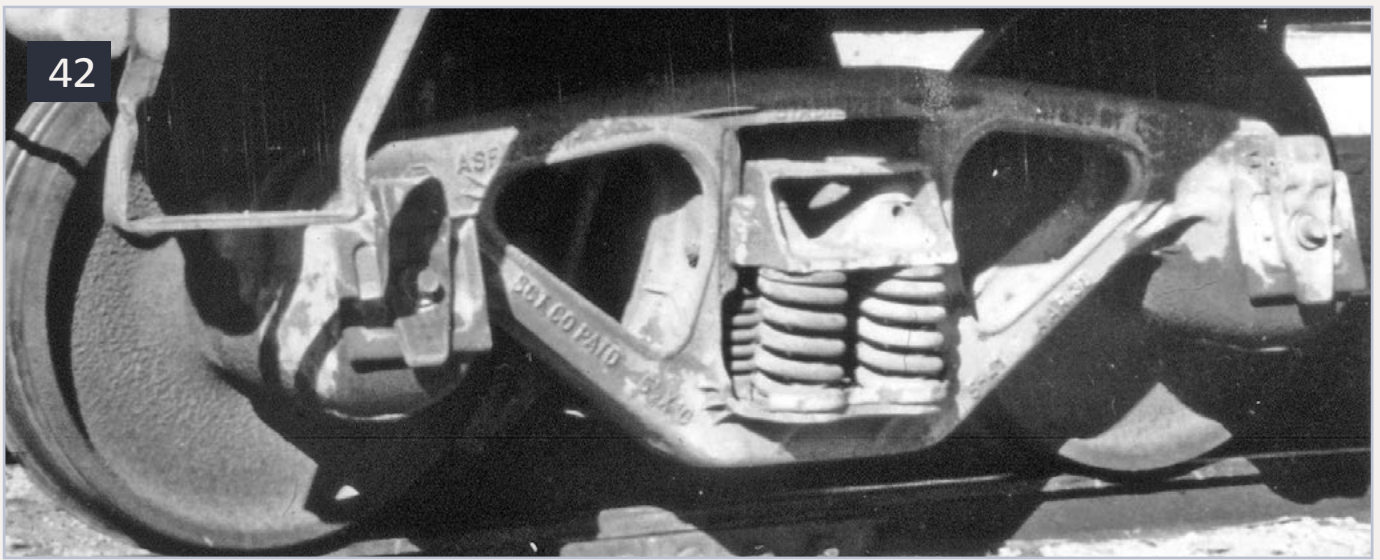

42: The final development of the Barber Stabilized design, this S-2 truck was self-aligning and spring-plankless. In this view a friction wedge spring can be seen behind the left front main spring. Note that this truck was made by American Steel Foundries under license from the Standard Car Truck Co.

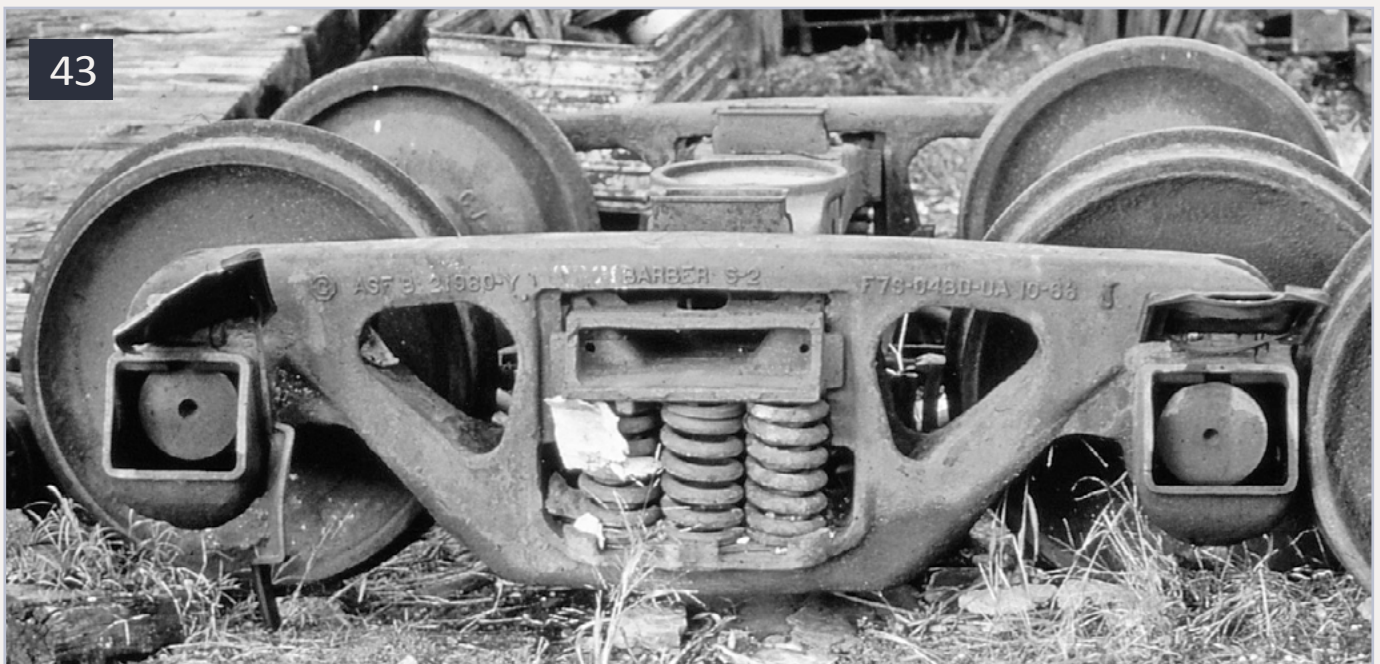

43: Though battered and long out of service, this 70-ton Barber S-3 truck has the friction wedge pockets of the Barber Stabilized design visible inside the bolster casting and the large journal boxes, longer wheelbase, and six spring cluster that were characteristic of 70-ton trucks.

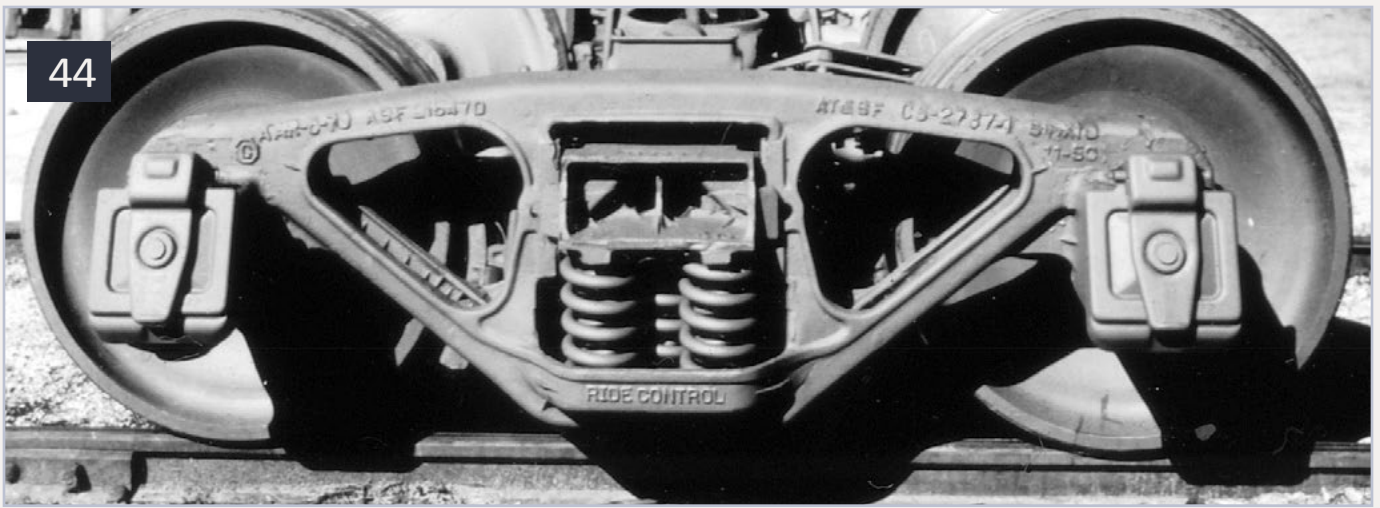

44: A typical truck of ASF A-3 Ride Control design, which was first introduced in the mid-1940s and rapidly become the most popular freight car truck on North American railroads. Distinctive features were tong travel springs (note that the inner springs are clearly visible) and the bulge at the bottom of the side frame which enclosed the lower part of the spring package.

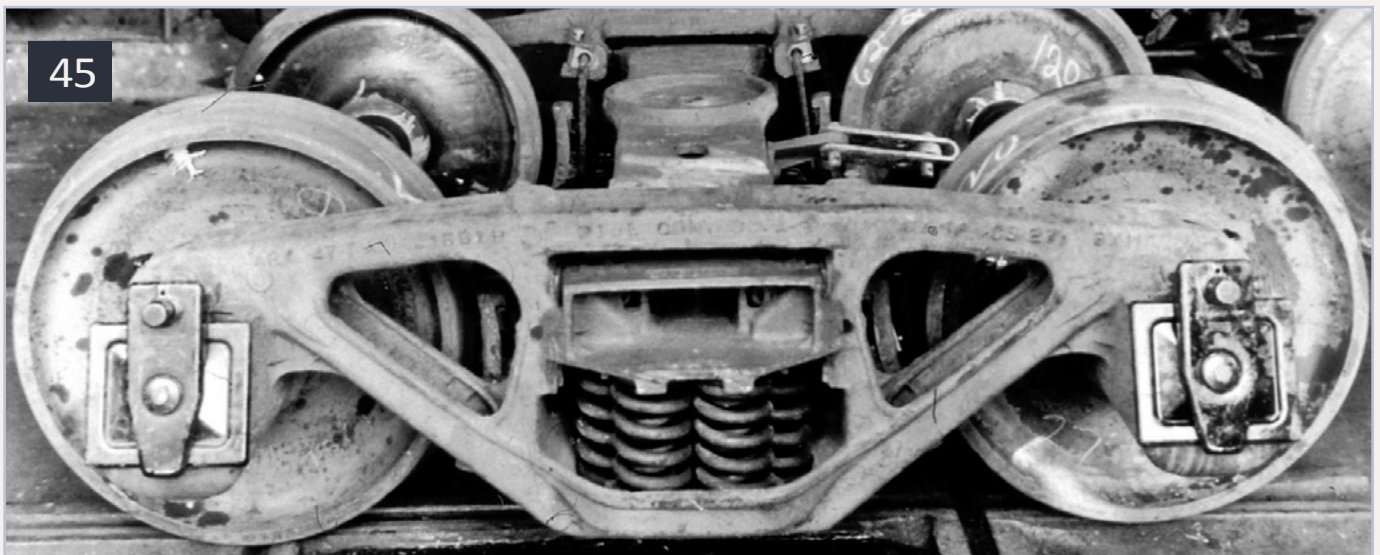

45: A 70-ton version of the ASF A-3 design with 5'8" wheelbase. The triangular pockets for the friction wedges between the side frame and bolster are apparent inside the bolster. What was different from the Barber Stabilized design was that, instead of separate friction wedge springs, the small springs inside the outer main springs applied pressure to the wedges.



contents



index

prohibited the production of new and unproven designs with what were then scarce materials. This restriction was withdrawn by 1944, however, and the A-3 truck quickly rivaled and eventually exceeded the popularity of the Barber S-2. It was a self-aligning spring-plankless truck and, like the S-2, it employed spring-loaded wedge type snubbers between the bolster and side frames for ride control (44 and 45). As with the Barber S-2, the ASF A-3 was licensed to other truck manufacturers, readily lent itself to the application of roller bearings, and continues to be produced as a roller bearing truck.

Other postwar trucks with ride control features

Following World War II, the success of the Barber S-2 and ASF A-3 trucks led a number of other truck manufacturers to design their own trucks with built-in friction snubbers. Several examples

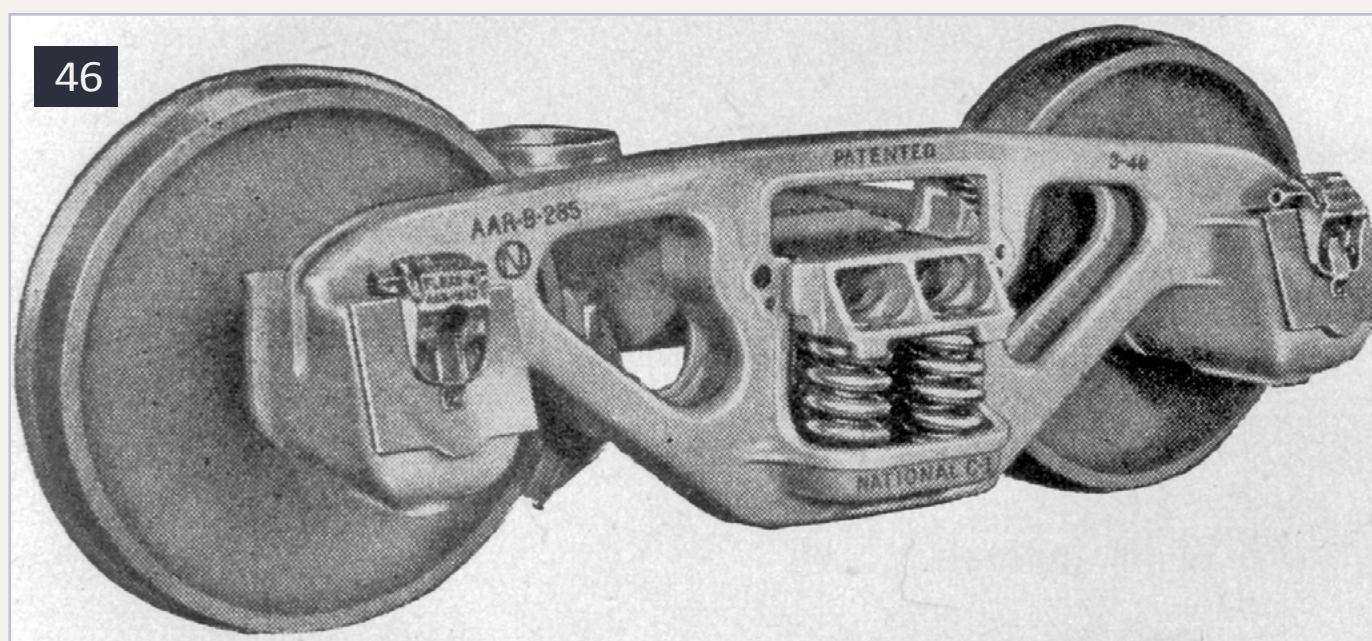

46: Another postwar truck design with built-in snubbers that enjoyed some success was the National C-1. It was similar to the ASF A-3 except that the friction wedges between bolster and side frames were inverted, with the wedge springs above them.

47

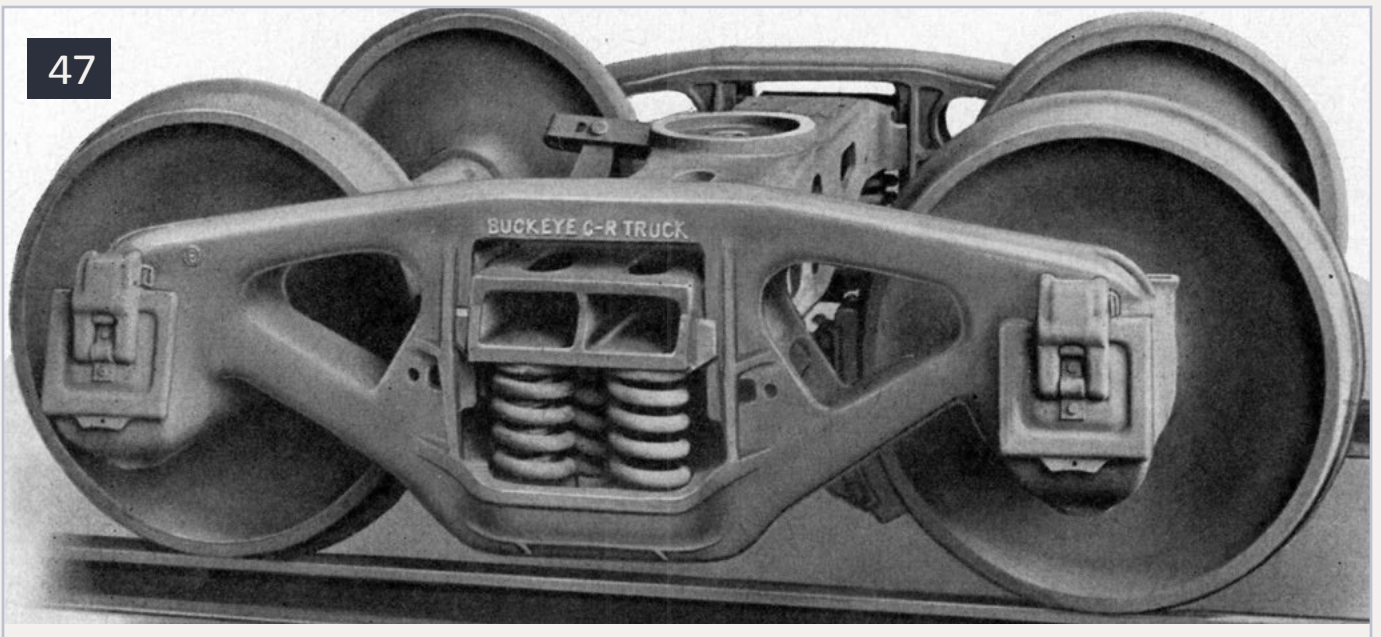

48

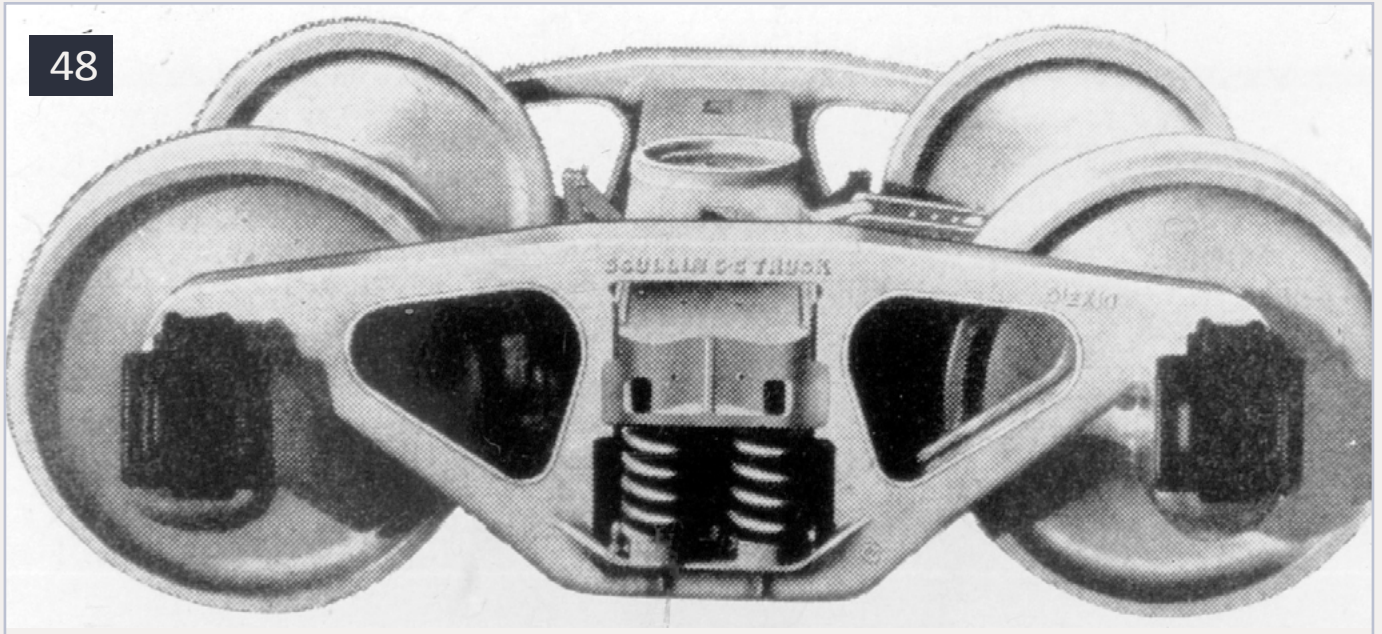

47-50 (following page also): Other postwar trucks with spring loaded snubbers included the Buckeye C-R, the Scullin S-S, the Gould Double Stabilized, and the Snub-Up. All rode better than conventional trucks, but cost more and failed to attract a large share of the market.

are shown here and on the following page (46 through 50) although none were remotely as successful as the S-2 and A-3.



contents



index

49

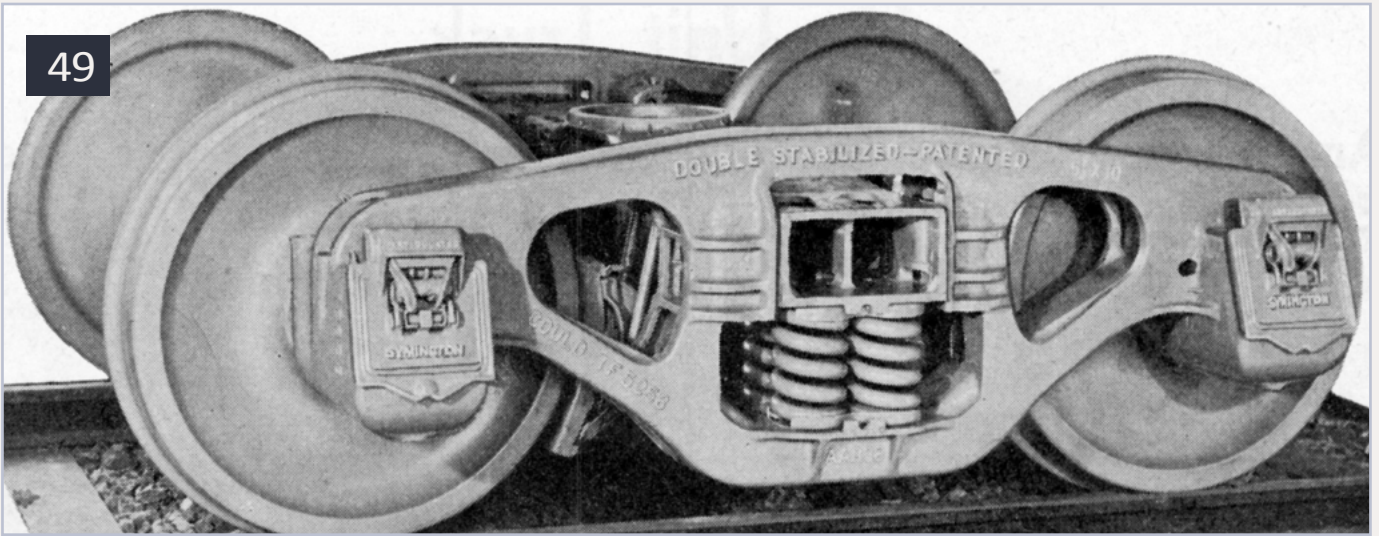

50

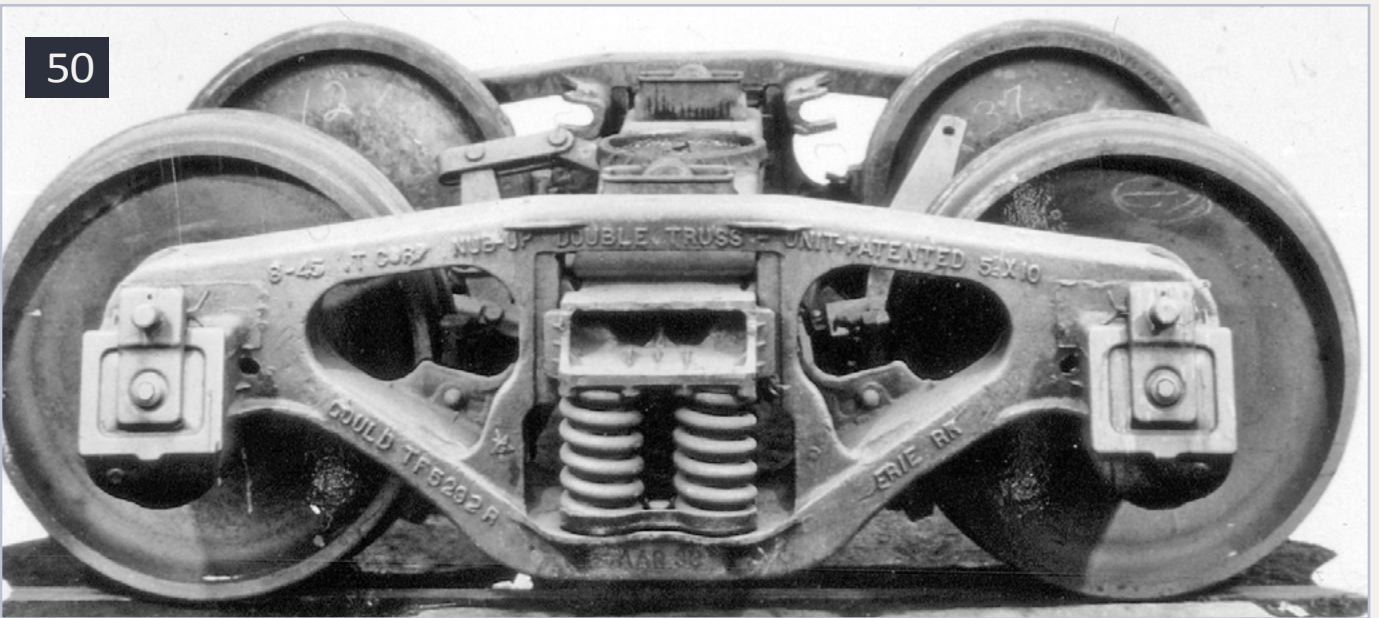

See previous page for caption.

Caboose trucks

Caboose trucks were easy on trucks, as they were lightly-loaded and received regular maintenance, but good riding qualities were, for obvious reasons, desirable. In the first quarter of the 20th century, most cabooses rode on arch bar or Andrews trucks with elliptical leaf springs (51). Then, in the 1920s, the Bettendorf Swing Motion caboose truck was developed. This truck improved riding qualities and durability by combining cast steel integral-journal-box side frames with leaf springs

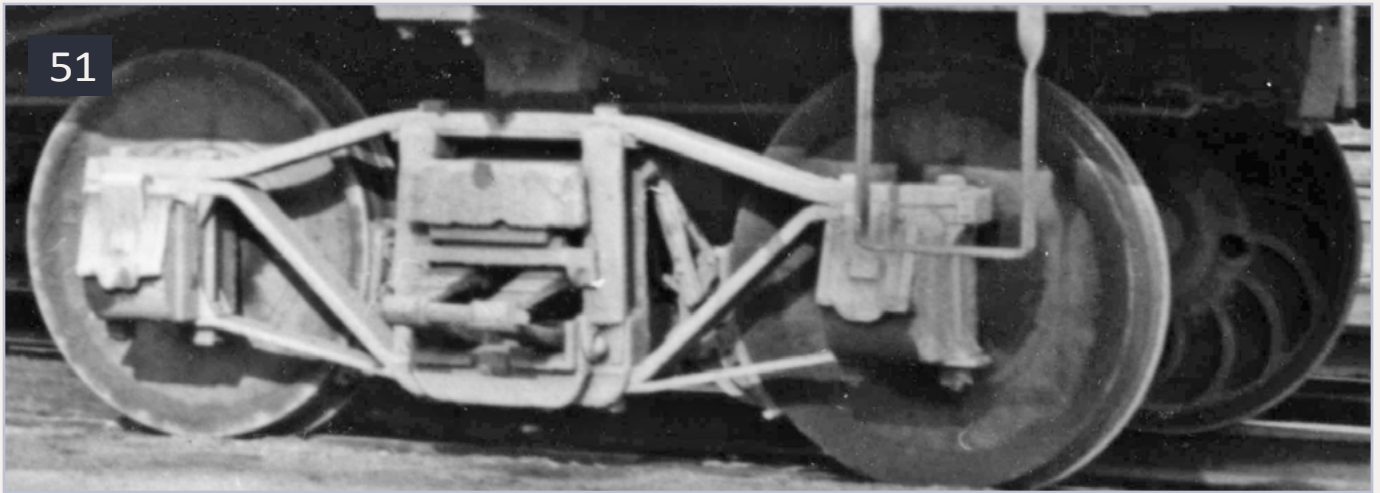

51: Prior to the mid-1920s, most cabooses rode on arch bar trucks with elliptical leaf springs, as shown here. The problems with arch bars when not consistently maintained were not an issue with lightly-loaded caboose trucks which never went off line, and the leaf springs provided damping action to reduce excessive jolts and bounces.

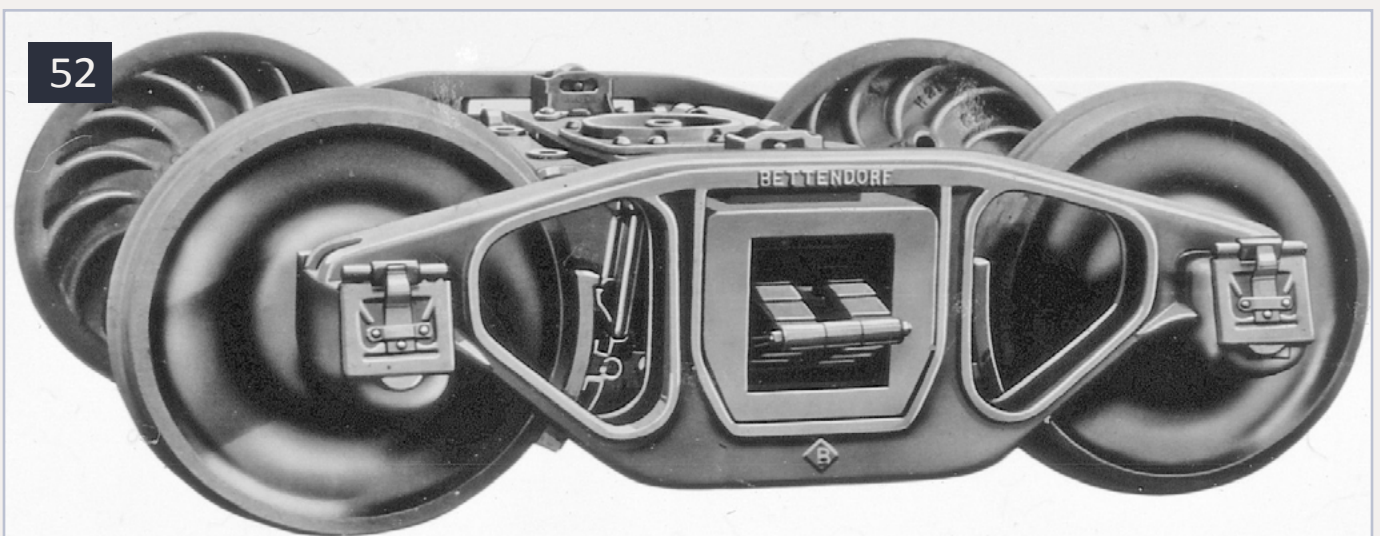

52: In the 1920s, Bettendorf's swing motion caboose truck was a major step forward in riding qualities for cabooses. It featured cast steel side frames with integral journal boxes, leaf springs, and a swing motion bolster.



contents



index

and a swing motion bolster (52). A decade later, Bettendorf made some improvements in the swing motion truck, and soon thereafter the design was sold to the Standard Car Truck Co., which marketed it in the 1940s and later as the Barber-Bettendorf caboose truck (53).

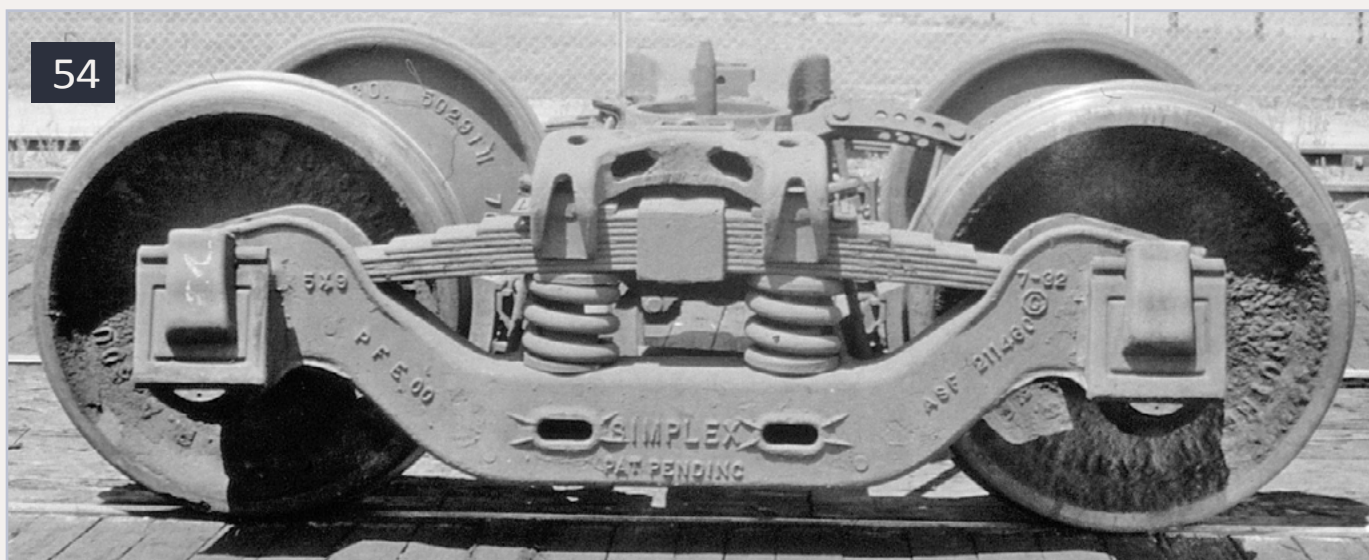
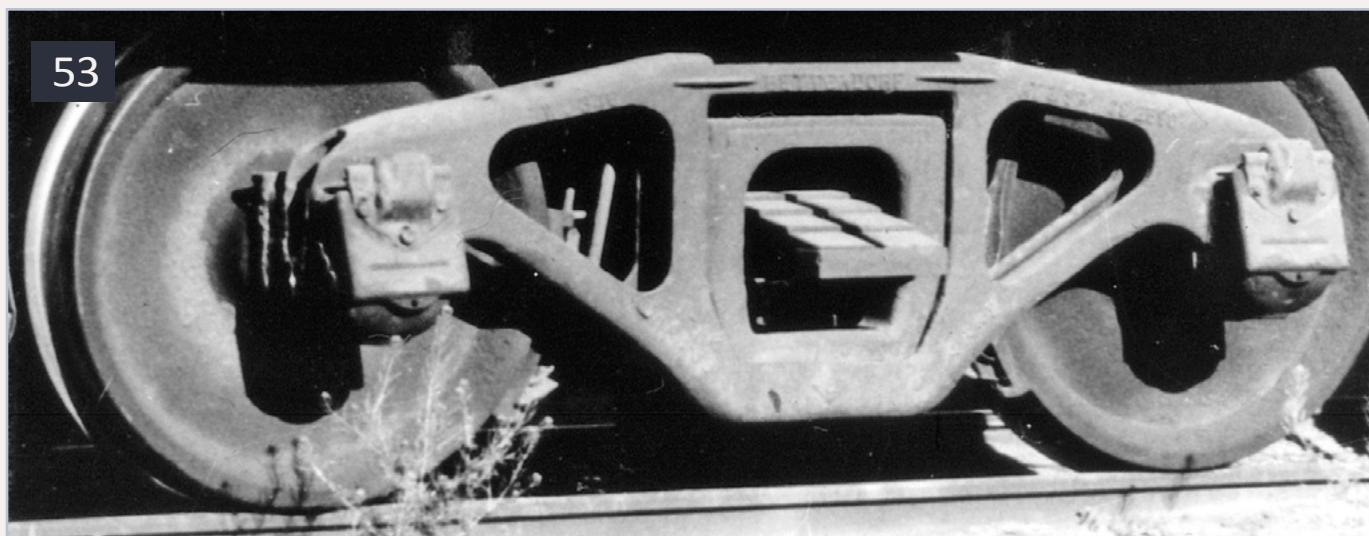

53: Bettendorf made some minor improvements to its swing motion caboose truck in the 1930s and then sold the rights to the design to the Standard Car Truck Co., which renamed it the Barber-Bettendorf swing motion caboose truck and continued to offer it through the 1950s.

54: Introduced in the 1930s, the Simplex truck employed long leaf springs, in addition to coil springs,

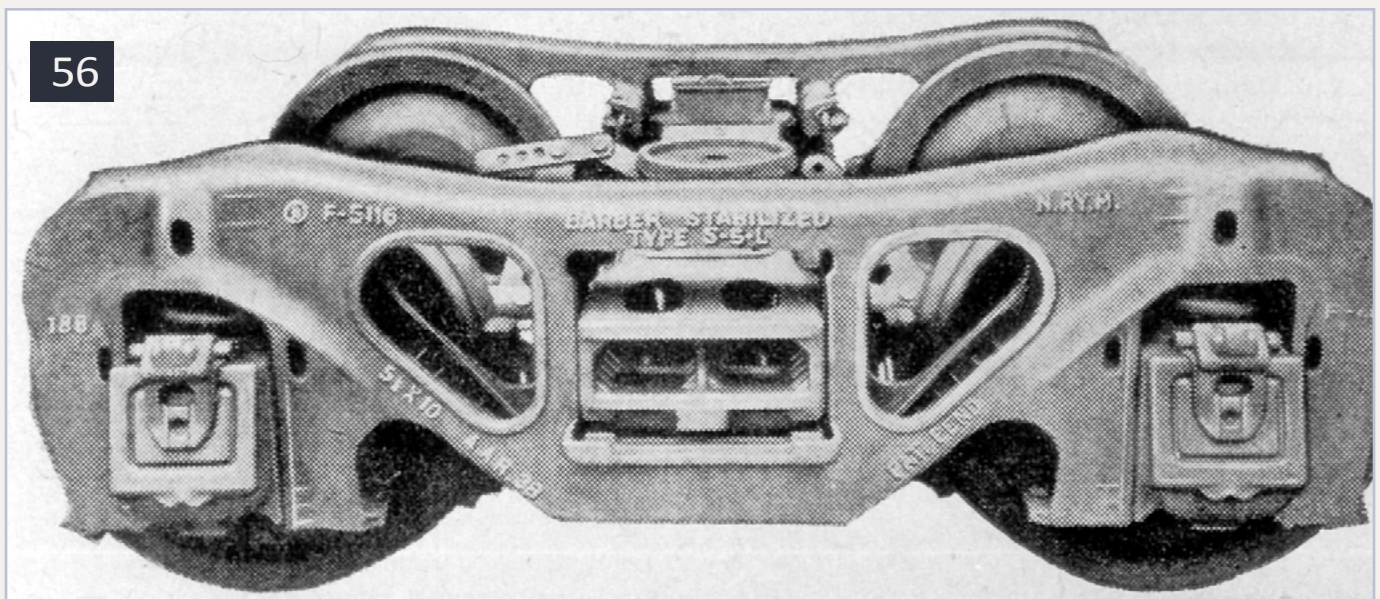
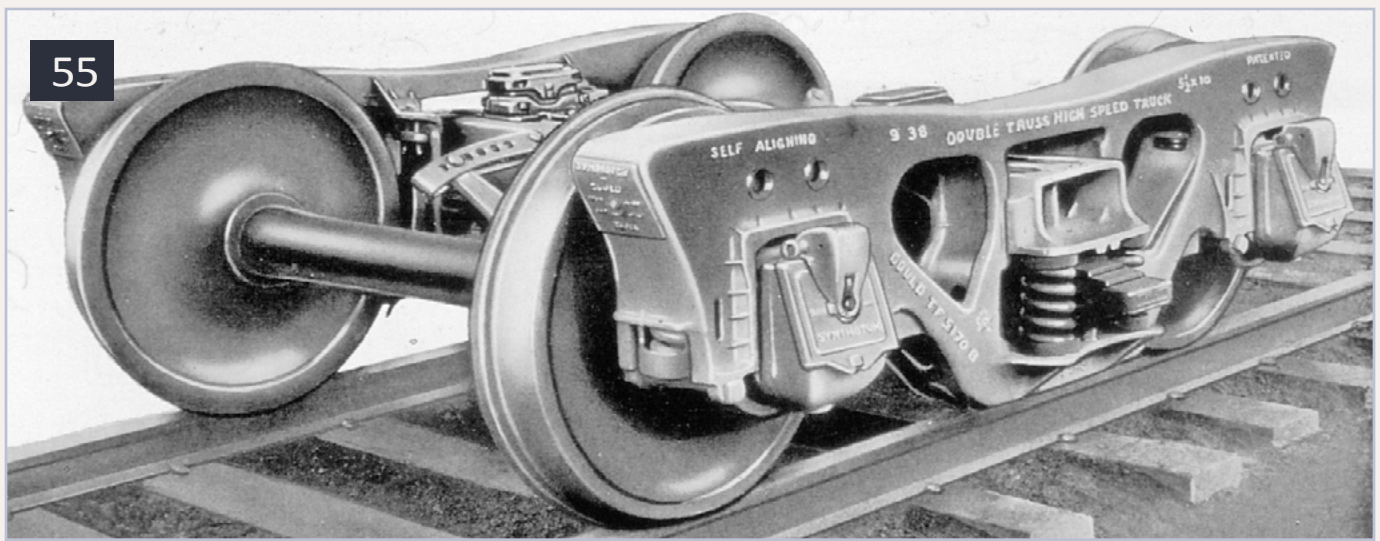

(54 Continued): to improve riding qualities at high speeds. Apparently it rode better but cost more than conventional trucks, and was not widely adopted.

55: The Gould high speed truck had sprung journal boxes in pedestal jaws, as well as both coil and leaf springs between the side frames and bolster. A self-aligning spring-plankless double-truss truck, it employed all of the innovations developed in the 1930s by the four-wheel railway truck consortium.

56: Another high-speed truck that employed sprung journal boxes sliding vertically in pedestal jaws was the Barber S-5-L, which also had Barber lateral motion devices.



contents



index

High-speed trucks

In the 1930s, as a number of railroads began using box and refrigerator cars in passenger express service, freight car trucks began to be developed for operation at passenger train speeds. The ASF Simplex truck, with its long and flexible leaf springs, was an example of a truck developed for this purpose (54). Other efforts to produce a high-speed freight car truck resulted in the Barber S-5 and Gould trucks with sprung journal boxes in side frame pedestal jaws (55 and 56). Commonwealth also offered a short wheelbase passenger-car-type truck with drop equalizers which had both coil and leaf springs (57).

The Allied Full Cushion truck, introduced in 1940, provided a better ride at higher speeds and was applied by a number of railroads to freight cars in passenger train service, as well as to a large number of freight-car-based troop sleepers and kitchen cars built during World War II for the federal government (58). However, it turned out that Allied trucks had derailment

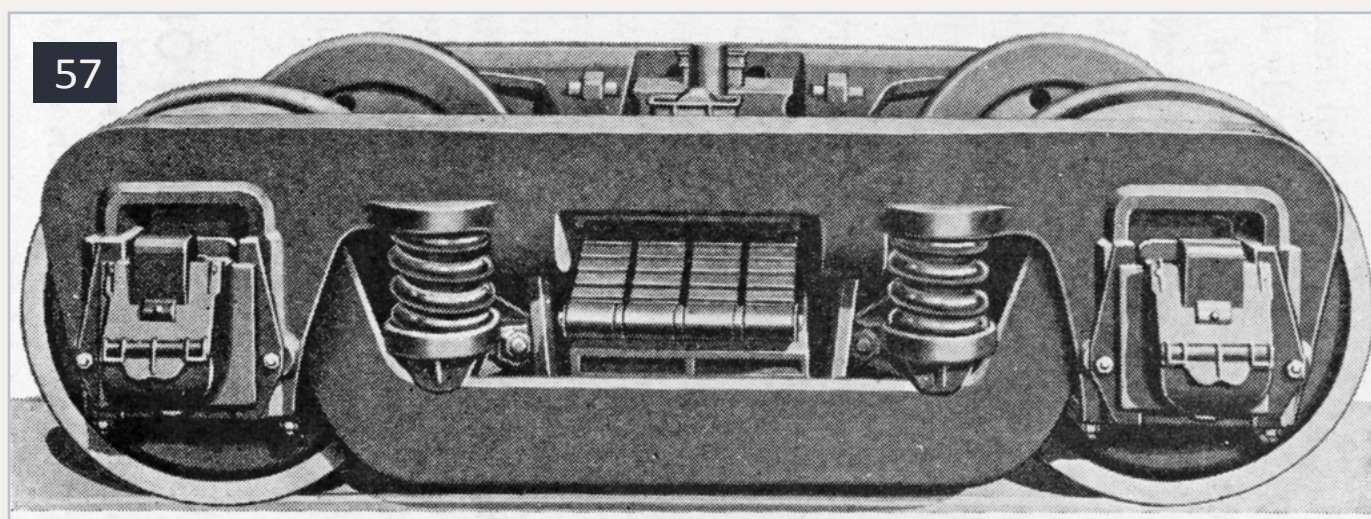

57: Commonwealth, primarily a maker of passenger car trucks, offered this high-speed truck whose drop equalizers and combination of coil and elliptic springs gave it the appearance of a short wheelbase passenger car truck.

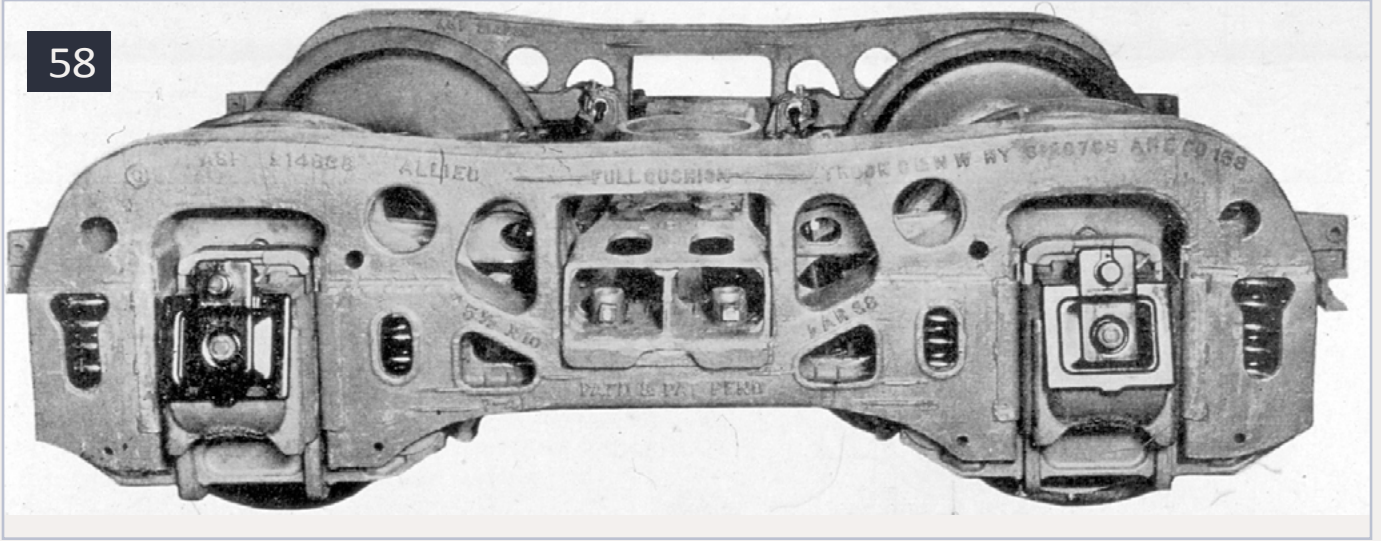

58: When it first appeared ca. 1941, the Allied Full Cushion truck was a revolutionary effort to provide a better riding high-speed truck for freight cars in passenger express service. However, its tendency to derail proved impossible to correct completely, and it was outlawed in interchange in 1955.

problems, and intensive efforts to cure this shortcoming were only partly successful, so they were little-used after the war, and finally were banned in interchange in 1955.

After World War II, the Chrysler Corporation attempted to improve truck performance by the use of automotive technology in the Chrysler FR-5 truck (59). This truck had a swing motion bolster and hydraulic shock absorbers, among other features, but these innovations did not compensate for its additional cost and increased maintenance requirements, and it was not widely adopted.

Heavy-duty trucks

Relatively few freight cars built between 1900 and 1960 had nominal capacities exceeded 70 tons. However, early in the 20th century some very large coal hoppers and gondolas were constructed with capacities of up to 100 tons, and those cars required special high-capacity six wheel trucks. Usually these



were especially designed for the cars they were used on, and none were made in large numbers. Some examples of those trucks were the ASF, Lewis, and Lamont trucks (60, 61, and 62).

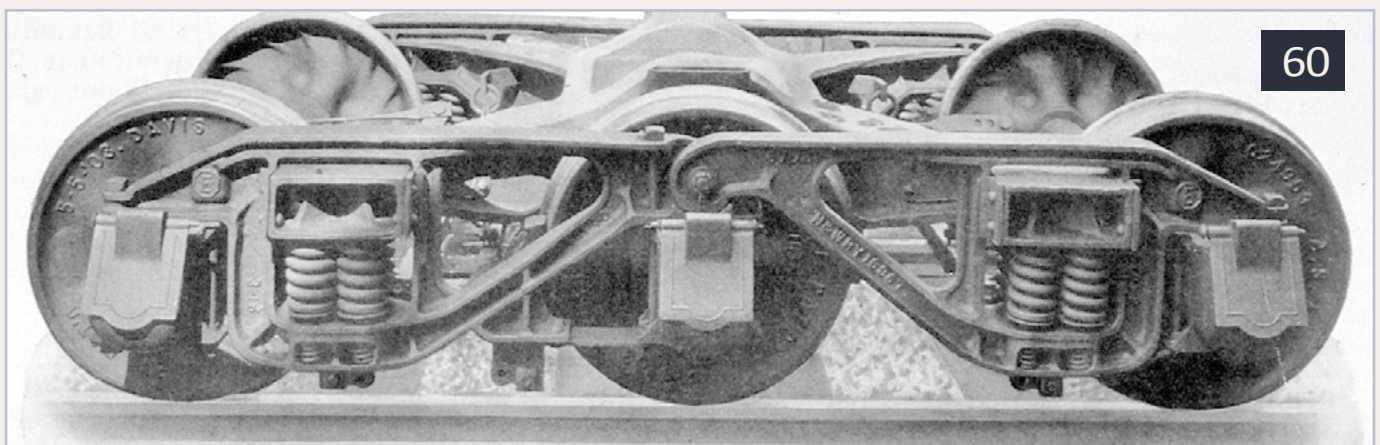
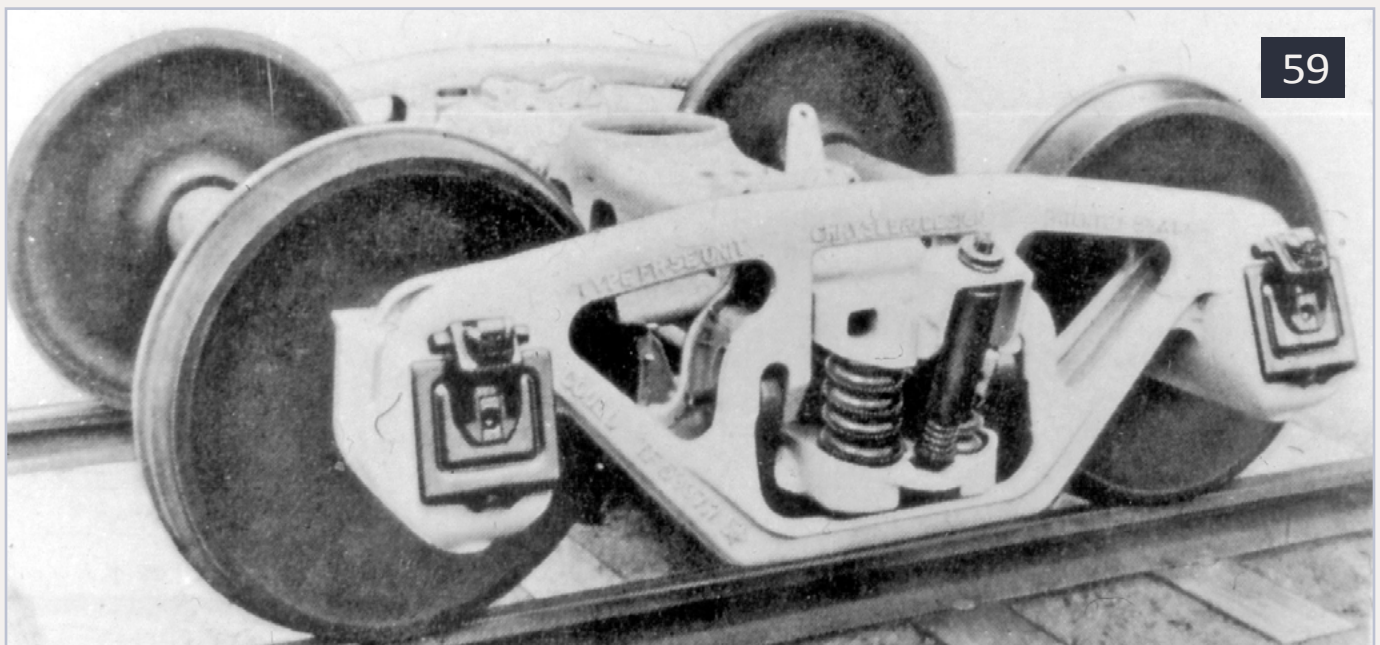

59: After World War II, Chrysler designed a high-speed truck using some concepts from automotive technology. The Chrysler C-5E truck had lateral-motion rocker arms connecting its side frames and bolster, and snubbing was provided by a tubular hydraulic shock absorber. It worked well but cost more and required periodic maintenance, so it was not adopted in large numbers.

60-62: High capacity freight cars were often equipped with six-wheel trucks. Here are three from early in

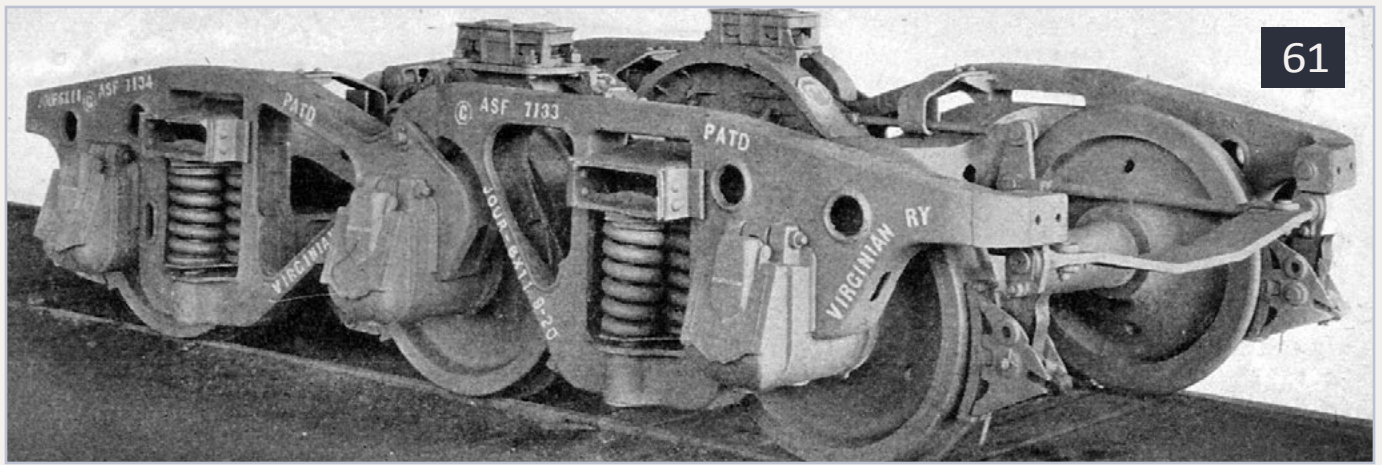

61

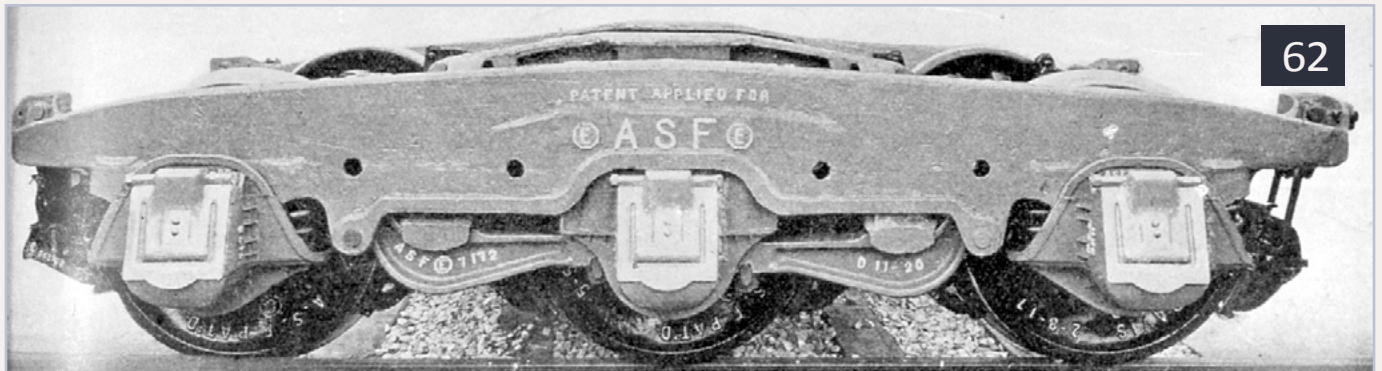

62

(60-62 continued) the 20th century, the ASF, Lewis, and Lamont trucks, all designed for 100-ton coal hoppers and gondolas. None were produced in large numbers.

In the 1920s, a small number of high-capacity flat cars began to be built to carry very heavy industrial loads, and these cars also required special heavy duty trucks. Cars of 90 tons nominal capacity usually had four-wheel trucks (63 and 64). Cars with 100 ton or higher capacities used six-wheel trucks (65 and 66). In a few extreme cases, two four-wheel trucks connected by a massive span bolster were used at each end of the car (67).

Early roller bearing trucks

Roller bearing trucks existed earlier than many modelers realize; the Stafford Roller Bearing Car-Truck Corporation introduced a roller bearing arch bar truck in the early 1920s (68). Those early roller bearings were costly and did not wear well,



contents



index

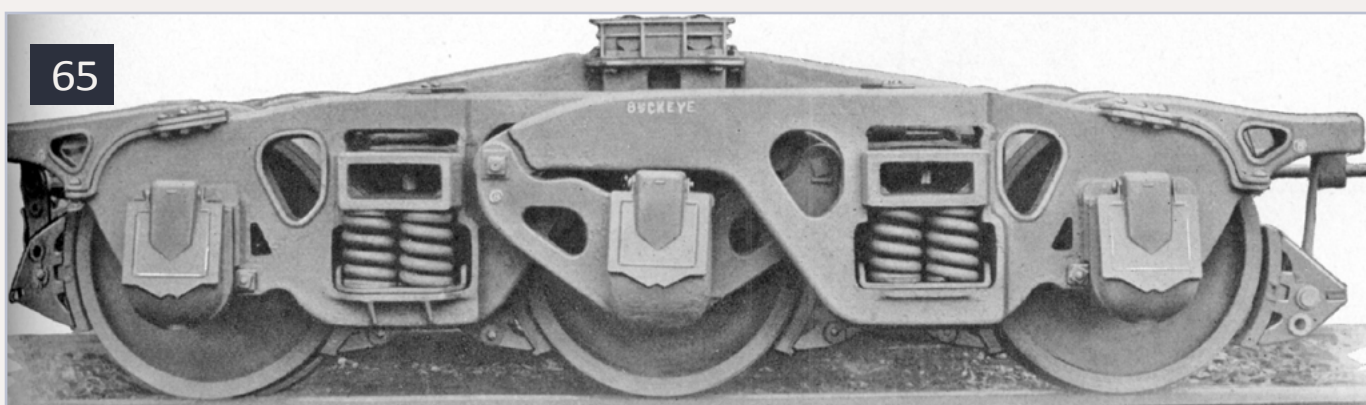
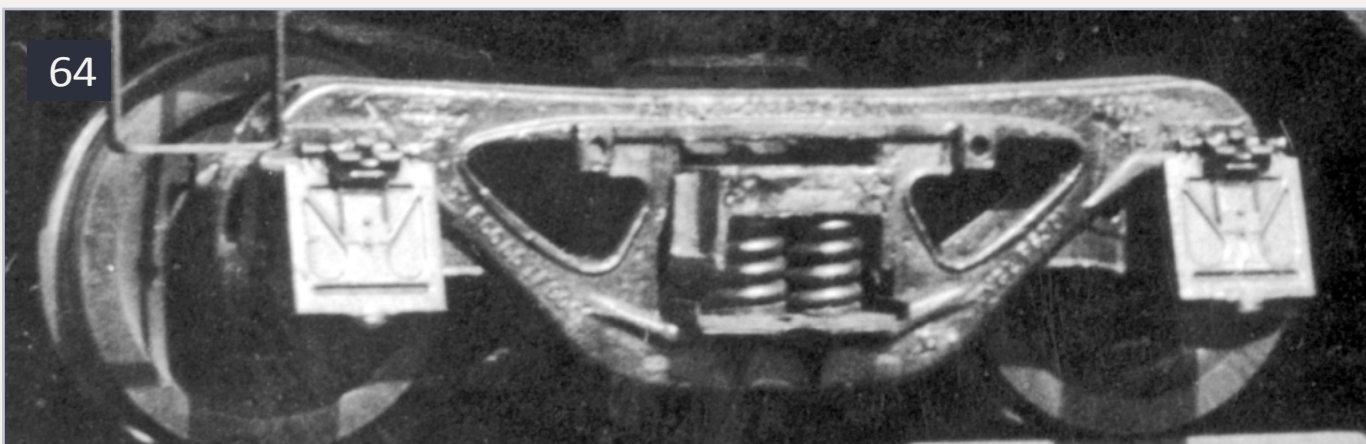
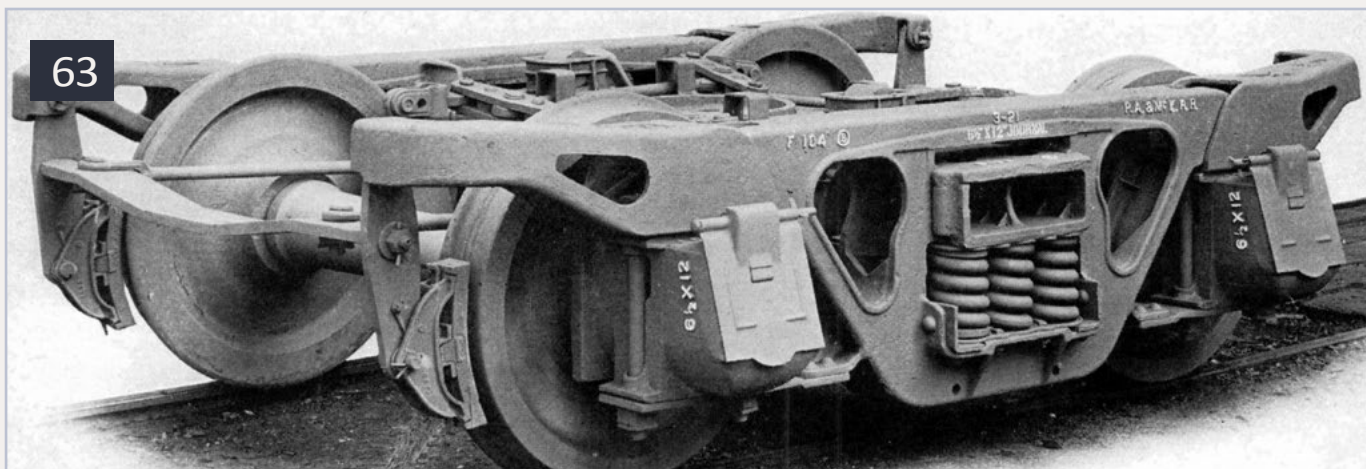

63: This 90-ton truck, built in the early 1920s and essentially of Andrews design, had very large journal boxes and side frame extensions to support the outboard brake rigging for clasp brakes.

64: Used under a 90-ton drop center flat car, this truck looked like an ARA standard truck on steroids. Although the design was essentially the same, its journal boxes were huge and the side frame and bolster castings had much heavier sections than on a truck of less capacity.

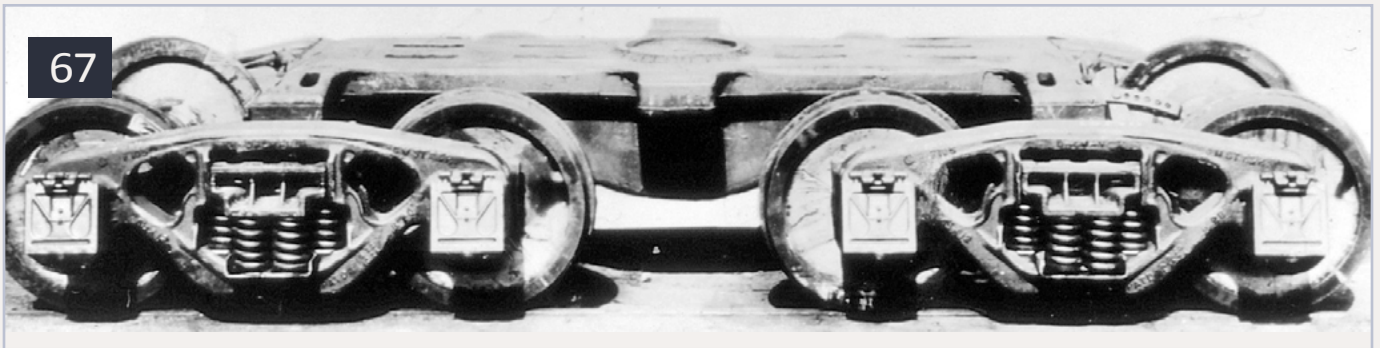
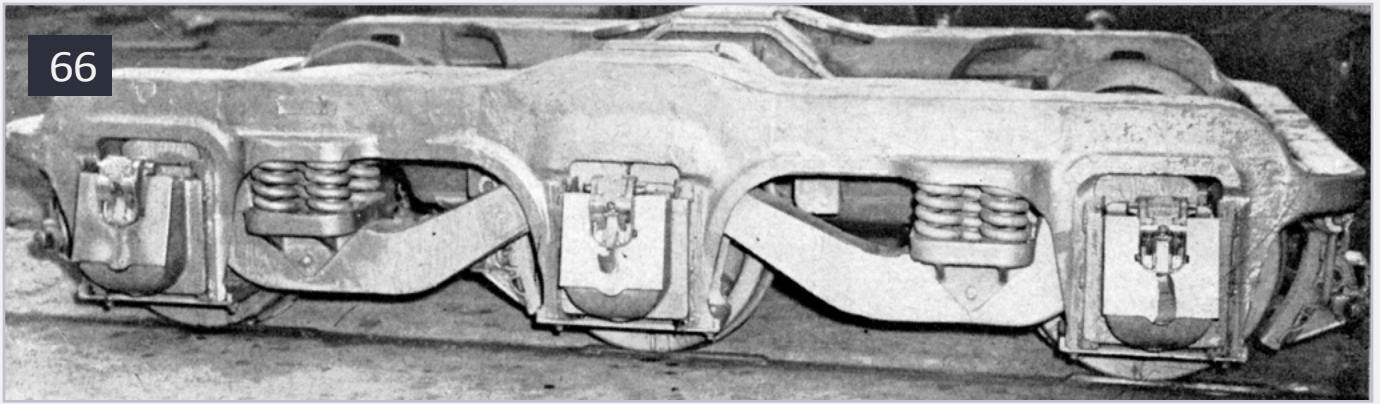

65: With articulated side frames for better weight distribution, this Buckeye six-wheel truck had a nominal capacity of 100-tons (i.e., a pair of them could support a hundred-ton load).

66: Drawing from passenger car truck practice, Commonwealth produced this heavy-duty six-wheel freight car truck with drop equalizers.

67: When even six-wheel trucks weren't enough to support a car's intended capacity, it was possible to put two four-wheel trucks under each end, with each pair connected by a massive span bolster. In this case, the trucks were Dalman Two Level.

however, it was not until advances were made in roller bearing technology in the 1930s and, especially, during World War II that roller bearings became available which were more suitable for use on railroad cars.



contents



index

Following the war, roller bearing manufacturers engaged in a vigorous promotional campaign to market their wares to the railroads, even going so far as to describe roller bearings as "anti-friction" bearings in contrast to "friction" (i.e., plain) journal bearings. This terminology was nonsense, of course; all bearings have friction, and though roller bearings have less resistance to starting and at low speeds, their advantage was relatively slight at normal train speeds.

In any case, railroad officials weren't inclined to spend money putting roller bearings on cars that spent much of their life off-line in interchange, so the relatively few cars that received roller bearing trucks were in assigned service and seldom or never left their owners' rails. One such example was the Union Pacific's DLS livestock trains from Salt Lake City to Los Angeles; in this case, roller bearings were fitted to existing trucks, and the only evidence of their presence was aluminum-painted journal box covers (68). Another was a small number of Akron,

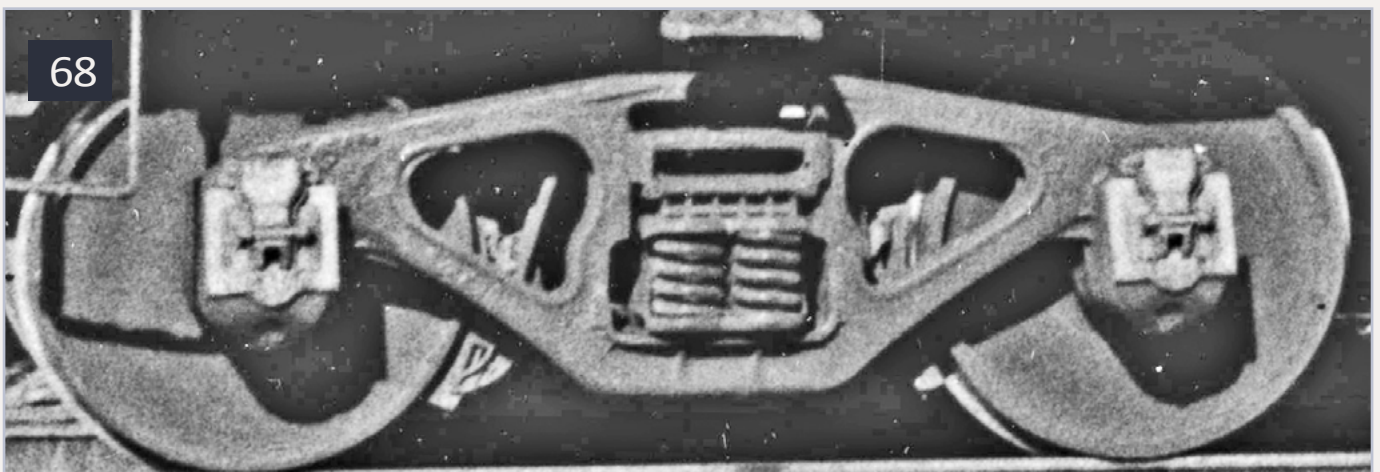

68: The simplest way to get roller bearings was to retrofit them in existing trucks, as the Union Pacific did on their DLS stock cars. As the bearings were invisible inside the original journal boxes, the journal box covers were painted aluminum so carmen would know not to pour journal oil into them.

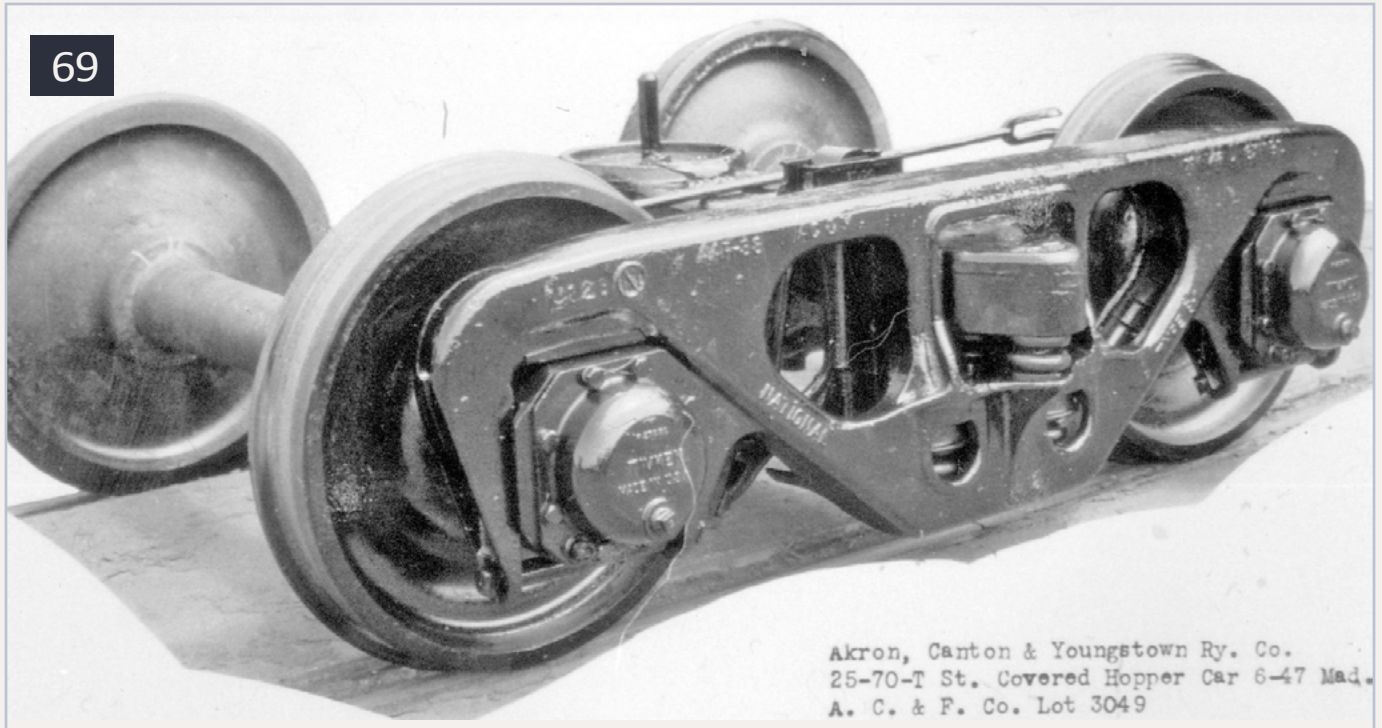

69: This roller bearing National B-1 truck for was applied to covered hoppers built by AC&F for captive service on the Akron, Canton & Youngstown. The side frames had pedestal jaws into which the Timken bearings were fitted.

Canton & Youngstown covered hoppers for on-line service which came from American Car & Foundry in 1947 with roller bearing National B-1 trucks (69).

In the late 1940s through the 1950s, applications of roller bearings to existing truck designs continued to be relatively isolated experiments (70 and 71). What apparently tipped the scales in favor of roller bearing trucks was the construction, beginning in the late 1950s, of growing numbers of 90 and 100 ton covered hoppers for grain service. On these cars, four-wheel plain journal trucks were overloaded, and they were very prone to overheated journals, the dreaded "hot boxes" which required them to be set out of trains at the earliest opportunity while en route. Roller bearing trucks solved



the hot box problem, and once larger numbers of them were in interchange service, many railroads began equipping all their new freight cars with roller bearings.

Continued use of plain journal trucks

Though the use of roller bearing freight car trucks increased rapidly in the early 1960s, well over a million cars remained in service with plain journal trucks. Intensive efforts were made to improve lubrication so that these cars would run for longer distances between journal box oiling and also be less prone to hot boxes. In the 1950s, a variety of patented lubricators and waste packing retainers were introduced which at least partially accomplished this objective, and by the 1960s most cars in interchange service were equipped with one or another of these devices. Thus improved, large numbers of plain journal trucks continued in service for many years and the last of them were not outlawed in interchange until the 1980s.

HO scale freight car trucks

I am reluctant to describe the available HO scale trucks because the list of what is available keeps changing as model

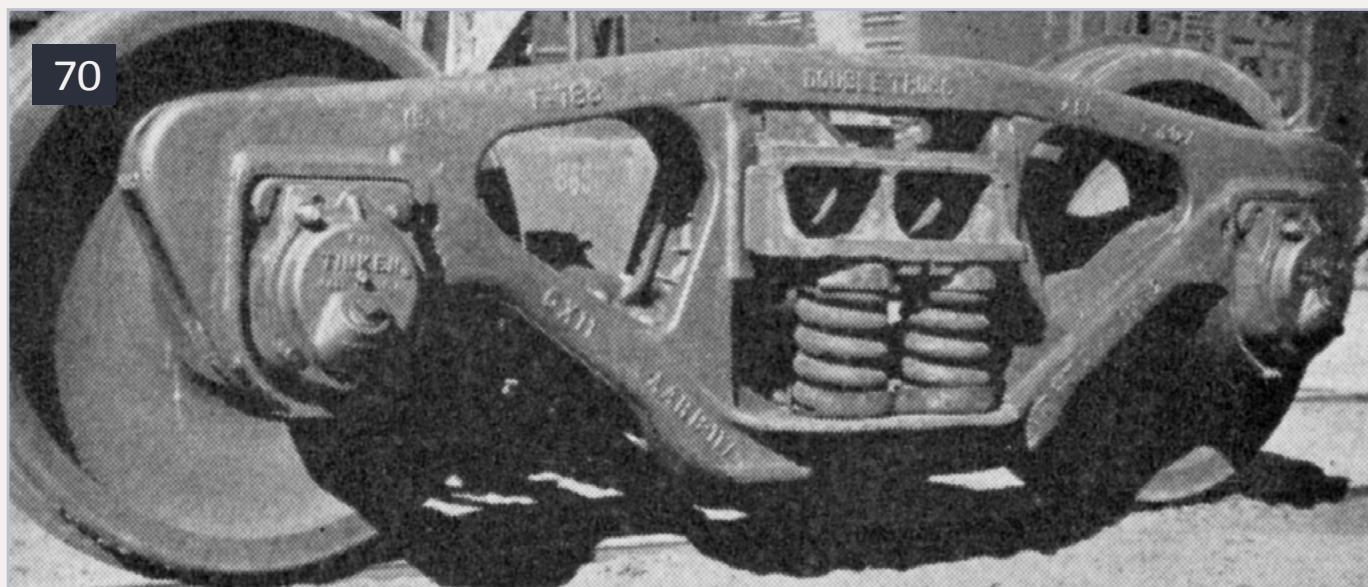

70: Here Timken roller bearings were fitted into an otherwise standard AAR self-aligning spring-plankless double-truss truck.

71

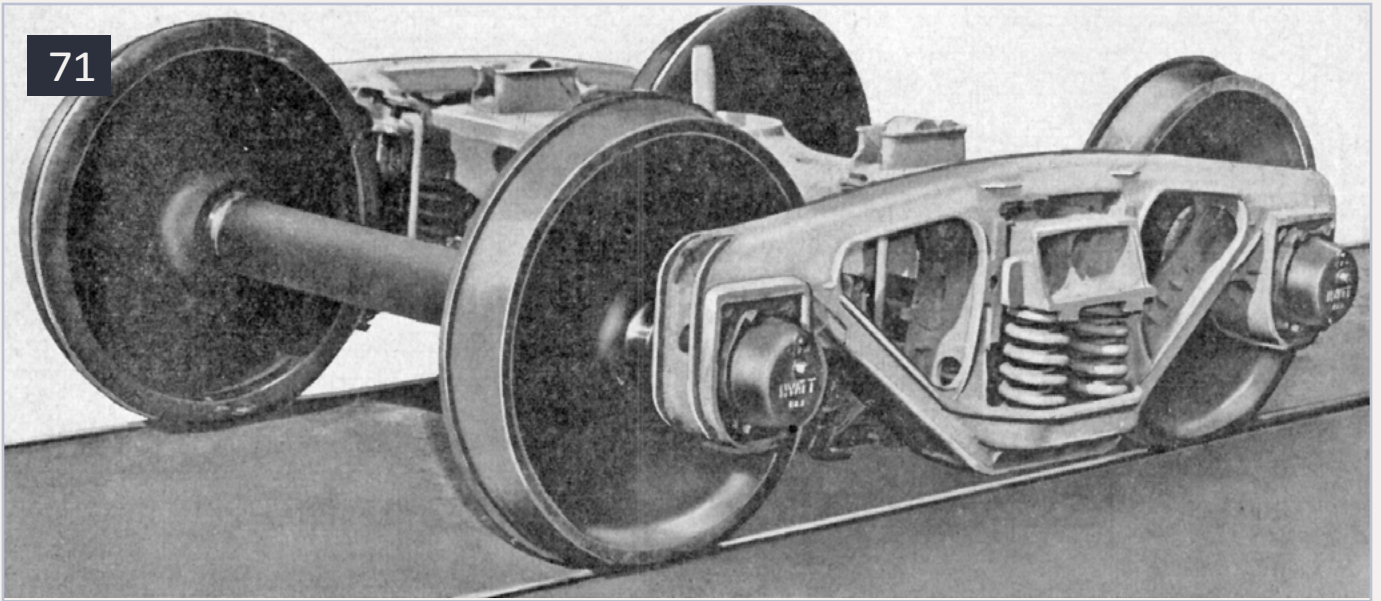

71: An ASF A-3 Ride Control truck reconfigured with pedestal jaws instead of journal boxes to accept Hyatt roller bearings.

manufacturers continue to introduce new freight car trucks. The solution has been to put a description on the Internet which can be revised as often as necessary to keep it current. That description can be found at: docs.google.com/file/d/0Bz_ctrHrDz4wMkpBYUw1RjhmRkE/edit?pli=1.

There is also a good description of available N scale trucks at: model160.com/n-scale-news-blog/freight-car-trucks-in-n-a-pictorial-comparison/.

although I can't say whether it will be kept current.



**Reader
Feedback**
(click here)



contents



index

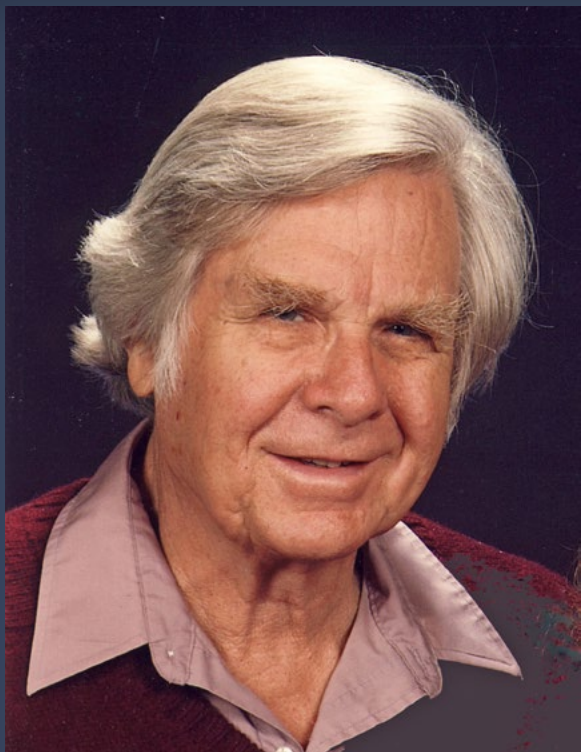

Richard Hendrickson grew up around the Santa Fe Railway in Southern California during and after World War II, when most trains were still steam powered.

Richard has authored or co-authored several books, several hundred periodical articles, and numerous seminar clinics.

When not busy with research and writing activities, Richard works on an operating diorama representing Rivera, CA on the Third District of the Santa Fe's Los Angeles Division in October of 1947.

Since the turn of the century, Richard and his wife Sandra have lived in Ashland, Oregon.



PWRS Club Lounge



PWRS Club Lounge Micro-Trains® Car #2

MILW Stormin Norman 50' Rib Side Boxcar



CLICK HERE FOR **Stormin Norman** 

NOT FOR \$ALE!... at any price!

PORTERS Club Lounge exclusive

PWRS Special Run



Canadian Pacific 40' Boxcar with Coopered Doors 4-pack



2 wood door
2 cardboard door



CLICK HERE FOR **Coopered Door** 

Pacific Western Rail Systems



A One-Turnout Layout



by Lance Mindheim

Photos by the author



1: Facing east at the Entemann's bakery complex in Mami. Beyond the boxcars are vegetable oil tanks. The silo in the distance is most likely for plastic pellets that are used in producing the packaging.

How much layout do you need to accomplish what's important to you, and how much do you *really* need to be satisfied? ...

A layout with only one turnout which offers diverse hour-long operating sessions without “make work” complexity? A layout that could be built in two weekends and then morph into something that provides several years’ worth of craftsman projects?

Is it a gimmick? Absolutely not. It's all a matter of selecting the right theme, understanding prototype operations, and understanding the fact that car spots, not turnouts, drive a layout's operating potential.

The plan below is an almost full-scale rendition of a bakery in Miami serviced by the FEC. Depending on the day, you'll see two to five boxcars, two to four vegetable oil tank cars, and a grain hopper spotted at the plant.

The layout lends itself to numerous 20- to 60-minute solo operating sessions, perhaps several times per week as a means of winding down after a long day. On a complex day of operations, a session would likely stretch longer than an hour.

An hour not long enough or sophisticated enough for you? My guess is that 90% of model railroaders don't operate an hour a YEAR, so let's put things in perspective. Thirty to 60 minutes a night several nights a week would be very rewarding.

Although I haven't seen them work this plant, I'd imagine an inbound train of loads would first pull the entire cut of cars currently spotted, empty or not, and then put them on the sorting track. At that point a protracted series of push/pull moves to “sort the deck” would be employed to re-spot everything. The fact that the crew would have to keep the surrounding streets clear adds another twist. (Note that all railcars are incoming loads/outgoing empties. Outbound product leaves via truck).



contents



index

Track Plan for a One Turnout Layout

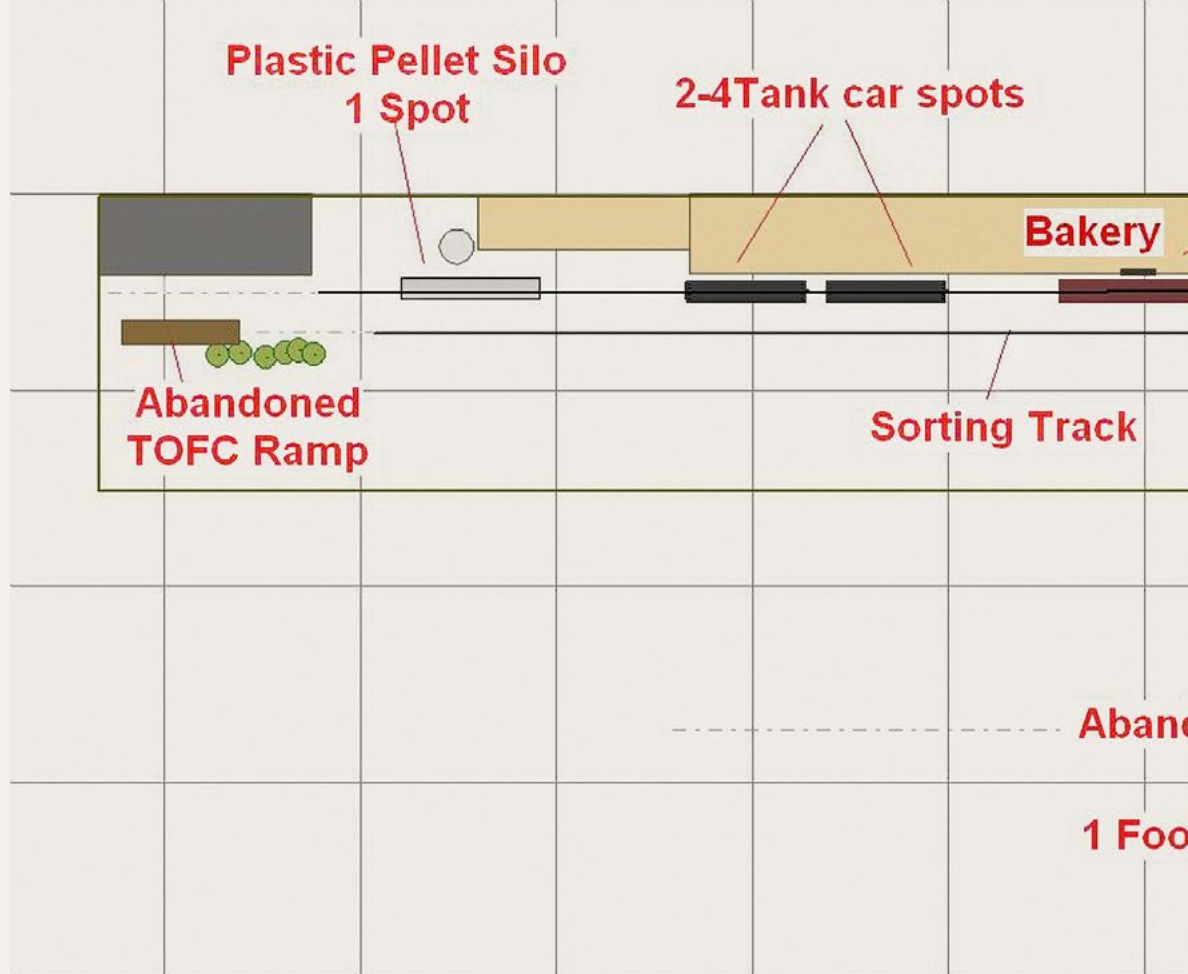

Things are probably tricky most days, in that when an inbound train of loads arrives, some of the cars are empty and need to be pulled, and some are still being unloaded. This means spotted cars that haven't been unloaded yet will need to be pulled and re-spotted.

I would imagine if they run out of space for incoming loads that they are temporarily placed 'off spot' on the sorting track until room clears up. Although I doubt it would be necessary, if you want more diversity you could always backdate and activate some of the abandoned track.

How to build it

If it were me I would approach construction this way: The first weekend, paint the drywall behind the layout sky blue and get the shelf brackets up. The next weekend, mount the hollow core doors and glue 1" thick extruded foam on top of them. After that, tack down some temporary Atlas code 83 track,

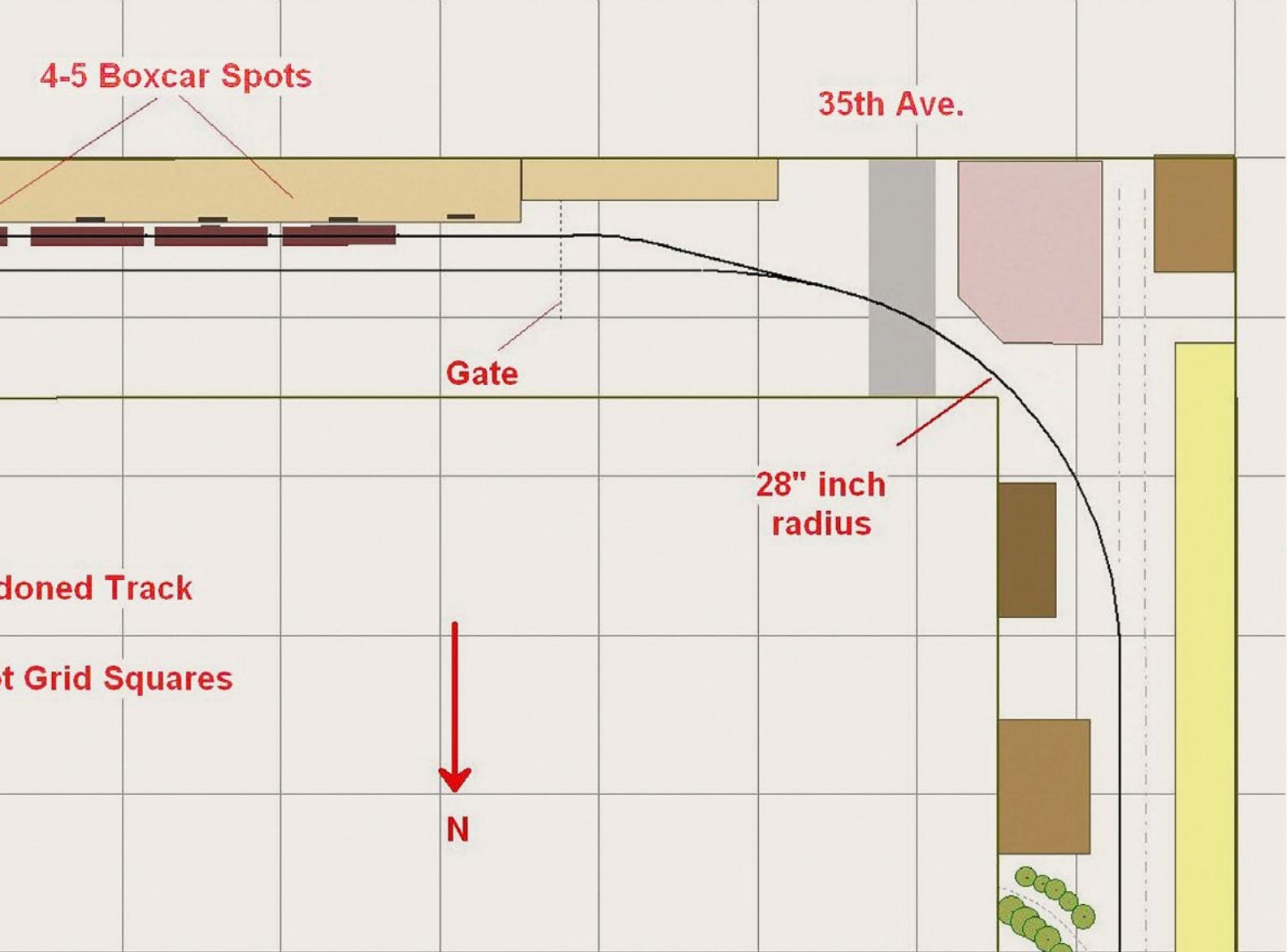

hook up a power pack or DCC system, lay down 3x5 cards for the car spots, and start operating. The cost at this point would be minimal.

Once up and running you could then go back and embark on a full-blown, all-out detail assault, picking projects as the mood strikes you. The beauty of a layout such as this is that it lends itself to a very focused effort without feeling overwhelmed by the pressure of



contents



index

completing vast swaths of real estate. Gradually replace the Atlas track with Micro Engineering a few feet at a time. Scratchbuild the needed structures and super-detail your rolling stock.

Don't laugh, it's a way to have a total blast, a 'grown up' layout, and at virtually no cost. These simple layouts serve the broadest spectrum of modelers, from entry level to those with decades of experience, looking for a highly-focused detail effort that will provide ongoing operations while construction is taking place.

The long leg of the "L" is composed of two 18" wide by 80" long hollow core door blanks for a total length of 160 inches. The short leg is a single 18" by 80" door blank. You could use narrower doors if you choose. Less common narrower widths can be custom ordered from Lowe's at nominal cost if you're willing to wait a few weeks for delivery.

An incoming train would likely start by pulling the entire cut of spotted cars first. That being the case, you need enough track below the turnout to hold the length of the cut plus the length of your incoming train.



Lance Mindheim is the owner of The Shelf Layouts Company (shelflayouts.com), a designer and builder of custom model railroads. He has also published several books about model railroad design and construction, which are available from his website.

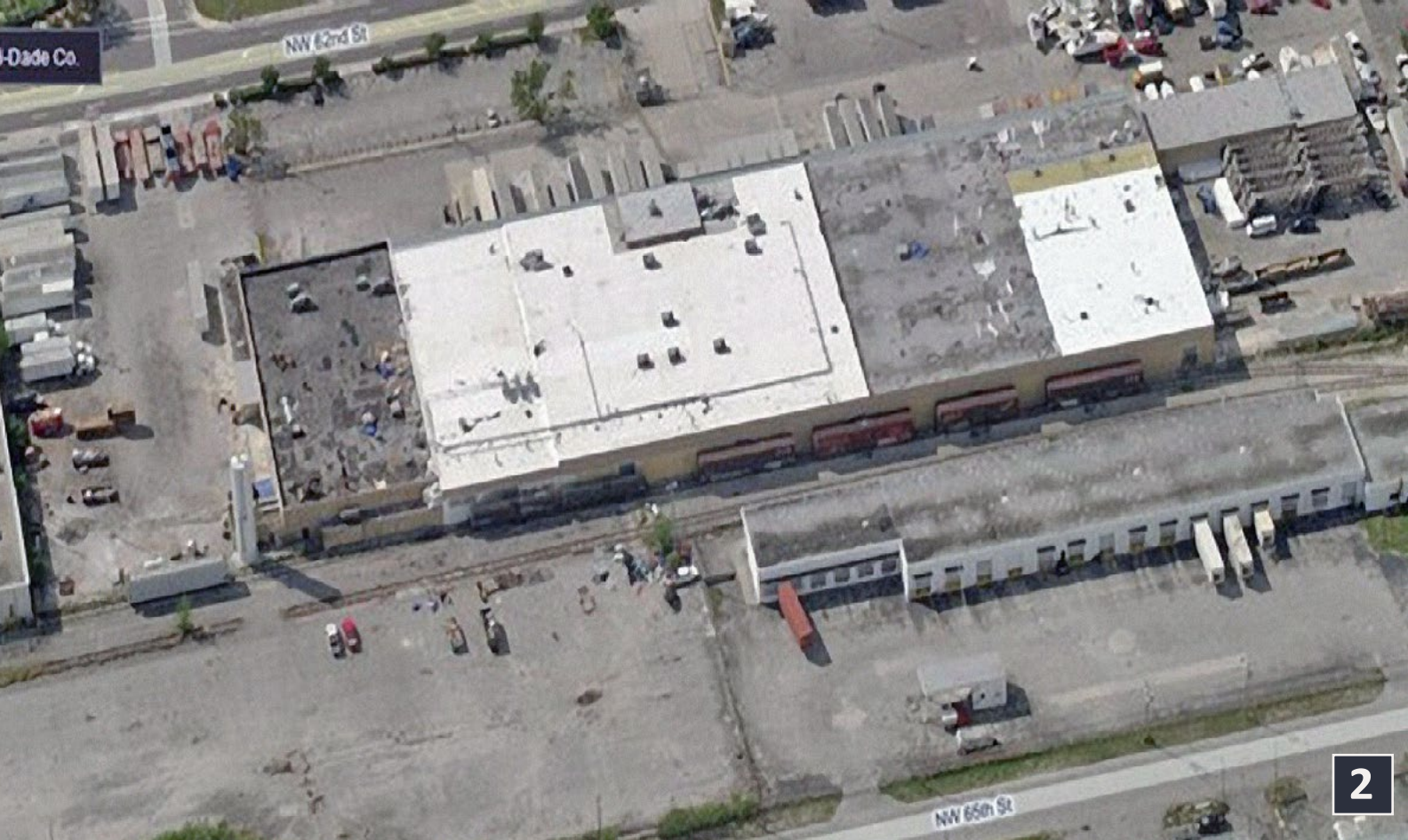

2: From the air, it's easy to see how the various car spots and sorting tracks line up alongside a commercial bakery served by the Florida East Coast railroad in Miami. (Aerial view facing due south.)

Get the Latest Model Railroading News, Tips, Reviews & Opinions

The SCOTTY MASON

S H O W

The Original Model Railroad Podcast

-Monthly Interviews

- Modeler's Spotlight: Top Modeler's Talk
- Narrow Gauge Modeling w/Chris Lane
- Contemporary Modeling w/ Mike Rose

-More Product Announcements & Reviews

 iTunes

Our feed has changed! To get the latest shows, Please search Scotty Mason and subscribe to the new feed!

www.TheModelRailroadPodcast.com

Scott Mason

Jimmy Simmons

Mike Rose

Joe Duckworth



contents



index

Yes, it's a model

**Model Railroad Hobbyist's
monthly photo album**



1: It is hard work hauling heavy tonnages up a 3.3% grade, but the mighty C&O H-8 Allegheny #1641 makes short work of it. Here we see one of these articulated monsters spewing great volumes of steam and smoke. Crandel Overton says "I used photo stacking to get the depth of field, and a colleague used Photoshop™ to add the nice smoke stack effect. I used Sage-light Image Editor™ to create the plume of steam from the mechanical lubricator's heater near the smokestack."





2: John Winters photographed this Pennsy GP-7 #811 as it crossed the city viaduct heading South to Connellsville with an empty string of hoppers on the JDS&E.

The JDS&E went into receivership in the late '20's. The Pennsylvania Railroad seized the opportunity to own a North South bridge route connecting Johnstown with Rockwood. The B&O has trackage rights on the JDS&E, with a connection at Debstergrove to Connellsville.

The GP7 is an Atlas model and is running on a Micro Engineering bridge kit.

We think John's done a great job capturing a gritty urban scene from the mid-20th century with this model scene. The low camera angle adds drama and realism to the photo. This is some excellent modeling and photography, John!



contents



index



3: Thoroughfare Gap Railroad #27 crosses over Short Ravine bridge on Luke Blackbeard's HO scale freelance railroad, located in New Zealand.

Luke says, “Set around the turn of the century, I scratchbuilt the bridge from balsa and stained it with acrylic craft paints. It was inspired by the Central Pacific Railroad's original wooden bridge over Long Ravine near Colfax, California. My version is much shorter and is curved.

“The bridge was covered to protect it from the elements but I wanted to show off the underlying structure so I decided to make a scene showing it being closed in. The two workers on the bridge are from Musket Miniatures and the locomotive is a Bachmann Spectrum 10-wheeler (still awaiting decals for the tender and a little weathering). I built the canyon walls using plaster castings from either Woodland Scenics or home made tin foil molds.”



4: Train 912 with CN SD70M-2 #8005, SD40-2W #5249, ES-44DC #2236 and ONT #1737, take Nairn, Ontario by storm.

Ted Koclya took this photo of train 912 passing the Nairn west siding switch on the Waterloo Region Model Railway Club layout. Here, CP train 912 (Chicago - Sault Ste. Marie - Montreal) has been taken over by modern CN power owned by a club member modelling part of the CN line between North Bay and Toronto. The freights on this line typically run with mixed CN and Ontario Northland power.

All four units are sound-equipped, and provided a spectacle of both sight and sound through this sleepy northern Ontario village.



contents



index



5: Also from New Zealand, Russell Postlewaight sent this photo of Black Creek #4.

Russell says, “I converted this locomotive from a Bachmann On30 2-6-0. I increased the tender body in height with styrene inserts and detailed the deck with coal boards, tool boxes and a new headlight.

“The locomotive had more major surgery, including a complete new cab fabricated from several layers of styrene which I placed further back on the boiler. I built styrene frame extensions under this and added a trailing truck. I installed a pump and headlight from PSC while I added an altered white-metal stack from a New Zealand supplier, which helped change the



outline of the locomotive. The pilot deck and cowcatcher were completely scratch built from brass.

“I painted the engine red and black in an attempt to emulate the colour schemes that were popular on British colonial lines in the first half of the 20th Century. I weathered it following methods outlined in British author Martin Welsh's wonderful book "The Art of Weathering."

“Finally I finished it off with some powders in places which couldn't be easily achieved with paint.”



contents



index



6: Over to Norway, Tore Hjellset posted this photo of a train on its way from Rise Station.

Tore describes the setting: “It’s June 1965...

“...and the privately owned railway company GFB (Grimstad Frolands Banen) is operating a small stretch of track from the Norwegian coastal town of Grimstad up to Rise, some 20 kilometers into the country. There it meets the NSB (Norwegian State Railways) line from Arendal. NSB still runs passenger trains on the Grimstad Line, but all the freight is now handled by the GFB. In real life, the Grimstad Line was closed down in 1961, but in my imagination, and in my layout room, it survived and we're now in 1965.”

To learn more, see grimstadline.blogspot.com



7: Bob Rivard's latest freight car project is this Kadee 50 foot cushion frame box car.

Bob says, “Thanks to fellow modeler Frank Jordan for turning me on to this one. Highball Graphics makes this decal set, F-243. Kadee offers the car in this 1965 paint scheme, however the green is too new for my 1977 modeling era. I removed the lettering and re-painted the car using a more faded PC jade green. The Fallen Flags web site provided the prototype photo of the 18095.

If anyone is interested, you can see my 1977 Soo Line RR on Youtube ([youtube.com/watch?v=ahtuFF8LLQ4](https://www.youtube.com/watch?v=ahtuFF8LLQ4)). The video was wonderfully shot and edited by Douglas Hildebrandt. Last year I replaced my 25 year old Grisswald scratch built signals with ones made by Mark Pruessler of Sheboygan, Wisconsin.



contents



index



8: From Paul Mack: “Early one morning my friend Charlie and I made the trek out to Baynes Valley trestle hoping to catch one of the early morning Haulers. Usually, the valley reverberates to the sounds of Alco 244 prime movers but this morning something very different emerged from the rising fog. SD70MAC said BN on the side and they were huge! After the train passed, I looked at Charlie and whispered, ‘I don't think we're in 1952 any more.’

“Charlie Comstock took the photo of my coal train led by BN SD70MACs on his 1952-era Bear Creek & South Jackson railroad. The photo was assembled in Helicon Focus from about 10 different exposures, each at a different focus point. I added some fog effect and jet contrails using Photoshop Elements.”



9: Now over to France! Doug Dickson sent 2 photos of a standard Great Western Railway HO engine shed he modeled that was built in 1890 at Wallingford terminus in Southern England.

Doug says, "I made the main walls from two layers of .040" and 0.080" card with the acrylic windows sandwiched between them. I make the windows by drawing the outline and glazing bars of the windows onto self-adhesive A4 paper labels which I stick to acrylic sheet and then cut out and peel off the 'glass' area.



contents



index



“The lower exterior walls are strips of cereal packet with the top edges cut at 45 degrees and then covered with Scalescenes texture papers. See: www.scalescenes.com. I glue all card-to-card joints with P.V.A. and I stuck the texture papers down with Pritt-Stick adhesive and rolled it smooth with a wallpaper seam roller.

“Weathering is all artists' pastel, black, medium grey, light brown and white that I scraped onto a saucer and then applied with a soft paintbrush.”



10: While a construction crew replaces a timber trestle with steel and concrete, California Northern #203 creeps by with cut of hoppers at the Shoofly in Sonoma, Ca.

M.C Fujiwara hauled his first Free-moN module (2'x6') into the San Francisco Bay Area open space to shoot under springtime sunlight. M.C. says, “The oak trees take about an hour each, scratched from twisted wire, sawdust-&-white-glue bark, poly-fil and groundfoam, but still are less labor-intensive than the vineyard on the other side of the module!”

M.C. and the other Silicon Valley Free-moN fellows enjoy getting together throughout the year to run long trains through ever-changing layouts.

Follow M.C Fujiwara through the construction and detailing of his first (2'x6') Free-moN module at mrhmag.com/node/7120 .



contents



index



11: Ok, so its clearly not a model, but we all got our start in the hobby somewhere – be it a train set under the christmas tree or something similar. Who knows what future modelers will start with ...



Get your photo here!

Our *Yes, it's a model* monthly photo feature presents some of the most inspiring modeling and photos from the MRH website. If you'd like to get *your modeling* in our photo feature, just start posting your photos on the MRH website, especially in the [Weekend Photo Fun thread](#) created each weekend.

Many of the photos posted show HO modeling, but we'd like to encourage modelers in other scales to post on the MRH website as well. We don't want this to just be an HO photo feature!

For info on how to post photos to our website, [see this help how-to](#). You need to be an MRH subscriber to post photos to our website, and becoming a subscriber is free, [just fill out this form here](#).



MRH's first eBook!

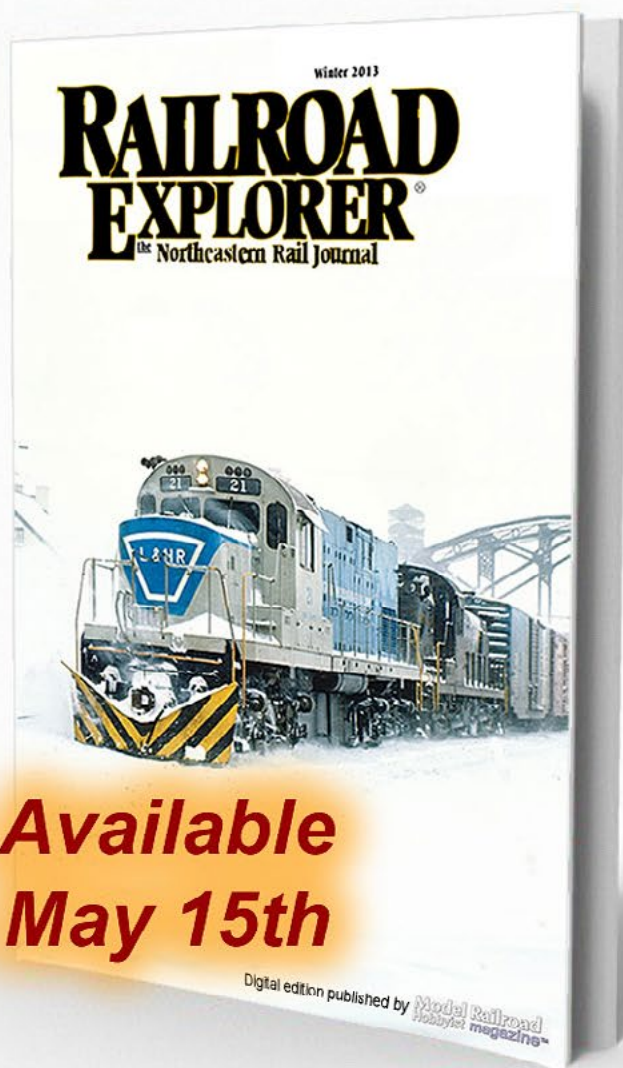

Over 70 pages of awesome northeastern prototype railroad photography ...

No ads! Just tons of great photos.

Get the Download

Formats: PDF - ePub - Kindle \$4.99

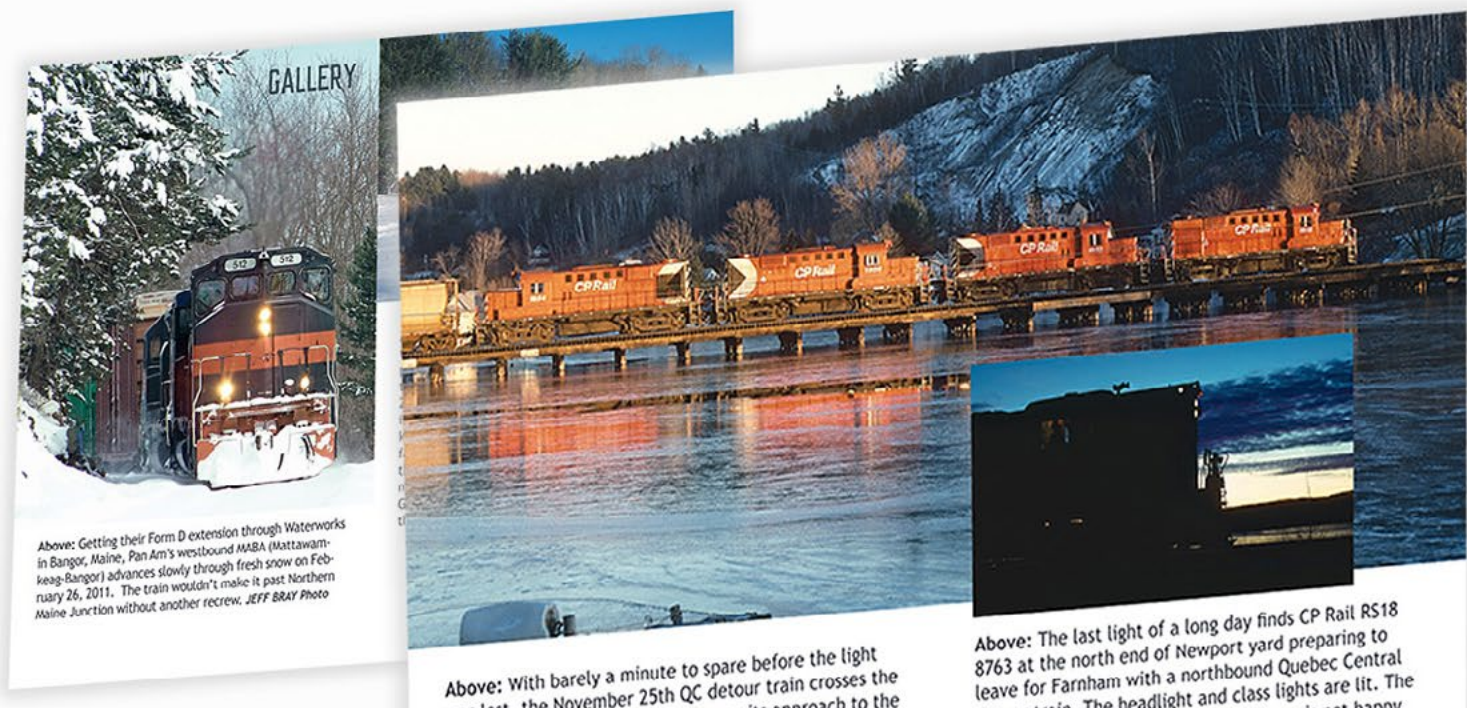

N SCALE 2'X4' LAYOUT FOR \$500

A starter layout you can build for under \$500

by Michael Brown

Second place winner of the MRH \$500 starter layout design challenge contest ...

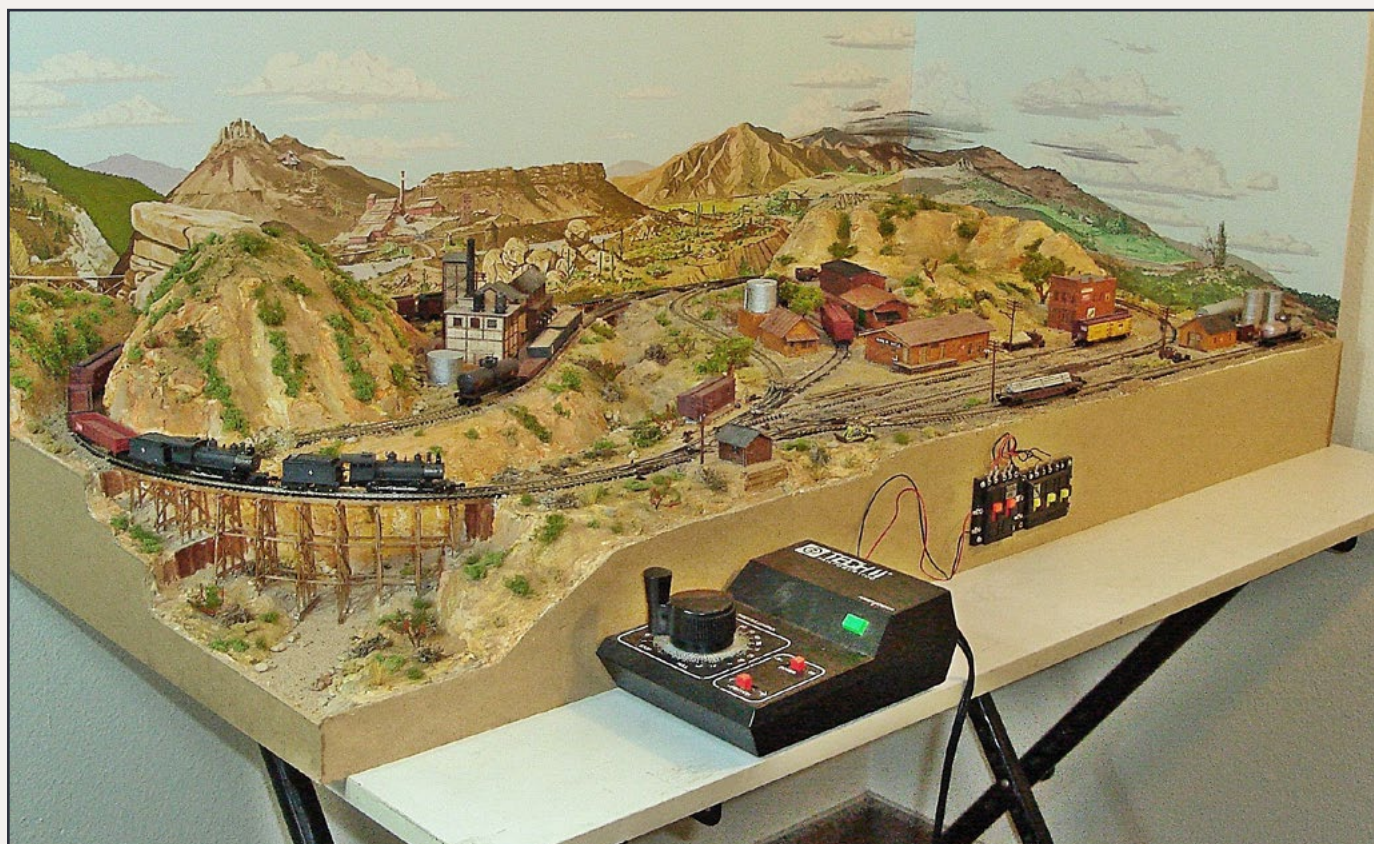

1: Author's 2x4 foot layout. Benchwork and scenery base are made from rigid EPS foam board laminated together. You can do a lot of railroading in 2x4 feet with N scale!

For this contest I thought I would design a beginner's project that everyone could build. Of course, several things affect what type of model



railroad project you can build, such as: money, time, ability, availability of tools, and, importantly, space. With this contest, we know the first criterion; the other variables will vary widely for everyone else.

With this beginner's project, everyone should be able to build it. No power tools will be required. All the materials can be transported in a small car. At a size of 2x4 feet, the layout is portable and can sit on any existing table you have, such as a kitchen table or coffee table. The layout will be made of entirely of rigid EPS (expanded polystyrene) foam. Best of all, we will also be able to meet that important \$500 limit. The basic concept for this model railroad is that it could also be expanded to a larger N scale layout (door size) or a 4x8-foot HO layout if you have the room.

I am sure this contest brings back memories of our first layout for most of us. Like a lot of people, I received a HO layout for Christmas when I was in grade school. We had a ping-pong table in a back room, and that's where I set up my train set, which consisted of a simple oval.

I acquired more equipment and track, and within a few years after reading Model Railroader magazine, I was ready for a permanent layout. I went for approval from my mom and dad for a 4x8 layout, and found they were less than enthusiastic about the idea. That seemed to be the end of my model railroading, and my HO railroad was packed up and stored away. I am sure this story is similar for some aspiring model railroaders.

Not long after that I came across N scale, and suddenly my dreams of a model railroad seemed possible. A 4x8 railroad could be done in 2x4 feet a very achievable goal. Soon I was on my way. I built an open-grid wood frame and used some old



contents



index

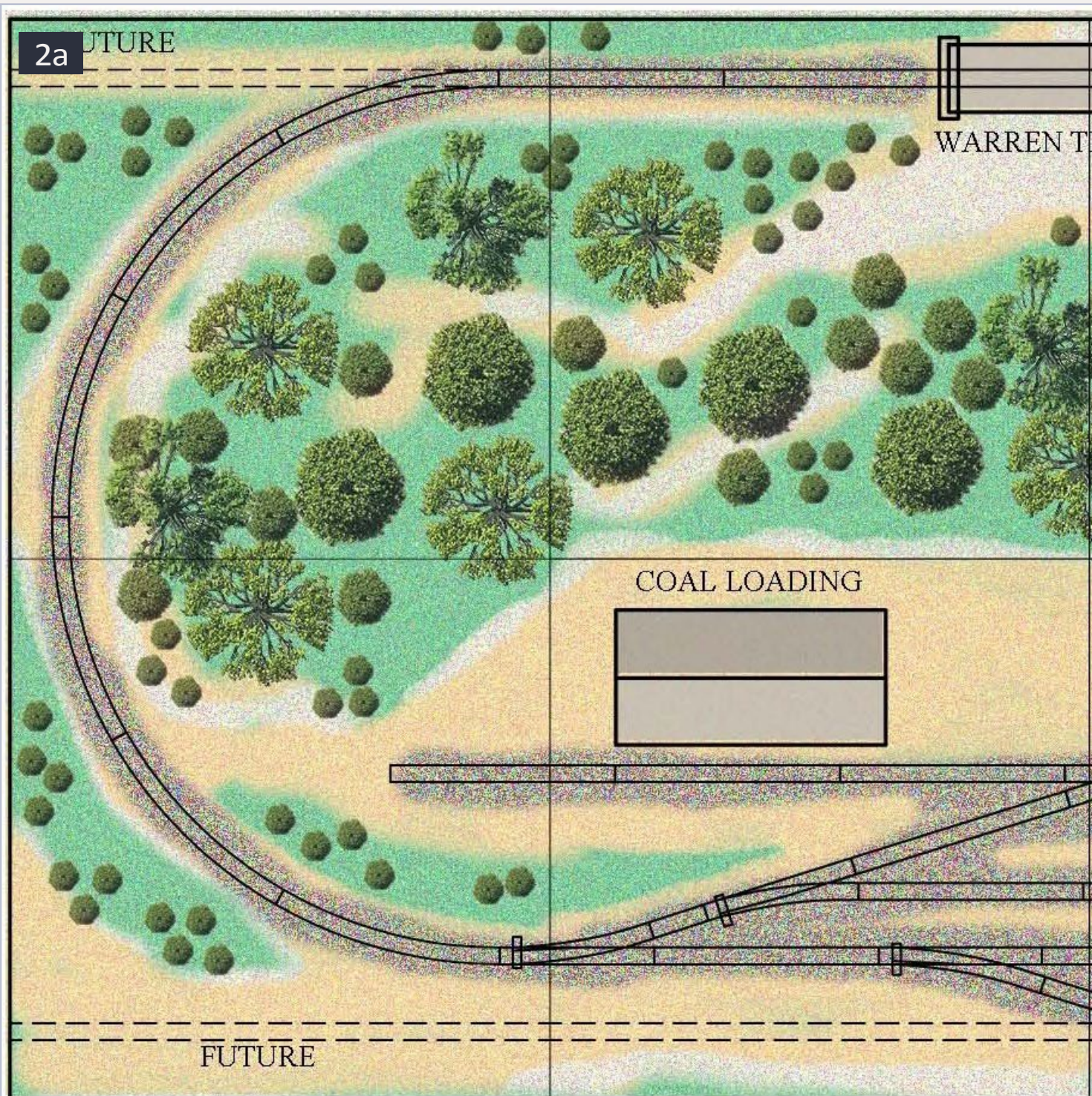

SCALE: N (1:160)

PLAN SIZE: 2'-0" X 4'-0"

MINIMUM RADIUS

MINIMUM TURNOUT

2a. Track plan.



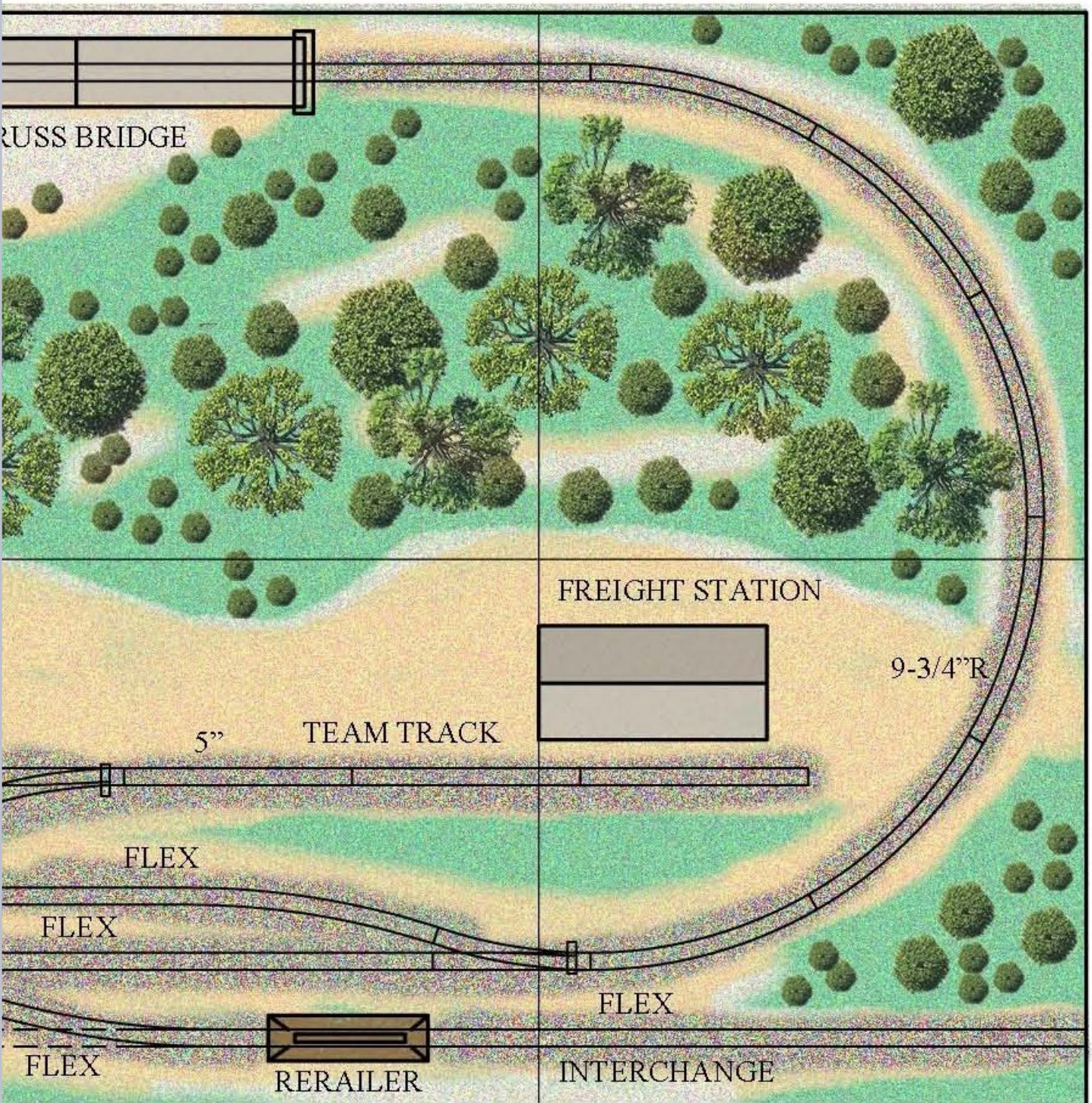

: 9-3/4" TRACK: ATLAS CODE 80
 UT: no. 4 TURNOUTS: PECO C80 SM RADIUS

2b

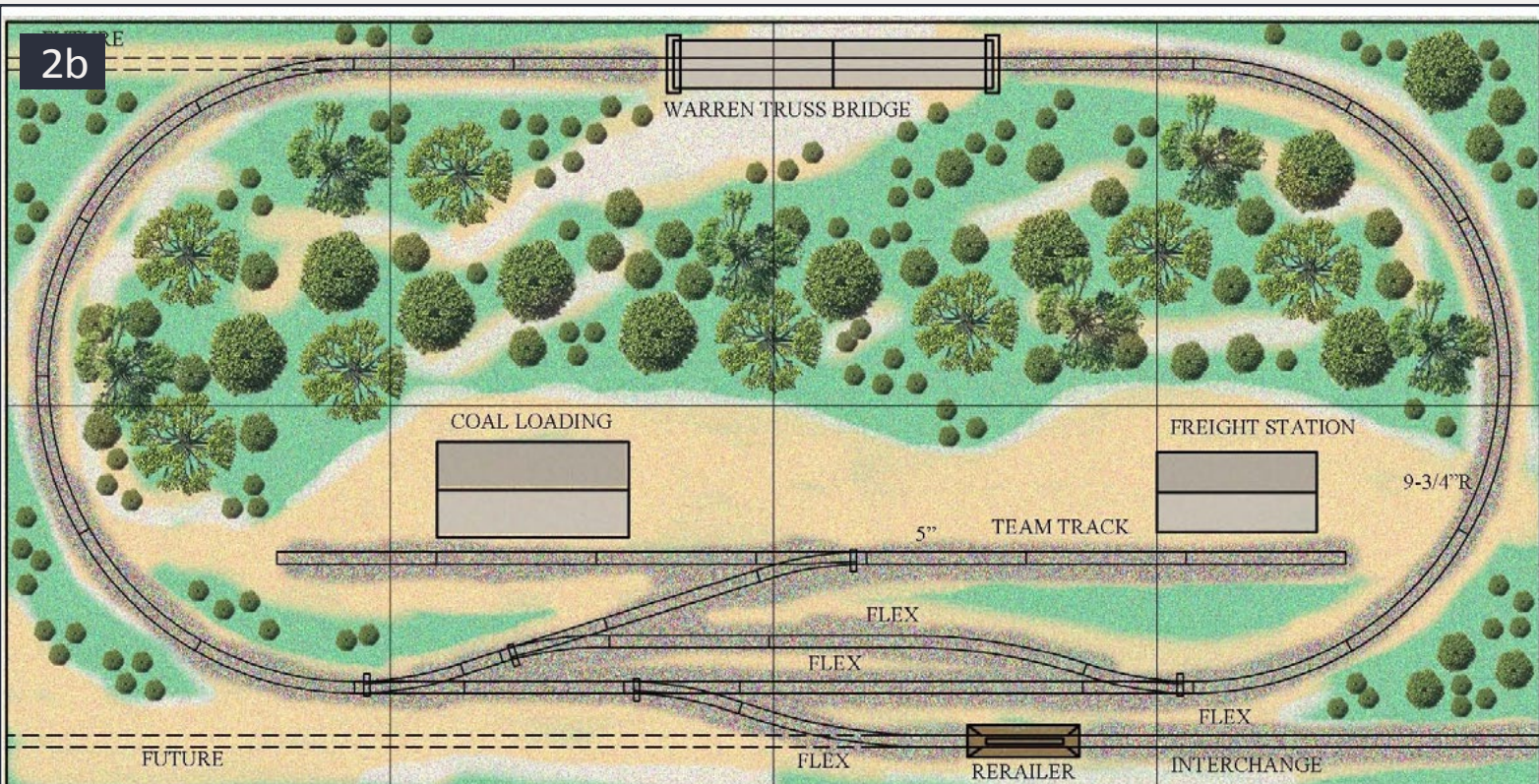

SCALE: N (1:160)

MINIMUM RADIUS: 9-3/4"

TRACK: ATLAS CODE 80

PLAN SIZE: 2'-0" X 4'-0"

MINIMUM TURNOUT: no. 4

TURNOUTS: PECO C80 SM RADIUS

2b. Smaller view of track plan.

drywall and paneling as a sub-roadbed that I could easily cut with a hand saw. The original plan I used wound its way up a mountain with 4% grades, sharp curves, and custom bridges. This, of course, was way beyond my abilities.

I had to start over building a basic oval with a reverse loop, passing siding, and one spur. I used Atlas code 80 flex track and switches over drywall sub-roadbed attached to my wood frame. I installed some hard-shell scenery with a few trees with lichens, and some sawdust I had dyed green. I purchased a few plastic structures, and I was finished. I was enormously proud of my first layout.

Soon I was off to college and I had little time for model railroads, and eventually the layout was disposed of. But that was



not the end of model railroading for me. I learned a lot from my first project, and I have gone on to build several small N scale railroads over the years. Included is a picture of my latest project, the N scale Deep Creek Railroad. My railroad was just completed this year. As I read about this \$500 contest, I thought that the techniques I used to construct it would be useful for a beginner's first model railroad project.

To obtain my bill of materials, I used the Internet such as eBay and Caboose Hobbies (my old hometown of Denver). You can find some good deals on Amazon or eBay for individual items, but you will need to pay shipping, which can add up quickly. A few large orders from online hobby stores will save on shipping costs. Locally (Las Vegas, NV), I used Home Depot and a local hobby shop called Hobby Town USA, which is a national chain. (See Bill of Materials on the following pages.)

The Trains

The first thing you will need is a train set. Most of us are introduced to the hobby with a train set, so that's a good place to begin. For this project, I suggest an Atlas N scale Trainman set. This will be a good nucleus for your layout. You will get a GP15 locomotive, three cars, caboose, and a power pack. The locomotive is DCC-ready, should you decide to go that route in the future. The set comes in Union Pacific, CSX or BN road names. The Atlas Trainman looks like a decent-quality train set, and provides you with important components you need to get started.

The Track Plan

For a beginner's layout in 2'x4' I would use a simple oval which gives you a display and test track, features I like. I put a small yard at the front of the layout, such as the John Allen Time



contents



index

Saver, which includes a passing siding, spur, and a switchback. The layout track has no grades. You can vary the terrain so it will be above and below track level. If you want to build the layout in a larger size, you will not have walkaround control, so all switching will be conveniently in front of you. See the plan in figures 2a and 2b.

Bill of materials

Benchwork & Sub-base

Description	Qty	Price	Total	Manufacturer	Source
24x4.8x1.5" foam base	2	\$4.32	\$8.64	Home Depot	Home Depot
Spray Paint	1	\$3.17	\$3.17	Krylon	Walmart
24x20x34 Boxes	2	\$7.95	\$15.90	U-haul	U-haul
Hard Board	1	\$3.97	\$3.97	Home Depot	Home Depot

Track & Controls

Description	Qty	Price	Total	Manufacturer	Source
Terminal Rail Joiners	2	\$3.58	\$7.16	Atlas	Hobbyshop
Insulated RailJoiners	1	\$1.68	\$1.68	Atlas	Hobbyshop
RailJoiners	1	\$3.08	\$3.08	Atlas	Hobbyshop
5" straight (6)	2	\$3.66	\$7.32	Atlas	Hobbyshop
9-3/4" Radius (6)	2	\$3.66	\$7.32	Atlas	Hobbyshop
Flex track	2	\$3.88	\$7.76	Atlas	Hobbyshop
Switches	5	\$15.68	\$78.40	Atlas	Hobbyshop
Rix Uncoupling tool	1	\$3.21	\$3.21	Rix	Hobbyshop
Model Power Wire	1	\$4.49	\$4.49	ModelPower	Hobbyshop
connector	1	\$8.76	\$8.76	Atlas	Hobbyshop
Track details	1	\$4.58	\$4.58	Atlas	Hobbyshop
Cork Road bed	8	\$0.99	\$7.92	Midwest	Hobbyshop



For the switches, we will use Peco C-80 small-radius turn-outs, which are compact and have an insulated frog to simplify wiring. The switches are power-routing and sprung, so they require no ground throws, and can be thrown easily with your finger. For uncoupling, we will use a Rix uncoupling tool, so no magnets are required. Wiring will be simple, with just

Structures

Description	Qty	Price	Total	Manufacturer	Source
Sand & Gravel	1	\$18.74	\$ 19.99	ModelPower	Hobbyshop
AMB General Station	1	\$19.99	\$ 19.99	Later Kit	Hobbyshop
Warren Truss Bridge 5"	2	\$ 6.08	\$ 12.16	Atlas	Hobbyshop
Bridge Pier Set (5pc)	1	\$10.88	\$ 10.88	Atlas	Hobbyshop

Trains

Description	Qty	Price	Total	Manufacturer	Source
Trainman UP Set	1	\$127.99	\$127.99	Atlas	Hobbyshop
Freight Cars.40' Box	2	\$9.09	\$18.18	Atlas Trainman	Hobbyshop

Scenery

Description	Qty	Price	Total	Manufacturer	Source
Complete Landscape Kit	1	\$34.50	\$34.50	Woodland Scenics	Hobbyshop
Hydrocal	1	\$6.48	\$6.48	Plaster of Paris	Home Depot
Wood Glue	1	\$2.47	\$2.47	Elmers	Walmart
Acrylic Paint	2	\$1.49	\$2.98	Delta Dream Coat	Walmart
Rubber Cement	1	\$1.88	\$1.88	Elmers	Walmart
Rock Molds	1	\$7.50	\$7.50	Woodland Scenics	Hobbyshop

Total: \$454.34



contents



index

two feeds on the oval in front of the switches. You can install electrical blocks if you want. If I were to expand operations, I would go with DCC control.

For a theme, keep it simple. Scenery from around your hometown is a great place to start. The track plan depicts a small town with a coal loading, a team track, and also an interchange track. The team track and interchange track can handle a wide variety of cars. A small layout like this is best operated with 40' or 50' freight cars.

Benchwork

Benchwork all will be EPS foam board. No wood is used. Where I live in Las Vegas, Home Depot is the only place where 2'x4' foam insulation board (white bead board) is sold. Extruded foam board such as the pink and blue are much stronger, but they are generally not sold to the public here, and are used by roofing contractors only. For our purposes, EPS foam board will work fine.

Foam provides a very dimensionally-stable benchwork. It does not expand or contract with temperature or humidity. It comes in two thicknesses: 1-1/2" and 2". Also, the foam has a plastic wrap on its outer faces that will need to be removed. You can peel it off, but sometimes this can be a tedious process. You will start with a base foam board of 2x4 feet. Next determine how far you want to go below track level. Then laminate as many foam boards to your base sheet as you will need to get the desired depth.

Cut out any areas you want to go below track level with a key-hole saw before you glue the foam together; do not cut your base sheet. I use a yellow wood glue to glue the foam sheets together. Any foam cut out can be used for land forms above track level.

If you have no table, you can set the layout on two 20x24x36 moving boxes from U-Haul, (wardrobe boxes), which you can paint black for a more cosmetic look. With this method you could scale up the layout to approximately a door-size or 4x8 with little change in cost. I would use 4'x8' foam cut down to the desired size, and laminated together. The resulting layout will weigh a lot less and be more portable than using a hollow-core door or plywood. If you want to use this method for a 4x8 layout glue a couple of 1x2 wood stringers underneath the foam to provide enough support.

The foam boards laminated together become very strong. Glue any excess foam to the top of your layout to form hills. The foam can be carved into whatever landform shapes you desire. I generally do this with a keyhole saw. This is very messy process, so keep a garbage can and vacuum close by.

When done with the carving the shapes, cover the foam with wet paper strips, and then cover those with plaster. You will have a very strong layout, and the foam is a good base to insert trees into later. The last step is to buy a sheet of hardboard and cut out a fascia that you can glue to the sides of your foam board for a finished look.

Track

The track is determined by the turnouts we will use. For such a small layout, I would use Peco code 80 small-radius turnout with insulated frogs. These small turnouts are only 3-1/2" long with a 12" radius through the turnout.

These are power-routing with insulated frogs, so they require no special wiring. The switches are also sprung so they can be flipped with your finger, so no special turnout controls are needed. For track, I would use the old standard – Atlas Code



contents



index

80 snap track and flex track. Since installing curves is the hardest part, I used sectional track with 5" straight pieces. For odd sections I used flex track. Although code 55 track would look better, the compact small radius switches are not available in code 55. For our sub-roadbed, we will use Midwest Products cork glued to the foam. I generally glue the cork down and hold with push pins until dry. We can attach the track with Atlas

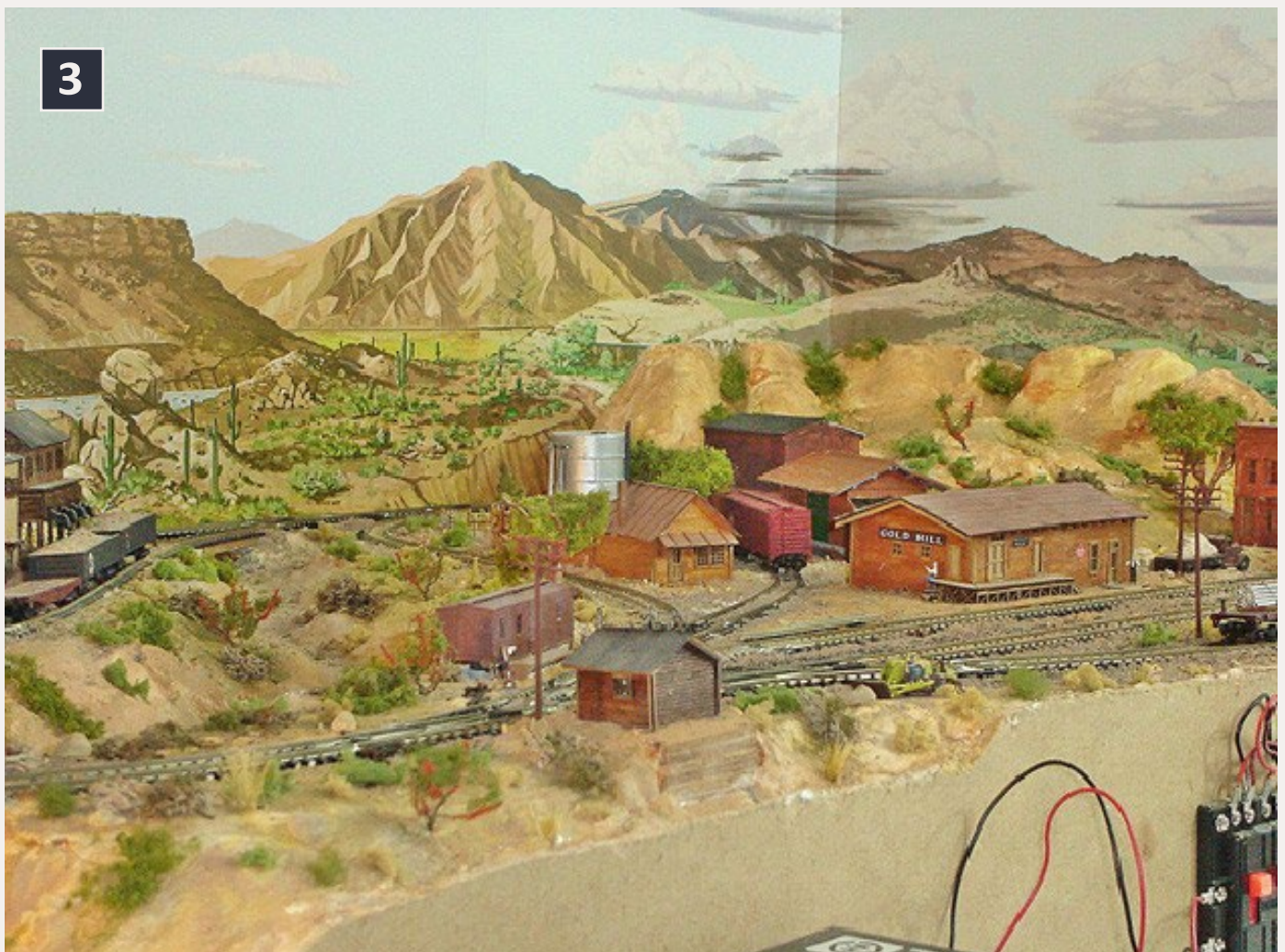

3: The Deep Creek Railroad is the theme for this small N scale railroad. The Deep Creek Railroad ran from Wendover, Utah 45 miles south to the Deep Creek Mountains and the mining town of GoldHill, Utah. A small N scale model railroad like this makes a good beginner's project.

track nails and glue. If you want any electrical blocks, use Atlas controllers, which you can attach to the front hardboard fascia.

Scenery & Structures

There is a small ridge down the middle of the layout to divide it into two scenes. One side is the industrial area and town, and the other side is scenery. I use water-based acrylic paints to color the plaster, which I bought at Wal-Mart. For landscaping, I selected a Woodland Scenics Landscape Kit, which includes directions and all the supplies you need to landscape the layout.

For structures, I have an AMB general-service building wood laser kit and a Model Power Stone & Gravel built-up plastic kit. The general-service building will become our freight depot. I used the Sand and Gravel kit for a coal-loading station. Also, I have included a couple of Atlas steel Warren truss bridges. Whatever theme you use, you can substitute buildings of your choice.

Many of the structures of Model Power are around the same price. The layout could be expanded with a larger yard and more industry. There are also several points the line can be extended to form a larger layout, when space and finances become available.

Conclusion

This model railroad will provide you with a basic layout to get started with. Of course, many elements of the layout you probably would want to upgrade over time. A backdrop adds a lot to a small layout. In thinking over this contest, I concluded that a lot of interesting layouts could be built in a variety of sizes



contents



index

and scales. I have tried building shelf and small switching layouts , but they don't appeal to me personally.

After more than 30 years in the hobby, I think that the 4x8 HO layout or 2x4 N layout plans are still the best way to get started in the hobby. A functional and interesting layout can be built without becoming an overwhelming project. HO definitely is the most popular scale to work in. The problem for most people is finding enough real estate. Also, having all the power tools you would need for a traditional wood table would be difficult for some of us.

N scale reduces the 4x8 railroad to a manageable size for almost anyone. There are a few things you need to know about N scale. The cost of working in N scale is virtually the same as HO scale. You could scale-up my plan to HO scale and it would cost the about the same or slightly less than N scale. Also, working in N scale probably will take you the same amount of time as in HO scale.

In short, if you like the 4x8 layout concept but lack the room, or maybe just want a small beginner's project to try first, a foam 2x4-foot N scale layout could be the answer.



\$500 Starter Layout Contest Rules

Here are the rules for the \$500 Starter Layout Challenge Contest we ran from August to November of 2012.

- You have a \$500 total budget.
- Assume basic tools: hammer, saw, drill, screwdriver, scissors, single-edged razor blades, soldering iron.





Michael Brown grew up in Colorado where he developed a deep appreciation for railroads, old mining towns and Western history. Riding narrow gauge trains and researching them became a hobby for him.

Upon moving to Nevada, Michael became interested in Nevada's railroads and history. Michael has written books on western history

that you can purchase on Amazon.

Michael works for a general building contractor in Las Vegas. He enjoys hiking, camping, model railroading and also plays banjo in a local bluegrass band.

- Assume advanced tools like a table saw, router, or lathe are NOT available
- Must design an operating layout or module (continuous running optional).
- Include a shopping list not exceeding \$500 - must cover benchwork, road-bed, track, wiring, control system, rolling stock, locos, structures, and scenery.
- Common items listed on the web like eBay or Yahoo train yard sale okay.
- Thinking outside the box encouraged.



contents



index



– Don Hanley
Model Photos by the author



The ERIE Railroad Boxcars Part 2

Not having a particular model available need not be a problem. Build most any car body you need with these techniques ...

In part 1, I covered the history of the Erie boxcars from these four different number sequences: 75000-75499, 75500-75999, 76000-76499, and 76500-76999. I also outlined my approach of building masters of each car series car side, end and underbody.

This allows me to cast as many copies of these parts as I need to construct my



Erie car fleet. Not having commercial models available doesn't keep me from getting an accurate car fleet for my planned 1950s Erie layout.

In part 2, I pick up where I left off, first with step 7a to finish off the floor for the 76500 car. Then I move on to building the masters for the roof. In part 3 next issue, I will do the end masters, then move into the casting process and finish up with how I assembled, detailed, and painted/decaled the cars.

1: The photo that started this odyssey, Erie 76185 and 76638 at Mansfield OH. Note the difference in the cars. Erie 76185 has a solid side sill with an interior height of 9'-3" and 76638 has the tabs along the sides with an interior height of 9'-4". (Author's collection and used with permission of George Elwood Fallen Flags Railroad Photos).

Advertisement

Interested in O Scale?

THE

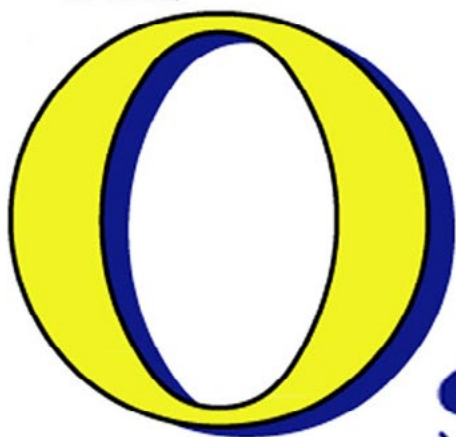

SCALE

RESOURCE ©

www.oscaleresource.com

Listings of O Scale manufacturers, dealers, and suppliers.



contents



index

STEP 7A: The Floor and Under Frame 76500 – 76999 Series

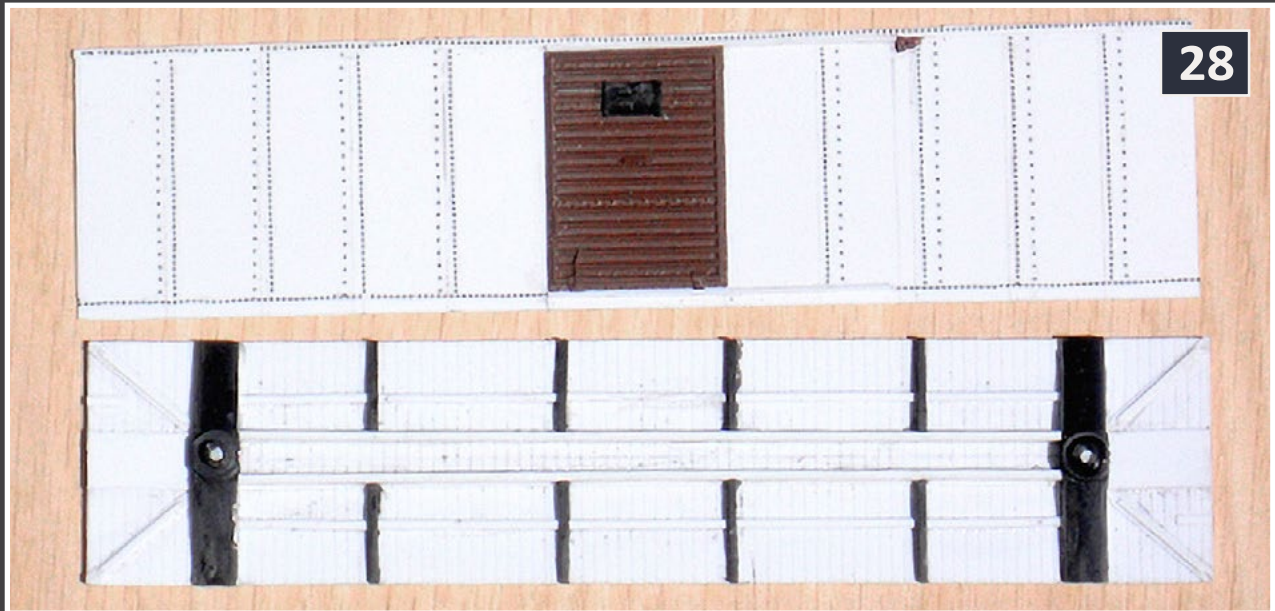

28: I followed the same procedure for this floor and frame as on the previous series of cars, except that the cross bearers need to line up with the tabs on the car sides. To make sure that I had everything lined up properly, I lightly cemented the cross-bearers in place and double-checked them against the sides.

I also flipped the sides over to verify that the tabs and the cross bearers lined up on *both* sides. I wanted to make sure that it didn't matter which car side was attached to which side of the floor.

Everything lined up as planned. Now with the floors completed, it's on to the next phase of the project.

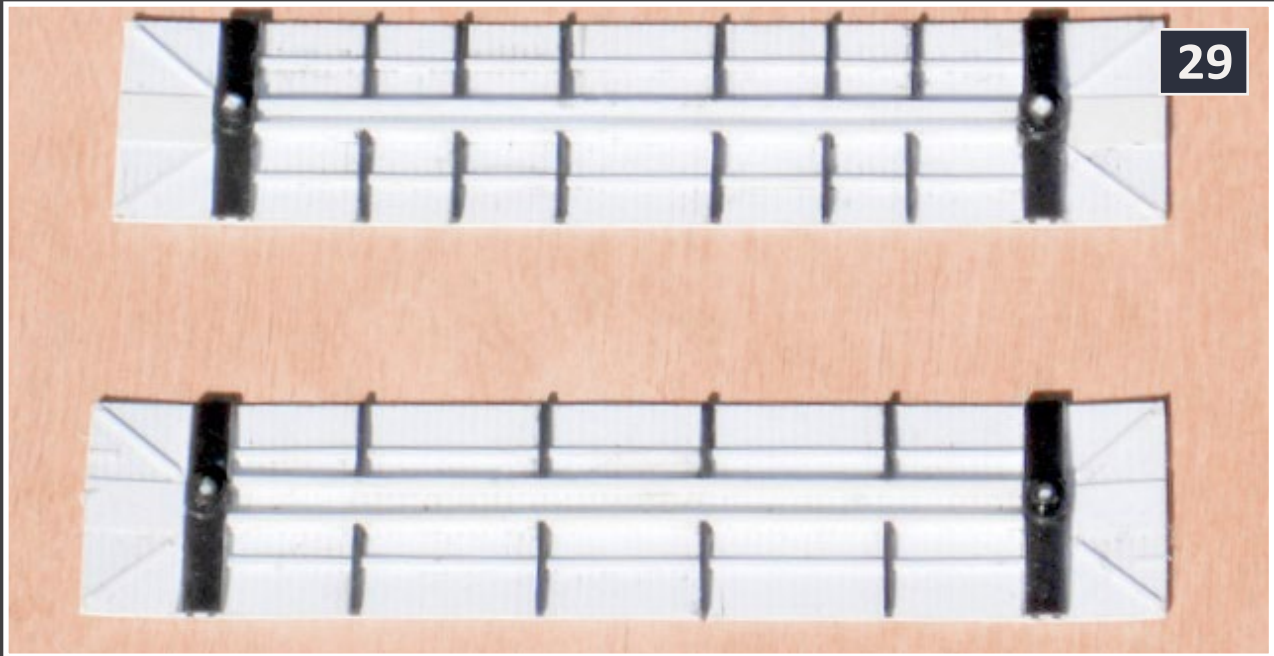

29: Here's a comparison of the underframes. The upper frame is used for the 75000-76499 series of cars with the straight side sill.

The lower frame is to be used on the 76500-76599 series of cars with the tabbed side sill.



STEP 8: The Radial Roof for the 76500 – 76999 Series *Continued ...*



30: Now to determine, or guesstimate of the size of the roof needed. In studying the photo of Erie 75893, and knowing that the rivet spacing is

approximately 2", I began counting rivets. Yes, the dreaded rivet counter! Anyway, it looks like the roof sets in approximately 2" from the side of the car.

From the freight car diagram, the width over the sills is 9'-4 ³/₄". That information, along with my guesstimate on the offset, I came up with 9' for the roof. I used masking tape to mark the edge of the cuts needed to reduce the width of the roof.

The tape provided a better line to follow than a pencil line does. My experience has been that the plastic lost from the width of the X-acto saw tends to cover over the pencil line and make it harder to see.

STEP 8: The Radial Roof for the 76500 – 76999 Series *Continued ...*

31



32

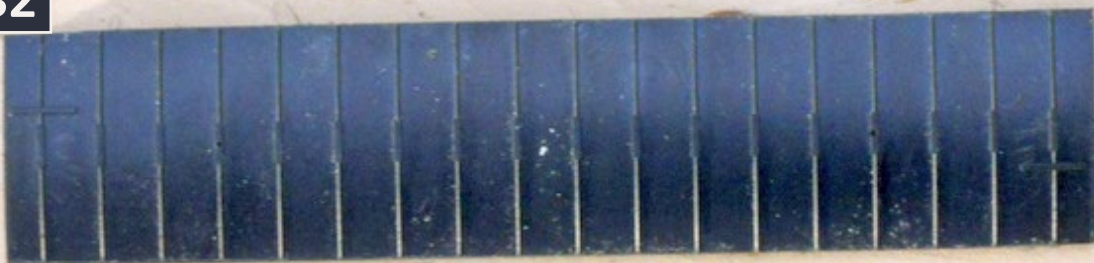

31: The Central Valley roof, trimmed down to the proper width.

32: Next comes determining the length. I measured the thickness of my ends and the length of the sides of the car. To have the same inset on the ends as the sides, the roof needs to be 40' long. This makes the final dimensions of the roof 9'-0" wide and 40'-0". I tapped off the ends and made the necessary cuts to reduce the length of the roof. Remember the old saying, "measure twice, cut once", well I didn't and I had to pay the price! I had an error in my measurements, which I discovered after the cutting was done and the ribs were sanded off. I was 12" short on my measurement.



contents



index

STEP 8: The Radial Roof for the 76500 – 76999 Series *Continued ...*

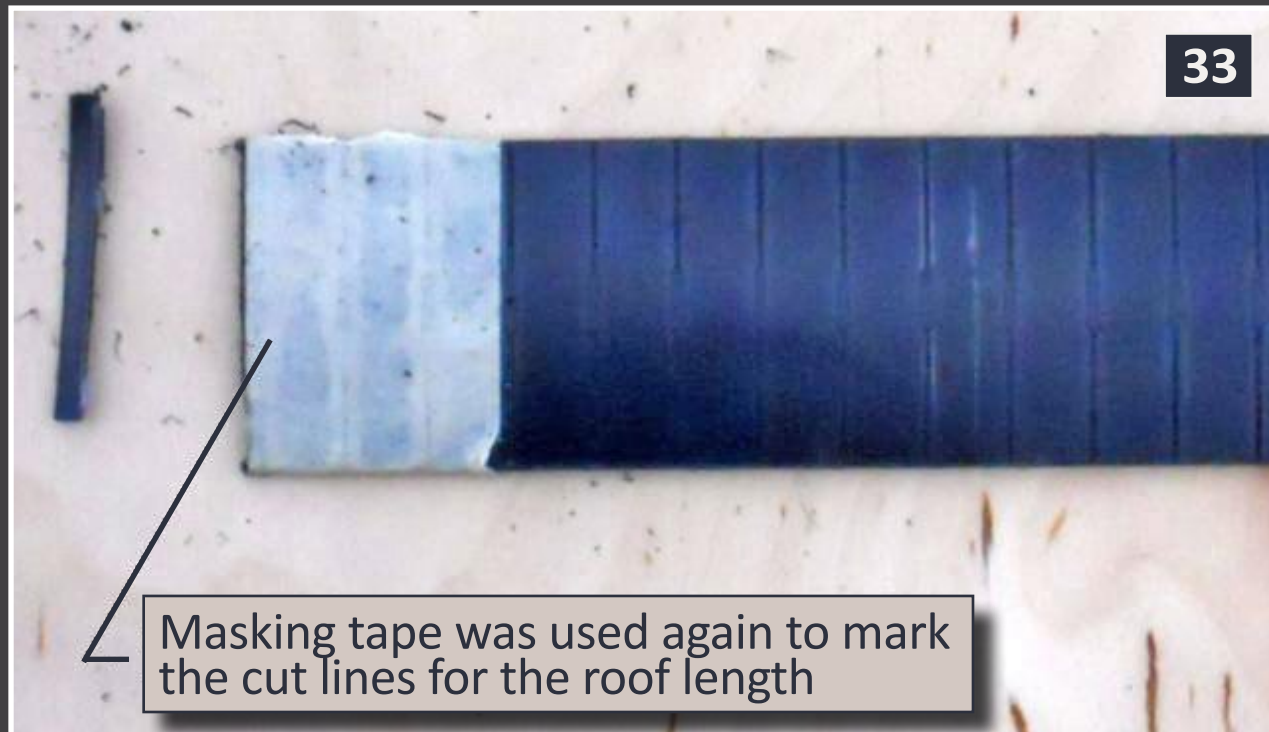

33: Next, I began sanding off all of the existing ribs and the extensions under the roof with 220 grit sandpaper. Once all of the ribs were removed, I used 400 grit wet dry sandpaper to produce a nice smooth surface. When doing this type of work I like to use a little water with the sanding. In my opinion, it helps to polish the plastic and remove any scratches.

STEP 8: The Radial Roof for the 76500 – 76999 Series *Continued ...*

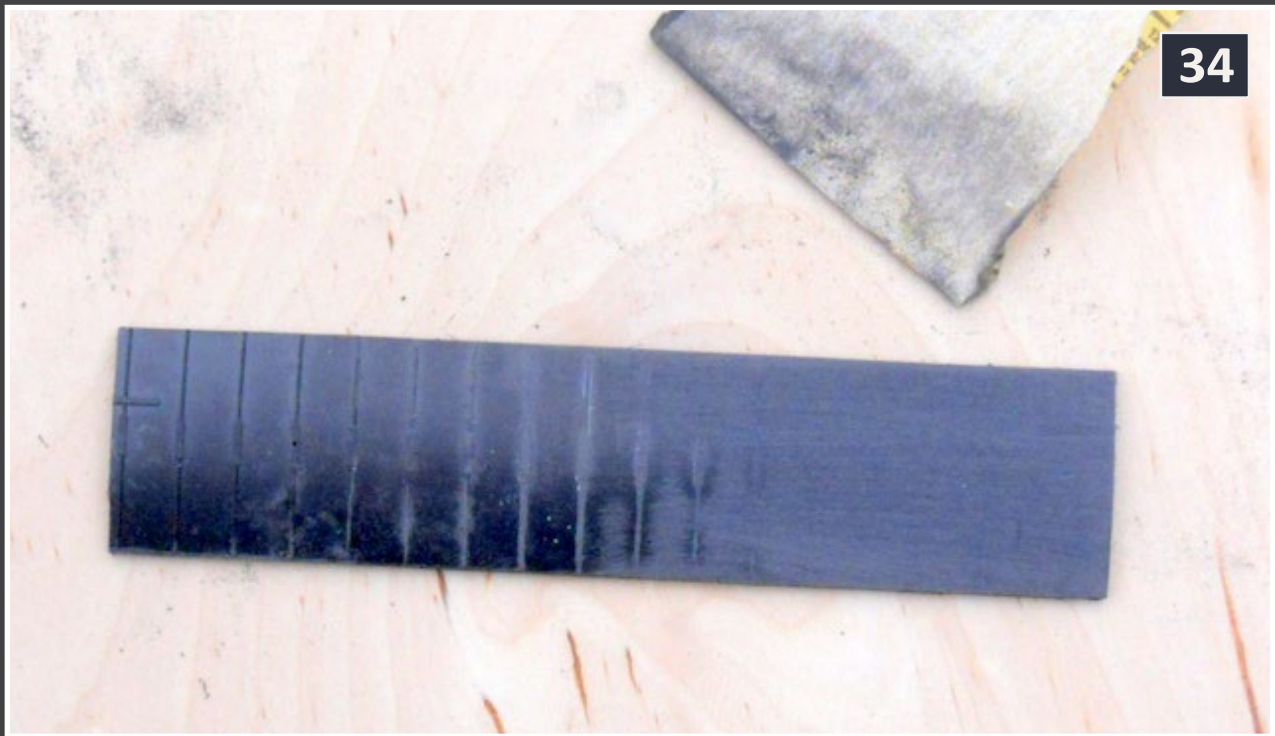

34: It was shortly after this point in the project that I discovered I had cut the roof too short and it needed to be lengthened. To correct the error I added 6" of styrene to each end and sanded it to match the arc of the roof. Not a big problem, but it's one of those things that happens every now and then!

The Central Valley stock car roof has had the extensions added and a final re-sanding with the 440 grit wet / dry sandpaper to polish it. With the sanding completed, I can begin adding the ribs.



contents



index

STEP 8A: Adding the Major Ribs



35: Next I needed to determine the spacing of the major ribs. In studying the photo of Erie 72893 (which provides a good view of the roof), I determined one rib sits in the exact center of the car end-to-end.

Next, I counted rivets (yes, I'm doing it *again*) and came up with a width of 20" from the edge of the roof to the edge of the first rib. That dimension also puts the rib under the running board corner that leads to the ladder down the side of the car.

All this counting and measuring gave me three reference points, so I marked these points with a pencil line. When cementing these ribs in place, I took extra care to make sure that they were square with the roof, since the rest of the ribs will be built off of these.

I cemented 1" x 6" strips of styrene at these locations. Starting in the center, I made sure that I was equal distance from each edge of the roof to each edge of the 1" x 6". I followed up with the outside ribs working the same methodology. Measuring in from the end of the roof to the edge of the 1" x 6" and also between the center rib and the outer rib.

STEP 8A: Adding the Major Ribs *Continued ...*

With the ends and the center set, I measured the distance between the 1" x 6" and found it was 17'-3". I divided by 2 to come up with the distance to the center of the rib which is 8'-8". I then subtracted 3" from that dimension which yielded 8'-5" This is the distance between the edges of the ribs.

Once the mid-point rib bases were placed, there are two rib bases to be placed in between all of the ribs. As I cemented the ribs down I used my calipers to make sure that the distance was equal for the length of the roof. I found it's easy to get a piece skewed a bit, so this is a good check.

I followed the same procedure at the ends, except I divided the distance by 3 since there are 2 ribs in this space. This time I needed to subtract 12" from the distance, the width of 2 ribs, generating a distance of 29" between the rib bases.

Again I used the calipers to make sure that the ribs were equal distance as I cemented them in place. When I finished, I had a 29" spacing between all the rib bases.



contents



index

STEP 8A: Adding the Major Ribs

The center rib is cemented in to place on one side of the roof. It will be pulled over the roof after the others are in place

36

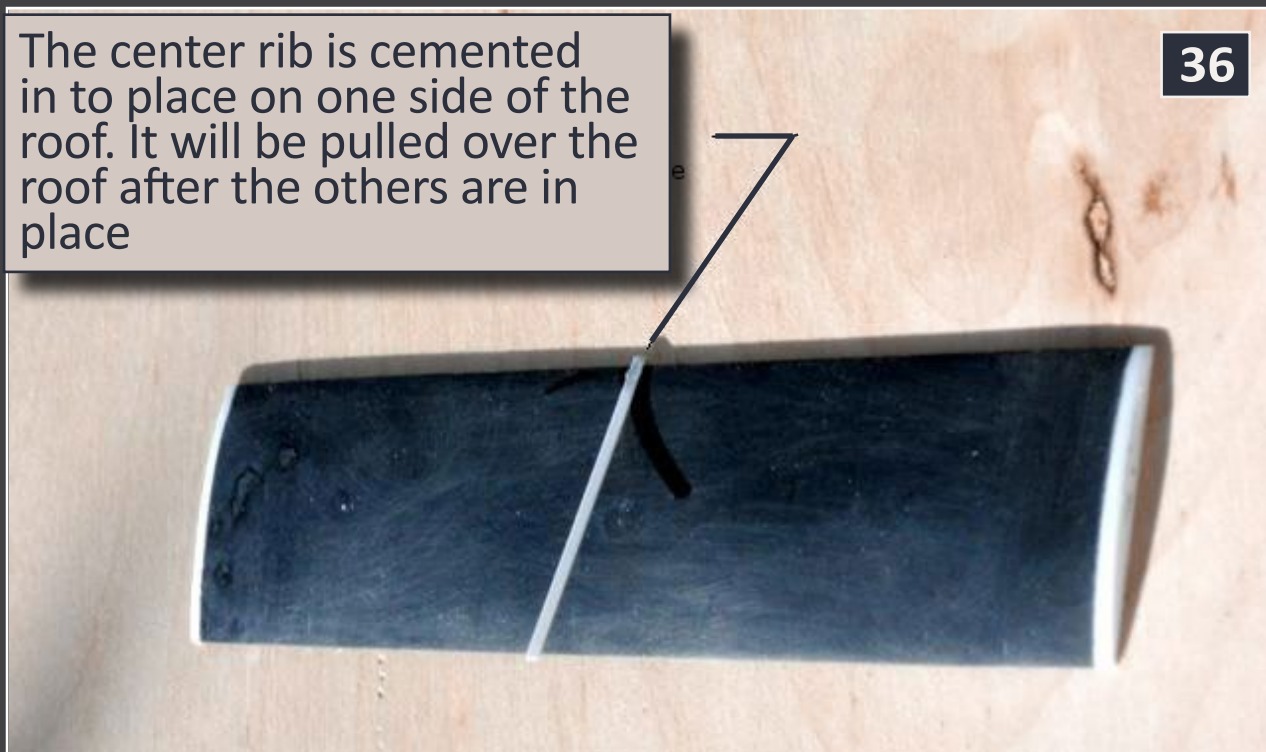

36: When cementing these ribs down, I discovered that it is best to cement one side down first and let it set. After the cement set, I pulled the rib over to the other side of the roof, applying cement as I worked my way across the roof. I also made the pieces longer than needed and trimmed them to length later.

STEP 8A: Adding the Major Ribs *Continued ...*

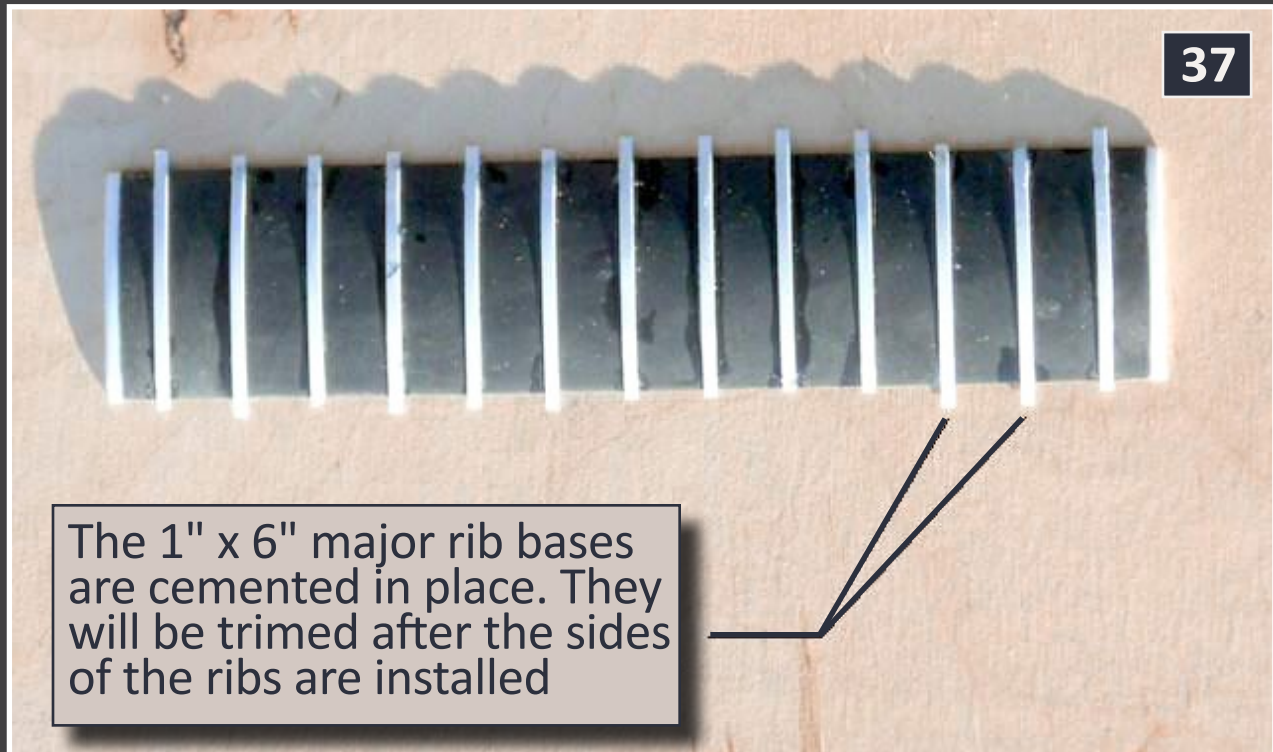

37: The base of the ribs continues down over the sides of the roof. I cut 26 pieces of 1" x 6" approximately 12" long (see 38). I really didn't care about the length because they will be trimmed.

Once all of these side pieces were cemented to the side and had dried I trimmed everything to length. After trimming, the edges are still rough, plus they need to be slightly rounded over. A little work with a file and and I achieved the desired effect.



contents



index

STEP 8A: Adding the Major Ribbs *Continued ...*

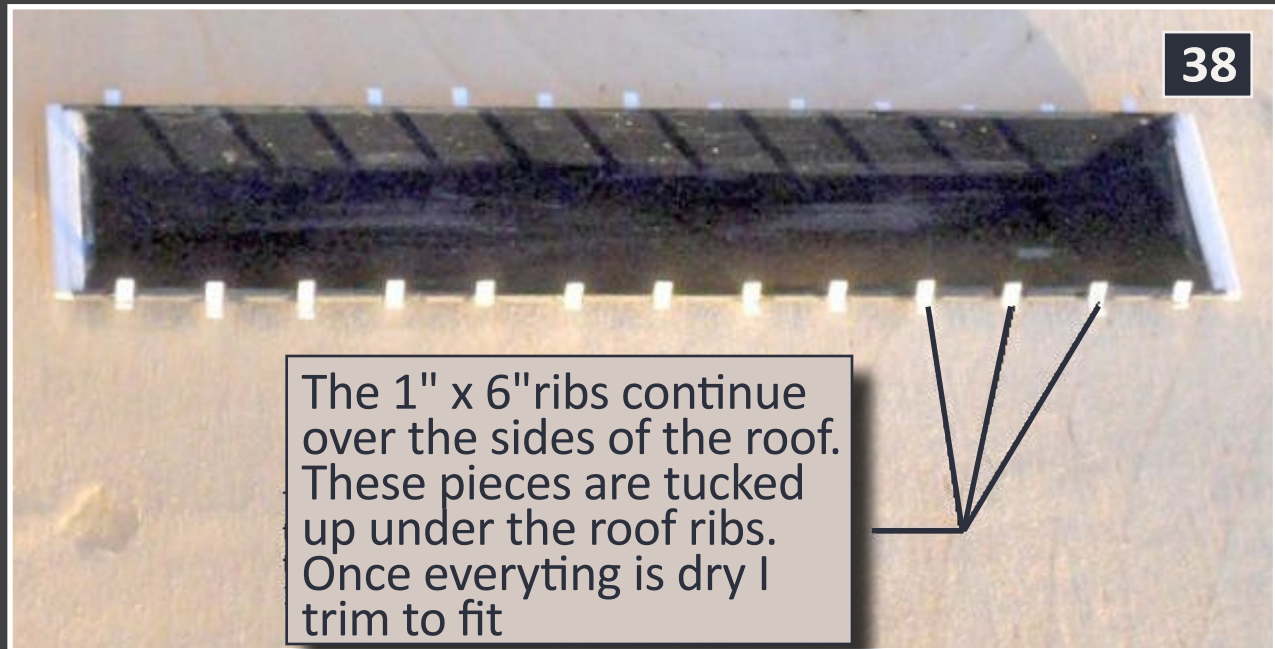

38: It's on to the vertical top portion of the roof ribs. I measured in 4" and drew a line parallel with each side. This line marks the limits of the vertical "top rib" that sits on top of the 1" x 6". For this top rib I cut 2" x 2" stock. I also cut these long since I would be trimming them in place. These were centered over the 1" x 6" pieces that form the base of the ribs.

Again I cemented one end into place and let it dry. Once it had set, I pulled the stock down and worked my way across the roof to the other side. I just used my eye and a pair of tweezers to center these. It really worked out well.

Once all of the ribs had dried, I trimmed them to the 4" line that I had previously marked. When trimming the pieces I cut them down vertically. This produces the slight angle as seen in the photo of Erie 72893.

STEP 8A: Adding the Major Ribs *Continued ...*

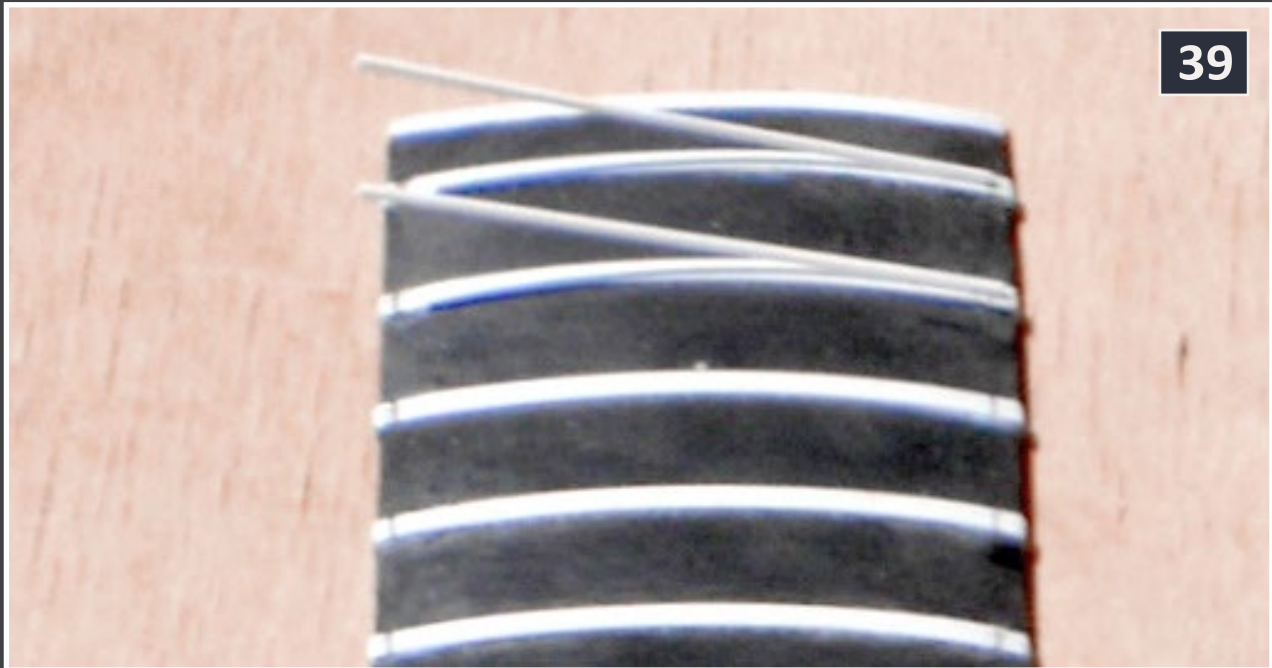

39: Next, I cemented the risers for the roof walk in place (see 40). The risers are 2" x 2" x 21" in length. I located the center of the roof and then measured over $\frac{1}{2}$ the length of the risers and marked the location for the edge of the riser.

With the work completed so far its beginning to look like a finished roof. But it's not done just yet.



contents



index

STEP 8B: The Minor Ribs and Rivet Detail

40

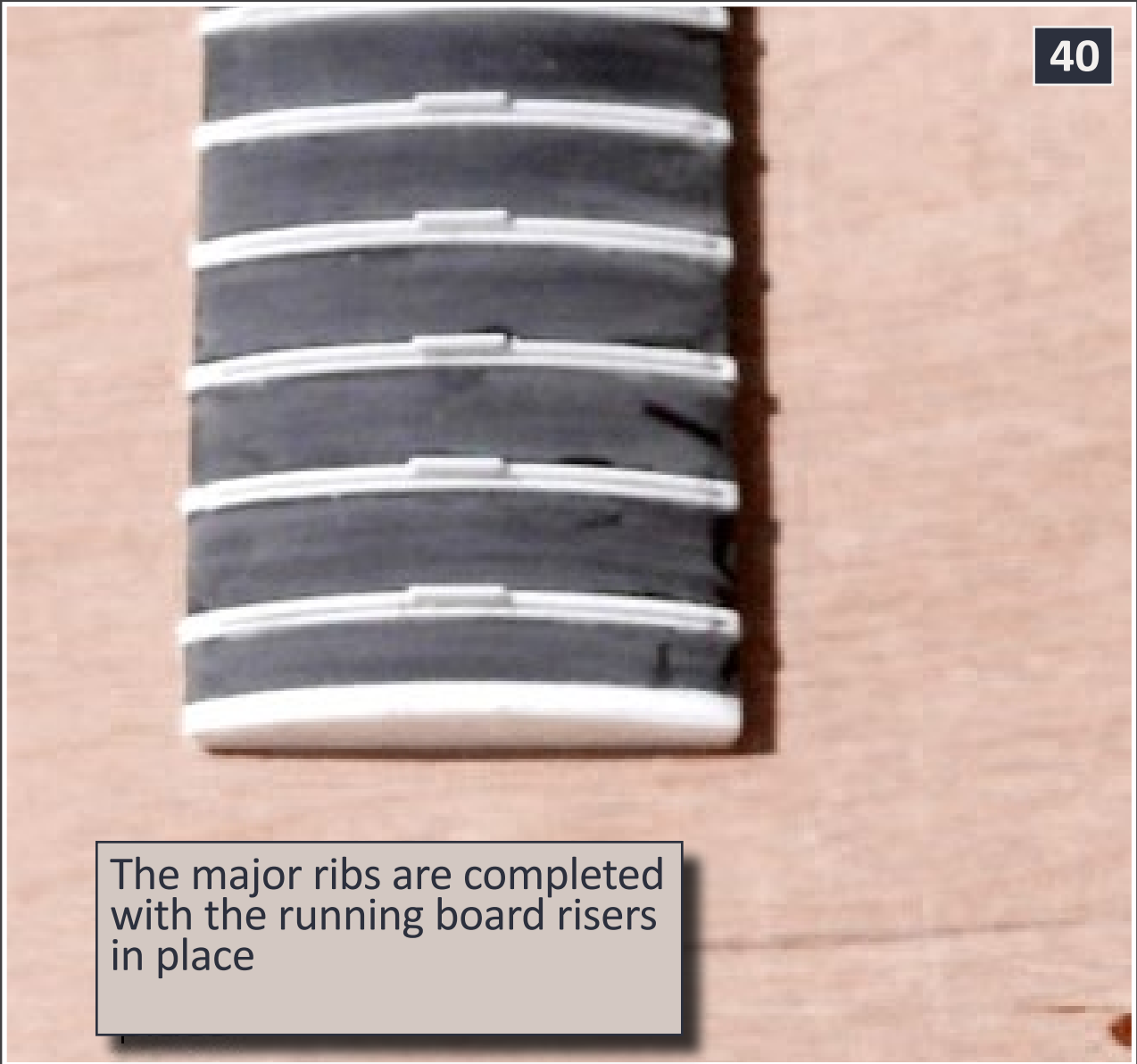

The major ribs are completed with the running board risers in place

40: Also in reviewing the photo of Erie 75893, you will notice that there are 2 minor ribs in between each of the major ribs. I could see two options for creating these. One was to use .010-diameter brass wire from Detail Associates, or the other was to use .010-diameter styrene rod from Plastruct. I chose the latter. After all, it seemed easier since it was styrene to styrene and I could use solvent.

STEP 8B: The Minor Ribs and Rivet Detail *Continued ...*

I cut the stock a little long so I could trim the pieces after they were cemented in place. It also provided me an area to grab onto with the tweezers to pull the rod down over the side, ensuring that it was snug the entire length of the roof.

I set my calipers to 8-3/4", which gave me 3 equal spaces. I used the same procedure as on the major ribs, getting one end cemented in place and set first, then pulling the rod over to cement the other end. I checked each piece with the calipers as I placed them, doing a little nudging to get them into final position before the solvent had set.

Again, back to the photo as the guide, the roof on these cars sets up a bit from the body. There is also a line of rivets along this step up, as well as along the major ribs of the roof. Yes, there are rivets on the roof, too.

To raise the roof above the car body I cemented 4" x 6" stock under each roof side and then filled in the ends with 4" x 6" stock. I made sure that the cuts are clean and that everything fits snugly.

Finally, it's time to decal on the roof rivets. The rivets are alongside the base of each of the major ribs, and on the 4" riser for the roof. I began by cutting sections of the rivet decals a little long for the roof. I could get 2 pieces out of each strip with the left-over being used on the 1" x 4".



STEP 8B: The Minor Ribs and Rivet Detail *Continued ...*

I discovered that placing black rivets decals on a black surface is a bit of a challenge. When I do this again, I would paint the roof a gray color to make this step easier. I made sure that the rivet strip was snug with the ribs by pushing it up against the rib base with the small paintbrush that I use to put on the Solvaset.

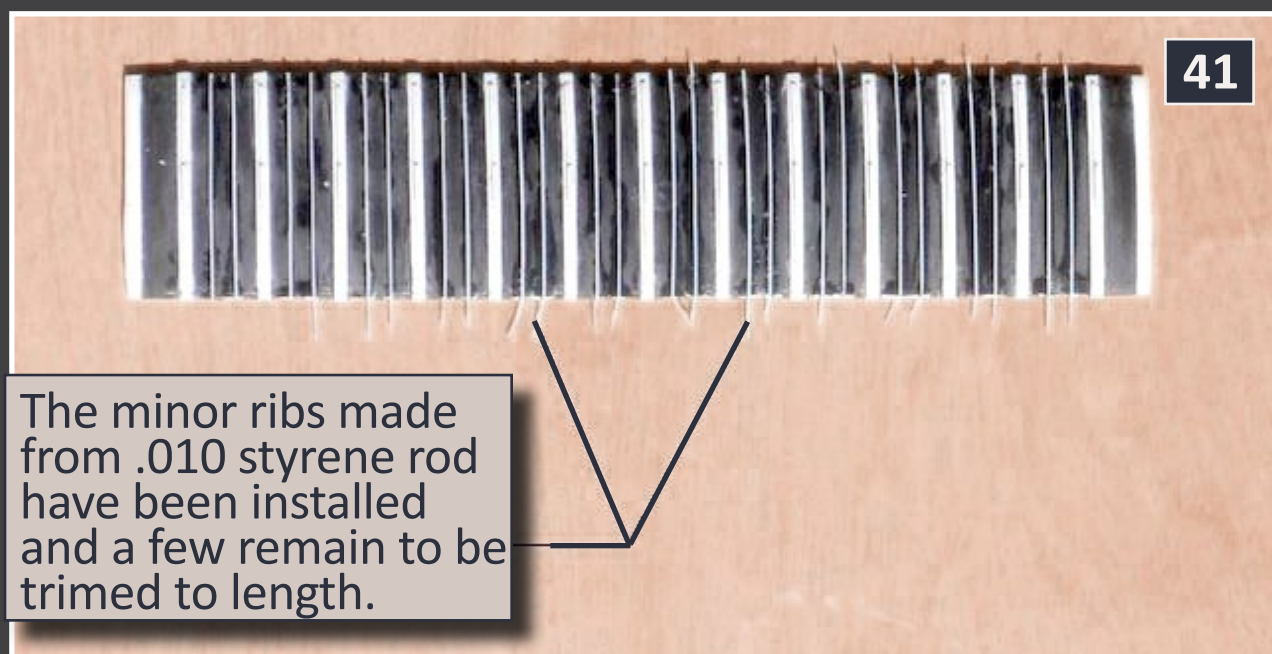

After rivet decals were set, I sprayed the roof with Floquil high gloss to seal them. This finishes up the construction required for the radial roof master.

In the next issue I will continue with the project by describing how I built the ends, the molds, casting and finally painting and assembly.

So until next time,
have fun with trains!

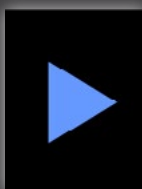

**Reader
Feedback**
(click here)



Railroad Explorer Magazine

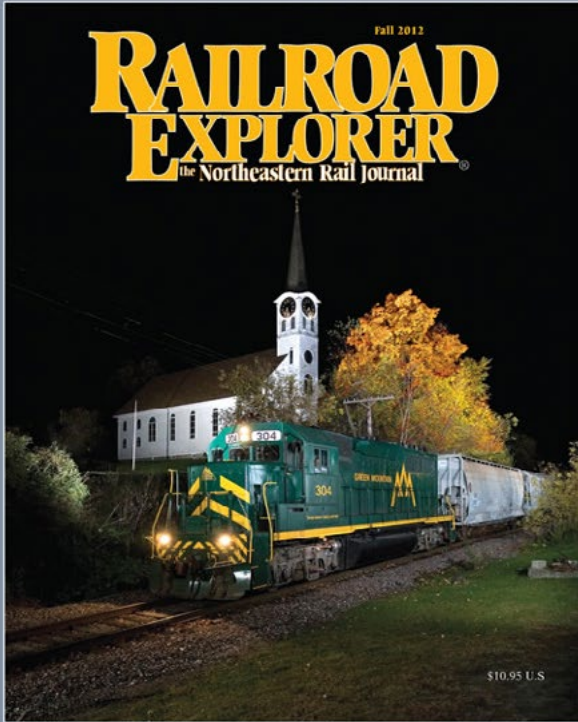

- Three, all-color issues per year.
- Exciting feature stories, spectacular photos.
- Best-in-class photo reproduction.
- Printed on heavy, glossy paper.
- Zero advertising. All content.
- Winter, Spring/Summer and Fall editions.

Issue 36 - Fall 2012

On sale now

Subscribe Today!

www.railroadexplorer.com



RailPro™

NEW TECHNOLOGY



Click here to watch our videos!

New Products

- Accessory Module
- Auto Reverse Module
- New Sounds and more!

For more information visit our Internet site: www.RingEngineering.com





Structures
of
simple
elegance ...

Made in
the USA

**ALPINE
- DIVISION
SCALE
MODELS**

**Click to
Learn
more...**

alpinemodels.com



**1st choice for model
railway supplies
and service.**

**Expedited mail
service available
across North America.**



Click to visit
WWW.CVRCO.COM
1 800 464 1730



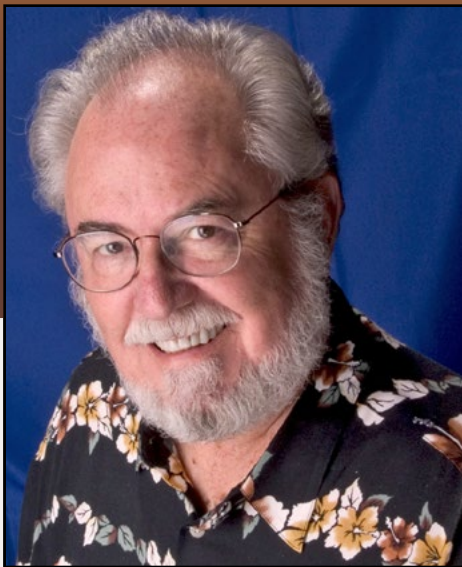

*The Old
Yardmaster*

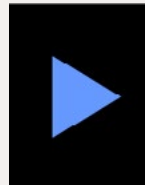

**Reader
Feedback**
(click here)



May 2013:

The latest model railroad products, news & events

by Richard Bale and Jeff Shultz

Michael Stephens 1953-2013



Michael Stephens, who served as a senior executive for several important model railroad firms, died April 9 at his home in Milwaukee, Wisconsin. He was 59. Michael's exposure to trains and model railroading came early. During the 1950s and early 1960s, his father, Hugh, was vice president of sales at Kalmbach Publishing Company. During his high school years, Michael worked at Amro Ltd., an importer of

European model trains founded by his father. Before leaving for college, Michael took a job at Kalmbach as a researcher on the publisher's *Airliners International* magazine. Following graduation from the University of Milwaukee, Michael spent several years in the field of advertising before rejoining Kalmbach in 1998 as the firm's vice president of marketing – essentially the same position held by his father 40 years earlier.



In 2007 Horizon Hobby named Michael president of Athearn Trains based in Long Beach, California. But the lure of Milwaukee was strong and in 2010 he returned to his home state where he joined Walthers as vice president of the company's proprietary brands. Michael's father Hugh, who died in 2004 at age 93, worked throughout the 1970s and '80s as executive secretary of the Model Railroad Industry Association (MRIA). Throughout those later years, Michael and his father continued to pursue their model railroad hobby at the elder Stephens' home in Cedarburg, Wisconsin. Michael Stephens is survived by his wife, Tammy, and his brother, Bill, of Manchester, Connecticut ...

Chinese Modelers Association

After a one year trial arrangement, the National Model Railroad Association has extended indefinitely its working agreement to share NMRA's standards and organizational information with HASEA (bbs.hasea.com/thread-479296-1-1.html), a Chinese social network of more than 100,000 model railroaders and railway fans ...

Bachmann Replacement Gears

In response to a nagging problem with gears on its On30 Shay, Climax, Davenport 0-4-0, Rail Truck, and Railbus models, Bachmann will establish a limited time program to provide modelers with replacement gears and gear assemblies at no charge. After June 1, 2013, modelers can send requests for replacement gears to On30support@bachmanntrains.com. Modelers who prefer to have Bachmann's service department install replacement gears can go to a soon to be announced website for detailed instructions. Special arrangements will also be available for locomotives that are no longer under the one-year product warranty ...



It's Indianapolis for 2016

The NMRA has selected Indianapolis as the site for the 2016 National Convention and National Train Show. The dates are July 3 through 10, with the official HQ hotel expected to be announced soon ...

20% Discount

Tichy has launched a new website at tichytraingroup.com. To encourage modelers to visit the new site, Tichy is offering a 20% discount and free freight (US only) on all orders over \$60.00. The special discount expires May 31, 2013 ...

Super Supertrain

Preliminary reports indicate that more than 13,500 people attended the 2013 edition of Canada's Supertrain Show. The event was held April 20-21 in Calgary's Subway Soccer Centre. Now let's take a look at new products, including several that debuted at Supertrain ...

NEW PRODUCTS FOR ALL SCALES

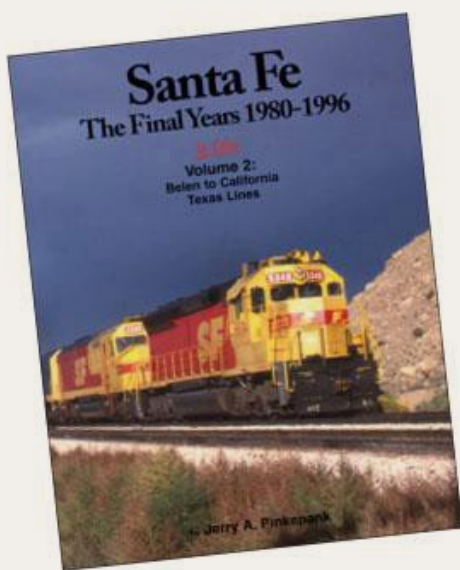

Morning Sun Books (morningsun-books.com) has released a new book about the Santa Fe by respected rail authority, Jerry A. Pinkepank. Titled "*Santa Fe, The Final Years 1980-1996 Volume 2*," the book provides a definitive look at the final years of the Texas Lines from Belen to California. The book is priced at \$59.99.



contents



index

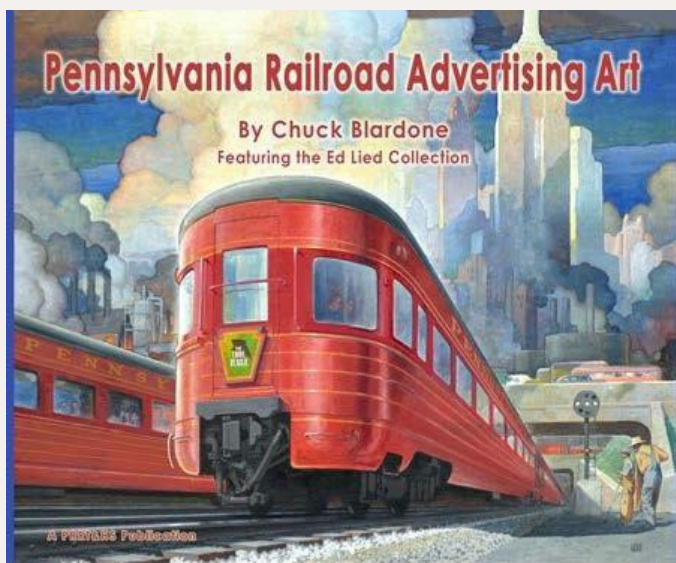

The Pennsylvania Railroad Technical and Historical Society (PRRTHS.com) has released “*Pennsylvania Railroad Advertising Art*”, by Chuck Blardone. The hard-bound book presents 492 images of art from posters, booklets, flyers, timetables, calendars, and magazine

advertising with all images restored to like-new condition. Some original artwork is also included. The 11” x 9” art book is composed of 284 pages printed on heavy, premium paper. It is priced at \$89.95 and is available at the above website.

O SCALE PRODUCT NEWS

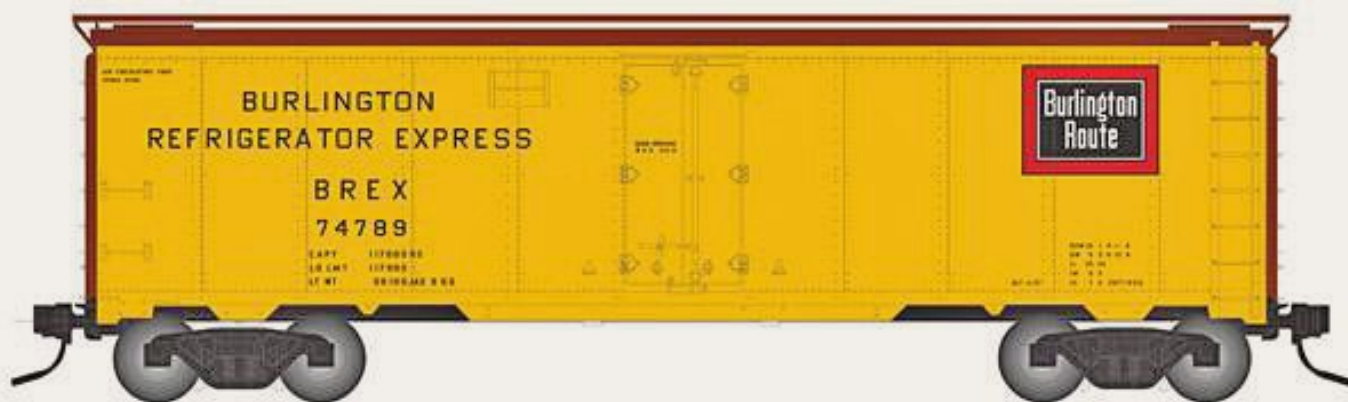

Atlas O (atlaso.com) will release a second production run of its 40’ steel refrigerator car in the fourth quarter of this year. The O scale ready-to-run model is based on class R-40-10 cars built for Pacific Fruit Express in 1936-37. In addition to the Burlington scheme shown here the car will be available decorated for Erie-URTX Union Refrigerator Transit Line, Fruit Growers Express, MDT/Illinois Central, and Pacific Fruit Express

with dual SP and UP heralds. An undecorated version will also be offered.

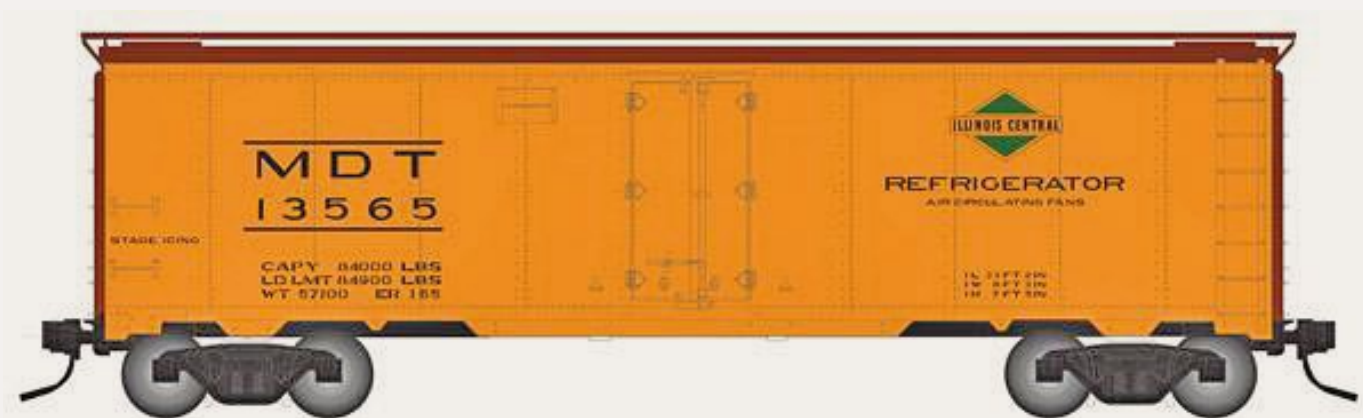

Models equipped for 2-rail operation will have an MSRP of \$69.95 each with 3-rail versions priced at \$74.95.



Also coming from Atlas O in the fourth quarter of 2013 are flat cars with both high and short bulkheads. Flat cars decorated for Colorado & Wyoming, and Cotton Belt will be available with short bulkheads. Flat cars with tall bulkheads will be available for Cotton Belt, Hollis & Eastern,



contents



index

Indiana Harbor Belt, and TTX. Two-rail models will have an MSRP of \$49.95 each. Three-rail models will list at \$52.95.



Boulder Valley Models (boulder-valleymodels.com) is selling a detailed resin body kit for an On30 18' composite boxcar. The kit consists of flat resin body

components including positionable doors; plastic sill steps and queen posts; wire for the brake shaft, grab irons, and truss rods; and extensive instructions for assembling and painting the model. The kit is available at \$36.00 each or in a 2-pack at \$70.00. Trucks, couplers, and decals are sold separately.

HO SCALE PRODUCT NEWS



Accurail Inc. (accurail.com) has released several new HO scale freight car kits this month including a three number set of Northern Pacific 40' steel refrigerator cars as shown above. The set is priced at \$47.98.



A second three-pack now available from Accurail is a trio of Southern Pacific 40' single-sheathed box-cars. Although similar, each of the cars has a different combination of ends and doors. As seen above, the top car has wood ends and National wood doors. The middle car also has National doors but comes with a Murphy corrugated steel end.

The bottom car has Youngstown doors and Dreadnaught ends. It also has a different lettering arrangement. The SP car kits are available individually at \$15.98 each or in a three-pack at \$44.98.



Also new from Accurail this month is an HO scale kit for a 55-ton USRA two-bay hopper car decorated for New York Central's Big

Four – a line with a rich and varied history. The line was established through the merger of the Cleveland, Cincinnati, Chicago & St. Louis Railway (CCC& StL); the Cleveland, Columbus, Cincinnati & Indianapolis Railway; the Cincinnati, Indianapolis, St. Louis and Chicago Railway; the Indianapolis & St. Louis Railway; and the Indiana, Bloomington & Western Railway. The amalgamation was acquired by the New York Central Railroad,



contents



index

which operated it as a separate entity until around 1930. It later became part of Penn Central and ultimately Conrail. The kit is priced at \$14.98.



An HO scale 50' welded-side insulated plug-door boxcar decorated for Illinois Central is also new from Accurail. The model represents a car built in 1967. The kit is priced at \$15.98. All Accurail HO scale car kits include appropriate trucks and Accumate couplers.



American Model Builders (laser-kit.com) is selling a pair of Louisville & Nashville tool sheds based on information supplied by the L&N Railroad

Historical Society. The prototype structures were used for storing handcars, tools, and supplies required for the construction and maintenance of roadbed and trackwork. The small structures were located along the mainline, at sidings, and in yards at intervals of three to 10 miles apart.

All wood components in the kit are laser-cut including board-and-batten wall siding, exposed rafter tails, interior flooring, and positionable trackside doors with hinge and hasp lock details. Rolled roofing material is provided along with code 70 rail for the handcar setoff. Each assembled shed measures 1.75" wide x 2.25" deep x 1.5" high. Kit #192 has an MSRP of \$24.95 and has enough material to build two HO scale sheds.



Also new from American Model Builders is Cullen Station, a small multi-purpose depot based on a structure from the Norfolk Division of the Virginian Railway.

The prototype housed the agent's office, a 9' 4" x 12' freight room with adjacent loading dock, and an attached open shed waiting shelter. The HO scale kit #180 is composed of laser-cut components. It has an MSRP of \$24.95.



At the recent Supertrain Show in Calgary, Canada, **Athearn Division of Horizon Hobby** (athearn.com) unveiled preproduction samples of a new group of

HO scale Genesis® EMD GP40-2L/-2W Canadian locomotives



contents



index

that include standard cab, Canadian comfort cab, and Canadian comfort cab “L” version. The initial release will include CN GP40-2L (No. 9549 above) in four road numbers. Because of its heavier frame the “L” locomotive sits higher than others in the series. It also has tall jacking pads. Other distinctions are the lack of classification lights and number boards at the rear of the locomotive.



The initial release also includes CN GP40-2W in three road numbers, CN GP40-2W (ex GO* Transit) in one road number (No. 9675 above), and GO Transit

GP40-2W in four road numbers. GO road numbers 703 (below) and 705 will have a short electrical cabinet air filter box (ECAFB) behind the cab. Road numbers 708 and 709 will be equipped with a long ECAFB. The HO scale Genesis® models will be available DCC-ready (MSRP \$189.98), or with factory installed SoundTraxx® Tsunami® and DCC decoder (MSRP \$289.98).

*Government of Ontario.



Details on all of the locomotives include Canadian-style ribbed anticlimber; Canadian safety cab with interior details including a single control stand; front triangular cluster of red, white, and green classification lights; sunshades; Sinclair ice skate antenna on cab roof; early Canadian Pyle nose headlight; standard raised exhaust; non-dynamic brake; trainline and MU hoses; Blomberg-M trucks; speed recorder; and a Salem air filter. Details specific to each version are summarized in the following chart:

CN GP40-2W (ex GO Transit)
 GO Transit GP40-2W
 CN GP40-2W
 CN GP40-2L

Raised locomotive frame				X
Tall jacking pads				X
Operating lampshade ditch lights		X	X	X
Operating ditch light mounted on pilot	X			
Medium CN front plow with white "V"			X	X
Curved pilot plow at front and rear	X	X		
CN-style uncoupling lever and brackets			X	X
Uncoupling levers mounted below coupler	X	X		
Nathan K-3 air horn mounted above bell				X
Nathan K-3 air horn in front of first radiator fan on left side		X	X	
Nathan K-3 air horn in front of exhaust stack	X			
Bell mounted on cab between number boards	X	X	X	
Radiused step wells	X	X		X
Angled step wells			X	
Canadian-style steps	X	X	X	
Pyle single lens rear headlight			X	X
Rear vertical twin headlight	X	X		
3,200 gallon fuel tank	X	X	X	
3,600 gallon fuel tank				X
Snow shields over air intakes		X	X	X
Rear classification lights	X	X		
Rear number boards	X	X		
End of train antenna on cab roof	X			



contents



index

US roadnames will be Seaboard Coast Line, Western Pacific, B&O, C&O, and Chessie's GM50 painted gold to celebrate General Motors 50th anniversary, all for standard GP40-2 models. Chessie-specific details include a side-mounted bell and rock pilot. Delivery of the GP40-2L/-2W models is tentatively scheduled for December 2013.



Athearn is scheduled to release the next production run of SD40-2 locomotives in July. The run will include

models with 81" nose decorated for KCS; Dakota, Minnesota & Eastern; and DM&E-Mount Rushmore scheme. Road names for models with an 88" nose will include CSX (current YN3 scheme), Oneida & Western, Missouri Pacific, and BN (black and green). Also in the mix is a Union Pacific "Fast Forty" version with a 116" nose as shown here. Athearn's HO scale ready-to-run standard DC analog SD40-2 locomotives have an MSRP of \$134.98. They are DCC-ready using Athearn's Quick Plug™ technology.



Also due from Athearn in July is a Genesis® series GP15-1 decorated for BN (green and black with white

face), Chicago & North Western, Conrail, and California Northern. Non-sound units with a DCC-ready Quick Plug™ will have an MSRP of \$189.98. Sound-equipped models have Soundtraxx® Tsunami® DCC decoders will list at \$289.98.



By late July or early August, Athearn plans to release another production run of GP38-2

diesel locomotives. In addition to the Rock Island-David P. Morgan version shown here, the Genesis® series model will be available decorated for Norfolk Southern (horse head scheme), Milwaukee Road, and Burlington Northern (black and green scheme). The model will have an MSRP of \$289.98 and will come with Soundtraxx® Tsunami® sound and DCC decoder. An undecorated non-sound DC unit will be offered at \$189.98.



Also due in late July or early August is a group of SD40T-2 locomotives in new decorating schemes. The HO scale models are in Athearn's ready-to-roll series with an MSRP of \$134.98. Road names will be Union Pacific, NYS&W-Susquehanna, Kansas City Southern, and Denver & Rio



contents



index

Grande Western. The KCS and DRGW locomotives have an 81" nose.



Athearn has scheduled an August release date for the next run of Genesis® series F3

units. In addition to the D&RGW model shown here, road names will include DL&W (maroon and gray Lackawanna scheme), and Santa Fe (red and silver warbonnet). F3A units for analog DC operation will list at \$169.99 or \$269.98 with Soundtraxx® Tsunami® DCC decoders. Matched A/A or A/B units with sound and DCC decoders will have MSRP of \$489.98. Matched A/B units for DC operation will list at \$309.98.

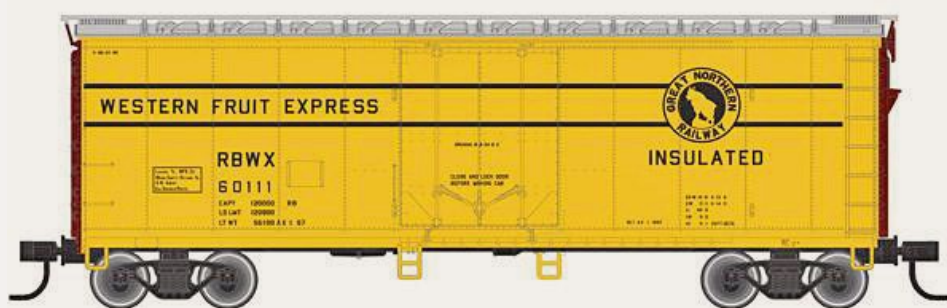

Atlas Model Railroad Company
(atlasrr.com)

has scheduled a second pro-

duction run of 40' insulated plug-door boxcars for delivery during the fourth quarter of 2013. In addition to the RBWX Western Fruit Express car shown here with a Great Northern herald, the ready-to-run model will be available decorated for PC-Fruit Growers Express, RBNX-Fruit Growers Express,

Milwaukee Road, PVYX-Merchants Despatch, and SSW Cotton Belt.



The HO scale Trainman® series model will have an MSRP of \$21.95 each.

An undecorated version will list at \$15.95.



Atlas has also scheduled the release of 40' wood reef-ers for the fourth quarter. Decorating schemes will include Kraft-WRX (silver body), MTC-Brookside



Creamery, NRC-A&P, NWX-Eatmore Cranberries, MRS-Ralston Purina, MSEX- Silver Edge, and the NRC Borden's car shown here that displays a different advertising message on each side of the car. The HO scale Master® series ready-to-run model will have an MSRP of \$31.95 each. An undecorated model will list at \$26.95.

At the Supertrain Show held in Calgary last month, **Bowser** (bowser-trains.com) announced preliminary plans to



contents



index

produce an HO scale version of the Canadian-built SD40-2. Few details were available but the reaction of Canadian modelers at Supertrain was universally positive.



Bowser has scheduled a spring release date for its Baldwin DS-4-4-10 switcher. The prototype saw service on innumerable railroads as nearly 500 of the locomotives were built between 1946 and 1951. Bowser's HO scale Executive series model will be available decorated for Canadian Pacific (maroon and gray), CP Rail (Pacman scheme), Western Maryland (fireball scheme), Santa Fe (black body, zebra stripes), SOO (red and white), Erie Lackawanna, Pennsylvania, Norfolk Southern, and Chicago Great Western.



The ready-to-run DS-4-4-10 models will be available for standard DC operation (equipped with an NMRA DCC-ready plug) at an MSRP of \$169.95. Models with sound and a DCC decoder will have an MSRP of \$279.95.

A second release of Bowser's ALCo Century C-636 road switcher is scheduled for this summer. Road names will be Morris-Knudsen Leasing, Conrail, Cartier (Quebec Cartier



Mining), PC-Conrail patch, NYSW, and SIXX. A model decorated for Delta Bulk Terminal is also in the run but has already been sold out. Standard DC units with an NMRA DCC-ready plug will have an MSRP of \$199.95. Models with sound and a DCC decoder installed will have an MSRP of \$299.95.



Bowser's summer delivery schedule also includes a special release of an Executive series U25b locomotive decorated

as Southern Pacific #3100. The model faithfully replicates the refurbished prototype housed at the Orange Empire Railroad Museum (OREM) at Perris, California. Features include new 9' 4" AAR B trucks, MU hoses, air hose, windshield wipers, properly positioned grab irons, uncoupling bar, and operating headlight. The handrails have been upgraded from Bowser's earlier release of the U25b. Standard DC models with an NMRA DCC-ready plug will have an MSRP of \$199.95. Models with sound and a DCC decoder will have an MSRP of \$299.95. Bowser will donate \$15.00 to OREM for each model sold.



contents



index

Broadway Limited Imports (broadway-limited.com) is scheduled to release HO scale models of two historic steam locomotives this month.



First up is the famous New York Central 4-6-4 class J3a Hudson. Industrial stylist Henry Dreyfuss designed the bullet-nosed Hudson to lead the Central's prestigious 20th Century Limited passenger train. Inaugurated on June 15, 1938, the streamlined steam locomotive completed the run from New York's Grand Central Terminal to Chicago in just 16 hours. BLI's HO scale model includes Paragon2 sound and control system with a factory installed DCC decoder for dual mode DC and DCC operation. The diecast hybrid construction consists of brass locomotive and tender superstructures mounted on diecast metal chassis. The model is available in two road numbers in the 1938 scheme, and three numbers decorated in the 1940 scheme. All versions have an MSRP of \$499.99 each.



The second new steam engine coming from BLI this month is a group of Santa Fe 3700 class 4-8-4 locomotives including restored No. 3751. Built by Baldwin Locomotive Works in 1927, Santa Fe No. 3751 was retired in 1957 and eventually found a home with the San Bernardino Historical Society. The fully operational locomotive has been making appearances and leading tour trains since 1991.

Since their construction in 1926, the 14 locomotives in the 3700 class went through several major rebuilding projects including changing the driver size from 73" to 80", fuel conversion from coal to oil, replacing two original sand domes with one larger one, and changing out the Elesco feedwater heater in favor of a more efficient Worthington system.

BLI's No. 3751 represents the prototype locomotive as she looks today. The model is composed of a cast ABS plastic boiler mounted on a diecast metal chassis. Electrical pickup is through the drivers which are all powered. Details include separately applied handrails, ladders, whistle, and brass bell. Additional features include operating cab roof vents, and Kadee[®]-compatible metal couplers on both the tender and locomotive pilot. Wheel flanges allow operation on rail as small as code 70. A minimum radius of 22" is recommended for reliable operation.



contents



index

The Santa Fe 4-8-4 model comes with Paragon2 sound and control system with a factory installed DCC decoder for dual mode DC and DCC operation. It is available in seven different road numbers plus a painted but unlettered version. The HO scale ready-to-run model has an MSRP of \$399.99.



Classic Metal Works (classicmetalworks.com) has completed tooling for the HO scale dump truck shown above. The HO scale vehicle has a positionable bed and swing-away tailgate. Decorating

schemes will include State Highway Dept. (orange cab), Smith & Sons Excavating (blue cab), as well as unlettered models with red and green cabs.



The new stake bed Chevy truck is available with either a red or green cab with brown stakes. Decorated models include Mobil Oil, Pillsbury Feeds, and Railway

Express Agency in dark green. All versions have detailed cab interiors, clear headlight lenses, chrome plated bright work, and separate side mirrors.



Concept Models (con-sys.com) has added two new items to its selection of HO scale cryogenic tank car body kits. Shown above is APRX 6009, a 19,200 gallon refrigerated argon prototype owned by Air Products & Chemicals, Inc. The plate B car measures 55' 6" in length. Shown below, IAPX 1011 is a 64' 6" cryogenic argon tank car based on a prototype operated by Air Liquide, Inc.



Concept Models kits consist of resin body castings, assembly hardware, and decals. Grab irons, ladders, wire, trucks, and couplers are not included. The kits are sold direct at \$24.99 each.

ExactRail (exactrail.com) has released five new road names for its HO scale PS-2CD 4427 cu ft low-side covered hoppers. Six road numbers each are available for Gold Kist-TLDX (yellow/orange body with a unique ACI plate outside of the ribs), Chicago & North Western in as-delivered gray paint, and



contents



index



D&RGW in the 1964 as-delivered gray (an earlier D&RGW release was a shopped repaint). Five road numbers are available for

Bunge Corporation-TLDX. The D&RGW TGS (Texas Gulf Sulfur) car shown below is available in just one road number.



Features on ExactRail's Platinum series model include a photo etched stainless steel roofwalk and brake platform. As

with previous releases, the PS-2CDEs ride on ExactRail's ASF 100-ton Ride Control® trucks with 36" machined wheels. The cars are sold direct only at \$36.95 each.



InterMountain Railway (intermountain-railway.com) is taking dealer reservations for

four-bay cylindrical covered hopper cars for delivery in November/December. Road names include Toronto, Buffalo & Hamilton; Canpotex; CNXL; CNIS; Trona; CP Rail; Potash; and CN (red wet noodle). The HO scale ready-to-run model will

have an MSRP of \$36.95 and will come with metal wheelsets and Kadee® couplers.



MRH readers will recall learning about InterMountain Railway's plans to build a GP10 Paducah locomotive in our news report last December. We can now update that initial report with an arrival date (November/December) and road names: ADMX, Conrail, Illinois Central, IC Gulf, Iowa Interstate, Chicago Central & Pacific, MidSouth Rail, and Arkansas-Oklahoma.

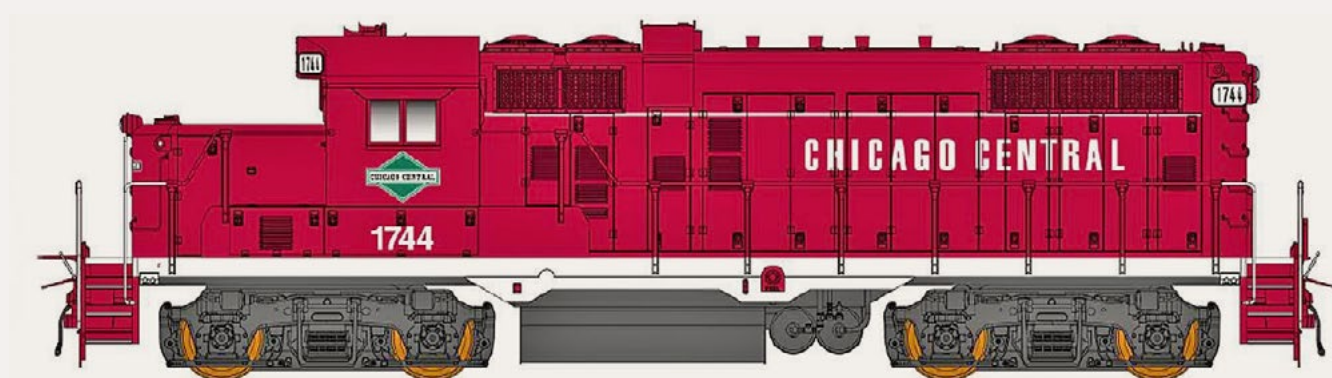

Several details including air filters, nose headlights, tool boxes, and engine access hatches will vary depending on the practice of the prototype road being modeled. The HO scale ready-to-run locomotive will be available for standard DC operation at \$189.95, and with ESU LokSound and DCC decoder at \$279.95.



contents



index



New HO scale freight cars scheduled for release in July from **Kadee Quality Products** (kadee.com) include a Maine Central 40' PS-1 boxcar with Youngstown door. Priced at \$34.95, the ready-to-run model reflects the colorful paint job applied when the prototype was shopped in 1963.



Also coming in July is a twin-bay SSW Cotton Belt PS-2 covered hopper car that replicates a prototype built in 1957 by Pullman Standard. The model is decorated in as-new light gray alkali resistant paint. The HO scale ready-to-run model has an MSRP of \$42.95.

Kaslo Shops (mgdecals.com/kaslo_shops.htm), a supplier of cast resin freight cars and locomotive shells, is currently working on an HO scale body kit for a Dash 8-40-Cm, the

Canada-specific version of a Dash 8-40CW locomotive but with a full-width cowl car body and unique four-piece windshield. Preliminary samples are expected soon with a good possibility of availability by this fall.

Another Canadian locomotive shell under development at Kaslo is an HR616 road switcher with a full-width cowl body built in 1982 by Montreal Locomotive Works. The 3000 H.P prototype was based on ALCo's Century 630. Introduction of the HO model is expected in 2014.

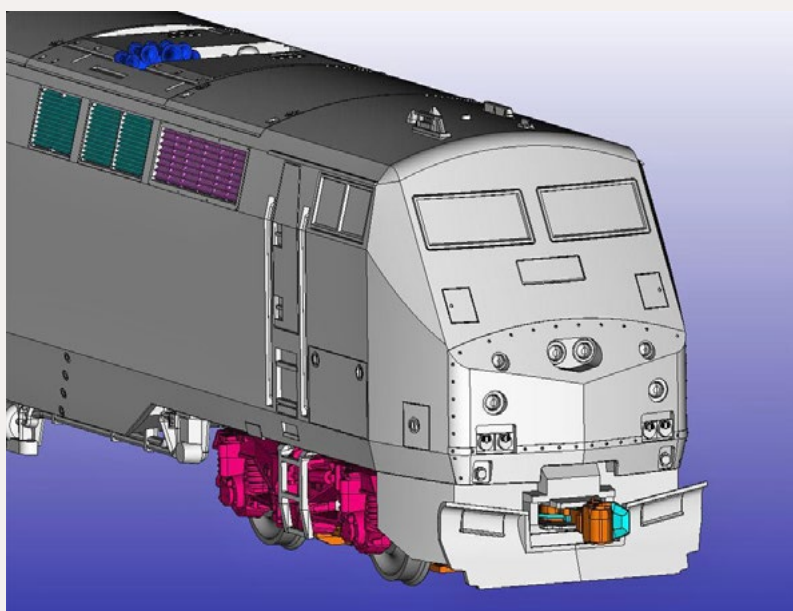

Here's an early look at Kato's (katousa.com) upcoming HO scale General Electric P42 locomotive. The computer-generated images show some interesting details including a new fiberglass nose panel. The bolt-on panels

make it easier to repair the locomotive nose in the event of damage due to grade crossing incidents. Also new are the rounded headlight bezels to match the smooth lines of the locomotive's front.

A P42 for DC operation is expected by July in three road numbers at about \$185.00 to \$195 each. Locomotives with DCC will follow about a month later. Models equipped with ESU Loksound will be priced in the range of \$305.00 to \$315.00 each. DCC locomotives equipped with Soundtraxx Tsunami[®] are expected to be about \$10.00 more.



contents



index

Availability of the new P42 locomotive will be coordinated with a new run of Kato's HO Superliner passenger cars (one number each of a coach, lounge, diner, and sleeper) in Amtrak's current Phase IVb (aka Phase VI) paint scheme. They are expected to have an MSRP of \$80.00 to \$90.00. An Amtrak material handling car will list at \$49.00 each.



Moebius Models (moebiusmodels.com) has released an HO scale kit for Mel's Drive-In, an iconic structure popular from the late 1940s to the '70s. The injection molded plastic kit has an MSRP of \$44.95. A newly released HO kit for the Munster's House is also priced at \$44.99.



Rapido Trains (rapidotrains.com) has scheduled a second production run of its highly-regarded HO scale lightweight coaches. The cars are based on a CC&F design that is similar to cars owned and operated throughout North America.

Rapido has revised the tooling to provide a more rigid construction and the underframe has been redesigned as a C-channel to eliminate any possibility of the ends and sides warping. Notable features on the ready-to-run models include factory-installed grab irons; multi-color interior with window blinds at different heights for each car; Rapido's "Easy-Peasy" battery-operated interior lighting; operating diaphragms with etched-metal end gates; and complete underbody detail with all air, steam and electrical lines in place.

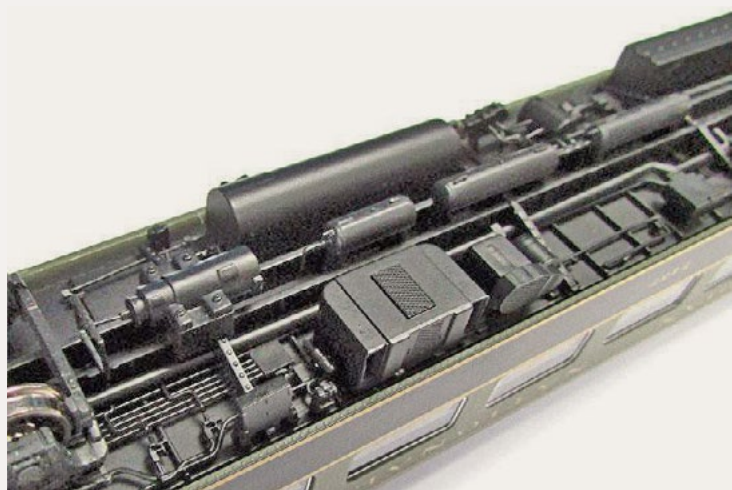

Variables dependent on the practice of the prototype being modeled include full or partial skirting, fixed steps, and either 41-BNO-11 or 41-N-11 trucks with metal wheelsets. The cars come equipped with magnetic

metal knuckle couplers. A minimum radius of 22" is recommended.



Road names from the original 2006 production run being repeated with new numbers are Great Northern, New York Central, Northern Pacific, Pennsylvania, Southern Pacific (gray with red letter board), Grand Trunk Western (1954 green scheme), Canadian National (1954 green scheme), Canadian National (wet noodle logo), and VIA Rail Canada. New



contents



index

schemes include Central New Jersey; Grand Trunk Western (wet noodle logo); Long Island Railroad; Monon (Chicago, Indianapolis & Louisville Railway); and the Richmond, Fredericksburg & Potomac.



An undecorated model will also be offered. The cars will have an MSRP of \$84.95. The deadline for dealer orders is June 28, with delivery scheduled for this fall.

Roundhouse, Division of Athearn (athearn.com) has released HO scale 36' boxcars and stock cars with new road names. The ready-to-run models feature a truss-rod underframe, arch bar trucks with 33" machined metal wheelsets, and McHenry® knuckle couplers. The cars are topped with an early Hutchins-type roof that had waterproof sheeting sandwiched between two layers of tongue-and-groove wood.



Road names for the boxcar include Minneapolis, Saint Paul & Sault Ste. Marie (aka SOO Line); IPC-Indianapolis, Peru & Chicago (decorated with Cutler & Savidge Lumber Co. advertising); D&RGW; and Colorado Midland.



Decorating schemes for the stock car will be Union Pacific, D&RGW, Canadian National, and AT&SF. The boxcar has an MSRP of \$23.98. The stock car lists at \$24.98.



Showcase Miniatures (showcaseminatures.com) has expanded its selection of HO scale Century Foundry Metal Works metal cast detail parts with the addition of ground and pole-mounted signal relay boxes. Pictured here is

item #2188 Union Switch & Signal-style double-door stacked relay cabinet available at \$6.95. Additional relays include US&S single door cabinets, and GRS-type front and rear double door cabinets. All of the units mentioned have detailed interiors and positionable doors.

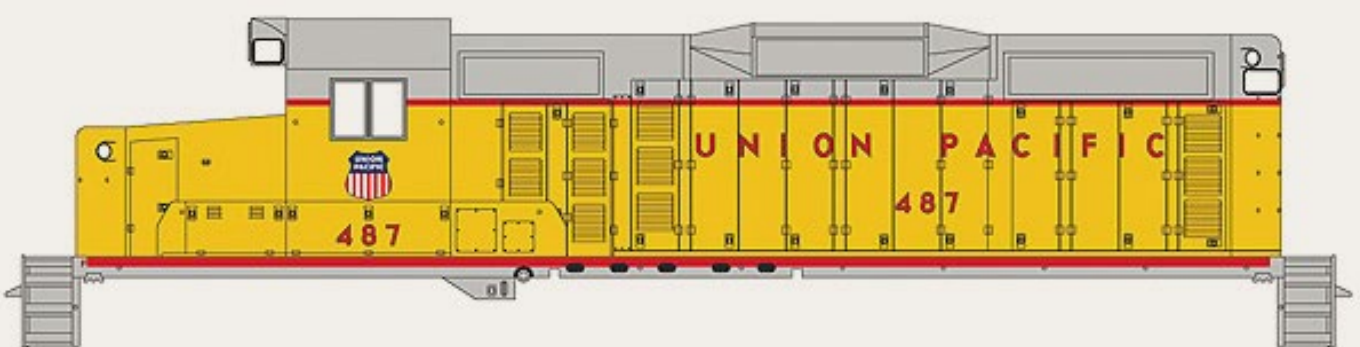

Walthers (walthers.com) is currently offering its HO scale Proto 2000™ EMD GP20 locomotive in four decorating schemes



contents



index

that will be discontinued when this production run is sold out. Road names include Union Pacific, Santa Fe (blue and yellow), Conrail, and New York Central.

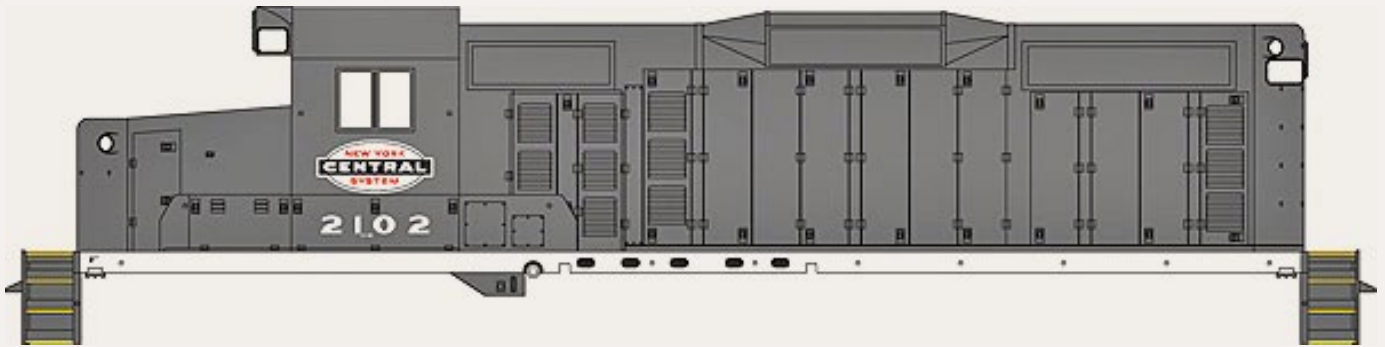

The ready-to-run models are available for standard DC operation at an MSRP of \$189.98, and with factory installed sound and a DCC decoder at an MSRP of \$289.98.



Also new are 50' Pennsylvania Railroad class R50b express refrigerator cars that replicate the more than 500 all-steel

prototypes PRR owned and operated from the 1920s until the late 1960s. Walthers has produced the ready-to-run model in four decorating schemes including the postwar version with dark yellow lettering (upper photo), the 1939 scheme of Tuscan red body with dark green trucks and underframe, 1945 summer scheme with Dulux gold lettering, and the Keystone scheme with twin heralds and PRR reporting marks (lower photo). All versions have a black roof. Additional features of the HO scale Proto2000™ model include separate grab irons and 36" turned metal wheelsets in PRR 2D-P5 passenger-style trucks. The cars have an MSRP of \$44.98 each.



SceneMaster™ 32' and 40' trailers are now available in two-packs at an MSRP of \$19.98. Carrier names on the 32' trailer include Penn Yan Express, Lombard Bros, Connecticut Fast Freight, and J A Garvey.



The 40' units are available decorated for Branch Motor Express, Spector Motor Service, Delta Motor Lines, Thurston, Western Express, and EMD Inc.



contents



index



Walthers Mainline™ 40' stock cars with steel Dreadnaught ends are now available in six packs with different numbers. Road names are CNW, CB&Q (green), Swift Livestock Express (Swift red), and Canadian National. The six-pack has an MSRP of \$119.98. The HO scale ready-to-run models are also available individually at an MSRP of \$21.98.



Westerfield Models (westerfieldmodels.com) has reissued its 3400 series PSC ore car. The prototypes were introduced by Pressed Steel Car Company in 1899. Both 40-ton and 50-ton versions were produced with most of the all-steel cars going to Lake Superior District roads. The “knock holes” in the sides allowed access to loosen frozen ore. The sturdily- built cars



lasted for decades. Some are reported to still be in service more than a century after their introduction.



Westerfield is offering kits for the original version of the ore car with decals for AC/Lake Champlain or with decals for Great Northern/ Eastern Minnesota Railway. The GN car had a running board on the right side only.

Kits for modernized cars with ladders and additional grab irons are available for Great Northern and Sierra/Yosemite Valley. Westerfield kits are HO scale unpainted urethane castings. Assembly instructions and a brief history of the car are included. Ore car kits with decals are \$40.00 each. Undecorated



contents



index



kits are \$38.00. Trucks and couplers are not included. Visit the above website for ordering information. The models are shown with PSC arch bar trucks with a 5' 6" wheel base available from Bethlehem Car Works (bethlehemcarworks.com).



Woodland Scenics (woodland-scenics.com) has released a fully-assembled and weathered structure of a two-story home. The HO scale house features a wrap-around front porch, cedar shingle roof, and all of the details shown in the photo including the bicycle. It has an MSRP of \$84.99.



Also new from Woodland Scenics is Mo Skeeters Bait & Tackle Store. This weathered structure has clapboard siding, a metal roof, and a sign in the form of a giant fishing lure.

Details on the assembled model include a live bait tank, fish cleaning table, fish nets, a barrel full of cane fishing poles, and assorted fishing gear strewn about the porch. The assembled model has an MSRP of \$84.99.

N SCALE PRODUCT NEWS



Atlas Model Railroad Company (atlasrr.com) plans to release an N scale model of a 40' PS-1 boxcar with an 8' door during the fourth quarter of 2013. In addition to the New York Central Pacemaker scheme shown here, road names will be Chesapeake & Ohio, Delaware & Hudson, Jersey Central, Rock Island, Seaboard Air Line (white body), and Union Pacific (Be Specific ship Union Pacific slogan). The Master® series ready-to-run model will have an MSRP of \$26.95. Depending on the practice of the prototype road, the models will have either Ajax or Miner brake wheels, and either Pullman, Youngstown, or Superior 6-panel doors. An undecorated version will have an MSRP of \$21.95 and will include all of the brake wheel and door options.

Atlas plans to release N scale models of a 90-ton triple-bay open-top hopper car during the fourth quarter of 2013. Road



contents



index

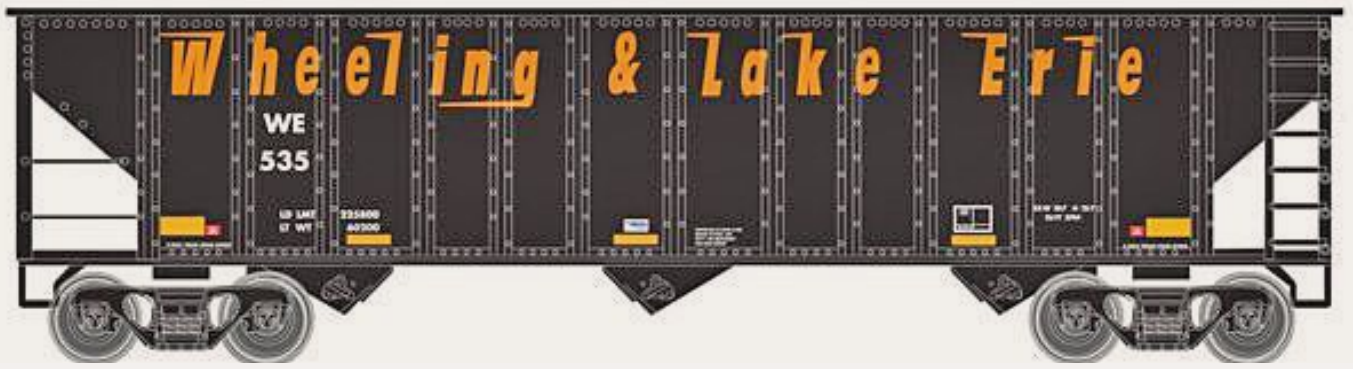

names will be Bessemer & Lake Erie, C&O (Chessie herald), W&M (Chessie herald), CC (Canadian National), Northern Pacific, and Wheeling & Lake Erie. The Trainman® series ready-to-run models will have an MSRP of \$17.95. An undecorated version will be available at \$13.95.



BLMA (blma-models.com) is taking reservations for a second production run

of its Trinity class RAF53C, 53' three-unit spine cars. The model features a die-cast metal frame, pre-assembled hitches, and numerous separately applied plastic and etched-metal detail components.



The models come with Micro-Trains® body-mounted couplers and ride on 70-Ton

ASF Ride Control® trucks fitted with BLMA's re-designed 33" wheelsets. The N scale ready-to-run three-unit models have an MSRP of \$84.95. Delivery is scheduled for early 2014.



Bluford Shops (bluford-shops.com) is accepting orders now for a new group of N scale offset-side wood chip triple-bay hopper cars. Cars fitted with rib side extensions will be available decorated for CP Rail (Pacman scheme); Missouri Pacific; Illinois Central; Grand Trunk Western (wet noodle); Soo Line; and ADNI-Ashley, Drew & Northern. Wood chip hoppers with flat side extensions will be available for Seaboard Air Line, SL-SF Frisco, CIRR-Chattahoochee Industrial, and GMSR-Gulf & Mississippi Railroad.

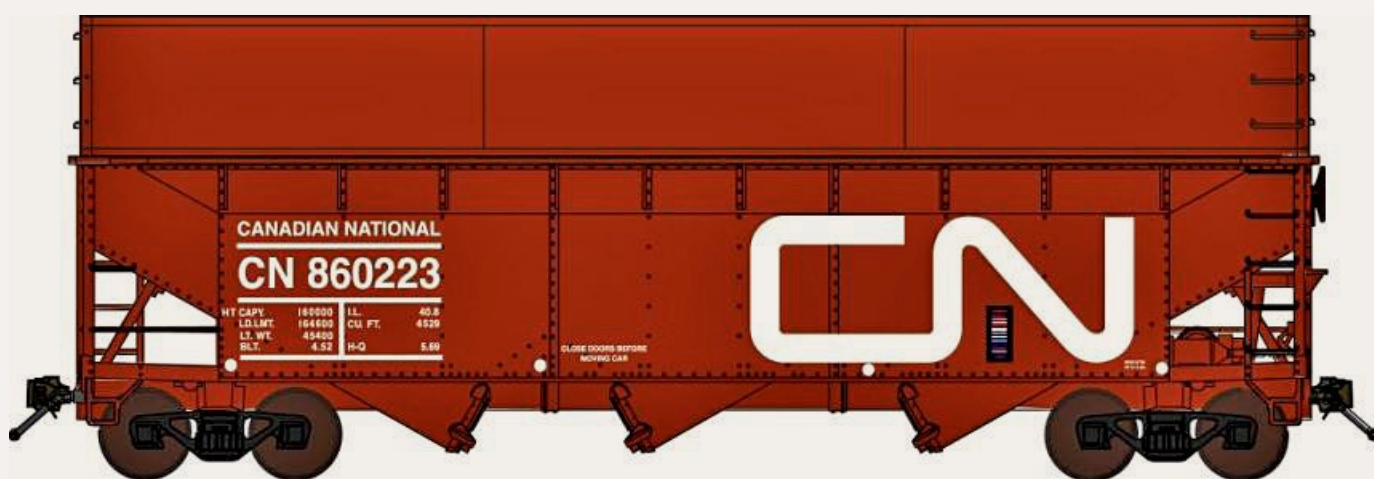

The N scale ready-to-run models are priced at \$24.79 each and in 2-packs at \$49.58. Delivery will be late this year.

According to Dave Ferrari of **DeLuxe Innovations** (deluxeinnovations.com), considerable in-transit damage occurred to their latest shipment from China. Hardest hit was a group of N scale wood chip cars decorated for TERX-Southeastern Industrial Enterprises, and GBRX-Greenbrier Leasing. Sufficient undamaged



contents



index

cars to cover pre-orders were received, but little remains for open stock inventory. No word yet on when the next shipment is expected to be received.



Fox Valley is developing new tooling for several versions of an N scale GEVO ES44 diesel locomotive. The initial release will include an ES44AC decorated for KCS in three road numbers, an ES44DC decorated for Canadian National in three numbers, and a BNSF ES44C-4 in four road numbers. Three variations of body style and three different cabs will be offered. Additional features include directional headlights, operating ditch lights, and either Hi-Ad or steerable trucks depending on the road being modeled. The models will be equipped for standard DC at an MSRP of \$124.95. Conversion to DCC will be relatively simple using a drop-in after market decoder such as Digitrax DZ1251N or TCS EUN651. Delivery dates for the initial production run are expected to be announced soon. InterMountain Railway is responsible for marketing Fox Valley products. For additional information visit intermountain-railway.com.

Great Lakes Models (greatlakesmodels.com) has introduced three new kits for N scale modelers. They include a wood tunnel portal that measures 2.767" high x 2.997" wide. The interior clearance dimensions are 2.019" high x 1.385" wide. The portal sells for \$8.00. Also new is a wood retaining wall that can also serve as a tunnel liner. The wall is 2.095" high and is priced at \$14.58 each.

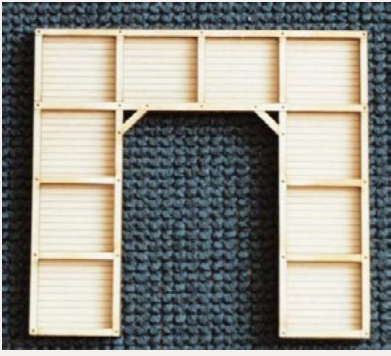

The final new kit from Great Lakes is a set of right and left stepped abutments (see illustration). Each abutment measure 4.463" wide x 2.769" high. They are priced at \$16.34 per pair. All of the above items are composed of basswood which makes them easy to modifying and staining.

InterMountain Railway (intermountain-railway.com) is taking dealer reservations for N scale four-bay cylindrical covered hopper cars for delivery in November/December. Road names include Toronto, Buffalo & Hamilton; Canpotex; CNXL; CNIS; Trona; CP Rail; Potash; and CN (red wet noodle). The N scale version of the ready-to-run car will have an MSRP of \$22.95.



Kato USA (katousa.com) has released N scale versions of General Electric's P42 Genesis locomotive decorated in four versions of Amtrak's 40th Anniversary scheme. Amtrak's Phase II scheme is shown here on road No. 66, Phase III on No. 145, Phase IV on No. 184, and Phase Vb on locomotive No. 61.

Features include magnetic knuckle couplers, directional LED headlights, and illuminated number boards. The DC models



contents



index



come ready for a drop-in (not supplied) Digitrax DN163KOA or TCS KOD8-A DCC decoder. The ready-to-run locomotives have an MSRP of \$120.00 except the Phase Vb version which has a list price of \$125.00.



Kato also has an N scale NW2 switcher decorated for Santa Fe, CB&Q, Burlington Northern, Northern Pacific, and Union Pacific.

The ready-to-run model comes with magnetic knuckle couplers, illuminated number boards, and directional LED headlights. The DC models have an MSRP of \$115.00 and come ready for a drop-in (not supplied) TCS K3D3 or Digitrax DN123K3 decoder.



Micro-Trains (micro-trains.com) has released several new N scale cars this month including this 40' Southern

steam-era boxcar available at \$17.50 each.



Also new is a 50' Great Northern plug door boxcar priced at \$28.10 each. Features include a three-color herald and mascot Rocky pointing to the car's Cushioned Ride capability. The model is based on a prototype built in 1964 by American Car & Foundry.

Also new is a 50' Great Northern plug door boxcar priced at \$28.10 each. Features include a three-color herald and mascot Rocky



This 36' double sheathed meat reefer with a steel underframe features a different sales message on each side. Pressed Steel Car Company built the prototype in 1925 for the North American Car Corporation which leased it to Nuckolls Packing Company. Micro-Trains N scale version has a list price of \$26.95.

This 36' double sheathed meat reefer with a steel underframe features a different sales message on each side. Pressed Steel Car Company built



Except for the bay window, this 31' Missouri Pacific caboose is windowless. The prototype was built in 1976 and saw regular service into the 1980s. Like the prototype, Micro-Trains N scale model rides on Bettendorf-type swing-motion trucks with elliptic springs. It has an MSRP of \$29.80.

Except for the bay window, this 31' Missouri Pacific caboose is windowless. The prototype was built in 1976 and saw regular service into



Micro-Trains 50' Chicago North Western rib-side boxcar represents one of 100 cars delivered to the original CNW (Chicago & Northwestern Railway) in 1974. The N scale ready-to-run model has an MSRP of \$29.15 each.

Micro-Trains 50' Chicago North Western rib-side boxcar represents one of 100 cars delivered to the original CNW (Chicago &



contents



index

In cooperation with the Florida East Coast Railway Society, Micro-Trains has produced a special limited run of FEC heavy weight coaches. They are sold as a two-pack (car numbers 136 and 141) by the society. They are priced at \$64.95 plus shipping. For additional information, or to purchase visit store.fecrs.com.



The Professional Car Society is selling a Riddle Coach & Hearse boxcar based on an early 20th century prototype. The deco-

rating scheme is based on an image from the company's 1905 catalog. The N scale double-sheathed wood boxcar with corrugated Murphy ends, steel underframe, and arch bar trucks was produced for PCS by Micro-Trains. The car is priced at \$31.95 plus \$5.15 shipping for any number of cars ordered. Checks can be made payable and mailed to Illini Chapter PCS, 918 W. Colfax Street, Palatine, IL 60067.

N scale Bi-level auto racks and 73' center-beam flat cars from **Red Caboose** are scheduled for arrival this coming November or December.



Cars with a standard centerbeams will be available decorated for Union Pacific and Canadian Pacific.



Reporting marks for cars with oval-window centerbeams include CSXT and TTZX.



Open-panel centerbeam cars will be available for BNSF and TTZX.

Each road name

for the ready-to-run N scale cars will be available in six numbers at an MSRP of \$22.95 each.

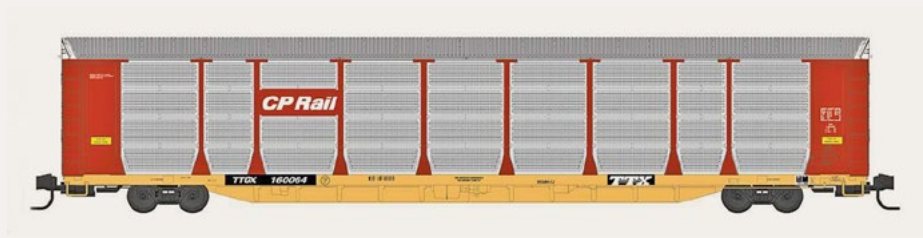

Red Caboose N scale bi-level auto carriers with see-through etched metal

side panels are also due in November/December. Road names for the ready-to-run models will be Santa Fe, MKT, Ferromex, UP (Building America slogan), Conrail, and CP Rail. Six numbers will be available for each road name at an MSRP of \$39.95 each. InterMountain Railway is responsible for marketing Red Caboose products. For additional information visit intermountain-railway.com.



Showcase Miniatures (showcaseminatures.com) has expanded its selection of N scale Century Foundry Metal Works metal cast detail parts with the addition of three signal relay cabinets. Pictured here is



contents



index

an HO scale version of a Union Switch & Signal-style double-door stacked relay cabinet. Also available are a US&S single door cabinet, and GRS-type front and rear double door cabinet. All of the units mentioned have detailed interiors and positionable doors. The signal cabinets are available at the above website at \$4.95 for a pack of two.

TrainWorx (train-worx.com) is booking orders through the end of June for a C&O 85' flat car and several B&O and C&O 40' trailers. The 85' flat car features a die cast metal underframe, separate air reservoir, etched metal deck supports, trucks fitted with Fox Valley metal wheelsets, and Micro-Trains body-mounted couplers. It will be available in six numbers at an MSRP of \$29.95 each.

Trailers with corrugated sides will be available for B&O Trailer Service, B&O TOFCEE Service, C&O Trailer Service, and C&O Piggyback Service. The trailers have an MSRP of \$15.95. Also available is a trailer with vertical exterior posts decorated for B&O TOFCEE Service at \$17.95.



Woodland Scenics (woodlandscenics.com) is selling a partially assembled N scale diner at an MSRP of \$34.99. Details include vintage signage, picnic table and benches,

bicycles, light poles, a convertible car, and two carhops on roller skates.

Z SCALE PRODUCT NEWS

InterMountain Railway (intermountain-railway.com) is taking dealer reservations for four-bay cylindrical covered hopper cars for delivery in November/December. Road names include Toronto, Buffalo & Hamilton; Canpotex; CNXL; CNIS; Trona; CP Rail; Potash; and CN (red wet noodle). The Z scale version of the ready-to-run car will have an MSRP of \$26.95.

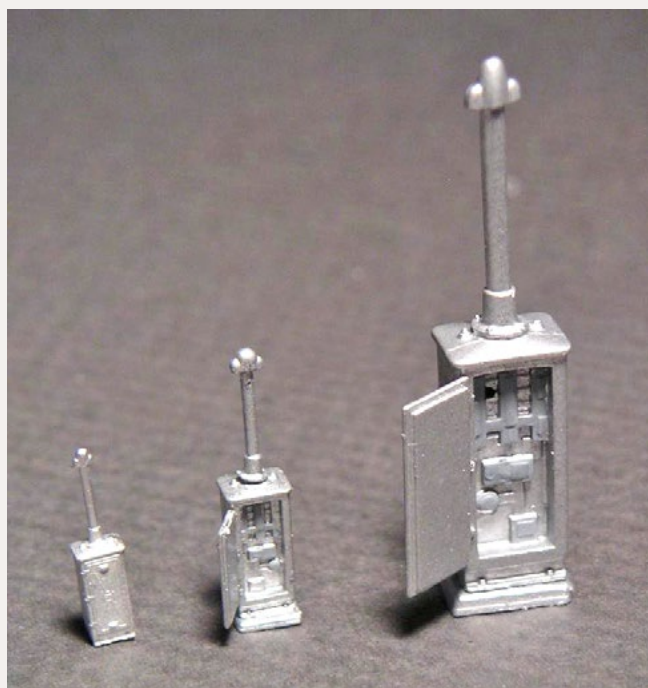

Showcase Miniatures (showcaseminatures.com) has expanded its line of cast metal detail parts with the introduction of Z scale signal relay cabinets. Item #4001 includes two US&S single door cabinets, two US&S stacked double-door cabinets, and two GRS-type single door cabinets. The new item is available at \$4.95 direct from the above website.

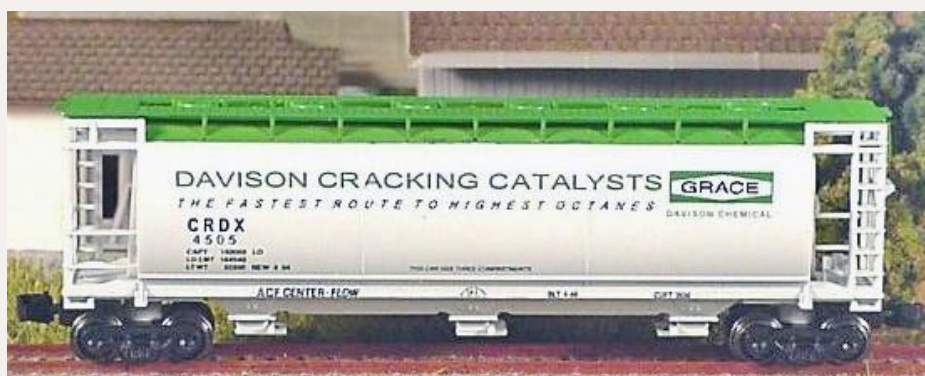

Full Throttle (wdwfullthrottle.com) is selling a Z scale 2013 cu ft triple-bay cylindrical covered hopper decorated for Grace/Davison. The car is based on a 51' prototype built by ACF. The ready-to-run model is offered as a two-pack at an MSRP of \$54.00. The cars are packed in an attractive clear plastic case with each car having a different road number



contents



index

-- CRDX 4503 and CRDX 4505. The model was sourced from Bowser and comes equipped with Bowser roller bearing trucks and blackened metal wheelsets.

NEW DECALS, SIGNS AND FINISHING PRODUCTS

Highball Graphics (highballgraphics.com) has released both HO and N scale decal lettering sets for Canadian National test track evaluation car #1501; VIA Rail Diet Pepsi Train F40PH-2 locomotive No. 6400; Pepsi Train steam generator unit and Pepsi train 89' flat car. The three Pepsi decals are priced at \$7.00 each for HO and \$6.00 each for N scale sets. Also new are decals sets for Canadian Pacific 60' Plate-F 220000 series boxcars, and Southern Railway of BC 50' Plate-F boxcars. The lettering sets are \$8.00 each for HO and \$7.00 each for N scale.

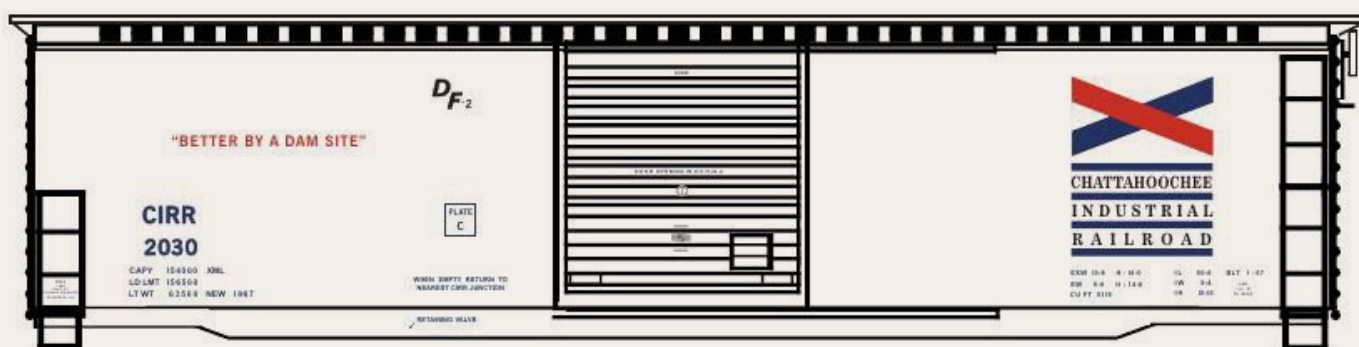

Mask Island Decals (maskislanddecals.com) has HO scale decals for CIRR-Chattahoochee Industrial Railroad 50' boxcars; SL-SF 40' rebuilt boxcars with white lettering and both white and black Frisco heralds, and SL-SF 50' rebuilt boxcars with white lettering and white Frisco herald. Also 50' SL-SF 50' grey plug door boxcar with black lettering and a white Frisco herald.



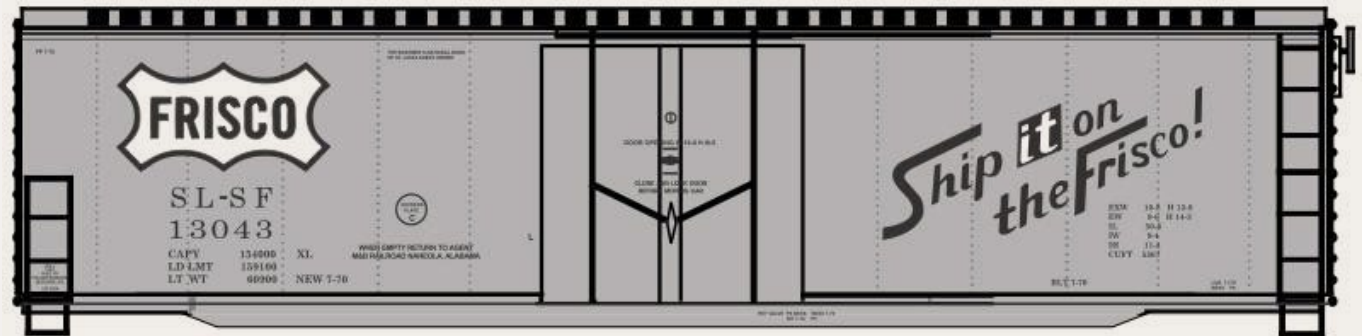
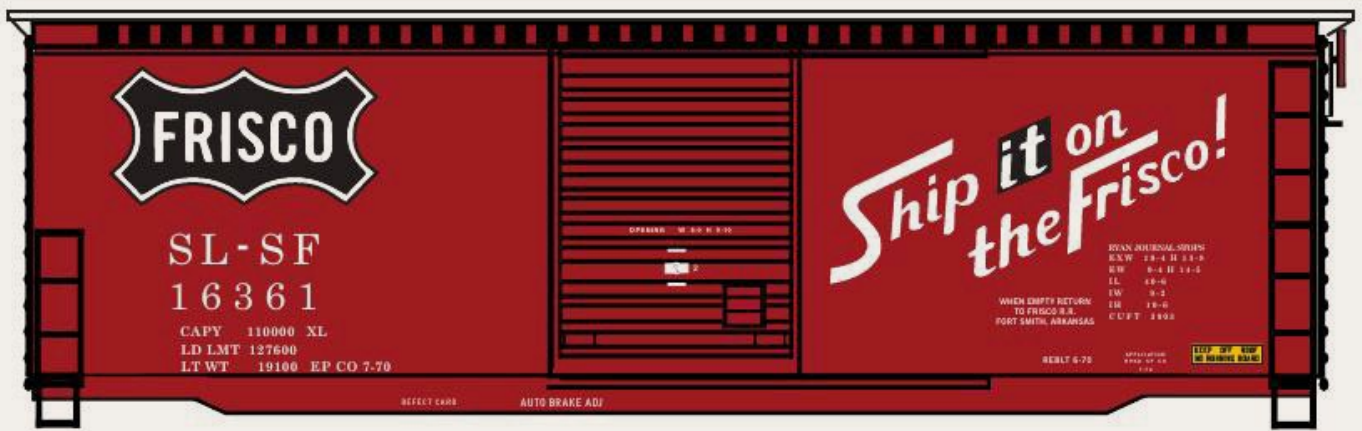

Other new decals from Mask Island include black lettering for a rebuilt Milwaukee Road 50' yellow boxcar, and an M-K-T 50' PS-1 boxcar with Hydroframe 60 slogan and a traditional Katy herald.

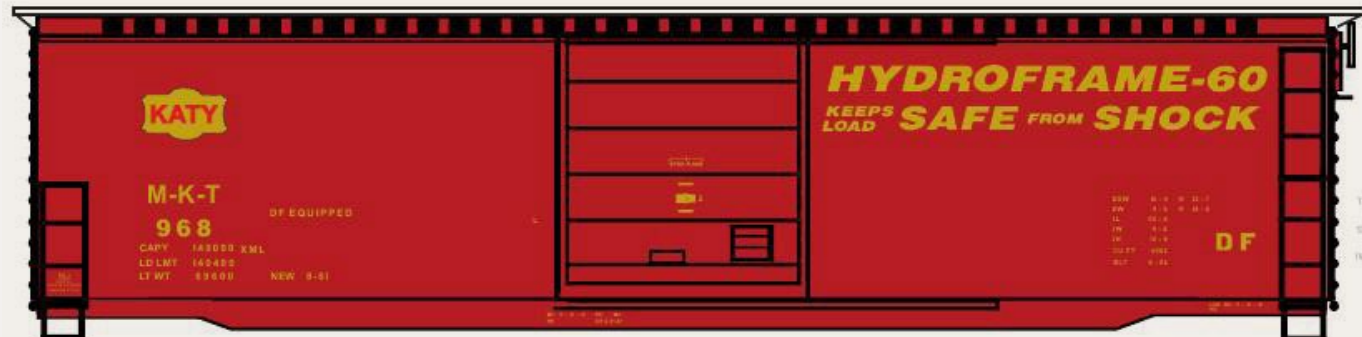

All Mask Island decal sets mentioned in this report are \$6.00 each and contain sufficient material to letter two cars.



contents



index

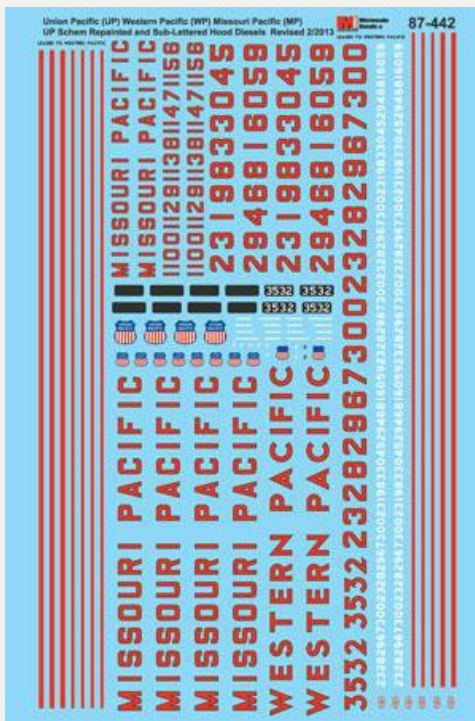

Microscale Industries (microscale.com) has released several new HO and N scale items including lettering sets for Missouri Pacific switchers and hood diesel locomotives circa 1984-86; 60'

insulated beer boxcars for Missouri Pacific, MKT, and Western Pacific; and a special lettering set for Oregon short line per diem 50' boxcars including Longview, Portland & Northern (blue); City of Prineville (black); Union Railroad of Oregon (green); Port of Tillamook Bay (blue); and Oregon & Northwestern Railroad (black). Also Kyle Railroad locomotives and cabooses including Oregon, Pacific & Eastern rebuilt 50' boxcars with Thrall doors; and Pend Oreille Valley rebuilt Pullman-Standard 50' boxcars. Additional new items include both black and white data sets for AutoMax articulated Autorack cars; and data for GATC 2600, 3500, and 4160 Airslide covered hopper cars.

Future releases still on the drawing board are locomotive, boxcar, and caboose decals for Northwestern Pacific, Texas Mexican, and Pan Am Railway. Also coming soon are new texture patterns for plywood and solar panels.

The Wisconsin Central (wc2scale.org) support organization is selling HO scale lettering sets for Wisconsin & Southern 50' Evans boxcars. Priced at \$10.00 each including shipping, the newest set will letter a W&S 5077 and a 5100 cu ft car. The decals were produced by Microscale. Specialty decals are also



available for Escanada & Lake Superior, WC, and CNW. For details visit wc2scale.org/index.php/marketplace/17-decals.

DISCLAIMER ..

The opinions expressed in this column are those of the writer and do not necessarily reflect the opinion of Model Railroad Hobbyist or its sponsors. Every effort is made to provide our readers with accurate and responsible news and information, however, neither Model Railroad Hobbyist or the writer of this column can be held responsible for any inaccuracies or typographical errors that may inadvertently appear in this column.



Send us your product announcements

If you are a hobby manufacturer with a product announcement, just [click here](#) and submit your announcement to us. Our web site and free magazine reach continues to grow, so get on board with this new media train that's hard to stop!

**Can't remember what issue
of MRH that article is in?**

**Have you checked the
online index?**

Click here to learn more ...



contents



index

Briefly noted at press time ...

... **Hornby America** (hornbyamerica.com) has announced plans to import an all-new Rivarossi U25C locomotive. The HO scale model of the General Electric diesel is scheduled for release during the second quarter of 2014. Road names will include Northern Pacific, Pennsylvania, CB&Q, and Atlantic Coast Line. Both DC and DCC/sound models will be offered.

... **True Line Trains** (truelinetrains.ca) is developing an HO scale version of a New York Central 190000 series standard wood caboose. The ready-to-run model will be available decorated for NYC and P&LE in both pre-1955 Roman lettering and post-1955 gothic lettering. Rutland versions will include models with "Route of the Whippet" slogan, and green and yellow paint schemes. Delivery is planned for 2014. The MSRP will be \$44.99, however, preorders booked through your favorite dealer before May 31, 2013 will be priced at \$39.99.

... **Yarmouth Models** (yarmouthmodelworks.com) has released an HO scale resin kit for a Canadian Pacific wartime plywood-sheathed boxcar. The craftsman style kit sells for \$55.00 plus \$8.00 shipping to addresses in North America. We'll have photos of the finished model in the June edition of MRH. ■

Selected Events



May 2013

AUSTRALIA, NSW, ALBURY, May 25-26, Annual Model Railway Show, hosted by Murray Railway Modellers. Featuring trader tables, model railway displays from various regions of Australia in N, HO and O scales, and special Thomas the Tank Engine display. Mirambeena Community Centre, 19 Martha Mews, Lavington. Info at murrayrailwaymodellers.com.

CANADA, ONTARIO, OTTAWA, May 4-5, Ottawa Train Expo, with operating trains, vendor displays, and railroad exhibits. Clinicians include Paul Anderson, Michael Boucher, Allan Egan, Mike Hamer, Chris Lyon, Peter Nesbitt, Ron Newby, Ralph Renzetti, and Don Smith. Carleton University Field House, 1125 Colonel By Drive. Details at ottawatrainexpo.com.

NEW ZEALAND, DUNEDIN, May 11-12, Dunedin Model Train Show sponsored by the American Modular Group, at Forbury Park, 146 Victoria Road. Numerous operating layouts including two Sn3, and five New Zealand Railways layouts, plus operating Thomas and Friends layout for kids. Additional details at dunedinmodeltrainshow@vodafone.co.nz.

ARIZONA, TUCSON, May 31-June 1, Train Show Arizona, sponsored by Gadsden Pacific Toy Train Operating Museum, at Tucson Expo Center, 3750 E. Irvington Road. Info at gpdtoy-trainmuseum.com.

CALIFORNIA, LONG BEACH (Area), May 18, Self-Guided Tour of home layouts in the Long Beach and South Bay area, sponsored by Model Railroads of Southern California. Layout descriptions and a tour map are available on request from Bob Chaparro at chiefbobbb@verizon.net.



contents



index

CALIFORNIA, SAN PEDRO, May 18-19, Open House & Swap Meet at Belmont Shores N Scale Model Railroad Club, 3601 S. Gaffey Street. Info at belmontshorerr.com.

CONNECTICUT, COLLINSVILLE, May 31–June 1, New England/Northeast Prototype Modelers Meet. Clinics, DCC roundtable, and manufacturers displays. Canton Community Center, 40 Dyer Avenue. Layout open-house tours on Sunday. Info from Dave Owens at daowens@gmail.com, or neprototype-meet.com.

FLORIDA, THE VILLAGES, May 11-12, Spring Rail Expo, with operating layouts, model train displays, railroadians, and vendor tables. Savannah Regional Recreation Center, 1545 Buena Vista Blvd.

INDIANA, INDIANAPOLIS, May 2-5, Mile Post 50, Annual Convention of NMRA Central Indiana Division. Banquet speaker is Thomas Hoback, president/CEO of Indiana Railroad Company. Event info at cid.railfan.net. Marriott Indianapolis East, 7202 East 21st Street. For hotel reservations call 317-352-1231.

MINNESOTA, BLOOMINGTON, May 16-19, Twin Rails to Twin Cities, NMRA Thousand Lakes Region Convention, hosted by Twin Cities Division. Best Western Plus at 952-854-8200. Info at thousandlakesregion.org/pages/conventions.html.

NEW MEXICO, ALBUQUERQUE, May 18, Railroad Fair & Model Train Show, sponsored by Golden Spike Enterprises, at Albuquerque Convention Center (west complex). Info at gserr.com.

OHIO, DAYTON, May 15-18, Operations Dayton 2013, NMRA Mid-Central Region Convention at Wyndham Gardens Hotel. Features clinics, model contests, layout tours, and railfanning

opportunities. For hotel reservations call 937-434-8030. Convention info at mcr2013convention.com.

OHIO, HILLIARD (Columbus area), May 18-19, 5th Annual N-Scale Weekend, sponsored by Central Ohio NTrak. Franklin County Fairgrounds. Info at centralohiontrak.org.

PENNSYLVANIA, PHOENIXVILLE (Philadelphia area), May 3-4, 21st National Model Trolley Meet, hosted by East Penn Traction Club at Greater Philadelphia Expo Center, 1601 Egypt Road. Info at eastpenn.org/meet.html. Vendors contact Charles Long, 227 Locust Rd, Ft. Washington, PA 19034-1425.

PENNSYLVANIA, PHOENIXVILLE (Philadelphia area), May 18, Narrow Gauge Modular Meet, Kimberton Fair Grounds. Additional info from Lee Snover at leetown@centurylink.net.

June 2013

CALIFORNIA, ONTARIO, June 1-2, The Big Train Show, Exhibits of all scales, all gauges, manufacturers displays, vendor tables, clinics, and operating scale and toy layouts. Ontario Convention Center, 2000 East Convention Center Way. Info at bigtrainshow.com.

CALIFORNIA, RICHMOND, June 22, San Francisco Bay Area Prototype Modelers Meet, Hosted by BAPM. St. David School, 871 Sonoma Street. Info at bayareaprototypemodelers.net.

CALIFORNIA, SAN DIEGO, June through August, Kids Summer Camp at the San Diego Model Railroad Museum for grades 3-8. Program includes constructing a diorama, create scenery, structures, and buildings their own freight cars. Weathering, trackwork, wiring, and an understanding of electricity are all on the curriculum. Also railroad history, culture, and science with field trips to the Santa Fe Depot and the San Diego Electric Railway Association at the National City Depot. Visit sdmrm.org/#/



contents



index

model-rr-camp/4533422272 or call 619-696-0199 for registration requirements and fees.

COLORADO, COLORADO SPRINGS, June 15-16, Train Expo Colorado, show and swap meet at 3660 N. Nevada Avenue.

FLORIDA, TALLAHASSEE, June 15, 22nd Annual Model Railroad Show & Sale, sponsored by Big Bend Model Railroad Association. North Florida Fairgrounds, 441 Paul Russell Road. Info at bbmra.org.

IDAHO, BOISE, June 26-30, Snake River Special, NMRA Pacific Northwest Region 2013 Convention. Info at pnr.nmra.org/3div/2013.html.

KANSAS, OLATHE, June 13-16, NMRA Mid-Continent Region 2013 Convention. Info at mcor-nmra.org.

MARYLAND, TIMONIUM, June 22-23, Great Scale Model Train Show. One of the nation's largest shows with more than 800 vendor tables. Hosted by Howard Zane at Cow Palace, Maryland State Fairgrounds. Info at gsmts.com.

NEW MEXICO, ALBUQUERQUE, June 6-9, Rails Along the Rio Grande, NMRA Rocky Mountain Region, Rio Grande Division 6 Convention, at Marriott Pyramid North. Info at rarg2013.org.

OHIO, DAYTON, June 22-23, 2013 Carillon Park Rail Festival with live steam engines, model train displays, vendor tables and free miniature train rides. 1000 Carillon Blvd. Info at rail-festival.com.

OHIO, MASON (Cincinnati), June 5-9, 29th Annual National Garden Railway Convention. HQ at Great Wolf Lodge, adjacent to Kings Island Amusement Park. Info at ngrc2013.com.

OREGON, PORTLAND, June 28-30, West Coast 2013 Garden Railway Regional Meet, hosted by Rose City Garden Railway Society. Info at rcgrs.com.

PENNSYLVANIA, TITUSVILLE, June 15-16, Oil Creek & Titusville Railroad 2nd Annual Train & Hobby Show, at Perry Street Station. Info at cleveshows.com.

TEXAS, IRVING, May 29 - June 2, Lone Star Express, 2013 NMRA Lone Star Region Convention at Sheraton DFW Hotel. Call 800-345-5251 for reservations request 2013 Lone Star Region rate.

WASHINGTON, BREMERTON, June 15, Annual Swap Meet, sponsored by Bremerton Northern Model Railroad Club, 9 AM to 3 PM at West Side Improvement Club, 4109 West E Street.

WISCONSIN, MILWAUKEE, June 26-30 National N Scale Convention. Info at nationalnscaleconvention.com.

Future 2013

CANADA, QUEBEC, LAVAL, November 2-3, Laval Expo Train Modelisme Show, (The Quebec Hobby Show), with operating layouts, product displays, and more than 550 vendor tables. Georges Vanier School Complex, 3995 Boulevard Levesque East, Duvernay. Info from M. Didier Piette at didier.piette@videotron.ca.

ARIZONA, PHOENIX, July 27, In the Heat Swap Meet, all scales, models, books, memorabilia, and accessories. North Phoenix Baptist Church, 5757 N. Central Avenue. Info from David Jerry 602-336-0973.

CALIFORNIA, McCLELLAND (Sacramento area), July 17-21, National Summer Steam Up, small scale live steam event. HQ at Lions Gate Hotel & Conference Center, 3410 Westover Street. Details at summersteamup.com.



contents



index

CALIFORNIA, PASADENA, August 28-31, 33rd National Narrow Gauge Convention. Nationally recognized speakers include Eric Bracher, Jack Burgess, Malcolm Furlow, Steve Harris, and Burton Maxwell. Modular displays at HQ hotel include California South Coast Modular, Central Valley Modular, California Central Coast Modular, and North Coast Narrow Gauge, plus vendor exhibits. Tours include numerous layouts and visit to the steam operations at Disneyland, Knott's Berry Farm, and the backshop at the Fillmore and Western Railway. At Hilton Hotel, 199 S. Los Robles Avenue. Full details at 33rdnngc.com.

CALIFORNIA, SAN BERNARDINO, September 25-29, NMRA Pacific Southwest Region Convention with contests, manufacturers displays, 50 clinics and raffle with grand prize of Tenshodo UP Big Boy. Prototype tours include Union Pacific hump yard, the Victorville CEMEX plant, and the Columbia Park Live Steamers. At Hilton Hotel 285 E. Hospitality Lane. Details at psrconvention.org/sb13/index.html or contact Bob Mitchell at CajonDivision@coastinet.com.

COLORADO, LONGMONT, December 8-9, Annual Train Show, sponsored by Boulder Model Railroad Club, with operating layouts, prize winning models, vendor tables, and layout raffle. Boulder County Fairgrounds. Info at bouldermodelrailroadclub.org.

FLORIDA, BRADENTON, October 11-13, Manatee Rails, NMRA Sunshine Region 2013 Convention, at Courtyard Marriott and Bradenton Convention Center. Info at sunshineregion.org/Conventions.aspx.

FLORIDA, ORLANDO, Aug 3-4, The Great Train Expo, at Central Florida Fairgrounds. Info at greattrainexpo.com.



GEORGIA, ATLANTA, July 14-20, NMRA Annual Convention. Cobb Galleria Centre with convention HQ at adjacent Renaissance Waverly Hotel. Info at nmra2013.org.

GEORGIA, ATLANTA, July 18-20, National Train Show, in conjunction with annual NMRA Convention. Cobb Galleria Centre, 2 Galleria Parkway. Info at nmra2013.org.

ILLINOIS, BELLEVILLE, July 27-28 The Great Train Expo, at Belle-Clair Fairgrounds. Info at greattrainexpo.com.

ILLINOIS, COLLINSVILLE (Metro St. Louis), August 2-3, St. Louis RPM, at Gateway Convention Center. Info from John Golden at golden1014@yahoo.com.

ILLINOIS, LISLE (formerly at Naperville), October 17-19, 20th Annual RPM-Naperville Conference featuring prototype models, vendor displays, and clinics with blue ribbon panel of speakers including Bob Van Arnhem, John Brown, Richard Hendrickson, Tony Koester, Clark Propst, Mont Switzer, and Tony Thompson. Friends of the Freight Car dinner Thursday. At Wyndham Lisle Hotel (new venue), 3000 Warrenville Road, Lisle. Call 630-505-1000 for hotel reservations. Event hosted by Joe D'Elia. Info at railroadprototypemodelers.com/naper_meet.htm.

MARYLAND, TIMONIUM, October 26-27, Great Scale Model Train Show. One of the nation's largest shows with more than 800 vendor tables. Hosted by Howard Zane at Cow Palace, Maryland State Fairgrounds. Info at gsmts.com.

MASSACHUSETTS, PITTSFIELD, November 7-9, Fine Scale Model Railroader Expo. Billed as "the only show dedicated to the art of scale model structure building," with model displays, vendor



contents



index

exhibits, and a layout tour of Dick Elwell's Hoosac Valley Lines. All-star list of clinician/speakers include Jon Addison, Michael Duggan, Dave Frary, Brett Gallant, Ken Hamilton, Bernard Kempinski, Marty McGuirk, Bob Mitchell, Dave Revelia, and Bill Sartore. Expo info at modelrailroadexpo.com. Event at Berkshire Crown Plaza Hotel, One West Street. Call 413-499-2000 for hotel reservations.

NEW YORK, GARDINER, October 25-26, Semi-Annual Mid Hudson On30 Meet at St. Charles Borromeo RC Church, 2212 Route 44/55. Details at groups.yahoo.com/group/midhudsonOn30meet/?yguid=120653266.

OHIO, VAN WERT, July 13-14, Model Train Show & Swap Meet with more than 100 vendor tables. Van Wert County Fairgrounds. Info from Jan Dunlap at snapshotjan@embarq-mail.com.

PENNSYLVANIA, PITTSBURGH, August 28-September 1, Annual Steel Mill Modelers Meet, includes seminars, model contests, "Dean Freytag" award, vendor tables, tour of Carrie Furnace, and more. Four Points Sheraton Hotel at Pittsburgh Airport, 1 Industry Lane. Call 724-695-0002 for hotel reservations. Meet info from John Glaab at peachcreekshops.com.

TEXAS, LIVE OAK (San Antonio), July 27-28, 11th Annual Summer Train Show, sponsored by San Antonio Model Railroad Association. Live Oak Civic Center, 8108 Pat Booker Road. Info at samratx.org.

VIRGINIA, STAFFORD, September 13-14, Mid-Atlantic Railroad Prototype Modelers Meet, at Hope Springs Marina Clubhouse, 4 Hope springs Lane. Info at marpm.org.

WISCONSIN, WEST ALLIS (Milwaukee area), November 9-10, Trainfest 2013, hosted by Wisconsin Southeastern Division of NMRA.

Future (2014 and beyond)

FLORIDA, COCOA BEACH, January 9-11, 2014, Cocoa Beach RPM meet.

GEORGIA, SAVANNAH, March 27-29, 2014. 2014 Savannah RPM meet.

INDIANA, INDIANAPOLIS, July 3-10, 2016 NMRA National Convention and National Train Show.

MAINE, AUGUSTA, 2016, date TBA, 36th National Narrow Gauge Convention.

MISSOURI, KANSAS CITY, September 3-6, 2014, 34th National Narrow Gauge Convention.

OHIO, CLEVELAND, July 13-19, 2014, NMRA National Convention and National Train Show.

OREGON, PORTLAND, August 23-30, 2015 NMRA National Convention and National Train Show.

TEXAS, HOUSTON, 2015, date TBA, 35th National Narrow Gauge Convention. ■



contents



index

The “one-module” challenge

Reverse Running: Stepping outside the box with a contrary view

by Joe Fugate

Have you been planning that dream layout for years? How's it coming?

Still stuck in analysis paralysis? Or maybe you've started construction, but can't seem to finish anything?

We modelers can dream big, but we do struggle making good on our aspirations.

Time for the "one-module" challenge!

Rather than aim for the stars, let's deliberately set the scope small so it's possible to finish in weeks or months instead of years.

Pick a subject/scene that interests you, but chose something that fits into a single module of no more than 6 feet in length. Then build it to completion at your workbench:

- All trackwork finished and wired, with turnouts fully functional
- All the scenery done, including ground cover, trees and water
- All the structures done, including any bridges and track-side details

Aim for a completely finished module that's operational. Granted, there may not be a lot of operation on just one module, but it's finished!

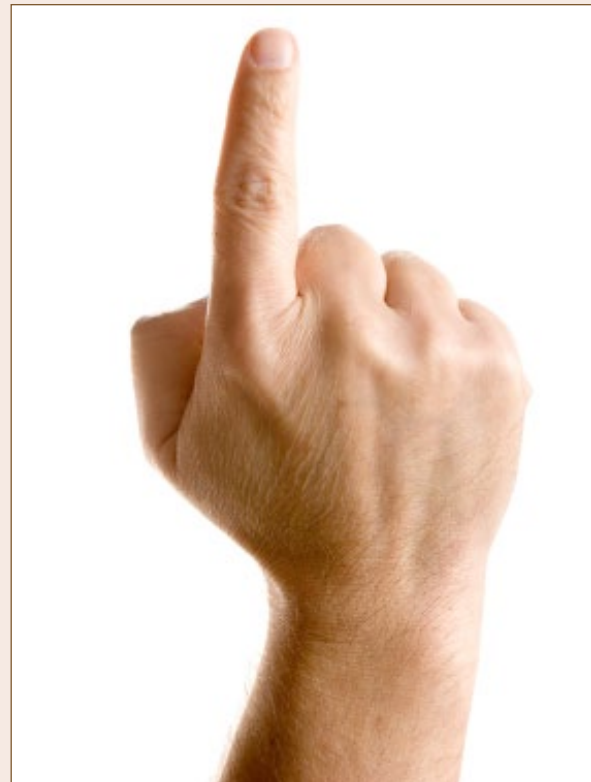

If you take up the challenge, it may be more work than you thought, and may take longer than expected. But by working at your workbench, you can turn the module over, for example, to mount any Tortoises or to run the wires - making otherwise tedious work into something that's halfway pleasant. You will tend to do better work at your workbench and be more satisfied with the result.

Once you have this module, now add a 1x12 at each end with some staging tracks and now run trains through your finished scene!

Next, do a second module. Add this module to the other one, and move the staging to the end. Now you can run trains a little farther through finished scenes and things have gotten more interesting. And notice - you have a finished-looking, operational layout in record time. Yes, it's small, but it's a complete layout!

So how about building your whole layout in this way, one section at a time? At any stage you can point to it with pride and have a complete layout. I think using this sectional approach has a lot going for it, as opposed to the more traditional approach that can take years before you see any real progress or can get your "running trains" fix. Or worse, the entire layout project will languish once you realize the massive scope of the project.

Turn the whole dream layout building process inside out and start tiny instead, with something you might actually be able to finish in less than a year! And then just do it over and over ... and quit at any point with a "complete" layout.

Anyone up for the "one module" challenge? 



contents



index

Clickable advertiser index

[Accu-Lites](#)

[Accurail](#)

[Alpine Division Scale Models](#)

[Backdrop Junction](#)

[Blair Line](#)

[BLMA](#)

[Bowser](#)

[Bullfrog Snot](#)

[Clever Models](#)

[Coastmans Scenic](#)

[Coffman](#)

[Credit Valley](#)

[Dallas Modelworks](#)

[Digitrax \(2 page spread\)](#)

[ExactRail](#)

[ESU](#)

[Fifer Hobby Supply](#)

[Great Decals](#)

[Horizon Hobbies](#)

[Interaction](#)

[Iwata-Medea](#)

[Jelsma](#)

[Knucklepin \(Passenger cars\)](#)

[Litchfield Station](#)

[Logic Rail Technologies](#)

[Microscale](#)

[Minimalist Model Railroad](#)

[Model Railroad Benchwork](#)

[Model Trains Video](#)

[Monster Modelworks](#)

[M.T.H.](#)

[Mullet River \(O scale\)](#)

[Nano-Oil](#)

[North American Railcar](#)

[NCE](#)

[Olin's Depot](#)

[Proto:87 Store](#)

[RailMaster Hobbies](#)

[Railroad Explorer](#)

[Rapido \(2 page spread\)](#)

[Ring Engineering \(1\)](#)

[Ring Engineering \(2\)](#)

[RSlaserKits](#)

[Rulers-of-the-World](#)

[Rusty Stumps](#)

[San Juan Car Company](#)

[SBS4DCC](#)

[Scenic Express](#)

[Scotty Mason Show](#)

[Soundtraxx](#)

[Southern Digital](#)

[TAM Valley Depot](#)

[Tony's Trains](#)

[TrainTek](#)

[True Line Trains](#)

[True Scene Modeling](#)

[Westerfield Models](#)

[Yankee Dabblers](#)



Clickable topic index

[DCC Impulses – Using Ohm's Law](#)
[Editorial – Publisher's Editorial](#)
[Editorial – Reverse Running](#)
[Getting Real – Kinter Milling](#)
[Layout – A One Turnout Layout](#)
[Layout – N Scale 2'x4' Layout for \\$500](#)
[News – May Newsletter](#)
[News – May Events](#)
[Q and A – MRH Questions, Answers, and Tips](#)
[Rolling Stock – The Erie Railroad Boxcars, Part 2](#)
[Rolling Stock – Freight Car Trucks](#)
[The Tool Shed – Build a Wood Staining Fixture](#)
[Yes It's a Model – MRH Monthly Photo Album](#)
[Up the Creek – Bending the Sky](#)
[What's Neat – What Has Ken Patterson Been Up To?](#)

[Other – Bonus Extras](#)
[Other – Cover](#)
[Other – Derailments](#)
[Other – Hobby Marketplace](#)
[Other – MRH Sponsors](#)
[Other – Staff Notes](#)
[Other – Table of Contents](#)

Derailments

humor (allegedly)

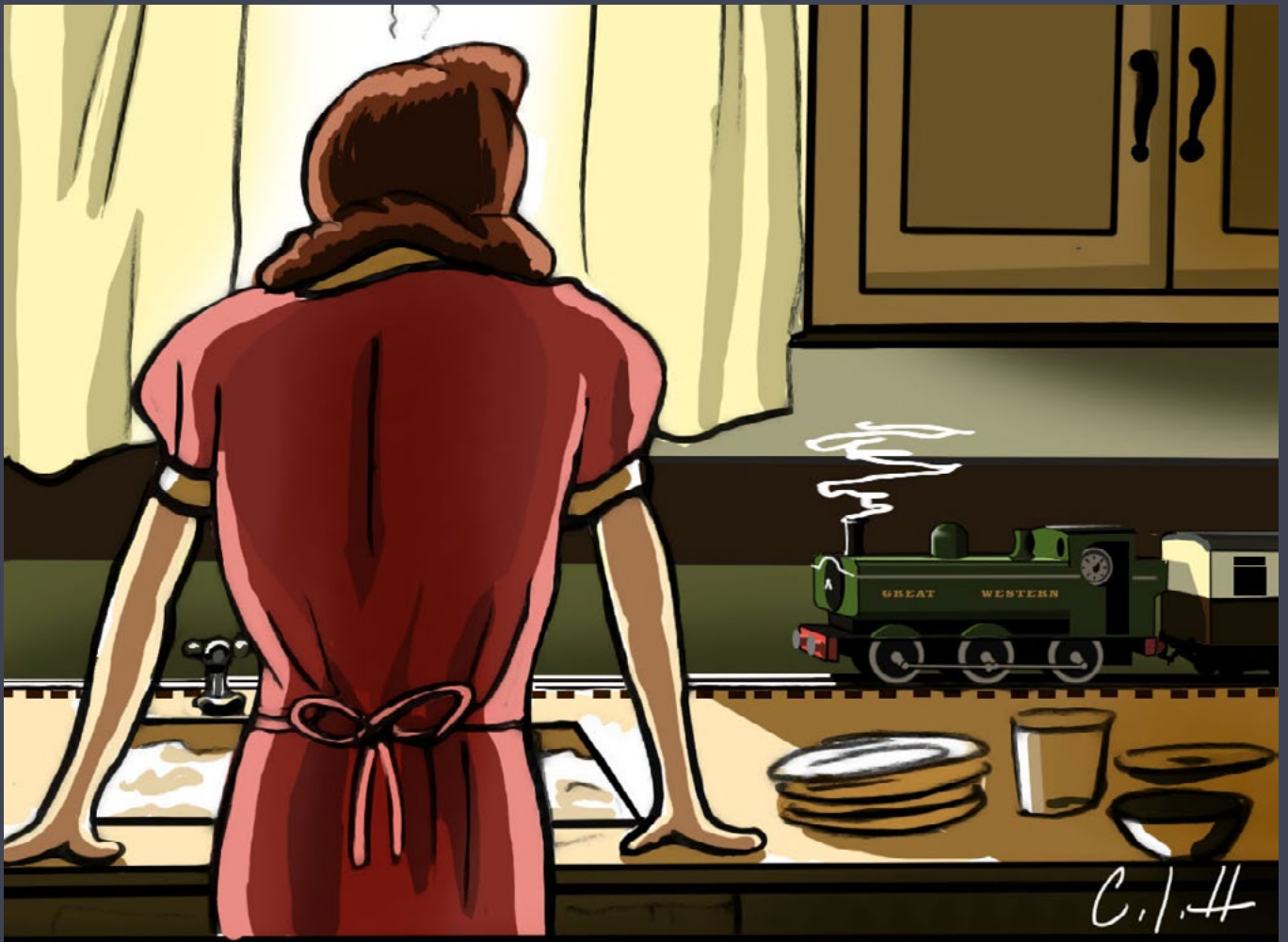

I should've known what he meant by "trackage rights" ...

If you're the first to [submit a bit of good humor](#) and we use it, it's worth \$25!



**Reader
Feedback**
(click here)



For the love of model trains

Coming in June

- We tour Rob Carey's incredible D&RGW Tennessee Pass
- Sound on your layout
- Modeling a rail bumper
- MOPAC shorty cabooses
- Modeling Erie boxcars from the 1950s finale
- AAR Rail clearances reference
- ...and lots more!

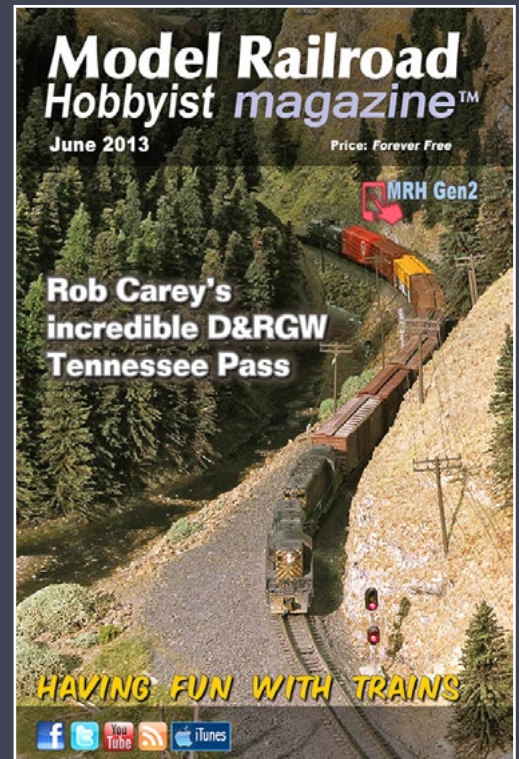

~~More Derailments humor ...~~

One day while working on a construction project, a railroad company truck was stuck in the traffic. As my co-worker and I walked by, one of the guys in the railroad truck hollered at us wanting to know how long before the roadwork was completed?

My co-worker replied, "When the trains run on time!"

Q: Why can't an engineer be electrocuted?

A: Because he's not a conductor!

Q: What is the difference between a school teacher and a steam locomotive?

A: The school teacher tells you to spit out your gum, while the locomotive says "Choo Choo Choo!"

Coming next issue



contents



index