

Allagash railfan trip • Turnout controls • Trackplan database

# Model Railroad Hobbyist magazine™

February 2014

Price: Forever Free

## HAVING FUN WITH TRAINS

**EXCLUSIVE!**

**Amherst Railroad  
Hobby Show Report**

*Bob Smaus  
on modeling*

# Structures in tight places

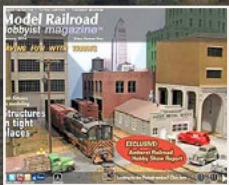

Click here for the  
landscape version



Standard edition - portrait



download



contents



index



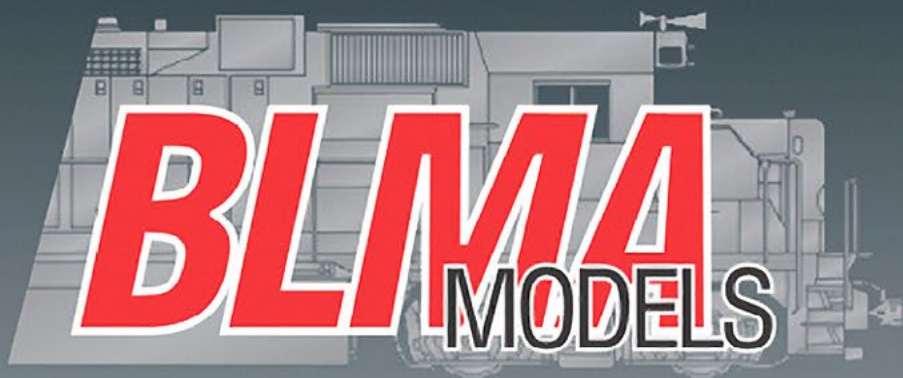

**PRE-ORDER NOW!**

**HO & N** SCALE

**COOLER  
THAN EVER!**



**TRINITY 64'  
MODERN REEFER**

*with  
new*

**CARRIER  
REEFER UNIT**

**CLICK HERE TO SEE MORE**





# Model Railroad Hobbyist magazine™

Issue 48

**Front Cover:** We feature Bob Smaus demonstrating how to build a detailed scene in a very small space. Follow along and learn how you can build and detail that small space on your own layout.

**ISSN 2152-7423**

## Editorial Staff

Joe D. Fugate, Publisher and Editor  
Don Hanley, Assistant Editor

## Production

Patty Fugate, pasteup and layout  
Joe Brugger, copy editing  
Mike Dodd, copy editing

## Technical Assistants

Jeff Shultz  
Jimmy Simmons

## Advertising

Les Halmos, Account Manager  
Daniel Nava, Advertising Assistant  
Jean-François Delisle, Marketing Assistant

Published for the glory of God. [What's this?](#)

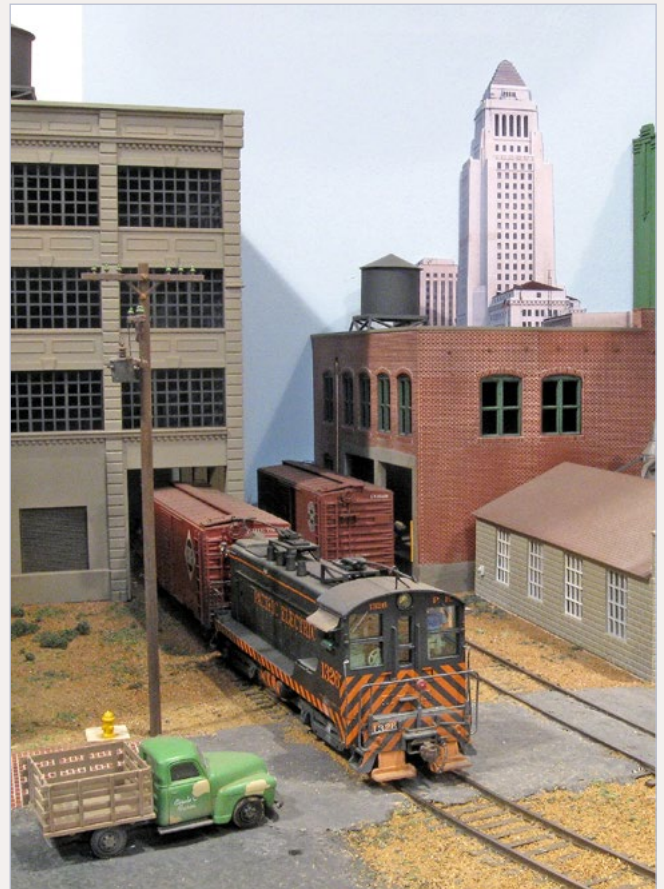

## Columnists

Richard Bale, News and events  
Jeff Shultz, News and events  
Les Halmos, Modular railroading  
Ken Patterson, Reporter at large  
Bruce Petrarca, DCC

## Special Correspondents

Joe Brugger, Questions & answers  
Charlie Comstock, Contributing editor

Issue password: Feb2013

Cover and MRH masthead



contents



index





click to learn more about this sponsor



click to learn more about this sponsor



click to learn more about this sponsor



click to learn more about this sponsor



**NEW SPONSOR!**

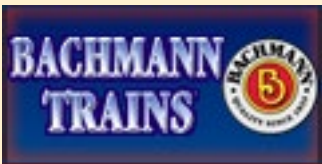

**NEW SPONSOR!**



click to learn more about this sponsor

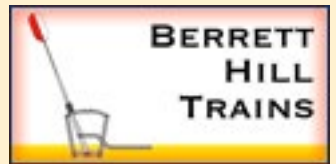

**NEW SPONSOR!**



**NEW SPONSOR!**



**NEW SPONSOR!**



click to learn more about this sponsor



click to learn more about this sponsor



**NEW SPONSOR!**



click to learn more about this sponsor



click to learn more about this sponsor



**NEW SPONSOR!**



click to learn more about this sponsor



click to learn more about this sponsor



click to learn more about this sponsor



click to learn more about this sponsor

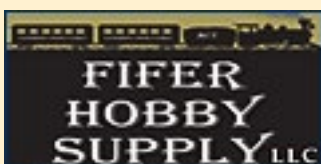

click to learn more about this sponsor



**NEW SPONSOR!**



**NEW SPONSOR!**



**NEW SPONSOR!**



**NEW SPONSOR!**



click to learn more about this sponsor



click to learn more about this sponsor



click to learn more about this sponsor



**NEW SPONSOR!**



click to learn more about this sponsor



click to learn more about this sponsor



**NEW SPONSOR!**



click to learn more about this sponsor



click to learn more about this sponsor



click to learn more about this sponsor



click to learn more about this sponsor







click to learn more about this sponsor



click to learn more about this sponsor



click to learn more about this sponsor



click to learn more about this sponsor



click to learn more about this sponsor



click to learn more about this sponsor



**NEW SPONSOR!**



click to learn more about this sponsor



**NEW SPONSOR!**



click to learn more about this sponsor



click to learn more about this sponsor



click to learn more about this sponsor



click to learn more about this sponsor



click to learn more about this sponsor



click to learn more about this sponsor



click to learn more about this sponsor

# Want your logo on this page?

Click to find out how....

# 90,000+ unique device views per month...

**Tell me more**



# Looking for something? Check our Hobby Marketplace!

**Take me there**





## Main Features

*Click title  
to view*



### Structures in tight places

Build a detailed scene for a small space

*By Bob Smaus*



### Modern commuter operations

Add operational variety to your layout

*by John Drye*



### The Allagash story – part 2

Railfan a fantastic layout

*by Mike Confalone*



### Yes, it's a model

MRH's great modeling photo feature

*compiled by the MRH staff*

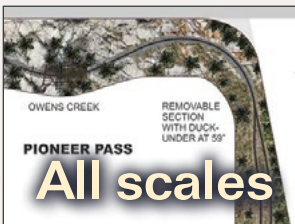

### MRH track plan database

Introduction to our online track plan collection

*by Bill Brillinger and the MRH staff*



### Turnout control protection

Protect your turnout controls

*by David Salsbery*



### Amherst Report

*by the MRH Staff*



### Feb News

*by Richard Bale  
& Jeff Shultz*



## Table of Contents - 2

# Other Features

*Click title  
to view*

[Intimidated or inspired?](#)

**Publisher's Musings**  
*by Joe Fugate*

[MRH Staff Notes](#)

**A blast from the past, and more ...**  
*by the MRH staff*

[MRH Q - A - T](#)

**Questions, Answers, and Tips**  
*compiled by Joe Brugger*

[Hobby Marketplace](#)

**Vendor ads**

[Derailments](#)

**Humor and bizarre facts?**

# Columns

[DCC addressing](#)

**DCC Impulses**  
*by Bruce Petrarca*

[1950s auto carrier](#)

**Getting Real**  
*by Nick Muff*

[Narrow gauge boxcars](#)

**Lite and Narrow**  
*by Larry Smith*

[Turbine masters, and more](#)

**What's Neat**  
*by Ken Patterson*

[Unlimited hobby funds](#)

**Reverse Running**  
*by Don Hanley*

[Subscriber-only extras](#) *(subscribers click here to access)*





**INCREDIBLE.  
UNBELIEVABLE.  
N SCALE.  
GMD-1.**

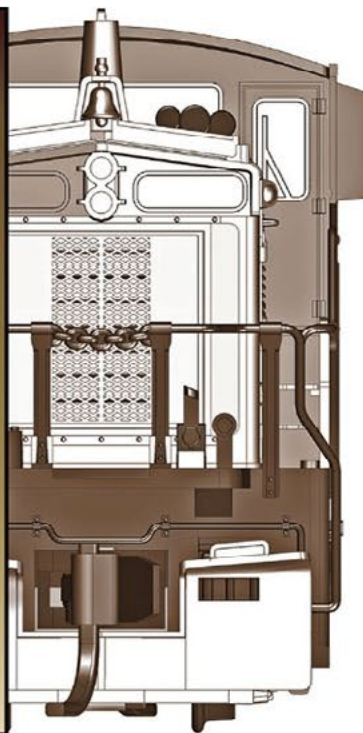

**START  
DROOLING  
NOW.**



[www.rapidotrains.com](http://www.rapidotrains.com)

in association with



Pre-production sample shown.

MRH-Feb 2013







# The PANORAMA Line™

SUPER-DETAILED N SCALE PASSENGER CARS BY RAPIDO TRAINS INC.

Order your  
**10-5 Sleepers**  
and  
**Cafe-Bar-Lounge cars**  
by 14 February  
or we'll never make N scale stuff again.

(Except for all the new N scale stuff we just announced.)  
(OK - We admit it. It was an empty threat. Sorry.)



**RAPIDO**



Email

Phone

contents

index





# EXACTRAIL®

The Next Generation of Model Railroading

▲ ON SPECIAL THIS MONTH AT [EXACTRAIL.COM](http://EXACTRAIL.COM)



## THRALL 2743 GONDOLA

Available in 5 Paint Schemes



[LEARN MORE >](#)

**HO** NEW AT EXACTRAIL  
THE WORLD'S  
FINEST WHEEL SETS >

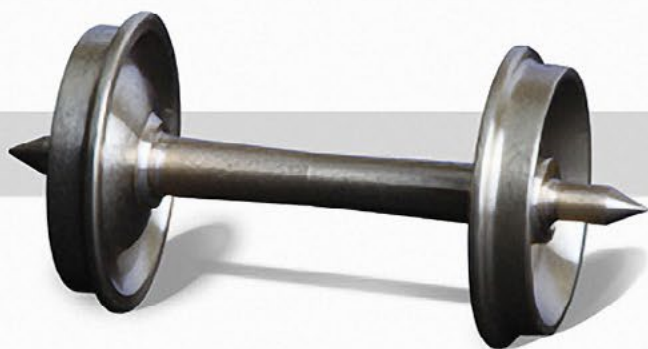

**HO** *ALL NEW*  
BETHLEHEM 3737 HOPPER

**COMING SOON**







## Intimidated or inspired?

Looking at our reaction when encountering excellent modeling



### Publisher's Musings

by Joe Fugate

**W**hen you see some especially well done modeling, how does it affect you? Are you inspired to try to raise your game on your modeling?

Or like some, do you feel intimidated and start entertaining thoughts like: why try?

If you are someone who is intimidated, then if at all possible, we need to figure out how to get you over into the camp that's inspired by good modeling.

First, it's important to remember this is a hobby, not a do-or-die competition. One of the things I especially appreciate about the Railroad Prototype Modelers' (RPM) meets is how they focus more on modeling project show-and-tell rather than contests.

Western culture, heavily influenced by the Greeks and their sports/military competitions, seems to have developed a sometimes unhealthy fetish for competition, allowing it to permeate everything we do.

While there's certainly value in healthy competition, there's a lot of life that should not be viewed through the mindset of winners and losers.





NORFOLK SOUTHERN  
Item No. 63753/63853

## BACHMANN UNLEASHES NEW "BULLDOGS" DCC-EQUIPPED EMD F7-A and F7-B DIESELS

DCC-equipped for speed, direction, and lighting, our EMD F7-A and B locomotives feature an all new drivetrain, precision motor, all-wheel pickup, die-cast chassis, new gear tower, and E-Z Mate® Mark II couplers. The A unit also has an operating LED headlight and teardrop windows. Visit your favorite hobby dealer to unleash these new bulldogs on your N scale railroad today!

Click for  
more information.



BALTIMORE & OHIO®  
Item No. 63751



BALTIMORE & OHIO®  
Item No. 63851



GREAT NORTHERN  
Item No. 63752



GREAT NORTHERN  
Item No. 63852



ERIE LACKAWANNA  
Item No. 63754



ERIE LACKAWANNA  
Item No. 63854

**MSRP \$115.00 each  
SHIPPING NOW!**



SANTA FE  
(War Bonnet)  
Item No. 63755



SANTA FE  
(War Bonnet)  
Item No. 63855



Bachmann Industries, Inc. • 1400 East Erie Avenue • Philadelphia, PA 19124 USA • [www.bachmanntrains.com](http://www.bachmanntrains.com)

Click to learn more.





There's also the notion that eastern cultures promote – helping the entire group succeed rather than just the individual. Individuals succeeding at the expense of the advancement of the group is seen as unhealthy and not to be encouraged.

Applying all this to model railroading, start by remembering *this is a hobby*, and as such the focus needs to be on entertainment and personal artistic achievement, rather than keeping score.

Succeeding as a group rather than just an individual can also apply here. So you aren't any good at weathering, you say? Well then, find one of your model railroading buddies who is better at weathering than you and partner with him.

Maybe you can become good at weathering by learning from a buddy who is better at it than you? Or if you are all thumbs no matter what, then trade some skill you are good at in exchange for him doing some weathering on your layout?

### Advertisement

## HOn3... Small Trains, Big Possibilities



Build your narrow gauge empire with our ready-to-run Drop Bottom Gondolas.

All new road numbers, available May 2014. Reserve yours today!

Click for more Information



See us on YouTube

Blackstone  Models™



Email



Phone



contents



index

We can't all be good at everything. Rather than seeing some weakness in yourself, how about taking something you *are* good at and offering to help out your fellow model railroader? Then ask if they'll help you out with some things they are good at.

Good modeling should inspire us to do more modeling ourselves, and to see ourselves as part of the larger team of all model railroaders everywhere who are working for the greater good of helping everyone become better modelers.

MRH and TrainMasters TV endeavor to do just that: foster a community that's ready and willing to help you become a better, more satisfied model railroader.

So get involved. Drop by the MRH online forum and provide some much-needed answers for other fellow modelers. And seek out advice on how to grow your own skills and improve your modeling too.

No need to keep score with our modeling. Part of the joy of the hobby is celebrating what others, who excel at some part of the hobby, have done. And remember how blessed we are to have people in the model railroading hobby who are often more than willing to share their talents and methods with the rest of us!

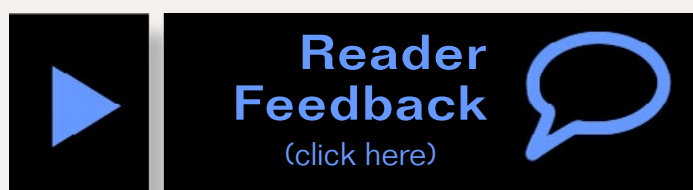
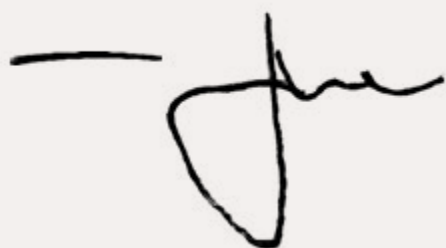





# WOW!

# Premier Scale Trees



Many species of  
Conifer trees available!

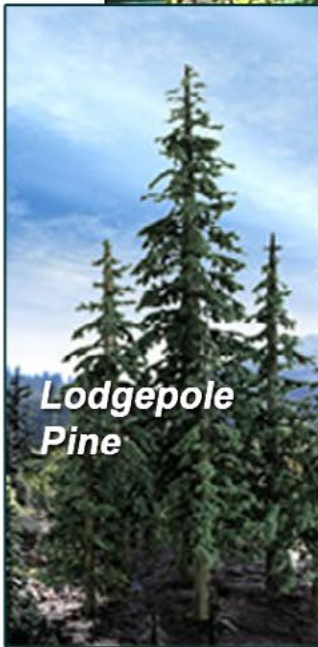

Lodgepole  
Pine



Green  
Spruce

Blue  
Spruce

Also see our other  
conifer offerings ...

Click for  
more -  
lots more!





# Notes from the MRH STAFF

Blast from the past, articles we need, and more ...

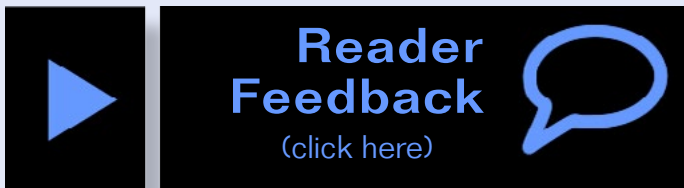

## Blast from the past?

**M**odelers who have been in the hobby for many years can sometimes be heard lamenting “there aren’t any craftsman left in the hobby”. One blogger we read recently remarked, “I can remember the day when suggesting you hand lay a turnout would not even make a modeler blink twice.”

A number of the MRH staff have been in the hobby since the 1960s, and we can’t remember such a day. Must have been *quite a while back ...*

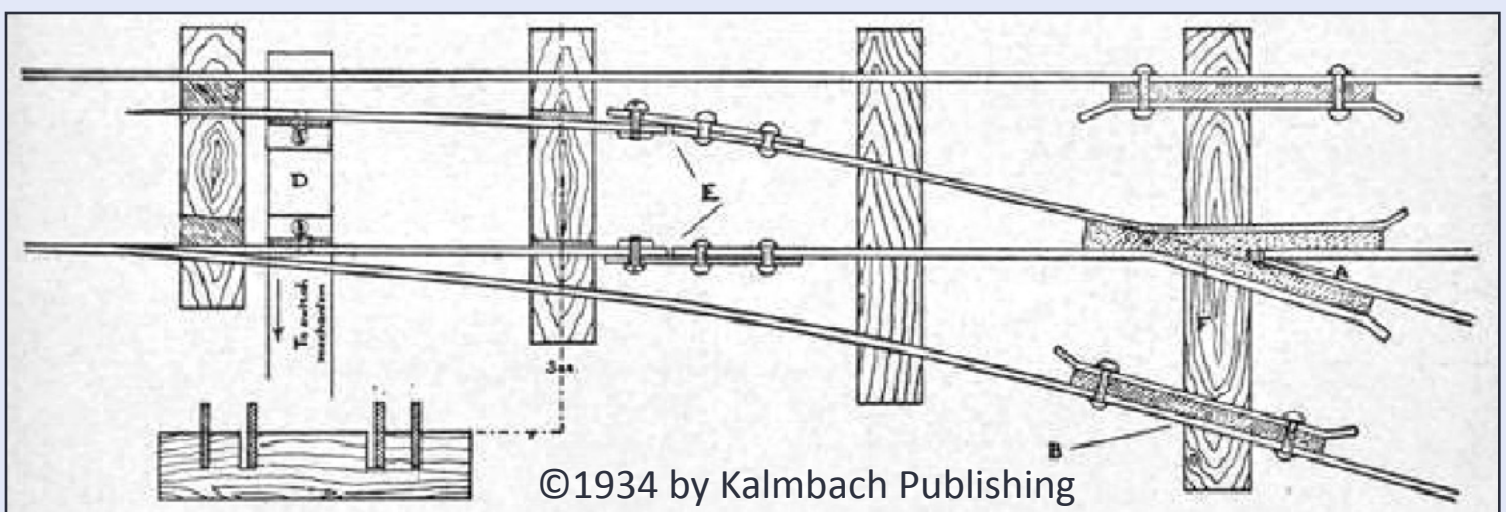

This drawing came from the March 1934 issue of *Model Railroader*. To get this issue in digital form, see: [kalmbachstore.com/15120](http://kalmbachstore.com/15120)







## Jan 2014 MRH Ratings

The five top-rated articles in the January 2014 issue of MRH are:

- 4.7 Journey to Allagash Country, part 1
- 4.6 DCC Impulses: Multiple speakers with DCC sound
- 4.5 Easiest way yet to make molds
- 4.5 Yes, it's a model
- 4.4 Questions, Answers, and Tips
  
- Issue overall: 4.6

***Please rate the articles!***

Click the reader feedback button on each article and select the star rating you think each article deserves. ***Thank you!***

Advertisement



**1<sup>st</sup> choice for model  
railway supplies  
and service.**

**Expedited mail  
service available  
across North America.**

Click to visit:  
**WWW.CVRCO.COM**  
**1 800 464 1730**



Let's take a quick look at the hobby's past and see if we aren't having a bit of amnesia about how it really was back in the "good old days".

Pulling out the first year of *Model Railroader Magazines* in 1934, the first mention of building your own turnout had a drawing of building your own turnout from strap metal (see the drawing on the previous page). We don't think that handbuilt turnout would pass muster on anyone's layout today!

Back in the model railroading magazines all through the 1930s and '40s, it wasn't uncommon to find articles about how to build your own motor or transformer. Even as late as the 1950s, you would find rather backward articles such as one on using stove polish to paint your metal steam locos. By today's standards, these construction methods and materials feel antiquated.

After World War II, ready-made power packs started to appear, and in the 1950s, some vendors introduced a revolutionary new type of track: brass flex track with fiber ties.

The introduction of ready-to-run (RTR) plastic cars and locos in the 1950s made quite a stir. By the 1960s, concerned readers sent in letters about how plastic RTR was "killing the hobby" – and if plastic didn't completely kill model railroading, then slot cars certainly would put the last nails in the hobby's coffin.

The ranks of the hobby in the '30s and '40s numbered in the thousands, and as the '50s and '60s wore on with its hobby-killing plastic trains, the number of model railroaders swelled to over 200,000. As the hobby has continued to see ever improving product over the last few decades, hobby officials estimate the world wide hobby audience today to be circa 500,000. Not exactly what you'd expect from a hobby that was going to die in the 1960s.





We believe the number of modelers who still build a lot of things themselves numbers a few thousand – which means the number today is likely similar to what it was back in the so-called “real craftsman” days at the dawn of the hobby.

In the meantime, these “plastic trains” have triggered huge growth in the hobby ranks and every one of us has benefited, including those lamenting the bygone craftsman days of the hobby.

History has proven the fears plastic trains would kill the hobby have been unfounded.

The hobby ranks have grown tremendously, thanks to these prolific plastic trains making the hobby something mere

Advertisement

IT'S TIME



LOCOMOTIVES, CARS, BUILDINGS AND KITS

[Click here to get started in TT scale](#)

[WWW.SAZMODEL.COM](http://WWW.SAZMODEL.COM)

**When talking  
to hobby  
vendors,  
please  
remember  
to mention  
MRH.**



contents



index

mortals can pursue. Oh, and in case you missed it, slot cars have not killed the hobby of model railroading, either.

## Model railroaders or railroad modelers?

Another implication of the “no craftsman in the hobby left” concern is that those of us lamenting the bygone craftsman days of the hobby seem to prefer model railroaders who are builders to those who take the broader theme of being railroad modelers.

Here at MRH, we feel it’s all in how you define model building. At some point you let someone else do the work and you just pay them for it.

Do you dig the iron and copper out of the ground yourself, or do you let someone else do that, and do you buy the brass sheet? Do you build your loco motors yourself, or do you let someone else do that, and you buy pre-built motors?

Do you let someone else make mold masters and cast the detail parts, and then you buy the cast parts?

Do you buy a car kit and assemble it yourself, or do you let someone else assemble it?

The hobby is trending today toward ever more prototype fidelity, be that proto-freelance or modeling a specific prototype.

Thanks to those RTR plastic trains, modelers can purchase some portion of their needs, and then focus on kitbashing or scratchbuilding only what they can’t buy. And in case you didn’t notice – you can’t model any prototype well and just buy everything. You will *have to* kitbash and scratchbuild if you intend to do your prototype justice.

Should the highest goal in the hobby be that modelers can show how macho they are by denying themselves of readily



available parts, and build by hand just to demonstrate their craftsmanship prowess? These days, that's called a special technique for more contest points – almost no modelers build layouts that way.

We contend a better goal, and one that actually is good for the hobby, is to get more modelers building more layouts. To make that practical, that means modelers need to focus their hobby efforts wisely by only building what they can't easily purchase.

We won't argue those old timer hobby craftsman like Carl Traub, John Allen, Jack Work, and Ben King did some amazing work, especially considering what they had to work with.

But modelers today are doing even more amazing work – if you consider how the end product looks. If you don't believe us, just look at the last 12 months of Ken Patterson's "What's

## February 2014 Bonus Extras!

***Available to subscribers!***

**DVD and HD quality versions of the videos in this issue, plus:**

- **Special coupon code good for 20% off on a Train-Masters TV 1-year or 2-year subscription**
- **Plans of Auto carrier in this month's Getting Real**

**Click here to access**



contents



index

## Combo Right Clamp™

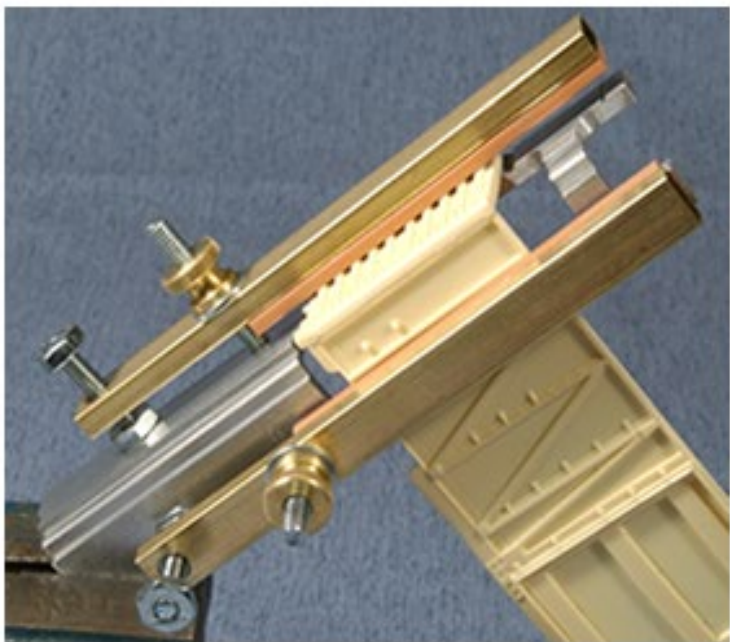

Combo Right Clamp™  
with cast resin boxcar

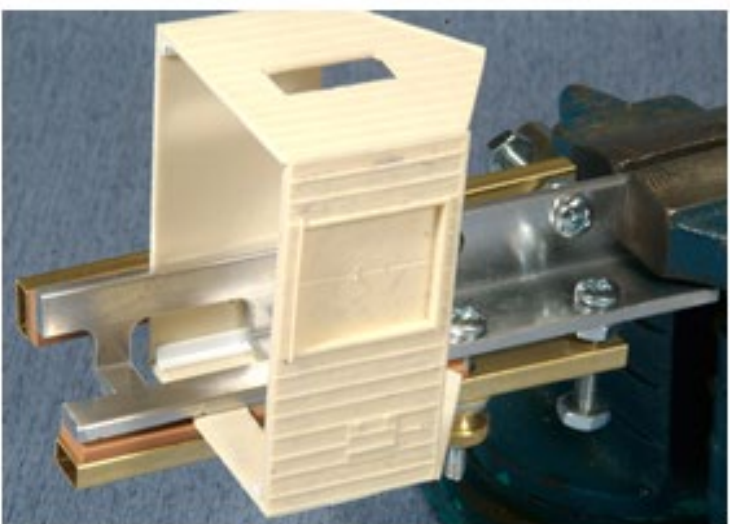

Combo Right Clamp™  
with Wolf Design Pump House

[Click here for  
all our products ...](#)

### Tools for Modelers

Coffman Graphic Solutions Co.  
1500 River Circle, Richmond,  
KY 40475-7907

Neat this Week” column or our “Yes, it’s a Model” photo feature to see the stunning realism in the modeling being done today.

We at MRH don’t lament the “good old days” of the hobby, frankly. We’re more excited than ever about the fabulous modeling being done today. When looking through back issues of the hobby magazines from the “good old days of hobby craftsmanship” – we find the general quality of the modeling back then was pretty crude in comparison to today.

## Buying your way into the hobby?

So what about those who don’t really build anything themselves but instead buy everything? Are they any less a model railroader?

We feel the ranks of those who take the buy everything



Staff notes - 4



contents



index



approach to the hobby are few in number. Most will at least do some building.

But even so, what's wrong with selecting the best the hobby has to offer, and paying those who are good at what they do to do it for you?

Somebody built it. It didn't just magically appear out of thin air, right? There's something to be said about someone who can assemble an awesome collection of modeling done by others and pull it together into an integrated whole.

The western (European and North American) mindset focuses a lot on being impressed by "self-made-men" and "self-made-women". If you can do it yourself, then you're a hero. If you have to get help from others, then you're a wimp.

The eastern mindset, however, appreciates the work achieved by a community of people and considers the self-made attitude to be somewhat arrogant. Perhaps another way to look at those who "buy their layout" is that they've got the means to pull together a community to achieve a fun goal and they're willing (and able) to compensate others for their efforts. The eastern mindset considers such "crowd-created" achievements to be noble ones.

If we westerners truly believe the rhetoric about "diversity" as being a good thing, then "doing it all yourself" (aka, being a "craftsman") is not the only way to be a good railroad modeler.

## **MRH \$500 Starter Layout Contest**

The \$500 Starter Layout Contest is complete and we're judging the entries. We expect to announce the winners in the March issue. Stay tuned!



contents



index

## Articles we're looking for

We have a number of topics on which we'd love to have someone do an article. If you are interested in writing an article for MRH, we do pay for articles, helping your hobby to fund itself. Please consider doing an article for us on one of these topics:

- Detailing a specific steam locomotive
- Detailing a specific steam loco tender
- Kitbashing a specific steam locomotive
- Tuning steam locomotives for better performance
- Scratchbuilding diesels using styrene
- Detailing a specific diesel locomotive
- Kitbashing a specific diesel locomotive
- Tuning diesel locomotives for better performance
- Kitbashing rolling stock
- Upgrading older rolling stock to modern standards

*Advertisement*



**TOP QUALITY PRODUCTS**  
FOR THE MODEL RAILROAD CRAFTSMAN

**Click to Order**

**CONCRETE  
BRIDGE  
GIRDER &  
ABUTMENT**

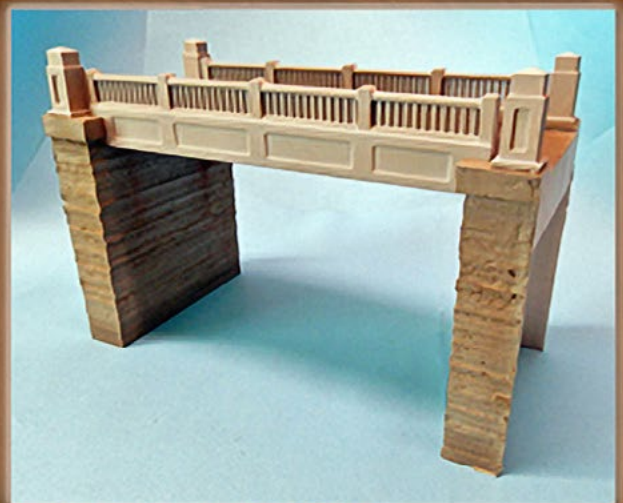

[WWW.GLXSCALEMODELS.COM](http://WWW.GLXSCALEMODELS.COM)





- Installing a decoder in a locomotive, step-by-step
- Kitbashing a model railroad bridge
- Kitbashing a structure
- Weathering structures
- Weathering rolling stock
- Weathering locomotives
- How to model water
- How to model people
- How to model automobiles
- Better ways to clean track
- Layout lighting with LEDs
- 3D prototyping for model railroaders
- Battery-powered locomotives

If you can't do an article on any of these topics, but you know someone who can, put in a good word for MRH and send them our way.

*Advertisement*



**Rusty Stumps**  
Scale Models

**WE ONLY SELL WHAT WE MANUFACTURE**

**DETAILS** IN HO, O, S & N SCALES

LASER CUT SHINGLES, DOORS & WINDOWS, FENCES, SIDING, CRATES. Also RESIN and WHITE METAL DETAILING CASTINGS.

**CRAFTSMAN KITS**  
IN HO, O & S SCALES

**CHECK IT ALL OUT AT**

**WWW.RUSTYSTUMPS.COM**

Send \$3.50 for Catalog - Specify Scale

**RUSTY STUMPS SCALE MODELS**

6785 Cherry Blossom W. Dr., Fishers IN 46038

Phone (317) 595-9489



Just use the MRH article query link:

[mrhmag.com/contact/Article\\_query](http://mrhmag.com/contact/Article_query)

So how about it, folks? Build us an article and send along some photos or video. As long as things are well lit and in focus, you can even use your smart phone to take the photos or video.

## **TrainMasters TV: MRH discount**

As most of you know, we launched TrainMasters TV (or TMTV for short) in November. It's basically a premium internet TV channel for model railroaders.

TrainMasters TV is only \$5.99 to subscribe for a month. You can try out TMTV and check out as many videos as you want. If you like what you see, MRH subscribers can subscribe for longer and get a 20% discount.

But you need to be an MRH subscriber, not just a reader. Becoming an MRH subscriber is free. Just go to this link:

[mrhmag.com/user/register](http://mrhmag.com/user/register)

(If you are already a subscriber, you will get your profile page when you click this link.)

Subscribers get access to the bonus downloads for each issue, and on the bonus downloads page you will find the coupon code that month good for a 20% discount to TMTV.

There are a number of extra special videos coming to TrainMasters TV. Also, TrainMasters members automatically get free access to any new DVDs that we release, like the upcoming "Extreme Diesel Weathering: No airbrush Required" coming from Mike Confalone.

[... On to next page of text →](#)





# NEW for FEBRUARY

**MC-5031 & 60-5031 (BLACK)  
MC-5032 & 60-5032 (WHITE)**  
Assorted 1970s - Present Era  
Boxcar Door Data  
Includes dimensional  
and security device  
nomenclature

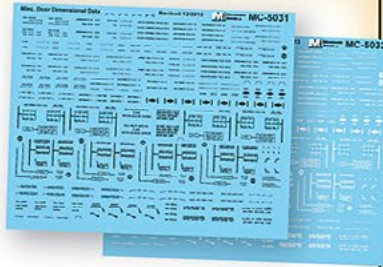

**87-1459 & 60-1459**  
Frisco (SLSF)  
Open Top Hopper and Gondolas



**87-1460 & 60-1460**  
Archer Daniels Midland(ADMX)  
25,500 Galon and 17,600 Gallon  
Trinity Tank Cars

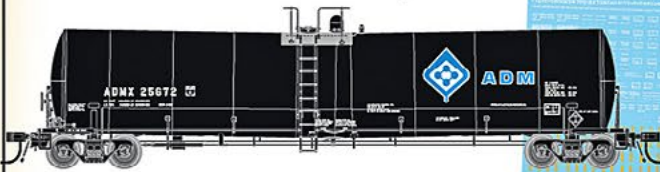

**87-1461 & 60-1461**  
Alaska Railroad (ARR)  
Modern Hood Locomotives



**87-1453 & 60-1452**  
ACME Foods  
Assorted Trailers



**87-1452 & 60-1452**  
California Western (CWR)  
Diesel Locomotives

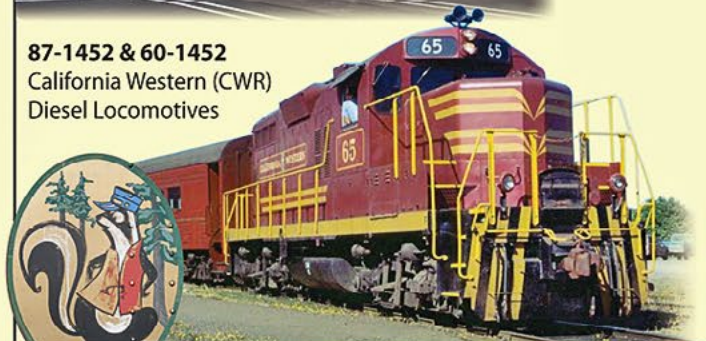

View all the past 2013 Decals [click here](#)



[microscale.com](http://microscale.com)

MADE IN THE USA

Remember  
You can click  
on the Email  
or Phone  
buttons to  
contact a  
sponsoring  
advertiser!

Also tell them  
“Thanks for  
sponsoring  
MRH!”



[← back to previous page of text ...](#)

## This issue

We have got a number of interesting articles coming your way this month.

In our cover story, Bob Smaus, a name some of you will probably recognize, shows how he detailed a tight corner of his layout with an industrial scene. Bob's an accomplished modeler, and we find his methods to be most helpful in solving this typical problem when trying to fit structures in on your layout.

Our N-scale columnist, John Drye, is back this issue, but with a regular feature article on how to model 21st century commuter operations. John goes over the considerations you need to make when modeling commuter operations, along with some of the methods for using some of the latest commuter equipment releases.

Mike Confalone is back with part 2 of his "Railfanning the Allagash" article. Mike's awesome nighttime layout photos really make his HO Allagash look like and feel like a full-sized railroad. Also, don't miss the first volume of Mike's in-depth Allagash Story eBook series, now available. Also, watch TrainMasters TV for a one-hour interview we did with Mike on how he built and operates the Allagash.

Ever wonder how to put turnout toggle controls on your fascia and keep them from accidentally getting bumped? Dave Salsbery gives you the solution in his clever Turnout Control Protection piece.

Did you know the MRH website has an extensive and growing database of track plans from subscribers? We give you some

[... On to next page of text →](#)





# TRAINMASTERS.TV

Coming in February...

## TRAIN·MASTERS



### MRH visits the Amherst Hobby Show

#### LAYOUTS



The best Amherst Show layouts

#### BACKSHOP CLINIC



Backdrop painting - Parts 3 and 4

#### KEN'S ROUNDHOUSE



More amazing diesel stories

#### BONUS: ALLAGASH SCENERY TECHNIQUES



Mike Confalone - outside the box

## Visit TrainMasters.TV website



MRH Subscribers  
save 20%



[← back to previous page of text ...](#)

samples of what you'll find in this database and tell you how to access the entire collection in our MRH Track plan database article.

As for our columns, Bruce Petrarca removes the mysteries around DCC addressing, and Nick Muff shows how to model a 1950s-vintage auto carrier truck. We also have some great material for you in our MRH QAT column and our "Yes, It's a Model" monthly photo feature

Larry Smith provides the details on how he builds his narrow gauge rolling stock fleet in his "Lite and Narrow" column.

Ken Patterson takes more of a potpourri tack in "What's Neat This Week" this time by giving us a bit of everything. We can't emphasize enough how you need to watch the video that goes with Ken's column. Ken puts a lot of effort into creating fabulous visuals for you, and you miss the best of Ken's column if you don't watch his video.

We wrap up this month's issue with "Reverse Running", our contrary view commentary, this time on why being short on cash can be a good thing for your hobby pursuits. And finally, let's not forget our somewhat infamous "Derailments" segment, MRH's alleged humor and bizarre facts endcap.

Enjoy the February issue!







# NARCorp High Performance MagnaLock Brake Lines

Copy 91150kg LO  
 Ld Lmt 91150kg  
 Ld Wt 28100kg  
 Vol 128.3m<sup>3</sup>

*If it was any more realistic,*

*you'd need a union card to operate it.*

- They look like the real thing
- They couple like the real thing
- They even uncouple like the real thing

*Turn the cars 180° and they will still connect properly!*



**Features:**

- Can be retrofitted to virtually any car or locomotive, regardless of manufacturer
- Compatible with Kadee and other popular couplers
- Hoses made of rubber for authentic appearance and flexibility
- Hands-free operation - connects and disconnects like the real thing
- Reversible, automatic operation regardless of orientation of car or locomotive
- Available with future releases of North American Railcar Corporation products

**HO** [click here](#)

Available exclusively through:

**N** [click here](#)

**Pacific Western Rail Systems**





# MRRH

## Questions, Answers and Tips

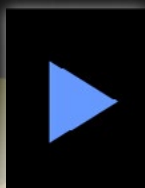

Reader  
Feedback  
(click here)



### QUESTIONS AND ANSWERS

#### Remote-control Tortoise

**Q.** I would like to know if it is possible to have a Tortoise switch motor be thrown from two separate locations by separate DPDT switches, and if so, how would you wire it?

– David

**A.** This circuit acts like 3-way wall switches. Toggling either switch will change the position of the turnout from where it was. I can't see any reason that you couldn't extend this to as many DPDT switches as you might desire. Here is a simple schematic in .jpeg form (1). Not my idea of the best user interface, but there you go.

The one big disadvantage for this approach is that the position of the toggles doesn't tell you which way the turnout is thrown.





So if you can't see the turnout position, you would need some kind of indicator.

(Notice that I didn't say anything about this circuit being wired like 3-way light switches. Only that it acts like 3-way light switches. Toggle either switch and the output will toggle, plus to minus in this case versus on/off with the light switches.)

– Mike Baynes

Rico asked, “Don't Tortoise machines need constant power to hold their position being that they are stall motors? I find mine back off a little when the power is off. I now use NCE 'switch its' to throw mine via DCC.”

Prof. Klyzlr explained: “In basic terms, yes, Tortoises need constant power *while changing position*. However, once at the desired position, power can be removed and they will stay essentially where they were left. With center off toggles, just flicking the toggle won't completely throw the Tortoise, you're absolutely on the ball there. However, if the user presses and holds the toggle, the Tortoise will make the desired movement.

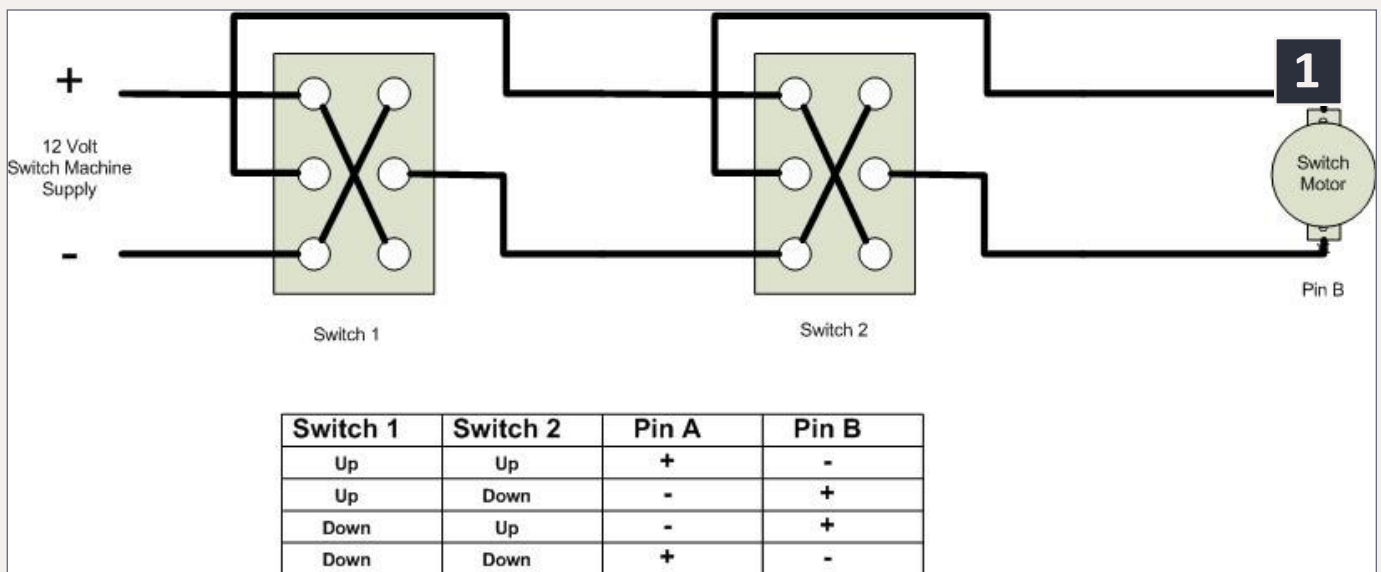

**1: Rig DPDT switches to run Tortoise switch machines from more than one location. Mike Baynes diagram.**



contents



index

Using such center-off/momentary toggles has the benefit of only powering any given Tortoise when it's in motion. The power supply is not being loaded down by Tortoises at stall. I see a potential issue if two or more operators try to throw the same turnout at the same time (and thus are holding down their respective momentary toggles). This could present a short circuit condition, with possible bad results.”

He suggests a stall-motor 555-based circuit a la the Rob Paisley "Electronics for Model RRs" website:

[home.cogeco.ca/~rpaisley4/556Stall08.html](http://home.cogeco.ca/~rpaisley4/556Stall08.html).

Multiple press-button (or momentary center-off toggle) switches can be parallel-connected, and are only switching 12-volt low-current logic lines. The 555 chip does not care if multiple operators try to throw the turnout at the same time, and will work out what to do if near-simultaneous contradictory commands are received. As always with model railroading, there are umpteen different ways to peel a feline.

“In Free-mo we use Mike's diagram,” says Chris Palomarez. “It's the simplest – two components (two double-pole, double throw switches) – and is very easy to wire. It's been 100% reliable and not subject to bad momentary buttons/bad electronic boards. We use DPDT on/on push buttons (2) due to liking their



**2: Push buttons don't show any switch position but can be more durable than toggles.**





**Playback problems? [Click to try a different version.](#)**

### **3: The LK&O Railroad uses a latching relay and momentary pushbuttons to control Tortoise machines.**

neutrality. They are not subject to having a toggle lever not in alignment with the points of the turnout.

“We use these switches:

[mrhmag.com/magazine/url/push-buttons](http://mrhmag.com/magazine/url/push-buttons)

“Many installations are 12 years old. The switches are very reliable with normal usage. There is a tactile click to them when being pushed that helps the operator know by feel when contact has been made and switch has been flipped. I have only replaced 3 in the past 12 years,” Chris said. “These were damaged from the back of the switch when a module leg broke them, not from normal usage.”

Toggles tend to break from usage. Some less-acclimated operators will try to throw the toggle the wrong way, side to side versus up and down, instantly disabling the toggle switch. With these push buttons, the layout becomes very intuitive for



contents



index

operators even if they have never run on the layout before. No special instructions or handling for these push buttons.

For the more electronically sophisticated railroader, Alan of [LKOrailroad.com](http://LKOrailroad.com) offers an arrangement using SPST momentary contact switches and an inexpensive latching relay.

You can have as many push button switches as you like for the same Tortoise. Press any button and the Tortoise will throw completely, even if you only tap the switch. No need to hold down the button and the Tortoise stays stalled, so no creep-back of the points. The original post describing the circuit is here: [lkorailroad.com/tortoise-control](http://lkorailroad.com/tortoise-control) (see video on the prior page).

For more information, see the complete thread at [model-railroad-hobbyist.com/node/16272](http://model-railroad-hobbyist.com/node/16272).

## Modifying track warrants

**Q. With timetable and train order authority, if an error is made with a train order, a totally new order is written. A train order once issued can never be modified. A new order must be written to amend an already issued one. Can a track warrant be amended after it's issued? Why would the railroads have changed that type of policy? It seems unsafe to modify a warrant once it's issued.**

– Ken Leaver

**A.** As always, the best answer depends on knowing the time period, the railroad and the rule book involved. Several railroaders offer answers from their work experiences.

Railroader Dave Husman said a "track warrant for bulletins" can have the engine number changed. A movement track warrant can have the limits reduced (a "roll up"). It can have a line voided. Issuing a track warrant for movement and then adding an "after arrival" later would be a rules violation on a real railroad.

Engineer Ken Rickman added, "The only modification I have ever



made on a track warrant was to OS by a location, thus reducing the length of the limits. It could only be done on a 'Proceed' and had to be a location at least 3 miles behind the engine, unless it was positively known that the rear had cleared the location. For anything other than an OS, a new track warrant would have to be issued.”

In this case, an “OS” is reporting the train's position to a dispatcher; a “Proceed” is a standard one-direction authority that allows a train to proceed from point A to point B.

Travis, who is “slow.track” on the MRH forum, explains the procedures. "A track warrant for bulletins is really just a way to get the needed track bulletins to a train, and every train gets one regardless of the territory. This grants you no authority, it's just a cover sheet basically.

“A real track warrant is not in effect until it is correct with time and initials of the dispatcher. If a correction needs to be made, a complete new warrant needs to be issued and the new one generally has the first line that states TW # \_\_\_\_\_ is void, and then you would copy the rest of the authority. Once that is correct and OK it automatically means the previous that needed changed is void and you have a new authority.

“The only changes that can be made without voiding is what's called ‘rolling up.’ This allows the dispatcher to give larger chunks of real estate at one time to following trains in dark territory.”

Let's look at the “track warrant for bulletins.” Some railroads use this language, some don't. It's a confusing name because it doesn't grant any authority to occupy track. Like a clearance card under timetable operations, it lists special circumstances that a train crew needs to know. The crew has to acknowledge having received and understood this information before it can depart.

“Other railroads, however, give the crew a track warrant



contents



index

at the beginning of their shift which lists all the bulletins in effect, by track bulletin number, for the territory over which they will operate. This track warrant grants no authority, only conveys information. The crew uses it as a reference and is able to acquire the appropriate Track Bulletins prior to beginning their trip.

“Since this track warrant does not issue authority, it can be

modified by the dispatcher. For example, if a maintenance crew finishes tamping an area and a speed restriction (Form A) is removed, the dispatcher can contact the train crew and have them modify that track warrant by removing the Track Bulletin that was listed on it originally.

“So to answer the original question, a track warrant can

**4: A track warrant gives a train authority to occupy main line tracks.**

TRACK WARRANT	
NO. _____	DATE: _____ <span style="float: right; background-color: black; color: white; padding: 2px 5px; font-weight: bold;">4</span>
TO: _____	AT: _____
1. <input type="checkbox"/> TRACK WARRANT NO. _____ IS VOID.	
2. <input type="checkbox"/> PROCEED FROM _____ TO _____ ON _____ TRACK.	
3. <input type="checkbox"/> PROCEED FROM _____ TO _____ ON _____ TRACK.	
4. <input type="checkbox"/> WORK BETWEEN _____ AND _____ ON _____ TRACK.	
5. <input type="checkbox"/> NOT IN EFFECT UNTIL _____.	
6. <input type="checkbox"/> THIS AUTHORITY EXPIRES AT _____.	
7. <input type="checkbox"/> NOT IN EFFECT UNTIL AFTER ARRIVAL OF _____ AT _____.	
8. <input type="checkbox"/> HOLD MAIN TRACK AT LAST NAMED POINT.	
9. <input type="checkbox"/> DO NOT FOUL LIMITS AHEAD OF _____.	
10. <input type="checkbox"/> CLEAR MAIN TRACK AT LAST NAMED POINT.	
11. <input type="checkbox"/> BETWEEN _____ AND _____ MAKE ALL MOVEMENTS AT RESTRICTED SPEED. LIMITS OCCUPIED BY TRAIN OR ENGINE.	
12. <input type="checkbox"/> BETWEEN _____ AND _____ MAKE ALL MOVEMENTS AT RESTRICTED SPEED AND STOP SHORT OF MEN OR MACHINES FOULING TRACK.	
13. <input type="checkbox"/> DO NOT EXCEED _____ MPH BETWEEN _____ AND _____.	
14. <input type="checkbox"/> DO NOT EXCEED _____ MPH BETWEEN _____ AND _____.	
15. <input type="checkbox"/> PROTECTION AS PRESCRIBED BY RULE 99 NOT REQUIRED.	
16. <input type="checkbox"/> TRACK BULLETINS IN EFFECT:	
_____	
17. <input type="checkbox"/> OTHER SPECIFIC INSTRUCTIONS:	
_____	
_____	
_____	
OK _____ DISPATCHER	
RELAYED TO _____ COPIED BY _____	
LIMITS REPORTED CLEAR AT _____ BY _____	
(Mark "X" in box for each item instructed)	



only be modified after it is issued if it does not issue authority. Any track warrant that gives a train authority on a main track must be canceled.

James Ogden explains. “There are two types of track warrants out there, sort of. A track warrant (4) is a track warrant, but they can have different purposes. Track warrants are used to give a train authority on a main track, and those track warrants cannot be modified once issued. If there is a mistake, they must be canceled and a new one must be issued.

“To explain the other type of track warrant, let me give you some background. Rarely does a piece of railroad have no temporary conditions that create hazards or restrictions of some kind. As such, railroads issue track bulletins that list these hazards and restrictions. They can be speed restrictions (which many railroads call a "Form A"), working limits for maintenance of way (which is often called a "Form B"), or any number of other things. Other things can be crossing warning system malfunctions, tripping hazards, switches that are hard to line, and missing bridge walkways. Usually these other items are referred to as either a 'Form C,' or a 'Track Condition Message.'

“Before a crew moves any train or engine on a main track, each crew member must receive a list of all the track bulletins in effect for the territory over which they will operate. Some railroads issue this as a General Bulletin Order, General Track Bulletin, which is basically a list of all the track bulletins that crew will encounter.

Ken Rickman gets the last word: “Railroading is still highly dependent on human beings making intelligent decisions and paying attention to what they're doing. As has been proven many, many times, it is entirely possible for simple human stupidity or frailty to circumvent every safety system we can invent. 'Old School' railroading, such as with timetables, train



contents



index

orders, or track warrants, required much more vigilance than the modern CTC/TCS operations. They also had quite a bit more character, in a way. I miss them as a railfan, but not as a professional railroader. Modern signaled operation is much safer and more efficient.”

– MRH

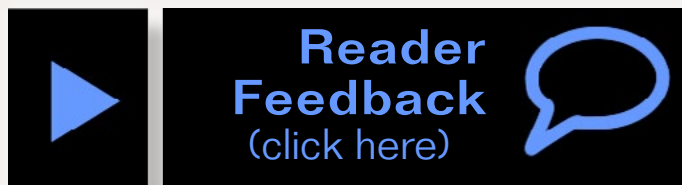

## TIPS

### **A jig for preparing feeder wires**

Whether you use IDCs (suitcase connectors), crimps, or solder to make connections to your bus wires, you still need to tin and solder feeders to your track.

Build a simple jig (5) from scrap wood to hold a group of feeder wires to be tinned. It takes about 5 minutes to build the jig and you'll save lots of time preparing your feeders because you won't have to pick up the iron for each wire. Just like switching, "fewer movements" means "done faster."

Use a small block of plywood for the base and a thin sheet of plywood or Masonite for the actual jig. Drill holes the size of your feeder wire about 3/8" apart, to hold the wires while you tin them.

Strip the ends of your wires and load them into the jig. Use some weights to hold the wires in place while you solder them. Now you can tin 10 or more wires in one move.

– Bill Brillinger



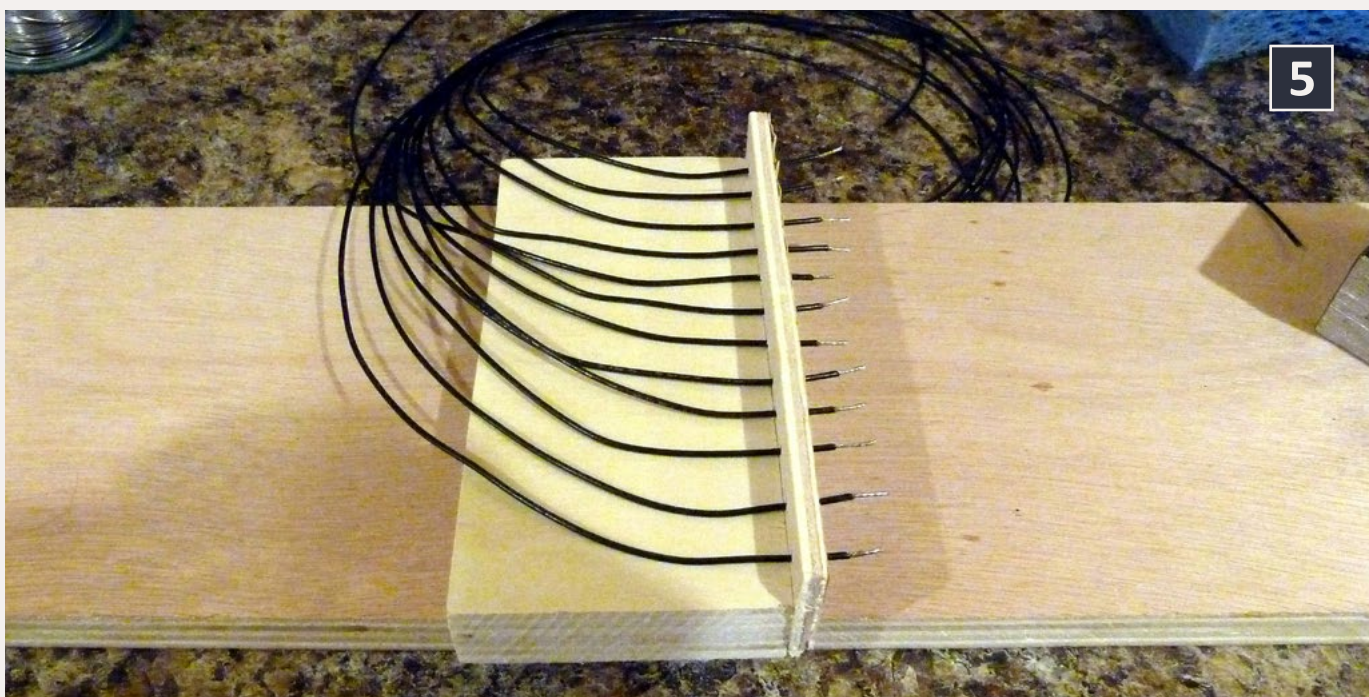

**5: This a simple jig from scrap wood holds feeder wires to be tinned.**

## **Stick 'em up**

When airbrushing, a good stand really helps. I find cast iron pipe works great. Use a short piece with one end threaded and put a base flange on it. It is sturdy and stable and \$5! Then just blue tape your models to the top end of the pipe.

– Jason Reis



## **GET \$25 PER TIP**

We pay \$25 USD for each tip we publish.

[Send your modeling tips to Model Railroad Hobbyist](#) and we'll get payment to you upon acceptance.

Just think, for only a few minutes effort, you could fund your next piece of rolling stock – or even pay for an entire train if you send in several tips and we publish them!

If you include any photos with your tip, we pay a bonus of \$10 per photo we use with the tip. ■



contents



index



# NM



# The Power

## Overstated? Not at All



585.265.0230  
 9am-4pm EST.  
[www.ncedcc.com](http://www.ncedcc.com)

The Number  
 Rated DC

Our products are proud





# FREE Cover of DCC

ALL - DCC at its *Finest*

Number ONE  
DCC System

Call or Email  
for FREE Brochure  
[support@ncecorporation.com](mailto:support@ncecorporation.com)



Made in the U.S.A.



Email

Phone

contents

index





**SO REAL...You'll Think You're There!**

**LokSound Select · 3 SIZES, ENDLESS POSSIBILITIES!**

**INDUSTRY LEADING  
MOTOR CONTROL**

- Multiple Bell types
- Multiple Brake squeals

**4 OR 8 Ohm  
SPEAKERS!**

- 4 or 6 Output functions depending on the style
- Up to 4 Prime Movers or Steam Sounds on EACH decoder
- 16 Very Playable, LOUD Horns or Whistles depending on Profile
- All Changeable by using ONE CV! No Programmers or Boosters needed!\*

Small Size  
**BIG POWER! 1.1Amp!**  
LokSound Select  
**"4 AUX"**



\$99.99

**NEW 2011**

**LOKSOUND SELECT**

Only Available From ESU LLC (USA) 

**ONE SIZE FITS ALL!**  
LokSound Select **"DIRECT"**



\$109.99

6 Outputs!  
LED Resistance  
Built In!

**NEW 2011**

**LOKSOUND SELECT**

Only Available From ESU LLC (USA) 

Tiny Size,  
**HUGE Versatility!**  
LokSound Select  
**"MICRO"**



\$99.99

**NEW 2011**

**LOKSOUND SELECT**

Only Available From ESU LLC (USA) 



[www.LokSound.com](http://www.LokSound.com) Now on facebook!



477 Knopp Drive - Muncy, PA - 570-649-5048







# Unraveling DCC Addresses

DCC tips, tricks, and techniques



## DCC Impulses column

by Bruce Petrarca

*Photos and illustrations by author*

## How to talk to your locomotive...

**D**ecoder-equipped locomotives can be like obstinate children. You have to talk to them using the name (address) they are prepared to hear. Children have a habit of deciding on a new name on a whim, and not responding unless you use the correct name. Frequently this goes something like “Tom” suddenly becomes enthralled with that cartoon loco and insists on being “Thomas.” At least with decoders, you have the option to select the name you want them to use. Fortunately, decoders change their minds fairly infrequently, unlike like children. But it does happen. When it does, it helps to know what the options are.

As DCC systems have become more sophisticated, address confusion has diminished. However, a bit of understanding of DCC history and applications may throw some light in a few corners. There are only a few CVs that come into play, so knowing what they are, and how to understand what they are telling you, can help to troubleshoot errant decoders.



# Types of Addresses

There are three types of addresses:

- Short, stored in CV 1
- Long, stored in CVs 17 & 18
- Consist, stored in CV 19

Initially, DCC systems only recognized addresses from 1 to 127 and they were stored in CV 1. Storing a value of zero (0) in CV1 will force the decoder OUT of DCC mode and into using an alternate power source defined by CV 12. Usually that is DC mode.

It was realized quickly that limiting the system to 127 rather arbitrary numbers was a serious limitation and the concept of the long, or extended, (sometimes incorrectly called 4-digit)



**1: Loco with a short cab address of 4 – I run it as a long address on NCE by programming it as a long address and selecting it as 04.**



2



**2: Loco with cab address of 268 – this will be a long address on any system, even though it has only 3 digits.**

address came about. Why is “4-digit” incorrect? Because there are at least 871 3-digit addresses that fall in to the long address realm. Addresses from 128 to 999 must be long addresses, but only have three digits. See figure 2 for an example.

However, the designers didn’t make it as simple as it could have been and put two digits in CV 17 and the other two digits in CV 18. No, there is a complicated formula for what is stored in the two CVs so the decoder knows its name. NMRA Recommended Practice (RP) 9.2.2 allows long addresses from 0 to 10239. I don’t know of a system that currently addresses locos above 9999, though. More on this later.

The decoder needs to know what name (address) to respond to: the short address in CV 1 or the long address in CVs 17 & 18. This is sort of like my Tom and Thomas analogy above.



contents



index

Enter the all-purpose CV number 29. Bit 5 of CV 29 tells the decoder whether it is to respond to the short or long address. If bit 5 = 0, the decoder listens to the short address. If the decoder is to respond to the long address, bit 5 needs to be 1, raising the number in CV 29 by a value of 32. Thus, if you read CV 29 and get a value of 32 or more – frequently 33 to 39 – the decoder is responding to a long address. If it is less than 32 you know that it is responding to the short address.

There is a fine online calculator available to determine the values to put in to CVs 17 & 18, if you want to do it yourself. It also calculates CV 29, for those so inclined. Check it out as this web



**3: Two diesel locos making up a consist – this is train 103 from the PCMRC layout after it has run around its train and is ready to run back home. Loco 2016 has a value of 103 in CV 19; the 2035 has 231 (103 + 128) in CV 19. See figure 7.**



link: [2mm.org.uk/articles/cv29%20calculator.htm](http://2mm.org.uk/articles/cv29%20calculator.htm). Thanks to the 2 MM Scale Association in the UK for permission to recommend their site. You may use DecoderPro similarly: go to the basic panel and make your selections, and go to the CV panel and see what the resulting values are.

The consist address (CV 19) is a bit less confusing. If CV 19 = 0, there is no consist address stored and the loco will respond to either the short or long addresses as dictated by CV 29, above. If CV 19 is anything other than zero, that will override whatever CV 29 dictates and become the operational name. So, now we have the option of “Tommy,” in addition to “Tom” and “Thomas.” Allowed consist addresses are 1 to 127. If the loco is to run in reverse when it is in a consist (think of locos running back to back), then 128 gets added to the consist address, making allowable values for CV 19 to be 1 to 255, when the loco is in a consist, or zero when it is not in a (decoder based) consist.

### Advertisement

**RailPro**™  
**NEW TECHNOLOGY**  
DIRECT™  
RADIO

**RE RING**™  
ENGINEERING  
Power ON Main Page  
Handheld Controller Model # HC-2

Control Locomotive  
17.6% Link Forward  
UP 5714 Info  
Frnt Light Dim Ditch Pop Off Next Page 1  
Horn Bell Engine Back Light Exit Page

**NEW Starter Kit**  
**\$399.99 MSRP**

- Includes Wireless Color Touch Screen Handheld Controller and 56 Watt Power Supply
- Expandable to Virtually any Size Layout

**NEW Locomotive Module**  
LM-2 & LM-2S

- Direct Radio RF
- Sound and Non-Sound
- New Tiny Size
- 6 Light Outputs

**Click Here to Learn More**

For more information visit our Internet site: [www.RingEngineering.com](http://www.RingEngineering.com)



Email



Phone



contents



index

## How does this help me?

Well, I always think that knowledge of inner workings and history helps, but only if you know how to apply it.

Let's look at a situation I had recently. One of my garden locos (2) was running just fine. There was a derailment and I re-railed rolling stock. Must have had a static discharge to the track that corrupted the decoder. The loco refused to run on its address (268) afterward. When I read CV 19 and found a non-zero number (166), I knew why I couldn't control it. It had changed its name and wanted to be talked to as 38 and run backwards ( $38 + 128 = 166$ ). Just for fun, I did run it on 38 before I reset CV 19 to zero. If your loco isn't responding to direction, speed and function commands and it is not intended to be in a consist, try setting CV 19 to zero and see if order is restored.

**“If your loco isn't responding to direction, speed and function commands, try setting CV 19 to zero and see if order is restored.”**

## System by system

The rest of this information becomes a bit system-specific, so let's talk about some systems. I'm not going to cover the entire history of DCC systems, but just discuss the current (2013) status of several systems. I'm not going to tell you how to set up your decoders for each system; just how they treat the addresses you set. Modern systems set CV 29 appropriately when you use them to set the address.

As frequent readers know, I favor DecoderPro to set up my locomotives. It will allow you to program any address from 1 to 127 as short, and any from 0 to 10239 as long in the same





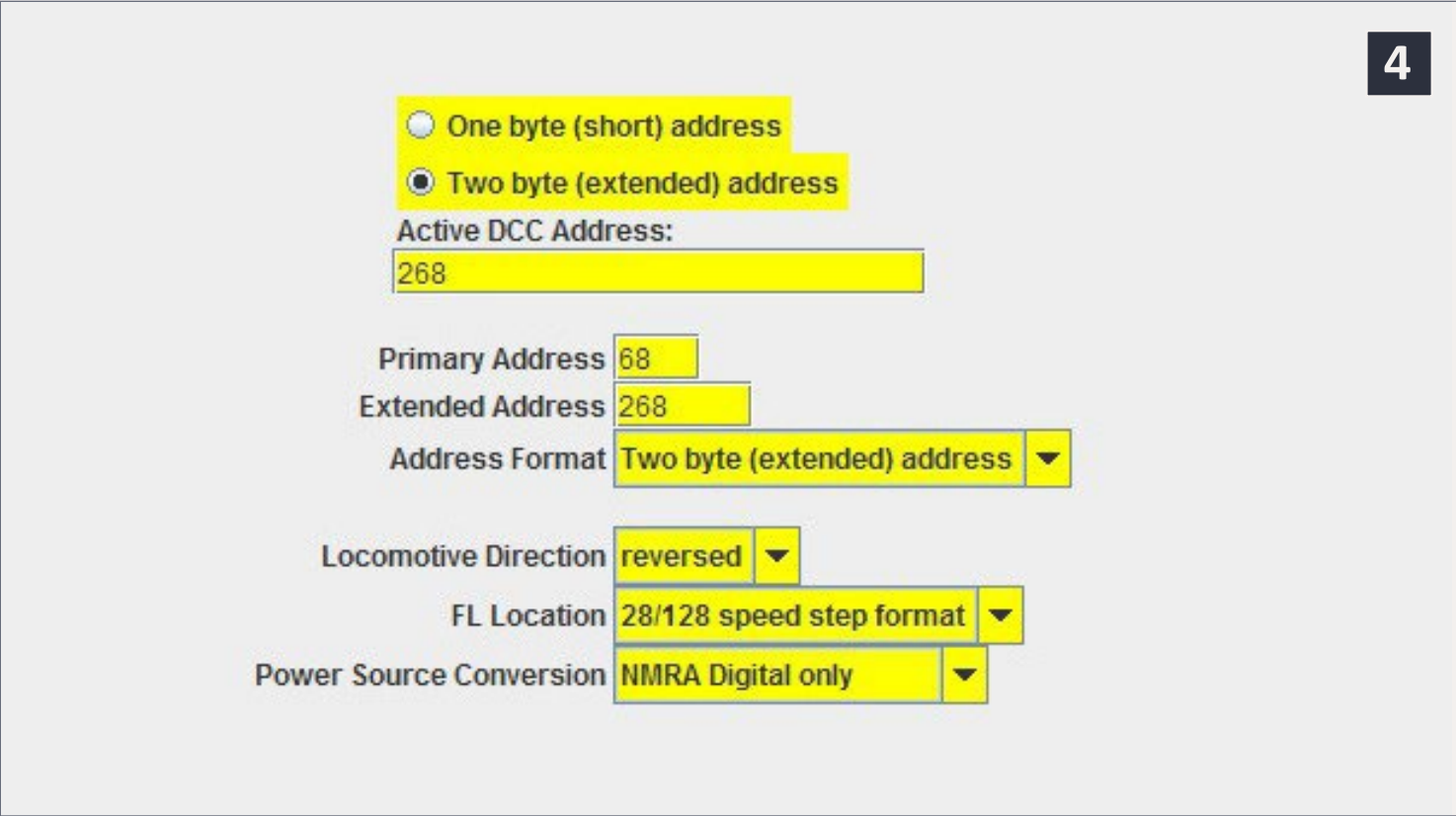

4: DecoderPro screen shot for the loco from figure 2. This is the basic panel setting short and long addresses and selecting the long (extended) address. The loco direction is reversed, as this is an Aristo-Craft garden loco, where the direction of motion is reversed from the NMRA standards.

decoder at the same time. You then tell it which address you want to use and it will set CV 29 accordingly.

Here we go, alphabetically.

### Digitrax

Digitrax reserves address zero for running locos without decoders. While this mode is not recommended, it is still there. No matter how you select an address on a Digitrax throttle, if it is between 1 and 127, the system will speak to it as a short address. You cannot override this behavior. Similarly, an address between 128 and 9983 will be spoken to as a long address. Addresses from 9984 to 10239 are not accessible.



## ESU

The ECoS system (50200) can address locos from 1 to 9999. It considers 1 to 127 short addresses and those from 128 to 9999 as long addresses. Addresses from 10000 to 10239 are not accessible with the current firmware.

## Lenz

Lenz reserves address zero for running locos without decoders. Lenz considers addresses from 1 to 99 as short addresses and those from 100 to 9999 as long addresses. Addresses from 10000 to 10239 are not accessible.

## MRC

While documentation for the Express and Elite systems state that they recognize long addresses from 1 to 9999, they don't

*Advertisement*

**IOWA SCALED ENGINEERING**

Looking for **AFFORDABLE**  
Slow-Motion Turnout Control?

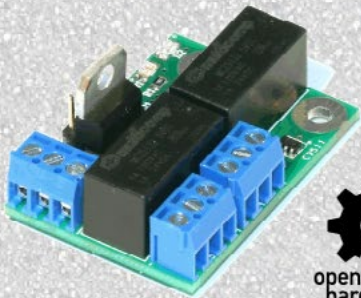

**CLICK TO  
LEARN MORE!**

Featuring  
**PowerFrog**  
Technology

Low Profile  
Short-Proof Power Routing  
No Calibration Required!  
Versions for Any Application

<http://iascaled.com/mrservo>

MRH-Feb 2013





include any information on how to talk to a long address less than 128. They also say that CV 29 is set automatically. So, I infer that they work just like the ESU ECoS.

## **NCE**

NCE allows you to decide whether an address in the lower range is short or long. Since NCE doesn't reserve address zero for locomotives without decoders, even zero is allowed as a long address. NCE is the only system I know of that allows you to use the entire range from 0 to 9999 as long addresses. If you make all your locos run on long addresses, you have the entire range from 1 to 127 (short) available for use in consisting – see Mr. DCC's Workbench at the end of this column for more on consisting. Addresses from 10000 to 10239 are not accessible.

**“NCE is the only system I know of that allows you to use the entire range from 0 to 9999 as long addresses.”**

## **The problem addresses: 100 to 127**

Okay, these addresses can be a pain if you move between brands of systems. NCE will allow you to address locos in this range as either long or short. This allows NCE to run any decoder setup on any NMRA compliant system. Digitrax, ESU and MRC call these short addresses. Lenz calls them long addresses. So, if you set them up as short addresses, you will be able to move among any system but Lenz. If you call them long addresses, you will be able to use them on NCE and Lenz only. See, there is no way to satisfy everybody. I had a set of Santa Fe FTs that I finally moved from their cab number of 127 to 27 just to get them out of the “danger zone.” But I had to

remember that I had done that, since it wouldn't respond to its cab number exactly.

## My recommendations

I don't like to try to remember what addresses I've used for my locos. The older I get, the harder it is to remember what I had for dinner yesterday, let alone these technical details.

I use the entire cab number for my loco address. This works, as I only model American railroads and all loco numbers have between one and four digits.

For my friends who model railroads with more than four digits in the cab number, I suggest that you use the same four digits all the time – the first four or the last four, but the same four.



**5: Programming the loco from figure 1 into an NCE Power-Cab with a long address of 04.**





## 6: ECoS system loco selection pane, calling up SP NW2 1315 on address DCC address 1315.

The ESU ECoS system helps with these longer loco identifiers. The system will remember some 16,000 locos and you can use many alpha-numeric characters as the identifier. When you set up the database (6), you can call the loco almost anything you wish and can even load a photo of it. The system will associate the NMRA compliant address you select with the loco name you input. Calling up a loco is as simple as walking through the database (possibly filtered by loco type) until you find the loco name and photo you want. Then, with a button press, you have it selected.

I use only NCE systems at my house, so I give all of my locos long addresses. When I'm programming an address of 268 into a loco, I give the system the address of 268 as I program it and



the command station sets the correct number into CVs 17 & 18 and sets CV 29 accordingly. All I have to do is remember to put the leading zero into the loco number when I'm calling it up to run it.

For a look at consisting methods, keep reading for Mr. DCC's Workbench, to follow after a short commercial break.

If you find this column helpful, please click on the Reader Feedback link here and rate it awesome. Please join in the conversation that invariably develops on the MRH Forum about the topics presented in the column. Share your experiences. Thanks.

Until next month, I wish you green boards. 

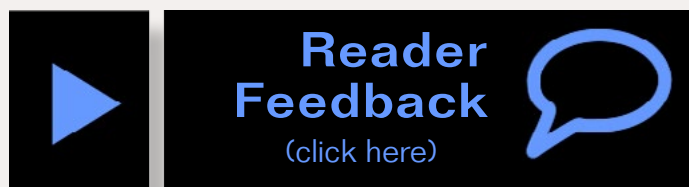

*Advertisement*

# END OF TRAIN DEVICE



**Bright Red Flashing Light!**

Installs in minutes with no freight car modification required!

**RE RING**  
ENGINEERING

Patented Technology - US Patent 7,549,609

**Does not affect Load!**

↓ Car without Load ↓

↓ Car with Load ↓



For video and more click here!

MRH-Feb 2013







# Southern Digital

*Specializing in DCC Since 1992*

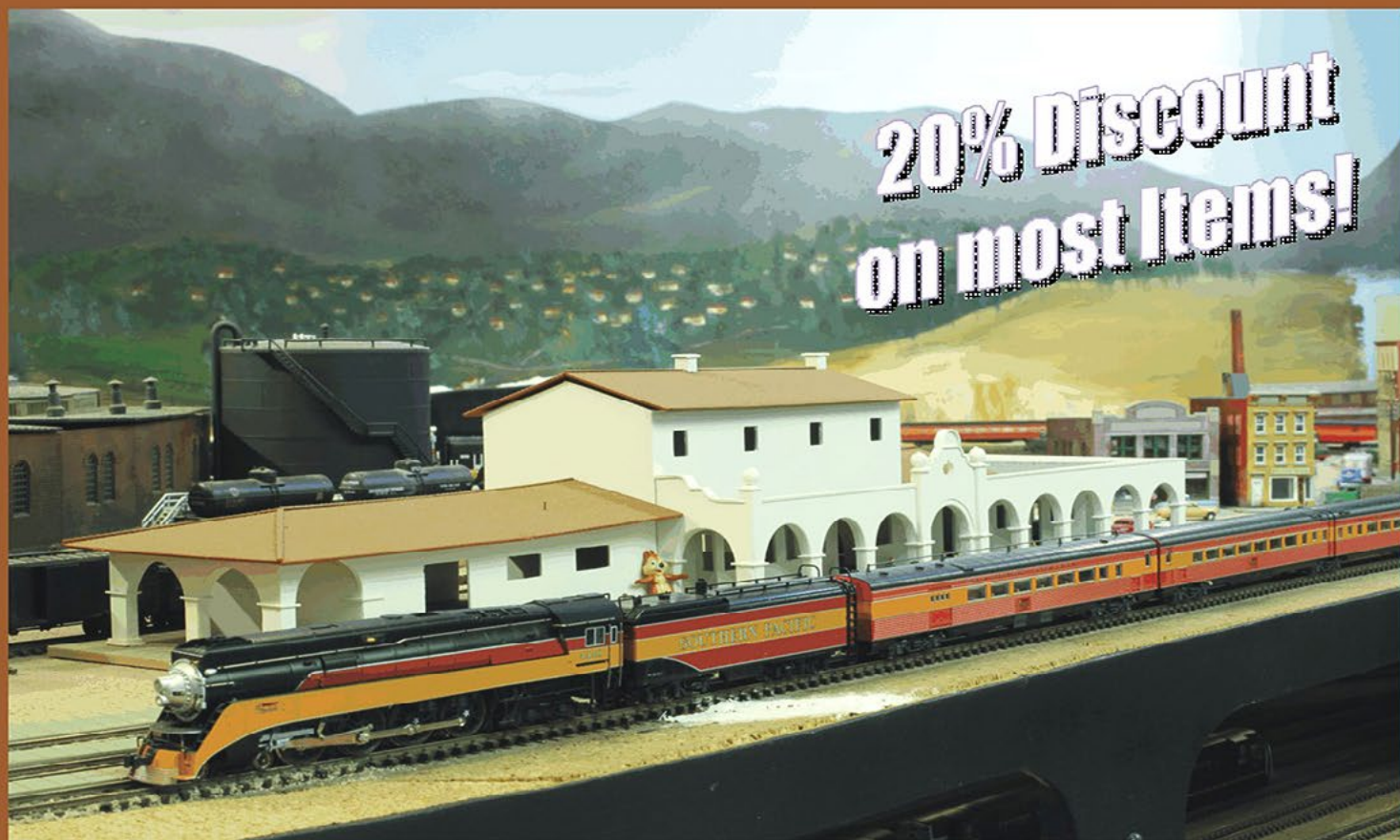

**20% Discount  
on most items!**



## DCC Conversions & Service

Orders Received by 3:00 pm EST ship the same day

**WWW.SODIGI.COM**

E-mail: [sales@sodigi.com](mailto:sales@sodigi.com)

(770) 929-1888

*(Photo's are from our N-Scale layout)*



# From Mr. DCC's workbench

## A short guide to consists

What is a consist? I was discussing this column with my wife, Linda, and she said, "Do your readers know what a consist is? I really don't, but I hear the term all the time."

So, let's get this out of the way. Prototype practice refers to the make-up of a train as the consist. Model railroaders refer to two or more locomotives that are running together as "a consist" or as being "consisted".

Okay, you want some locos to run together. How do we do this? There are several ways:

### Basic Consisting – brute force

If you have a set of locos that you want to run together, you can give all the decoders the same address (whether it is a short or long address). If you have a loco to run backwards, change its direction of operation by adding one to the value of CV 29 if it is even, or subtracting one, if CV 29 is odd.

**“While command station consisting is easy, there are some drawbacks, too.”**

This doesn't require any special features in the decoders and creates a consist that is virtually bulletproof. It will work on any system and doesn't require any special input to the system. Just dial it up and run. It only uses one location in the system memory, no matter how many locos are in the consist.

[... On to next page of text →](#)





# Get Better Sound from your Locomotives

Can't get a good sound from your sound decoder?  
Give our speakers a test drive with your ears.



**RAILMASTER HOBBIES**  
**9815 WALNUT ST #106**  
**BELLFLOWER, CA 90706**

Bass Reflex  
Speakers



High Bass  
Speakers



When it comes to speakers we have high quality speakers to fit many different applications. We are also a full line hobby shop. Need anything? We are an authorized dealer for Soundtraxx, Digitrax, Athearn, Walthers and many others. We provide quality speakers for your DCC sound systems and quality service.

**Click here for  
the *sound* answer ...**



Email



Phone



contents



index

[← back to previous page of text ...](#)

This will work with any collection of decoders ever made, as long as all the decoders in the consist understand the same speed step setting.

The downside is that the setup is a bit complex, having to set the addresses and running directions in each of the locomotives. Also, it is not easy to add or subtract a locomotive from the consist, so you can't easily run one of the locos outside the consist.

## Advanced Consisting – decoder based

Modern decoders support the use of CV 19 as a way for the decoder to know that it should run on a consist address and which direction it should run. Most of these decoders also support the use of CVs 21 & 22 to tell each locomotive which

7

Consist Address (0-127) <input style="width: 50px;" type="text" value="103"/>	Consist Acceleration Rate (0-127) <input style="width: 50px;" type="text" value="0"/>	
Loco Direction In Consist <input style="width: 50px;" type="text" value="Reversed"/>	Consist Acceleration Sign <input style="width: 50px;" type="text" value="Add value to base acceleration rate (increases acceleration delay)"/>	<input type="button" value="v"/>
	Consist Braking Rate (0-127) <input style="width: 50px;" type="text" value="0"/>	
	Consist Braking Sign <input style="width: 50px;" type="text" value="Add value to baseline braking rate (increases braking delay)"/>	<input type="button" value="v"/>

---

Will decoder respond to function requests at consist address?

Consist Address Activation for F0(f) in Forward	<input style="width: 50px;" type="text" value="Respond to consist address"/>	<input type="button" value="v"/>
Consist Address Activation for F0(r) in Reverse	<input style="width: 50px;" type="text" value="Respond to locomotive address only"/>	<input type="button" value="v"/>
Consist Address Activation for F1	<input style="width: 50px;" type="text" value="Respond to consist address"/>	<input type="button" value="v"/>
Consist Address Activation for F2	<input style="width: 50px;" type="text" value="Respond to consist address"/>	<input type="button" value="v"/>
Consist Address Activation for F3	<input style="width: 50px;" type="text" value="Respond to consist address"/>	<input type="button" value="v"/>
Consist Address Activation for F4	<input style="width: 50px;" type="text" value="Respond to consist address"/>	<input type="button" value="v"/>
Consist Address Activation for F5	<input style="width: 50px;" type="text" value="Respond to consist address"/>	<input type="button" value="v"/>
Consist Address Activation for F6	<input style="width: 50px;" type="text" value="Respond to consist address"/>	<input type="button" value="v"/>
Consist Address Activation for F7	<input style="width: 50px;" type="text" value="Respond to consist address"/>	<input type="button" value="v"/>
Consist Address Activation for F8	<input style="width: 50px;" type="text" value="Respond to consist address"/>	<input type="button" value="v"/>
Consist Address Activation for F9	<input style="width: 50px;" type="text" value="Respond to consist address"/>	<input type="button" value="v"/>
Consist Address Activation for F10	<input style="width: 50px;" type="text" value="Respond to consist address"/>	<input type="button" value="v"/>
Consist Address Activation for F12	<input style="width: 50px;" type="text" value="Respond to consist address"/>	<input type="button" value="v"/>
Consist Address Activation for F11	<input style="width: 50px;" type="text" value="Respond to consist address"/>	<input type="button" value="v"/>
Consist Address Activation for F12	<input style="width: 50px;" type="text" value="Respond to consist address"/>	<input type="button" value="v"/>

**7: DecoderPro screen shot – setting up CVs 19, 21 & 22 within the Consist panel – loco # from the PCMRC layout.**



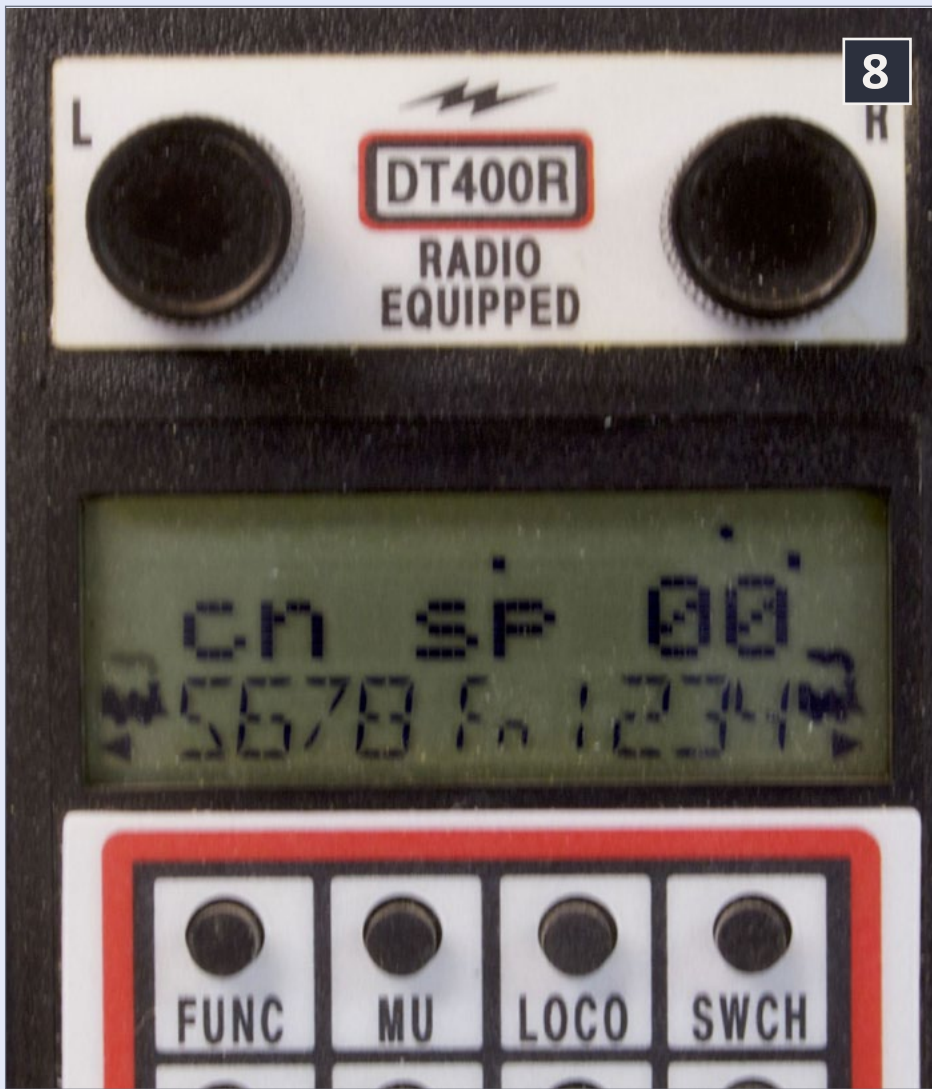

## 8: UniVersal consisting on a Digitrax DT400 throttle – 1234 is in the lead with locos facing away from each other.

train 103, as shown in figure 3. If the loco runs backwards in the consist, we tell the decoder that in CV 19, too. Then, in CVs 21 and 22, we tell each loco what function commands they should respond to. For example, we tell the loco at each end of a doubleheader not to respond to the FOR (reverse light) function. That way, we don't have the lights on between units.

Units that are set up this way take only one system location and they can be moved between systems with impunity, just like the basic consisting. Once CVs 21 and 22 are set up, locos

functions it should respond to. This is a most elegant way to run.

For example, we have double-headed power on the through trains on our club layout [pcmrc.org](http://pcmrc.org). They have train numbers that are less than 127. So we've used the train number as a consist address and programmed it into CV 19 – see figure 7 for the rear loco on



contents



index

# From Mr. DCC's workbench

## - A short guide to consists *Continued ...*

can be added to or taken out of the consist by merely programming CV 19 on the main. However, older decoders may not support this consisting method.

## Command Station Consisting

Here is where things get more complicated. Some command station manufacturers offer a quick way to set up a consist (or multiple unit block – MU). While command station consisting is easy, there are some drawbacks. Let's look at two systems:

### Digitrax

Digitrax uses what it calls UniVersal (yes, that's the way they capitalize it) consisting. It is easy to set up on their DT40x series throttles.

You select the lead loco on the right knob and the next loco on the left. You adjust the direction of each loco until both are going the same direction on the track. Then you press the MU button, and then the + button. To add more locos, select the new loco on the left knob, set its direction, and repeat the MU and + button presses. The command station remembers which locos are running together and sends the appropriate commands to each loco. To remove a loco from the consist, select the consist on the right knob and the specific loco to be removed on the left knob and press MU, then the – (minus) key.

While this is simple to use, it takes up a system slot for each loco in the consist, so if you have a limited system like the Zephyr, you can run out of slots quickly. Also, the consist is



unique to the system where it was created. If you set it up at home and then take it to the club, you have to start over and set it up again. Since there is no memory of the consist in the decoders, you don't have to do anything special on the second system to undo what was done on the first. But you do have to start over educating the new command station.

## NCE

NCE has what it calls Advanced Consisting. It automates the setup of an Advanced (decoder-based) consist. If CVs 21 & 22 are already set up, they will help control the functions the decoders respond to. It uses a single slot for the consist address, which it assigns automatically.

However, here is the slick part. If you have a consist with 1234 on one end and 5678 on the other, you don't need to know the consist address. If you select 1234 and say "go," the consist will move together with 1234 in the lead. If you reach the end of your turn and run around the train and get set to run back, then you select 5678 and the train will run forward (the opposite direction from earlier) when you select forward.

You can press the Kill Consist buttons and then enter 1234 or 5678 and the consist will be removed, as long as the locos are still on the layout.

Consists set up this way and moved from layout to layout can become problematic. I recommend that you kill the consist on the layout where it was created before you remove it. If you forget and move the locos without killing the consist, then take the locos to the programming track and set CV 19 to zero on all of them. You can then use them solo, or rebuild the consist on the new system.



contents



index

# From Mr. DCC's workbench

## - A short guide to consists *Continued ...*

With either the Digitrax or NCE scenario, loss of command station memory (changing battery, for example) will drop the consist information. In this case, it is just as if you took the consist to a new layout. You start over from scratch.

This is why I favor Advanced Consisting – decoder based. It is system independent and transportable. It only uses one system slot for the consist, no matter how many locos are in it. ■



### Advertisement

**Free Shipping on all US WEB orders over \$125.**

**ACCU-LITES, inc**  
Your DCC Center!

**New from ACCU-LITES!  
Make LocoNet wiring extremely simple!**

*"... great time saver as well as providing flexibility to change things ..." - Terry Nathan*

**PM42**  
breakout board



**SE8C**  
breakout board



<http://www.acculites.com>

**BDL168**  
Multi-zone  
breakout board

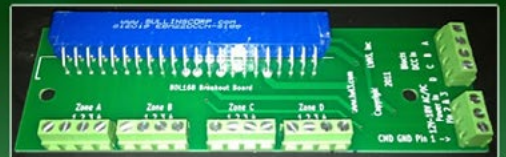

**BDL168**  
Single-zone  
breakout board



**CLICK TO LEARN MORE ...**

MRH-Feb 2013







Installing DCC sound just **NOT** your thing?

Trust Traintek for sales and installation of sound decoders from these fine vendors!



**RailPro**™

*"Taking model railroad control to the next level ..."*



**traintekllc.com**

Click here for more details...



"Traintek **was** the way to go!"







# Digitrax No Worries Warranty

That's it! A simple, straightforward warranty with no tricky language



You're protected against

Learn

Need tech support?

[www.digitrax.com/contact](http://www.digitrax.com/contact)

Need a repair?

[www.digitrax.com](http://www.digitrax.com)





**NO WORRIES  
WARRANTY**

**Keeps Your Layout Running!**

**For one year  
or more!**

**Protects against defects and accidental damage.**

Learn more at: [www.digitrax.com/noworries](http://www.digitrax.com/noworries)

[www.digitrax.com/repair](http://www.digitrax.com/repair)

**Need a throttle conversion?**

[www.digitrax.com/upgrade](http://www.digitrax.com/upgrade)



# iwata

by ANEST IWATA

## *Just Rolling By...*

## Make It **REAL** With Iwata *Climb Aboard!*



**Eclipse  
HP - CS**



**Revolution  
HP - TR1**



## **Visit...** [www.iwata-medea.com](http://www.iwata-medea.com)

## **To Check Out Our Full Product Line!**

*Models By... Alan Houtz,  
North American Prototype Modelers*







# 1950s Auto transport semi-trailer

Modeling real railroads and what they do

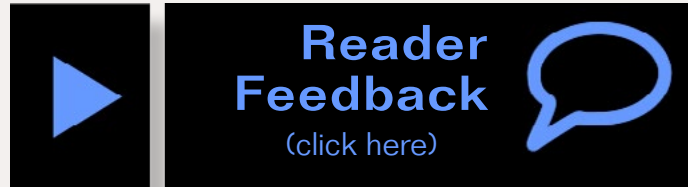

## Getting Real column

by Nick Muff, MD

*All photos by author unless noted otherwise*

## A unique detail for your layout ...

I cannot count how many times I have driven I-5 through Marysville, Washington. For many years I was intrigued by an auto carrier trailer that sat across the road. So I finally decided to get off the highway and investigate. What fascinated me about the trailer was its Art Deco look, with its round porthole openings and stainless steel horizontal trim bands. A decorative cast metal logo, for the “Mechanical Handling Company” was placed at the front of the trim bands. I took photos for future reference. At that time the trailer was located at J. K. Eastbury Salvage Metals. In fall of 2008 one these trailers was for sale on eBay, “Some rust, no ramps, has air brakes, you could pull it home”.

By the time I turned back to this project, the trailer had been moved to Quill Ceda Auto Wrecking. When I made it to the new location, they had gone out of business. The trailer still sat there awaiting sale. In the intervening time, the trailer had been cut down to the frame. I was told by the folks at the



1



1: Photo; Baker Driveaway Company, Detroit, Michigan. Courtesy of Ron Adams. Reproduced with his permission.

2

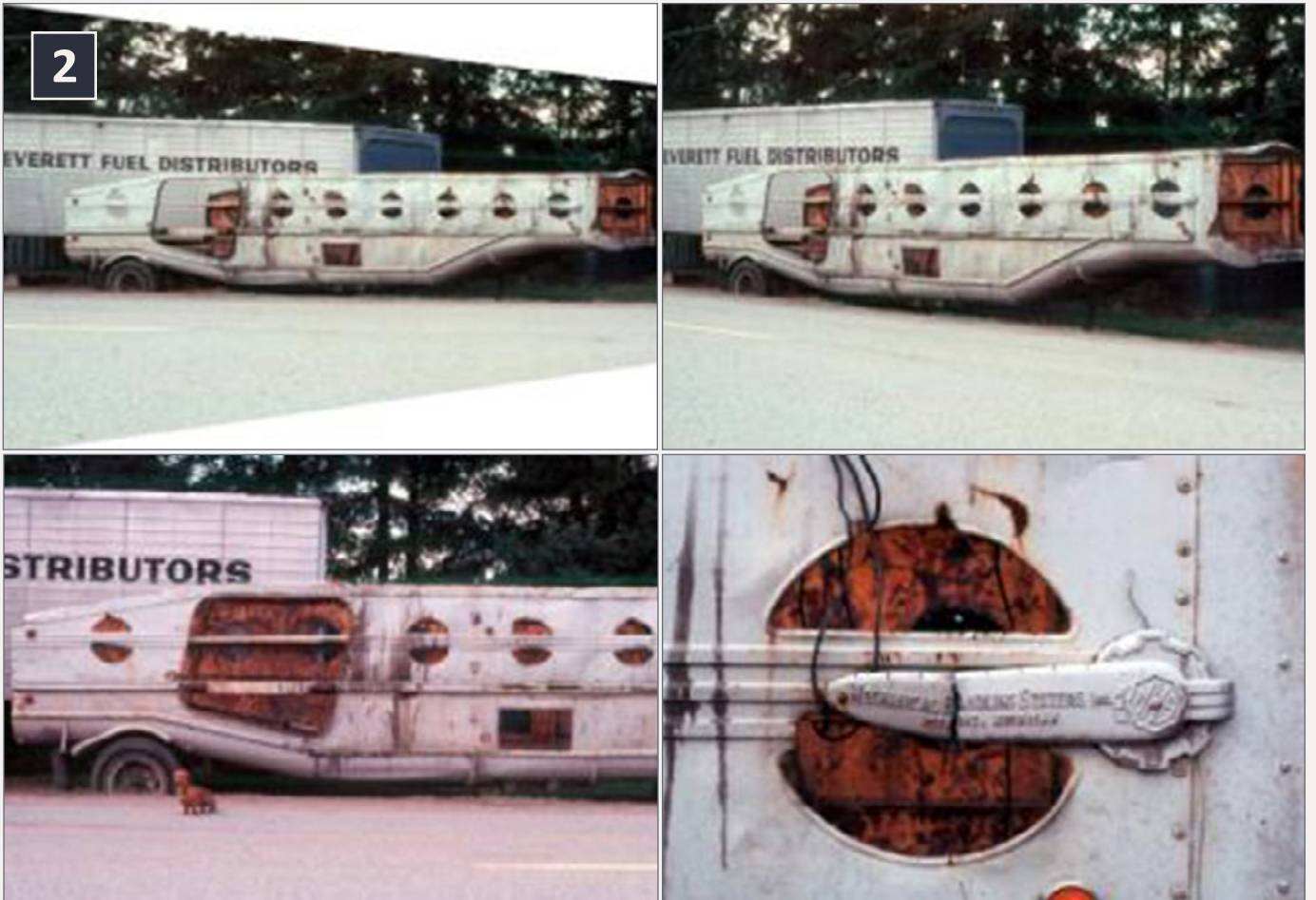

2: This series of photos were taken at Eastbury Salvage.







### 3: Additional photos of the trailer taken at Eastbury Salvage.

Eastbury Salvage that the trailers were very well-built, and suitable for heavy hauling. I took additional photos and also was able to get basic measurements.

A great photograph of the Mechanical Handling Companies trailer appeared in the book, “Big Rigs of the 1950s” by Ron Adams. This is a great book for those modeling the transition era. The photo shows an MHS Auto Carrier trailer lettered for the Baker Driveaway Company, Detroit, Michigan. I contacted the author the book, and was able to get a quality 8 x 10 print, reproduced here with his permission.

This trailer was built in 1949, the era I am modeling on my Kansas City Southern layout. It's right from the golden age of train travel, Harley Earl and automobile design. That influence can be seen in the design of the trailer. Look at the fins on those 1960 Dodge autos!

For some time I contemplated how to model this unique vehicle. The curved bottom sides would be the greatest challenge. I decided the best construction method would be to use styrene sheet and shapes.



contents



index

I laid out the sides and vehicle ramps to be laser-cut and etched in .020" styrene sheet. I laid out the inner framing for the sides to be laser-cut in .040" styrene sheet. The underfloor framing members are pieces of styrene rectangular stock.

I could not find an easy way to get the 1/8" quarter-round styrene shape for the body edge of the sides. So I took a length of 1/4" styrene tube and used a sharp knife to cut it into quarters lengthwise.



**4: The next time I found the trailer it was located at Quill Ceda Auto Wrecking. By this time the trailer had been cut down to its frame, and still in fairly good condition considering its age of 60+ years. The next series of photos are detail pictures I took of the trailer. I wasn't about to miss what may be a final opportunity.**





5: Details of the rear axle. Notice the fender over the wheels. The mud flaps are located farther back.

Advertisement

**Bachrus** inc  
RUNNING ON QUALITY

Click  
me!



Email



Phone



contents



index



Final details to add were the fenders, from .020" styrene, and the folding steps up the side, made from individual chain links with a small styrene strip below. The side trim strip and Mechanical Handling Systems medallion were laser-cut in .020" styrene.

The wheels, rear axle, mud flaps, and landing gear are commercial parts. The parts were assembled with MEK cement. The original photos are all black-and-white, but I came up with a convincing 1950s, off-white and tan, two-tone paint scheme by looking through a number of books on trucks from that era. The tire ramps are painted aluminum.

I created the decals and printed them on my ALPs printer. The tractor is a repainted, re-lettered Mini-Metals vehicle.

The final result is a convincing reproduction of this distinctive vehicle. 



## 6: The trailer axle mount and brake detail.





7: Here is detail of the ratchet system that is used to tie down the autos during transport.

Advertisement



con-cor.com



Shipping Now!



"N" Amtrak "Wave" Paint Scheme  
12 Different Body Styles



N Tri-Level Auto Carrier

Labelle Lubricants

The model rail-roaders' #1 choice in lubricants since 1975



www.con-cor.com/Labelle.html



New!  
HO & N 53' Containers



www.con-cor.com



2-Packs:  
HO \$27.98  
N \$18.98









**AUTO CARRIER TRAILER**  
**MECHANICAL HANDLING SYSTEMS, INC., DETROIT, MICHIGAN**

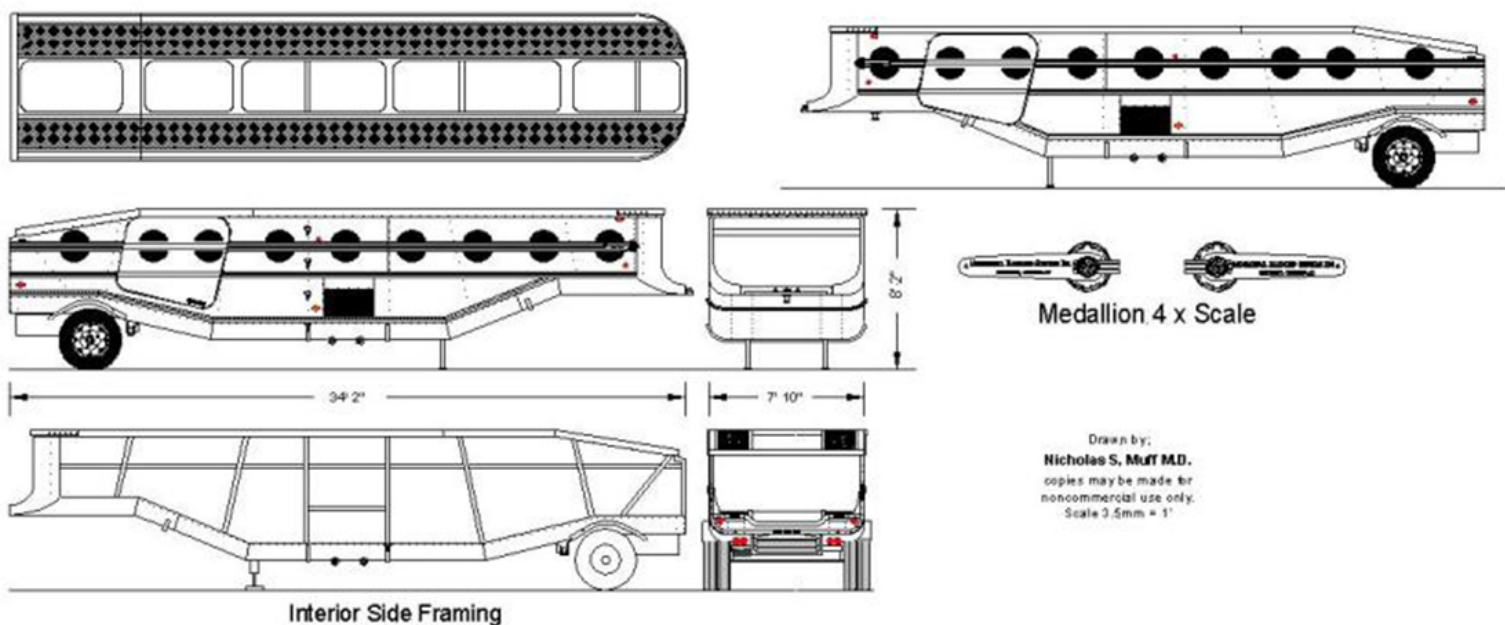

*Advertisement*



**THE ORIGINAL  
 SURFACE DETAILS**

PRECISE SCALE RESIN RIVETS,  
 LOUVERS, TREADPLATE, WELD BEADS  
 AND MORE ON CLEAR DECAL FILM

**CLICK HERE TO WATCH  
 VIDEO TUTORIAL**

**CLICK HERE TO SEE  
 THE RESULTS**

**CLICK HERE TO BROWSE  
 AND BUY**

Archer Fine Transfers • PO Box 1277 • Youngsville, NC 27596 • USA  
 (919) 570-1026 • info@archertransfers.com • archertransfers.com



contents



index

8: The lower deck over the kingpin. It is still in good shape after all of these years.

9: I crawled under the trailer to get a good detail shot of the frame and air brake system.

10: Plans of the trailer that I developed to build the model. PDF file plans for this trailer are in this issue's subscriber bonus downloads.







11-14: Photos of my finished model, painted for Baker Driveaway Company. A one-of-a-kind vehicle.

▶ **Reader Feedback** (click here) 🗨️



**New  
Innovation**



# Nano Technology Lubricants

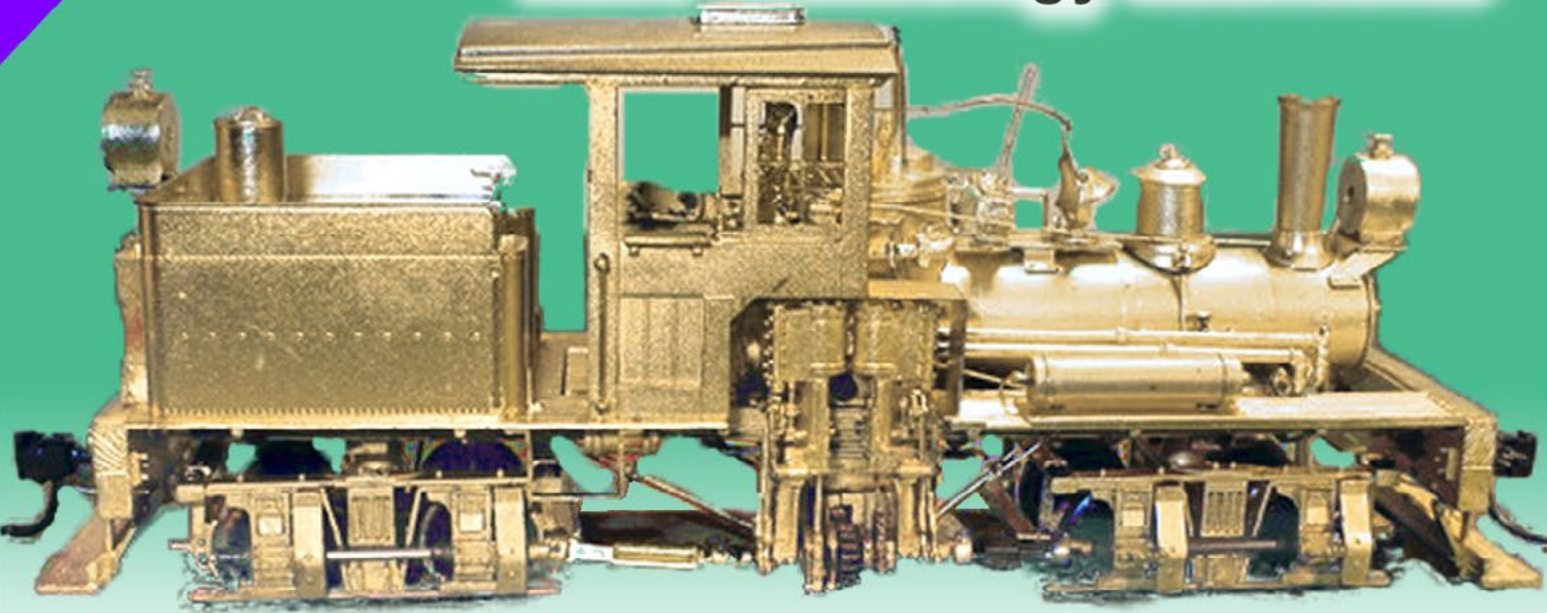

**Nano-Grease**

"After eight years of extensive testing, the only lubricants now used in my shop are Nano-Oils and Nano-Grease. The extreme reduction in power draw by mechanically minimizing friction is simply technologically superior."

- Phil Floyd, 'The Shay Fixer'

**THE SHAY FIXER** 

VISIT US AT... [SHAYFIXER.COM](http://SHAYFIXER.COM) 

*Specializing in brass Pacific Fast Mail / United geared locomotives*

**For more details  
click here ...**





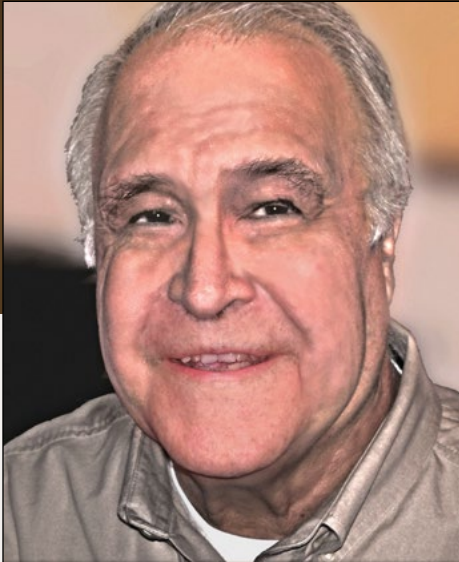

# Evolution of my Railroad

## Ramblings on Narrow Gauge and Branchline Modeling

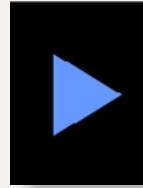

**Reader  
Feedback**  
(click here)



### **The Lite and Narrow column**

*by Larry Smith*

## **A multiscale overview of narrow gauge freight cars beginning with boxcars ...**

**T**his is the first in an irregular series of columns about narrow gauge freight cars. Freight cars will be discussed by type, with references made to who produces the models of those specific types of cars in the various scales. Additionally, cars may be presented that are unique to one railroad, but the construction methods for scratchbuilding them can be applied across all modeling scales.

Let's start with the boxcar. No one really knows when the first boxcar was built or the reason it was built. Speculation is that someone had a shipment that would be ruined if it got wet. It was a simple matter to build a shed-like structure on a flatcar to cover the shipment, much the way logging companies did to transport supplies to the camps.

By the time of the Civil War many car companies were in existence, supplying boxcars and other rolling stock to the railroads. Over time the standard gauge cars grew in size to first 36' long,



and then to 40', and then much larger and taller until arriving at the sizes used today. Narrow gauge cars stayed smaller due to using lighter rail and tighter curves than their bigger brothers.

I recently conducted an informal survey among narrow gauge groups on the Internet and received some interesting feedback. The primary purpose of this survey was to determine the mix of rolling stock individuals had, and to find out who the manufacturers are in the different scales. On3 and larger scales are not included.

## On30

Boxcar kits are available from International Hobbies, who import Chivers Finelines plastic, Boulder Valley resin, Foothill Model Works resin, Bachmann plastic ready-to-run, On30IMA laser wood, Deerfield River laser wood, AMS plastic, Accucraft plastic,



**1: Rio Grande 3000 series cars are the most modeled narrow gauge boxcar across all scales. Photo courtesy of BHI Publications, Tim Mulina collection.**





**2: Sandy River and Rangeley Lakes boxcars 135 and 83 are examples of the two-foot boxcars. Photo courtesy of BHI Publications from their Two Foot Gauge Pictorial Guide Books, Peter Barney collection.**

San Juan Car Co. plastic, S-Helper Service (S-scale converted to On30), Wiseman Model Services, Mount Blue Models laser wood, and Morgan Hill Models laser wood.

Several modelers replied that they scratchbuilt their cars and some commented about the length of cars they model. Some use the 18' Bachmann cars while others build their own to 30' long, with most of them falling in the 20' to 22' range. In my research on car lengths, I found that most two-foot prototype boxcars were longer at 24' and 30'. Most of the respondents stated that they follow no particular prototype.

## **Sn3**

The modelers in Sn3, for the most part, are Rio Grande modelers. P-B-L is the dominant manufacturer in this scale and



provides both ready-to-run rolling stock and kits. Their boxcar is the Rio Grande's 3000 series car. The Rio Grande had 750 of these cars in service, more than most narrow gauge railroads had in their entire fleet. Other products come from Precision Vintage Classic Models, former Berwyn kits, Overland brass, The Cimarron Works, Design Tech, Miller Engineering & Design laser wood, BTS laser wood, RailMaster, Wiseman Models, and MDC and Athearn, kitbashes.

## HOn3

You would think in HOn3 that there would be lots of boxcars offered, but this is not the case. Blackstone offers two versions of the 3000 series cars; however one of those is out of produc-



**3: East Broad Top single-sheathed steel boxcar. Its number is unknown and there is no identification visible. Photo courtesy of BHI Publications, Tim Mulina collection.**

tion. Rail Line also has a kit 3000 series car. Grandt Line has a limited amount of C&S boxcars and Micro-trains no longer list any freight cars on its web site. LaBelle has a very good selection of wood





**4: Tweetsie off-center door boxcar. Speculation has it that the cars were sized up from 28' cars, leaving the door where the center of the car would have been. Johnny Graybeal collection.**

craftsman kits for boxcars including a Florence and Cripple Creek that migrated to Pearl Harbor in WWII. Trout Creek Engineering has a very good selection of boxcars for the Southern Pacific; these are also wood craftsman kits. For eastern modelers, the selection is slim with LaBelle producing the only Ohio River and Western car. Tweetsie cars are produced by David Hoffman and Mt. Blue has reissued the Train and Trooper 32' car. Funaro and Camerlengo offers a boxcar for the Cairo and Kanawha and both the 150 series wooden East Broad Top boxcar and the steel East Broad Top boxcar. If you can find them, Gloor Craft (Quality Craft) made the East Broad Top boxcar 170, which was a composite car having a steel underframe and wood sides.

## HOn30

The manufacturers identified for HOn30 that are currently available include Funaro and Camerlengo resin, Chivers Finelines plastic, Railway Recollections resin one-piece casting,



Shapeways, 3D printed in resin, Steven's Creek wood, Mt. Blue wood, Clever Models paper. Other kits and ready to run that can only be found on eBay or at swap meets include: Joe Works brass, Sandy River Car Shops, PolyMold 1970s resin, C&D, Sango brass.

## Conclusions

1. There are more manufacturers of boxcars in all scales than you would think. Most of them are one-man cottage industries producing a very limited amount of product.
2. What is modeled varies greatly among the scales. On30 modelers are mostly freelancers although some follow the Maine two-footers. Others follow industrial type of railroads. Sn3 is mostly Rio Grande modeling. Of the layouts I saw at the St. Louis National Narrow Gauge Convention, most were well-executed



**5: Model of a crude boxcar used by the Sewell/Babcock lumber company in West Virginia. This is based on dimensions and photos published in "West Virginia Narrow Gauge: The Mann's Creek."**





6: Tweetsie box car built from Train and Trooper laser kit. The trucks are the proper ones for the car (McCord archbars) and this is typical of the 32' cars operated by Tweetsie.

Advertisement

# THE **O** RESOURCE

NEWS, REVIEWS, INFORMATION TO USE

**SCALE** *New* **On Line Magazine**

[www.oscaleresource.com](http://www.oscaleresource.com)



Rio Grande layouts. HOn30 has a heavy Maine following and most of the rolling stock that is offered reflects it. HOn30 seems to be the most innovative with Clever having models available in paper and Shapeways doing 3D printing.

3. The most modeled boxcar is the Rio Grande's 3000 series boxcar, offered in all scales except HOn30. It is offered in ready-to-run versions by P-B-L in Sn3 and Blackstone in HOn3, and in kits by P-B-L in Sn3 and Trout Creek Engineering and LaBelle in HOn3. It is also offered as a kit in On30 by AMS.

## Building the roster

Although my Clinch River is a coal railroad, it still needs boxcars to haul material to the company stores and tipples. Until three years ago, my boxcar fleet consisted of a Gloor Craft EBT 170,



**7: Linville River Number 4. The 36' car was never lettered for Tweetsie and was off the roster by 1942. This is the Hoffman kit with a brass door and fittings.**



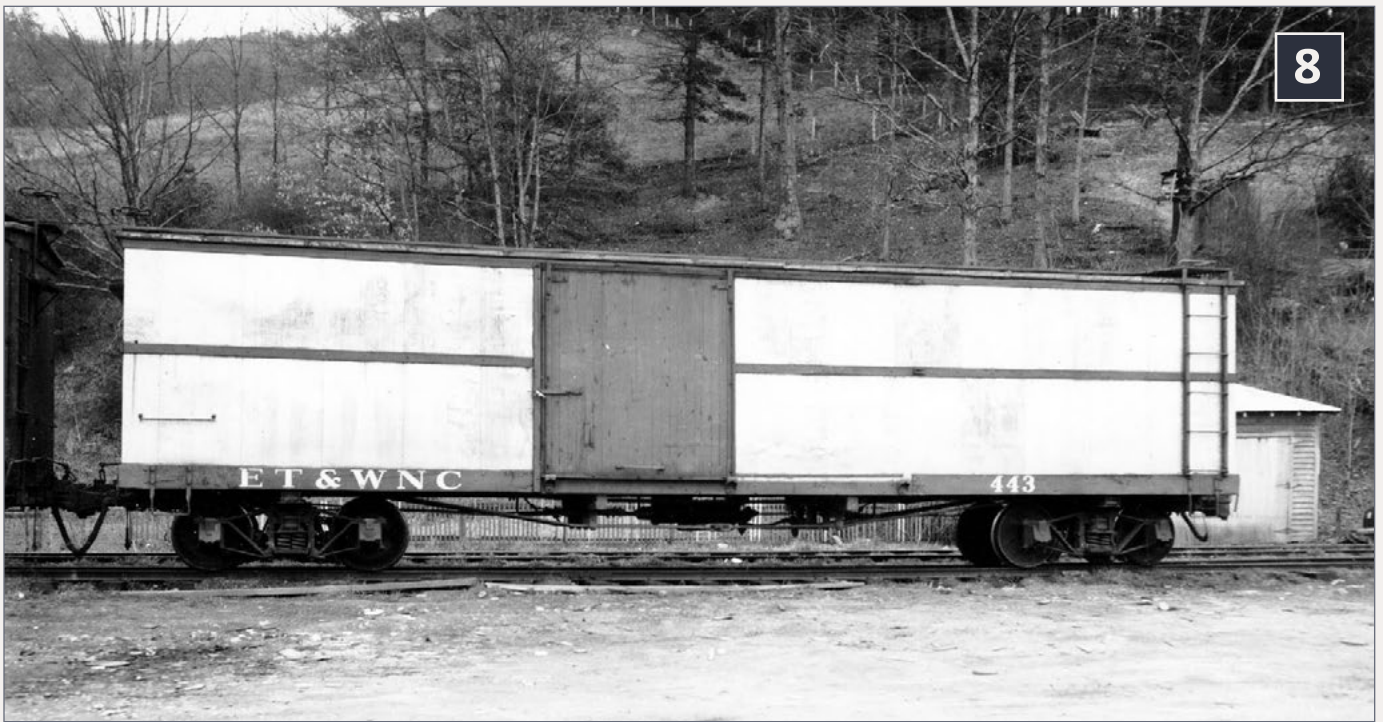

**8: Tweetsie galvanized metal car 443. This was the only 36' car to receive this rebuild. Johnny Graybeal collection.**

one that I modified to represent the 150 series cars, and several of the Funaro and Camerlengo East Broad Top steel cars.

I have had an interest in Tweetsie (the Eastern Tennessee and Western North Carolina RR) and had followed the construction articles of Julian Cavalier that were published in the *Narrow Gauge & Shortline Gazette* in 1985. I was confused by the drawings of the boxcar presented, which showed the door off-center. I thought that some mistake had been made or that all of the railroad's boxcars were that way. For some reason I never got around to building the car.

In 2011 I built a complete Tweetsie freight train for the *2011 HOn3 Annual*. Prior to this, I had purchased "Along the ET&WNC, Volume IV: Freight Cars Part A" by Johnny Graybeal. This is a very comprehensive book on the Tweetsie's boxcars. It was there that I learned that the railroad had two types of boxcars, a 32' car with center doors, and a 36' car with the offset doors.



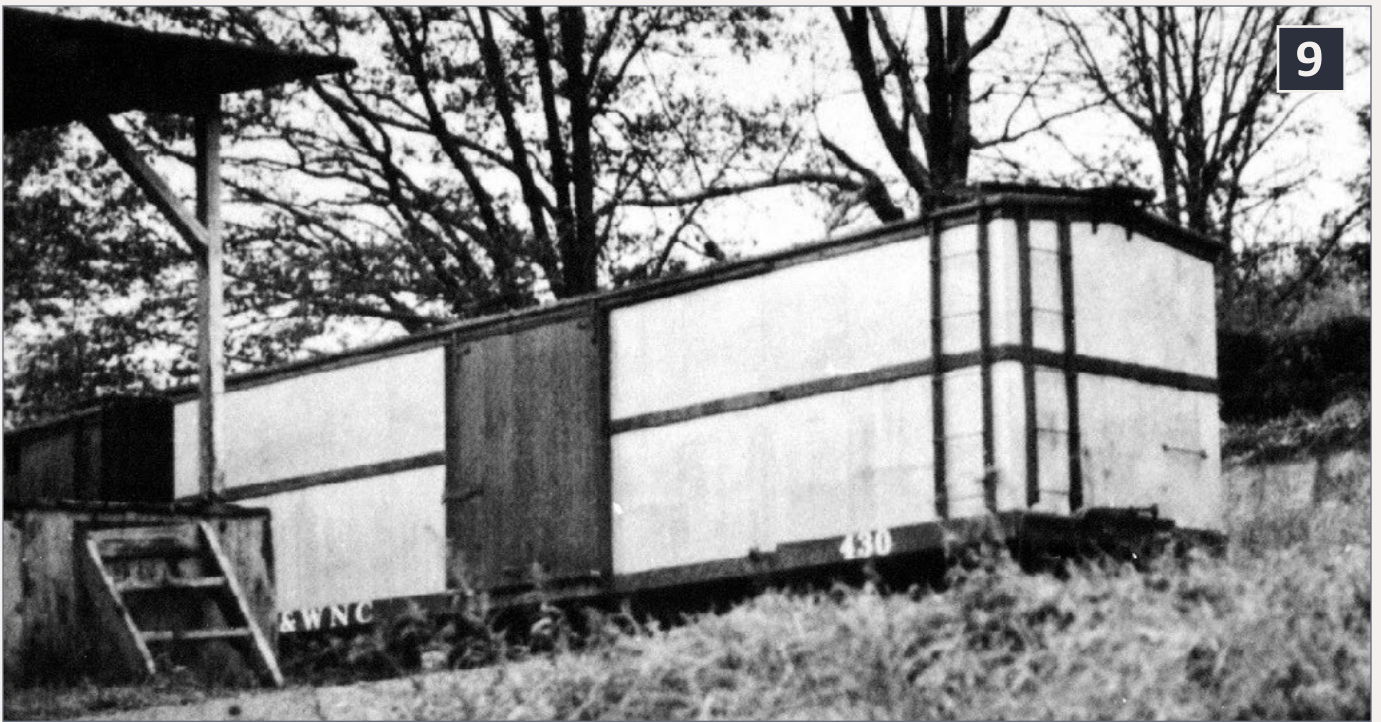

**9: Tweetsie boxcar 430. The only 32' car to receive this rebuild. Johnny Graybeal collection.**

When it comes to modeling ET boxcars, you have a choice of kits or scratchbuilding. If you choose the kit route, then you will find that currently there are only two kit makers: David Hoffman and Mt. Blue Models. David Hoffman has kits for both the 32' and

*Advertisement*

# Rslaserkits

Kits in all scales from O to Z and even some

**New HO scale small  
water tower perfect for  
small town on Industry  
water supply**



**Now in O and N scales  
Mispillion Lighthouse**

**Dealers welcome  
Salem, OR**

**503-371-4290**

[Sales@rslaserkits.com](mailto:Sales@rslaserkits.com)



**Custom Laser Cutting  
and design**

[www.rslaserkits.com](http://www.rslaserkits.com)







**10: Both cars in a freight train on the Tweetsie. They are a stark contrast to the wooden cars in the train. Johnny Graybeal collection.**

36' cars, while Mt. Blue makes only the 32' car. The Hoffman kits include details and trucks that are specific to cars that are offered, however they are in short supply and you need to check

*Advertisement*

**Click Here**

**FIFER HOBBY SUPPLY LLC**

**Your Local Online**

**HO & N Scale Hobby Shops**

575-523-9743 • fiferhobby.com • fiferhobbyho.com



with him before ordering. His address is David Hoffman, 8682 U.S. Hwy 61 North, Woodville, MS 39669.

I obtained kits from both producers and built both. What follows is a description of each car and illustrates how much the hobby of model railroading has changed in the last 20 years. Each kit does have errors, but given the current amount of information that has come to light in recent years, those are easily corrected.

The 32' and 36' dimension was not taken from the actual size of the car, but represents the inside usable space. The 1936 roster shows a total of 38 boxcars. This did not take into account the 10 cars that were on the Linville River roster. These cars made up approximately 21% of the ET fleet, while boxcars made up half of the Linville River fleet. It would not be until 1947 that the two fleets would be combined.



**11: Scratchbuilt model of boxcar 443 on display at the National Narrow Gauge Convention in Hickory, North Carolina.**





**12: Boxcar 430 still under construction. The model has truss rods to be added, along with other finishing details.**

The boxcars were numbered in the 400 series, however you have to be very careful when choosing numbers for the modeled cars, as they weren't numbered in any specific order, and you might put a wrong number on the wrong type of car. As an example of this, 418 is a 36' boxcar and 419 is a 32' boxcar, as is 420. Yet 421 reverts back to 36'. All Linville River boxcars were 36' cars.

## **Linville River 4**

In December, 1916, the ET built 10 boxcars for the Linville River, which they had acquired from the W.M. Ritter Lumber Company in 1913. The 10 cars were 37' long; the ET called them 36' cars because of the internal usable space. These cars, as well as other ET boxcars, are readily recognizable by the offset door. If you take a measurement, you will find that the doors are centered



on what would be a 28' car, thus making it look like the ET stretched the car on one end only. This particular car retained the wooden bolster and had the "jacked up" archbar trucks. The car was retired and sold in December 1940.

The Linville River 4 was constructed from a David Hoffman kit. David's kits represent the traditional type of kit, with scribed siding and stick construction with the addition of brass castings. The brass castings, door, bolster and end sill, brake gear, and trussrods, have the added advantage of lowering the center of gravity of the car while at the same time adding weight to the car. However, they do add some challenges when it comes to finishing the cars as the brass, especially the large door casting, doesn't take paint the same way the rest of the

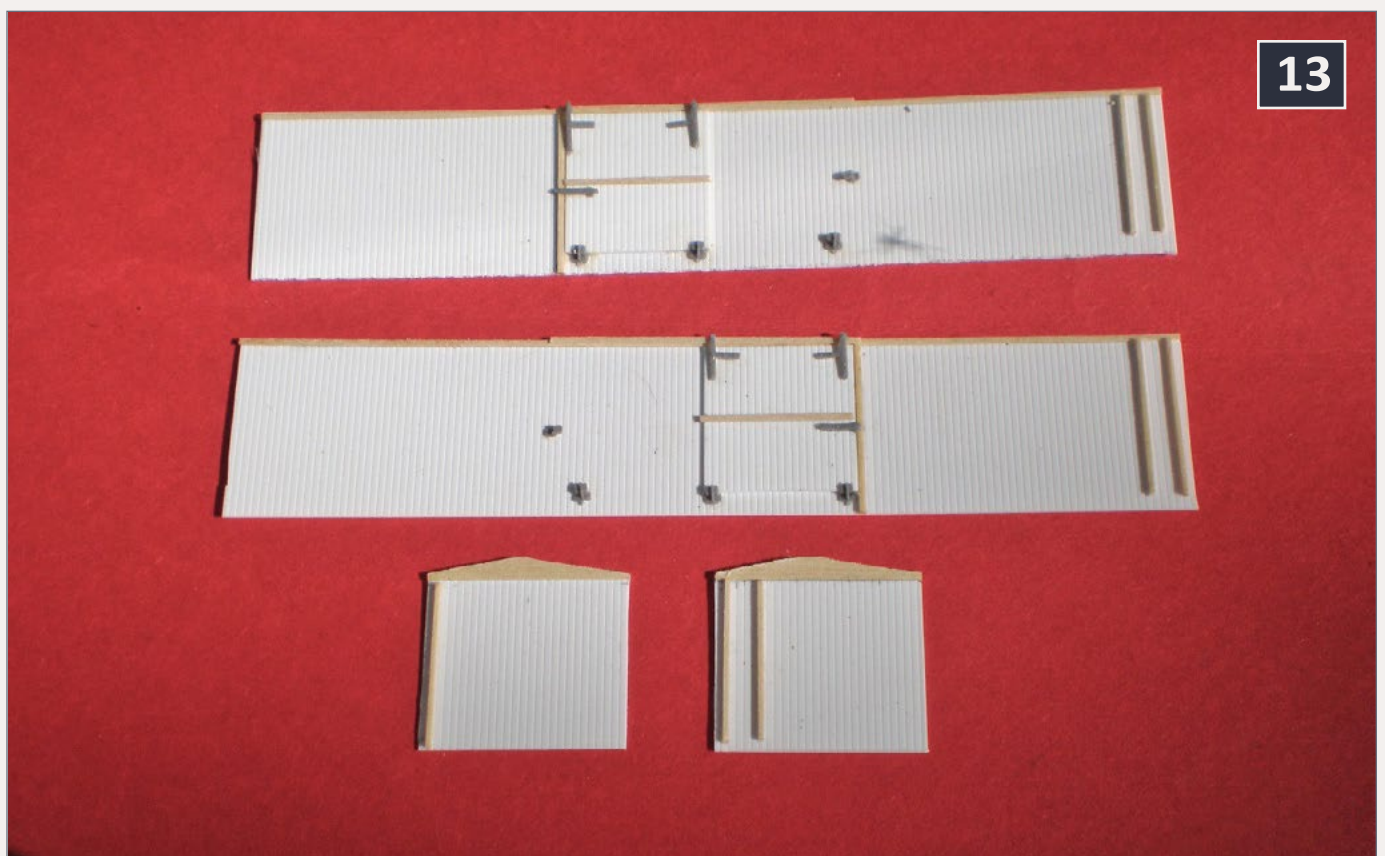

**13: Car sides and ends for a wood Tweetsie boxcar using a composite of styrene and scale wood. The corners of the sides were notched to fit over the end sills as per the prototype.**



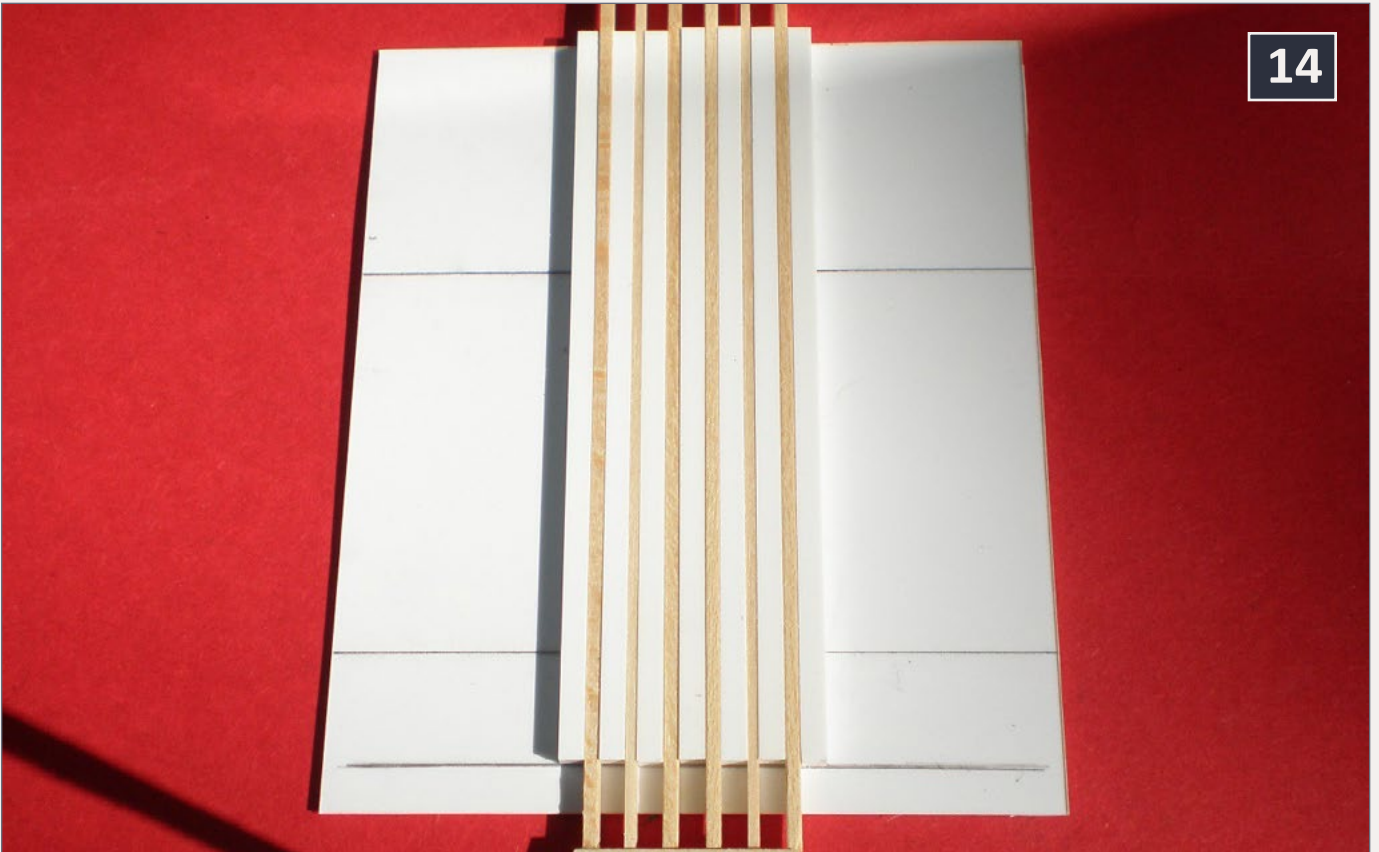

**14: Underframe and jig for the Tweetsie boxcars. This can be used for both the 32' and 36' cars. It can also be used for other railroads' cars.**

car does. The proper “jacked up” archbar trucks are included with the kit and they do need to be assembled. This is easily done using a #56 drill and then a #80 tap. They then assemble with a screwdriver. I recommend the purchase of a Kadee drill and tap set for assembling the trucks as everything you need is included in the package.

There were three modifications made to the kit, and they were made for appearances. The roof was thinned substituting 1/64” plywood for the 1/32” basswood that was supplied in the kit. Over this was applied a sheet of 80# paper to simulate a tin roof. I painted the roof with Testors Silver and then used a Floquil Rust marker to streak the roof. I wiped off the surplus with a paper towel and then brushed Bragdon dark rust chalk onto the roof to give it that unpainted and weathered look. The injection-molded



ladders were replaced using information from the bill of materials in the ET books on the freight cars, using scale 2 x 3s and adding rungs made from .010" styrene rod. This gives a more realistic and delicate appearance to the ladders.

## ET&WNC 428

Boxcar 428 was built in June 1924 as part of a group of five cars. The car body had an inside length of 32' and was of all-wood construction. It had fabricated steel body bolsters and Simplex trucks. The car was retired in December, 1945.

My kit was from Train and Trooper, best known for their Maine two-foot equipment. This kit was just rereleased by Mt. Blue with the problems I encountered corrected and upgraded. The kit is a laser-cut kit with full interior so the doors can be left open. All ET cars had tin or galvanized roofs and the new kit has been modified to represent this. For the car that I built, I took

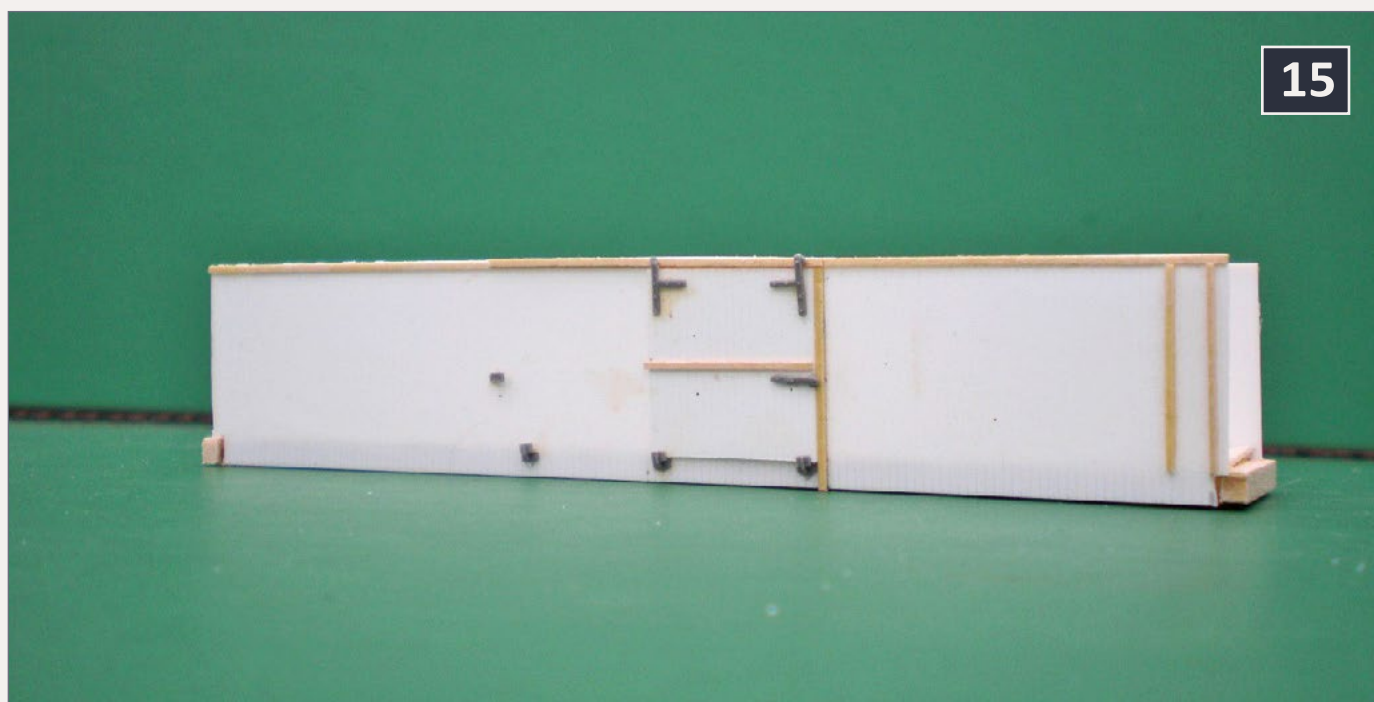

**15: The 36' car attached to the underframe. Note the end sills are not yet filed even with the car sides. They also need a metal corner plate attached to them.**



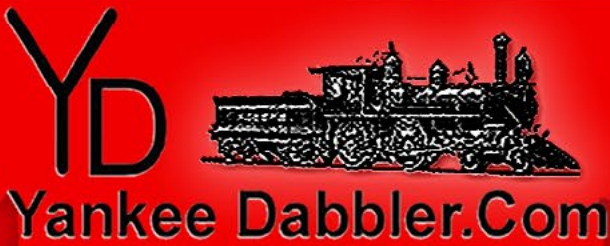

**People  
who buy  
with us  
ALWAYS  
save!**



*- Kadee - NCE - SoundTraxx  
- Digitrax - And more!*

**Click NOW  
to save!**

**HO**

**DCC**

**ALL SCALES**

a Floquil rust marker and painted the roof, moving the marker from the roof walk to the edge of the roof. I used a paper towel and wiped off the rust, leaving visible traces on the roof. Next, Bragdon dark rust weathering chalks were applied to the roof to get the finished blend of colors for a rusted roof.

On the Mt. Blue re-release car, you have choice of fascia strips for the car ends. To be sure which to use – and this applies to all freight cars – check a photo of the car you are modeling. In the original kit, a Tichy standard K brake system was supplied. This was too large for narrow gauge equipment. With the new kit, this has been changed to the smaller Grandt Line narrow gauge K brake system. The new kit also includes three different types of bolsters that Tweetsie used, allowing for the car to be at a proper height, unlike the previous kit. With car 428 having the



contents



index

built-up bolster, the Hoffman Simplex trucks were used for the car.

## Scratchbuilding boxcars

In the process of developing my Tweetsie fleet of boxcars, I discovered two unique cars. They are cars 430 and 443, one of each size car. What makes them unique is that they are covered in galvanized metal that Tweetsie applied to them on the sides and ends. For years there has been a discussion about the metal used on these cars, and many thought that it might be aluminum. Recent research on the cost of aluminum at the time of this conversion suggests otherwise.

The methods I am using to build these and other freight cars can be used in any scale. So if you have a unique car that you want to build, or there are none produced for your favorite railroad, then feel free to try them.



**16: An early Funaro and Camerlengo steel East Broad Top steel boxcar with the Clinch River herald. I letter the cars for my railroad but they are numbered for the prototype.**



I prefer to work on flat surfaces for my car construction. This is because I have made masters in the past for cars that weren't available at the time. For these cars, I used Evergreen freight car siding, reversed for the metal cars.

Using drawings from "Along the ET&WNC," I cut both sides to length and height. I took the measurements from the data in the drawing and cut the fascia from scale 1" x 3" wood. This was glued into place using CA. The door was cut from styrene and positioned according to the drawings. I made the ladder uprights from 2" x 3" wood and glued them into position with CA.

Tichy has made boxcar building an easy chore with their hardware releases. Part number 3070 provides all that you need to build several cars, with the door hangers and stops and locks. They have also introduced roofwalk supports since I built the galvanized cars, making that job much easier.

With the car sides and ends completed, I constructed a jig for the underframe. I used the drawings to get the correct spacing and used the correct size of wood to glue the spacers into place. These were glued to a sheet of .040" styrene and were made short enough to use with various lengths of cars. I cut the wood for the frame to length and squared them before attaching the end sills. After the glue had dried, I removed the underframe from the jig and glued scale 2" x 8" boards to the floor.

I glued the sides and ends into place, bracing them with scrap styrene strips. The roof is cut from Evergreen freight car siding and reversed to show the smooth side. Panels were scribed in the roofing to represent the tin roof on the cars. For the roof support, .080" styrene was run down the middle of the car. A better solution is to make roof supports in the same shape as



contents



index



**17: Gloor Craft model of East Broad Top boxcar 170. 170 was East Broad Top's only wooden car with a steel underframe. I inherited this car from Dr. Charles Grant's collection after his death.**

the ends and then add the center beam. Much stronger, and without sag.

Flip the car over, and add the queen posts and brake cylinder. You can add as much detail for the brakes as you wish. I used wire for the truss rods, but for future projects I am going to use monofilament as wire has a tendency to cause truck movement problems. Apply the trucks of your choice and test-run the car. Final details include using .010" styrene rod for ladder rungs, and adding grab iron stirrup steps and a brake staff.





**SOUNDTRAXX™**

Blackstone  Models™

*Litchfield*  
  
S T A T I O N

## Year Round

We have the BEST selection of  
DCC Products, Great Service  
& Professional Installation!

*Check us out  
on the web!*



**Litchfield Station**

**www.Mr-DCC.com**

**623-298-7355**





BCOL VARIATION SHOWN WITH METAL ROOF WALK AND ICICLE BREAKERS. CP VARIATIONS INCLUDE WOOD ROOFWALK, WITH AND WITHOUT LUMBER DOORS.

# YOUR ORDERS ARE DUE NOW. MADE. TO. ORDER.

**CP Rail** **CANADIAN** **BCOL**



**PACIFIC RAILWAY**  
**CANADIAN**

*Canadian Pacific*  
**PACIFIC**

TRUE LINE TRAINS and its' intellectual property are solely owned by HOBBYCRAFT CANADA a division of 2236675 ONTARIO LIMITED, 445-1 EDGEMOUNT BLVD, COOKSDALE, ONTARIO L4K4G1 (905) 738 6556 - contact us in the USA at [usinfo@truelinetrains.com](mailto:usinfo@truelinetrains.com) and in Canada at [canrec@truelinetrains.com](mailto:canrec@truelinetrains.com)







# Blade masters, industrial bins, autoracks, and more!

Photos and video of superb models

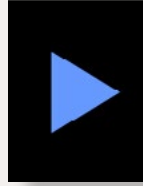

**Reader  
Feedback**  
(click here)



## **What's neat this week column** by *Ken Patterson*

1



**1:** Kim Hornbaker and Austin Kassmeyer, and their cast wind turbine blade freight cars.





This month in text and in video, we are featuring the models of Kim Hornbaker, Austin Kassmeyer, and Mike Budde, plus some cool industrial structures fresh off the boat and new to the U.S. market.

The video includes a prototype runby, along with a prototype Ice cream structure out in the field that matches a new prebuilt model recently shipped to hobby shops.

We start with “The Blade Masters,” Kim Hornbaker and Austin Kassmeyer, who have cast wind turbine blades from a hand carved master, making for a fabulous looking and working unit freight train fresh from the Siemens plant. Kim will take it from here and explain his endeavor in his own words.

“The idea generated from the fact my youngest daughter worked for the Siemens plant in Fort Madison, Iowa. She told me they were going to start shipping them by rail. I took a day



**Playback problems?** [Click to try a different version.](#)





## 1: Kim Hornbaker and Austin Kassmeyer load their cast wind turbine blades onto special unit-train flat cars.

off from work to photograph the first train leaving the plant. After seeing these cars in action, I decided this would be a cool prototype to model.

“As I was hand-carving a model blade, I realized I needed to be able to have these operate on 30” radius curves on my layout. I experimented with length of the blades and modifications of spline cars so this could be achieved. After several tries , this finished model of six Con-Cor five packs and 12 wind blades will operate on 30” radius curves.

“The shows in the Midwest I have attended have let me meet people who say 'this is really neat,' or “I haven’t seen this load in real life, alone in model form.’

“There is real satisfaction in knowing I have the only models of these, and built them myself.”



This month, Mike Budde explains in his own words why and how he built this fantastic model of an autorack, complete with cars fresh from the GM factory in Kansas (3-4). It took Mike 30 years to build this model little by little, finally finishing it in 2010. The flat is wood, the rack is styrene, and the cars are resin kits and plastic kits modified to match the prototypes look fresh out of the plant and ready for showroom prep.

The sincerity that Mike conveys while telling his story on video really brings home the fact that some models witness one's life while being constructed over time. It's a really good interview.

3



**3: Mike Budde's 1/25th scale scratchbuilt autorack, loaded with his beautiful '69 Chevelle car models.**





4a-4b: Another view of Mike Budde's autorack. Mike finished building this car model out of wood and styrene in the summer of 2010.

### Advertisement



Announcing our newest HO-Scale  
Craftsman Structure Kit . . .

## The Tiffany Clockworks



Order yours today at [www.motrakmodels.net](http://www.motrakmodels.net)











contents



index

I shot this sunrise photo of some new industrial buildings from Bachmann. They are metal and resin and come prebuilt and painted, ready to install on your layout. These structures are neat and fill a void in the building market. I review them in this month's video (5).

While road-tripping through Illinois, I found the prototype of an ice cream stand that Bachmann has just released as a pre-built structure in their SceneScapes line of scenery products.

The owners purchased the building on eBay and had it shipped from Ohio. It took two weeks to reassemble. Now, you too can buy ice cream from this treasure of Americana. The prototype is covered in this month's video (6). 

5



**5: Were you aware Bachmann makes these nicely detailed metal and resin bins with conveyors? They're great for industrial scenes on your layout.**





6: Bachmann's new resin kit of an ice cream stand. Watch Ken's video to see the full-sized prototype for this kit!



**Reader  
Feedback**  
(click here)



Get the Latest Model Railroading News, Tips, Reviews & Opinions

# The SCOTTY MASON SHOW

S H O W  
*The Original Model Railroad Podcast*

## -Monthly Interviews

- Modeler's Spotlight: Top Modeler's Talk
- Narrow Gauge Modeling w/Chris Lane
- Contemporary Modeling w/ Mike Rose

## -More Product Announcements & Reviews

Apple iTunes

**Our feed has changed! To get the latest shows,  
Please search Scotty Mason and subscribe to the new feed!**

[www.TheModelRailroadPodcast.com](http://www.TheModelRailroadPodcast.com)

*Scotty Mason*

*Jimmy Simmons*

*Mike Rose*

*Joe Duckworth*



contents



index



# MRH HOBBY MARKETPLACE - 1

**NEW!**

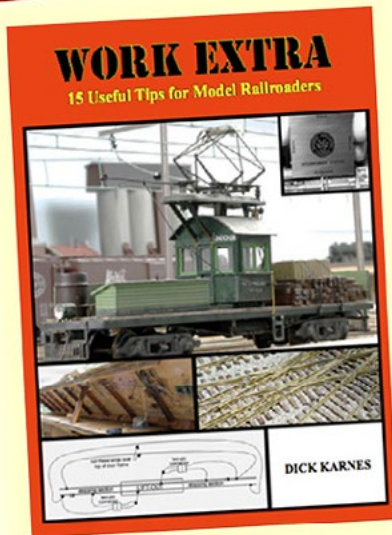

Where?

**Here!**

**RLN**Publishing

PO Box 6104, West Orange NJ, 07052-6104  
www.1-64ModelingGuide.com rlnpublishing@me.com

Affordable custom and modular benchwork.

MODEL RAILROAD

**BenchWork**.com

## Minimalist Model Railroading

*New Approach to Model Railroad Design*

Click here to learn more...

[minimalistmodelrailroad.com](http://minimalistmodelrailroad.com)

Post-holiday **BLUES**? Spend some of your **GREEN** with us!



**LOGIC RAIL**<sup>TM</sup>  
**TECHNOLOGIES**

"Sophisticated Model Railroad Electronics"



Please visit our website and online store!

21175 Tomball Pkwy  
Suite 287  
Houston, TX 77070

Phone: (281)251-5813  
<http://www.logicrailtech.com>  
Info@logicrailtech.com

**CLEVER** models LLC

Cardstock models & Building materials

**CLICK HERE**

[www.clevermodels.net](http://www.clevermodels.net)

## True Scene<sup>TM</sup> Modeling



**FusionFiber**<sup>SM</sup>

Scenery Base Material for the 21st Century!

**SATISFACTION GUARANTEED!**

[www.truescene.com](http://www.truescene.com) or 716-523-7305





# MRH HOBBY MARKETPLACE - 2

## RULERS-of-the-WORLD

Scale Rulers \$4 each

Over **150** scales!

Metric or Imperial

[www.rulers-of-the-world.com](http://www.rulers-of-the-world.com)

**Railroads  
Done  
Right!**

Rail Design Services

[click HERE to learn more](#)

## Great Decals!

is now selling decals produced by *After Hours Graphics* for Midwestern railroads. Roads offered include C&O, Cincinnati Union Terminal, Conrail, CSX, DT&I, Great Miami, Indiana and Ohio, Interstate, NKP, Norfolk and Western, Pere Marquette, Southern, Transkentucky, and private labels Dow and Owensboro Grain.

For the complete list, see:

[www.greatdecals.com/  
AfterHours/AfterHoursList.  
html](http://www.greatdecals.com/AfterHours/AfterHoursList.html)

Great Decals!

P. O. Box 994, Herndon, VA 20172

MRH dared to put  
*THIS* on video?



Watch the  
video now



Your ad could  
be in this space  
for just \$55 a  
month.

Click to  
learn more ...



# MRH HOBBY MARKETPLACE - 3

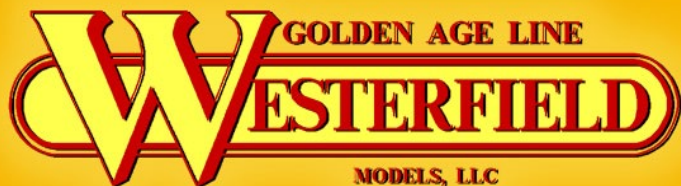

**4900 Series R-30-4/5/6 PFE  
Reefers Re-Released!  
NEW KITS AVAILABLE.  
westerfieldmodels.com**

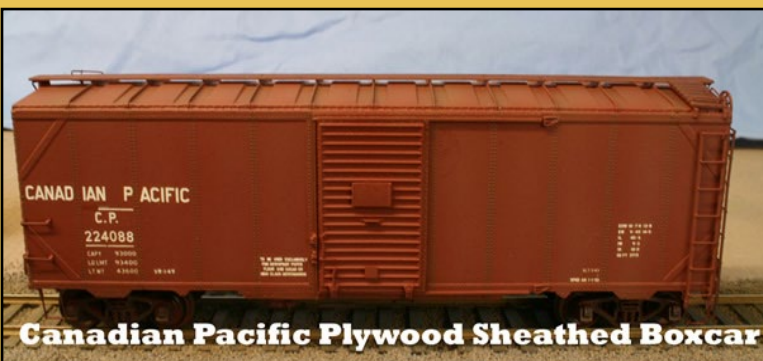

**Canadian Pacific Plywood Sheathed Boxcar**

**Yarmouth Model Works**  
HO scale resin kits and detail parts

Tel. 519-633-7574  
pierre.oliver@start.ca

[www.yarmouthmodelworks.com](http://www.yarmouthmodelworks.com)

..... U.S.A. MAILING ADDRESS  
3560 Pine Grove Ave. Unit 617  
Port Huron, MI 48060

..... CANADIAN MAILING ADDRESS  
85 Hiawatha St.  
St. Thomas, ON N5P 2T5

Avoid the hassle and let us plan your  
**SurroundTraxx**  
Integration and Transponding System  
from **DCC by Design**  
Take advantage of our experience  
[www.dccbydesign.com](http://www.dccbydesign.com)

## Backdrop Junction

Your stop for  
**Model Railroad Backdrops**



*click here to visit our website*  
**backdropjunction.com**  
**N, HO, O Scales • Custom Orders**



Railroad Art-Prints,  
Caps, Jackets,  
Shirts and More ...  
Jackets starting  
at \$79.95

[www.jelsma.com](http://www.jelsma.com)

1-904-221-3513 • Jacksonville, FL.

**HOBBY  
MARKETPLACE**  
ads are  
economical and  
effective.

Click HERE to learn more.





## New Baseline Capture Feature

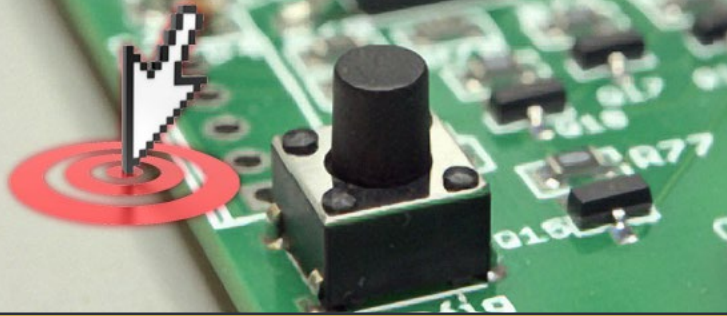

Have you seen these popular blogs on the MRH website?



### Tom Johnson's L&IN

179,000 reads

[CLICK TO READ IT NOW](#)



### STREAMLINED BACKSHOP

Sales  
... Services  
..... Solutions

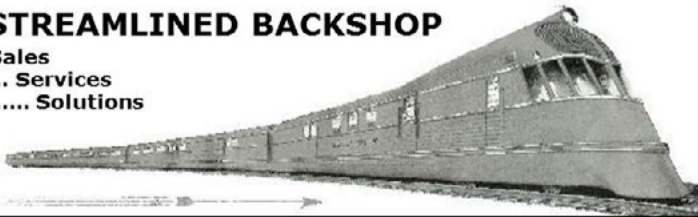

### "SUGAR CUBE" SPEAKERS...

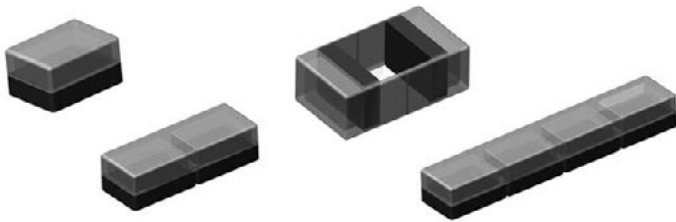

4 Sizes \* 4 Baffles

... "Sweet" Speaker Options!



[www.SBS4DCC.com](http://www.SBS4DCC.com)



### Ken Glover's Shelf Layout

40,000 reads

[CLICK TO READ IT NOW](#)





# Structures in tight places

– Robert Smaus

Model photos by author







contents



index



# Filling in that awkward corner ...



Reader  
Feedback  
(click here)



**N**o matter what kind of layout you have, I'll bet there are some awkward corners somewhere. In my case, there was one in particular. I had to move a layout of the Southern Pacific in Los Angeles, which was in Los Angeles, up to the Seattle area. And make it much smaller at the same time, since I no longer had the time or the room for my former garage-filling layout.



**1a-1b: The prototype buildings that are the inspiration of this article. They are located in LA and I vividly remember watching the business being switched.**





I managed to save and move a favorite part of downtown. The buildings were packed away and this section cut from the old layout, but when I reattached it to the new benchwork there was an odd corner where tracks had formerly gone into a tunnel and through a backdrop. Now there was nothing. I even had to scrape off the old track and ballast, since it's nearly impossible to save ballasted track. Actually, let's not get your hopes up if you are planning to relocate a layout – it is impossible!

The easiest way to fill corners is with trees and hills, but if you model an urban area the only natural fillers would be cemeteries or city parks, which are not normally found near tracks, even though they would be fun to model. So that leaves buildings which are not only logical, but can hide where the tracks end or disappear into a backdrop.

There had been two tracks leading to the tunnel, so I put back two tracks, though this time as curving sidings. One would disappear inside a covered loading dock, and the other down an alley. The part of downtown LA that I model – called the Rathole by crews who switched it – is stuffed with narrow alleyways and a great variety of buildings, including some with covered loading docks. I've not sure why they were covered since it hardly ever rains in LA, but they sure are interesting to switch. I made my first years ago, building it from scratch, but since then Walthers has come out with several models having covered loading docks, and I was anxious to try one.

Since there was little space to fill, I didn't even need a full kit. I got the Cornerstone Heritage Furniture Background Building. Though it is meant to be used parallel to the background, I planned to reconfigure it so it would be perpendicular, and hide the end of the track. The kit was surprisingly similar to an actual warehouse in the area I model – the Haas Iris Foods



contents



index

Warehouse, torn down several years ago. Maybe it had a covered dock, because in the 1950s (the era I model) it handled mostly food stuffs, such as sugar and flour, and many canned goods. You don't want to get flour or sugar wet.

To represent the narrow alleyways, I wanted to place another building right next to it. I'd always wanted to model the old brick Mission Furniture building with its large recessed and open loading docks. Actually located in another part of town switched by the Santa Fe, modeler's license allowed me to move it here. ATSF modeler Keith Jordan turned me on to the very versatile Walthers Cornerstone Merchant's Row III kit. He used it to model a fascinating building I had modeled a decade or two earlier, but his model was so much better thanks in part to this kit. It has the kind of arched brick window recesses found in several of my favorite old buildings in LA. Ever since

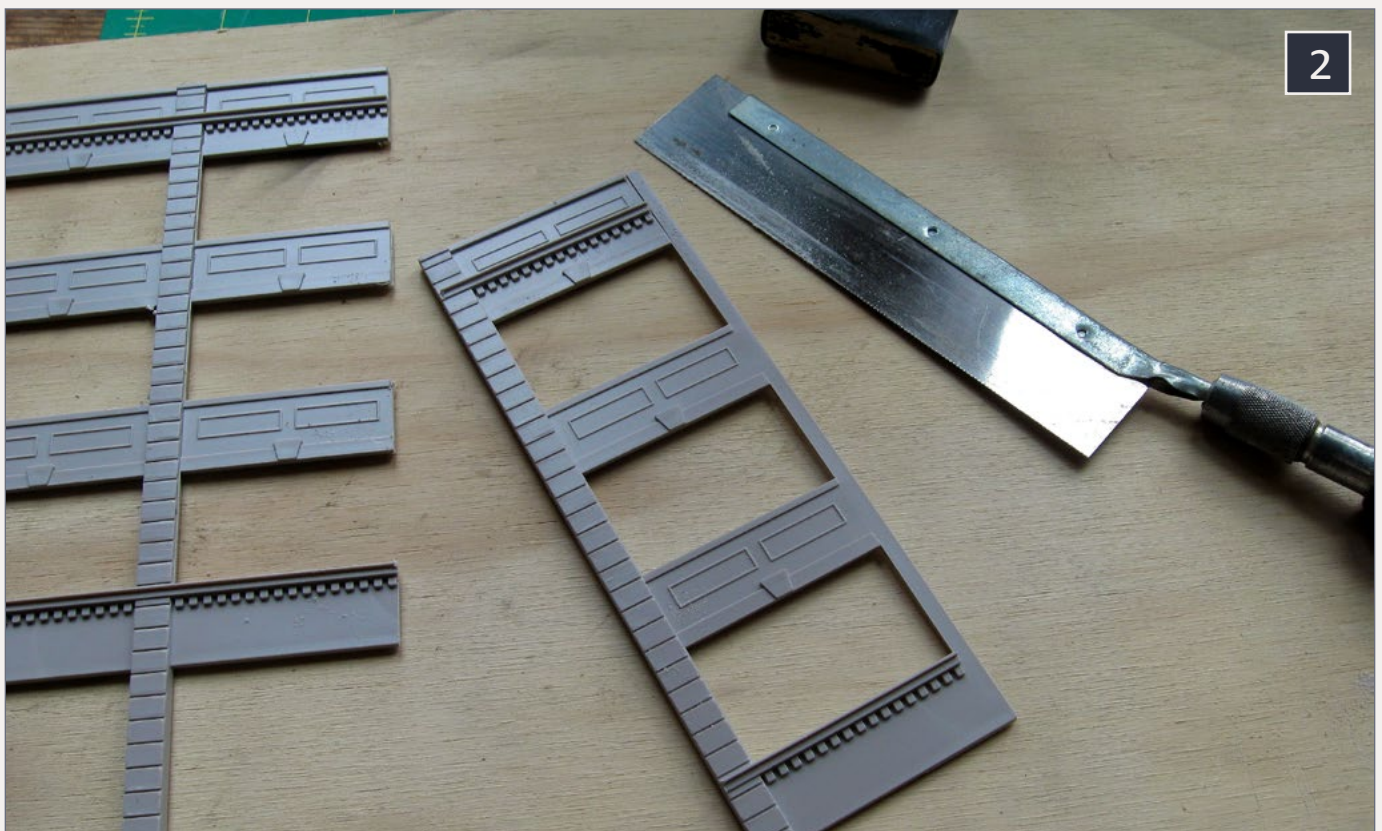

**2: Cut one bay of the long loading dock wall off so it can be added to the front wall to make it longer.**



Keith showed me his model made with this kit, I'd been dying to make one myself.

Once again, I only needed parts of the kit since most of the building would be hidden or open loading docks. I ended up using part of the back and one side wall so I still have enough of the kit to build the storefronts (if I only had room for them, but I'll find a use).



**3: Then cut it flush to the windows, using a razor saw.**

It's worth making note of kits that make good kitbashes, because not all do. They need to be easy to cut apart and join back together. While the Merchant's Row was a snap, the





Heritage Furniture was not, since it has rather complicated corners and supporting columns with corners, and in at least one spot I had to slap on a piece of styrene because of an ill-fitting joint. It is unseen on the back but it still bugs me. I wish I could have come up with a better solution.

But first I had to realign my curving track and fit it to the buildings (and vice-versa). I kept playing with them until buildings and track worked together – the kits were simply taped together and the track held in place with push pins. When it all looked good, I nailed down the track in a few places and ran a switcher and car into the covered dock and alleyway to make sure they fit and didn't bump anything. It is a tight fit, which is why I added a sign I once saw on the ATSF that says "Warning – Structures on This Track Will Not Clear Man on Side of Car."

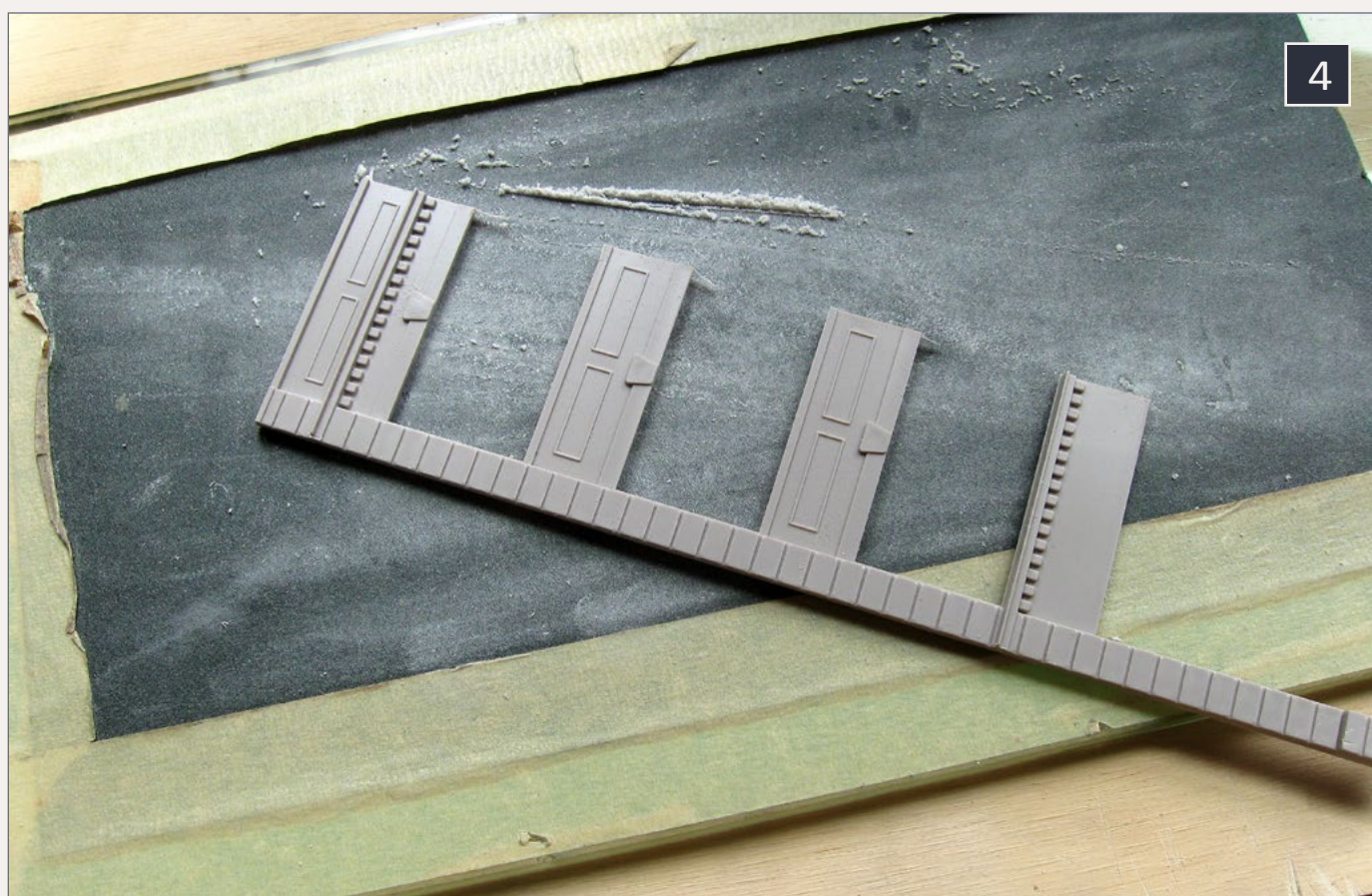

#### **4: True them up on a homemade sanding plate.**



## Haas Warehouse

Heritage Furniture was the first to get cut up and reassembled. I needed to make one wall longer with a piece cut from a wall that was too long. Cutting a line with a hobby knife and then snapping works great on styrene, but it won't work on plastic kit walls, so these were carefully cut with a hobby saw and then a little sandpaper to get rid of any plastic fuzz. I use 220 waterproof sandpaper taped to a piece of plate glass for a flat and true edge.

With the windows fitted, but not glued, the walls were joined on a quickly-made jig to keep everything square. Though you can't see them, pieces of .040" styrene strip run across the seams on the back or inside to keep them together no matter what. These were added after the dried wall was turned over.

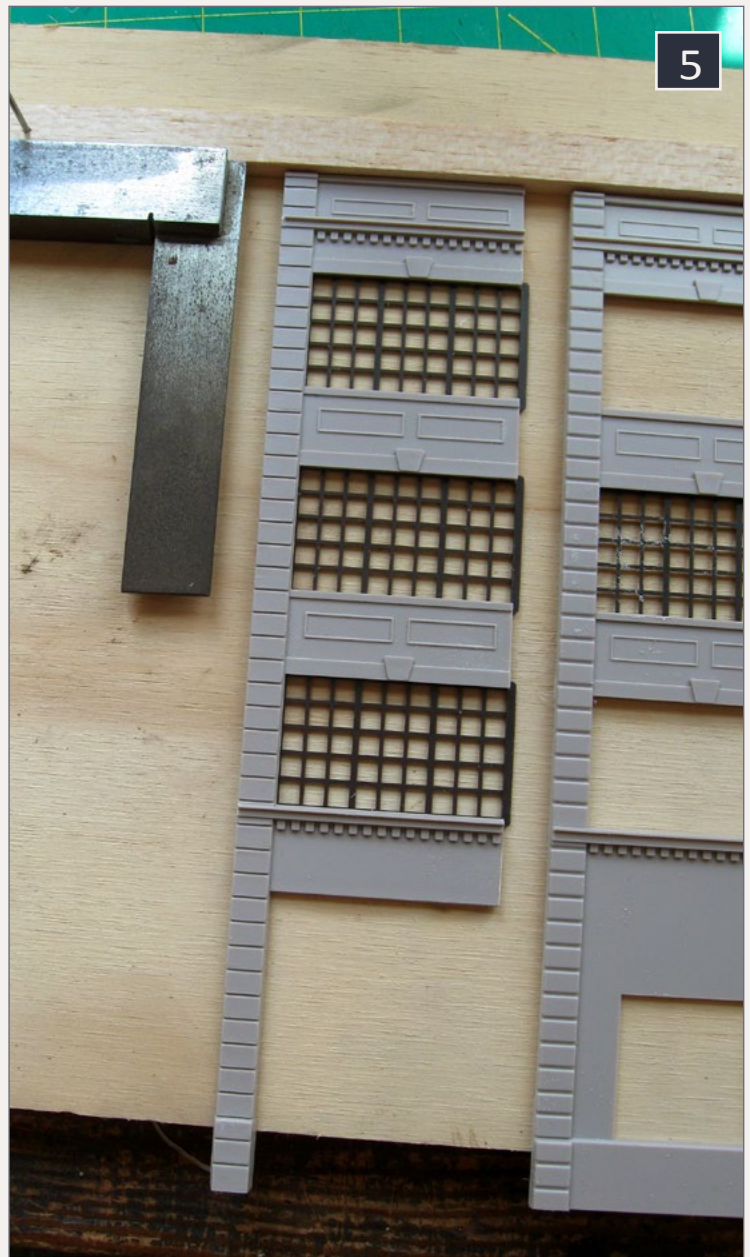

**5: A homemade jig will keep things square as you cement the wall to the rest. Don't cement the windows in, but place them in the opening to make sure they'll all fit later.**

[... On to next page of text →](#)



contents



index



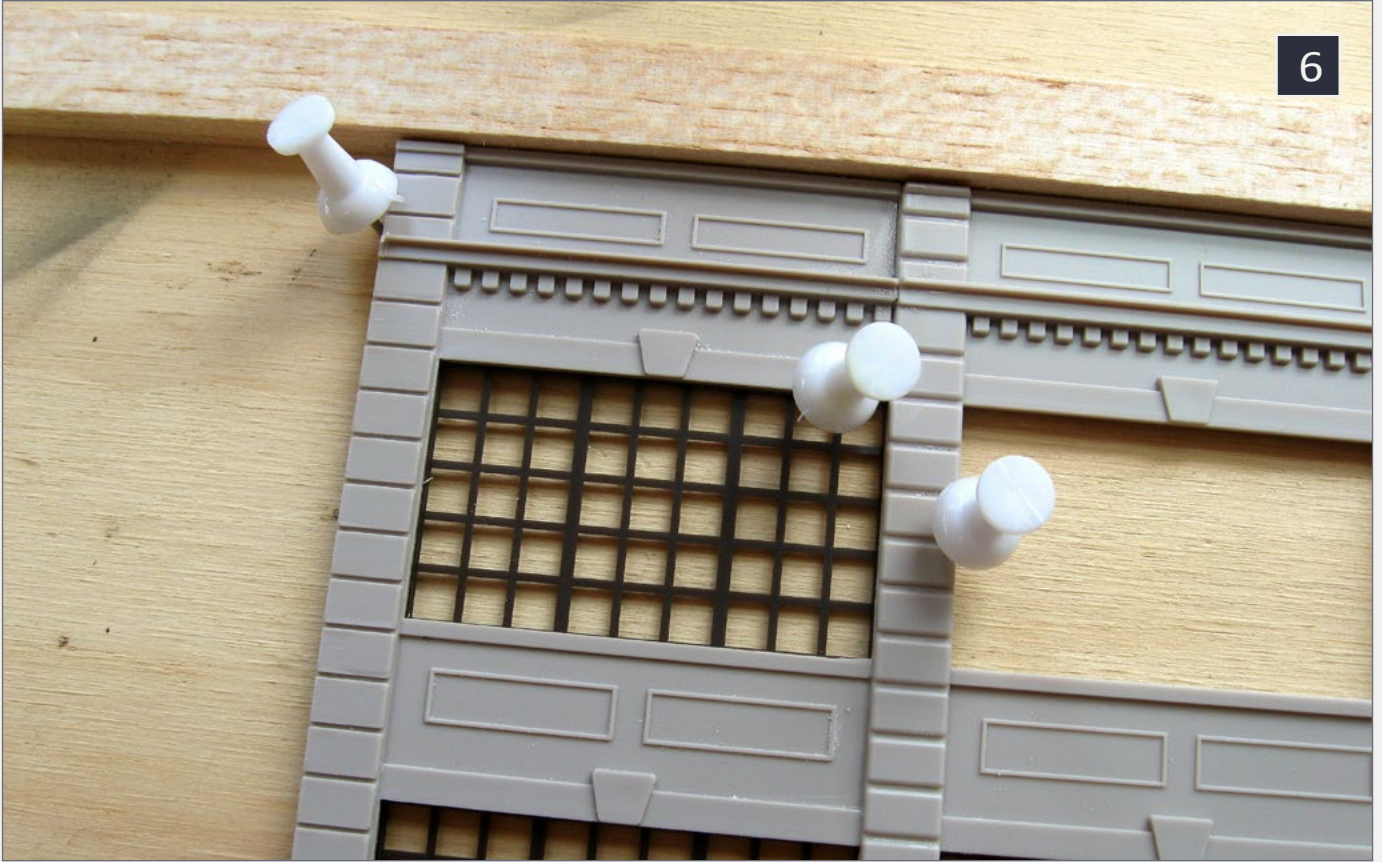

**6: Push pins hold it together while I add cement. Pushing the parts together as it sets will eliminate most gaps. Any plastic that squeezes out is easily removed after it has thoroughly dried. Use a hobby knife.**



**7: My trusty (and rusty) old magnetic jig keeps walls square as cement dries.**



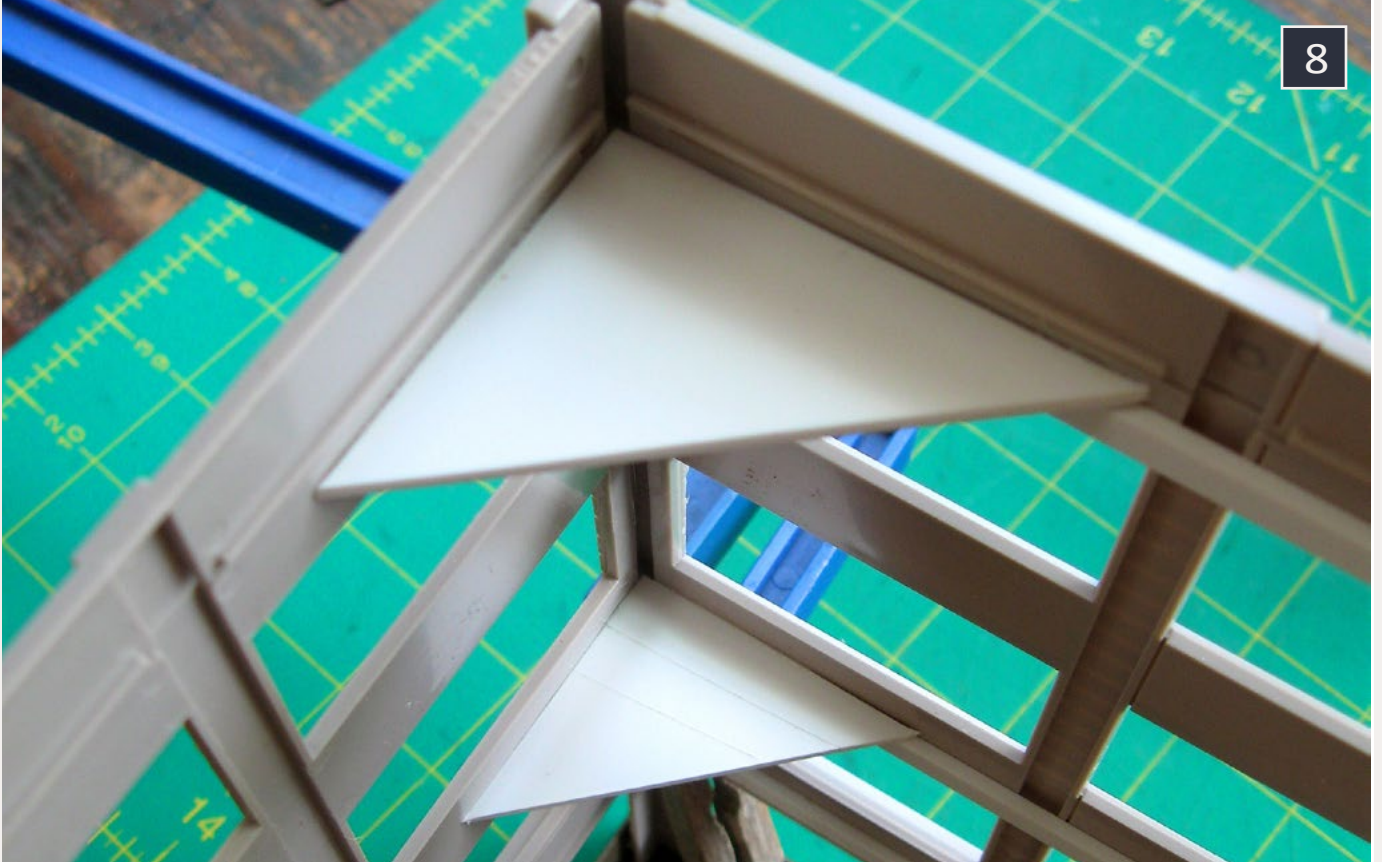

**8: Corner braces make sure it stays square.**

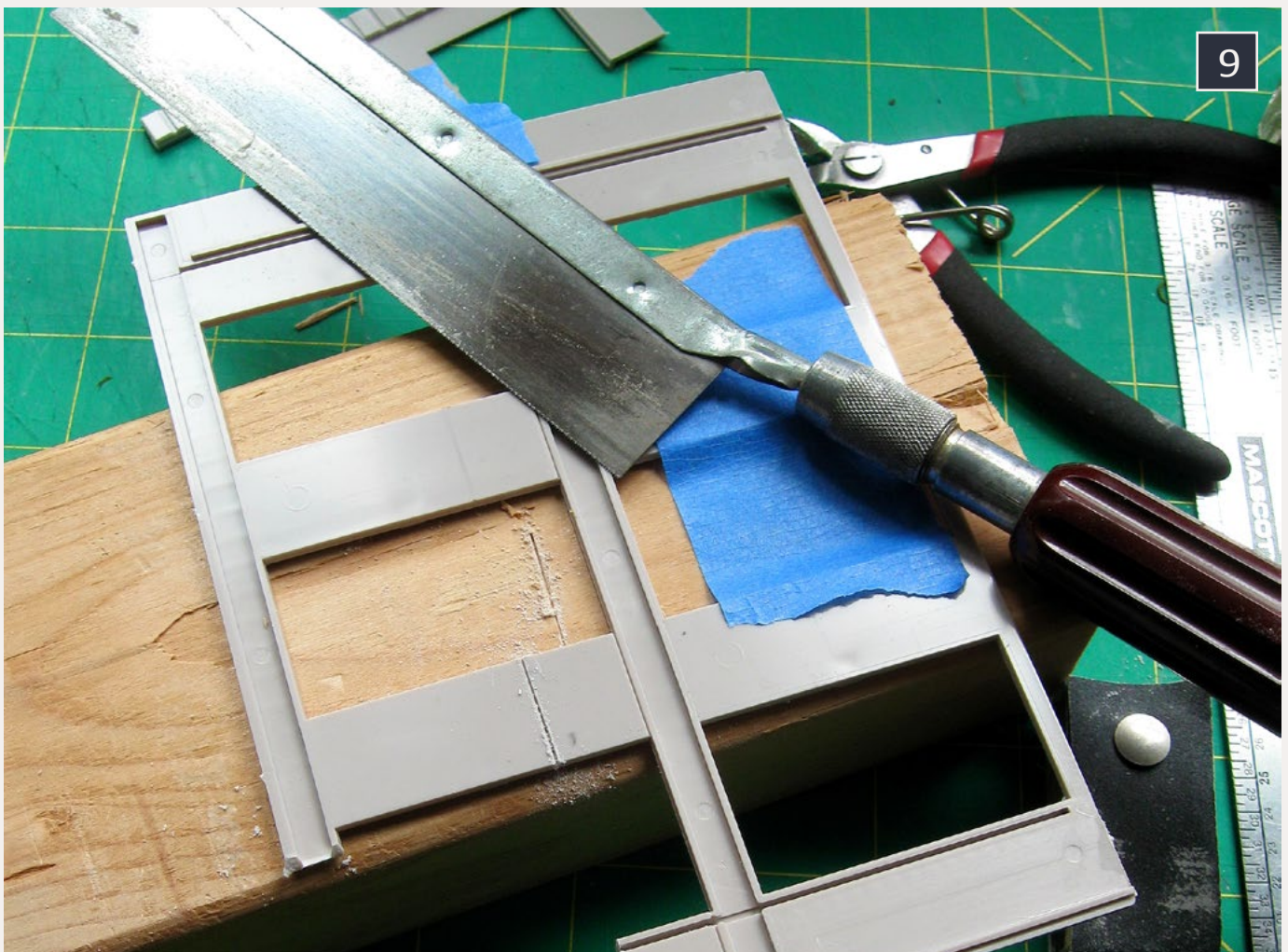

**9: The rear wall was cut from behind.**



contents



index



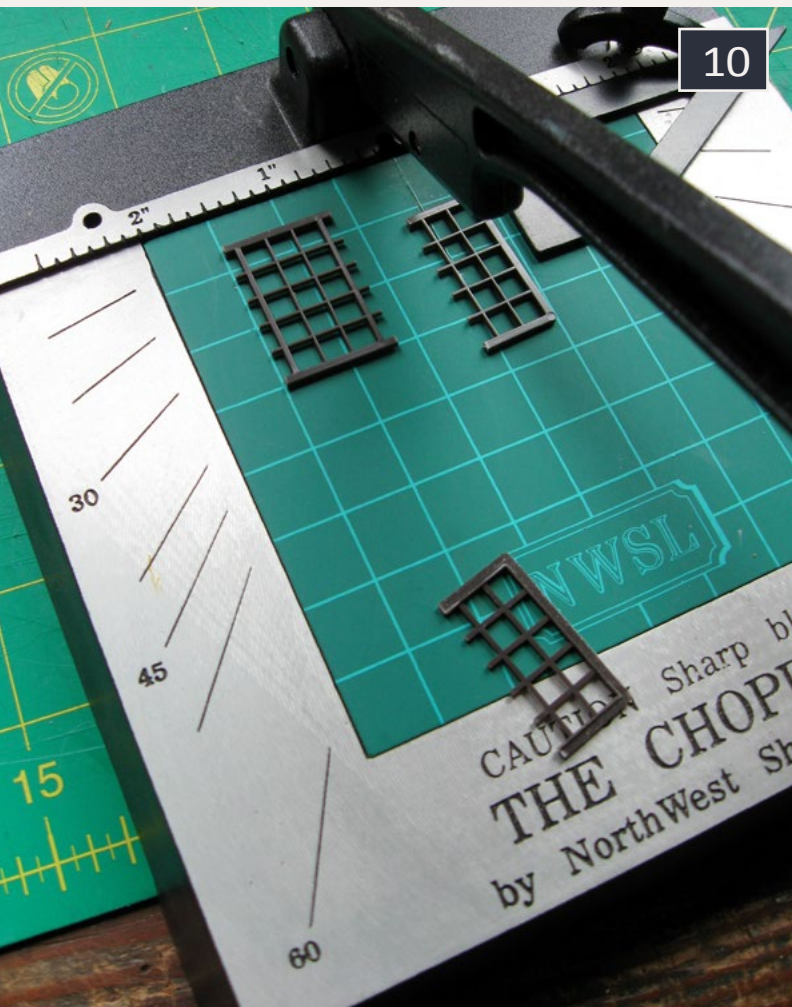

## 10: The Chopper-shortened windows.

big piece of styrene cemented to make the outside wall. After scribing these big pieces of plain .040" styrene, I snap them by putting them in a vise with the scribe just above. Works great. Neither of these walls is visible on the layout and the back one is where that awkward joint is. You can see the long piece of styrene in one of the construction photos. The blank wall is against an edge of the layout that is supposed to look, diorama-style, like the city was sliced down the middle so you could better see it.

Interior braces and light baffles were added, plus a flat roof and it was done, ready for some paint. Since this is supposed to be a concrete building it was painted with Polly-S Concrete.

[← back to previous page of text ...](#)

Since this piece was cut from the loading dock wall, I had to fill the open area with styrene.

The now-shortened side wall was trimmed flush and cemented to the new front wall using a trusty magnetic jig I got from Micro-Mark years ago [micromark.com/magnetic-gluing-jig-10-1and4-inch-square,7038.html](http://micromark.com/magnetic-gluing-jig-10-1and4-inch-square,7038.html). It's almost impossible

to kitbash without something similar. The back wall was cut down to fit the back of the triangular space and a



The windows were painted separately and added later. A few had to be cut down so I used a Northwest Short Line Chopper [nwsl.com](http://nwsl.com) for this. Again the Number One rule in kit bashing is “keep everything square” so it all fits tightly and joints are nearly invisible. Notice how many aids I use to accomplish this, from painters tape and thumbtacks to homemade jigs and metal squares.

## Mission Furniture

Next came the Merchant’s Row III kit. Using a section of the long back wall, I marked off my loading bays, then cut them out with a hobby knife, sanding the edges flat. Cutting kits with a hobby knife takes time, so be patient. I cemented strips of .040" styrene against the cut edges to represent the concrete beams and columns. I gave the columns’ sides with more styrene.

Have I mentioned I use Tester’s liquid Plastic Cement for most joints because it is not too quick to set up? You can actually

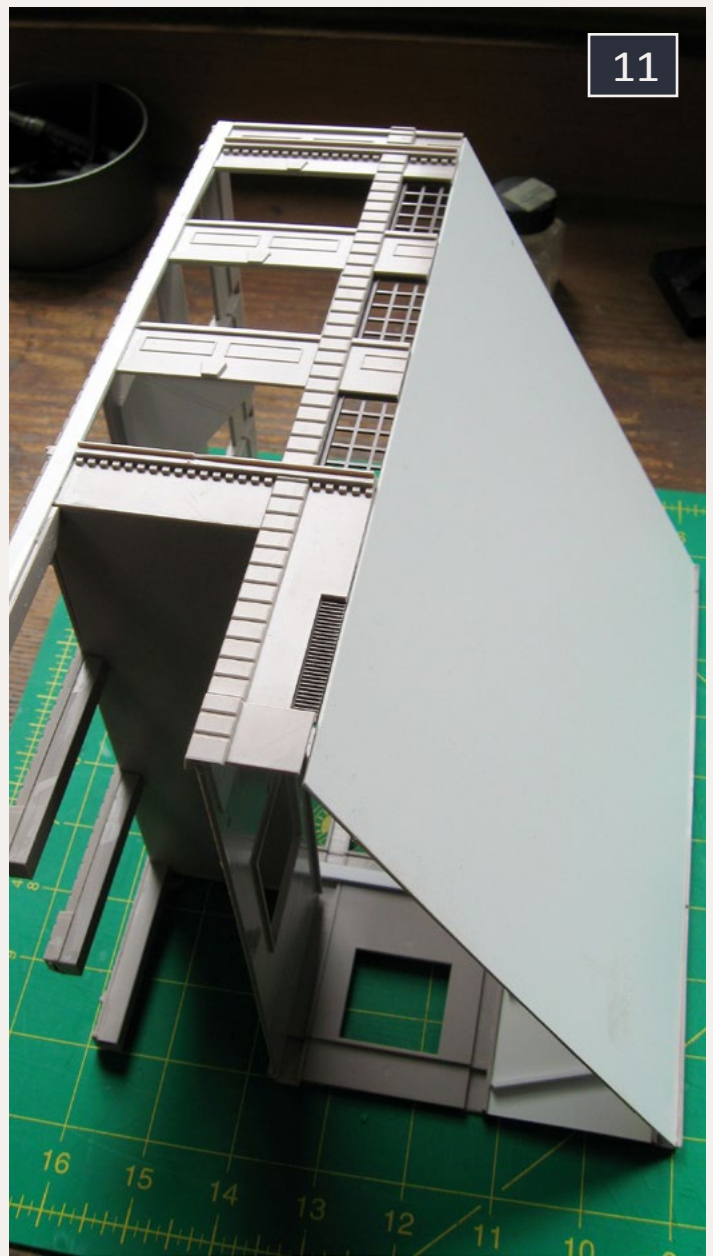

**11: Here’s the rear wall installed with a strip of styrene hiding an awkward joint. The final wall faces out from the layout, so it is made of plain styrene and was painted to match the rest of the building.**



contents



index

push pieces together, squeezing out a little plastic that is easily removed later. This makes a super tight and secure joint. If I need things to set up quickly I switch to Ambroid ProWeld “plastic welder” which is exactly what it does, quickly.

Once again the walls went into the squaring jig and were cemented together. Before adding the roof, I made the interior loading docks and a few interior walls of plain styrene. The building was painted with Floquil ATSF Mineral Red, and later grouted with spackle carefully rubbed on, then lightly rubbed off, so just enough sticks inside the cracks. It is possible to remove the dry paint if you rub or push too hard. Weathering washes were added later, as were those little Grandt Line



**12: The cutout with styrene columns and beam for the loading docks on Merchant's Row III.**





**13: Here it is mounted on top of its raised foundation and loading dock. Note the added cornice on the parapet wall above the roof.**

nut-bolts for earthquake braces, always necessary in LA. I weather with very, very, dilute mixtures of water and Polly-S Weathered Black and I weather the nut-bolt details with rust-colored paint and chalks.

The windows were painted and added, and the finishing touches were the corner protectors on the concrete columns, made of styrene angle and painted bright yellow. It's a nice touch since it's pretty dark in that little model alley and these really stand out (and they were on the real Mission Furniture docks and many others).

Another finishing touch not to be missed is trash. It collects between rails and especially inside covered docks. And, before





they passed tough littering ordinances in California, it's amazing how much trash floated around the city in the 1950s. I cut up pieces of paper and sprinkled them about, gluing them down with a 50/50 diluted white cement. I even pulverize pieces of glass and scatter it around to represent all the broken bottles. If you don't believe me about all the trash, look at period photos.



**14: Pacific Electric 1326, equipped with trolley poles to activate street signals, digs deep into Haas Warehouse to find its boxcar.**





**15: Here's where the two kitbashed buildings fit. The backdrop actually ends just behind the Haas Warehouse so I can reach things on this side of the layout. For photos I can hold up a temporary backdrop that sort of does the job. That's an old Ulrich tractor crossing the tracks and it still looks pretty good for its age. Los Angeles City Hall is in the background.**

## Operating

Switching these two docks is more fun than I expected. Even my grandkids like to sit on their stools and watch the boxcars pushed into these tight spots, where they seem to disappear, and then are pulled out later. To do this, I have a magnetic coupling ramp at the start of these sidings so I can delay-uncouple the cars before pushing them in. It's just like I remember watching years ago in downtown Los Angeles. "Pull the pin" and push it in.



[... On to next page of article →](#)



contents



index





**16: Warning sign – They're not kidding – it's a tight fit. It's from Santa Fe Modelers and was called the "Santa Fe Standard Roadway Sign decals" made by Microscale in 1992, but is currently unavailable.**





17: The wide open loading docks of Mission Furniture, with corners protected by angle painted bright yellow.

Advertisement

*It's not just a model,  
it's a piece of history.*



80+ HO Prototype Craftsman Kits  
400+ HO Pewter Castings  
200+ Styles of Shingles in N, HO, and O



**Bollinger Edgerly  
Scale Trains**

[www.besttrains.com](http://www.besttrains.com)

91,000 have seen this  
MRH video - have you?



**Watch the  
video now**



Email



Phone



contents



index



## Letter Your trucks!

The first thing my son did when he bought a new truck was put the name of his business on the side – Native Root Designs – in big bright letters. Most companies do, and modelers should do the same. There are some decals out there for trucks, but I really wanted to copy a couple of old photos with trucks in them, one with several lined up outside Davies Warehouse, a business I modeled, plus a panel truck that was owned by my grandfather Spangler's sheet metal business. I have a photo of the bright red Ford panel truck with my grandfather and uncle posing next to it. They were helping my dad build our house. The HO 1951 Ford panel truck by Alloy Forms was found on eBay. The Davies Truck is a real cheap model I found somewhere that is supposed to be a Ford.



**18: The bright red Ford panel truck with my grandfather and uncle posing next to it. They were helping my dad build our house.**



1:87 panel truck sides are pretty darn small, and the doors are even smaller, but I found someone up to the task. Joe Schulte at Diecast and Decals [diecastanddecals.com](http://diecastanddecals.com) makes decals for trucks, among other things. All I had to do was send him the wording (trying to keep it short) and he did the artwork and made the tiny decals.

When you are almost done with your layout, this is the fun kind of thing you can get sidetracked into. The trucks really finish their scenes. Note that my grandfather and uncle bear no resemblance to the characters outside my model of their shop, though those two guys are probably my favorite HO figures. I believe they were made by Merten, a set called “Chubby Groups” [walthers.com/exec/productinfo/447-2400](http://walthers.com/exec/productinfo/447-2400). Also note that I have a bit more detailing to do on both trucks, especially the Ford panel, and still have several decals in case I want to expand the fleet. ■



**19: My bright red Ford panel truck inspired by the photo of my grandfather and uncle.**



contents



index





Bob Smaus retired from garden writing for the Los Angeles Times, located but a few blocks from his favorite switching area near Alameda and 2nd. He moved to rural Kingston, WA so he could take on an even bigger garden of his own, covering part of their 10 acres. Bob has also written dozens of modeling articles for modeling magazines. He continues to model when it's too dark to garden.

 **Reader Feedback**  
(click here) 

Advertisement



find  
**TREE  
KITS**  
and  
**REAL  
CEDAR  
TRUNKS**  
at

Coastmans



**Click Here**

40,000 have seen this  
MRH video - *have you?*



**Watch the  
video now**



MRH  Feb 2013  
**Email**

  
**Phone**

  
contents

  
index



# Bowser

## EXECUTIVE LINE

HO Scale

New Products - See our web site for details



ALCo Century C-430

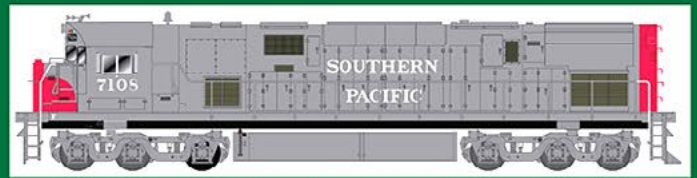

ALCo Century C-628

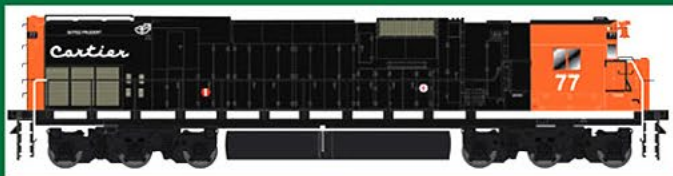

ALCo Century C-636



U-25B

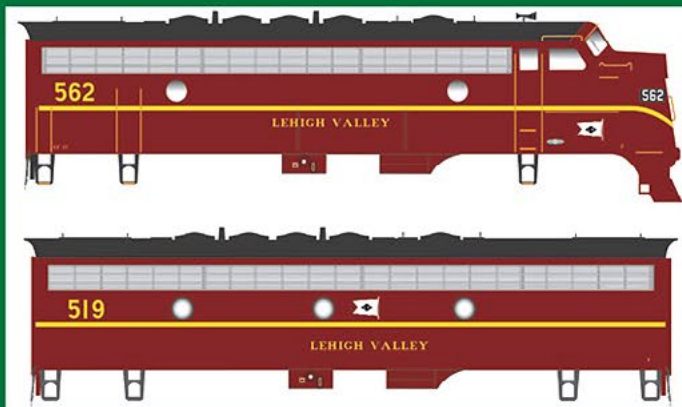

F Units

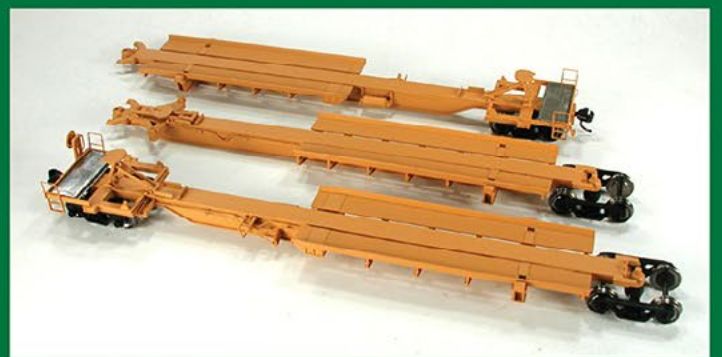

3 & 5 Unit Spine Cars

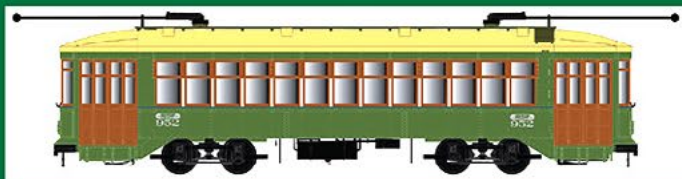

New Orleans Streetcars



53' Roadrailers



G-39 Ore Jenny



Baldwin S-8 & S-12 Switcher

70 Ton 2 Bay Covered Hoppers



GLa 2 Bay Hoppers



Click here to check out the details for these and other great Bowser products!





# YOU DON'T HAVE TO BUILD IT...

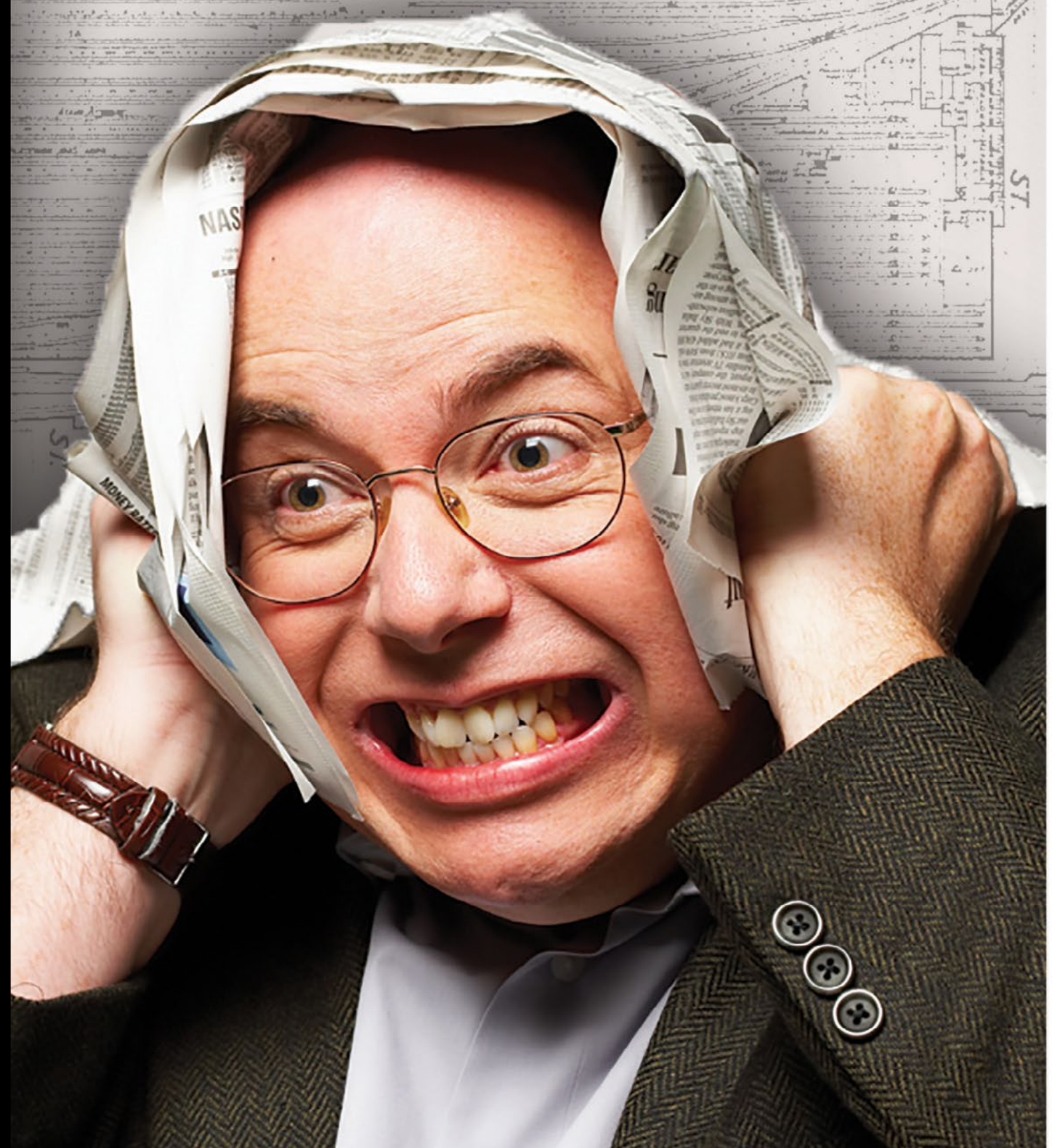



# YOU GET TO BUILD IT!

With track building tools and supplies from...

## **FAST TRACKS!**

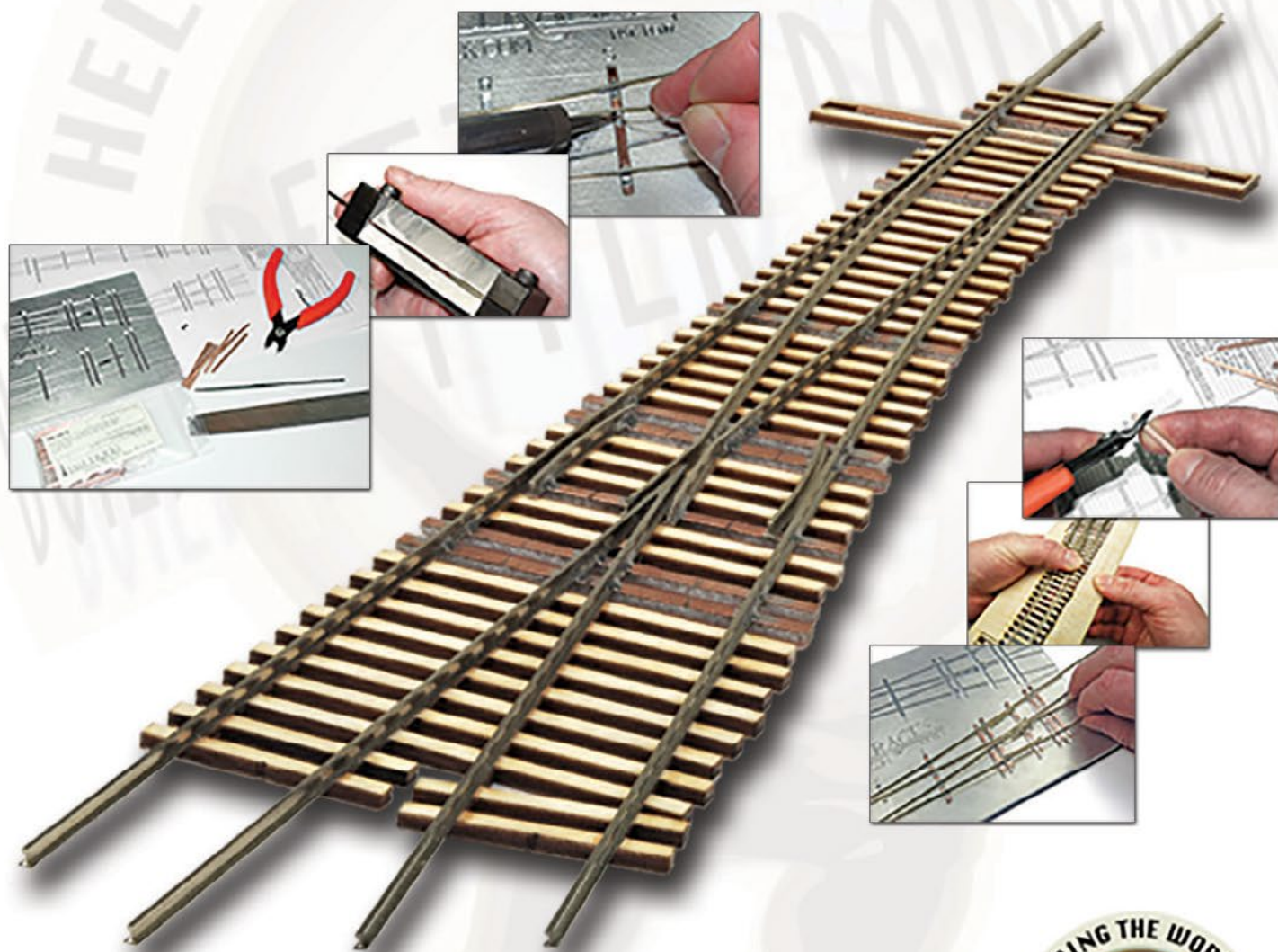

Visit [handlaidtrack.com](http://handlaidtrack.com) and start today.



Email



Phone



contents



index



# Modeling 21st Century Commuter rail service



– John Drye  
Model Photos by the author



Increasing operating  
variety on your  
model railroad ...

1: A VRE commuter train passes a NS local between Alexandria and Manassas, VA. Adding 21st century commuter rail operations to a layout begins with acquiring the appropriate equipment.

**A**dding commuter rail traffic can increase operating variety on a model railroad. Commuter trains usually use the same rails as freight service, adding interest and providing dispatching challenges without the need for additional trackage.

This article describes how to utilize recent N scale releases by from Kato, Athearn, Wheels of Time, and others to add this service to your modern model railroad.



# Prototype Operations

Environmentally conscious governments have added commuter rail as a commuting option in and near cities all across the US. One does not have to model New York or Chicago to include commuter railroading, as the service exists in cities as diverse as Albuquerque, NM and Nashville, TN. Urban scenery is not required either, as commuter rails go well into the suburbs, often 50 or more miles from the city center.

Size of service is as varied as the different cities served; with some locations operating half a dozen trains in the morning and afternoon, and the largest well into the hundreds. For a layout focused on freight operations, adding commuter service representing a smaller city can be achieved with a few locomotives and cars and maybe a little infrastructure.

A great example of such an operation is the New Mexico Rail Runner Express (NMRX). The Rail Runner serves Albuquerque and the surrounding area on trackage rights purchased from BNSF. The system runs round trips from Albuquerque 30 miles north to Santa Fe; from Albuquerque to Belen (20 miles south of the city) and from Santa Fe to Belen. Equipment includes nine MP36PH-3C locomotives and about 20 bi-level Bombardier coaches, including nine cab cars.

NMRX operates about a dozen trains weekdays, mostly during morning and evening rush hour, with additional trains on weekends and for special events. Trains operate push-pull with no need for turning trains. The locomotives always face south. Most commuter railroads share this scheme, which helps make model operation easy to implement.

Another “small city” commuter operation is Utah’s FrontRunner, which connects the Ogden, Salt Lake City, and



contents



index

Provo metropolitan areas. FrontRunner operates on a portion of the right-of-way of the Utah Central Railroad, built in 1869 to connect the first transcontinental railroad with Salt Lake City. Most of the single-track railroad is separate from the UP, except for about six miles of shared track north of Ogden. Of course, your version could include more shared trackage. The railroad has operated MP36PH-3C locomotives and hi-level Bombardier cab cars and coaches, supplemented by additional Comet Coaches acquired used from New Jersey Transit.

A larger example of commuter rail operations is the former Southern Pacific commuter service in and around San Francisco. SP once operated over the same rails, with Fairbanks Morse locomotives and a variety of classic equipment. Today,



**2: Both running in reverse, a pair of VRE consists demonstrate a variety of equipment and paint schemes, available from Wheels of Time and Kato.**



3



### 3: A prototype VRE train departs Alexandria station on rails shared with Amtrak, CSX and NS.

Maryland Area Regional Commuter (MARC), and Virginia Rail express (VRE).

MARC operates on some of the oldest right-of-way in the country, including from Baltimore to Ellicott City, MD. The former Baltimore and Ohio trackage supports service from Baltimore to Washington on three lines connecting the two cities with stations as far west as Harper’s Ferry, MD. One of the lines shares northeast corridor rails with AMTRAK and uses electric locomotives. The other two use diesels and a variety of conventional and bi-level equipment.

VRE provides service from downtown Washington to the Virginia suburbs. There are two lines – one south to

Caltrain operates almost 100 trains a day with a mixture of Bombardier and Nippon coaches, and EMD and MPI locomotives. Some of the coaches were purchased from the Seattle “Sounder” fleet, an example of the prototype’s exchange of equipment as needs vary.

### A “local” example

There are two fleets of commuter rail operations in my hometown area of Washington DC;



contents



index

Fredericksburg and another west (RR south) to Manassas. This service operates on Norfolk Southern and CSX freight lines and also shares the rails with Amtrak. VRE's line from Washington to Manassas runs less than a mile from the layout in my basement. It is easy to study in order to learn how to represent modern commuter operations, since a half-a-dozen train pass by each morning and afternoon.

Today's VRE is an easy example to implement, since all of the equipment currently used is readily available in model form. Kato recently released sets of VRE Nippon Sharyo Bi-Level commuter cars and both MP36 and F40PH locomotives. Cars and motive power are also available separately. In addition to the Nippon Sharyo cars, VRE still operates former Chicago and Northwestern (Chicago Metra) Pullman-Standard bi-level cars. These are available from Wheels of Time and Con-Cor.

4



**4: Like most commuter trains, VRE consists include a single locomotive and up to six bi-level cars. These cars currently are available from Kato in VRE and Chicago Metra livery.**





**5: A VRE train departs Backlick Road station on bi-directional NS trackage, running wrong-way to occupy the platform.**

## **Commuter Traffic Operations**

Like many commuter rail systems, VRE has used, and continues to use, a variety of passenger equipment. VRE began with conventional coaches and previously leased full trainsets from the Seattle “Sounder” fleet. The road also obtained bi-level cars from Chicago Metra and most recently has purchased the Nippon Sharya cars. At any one time VRE has used several varieties of trainsets.

VRE trainsets usually consist of a single locomotive (currently an MP35PH, but formerly a variety of EMD units including F40PH-2s and GP40-H2s) and from four to seven cars including one cab car. The locomotives always face south. Exceptions exist, and sometimes trains include more than one



locomotive or cab car. Usually the cars are of the same type, except when a Nippon cab car is used at the north end of a former-Metra consist.

This variety in equipment can be suggested by the use of two different trainsets in a model operating system. The prototype VRE currently uses 13 trainsets to operate 30 numbered trains on the road's two lines. Two of the trainsets make a pair of round trips into the city each day, and the others one apiece.

Adding this commuter activity doesn't necessarily mean adding a dozen trainsets to your inventory. On a loop layout, the same trainset can be run several times to represent the repeated inbound traffic. With a point-to-point design, the trainset can be run back and forth to represent trains that make more than one round trip.



**6: An Amtrak train shares the afternoon rush hour with VRE, loading passengers at Alexandria station.**





**7: VRE V65 approaches one of VREs “bus stop” stations. These simple shelters provide intermediate stops between the classic stations at the ends of the VRE lines in Manassas and Fredericksburg.**

The NS trackage used by VRE is a secondary main line, but still boasts fully-signaled double track. NS runs several locals over this trackage, plus short unit trains of gravel and ethanol to destinations right in the middle of the commuter run. Keeping this traffic clear of the commuters, plus the Amtrak trains that also use this track, creates operational challenges for a model railroad.

The VRE runs south from Washington over the former Richmond, Fredericksburg and Potomac (RF&P) trackage, now operated by CSX. This is a busy portion of the road’s main route





to Florida. CSX does try to move some trains out of the way at rush hour, but hotshots like the orange juice train (a solid string of expedited reefers from Florida to New York) and intermodal trains get shuffled in with the commuters. More operating fun!

Both lines use some great historic stations along the way. Trains to both Manassas and Fredericksburg stop at Alexandria Union Station, built in 1905 and extensively refurbished at the end of the century. At the other end of the Fredericksburg Line is a former RF&P station built in 1910, now partly occupied by a German restaurant. The former Southern RR station, built in 1914, serves as a stop for VRE and three Amtrak trains in Manassas. Coincidentally, the Manassas station serves as the cover for a 1972 record album by Steven Stills.

8



**8: A VRE consist passes a CSX single-stack train south of Quantico. Fitting commuter operations into other high-priority traffic can provide an operating challenge on a modern layout. (The single-stacks are required because of clearances in the Washington area).**





**9: VRE V53 carries passengers home from work. Readily-available equipment can add commuter operation to any modern layout.**

In addition to these classic brick buildings, VRE trains also stop at 15 other stations, mostly modern “bus stop” type structures consisting of a concrete platform and a canopy. A few of these are more significant edifices, including the VRE/Amtrak station in Quantico.

## **Modeling Options**

As previously mentioned, Kato has released Motive Power International MP36PH locomotives and Nippon Sharyo-built Gallery Bi-Level car sets in several road names, including VRE. Wheels of Time offers the former-Metra cars in VRE and Caltrain paint, as well as the original CNW and SP schemes. Con-Cor also offers both a smooth-side and corrugated version of these cars in a variety of schemes. Some of the mostly-silver



version Con-Cor cars would be a good starting point for a free-lanced commuter railroad.

Athearn offered sets of F59PHI locomotives and Bombardier cars for many of the railroads that operated this equipment, including New Mexico Rail Runner, Utah Front Runner and the Seattle Sounder. Some road names remain out of production, but occasionally can be found at shows or auctions. Others have recently been re-released and remain available, including Cal Train, West Coast Express (in Vancouver, BC), and Metrolink. “Leasing” these cars, as VRE did, is an easy way to add commuter rail to your operations. All VRE did was to add a blue decal over the Sounder Logo.

The classic brick stations still used by VRE and other commuter railroads can be easily represented (if they are not already on the layout) by a suitable structure from Atlas, Walthers or other supplier. Kato offers a nice kit of the modern “bus stop” type station. Not particularly attractive, they are nonetheless a key element of the frequent-stop operation of modern systems and supplement the older stations.

Commuter rail is a fascinating element of modern railroad operation. An investment of a few trainsets of varied equipment and perhaps a few commuter stations can add this element to most any modern layout, providing a new challenge to your dispatchers and operators.





## Convention Information

You can visit the Virginia Rail Express at the “Capitol Limited” N Scale East Convention in Chantilly, VA this August. Hosted by Northern Virginia NTRAK, the Convention celebrates 40 years of NTRAK Modular Railroading. The convention will offer a tour of the VRE shops near Chantilly and provide Railfan maps and info to attendees.

More information at: [bigtrainlayout.org](http://bigtrainlayout.org). ■



**John Drye is our N-scale editor and columnist. John Drye has been model railroading since receiving the traditional Lionel set at age 8. John is currently building two layouts: an N scale switching module based on the modern Norfolk Southern, and a basement layout based on the transition-era Pennsylvania Railroad.**

**When not doing trains, John works as a contractor for the US Navy and volunteers for the American Red Cross and Operation Lifesaver.**



contents



index





# Journey to Allagash Country – Part 2

– **Mike Confalone**

Model photos by the author



**Reader  
Feedback**  
(click here)



contents



index

# Allagash after dark. ...

## Part 2

**T**emperatures were dropping fast as we left the motel. Just as we were getting ready to hop in the car, we heard a horn coming from town. We raced down to the tracks and found a pair of green Geeps parked on the passing siding with a train. This was M2, the local out of Madrid, which worked down to the old Androscoggin Paper mill at East Dixfield. It also worked consignees at Weld and Carthage along the way. The crew headed over to the store, so we set up the cameras and got the flashbulbs ready. Joe worked the cameras as I flashed off seven or eight #2 flashbulbs on the flanks of the Geeps. I also was able to flash some light onto the bell tower of the Weld Congregational Church (18).

After a few minutes, the crew returned with coffee in hand. They were a friendly bunch of guys, and explained that they would be in town for just a little while. They had only one empty boxcar to pick up from Osgood's. After that, they would

18



**18: Local M2, with Geeps 500 and 509 parked on the passing track at Weld while the crew fetches coffee from the store.**





## 19a-19b: M2 steps across Route 156 in Weld. They will switch out Osgood's.

head south for the paper mill. The brakeman mentioned that they had an opposing train (DA2 – empty “Lumberjack”) that they would have to deal with. They’d make a run for the mill, but they’d likely meet at Carthage. We got another shot of the 500 and 509 paused on Route 156 (19), and then a moody view of the Geeps grabbing an empty grain boxcar from the siding alongside the bagged feed shed at Osgood’s (20). After this move, the M2 crew got their horses in motion and accelerated out of town. We decided to go grab a soda at the store and hang out in the car with the tunes. We weren’t up for chasing in the dark, and we wanted to be in position for DA2, since that AGE unit would be on the point.

An hour passed and still no DA2. It was after 9 p.m. We were starting to get discouraged, but decided to tough it out.

[... On to next page of text →](#)



contents



index







contents



index

[← back to previous page of text ...](#)

Suddenly, the flashers started going. Yes! Soon AGE RS11 895 came into view and stepped across the crossing. The crew had to set out a couple of empty pulpwood flats on the team track, which was south of the crossing in the pitch black. We had just a minute to get set up and rip off a couple of bulbs on the grain store and on the nose of the 895 (21). A quick word with the crew revealed that they would make it into Madrid unopposed, since MB1 (Madrid-Bethel), usually a night train, was set back eight hours. That would put him through Weld at 3 a.m. We weren't sticking around for that. It wasn't long before DA2 thundered out of town. It appeared that day one had come to an end. We crawled back to the motel and crashed...hard.



**20: The 500 couples onto an empty CP Rail boxcar spotted on the grain shed siding.**





**21: DA2, the empty “Lumberjack” pauses at Weld to set out empty pulpwood racks. Atlantic Great Eastern Alco RS11 895 is in the lead.**

April 20th dawned cold with what appeared to be a mostly clear sky. There was frost everywhere. We got up before the sun, and decided to get trackside as soon as possible, just in case MB1 was late getting out of Madrid. We headed toward the crossing by the farmhouse near Milepost 7. We got there and were amazed to find a train canned just north of the crossing. It looked like a “Lumberjack,” with a string of loaded pulpwood on the head-pin. Power was M420 205 and C425 250. After just a few minutes, a taxi pulled up, and out popped the relief crew. It turned out that this was actually Second AD1, a tonnage-relieving second section of yesterday’s “Lumberjack!” We didn’t have long. The sun was beginning to rise in the eastern sky, glinting off the rails and silhouetting the farm house on

[... On to next page of text →](#)



contents



index







RAILROAD  
CROSSING  
ROAD



contents



index

[← back to previous page of text ...](#)

the hill. We set up the cameras, and Joe did the honors with the flash bulbs. Footing was slippery, with frost on the grass of the embankment. He nearly fell into the river below! Despite the limited time and tight conditions, we nailed what might just be THE shot of the entire trip (22). We quickly got out of the way as the crew got onboard. The Alcos notched up, nearly stalling on the frost-covered rails as they pulled their tonnage up the 1.1% grade. What a sound!

After that, we were faced with a decision. Our original plan was to spend the day on the Kennebec Sub. around New Sharon. But where was MB1? We probably would have heard it blowing through Weld if it had passed in the wee hours of the morning. Something told us to stay put. We crossed the river and walked down the track of the White Mountain Branch for a bit until we found a spot. By now, the sun had come up and

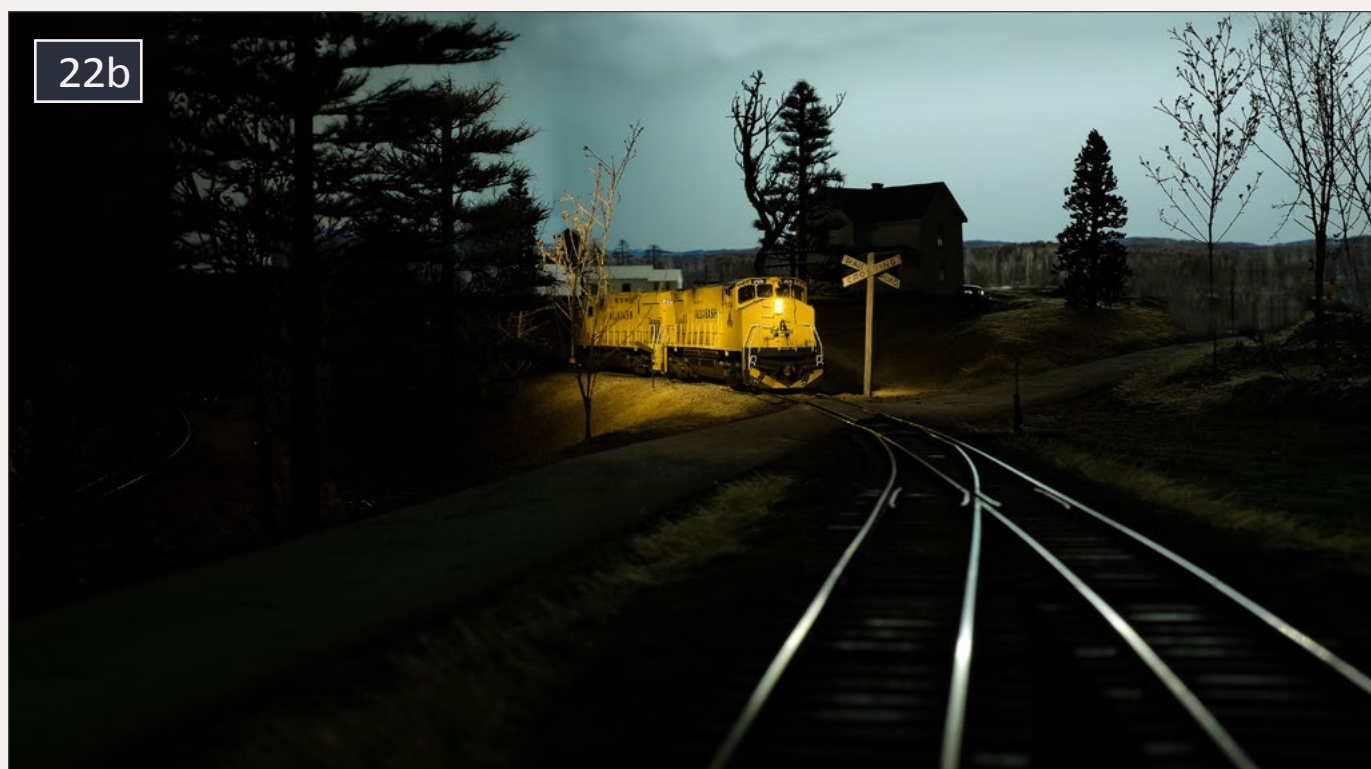

**22: Second AD1 awaits a new crew at the crossing at Milepost 7 at dawn.**





**23a-23b: An all-yellow consist of Alco and EMD power leads MB1 at Milepost 7 on the Androscoggin Sub. as the sun finally makes an appearance.**

the sky was clearing to a deep blue. And then, in the distance, a horn! Our patience was rewarded as MB1, powered by Alco C420 208, a freshly-shopped GP9 and an M420 came into view, many hours late and clearly looking to make up time. Now THIS was railroading!

There would be no chase because we had walked in. By the time we got out of the woods, the train was long gone. We knew we nailed a killer shot. Besides, it was time to head for the Kennebec Sub. We headed north to Madrid and then onto Route 4 south for the one-hour drive to New Sharon. New Sharon was an important spot on the AGR, home to a modest yard, diesel servicing facilities, and a major AGR customer, the Franklin County Feeds mill. It was also the location where the Atlantic Branch veered off toward the Maine Coast at Lincolnville.

[... On to next page of text →](#)



contents



index









contents



index



[← back to previous page of text ...](#)

The clouds increased as we drove, and by the time we reached New Sharon it was socked-in again. So much for the blue sky and sun! We arrived around 11 a.m. and found the New Sharon Switcher posed at the north end of the yard, with soot-covered Alco RS32 701 for power. We didn't have to wait long for the action to pick up as northbound Kennebec Sub Train KA2 (Kennebec Jct.-Allagash) came into view (24). On the point was another surprise – Alco C424 241. A talk with another railfan revealed that the 241 was one of two former Conrail (ex-Erie-Lackawanna) units that had gone through a rebuild program at GE-Hornell, New York, along with several other C424s that went to the Delaware & Hudson. The unit had been in service only a couple of weeks, and wore a brand-new paint design. We all agreed the new look was striking!



**24: The New Sharon Switcher pauses at the north throat of the yard at New Sharon as KA2 passes the New Sharon post office.**





## 25: Alco C424 241 passes the station sign for Atlantic Jct. as KA2 makes a setout at New Sharon yard.

KA2 had a setout for the yard so we shot the 241 at the Atlantic Junction station sign (25). A pair of GP38s trailed. We could see cars being unloaded under the shed at Franklin County Feeds. After KA2 departed for Madrid, and the switcher tied up, we crossed the tracks and grabbed lunch over at Ken & Sadie's Country Store, and waited for P1, the local down from New Portland. It wasn't long before AGR 202, running long-hood forward, crept past the old passenger station, now utilized by MOW crews (26-27). The 202 and crew didn't hang around long, and in less than an hour the abbreviated train departed for New Portland (28-30). We followed the job back to the St. Regis pulp mill, where we grabbed a couple of interesting shots as the 202 spotted a lone B&M boxcar in the pulp loading shed (31-32). After this, it was lunch in New Portland and a deadhead back to New Sharon. By the time we got back in town it was nearly dark. The 701 was making a final spot at the grain mill. We grabbed a neat shot as the setting sun popped

[... On to next page of text →](#)



contents



index



26



27



28





29



30



**26-27: Local P1, powered by GP38 202, enters the yard at New Sharon. The former station serves as a MOW depot.**

**28-30: The 202 and one-car train depart New Sharon, headed for New Portland.**



contents



index



31



32a



**31-32a-b: P1 has arrived back in New Portland and is seen switching the St. Regis pulp mill.**







**33-34: RS32 701 gives one final switch to Franklin County Feeds at New Sharon as evening arrives.**



contents



index









contents



index

[← back to previous page of text ...](#)

out for just a second (33). As darkness descended, it began to rain lightly. We pulled out the flashbulbs one last time, and lit up the 701 as the crew grabbed a coffee and a smoke inside the yard office. Off to dinner we went. When we got back, we headed down to the fuel pad and were psyched to find F7 602, just back from a trip down the Atlantic Branch, getting fueled and sanded (35). The 602, along with GP38 212, would make up the power for train NM2, a night turn job to Madrid. At this point we decided to call it a night. We drove back to Weld and hit the motel.

The next morning we awoke to more clouds. We had a little bit of time before we had to begin the long journey home, so we decided to make a side trip through Madrid to see if anything interesting was there. The same railroad cop who helped us the other day greeted us again, and tipped us off that the MX had made a pre-dawn jaunt out to White Mountain Jct. to



**35: Power for NM2 is getting fueled as the New Sharon Switcher ties up for the night.**





### 36: Former Conrail (Penn Central) RS11 7605 has loaded pulpwood in tow as it leads the Madrid Extra toward Sandy River Jct.

grab pulpwood loads. We made a mad dash over to the now-familiar farm house on the hill. We knocked on the door and obtained permission to stand in the yard to set up for a picture looking across the river. The lady said there hadn't been a train since before dawn. We waited a while, and our patience was once again rewarded as we got a great shot of the MX on the branch with the Androscoggin mainline in the foreground (36). The power was another of the Conrail cast-offs – former Penn Central Alco RS11 7605. What a way to end the trip!

As we drove back to Scranton, we reflected on what had turned out to be an incredible trip. We witnessed around a dozen trains over the two days and nights. And although the weather didn't cooperate, the Allagash certainly did. The only question was ... how soon could we get back?



**Reader  
Feedback**  
(click here)



contents



index



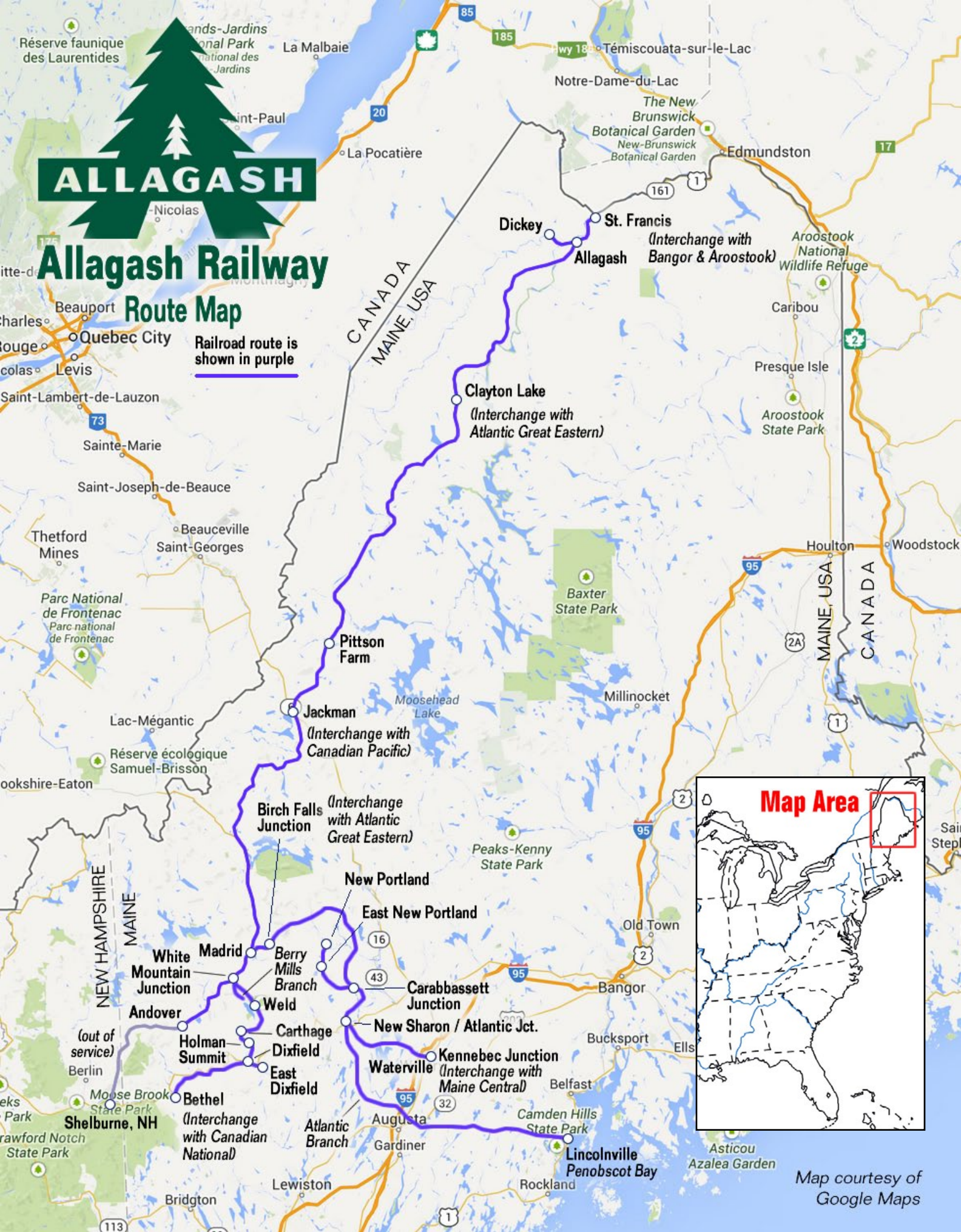

37: Route Map of the Allagash Railway (zoom in to study the details).





Mike Confalone's

# ALLAGASH STORY



## 4 volume eBook series

**Includes Video!**

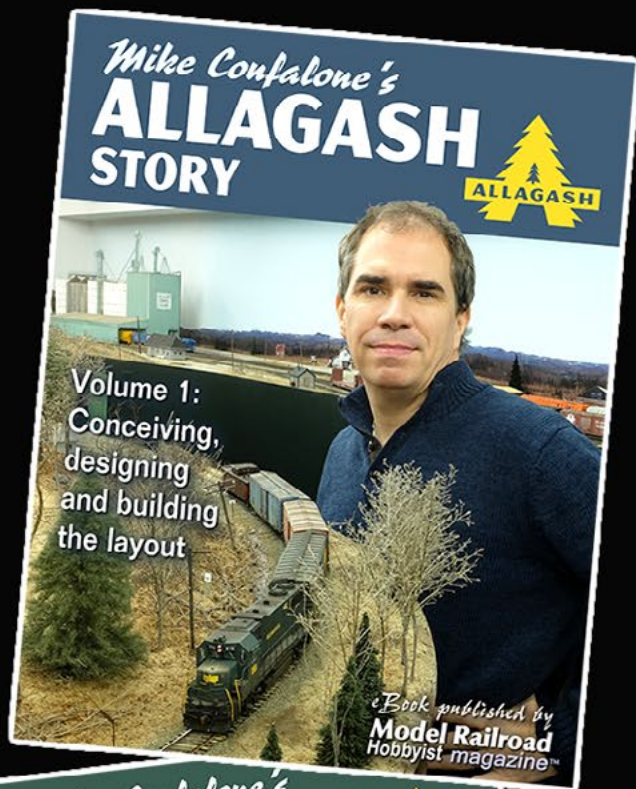

**Vol 1: Building the layout**  
Now available - \$8.99

**Vol 2: Building the roster**  
February 28th - \$8.99

**Vol 3: Planning prototype ops**  
March 28th - \$8.99

**Vol 4: Bringing the layout to life**  
April 28th - \$8.99

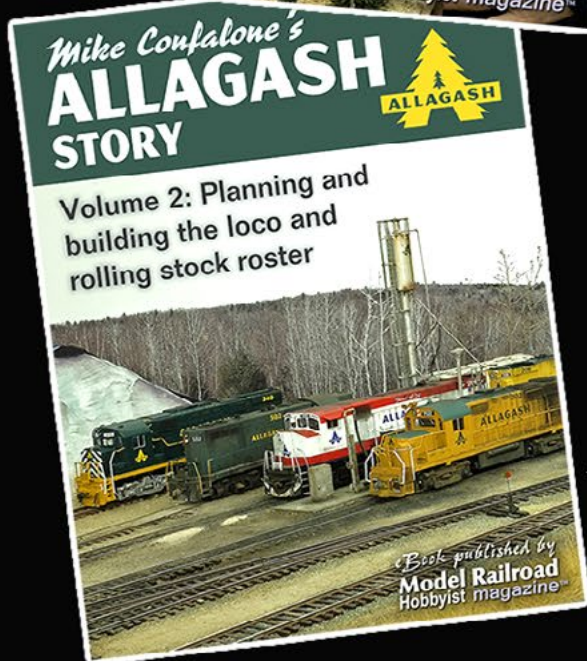

4 volume set: ~~\$35.96~~

**Special: \$29.99**

 **Order Allagash Story**

Formats: PDF - ePub - Kindle

from the  
**Model Railroad  
Hobbyist Store**



# Yes, it's a model

**Model Railroad Hobbyist's  
monthly photo album**



1: Shop workers ready the power for another run to Davidson Mines, the job locally known as "The Midnight Alice." All the crews try to avoid this trip. Thomas Smith captured this scene, all too typical for many a railroader working the night shift.

The lighting for the picture is from a NJ International twin search-light and from the shop lights. The headlights for the F unit were Photoshopped in afterwards. The headlights for the other unit were on during the photo shoot.







2: The sun is setting as the maintenance -of-way crew finishes up a long day of dumping and spreading ballast. It's time to go back to the bunk cars for a meal and some sleep, before repeating it all again tomorrow.

Rick Ritchie took the photo in his back yard on a small diorama. The spreader is a modified Walthers kit, and the hopper car and caboose are Atlas products. His picture is a great example of what can be accomplished with a well composed scene.

3: After finishing its work at the Monadnock Paper Mill, Boston & Maine Local NA-1 crosses the partially-frozen Contoocook River in Bennington, NH on its way back to Nashua on a cold day in December 1980.

Neil Schorfeld took the photo outside on a small module salvaged from a previous layout. The model closely replicates the prototype location, formerly the site of a covered bridge on the B&M Bennington Branch out of Nashua, NH.



contents



index







contents



index





### Advertisement

**Lasercut structures. Highway, storefront and billboard signs.**

**NEW KIT! HO & N scale  
Farmers Fertilizer Supply**



**WHAT'S  
NEW?**



**Our 20th year!**

**Blair Line**

MRH Feb 2013

Email



Phone

YIAM - 3



contents



index

4: It's a warm spring Saturday as UELX 15327 has been emptied and shoved out of the local dealers yard onto the siding lead. The local will pick it up early Monday morning and send it back on its way to be loaded.

Thomas Gasior took the photo of this Atlas 17,000 gallon tank car. A base coat of yellow primer was applied and then covered with hairspray along the top of the car. Black paint was applied over the hairspray and then gently washed off with warm water, leaving the yellow primer. Tar spills were made from Micro Flat and powders.





5: Local Freight no.77 pauses at the station of Noorinbee while the crew perform safe working duties in the signal box.

Darren French photographed the scene on his layout, which is a proto-freelanced N scale layout modeled on the State Government-owned Victorian Railways. The layout location is based in Gippsland, Victoria, Australia. The model was built by Ian Fletcher.

### Advertisement



## N Scale B&O I-12 Wagontop Caboose

Arriving this Summer

B&O Red  
1941-45



B&O Red  
1955-62



B&O Blue  
1965-69



B&O Chessie  
1973-83



Reserve yours today!

[www.foxvalleymodels.com](http://www.foxvalleymodels.com)

Y109 is a fully detailed Spirit Design (local Australian manufacturer) etched brass kit mounted on a LifeLike SW9/1200 mech, the gray and orange airbrushed with Badger Modelflex water based acrylics pre-mixed to suit the prototype. Black and white detail was hand brushed on with Humbrol enamels, and the model weathered with powdered artists pastels and finished with a light airbrushing of an earth wash.



Email



Phone



contents



index





Here at MRH we want to keep you up to date with the latest equipment to hit the model railroading market. This American Flyer Lines 2-4-0 comes complete with power pack, track, baggage and passenger cars. Buildings and scenery not included. Frank Weiser a.k.a driline, who started the weekend photo fun thread, posted this picture of a prewar trainset. Baby, we have come a long way since then.



**33,000 have seen this MRH video - have you?**



**Watch the video now**





# Get your photo here!

Our *Yes, it's a model* monthly photo feature presents some of the most inspiring modeling and photos from the MRH website. If you'd like to get *your modeling* in our photo feature, just start posting your photos on the MRH website, especially in the [Weekend Photo Fun thread](#) created each weekend.

Many of the photos posted show HO modeling, but we'd like to encourage modelers in other scales to post on the MRH website as well. We don't want this to just be an HO photo feature!

For info on how to post photos to our website, [see this help how-to](#). You need to be an MRH subscriber to post photos to our website, and becoming a subscriber is free, [just fill out this form here](#).

Advertisement

## Railroad Explorer Magazine

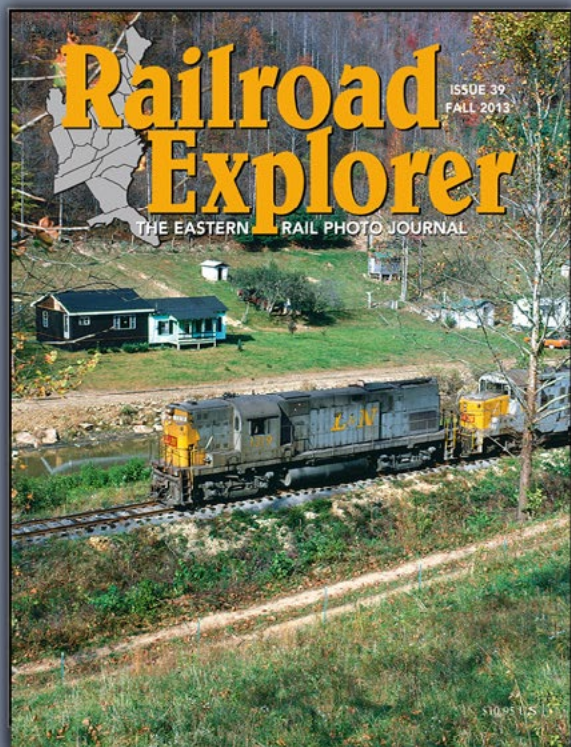

- Three, all-color issues per year.
- Exciting feature stories, spectacular photos.
- Best-in-class photo reproduction.
- Printed on heavy, glossy paper.
- Zero advertising. All content.
- Winter, Spring/Summer and Fall editions.

**Issue 39 - Fall 2013**

**On sale now**

**Subscribe Today!**

**[www.railroadexplorer.com](http://www.railroadexplorer.com)**



*Model Railroad Hobbyist's*

# Track plan database

Compiled by Bill Brillinger and the MRH staff



## Introduction to the reader-created track plan database on the MRH website

One of our hopes when launching the *Model Railroad Hobbyist* website back in the summer of 2008 was that we would spark a new level of information-sharing among model railroaders. Thanks to pro-active subscribers like Bill Brillinger, we're seeing this hope be realized in ways we only dreamed about back in 2008.

Bill Brillinger has spearheaded compiling a trackplan database, which as of this writing has well over 100 track plans. We're sampling a few of the more interesting track track plans that have been posted here. To view the entire thread and all the track plans, see this link: [mrhmag.com/track-plan-database](http://mrhmag.com/track-plan-database).

Subscribers are to use the above thread to post the track plans. If you want to discuss one of the track plans, then use this link: [mrhmag.com/track-plan-database-discussion](http://mrhmag.com/track-plan-database-discussion)

Over the next few pages, we present examples of what you'll find on this fascinating and ever-growing MRH founm thread. 





1a

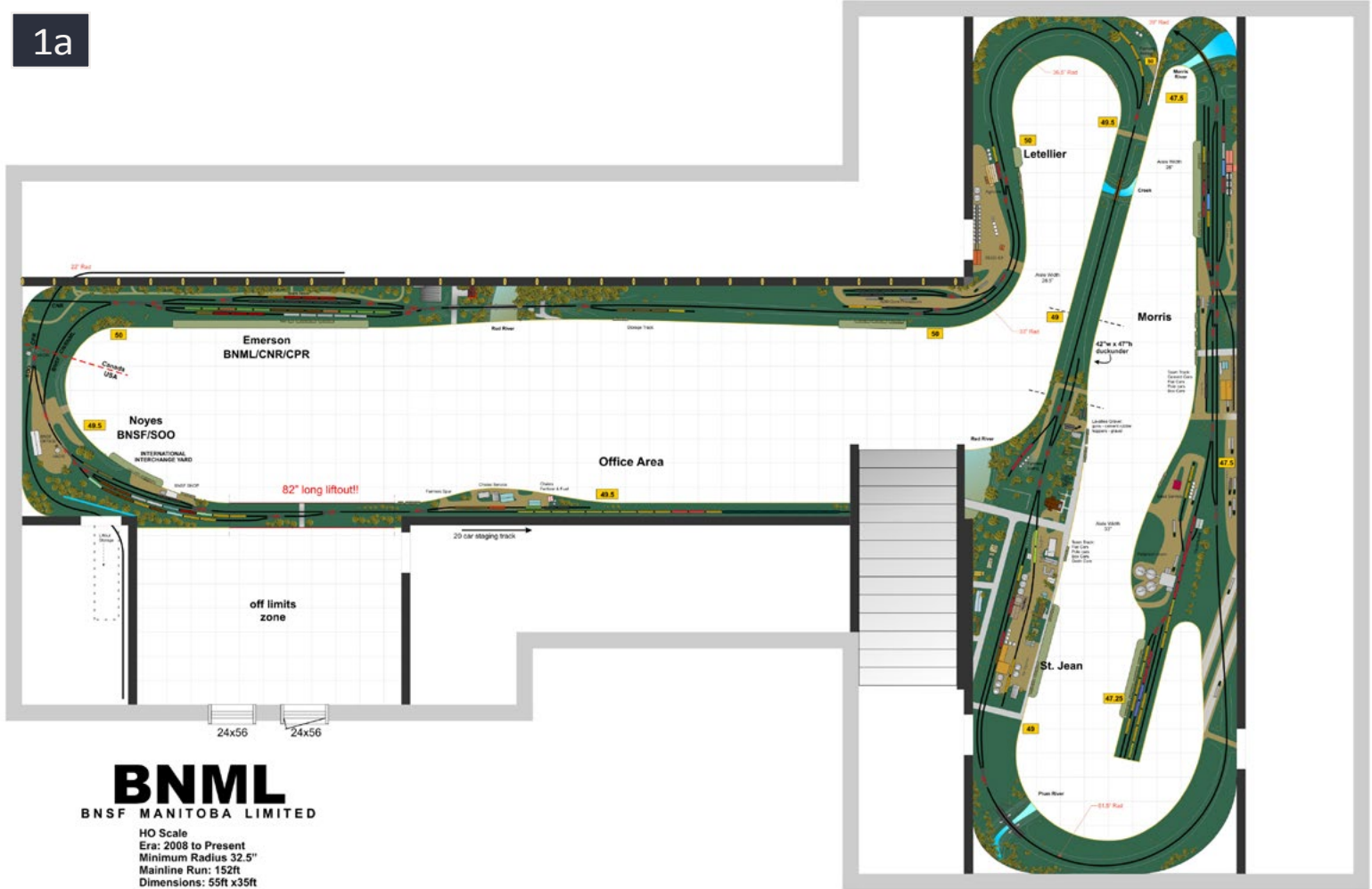

2

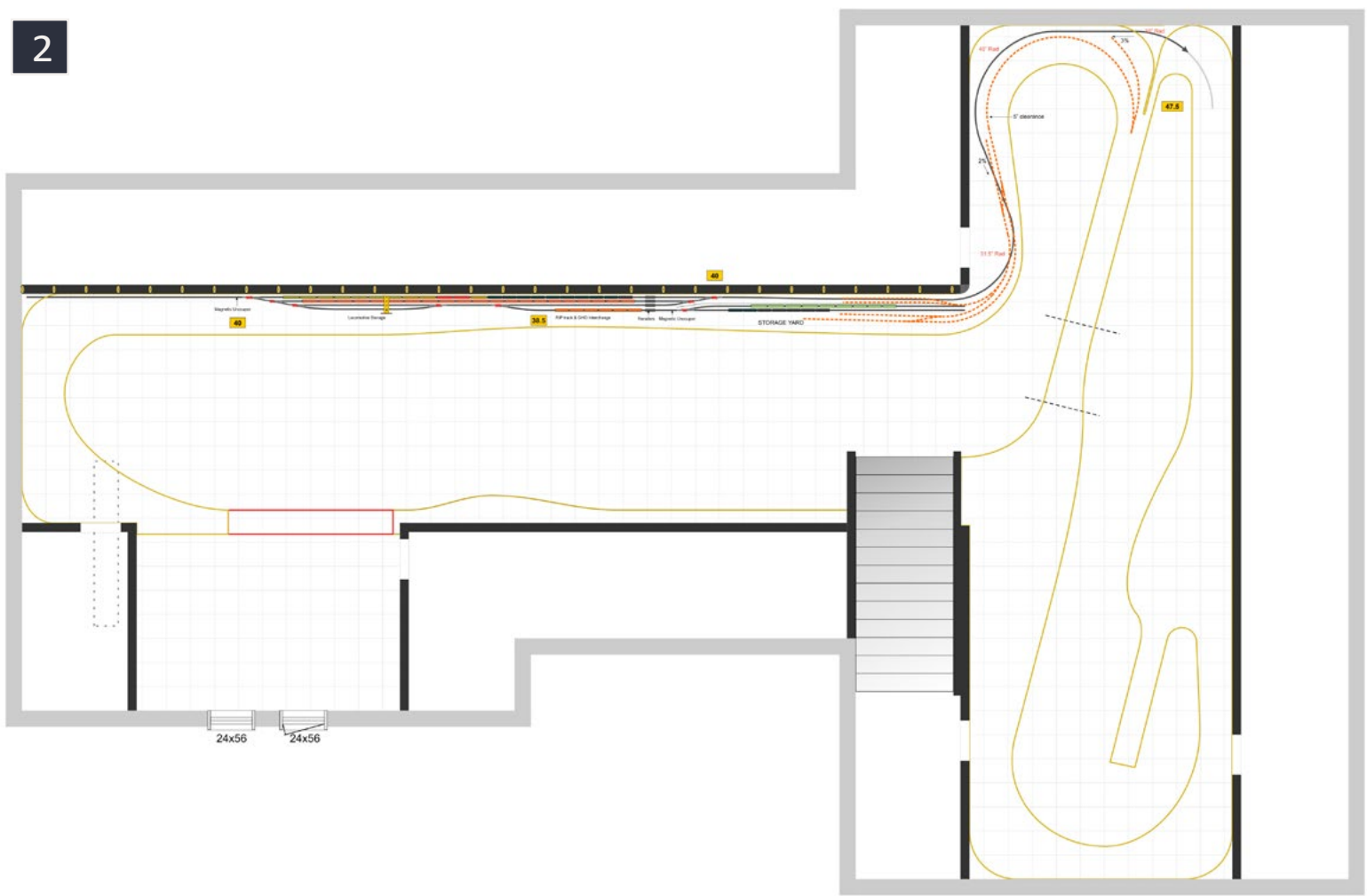

1a and 2: Bill Brillinger's BNSF Manitoba Limited track plan.



contents



index

## Zoomable track plan: Zoom in to study the track plan details up close.

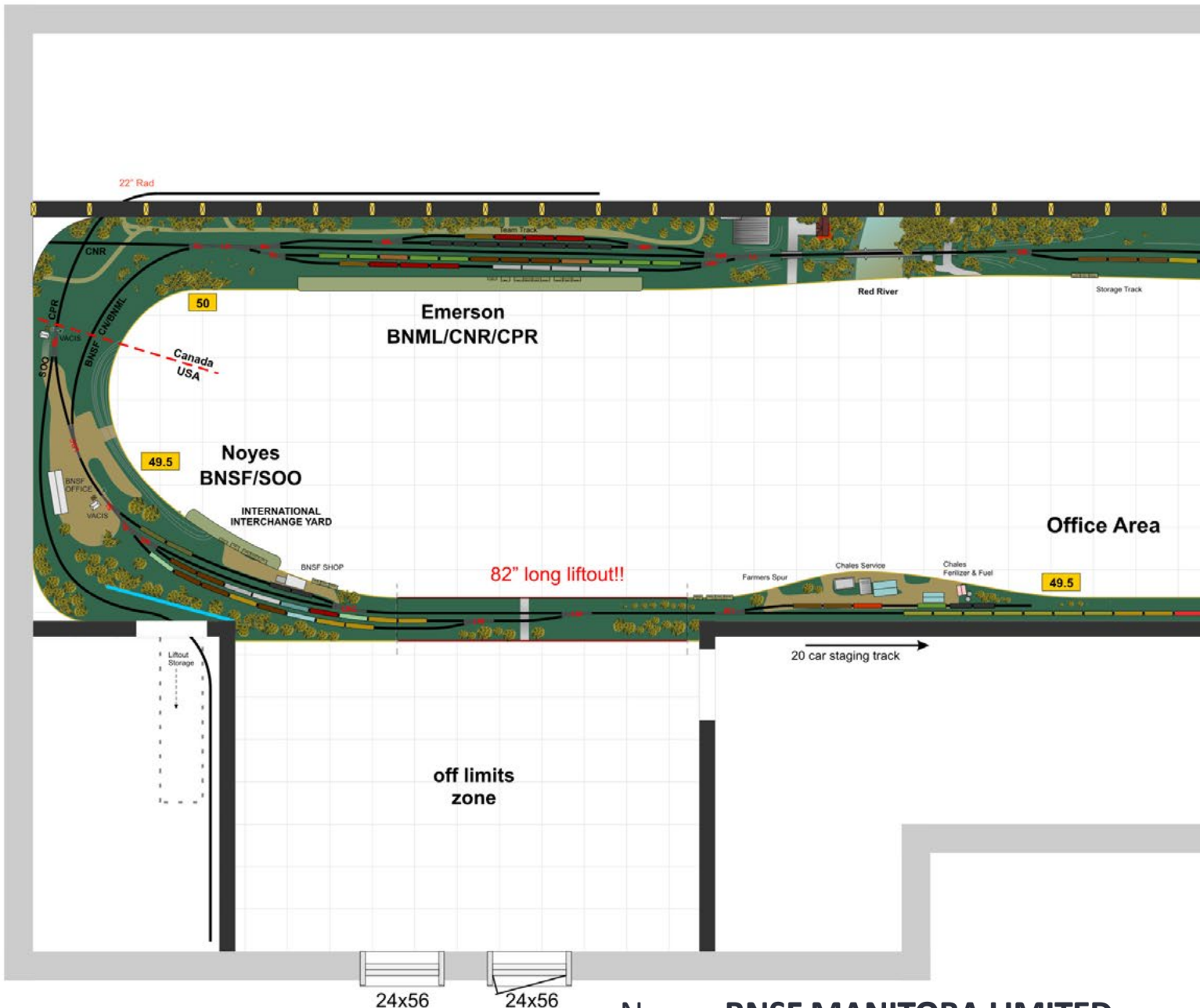

**BNML**  
BNSF MANITOBA LIMITED

Name: BNSF MANITOBA LIMITED

HO Scale

Era: 2008 to Present

Minimum Radius 32.5"

Mainline Run: 152ft

Dimensions: 55ft x 35ft

1b: Larger version of Bill Brillinger's BNSF track plan.



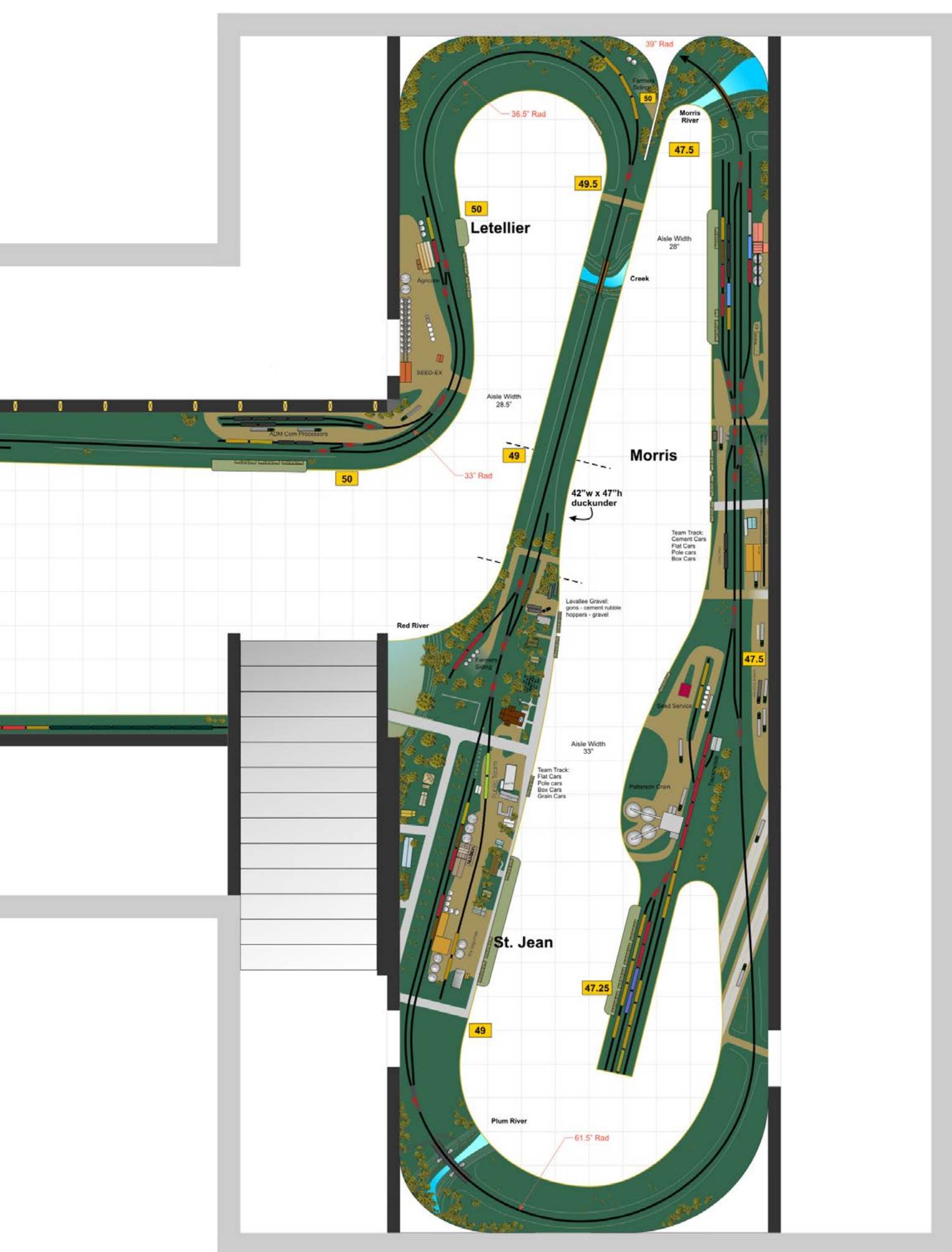

For more on this track plan, see: [mrhmag.com/blog/23320](http://mrhmag.com/blog/23320)



contents



index

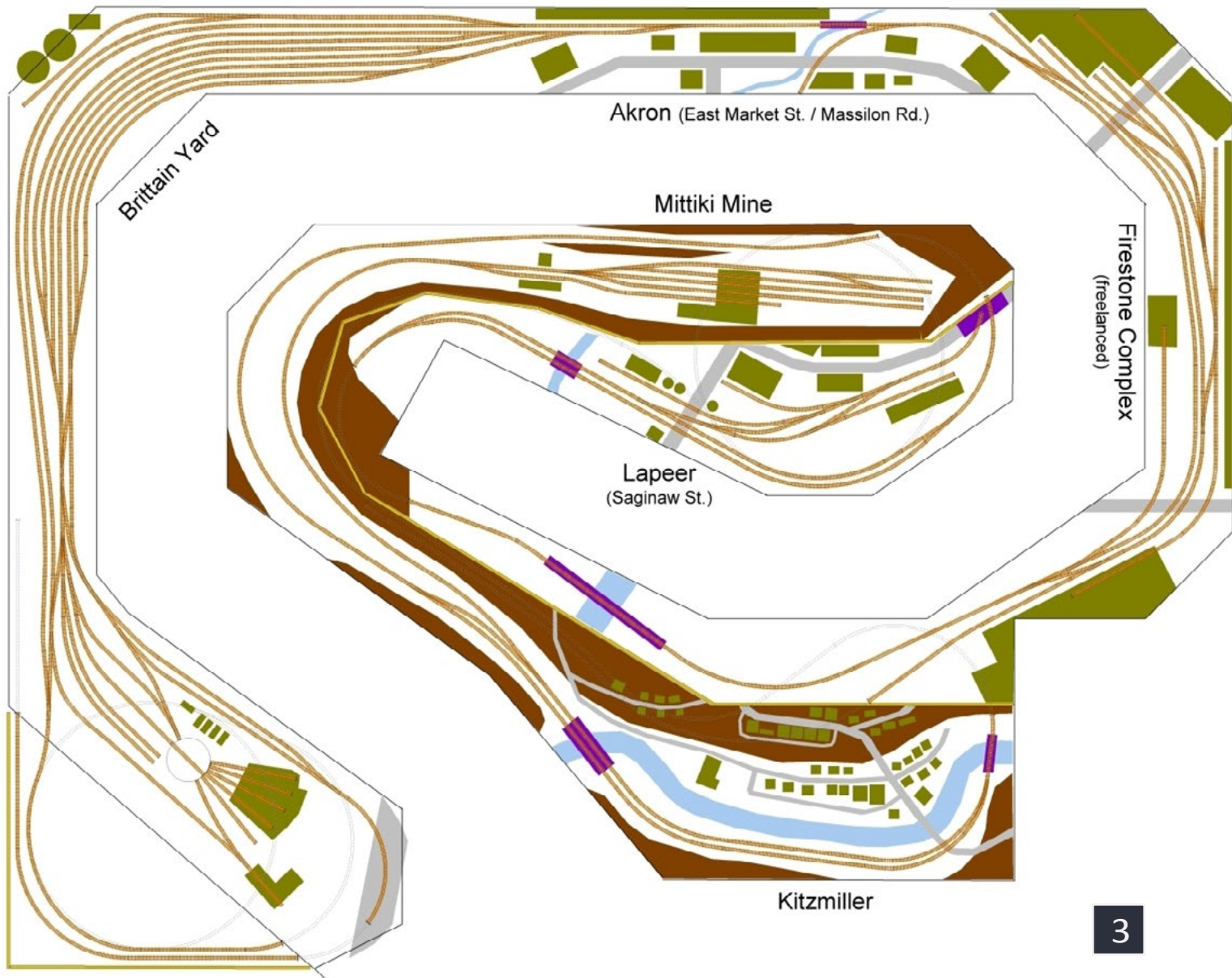

3

3: Alan Bailey's LK&O proto-freelance layout design, upper deck. For more on Alan's layout, see his blog: [korailroad.com](http://korailroad.com)

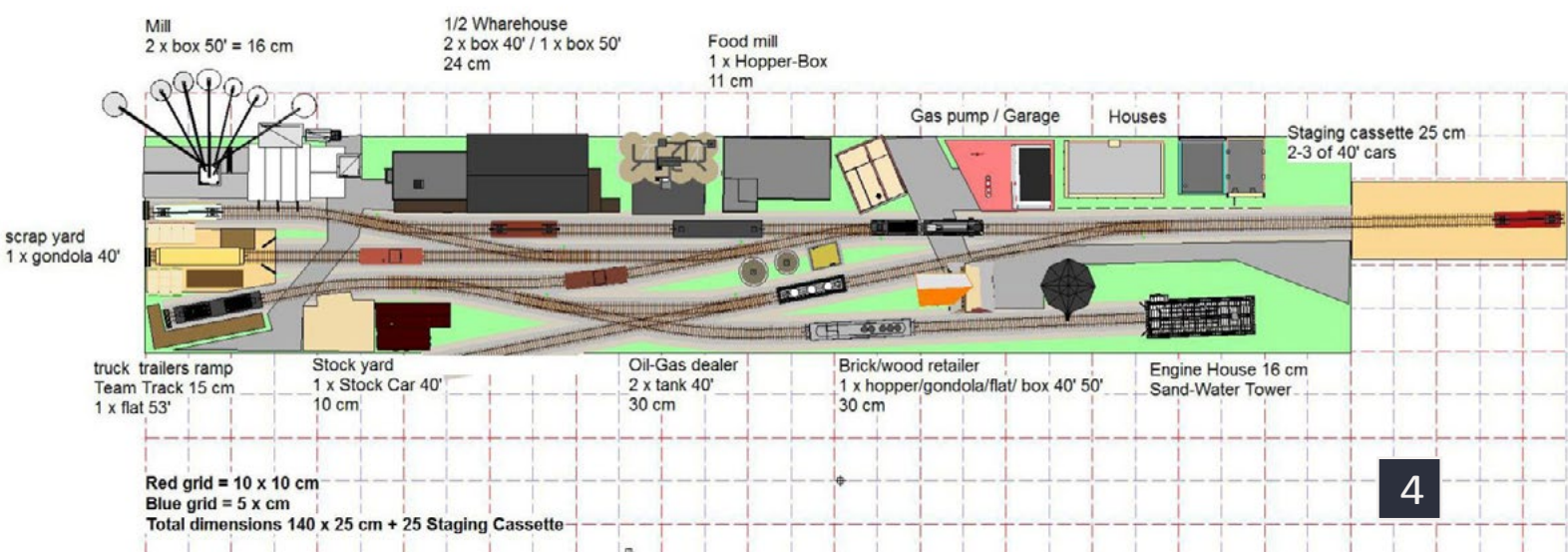

4

4: Enzo Fortuna's N scale switching layout design. Zoom in to study it closer.





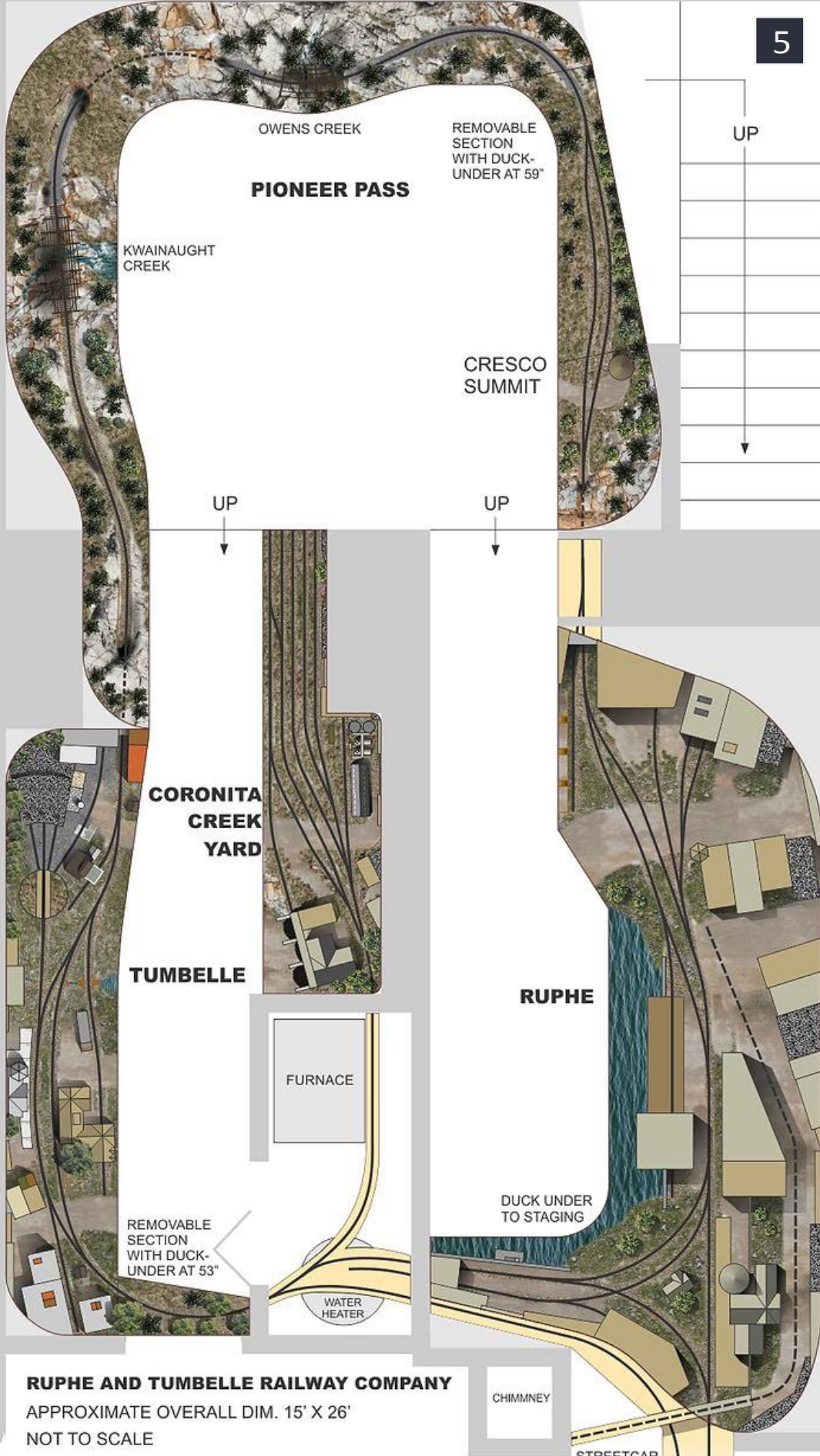

**RUPHE AND TUMBELLE RAILWAY COMPANY**  
 APPROXIMATE OVERALL DIM. 15' X 26'  
 NOT TO SCALE

**5: Rick Reimer's On30 freelanced Ruphe and Tumbelle Railway. See: [mrhmag.com/track-plan-database?page=1#comment-101749](http://mrhmag.com/track-plan-database?page=1#comment-101749)**



contents



index

6a

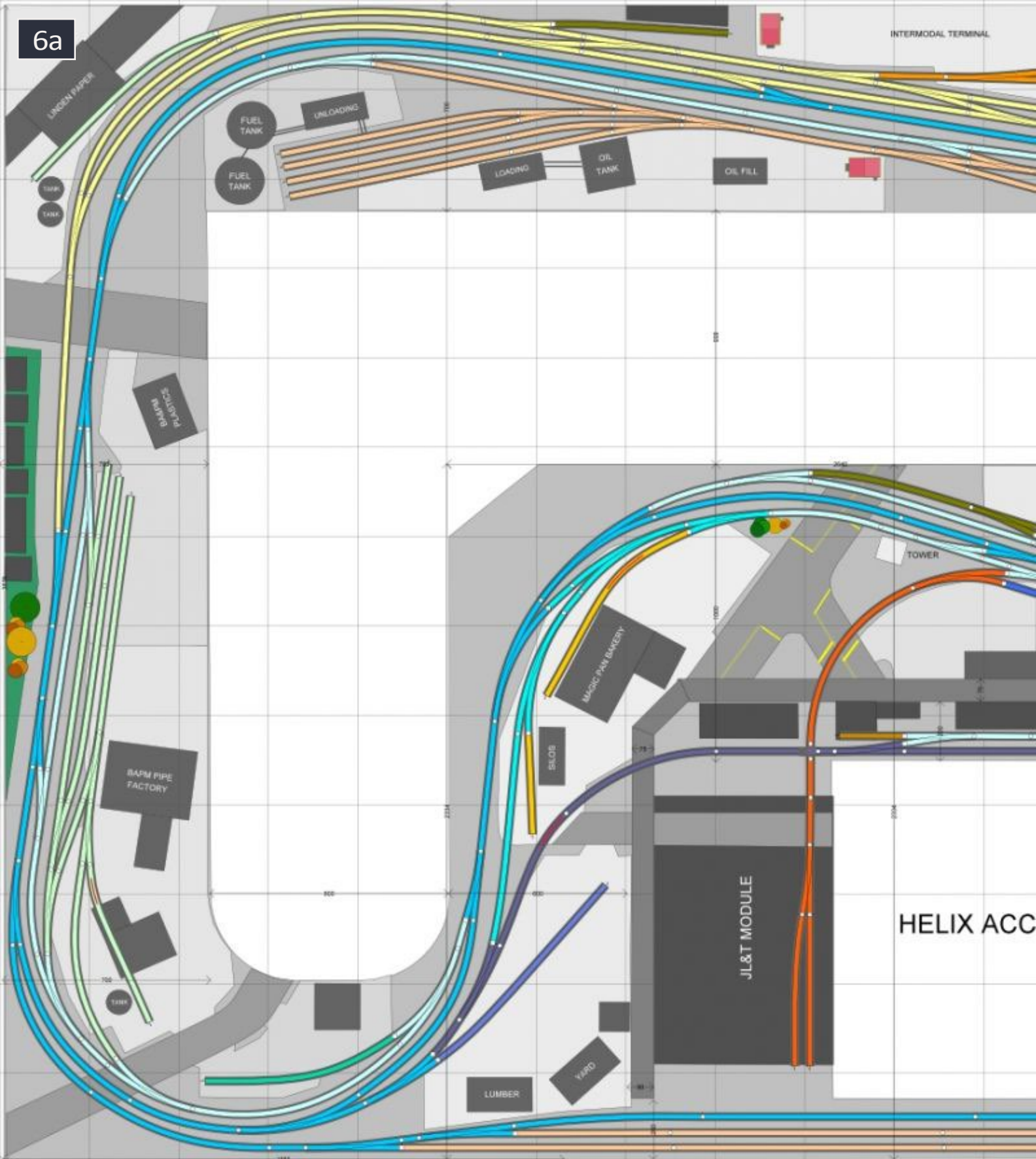

6a: Jason Miller's JL&T Railroad, modeling the Reading Lines during the Conrail era, as if the Reading lived on. You can find this trackplan post at: [mrhmag.com/track-plan-database?page=2#comment-101867](http://mrhmag.com/track-plan-database?page=2#comment-101867)





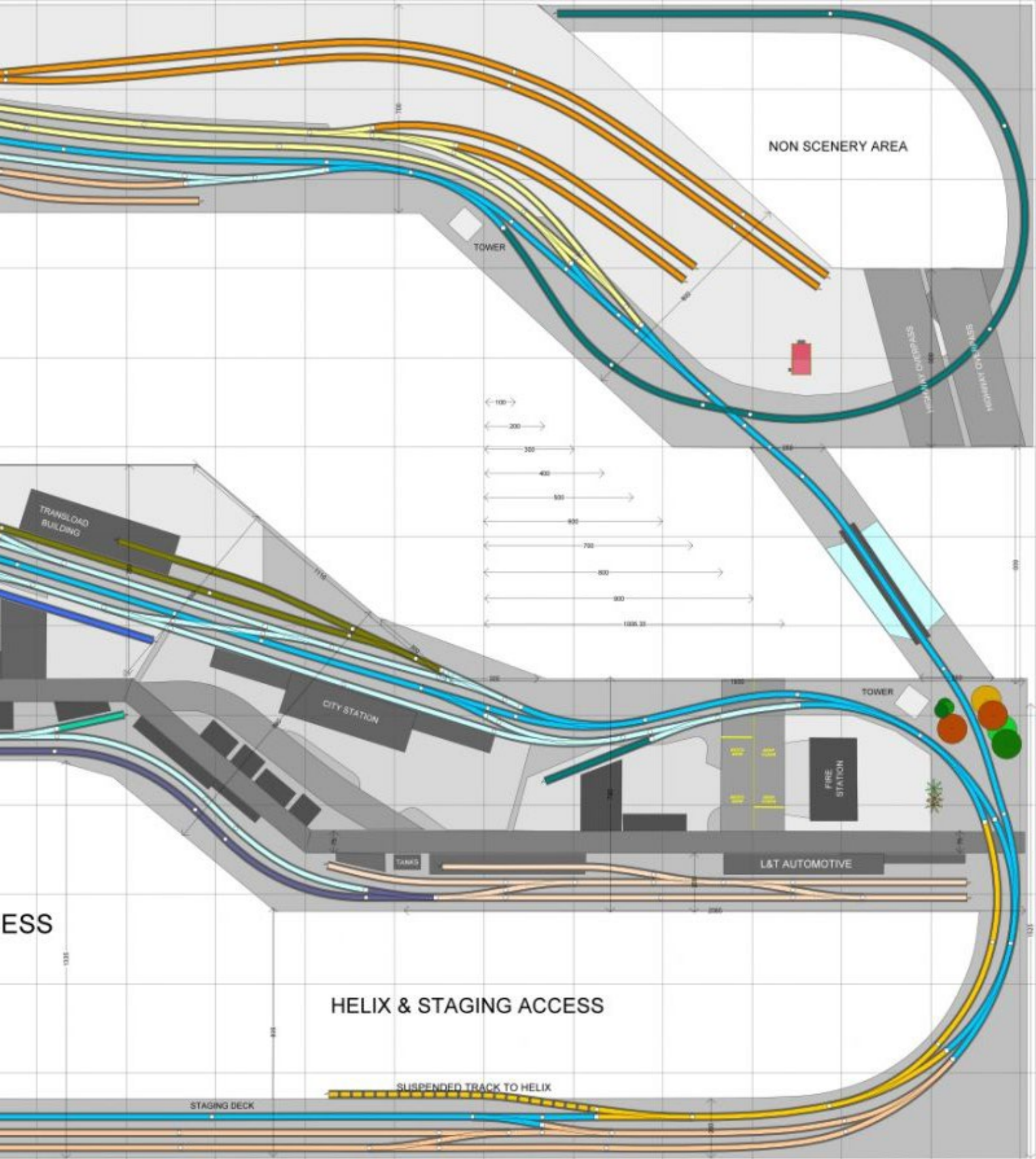

Jason also maintains a very rich MRH blog full of great ideas, complete with photos and videos. See: [mrhmag.com/blog/jlandt](http://mrhmag.com/blog/jlandt)





contents

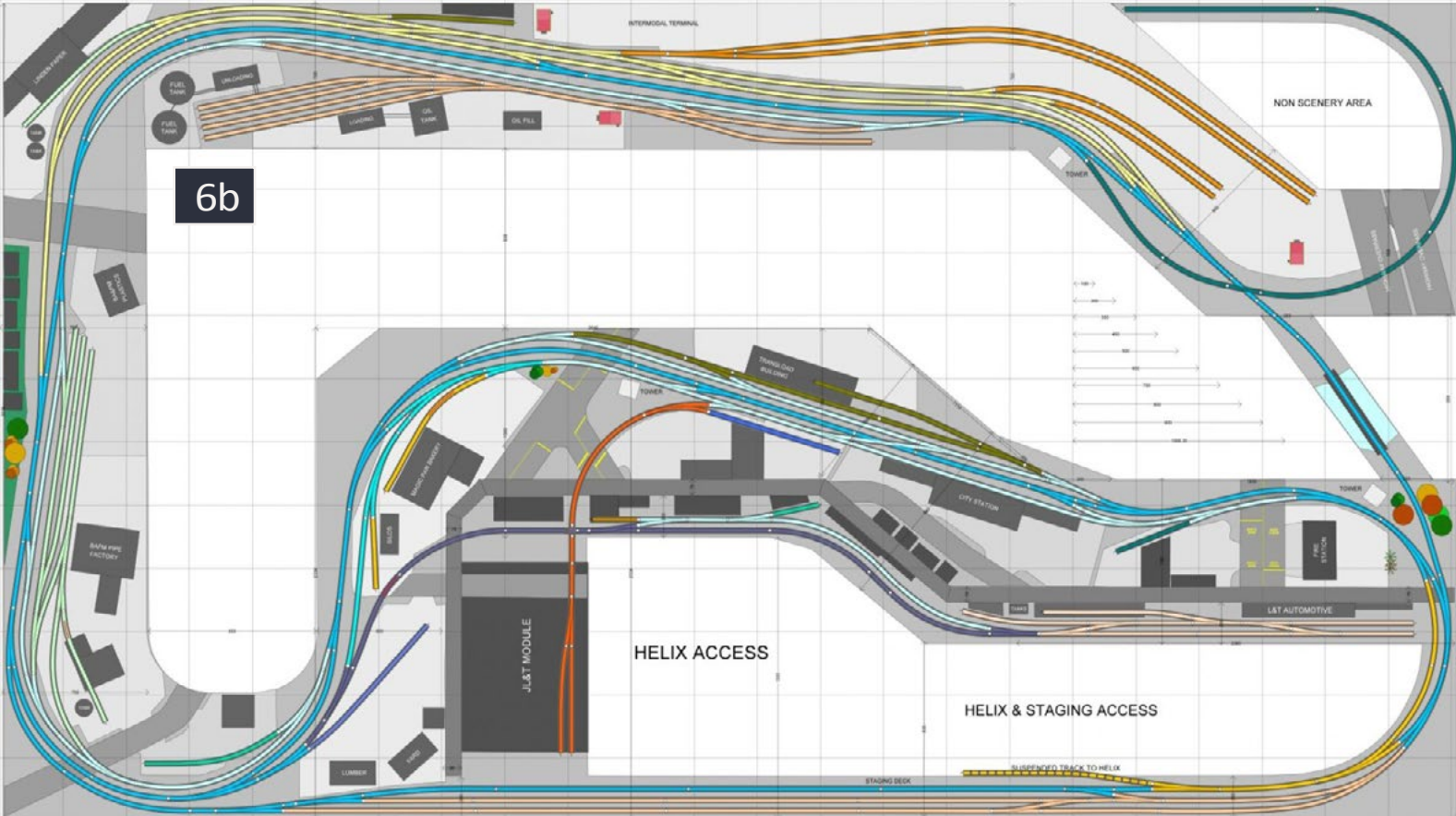

index



6b: Smaller version of Jason Miller's JL&T Railroad trackplan to fit into a single portrait magazine page. Zoom in to study it. You can also try zooming in to the larger version on the previous page(s).

Reader  
Feedback

(click here)

Get the Latest Model Railroading News, Tips, Reviews & Opinions  
**The SCOTTY MASON**  
 S H O W  
*The Original Model Railroad Podcast*

-Monthly Interviews

- Modeler's Spotlight: Top Modeler's Talk
- Narrow Gauge Modeling w/Chris Lane
- Contemporary Modeling w/ Mike Rose

-More Product Announcements & Reviews

 Our feed has changed! To get the latest shows, Please search Scotty Mason and subscribe to the new feed!

www.TheModelRailroadPodcast.com

Scott Mason    Jimmy Simmons    Mike Rose    Joe Duckworth



# NEW FROM ACCURAIL



## EASY TO ASSEMBLE HO SCALE KITS

#2424 Philadelphia & Reading  
USRA Hopper



#8957 Union Pacific 89' TOFC Flat Car  
3-Car Set



*Also available as singles #8918*

CSX 'How Tomorrow Moves' 3-Car Set #20998



#5652 Burlington 50' Steel Boxcar



3-Bay ACF Hopper

*Also available as singles #2099*



#4638 DT&I  
Double  
Sheath  
Wood  
Boxcar



#4115 Central  
New Jersey  
40' Exterior  
Post Wood  
Boxcar

#1217 FGEX/WFEX 2-Car Set



#8315 Canadian National



40' Steel Reefer

#8041 B&O USRA Hopper  
3-Car Set



#8042 Pennsylvania  
'Coal Goes to War' Twin Hopper



**PLEASE SEE YOUR LOCAL HOBBY DEALER FIRST  
OR CALL 603-965-1173 FOR DIRECT ORDERS  
ACCURAIL INC. PO BOX 278 ELBURN, IL 60119**





# Ultimate turnout control protection

– David Salsbery  
Model Photos by the author

Protect your turnout controls from getting hit accidentally ...

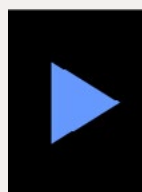

Reader  
Feedback  
(click here)



I started building modules, I knew that I wanted remote turnout control. This is the method I use to keep my control switches from getting damaged. The modules get moved around a lot and this has worked awesome for years now.

The turnout controls are flush-mounted in the operator side fascia, and control the turnout motors mounted under the table.

My controls are mini momentary center-off toggle switches, mounted to 1 ¼" "tips" from Ace Hardware. Spring-loaded momentary switches are needed for twin-coil snap-action





machines like Atlas and Peco. For stall motors like a Tortoise, use a standard toggle switch. The toggles are mounted into a ¼” hole drilled into the frame. A 1” hole in the fascia material gives access to the control (1).

## Ultimate protection for traveling

This same method could be used for larger toggles but you will need to use a larger cup or tip, like a cap for PVC plumbing material, and larger holes. The mini toggle switches and the tips are nice for modules as they are low profile, which helps protect them from damage underneath as well as from the outside.

The modules have a mix of Atlas and Peco turnouts and switch machines. They all work great, but I like the Atlas products a little better because of the lower profile of the switch machines and their quiet operation.



**1: Recessed toggle switches are protected from damage and accidental use.**



contents



index

The controls in the fascia are lined up with the turnout that they control, so most do not need labeling. Almost all of the turnouts and controls are installed in this manner. This keeps operators' giant hands from entering the scene for turnout control, and is well worth the effort and expense. ☑

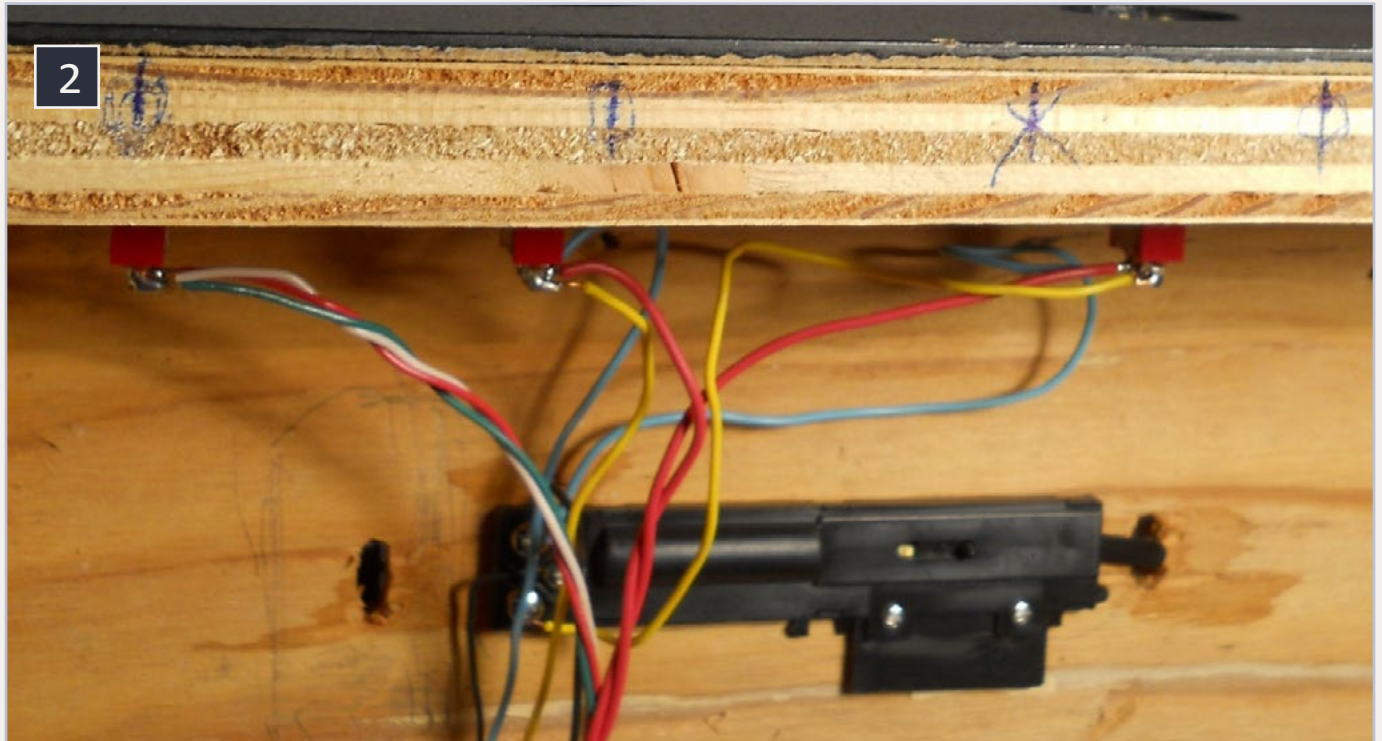

2: View from below shows the flush mounting of an Atlas switch machine.

Advertisement

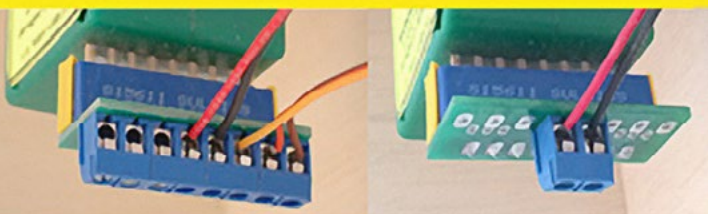

Wire a Tortoise without solder?  
Really?

Adapters that fit properly - with all the connections - or just to the motor!



[www.berretthillshop.com](http://www.berretthillshop.com)

What will they think of next?







**3: Plastic tips in several diameters and depths are available at hardware stores and online.**

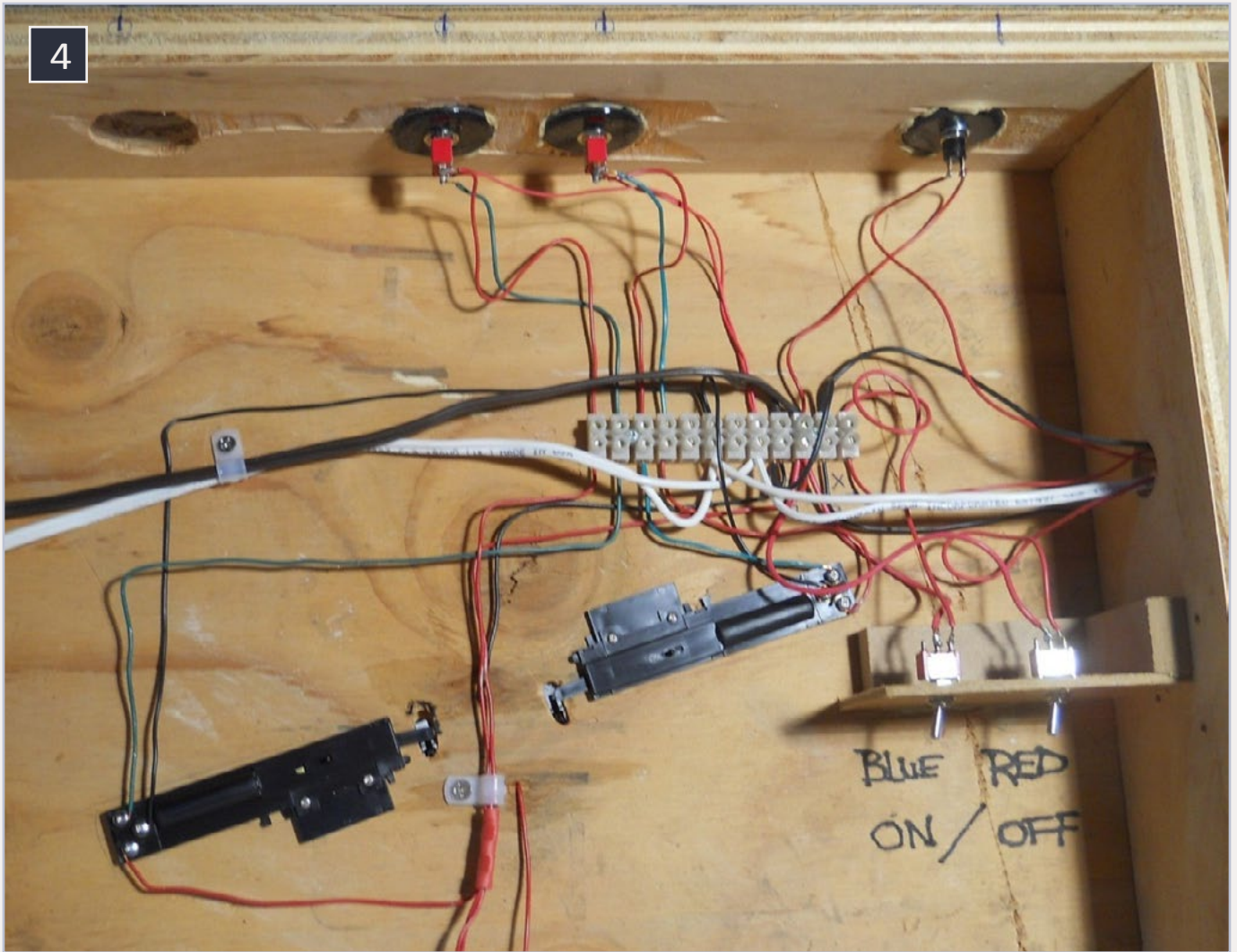

4: Wiring from toggles is routed to a terminal block for distribution to turnout motors.

Advertisement

**NEW!**

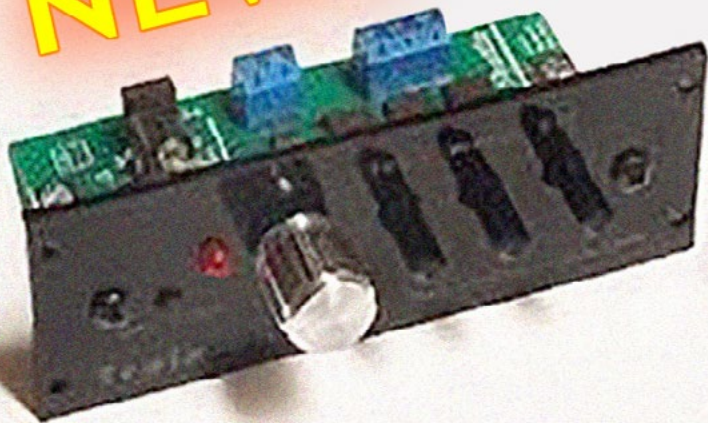

DCC Train Shuttle ...  
aka, "Prof Silencer"

[TamValleyDepot.com](http://TamValleyDepot.com)



contents



index



5

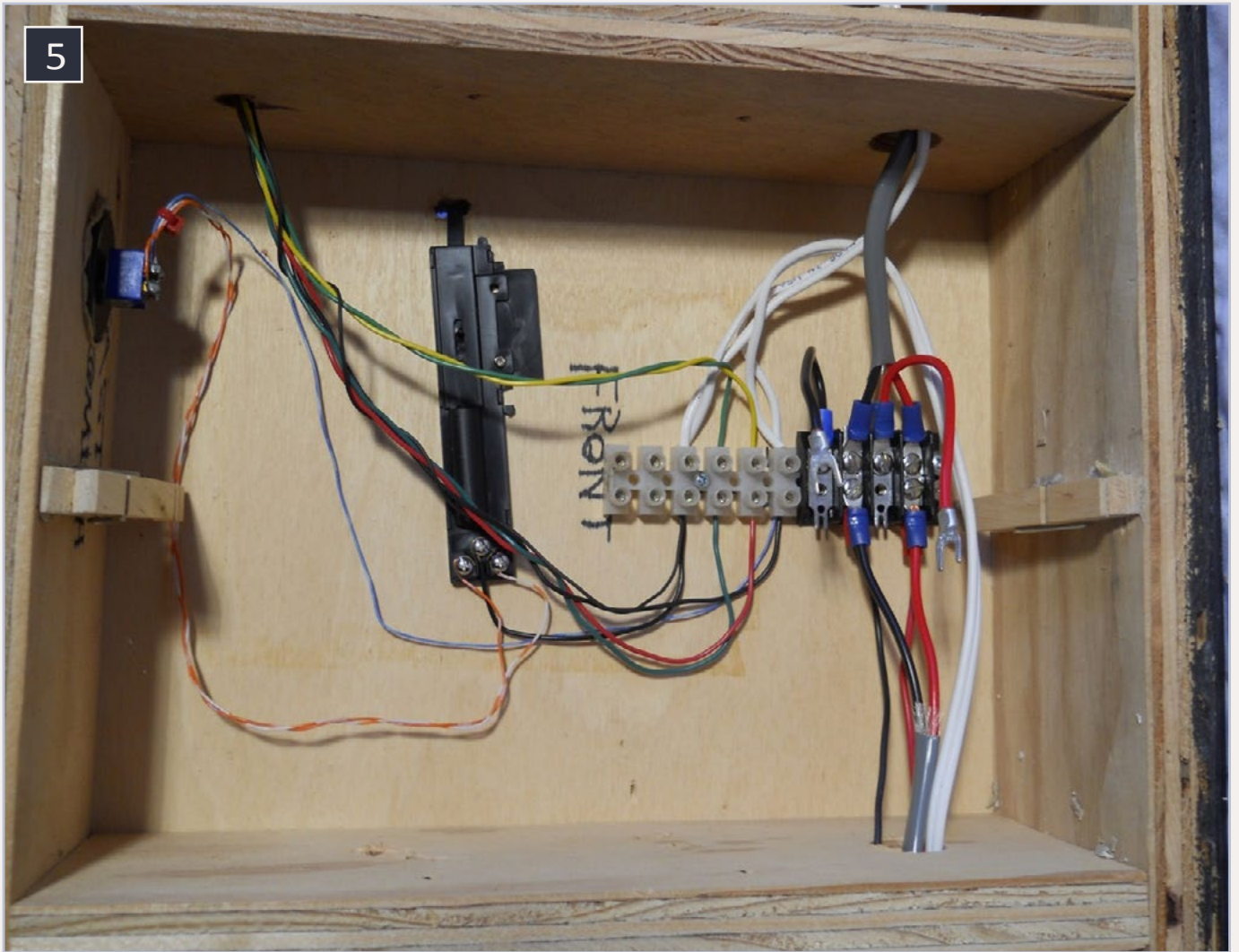

5: The power buss wiring at the right supplies electricity to the terminal strip.

Advertisement



Mount a servo on your layout with just a drill?



BERRETT  
HILL  
TRAINS



Hide with scenery -  
Mount from the top -  
No bending over!

[www.berretthillshop.com](http://www.berretthillshop.com)

What will they think of next?



Email



Phone



contents



index



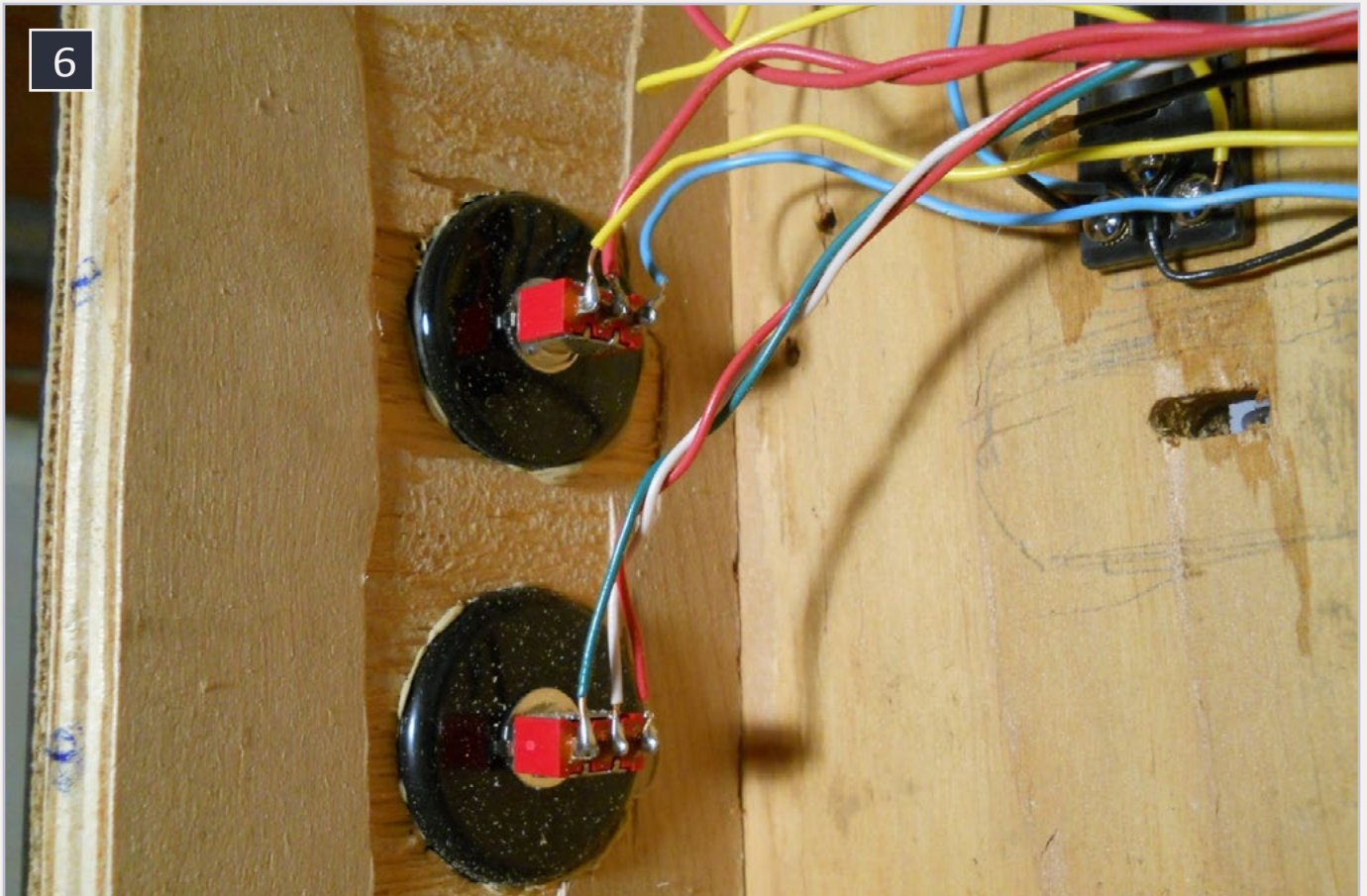

## 6: Back side of toggles.



A Portland, Oregon native, David's been modeling trains since he was 12.

David got more serious in the '90s when he discovered N scale. After building some small layouts, David discovered modular and club railroading. His current Stevens Pass oNetrak layout models the Great Northern.

David owns his own painting contracting business.





# *Amherst Railway Society*

# Railroad Hobby Show

# 2014



## An MRH Exclusive Report

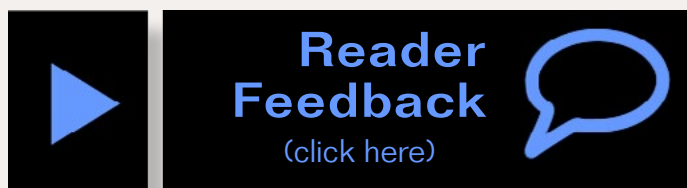

**O**ver 20,000 people turned out at the Eastern States Exposition (known by locals as the “Big E”) grounds in West Springfield, MA on January 25th and 26th, 2014. Model Railroad Hobbyist had a booth at the show, and we recorded a few of the interesting happenings during this annual show that’s always the last weekend in January.

Here’s our exclusive report of what may be one of the largest events of its kind in the world ...







**1: This shot shows 25% of one building at this show! There's also three more buildings just like this one, all packed with people wanting to enjoy some trains. Yes, indeed, looks like the hobby is dying to us ...**

**2: We asked this young fellow if we could take his picture. He was admiring the Chester & Beckett large scale layout. The prototype Chester & Beckett was a granite hauling line that became part of the Boston & Albany.**



contents



index





**3: Here's a closer look at the Chester & Beckett layout. That marble looks like the real deal, but the modelers who helped build this layout tell us this is just nicely weathered plaster.**

**4: Speaking of nice models, here's some inkjet and cardstock structures by Clever Models. That's right, this is cardstock printed on an inkjet and assembled. Impressive!**





**5: On Sunday before the show opened, we grabbed this shot of the Costal Mountain Railroad club's modular HO layout. Talk about a nice l-o-n-g layout ...**

**6: If you want really big models, there's the Pioneer Valley Live Steamers, who had some of their equipment on display in the Mallary building. This stuff's big enough to ride on.**



contents



index



7



8







**7: The Dry Hill Model Railroad, a special interest subgroup of the Amherst Railroad Society, has their own HO modular layout at the show. They've gained some notoriety because of their annual traffic accident scene on the freeway bridge over the passenger yard.**

**8: In this closeup of the traffic accident, you can see there's a truck trailer on its side, and some cows running loose. It also looks like one overturned car even took the ultimate high-jump plunge in the lower left of the picture. Reminds us of crazy things we did as kids with our Hotwheels cars.**



contents



index





9: We do love FREE-MO modular layouts! The single-track mainline makes the layout look so much more like a sectional home layout, and it's great if you're into realistic operation. This is the New England HO FREE-MO group.

10: Here's a bridge scene on this same FREE-MO layout. This scene isn't finished yet, but it already looks quite good.





11: And speaking of FREE-MO, here's another wonderful layout by *The Sn2 Crew* superbly demonstrating both the realism of FREE-MO and the delight of S scale.

12: This impressive tight-space wye on a bridge scene on the modular FREE-MO layout of the On30 Narragansett Bay Railway & Navigation Company group.



contents



index





13



14

**13:** Yes, there's N scale at the Big E too! This is a scene from the Northeast N-Trak group. That's a circus scene, complete with all the cars needed to bring the show to town. Love how N scale lets you fit a lot of layout into the space.

**14:** This wonderful scenicked O scale module from Atlantic Scale Models features some of their Dave Frary-inspired kits.





15: It's the end of the first day of the show at the MRH booth and a tired Dave Abrams (local volunteer show helper) is taking it easy now that the crowds have let up.

16: On Sunday before the crowds arrived, the TrainMasters TV crew shot interviews. Look for extensive Amherst Show coverage to come to TMTV in February.



contents



index





**20: Andy Edleman, MTH vice president of marketing talks with some visitors to their booth. MTH has been a faithful MRH sponsor for several years now.**

**21: MRH author Mike Tylick demonstrates kit-building techniques at the Bar Mills booth. Mike's got some more articles in the works for us, so watch for them!**





**22: MRC announced their new Prodigy Explorer system, a starter DCC system for just over \$100 retail. Using their handheld throttles, this system is expandable.**

This show report just scratches the surface of what's at this huge show. TrainMasters TV will be providing a lot of coverage of this show in February, including some of the Amherst show's intriguing history and backstory.

We believe every serious model railroader owes it to themselves to at least attend this show one time in their lives. We've never seen anything else of quite this magnitude elsewhere, in the dead of winter in North America, no less!



contents



index

# ALL ABOARD!

## FOR OTTAWA TRAIN EXPO

### EASTERN CANADA'S LARGEST TRAIN SHOW

#### APRIL 26TH & 27TH, 2014



IN PARTNERSHIP WITH THE  
"BYTOWN RAILWAY SOCIETY"

30,000 sq. ft. of manufacturers, vendors, layouts, clinics and displays.  
All dedicated to the passion for trains.

**ERNST & YOUNG CENTER**  
4899 Uplands Drive, Ottawa, ON K1V 2N6

Adults - \$12.00 6-12 years old - \$8.00 Children 5 and under - Free with adult accompaniment  
Saturday - 10:00 - 4:30, Sunday - 10:00 - 4:00



*We proudly support  
Rogers House*



Thank you to local businesses/companies for your support



PATHWAY HYUNDAI



FOR MORE INFORMATION VISIT  
[WWW.OTTAWATRAINEXPO.COM](http://WWW.OTTAWATRAINEXPO.COM)





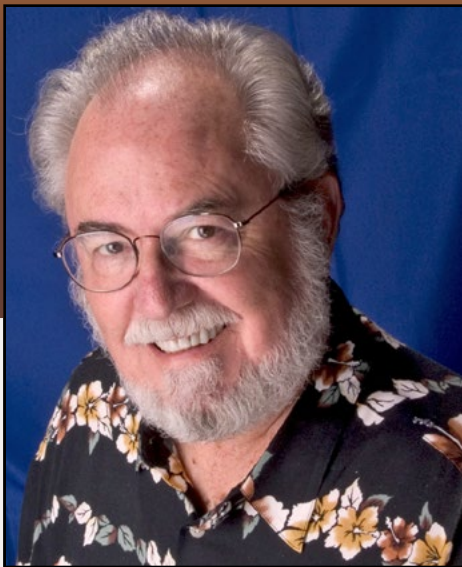

The Old  
Yardmaster

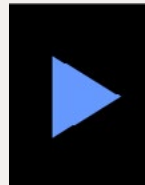

Reader  
Feedback  
(click here)



## February 2014: The latest model railroad products, news & events

by Richard Bale and Jeff Shultz

### Franciscan Hobbies 1946-2014

For nearly 70 years Franciscan Hobbies, located on Ocean Avenue in San Francisco's Ingleside district, was a welcome hangout for modelers both young and old. Citing tight margins and reduced sales volume, the company issued a statement late last year that said it would close its doors for good at the end of January. A hobby store quietly calling it quits is hardly front page news, but the San Francisco *Chronicle* saw it differently and published a feature article about the demise of what it considers a local institution. According to the *Chronicle*, "The Franciscan was a kind of clubhouse, a bit like a neighborhood bar, without the liquor. The customers, mostly men, would come to buy a model kit, or a part for some tricky model project, and stay to talk – hobbies, politics, city gossip, troubles."

John Gunther, the son of founder Bill Gunther, said, "Franciscan had thousands of old customers, and many of them first came in as children to buy model ship kits, model airplanes, trains and



supplies to build train layouts. But their own kids, and the kids after them, found something else to do. We were done in,” said Gunther, “by changing times, by the Internet, by suppliers who undercut the prices in the retail hobby shops, and by a demographic shift. The pricing policies of the distributors, suppliers, and the internet have left little to no room for the needed profit margin to remain in business, especially in a major city such as San Francisco where rent and other operating expenses continue to spiral upward.” ...

## **Sellios postpones retirement**

George Sellios has decided to postpone his retirement and the subsequent closing of Fine Sale Miniatures. In announcing that he will continue to produce new structure kits for at least two years, Sellios acknowledged that his original decision to call it quits was made in haste. He said the overwhelming response from FSM customers, plus urging from family members, caused him to rethink his retirement timetable. The founder and guiding hand behind Fine Scale Miniatures apologized for any inconvenience he may have caused FSM customers ...

## **Classic Miniatures missing masters**

In response to numerous requests, Classic Miniatures would like to reissue its HO scale structure kit for Union Brass Foundry. The kit has been off the market for some time and CM owner Clifford Mestel reports that he is missing the masters for some parts. He would like to borrow an unbuilt kit to recreate the lost items. Anyone willing to lend an unbuilt kit to Cliff is asked to contact him at [cmestel@troutcreekeng.com](mailto:cmestel@troutcreekeng.com) ...

## **John Pryke 1940-2013**

John T. M. Pryke, 73, of Orleans, Massachusetts, passed away after a long illness on December 22, 2013. Known throughout the model railroading community, John developed his passion



for modeling the New Haven Railroad as a young boy watching steam locomotives in Old Saybrook, Connecticut. John was widely recognized as an innovator in the hobby with frequent contributions to *Model Railroader* magazine. He was an active member of the Nauset Model Railroad Club, and was a founding member in the New Haven Railroad Historical and Technical Association. A native of New York City, John graduated from MIT in 1962 with a degree in mechanical engineering, and a masters degree from Northeastern University. He is survived by his wife Sandra. ...

## **Earl Smallshaw 1933-2014**

Earl Smallshaw, of Connecticut, passed away on January 3rd, 2014. He was 80 years old. Earl earned an international reputation as a master modeler whose work was the subject of numerous magazine articles and clinics on the art of model railroading. His beautifully executed Middletown & Mystic Mines HO scale layout served as the basis for several of his popular how-to structure articles. He was a life member of the National Model Railroad Association. Earl served in the United States Army, 82nd Airborne Division, during the Korean War. In addition to Barbara, his wife of 57 years, Earl is survived by four children and 11 grand children. His layout and craftsmanship can be viewed at [smallshawrailroad.com/htfdworkshop-1.htm](http://smallshawrailroad.com/htfdworkshop-1.htm) ...

---

## **NEW PRODUCTS FOR ALL SCALES**

The Missouri Pacific Historical Society ([mopac.org/index.php/store](http://mopac.org/index.php/store)) is offering a special on its two-volume set of Maintenance of Way information. Although specifically MP, the information is of great value to all modelers interested in learning about standard prototype railroad practice.



contents



index

Volume 1 includes actual construction drawings of freight loading /unloading platforms, culverts, pile trestle bridges, section houses, cattle guards, roadbed and ballast sections, motor car set-offs, privies, coal boxes, and train order signals. The drawings in Volume 2 offer details on water tanks, pump houses, stock yards, and painting diagrams for MP's frame structures.

The softback 8.5" x 11" books are professionally reprinted from the original documents in landscape format. Spiral binding permits flat opening. Both volumes are available for \$19.95 plus \$8.00 postage and handling. For additional information visit the above website.

---

**Trackside Scenery** ([tracksidescenery.com](http://tracksidescenery.com)) has introduced what it calls a new generation of model railroad backdrops that are specifically scaled for scenes in N, HO, or O scale. The photo-realistic backdrops feature a trackside view that is said to be scale-proportionate where the backdrop meets the layout. Many of the backdrops have a repeating design that offers seamless continuity. For details including a gallery of scenes visit the above website.

---



## **S SCALE PRODUCT NEWS**

**Monster Model Works** ([monstermodelworks.com](http://monstermodelworks.com)) has introduced a laser-kit craftsman-style kit that makes



into a distinctive S scale structure. The model is based on a 120-year-old prototype in South Pass City, Wyoming. Although billed as a Saloon, the storefront structure could serve almost any small-town business. The split-log siding and quarried stone foundation are made of 3D engraved basswood. All components are laser-cut and feature tab & slot construction. Visit the above website for pricing and availability.

---



**P-B-L ([p-b-l-models.com](http://p-b-l-models.com))** will be delivering two versions of Denver & Rio Grande

Western 6000 series flat cars later this year. Models with either cast steel striker plates or wood buffer beams will be available in the correct number series. The same car used by the Rio Grande Southern all had wood buffer beams. Features of the S scale narrow gauge model include a cast underframe for enhanced tracking, rubber air hoses, Kadee® couplers, and arch bar trucks with a 3' 7" wheelbase. Visit the above website for additional information.

---

## HO SCALE PRODUCT NEWS



New HO scale freight car kits from **Accurail ([accurail.com](http://accurail.com))** include a limited run of Great Northern – Western Fruit Express

cars in three different liveries. The GN kits are priced at \$17.98 each. The rest of the Accurail kits mentioned in this report all have an MSRP of \$16.98.



contents



index



A Soo Line 40' steel boxcar with combination plug and sliding side doors is also new.



Accurail has released a kit for a Gulf Mobile & Ohio 50-ton twin-bay hopper car with offset sides, and a kit for a 50' Pittsburgh & Lake Erie boxcar with riveted steel sides.



Additional new HO kits from Accurail include a 40' New Haven single-sheathed boxcar with wood sides and ends, and a Milwaukee Road 40' insulated steel boxcar with a plug door.

---

steel boxcar with a plug door.



**Athearn** ([athearn.com](http://athearn.com)) plans to release its Genesis series GP40-2 with new road names in August. They include Conrail (Phase IIa, 81" nose), Iowa Chicago & Eastern (88" nose), Norfolk Southern (both Phase I and IIa), and DRGW (both Phase I with 81" nose and Phase III with 88" nose). Standard DC non-sound versions of the HO scale Genesis series model, priced at \$169.98 each, will be DCC-ready using Quick Plug™ technology.



Sound-equipped models have Soundtraxx® Tsunami® DCC decoders and are priced at \$269.98 each.



Athearn continues to release products decorated in fictitious schemes that never appeared on the prototype. New “what if” schemes coming this August include a CF7 locomotive decorated for Amtrak, Santa Fe (blue & yellow warbonnet), BNSF (Heritage I scheme), and WATCO (repaint over ATSF blue and yellow). The ready-to-roll series model will have an MSRP of \$114.98 each.



Also scheduled for an August release is a 40' triple-bay rib-side hopper car. In addition to

the UP version shown, the open-top car will be available for Canadian National, Chesapeake & Ohio, SLSF-Frisco, and Reading. The HO scale ready-to-roll model will be priced at \$27.98 each or in four-packs at \$99.98.



In addition to the CAXX-Cemento Cruz Azul scheme shown here, Athearn will offer this 50' FMC 5347

boxcar in five additional road names: Columbus & Greenville, East Camden & Highland, East Erie Commercial Railroad, North



contents



index

Louisville & Gulf, and Railbox. The ready-to-roll models will be available in August at an MSRP of \$24.98 each.



Also coming in August in Athearn's ready-to-roll series is a 50' steel gondola decorated for Burlington Northern, Grand Trunk Western, NdM, Rio Grande, Soo Line, and The Rock. The MSRP will be \$23.98 each.

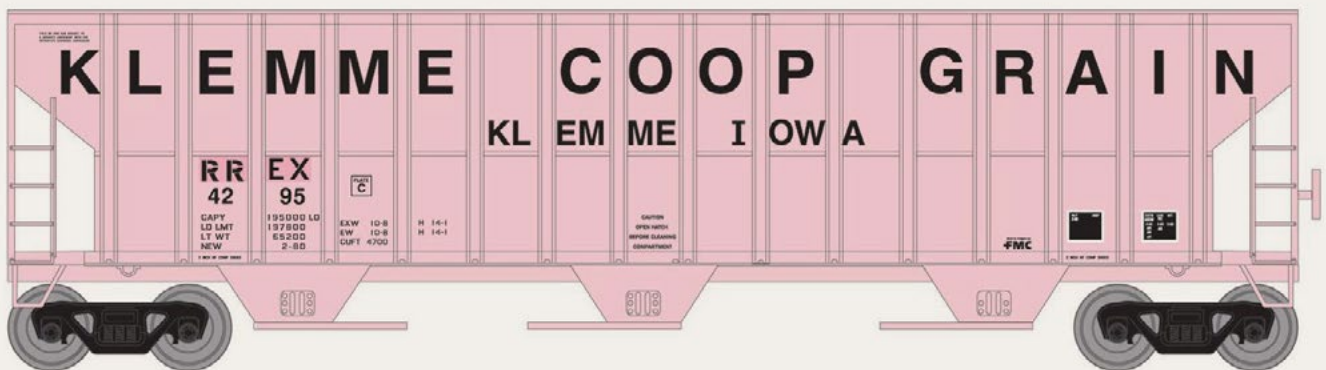

An FMC 4700 cu. ft. triple-bay covered-hopper car with an MSRP of \$34.98 is included in Athearn's August production run. Road names will include the RREX – Rex Railways Leasing (ex Klemme Coop grain) car shown here. Additional road names will be BHN (ex Arthur Farmerslev Co.), CFWR – Casey Fork & Western (ex XTRA), Milwaukee Road, Northwestern Oklahoma (ex C&NW), and Procor.

The final item coming from Athearn in August is a series of heavyweight passenger cars shortened for use on 18" radius curves. The run includes a baggage, RPO, coach, diner, sleeper, and an open-end observation car. Decorating schemes will be Santa Fe (Pullman green), Southern Pacific (Daylight), Union Pacific (yellow and gray), Canadian National (green and black with maple leaf), Pennsylvania (Tuscan red), and Milwaukee



Road (orange and maroon). All of the HO scale ready-to-roll cars will have an MSRP of \$29.98 each. Suitable lighting kits are sold separately.

---



**BLMA** ([blmamodels.com](http://blmamodels.com)) has released the yellow version of its Trailer Train TTX F89-J 89' flat cars (above). The HO scale model is based on a prototype ACF built in the early 1970s for TOFC loading. The model features elephant-style trailer loading (two hitches facing one direction), ACI placards, cut levers and rub rails that are both era-specific. Hobbyists have a choice of either wood or steel risers which are both included in the otherwise ready-to-run model. Additional features include die-cast metal frame, positionable hitch detail, 70-ton trucks with metal wheel-sets, and body-mounted Kadee® #58 couplers. For additional information including pricing, visit the above website or see your favorite dealer.

A second production run of BLMA's 64' Union Pacific (ARMN) reefers will be ready for release late this year. They will be fitted with the latest Carrier Reefer Units. The HO scale ready-to-run model will be available in 24 numbers at an MSRP of \$39.95 each.

---



**Bowser** ([bowser-trains.com](http://bowser-trains.com)) has a kit for an HO scale class N-5a steel cabin car with port hole windows. The model is



contents



index

based on a Pennsylvania Railroad prototype built in 1942 and features the early-style lettering of that period.



Bowser also has kits for open-top hoppers including a PRR 100-ton triple-bay car, and a NYC 70-ton 14-panel triple-bay car.



Additional items available now include a 55-ton hopper car with fish-belly side sills decorated for

either Central of New Jersey or Delaware & Hudson.



All of the Bowser kits mentioned have an MSRP of \$14.95.



**Broadway Limited** ([broadway-limited.com](http://broadway-limited.com)) is scheduled to deliver an HO scale ready-to-run model of a Pennsylvania 2-8-0 steam locomotive this spring. The

class H10s Consolidation was popular with Pennsy management with the road eventually owning more than 1,500 of them. BLI's HO scale version features Paragon2 Sound, and a diecast body



with separately applied handrails, ladders, whistle, and bell. The MSRP will be \$399.99.

---



**Funaro & Camerlengo** ([fandckits.com](http://fandckits.com)) has a resin kit for an HO scale Southern quadruple-bay covered hopper car. Of note are the 12 loading

hatches. F&C kits consist of a one-piece cast resin body, detail parts, and appropriate decals. The kit is priced at \$49.99 each. Trucks and couplers are not included.

---



**InterMountain** ([intermountain-railway.com](http://intermountain-railway.com)) has announced eight new decorating schemes for its AAR alternate stan-

dard twin-bay open-top hopper cars. The HO scale ready-to-run models are scheduled for release late this summer. In addition to the C&O car shown here, other road names will be Baltimore & Ohio (arch ends), Louisville & Arkansas, Erie Railroad (large herald, flat ends), Pittsburgh & West Virginia (red body with yellow lettering), Montour Railroad, Nickle Plate Road (ex W&LE), and Clinchfield. Features include individual wire grab irons and Kadee® couplers. The models will have an MSRP of \$39.95.

Intermountain has released the third production run of its SP cab-forward steam locomotive. The HO scale ready-to-run model is available in classes AC-8, AC-10, AC-11, and AC-12 with variations of the lettering scheme within each class. Locomotive No.



contents



index



4197 shown here is a class AC-8 with “Southern Pacific” lettering on the tender. The locomotives are powered with a Northwest Short Line motor. Models with ESU LokSound® have an MSRP of \$479.95. Non-sound models list at \$369.95.



InterMountain reports that the second run of Norfolk Southern ES44AC Heritage series diesels will be released in May. In addition to the Monongahela and Pennsylvania schemes shown here, the HO scale ready-to-run model will be available decorated for Conrail, Nickel Plate Road, Interstate, Norfolk & Western, Central of Georgia, Southern, Norfolk Southern, and Lehigh Valley. Additional details, including pricing, is available at the above website.







Kadee's ([kadee.com](http://kadee.com)) April production schedule lists two new HO scale ready-to-run cars. They will be a 50-ton AAR standard

twin-bay open-top hopper decorated for the Reading Railroad, and a 50' PS-1 steel boxcar with 10' sliding doors. The boxcar is lettered for Louisville & Nashville and is decorated in the original (1962) blue and silver scheme featuring "The Dixie Line" slogan.



The MSRP for the new Kadee models will be \$43.95 for the hopper and \$36.95 for the boxcar.



Kato USA ([katousa.com](http://katousa.com)) has added a baggage car to its lineup of Amtrak Superliner models. Features of the HO scale ready-to-run model include prototypical exterior fluting and appropriate trucks with working bearing caps and shock absorber. Optional Kinematic tight-lock couplers are included. The late additions to the Superliner group will be available in two road numbers in Amtrak's phase IVb scheme. The final MSRP is estimated at \$85.00 to \$90.00 each.



contents



index



**Monster Model Works ([monster-modelworks.com](http://monster-modelworks.com))** has introduced a laser-kit craftsman-style kit that makes into a distinctive HO scale structure. The model is based on a 120-year-old prototype in South Pass

City, Wyoming. Although billed as a Saloon, the storefront structure could serve almost any small-town business. The split-log siding and quarried stone foundation are made of 3D engraved basswood. All components are laser-cut and feature tab & slot construction. The finished HO scale structure has a footprint of 4.75" x 3.125" wide by 2.75" high. Visit the above website for pricing and availability.

---



**Precision Scale Models ([precision-scaleco.com](http://precision-scaleco.com))** has scheduled an April delivery date for a brass model of C&O's famous Allegheny H-8 class 2-6-6-6 steam locomotive. Three handcrafted

versions of the HO scale model will be offered based on prototype production runs delivered in 1941, 1944, and 1948. A Virginian Railway Allegheny in the 1945 as-delivered black paint and graphite smoke box scheme will also be available. Pricing is



expected to be in the range of \$3,000.00. Contact a PSC dealer for additional information.

---



**Rapido Trains ([rapido-trains.com](http://rapido-trains.com))** has released its long-awaited HO scale 37' wood side reefer that is based

on a prototype General American Transportation Corporation built between 1937 and 1941. To insure adherence to the prototype Jason Shron, owner of Rapido, employed an impressive group of freight car experts that included Ed Hawkins, Richard Hendrickson, Frank Peacock, Jerry Stewart, and Pat Wider.

The wood sheathed body and roof give the car the look of an earlier era, but the reefers were entirely modern for their time. They were constructed on a steel underframe of similar construction to boxcar underframes of the period and featured AB brakes and Barber S-1 trucks. Steel ice hatches with unique latches and Equipco brake wheels and gear housing contrast with the tongue and groove body sheathing and wood running board. To see MRH's exclusive 360° Click-n-Spin view of the model go to [vps880.inmotionhosting.com/~modelt5/assets/media/mrh11-08-std/Rapido-HO-URTX-reefer-QT.php](http://vps880.inmotionhosting.com/~modelt5/assets/media/mrh11-08-std/Rapido-HO-URTX-reefer-QT.php). A detailed study of the prototype is included in Railroad Prototype Cyclopedia #14 available at [rpcycpub.com](http://rpcycpub.com).

When new, the prototypes were typically painted yellow-orange with the roof and ends painted boxcar red. Rapido's initial release follows this pattern, with the exception of a Swift car from the 1950s decorated in distinctive red livery (above). According to Rapido, the Swift car is actually a 1936-built car



contents



index

which should have the earlier underframe arrangement with straight side sills and a vertical brake staff. Decorating schemes for all of the other wood reefers are correct for the version of the car being modeled.



Other schemes in this release include GARX-Dugdale Packing Company, GARX-American

Stores Company, URTX-Dubuque Packing, GARX-Refrigerator, URTX-Geo. A. Hormel Co., KGNX-Hygrade Food Products, KGNX-Kingan, URTX-Morris Rifkin & Son, URTX-Oscar Mayer, GARX-Tobin Packing, URTX-Refrigerator, plus a painted but unlettered car. The ready-to-run models have an MSRP of \$39.95 each. An undecorated kit is expected soon at a list price of \$34.95.

---



**Red Caboose** is scheduled to release another run of its 42' steel flat car with fishbelly side sills later this month. Seven road names will be in the run, including the Central of Georgia shown here. Others include Chesapeake & Ohio, Great Northern, Baltimore & Ohio, Pennsylvania, Canadian Pacific, and Pere Marquette. The HO scale ready-to-run models will have an MSRP of \$28.95 each. InterMountain Railway is responsible for marketing Red Caboose products. For additional information visit [intermountain-railway.com](http://intermountain-railway.com).

---



**Walthers** ([walthers.com](http://walthers.com)) is in the process of releasing four 85' Amfleet cars. The HO scale versions are based on the prototype Metroliner series Budd manufactured in the mid 1970s. The ready-to-run models will be available in various Amtrak decorating schemes. Specific information is available at the above website.

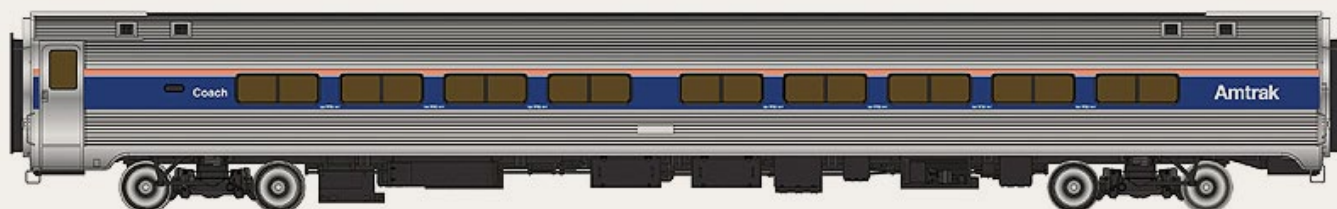

Scheduled for arrival this month are two coaches: a 59-seat car (shown above in Phase IV scheme), and an 84-seat coach (below, in the Phase I scheme with two arrows).



Two additional Amfleet cars set for arrival next month include an Amcafe (shown below in the single-arrow version of the Phase I scheme), and a lounge car (bottom, in Amtrak's Phase IVb scheme).



Models with factory installed LED lighting have an MSRP of \$89.98. Non-lighted cars list at \$79.98 each.



contents



index

Walthers plans to release another run of its Mainline® series stock cars next month. Road names will be ATSF, Great Northern (vermillion scheme), Great Northern (blue scheme), and Milwaukee Road. Features of the HO scale ready-to-run model include Dreadnaught ends and turned metal wheelsets. The MSRP will be \$24.98.



Walthers is selling its Proto® series 50' REA riveted steel express refrigerator car in four liveries. Shown

above is the early dark green paint scheme with the classic Railway Express Agency herald. The car below is decorated in light green with a modernized herald.



Also available is a Great Northern car in Pullman green. The HO scale ready-to-run models have an MSRP of \$39.98.



Walthers has released six new decorating schemes on a 37' twin-bay covered hopper. The 2989 cu. ft. car is available in two numbers each

for CDRX, GATX, GNAX, ITFX, ITLX, and MWCX. Features include 36" turned metal wheelsets. The HO scale Mainline® series ready-to-run models have an MSRP of \$24.98 each.





Coming from Walthers next month are four new decorating schemes for an ACF 8,000-gallon Type-21 Tank Car. Road names

on the Proto® series HO scale model will be Everett Distilling, Gillespie & Sons, RPX-Shell Roxana Petroleum, and COSX-Mid Continent Petroleum as shown here. The ready-to-run model will have an MSRP of \$37.98.

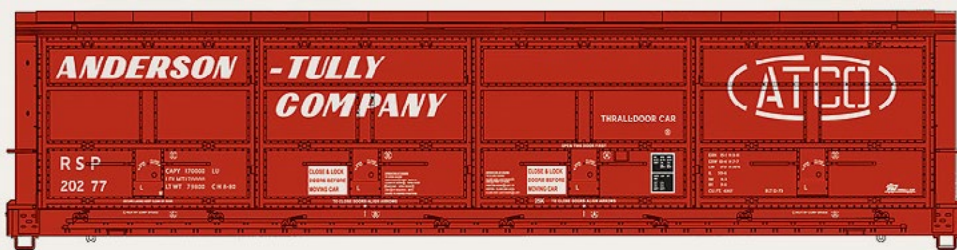

New HO scale models scheduled for April include a Thrall 56' All-Door

Boxcar. Since the last production run, the brake platforms, cross-over grabs, and ladders have been retooled. In addition to the Anderson-Tully car shown here, road names on this release will include LUNX-Brooks Scanlon, MNS-Minneapolis Northfield & Southern, and OP&E-Oregon Pacific & Eastern. The Proto® series ready-to-run model will have an MSRP of \$37.98.

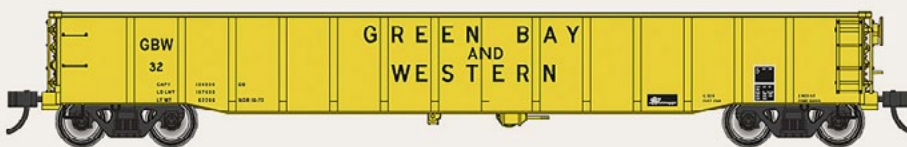

Another WalthersProto® series HO model

due in April is a Thrall 53' Gondola. The ready-to-run model will have an MSRP of \$31.98. Road names will be CNW, ICG/CN, CSX/ NYC (ex Conrail), and Green Bay & Western.



Also due in April is a UTLX 40' 16,000 gallon Funnel Flow Tank Car. WalthersProto® series



contents



index

HO scale ready-to-run model will feature etched metal walkways and platforms, and road-specific placement of manways and safety valves. In addition to the DUPX car shown above, decorating schemes will include Englehard, ACFX-Georgia Kaolin, Specialty Minerals, and JMHX-J. M. Huber.

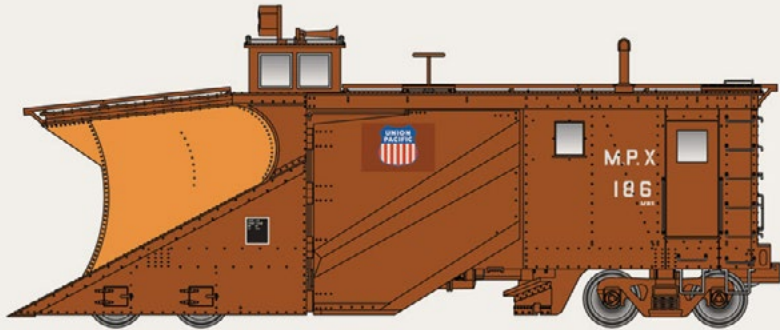

Walthers has re-tooled its Russell Snowplow and plans to release it in June as a ready-to-run Proto® series model. Road-specific details will include

either wood or steel running boards, three styles of headlights, and either a Bettendorf-style or modern roller bearing truck at the rear. Road names for the run will be Canadian National, Chesapeake & Ohio, Northern Pacific, Pennsylvania, Soo Line, and MP/UP as shown here with three-color herald. The HO scale model will have an MSRP of \$69.98. An undecorated kit also will be offered. Walthers catalog currently lists a front coupler pocket kit for its Russell plow. Item 247-311 is currently available at \$5.95, but there is no assurance that they still will be available when the plows are released in June.

---

## N SCALE PRODUCT NEWS



Athearn ([athearn.com](http://athearn.com)) has scheduled an August release date for a 40' triple-bay

rib-side hopper car. In addition to the C&O version shown, the open-top car will be available for Canadian National, union



Pacific, SLSF-Frisco, and Reading. The N scale ready-to-roll model will be priced at \$19.88 each or in four-packs at \$74.98.

---



**Bachmann** ([bachmann-trains.com](http://bachmann-trains.com)) has a motorized turntable with 12 indexed track positions. The ready-to-use N scale model features a center-off spring-loaded direc-

tion switch that controls the slow-speed gear drive system. The turntable has an MSRP of \$145.00. Although designed for use with Bachmann's E-Z Track, the manufacturer states the turntable is easily adaptable to other popular N scale track.

---

**BLMA** ([blmamodels.com](http://blmamodels.com)) will have a second production run of its 64' Union Pacific (ARMN) reefers ready for release late this year. They will be fitted with the latest Carrier Reefer Units. The N scale ready-to-run model will be available in 24 numbers at an MSRP of \$27.95 each.

---



**Centralia Car Shops** is scheduled to deliver a new run of 4-4-2 sleepers in June or July. The N scale ready-to-run models will have individual wire grabirons and truck-mounted knuckle couplers. In addition to the New York Central car shown here



contents



index

in the post-war scheme, road names will include Atlantic Coast Line, Canadian National, Long Island Railroad, Chicago & North Western, Penn Central, Union Pacific (gray scheme), and Southern Pacific (red and gray Golden State scheme). The MSRP will be \$34.95. InterMountain Railway is responsible for marketing products manufactured by Centralia Car Shops. For additional information visit [intermountain-railway.com](http://intermountain-railway.com).

---



**Kato USA** ([katousa.com](http://katousa.com)) will release its all-new aluminum Autoracks to dealers this month. The N scale models represent

a modern prototype introduced in 2004 in Canada. The fully enclosed aluminum body shell is more resistant to weather than the earlier open or grated design. The newly tooled ready-to-run model offers all-wheel electrical pickup to support the installation of aftermarket FREDs. Decorating schemes will be Canadian Pacific, Canadian National, and Amtrak as used on the Auto Train. They will be available in four-car sets at an MSRP of \$90.00.

---



**Micro-Trains Line** ([micro-trains.com](http://micro-trains.com)) has released several new ready-to-run N scale models including the

S&NC 50' rib-side boxcar shown here. It is based on a prototype built in 1980 by Pullman-Standard. The MSRP is \$27.30.





Micro-Trains has priced this 50' Erie Lackawanna steel box-car at just \$20.30.



Also newly released is a 34' Canadian National wood cabooses based on a 1943 prototype rebuilt from 30 ton box-cars. The MSRP on the cabin car is \$32.10.



M-T is selling this 36' ice reefer decorated for Peter Fox Brewing at an MSRP of \$26.95. Note the double-sheathed wood sides and ends on this truss rod-era model.



Also new from Micro-Trains is a 39' ACF single-dome tank car decorated for SHPX-Sherwood Refining Company.

The MSRP on the N scale ready-to-run model is \$26.95.

---

**Rapido Trains ([rapidotrains.com](http://rapidotrains.com))** has extended the order date for its Panorama-series 10-5 sleepers and café-bar-lounge cars until February 14th. Production will begin in March, with delivery anticipated in late spring. In addition to the Erie-Lackawanna



contents



index



car illustrated here, decorating schemes will include Erie (two-tone green), Amtrak (Phase I), Great Northern, Baltimore & Ohio, Milwaukee Road, Missouri Pacific, New York Central, Northern Pacific, Southern Pacific, Via Rail Canada, Canadian National (1954 scheme), and CN (wet noodle). An undecorated model also will be available. For complete details on Rapido's N scale Panorama cars visit the manufacturer's website or see the August 2013 edition of MRH at [mrhpub.com/2013-08-aug/port/#257](http://mrhpub.com/2013-08-aug/port/#257).



Here is an early engineering sample of Rapido's N scale Canadian National GMD-1A freight locomotive. Designed by

General Motors of London, Ontario, the initial prototypes were delivered to CN and Northern Alberta Railways in the late 1950s. CN still has many of the versatile locomotives in regular service. Rapido's N scale version will be available with a DC/DCC dual mode ESU decoder or an ESU DC/DCC/Sound LokSound decoder, full cab interior, and body-mounted Micro-Trains couplers. Development of the locomotive is still a work-in-process and Rapido would like to hear from hobbyists with suggestions for special features or information on variations on specific road numbers. Submit your suggestions by email to [rapido3@rapidotrains.com](mailto:rapido3@rapidotrains.com) – Attention: Mike.



**Trainworx** is scheduled to deliver a new N scale model of NACC PD3000 covered hopper cars this summer. Ten decorating schemes will be offered including AEX-Anderson Rail, BM-Boston & Maine, DSIX-Dowell Schlumberger, FURX-First Union Rail, GACX-General American, and MLX-Millpark Drilling Fluids. The mix also includes four NAHX cars: Ideal White Cement, Milchem, North American (red), and North American (white body with Roman lettering). The ready-to-run models will have an MSRP of \$27.95.

Also scheduled to arrive from Trainworx late this summer is a Great Northern TOFC flat car and a selection of eight drop-frame trailers decorated for GN and Northern Pacific. InterMountain Railway is responsible for marketing Trainworx brand models. For additional information visit [intermountain-railway.com](http://intermountain-railway.com).

---

## NEW DECALS, SIGNS AND FINISHING PRODUCTS

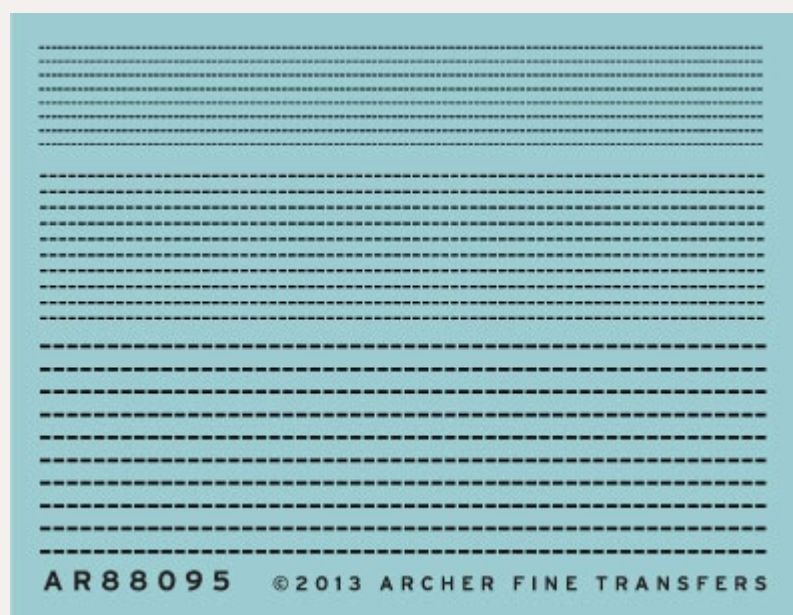

**Archer Transfers** ([archertransfers.com](http://archertransfers.com)) has a new decal set of generic piano hinges suitable for use in various scales. The 2.75" x 2.25" sheet has three different sizes of resin piano hinge. Visit the above

website for pricing and availability.

---



contents



index

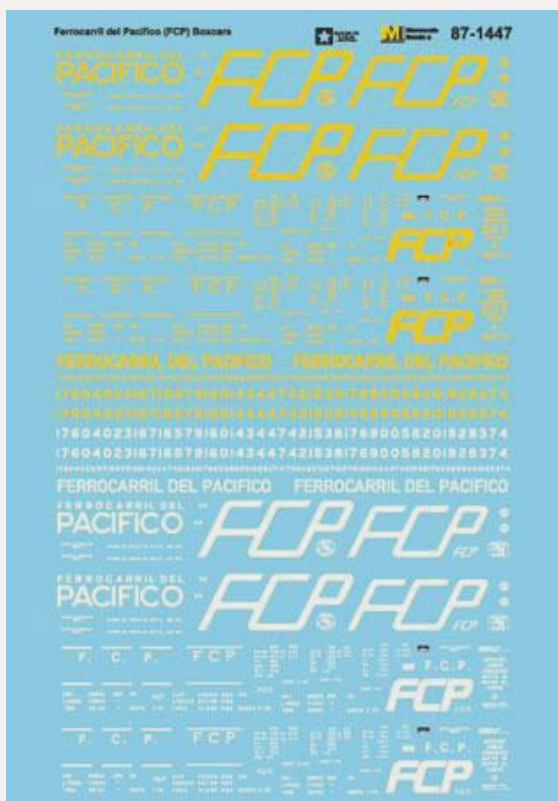

New HO and N scale decals from **Microscale Industries** ([microscale.com](http://microscale.com)) include complete lettering sets for Ferrocarril del Pacifico (FCP) boxcars.

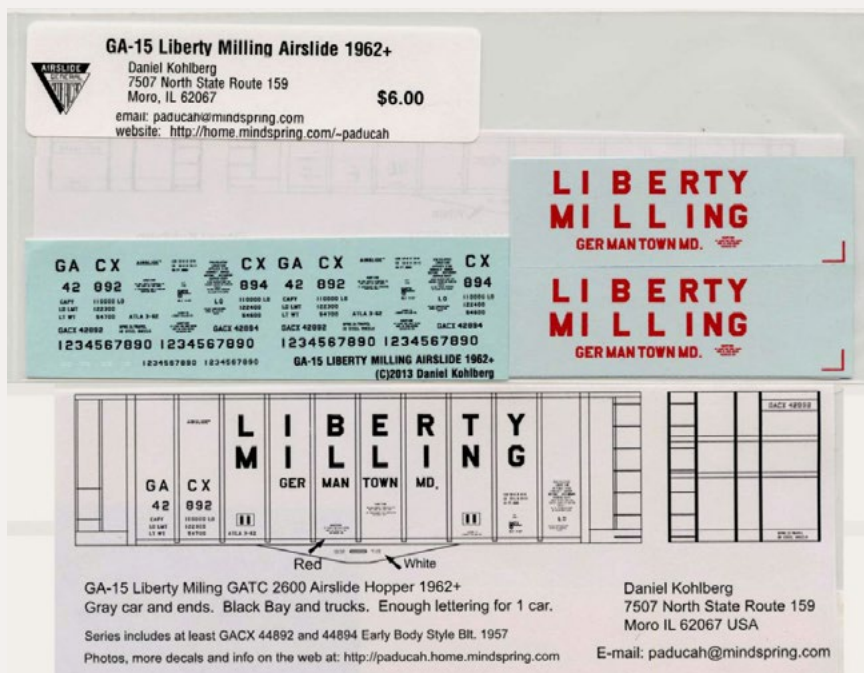

**Dan Kohlberg** ([paducah.home.mindspring.com](http://paducah.home.mindspring.com)) has released the following new HO scale decals for GM&O and GN/BN boxcars, and private milling Airslide hoppers: Liberty Milling General American

2600 cu. ft. single-bay Airslide (GA-15), Mennel Milling General American 2600 cu. ft. single-bay Airslide (GA-16), Great Northern 50' Plate-C double-door boxcar (BN-04), Burlington Northern 50' Plate-C double-door boxcar (BN-05), GM&O 50' PS-1 green boxcar DF non-cushioned (ICG-67), GM&O 50' PS-1 green boxcar with 40" Hydroframe cushioning (ICG-68), and GM&O 50' PS-1





green boxcar with 60" Hydroframe cushioning (ICG-69). Visit the above website for full details including pricing and ordering information.

---

**San Juan Decals** ([sanjuandecals.com](http://sanjuandecals.com)) has released a new 1:20.3 scale lettering set for a D&RG 4000 series boxcar. Item SJD-299 is available now at \$10.95.

---

### **DISCLAIMER ..**

The opinions expressed in this column are those of the writer and do not necessarily reflect the opinion of Model Railroad Hobbyist or its sponsors. Every effort is made to provide our readers with accurate and responsible news and information, however, neither Model Railroad Hobbyist or the writer of this column can be held responsible for any inaccuracies or typographical errors that may inadvertently appear in this column.



## **Send us your product announcements**

If you are a hobby manufacturer with a product announcement, just [click here](#) and submit your announcement to us. Our website and free magazine reach continues to grow, so get on board with this new media train that's hard to stop!



contents



index

## Briefly noted at press time...

... The Amherst Railroad Hobby Show, held each year in West Springfield, Massachusetts, is one of the largest and more important annual shows for model railroad hobbyists and suppliers alike. This year's event was held in late January and several MRH staff members were in attendance. Here is a brief recap on some of the new items that caught their eye.

**ExactRail** previewed their all-new Bethlehem 4000 open-top hopper cars. The modern Evolution series HO scale model is ready-to-run. Also on display was ExactRail's new Evans 4780 covered hopper that will be released in seven new road names.

**Bachmann's** large product booth was full of models from N through G scale. Among the more popular attractions was a well-executed HO GG-1 Electric Locomotive aptly decorated in Pennsy livery.

**Eastern Seaboard Models** showed preproduction samples of their N scale Burlington class XML-14 (ex-X58) boxcars. No firm release dates yet.

**Hornby America** showed several undecorated preproduction samples of its forthcoming HO scale U25C diesel locomotives. The company handles the distribution of several European brands in North American including Rivarossi.

**Bowser** had samples of a number of future products on display including M-636 and Alco C-636 diesel locomotives. Also a new H30 class covered hopper. All should be available late this year.

**Atlas** showcased their N scale PS 2750 hopper car along with a new 70-ton Hart Ballast car that will be released in several new road names.

**Walthers** large product booth included several pre-production models including its recently-announced Russell snow plow. Although appropriate for January weather in West Springfield, the HO scale model won't be ready for delivery until sometime



this summer. Also available for close inspection were samples of Walthers recently announced HO Proto series SD7 and SD9 diesel locomotives.

**Athearn** continues to focus on EMD products with the announcement of a long hood SD70M with flared radiators. Developing the project involved some new tooling combined with existing SD70 components. Additional new HO scale items coming from Athearn this fall are SD40-2 diesels decorated for Conrail, Florida East Coast, and BNSF's Heritage I scheme. Athearn also showed off its handsome FEF 4-8-4 steam locomotive decorated in four different Union Pacific paint schemes, along with a Genesis edition of a Canadian GP9.

**Rapido** displayed samples of seven new road names for the second run of their hot-selling General American 37' wood-side meat reefer. The run is scheduled for late this year and will include another Swift car – this time in a yellow body. Other road names will be Abraham Bros, Armour, Cudahy, Decker, Wilson, and WIMP.

Watch for more details on these and other new products in the next edition of MRH. ■

26,000 have read this MRH forum thread - *have you?*

[Home](#) / [Forums](#) / [Track and electrical/DCC](#) / [What DCC system do you use - and why?](#)

## What DCC system do you use - and why?

Mon, 2010-08-02 11:03 — [joef](#) [Track and electrical/DCC](#) [DCC - Electrical](#)

I'm curious what DCC system various modelers on here are using, and why? I think the discussion could be useful - so post a bit about the system you use and how you came to chose it. Also if you have any interesting learnings, that's always helpful!

[< Wire guage](#)

[Getting ready for First DCC Install >](#)

Read  
now



contents



index



## Selected Events

### February 2014

**CANADA, ONTARIO, BARRIE**, February 15-16, 44th Annual Barrie Allandale Model Train Show, “under the glass” at Bradford Greenhouse, 4346 County Road 90. Info at [barm.ca](http://barm.ca).

**CALIFORNIA, SANTA CLARA**, February 6-8, O Scale West and S West combined meets with both standard and narrow gauge modular layouts, clinics, videos, and contests. Hyatt Regency, 5101 Great America Parkway. Info at [oscalewest.com](http://oscalewest.com).

**MARYLAND, TIMONIUM**, February 1-2, Great Scale Model Train Show featuring more than 700 vendors. Produced by Howard Zane at State Fairgrounds, 2200 Yorke Road.

**OREGON, PORTLAND**, February 1, SP&S Railway Historical Society Railroad Swap Meet, Holiday Inn at Portland Airport, 8439 NE Columbia Blvd., Portland, Oregon. Additional information from Jerry Pickell at [pickell5141@nsn.com](mailto:pickell5141@nsn.com) or call 360-735-0516.

**SOUTH CAROLINA, EASLEY**, February 1-2, Annual Train Show with HO layouts, G scale live steam, motor cars, kids activities, and 200+ vendors. Sponsored by Central Railway Model & Historical Association, at Larry Bagwell Gymnasium, 111 Walkers Way. Info at [CRMHA.org](http://CRMHA.org).

**TEXAS, IRVING (Dallas area)**, February 26-March 1, 29th Annual Sn3 Symposium, at Sheraton DFW. Info at [Sn3-2014.com](http://Sn3-2014.com).





**TEXAS, HOUSTON**, February 15, Greater Houston Train Show featuring 20,000 square feet of operating layouts, instructive classes, photo and model contests, and vendor displays, presented by San Jacinto Model Railroad Club. At Stafford Centre, 10505 Cash Road. Info at [sanjac.leoslair.com](http://sanjac.leoslair.com).

**UTAH, OGDEN**, February 28 - March 2, 25th Annual Hostlers Model Railroad Festival, at Union Station, 25th Street and Wall Avenue. Info at [hostlers.info](http://hostlers.info).

## March 2014

**DENVER, COLORADO**, March 1-2, Largest all-scales model railroad show West of the Mississippi. Denver Mart, 451 E. 58th Ave., Denver, CO 80216. \$9 Admission, and under 12 free. Discount coupon available on our website ([rockymountainToy-trainshow.com](http://rockymountainToy-trainshow.com)). 2-1/2 acres filled with 30 operating layouts, 600 sales tables, free modeling clinics, and many national manufacturers in attendance.

**CANADA, TORONTO**, March 15, Toronto Railway Prototype Modellers Meet, at Humber College, North Campus, Building B, rooms B201& B202. \$10.00 admission. Info at [torontoprototypemodellers.wordpress.com](http://torontoprototypemodellers.wordpress.com), or contact Brian Gauer at [bdgauer@rogers.com](mailto:bdgauer@rogers.com).

**ILLINOIS, LOMBARD**, March 14-16, Chicago O Scale Meet, at Westin Lombard Yorktown Center. Info at [marchmeet.net](http://marchmeet.net).

**MISSOURI, SPRINGFIELD**, March 15, 36th Annual Train/Swap Meet with operating layouts, kids activities, track laying contest, switching challenge, and appraisals/diagnostics for pre-1970 trains. At Remington's, 1655 W. Republic Road. Info at [omraspringfield.org](http://omraspringfield.org).



contents



index

**OHIO, GREENFIELD**, March 20-22, 21st Annual Midwest Narrow Gauge Railroad Show, cosponsored by the Cleveland Narrow Gauge Society and the Mini Bunch. With clinics, vendor tables, and tour of Baird Brothers Sawmill. At Greenfield Space Center and Smokehouse Restaurant, Route 165. Info at [maine-2footquarterly.com/midwest.htm](http://maine-2footquarterly.com/midwest.htm) or [midwestnarrowgauge-show@yahogroups.com](mailto:midwestnarrowgauge-show@yahogroups.com).

**OKLAHOMA, TULSA**, March 21-23, 5th Annual Layout Design & Operations Weekend, sponsored by NMRA Indian Nations Division in conjunction with the Layout Design and Operations SIGs. At Shriner's Temple, 28th and Sheridan. Info at [ldopsig-meet.tulsanmra.org](http://ldopsig-meet.tulsanmra.org).

**OREGON, ELSIE**, March 1, 10th Annual Pacific Model Loggers' Congress, hosted by Lon Wall and Jeff Johnston. At Camp 18 Restaurant & Logging Museum, 42362 Highway 26. Info at [pacificmodelloggerscongress.com](http://pacificmodelloggerscongress.com).

**OREGON, PORTLAND**, March 15, 29th Annual Model Railroad Swap Meet, sponsored by Willamette Model Railroad Club, Kliever Memorial Armory, 10000 NE 33rd Drive. Info from Keith Kieres at [wmrswapmeet@yahoo.com](mailto:wmrswapmeet@yahoo.com).

**PENNSYLVANIA, MALVERN**, March 28-30, 6th Railroad Prototype Modelers Valley Forge Meet, at Desmond Great Valley Hotel. Info at [phillynmra.org/rpmmeet.html](http://phillynmra.org/rpmmeet.html).

## **Future (By location)**

**AUSTRALIA, NSW, ALBURY**, May 24-25, 2014, Annual Train Show sponsored by the Murray Railway Modellers Inc., at Mirambeena Community Centre, 19 Martha Mews, Lavington. Info at [murrayrailwaymodellers.com](http://murrayrailwaymodellers.com).





**CANADA, ONTARIO, OTTAWA**, April 26-27, 2014, Ottawa Train Expo sponsored by Bytown Railway Society. At Ernst & Young Centre, 4899 Uplands Drive. Info at [ottawatrainexpo.com](http://ottawatrainexpo.com).

**NEW ZEALAND, DUNEDIN**, May 10-11, 2014, Dunedin Model Train Show at Forbury Park, 146 Victoria Road. Info at [dunedin-modeltrainshow@vodafone.co.nz](mailto:dunedin-modeltrainshow@vodafone.co.nz).

**CALIFORNIA, SAN LUIS OBISPO**, April 30-May 4, 2014, NMRA/PCR Pacific Coast Region Convention, Sands Inn & Suites, 1930 Monterey Street. Info at [pcrnmra.org/conv2014](http://pcrnmra.org/conv2014).

**CONNECTICUT, COLLINSVILLE**, May 30-31, 2014, New England/Northeast Prototype Modelers Meet. Info at [neprototype-meet.com](http://neprototype-meet.com).

**GEORGIA, KENNESAW**, September 19-20, 2014, Atlanta Railroads Prototype Modelers Meet, sponsored by the Southern Railway Historical Association, Atlantic Coast Line & Seaboard Airline Railroads Historical Society, Central of Georgia Railway Historical Society, and Nashville Chattanooga & St Louis Preservation Society. At the Southern Museum of Civil War and Locomotive History, 2829 Cherokee St. Info at [srha.net](http://srha.net) or contact Frank Greene at [frgreene290@comcast.net](mailto:frgreene290@comcast.net).

**ILLINOIS, COLLINSVILLE (Metro St. Louis, Missouri)**, August 8-9, 2014, St. Louis Railroad Prototype Modeler's Meet, with clinics, displays, manufacturer's exhibits, layout visits and operating sessions. At Gateway Convention Center. Info at [icg.home.mindspring.com/rpm/stlrpm.htm](http://icg.home.mindspring.com/rpm/stlrpm.htm).

**INDIANA, INDIANAPOLIS**, July 3-10, 2016, NMRA National Convention and National Train Show. Info at [nmra2016.org](http://nmra2016.org).



contents



index

**MAINE, AUGUSTA**, Sept. 7-10, 2016, 36th National Narrow Gauge Convention. Info at [nngc2016.org](http://nngc2016.org).

**KANSAS, OVERLAND PARK (Metro Kansas City, MO)**, September 3-6, 2014, 34th National Narrow Gauge Convention. Info at [kansascity2014.com](http://kansascity2014.com).

**NORTH CAROLINA, SPENCER**, May 29-June 1, 2014, Streamliners at Spencer, a gathering of prototype locomotives from the 1930s through the 1950s at the North Carolina Transportation Museum including an Atlantic Coast Line E3 and the Southern Railway's E8 and FP7. Details at [nctrans.org/Events/Streamliners-at-Spencer-\(1\).aspx](http://nctrans.org/Events/Streamliners-at-Spencer-(1).aspx).

**OHIO, CLEVELAND**, July 13-19, 2014, NMRA National Convention and National Train Show. Info at [2014cleveland.org](http://2014cleveland.org).

**OREGON, PORTLAND**, August 23-30, 2015, NMRA National Convention and National Train Show. Info at [nmra2015.org](http://nmra2015.org).

**PENNSYLVANIA, MONACA**, April 13, 2014, Beaver County Spring Model Train Show, at Center Stage, 1495 Old Brodhead Road. Info at [bcmrr.railfan.net](http://bcmrr.railfan.net) or contact Walt Steiner at 724-843-3783.

**TEXAS, HOUSTON**, 2015, September 2-5, 2015, 35th National Narrow Gauge Convention. Info at [nngc-2015.com](http://nngc-2015.com).

**VIRGINIA, STAFFORD**, September 12-13, 2014, Mid-Atlantic Railroad Prototype Modelers Meet, with model displays, clinics, and RPM camaraderie. Wingate by Wyndham Hotel, Fredericksburg, VA. Info at [marpm.org](http://marpm.org). ■







# MRH's streaming internet TV channel for Model Railroaders

## TMTV Subscription

**\$5.99 / month**

*MRH subscribers  
(save 20%)*

1 year: ~~\$71.88~~

**\$55**

**\$44.00**

2 year: ~~\$143.76~~

**\$99**

**\$79.20**

*(best value)*

*MRH subscribers: get TMTV discount code on Feb bonus downloads page*

**Visit TrainMasters.TV website**





# Unlimited hobby money?

## Reverse Running: Stepping outside the box with a contrary view

by Don Hanley

**W**henever our four-year-old grandson sees an advertisement for a toy, he looks at us and says, "I need that."

How often do we look through the ads in MRH or a catalog and think, "I need that?" Our eyes are bigger than our bank account.

Let's look at some advantages of having limited model railroading resources.

Let's begin with the layout.

Instead of space for a 200' x 200' layout, you must work with the space you have, say 20' x 20'. How is that an advantage? Like many of us – we really don't realize how much is required to build a scenicked layout.

When building the layout, you often find it doesn't go as fast as you thought. You find that siding needs to be extended by 3" to maintain desired capacity and clearances. No problem: you just lengthen it and adjust a turnout location.

Oh-oh, the turnout is over a riser and that turnout must be powered. Now you need to adjust the location of the riser, but to do that you need to change the town area supports ... and so it goes.

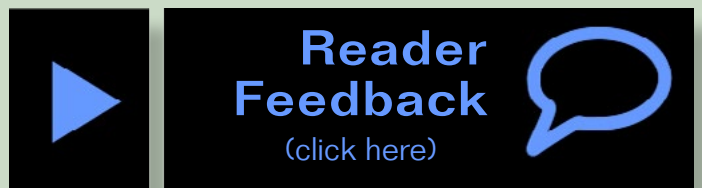



What about rolling stock or structures? Can limited funds be an advantage? Instead of purchasing all the latest highly detailed rolling stock for \$50 per car, develop the skills needed to add details to existing rolling stock.

Before you think, "I can't do that -- upgrading used cars," consider the tools and parts needed are minimal: X-Acto knife, pin vise with drill bits, tweezers, the necessary detail parts, paint, decals, and the willingness to learn. If you ruin the first few cars – so what? You only spent a few dollars on each one: consider it the cost of getting some hobby training.

If during this process you come up with a innovative way to achieve the results you desire, you have developed something better and succeeded at it.

There's a satisfying sense of pride and a feeling of accomplishment every time you look at what you have created, knowing the obstacles you overcame to finish it. You're then encouraged to do more, and to push the limits of your abilities.

I know it works this way for me. If you can purchase whatever you want, you will never know that sense of pride or accomplishment.

The time you spend building the models adds value to them. They serve as reminders of what you have accomplished in the hobby and how your skills have grown. I say the purpose of the hobby is to become railroad *modelers*. If you buy everything that you want, would you really be a railroad modeler or just a train collector?

As Plato said "Necessity is the mother of invention." 



contents



index

# Clickable advertiser index

[Accu-Lites](#)  
[Accurail](#)  
[Archer Fine Transfers](#)  
[Bachmann](#)  
[Backrus](#)  
[Backdrop Junction](#)  
[Berrett Hill \(1\)](#)  
[Berrett Hill \(2\)](#)  
[Blackstone](#)  
[Blair Line](#)  
[BLMA](#)  
[BEST](#)  
[Bowser](#)  
[Clever Models](#)  
[Coffman Graphics](#)  
[Con-Cor](#)  
[Coastmans Scenic Products](#)  
[Credit Valley](#)  
[DCC by Design](#)  
[Digitrax \(2 page spread\)](#)  
[ExactRail](#)  
[ESU](#)  
[Fast Tracks](#)  
[Fifer Hobby Supply](#)  
[Fox Valley](#)  
[GLX Scale Models](#)  
[Iowa Scaled Engineering](#)  
[Iwata-Medea](#)  
[Jelsma](#)  
[Litchfield Station](#)  
[Logic Rail Technologies](#)  
[Microscale](#)  
[Minimalist Model Railroad](#)  
[Model Railroad Benchwork](#)  
[Motrack Models](#)  
[MRH Store \(Model Trains Video\)](#)  
[M.T.H.](#)  
[Mullet River \(O scale\)](#)  
[Nano-Oil](#)  
[NCE \(2 page spread\)](#)  
[North American Railcar](#)  
[Olin's Depot](#)  
[Ottawa Train Show](#)  
[Rail Design Services](#)  
[RailMaster Hobbies](#)  
[Railroad Explorer](#)  
[Rapido \(2 page spread\)](#)  
[Ring Engineering \(1\)](#)  
[Ring Engineering \(2\)](#)  
[RLN Publishing](#)  
[RSlaserKits](#)  
[Rulers-of-the-World](#)  
[Rusty Stumps](#)  
[SAZ Models](#)  
[Streamlined Backshop](#)  
[Scenic Express](#)  
[Scotty Mason Show](#)  
[Southern Digital](#)  
[TAM Valley Depot](#)  
[TrainMasters \(1\)](#)  
[TrainMasters \(2\)](#)  
[Traintek LLC](#)  
[True Line Trains](#)  
[True Scene Modeling](#)  
[Westerfield Models](#)  
[Yankee Dabblers](#)  
[Yarmouth Model Works](#)





# Clickable topic index

[DCC Impulses – Unraveling DCC Addresses](#)

[Editorial – Publisher’s Musings](#)

[Editorial – Reverse running](#)

[Getting Real – 1950s Auto transport semi-trailer](#)

[The Lite and Narrow – Evolution of my Railroad](#)

[Layout – Journey to Allagash Country Part 2](#)

[News – February Newsletter](#)

[News – February Events](#)

[Q and A – MRH Questions, Answers, and Tips](#)

[Rolling Stock – Modeling 21st Century Commuter rail](#)

[Structures – Structures in tight places](#)

[Trackwork – Ultimate turnout control protection](#)

[Track Plan – Track plan database](#)

[Yes It's a Model – Monthly photo albumn](#)

[What’s Neat – Blade masters, industrial bins, autoracks](#)

---

[Other – Bonus Extras](#)

[Other – Cover](#)

[Other – Derailments](#)

[Other – Hobby Marketplace](#)

[Other – MRH Sponsors](#)

[Other – Staff Notes](#)

[Other – Table of Contents](#)

# Derailments

humor and bizarre facts (allegedly)



Who says you need a mountain to have tunnel portals?



So much for making reservations: Yes there's a train in there (look close) ...



# For the love of model trains

## March issue coming Feb 24

- Batch building freight cars
- Using vises and angle plates to improve your modeling
- Bob Bartizek's O-scale Pennsy
- Kit bashing a Seaboard BQ23
- Railroad merit badge
- First Look: MicroLux paint  
*...and lots more!*



## More Derailments ...



Well, there goes the neighborhood ...

If God had meant for us to fly, he wouldn't have given us the railways.  
— *Unknown*

If you're the first to [submit a bit of good humor](#) and we use it, it's worth \$25!



**Reader Feedback**  
(click here)



Coming next issue



contents



index