

DCC short protection • Battery-powered locos • Fast clock

# Model Railroad Hobbyist magazine™

November 2014

Price: Forever Free

*Eric Warhol details an*  
**Extended-vision  
BN caboose**



Click here for the  
landscape version



Standard edition - Portrait



download



contents



index



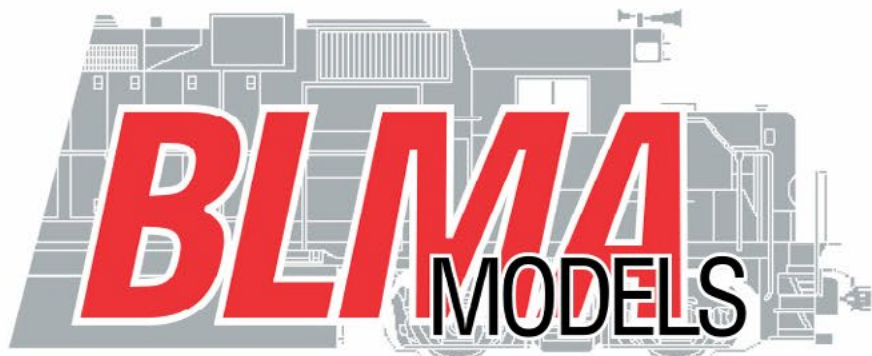

HO & N SCALE



# ★ Brass Bridge ★

Introducing the *Second Release*

▶ **200' TRUSS BRIDGE**

**CLICK HERE TO SEE MORE**





# Model Railroad Hobbyist magazine™

Issue 57

**Front Cover:** Eric Warhol walks us through the process of detailing a BN Extended-vision caboose for his garden railroad in this issue's cover story.

**ISSN 2152-7423**

## Editorial Staff

Joe D. Fugate, Publisher and Editor  
Don Hanley, Assistant Editor

## Production

Patty Fugate, pasteup and layout  
Joe Brugger, copy editing  
Mike Dodd, copy editing

## Technical Assistants

Jeff Shultz  
Jimmy Simmons

## Advertising

Les Halmos, Account Manager  
Daniel Nava, Advertising Assistant  
Jean-François Delisle, Marketing Assistant

Published for the glory of God. [What's this?](#)



## Columnists

Richard Bale, News and events  
Jeff Shultz, News and events  
Les Halmos, Modular railroading  
Larry Smith, Narrow Gauge/Shortlines  
Bruce Petrarca, DCC  
Ken Patterson, Reporter at large

## Special Correspondents

Joe Brugger, Questions & answers  
Charlie Comstock, Contributing editor

Issue password: Nov2014

Cover and MRH masthead



contents



index





click to learn more about this sponsor



click to learn more about this sponsor



click to learn more about this sponsor



**NEW SPONSOR!**



click to learn more about this sponsor



click to learn more about this sponsor



click to learn more about this sponsor

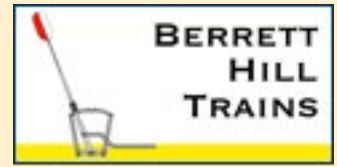

click to learn more about this sponsor



click to learn more about this sponsor



click to learn more about this sponsor



click to learn more about this sponsor



**NEW SPONSOR!**



click to learn more about this sponsor



click to learn more about this sponsor



click to learn more about this sponsor



click to learn more about this sponsor



click to learn more about this sponsor



click to learn more about this sponsor



click to learn more about this sponsor



click to learn more about this sponsor



**NEW SPONSOR!**



click to learn more about this sponsor



click to learn more about this sponsor



**NEW SPONSOR!**



click to learn more about this sponsor



click to learn more about this sponsor



**NEW SPONSOR!**



click to learn more about this sponsor



click to learn more about this sponsor



click to learn more about this sponsor



click to learn more about this sponsor



**NEW SPONSOR!**



click to learn more about this sponsor



click to learn more about this sponsor



click to learn more about this sponsor



click to learn more about this sponsor







click to learn more about this sponsor



**NEW SPONSOR!**



click to learn more about this sponsor



click to learn more about this sponsor



click to learn more about this sponsor



click to learn more about this sponsor



click to learn more about this sponsor



click to learn more about this sponsor



click to learn more about this sponsor



click to learn more about this sponsor



click to learn more about this sponsor



click to learn more about this sponsor



click to learn more about this sponsor



click to learn more about this sponsor

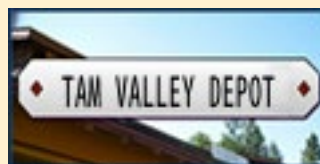

click to learn more about this sponsor



click to learn more about this sponsor



click to learn more about this sponsor



click to learn more about this sponsor



**NEW SPONSOR!**



click to learn more about this sponsor



**NEW SPONSOR!**



click to learn more about this sponsor

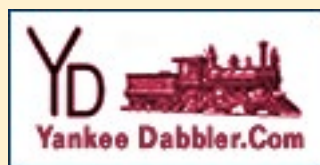

click to learn more about this sponsor

100,000+ unique device views per month...

**Want your logo on this page?**

Click to find out how....

**Tell me more**

Looking for something? Check our Hobby Marketplace!

<b>MRH HOBBY MARKETPLACE - 1</b>		<b>MRH HOBBY MARKETPLACE - 2</b>	
<b>STREAMLINED BACKDROP</b> www.SBS4DCC.com	<b>CLICK TO SEE THE DIRTY TRUTH ABOUT 3D PRINTING</b> Dave's Model Railroad Stuff www.davesmodel.com	<b>RULERS-of-the-WORLD</b> Scale Rulers \$4 each Over 150 scales! Metric or Imperial www.rulers-of-the-world.com	<b>2015 Trolley Calendar</b> Color cover; 13 B&W photos with descriptive captions from mid-Atlantic area: PTC, PSL, SEPTA, UVI, Wilkes-Barre, Baltimore, York and others. To order the calendar by check or money order (payable to East Penn Traction Club), please send it to: East Penn Traction Club c/o Charles Long 227 Locust Road Fort Washington, PA 19034-1425
<b>DCC SOUND CARS</b> www.SBS4DCC.com	<b>An Affair with Trains</b> Your Arizona Model Railroad Hobby Headquarters Shop, Auction, & Car 24 Hour Web Store: www.azmodel.com	<b>Need a Track Plan?</b> click HERE to learn more	only \$5.99
<b>Backdrop Junction</b> Your stop for Model Railroad Backdrops	<b>Great Decals!</b> FEC, Interstate, Virginian Railway, & L&N Ties Alter Hours Graphics Line Coupler Gages and More In O, S, HO, and N Scales	<b>MRH allowed this video to be posted?</b>	

**Take me there**





# Table of Contents - 1

## Main Features

*Click title  
to view*



### Tool shed:

Files, rifflers and reamers

*by Jack Burgess*



### USA Trains extended-vision caboose

Detailing a large-scale caboose for BN

*by Eric Warhol*



### Battery-powered models

Moving to dead rail

*by Dr. Geoff Bunza*



### PanAm SD45R part 2

Building a contest-quality locomotive

*by Andrew Castle*



### Portable air supply

A low cost alternative to an air compressor

*By Ronald Christopher LeMay*

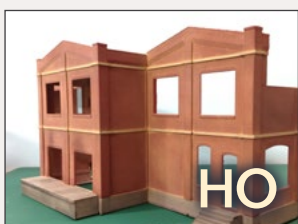

### Hiding modular seams

Clever trick for dealing with seams on modular kits

*by Jason Miller*

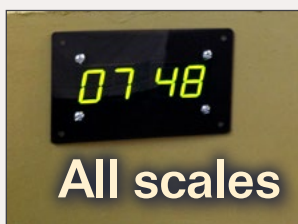

### First look:

Iowa Scaled  
fast clock



### Nov News

*by Richard Bale &  
Jeff Shultz*





## Table of Contents - 2

# Other Features

*Click title  
to view*

**Thanksgiving season**

**Assistant editor's thoughts**  
*by Don Hanley*

**MRH Staff Notes**

**Video survey results**  
*by the MRH staff*

**MRH Q - A - T**

**Questions, Answers, and Tips**  
*compiled by Joe Brugger*

**Yes, it's a model**

**Great modeling photo feature**  
*compiled by MRH staff*

**Hobby Marketplace**

**Vendor ads**

**Derailments**

**Our attempt at humor**

# Columns

**Short protection**

**DCC Impulses**  
*by Bruce Petrarca*

**Adapting prototype ops**

**Getting Real**  
*by Jack Burgess*

**Soundtraxx 7-Band Equalizer**

**What's Neat This Week**  
*by Ken Patterson*

**Watching others run trains?**

**Reverse Running**  
*by Joe Fugate*

**Subscriber-only extras** (*subscribers click here to access*)





# *NCE The Power*

**New Web Site!**

[www.ncedcc.com](http://www.ncedcc.com)

New products

How to Videos

New Listings

Information Station

Secure Online Sales



# NCE

*The Power of DCC*

C  
for F  
support@





# Power of DCC

The screenshot shows the NCE website interface. At the top, there's a navigation bar with links for Information, How To Video, Online Store, Dealer List, and Login/Sign up. A Facebook icon is also present. Below the navigation, there are two main links: "Go to the NCE Information Station" and "What is DCC?". The main content area is a grid of 15 product categories, each with a representative image, a title, and two buttons: "Information" and "Buy Now".

New Products	DCC Systems	Mobile Decoders	Throttles and Cabs	Accessory Decoders
Information	Information	Information	Information	Information
Buy Now	Buy Now	Buy Now	Buy Now	Buy Now
Cab Bus Accessories	Circuit Breakers	Boosters	Command Stations	Parts and Pieces Depot
Information	Information	Information	Information	Information
Buy Now	Buy Now	Buy Now	Buy Now	Buy Now
Automation and Detection	Jacks and Panels	Cables	Power Supplies	NCE Merchandise
Information	Information	Information	Information	Information
Buy Now	Buy Now	Buy Now	Buy Now	Buy Now

## Discover the FUN!

• Made in the U.S.A. •

Call or Email  
FREE Brochure  
@ncecorporation.com

585.265.0230  
9am-4pm EST.  
www.ncedcc.com





FLUTED PASSENGER CARS FROM RAPIDO TRAINS INC

SUPERIOR *Stainless*



DOME  
CARS!







# Thanksgiving season

Appreciating our great hobby



## Assistant Editor's thoughts

by Don Hanley

**H**ere in the USA, Thanksgiving is approaching again, and so I have been thinking about the different aspects of the hobby for which I am thankful. As I see it, there are two primary parts to the hobby; one the hobbyist, the other the products. Both are equally important; you can't have one without the other.

I recently attended an operating session at a friend's layout. A regular group of five or six of us get together, along with others who attend on an irregular basis. At the last session I had the opportunity to meet someone new, as well as renew some acquaintances. In addition to running the trains, I enjoy the fellowship with the guys.

Part of the session is sharing work that we have completed on our models. As a transplant from the Midwest to the West, I get some good-natured teasing about modeling "that road that begins with an E, Erie," or when I bring some of my modeling work to share I am asked if it has "the 'E-word' on it."

Another common question is, "what have you accomplished on your layout?" For me, it was "I finished scratchbuilding two skewed through-girder bridges, but not much else.





# TAKE CONTROL WITH OUR DIGITAL TRAIN SETS IN BOTH HO AND N SCALE!

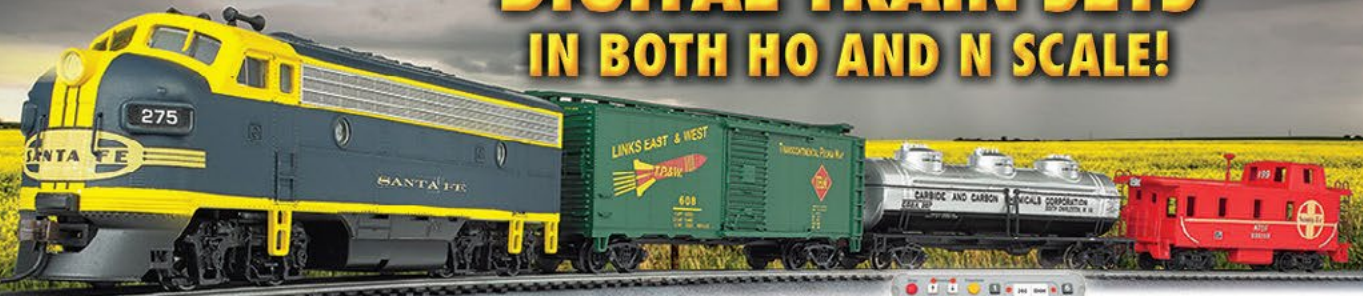

**THUNDER CHIEF with DIGITAL SOUND**  
 Item No. 00826 • MSRP \$349.00 • Shipping now!



E-Z Command® Control Center with Plug-In Wiring

Bachmann offers DCC-equipped ready-to-run electric train sets for both HO and N scale modelers. Our sets include everything needed to get started in DCC model railroading: locomotive, cars, nickel silver *E-Z Track*®, power pack, and *E-Z Command*® Controller. Our Digital Sound sets—the *Echo Valley Express* and *Thunder Chief*—include a DCC sound-equipped locomotive with either a steam or diesel sound package. The HO *Digital Commander* and N scale *Golden Spike*® each come with two DCC-equipped diesels. Visit your favorite hobby dealer to take control with these complete train packages!

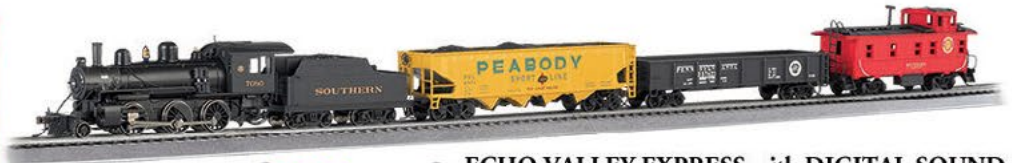

**ECHO VALLEY EXPRESS with DIGITAL SOUND**  
 Item No. 00825  
 MSRP \$349.00  
**SHIPPING NOW!**



E-Z Command® Control Center with Plug-In Wiring



**DIGITAL COMMANDER with DIGITAL CONTROL**  
 Item No. 00501  
 MSRP \$399.00  
**SHIPPING NOW!**



E-Z Command® Control Center with Plug-In Wiring



Click for more information.



**GOLDEN SPIKE® with DIGITAL CONTROL**  
 Item No. 24131  
 MSRP \$459.00  
**SHIPPING WINTER 2014**



E-Z Command® Control Center with Plug-In Wiring



Bachmann Industries, Inc. • 1400 East Erie Avenue • Philadelphia, PA 19124 USA • [www.bachmanntrains.com](http://www.bachmanntrains.com)

Click to learn more.





Does that count?" Another round of good-natured teasing followed.

As people we are not created to be the lone wolf, but rather to interact with others. An aspect of the hobby that I find very appealing is to meet and talk to new people, and having a common interest makes that easier.

Let's face it, if you meet somebody and you have nothing in common it is rather difficult to strike up a conversation that is more than what the weather is like? However, having a common point of reference, I can easily talk to a total stranger about the hobby, learn something about them, maybe learn a new technique, or about a new product, and make a new acquaintance. It adds to my hobby experience, and to my overall growth in the hobby.

The other part of the hobby that I am thankful for is the variety of products available to us. Every month I look at the product news in our magazine and am amazed. The variety

*Advertisement*

# **ATLAS SALES AND SPECIALS** **DEALS & FINDS FROM OUR WAREHOUSE**

**Visit the Atlas Sales and Specials section of our online store for great deals on shells and display models!**

**SHOP NOW!**



**New products are  
added regularly!**



and the quantity of products shown is phenomenal. But that is only the tip of the iceberg. By clicking on different advertisers and looking at their websites, another universe of products comes to life. Many of these are small sole proprietors that work out of their homes on a shoestring budget. Yet the variety of products and services they provide is astounding.

When I reflect on my early days in the hobby, the variety and the quality of products available were nowhere near what we have available to us today. Technology, the Internet, and a host of other factors have contributed to what is currently available to us.

New methodologies and techniques have built upon, improved, and raised the standard of what we expect, and is acceptable. Kits and ready to run products that are available to the beginner would have been considered craftsman quality work two decades ago.

I believe that we are at the beginning of a new golden era of the hobby. It is time to be thankful and enjoy what we have. As technology and manufacturing techniques improve, the products and services available to us will grow. However, it is up to us, the hobbyist.

Are we willing to share with others, be thankful for our blessings, and support the manufactures of the products with our hard-earned dollars? It is time to share with others what a gem of a hobby we have.

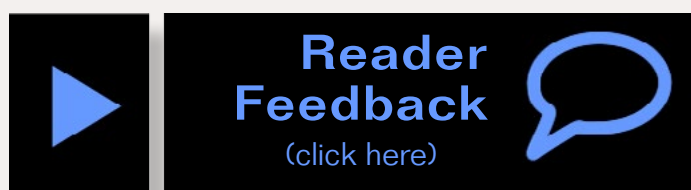



# MRC's "Freedom One" Adds Lights, Sounds and Wireless to DC Locos.

- Control headlights, bell, horn, whistle, throttle and direction
- No DCC system to buy
- Use your existing DC power pack

To learn more about Freedom One  
for your HO locos.



MODEL RECTIFIER CORPORATION  
80 Newfield Ave. ■ Edison, New Jersey 08837 ■ Phone: 732 225 6360 [www.modelrectifier.com](http://www.modelrectifier.com)

TECHNOLOGY. PERFECTED.

Model railroads  Plastic model kits  Battery chargers  Radio control helicopters, planes, cars & boats  Slot Cars  Scenery  Die cast



contents



index



# Notes from the MRH STAFF

Video survey Kindle Fire winner, video survey results, latest great MRH website threads, and more ...



## Video survey Kindle Fire HD winners

We're excited to announce the winners of the Kindle Fire HD drawing among those who took our MRH/TMTV video survey: David Rowlandson and Michael Stikkel. They get a free Kindle Fire HD loaded up with MRH magazines from January 2013 on, when we first started doing the portrait version of MRH.

We had over 3,000 responses to our survey, and we thank all of you for participating. Your responses are most helpful and enlightening.

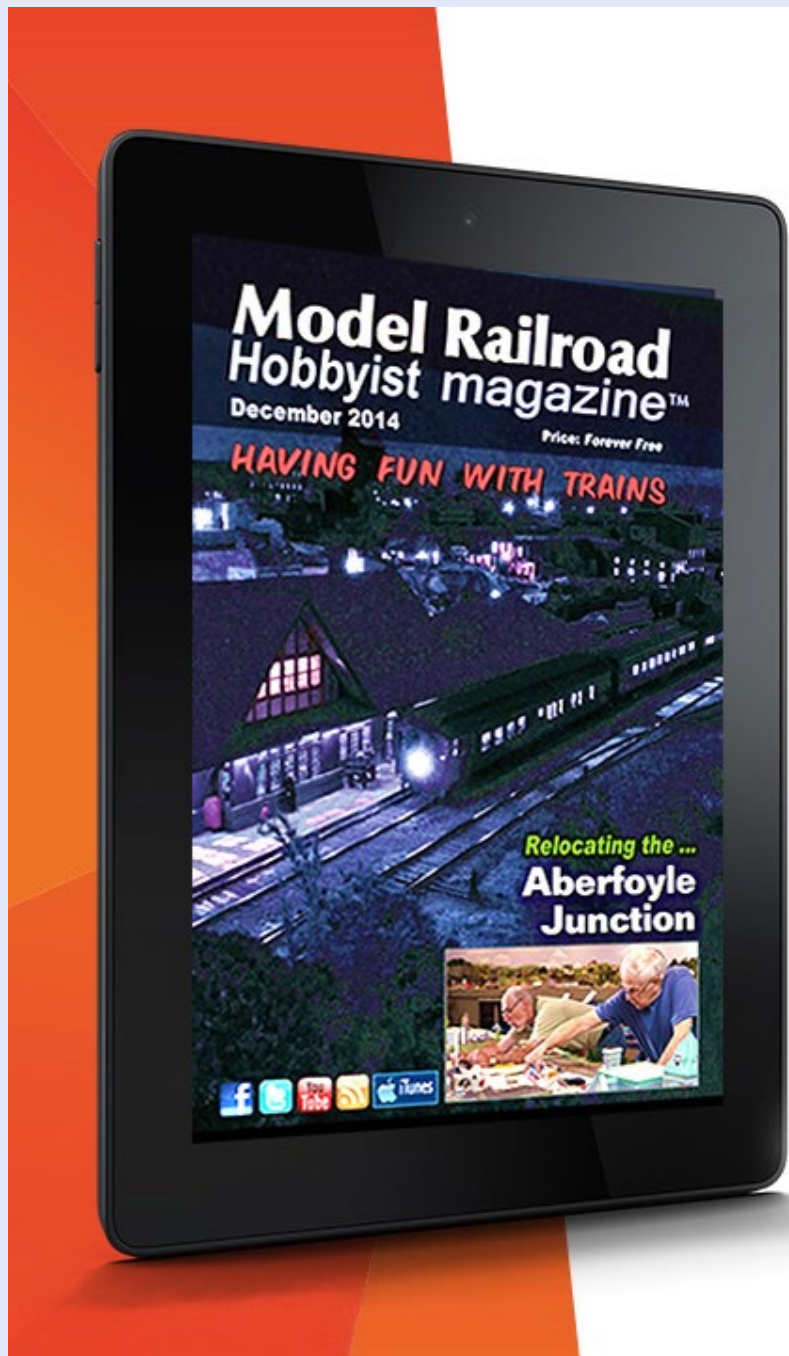



Surprise new run of...

# Rapido's **AWESOME** HO Scale Gondola!

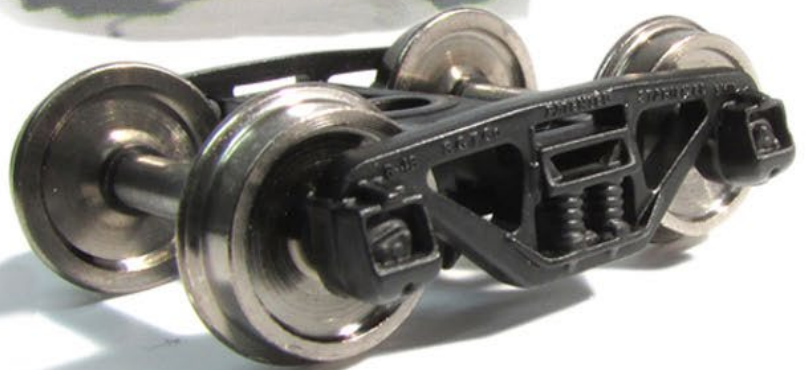

They are here **NOW!**

Order yours before they are all **GON!**

CP (Delivery) • CP (Action Red) • CN (Delivery) • CN (Noodle) • TH&B



Email



Phone



contents



index



## October 2014 MRH Ratings

The five top-rated articles in the [October 2014](#) issue of MRH are:

- 4.6 Modeler's guide to box car ends
- 4.6 Layout design assessment formulas
- 4.6 Build a PanAm Railways SD45R
- 4.5 Yes, it's a model
- 4.5 October 2014 News
  
- Issue overall: 4.4

***Please rate the articles!***

Click the reader feedback button on each article and select the star rating you think each article deserves. ***Thank you!***

Advertisement



**CABOOSE  
HOBBIES**  
WORLD FAMOUS  
MODEL TRAIN STORE  
Since 1938!

The World's  
**Largest**  
Model Train Store!

Model trains G to Z, DCC, brass models, kits, RTR, collectable models, scenery, structures, books, magazines, DVD's, hobby tools & supplies and a full service repair department.



[WWW.CABOOSEHOBBIES.COM](http://WWW.CABOOSEHOBBIES.COM)

MRH-Nov 2014



Email



Phone



contents



index



Several of you asked if you could see the results of the survey, so here's a summary of the key findings.

## Video survey results

First, we asked how long you've been doing the hobby.

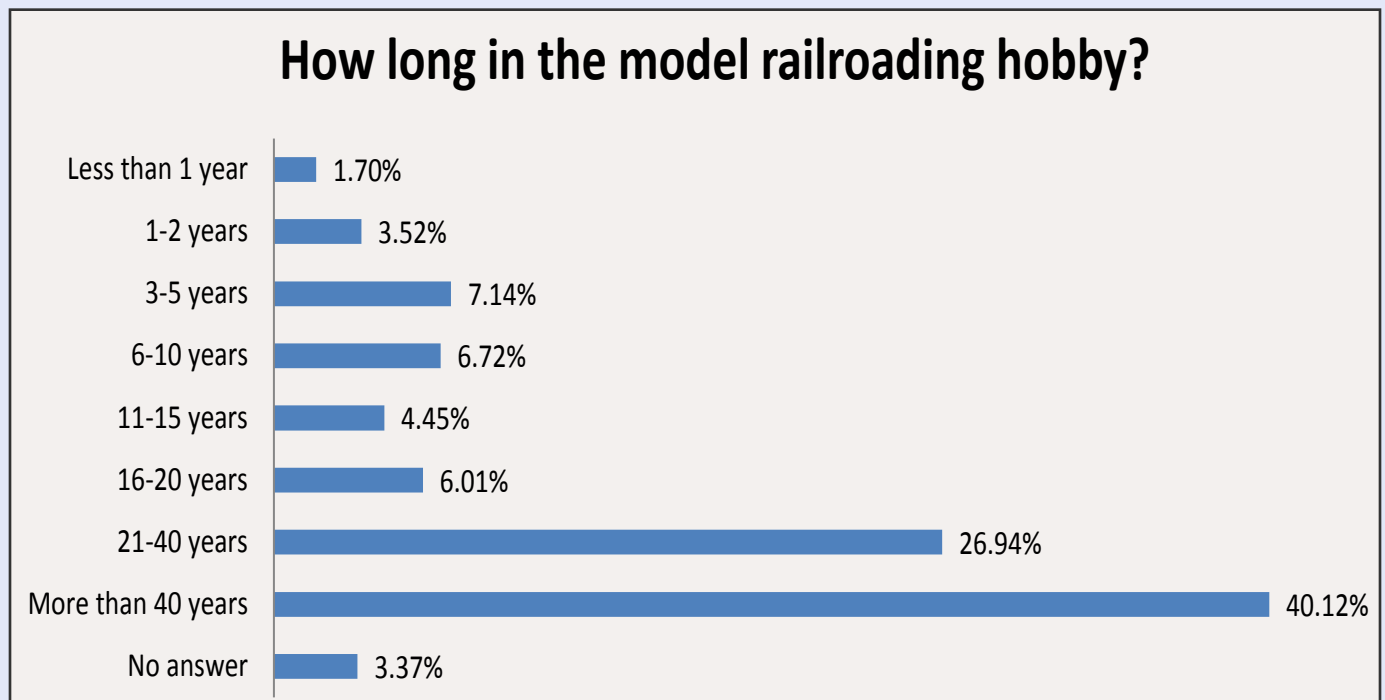

### Advertisement

Want to build better models?

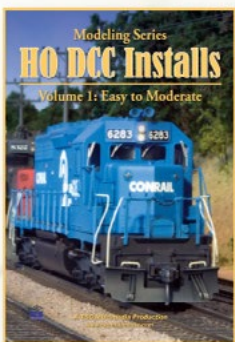

HO DCC Installs  
Videos

CLICK FOR  
DCC

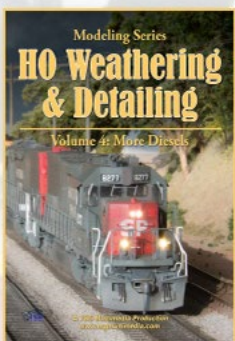

HO Weathering &  
Detailing Videos

CLICK FOR  
WEATHERING



TSG Multimedia

When talking  
to hobby  
vendors,  
please  
remember  
to mention  
MRH.



contents



index

# the SOLUTIONS for BETTER model building microscale.com



**MI-SP**  
Microscale  
System Pack



**MB-SP2**  
Micro Bond System Pack

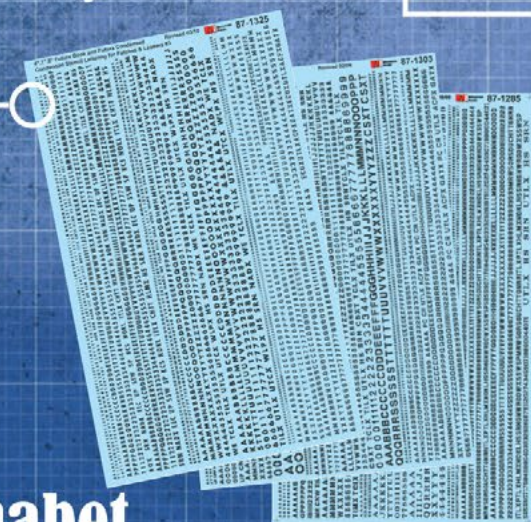

**Alphabet**

[Click to View November New Releases!](#)



As you can see, 63% of those surveyed have been in the hobby for 21 years or more, with about two-thirds of them being in the hobby for 40 years or more. That leaves about 35% who've been in the hobby for 20 years or less.

In the comments on this question, by far the most common response was, "I got into the hobby when I was younger, then took a 20-30 year hiatus to raise a family, grow a career ..." and so on. This is a very typical demographic.

Most modelers don't have the resources to do much in the hobby when they're young, but when they come back to the hobby later in life, they finally have the resources to do it up right. That's also why you see many older guys at shows. They're the ones who have come back into the hobby after this hiatus.

The next series of questions asked which video format you preferred: DVD, downloadable,





# Happy first birthday to TrainMasters TV!



click here to become a member at our birthday celebration discount prices!



## TrainMasters TV's first year: 72 all-new videos!

- Tim Warris' Bronx Terminal
- Tom Patterson's Chesapeake, Wheeling & Erie
- Backshop Clinic: What's in your toolbox?
- Backshop Clinic: Soldering a brass kit
- NMRA 2013 National Train Show Report
- MLW's pinnacle modern diesel locomotive, CPR 4744
- Lex Parker's On3 D&RGW layout 1
- Lex Parker's On3 D&RGW layout 2
- Mike Daugherty, Whistlemaker **HOT!**
- MyLayout: Gail and Greg Whayman
- Backshop Clinic: Painting detail parts
- Cass Scenic Railway
- Jim Rollwage's Union Pacific layout
- Oak Ridge Horn Honk 1
- Oak Ridge Horn Honk 2
- Barry Birkett's G scale garden RR 1
- Barry Birkett's G scale garden RR 2
- Barry Birkett's G scale garden RR 3
- Backshop Clinic: Painting backdrops 1
- Backshop Clinic: Painting backdrops 2
- Backshop Clinic: Painting backdrops 3
- Backshop Clinic: Painting backdrops 4
- The Amherst Railroad Hobby Show 1
- The Amherst Railroad Hobby Show 2
- The Amherst Railroad Hobby Show 3
- Bob Bartizek's O scale Pennsy
- MyLayout: Watertown club
- Backshop clinic: Bluebox kits
- Backshop clinic: Easy "fleet" weathering
- Backshop clinic: Extreme car weathering 1
- Backshop clinic: Extreme car weathering 2
- Backshop clinic: Extreme car weathering 3
- Backshop clinic: Extreme car weathering 4
- What ever happened to the NEB&W? **HOT!**
- Legend in high speed passenger rail
- The Allagash Story - Mike Confalone in-depth interview
- Sundance Central Fn3 modular layout **HOT!**
- Visiting the Ottawa Train Expo
- Bill Doll's Forest Park Southern
- Bill Doll's Forest Park Southern bonus scenes
- Backshop clinic: Extreme loco weathering 1
- Backshop clinic: Extreme loco weathering 1
- DCC Decoded: TCS Solution for electrical gremlins
- O-scale structures by the book
- Michel Boucher's Delaware & Hudson
- Basic Tsunami Decoder Programming
- Steel industry modeling
- New York Alcos story
- First op session on Barry's Backyard
- Vendor Profile: North American Railcar
- Jerry Fassnacht's Pennsy/Reading
- Streamliners at Spencer 1
- Streamliners at Spencer 2 **HOT!**
- Streamliners at Spencer 3
- DCC Decoded: All about TCS WOWSound for steam
- Back to the basement - room prep and backdrops **HOT!**
- Lionel sneaks into the 2014 Train Show setup
- Layouts at the 2014 National Train Show
- Lionel visits the 2014 NMRA Celebration Room
- Back to the basement - track planning
- Backshop Clinic: Structure graphics
- John Miller's Kanawha and Lake Erie
- New Free-Mo Roadshow series - concepts
- MyLayout: Dick Joyce's Ingleside & Oakdale
- DCC Decoded: 44-tonner sound
- Back to the basement: benchwork
- Quebec & New England RR operations
- Backshop clinic: Switchman's class
- Roadshow 2: benchwork
- Back to the basement: Subroadbed
- NTS 2014: SoundTraxx SoundCar demo
- Backshop Clinic: Structure scratchbuilding



## Preferred method of watching model railroading videos?

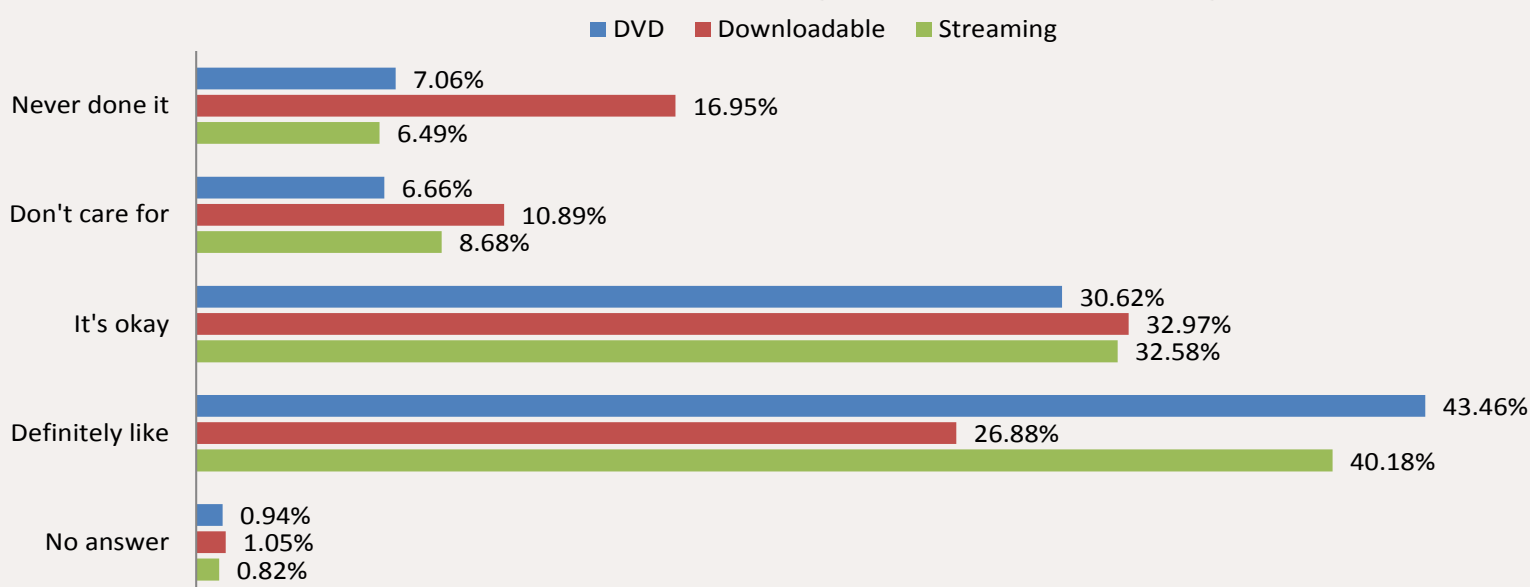

or streaming. The chart above summarizes the results across the three methods of viewing. From this it's clear most prefer DVDs, with streaming a close second. Trailing by quite a distance is downloaded video.

The comments on this question are all over the map:

"DVD can be played most anywhere, on any large screen TV. The others rely on a computer or smart TV."

"I don't care for DVDs these days ... I haven't turned on my television's DVD player for months. My TV viewing habits have changed to Netflix, Roku and Chromecast."

"I like the downloadable the best because it's quick, convenient and I can take it anywhere and watch it even offline. DVD's are OK, but have to be stored somewhere and are subject to damage. Streaming is limited by connection availability and speed."

"We have hundreds of DVDs and Blu-ray discs in binders in our house. Guess how often we actually get them out? Rarely. Now we have streaming Internet like YouTube, Netflix, Vudu, Flixster, etc... and we use those on an almost daily basis."

"I prefer DVDs that way you do not have to worry about computer crashes and losing the material."



**New  
Innovation**



# Nano Technology Lubricants

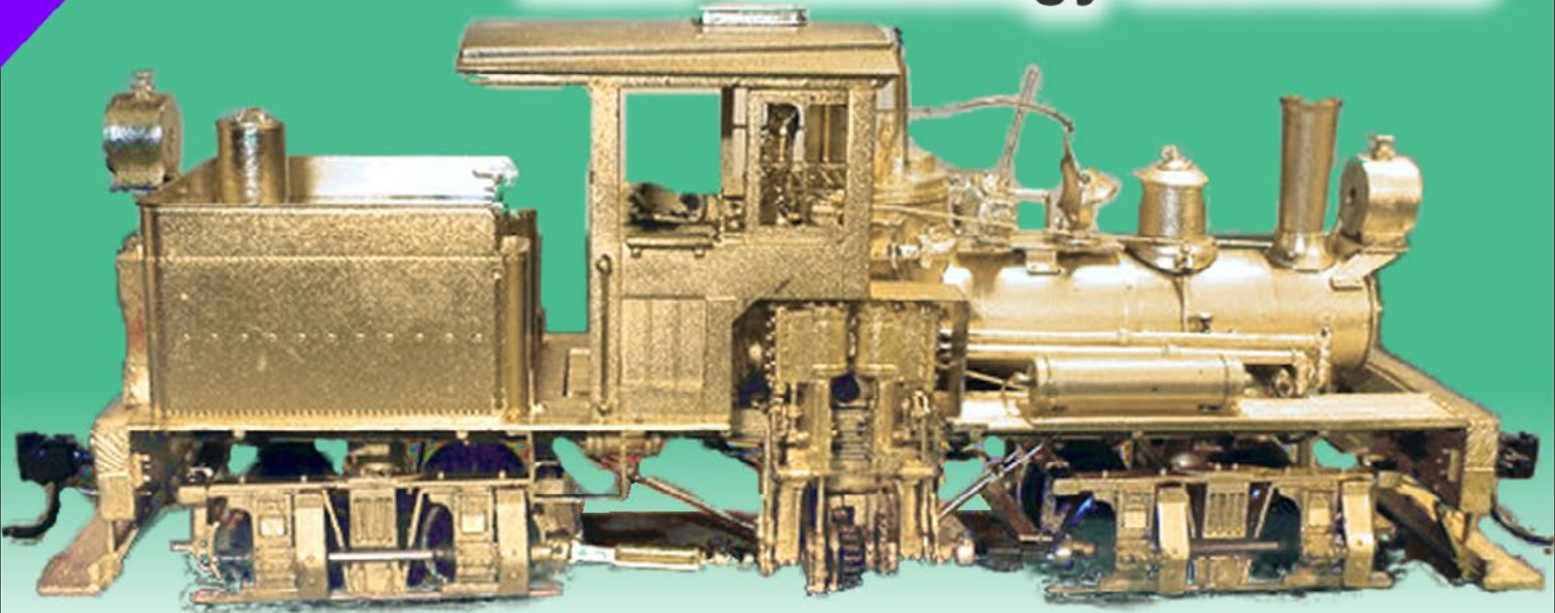

**Nano-Grease**

"After eight years of extensive testing, the only lubricants now used in my shop are Nano-Oils and Nano-Grease. The extreme reduction in power draw by mechanically minimizing friction is simply technologically superior."

- Phil Floyd, 'The Shay Fixer'

**THE SHAY FIXER**  
VISIT US AT...  
**SHAYFIXER.COM**

*Specializing in brass Pacific Fast Mail / United geared locomotives*

**For more details  
click here ...**



“Prefer to watch on a tablet, so downloading is easier.”

“DVD doesn’t require Internet access, a big plus.”

“I think the DVD is going the way of the 8-track.”

“DVDs take up less space than downloads<sup>1</sup>.”

“Prefer instant download...easier to store.”

Based on these comments, we do see there’s quite a bit of interest in DVDs and yes, even downloadables. We’ll be making TrainMasters TV videos available on DVD and as downloadables for those who have bandwidth issues with streaming or who prefer to get a download instead. If you prefer a DVD so you can enjoy it on your big screen TV, then the TMTV episodes on to DVD will make this possible.

1 Not quite sure we understand this comment that DVDs are easier to store than downloads, unless the author isn’t computer savvy and doesn’t understand how to access downloadable video using things like iTunes.

## November 2014

## Bonus Extras!

### *Available to subscribers!*

**DVD and HD quality versions of this issues videos, plus:**

- **Yosemite Valley clearance card / assignment card files**
- **Code files from Geoff Bunza’s battery power article**

**Click here to access**





Next, we asked what video topics are of greatest interest.

### Which general video categories do you like best? (ranked)

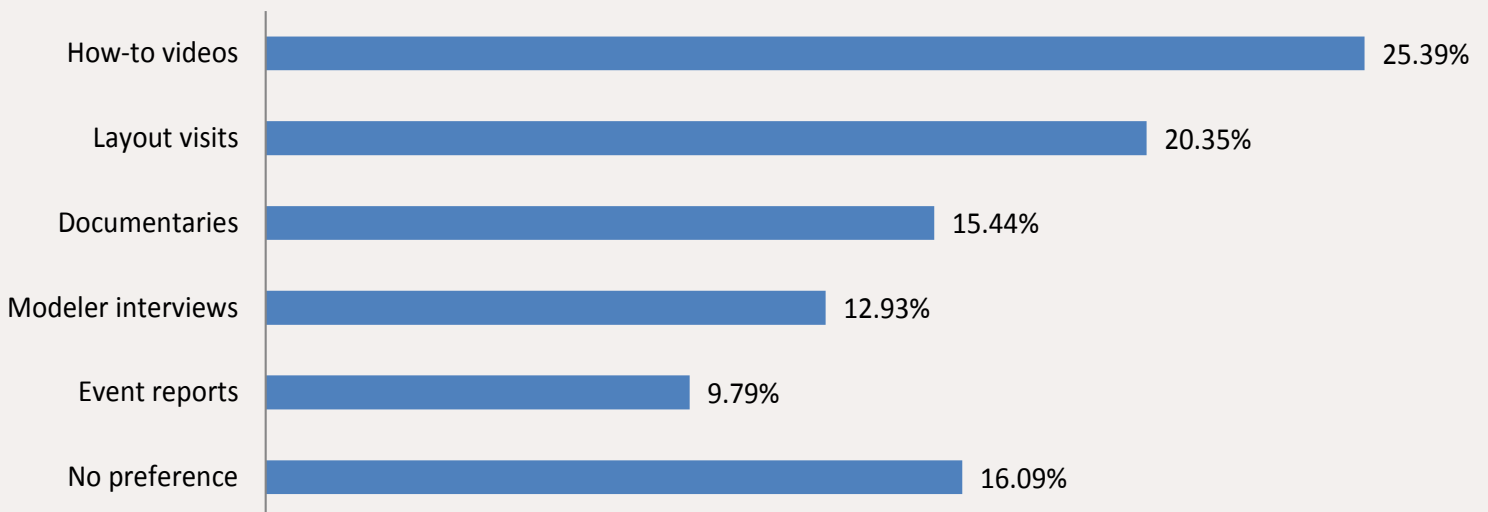

The most popular video topic category is how-to videos, followed by layout visits and documentaries. Modeler interviews and event reports bring up the rear. For comments, we asked if we missed any categories, and two additional categories were mentioned frequently: product reviews/demos and videos on operations.

Advertisement

**THE** **O** **RESOURCE**

---

NEWS, REVIEWS, INFORMATION TO USE

**SCALE** *New* **On Line Magazine**

**www.oscaleresource.com**



Thanks to everyone who participated in this survey!

## Interesting new MRH website threads

Here's a few of the more interesting threads on the site this month.

Making car cards

[mrhmag.com/node/19960](http://mrhmag.com/node/19960)

Opinions on sheet cork

[mrhmag.com/node/19892](http://mrhmag.com/node/19892)

Weathering (started by Jim Six)

[mrhmag.com/node/19784](http://mrhmag.com/node/19784)

Signaling adventure ...

[mrhmag.com/node/19716](http://mrhmag.com/node/19716)

Enjoy the November MRH!



*Advertisement*

**Lasercut structures. Highway, storefront and billboard signs.**

Neat ag customer for your railroad:  
**Farmers Fertilizer Supply**



**WHAT'S NEW?**



Established 1993...

**Blair Line**

**We're not mind readers.**

**Please click reader feedback buttons on articles!**





# \$1.5 MILLION MODEL RAILROAD EXHIBIT

Tuesday, November 11, 2014 at 12:00PM EST

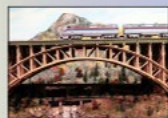
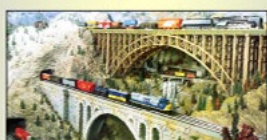

Held at 7903 State Route 9  
Pottersville, NEW YORK 12860



An AMAZING model train attraction created by Broadway Set Designer Clarke Dunham, currently on display as a museum attraction known as "Railroads on Parade". These fully complete, functional model train layouts are displayed as THE STATION; NEW YORK CITY SUBWAYS; THE HELL GATE BRIDGE; and 1939 WORLD'S FAIR. Will sell individual layouts or as a whole. This exhibit is in EXCELLENT shape, having been continuously updated, added to and improved.

## 4 Amazing & Extensive Model Train Displays

Offered As Four Separate Exhibits  
or as One Whole Exhibit

Live and On Line Auction  
Professionally Conducted  
By



FOR DETAILED INFORMATION, PHOTOS,  
REGISTRATION TO BID LIVE ONLINE  
AND TERMS OF AUCTION VISIT  
[www.adamsauctions.com](http://www.adamsauctions.com)

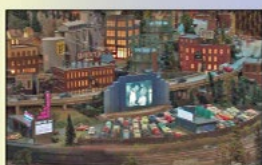

# TRINITY 3281



CMO - 12 road numbers \$48.95 each



CSX - 12 road numbers \$48.95 each



TILX - 6 road numbers \$48.95 each



WSOX - 6 road numbers \$48.95 each  
plus CRDX and MCEX



[www.americanlimitedmodels.com](http://www.americanlimitedmodels.com)



## NICK & NORA DESIGNS

Uniquely inspired craftsman kits



Come see us at our upcoming shows!

October 4 & 5 - Great Berea Train Show  
Cuyahoga County Fairgrounds, Berea, Ohio

October 9-11 - Railroad Prototype Modelers  
Sheraton Lisle-Chicago Hotel - Naperville (Lisle), Illinois

October 25 & 26 - Great Scale Model Train Show  
Maryland State Fairgrounds, Timonium, Maryland

Craftsman Structure Kits,  
Detail Parts, Shingles,  
Vehicle kits from:  
Sylvan & Jordan  
Tru-Color paint, glues & more!



Want to  
help keep  
MRH free?  
Then click  
on Ads!







Photo courtesy of Dave Minshall

# YEAH, ITS TRUE WE HAVE A SINGLE TRACK MIND.

The ALL NEW HO SCALE SINGLE TRACK CN SNOW PLOW...WITH OPERATIONAL WINGS!

Features include:

- KADEE couplers
- correct trucks
- CODE 88 stainless steel wheels
- real chains
- operational wings
- ESU equipped decoder
- Available in CN and CP
- correct plow contour
- interchangeable cupola
- finely detailed
- Lights
- unique sound and horn

SCAN ME TO GET UPDATES!

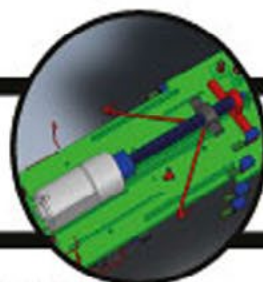
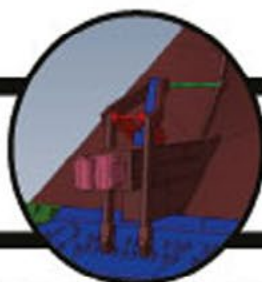

True Line Trains Exclusively distributed in Canada by Canadian Hobbycraft Ltd. 445 - 1 Edgeley Blvd, Concord, Ontario L4K 4G1  
For More Info, Please Call (905) 738 - 6556 or find us online at [www.truelinetrains.com](http://www.truelinetrains.com) Dealer Inquiries Welcome





# MRRH

## Questions, Answers and Tips

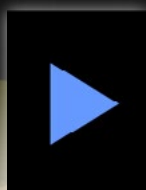

Reader  
Feedback  
(click here)



## QUESTIONS AND ANSWERS

### Quiet roadbed

**Q.** A few years ago there was an article in one of the magazines about the quietest roadbed. The guy tried about 15 different roadbeds to find the one that gives the lowest mechanical sound transfer. Can anyone remember the article?

– DCSnr

**A.** There are three factors at play in creating quiet railroads. The first question is, do we want noise, or not? The second is materials, and the third is installation.

**Nelson Beaudry:** Just being the devil's advocate, but what's all the fuss over "quiet" track? Can't say as I've ever heard a train roll by quietly! Personally, I just lay good old cork roadbed down,



and I find that works well for me. Trains make a lot of noise in real life, so a small amount of track noise to me is appropriate.

**Paul Schmidt:** Sound doesn't scale down any more than weight does. Ergo, the quest for quiet roadbed is quixotic.

**Dissenting view:** A downhill train on continuously welded rail, or a freight car coasting in a yard, can be *very* quiet, to the point of being dangerous. Let's go on.

Bob Kingsnorth, "the guy," wrote "Quiet roadbed, better train sounds" for "How to Build Realistic Reliable Track," a *Model Railroader* special issue published in June 2009. Find it at [kalmbachstore.com/mr6090801.html](http://kalmbachstore.com/mr6090801.html).

**Crandell:** Kingsnorth's analysis settled on camper tape for roadbed, and caulk-installed track as the overall quietest system. If you use acrylic latex caulking sparingly to affix your tracks to the roadbed, no matter what the latter is, you will have reasonably quiet track. As soon as you ballast, your tracks will be more-or-less as noisy as any other. The single greatest culprit for noisy tracks is the hardened ballast. I have always been amazed at how quiet the tracks are over my wooden trestles and bridges. While my ballasted rails are noisy, when my trains pass over a bridge, they go dead quiet.

**Bruce:** Hollow plastic boxes are noisy, and deadening the echo and rattle helps. Dampen the sound in enclosed cars with a square of foam carpet pad bent into a U between the sides of the car. For HO or smaller scales, use a cotton ball or makeup sponge.

**Pat Miller:** I used lauan plywood roadbed. I found it to be extremely loud, so I'm back to cork after using the plywood in a whole yard. A friend of mine tried camper tape but the tape dried out after a couple years and caused track to come loose in places. It was a disaster.



**Bob Kingsnorth:** “The camper tape dried out after a couple years – disaster!” Sorry to hear it. Mine has been in place for six years and is as good as new. I used model V610BK Gaska Tape ([www.gaska.com](http://www.gaska.com)). I use a layer of Alex caulk between the camper tape and the plywood, and do not rely on the manufacturer’s adhesive. The Alex allows me to adjust the position of the tape, and I use Alex to glue the cork to the camper tape. Some adhesives could cause a deterioration of the camper tape.

My layout has seen seasonal temperature swings from 55 to 85 degrees Fahrenheit, and unknown humidity swings but I have never experienced any negative effects. Rigid it is not. Just quiet.

The glue used for ballast and plaster hard shell scenery can transmit noise. I used DAP 3.0 caulk to glue the flex track and



**1. Earplugs will cut down on noise in the train room but negate the investment in sound-equipped locomotives.**



contents



index

apply the ballast at the same time. Alex caulk would also work. I believe the flexible caulk helps to control the noise. I used Sculptamold for scenery, expecting that material to transmit less noise than plaster. Although the Sculptamold touches the cork, I am not hearing a “soundboard” effect.

**Rick:** If train noise is a problem just get you a pair of foam ear plugs [1], insert, and enjoy the quiet!

**B Hutchinson:** If you are having sound coming from the ballasted track, have a look at your sub-roadbed frame. Is it a box open at the bottom? If so, you have a sound amplifier. I use foam under my 3mm MDF road bed (I'm in N scale) and have a very quiet layout.

**Ted Shasta:** My highest priority is perfect, permanent vertical and horizontal alignment of all track work. You need stiffness to prevent the roadbed from behaving like a drum. First, my benchwork is extremely stiff and stable with robust risers supporting the roadbed every foot. Second, use a sub-roadbed of high quality 3/4" plywood which is screwed to the risers. Third, roadbed of 1" thick milled basswood is screwed to the plywood sub-roadbed. Everything is always screwed together which is easier, faster and more easily adjusted or changed, relative to using glue. The combination of stiffness and mass results in a near-silent track structure. Yes, this approach is material-intensive and expensive, but these costs can be spread over many years.

**Richard Todd:** My son and I use hardboard spline hot-glued to make the sub-roadbed. We use Alex Plus to glue down the cork roadbed, and we use Alex Plus to glue down flex track. Our next step is to glue cardboard strips to form the scenic contours. Then we hot-glue red rosin paper to the cardboard frame. We



cover the rosin paper with Lou Sassi's "Ground Goop." The last step is to ballast the rail, securing it with thinned white glue.

The roadbed is dead quiet without scenery. It appears that the paper and cardboard scenery doesn't amplify the sound the way our old hard shell did.

**Bob Kingsnorth:** To my ear, our models sound nothing like the prototype. But many other modelers will have different expectations, which is what makes the hobby a great place.

The construction techniques in the "Realistic Track" special issue are designed to attenuate the clatter, and enhance the sound system.



**2. Milled Homasote roadbed over plywood or spline will help to reduce the sounds of a rolling train because the different materials transmit sound vibrations differently.**



contents



index

“Sound barrier” – I am not an acoustical engineer, but I believe the effectiveness of the roadbed sound attenuation comes from the mixed materials. Doubling the thickness of a cork roadbed does not change the sound very much. Thicker Homasote has little effect. But mixing layers makes a difference. Each material will tend to transmit a different spectrum of sound waves. What vibrations get passed through cork will be somewhat different than the spectrum transmitted by camper tape. I suspect that in the cork/camper tape mix, the cork provides some damping and the camper tape does a good job of isolating the sound from the plywood.

**Montanan:** I use a product called Homabed [2] and it is fairly quiet, but you can still hear some noise. There will always be some noise, I guess. I really don't notice it. The only time I ever noticed any noise is when I put a camcorder on a flat car and ran it around the layout.

**J. Graffi:** I went with a foam roadbed by Woodland Scenics and glued the track down with diluted white glue. I did not drive the locating nails tight with the ties and made sure there was some give. I ran the trains without ballast for a year or so, and was impressed that there was little if any noise. I could hear the clackity-clack of the wheels going over rail junctions and turnouts everywhere on the layout, even with two trains running. Recently, I began the ballasting process and hear no difference.

**Rick:** On my previous layout I had a large (3' high) plaster cloth mountain, and when the train went through that area there was a disturbing unnatural roaring sound. I cut the plaster cloth where it attached to the plywood sub-roadbed and stuffed foam rubber between the two, then used rubber cement to glue down the ground foam onto the foam rubber. The roar was gone.



**Prostreetamx:** Most of my code 83 Atlas flex track is mounted on Midwest cork over Bituthene. See [grace.com/construction/en-us/waterproofing/Bituthene-System-4000](http://grace.com/construction/en-us/waterproofing/Bituthene-System-4000). The stuff is used to weatherproof around home windows and comes in wide rolls with an adhesive backing. I cut it into narrow strips and put it on top of the plywood roadbed. I use adhesive caulk to stick the cork to the base and also caulk the track. Bituthene is very similar to Dynamat and other sound deadening products used in the automotive stereo industry.

**Ntraker:** The best I have found is a product called Vinylbed. The name changed recently to Flexxbed. It can be ordered directly from the factory at Hobby Innovations.

**Quiet roadbed:** [mrhmag.com/node/18525](http://mrhmag.com/node/18525).

**Courtesy of Prof Klyzlr:**

*Foam Drum:* [mrhmag.com/node/15325](http://mrhmag.com/node/15325).

*Foam Drum II:* [mrhmag.com/node/15420](http://mrhmag.com/node/15420).

*Foam Drum redux:* [mrhmag.com/node/15621](http://mrhmag.com/node/15621).

## **TT&TO: Rule 91**

**Q. My train, No. 24, is in a siding waiting for No. 6 to pass. When No. 6 passes, how soon can I come out of the siding and how closely can I follow?**

**A.** Check out Rule 91. First, check your timetable again for traffic that may have moved up on you since you went into the siding. Review your other orders. If all is clear, by the time you throw the switch, get the brakeman back on, it's going to be about 10 minutes. By the time you get your train up to speed, it's almost certainly going to be 10 minutes.



contents



index

Here's what Rule 91 says:

“Unless some form of block signals is used, trains in the same direction must keep not less than ten minutes apart, except in closing up at stations.”

It meshes with Rule 99, which says, in part:

“When a train is moving under circumstances in which it might be overtaken by another train, the flagman must take such action as may be necessary to insure full protection. By night, or by day when the view is obscured, lighted fusees must be thrown off at proper intervals.”.

Those rules are out of the 1945 Consolidated Code of Operating Rules. Other railroads had similar rules under the same numbers, but with variations to suit their particular situations.

– MRH



## TIPS

### Save the signs

Railroad crossing signs [3] are always in danger of being broken, especially when close to the edge of a layout. I drive a concrete-colored flathead screw in the sign's location. The screw has to be magnetic. Brass and aluminum won't work.

With a one-hole paper punch, I punch out a circle from a magnetic tape strip and paint it concrete. Drill a hole in the





3. A magnetic mount saves signs from being snapped off and makes them easy to remove and replace for cleaning. Larry Brinker photo.

punched-out magnet to accept the post of the sign and glue it in. The sign can now be positioned on top of the screw.

A wayward arm will just knock it over, not break it. When you want to clean the track in that area, just move it out of the way.

– Larry Brinker



## GET \$25 PER TIP

We pay \$25 USD for each tip we publish.

[Send your modeling tips to Model Railroad Hobbyist](#) and we'll get payment to you upon acceptance.

Just think, for only a few minutes effort, you could fund your next piece of rolling stock – or even pay for an entire train if you send in several tips and we publish them!

If you include any photos with your tip, we pay a bonus of \$10 per photo we use with the tip. ■



contents



index





**SO REAL...You'll Think You're There!**  
**LokSound Select • 3 SIZES, ENDLESS POSSIBILITIES!**

**INDUSTRY LEADING MOTOR CONTROL**

- Multiple Bell types
- Multiple Brake squeals

**4 OR 8 Ohm SPEAKERS!**

- 4 or 6 Output functions depending on the style
- Up to 4 Prime Movers or Steam Sounds on EACH decoder
- 16 Very Playable, LOUD Horns or Whistles depending on Profile
- All Changeable by using ONE CV! No Programmers or Boosters needed!\*

**Small Size  
 BIG POWER! 1.1Amp!  
 LokSound Select  
 "4 AUX"**



**\$99.99**

**NEW 2011**

**LOKSOUND SELECT**

Only Available From ESU LLC (USA)

**ONE SIZE FITS ALL!  
 LokSound Select "DIRECT"**



**\$109.99**

**6 Outputs!  
 LED Resistance Built In!**

**NEW 2011**

**LOKSOUND SELECT**

Only Available From ESU LLC (USA)

**Tiny Size,  
 HUGE Versatility!  
 LokSound Select  
 "MICRO"**



**\$99.99**

**NEW 2011**

**LOKSOUND SELECT**

Only Available From ESU LLC (USA)

- Great NEW Size 1.18" x 0.61"
- Versatile DCC & DC "Dual Mode" decoder!
- 8 channel sound system!
- FOUR lighting outputs and a 1.1A motor controller
- Available with ALL Current LokSound Select Sound Profiles
- Use 4, 8, or 16 Ohm Speakers

- Easy Drop in Design
- Versatile DCC & DC "Dual Mode" decoder!
- 8 channel sound system!
- SIX lighting outputs ALL with built in resistors for LEDs
- Available with ALL Current Diesel Sound Profiles
- Use 4, 8, or 16 Ohm Speakers

- Great NEW size ONLY 0.98" x .417"
- Versatile DCC & DC "Dual Mode" decoder!
- 8 channel sound system!
- FOUR lighting outputs and a .75A motor controller!
- Standard 8-pin NEM 652 plug included
- Available with ALL Current LokSound Select Sound Profiles
- Use 4, 8, or 16 Ohm Speakers!

\* ESU LokProgrammer needed to "Replace" Sound and for Firmware updates, not for normal editing

[www.LokSound.com](http://www.LokSound.com) • 477 Knopp Drive Muncy, PA • 570-649-5048

Now on facebook!







# The lowdown on bulbs and circuit breakers

DCC tips, tricks, and techniques



## DCC Impulses column

by Bruce Petrarca

### A look at different methods of short protection ...

**W**hat causes a short on the layout? Close clearances in turnouts. Derailed rolling stock. Tools on the track. Wiring failures in the loco or on the layout.

Protection, that is the name of the game. The DCC booster includes a short circuit detector that shuts off the power in the event of a short on the track or the DCC bus. This protects the booster, but is not necessarily designed to protect the rolling stock.

This month we'll talk about protecting your locos and cars and sanity. It is so distracting to be working on a set of moves and have your loco stop dead because someone somewhere else on the layout shorted. There are several ways to accomplish this task. I'm gonna show you the pros and cons of each.



## Light bulbs

Light bulbs in series with the potential shorting point are the most rudimentary version of short circuit protection. They are not circuit breakers, but circuit protectors.

Implementations run the gamut from a simple 1156 (2.1 amp) automotive bulb connected between the DCC bus and the frog of a turnout, to the 6-position unit sold by NCE, called the CP6.

Quickly, let's look at how a light bulb [1] protects a track section. When nothing is in the protected section, no current flows and the bulb has a very low resistance (almost a direct connection). If a loco enters the section, the power is shared between the loco and the light bulb. Until the current being drawn through the bulb approaches the rated current for the bulb, the majority of the power is routed to the loco. More current draw (a second loco entering the protected section) will

result in the bulb getting more of the power, perhaps glowing dimly. Correspondingly, the track voltage will drop a bit. A full short will result in the bulb glowing brightly and the track voltage will go to zero.

When DCC was in its infancy, there were few electronic circuit breakers. They were expensive and sometimes difficult to deal with. That led folks seeking inexpensive solutions.



**1. 1156 automotive bulb, rated at 2.1 amps.**

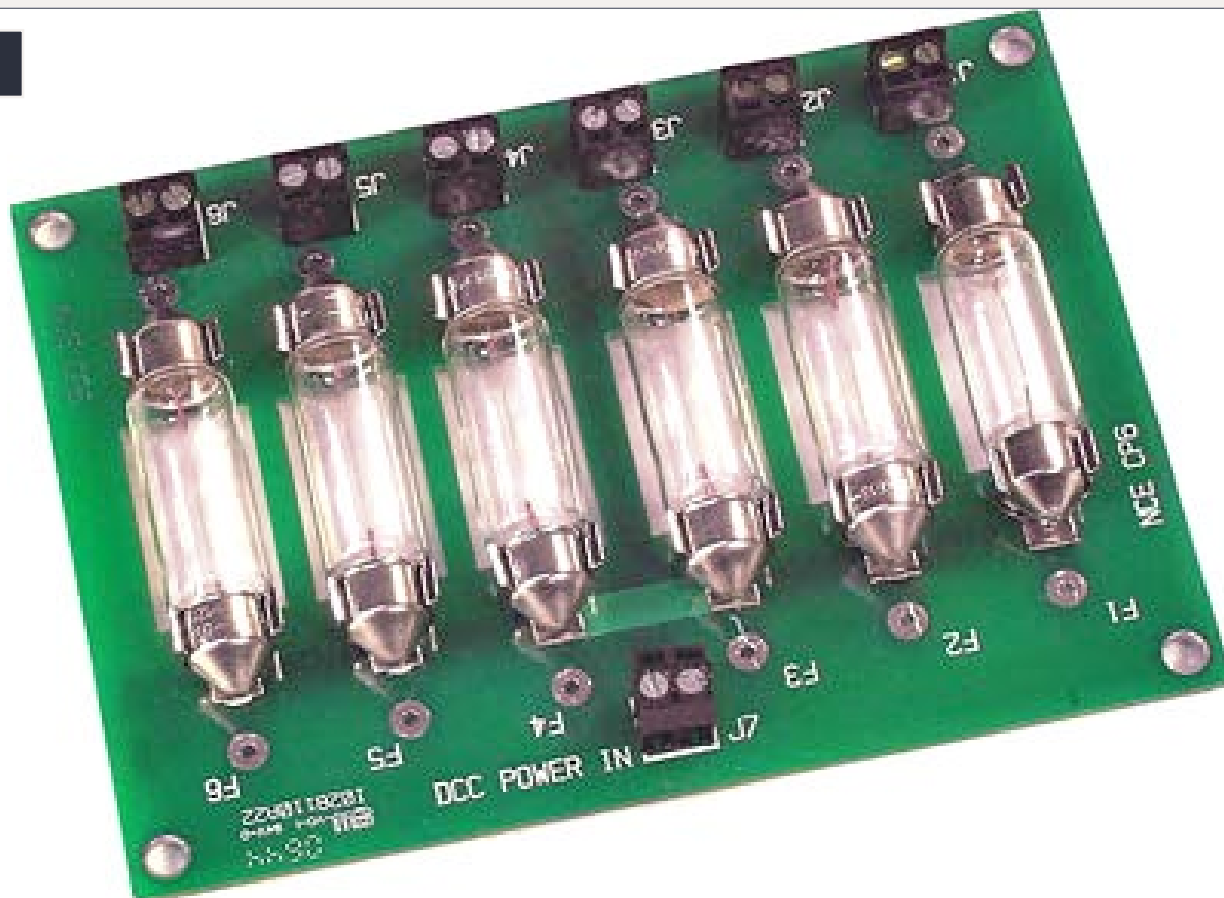

**2**

## 2. CP6 - 6-bulb circuit protector from NCE. NCE Corp. photo.

Over the years, folks who have asked my opinion of bulbs have learned that I don't favor them. Here's why. They can isolate one section of the layout from another. For example, they can prevent a short in one yard from impacting operations in another yard. However, the full bulb current is flowing in the path from the bus through the bulb and the short. If one uses a robust bulb, for example one that has a 2.1-amp rating, then the short (perhaps a wheel crosswise on a turnout) is carrying the full current. Yes, the power is being limited by the bulb, but current can pit and even spot-weld parts. Also, the DCC system is supplying that power, about 30 watts (15 volts X 2.1 amps) to the short.

Even with their limitations, bulbs still are being installed on layouts. Let's look at their pros and cons.



contents



index

## Advantages of bulbs

- Bulbs are inexpensive
- Bulbs operate instantly, allowing even fast systems like the NCE PowerCab to be separated into sections.

## Disadvantages of bulbs

- Bulbs generate light (distracting) and heat (possibly a hazard) when they are protecting a short.
- Bulb protection draws the bulb's rated current from the DCC system during a short.
- The spike of current (seen as a spark) when a short occurs can pit wheels or whatever is causing the short.
- When you have a bulb in series with a track section, the track voltage will vary a bit, depending upon power being consumed in the section. Two locos or a power hungry loco may change speed upon entering the protected section.

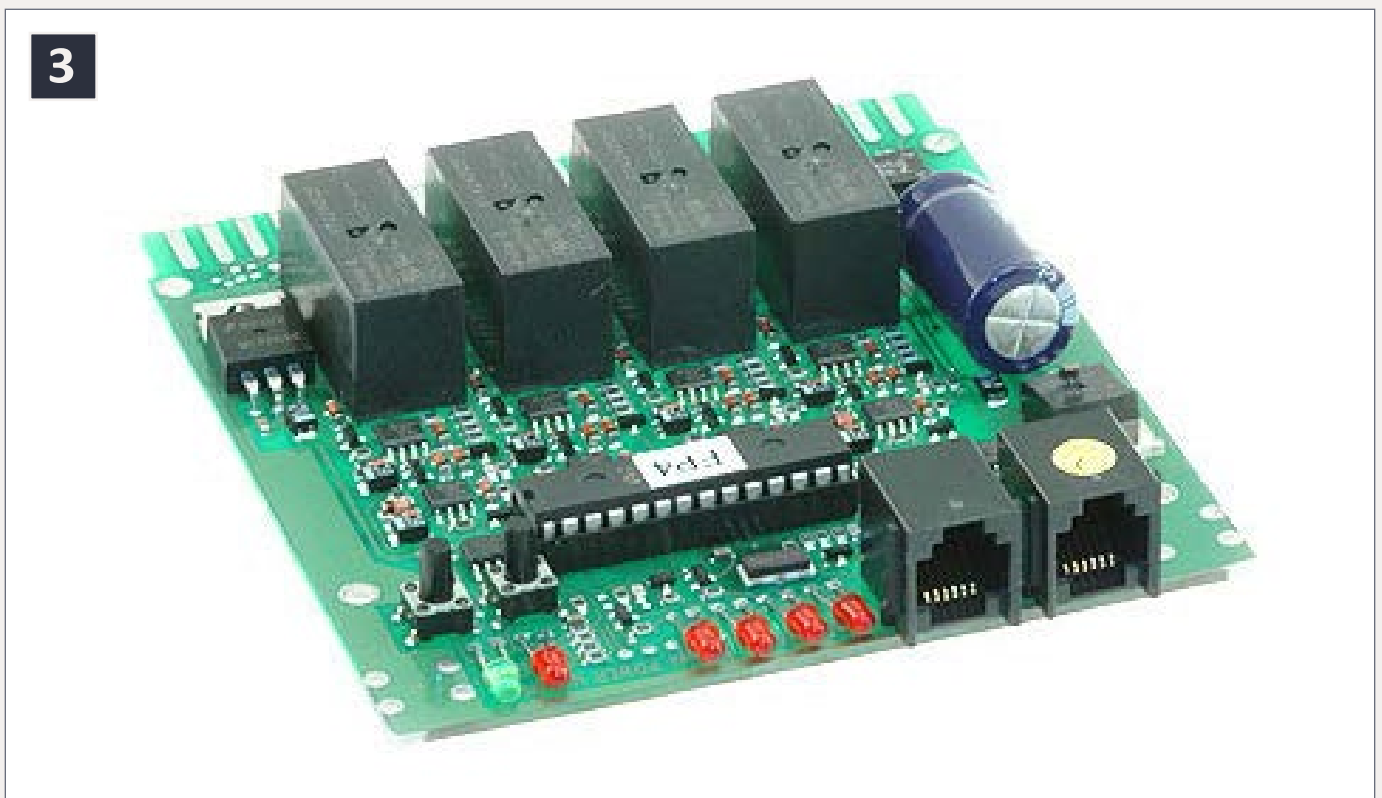

3. PM42 4-section power manager from Digitrax. Digitrax, Inc. photo.



When the NCE PowerCab (all-in-one DCC system) was being developed, there was no electronic circuit breaker that would react fast enough to keep the protection circuitry in the PowerCab from tripping. In response to the desire by users to separate districts, NCE developed the CP6 [2]. This circuit board holds six bulbs, allowing a PowerCab user to split his pike into six sections. The user has a choice of (standard) 1-amp bulbs or (optional) 1.75-amp bulbs. The PowerCab can only supply about 1.75 amps. So, consider the standard 1-amp bulbs. If a short occurs in one district, the remaining five continue to operate, but only have about  $\frac{3}{4}$  amp remaining available. If a second district has a short, the combined two bulbs will try to draw 2 amps from the PowerCab (plus any current being drawn in the remaining four districts) and the PowerCab will still shut down.

*Advertisement*

## What's Missing From Your Model?

More than just a clickety-clack, the Tsunami SoundCar provides over **20 sound effects** for rolling stock!

Hear what your train *should* sound like!

**SOUNDTRAXX**<sup>®</sup>



If you want to use bulbs on your layout, consider these selection criteria:

The bulb must be rated for the track voltage of the DCC system. Automotive systems are called 12 volt, but they actually push 15 volts with modern alternators. So automotive bulbs are good for all but the highest voltage DCC systems (such as 20+ volt garden layouts).

The bulb current rating must be a fraction of the maximum current the DCC system will supply. I recommend the bulbs be rated at less than half the DCC system's capabilities. That way, two districts shorted at the same time may not take down the system.

Given all of the above, I would stick with 1¾ amp automotive bulbs on 5-amp rated DCC systems running track voltages up to 16 volts.

### Advertisement

**RailPro™**  
**NEW TECHNOLOGY**  
DIRECT™  
RADIO

**RE RING™**  
ENGINEERING

**NEW Starter Kit**  
**\$399.99 MSRP**

- Includes Wireless Color Touch Screen Handheld Controller and 56 Watt Power Supply
- Expandable to Virtually any Size Layout

**NEW Locomotive Module**  
LM-2 & LM-2S

- Direct Radio RF
- Sound and Non-Sound
- New Tiny Size
- 6 Light Outputs

Click Here to Learn More

For more information visit our Internet site: [www.RingEngineering.com](http://www.RingEngineering.com)





# Relays

Some of the earliest circuit breakers were current sensors that drove relays to interrupt the current flow to the track. The sensing circuitry was pretty rudimentary on some versions, resulting in some rather spectacular sparks and the resulting wheel pitting.

The Digitrax PM42 four-section circuit breaker or auto-reverser [3] was one of the first electronic units to achieve wide usage.

As low-on-resistance transistors have become more available and less expensive, the relay-style circuit breakers have tended to fade away. Given today's technology, I would eschew relay breakers on a new layout and suggest upgrading to fully electronic units on older layouts.

## Advertisement

Make LocoNet wiring extremely simple!



# ACCU-LITES, inc

Your DCC Center!

"... great time saver as well as providing flexibility to change things ..." - Terry Nathan



**PM42**  
breakout  
board



**BDL168**  
Multi-zone  
breakout board

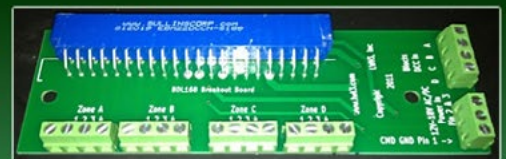

**SE8C**  
breakout  
board



**BDL168**  
Single-zone  
breakout board



<http://www.acculites.com>

**CLICK TO LEARN MORE ...**





4

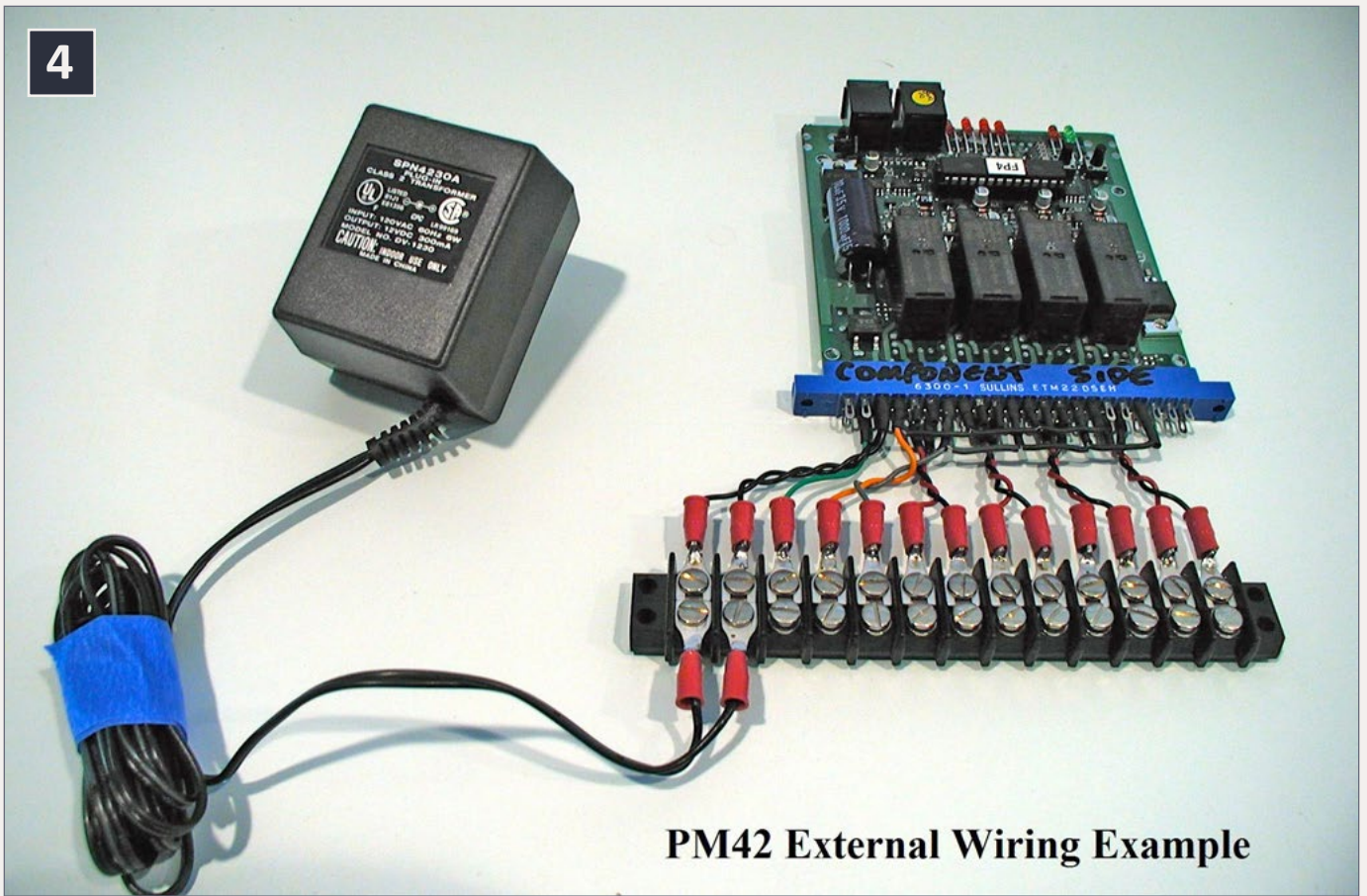

PM42 External Wiring Example

4. PM42 wired to terminal board and external power supply. Bruce Petrarca photo.

Advertisement

# Small Miracles

## End wiring frustration with Touch Toggles™



- Elegant controls
- No drilling
- No soldering

See our website for a video introduction!



Made in the USA



What will they think of next?

[www.berrethillshop.com](http://www.berrethillshop.com)





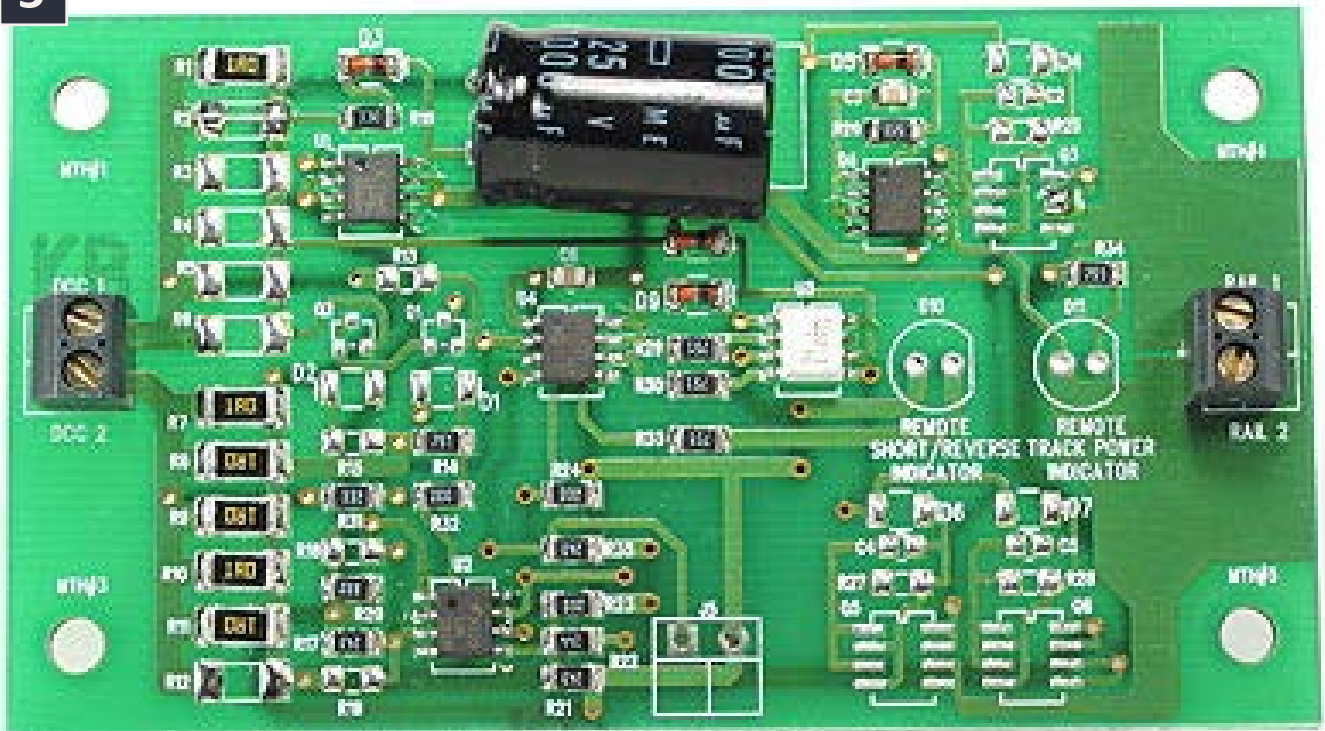

## 5. OG-CB basic electronic circuit breaker from DCC Specialties. American Hobby Distributors photo.

### Electronic

Modern detection circuitry and switching transistors make for durable, reliable and relatively inexpensive circuit breaker modules from several manufacturers.

If you have electronic circuit breakers on your layout and are not having any issues, I see no reason to change.

For those of you who are having issues, or designing a new layout, or converting an existing layout to DCC, or have relay style circuit breakers, or are using bulbs as your primary circuit protection, I recommend electronic breakers.

I like to divide electronic circuit breakers into three categories: basic, general purpose and advanced.

Basic versions are represented by units like the OG-CB (MSRP \$30) [5] from DCC Specialties and the similarly priced AR1 from Digitrax. Units in this group tend to have less sophisticated detection circuitry, resulting in larger sparks (causing more wheel pitting) than the more advanced units.

Some units in this group have knob-adjustable current settings. My experience with these has shown that many users have a hard time adjusting them to their liking. With the possibility of the knob getting bumped as well, I tend to shy away from those with knobs.

Most of the basic units were designed before sound decoders became so prevalent, so they tend to not make allowances for the inrush current to the energy storage schemes prevalent with sound decoders. Symptoms of this are that you have

6

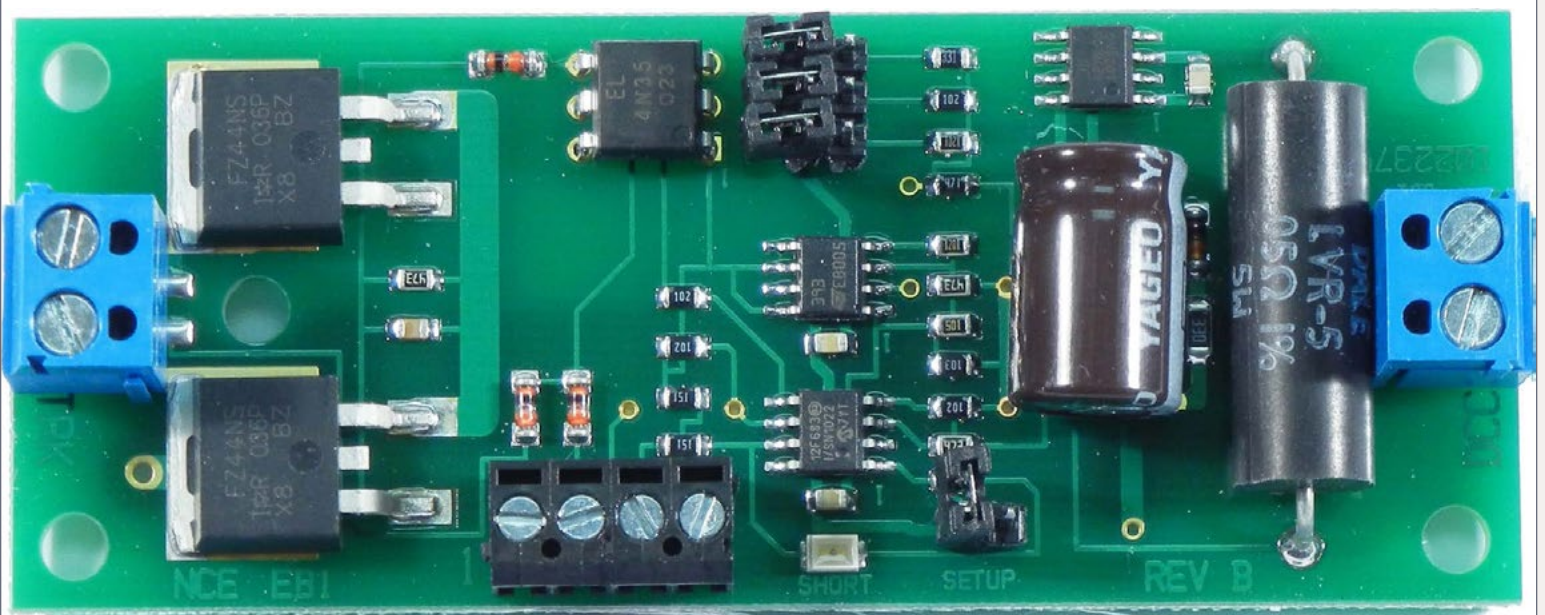

**6. EB1 general purpose circuit breaker from NCE. NCE Corp. photo.**





# Southern Digital

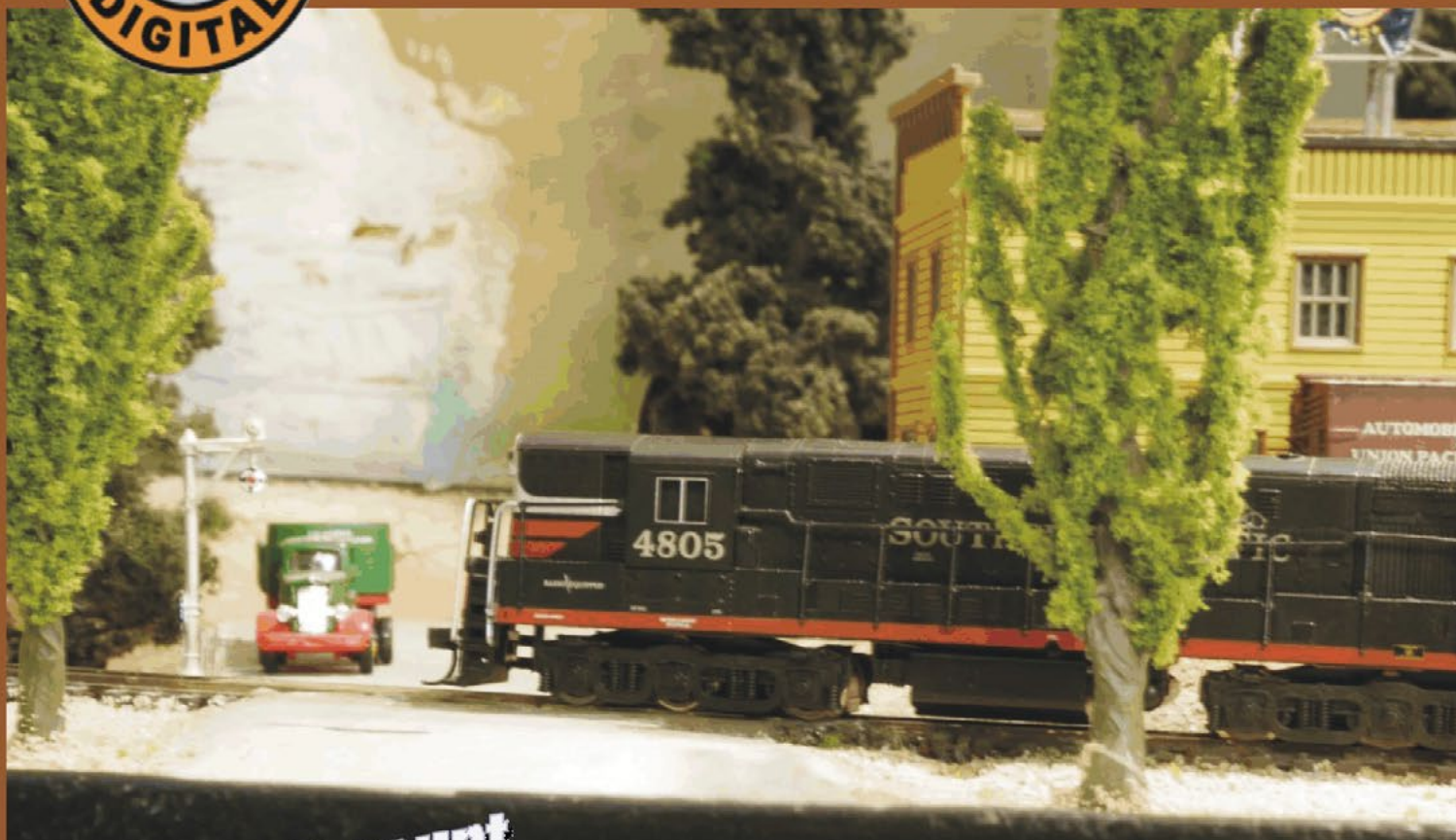

**20% Discount  
on most items!**

*Specializing in DCC Since 1992*



## DCC Conversions, Service & Support

Orders Received by 3:00 pm EST ship the same day

# WWW.SODIGI.COM





# TONY'S TRAIN XCHANGE

Committed to your DCC support!



Erik Claus and his trusty Tony's Reindeer

## CMX Cleaner Cars™

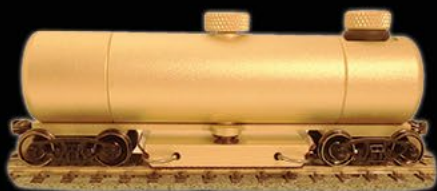

Superior, All-Brass Build Quality, Super Easy To Use & Cleans Exceptionally Well!

N, HO, S, O, & G Scales

Starting at \$144.95

[Order Yours](#)

## Athearn Genesis HO ES44AC GEVOs Are IN STOCK!



Great Christmas Gifts!

Get Yours Now at a Great TTX Price!

DCC Ready \$149.95    DCC & Sound \$224.95

[Order Yours](#)

## DCC Specialties R RampMeter™



Accurately measures DCC, AC and DC Volts and Amps!

Versions I, II, III & IV

Starting at \$59.95

[Order Yours](#)

### Do you need a Sound or DCC Installation done?

[Get a quote!](#)



Providing unmatched person to person DCC support for more than 20 years, the kind of service that has made us #1 in DCC.

**DCC questions? CALL US! 1-800-978-3472**

\*Mention this ad for \$5.00 off your next order over \$100!

*We'll get you on the right track!*

Nov 2014





# A Little Something Steamy



## NEW!

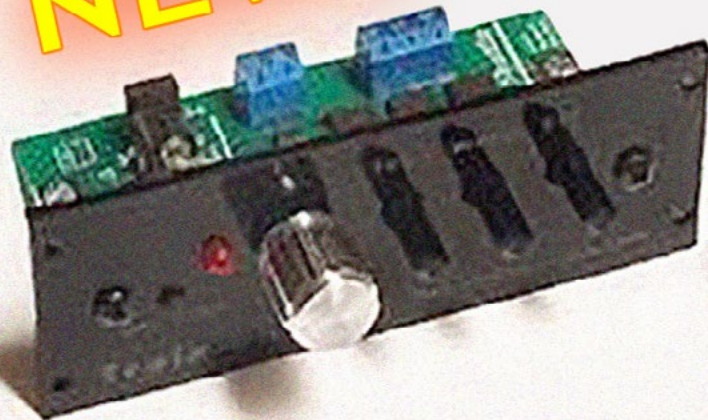

DCC Train Shuttle ...  
aka, "Prof Silencer"

**TamValleyDepot.com**



contents



index

a short in a section with a bunch of sound locos and the system won't start without having locos removed from the layout.

A fine example of a general purpose circuit breaker is the EB1 [6] from NCE. Do not confuse this with the predecessor EB3. The EB1 has been redesigned with sound decoders in mind and offers good performance at a price similar to the basic units mentioned above.

The PSx series of circuit breaker fits my advanced category. Priced about \$10 above the basic units, it offers a lot of bang for the buck:

- It can handle sound.
- It can handle up to 20 amps with an external heat sink.
- It offers manual or automatic reset.
- It is faster than any booster currently on the market. That, coupled with a 1.27-amp setting and manual reset, makes it the only circuit breaker currently on the market that works with the NCE PowerCab.

- It has a “weak booster” setting to ease the load onto boosters so that a bunch of discharged capacitors in sound locos don’t shut it down.
- It has a very controlled trip, so there isn’t a large spark (pitted wheels) when the short occurs.
- It has connections for external LEDs to show status.
- It has parallel input terminals for easy daisy-chaining of the DCC supply bus.
- There is a location to add a buzzer on board if you want a sonic alert.
- All the current settings are done by jumpers or setting CVs, so there are no knobs to bump. I recommend using the jumpers unless you need finer trip current settings that can only be achieved with CV settings. As they come, they

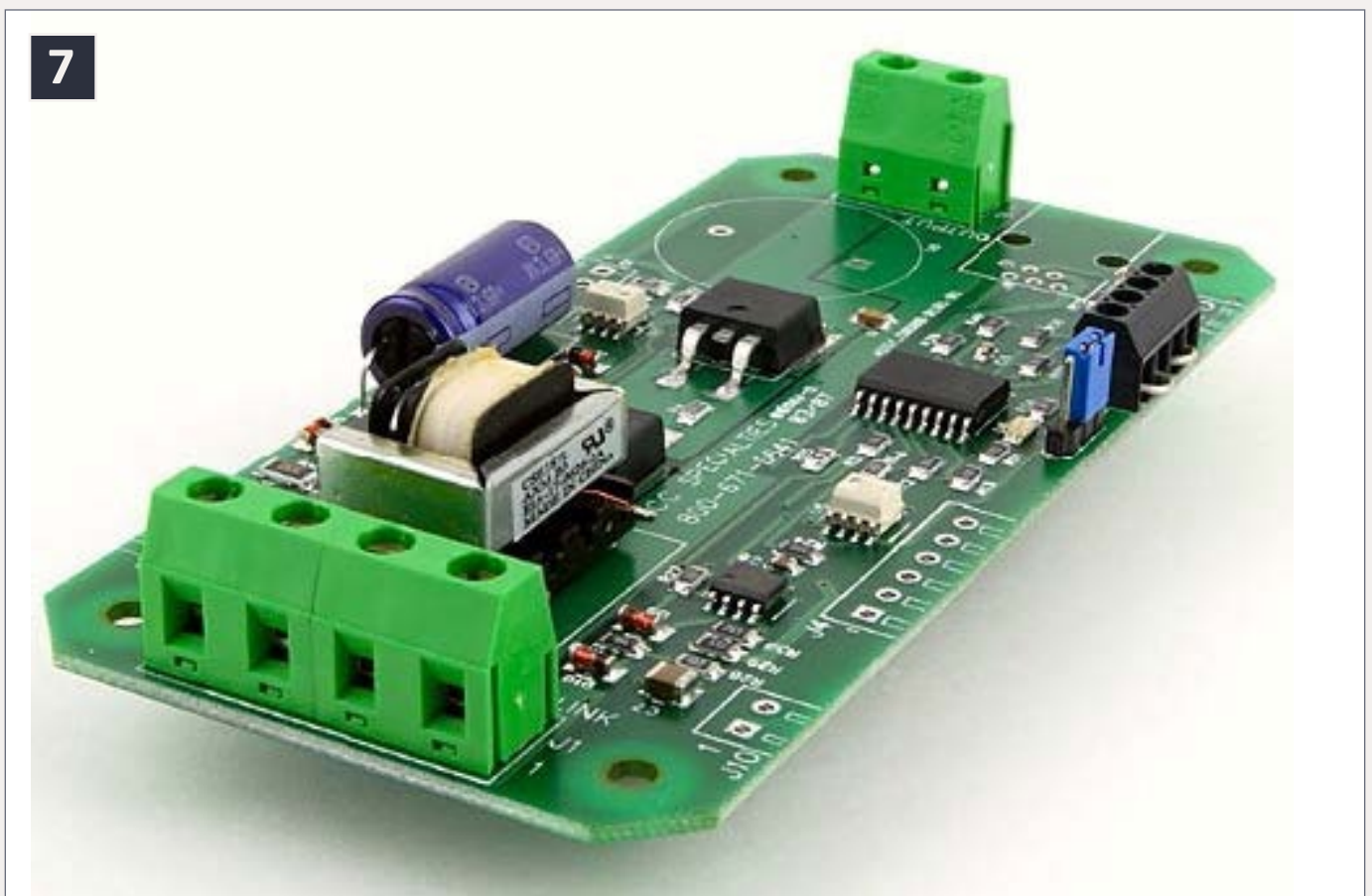

**7. PSx advanced circuit breaker from DCC Specialties. American Hobby Distributors photo.**



are set for 3¾-amp trip current. This is a good compromise for use with a 5-amp system. Remember, unlike the circuit protection bulbs, when the circuit breaker trips, it removes all the load. That way, the full power of the system is available for the remaining (functional) districts.

## **Auto-Reverser technology**

The heart of a circuit breaker is exactly what is needed for an auto-reverse module, the ability to detect a short.

The PSxAR is an example of sophisticated design technology. It combines an auto-reverser and a PSx series circuit breaker into one board. When a short is detected, first the module will flip the polarity. If the short persists, then the module will shut off the power.

*Advertisement*



The advertisement features a dark blue background with a spotlight from the top left illuminating a blue train. The train is moving towards the right. The text "Traintek" is written in a stylized, italicized font with a blue and white gradient, and "LLC.COM" is written in a smaller, white font below it. A white mouse cursor arrow points to the text "Click for More" in red. Below this, the text "Shine Some Light on Your Decoder Installations!" is written in a yellow, sans-serif font. The background is filled with small, white, star-like specks.



The subject of auto reversing is a topic unto itself. Guess that will be something for a column in the near future.

## One rail or two?

Relay-designed circuit breakers tended to disconnect the power from both rails. Electronic breakers tend to only open one rail. In normal usage, the difference is very minimal. There is one circumstance where there can be an issue with only one rail opening.

Consider a modular meet where two adjoining (sets of) modules are wired differently, one interrupting the outside rail and the other interrupting the inside rail. It is possible to have a short on the boundary between these two (sets of) modules that will not shut down the districts, but will take down the booster(s) supplying them.

### **There are two ways to remedy this.**

- Set a standard that a specific rail is interrupted and enforce it.
- Use a circuit breaker that interrupts both rails.

If I were setting standards for a modular club, I'd include a requirement that each section (group of modules that must be used together) drive a local DCC bus off the main DCC bus that passes through the module (set). This local bus would be isolated from the DCC bus with a circuit breaker that interrupts the outside rail. Thus every scene becomes its own domain and a short within it won't bring down the entire setup.

I asked Larry Maier, the designer of the PSx series about this. His reply: "The PSX breaker only opens one rail because we know that model railroaders have a limited budget and we are trying to make them as cost effective and affordable as possible. To answer your question: Yes, the PSX-AR opens both



leads. Should you have a situation that requires BOTH track leads opened, the PSX-AR will do it.”

There you have a bit about circuit protection, both bulbs and breakers. In a future column, I’ll delve into auto-reverser modules, based the start we made here.

I invite you to share your experiences on the blog that stems out of is linked to this column. Just click on the Reader Feedback icon at the beginning or the end. If you liked this column, you can register your “awesome” vote there, too. Until next month, I wish you green boards.

This month, I have an installation to share with you. Check out “Mr. DCC’s Workbench,” coming up next.



Advertisement

**HobbyOn**

[www.hobby-on.com](http://www.hobby-on.com)



**Name Brand Hobby Products at Discount Prices!**



# Get Better Sound from your Locomotives

Can't get a good sound from your sound decoder?  
Give our speakers a test drive with your ears.



**RAILMASTER HOBBIES**  
**9815 WALNUT ST #106**  
**BELLFLOWER, CA 90706**

Bass Reflex  
Speakers



High Bass  
Speakers



When it comes to speakers we have high quality speakers to fit many different applications. We are also a full line hobby shop. Need anything? We are an authorized dealer for Soundtraxx, Digitrax, Athearn, Walthers and many others. We provide quality speakers for your DCC sound systems and quality service.

**Click here for  
the *sound* answer ...**





# From Mr. DCC's workbench

## An O-scale diesel sound installation

Our club [pcmrc.org](http://pcmrc.org) is building a set of modules for a layout set in the late '50s to early '60s, centering on the Pennsylvania Railroad. Toward this end, they purchased a 2-motored Weaver RS3 without DCC or sound. Here are some of the obstacles that I encountered installing the decoder. For more information, go to my web site:

[mrdccu.com/install/o-scale-sound/weaver-rs3.htm](http://mrdccu.com/install/o-scale-sound/weaver-rs3.htm).

The first step was to select a decoder for the loco. A stall current test showed that each motor drew close to 2 amps. That means that, if the motors are in parallel, the decoder needed to handle almost 4 amps. Even in series (which was



8. QSI Titan Magnum decoder rated for 6-amp stall, 10-amp run. QSI photo.

my plan to limit top speed), they would need more than a simple HO scale decoder. Josh at QSI suggested that one of the Titan Magnum decoders [8] would fill the bill and he was, justifiably, proud of the sounds that they put into the decoder.

Next came the speaker selection. There was a 50 mm diameter boss molded into the fuel tank. I had a 50 mm speaker with a tall magnet structure in my stock, but it was rated for ¼ watt. With the decoder able to supply 2 watts of power, I wanted a more robust speaker. Chatting with Jack at Litchfield Station, I found exactly what I needed, a thin-profile 50 mm speaker with a 1½ watt rating.

The next stumbling block was fitting the decoder into the loco. The Magnum is designed with garden scale in mind and the RS3 is a very narrow and low hood loco. Well, I was all set to install the decoder on the floor pan of the loco when I realized that the hood opening is narrower than the decoder.

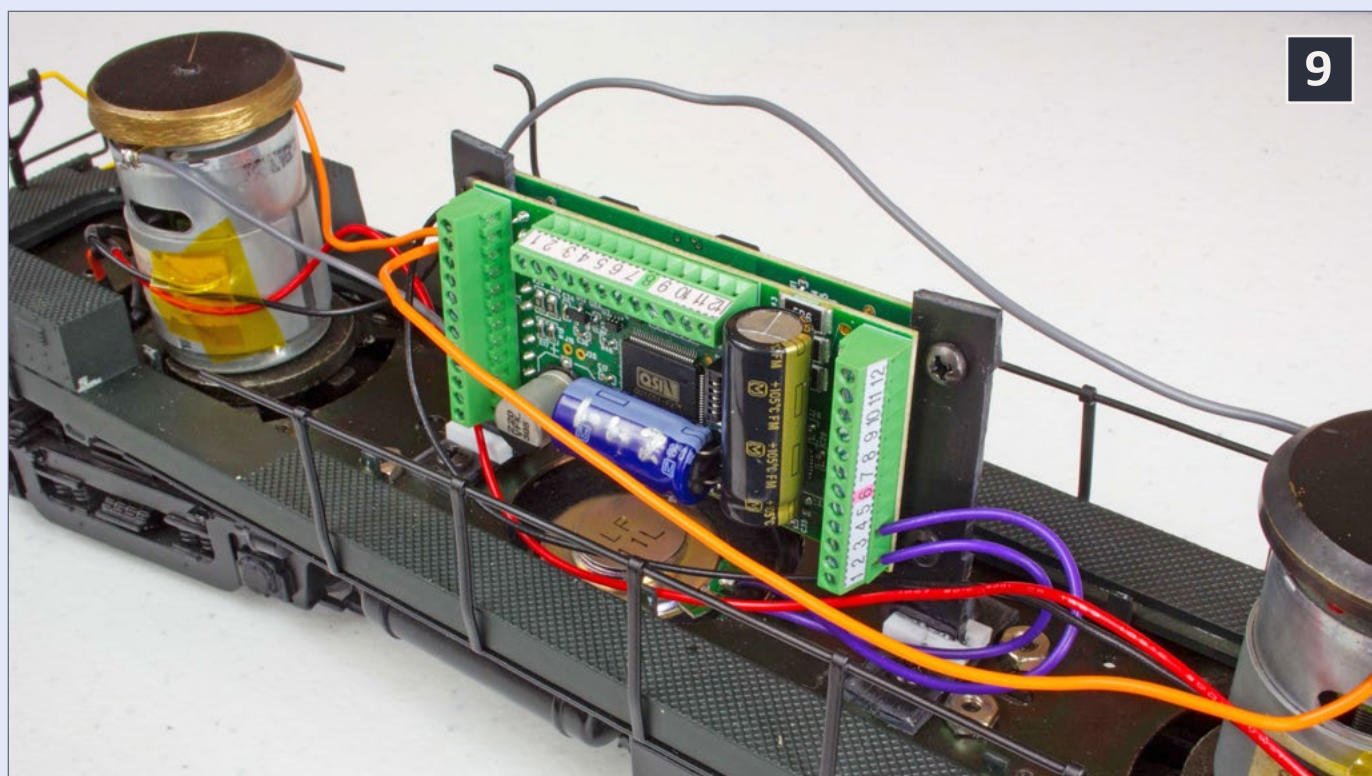

9. Decoder installed in the loco floor. Bruce Petrarca photo.





# HO GP60s

ARRIVING WINTER 2014



GP60M ATSF - 4 ROAD NUMBERS

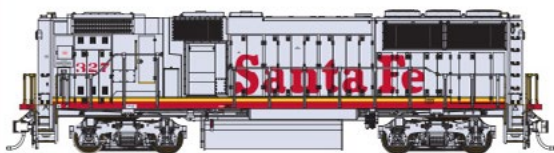

GP60B ATSF - 4 ROAD NUMBERS

NEW TOOLING  
SOUND AVAILABLE



NORFOLK SOUTHERN - 3 ROAD NUMBERS



RESERVE  
TODAY!

NORFOLK SOUTHERN - OPERATION LIFESAVER  
www.foxvalleymodels.com



OK, I had to design a vertical mount and even then, the decoder reaches almost all the way from the floor to the roof.

Once all of these issues were addressed, the installation was straightforward. I did adjust rail wires to the NMRA color code of red and black, away from orange and black. I'm still experimenting with series vs. parallel for the motor connection. But the decoder is capable of handling either connection.

## RR-CirKits, Inc.

Affordable Electronics for Model Railroads

The venerable  
**LocoBuffer-USB**  
has a new face!



**Rev-n**

Leaner  
Smarter  
Tougher

LocoNet® to USB interface

LocoNet is a trademark of Digitrax

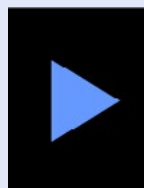

**Reader  
Feedback**  
(click here)



contents



index



# Digitrax No Worries Warranty

That's it! A simple, straightforward warranty with no tricky language



You're protected against

Learn

Need tech support?

[www.digitrax.com/contact](http://www.digitrax.com/contact)

Need a repair?

[www.digitrax.com](http://www.digitrax.com)





**NO WORRIES  
WARRANTY**

**Keeps Your Layout Running!**

**For one year  
and more!**

**Protects against  
defects and accidental damage.**

Learn more at: [www.digitrax.com/noworries](http://www.digitrax.com/noworries)

[www.digitrax.com/repair](http://www.digitrax.com/repair)

**Need a throttle conversion?**

[www.digitrax.com/upgrade](http://www.digitrax.com/upgrade)





FLUTED PASSENGER CARS FROM RAPIDO TRAINS INC

# SUPERIOR *Stainless*

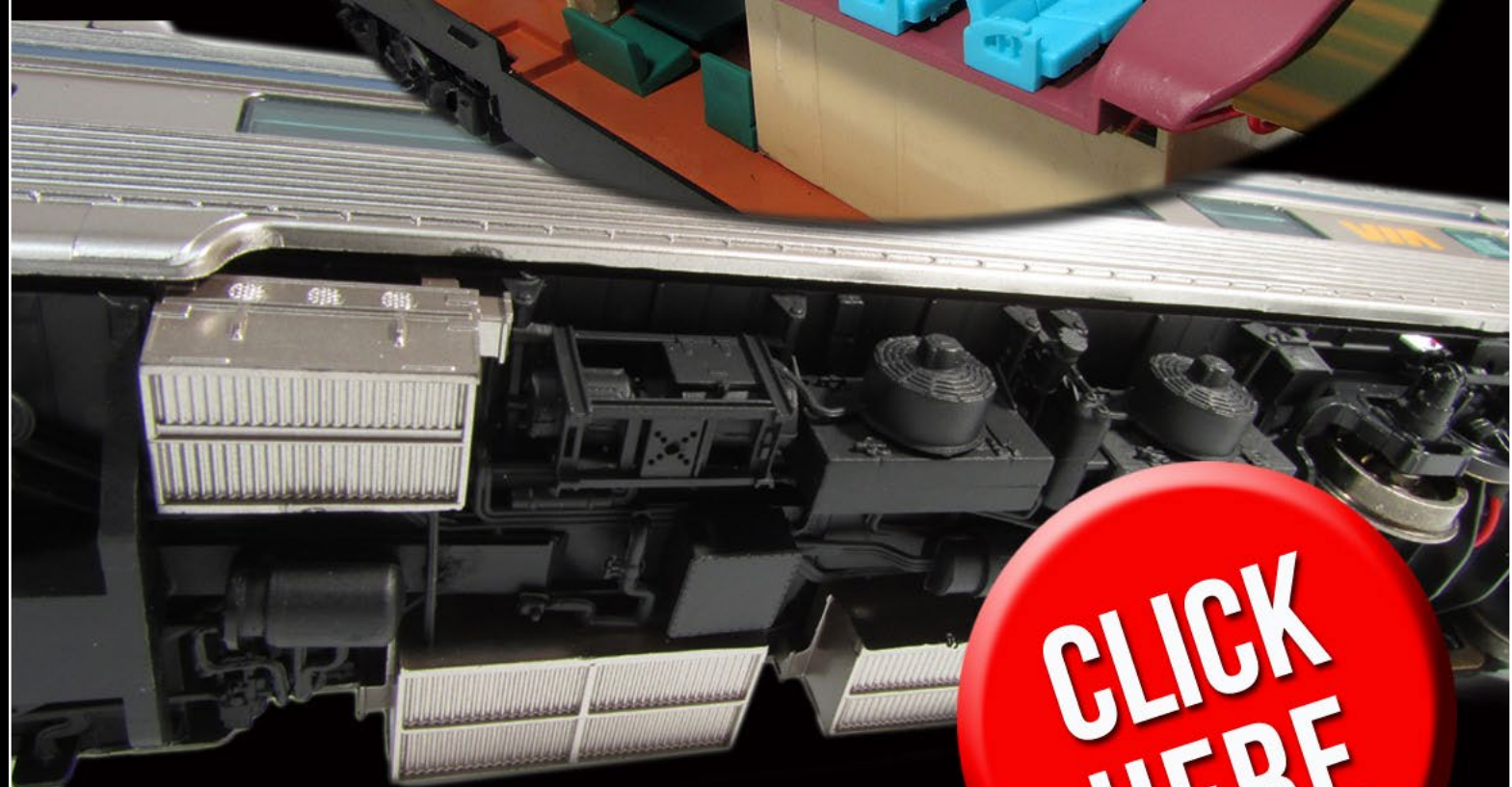
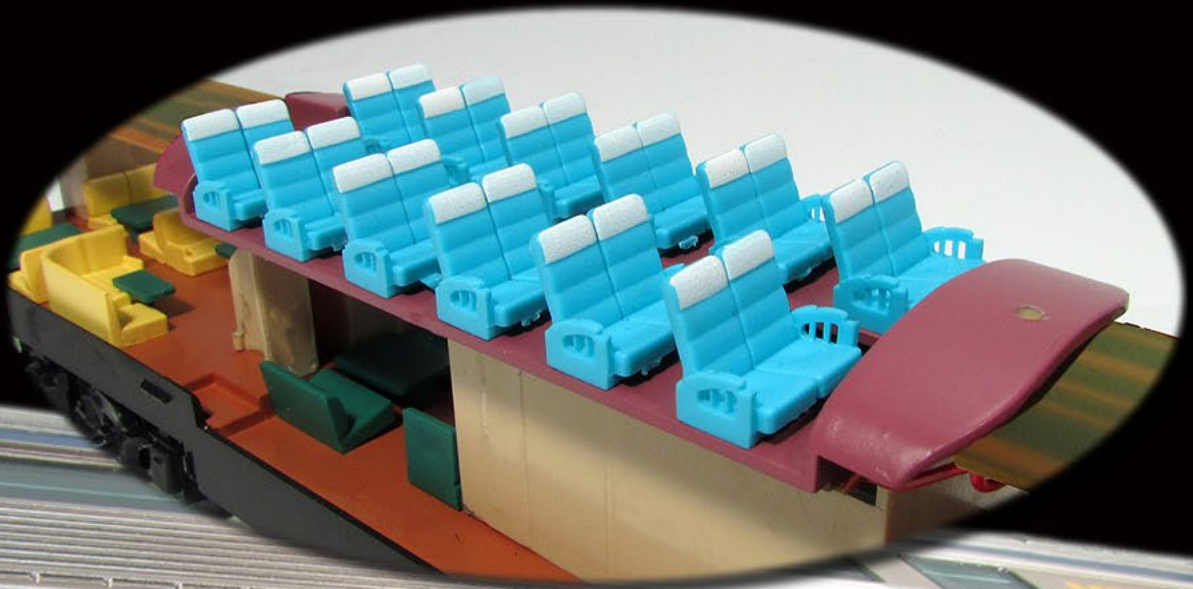

**CLICK  
HERE**

**It's Time To Upgrade...**







# Adapting Prototype Operations to Model Operations

Easier Operations



## Getting Real column

by Jack Burgess

### Making it easier for visiting operators ...

**W**hen I designed my Yosemite Valley Railroad layout back in 1980, I was not very interested in operations, but I also assumed that sustaining my interest in a completed layout required that it also be fun to operate.

Given my lack of interest in operations at the time, I didn't envision a regular operating crew. Therefore, one of my design goals was to develop a track plan that easily accommodated visiting operators.

That meant a logical point-to-point design, and one with a relatively easy-to-follow track plan. Hence, all the tracks are visible except for a one-turn helix and a hidden grade to climb from the first level to the second deck. There are no mysteries as to where a hidden track might come back into the open.

I also closely followed my prototype when it came to designing the yards and locations of passing sidings. By having the yards on the layout follow my prototype, I felt confident that I would not find the need to add more turnouts later, or otherwise



change the design of the yards once operations got underway years after construction had started.

## Getting started with prototype operations

I started construction of my current layout in 1980 and wired it for “progressive cab control.” Rather than using traditional

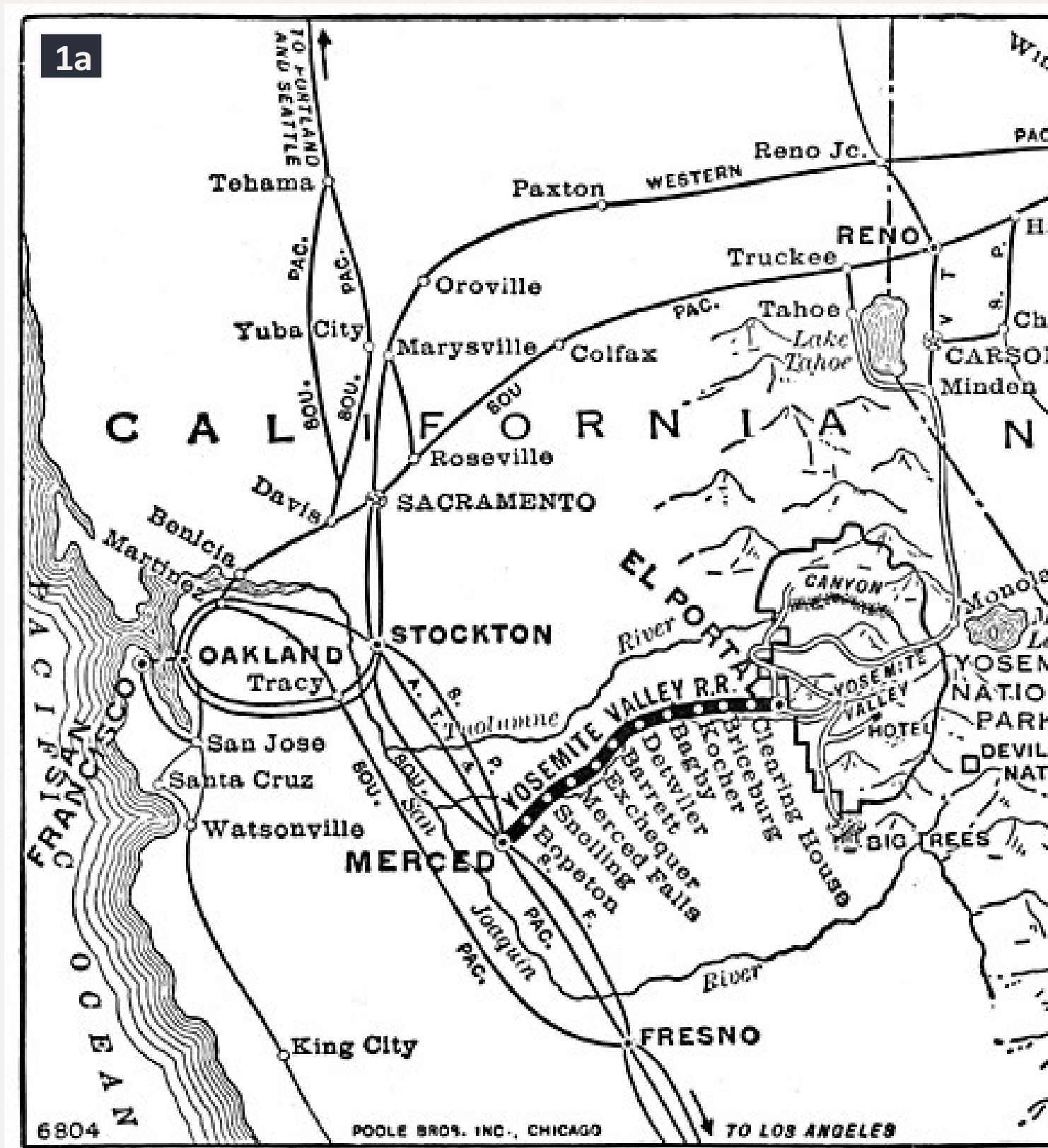



control panels to assign blocks, progressive cab control uses track detectors to automatically assign blocks based on locomotive direction and turnout positions.

Occasional informal operating sessions were run under this control system, but I was always limited to running no more than two trains at a time. The system could be expanded to

accommodate dozens of trains at a time, but I never installed the additional circuit boards to do that.

With only two trains running at a time, operations were limited to each operator making up a train at one of the two terminal yards, and passing each other somewhere in the middle of their runs.

In 1997, I rewired the layout for DCC and installed

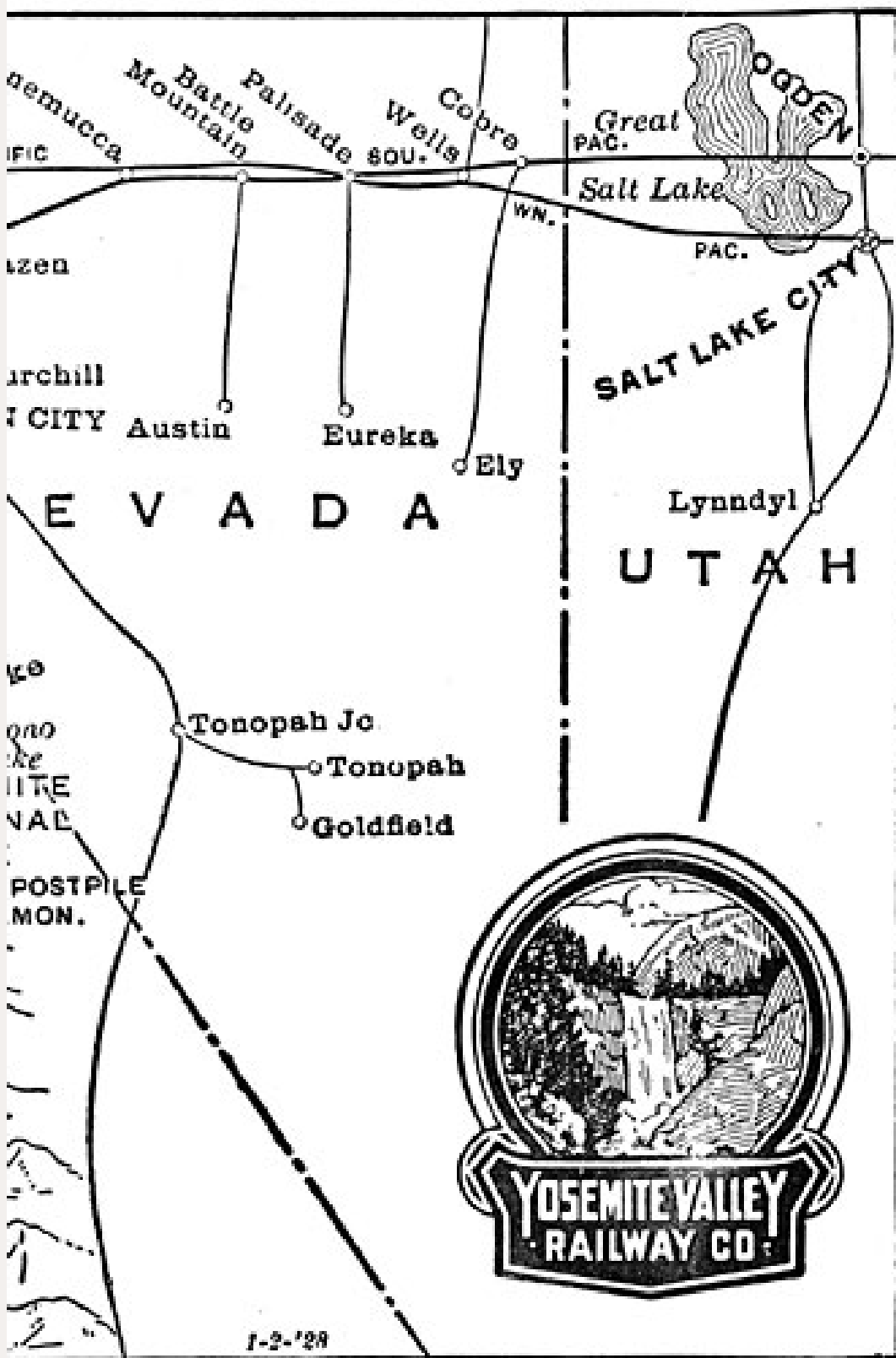

contents



index

SoundTraxx decoders in all of my locomotives. Finally, 17 years after starting construction of the layout, things were finally in place to begin duplicating the prototype operations of the Yosemite Valley Railroad.

In order to model the trains that actually operated on your prototype, you first need to understand what trains were typically run in the period being modeled. The Yosemite Valley Railroad was operated under TT&TO (timetable and train orders) and the first place to look for that information is an employee timetable for the period. Timetables are not difficult to find at railroadiana shows, on eBay, and so on.

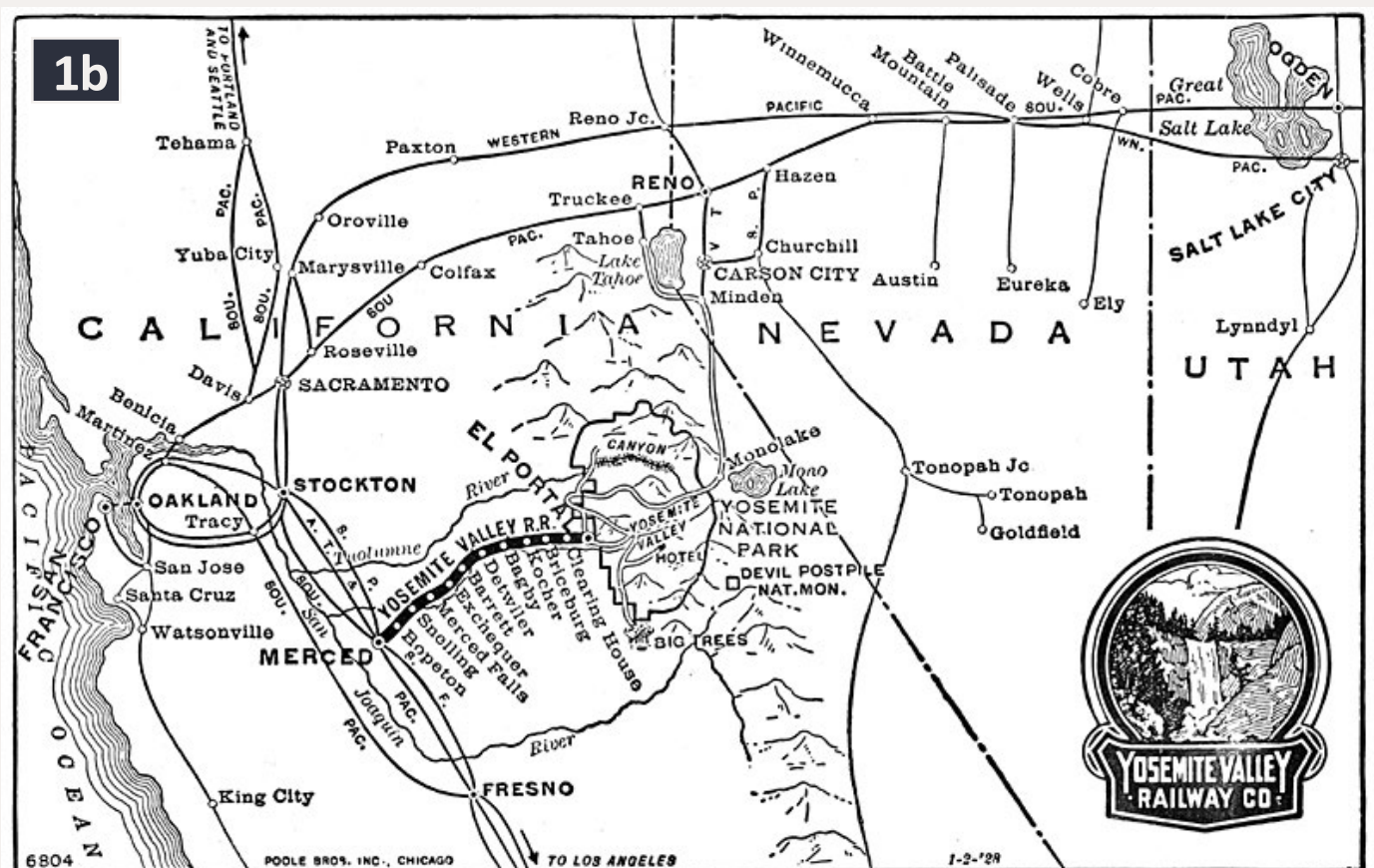

**1a-1b.** This map of the Yosemite Valley Railroad, from a public timetable, shows its connections with the Southern Pacific and AT&SF railroads in Merced and the major towns and places along the 78-mile route from Merced to El Portal, at the western boundary of Yosemite National Park.





The YV timetable covering August 1939 listed two daily first class passenger trains and two daily (except Sundays) second class freight trains.

The eastbound (toward Yosemite National Park) No. 2 passenger train departed the Southern Pacific RR interchange in Merced each day at 5:30 a.m. after picking up any Pullmans destined for Yosemite National Park. It arrived at the end of the line, at the western boundary of Yosemite National Park, at 9:40 a.m. It then departed El Portal as the westbound No. 3 at 7 p.m., arriving back at the SP depot at 10:45 p.m. Figure 1 shows the general route of the prototype from Merced to El Portal.

The two scheduled freight trains were the No. 8 and No. 9, actually daily log trains which ran between Merced Falls at MP 24 (milepost) and Incline at MP 73. Merced Falls was the location of the Yosemite Sugar Pine Lumber Company sawmill, drying yards, and planing mill. Incline was the lower end of an 8,600-foot-long logging incline down which the YSPLCo lowered loaded log cars from the cutting areas back in the woods.

The crew of the No. 8 went on duty at 7 a.m., pulled out the empty log cars, ran around them and added a caboose before departing at 8 a.m. They arrived at Incline at 11:10 a.m., dropped the empties and grabbed their caboose, running light for the nearby wye at Moss Canyon. Upon turning, they became the No. 9 and returned to Incline to pick up the loaded log cars there. They departed at 12:10 p.m. and were back at Merced Falls at 3:50 p.m.

I share this level of detail for these two trains so that you can better understand them. What I realized, once I studied the prototype YV timetable, is that the passenger train passed Merced Falls at MP 24 even before the log train crew went on duty. That passenger train then laid over at El Portal and departed back toward Merced 3 hours after the log train crew had tied up. So, neither train had any meets while out on the line.



contents



index

Of course, an employee timetable only lists regularly scheduled trains. A railroad could also run extra trains under train orders issued by the dispatcher. These extra trains (along with the scheduled trains) would be listed each day on the Dispatcher's Record of Movement of Trains, also known as a train sheet.

The late Al Rose, a well-known railfan in the 1930s-1980s, was able to collect nearly the entire set of train sheets from the YV when it was abandoned, along with a number of dispatcher train order books. After realizing how passionate I am about the YV, Al gave me photocopies of all of the train sheets for August 1939, along with the original train order book covering that month.

From these train sheets I learned that the YV ran a pair of extras every day, called the Merced Local and the El Portal Local. These freight trains departed their respective yards at around 4 p.m., usually meeting at Detwiler near the middle of the line. A typical train order for these two trains would read:

*Eng 26 run extra Merced to El Portal meet Ext 29 west at Detwiler Eng 29 run extra El Portal to Merced.*

After making up their trains, these two freights worked sidings along the line, making set-outs and pickups as specified in their switch lists. With a departure at 4 p.m. or so, the westbound extra needed to be clear of the westbound passenger train, which left El Portal at 7 p.m. and which would overtake it west of El Portal. The eastbound extra likewise needed to be clear of the same passenger train.

## Compromises

I decided during the layout design phase to not plan for passenger train operations. A typical passenger train in August 1939 would have included a 40-foot-long RPO car, a leased SP



# iwata

by ANEST IWATA

## *Just Rolling By...*

Make It **REAL** With Iwata  
*Climb Aboard!*



**Eclipse  
HP - CS**



**Revolution  
HP - TR1**

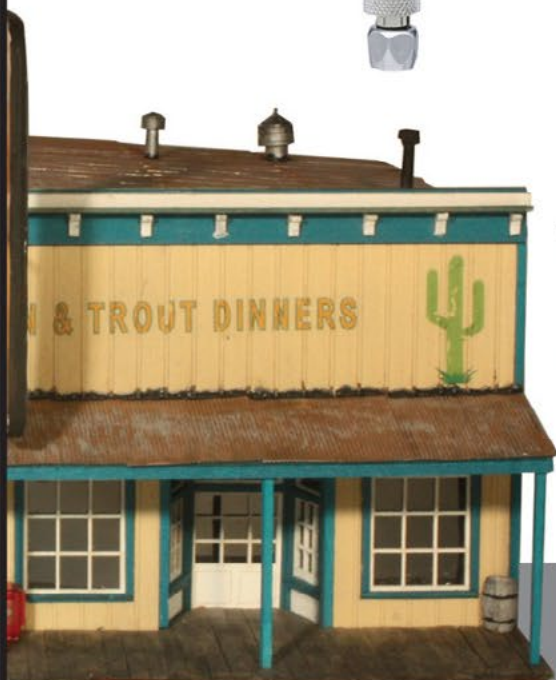

**Visit...**  
[www.iwata-medea.com](http://www.iwata-medea.com)

**To Check Out Our  
Full Product Line!**

*Models By... Alan Houtz,  
North American Prototype Modelers*



Phone



contents



index

diner, one or two heavyweight Pullmans (sometimes more), and the YV's 69-foot-long wooder observation car.

Motive power for these passenger trains was one of the YV's five 2-6-0s but a model 2-6-0 doesn't have tractive effort in proportion to the real locomotive. Accommodating passenger train operations would have required reducing the ruling grades on the layout while increasing track radii, siding lengths, and clearances.

If I had planned to run just the same trains run by the YV in August 1939 without the passenger trains, I would be left with four daily trains without any interactions, such as meets, with the exception of a single meet between the extras. That pace would certainly not be very appealing to visiting operators.

To make things more interesting, I made two changes. First, I chose to add a pair of non-prototype freight trains to handle a portion of the cars typically handled on the prototype by the extras. In addition, the times for departure of all of the daily trains were moved to the morning. This resulted in a fairly busy 2½ -3 actual hours of operation with each operator making three or four meets during the session.

With these changes, the trains run during an operating session include the prototype No. 8/9 log train, the prototype Merced and El Portal Locals (although they run as scheduled trains rather than as extras), and a non-prototype "rock train" which moves what the YV called rock cars (22-foot ex-Great Northern hopper cars) between a limestone quarry operation and the Yosemite Portland Cement Co. plant. These cars were handled on the YV by the locals.

The addition of the rock train provides a job for a fourth operator and, like the log train, it runs the length of the mainline and turns to return to its initial departure yard. I do not have the aisle space for two-person crews, so all engineers also take care of uncoupling cars, paperwork, etc.



# Paperwork

In order to operate under TT&TO, you need an employee timetable, train order forms, and clearance cards. For my timetable, I followed as closely as possible the format of the YV timetable in effect in August 1939. I used a desktop publishing program to prepare my timetable, but Excel or even MS Word would

**2** EASTBOUND TRAINS HAVE RIGHT OVER WESTBOUND TRAINS OF THE SAME CLASS

**YOSEMITE VALLEY RAILROAD COMPANY**

EASTWARD			Miles from MERCED	TIME TABLE			Miles from EL PORTAL	Capacity of Sidings - 40' cars (No. incl. engine and caboose)	Fuel, Water, Turn tables, Wyes and Phones	WESTWARD		
Second Class	Second Class	Second Class		Rating Grade Ascending	No. 103a May 27, 1939	Rating Grade Ascending				Second Class	Second Class	Second Class
No. 14 Freight	No. 12 Freight (Rock)	No. 8 Freight (Log)			STATIONS					No. 9 (Log) Freight	No. 11 (Rock) Freight	No. 15 Freight
Leave Daily	Leave Daily	Leave Daily				Arrive Daily	Arrive Daily	Arrive Daily				
			0.0		MERCED-S.P.Depot	5	77.7					
9:55 AM	2:45 PM	7:30 AM	0.5	0	MERCED-Y.V.Depot	0	77.2	YARD	W.F.T.P.	8:05 PM	1:00 PM	6:05 PM
				0	Merced-S. Fe Depot	0						
			1.0	15	A.T.S.F. Crossing	15	76.7					
			2.5	20	Portland Cement	35	75.2				12:55	
	4:15		10.9	40	Edendale	37	66.8	4				
			15.2	23	Hopeton	0	62.5					
<b>10:30</b>	<b>4:30</b>	<b>8:05</b>	24.2	41	<b>MERCED FALLS</b>	0	53.5	8	F.W.T.P.	<b>5:45</b> <sup>12</sup> <sub>15</sub>	<b>11:45</b> <sup>14</sup>	<b>4:50</b> <sup>9</sup> <sub>12</sub>
<b>11:45</b> <sup>11</sup>	<b>4:45</b> <sup>9</sup> <sub>15</sub>	<b>9:34</b>								<b>4:42</b>	<b>11:40</b>	<b>2:30</b>
			29.6	53	Starr	0	48.1					
			30.7	53	Exchequer	0	47.0		P.			
			44.2	53	Kittridge	0	33.5					
<b>12:55</b>	5:25	<b>10:27</b>	47.7	53	<b>BAGBY</b>	0	30.0	4	W.T.P.	3:50	<sup>8</sup> 11:00	<sup>14</sup> 12:55
<b>1:10</b> <sup>15</sup>	5:35	<b>10:45</b> <sup>11</sup>								3:30	<b>10:40</b>	<b>12:30</b>
			60.8	53	Briceburg	0	16.9		P.			
<b>3:10</b> <sup>9</sup>	6:55		67.0	53	Emory	0	10.7	5	P.	<b>3:15</b> <sup>14</sup>	10:25	
			70.4	53	Bloss	0	7.3		P.			
		<b>11:15</b>	73.0	79	Incline	0	4.7	14	P.	3:05	9:37	<sup>8</sup> 11:20
3:40	7:12	<b>11:38</b> <sup>15</sup>								1:17		<b>11:10</b>
4:00	7:24	12:01	75.0	0	Moss Canyon Tank	0	2.7		W.P.		9:01	
		12:15 PM	76.7	0	Moss Canyon Wye	0	1.0	5	Y.	12:50 PM	8:50	10:30
5:00 PM	7:40 PM		77.7	105	<b>EL PORTAL</b>	0	0.0	YARD	T.P.		8:10 AM	9:50 AM
Arrive Daily	Arrive Daily	Arrive Daily								Leave Daily	Leave Daily	Leave Daily

2. My employee timetables are folded, four-sided forms, as were the prototype timetables. This is page three, which is the most important page. The times in bold are meets. I also have a variation of this timetable which deletes the Merced and El Portal Locals (Trains 14 and 15). Under that timetable these two trains are run as Extras. Only one group of operators has ever chosen this option.



contents



index

work. The main page of my employee timetable is shown in Figure 2.

One method of developing a timetable is to graph all the trains that will run during an operating session so locations and times of all meets can be determined. That method seemed to me to be most useful when working with scheduled through or first class trains instead of locals and other trains which have work to do along the line. Instead, I needed an approach that would work with visiting operators and accommodate the switching each train needed to perform.

I began by running a number of trains at appropriate speeds between each town or yard and recording how long they took. I also measured how long it took for each train to perform the typical switching needed at each location during an operating session. From this information, I could start building a working timetable. I used Excel for this task since it was easy to continually change arrival and departure times at various locations along the line and to adjust times for the meets.



*The* Get the Latest Model Railroading News, Tips, Reviews & Opinions

# SCOTTY MASON

S H O W

*The Original Model Railroad Podcast*

**-Monthly Interviews**

- Modeler's Spotlight: Top Modeler's Talk
- Narrow Gauge Modeling w/Chris Lane
- Contemporary Modeling w/ Mike Rose

**-More Product Announcements & Reviews**

 **Our feed has changed! To get the latest shows, Please search Scotty Mason and subscribe to the new feed!**

[www.TheModelRailroadPodcast.com](http://www.TheModelRailroadPodcast.com)

*Scott Mason Jimmy Simmons Mike Rose Joe Duckworth*





In order to build a timetable, you'll also need to decide on a fast clock ratio. Of course if your layout is large, with long distances between towns, the fast clock ratio can be fairly low, such as 2:1 (meaning that 10 minutes by the fast clock is equivalent to 5 actual minutes). Over the years, it seems that operators are moving to lower and lower fast clock ratios. One argument in favor of this trend is that some tasks can't be compressed, such as the time needed for switching and issuing train orders.

However, one of my goals in developing the timetable for my layout was to also produce a timetable which provided travel times between stations reasonably close to the prototype timetable. For example, the prototype YV log train departed Merced Falls at 8 a.m. and arrived in Incline 3 hours 10 minutes later. On my layout the same train takes about 22 minutes for the same run. But if I use a 10:1 fast clock, that 22 minute run will take 3 hours 40 minutes, very close to the prototype timetable run time.

Now, a 10:1 fast clock is a very fast ratio! That means that one minute on the fast clock takes only 6 seconds. If you need to leave a yard at 9:55 a.m., you only have a "6-second window" to leave on time. This can be stressful for some operators. However, while I built my timetable using a 10:1 scale time ratio, I actually operate it with an 8:1 fast clock.

While that might not seem like much, it does give a little more time for things. More importantly, when I timed how long it took to run between yards, I ran trains at only 18 scale miles per hour. In addition, I was very conservative when timing switching moves. Together, these factors allow operators more time to run between times and complete needed switching.

In addition, all the major switching needed to build the two locals prior to departure is done long before their departure times. For example, the operator for the Merced Local typically needs to pull their cabooses from the caboose track and then



contents



index

pull four or five cars from the yard tracks to build their train. Some of these cars might be “buried” behind other cars which need to be put back where they started. But the operator of

this local will typically “go to work” at 5:30 a.m. for a 9:55 a.m. departure.

The fast clock is set to 5:30 a.m. when this operator has looked over the switch list, figured out an efficient approach for the work, and is ready to “go to work.” That gives this person over 30 actual minutes to complete this switching. If I feel the operator might need more time, I just have him or her go to work earlier. Likewise, time basically stops for the operators of the locals when they reach their final arrival yard. They still have work to do to switch out the cars in their train, but this work is not governed by the timetable.

(Form 320 5M-2-42 JJC) **3**

Yosemite Valley Railway Company  
SWITCH LIST

At Station, Aug 13 1945

TIME \_\_\_\_\_ M.

CAR	INITIALS		FROM	CONTENTS	REMARKS
	No.				
1	UTLX	57954	✓		x Tank
2	-	58280	✓		-
3	SP	31646	✓		One
4	-	96875	✓		-
5	-	97072	✓		-
6	Eric	51766	✓		-
7	C+D	40560	✓		-
8	DRY	50287	✓		-
9	SP	20456	✓		X
10	-	30097	✓		X
11	-	31222	✓		X
12	IMP	12490	✓		X
13	SP	20364	✓		X
14	-	37618	✓		X
15	-	31851	✓		X
16	-	32089	✓		X
17	INC	12338	✓		X
18	-	12502	✓		X
19	-	12101	✓		X
20					
21					
22					
23	RD	26154	✓		x Ref.
24	UP	191662	✓		One
25	W+W	47901	✓		-
26					
27					

**3. This is a prototype YVRR switch list from August 13, 1945. This switch list was written up for a Merced yard crew, since all of the cars on it are to be taken to the SP and AT&SF interchange tracks. Note that this form shows the name of the railroad as the Yosemite Valley Railway. That change was part of a bond refinancing plan which took place in 1934. I chose to retain the original name since that was the name most commonly associated with the railroad.**





Get the first 50 issues of  
**Model Railroad  
Hobbyist magazine™**

Save  
yourself  
endless  
hours of  
downloading

On a data DVD for \$10!

**Send me one!**

*(Sold by Model Trains Video)*

*Includes a coupon  
good for \$20 off on  
TrainMasters TV*

*Over 5000  
pages of  
how-to  
information  
on model  
railroading*



A relatively fast clock (but with a very forgiving timetable) can be a little stressful for visiting operators who have never operated before on my layout. However, I tell everyone they will have more than enough time to complete all of their required work with plenty of time to sit and wait before timetable departure times. In fact, if every single train runs on time, each operator will spend 15-20 actual minutes out of the 2½ to 3 hour-long operating session waiting for departure times and meets.

4

(Form 320 5M-2-39 JJC)

**Yosemite Valley Railroad Company**  
**SWITCH LIST**

At \_\_\_\_\_ Station, \_\_\_\_\_ 19\_\_\_\_

\_\_\_\_\_ TIME \_\_\_\_\_ M.

	CAR			TO	TRACK
	Initials	No.	Type		
1					
2					
3					
4					
5					
6					
7					
8					
9					
10					
11					
12					
13					
14					
15					
16					
17					
18					
19					
20					
21					
22					
23					
24					

Conductor  
Agent  
Switchman

I also tell visiting operators that not only will they have plenty of time to get their jobs done in a prototype manner, but will also time to wait for the “brakeman” to throw switches and make a standing brake test after making up a train.

Operators of the locals use switch lists I prepare in advance. This means no car card shuffling or moving car cards from one box to another.

**4. To help operators, I’ve added a Car Type column and deleted the Contents column of the prototype switch list on my switch lists. Instead of a Remarks column, I’ve substituted a Track column which indicates where the car is to be spotted.**





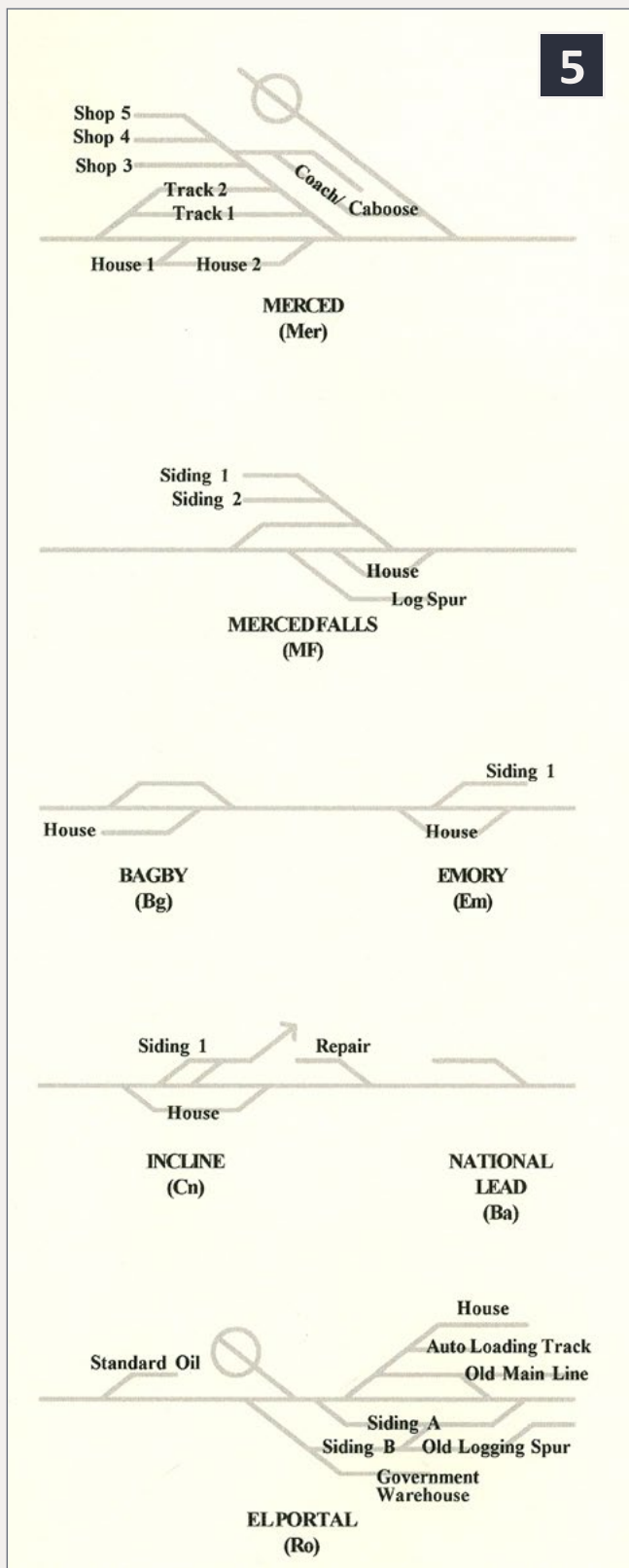

The format of my switch lists generally follows the prototype YV switch lists. My clearance cards also are replicas of the actual prototype forms and list any train orders an operator needs to have in their possession before leaving their departure station. Figures 3, 4, and 5 are of a prototype YV switch list and the front and back of my own switch list. Figure 6 shows one of my clearance cards.

## Operators

It seems there might be a couple of types of model railroad operators. One type, and possibly the most common for many layout owners, are members of the regular crew. These are the ones who show up on a regular basis, maybe once a month or more often, to operate a layout. They might have also been involved in certain

**5. The YV used milepost designations on their switch lists for cars to be switched along the line. Instead, I use station names and siding names. The siding names match the prototype ones. The back side of my switch list includes this graphic to assist a visiting operator. The two or three letter abbreviations under the station names are the telegrapher's abbreviations.**



aspects of its construction. Regardless, they are intimately familiar with operations on it, the owner's vision for its operation, and all of the jobs on the railroad.

I've never had a dedicated crew who operated my YV on a regular basis, although there are many modelers here in the San Francisco Bay area who have operated on it a number of times. I don't personally operate trains during these sessions. Instead, I am the dispatcher, as needed and trouble-shooter. Keep in mind that operation is not my main interest (which is research and model building). But I still enjoy sharing my layout with those whose primary focus is operations. It is entertaining.

Accommodating visiting operators, especially those who have never visited my layout, means incorporating easy-to-understand controls and logical operating practices. As part of this

FORM 325-5m-9-39

**6**

**YOSEMITE VALLEY RAILROAD COMPANY  
CLEARANCE CARD**

\_\_\_\_\_ STATION \_\_\_\_\_, 19\_\_\_\_

**CONDUCTOR AND ENGINEER No.** \_\_\_\_\_

ORDERS FOR YOUR TRAIN ARE

{ **FORM "19"** \_\_\_\_\_  
**FORM "31"** \_\_\_\_\_

(If no orders form "19" or "31" endorse "NONE" in space provided for order numbers.)

**TIME,** \_\_\_\_\_ **M.** \_\_\_\_\_ **OPR.**

Operators must retain a carbon copy of this clearance.  
This does not interfere with or countermand any orders you may have received.  
Conductors must sign orders Form "31" before accepting from Operator.  
Conductors and Enginemen must each have a copy and see that their train is correctly designated in the above form, also see that the numbers of all train orders received correspond with numbers inserted above.

**6. This clearance card uses the same format as the prototype.**





**YOSEMITE VALLEY RAILROAD COMPANY  
ASSIGNMENT CARD**

**ENGINEER** \_\_\_\_\_

**TRAIN NO.** \_\_\_\_\_

**TRAIN NAME** \_\_\_\_\_

**Locomotive No.** \_\_\_\_\_

**Caboose No.** \_\_\_\_\_

**REPORT TO DUTY:**

\_\_\_\_\_ STATION AT \_\_\_\_\_ M. ON \_\_\_\_\_, 19\_\_

To turn on the throttle, push the red Emergency button.

**7. This assignment card provides each operator with information on the train number and name of the train they will be running, the numbers of their locomotive and caboose, and where and when they are to report for duty.**

goal, I use two non-prototype forms. The first is a very basic but authentic-looking assignment card [7].

Once I either assign a specific train to each operator (or they choose themselves, always an option), I give each operator one of these forms. The form simply lists which train (by name and timetable number) each operator will be operating, which locomotive and caboose is assigned to that train, the yard where they will start their run, and the on-duty time for that operator. The form makes it easy for an operator to know when they are to “get on the clock” and know which locomotive and train is theirs for the session.



Together with an assignment card, and a copy of the timetable (and switch list if required), each operator is also provided a job card for their train [8]. One side provides detailed information on what the operator needs to do throughout the session,

and the other side provides standard YV whistle signals (for those not so stressed that they forget to whistle for grade crossings, when approaching stations, etc.). These forms are 4¼" wide by 5½" high, are printed back-to-back, and are laminated at the local copy store for permanency.

The purpose of these cards is to

8

### YOSEMITE VALLEY RAILROAD

#### Job: Train 14 Merced Local

##### *TRAIN NO. 14*

**MERCED** - Make up train using Switch List. Obtain Clearance Card from Agent at station. Run to Merced Falls per TT.

**MERCED FALLS** - Make setouts and pickups as required. Take water. Meet No. 11. Run to Bagby per TT.

**BAGBY** - Make setouts and pickups as required. Meet No. 15. Take water. Run to Emory per TT.

**EMORY** - Make setouts and pickups as required. Meet No. 9. Run to Incline per TT.

**INCLINE** - Make setouts and pickups as required. Run to Moss Canyon per TT making setups and pickups as required.

**MOSS CANYON** - Take water. Do not turn on wye. Run to El Portal per TT.

**EL PORTAL** - Make setouts as required. Leave cabooses on turntable lead and engine on Siding "B" (oil stains on the track in front of the Government Warehouse.)

Non-OS

8. This is a job card for Train No. 14, the Merced Local. It gives the operator the general scope of work for their train. The notation "Non-OS" in the bottom right corner identifies this job card as one where there isn't a dispatcher on duty. A slightly different job card includes notes on calling the dispatcher at each station or telephone location, and giving their OS (or "on sheet") time when a dispatcher is available during an operating session.







**9. There are no known photos of local freights on the YV while they were running as extras. However, this photo of a mixed train leaving Merced some time after June 1943 shows what might have been a typical consist in those days. The engine has just passed the semaphore for the AT&SF interlocking plant. Fred Stoes photo.**

provide to a visiting operator with the experience gained by a real YV engineer running the same train every day — the need to obtain a clearance card before leaving the initial station (and possibly later before changing train numbers), when to take water, etc. As such, it is much like having a mentor working with you as you take out your first train.

## **Orientation**

All of these efforts to help visiting operators might seem excessive if you have only regulars operate your layout, but every operator is a newbie on a new layout. I also provide a quick



orientation for visiting operators before the operating sessions. I have a checklist of the things I want to cover during these orientations. For example, I like operators to take water at all



**10. Locomotive No. 29 is on the head end of train No. 14, the Merced Local, this day. It is shown waiting for the semaphore to drop at the AT&SF interlocking plant so that it can proceed toward Merced Falls and, ultimately, El Portal.**



**11. While train No. 14 was switching cars onto its train in Merced, locomotive No. 25 was doing likewise in El Portal for the El Portal Local. Here is it pulling a YV flat car loaded with a state roads department Fresno scraper out of the auto loading track.**





**12. Earlier today, the engineer of the Log Train, the No. 8, picked up its assigned caboose and left Merced at 7:30 a.m., running light to Merced Falls. There it pulled out the log cars spotted the previous day on the Log Spur, ran around them and then coupled back onto its caboose. It is now 9:34 a.m. and the No. 8 is just crossing the county road as it leaves Merced Falls for Bagby and a meet with the Rock Train.**

water tanks or water plugs. Some of them are operational so I demonstrate how those work. I also point out the need to return all mainline switches to be lined for the mainline as required by Rule 104, and remind them that all of the derails on the layout are operational.

## **The goal**

During the orientations, I also encourage operators to not chat with each other about current day subjects, such as what television show they watched the night before while waiting for



meets or a departure time. It is not a hard and fast rule, but I like operators to get completely immersed in the time and place being modeled. Ideally, by the end of the operating session they will have felt that, for a few hours, they were actually operating a real train in a real place on a warm day in August 1939. 

*Pictures continue on the following pages ...*



**13. An hour after the departure of the Log Train from Merced Falls, the Merced Local arrived and made its pickups and setouts. Here No. 29 carefully spots a Great Northern box car along the planing mill shipping dock. It will have plenty of time to complete this work (and its other work) before leaving Merced Falls an hour and 15 minutes after arrival (10 actual minutes).**





14. No. 11, the daily Rock Train, departed El Portal at 8:10 a.m. this morning, running light with just its caboose. It is now around 10:30 a.m. and the 4-4-0 has left its caboose on the main and backed into the siding at Emory to pick up the loaded YV rock cars.

### Advertisement



## HO Old Time Passenger Cars

PRE-ORDER NOW!  
Late 2014 Delivery.

### 2 Body Styles

Right from Top:  
01-000224 Pennsylvania  
Coach  
01-000325 Union Pacific  
Baggage-Mail



## "HO" & "N" 53 Foot Containers with Heaters



New Body Style!

## HO 65' Heavyweight Passenger Cars

4 Body Styles

PRE-ORDER NOW! Early 2015 Delivery



Milwaukee "Olympian" & Other NEW Roads

Check our website for full details on all items. [www.con-cor.com](http://www.con-cor.com)





15



15. No. 8, the eastbound Log Train arrived at Bagby at 10:27 a.m. After taking water, it pulled forward to the clearance point for the siding. Since it is superior by direction, it stayed on the main line. It is now 10:40 a.m. and the westbound Rock Train has arrived for their meet. The Log Train is longer than the siding and is blocking the west switch. Fortunately, the cars in the Rock Train are only 22 feet long and locomotive will slowly pull forward until its caboose is clear, allowing the Log Train to pull out and leave for Incline.







**16. The lack of a blackout visor on the headlight dates this photo to probably 1940 or 1941. Visors were installed on all YV locomotives in early 1942, after the United States joined the Allies in World War II in December 1941. Train No. 9 appears to be passing Jenkins Hill, about 6 miles west of Incline where it picked up the loaded log cars. Al Rose photo.**



**17. Train No. 9 has just left Incline with an empty UTLX "Van Dyke" frameless tank car coupled behind the engine and a line of loaded log cars in tow. Jenkins Hill is just around the curve beyond the trestle.**



contents



index



# NORTH AMERICAN RAILCAR CORPORATION

- National Steel Car -

# Agrium®

*New Paint Scheme  
Coming Soon!*



LD LMT 227,400 LBS 103,100 KGS  
 LT WT 58,600 LBS 26,600 KGS

CLICK HERE FOR  
**HO Scale**

CLICK HERE FOR  
**N Scale**

**Agrium (NAHX)**  
 4275 cu. ft. 3 Bay Covered Hopper

NARC Cars are sold exclusively through **Pacific Western Rail Systems**

Check Back...

Sale starts November 27<sup>th</sup>



(aka - Dan's  
 Turkey Coma Sale!)

# BLACK FRIDAY

# SALE

CLICK HERE FOR  
**HO Scale**

CLICK HERE FOR  
**N Scale**

**Pacific Western Rail Systems**







# Soundtraxx decoder's 7-Band Equalizer

Photos and video of superb models

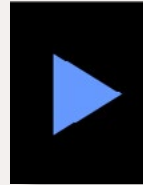

**Reader  
Feedback**  
(click here)



## What's neat this week column by Ken Patterson

1



1. In the weathering segment, Jeff Meyer makes a few hand-held shots of his Conrail boxcar. This is an Atlas car with a factory Penn Central paint job that he tricked out with weathering. In the video, Jeff explains how he weathered this model.





**I**n this month's video I cover spray booth design and the Soundtraxx decoder's 7-Band Equalizer. Jeff Meyer explains how he weathered his fantastic looking ex-Penn Central box car. Check out the interview we did during a photo shoot. Drop in a few good modeled runbys between segments and you have this, my 23rd show produced for *Model Railroad Hobbyist* magazine. I have had a lot of good video editing practice in the past two years in this interesting entertainment format. A monthly TV show in the hobby? That's a cool job to have. Let's see where this leads, together.



**Playback problems?** [Click to try a different version.](#)



2



2. The project is amazing in that all of the weathering and aging is achieved using oil paints and small to fine brushes. A wash of white paint ages the jade green perfectly.

*Advertisement*



*Announcing*  
***Scalecoat II FLAT PAINT***

Motrak Models is the ***ONLY*** dealer that carries Scalecoat II paint that dries flat. We have 15 weathering colors in our flat line of paint.

We will be at the Trainfest Train Show in Milwaukee, WI. Nov. 8-9, 2014.

To order or get more information, please send an email to: [motrakmodels@centurylink.net](mailto:motrakmodels@centurylink.net)

**CHECK IT OUT!**







**3-5. In another video segment, I discuss the design of my airbrush painting booth. Using  $\frac{3}{4}$ " and  $\frac{1}{4}$ " oak plywood made this booth strong. It is ventilated by a 500 cubic-foot-per-minute blower motor and squirrel cage blower from Grainger.**





This is the second motor. The first one wore out after 15 years of daily use. Three air outlets are built into the base, with shutoffs to run various air brushes. Roof-mounted lights cast bright light on the paint project. A 16 x 24" air filter slides in from the top to catch paint particles that could clog the blower fins and cause air flow to be lost. There is an air dryer with a regulator and air pressure gauge. Copper 1/2" tube was soldered together to run the air from this dryer to the three outlets that supply air. It is a great painting tool that looks good in the shop. The polyurethane finish matches the rest of the decor in the studio. On the video you can actually see it at work.





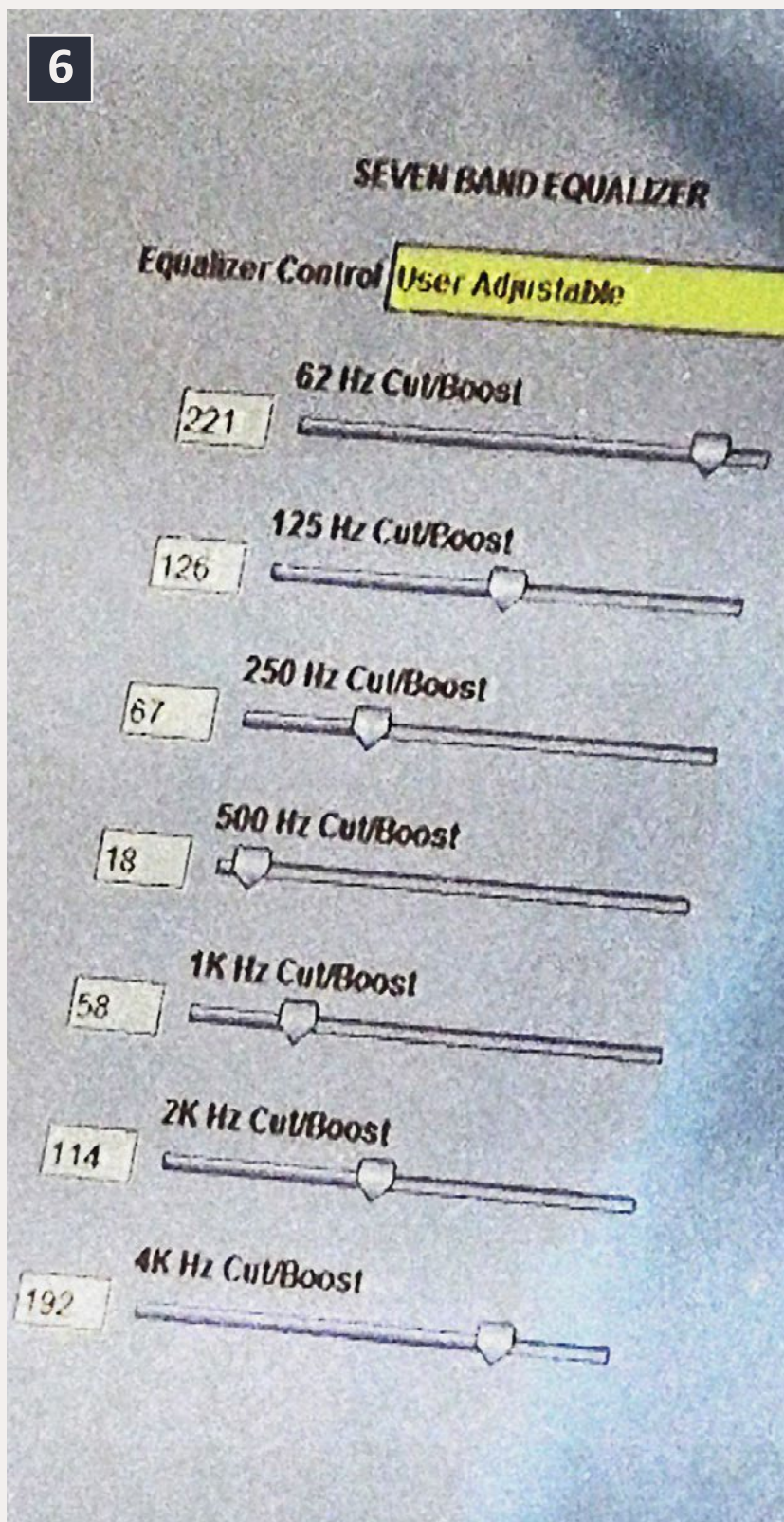

6. In the final video segment, I discuss how the equalizer works in Soundtraxx decoders. Using Decoder Pro's programming screen, sliders let you adjust the volume, bass, and high level sounds that your speaker will produce. It is very effective on steam and diesels alike, as I demonstrate in the video with side by side comparisons. Many manufacturers' sound locomotives come with Soundtraxx decoders and they all include the 7-Band EQ. Walthers, Intermountain, Athearn, and the

Blackstone line of narrow gauge locomotives all include the equalizer. I was surprised to learn about this feature, but I tried it and it works, as you will hear in the video.





7



7. Two identical Bachmann locomotives are my test subjects. The one on the rear track has its decoder adjusted for more bass, and the model in the foreground has more highs in its factory setting. The difference can be heard on the video.

8



8. I show you how to program CVs 153 through 160 the long way, using handheld throttles. You don't need to be an audio wiz to optimize sounds using the equalizer. Have fun and play with the settings to find out what sounds best to you. For more detailed information on tips

using the equalizer, watch this month's video and visit the Soundtraxx website at [soundtraxx.com](http://soundtraxx.com). 



contents



index



# MRH HOBBY MARKETPLACE - 1

## STREAMLINED BACKSHOP

Sales  
... Services  
..... Solutions

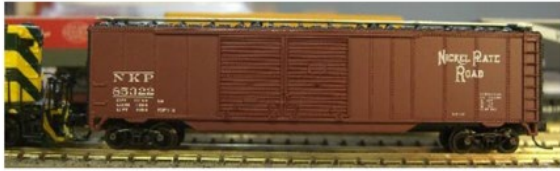
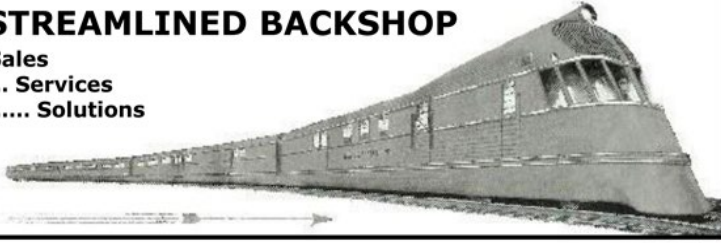

## DCC SOUND CARS



[www.SBS4DCC.com](http://www.SBS4DCC.com)

## Backdrop Junction

Your stop for  
Model Railroad Backdrops



[click here to visit our website  
backdropjunction.com](http://backdropjunction.com)  
N, HO, O Scales • Custom Orders

## CLICK TO SEE THE DIRTY TRUTH ABOUT 3D PRINTING



Dave's Model Railway Stuff  
[www.davesmrs.com](http://www.davesmrs.com)

HO & S  
Scale

## An Affair with Trains

Tuesday-Friday: 10:00 am - 5:30 pm  
Saturday: 9:00 am - 5:00 pm  
Closed Sunday and Monday

301 W. Deer Valley Road  
Phoenix, AZ 85027-2117  
623-434-6778



Your Arizona  
Model Railroading  
Headquarters

Shop Anytime At Our 24-Hour Web Store:  
[www.aawtrains.com](http://www.aawtrains.com)

## Great Decals!™

FEC, Interstate, Virginian  
Railway, & L&N Titles  
After Hours Graphics Line  
Coupler Gages and More  
In O, S, HO, and N Scales



P.O. Box 6 Paonia, CO 81428  
Ph. 970 527 4586  
Made in The USA

Cast resin items for your O & On layout.  
Tunnel portals, bridge piers, abutments,  
culverts, and retaining walls.  
Trackside details and sage brush tree  
armatures.

## True Scene Modeling™



**FusionFiber™**

Scenery Base Material for the 21st Century!

**SATISFACTION GUARANTEED!**

[www.truescene.com](http://www.truescene.com) or 716-523-7305





# MRH HOBBY MARKETPLACE - 2

## RULERS-of-the-WORLD

Scale Rulers \$4 each

Over **150** scales!

Metric or Imperial

[www.rulers-of-the-world.com](http://www.rulers-of-the-world.com)

## 2015 Trolley Calendar

Color cover, 13 B&W photos with descriptive captions from mid-Atlantic area:

PTC, PST, SEPTA, LVT, Wilkes-Barre, Baltimore, York and others.

To order the calendar by check or money order (payable to East Penn Traction Club), please send it to:

East Penn Traction Club

c/o Charles Long

227 Locust Road

Fort Washington, PA 19034-1425

[click HERE to learn more](#)



MRH *allowed* this video to be posted?



Watch the video now



An advertisement for Coastmans Scenic Products. It features two product packages: 'Stamp Stuff' and 'Windfall'. The 'Stamp Stuff' package is shown with a circular inset image of the product. The 'Windfall' package is shown with a rectangular inset image of the product. The text 'only \$5.99' is written in large white letters over the 'Stamp Stuff' package. The text 'only \$7.99' is written in large white letters over the 'Windfall' package. The text '-try- Coastmans Scenic Products' is written in white at the bottom right.





# MRH HOBBY MARKETPLACE - 3



[www.modelrailroadtunnels.com](http://www.modelrailroadtunnels.com)



Online store Veterans Day  special  
Nov 8-12. Support our Vets!



Please visit our website and online store!

21175 Tomball Pkwy Phone: (281)251-5813  
Suite 287 <http://www.logicrailtech.com>  
Houston, TX 77070 [info@logicrailtech.com](mailto:info@logicrailtech.com)



Railroad Art-Prints,  
Caps, Jackets,  
Shirts and More ...  
Jackets starting  
at \$79.95

[www.jelsma.com](http://www.jelsma.com)

1-904-221-3513 • Jacksonville, FL.

## Yarmouth Model Works

HO scale resin kits and detail parts



----- U.S.A. MAILING ADDRESS  
3560 Pine Grove Ave. Unit 617  
Port Huron, MI 48060

----- CANADIAN MAILING ADDRESS  
85 Hiawatha St.  
St. Thomas, ON N5P 2T5

Tel. 519-633-7574  
[pierre.oliver@start.ca](mailto:pierre.oliver@start.ca)

[www.yarmouthmodelworks.com](http://www.yarmouthmodelworks.com)



Have you seen these popular blogs on the MRH website?



**Ken Glover's Shelf Layout**  
54,000 reads  
**CLICK TO READ IT NOW**



**Mike Rose's N scale empire**  
70,000 reads  
**CLICK TO READ IT NOW**





# MRH HOBBY MARKETPLACE - 4

Can't remember which cars you've bought?

## Yard Boss

### Model Train Inventory Software

from DCC by Design

Under \$15

Download free trial now

[www.dccbydesign.com](http://www.dccbydesign.com)



## MODEL RAILROAD STRUCTURE KITS AND ACCESSORIES



[www.monroemodels.us](http://www.monroemodels.us)

## Minimalist Model Railroad Design

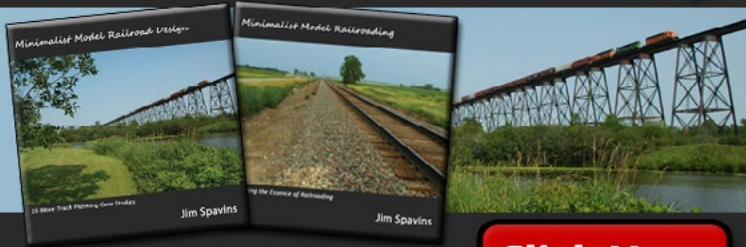

All New 2nd Edition!

[Click Here](#)

[CLICK HERE](#)

CANYON CREEK  
SCENICS

# CLEVER

models LLC

## Cardstock models & Building materials

[CLICK HERE](#)

[www.clevermodels.net](http://www.clevermodels.net)

## Mr. Detail Parts



New Parts Added Weekly!

[Click Here](#)

[www.mrdetailparts.com](http://www.mrdetailparts.com)







## Files, rifflers, and reamers

### Some common and not-so-common tools ...

by Jack Burgess



**F**iles are one of those tools which are found in just about every modeler's toolbox. For decades, I had a set of 12 Swiss-pattern files in different styles which I bought for probably under \$10. But they weren't very good files. Similar sets are still available under \$10, which likely means that the quality has dropped even more over the years.

One problem with such low-cost file sets is that the files in them are typically a medium cut. "Cut" refers to the coarseness of the file surface. Good Swiss-pattern files have cuts which range from 0 (64 teeth per inch), 2 (79 teeth per inch), and 4 (117 teeth per inch) to 6 (173 teeth per inch). The more teeth per inch, the finer the resulting finish. A "medium" cut is basically meaningless since there is no reference to the number of teeth per inch.

My first set of files was eventually replaced by a slightly better set of files which was later replaced with another set of files I hoped was better than the previous set. But I finally realized that if I really wanted to do precise model work, I really need some good Swiss-pattern files.



I decided to purchase three equaling files [1], also referred to as rectangle files, in different cuts (No. 0, No. 2, and No. 4) along with a half-round file and a round file, both with No. 0 cuts, and a square No. 2 cut file. Remember, the higher the number, the finer a cutting surface. Even though the cuts are obvious when viewed close-up [2], I applied two red paint dots to the No. 2 cut file and four red paint dots to the No. 4 cut file to make sure that I could keep them straight.

While there are dozens of places to purchase files online, many online stores don't identify the cut of the files. I bought my files from McMaster-Carr ([mcmaster.com](https://www.mcmaster.com)) for about \$15.00 each. They are Swiss-pattern files made by Nicholson.

In hindsight, typically only the No. 0 and 4 cut files are needed in the rectangular pattern. If you want to quickly file off a part of a metal casting or plastic sprue, the coarser No. 0 file will do the job quicker. On the other hand, if you are filing some

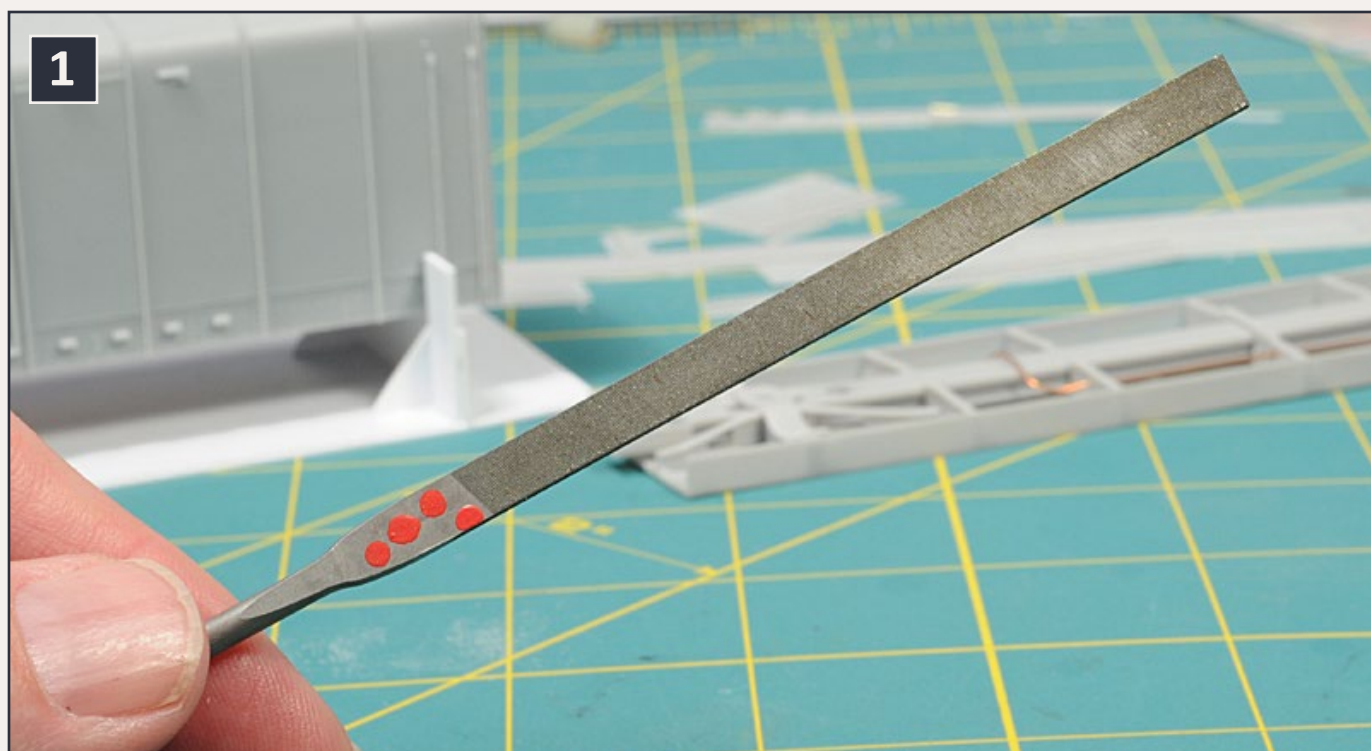

**1. My Cut No. 4 precision Swiss-pattern file. These files are 6¼" long with a round knurled handle.**



contents



index

non-prototype details off a plastic boxcar side, you will want to use a finer file such as a No. 4.

Occasionally, even a precision file may be too large for the job if you need to get into a small space. That is when you need an escapement file [3]. These are available in the same patterns as the precision files but have a much smaller cross-section. I purchased four of them (rectangle, round, three-square or



**2. On the left is a Cut No. 0 file while in the middle is a Cut No. 2 file. The finest cut file, a No. 4, is on the right. The finer cut on the No. 4 file is obvious.**

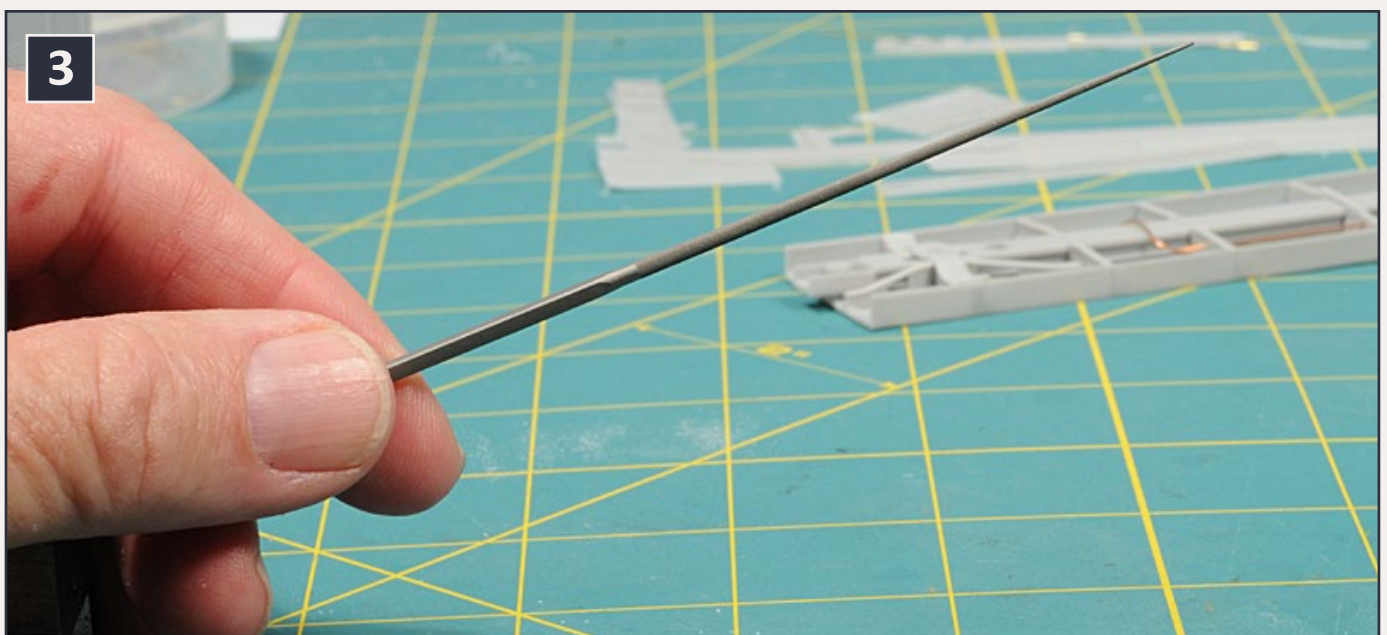

**3. A round escapement file. These files are 5½" long, and this round escapement file gradually tapers to a very fine tip.**



4

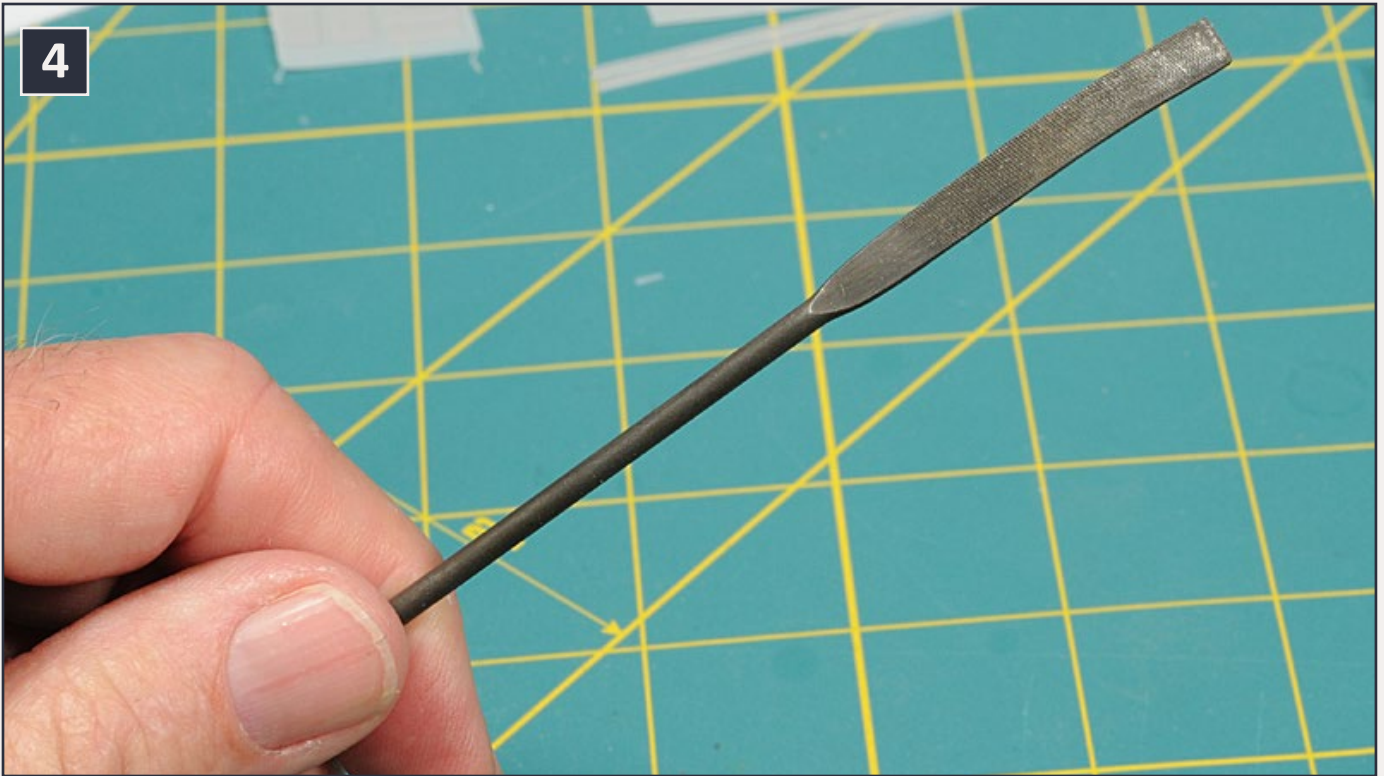

**4. A rectangular riffler file with the working surface curved to allow it to get into constrained areas. Both ends of the file have curved ends.**

triangle, and cross-cut/oval) from Otto Frei ([ottofrei.com](https://www.ottofrei.com)) for around \$14.00 each.

These are all high quality files, have a good feel, and are a joy to work with. If you want to be able to do precision work, you really need good files.

## **Riffler files**

Riffler files are a special type of file with a curved tip [4]. They are also called precision detail files. But, why would you want a file with a curved tip? To explain, let us assume that you have constructed a box with a floor and four sides. After building that box, you realize the floor has an irregularity that needs to be removed. The space is too tight to dislodge with a chisel-blade X-Acto knife, and grinding it off with a round bit



contents



index

in a motor tool might dig into the adjacent surface. The other option is to remove it by filing it off with a riffler file.

Riffler files are available in trade numbers based on the tip design of each file. Professional quality riffler files are about \$25.00 per pattern. My set of ten riffler files was purchased from Woodcraft ([woodcraft.com](http://woodcraft.com)) for about \$25.00.

A riffler file is one those tools that you only need a few times but, when you need to file down an area in a constrained space, it is the answer.

## Reamers

There are 20 drill bits in the range from #61 (0.0390") to #80 (0.0135"). But sometimes we need a drill bit just a little bit

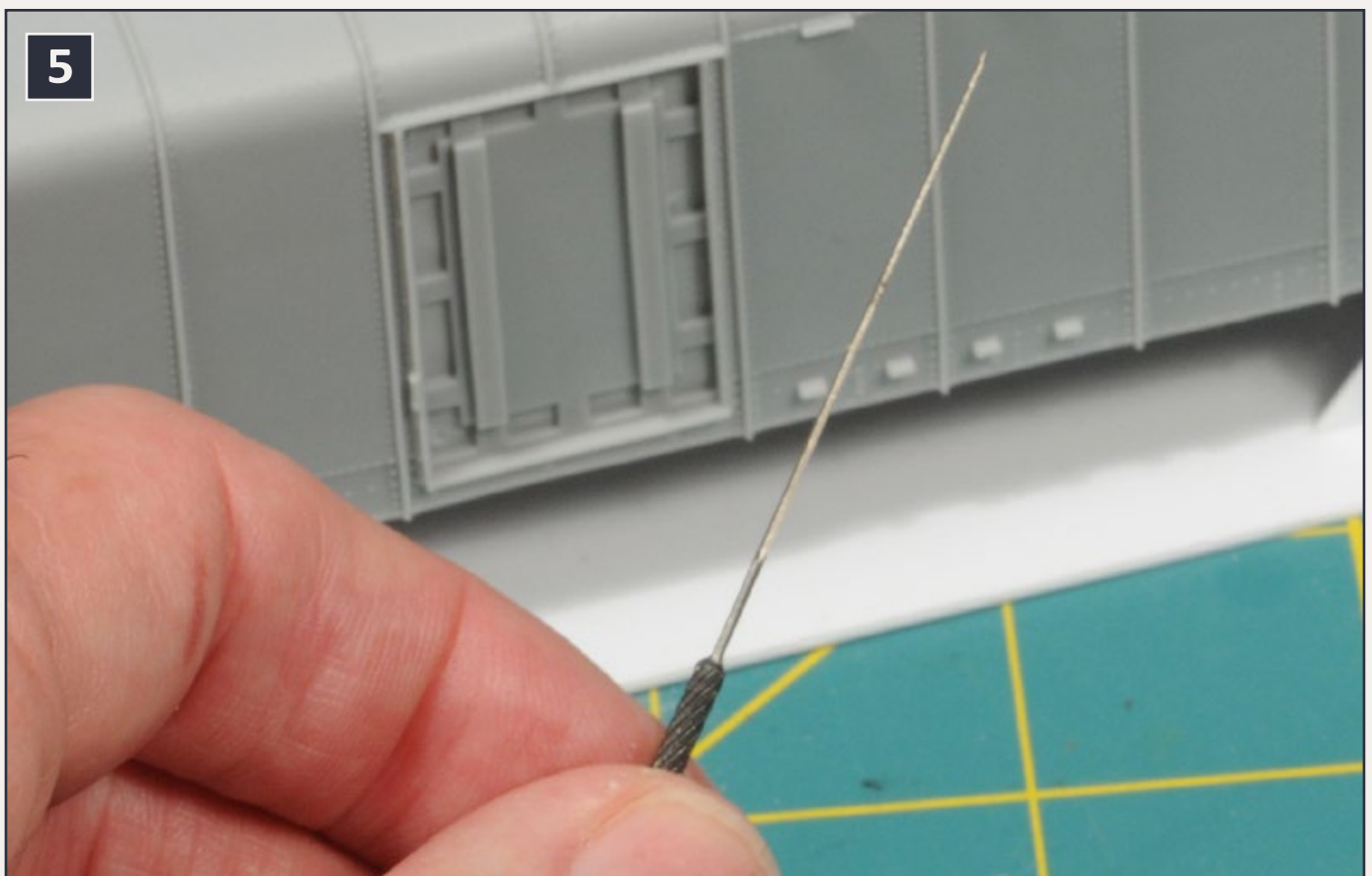

**5. The smallest reamer in my set measures .029" at the handle end and tapers to .019" at the tip, which means that it can fit into a .019" diameter hole.**





6. Here is my set of six reamers. The size of each reamer overlaps the next smaller one so that the set can enlarge holes from .019" to .100" in diameter.

larger than one available. For example, if you try to drill a hole slightly larger than the size of a part you need to fit into the hole with the drill, but it still won't fit. And the next larger drill size is too large. Reamers are the solution [5].

Reamers are tapered cutting tools with four square sides used to enlarge a hole to an exact size. They typically are available in a package with several ascending sizes [6]. Unfortunately, I don't remember where I found my set. Micro-Mark has a set of six reamers, but the smallest one is .024" while mine goes down to .019". Otto Frei has a set of cutting broaches very similar to my set that sells for \$25.00.

These tools are the answer when something won't quite fit in a drilled hole.

## Scrapers

If you have done any soldering other than electrical wire, you may have realized that files don't do a very good job at removing excess solder from a joint. Files tend to get clogged with the solder, and it is also easy to inadvertently start removing



contents



index

material from the area around the solder joint. A scraper [7] is a good tool for removing excess solder since the solder is soft enough to be removed by scraping but the metal (such as brass) is hard enough that it is unaffected.

I purchased a set of three scrapers from some unknown source a few years ago. Micro-Mark ([micromark.com](http://micromark.com)) has a set of four scrapers with different heads, with the largest usable for scraping excess solder. The set sells for about \$12.00.

## Sanding sticks

Sanding sticks [8] can be thought of as emery paper bonded to a piece of foam-core in the shape of a "file." They are available from a number of online sites including beauty supply companies such as Sally Beauty Supply ([sallybeauty.com](http://sallybeauty.com))



**7. Scrapers work well in removing excess solder. The wide head makes it easy to remove solder without damaging the underlying metal.**





**8. This sanding stick features four different grits. Unfortunately, I don't remember where I bought it. But single-grit sanding sticks are available from a number of sources.**

where they are called “nail files,” but it is difficult to determine the grit of their nail files. Another online supplier, Flex-i-file ([flex-i-file.com](http://flex-i-file.com)), has a number of options, although they are more expensive.

These sanding sticks range in grit from coarse to ultra-fine. Be sure to get a set which covers this range and not just the ultra-fine end of the range. I don't use mine very often, but I did while working on a model which used brass shapes, since the ultra-fine grit sticks worked very well in cleaning surfaces for soldering. I also use one to clean the tips of my resistance soldering tweezers, since they need to be very clean to function. They are handy tools.

## **Diamond sharpeners**

A friend recently told me about diamond sharpeners [9] which are sold for sharpening tools and knives. They consist of an



contents



index

absolutely flat resin body covered by an industrial diamond sharpening surface with an “interrupted” polka-dot pattern to collect the fines removed during use. While designed for sharpening tools, they are wonderful tools for filing down long surfaces such as the floor or underbody casting for a resin freight car [10], filing the running board supports on resin house cars so that they are all level [11], and sanding the back of thin resin castings to remove flash. Rather than holding a file to do these tasks, the sharpener is positioned on the workbench and the part moved over it. One of the advantages of a diamond sharpener is that, unlike a file, it cuts when moving the part in any direction.

I bought my 8” DMT diamond sharpener from Woodcraft ([woodcraft.com](http://woodcraft.com)). They are available in different combinations of grit. Mine has a Coarse grit on one side and Extra Coarse on the opposite side. While these might seem too coarse for model work, they are equivalent to 220 and 325 grit sandpaper respectively. These are made in the USA, and are high-quality tools. They come with a non-skid mat, but mine works without it on my self-healing cutting mat. Mine cost \$103.00. They are expensive tools, but really worthwhile if you build a lot of resin kits.

*Disclaimer – I love good tools and don’t hesitate to invest in them. ✓*

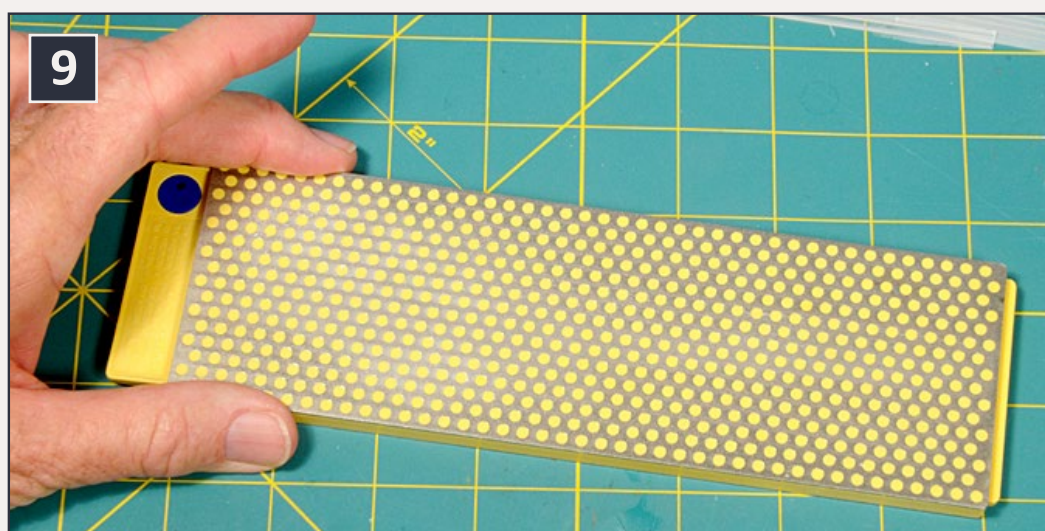

**9. My diamond sharpener is 8" long by 2½" wide.**



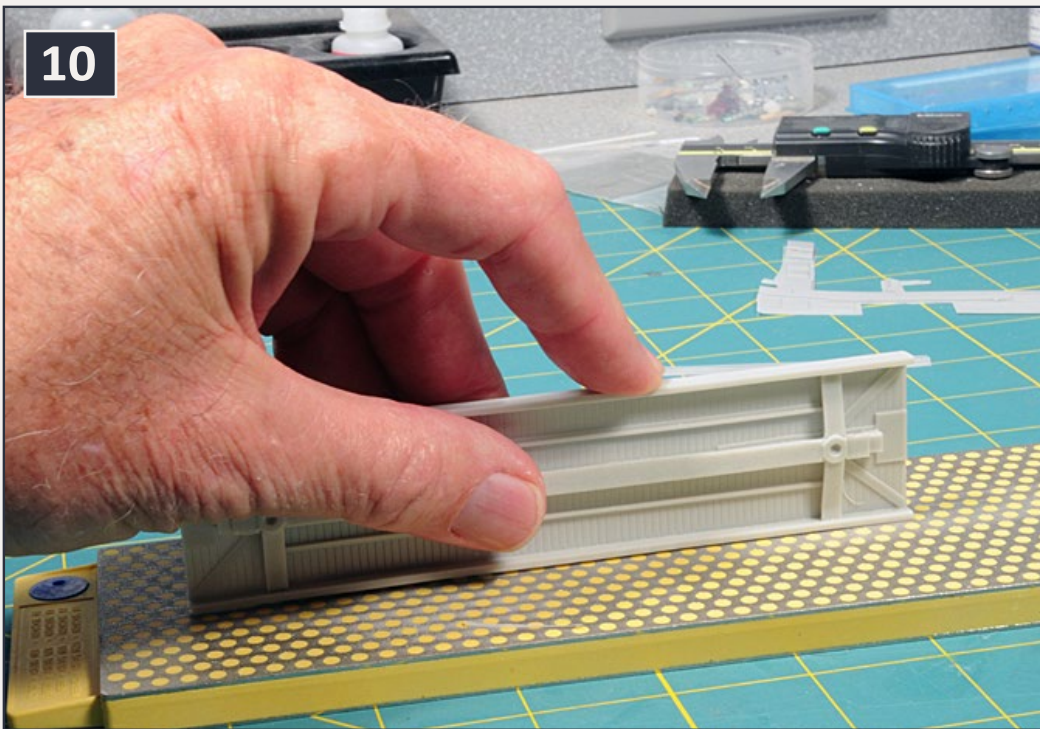

10. Sanding a resin kit floor using a diamond sharpener. A diamond sharpener makes it easy to reduce the width of the kit floor evenly over

the length of the resin casting.

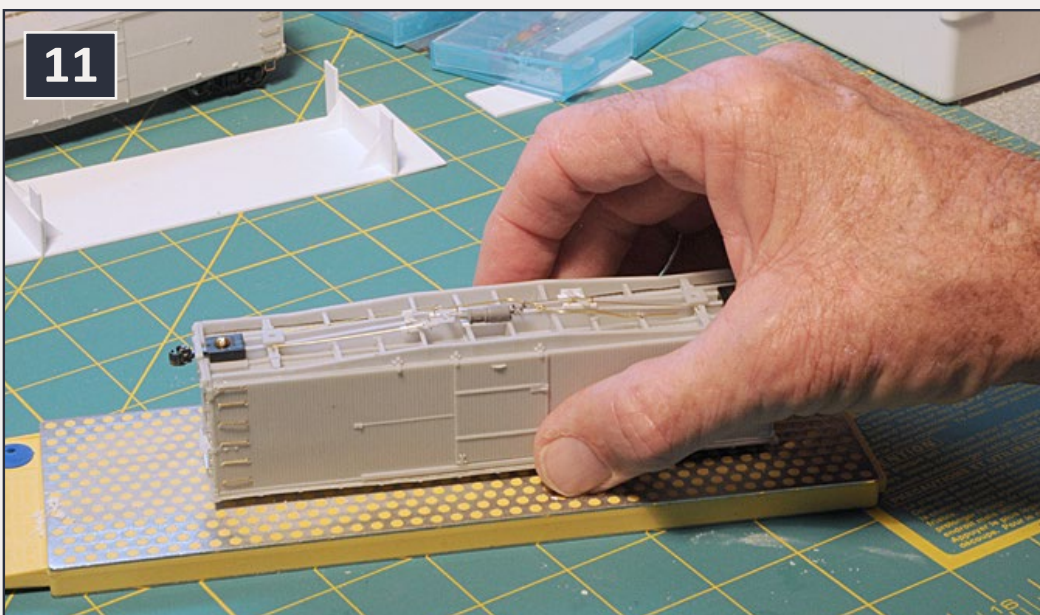

11. Making sure all the running board supports on a resin house car are even can be difficult with a standard

file, since it is hard to keep the car level and also at a right-angle to the file. Using the diamond sharpener, I slide the car back-and-forth and know that all of the running board supports are even when there is resin dust next to each support.



contents



index

# *Detailing a* **USA Trains**

## **Extended-vision caboose**



– by **Eric Warhol**  
Photos by author





**BURLINGTON  
NORTHERN**

**12206**

**FULL BATTERY SWITCH  
12 VOLT D.C. ONLY**

**3" N.E. COMP. SHOE**

**WATCH YOUR STEP**



contents



index



## Upgrading a large scale caboose...

**I**n January 2013 my wife, Joni, shared wonderful news with me. She told me that we would be expecting our third child. We live in a three-bedroom house with a den, and I had a small HO scale layout in there. I knew what this wonderful new blessing on its way meant for the layout. It would be coming down to turn the den into a toy room. I have to smile as I now hold our first daughter and tell her I'm wrapped around her little finger. She can even get Dad to tear down a layout (of course, she smiles back).

We are waiting to build our dream home on a few acres. In the meantime this left



**Reader  
Feedback**  
(click here)





me with a few options. One, I could be an armchair modeler. I could read, learn, dream, and plan. Or I could put to use the G scale equipment I 'd been collecting in hopes of having a garden railroad someday. I picked option two. I figured this would be a good time to start a small garden railroad. This way I will develop the skills needed for building a larger garden railroad. After all, most of us didn't start with large layouts, no matter what our chosen scale. We started small, learned the skills of the hobby, then built larger layouts.

## Getting started

For my first project I decided to detail the interior of a Burlington Northern caboose [lead photo] and [2]. I began by turning to Google to find images of caboose interiors and



### 2. USA Trains extended-vision caboose.



contents



index

Burlington Northern cabooses. There are lots of great websites for doing this, such as Google, Flickr, [rrpicturearchives.net](http://rrpicturearchives.net), [locophotos.com](http://locophotos.com), and [railcarphotos.com](http://railcarphotos.com).

I already have most of the standard tools needed for model railroading, but realized I lacked a few things. One was a foam cradle for holding locomotives or rolling stock while working on them. I went to a craft store and purchased a piece of foam 2" thick. I cut the bottom a little longer and wider than my largest locomotive. I then cut the sides to be halfway up the sides of the locomotive. I used Woodland Scenics Foam Tack Glue to glue the cradle together. I also realized I didn't have scale rulers. After a Google search I found [rulers-of-the-world.com](http://rulers-of-the-world.com) where I purchased 1:29 and 1:32 scale rulers. These rulers are made from 0.060" or .10" plastic, and come in various lengths. They work great for measuring, but I still turn to a metal ruler as a guide for cutting things [3].

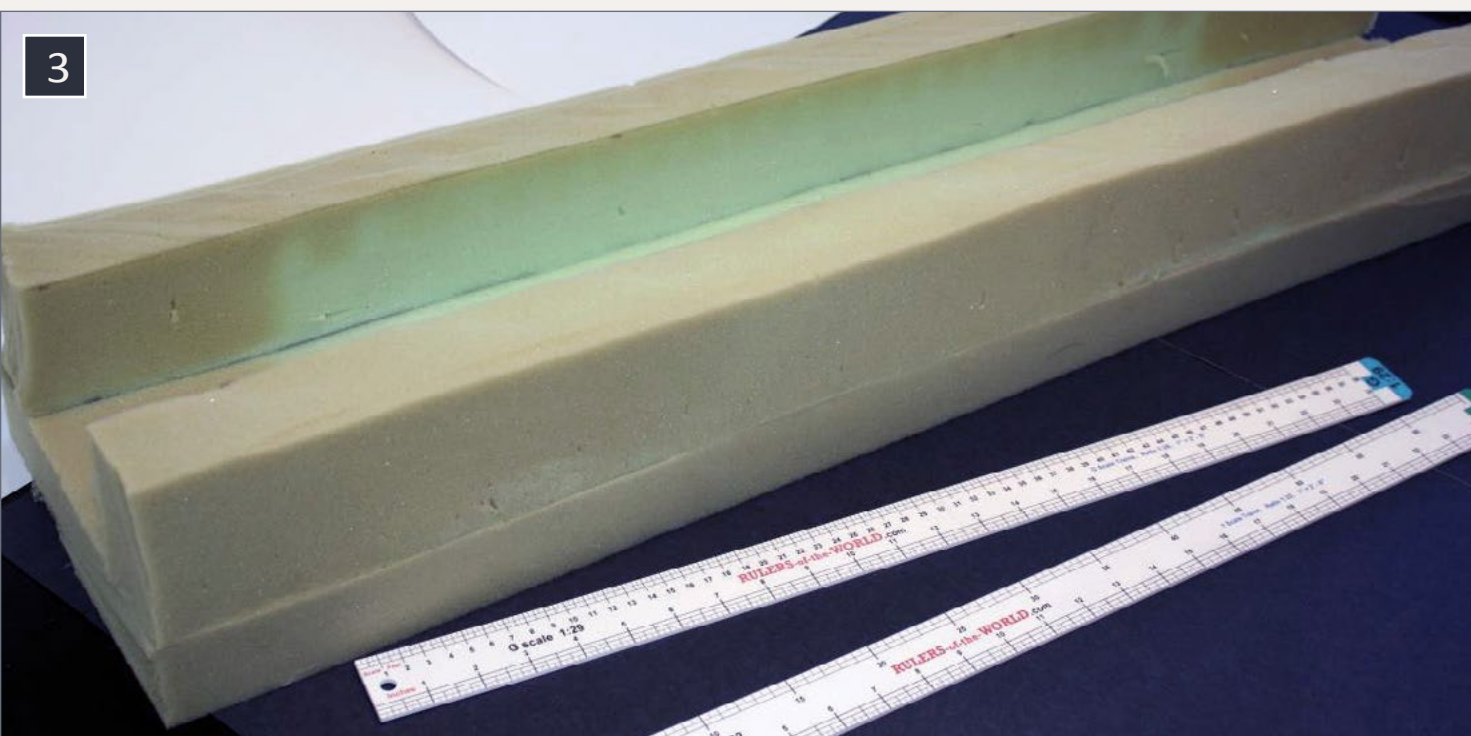

### 3. Homemade foam cradle and scale rulers.





## 4. Interior pieces and figures.

After looking at photos of extended-vision caboose interiors, I noticed a few common things. These are the upper-level viewing area, a chair and table, and a stove. I turned to eBay to see about caboose interiors, and found some LGB interior parts that would work [4]. I even picked up a few people to put in the caboose. As for the stove, I couldn't find anything that matched what I was looking for; the stoves in the pictures appeared to be black rectangles. I decided to scratchbuild one from styrene.

## Disassembly

After forming a plan to detail the interior, I took the caboose apart. I placed it in the foam cradle with the bottom side up. [5] shows the screws that need to be removed. With the screws out, I removed the caboose from the cradle and placed it on a flat surface right-side-up. Next I removed the end platform, ladder, and details. I started by gently pulling up the end ladders and moving them to clear the rooftop [6]. The rest of the details are held in place by three small plastic pins located



contents



index

down by the walkway. Be very careful prying/pulling these out – I broke a couple of them. I then placed the caboose back into the cradle, bottom-side up. Three more screws must be removed from each end [7]. Then I pulled off the roof.

My goal for the interior was to provide a basic representation of a caboose. I also wanted to replace the interior lighting. The lighting provided by the manufacturer wasn't very realistic to me, so I removed it all (light bulbs, circuit board, etc.). I planned to add 0604 warm white surface-mount (SMD) LEDs. I also thought of adding a desk lamp on the conductor's table.

The caboose came with a flashing red LED on the rear, but some local rail fans told me BN cabooses have a steady, non-flashing, rear light. I decided to change that as well.

5

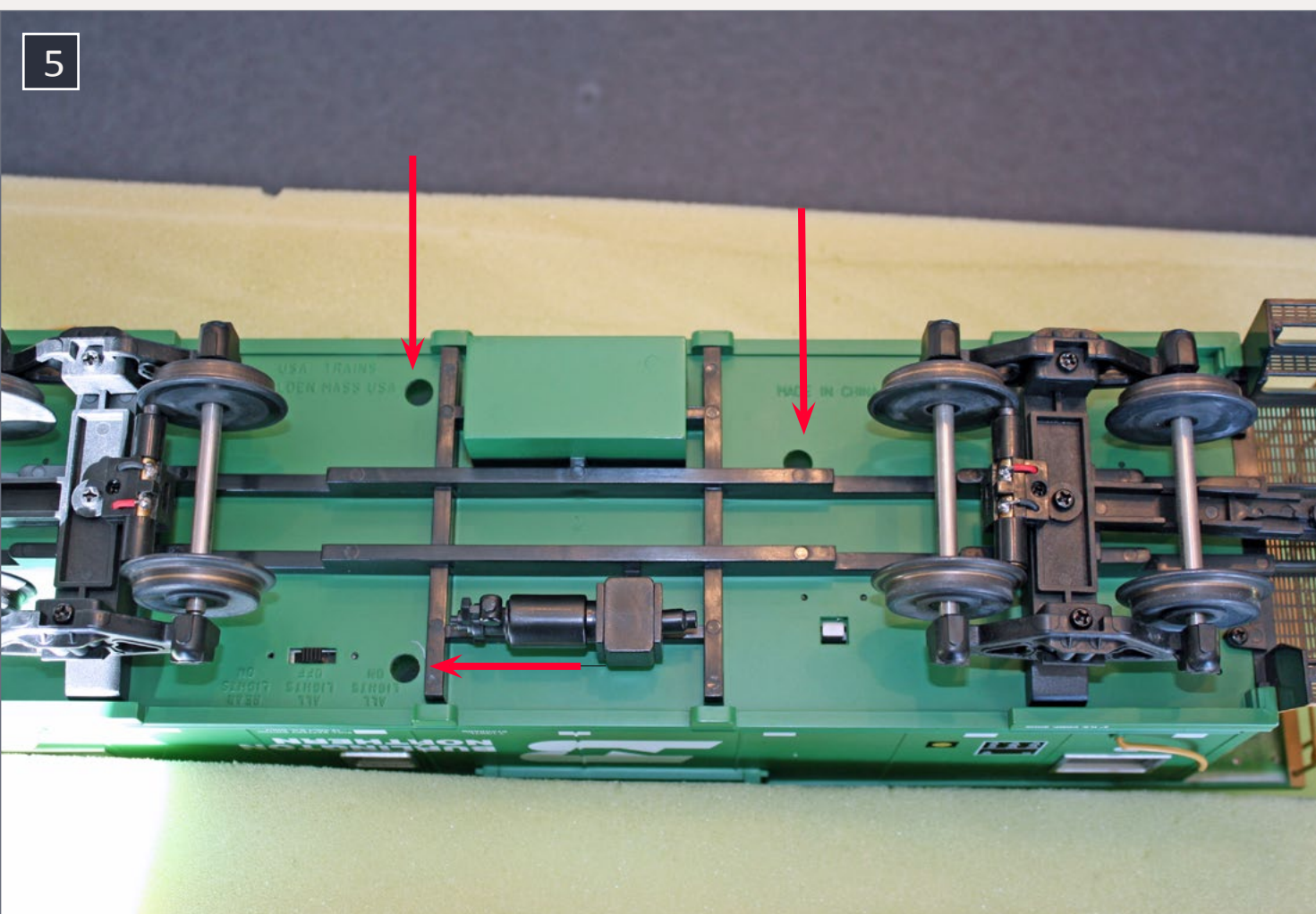

## 5. Three underbody screws to be removed.



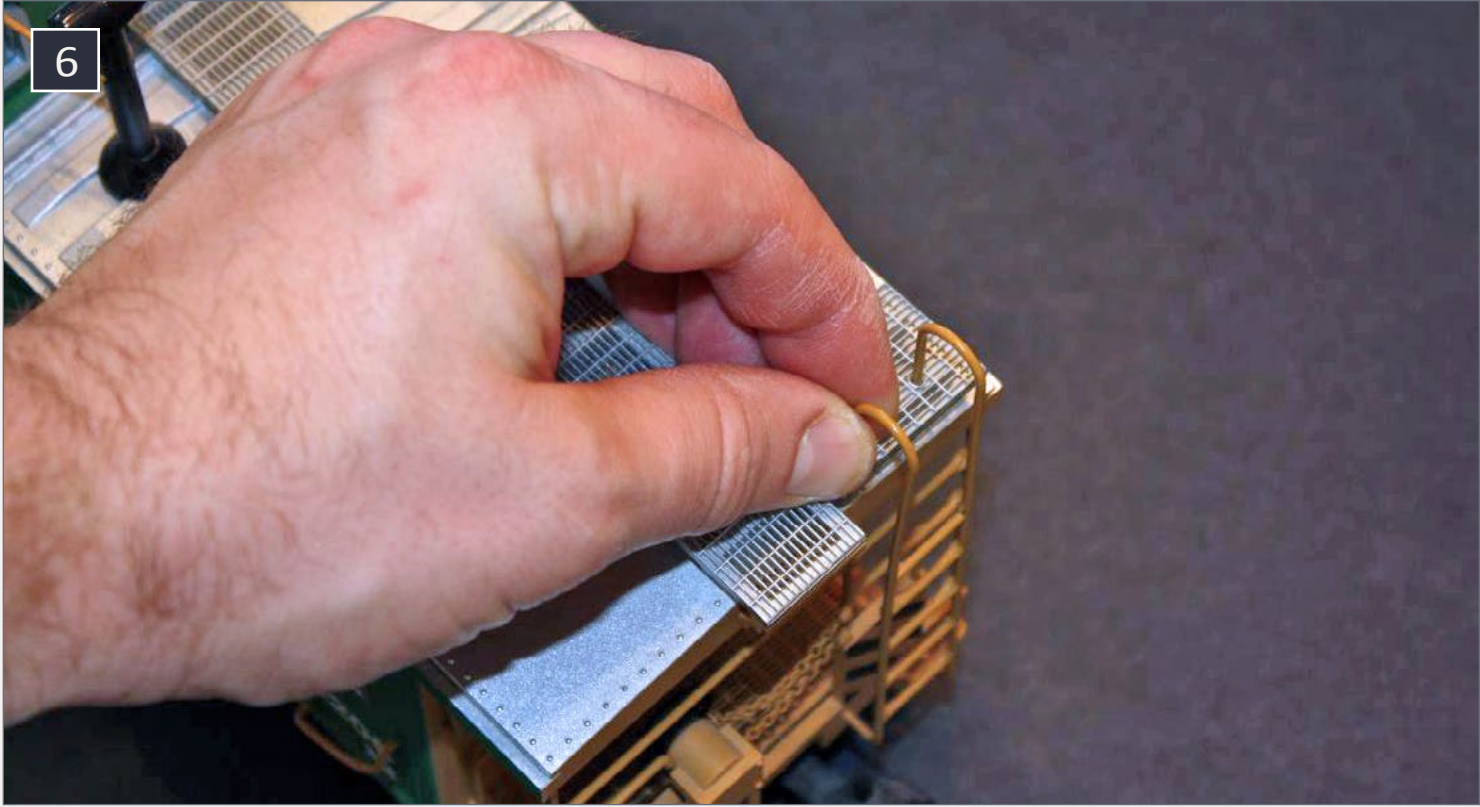

**6. Gently pull the ladder and end platform details off. Be careful of the three pins by the platform.**

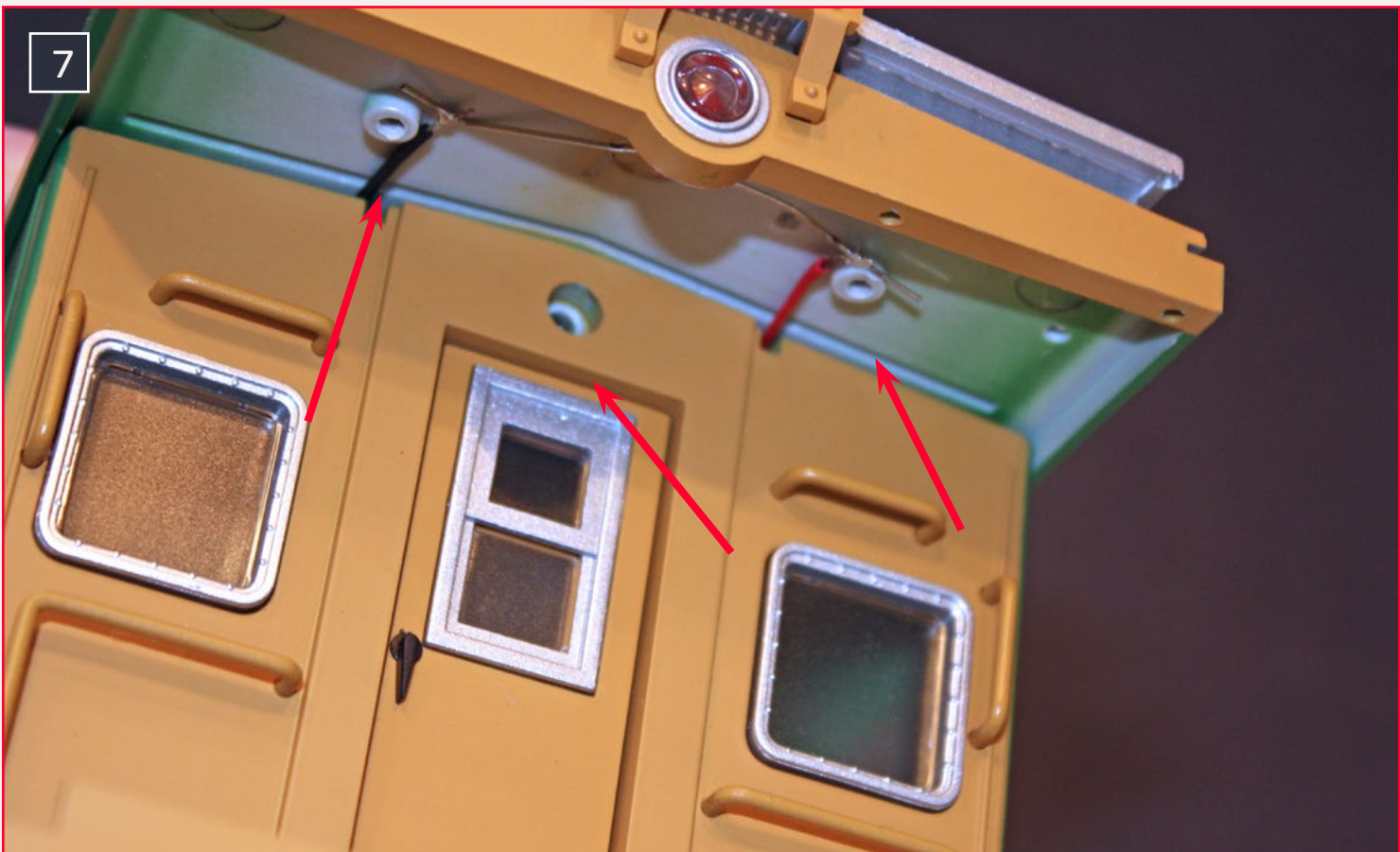

**7. Remove the screws from these three locations at each end of the caboose. This is the last step before removing the roof.**



contents



index

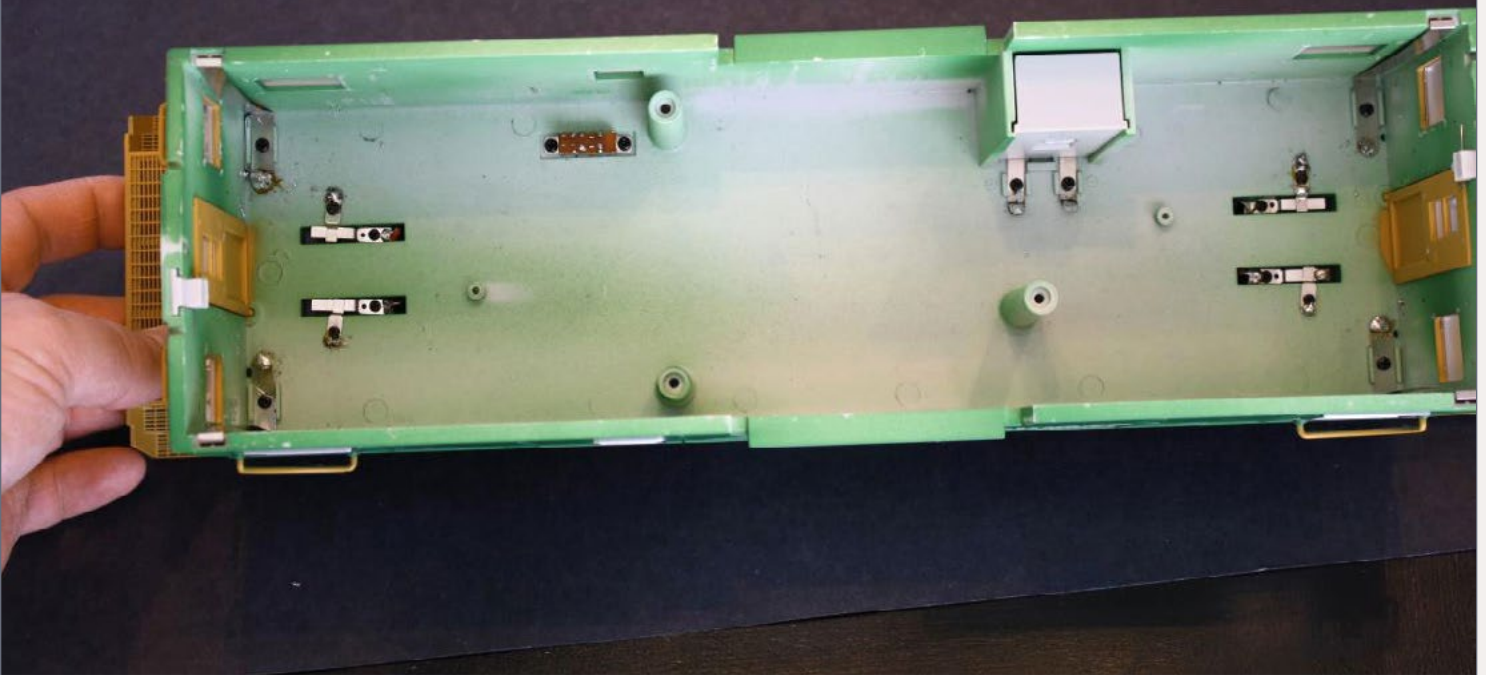

**8. The interior of the caboose. The manufacturer's electronics were removed prior to this photo.**

## Interior details

First I prepared the interior for painting. The walls appeared to be primer-gray in the photos I looked at. [9] shows the interior pieces in their respective places as I was test-fitting everything.

Before masking the exterior for painting, I wiped it down with window cleaner and paper towels. Normally one washes parts with warm soapy water to remove fingerprints and oil, but I wasn't removing the trucks so I used the window cleaner method. I masked the exterior with tape and newspaper [10]. The cupola is held to the roof by four small screws. I removed it and painted the interior. I didn't bother masking of the inside of the windows, because the original panes were fogged, and I replaced them (more on this later).

I changed some of the interior detail pieces. I used a small hand saw and an X-Acto knife to cut the chairs and tables free from their sprues, then sanded these pieces smooth with





## 9. Test-fitting the interior pieces.

coarse and fine sanding sticks. [11] shows the tools used and the detail pieces after cutting them from their sprues. I made an airbrushing jig from clothespins and a block of wood [12] and [13], as described in Pelle Soeborg's books "Done in a Day" and "Detailing Projects for Freight Cars and Locomotives."

I built the stove to 1:29 scale from sheet styrene. It is 2' wide by 3' high. This looked close to the real-life pictures. I first marked the dimensions on the styrene, then carefully scored a line with a sharp X-Acto knife, using a metal ruler as a guide. I cleaned up the edges with sanding sticks. I glued the four sides together with liquid styrene cement, then measured and cut the top, and glued that in place.

While the paint was drying on the interior and detail parts, I removed the end-of-train (EOT) lens and painted it red. The clear lens was easy to push from inward from the outside. I used Tamiya clear red paint on a toothpick to put a tiny bit on the inside and at the top of the lens [14].





10



**10. Getting the interior ready for painting. I wiped the interior with window cleaner and paper towels, and masked with tape and newspaper.**

11

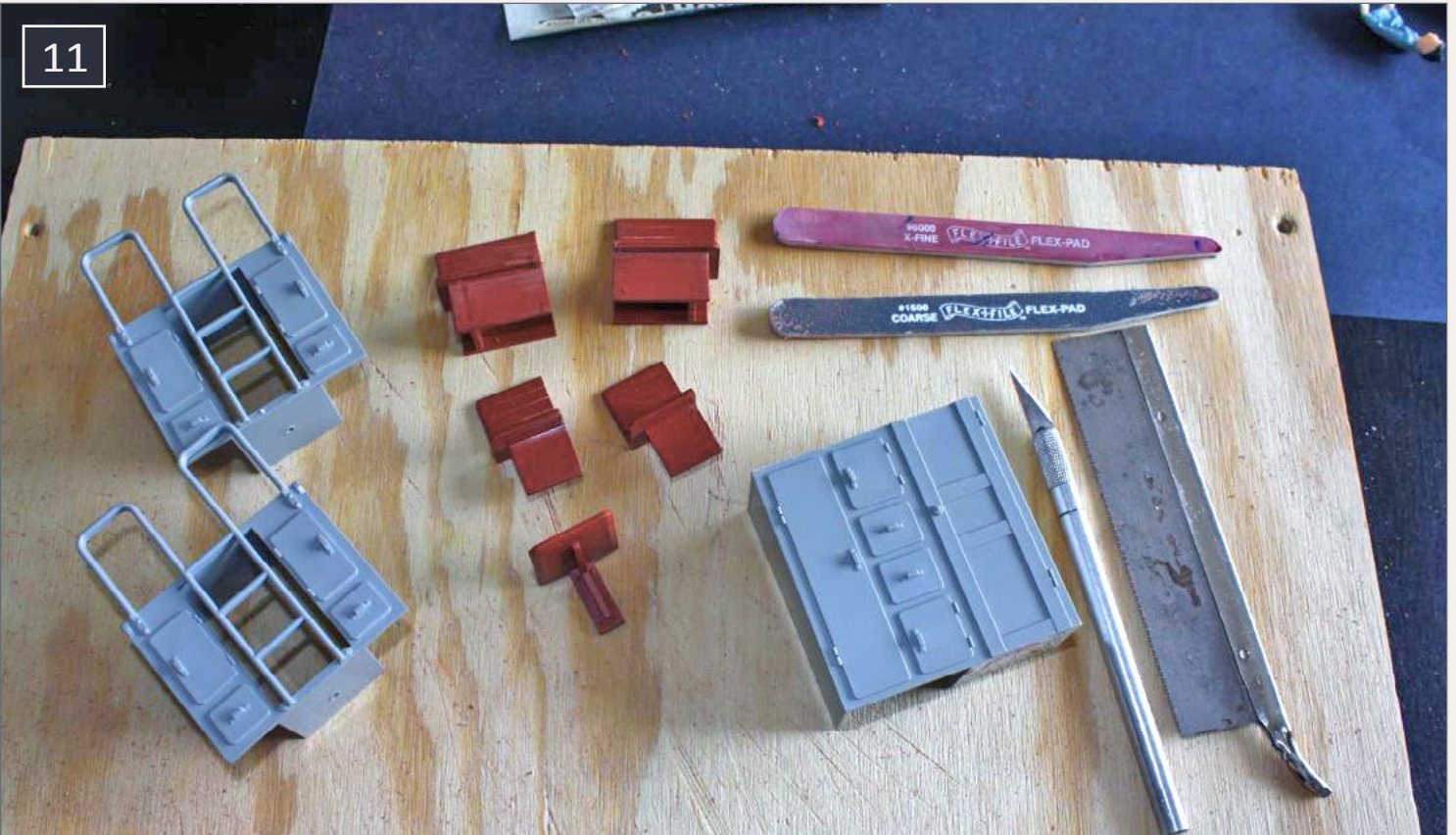

**11. Detail parts after removing them from their sprues.**



12

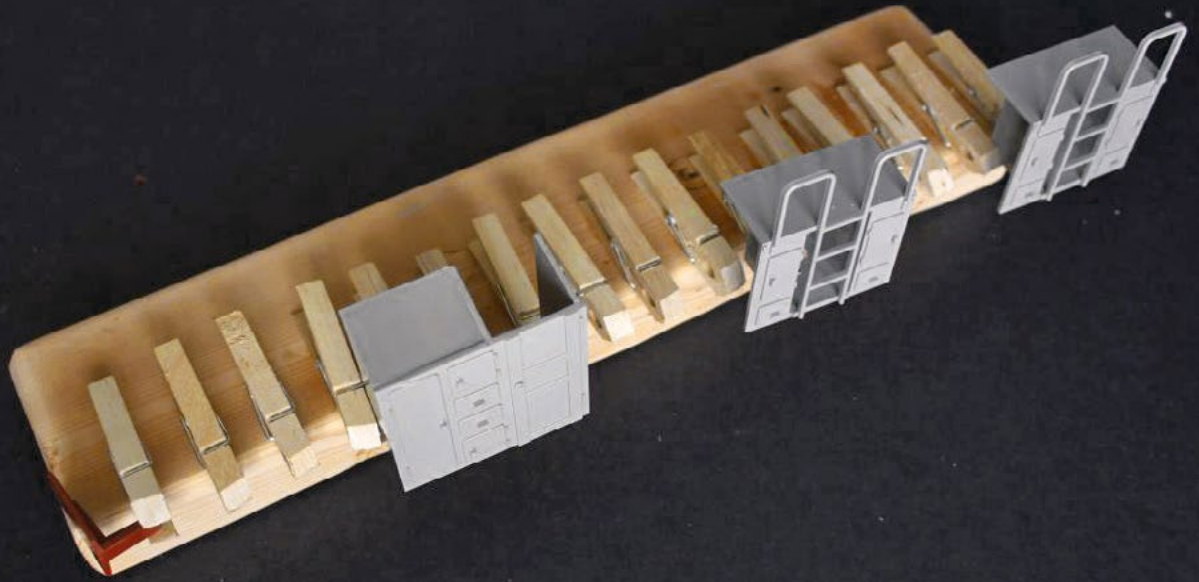

**12. Airbrushing jig from Pelle Soeborg's books. These pieces will be painted gray to match the interior.**

13



**13. The white styrene box will be used as the stove. These pieces will be painted black.**



contents



index

14



**14. Using Tamiya clear red paint to color the clear EOT lens red. I painted the inside bottom, plus at the top. I did not paint the lens exterior.**

15



**15. The interior after being painted gray. The areas around the electrical contacts that had been taped off were hand-painted gray. The circuit board on the roof was later removed.**



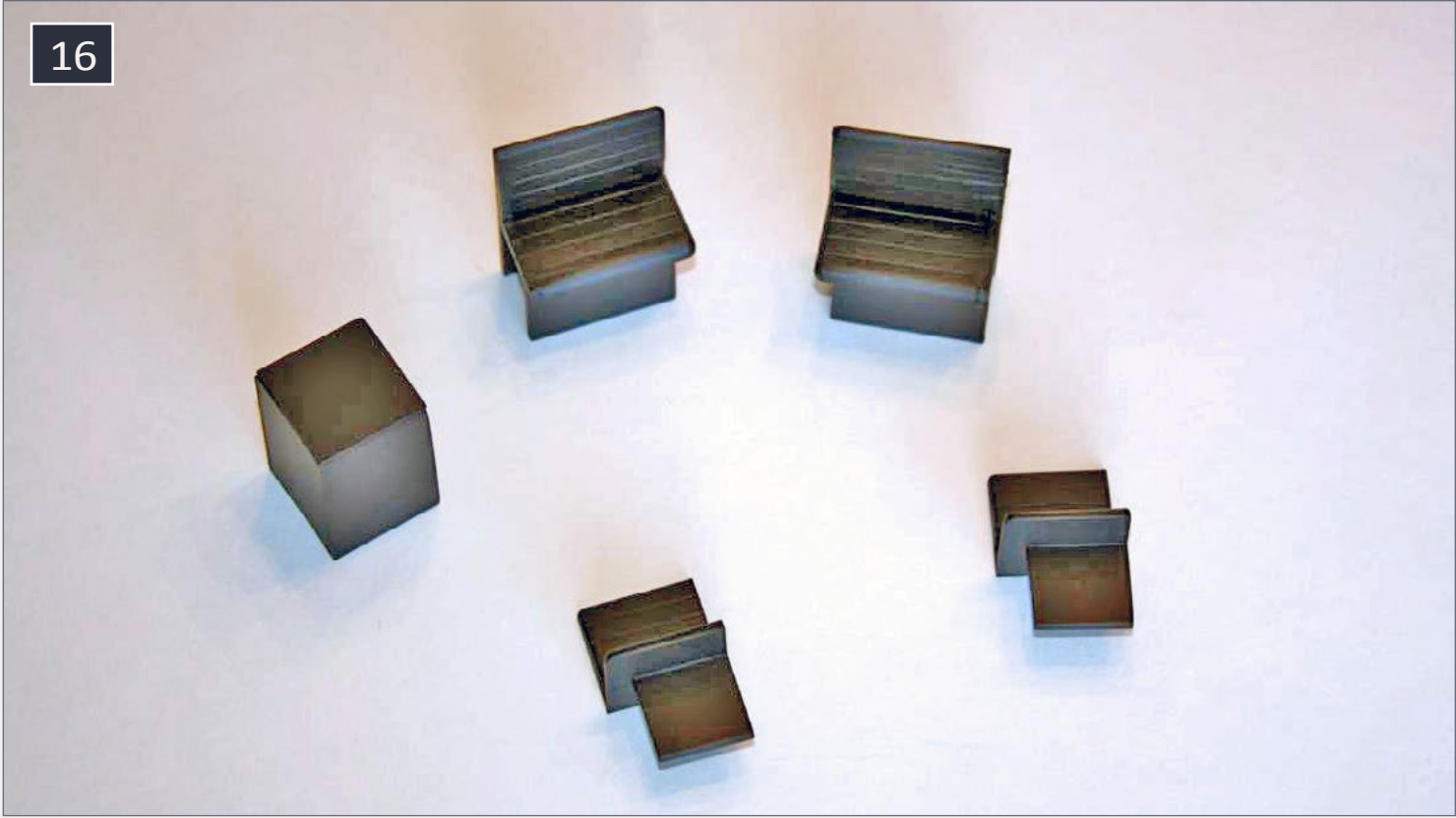

## 16. Chairs and stove painted black.

Don't paint the outside of the lens where you'll be looking at it – build up the paint on the inside in small layers. It took three coats before it reached the density I was looking for. With all the interior pieces painted, I glued them in place using cyanoacrylate (CA) glue [15] and [16]. Now I turned to installing the new LEDs. Also before wiring, I painted the areas around the electrical contacts.

## Lighting and electronics

Don't be afraid of electronics. Bruce Petrarca's "DCC Impulses Column" and the forums on *Model Railroad Hobbyist's* website are very helpful. I asked my fair share of questions on the forum, and those who responded were very helpful and kind.

One slide switch, one bridge rectifier, one capacitor, one diode, two potentiometers, three resistors, and five LEDs are all it took to build the circuit. Fellow MRH forum user Ken Klipple drew and posted the initial schematic. I modified it to show how I wired the lighting. [17] shows the circuit used for



constant lighting from track power, while [18] adds a potentiometer to adjust the light brightness.

I started by connecting the right-hand pickups from both trucks together, as well as the left-hand pickups. [19] shows metal tabs in the center of the floor at each end. These bring the truck pickup wires and the interior wiring together. These pieces do not move, and so I soldered them together for a better connection.

I cut a piece of electronic breadboard from Radio Shack small enough to fit into the 9-volt battery compartment [19]. Wired to this board are the bridge rectifier and resistor R1. The AC power is wired with green wires, and the DC power is wired with red and white wires. Next to the metal tabs of the 9V battery compartment, the manufacturer stamped positive and negative symbols on the floor. To keep things simple, I wired the positive and negative leads from the bridge rectifier to those respective metal tabs. From there, the positive and negative wires run to their respective places on the slide switch;

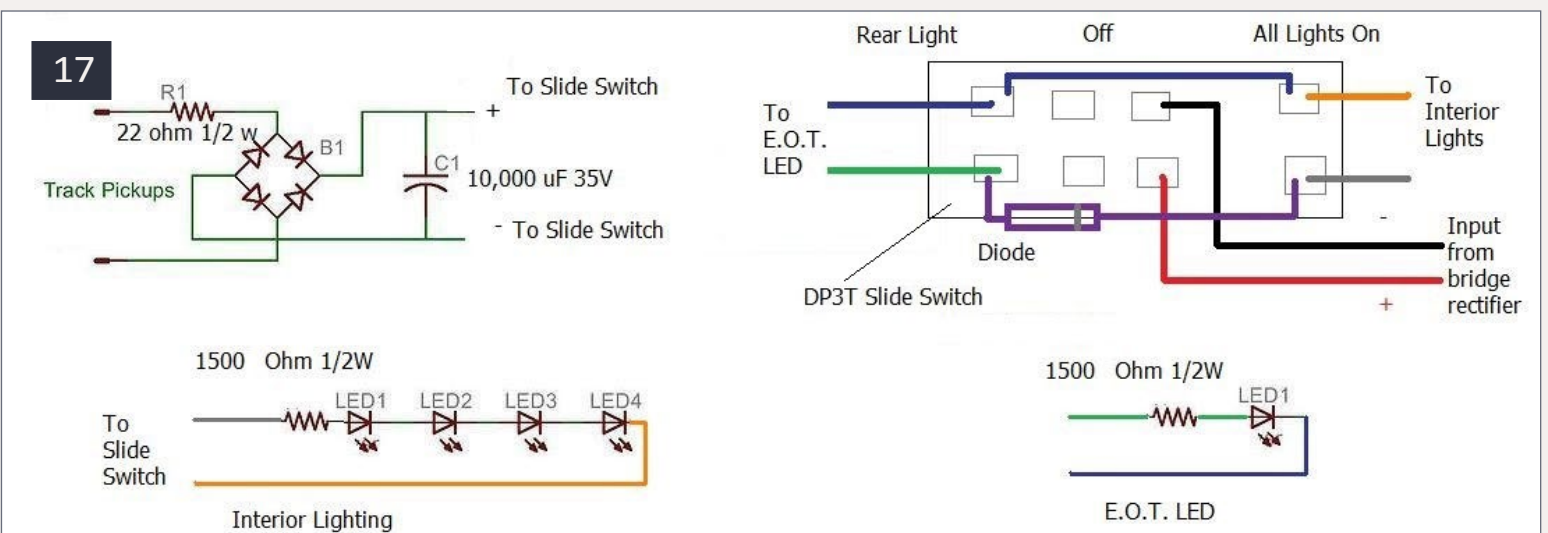

**17. This is how I wired the lighting and the DP3T slide switch. The lights are fairly bright, but not as bright as the manufacturer's lights.**



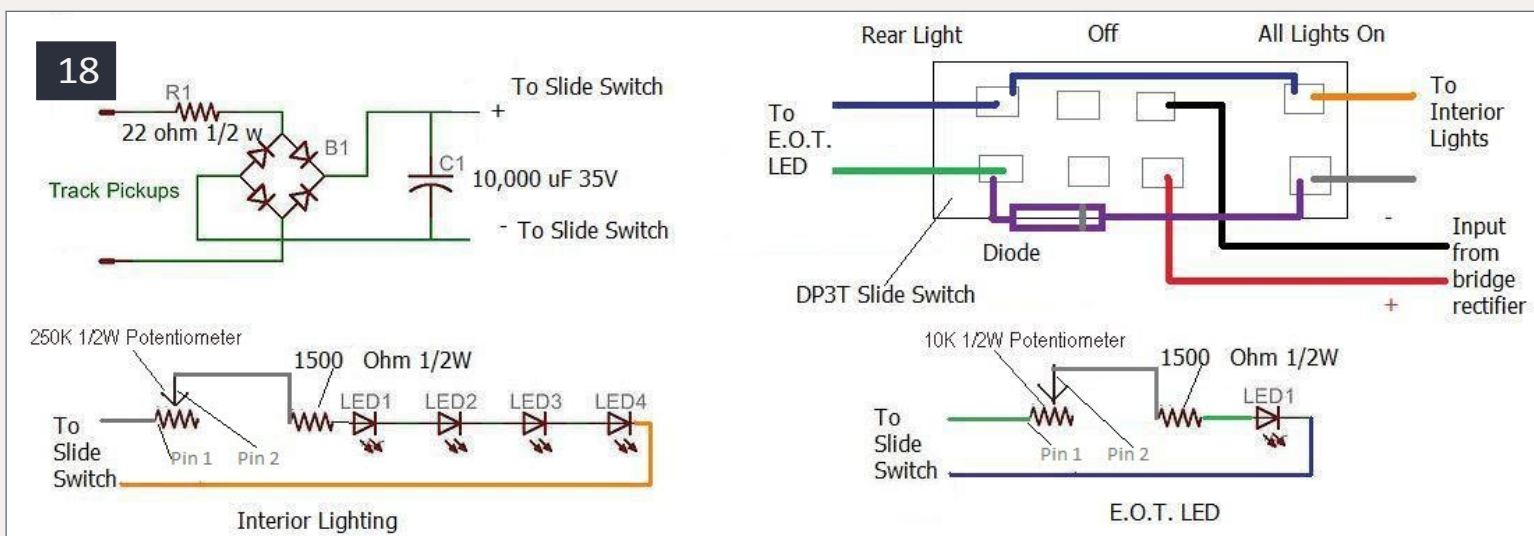

**18. Here I added in potentiometers to control the brightness for the interior lights and the EOT light. The resistors near the LEDs prevent damage to them if the potentiometer is turned all the way down.**

see [17] and [18]. The capacitor is also wired to the same tabs on the slide switch as the positive/negative power inputs. I wanted a capacitor large enough to keep the LEDs from flickering due to dirty track. I put in a 10,000  $\mu\text{F}$  35v capacitor. Some say this is fine, others say overkill. For me, it's doing the job I want it to do. Running over semi-dirty track has resulted in no flickering. From what I've read, 2,200  $\mu\text{F}$  through 10,000  $\mu\text{F}$  will keep lights from flickering, but it all depends on how much interior space you have to work with.

Electrical power is carried to the roof by metal tabs that run up the side in each corner. I soldered a negative wire to one tab at each end, and did the same thing for the positive wire. If you look at the upper-left corner of [19] you'll see the conductor's table I added. I used an N scale building door light as a desk lamp. It seemed to be the right size at first, but now I'm wondering if an HO scale lamp would have been better. [20] shows the conductor's desk before being glued into place.



contents



index

The wires are very small magnet wire. This wire is extremely fragile and easy to break, so work slowly and carefully.

Magnet wire that has thin insulating varnish on it. To solder it, you'll have to tin it. Melt a dab of solder on your iron and dip the end of the magnet wire into the solder. Hopefully the heat will burn off the varnish, and leave a thin coating of solder on the wire. If the varnish doesn't burn off, use 800-grit sandpaper to sand it off, then tin the clean bare wire with solder.

You can easily install SMD LEDs in small areas with magnet wire. I purchase #40 from Remington Industries ([remingtonindustries.com](http://remingtonindustries.com)). 8,304 feet of #40 wire sells for \$9.30, and 16,609 feet sells for \$15.45, basically a lifetime supply.

After installing the conductor's table, I wired the three LEDs for the roof, and the EOT LED. I connected the roof LEDs in series.

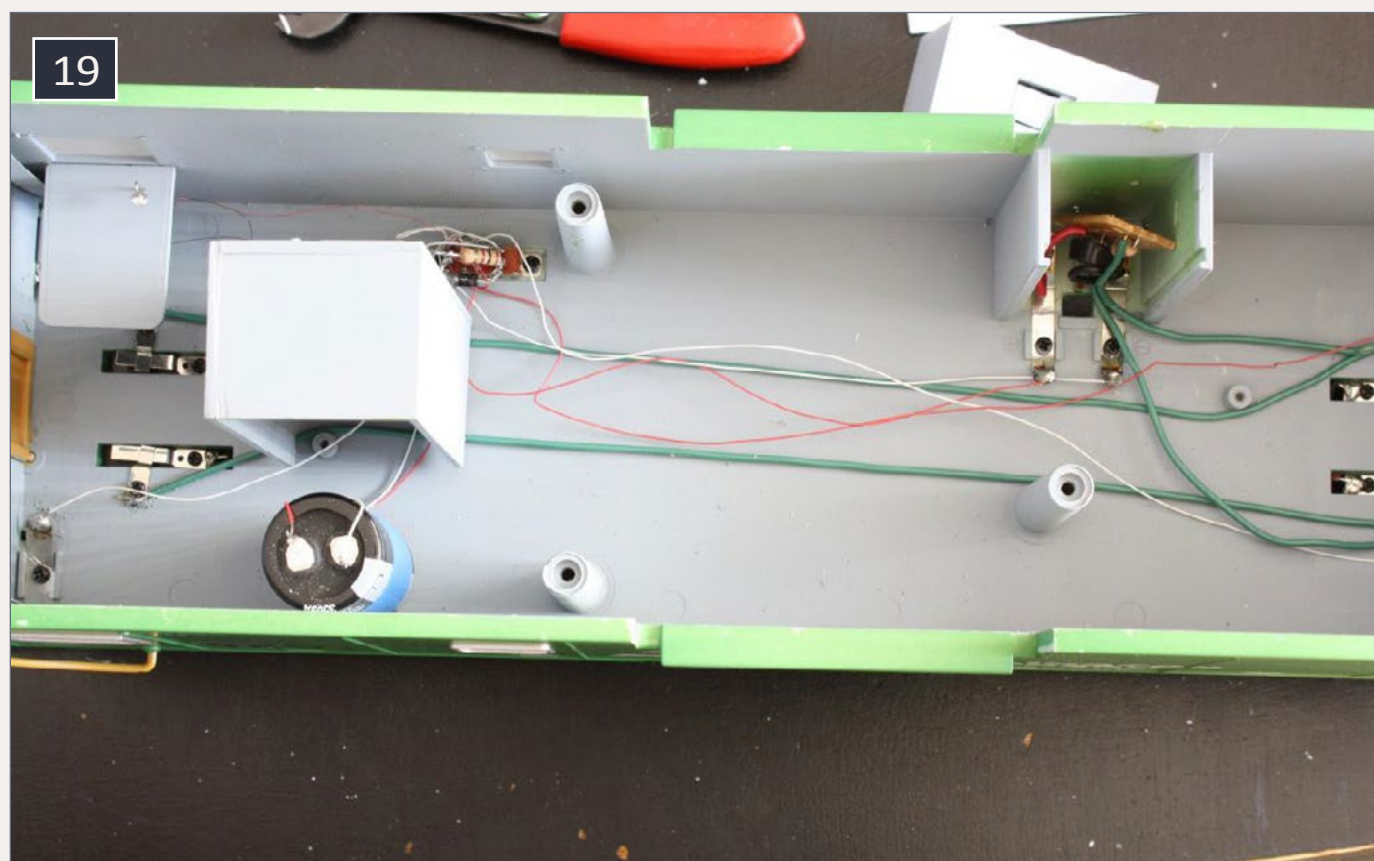

**19. The electronic components. The metal tabs from the trucks were soldered together.**





## 20. The conductor's desk with lamp.

for the interior lighting circuit, but the LEDs were too dim for me. I found there was a fine line between being too bright and looking toy-like, and not being bright enough to see the interior detail.

So I used potentiometers [22] to adjust the brightness of the LEDs. Use a multimeter in ohms mode to check which two pins show the resistance value changing when the potentiometer is turned. For the potentiometers I used, pins 1 and 2 were the pins that showed the resistance changing. I clipped off pin 3 to avoid any confusion while wiring.

For the interior lighting I used a 250K ohm  $\frac{1}{2}$  watt potentiometer. For the EOT LED I used a 10K ohm  $\frac{1}{2}$  watt potentiometer. The LED brightness can now be adjusted like your car dashboard—from very dim to nice and bright.

“Series” means wiring a string of LEDs together with the negative terminal from one connected to the positive terminal of the next. I glued the LEDs to the roof using CA [21].

The EOT LED fit nicely into the lens without any kind of adhesive. The EOT LED was wired like any other single LED. As seen in [17] and [18], both LED circuits used a 1500 ohm  $\frac{1}{2}$ W resistor. I tried using a larger value



I glued the potentiometers to the floor with CA just inside the doors. I also glued a piece of styrene behind each potentiometer to reinforce it. The one that controls the interior lights is by the conductor's desk. The one for the EOT light is at that end. To adjust the lighting, I push the caboose door open and use a small flat-blade screwdriver to turn the potentiometer. At first I wasn't sure about adding the potentiometers, but I'm glad I did. It's great being able to make the lights brighter in sunny conditions, and a faint glow in the middle of the night. [23] - [25] show the interior at night.

## Finishing interior details

After I finished the wiring, I wasn't happy about the wires running across the caboose floor. I should have done the basic wiring first, put in a false styrene floor, painted the interior, and

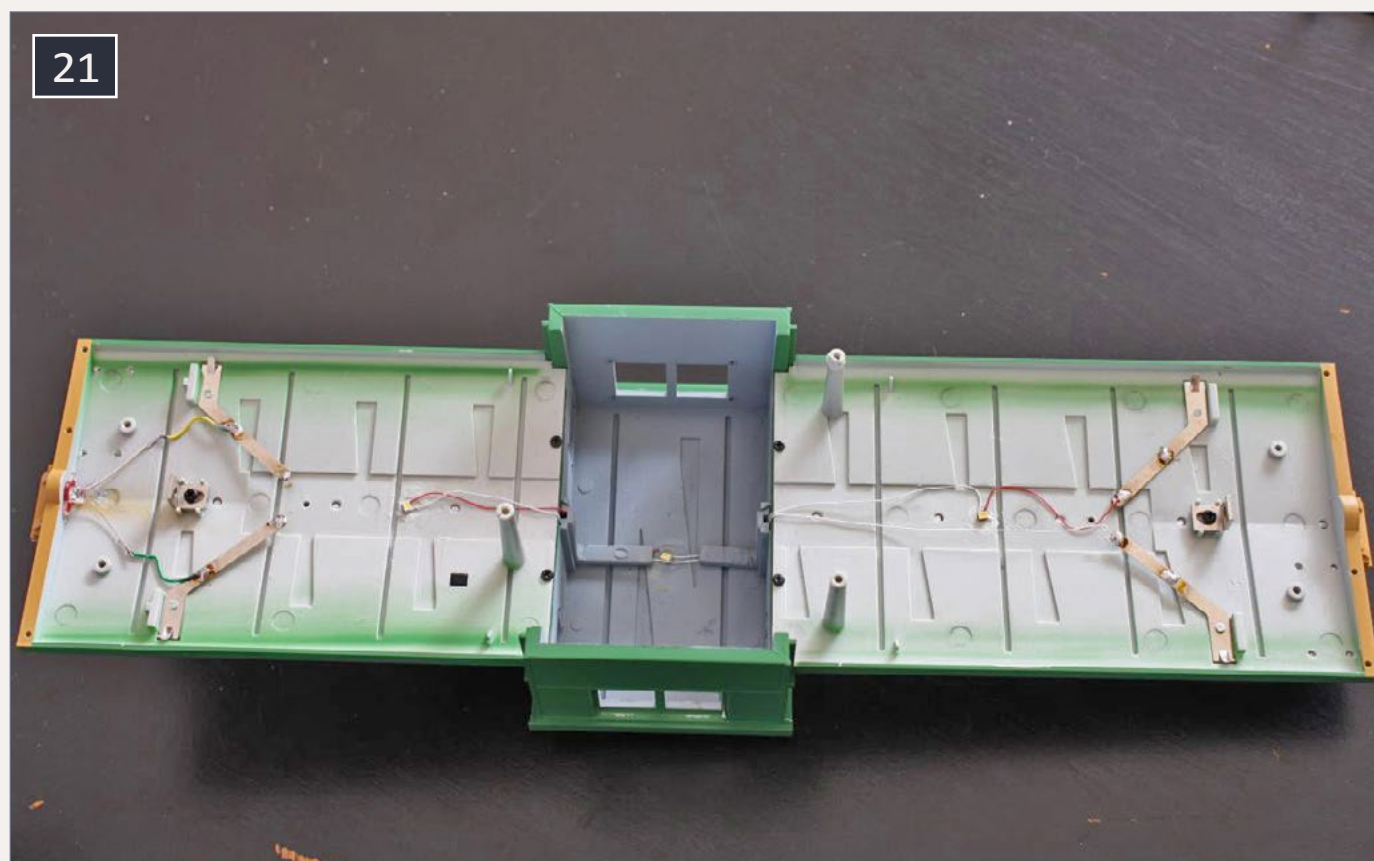

**21. The three interior LEDs are in place, as well as the EOT LED.**



22

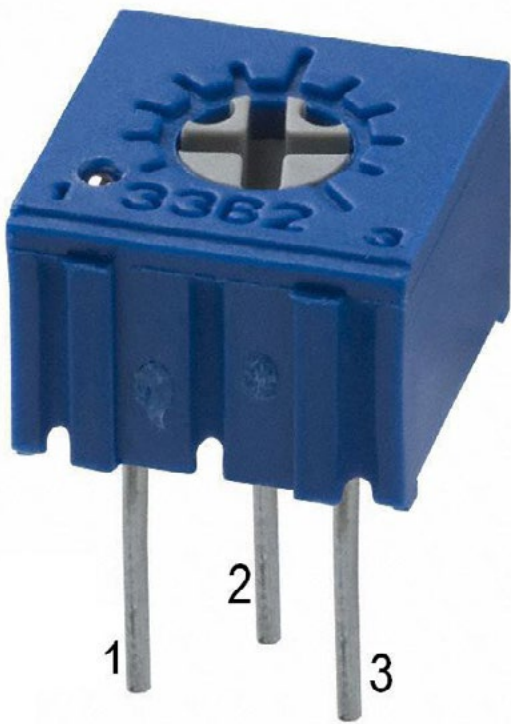

22. Pins 1 and 2 adjust the resistance level when the potentiometer is turned. Pin 3 was clipped off to avoid confusion while wiring.

23



23. The EOT LED



contents



index



**24. The conductor at his desk. The LEDs for the photos were as bright as they can get. Using the potentiometer, the LEDs can be reduced to a faint glow.**



**25. The brakeman in the cupola.**



then added the interior details. What I did for now was use painter's tape to cover up as much as I could. I applied a few drops of CA on the sticky side of the tape to help hold it down (hopefully for years to come). I then hand-painted the tape and all the wires. Once everything was camouflaged, it looked better. [26] shows the interior after the wiring was camouflaged.

Now I was able to add additional interior details I had noticed in the real-life pictures, like numbers by the doors and in the cupola, phones/radios, and miscellaneous paperwork. I used a fine-tip pen to add the railroad and car number. I did this above each door, as well as in the cupola area [27]. I could have used decals, but I didn't have any black letters/numbers on hand.



**26. The wiring and detail pieces are installed and the wires are camouflaged.**



contents



index

The next detail item was adding the phone/radio. Turning to Google again, I found a phone/radio that looks like a telephone with knobs. I measured my landline phone receiver (the part you listen and talk with). It measured 10" so I figured the phone/radio must be around 12". How could I print a 12" phone in 1:29 scale? A Garden Railways contributor mentioned the website [printmini.com](http://printmini.com). I found lots of things to print. Most of the items are for doll houses, but there are many neat things that can be used in the model railroad world.

There is a calculator on the website to calculate the right printing size. Put in the real-life dimensions and the scale you're using. The calculator tells you the actual dimensions to print it to scale. For example, see [28]. I was going to make the radio 12" x 12". I selected 1:29 scale for the conversion, then clicked

27



## 27. Adding the railroad and car number.





Home About Small Stuff Contact Us Links

### Information

- [What Are Printables?](#)
- [Printing to Fabric](#)
- [Which Scale?](#)
- [Hobby Calculators](#)
- [Translate This Site](#)

### Printables

- [Playscale \(1:6\)](#)
- [1 Inch \(1:12\)](#)
- [½ Inch \(1:24\)](#)
- [¼ Inch \(1:48\)](#)
- [Gallery](#)

### The Heritage Dollhouse

- [Duracraft HR 560 Kit Instructions](#)

### Hobby Calculators

Enter the original size in either English or Metric units. Pick the original scale and the scale to convert to. Then press "Calculate." The answer will be shown in both English and Metric units. You must have a **Javascript-enabled browser** for this to work. Just about any newer web browser (Firefox or Internet Explorer) will automatically include Javascript. If the calculator doesn't work for you now, you'll want to download a newer version of your web browser.

Take this  measurement

in English units

Feet +  Inches +  /  of an inch

or

in Metric units

and convert them to

Show English units answer as

(don't type in these fields, they are for the answer)

Feet +  Inches +  of an inch (may be rounded)

or (unrounded):

inches

mm

## 28. Hobby calculator on [printmini.com](http://printmini.com).

Calculate and all the information was filled in. According to the calculator resizing the Google image, 7/16" x 7/16" is the correct size for 1:29 scale. Everything on Printmini is free.

Another detail I wanted was track warrants. A Google search brought that up, and the calculator gave me the dimensions to print scale 8" x 10" paper. I used Microsoft Word to resize my images and print them. [29] shows the printed material scaled to size.

Using a metal ruler as a guide and a sharp X-Acto blade, I carefully cut out the images [30]. One thing that helps this process is a piece of glass underneath. I got my glass from a picture frame at the local dollar store. Caution! Picture frame glass



contents



index

typically has sharp edges and breaks easily – be careful! [31] shows the images after they have been cut out. I glued the track warrant papers to the conductor’s table using a glue stick. Don’t use CA to glue paper; it will turn the paper transparent.

As for the phone/radio, I didn’t want to just glue it on the wall – I wanted a little depth and detail to it. This meant using styrene to make the phone/radio look thicker [32]. I also used #30 wire as a coiled phone cord [33]. I wrapped the wire around a

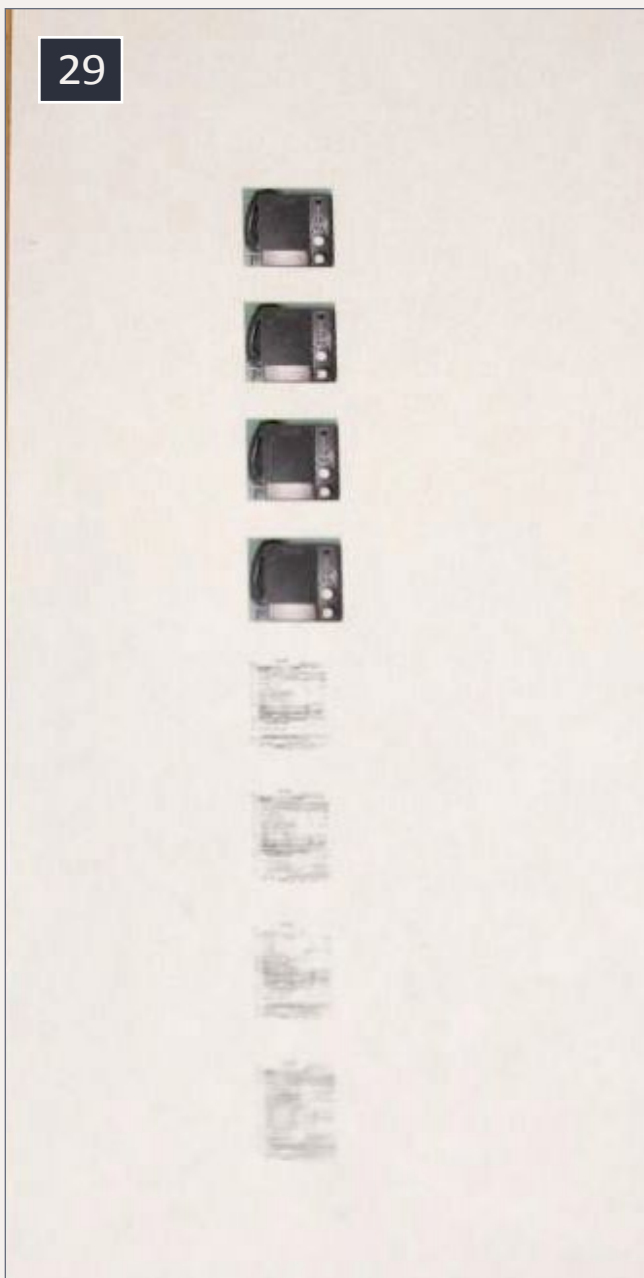

**29. Phone/radio and track warrants printed to scale.**

piece of music wire. After cutting out the styrene, I marked on the back side the approximate locations of the phone cord. I cut slots in the styrene to hold the wire, and used CA to glue the wire to the styrene. After the glue dried, I painted the wire black.

Again I used a glue stick to attach the paper. After allowing for drying time, I noticed that the white edges of the paper and styrene stuck out. I carefully painted the edges of the styrene and paper black with a small brush. I then used CA on the back side of the styrene to glue it to a wall in the caboose. I made three of these phone/radios. One is by the conductor’s desk, and the other two are up in the cupola by the chairs.



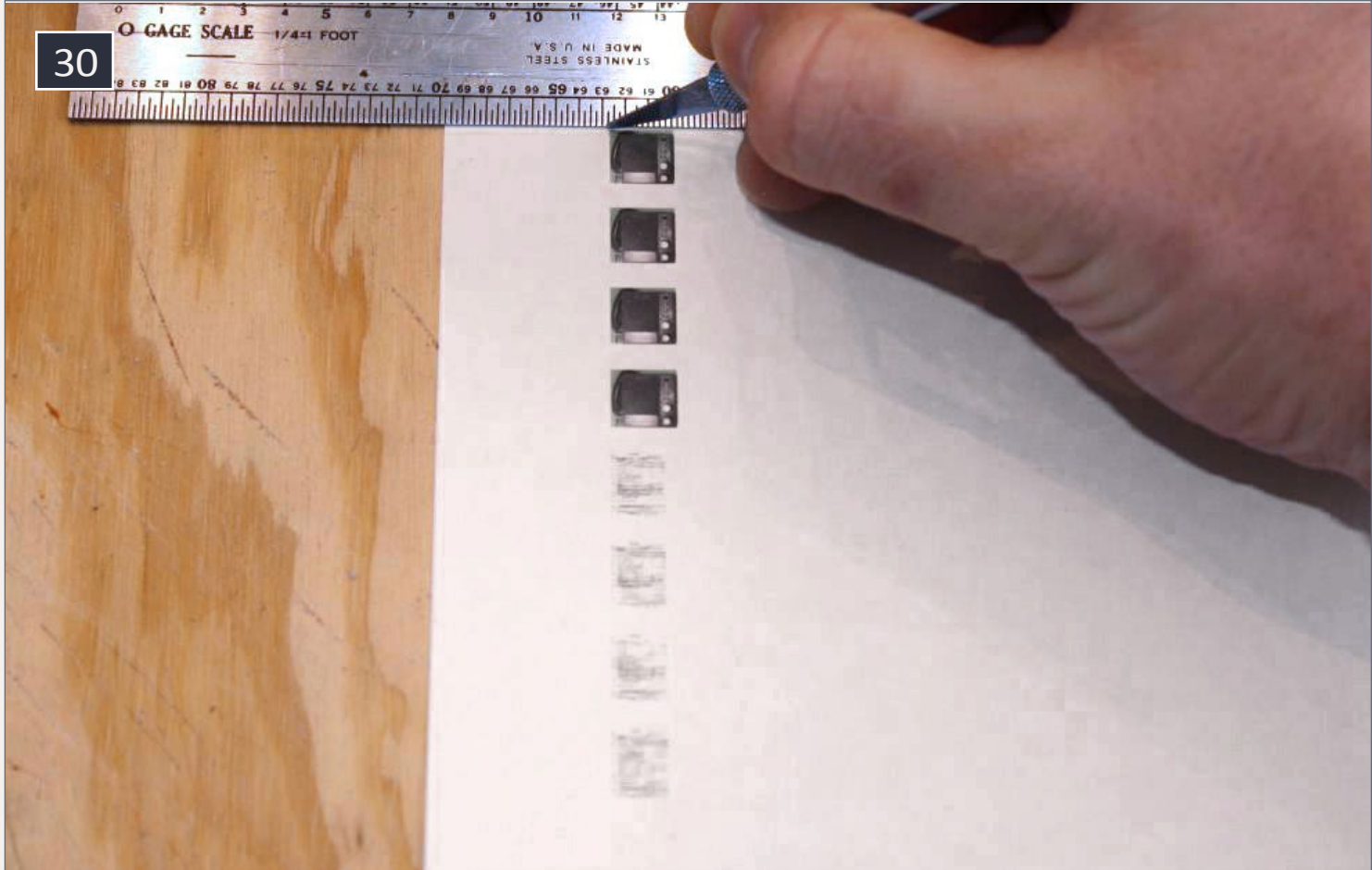

**30. Using a metal ruler as a guide and a sharp X-Acto knife to cut out the images. I cut on a piece of glass for ease and accuracy.**



**31. The images have been cut out.**



contents



index

32

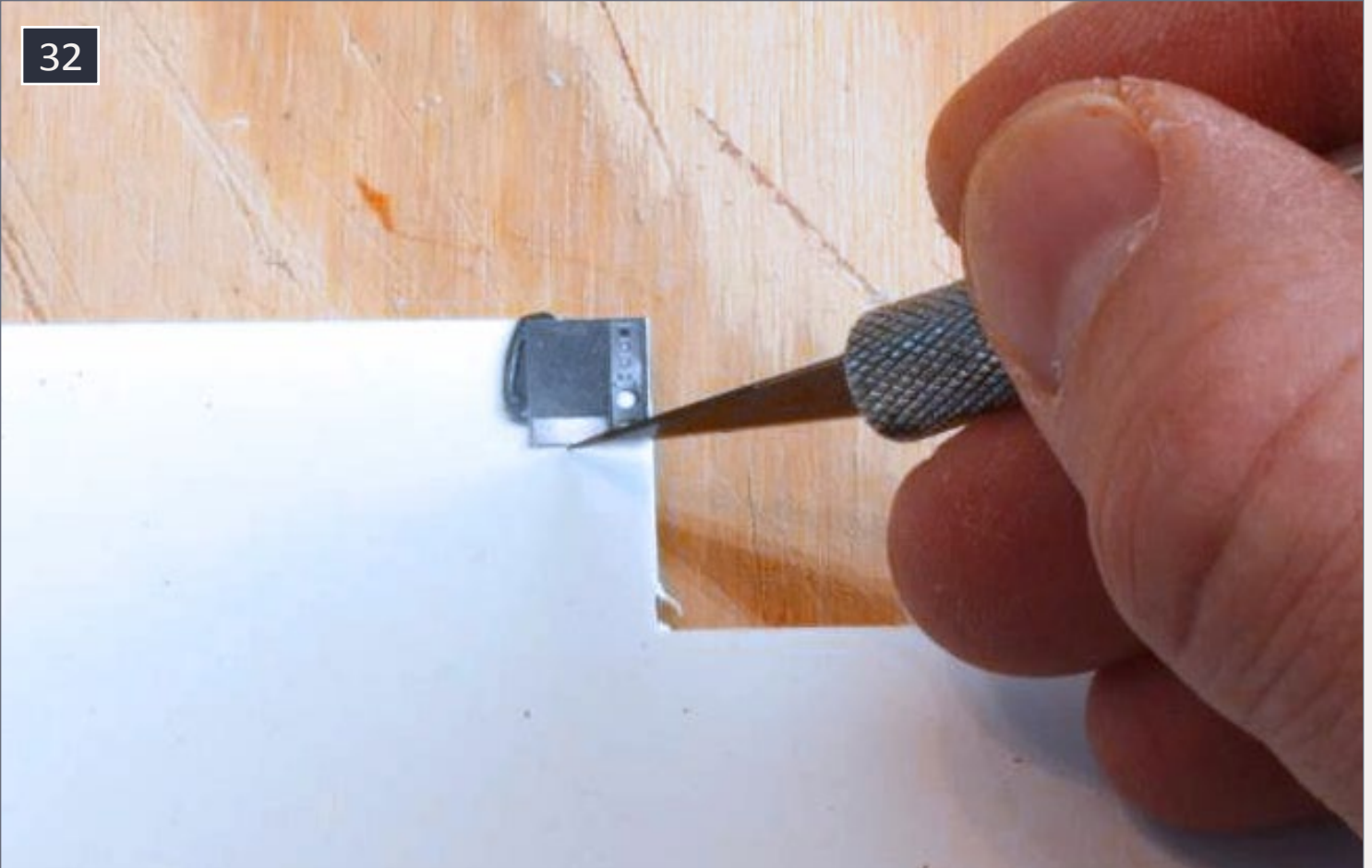

**32. Measuring styrene to use as back plate.**

33

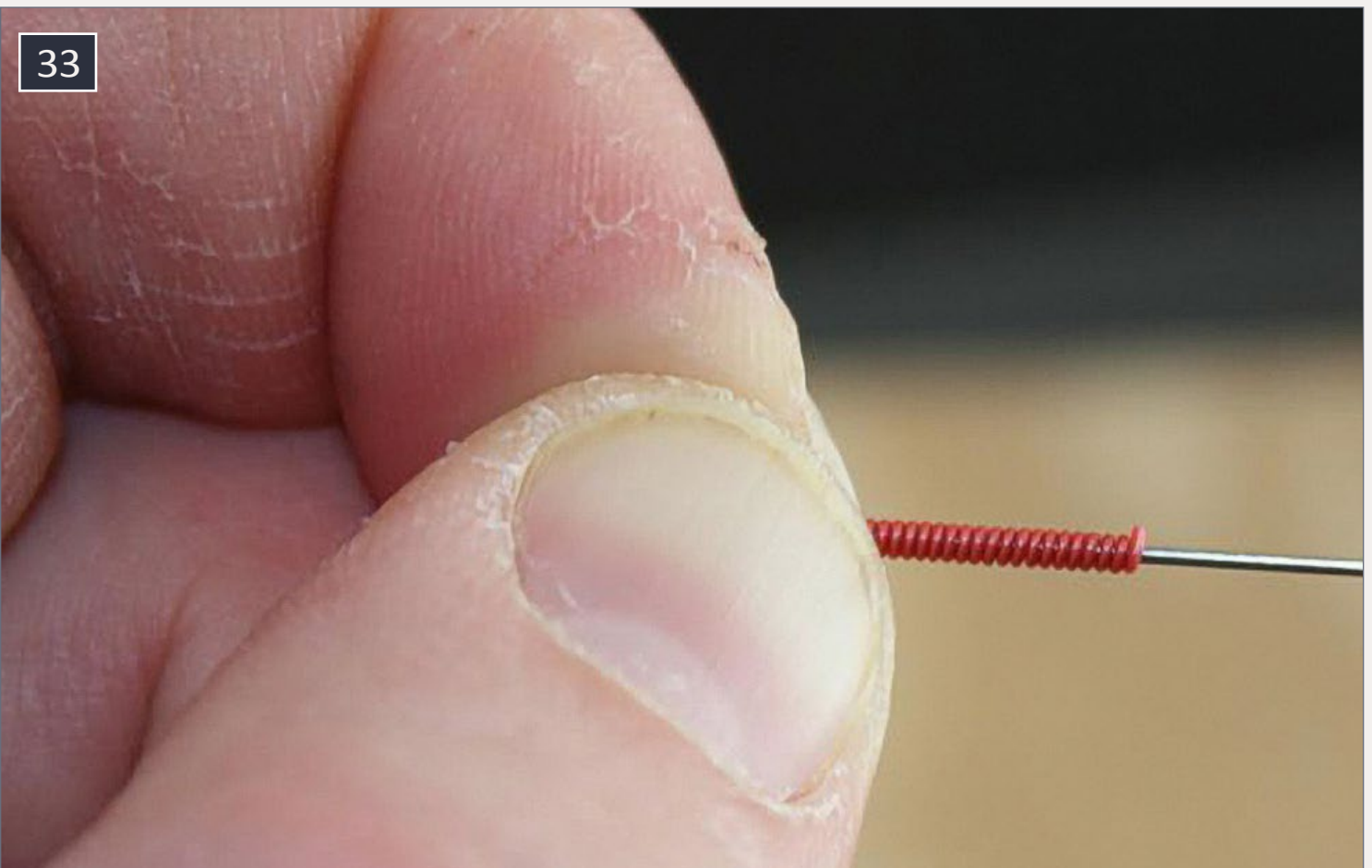

**33. Using #30 wire to make a coiled phone cord.**



## Figures

Now that the interior details were complete it was time to paint the figures. If you're not comfortable painting figures I recommend watching some YouTube videos. There's a lot of talent out there. Since the figures were inside the caboose, this helped me improve figure-painting skills. It built my confidence for painting figures that will be out in the open.

I started out by scraping off flash from the molding process. I noticed fine lines running down the arms and legs, so I used a sanding stick to remove them [34] - [36]. I repeated the process for the other figure, which will be the conductor. The conductor figure's arm was not high enough for the hand to clear the conductor's table. Using a small saw, I removed the arm [37]. I test-fit the figure and arm height, then used CA to reattach the arm. When dry, I put a little more medium-viscosity CA around the arm to fill the gap [38-39].



**34. Figure has molding flash to be removed**



contents



index

One YouTube video artist recommended using Caucasian flesh color for the primer. Another recommended using light gray. I chose light gray. It will show through a bit after the figure is painted, but this will add highlights to the figure. I dry-brushed the figures. With dry-brushing, the goal of this is to have only a little paint on the brush. It allows you to build up the paint in layers rather than having thick coats.

I washed the figures in warm soapy water, then airbrushed a primer coat. Next I painted the eyes white. After the eyes dried, I used a fine brush to add tiny black dots for pupils. Place the pupils in the center of the eye, or off-center if your figure is looking to one side. The next step was to paint all the exposed flesh (face, neck, hands, etc.). I used red paint for the lips, but it was too bright. I went back and dry-brushed the flesh color very lightly, this helped tone-down the lips. For the hair and clothes I dry-brushed the main color, then added some lighter and darker colors for highlights.

35



**35. Using a sanding stick to remove molding lines on arms and legs.**





## 36. The sanding is complete and the figure is ready to be repainted.

After all the painting was complete, I airbrushed the figures with a flat clear overspray. [40] shows the painted figures. Have fun painting the figures. If you don't like the way they look, you can always start over.

## Windows

I didn't glue the figures into the caboose yet. The original windows were fogged, so I replaced them. I carefully pushed each window out from the inside. The silver frame around each window holds it in. The frame is held in place by a pins in each corner. No matter how careful you are, these pins are bound to break [41].

After all frames and windows were removed, I gently put them back in. Why did I not replace them with clear styrene?



37



**37. Using a small saw to cut off the arm so the hand can be raised**

38



**38. Arm has been glued back on, allowing the hand to clear the table.**



39



**39. Back side of figure after arm has been adjusted and sanding is complete.**

40



**40. Completed conductor, left, and brakeman, right.**



contents



index

Because I plan on weathering the caboose later, and I don't want to get the new windows dirty. After weathering I'll use the old windows as a template to cut new ones. Don't use CA to glue the window frames back in, as this may cause the clear styrene to fog (called crazing). Use something like Microscale's Kristal Klear. Just place a small dab on the pins and around the window frame.

After the windows were removed and loosely put back in, I glued the figures in place. [42] shows the completed interior.

41

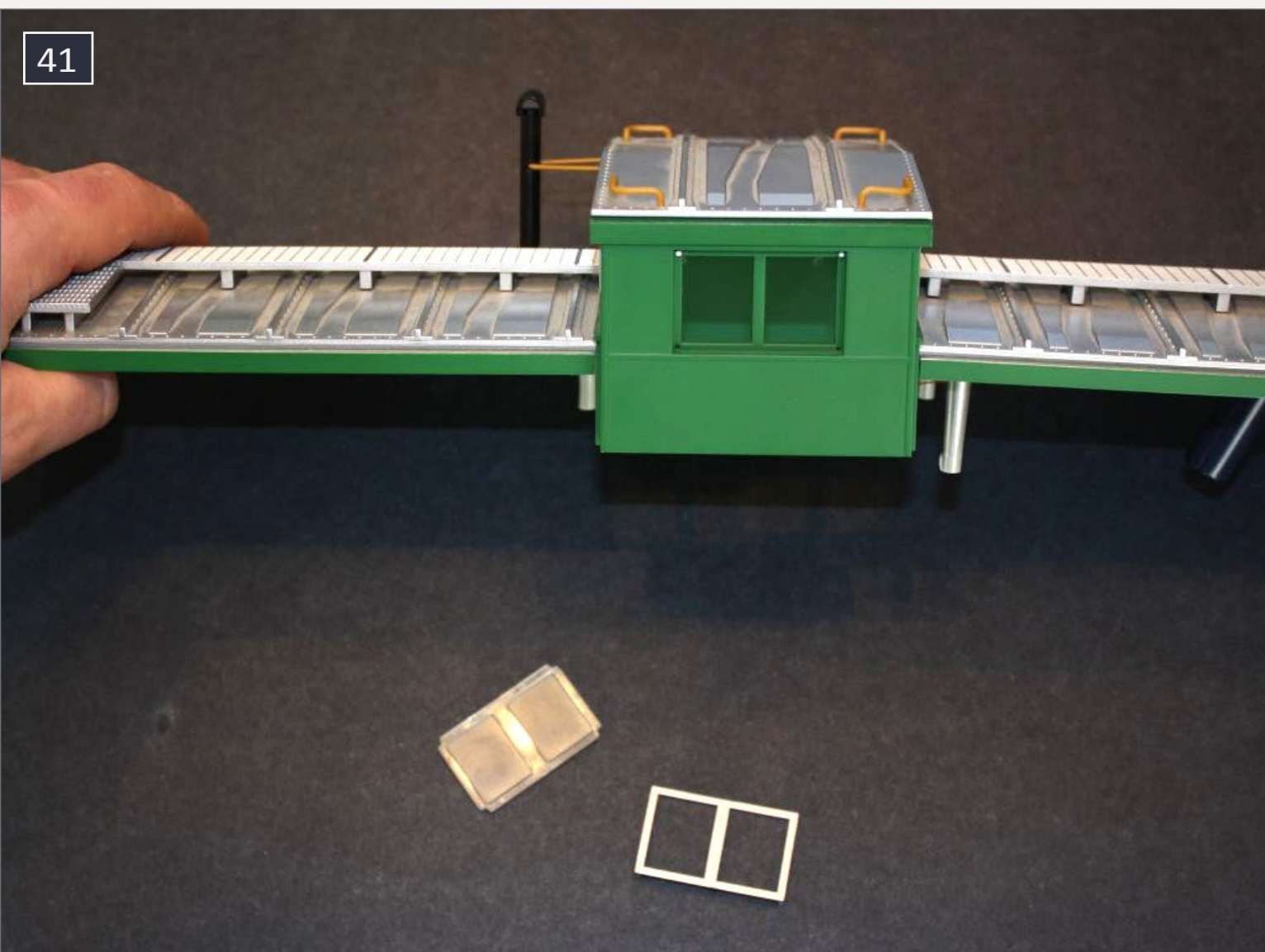

**41. I pushed the windows from the inside out, being careful not to damage the pins that hold the window frame.**





## 42. The figures have been installed.

Then I reattached the roof in the reverse order it was taken apart. Next I added Kadee body-mounted couplers.

### **Body-mount couplers**

If you're going to add body-mount couplers, make sure to cut off the truck-mounted coupler after you remove the roof. This way you can set the caboose upside-down on a table and apply pressure to cut off the couplers.

I began by removing the truck-mounted coupler with a chisel blade. I carefully applied downward pressure to the coupler arm. I rocked the chisel from side to side to help with the cutting.

Now I built a styrene mounting block to hold a body-mount coupler. I used .08" styrene. I used CA to glue each section of



styrene together [46], and let the glue dry overnight. A test-fit was next [47], and it was snug. I sanded the block to make it fit. Once the block fit into place, I held the coupler in place to check it with the coupler gauge.

After verifying the correct coupler height, I removed the styrene block. Then I used liquid styrene cement on the sides to help reinforce it, again giving it time to dry overnight. I washed the block in warm soapy water to remove oils. The block was then airbrushed a yellow that closely matched the caboose ends. CA was applied to the four sides of the block, then it was pushed into place for the final time. After letting that dry, I used more plastic cement around the sides. I added a centering line [48], so the coupler will be mounted in the center of the caboose.

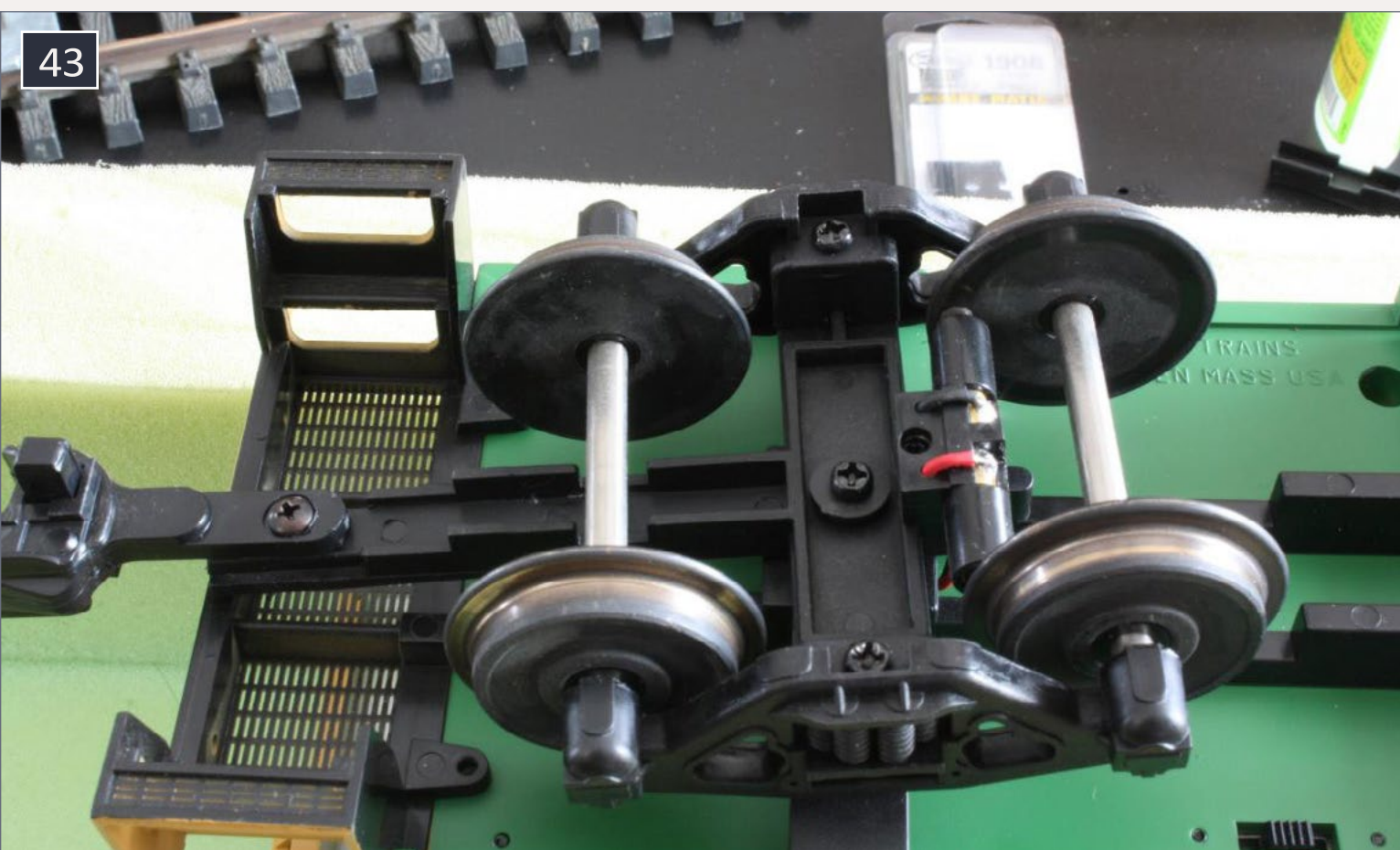

**43. Truck-mounted coupler provided by the manufacturer.**



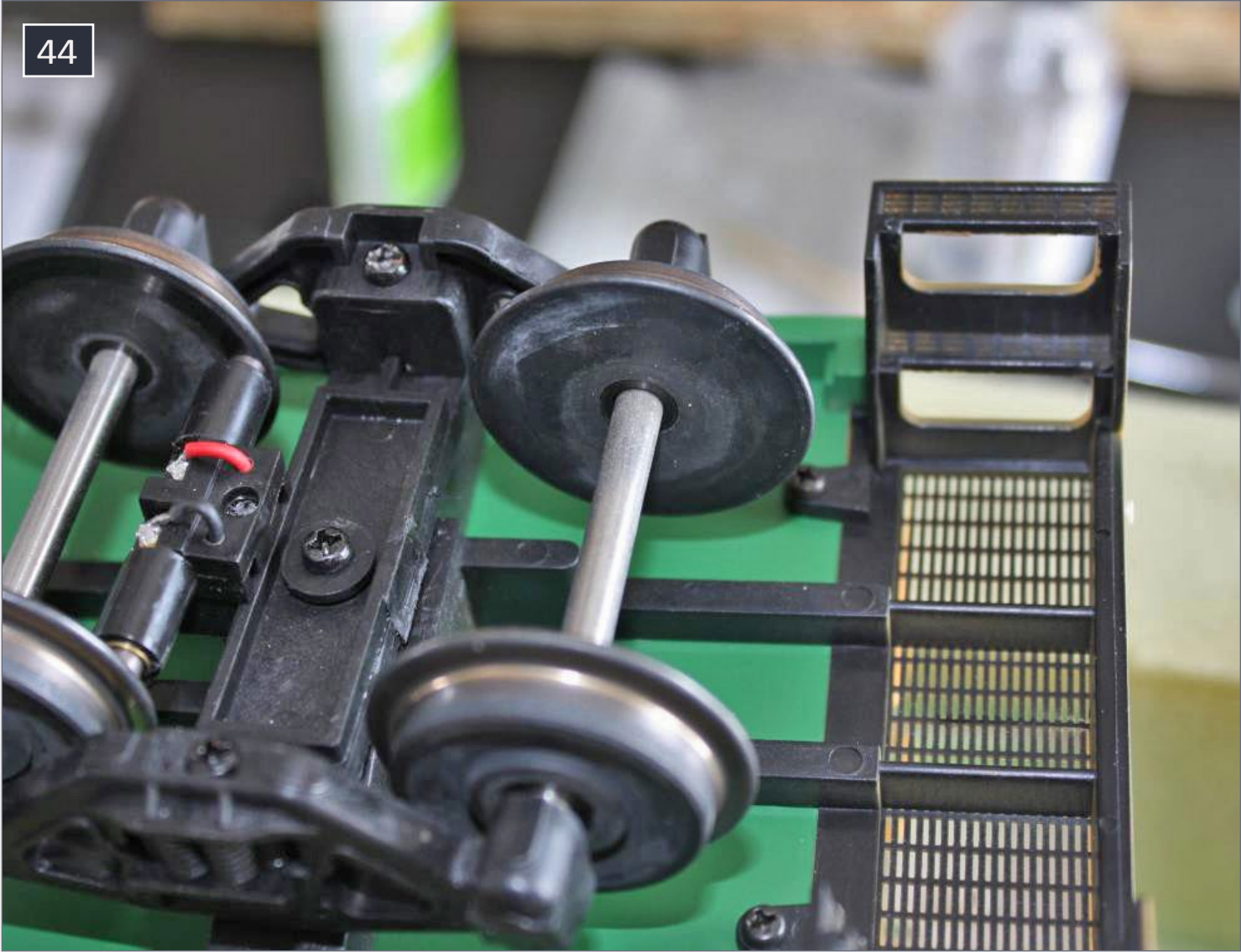

## 44. After the truck-mounted coupler has been removed.

The screws that came with the Kadee coupler kit were too long. I found correct screws at a local hardware store, and drilled holes for them in the mounting block.

Before the final mounting of the coupler, I used a Dremel cutting disc to cut off the trip pin. I airbrushed the coupler roof brown and the coupler box yellow. I checked the coupler height with the coupler gauge, and made any necessary adjustments.

## Weathering

Before weathering, I painted the grab irons and end rails white [49]. The grab irons pull off easily with smooth pliers (no teeth). I used HO scale 2" white striping for the stripes on the





45



**45. Building the coupler mounting box from styrene.**

46

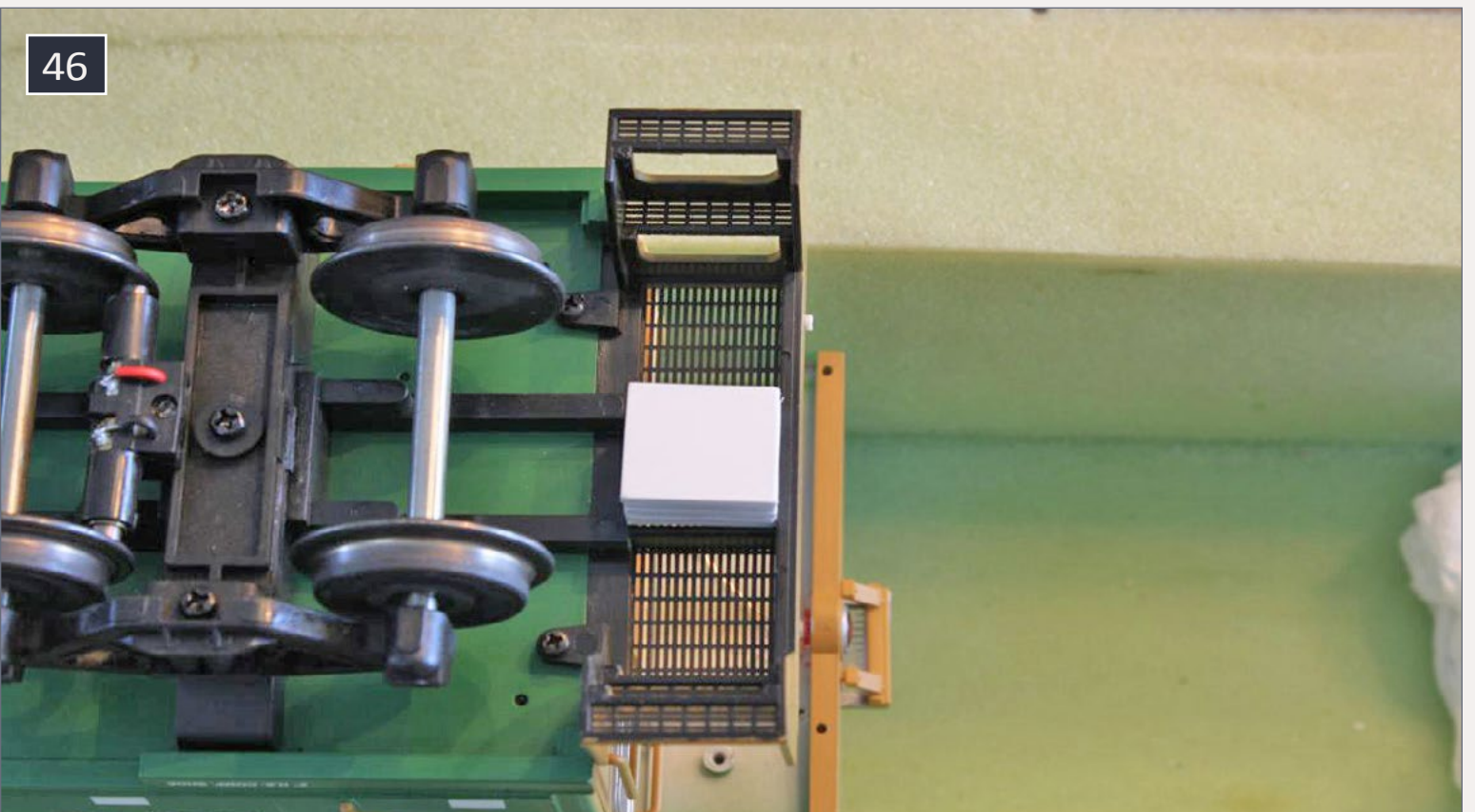

**46. Test-fitting the styrene block. I pressed on the walkway where the beams run underneath, to prevent it from breaking.**



47

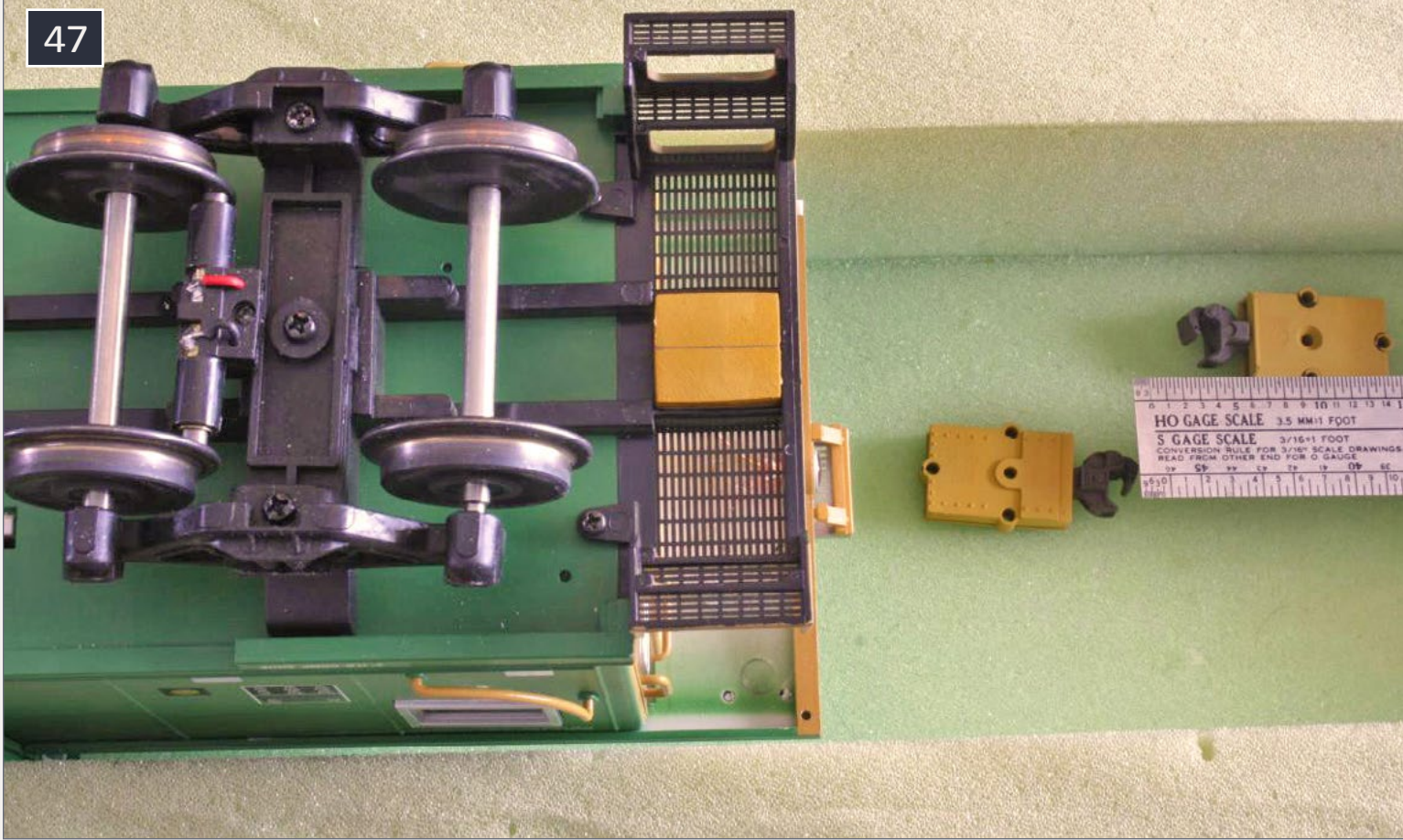

47. Mounting block glued in place, with centering line added.

48

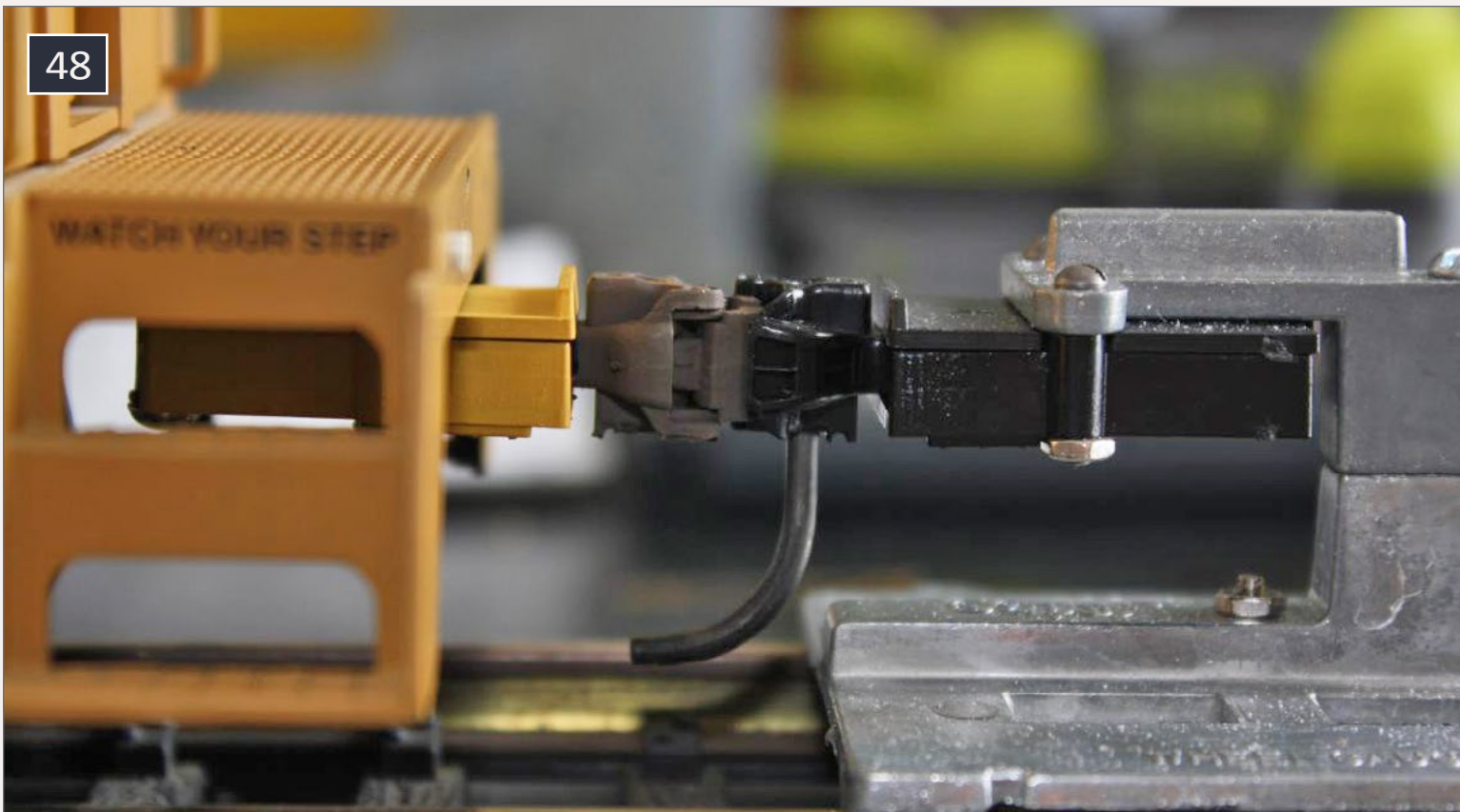

48. Checking coupler height after final mounting.



contents



index



steps. As the decals were applied I used Microscale Micro-Set. After the decals dried I used Microscale Micro-Sol to give the decals a painted-on look.

I brushed the roof to remove the dust that accumulated over the years, then blew off the loosened dust with a compressed air can. The caboose had been handled a lot, so it needed cleaning before weathering. I used window cleaner and a rag.

Next I airbrushed the caboose with a very thin wash of light gray. This alone makes the car look older and the paint faded. I followed this by airbrushing a dirt color on the lower portion of the caboose, making sure to fade it out as I moved toward the roof [53].



**49. End rails and grab irons painted white. I placed tape over the EOT lens during the weathering stage.**



I used artist's chalk for the remainder of the weathering. For the streaks of rust that run down the side, I used chalk powder mixed with isopropyl (rubbing) alcohol. I used drywall sanding screens to turn the light rust-color chalk sticks into powder, and mixed in a little alcohol to make a wash.

I applied the wash to the car with a brush [53]. The alcohol dries very fast, leaving the chalk behind. I applied the chalk in layers, and wiped off the excess if I applied too much.

After the wash part was complete, I applied darker powder dry to resemble rust. Don't use isopropyl alcohol to clean off chalk if you put on too much. It may remove the thin airbrush coats, as I found the hard way.

For darker rust spots I mixed chalk powder with flat acrylic clear coat. It takes only a drop or two of clear coat for this. I used a toothpick to mix the powder and clear coat until its



50

**50. Light gray wash and dirt color have been airbrushed.**



contents



index

consistency was like paint . Use a cosmetic sponge or a cotton swab to apply the dark chalk. Use a stippling technique to apply. Although it can't be seen well in the photos, this leaves textured chalk that looks like pitted rust [51].

For the trucks, I started by mixing light rust powder chalk and darker rust powder chalk 50/50, and making it into an alcohol wash. I applied this wash to the trucks and wheels. After it dried, I dry-brushed dark rust powder onto the wheels. This same techniques was used for the couplers [53].

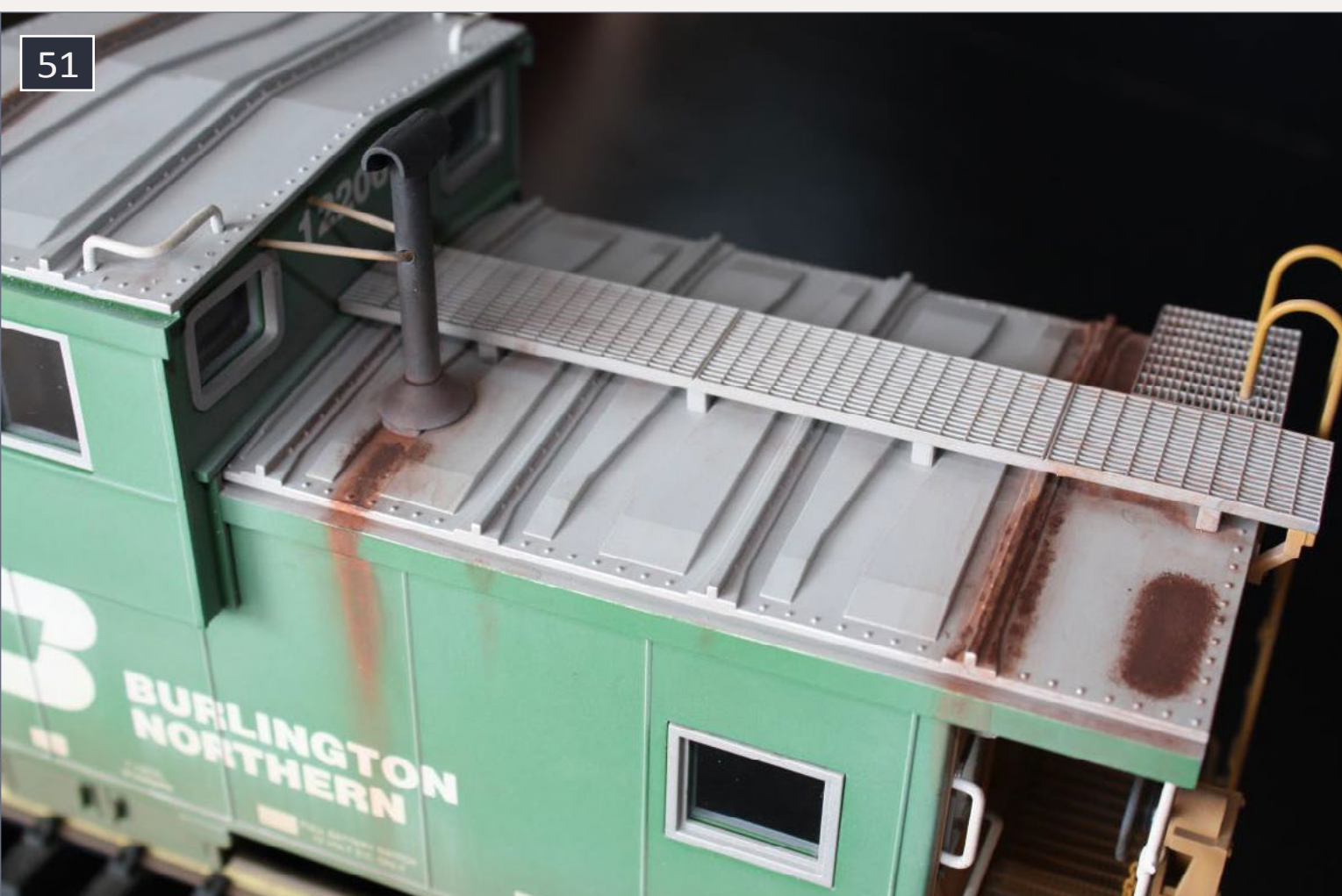

**51. The dark spots on the roof were made with powdered chalk mixed with flat acrylic clear coat. A cosmetic sponge or cotton swab can be used to apply the paint-like wash. I used a stippling (dabbing) motion to apply these spots.**





## 52. The roof rust has been carried down the side near the chimney.

To make the BN logo and the stenciling look faded, I applied a white chalk stick directly to these, then used a stiff brush to drag the chalk straight down the side of the car, not at an angle.

I applied flat clear coat to seal the weathering. The clear coat prevents smudging from your fingers while handling the car. This can be done with an airbrush or from a can. Chalk tends to fade after a clear coat is applied.

## Summary

Sitting back and looking at the finished caboose, I'm glad I chose to build a small and basic garden railway. One of the greatest parts about working on this caboose is that my two





### 53. The finished caboose.

boys (seven and four years old) were able to help. They helped with photography, airbrushing, weathering chalk powders on the trucks, and gluing the styrene pieces together for the coupler mounting pads. This provided great bonding time with them, and maybe they'll stay bitten by the model railroad bug for life. Now I look forward to having their help on building the garden railway. We'll also be installing a QSI Titan Magnum decoder in a USA SD40-2. The boys (and I) are excited to hear the engine rumbling down the tracks. ✓





Eric Warhol lives in Becker, MN with his wife, Joni. Life is busy raising three children, Matthew (7), Nathan (4), and Katherine (9 months). When not busy with parenting and school or sport activities, Eric tries to squeeze in a few minutes of model railroading.

As a young child, Eric was bitten by the train bug when his father brought home a Lionel set. He set up the Lionel

trains, and was hooked. He remembers being at Grandma and Grandpa's, and waking up in the middle of the night to run outside to the porch and watch a Soo Line train pass by less than half a block away. Eric has modeled HO scale for over 25 years, but has recently gotten into garden railroading. His dream is to have a garden railroad on some acreage he and Joni own.



**Reader  
Feedback**  
(click here)



contents



index

# Bill of materials

USA Trains [usatrains.com](http://usatrains.com)

BN Extended-vision caboose

DP3T slide switch comes installed in the caboose

EBay (Search/purchases) [ebay.com](http://ebay.com)

LGB caboose interior

Large-scale figures

0604 SMD LEDs, warm white (from China)

N scale building light with shade

Rulers of the World [rulers-of-the-world.com](http://rulers-of-the-world.com)

– G scale 1:29 25" ruler 25-I-0029-G

– 1 scale 1:32 25" ruler 25-I-0032-1

Kadee Couplers [kadee.com](http://kadee.com):

#1906 #1 scale type E straight center-set coupler with body-mount box

#1929 #1 scale type E coupler gauge (five tools in one)

Radio Shack [radioshack.com](http://radioshack.com):

Dual mini board (I cut it down to fit) 276-148

#30 wire (strip insulation to make coiled phone cord) 278-501

Remington Industries [remingtonindustires.com](http://remingtonindustires.com):

– #40 magnet wire

Digi-Key [digikey.com](http://digikey.com):

Capacitor aluminum 10,000  $\mu$ F 35V P6913-ND

Resistor 1.5K ohm 1/2W 1.5KH-ND

Resistor 22 ohm 1/2W S22HCT-ND

Potentiometer 10K ohm 1/2W 3362H-103LF-ND

Potentiometer 250K ohm 1/2W 3362P-1-254LF-ND



**Bridge rectifier 200V 1A DF02MDI-ND**  
**– 1N4001 diode 50V 1A 641-1310-1-ND**

**Misc. Tools/Supplies:**

**X-Acto (Standard and chisel blades)**

**Sanding sticks/sand paper**

**Razor saw**

**Airbrush**

**Masking/painters tape**

**CA**

**Micro Scale Krystal Klear**

**Soldering iron/solder/flux**

**Paint brushes**

**Hobby paints**

**Weathering chalk**

**Tamiya clear red paint**

**Styrene (for stove, couplers, etc)**

**Clear styrene (for windows)**

**Digital caliper**

**Small drill bits and pin vise**



contents



index

# Yes, it's a model

**Model Railroad Hobbyist's  
monthly photo album**



1. Fritz Milhaupt posted this photo of a “long-gone module” that he lost when the Rails on Wheels trailer was stolen in 2009. He had just gotten the scenery to where he was happy with it. We are glad he took the photo and shared it with us. It is one of those everyday scenes that are too often ignored by modelers.







2. Jeorn Pachl posted this photo on MRH's forum under jpachl. The models are TT scale and the diorama was photographed against a light background and then had a new background added as a separate layer. He has created the gritty look of an inner-city industrial site. To see more of his work, go to his homepage at [joernpachl.de/model\\_rr.htm](http://joernpachl.de/model_rr.htm).

3 (next spread). A leased Bangor and Aroostook GP7 and a Canadian Pacific FP7A ride the St. Luc Yard (Montreal) turntable on Ian Stronach's posted CPR Montreal Terminals Division. The GP7 is an old yellow box Atlas masterfully detailed and painted by Mark Roach. The FP7A is a old Atlas Roco, painted by Dave Jenkins. Ian posted this photo along with the inset photo that inspired him.



contents



index









contents



index



4. Engine 207 with a local freight on Skaarerbanen in August '59. The picture is taken on a FREMO module. Forum member Steinar posted this photo of his Norwegian branch line. To see more go to: [skaarerbanen.blogspot.com](http://skaarerbanen.blogspot.com).

5a-5b. Forum member k4\_pacific posted these photos of a modified Bachmann On30 2-8-0. "I shortened the tender, changed out the tender trucks, built a smaller cab, rearranged the domes and other detail parts, lengthened the running boards, wrapped and detailed the cylinders to make it into a piston valve engine, scratchbuilt a steel pilot and painted and lettered it. Now it's an S scale model of a 42" gauge Baldwin export locomotive." He also posted some links to the Ecuadoran prototype:

- [railpictures.net/viewphoto.php?id=167115&nseq=11](http://railpictures.net/viewphoto.php?id=167115&nseq=11)
- [rrpicturearchives.net/showPicture.aspx?id=3003704](http://rrpicturearchives.net/showPicture.aspx?id=3003704)
- [rrpicturearchives.net/showPicture.aspx?id=3059374](http://rrpicturearchives.net/showPicture.aspx?id=3059374)
- [rrpicturearchives.net/showPicture.aspx?id=3260860](http://rrpicturearchives.net/showPicture.aspx?id=3260860)



5a



5b



contents



index



6. Sortin' and labelin'. No it's not a model, just an amazingly well organized work area. Alan, who posts in the forum under LKandO, shared this photo. He took a month to organize all of those little parts and pieces that accumulate over the years. From the staff at MRH we say "hats off" for leading the way on organizing all of that "stuff."





# Get your photo here!

Our *Yes, it's a model* monthly photo feature presents some of the most inspiring modeling and photos from the MRH website and other locations. If you'd like to get *your modeling* in our photo feature, just start posting your photos on the MRH website, especially in the Weekend Photo Fun thread created each weekend.

Many of the photos posted show HO modeling, but we encourage modelers in other scales to post on the MRH website as well. We don't want this to just be an HO photo feature!

For info on how to post photos to our website, [see this help how-to](#). You need to be an MRH subscriber to post photos to our website, and becoming a subscriber is free, [just fill out this form here](#).

Advertisement



Your Local **N Scale**  
Online Hobby Shop

575-523-9743  
fiferhobby.com



Email



Phone



contents



index

# BATTERY-POWERED MODELS IN *HO scale*



**KAOS comes to model  
railroading ...**

**– by Dr. Geoff Bunza**

Photos by author



**Reader  
Feedback**  
(click here)



**M**any modelers have experienced DCC-controlled locos sputtering off and resetting over dirty track, and DC loco stalls necessitating five-finger encouragement. Some modelers have resorted to the use of “super cap” keep-alive supplemental circuits which can power the decoder and loco for a few seconds, but some keep-alive implementations do not meet clearance requirements on HO layouts.







What if a loco carried its own power on board? It would enter the realm of battery-powered model railroading. This article is an exploration of battery power for HO scale modeling, from relatively simple to more complex applications. Different approaches are presented with successful results and problems encountered along the way.

Battery-powered scale models exhaust all their power. Constantly replacing them can be both expensive and prone to damage in small scales. One then considers rechargeable



contents



index

batteries, but recharging them has often resulted in special connections and more handling.

This leads to considering combinations of techniques and technologies, eventually resulting in “KAOS”-- Keep-Alive On Steroids. KAOS power uses high energy density, lithium polymer (LiPo) batteries, a low-cost, battery manager/converter board, and a simple scheme to charge the battery from whatever power is on the rails —DCC or DC power. Both work just fine. We will explore a number of alternatives and their issues. We’ll also consider a low-cost approach for remote control. This lays the groundwork for more modeling possibilities, and, of course, more fun!

## Power, regulation, recharge, and conversion

This began as an experiment to see how the small but powerful LiPo batteries could be used for modeling. I have had some success using them with my small mobile cranes (See [model-railroad-hobbyist.com/blog/geoff-bunza](http://model-railroad-hobbyist.com/blog/geoff-bunza) ) and I wanted to put them on the rails. There are additional complications with charging and maintaining multi-cell LiPos used to get the higher voltages we are familiar with – like 12 volts.



### 2. 2600 farad keep-alive capacitor with clearance problem.



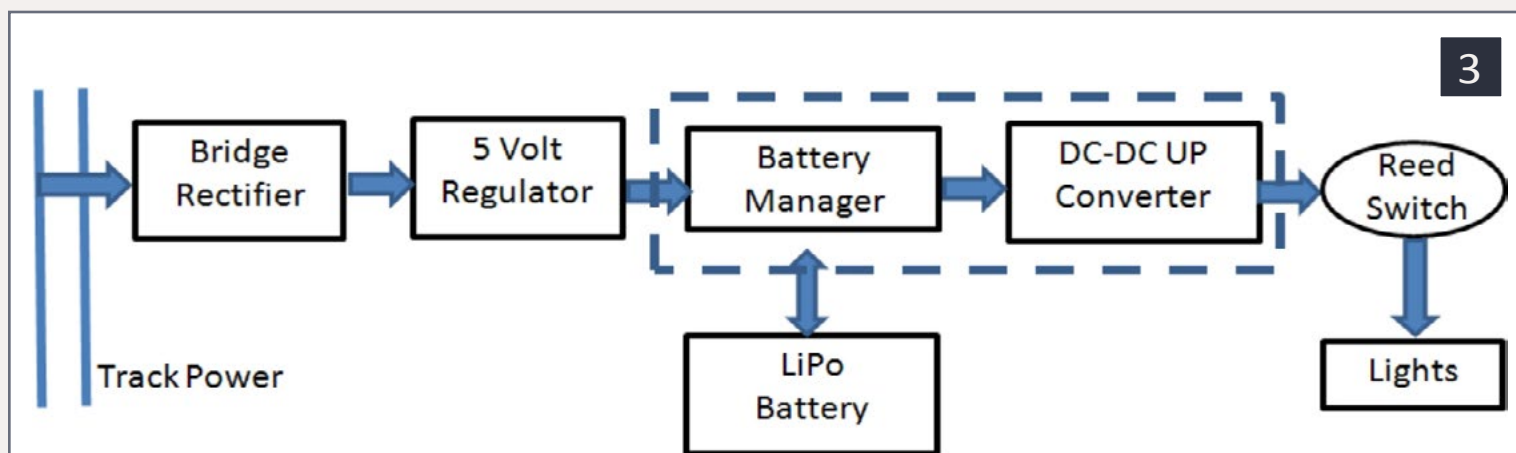

### 3. Basic power block diagram.

To keep things simple I elected to use a single 3.7 volt cell, recharged from the rails. LiPo batteries have a usable voltage range from about 3 to 4.2 volts, so part of the problem is converting battery power to a usable range for model railroading. Low cost and ease of construction were important constraints too. The other problem is one of control. If the model is independently powered, then how does one control it? It may be possible to open up a DCC decoder and re-wire it, but my ultimate goal was for autonomous animation applications. So, I didn't pursue the DCC mod approach at all.

Before getting into the aspects of control, let's look at the basic power source. The power block diagram is in [3]. Whatever power is on the rails is put through a small full-wave rectifier, regulated to 5 volts, and fed to the charging inputs of a commercial battery-manager/converter board. This board prevents overcharging the lithium polymer 240 milliamp-hour (MAH) battery. The module also controls the charging pattern and prevents over-discharge which can also damage the battery.

One version of the maintainer board contains a 5 volt DC-DC converter, which provides a stable, regulated 5 volt power source until the battery is turned off to prevent over-discharge. This combination of components provides a stable 5 volt, .45



amp mobile power source whose battery is recharged whenever it finds 6-25 volts on the rails, in any form, DC or DCC, even AC! It will recharge and protect the LiPo battery simultaneously. Later, we'll look at another variation.

Not everyone may be familiar with LiPo batteries, but they are actually quite common. They power many cell phones and tablets. They are light in weight compared to many other battery types. LiPo batteries have very high energy density. That is, they pack a great deal of electrochemical power in a very small volume. As such, if shorted out they can generate a great deal of heat in a short time, and can even explode and catch fire. Therefore, protection circuitry is essential for safe use. Damaged LiPo batteries should not be used, and should be disposed of properly and safely. When fully discharged for disposal they are not a toxic hazard. Over-charging and over-discharging damages a LiPo battery.

All these concerns for charging and use are handled by a small, low-cost (\$3.99) battery manager board. This board is available

4

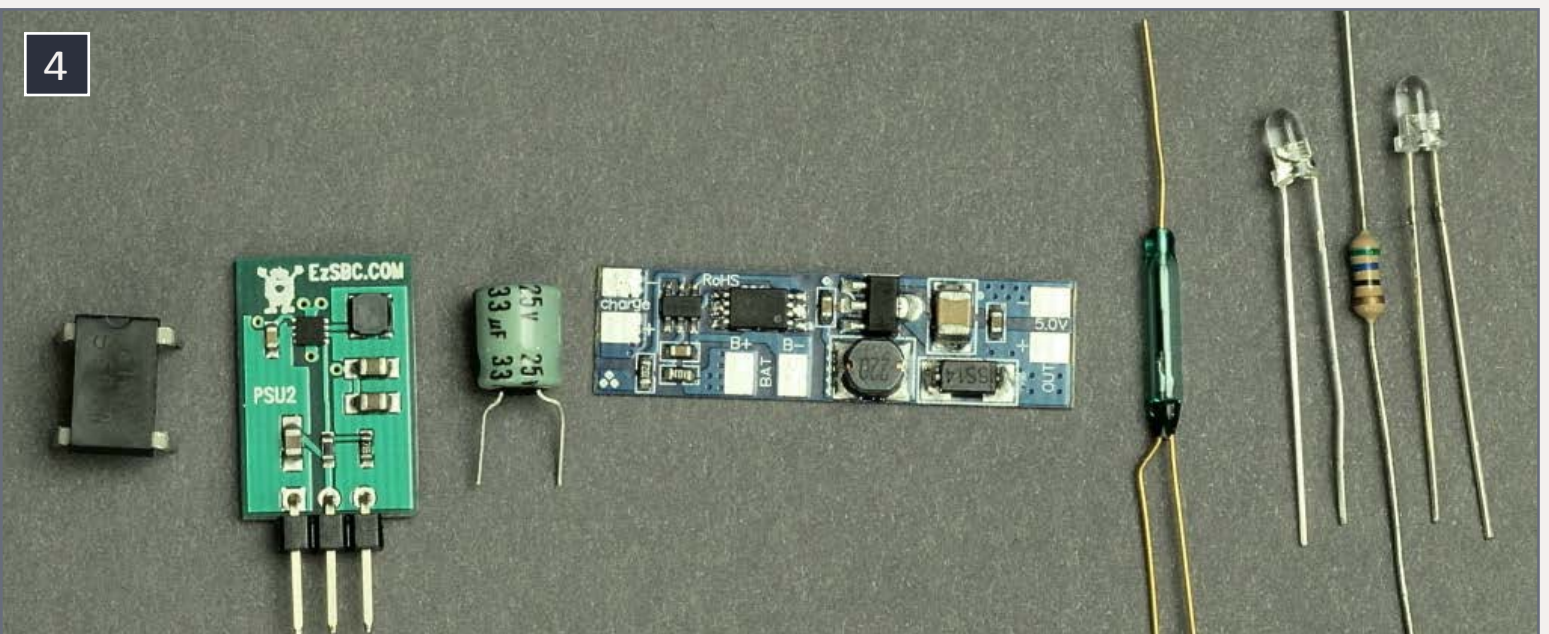

## 4. Basic power block components.



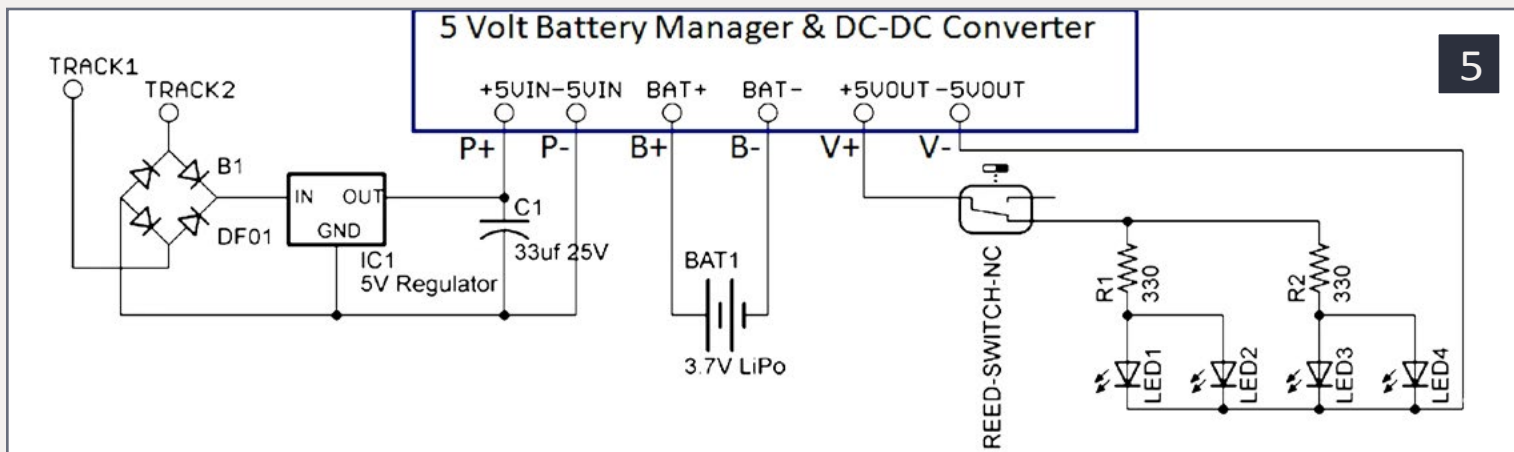

## 5. Basic power block schematic.

via eBay [ebay.com/itm/121003094575](https://www.ebay.com/itm/121003094575) as “Lithium battery charging 5V step up, protection all-in-one PCB.” I use a 240 MAH battery because it is small and fits many of my models, but larger single-cell LiPos will work too, if they meet the physical space requirements. You should note the rating pictured on each battery of 20C or 30C. This is the maximum charging rate specified for the specific battery. This would refer to 30 times 240 milliamps or 7.2 amps max charging rate. Or 20 times 250 milliamps or 5 amps max charging rate. These charging rates should never be exceeded, to prevent damage to the battery. Some LiPo batteries come with a small battery manager circuit board embedded in the battery package, but many, particularly the small LiPos, do not have them.

The first battery manager board I used expects 5 volts input to the board. We will use track power (DC or DCC) for board power. First, we convert track power to DC with a full wave bridge rectifier, and then regulate it to 5 volts. The bridge rectifier is a 1.5 amp DF01 bridge rectifier from [goldmine-elec-products.com](https://www.goldmine-elec-products.com). The first attempt used a 5 volt, 1 amp LM2940CT-5.0/NOPB-ND from [Digikey.com](https://www.digikey.com), similar to a common LM7805. But the peak current draw (charging a very low battery) was close to 900 milliamps, and the regulator ran quite





## 6. LiPo batteries.

hot to the touch, even with a small heat sink attached. This was too hot for a closed plastic shell. A melt-down was coming.

Fortunately, there is relatively new technology in the form of switching regulators to save the day. I had on hand a few 78ST105HC modules which come in a plastic frame with no heat sink. They provided the same regulation function and worked great, generating little heat if any. While the 78ST105HC is hard to get, their success prompted me to find the PSU2-5 from EzSBC.com, also available from their eBay store, an even smaller switching regulator in the same package outline as an LM7805. The heat problem was solved. A small capacitor was added across the output of the regulator — about 33uf at 25 volts. This capacitance value is not critical but use at least a 10 volt rating.

The last component in the basic power unit is a magnetic reed switch to turn the unit on and off. A plain single-pole



single-throw switch can also be used. LiPos are supposed to have a limited lifetime of charge/recharge cycles, as do most if not all rechargeable batteries. So when I'm done operating, I switch the unit off either with a tiny magnet attached to a figure [8], a small wand, or other device.

The reed switch is a single-pole double-throw switch, whose "normally on" side is used, such that when the switching magnet is taken away it assumes the "on" position. I was able to locate these easily on eBay [ebay.com/itm/251461210780](http://ebay.com/itm/251461210780). A mechanical switch will also do well, but it requires more handling of the model to operate. Small reed switches like these are easily hidden, and can be activated by a small magnet without direct contact. This is a nice feature to build into a model. If the model is not used for a long time (say a week), it may be necessary to use the switch to disconnect the load, and recharge the battery back-up.

I have been able to operate the twin motors of one diesel (described later), for over an hour with no other power source. Current draw was about 180 ma. For lower-power LED lighting in cars, operation is much longer. While this will not provide

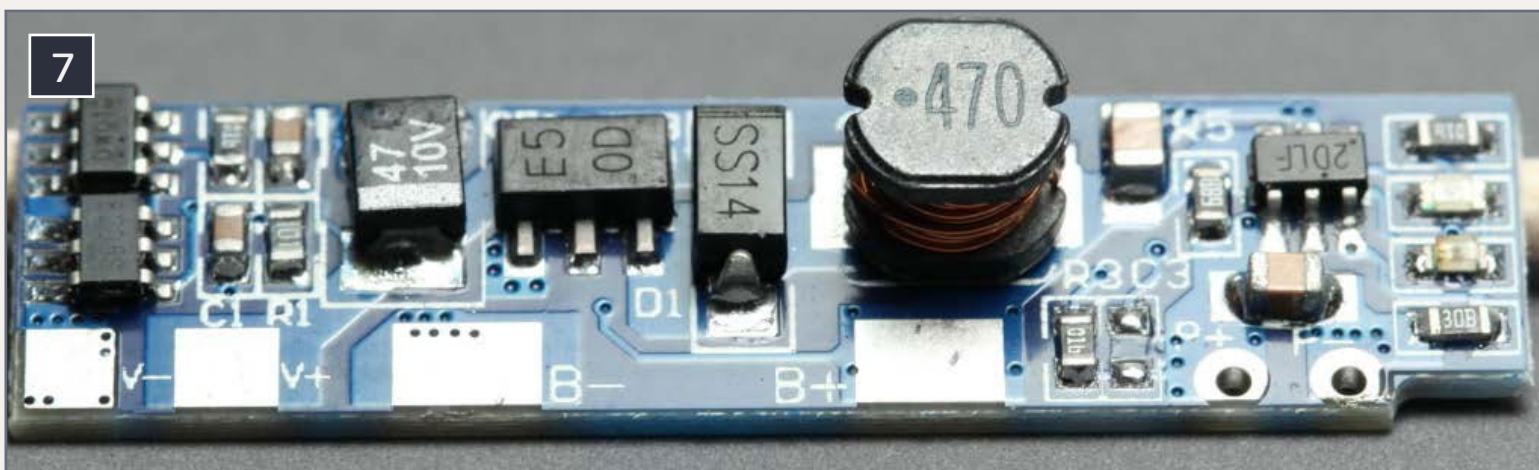

## 7. Battery manager board with built-in DC-DC 5V converter.



contents



index



8



8. Caboose lights on.

9

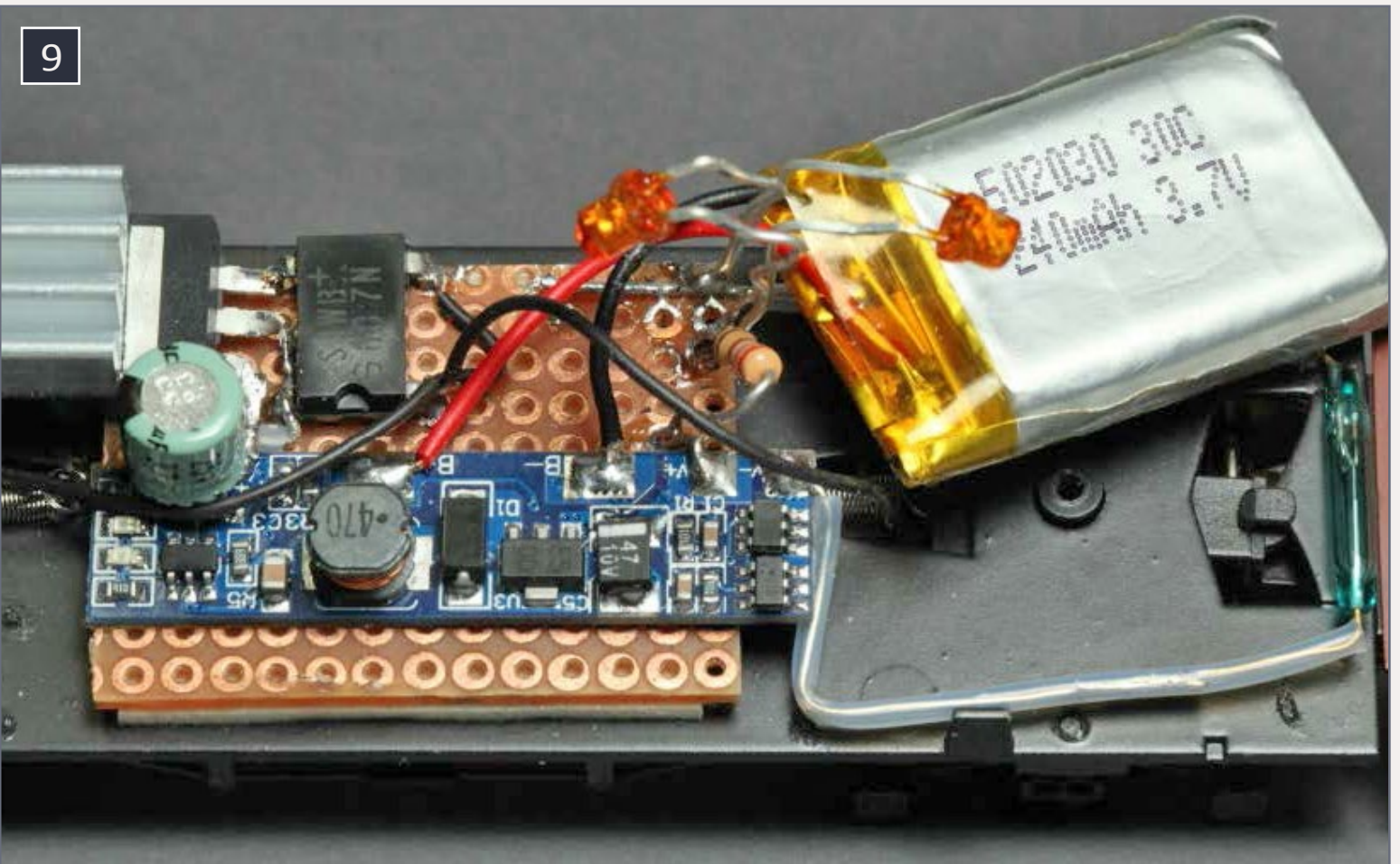

9. The basic power block installed in the caboose.



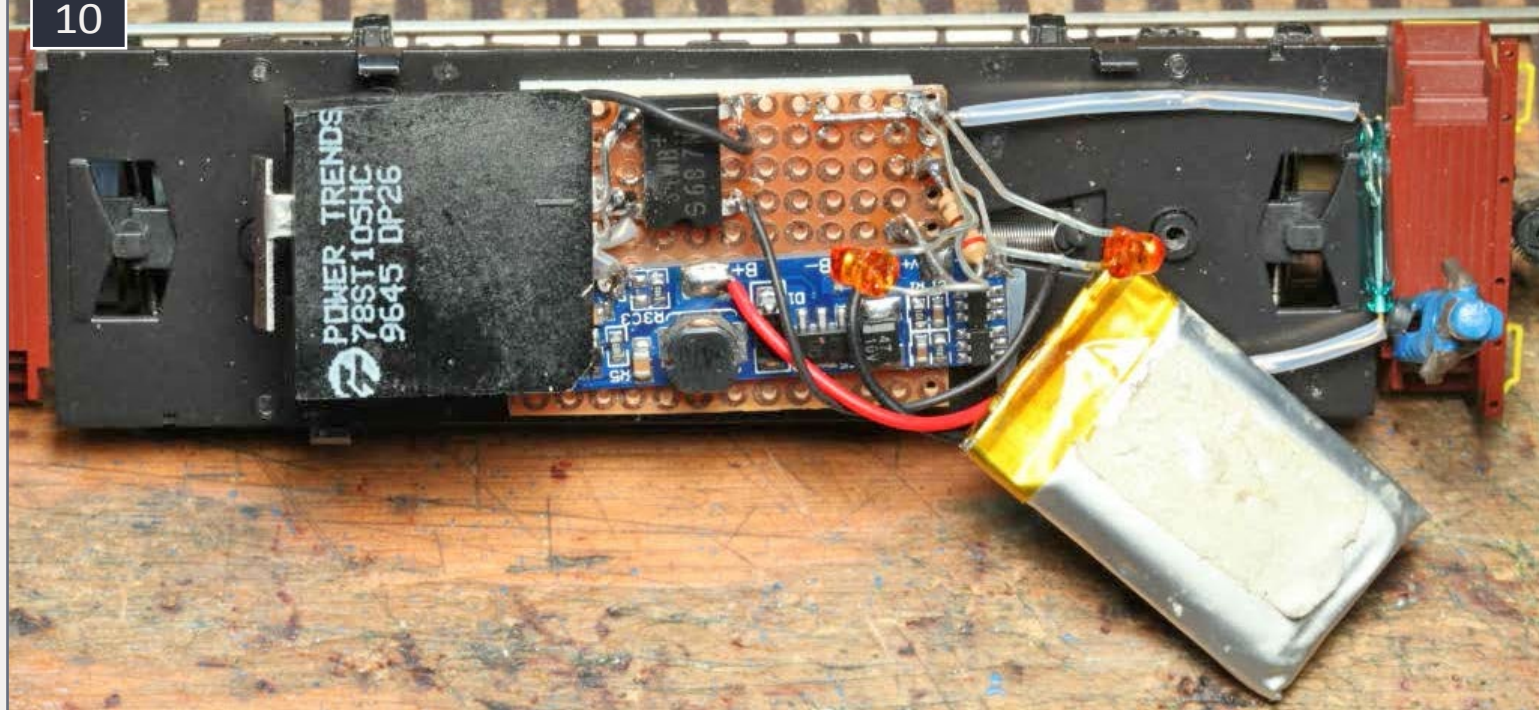

## 10. Caboose using the upgraded basic power block.

power by itself for a multi-hour operating session, operation on powered track, even incredibly dirty power track, allows for recharging on the fly, and for smooth, continuous power. It's like a Keep-Alive module on steroids – hence, KAOS power.

### Caboose lighting details

Using the KAOS module just described provides an uninterrupted power source which can be used to light car interiors with no light flickering at all – unless you really want to make them flicker! The caboose pictured was my first test. It uses four LEDs, all lit with KAOS power. Figure [9] shows the basic power block installed in a caboose. Note the first use of the silver-finned, heatsinked regulator on the left. Figure [10] has the later version using the 78ST105HC to avoid a caboose meltdown.

Two of the LEDs are powered through a 270 ohm 1/8 watt resistor. Dropping resistor values are lower than you might be used to, as the LED power is from 5 volts, not 12 volts. The



marker LEDs are powered similarly. This is very straightforward. The components are soldered to a scrap piece of perforated circuit board, mounted to the caboose floor with double-sided foam tape. No attempt was made to reduce the overall size. Many variations were tried. The components are such that all should fit with little effort, even in a four-wheel bobber caboose. I used Kadee trucks with Intermountain metal wheelsets, and added .08" phosphor bronze pickup wire pairs to each truck. Track power was fed with very flexible 30 gauge wire through the floor to the bridge rectifier. The regulator limits the track voltage to the battery manager to 5 volts, when power is available from the track.

The caboose marker lights are Utah Pacific marker housings painted black. The lenses are created with Micro Kristal Klear from Microscale. Once dry, they are colored with Tamiya clear paint. The markers are lighted with a 0603 surface mount (SMD) LED with 38 gauge wire leads. Working with such small LEDs was covered in the February 2012 MRH article "Points of Light" [mrh12-02-feb2012](#). Once you get used to it, it's easy and satisfying. When I don't want the lights on, I position magnetic Mike on the caboose deck near the hidden, internal

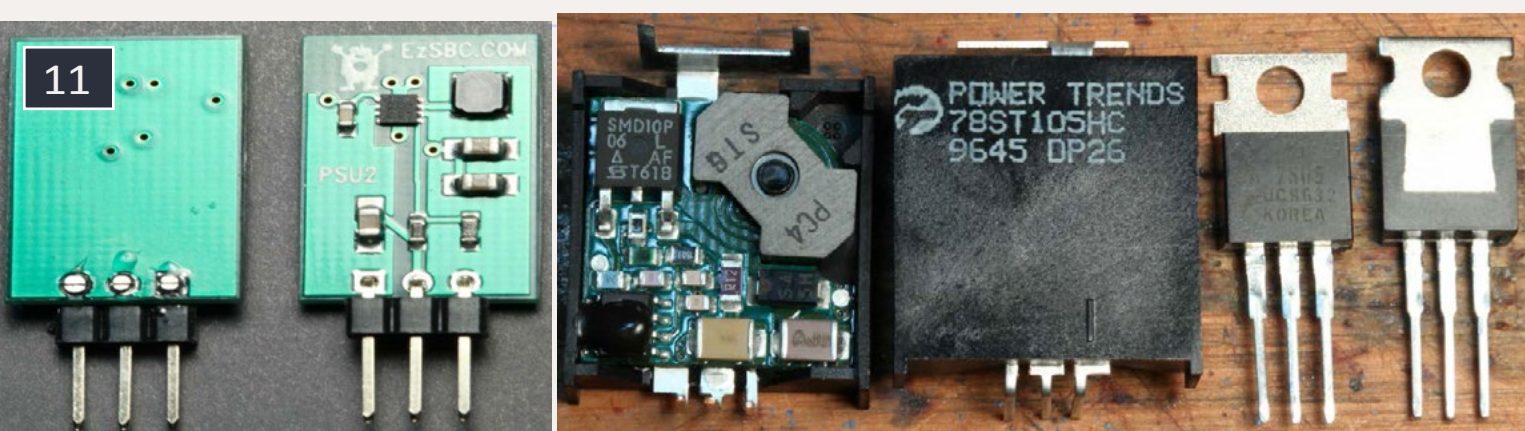

**11. Regulator comparison (left to right): PSU2-5, 78ST105HC, LM7805.**



12

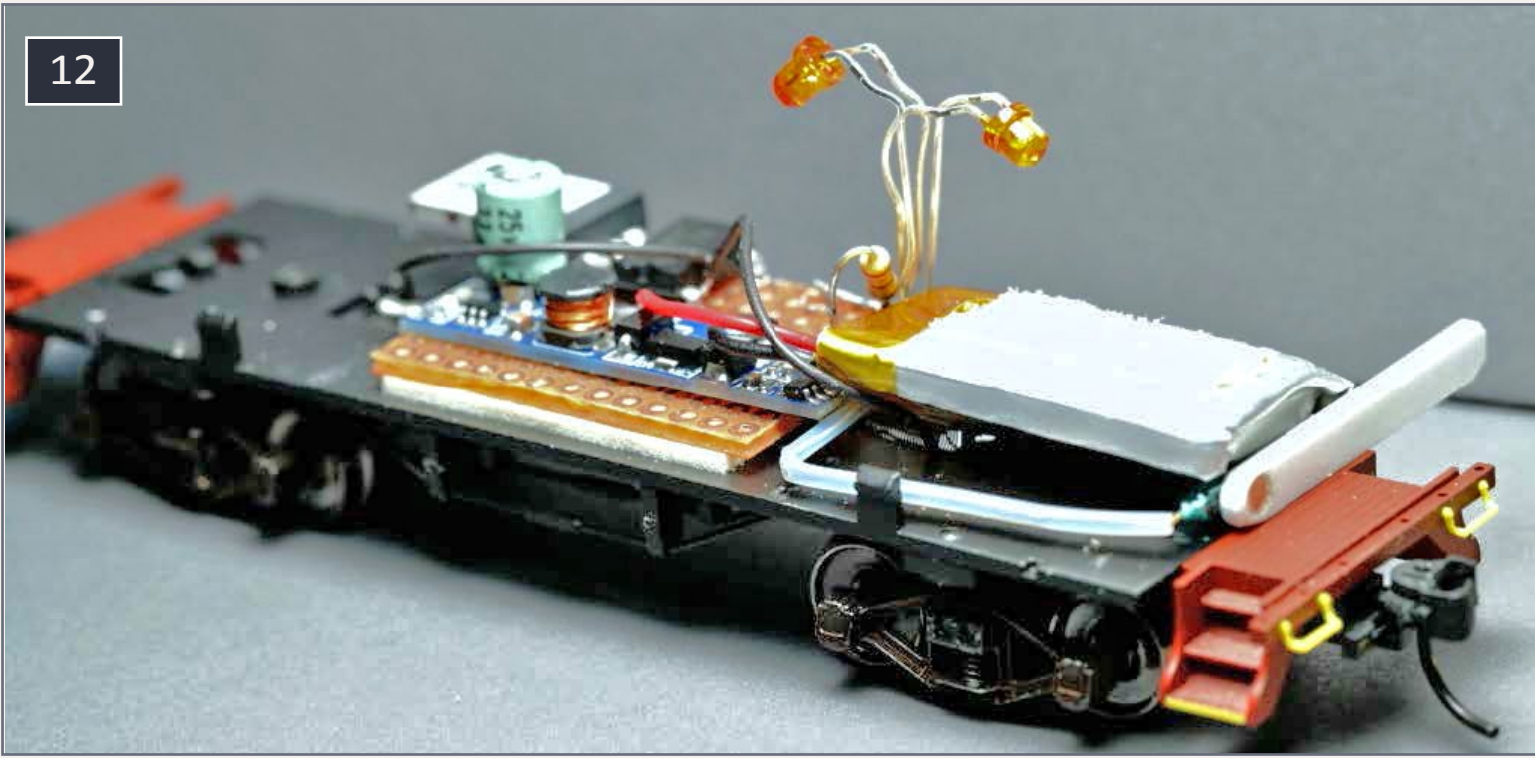

13

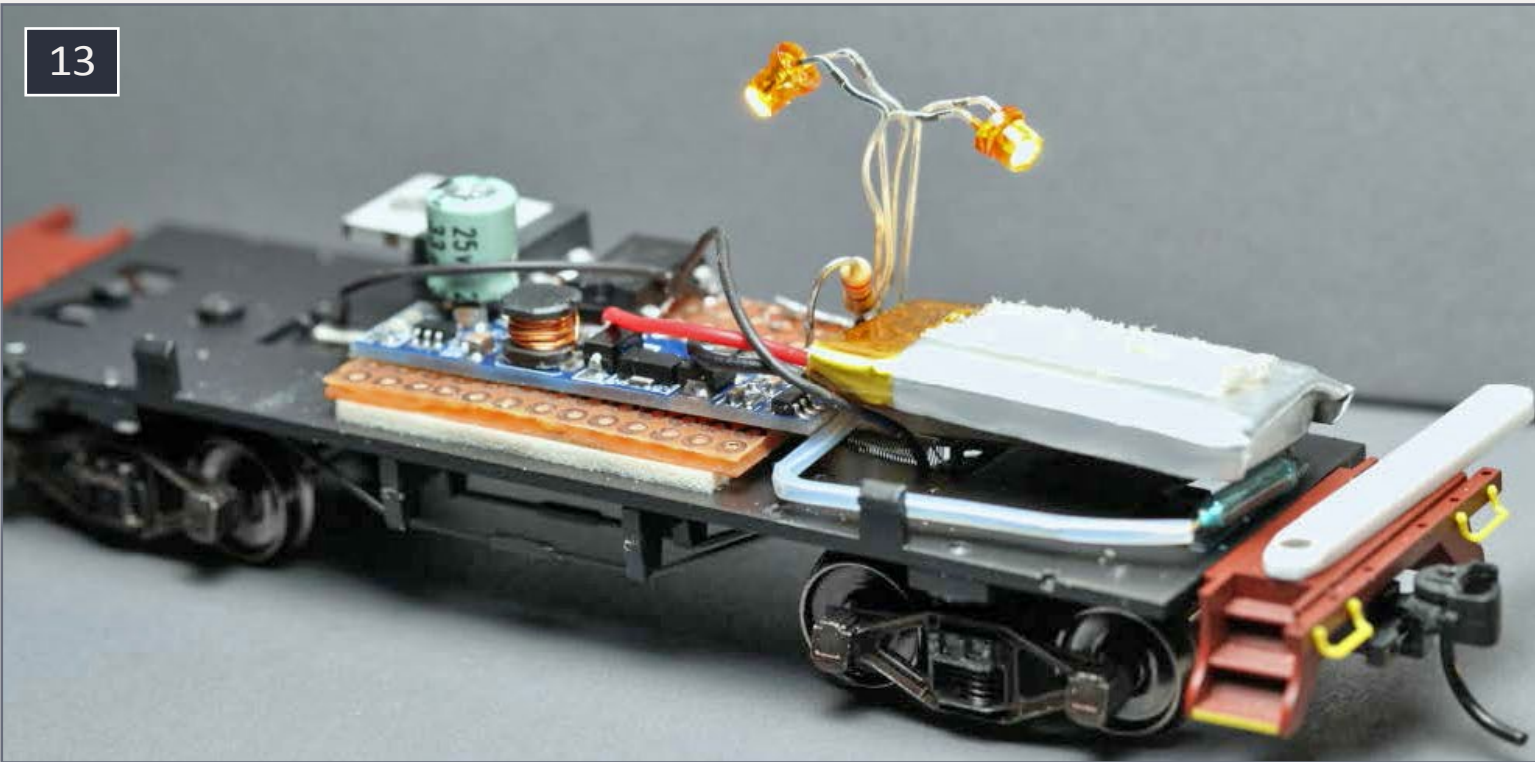

## 12-13. Caboose power unit w/reed switching via magnet wand. 12 is off, 13 is on.

reed switch to shut things down. The battery will still charge if there is power on the rails, until it reaches the charge limit and stops. Simply remove Mike when you want the lights back on. I have left Mike on board with a charged battery and come



contents



index

14



## 14. Caboose wheel wipers.

15



## 15. Lighted battery-powered caboose.

back a day or two later to find that power is still available for the lights. There is some current draw even when the lights are switched off, due to the built-in DC-DC converter. Eventually the battery will be drawn down. I haven't done any long-term tests on this scheme.

## Powering a locomotive

Since I had found the great little battery manager with built-in converter, I thought of using it to power a locomotive, even





## 16. Unlighted caboose with Mike as the switch.

though it only puts out 5 volts at .45 amps. I was going to modify a loco to use a lower voltage motor when I remembered the outstanding low voltage performance of the old Bachmann 44-ton GE switchers. But these units were also plagued with split gears. Besides, there was virtually no space inside the body for my experiments and trials.

Willing to accept the impossible as a challenge, I looked for the maximum size body I could put on top of the 44-tonner chassis. From the pile of misbegotten acquisitions, I found an old MDC/Roundhouse boxcab shell that fit nearly perfectly on the switcher frame! I opened an old early-run two-motor 44-ton switcher box, thinking that nothing could have affected the gears inside. To my chagrin, all four axle gears were starting to crack from the outside in, but none of the cracks had reached the gear teeth.

The weeping and gnashing of teeth over splitting gears, and the valiant efforts of expert machinists and tubing mashers, has been well recorded in the MRH forums. With neither the proper size tubing, nor the right stock on hand to machine,



necessity and desperation inspired yet another approach. I had been working on a model waterfront pier, and realized that the piling reinforcement often found with hemp rope might work here. I had a spool of very fine, strong thread on hand, and decided that pilings and axle gears are close enough!

After removing and cleaning the gear, I verified that the crack had not progressed to the center of the gear. The axle gears are made of a slippery plastic, much like Delrin which typically does not glue well at all. I applied a thin coat of CA glue surrounding the end of each side of the gear and wound several turns of thread through the glue. It is imperative that you make this as thin and strong as possible, as clearances in the motor truck are tight. So far, the reassembled trucks have worked fine and the crack did not progress to the gears.

Considering that power might be at a premium in this loco, other variations were tried to reduce the current draw. First, the motor and truck gears were removed completely, leaving only the two freely turning axles in one truck. This obviously reduced the tractive force available, but also halved the total power. On another truck I removed the intermediary gears

17



## 17. Bachmann 44-ton switcher, in sections.



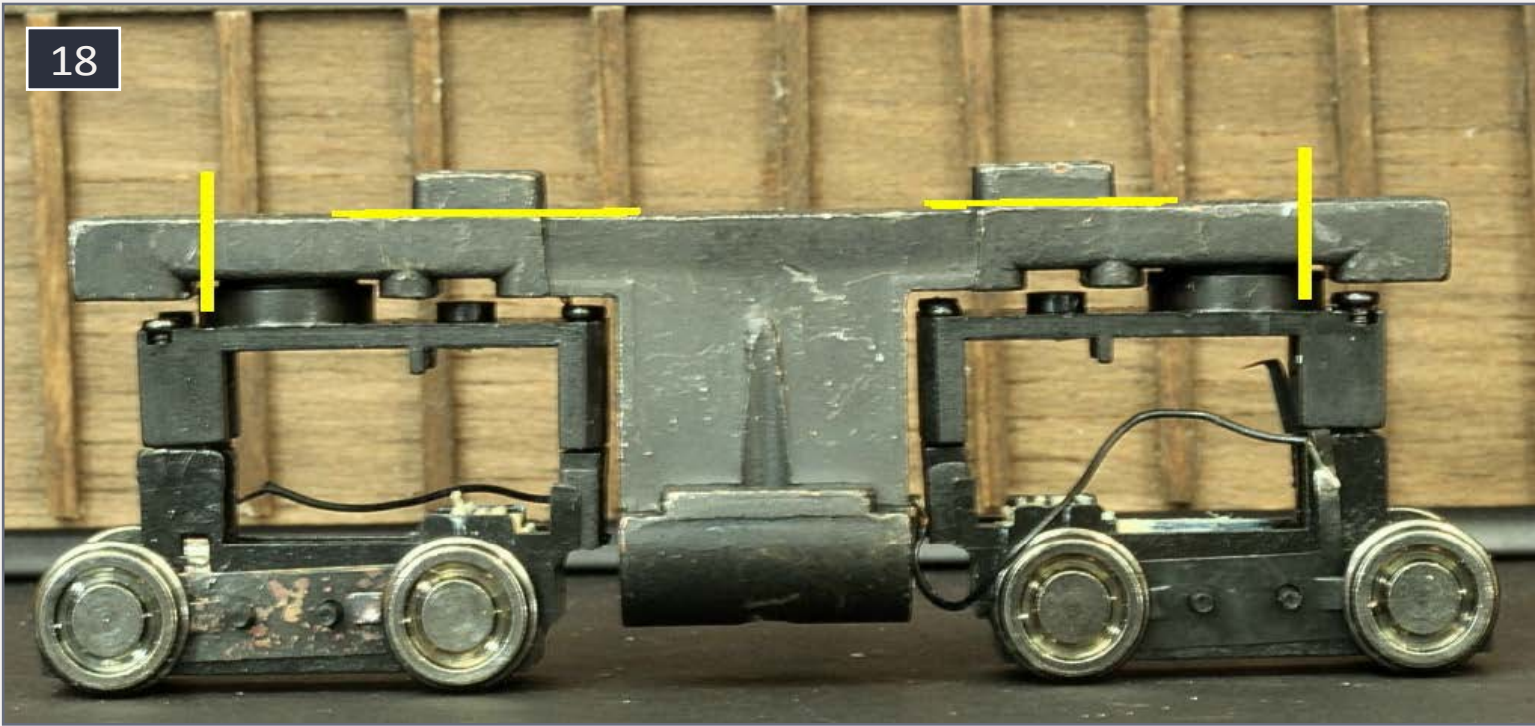

## 18. Bachmann 44-ton switcher, chassis cuts.

between the directly driven axle and the other axle. Again some power was saved at the expense of traction. I also used Northwest Short Line's (NWSL) geared replacement wheel sets as another alternative. All worked, but ultimately I found that two fully geared motored trucks could easily be driven by battery power.

The boxcab loco is built with the body of an old Roundhouse/MDC locomotive also available as a track cleaner, powered and non-powered. Its lower mounting "ears" are cut off. These bodies are no longer in production but are readily available in swap meets and on eBay.

As mentioned above, the chassis and drive motors are from an old dual motor Bachmann GE 44-ton switcher. The body is removed and cut down to the walkways [17]. The wiring board is removed and the top of the metal chassis is shortened as much as possible [18]. The top metal protrusions are removed. The metal chassis is used to support the power trucks and



the body. The motor trucks are disassembled. Cracked axles should be replaced or repaired. Solder two thin, very flexible wires to the side frame contacts directly (I replaced the ones that came with the unit), and carefully solder two more directly to the motor brush supports. Don't melt the housing or you may destroy the motor. This gives us independent pickups and isolated motor contacts for independent control. I covered the leveled top of the metal chassis with Kapton tape to prevent any possible electrical shorts.

The block diagram outlines the power and control scheme. In the first model, everything is powered with 5 volts from the basic power block, exactly the same as the caboose lighting application. Even if you're used to working with electronics, battery power adds more constraints to design. I started using the same H-Bridge devices I had used before (like the SN754410 driver and the L298 device). But with only 5 volts

19



**19. Original boxcab shell on right before bottom tabs are removed.**



available they did not provide enough voltage swing out to the nominally 12-volt motors.

As an aside, I did consider re-motoring with 6-volt motors but found success before I had to resort to this. I am now considering using a 6-volt or even a 3-volt motor in the original Roundhouse Boxcab mechanism, even with its poor power transmission. The H-Bridge designs usually solve the problem of using a single voltage source to power a DC motor both forward and reverse. I even tried using a discrete FET H-Bridge with poor results. Success came via a throwback! I used an electromechanical relay as a double-pole double-throw switch, just like DC power packs typically use. The problem was the typical relay would constantly draw power in its activated state, decreasing battery life.



**20. Repairing gears.**

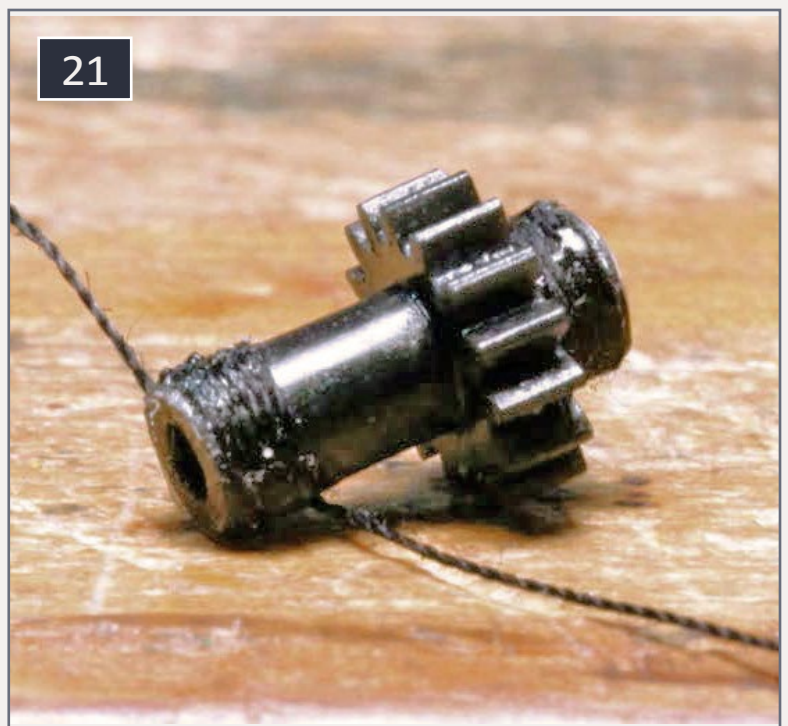

**21. Wrapping the axle.**



contents



index



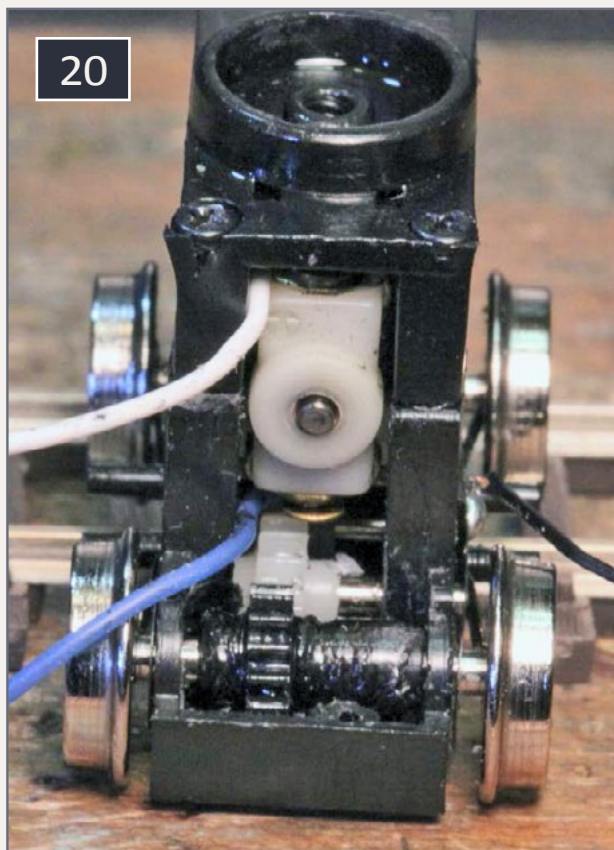

The solution was to use a tiny latching relay which only needed a short pulse to switch the contacts. Look for 4.5-volt dual coil latching relays at [Digikey.com](http://Digikey.com) or [Mouser.com](http://Mouser.com). The relay holds its position until pulsed to the opposite position. To maximize the voltage swing to the motor, a single, logic level FET transistor was used to pulse (Pulse Width Modulation - PWM) the power

**22. Repaired gears back in the power truck. Note the new motor wiring.**

**23. Loco1 boards mounted atop the 44-ton chassis. Note that the left power truck has had its motor removed.**

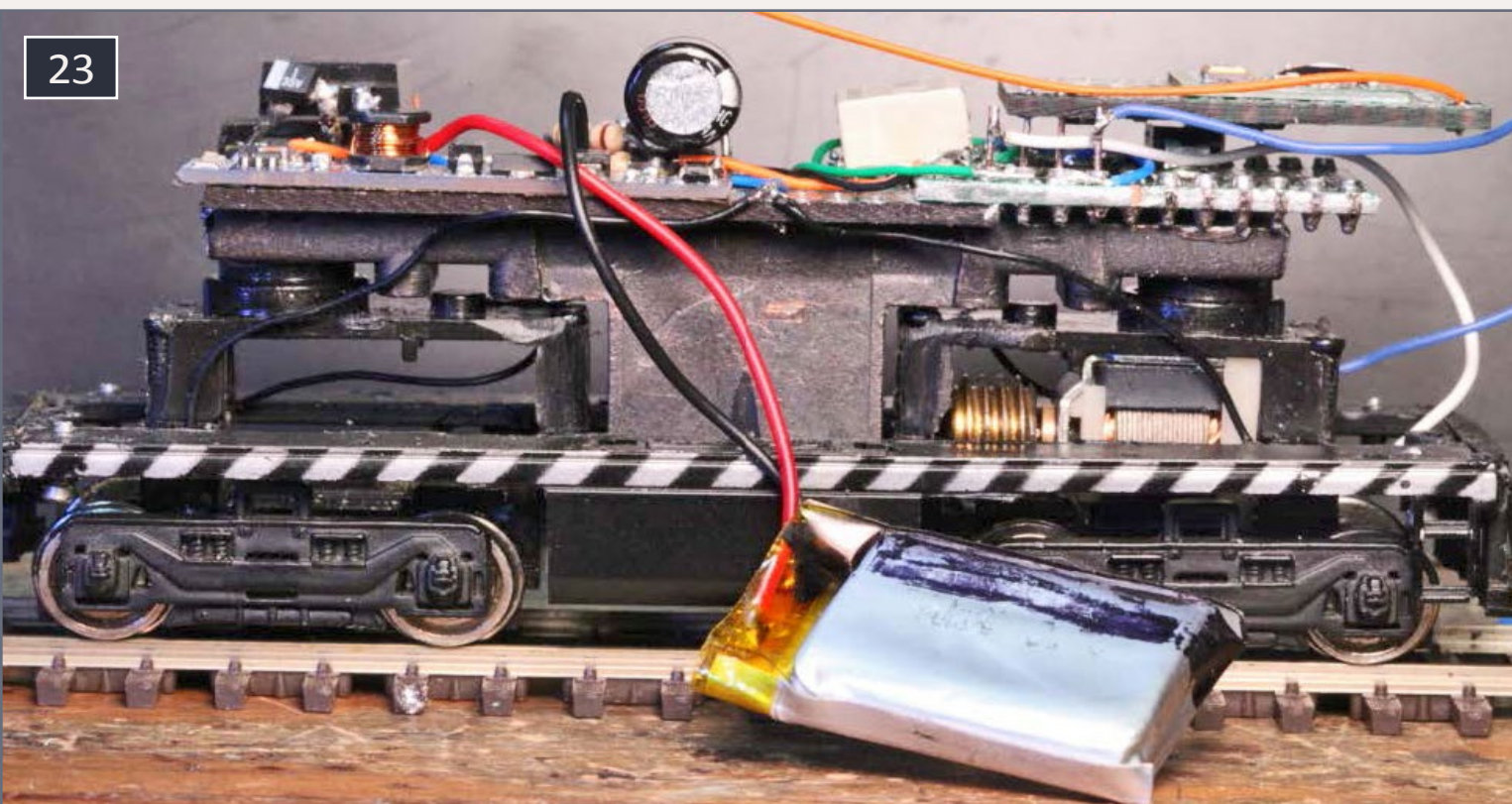



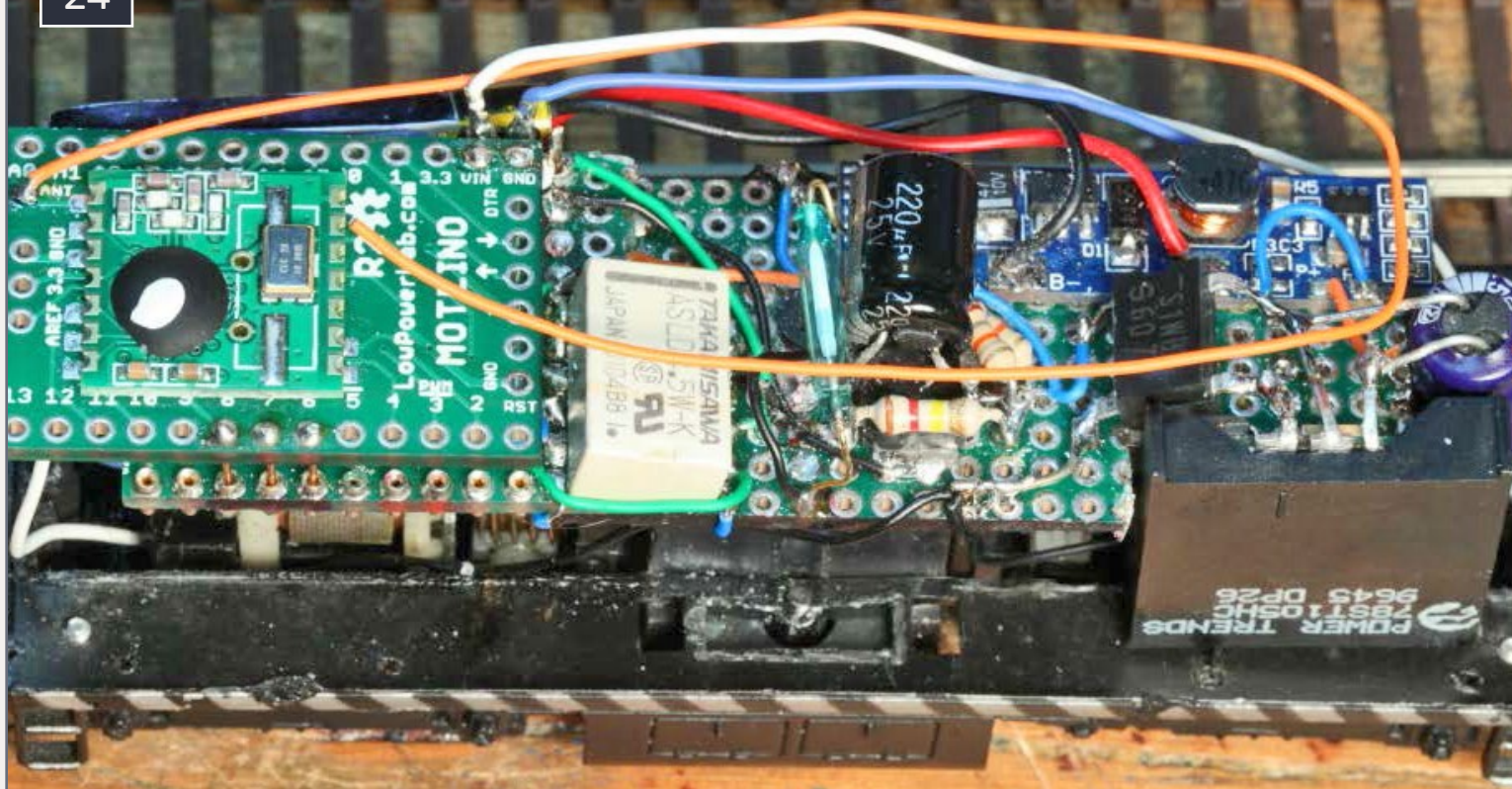

24. Loco1 with 78ST105HC regulator mounted.

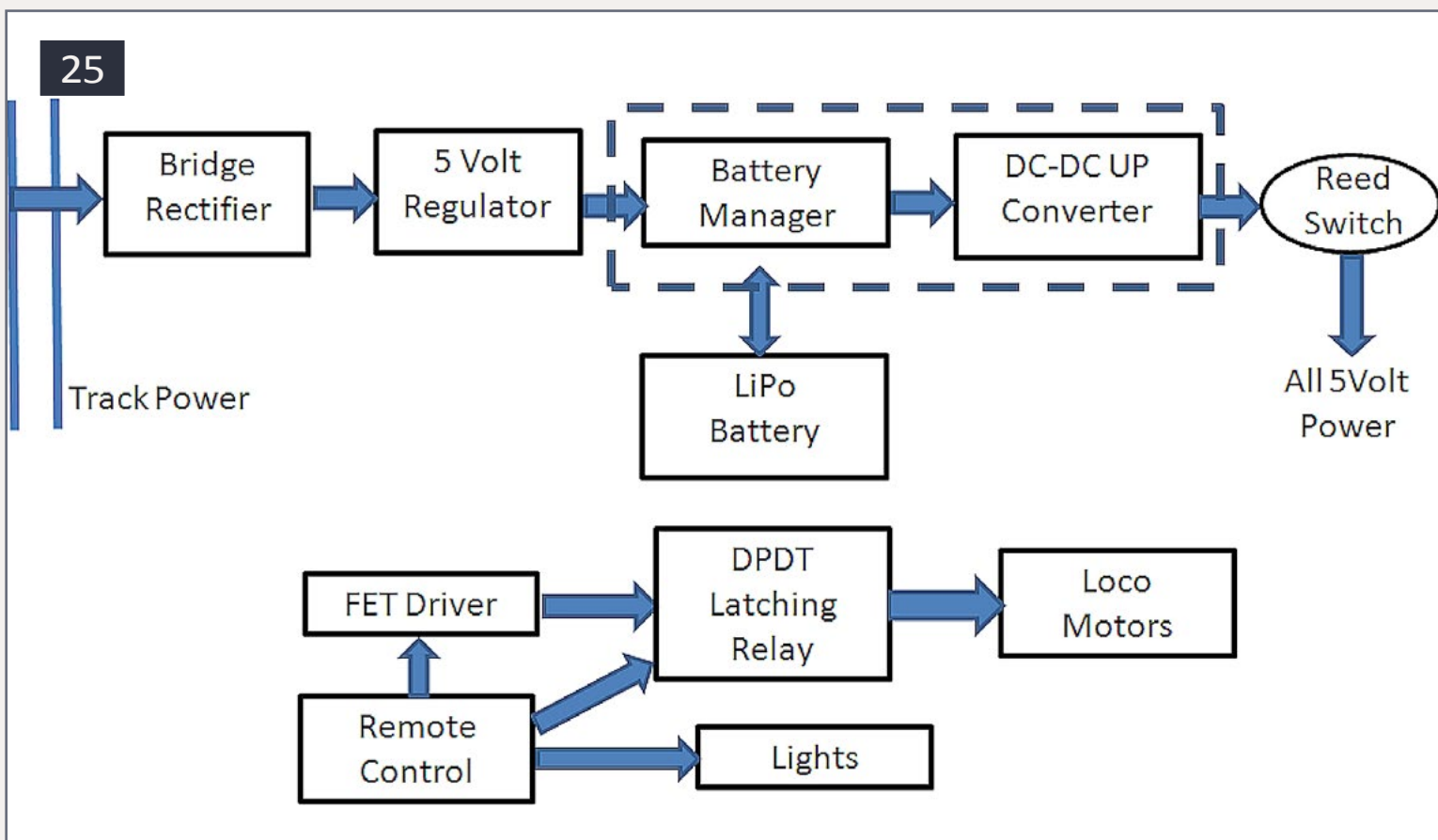

25. Locomotive battery power block diagram.

26

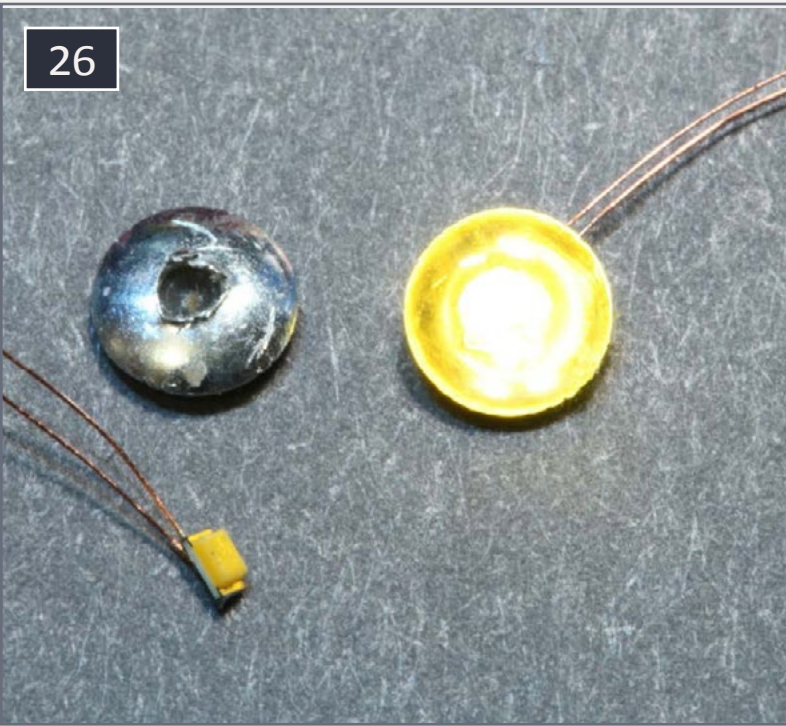

## 26. 0603 White LED & MV lens with rear hole.

Working headlights are built by gluing sunny-white 0603 LEDs onto the back of an MV Lens, with a 1/16" shallow hole barely drilled into its center rear [24]. I use the pre-wired LEDs available from LedBaron [stores.ebay.com/ledbaron](http://stores.ebay.com/ledbaron) quite

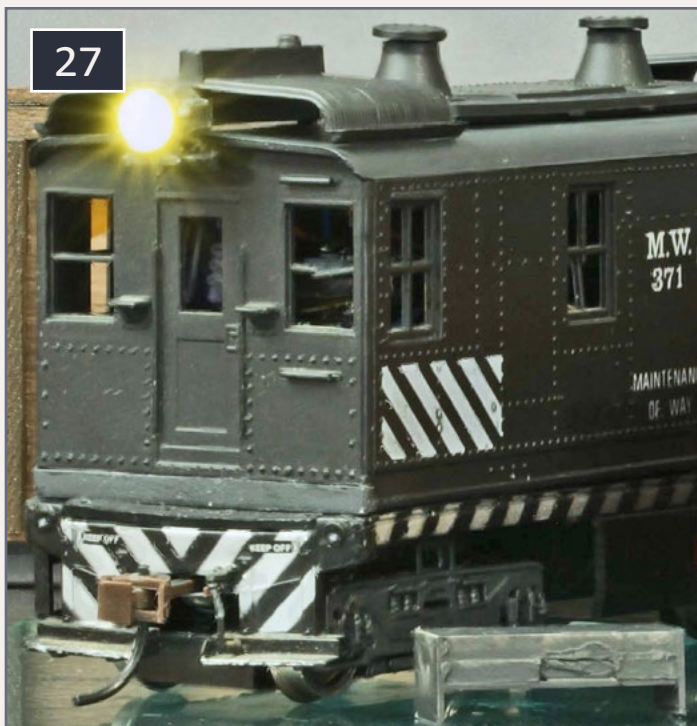

## 27. Loco with “magnet box.”

to the motor, similar to a DCC decoder’s speed control.

If left idle for many days the battery will drain down. The battery manager board will isolate the battery from further discharge to protect it. The DC-DC converter needs to be isolated from its load to reset its operation. So a magnetic reed switch is used to remove the load when not in use, and limit battery drain.

## Headlights

able from LedBaron [stores.ebay.com/ledbaron](http://stores.ebay.com/ledbaron) quite a bit. For older models, I like the effect it gives, with a white LED with a yellowish tint. I used to simply glue the LED in the back of the headlight housing, and cover the front with a clear styrene disk punched out with a paper hole punch. But I think the MV Lens combination is an improvement. Add some clear glue





least in part) independent of the rails. My own interest is not in enabling KAOS power for DCC, but in rail-mounted animation.

The solution for loco control is a relatively simple, low-cost (\$3.60) radio link to the loco, using an RFM12B transceiver module (transmitter/receiver). This is not traditional RC control, even though traditional RC control could be used here at greater cost, and using more space in the loco. This scheme is more like a 2-way serial data link via radio. The RFM12B is controlled with a small Arduino.

The combination of the RFM12B mounted on the back of a small Arduino, nearly in the form factor of an Arduino Pro-Mini, is available as a Moteino from Low Power Lab [lowpowerlab.com/moteino/](http://lowpowerlab.com/moteino/). This saves even more space, and comes with its own program sketch library including working examples. As I recommend quite often, I copied a basic example and edited it for use in a small, 9-volt battery-operated remote control. The example library will support 255 channel IDs, allowing many different locos to be independently addressed.

29



## 29. Remote controller.



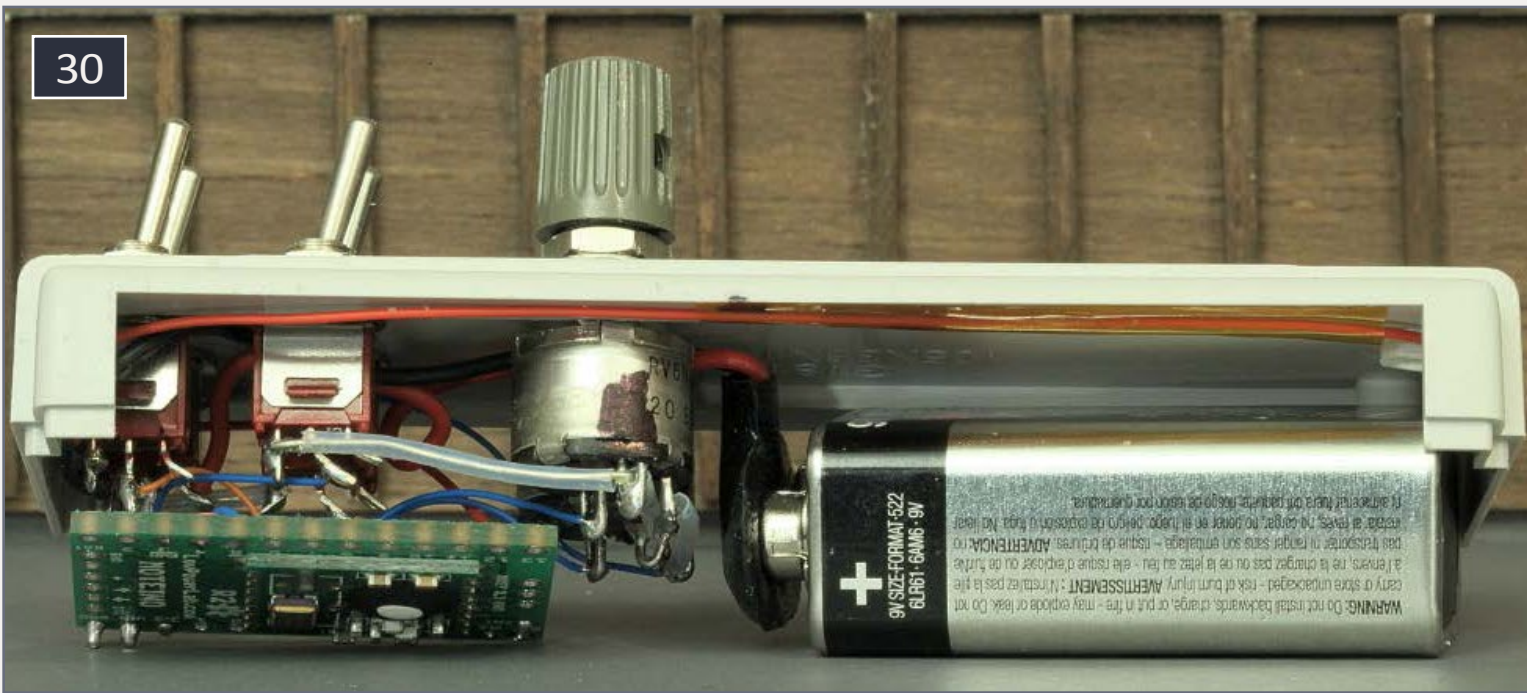

## 30. Remote controller internals.

The remote has more knobs and switches than you need for this model, but I am anticipating expanded use later. There is a power switch, a direction switch, a lights switch, and a speed knob. Lights are directional when turned on. Two Moteino boards are used, one in the loco and the other in the controller. RFM12B's can be operated at 434 MHz (universal), 868 MHz (EU), and 915 MHz (US, Australia, etc.). There are several versions now available. I used the R2 version. Both programs are included in the additional materials with this article. There is more information on the Low Power Lab website.

They are set up very much like the cheap Arduino Pro Minis I use. (See the sidebar following this story). Besides power and ground, there are five other connections to the Moteino, and two are for the lights! The controller Moteino just connects to the switches and knobs. This version is very basic. The enterprising individual could add momentum effects, sound, classification lights, and more. This is enough for a start.



## A more powerful locomotive

The 5-volt power set-up works quite well but if you really want to power stubborn 12-volt motors, one might want a bit more oomph! This next loco separates the DC to DC converter from the battery manager and allows for converting the varying (3-4.2 volt) battery voltage to anywhere from 6 to 14 volts [tinyurl.com/lhvay2w](http://tinyurl.com/lhvay2w). I adjusted mine to run at 10 volts. I thought it was a good tradeoff for higher motor power and reasonable battery drain. The converter will put out voltages up to 35 volts but you may destroy the electronics and motors! So please make adjustments before you connect it in your model loco! You'll need a voltmeter to make the adjustment. Pay close attention to all pins and connections.

This design uses a different battery manager board as well, the inexpensive protection circuit module at [tinyurl.com/n9mrl75](http://tinyurl.com/n9mrl75), and is wired into the circuit differently. Battery manager/protection boards must always be connected to the battery. In this circuit, the reed switch disconnects the load and the track power (lowered to 4.4 volts) to the battery manager. This

31

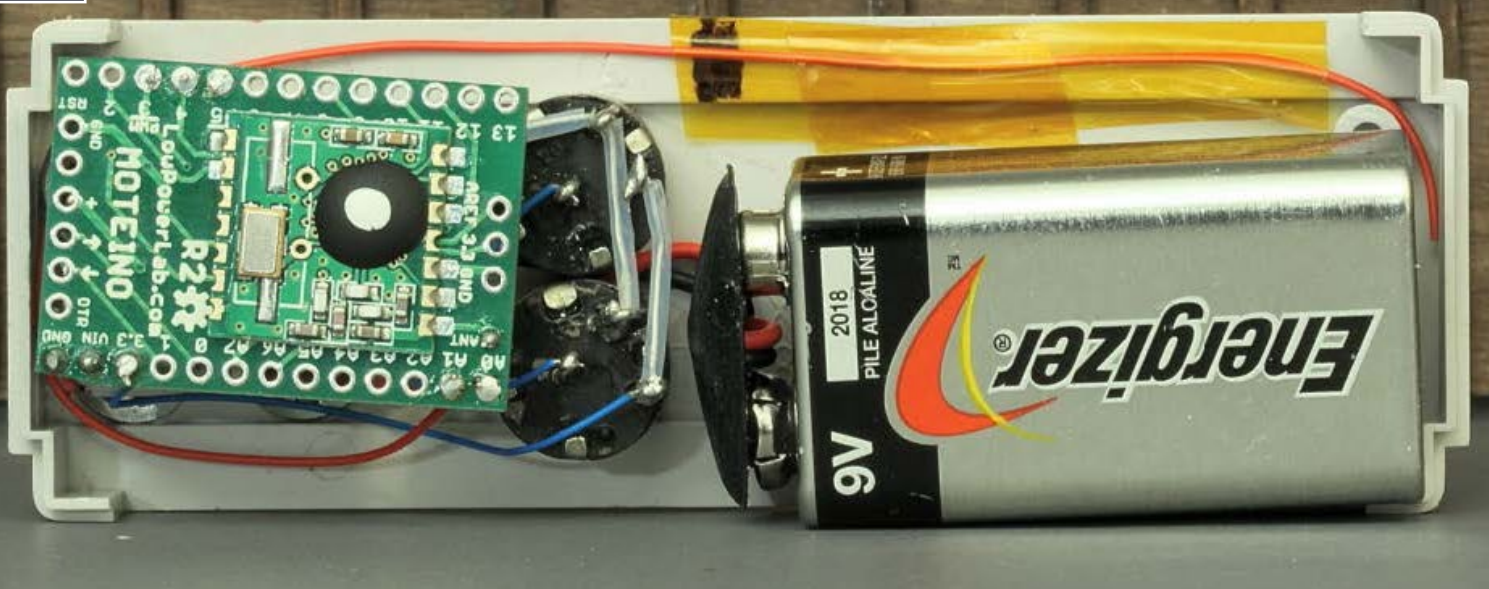

31. Another view of the remote controller internals.



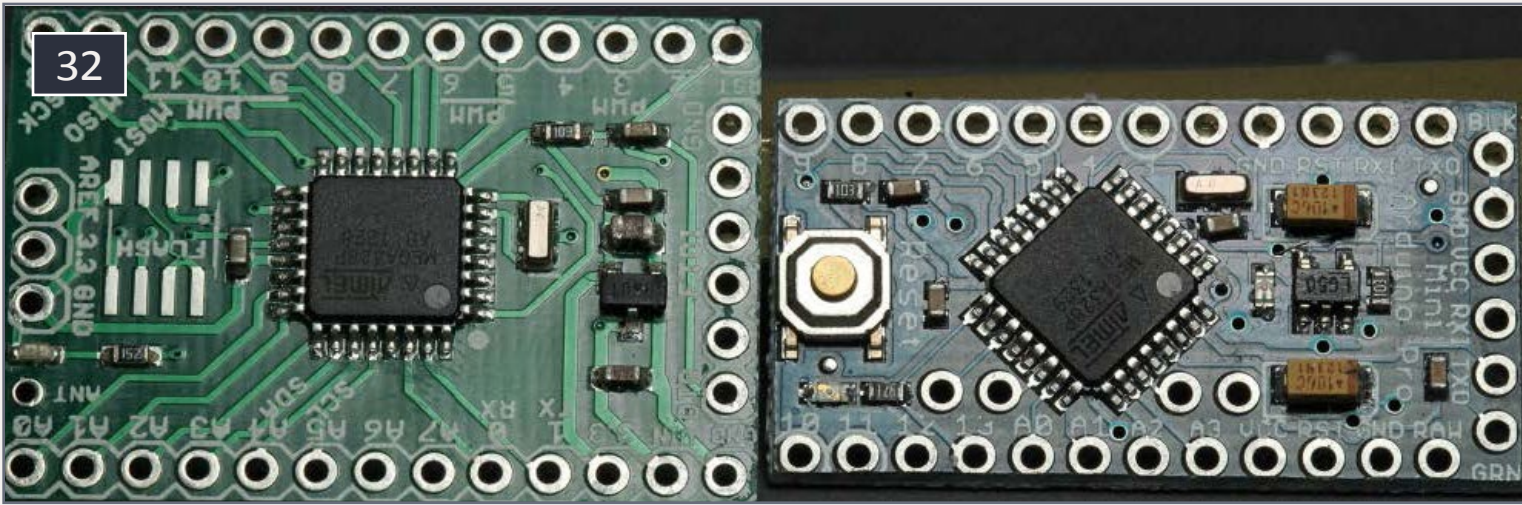

## 32. Controller comparison: Moteino (left) & ProMini.

allows the battery to hold its charge longer when not in use. The battery is charged in this design only when the reed switch is on (i.e. no magnet present).

You will get noticeably more power delivered to the motors, but battery drain will occur more rapidly. Because the DC-DC converter accepts a wide range for input, and regulates the output, the voltage delivered will remain relatively constant whether powered from the rails, or from the battery directly throughout its 3-4.2-volt range. It's quite something to see the locomotive go over dirty track, switch frogs, and uneven rails without missing a beat. Take a look at all the models in operation:

Even though this version provides more power, I am not happy with it. The battery manager used here allows a very high charging current, only limited by the 5-volt switching regulator's current limit. Fast recharging in these models is not necessary. As such, this still performs within the limits of the LiPo battery specification. A better design would have used a special charging circuit specifically for LiPo batteries, rather than the 4.4-volt circuit. Moreover, to my thinking, the slow speed of the locomotive at 5 volts is a benefit, not a weakness. In my own modeling, I have more confidence in the previous design, and will prefer its use.



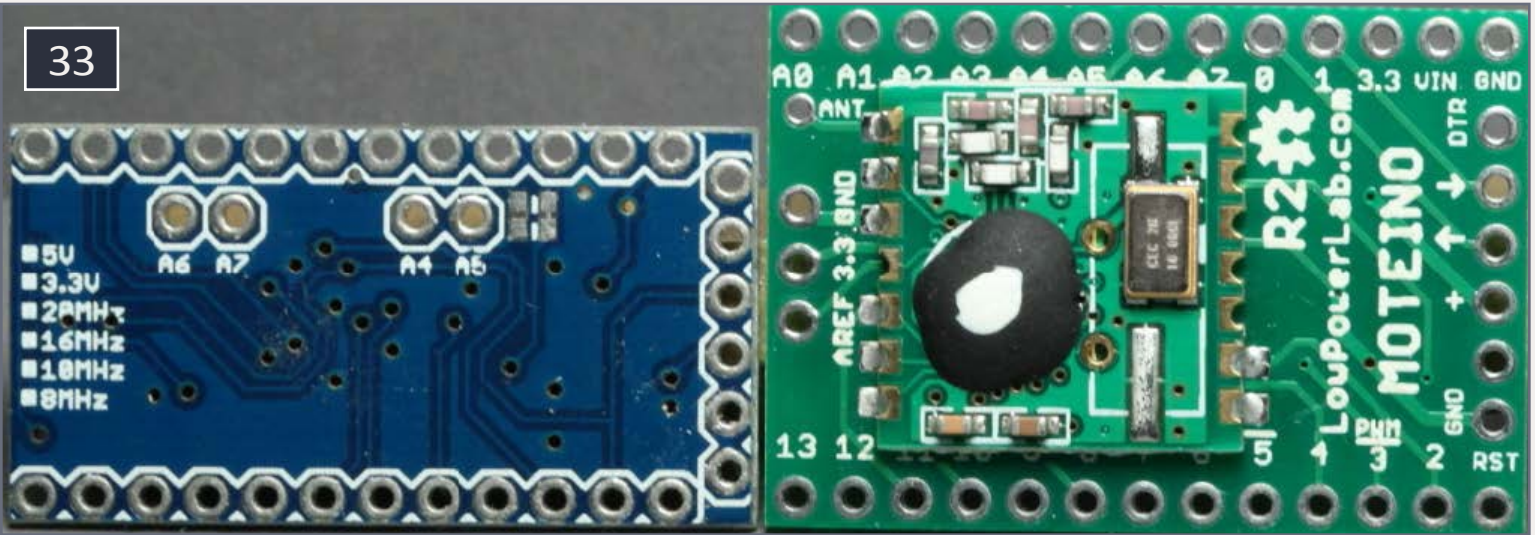

### 33. Bottom comparison: Moteino (right) & ProMini.

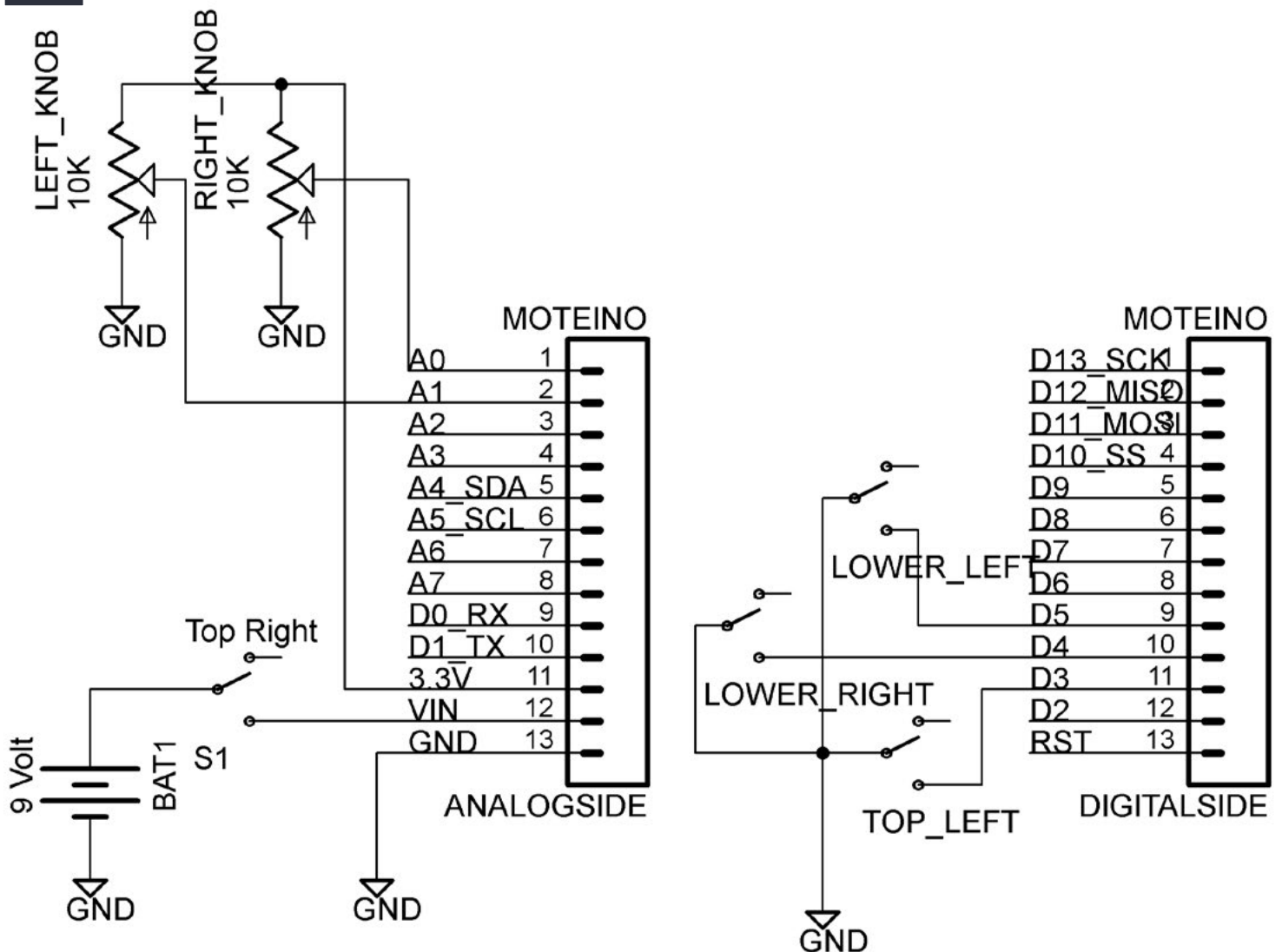

### 34. Loco controller schematic.



35

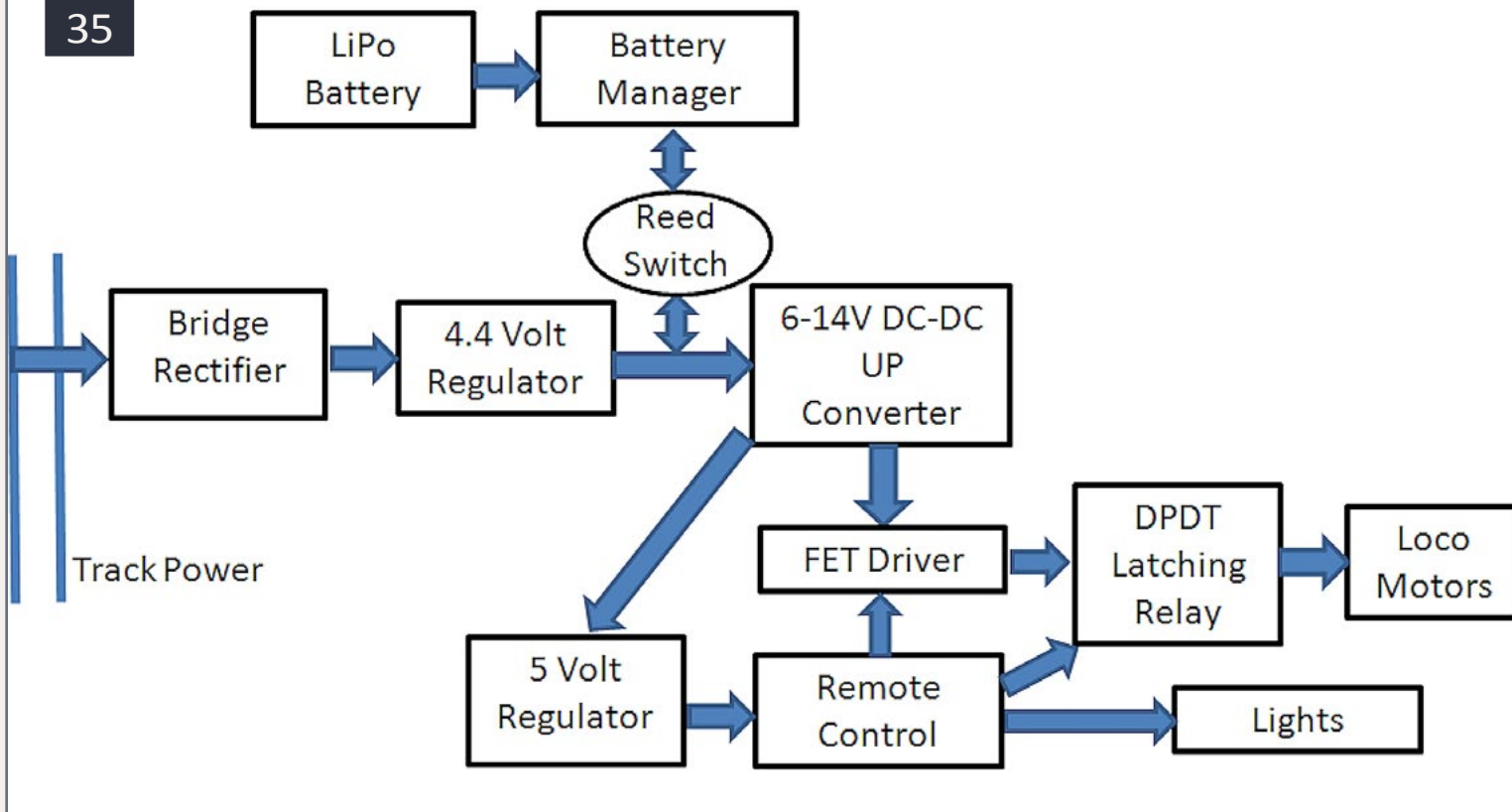

35. Locomotive higher power block diagram.

36

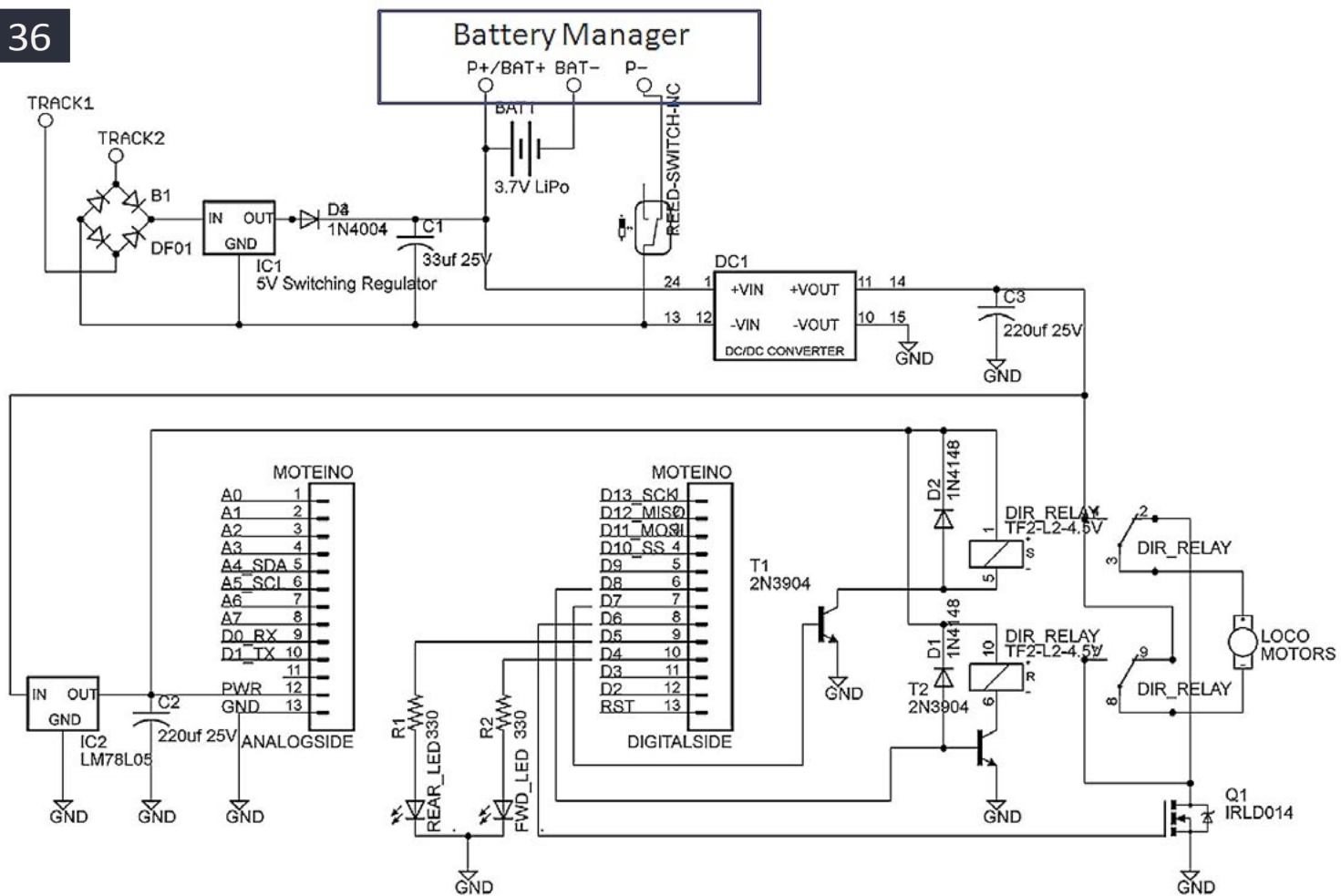

36. Locomotive higher power schematic.



contents



index

37



**37. Battery manager (on left) and DC-DC converter.**

38

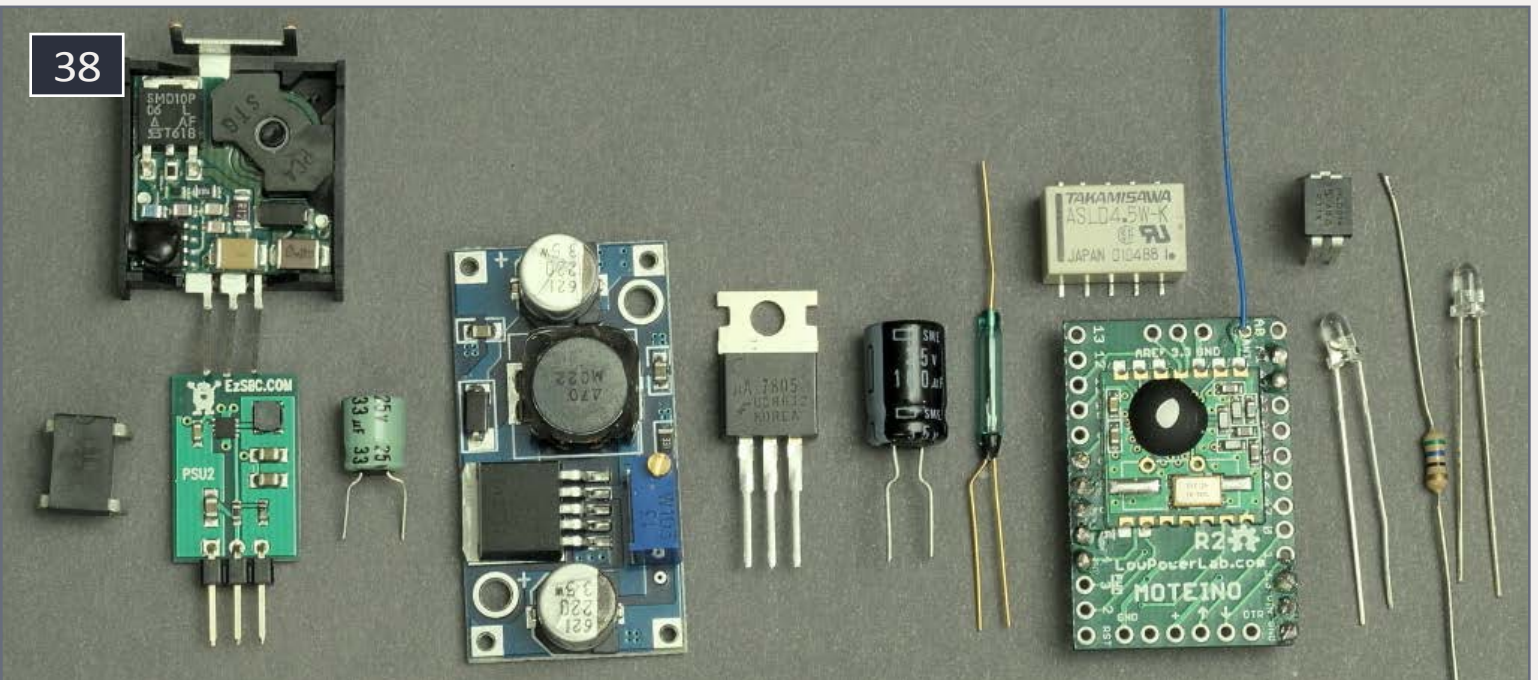

**38. From left, bridge rectifiers, 5-volt switching regulators, capacitor, DC-DC up converter, 7805 5-volt regulator, capacitor, reed switch, latching relay (top), Moteino (bottom), FET transistor (top), LEDs and resistor.**

As I mentioned before, this project was built to lay the groundwork for later animation-on-rails projects. I was somewhat surprised just how well these worked, using off-the-shelf parts and LiPo batteries with relatively simple controls at low cost.



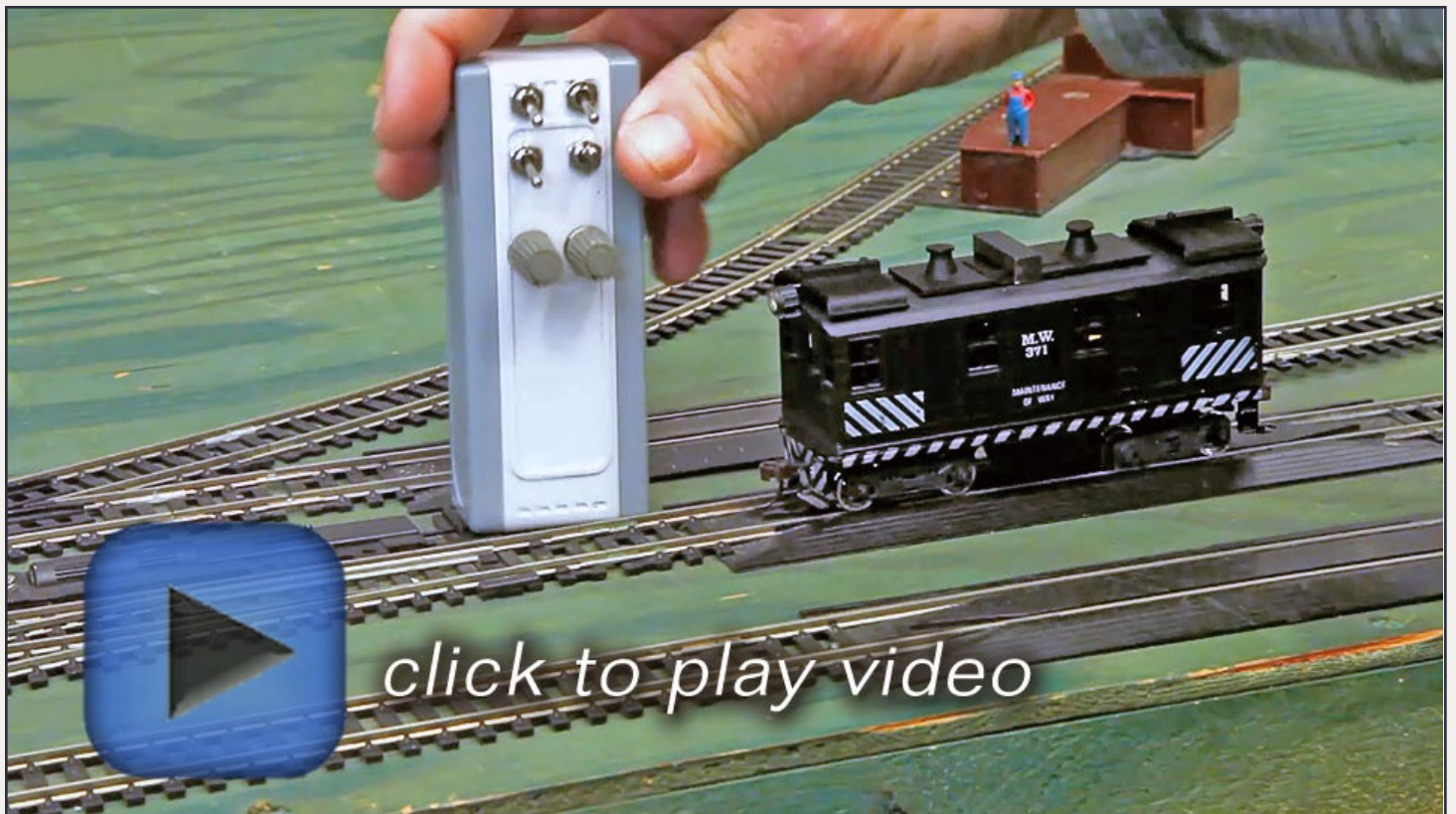

**Playback problems?** [Click to try a different version.](#)

These efforts were made to establish the viability of running motive power at reduced voltages with small, on-board batteries. The same power is used to provide remote control for these models.

In the future, I hope to use the same platform to power roving inspection engines which mix with normal operator-controlled rail traffic. A small sound module would not be too hard to add, and I might try that first. I hope this provides you with some ideas and encouragement to try new ways to power and control your layout too!



contents



index



39

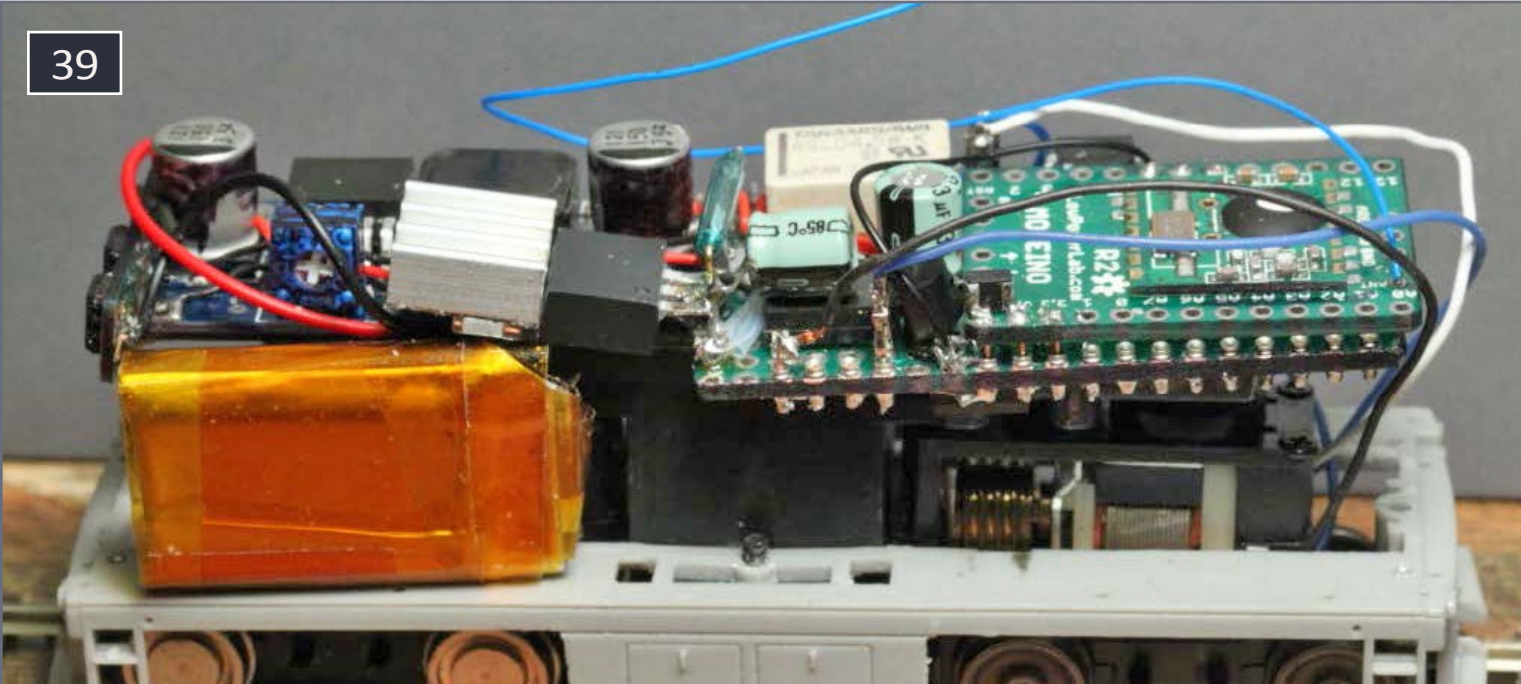

39. High power version.

40

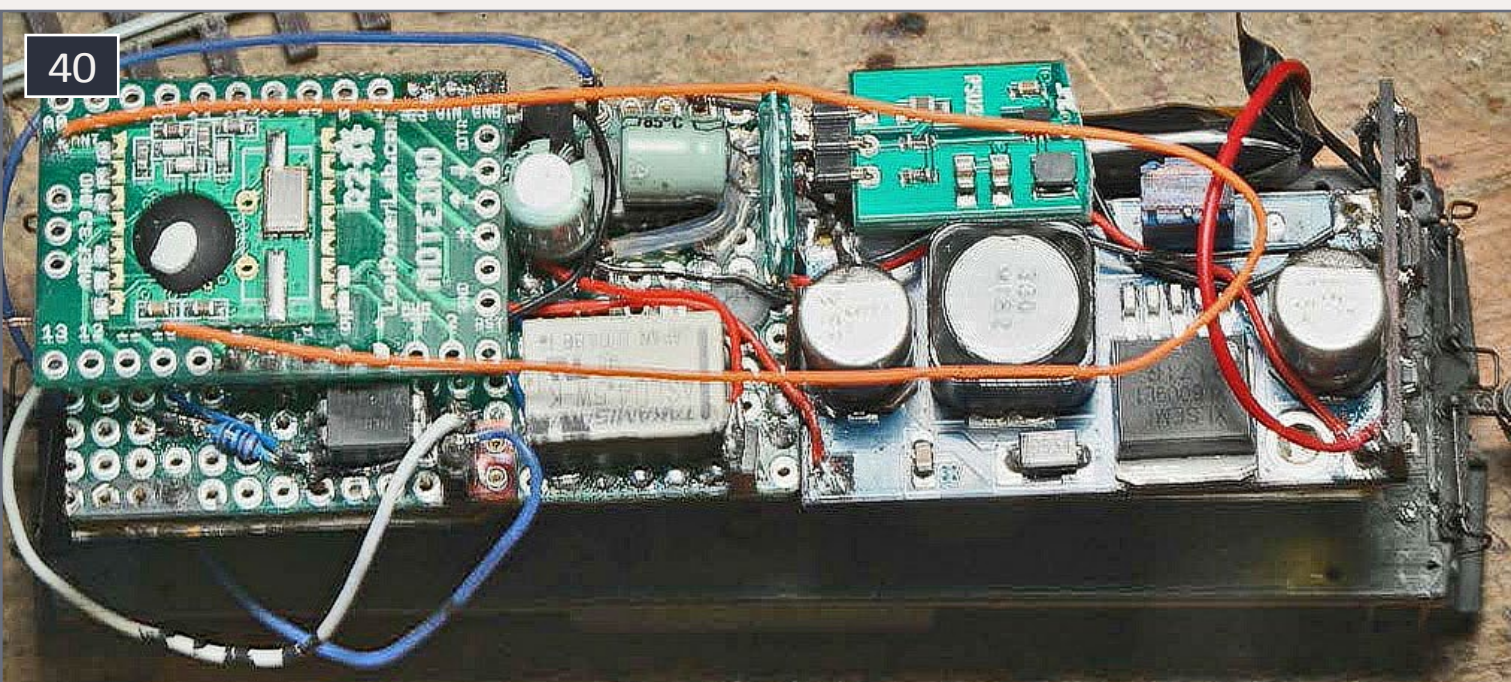

40. High power version with switching regulator.

 **Reader Feedback**  
(click here) 





Geoff Bunza started as a model railroader when he received a Mantua train set for Christmas, at age 6. Interest in the New York Central was cemented when riding on a NYC fan trip to Harmon in November, 1966 behind S-Motor 110. He fed his interests through college, becoming a member of the Tech Model Railroad Club (TMRC) at MIT while getting his doctorate and three other degrees in electrical engineering.

Geoff has lectured on various aspects of electronic system design in over 15 countries around the world. He is blessed with his wife, Lin, in marriage for 33 years, and their two terrific sons. He is a member of the New York Central System Historical Society.

### Advertisement



**NEW YORK CENTRAL SYSTEM**  
HISTORICAL SOCIETY, INC.



NYCSHS President Rich Stoving's Layout (Photo by NYCSHS member John Heilmann)

**The NYC is a great Railroad to model...**

**Join Today !**

Regular Memberships are only \$39.00 a year!



As a member of the New York Central System Historical Society, you will receive the Central Headlight, our quarterly, popularly acclaimed magazine, and can chat with other NYC modelers and fans on our NYCSHS members-only Yahoo Group. You will also be able to purchase NYCS locos and rolling stock at great discounts. You will benefit from the first-hand knowledge of former NYCS employees and from the expertise of NYC historians, researchers, modelers and writers who will help you with answers to questions about NYCS history, locos, rolling stock, structures, and operating practices. Do it right! Join today!

**NEW YORK CENTRAL SYSTEM**  
**HISTORICAL SOCIETY, INC.**

DEPT GMR15 • P.O. BOX 130 • GATES MILLS, OH 44040-0130

Visit our website and  
join today  
<http://www.nycshs.org/>



contents



index

# Starting from Scratch with an Arduino Pro Mini (or Moteino)

Many projects can use an Arduino Pro Mini Board US\$2.59 each with free shipping off eBay. See: [tinyurl.com/oamynj5](http://tinyurl.com/oamynj5). Add a USB-to-TTL cable to set up the programs on the little board, now US\$7.24 off eBay see: [tinyurl.com/lydcv99](http://tinyurl.com/lydcv99).

While you are waiting to get these download the Arduino IDE (Integrated Development Environment) free software off the net from: [arduino.cc/en/Main/Software](http://arduino.cc/en/Main/Software) or [arduino.googlecode.com/files/arduino-1.0.5-windows.zip](http://arduino.googlecode.com/files/arduino-1.0.5-windows.zip) (for Windows specifically) which has an editor, a library, and examples for you to use.

Note this IDE will run on Windows, MACs, and Linux machines, so pick the right one for your computer. When you unzip the package, write down the full path name to the folder, like: C:\arduino-1.0.5 or wherever you put it. This will be important later.

Now take a glance at the Getting Started info: [arduino.cc/en/Guide/HomePage](http://arduino.cc/en/Guide/HomePage) and the info at [arduino.cc/en/Guide/ArduinoProMini](http://arduino.cc/en/Guide/ArduinoProMini). Just a quick read to give you some context. I had people get lost at this point, so I'll step you through the rest.

The accelerated learners among you can also glean more info from: [arduino.cc/en/Tutorial/HomePage](http://arduino.cc/en/Tutorial/HomePage). There are a lot of topics there:

[instructables.com/files/orig/F3J/MTJN/FVW22MXN/F3JMTJNFVW22MXN.pdf](http://instructables.com/files/orig/F3J/MTJN/FVW22MXN/F3JMTJNFVW22MXN.pdf) or

[richardvannoy.info/arduino.php](http://richardvannoy.info/arduino.php) or <http://arduino-info.wikispaces.com/TUTORIALS>.

These offer info at different learning levels so pick one you are comfortable with.



The Moteino used in the accompanying article is a repackaged Arduino combined with the RFM12B radio module. You can find additional information here: [lowpowerlab.com/moteino](http://lowpowerlab.com/moteino) and here [w5vwp.com/moteino.shtml](http://w5vwp.com/moteino.shtml).

You can follow the steps below to use either a Pro Mini or a Moteino.

Now you should have at least one Pro Mini Board, a cable, and the IDE software loaded.

If you ordered the Pro Mini I referenced before, it came with a set of header pins. Cut off a six-pin group and solder it into the six holes on the end of the Pro Mini Board. Either side will do, I prefer the header to stick out the component side with the button on it.

In some model settings you may prefer not to solder the header on at all. I'll show you later how to deal with this. Notice that ends of the six holes are either labeled BLK and GRN, or GND and DTR.

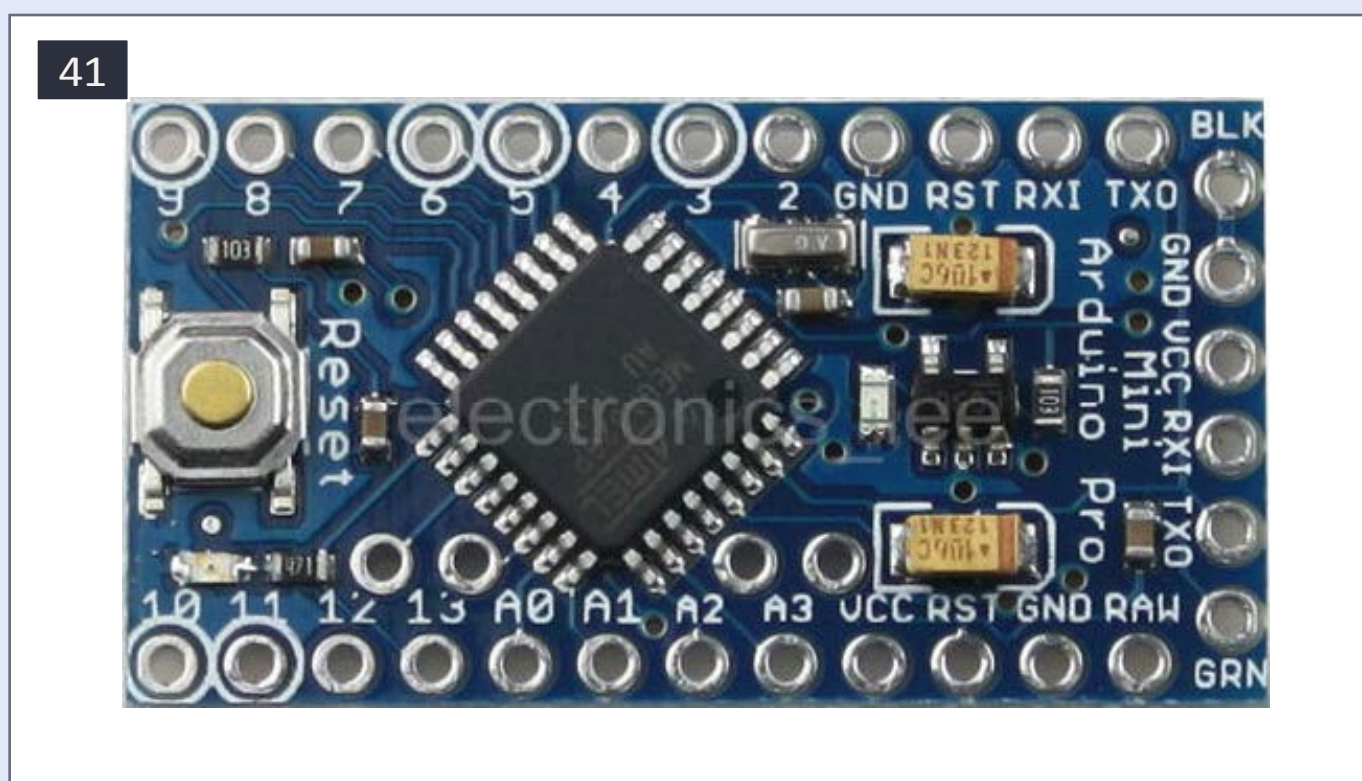

## 41. Arduino Pro Mini.



contents



index

# Starting from Scratch with an Arduino Pro Mini (or Moteino) Continued ...

The black wire on the six-pin USB to TTL Serial cable will connect to the BLK/GND pin, and the other end of the cable connector will connect to the GRN/DTR pin. (If you didn't want to solder the 6 pin header to your board for some reason, insert the long end of the header pins into the 6 pin cable connector.

When you are ready to load a program onto the board, insert the connector with pins into the top of the board, observing the proper orientation I described above, and hold placing side pressure during the programming download.) Plug the USB side of the cable into your computer.

In all likelihood Windows will need to load a driver. For Windows XP, here: [arduino.cc/en/Guide/UnoDriversWindowsXP](http://arduino.cc/en/Guide/UnoDriversWindowsXP) is a good detailed, step-by-step. The drivers you want to install are in the Arduino folder (from my example above) C:\arduino-1.0.5\drivers\ You might also benefit from reading [arduino.cc/en/Guide/Windows](http://arduino.cc/en/Guide/Windows)



## 42. USB to Serial TTL Programming Cable.

For other operating Systems go to [arduino.cc/en/Guide/HomePage](http://arduino.cc/en/Guide/HomePage) and poke around there.

Remember the serial port number for the serial cable installation. Now start up the Arduino IDE software you loaded, and you should get a window like [43]: (All my examples will be MS Windows based.)



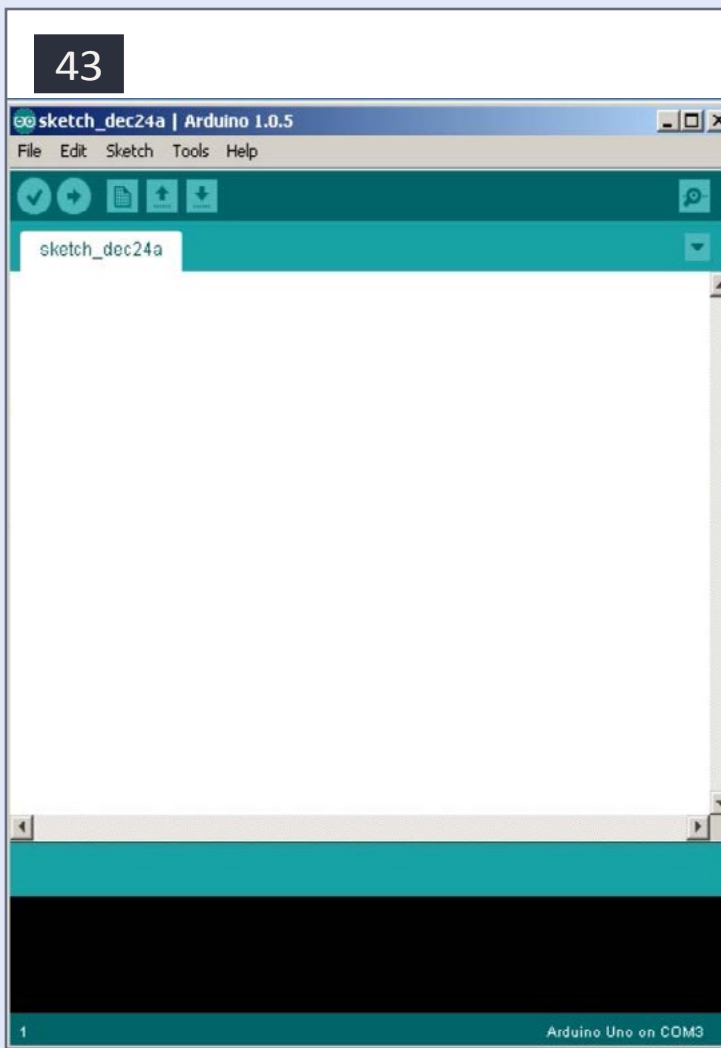

### 43. Start-up window.

43. This is the window for the Arduino Editor, where you can recall programs from libraries or create your own.

Go to the top menu bar, mouse click on Tools, then Board, then Arduino Pro Mini (5V, 16MHz) w/ Atmega328. This will place a black dot next to your selection, and corresponds to the Pro Mini Board I referenced before.

Note that there are many variations of Arduinos. They all can run the same examples we will use. The Arduino Pro Mini is small, low power, cheap, fast, and comes with a large program memory. If you are setting up for a Moteino, then select Arduino Uno instead of the Pro Mini selection above.

Now go back to the top menu bar, mouse click on Tools, then Serial Port. Select the Serial Port corresponding to the USB cable you set up before. All that we've done so far only needs to be done *once*.

OK, now we are ready to do something with the Pro Mini. In the open window of the Arduino IDE, click on File, then Examples, then 01 Basics, then Blink:

And the window [46] should open.



contents



index

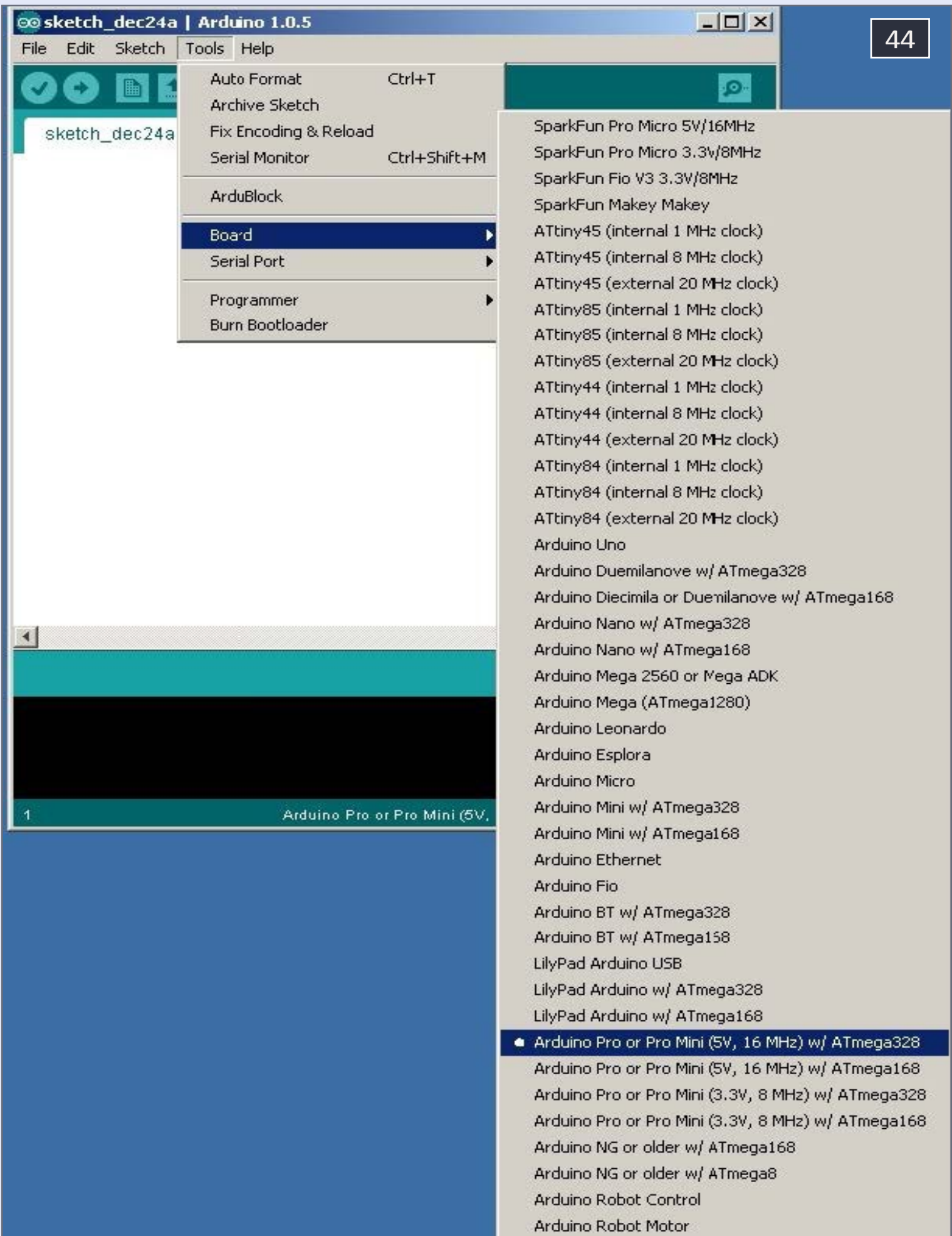

## 44. Tools menu and board selection.



# Starting from Scratch with an Arduino Pro Mini (or Moteino) *Continued ...*

This is the editor screen in which you can load, edit, save, and download your programs, called sketches, for the Arduino. The program shown is from the list of examples which are great starting points for you to learn just how much you can do. With NO modification, making sure your Pro Mini Board is connected and selected properly, click on the circled right arrow button below the edit menu pick, to the right of the circled checkmark. These two screens should appear in succession:

You will also see the LEDs on the Pro Mini Board blinking along. After a short time, a LED connected to Digital Pin13 will blink one second on, one second off. You have now successfully set up your Pro Mini Board! To prove a point, go back to your computer, and in the IDE window with the Blink program, highlight and change both of the `delay(1000)`, lines to `delay(90)`, need space, “and” that is change the 1000 to 90. Hit the right arrow to download the now-modified program and watch the change. Now the blink rate is 90 milliseconds (0.09 seconds) on and off. This is how simple it is to change the behavior of the Pro Mini.

## Back to model railroading

While blinking a LED was instructive it is not particularly useful. So here are some small projects that might be of interest to modelers:

We do Windows!

One of the neatest animations I use is relatively simple to set up with a Pro Mini. This was built as an example for my animation clinics. This sketch (program) randomly turns on 16 LEDs



contents



index

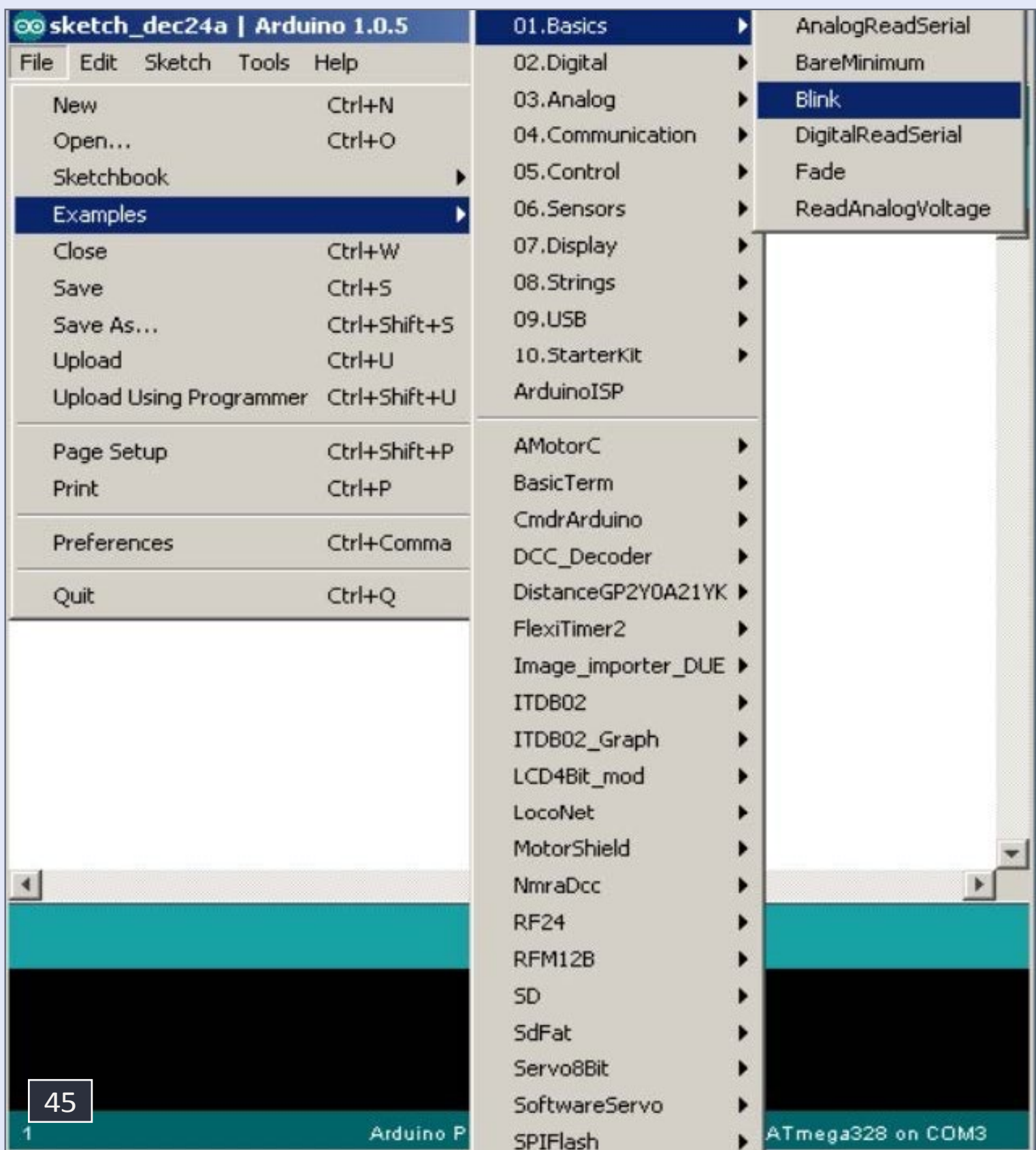

## 45. Examples window.

used for room lights in my model structures. It can turn background buildings from lifeless shadows into hives of activity.

Here is the sketch:



```

#define numleds

16 byte ledpins [ ] =
{ 0,2,3,4,5,6,7,8,9,10,11,12,13,14,15,16,17 } ;

void setup( ) {

for ( int i=1; i <= numleds; i++ ) {
    pinMode ( ledpins [ i ], OUTPUT) ;
    digitalWrite ( ledpins [ i ] , HIGH) ;
}

void loop ( ) {
    digitalWrite ( ledpins [ random ( 0, numleds+1 ) ], lightsw ( ) ) ;
    delay ( 900 ) ;
}

boolean lightsw ( ) {
    if ( random (0,100) > 40 ) return LOW ;
    else return HIGH ;
}

```

Copy, paste , and save it as a text file, but name it with a “.ino” suffix like “building.ino”

Then open the file with the Arduino IDE and load it into your Pro Mini. You can also copy and paste the text directly into the Arduino editor window. (See this issue’s subscriber downloads for the code.)

Now let’s set up the Pro Mini Board. Since this will be part of a freestanding model, we need to power the board independently. A cheap and easy alternative is a “wall wart” 5 Volt DC power adapter commonly available. I cut off the connector at the end. Strip the two wires exposing the bare wires, not allowing them to touch.



contents



index

```
/*
Blink
Turns on an LED on for one second, then off for one second, repeatedly.

This example code is in the public domain.
*/

// Pin 13 has an LED connected on most Arduino boards.
// give it a name:
int led = 13;

// the setup routine runs once when you press reset:
void setup() {
  // initialize the digital pin as an output.
  pinMode(led, OUTPUT);
}

// the loop routine runs over and over again forever:
void loop() {
  digitalWrite(led, HIGH); // turn the LED on (HIGH is the voltage level)
  delay(1000);             // wait for a second
  digitalWrite(led, LOW); // turn the LED off by making the voltage LOW
  delay(1000);             // wait for a second
}
```

## 46. Simple LED blinking program

Connect a LED in series with a 1000 to 3000 ohm resistor. Typically the longer length LED wire is the positive side. Touch the resistor/LED combination to the exposed power adapter wires.

When the LED lights, you know which of the wires is positive and which is negative. Connect the Negative wire to GND on the pro Mini and the Positive wire to the hole on the Pro Mini marked VCC. Note this works for the Pro Mini mentioned before. There are other variations for which this will NOT work. Only use a 5 volt



DC adapter here, rated 400 milliamps or more. Place your LEDs in building rooms or where ever you want them, connecting all LED anodes (Plus or positive sides) together and to the positive side of your power source, in my case the 5 volt wall wart.

For each LED connect a 1/8-1/4 watt resistor of somewhere between 330 and 2000 ohms depending on your LED and the LED brightness you desire (experiment a little here) to the LED cathode (Negative side). The other side of the resistor connects to one of the Arduino pins labeled 2-13 and A0-A3 on the Pro Mini Board. These are referred to as Arduino Digital Pins 2-17.

The assembly pictured below is my demo of this very project. The LEDs will come on randomly, and, on the average, stay on for 60% of the time. On the next page is a video demoing the final result.

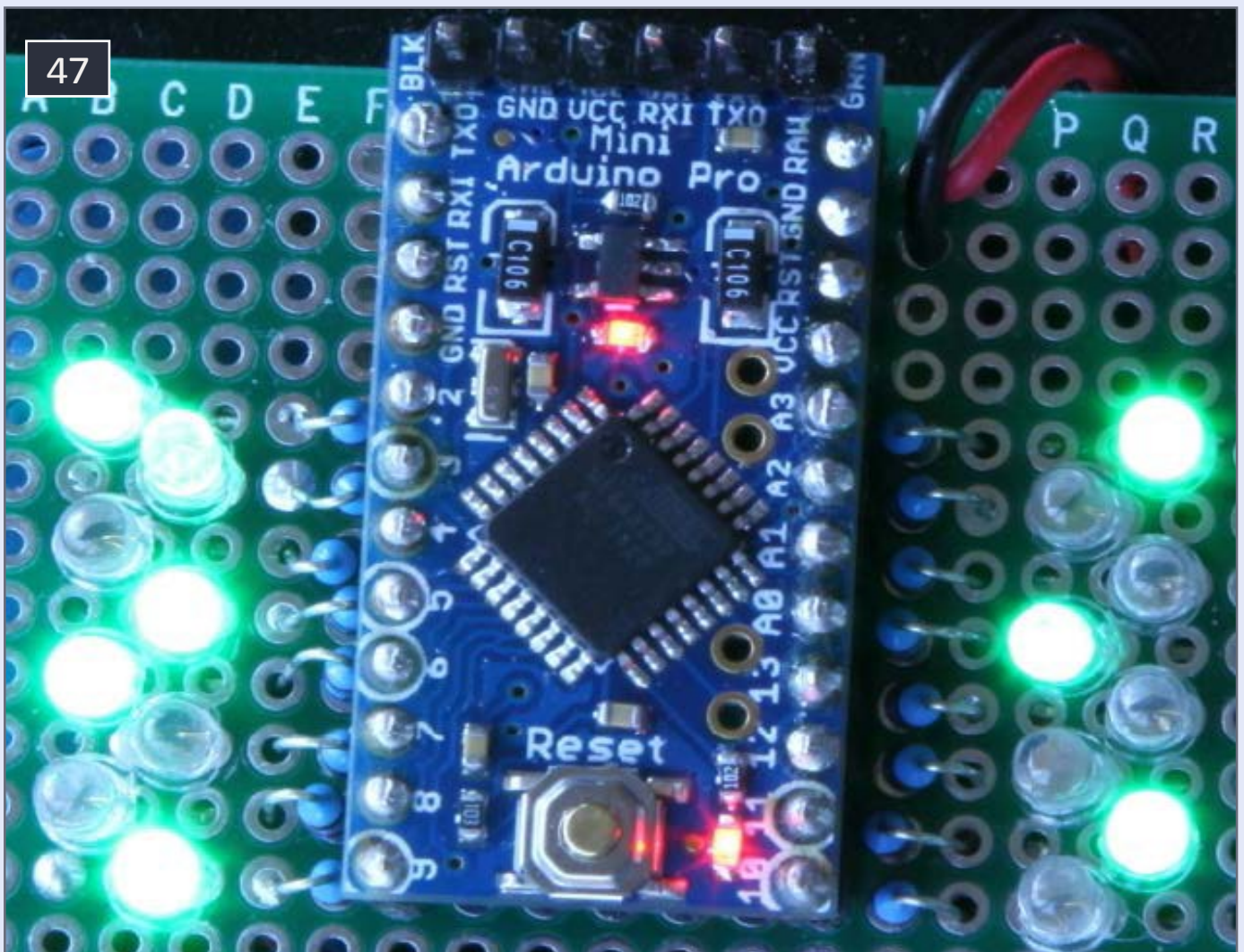

**47. Building lighting demo board.**



contents



index



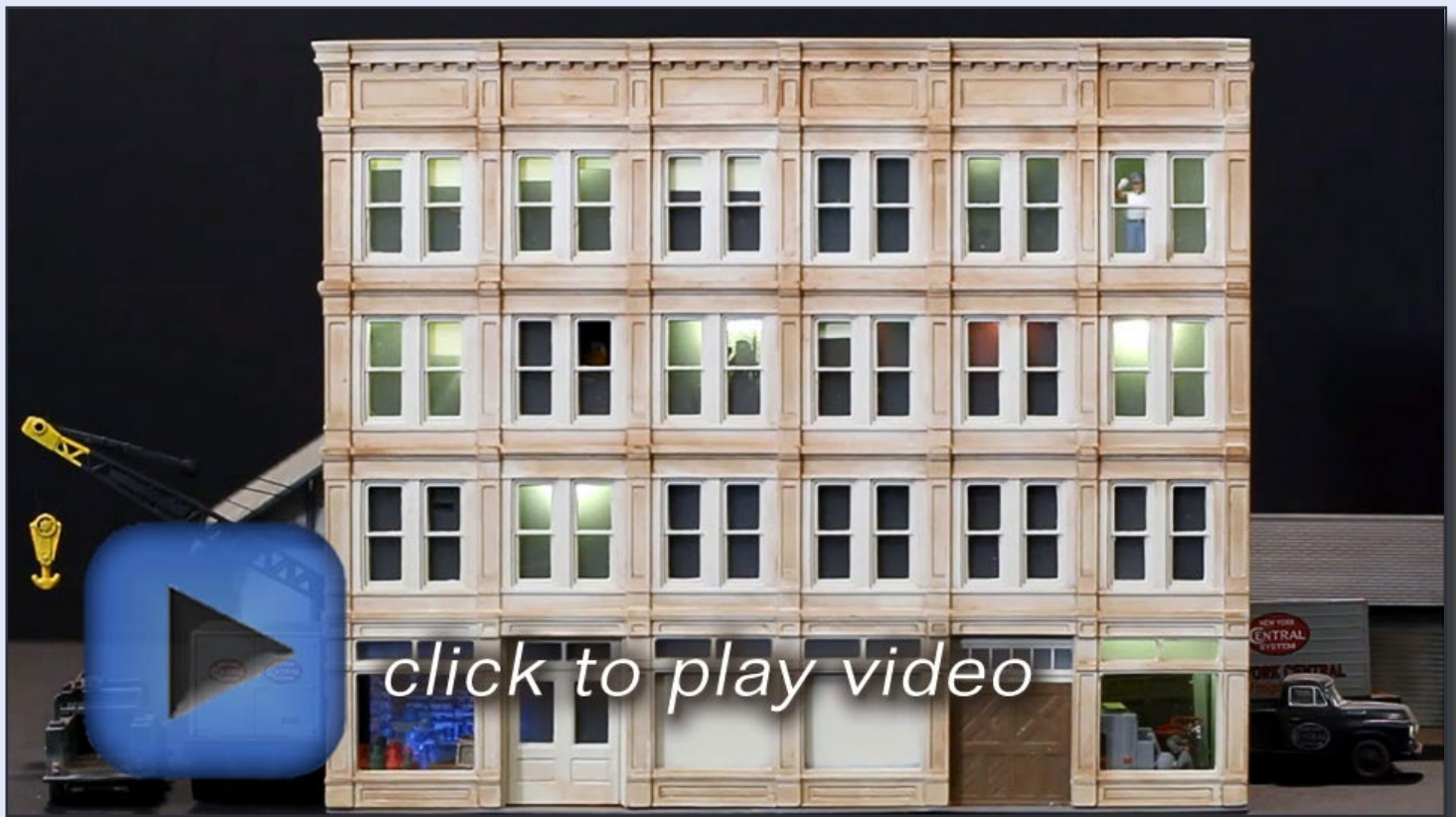

Playback problems? [Click to try a different version.](#)



Advertisement

**ONE STOP SHOP**

**N, HO, O, ON30, S & G**

**SHOP ON-LINE 24/7**

**FOR YOUR FAVORITE PRODUCTS:**

ATHEARN | ATLAS | ARISTO-CRAFT | BACHMANN | BROADWAY LTD.

DIGITRAX | KADEE | KATO | K-LINE | LIFE-LIKE | LGB

LIONEL | MANTUA | MICROTRAINS | MODEL POWER | MRC

MTH | NCE | PECO | PIKO | SOUND TRAXX | TCS

WALTHERS | WILLIAMS | WOODLAND SCENICS | AND MORE...

**SIGN-UP FOR OUR E-MAIL SALES**

**TRAINWORLD.COM**

**1-800-541-7010 e-mail: [ORDERS@TRAINWORLD.COM](mailto:ORDERS@TRAINWORLD.COM)**

**TRAINWORLD®/TRAINLAND® - AMERICA'S LARGEST INTERNATIONAL MAIL ORDER DISCOUNT TRAIN STORE**

MRH-Nov 2014







It's the Season of Giving  
...Gifts from

*Litchfield*  
  
S T A T I O N

623-298-7355 • [www.Mr-DCC.com](http://www.Mr-DCC.com)  
[www.LitchfieldStation.com](http://www.LitchfieldStation.com)



# Build a **Pan Am Railways SD45R Part 2**



Building a contest quality model ...

– by **Andrew Castle**  
Photos by author



**Reader  
Feedback**  
(click here)







**N**ow that the shell is complete we can move onto the frame. I first removed the circuit board and light bulbs, if you plan to leave the model DC with 1.5 Volt bulbs, you may want to keep the board. However, if you plan to convert the model to DCC or use LEDs, you can throw the circuit board and light bulbs in the garbage. On my models I prefer to use LEDs and a hard-wired DCC decoder, so that is what you will see here.



contents



index

Remove the weight, trucks, motor, and fuel tank. The weight is held on by four small screws. The trucks are held on by the worm gear covers. The fuel tank is held on with double-sided tape, so you should be able to pull it off. Once it is off you can use a screwdriver or similar object to push out the motor mounts from below. Scrape off as much of the double-sided tape as you can, use a cloth and a bit of acetone or lacquer thinner to remove the tape residue from the bottom of the frame. Remember to wear gloves and work in a well-ventilated area.

Remove the details from the fuel tank except for the vertical sight glass on each side and round fuel gauge on the right. You can soak the fuel tank in isopropyl alcohol to remove the paint as you did with the shell. I chose not to strip the paint from the frame, as it is a different type of paint and seemed like too much work.

38

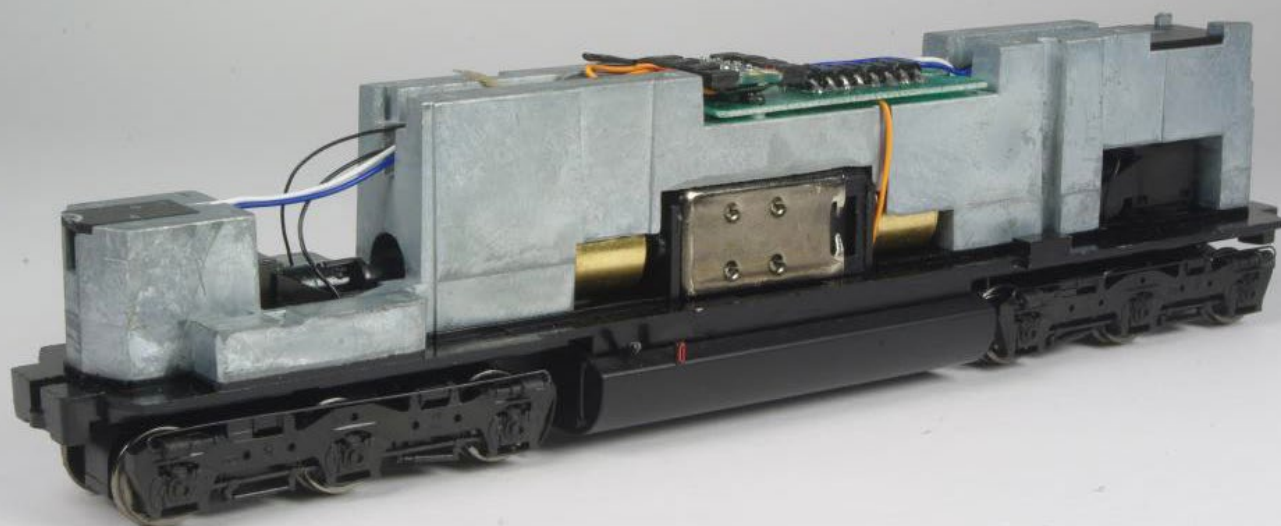

### 38. Proto 2000 chassis before disassembly.



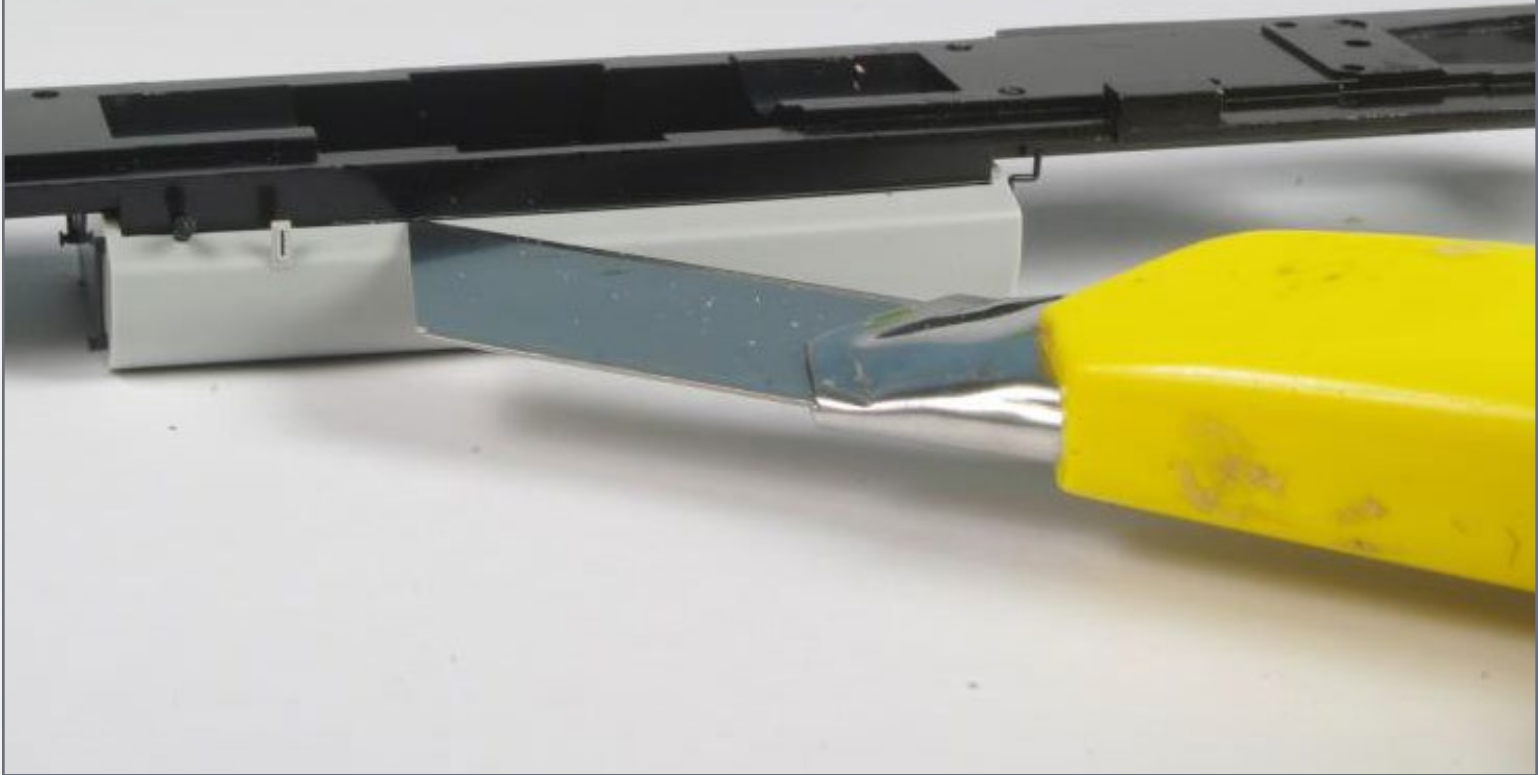

### 39. Marking the top of the fuel tank on the frame.

I found the Proto 2000 model did not look right in the area above the fuel tank and below the side sills. Too much of this space was filled with metal, there was no representation of the prototype's I-beam frame, and the top of the fuel tank did not extend in toward the frame far enough. I chose to modify the frame to fix these problems. The same steps can also be applied to Atlas frames from their HO scale GP38, 40, and 40-2 series models. I did my modifications with a standard hacksaw and motor tool (Dremel is the most common brand), but if you have access to a milling machine, it may make things a lot easier. When using hand or power tools, remember to wear appropriate protective equipment. Tools can easily slip and cut your hand; motor tools are guaranteed to throw stuff into your eyes if you are not wearing safety glasses.



I temporarily fitted the fuel tank on the frame and used a sharp utility knife to mark the top edge as shown in [39]. The marked frame is shown in [40].

Using a hacksaw, I made two vertical cuts in the fuel tank area that come down just below the line just marked. Make four horizontal cuts on each side, one at the front of the fuel tank, one at the rear of the fuel tank, one about ½" ahead of the fuel tank, and one about ½" behind the fuel tank. These cuts should be made all the way through the thinner part of the frame; stop cutting when you get to the thicker part. These cuts are shown in [41].

Next use a cut-off disk in a motor tool to make a horizontal cut along the whole length of the fuel tank. This cut should be made below the line you marked and should go in to the same depth as the horizontal cuts you made in the frame with the hacksaw. Do this on both sides of the fuel tank.

40



## 40. The frame marked for modification.



41

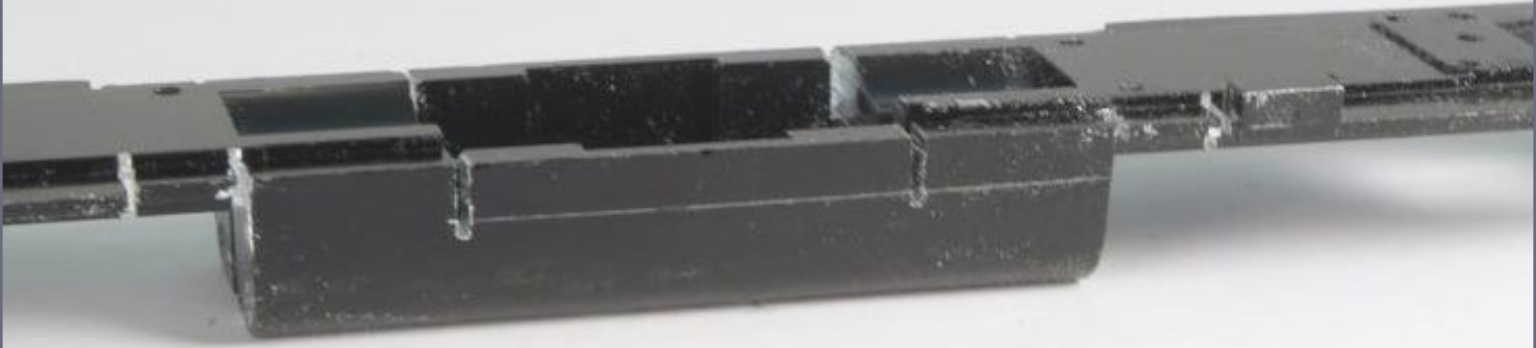

**41. The frame after the first cuts.**

42

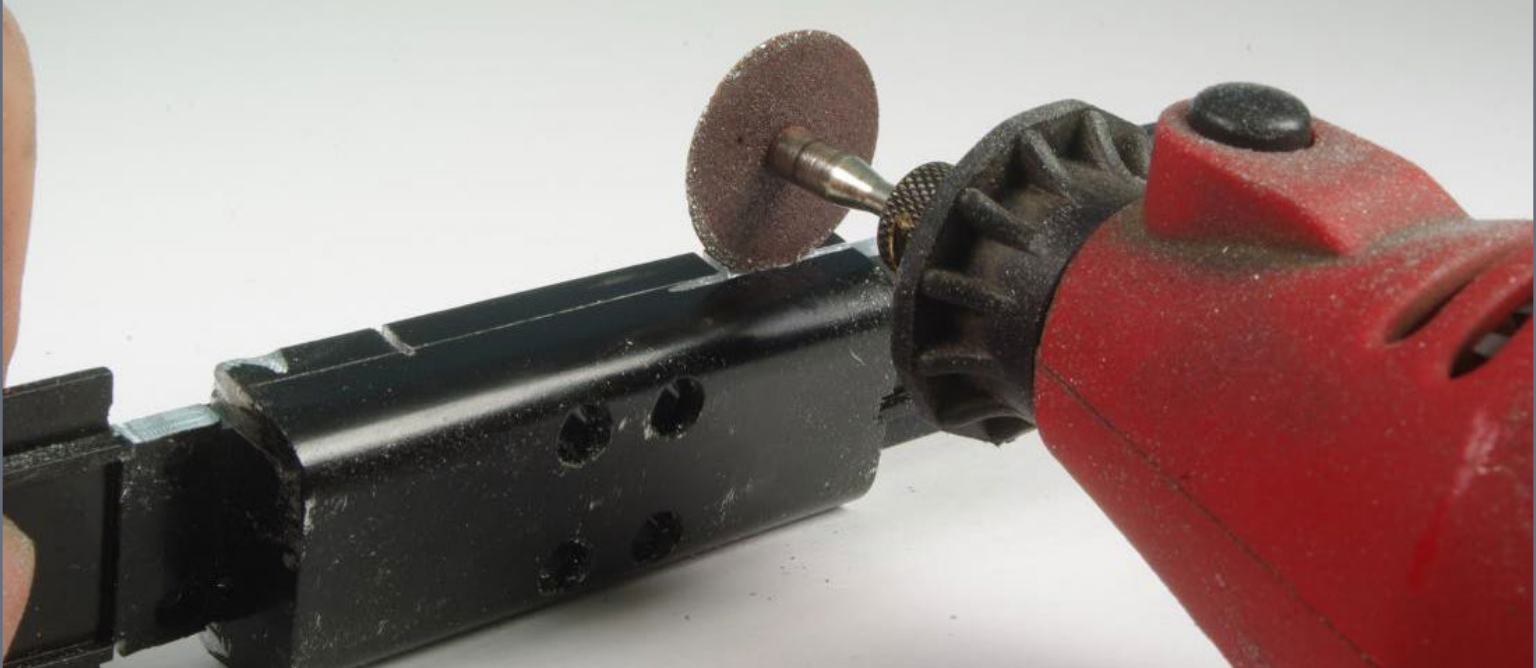

**42. Making the horizontal cut to the fuel tank.**



contents



index

43

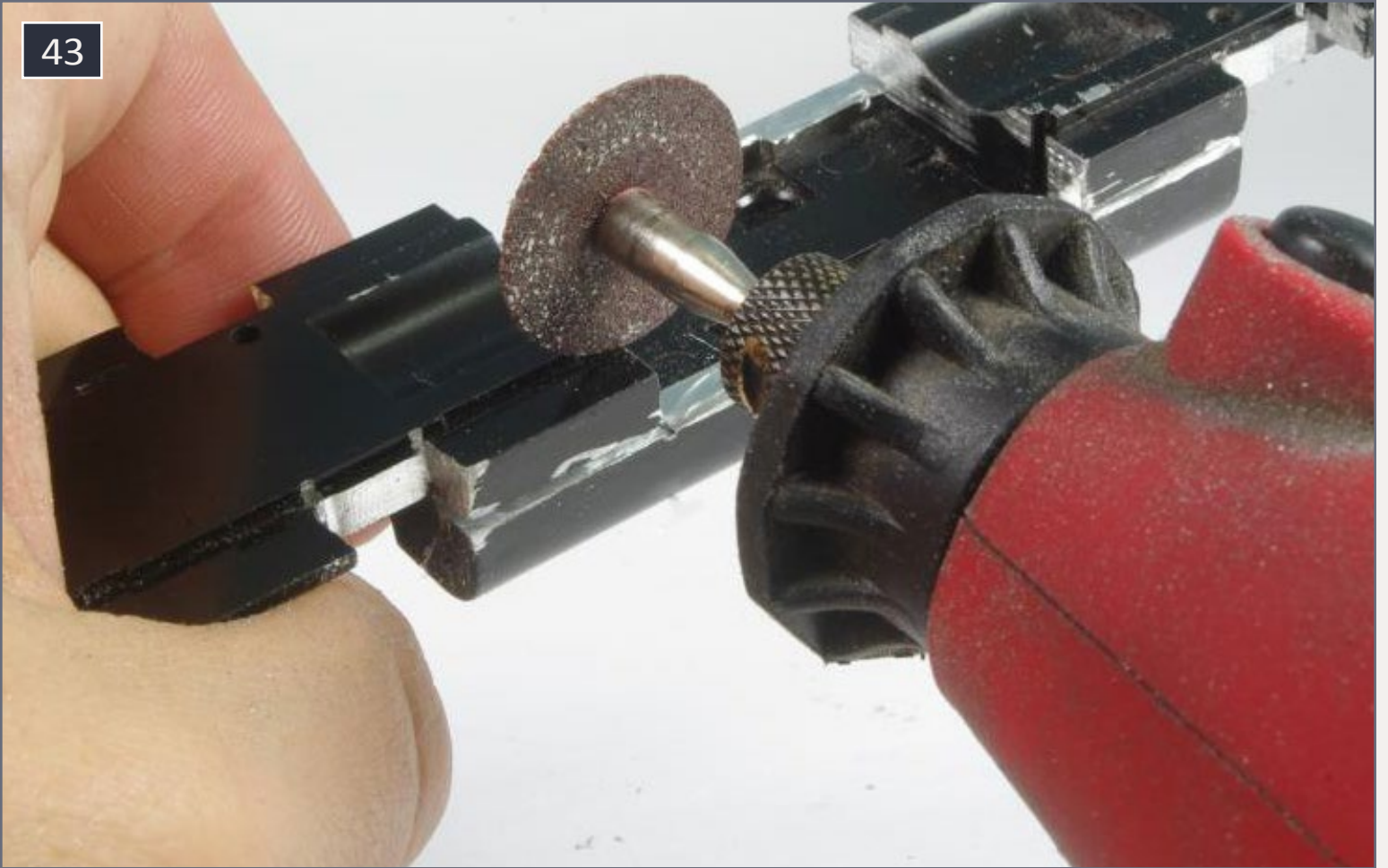

**43. Making additional vertical cuts to the fuel tank.**

44



**44. The frame after all cuts and milling.**





## 45. Fuel tank installed, styrene strip added.

Once you have finished the cuts on the sides of the fuel tank make cuts from the top as shown in [43]. These cuts should be made along the edge where the frame gets thicker, and should be deep enough to meet up with the cuts made from the sides.

Once you have finished cutting with the motor tool, clean up any rough areas with a small flat file, and wash the frame with soap and water. Your frame should now look like [44].

The next step is to glue the fuel tank to the frame. I used MicroBond for this but you may want to use epoxy or another adhesive. Glue a piece of .010"x.060" and a piece of .060"x.060" styrene strip together for each side of the fuel tank giving you two strips that measure .060"x.070". Glue in place on the fuel tank as shown in [45].

Fill the remaining gap at the front of the fuel tank top with a piece of .060"x.080" styrene strip. Once the glue has dried you can file, sand, and putty the top of the fuel tank to match the profile of the ends.





## 46. Cutting new styrene fuel tank end plates.

The fuel tanks on second-generation EMD locomotives are made by welding the end sheet onto the fuel tank from the outside. This means the end pieces are slightly larger than the sides of the tank. To simulate this, cut two pieces of .010" styrene sheet that are .500"x1.5". Glue one piece on each end; once the glue is dry, hold a scrap piece of .010" styrene sheet against the oversize end piece and trim it flush as shown in [46]. Once the rough cutting is done, use the same scrap of .010" styrene and a small file to shape the new end sheets to their final profile as seen in [47]. Sand with fine sandpaper as necessary to remove any marks left by filing. You should now have a .010" lip around each end of the fuel tank.

Now build new sides for the frame from pieces of .020"x.080" styrene strip. Add additional layers as necessary to match the rest of the frame. Test-fit the motor to make sure the styrene



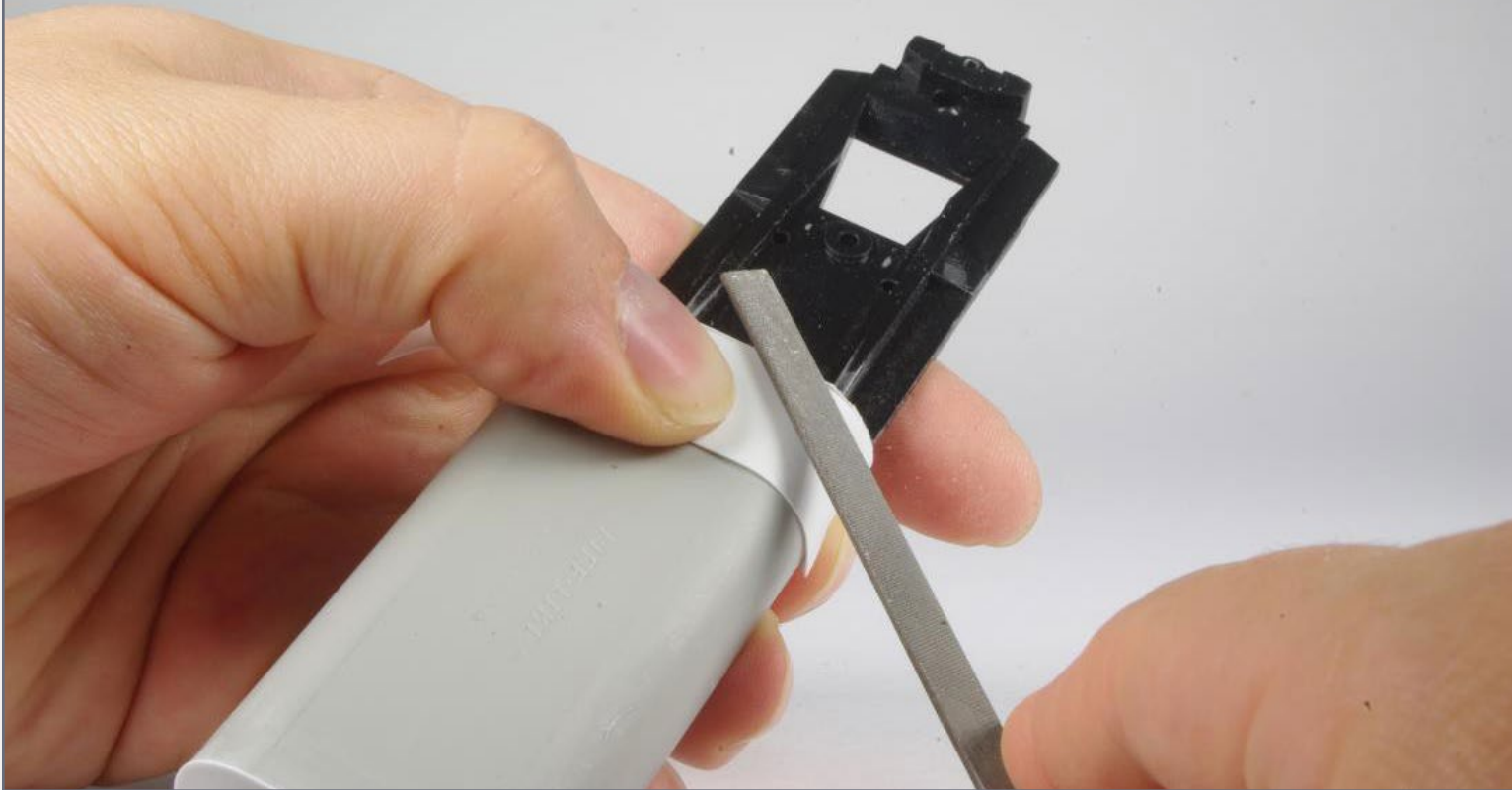

## 47. Filing new fuel tank end plates.

strip does not interfere with it sliding into position. Putty and sand the joints; once everything is dry and smooth, glue a piece of .020"x.020" styrene strip along the bottom of each side of the frame. This simulates the frame being made from two parallel I-beams.

Following photos, add the applicable pieces from the Cannon & Company 2156 fuel tank detail set. Drill a #56 hole in each side of the fuel tank .250" from the front for the fuel filler. Drill a #66 hole on each side for the top fuel gauge.

I also used the fuel tank brackets from this set rather than the brackets included in the Details West SD45 detail kit. Be aware the fuel tank brackets cover a couple of screw holes in the frame. You may want to modify the brackets so the screw holes are not blocked, or glue them in place after painting and final assembly. I simply did not install one screw and modified the



48

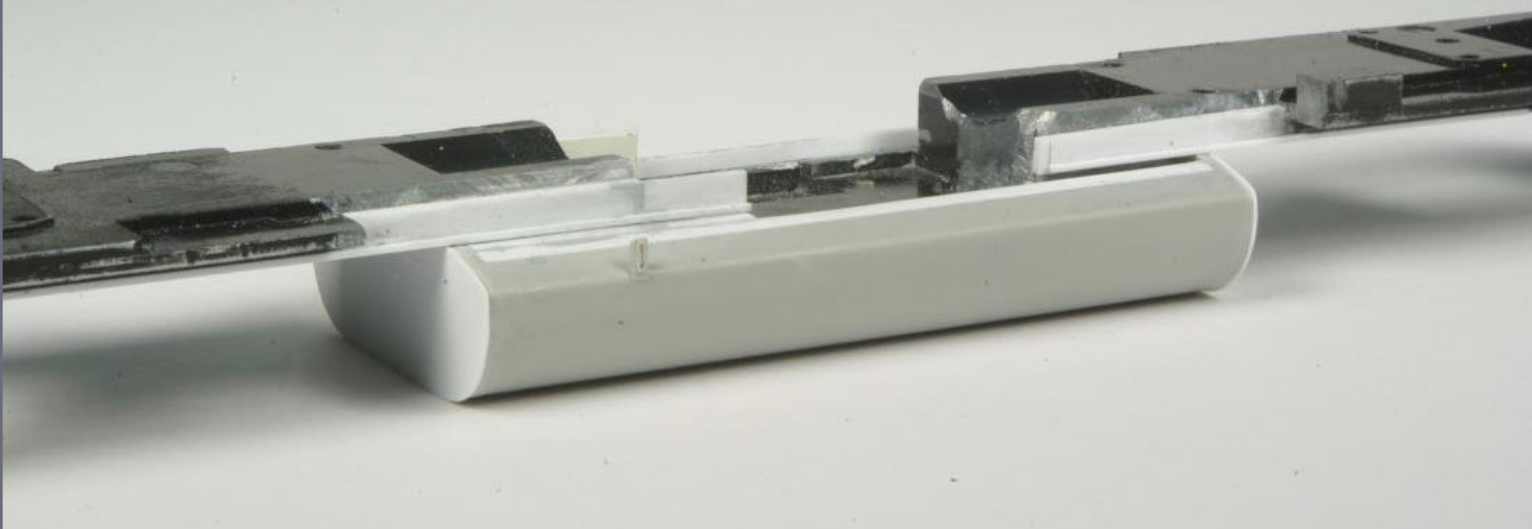

**48. Styrene strips added to simulate frame I-beams.**

49

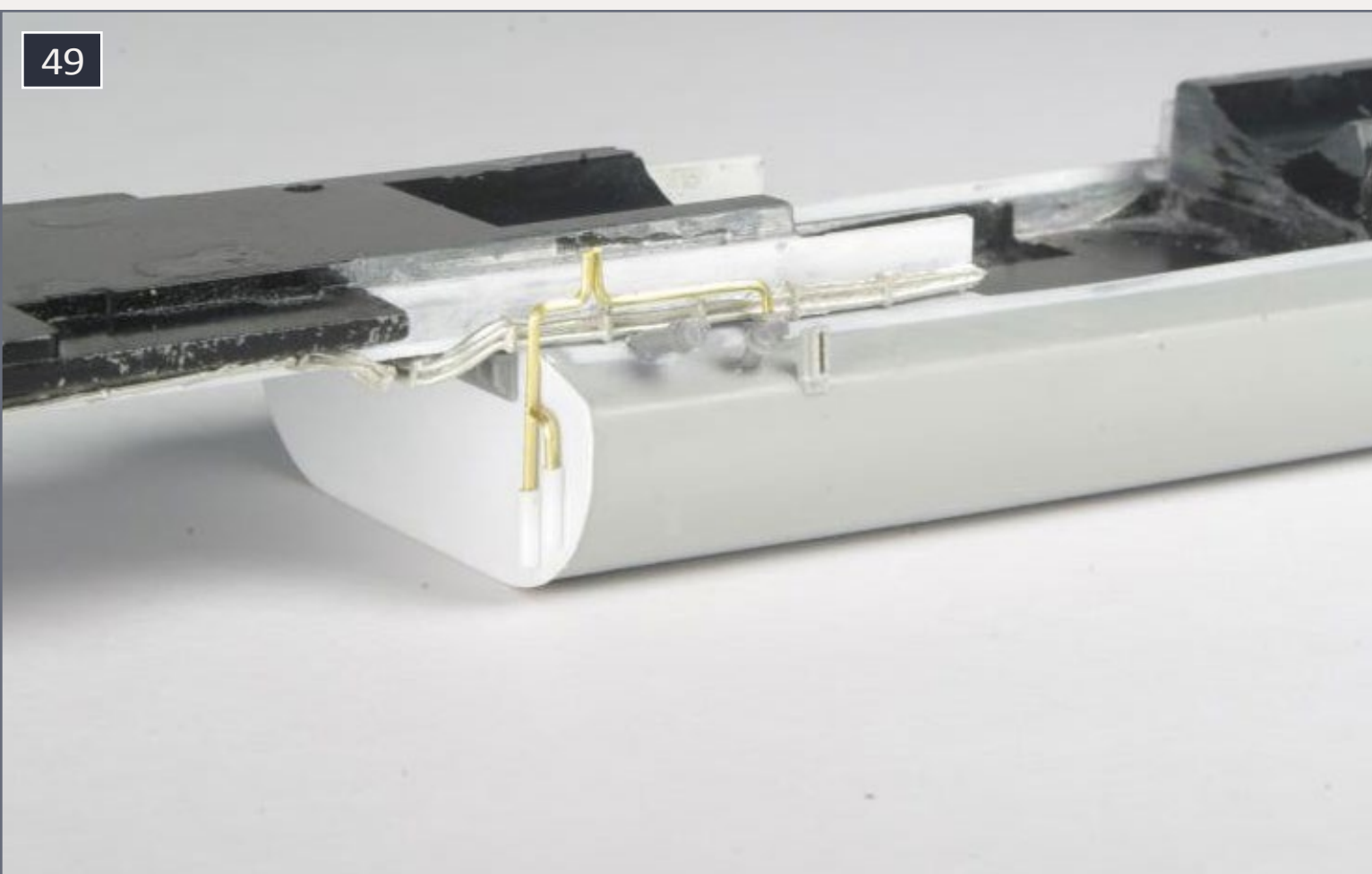

**49. Fuel tank details added.**



rear bracket so I could install the others. Make the piping on the left front of the fuel tank from pieces of .040" styrene rod and .022" brass wire. You can do this or use some of the piping from the Cannon & Company kit. Glue the Hi Tech Details 6009 waste retention tank to the rear of the fuel tank, and glue a piece of .020" styrene rod on the rear left of the fuel tank.

## Traction motor details

Install the Details West traction motor cables. I followed the guide on Brian Banna's website at [6axlepwr.com/TM\\_CABLES\\_cover](http://6axlepwr.com/TM_CABLES_cover). I ended up using three packages of Details West traction motor cables. The cable routing is shown in [50].

Because we replaced the Proto 2000 cab and short hood with Cannon & Company parts, the shell will no longer fit over the frame weight. The easiest way to fix this is to use a hacksaw to cut off the front portion of the weight as seen in [51]. Discard the front portion.



**50. Bottom view showing traction motor cable routing.**



contents



index

## The trucks

Completely disassemble the trucks, keeping track of how everything goes together. Notice the gears are not reversible; they must go in a particular direction for everything to work. I like to put all the small pieces in an old margarine dish so they do not disappear. Wash all of the truck pieces to remove the factory lubricant.

Take the four side frames and cut off the sanding lines. I prefer truck air lines made from brass wire. If you choose to do this, first glue the Proto 2000 brake cylinder air lines into the brake cylinders. Once the glue is dry, cut off the small air line leaving the slightly larger end piece glued in the brake cylinders. Drill #79 holes in the end of each brake cylinder.

On the two side frames from the front truck, drill out the center axle bearing to fit a Details West 244 axle bearing. Drill the right-rear bearing on the front truck to fit a Detail Associates 2808 speed recorder. Trim the back of the speed recorder so

51



### 51. Weight cut into two pieces.





## 52. Completed front truck.

it does not interfere with the end of the axle. Glue the speed recorder and axle bearings in place. Use a cut-off disk in your motor tool to remove  $1/32$ " from the ends of the wheelset that will go in the center position of the front truck. This is necessary so the wheelset will roll freely with the new axle bearings installed in the side frame.

Bend new brake air lines from  $.010$ " brass wire following photos, and glue in place. Install the Details West sand hose brackets on the outboard end of the truck side frames. There are no brackets on the inboard ends of the trucks. It is not necessary to model the sand lines themselves, as they would be hidden behind the steps. Make a speed recorder cable from  $.008$ " brass wire.



## Painting and decaling

Now is a good time to temporarily assemble all the components of your model to make sure no modifications are required before painting. If you are happy with everything, disassemble the model and wash the shell, frame, and truck side frames with a toothbrush and warm soapy water. Rinse everything well. Once the parts are washed, be sure not to touch them with your bare hands as the oil from your skin could interfere with the paint. I often use my airbrush with no



53

### 53. Model ready for painting.



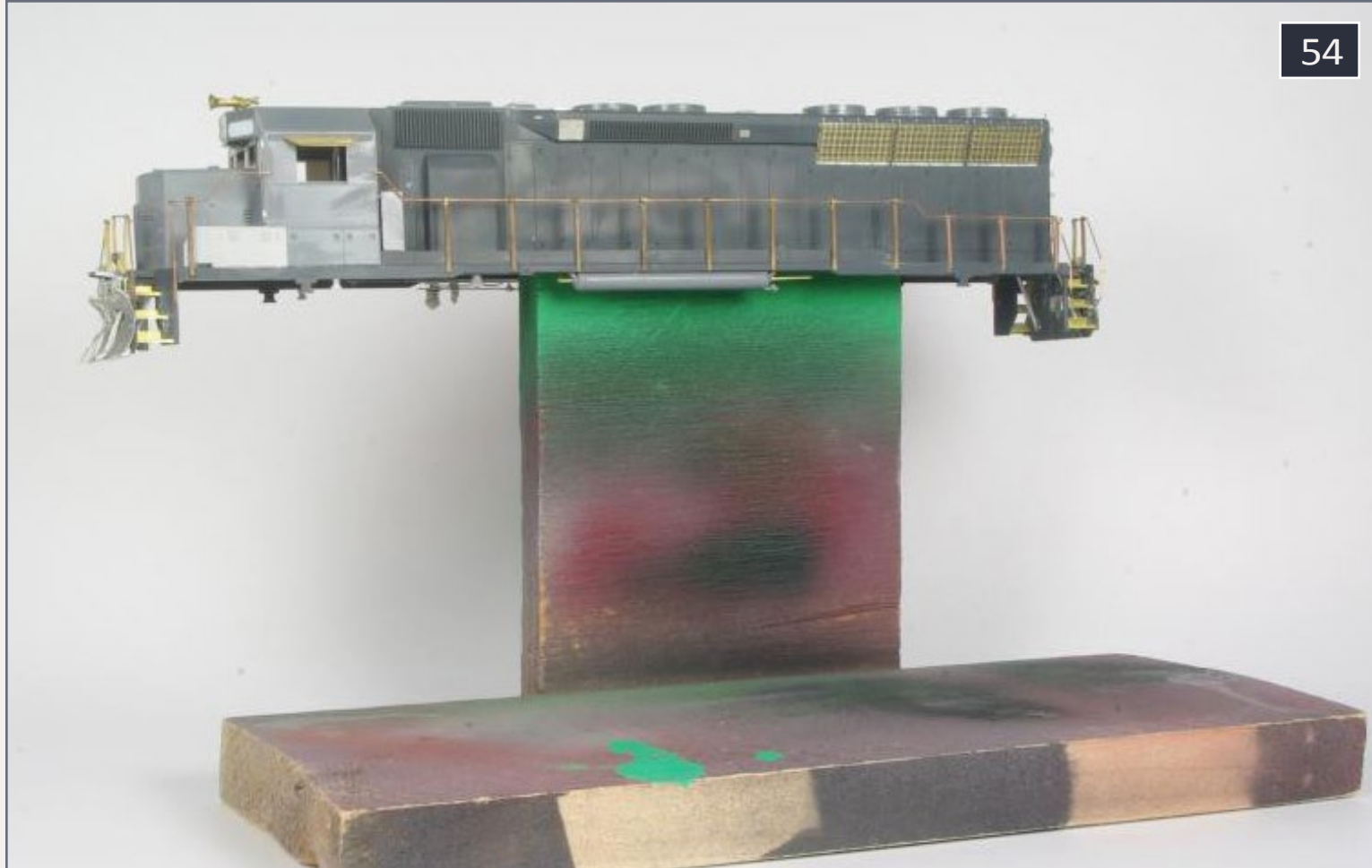

## 54. Painting stand for shell.

paint to blow the water off parts before I attach them to holders for painting.

My painting holder for the shell is made from a piece of 1x4 wood and a scrap of  $\frac{1}{2}$ " plywood. I put a couple pieces of folded-over masking tape on top of the holder to keep the shell from sliding around.

My painting holder for locomotive frames is made from a piece of 1x4 wood and two sheet metal screws. Originally I made this holder for painting Athearn blue-box frames, but I have also used it for Atlas and Proto 2000 frames by adjusting the spacing of the screws. The side frames can be taped to a scrap of wood or held with alligator clips. If you are using the Proto 2000 coupler boxes you can also prepare them for painting.



Give the model a coat of primer; I used Tamiya Fine Surface Primer in a spray can. Fill any scratches or imperfections with putty, and sand them smooth. Sand any other areas that require touch up and if necessary give your model another coat of primer.

Brush-paint the wheel faces a dark rusty brown color, I used Polly Scale Roof Brown which is no longer available, but you can use Testors Model Master Roof Brown or your favorite wheel color.

You would think an all blue-paint job would be as simple as it gets, but I had trouble matching the color I wanted. If you

55

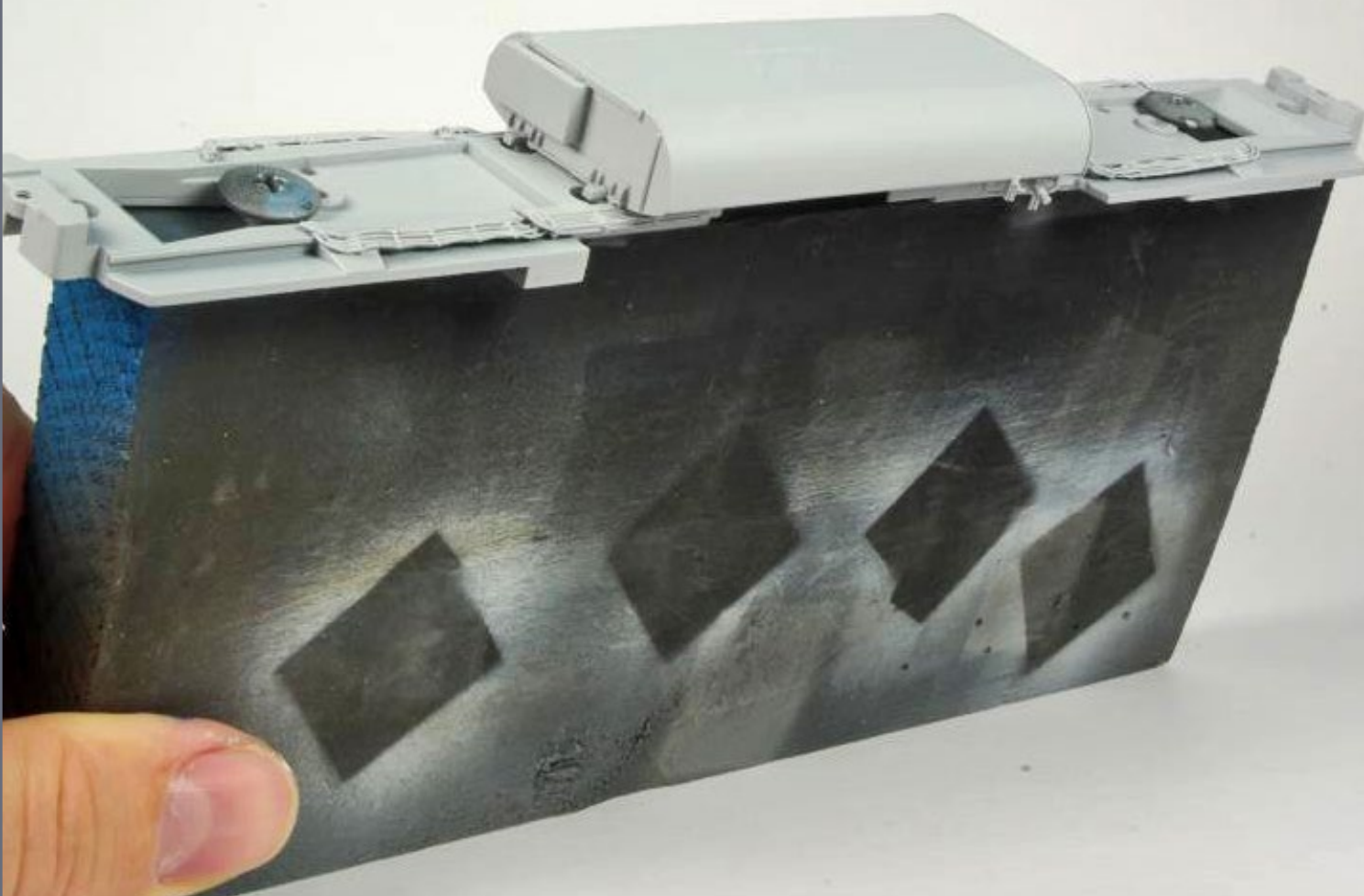

## 55. Painting stand for frame.



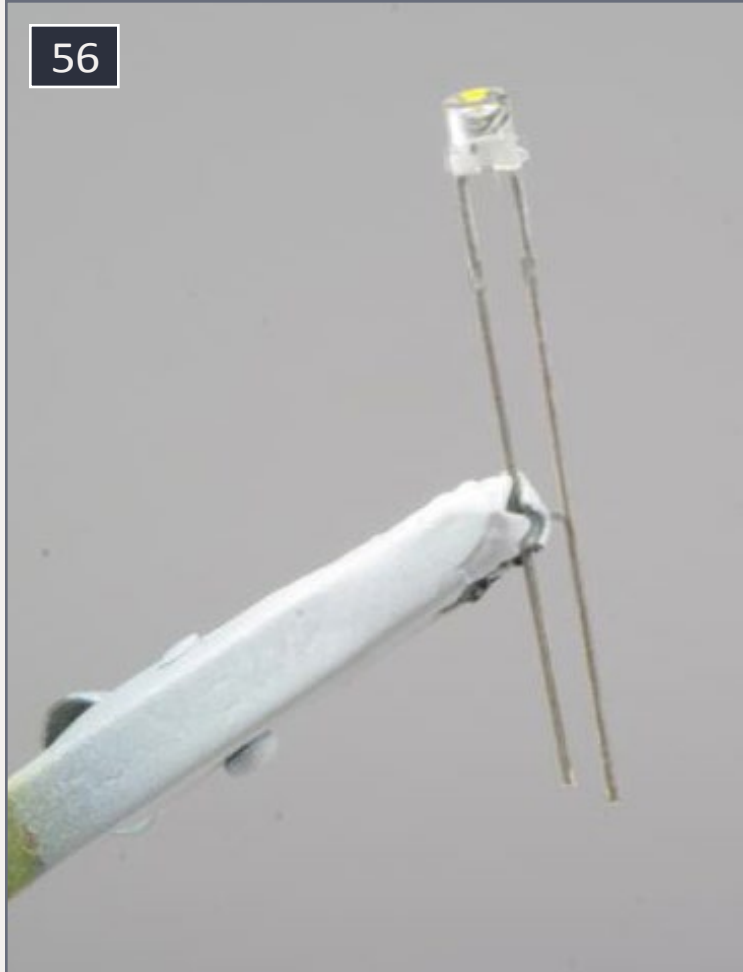

## 56. Modified 3mm LED.

search online you can find lots of debate about the exact color of the blue Pan Am engines. I first tried Tru-Color Pan Am Blue but I found it way too purple. The Microscale decal instructions suggest Santa Fe blue, I tried Modelflex Santa Fe Blue but found it too dark. In the end I painted my model with a custom blend of Modelflex paint consisting of six parts Santa Fe Blue, one part Conrail Blue, and one part Wisconsin Central Maroon.

Let the paint dry for 24 hours before handling the model. Modelflex paint usually dries with a gloss or semi-gloss finish, so no clear coat is required before decaling; if you think your model is not glossy enough, give it a coat of your favorite gloss finish. Brush-paint the corner handrails and coupler lift bars white. Notice the horizontal parts of a few grab irons are white. Brush-paint these as well.

Apply the decals from the Microscale Pan Am decal set. I cut the side sill stripes to a scale 4" width before applying them, and the decals for the step edges to a scale 2". Following photos, apply the small warning decals from Microscale 87-527, make the small red square around the fuel cutoff on the side sill from a piece of red trim film or a scrap decal. This square could be painted on, but I find it is easier to get



square edges using a decal. Use Microscale set 87-904 for the number boards.

Once all of the decals are applied, give your model a clear coat to seal everything. I wanted my model to look like it was recently painted but had been working hard, so I used a 50:50 mix of Testors Glosscote and Dullcote applied with an airbrush.

Brush-paint the window gaskets black, the MU and brake hoses grimy black, and dry-brush a bit of silver paint onto the ends of the MU hoses. Paint the fuel filler cap and fuel gauges red. Paint the spare coupler knuckles on the rear pilot roof brown or another rusty brown color.



57

## 57. Installing nano-LEDs in ditch lights.



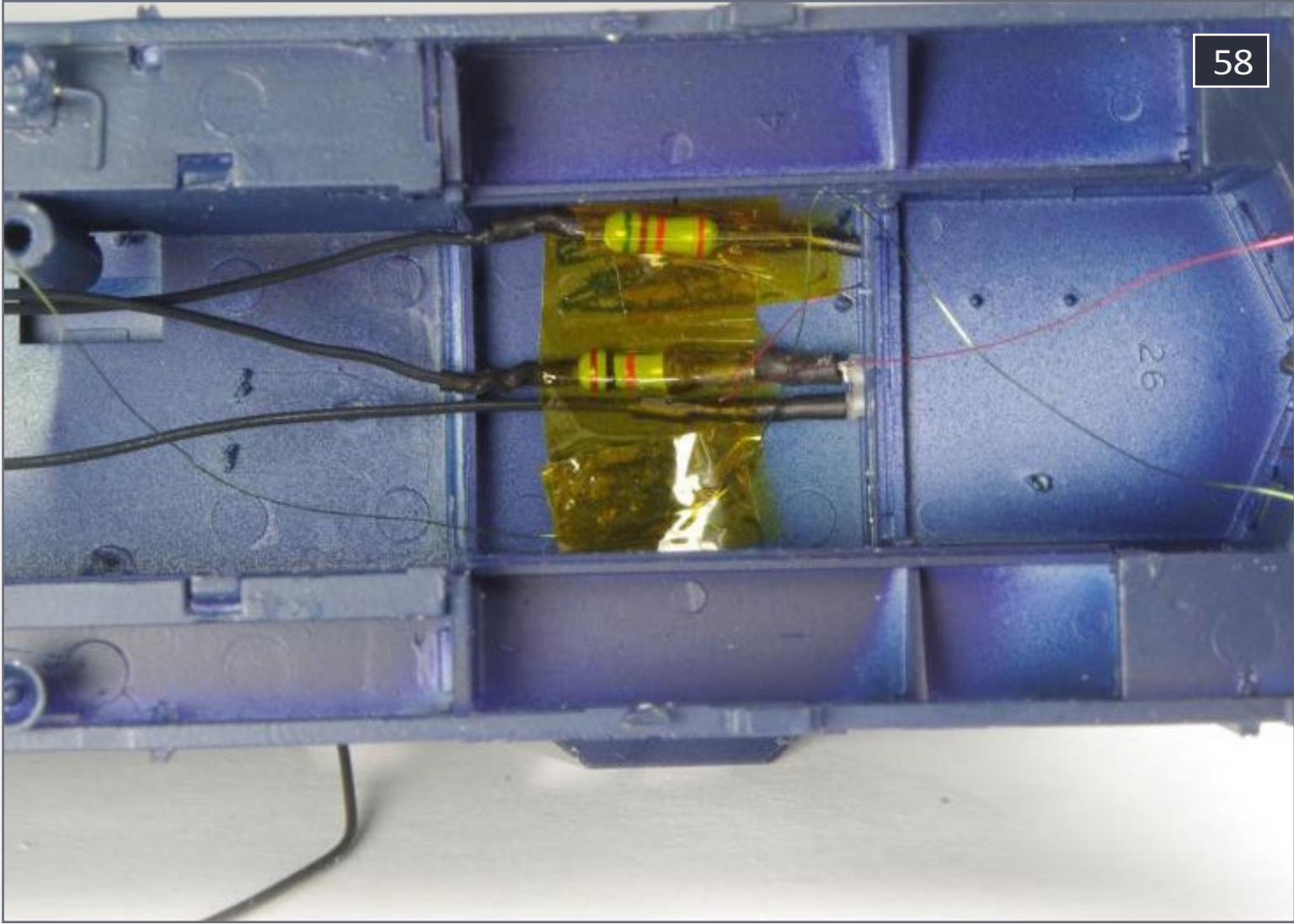

**58. Resistors and wires secured in shell with Kapton tape.**

## **Assembly and weathering**

Assemble the trucks, ensuring you have the right side frame in the right position and the wheelset with the shortened ends in the center position of the front truck. Add some Labelle 106 grease to the gears as you assemble the trucks. Install the motor, drive shafts, and trucks into the frame. Use a bit of Labelle 106 grease on the sliding portion of each driveshaft and a drop of Labelle 102 oil on each worm gear bearing. Install the frame weight and place the shell on the chassis. Do not worry about securing the shell with screws at



contents



index

this point; once the weathering is complete you will have to remove it again.

When weathering a model I like to use water-based paints for dry-brushing, I used Polly Scale paints for this model but, as they are no longer produced, you will have to use another brand of paint such as ModelFlex or Testors Model Master Acryl. To get the patchy dirty look on the walkways and top of the short hood, dry-brush a bit of roof brown followed by a medium gray on both areas.

For overall grime and dirt, I like to use washes of Testors Model Master enamel paint applied with an airbrush. I find the solvent-based paint has finer particles than water-based paint;

59

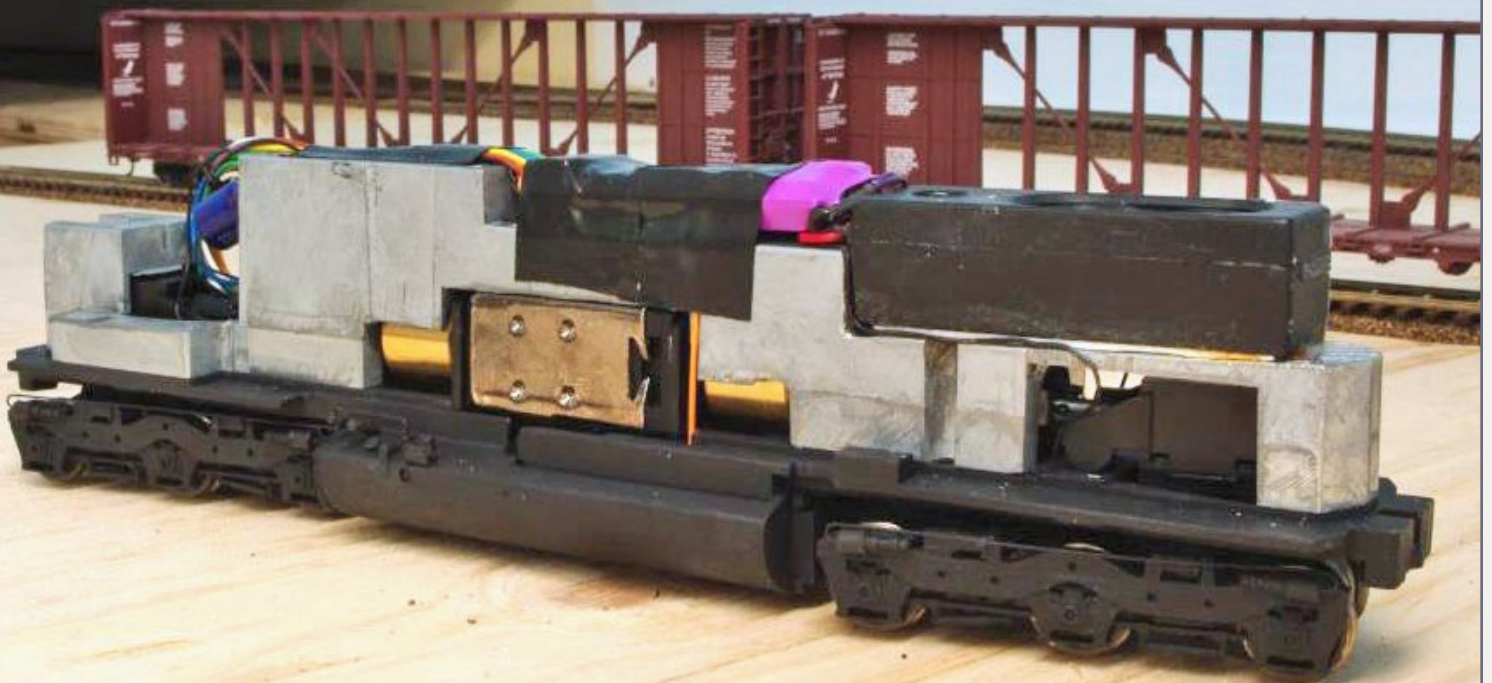

**59. SD45 frame from another model with Soundtraxx Tsunami and Railmaster Hobbies DSM-8 speaker installed.**



when applied with an internal-mix airbrush, it gives a nice effect. Mix up three washes of paint. The first is two parts Flat Black, one part Gunship Gray, and 24 parts thinner. This wash gives a nice exhaust color and should be sprayed on the roof, particularly ahead of and behind the exhaust stack. Next mix up a wash of one part Dark Skin Tone Base to eight parts thinner; this is a nice dirt color and should be sprayed on the pilots, steps, trucks, and fuel tanks. Finally mix up a wash of one part Sand to eight parts thinner; this is a light gray-beige color and should be sprayed around the trucks.

Seal the weathering with another clear coat. In this case I used Testors Dullcote thinned with lacquer thinner and applied with an airbrush. I tried not to get any Dullcote on the sides of the hood and cab, so they would keep the bit of gloss from the previous clear coat and the locomotive would still look like it had been recently painted.

## **Use Krystal Klear for water sight glass ...**

Install lengths of A-Line chain across the openings in the front and rear handrails. Dry-brush the chain with the same blue paint as used on the rest of the model. Use a bit of Microscale Krystal Klear to make the window in the water sight glass on the right side of the long hood.

Install the cab windows from the Cannon & Company cab kit. Brush-paint the right side window frames silver and the left side window frames blue before installing. Drill two #80 holes ahead of the left side cab window, install a Details West 357 wind deflector and brush-paint it blue. Paint the Detail Associ-



contents



index

ates windshield wipers, use blue for the wiper arms and black for the blades. Glue the wipers in place on the shell.

## DCC and lights

I chose to install a non-sound DCC decoder from Soundtraxx. This model will spend most of its time on a display shelf, so I did not want the expense of sound, but I did want to be able to run it with the rest of my Tsunami-equipped fleet. I also installed LED lighting in place of the original bulbs; you may prefer to use micro incandescent bulbs.

Remove the shell from the chassis. If you plan to leave your model DC you may choose to reinstall the Proto 2000 circuit board and light bulbs or you may choose to replace them with your own bulbs and lighting circuit. If you plan to install a basic DCC decoder, you will find it fits well in the spot where the Proto

60



**60. Finished model front left view.**



2000 circuit board used to sit. Install and wire it following the manufacturer's directions with the exception of the motor wires, you will need to connect the orange decoder wire to the gray motor wire and the gray decoder wire to the orange motor wire to get your model to run in the proper direction.

For the front and rear headlights, use 3mm sunny-white LEDs connected in series with a  $\frac{1}{4}$ W 1K Ohm resistor. Solder the wires, LEDs, and resistors all together and put heat-shrink tubing on all the solder joints before gluing the LEDs in place. Glue the rear LED in place with a bit of Micro Bond, Micro Krystal Klear, or silicone where the original Proto 2000 bulb used to sit on the frame weight. The front LED is installed in the shell inside the number board casting. A standard 3mm LED may be a bit too long for this, but you can file it shorter. After it is the right length, polish the end with 1000- and 1500-grit sandpaper.

## Glue the rear LED in place ...

I used 0402 LEDs for the ditch lights; the company I bought them from is no longer in business so I suggest using nano-LEDs from Ngineering. In fact, if you go to Ngineering's website at [ngineering.com/nano\\_wiring.htm](http://ngineering.com/nano_wiring.htm) you will find several tools and lots of tips to help you solder and wire the LEDs.

Cut four lengths of magnet wire around 5" long; solder two of these to each nano-LED. Drill two #79 holes through the rear of each ditch light; these holes should extend all the way through the pilot. Run the magnet wire through the holes as shown in [56], and glue the LEDs in place.

Connect the LEDs in series with a 5.1 Ohm  $\frac{1}{4}$ W resistor.



contents



index

Secure the wires, resistors, and front headlight LEDs in place with Kapton tape as shown in [58]. The LED from the front headlight will also light up the interior of the cab. To prevent this use a small piece of black electrical tape to cover the back of the LED and number board casting. Glue Details West 341 light lenses in the front and rear headlight castings with a bit of Microscale Krystal Klear. Cut the smaller rear portion off of two additional lenses and glue the remaining front part in the ditch light castings.

Many of my locomotives have Soundtraxx Tsunami DCC sound decoders connected to Railmaster Hobbies DSM-8 speakers. I used this set up in a previous Proto 2000 SD45 model I built; it is shown in [59]. If you choose to install sound in your model, the purple shrink-wrapped TSU-1000 Tsunami is a good fit. You will need to cut away part of the weight to fit the speaker; the

61



**61. Finished model front right view.**





capacitor will fit in the cab area. The rear headlight LED can be glued inside the shell or glued to the rear of the speaker.

Connect the wires from the LEDs to the DCC decoder. Keep the wires as short as possible so there is less wire to fit inside the shell. Insulate all your solder joints, and test the decoder and lights to make sure everything is working. Place the shell on the chassis and install the screws which hold it in place. Install the couplers; if you used the Details West scale coupler buffers, file the sides of the Kadee couplers following the Details West directions. I used Kadee 153 couplers with the trip pins cut off. If you do not plan to cut off the trip pin, you will need to use a long-shank coupler on the front. If you used the Details West scale coupler buffer you can cut off the front part of the Proto 2000 coupler boxes and use the rear part to hold the couplers in place. Dry-brush the couplers with a bit of roof brown paint.



contents



index

Clean the wheels on your model and program the decoder so everything functions like you want it to. Because of the high speed gearing of the Proto 2000 SD45 model, it runs much faster than other model locomotives. I used a speed curve which limited the top speed to about half of what it was originally; the SD45R now runs beautifully with models from Atlas, Athearn, and Kato. I also set a four-digit address and a bit of momentum for both acceleration and deceleration.

The Pan Am SD45R is now ready to enter service on the layout. I hope you have enjoyed the project and picked up a few tips and techniques along the way.



*Advertisement*



**1<sup>st</sup> choice for model railway supplies and service.**

**Expedited mail service available across North America.**

Click to visit:  
**WWW.CVRCO.COM**  
**1 800 464 1730**





Surprise new run of...

# Rapido's **AWESOME** HO Scale Gondola!

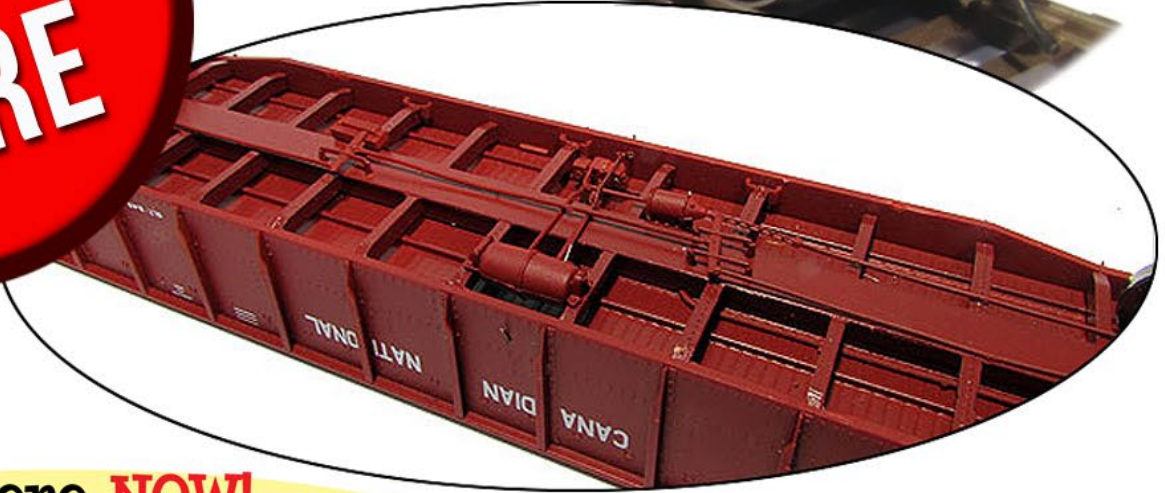

They are here **NOW!**  
Order yours before they are all **GON!**

CP (Delivery) • CP (Action Red) • CN (Delivery) • CN (Noodle) • TH&B



Email



Phone



contents



index



RITERAK

**TASK FORCE**

# AIR TANK 10-GALLON CAPACITY

ITEM/ART#  
#0094

**WARNING:** This air tank is capable of containing up to 125 PSI. maximum pressure. Overfilling may result in property or personal injury. Never exceed recommended pressure at any time. Burst Hazard - do not fill from any compressed cylinder or system charged with more than 150 PSI. Only fill with air from a service station or low pressure air compressor system. Do not fill with other gas under any circumstances. Always wear safety glasses when using this equipment. Indoors, do not expose to moisture or heat radiation.

**ADVERTENCIA:** Este tanque de aire es capaz de contener hasta una presión máxima de 125 PSI. Una sobrecarga puede ocasionar lesiones personales o propiedad. No exceder la presión recomendada en ningún momento. Riesgo de explosión - no llenar desde un cilindro de gas comprimido o un sistema cargado con más de 150 PSI. Llenar únicamente desde una estación de servicio o sistema de aire comprimido de baja presión. No llenar con otro gas en ninguna circunstancia. Coloque antiparras de seguridad para utilizar este equipo. Almacenar en interiores. No exponer a la humedad o al calor irradiado.

0411

MADE IN

# AIRBRUSH Air Supply







# Make a low cost airbrush supply ...

– by **Ronald C. LeMay**

Photos by the author

I was interested in a low-cost airbrush air supply that provided adjustable pressure, filtered air, no pulsing, and was silent so it would not disturb other members of the household. Rather than purchasing a dedicated airbrush compressor or relying on cans of propellant or a cylinder of CO<sub>2</sub>, I thought a better option would be to modify a portable 10-gallon air tank to become an airbrush supply. This approach meets all the criteria above and has some strengths, specifically:

- No noise.
- No pulsing.
- No frozen valves on a propellant can.



**Reader  
Feedback**  
(click here)



contents



index

The tank can be refilled with a large compressor or at a garage, auto body shop, or gas station.

If your source air was filtered, the air in the tank is free of moisture.

The tank can still be used to fill car and bicycle tires, beach toys, and other things that require a portable air supply.

A 10-gallon air tank at 100-125 PSI is enough to run an airbrush long enough to complete several projects. Even a 50-pound charge is enough to prime, paint and weather two HO railcars with ample air left over to clean the airbrush.

The portable tank air supply is also useful for people who have a large air compressor to operate pneumatic tools, but want a more convenient and portable air supply for airbrushing. The tanks are available in sizes from five to 15 gallons.

Here is all there is to it:

Purchase an air tank of the size you prefer from a “big-box” home improvement store or an auto parts store. Portable air tanks are available from Lowe’s, Home Depot, Sears, Costco, and most auto parts stores under various brand names, colors and sizes. I used a 10-gallon model available at Lowe’s for approximately \$40.00.

Additional parts to convert the tank into an airbrush air supply are available from most hardware stores (or big-box home improvement stores):

- Two ¼” National Pipe Thread (NPT) barbed male fittings to fit the air hose that comes with the air tank.
- Two female Milton 715 type M airline connectors.
- Three male Milton type M Male airline connectors.



- Two 3/8 “ aircraft-style stainless steel hose clamps (hardware department).
- Teflon tape (Iwata moisture/pressure regulator includes this) (plumbing department).

Available from a hobby shop or an art supply store:

- Iwata moisture regulator and pressure regulator “F.”
- Connector to allow Male Type “M” connector to attach to your airbrush hose.

The connectors allow you to connect or disconnect the air line without loss of pressure. “Type “M” disconnects are the most common, and cost the least, but as long as you stay with a single type, they interchange. Use whatever version of disconnect you prefer or find available.

### Advertisement

LASERMODELING **3** **ELBA Coal and Heating Oil**  
Newest Craftsman Structure Kit:  
HO/HOn3 12" X 12"

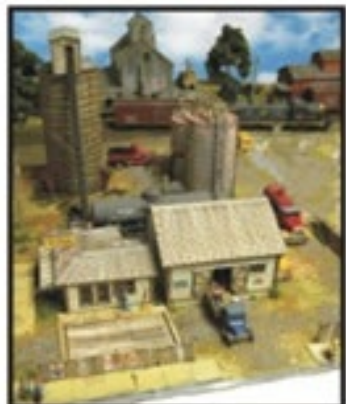

## STEP 1: Cutting the valve off



Cut the valve off several inches from the end, retaining most of the rubber hose with the air tank. Insert a barbed fitting into each cut end until seated. You may need to lubricate the brass barbs with a soap solution to get them to seat. Then tighten a hose clamp over the barbed portion. [2-4]

If you still want to use the air tank to inflate tires, beach toys, etc., insert the other barbed fitting into the other end of the air tank's hose and install a male quick-disconnect fitting [5].



# STEP 1: Cutting the valve off Continued ...

3



4



contents



index

## STEP 2: Fittings

Wrap a couple of turns of Teflon tape around the threads of the barbed fitting now connected to the hose from the air tank. Install a female Type M Milton connector to the fitting [5], and tighten using two wrenches, one holding the barbed coupling still and the other tightening the air hose quick-disconnect to assure it does not leak when it is pressurized

Install a Type M male fitting onto the pressure supply end of your airbrush's hose. If using an Iwata hose, you will not need an adapter. If using another brand, you may need an adapter. This will be easy to find at a hobby shop or art supply store. A hardware store may also offer something that works at a lower price.

Place another male fitting on the "in" side of the regulator/moisture filter and a female on the out side of the regulator/moisture filter, again sealing the threads with Teflon tape. This is done to remove the regulator when refilling or using the air supply for something that may not require filtered air. The male (inlet) end of the regulator will attach to the hose from the air tank. Female air connectors should always be on the pressure supply side of the air path, and the male end that fits them on the tool side. 



## STEP 2: Fittings *Continued ...*

5



6

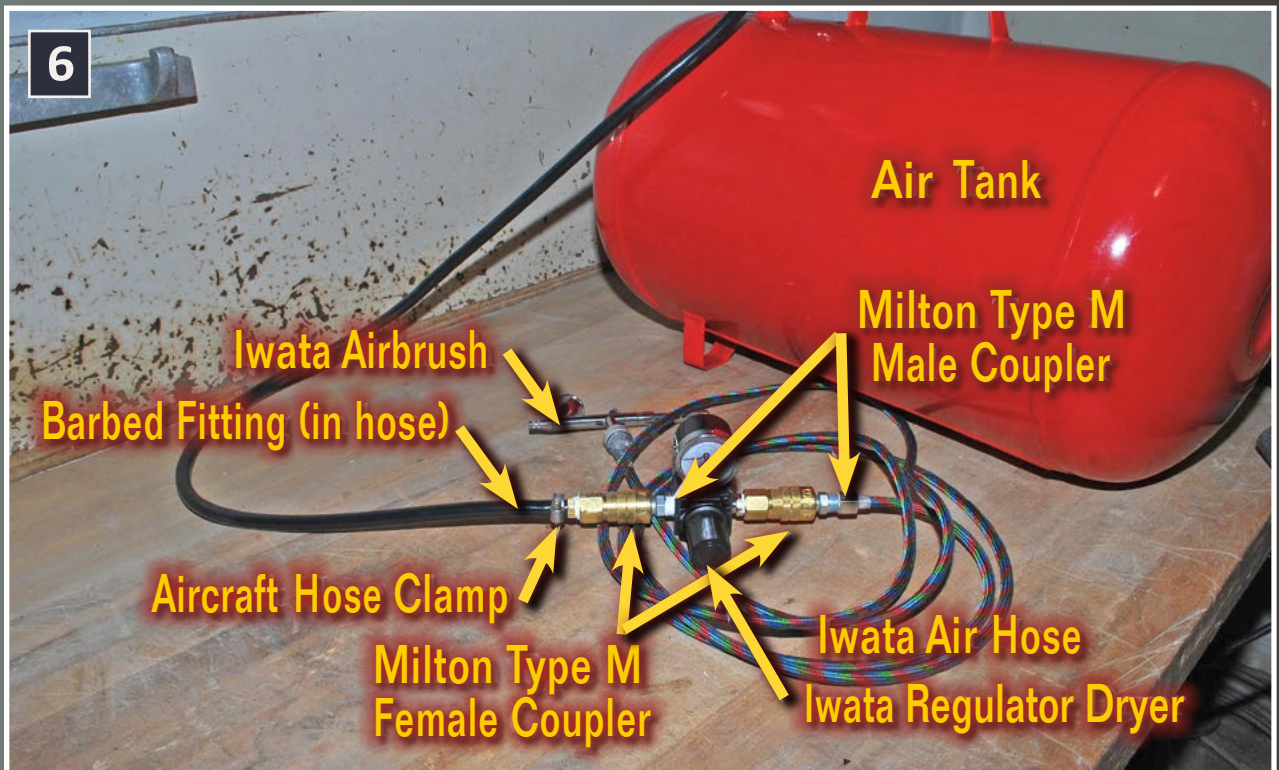

contents



index



YD



Yankee Dabbler.Com

# Have You Seen Our Autumn Sales?

**HO**

**DCC**

**ALL SCALES**



- **Kadee**
- **NCE**
- **Digitrax**
- **SoundTraxx**
- **And more!**



Ron LeMay lives in Jacksonville Florida with his wife and two children and works in labor relations in the rail industry.

Originally from the Midwest, he is most interested in modeling the Milwaukee Road in Illinois and Wisconsin, but splits his available time among wood working, auto repair and restoration in addition to model railroading.



**Reader Feedback**  
(click here)





**NEW!**

# FREIGHT CRATE

## Rolling Stock Transport Box

Secure storage and transport for your delicate models



You have invested heavily in your collection of rolling stock, now you can transport and store them confidently with Fast Tracks

## FREIGHT CRATE

- Stackable
- Secure, locking lid
- Assembles in 15-30 minutes
- Pre-cut bubble wrap cradles included
- Precision cut from 1/8" hardboard
- Easy to assemble tabbed construction
- Designed to fit equipment precisely - no compromises necessary!



Click here to visit Fast Tracks and order your **FREIGHTCRATE** today!



**FAST TRACKS**

www.handlaidtrack.com  
service@fast-tracks.net  
1-888-252-3895





# HIDING modular seams

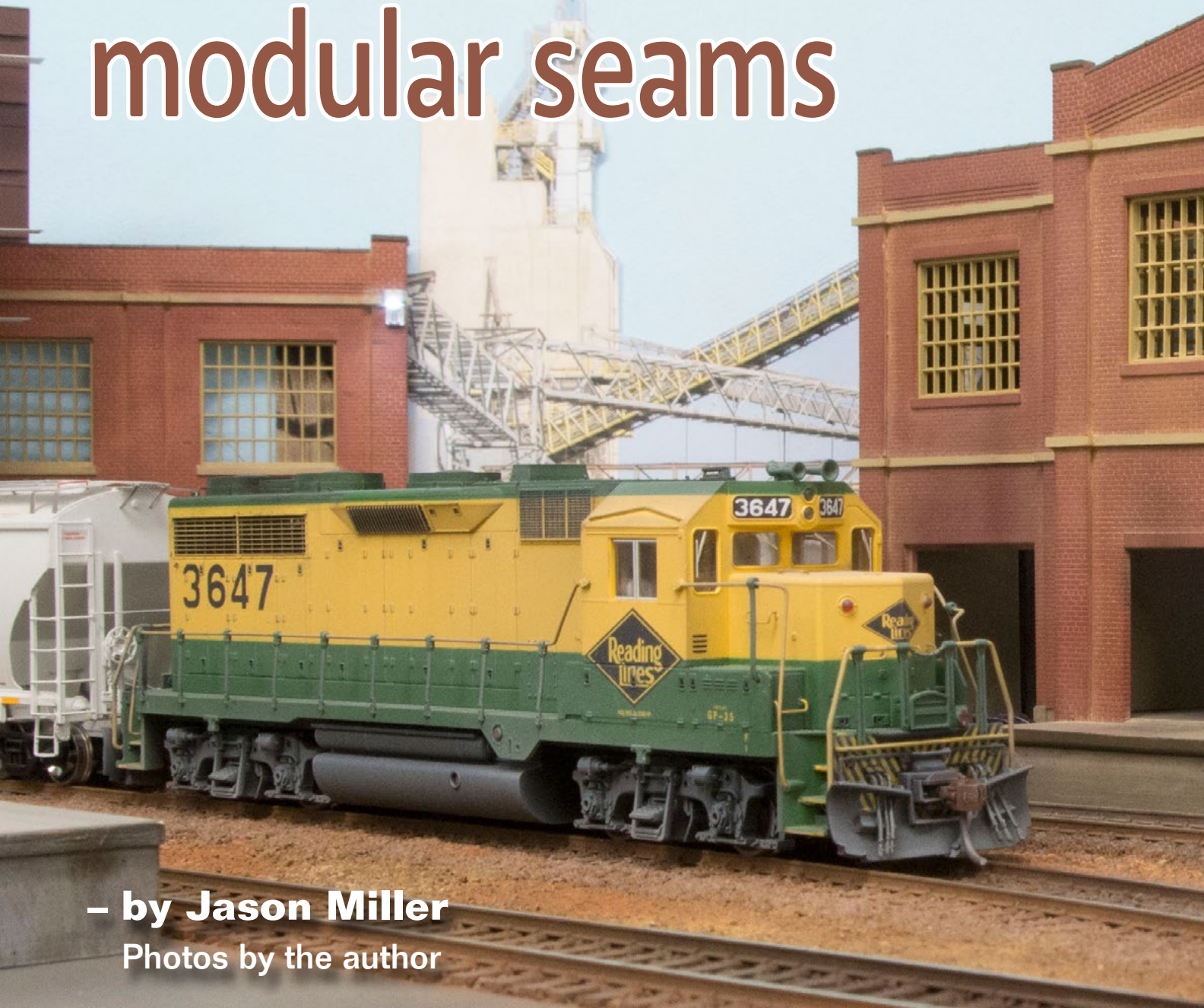

– by **Jason Miller**  
Photos by the author

**S**ince starting in the hobby around three years ago, one of the many aspects that has really stimulated and furthered my interest is the ability to be able to create almost any type of structure from the wide variety of plastic kits on offer.

In particular one of my favorites is the Walthers Cornerstone modular kit system. These kits let you design, build and expand







## A quick fix adding prototypical detail to your structures ...

buildings to any shape or configuration and occupied use. The only real limitation is the extent of your imagination, your creativity, and the space available.

I chose these modular kits to build the structures that required more flexibility than standard kits. I have



contents



index

scratchbuilt structures before, and built the Walthers “Quality Investments Kit,” which is a modular kit. These kits can be built quickly and are easy to assemble, even for a beginner.

Our layout has two areas where tracks penetrate the center peninsula backdrop, to allow access to the L&T Branch area which sits behind the main JL&T area. These connections allowed me to expand the layout design and incorporate more operating areas.

The penetrations also required a unique solution to hide the drywall edge of the backdrop and the framework in the middle. I thought through several solutions to hide the plaster edge,

1



**1. Walthers “Modulars” allow the builder to adjust the width, height and depth of a building to fit their own special needs. The segments are easy to assemble, even for a beginner.**





**2. The modular parts include sections with large and small windows, personnel doors, and other variations. When more than one level is assembled, the joint between the two sections becomes an unsightly line that can be concealed using Jason's techniques.**

and came up with the solution of a modular kit to hide the dry-wall and the wood backdrop framing on both sides.

However, there is one issue with these kits that I'm sure has been faced by many modelers in the past and has caused many a frustration about a structure looking like a model instead of the real deal. This is the small gap that is left when two sections are joined vertically.

The solution? Hide the gaps with a small piece of styrene on the front façade that will simulate either a decorative ledge or a structural piece of the building frame. Follow me as I show how



3

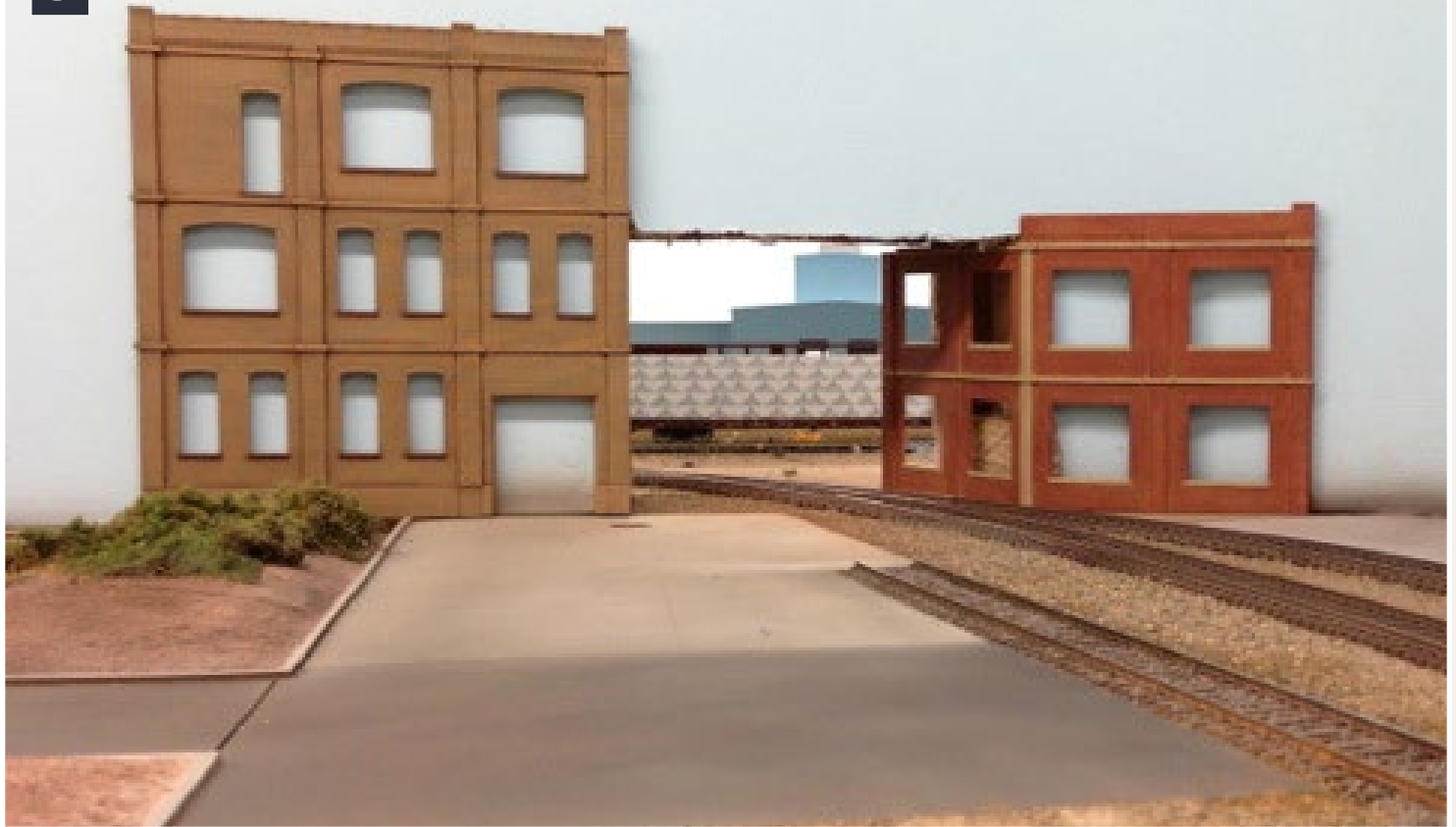

**3. Two buildings will help to hide a passage through a backdrop that connects two layout areas.**

4



**4. Precision sanding and filling might hide the gap between modular sections, but would also take a lot of time.**





**5. Tools needed: sprue cutters, pointy nose pliers, tweezers, X-Acto knife, pencils, rulers in various sizes, CA glue, Instant Set, and Walthers modular sections as needed.**

to achieve this simple and quick solution to a common problem, and provide a great prototypical detail to your structures.

*Article continued on the next page ...*



contents



index

## STEP 1: Layout the sections

Once you decide on the final design of your modular wall, take care to align the wall sections. This will ensure that the gap between the vertical sections is as small as possible, and that the gap is hidden when the decorative cap is installed.

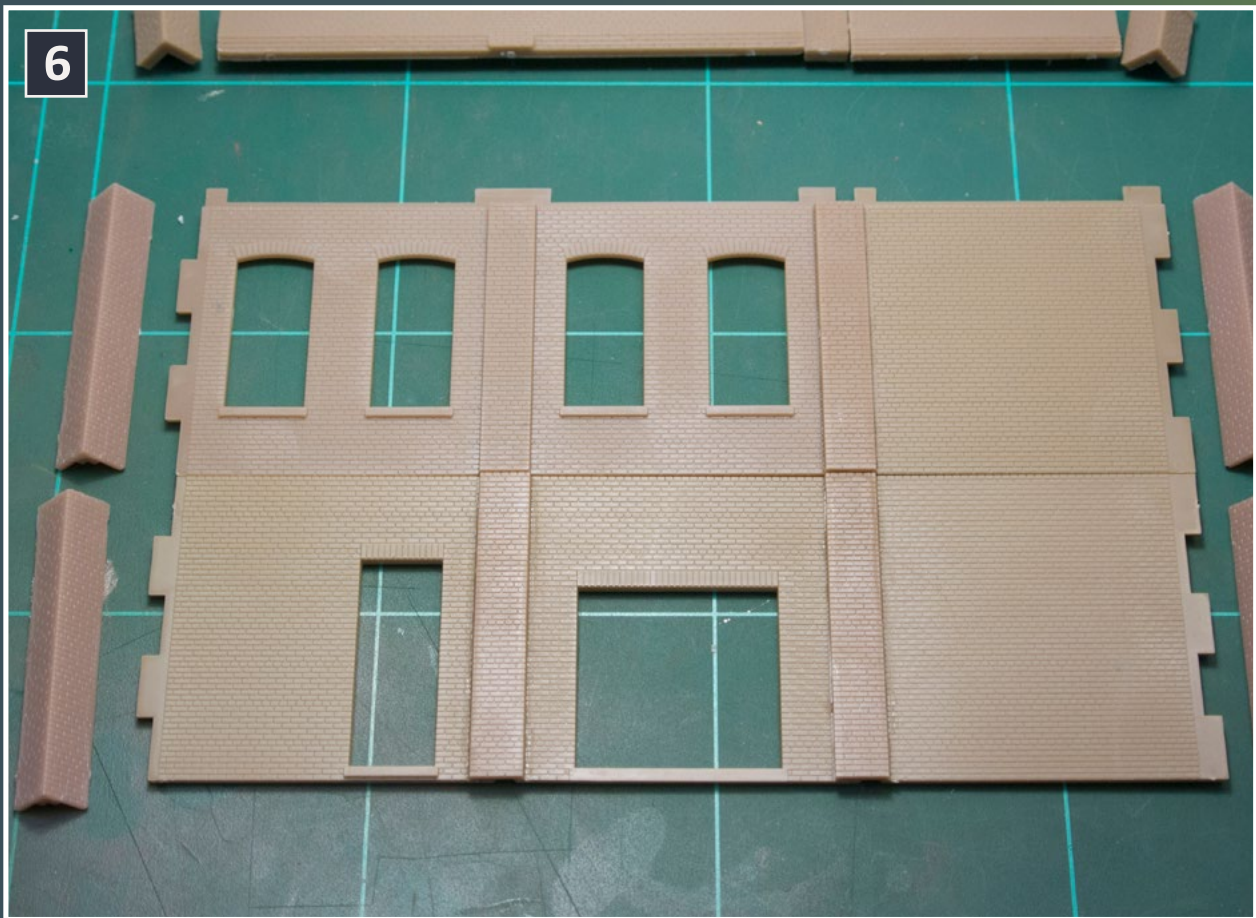

**6. Line up the sections and glue them together so they are square and plumb.**



## STEP 1: Layout the sections *Continued ...*

7



7. Even with careful fitting, a joint line will be obvious between the sections.



contents



index

## STEP 1: Layout the sections *Continued ...*



8. The line between the segments doesn't look like anything you'd find on a real building.



## STEP 2: Choosing an architectural detail

Pick the profile of the decorative cap. I chose to use a HO scale 4" x 8" strip, part 8408 from Evergreen Scale Models. It comes in a packet of 10 strips. You could use a different profile, such as a quarter- or half-round strip to change the profile and add some variety to the detail on different structures.



9. HO scale 4" x 8" styrene strip, part 8408 from Evergreen Scale Models, makes a good cap. Other sizes and profiles will give some variety from building to building.



contents



index

### STEP 3: Internal cap detail

Measure the internal width in between brick columns. I usually leave the piece about a millimeter short so that it fits in easily when it is glued into place. The small gap at either end will be hidden by the column cap that overhangs the end of the internal piece. (Editor's note: Jason is Australian and accustomed to working with metric measurements. One millimeter falls between 1/16th and 1/32nd of an inch, if you do not have a metric ruler.)

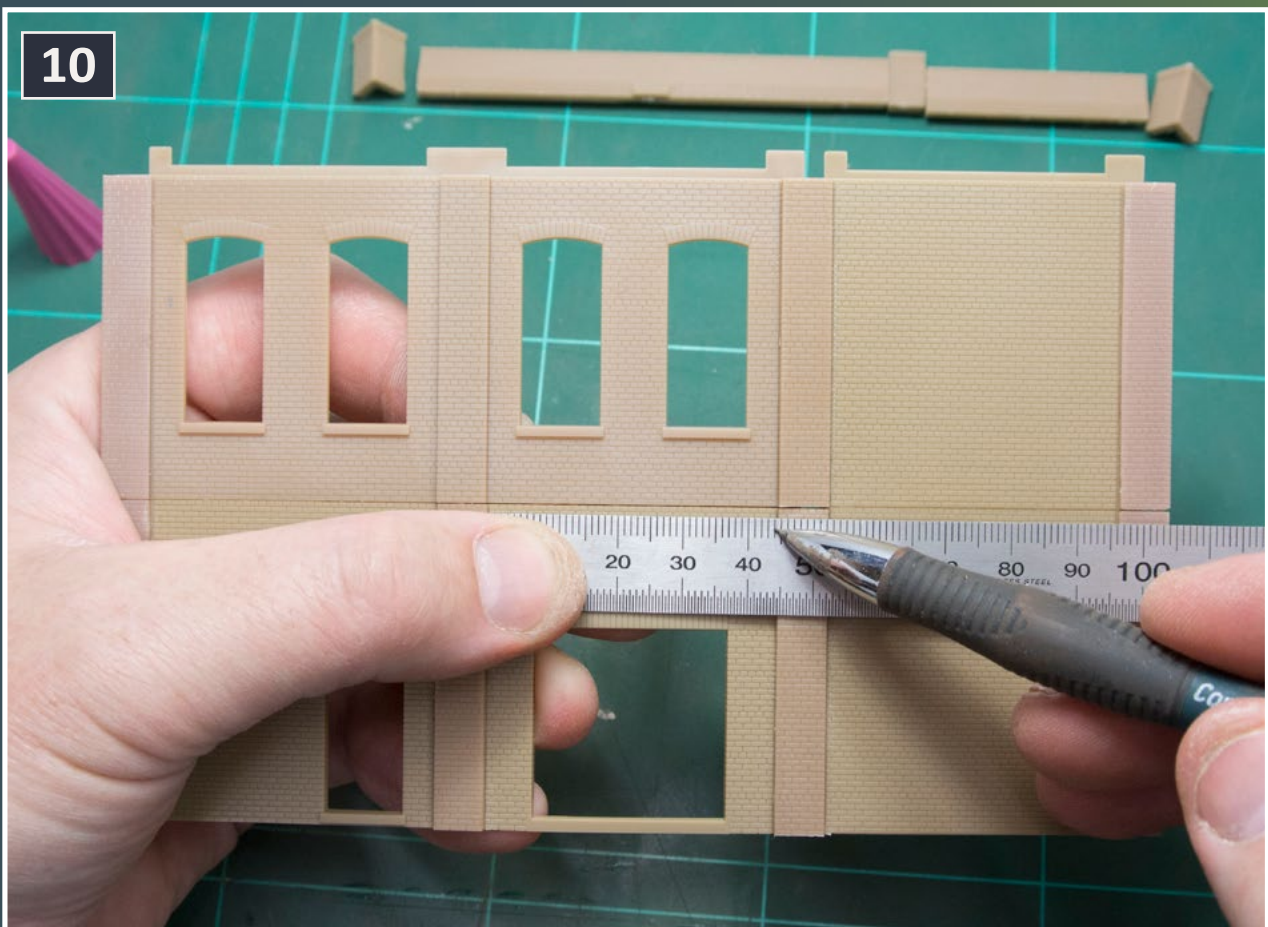

**10. Measure and cut the internal cap sections, leaving them just slightly short so they will drop into place. The column cap that overhangs the end of the internal piece will hide the small gap at either end.**



## STEP 3: Internal cap detail *Continued ...*

11

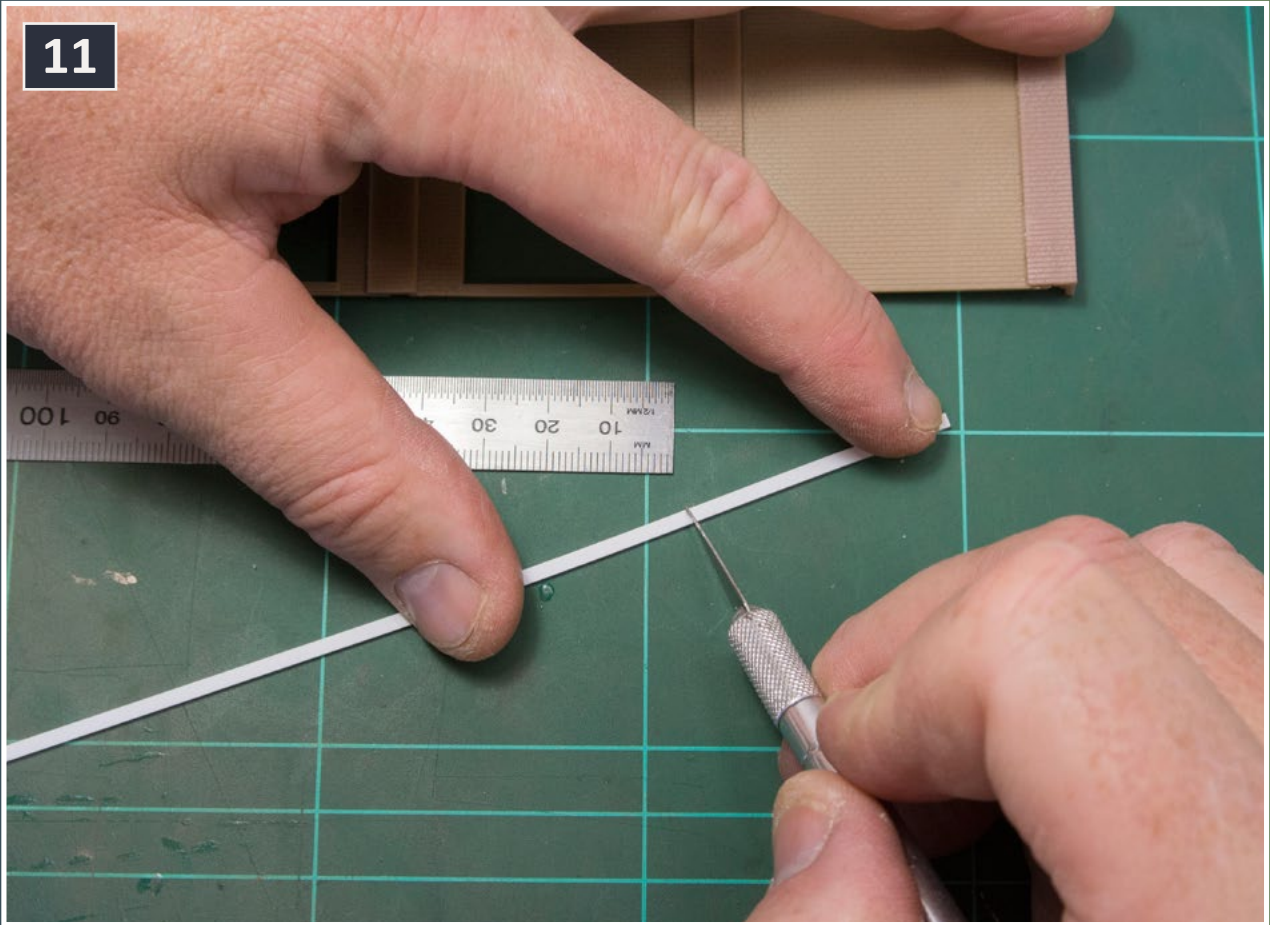

11. Mark the Evergreen styrene strip and cut it to length with an X-Acto knife or a Chopper.



contents



index

## STEP 4: External cap detail

Measure the external brick column sections' width. These pieces need to overlap the internal section by about one millimeter either side. This helps hide the small gap at the end of the internal sections and visually ties in the internal and external column sections.

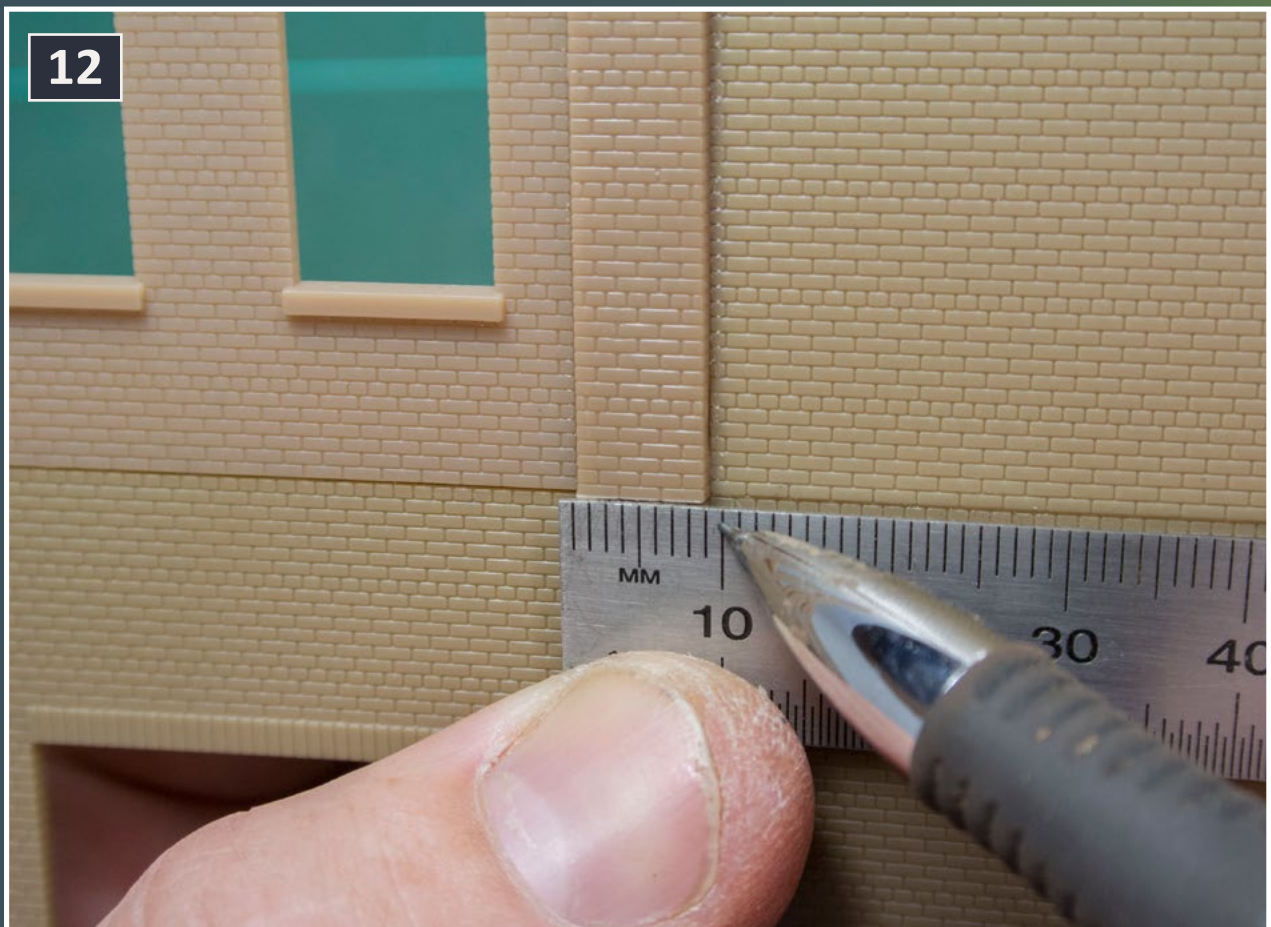

**12. Measure and cut the external column cap sections. Measure the external brick column sections so they overlap the recessed section slightly on either side.**



## STEP 4: External cap detail *Continued ...*

13

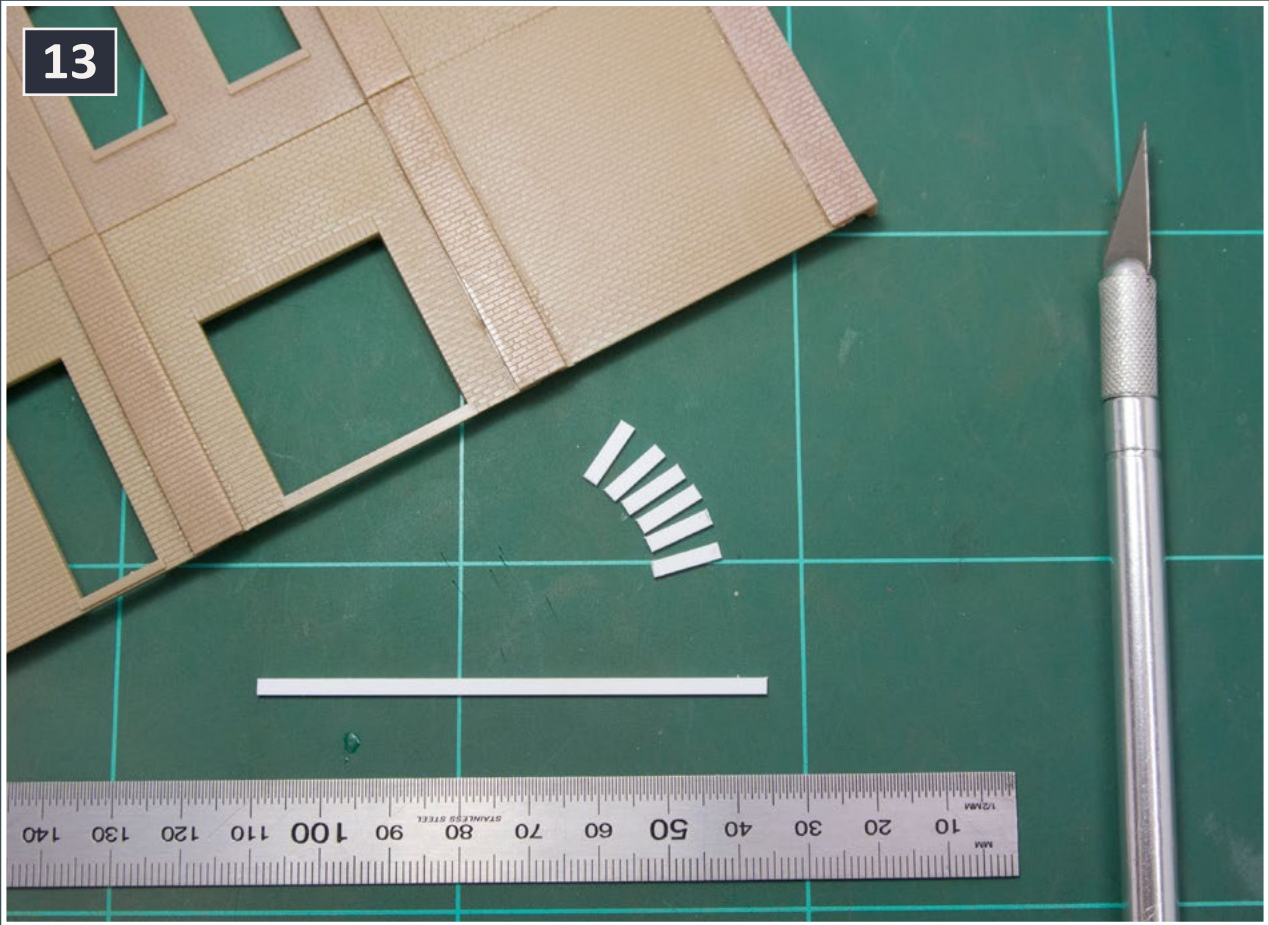

13. The column caps, in white, will be glued over the joint between the vertical brick pillars.



contents



index

## STEP 5: Gluing the internal cap detail

I use a CA glue from Bob Smith Industries called “Maxi-Cure” for gluing the individual sections onto the modular kit.

I place the section so that the top part of the styrene piece finishes flush with the actual gap, ensuring that the gap is hidden. Align the sections using the modular brickwork as a guide, and use a small metal ruler to ensure they are all plumb.



14

14. CA “Maxi-Cure” glue is used to attach the parts.



## STEP 5: Gluing the internal cap detail *Continued ...*

15

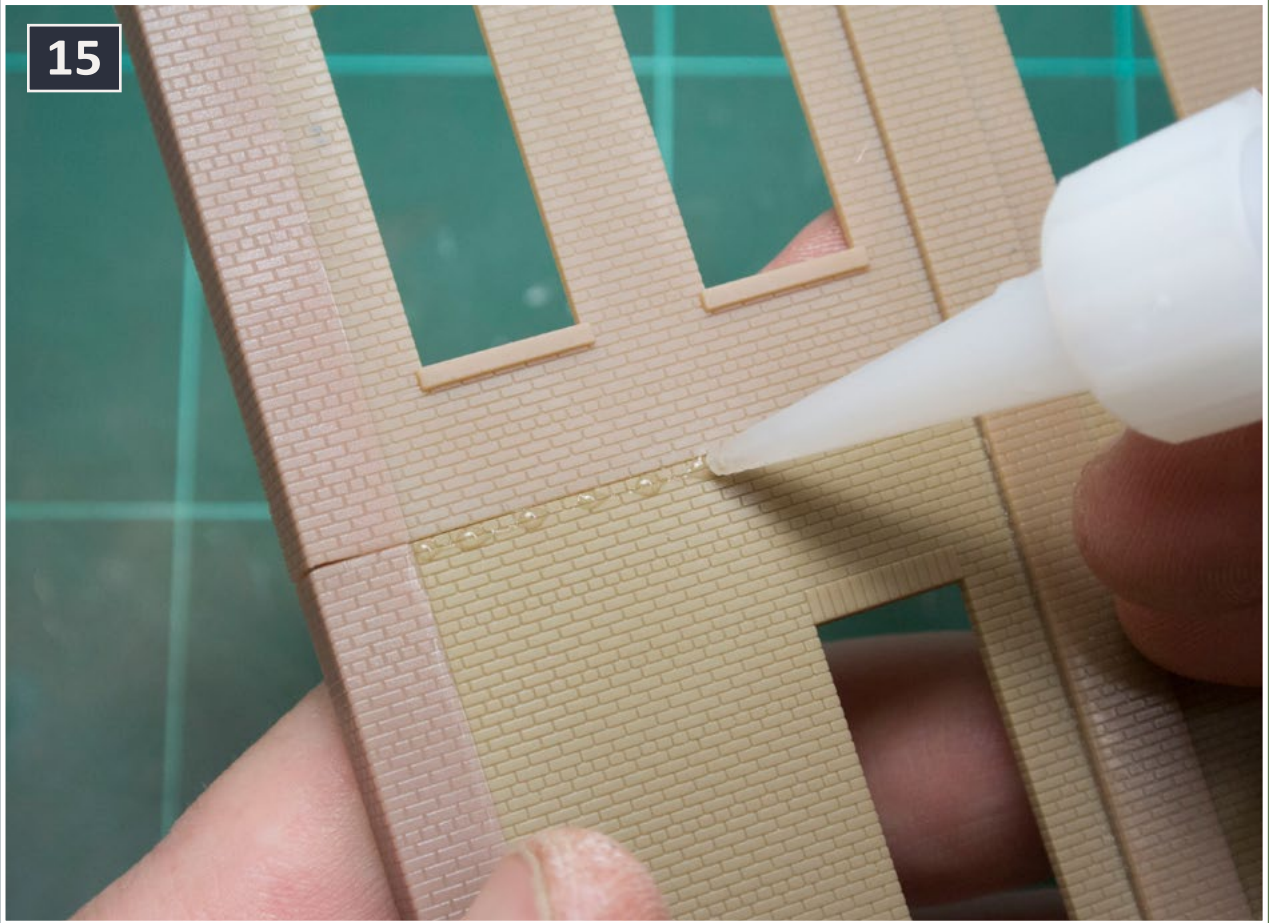

15. Tiny dots of CA are all that are needed. Use too much and the glue will squeeze out onto the finished brick surface.



contents



index

## STEP 5: Gluing the internal cap detail *Continued ...*

16

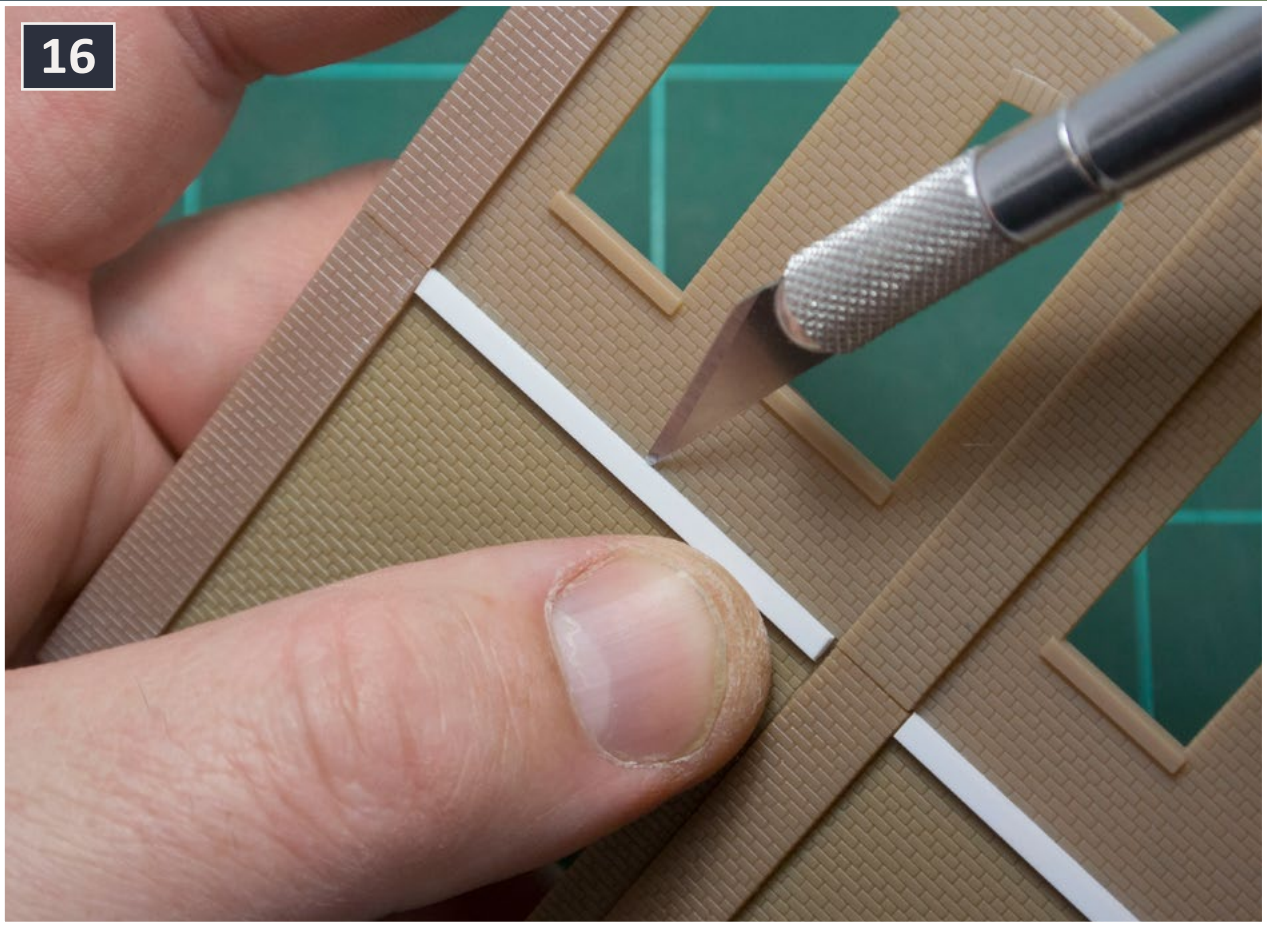

16. Place the section so the top part of the styrene piece is flush with the actual gap. Be sure all of the caps are lined up across the face of the building.



## STEP 5: Gluing the internal cap detail *Continued ...*

17

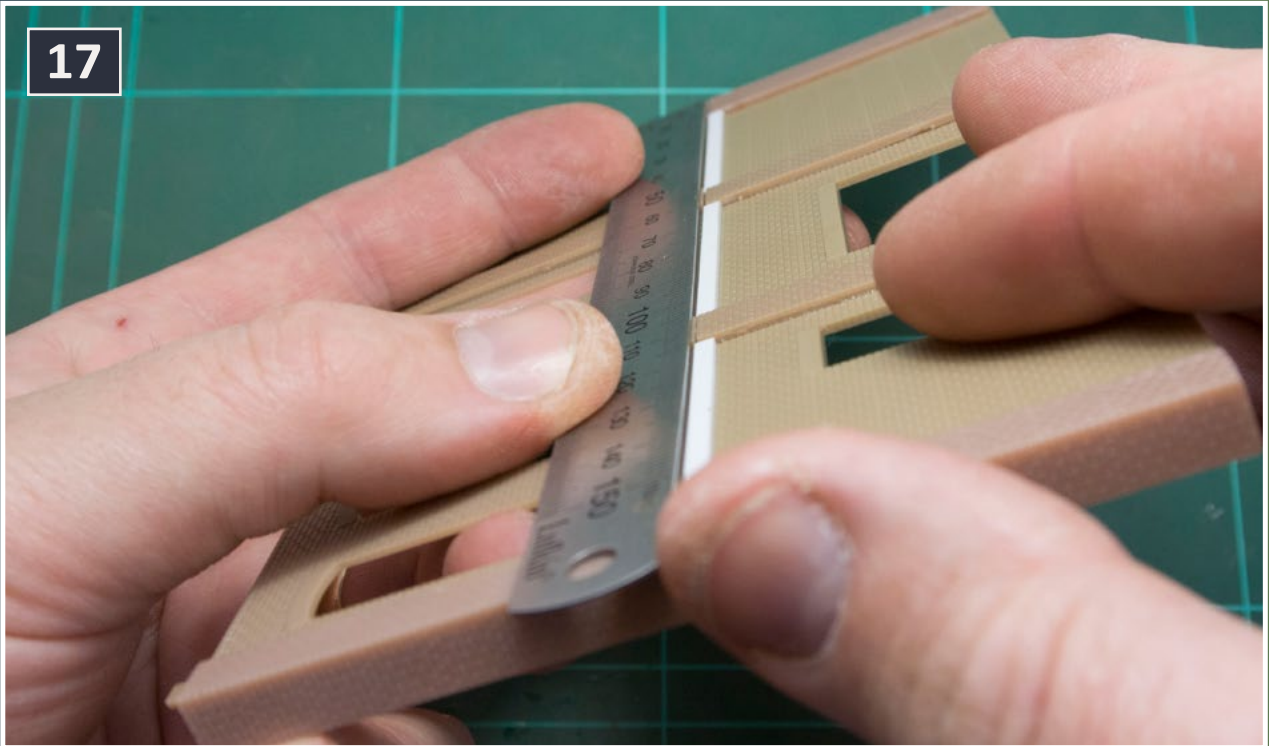

17. Align the sections using the modular brickwork as a guide, and a metal ruler as a final check.

Advertisement

# Railroad Explorer Magazine

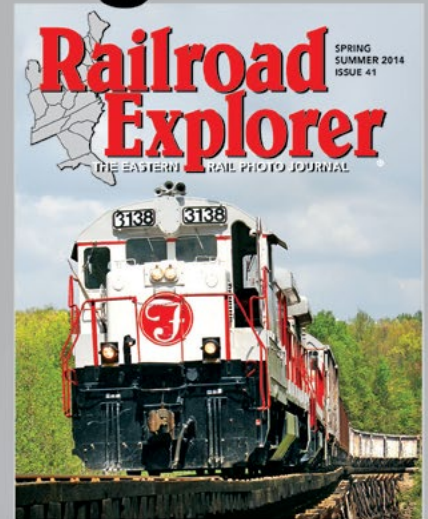
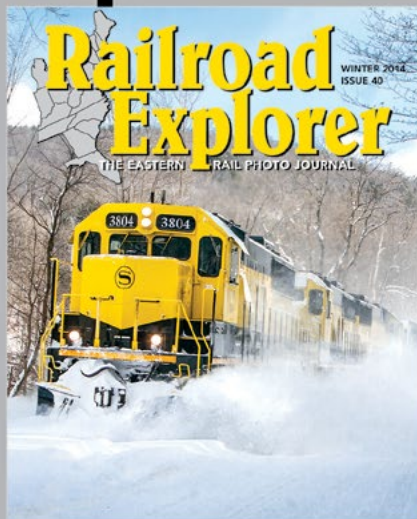
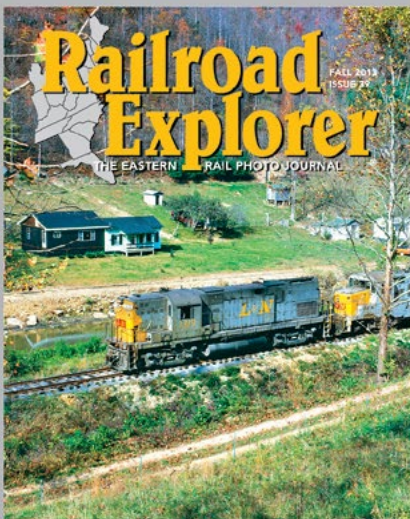

## THE EASTERN RAIL PHOTO JOURNAL

- Three all-color issues per year. Exciting feature stories and spectacular photos of Eastern Railroading
- Best-in-class photo reproduction. Printed on heavy, glossy paper. Zero advertising.
- Three times per year - Winter, Spring/Summer and Fall editions.

**Subscribe today!**

[www.railroadexplorer.com](http://www.railroadexplorer.com)



Email



Phone



contents



index

## STEP 5: Gluing the external cap detail

18

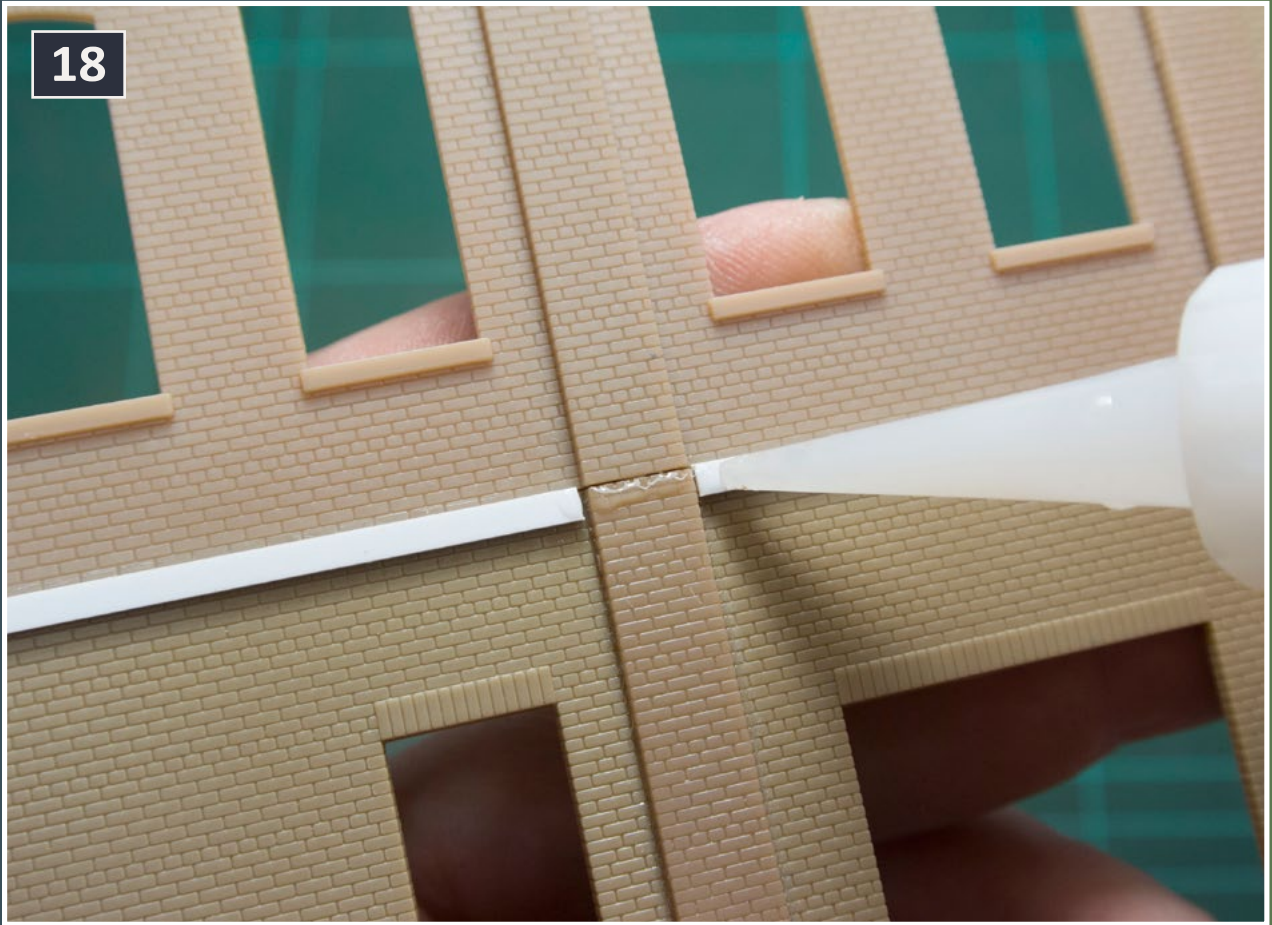

16. Place the section so the top part of the styrene piece is flush with the actual gap. Be sure all of the caps are lined up across the face of the building.



## STEP 6: Gluing the external cap detail *Continued ...*

Glue the external sections onto the columns. These sections overlap the internal sections and help tie the whole effect in place. They also hide the small gaps in between the columns and internal sections. Again, use CA glue and a metal ruler to ensure that everything lines up and is plumb.

These sections need to overlap the internal ones by one millimeter.

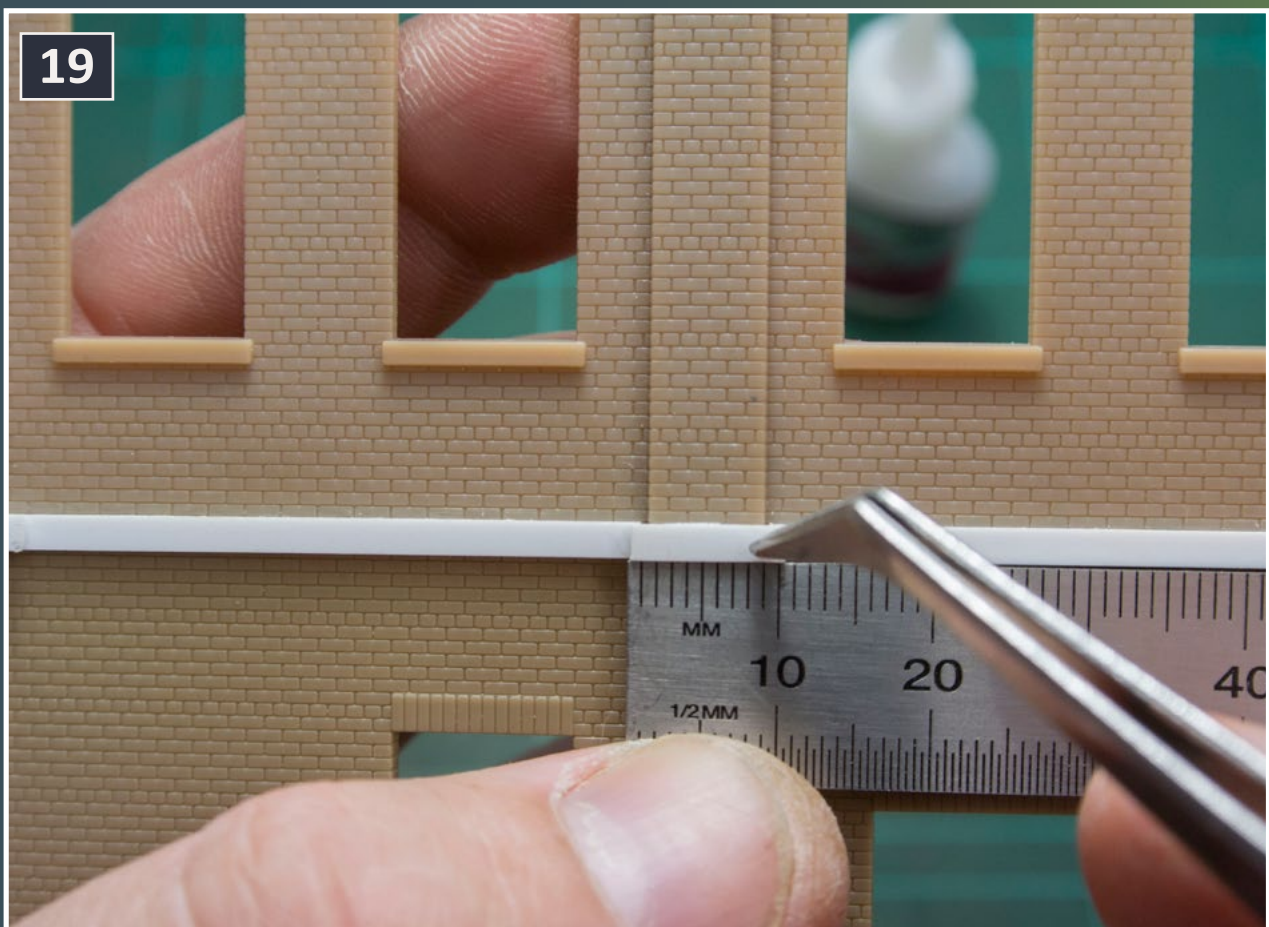

**19.** Align the sections using the modular brickwork as a guide, and a metal ruler as a final check.



contents



index

## STEP 7: Finishing the cap detail

Install further sections where gaps are present. Gaps can also present themselves along the top seam of sections where they meet the parapet sections of the modular kit. If the gap is there, follow the process used on the internal vertical sections.

20



20. Finish installing the sections where gaps are present. The caps give the building walls a strong, unified appearance.



## STEP 8: Painting and weathering

I find it easier to paint the entire structure with the base color first. This is a personal preference due to the way that I weather my structures, and the fact that I can paint the sections by hand quite easily.

Because the add-on trim parts are white styrene, primer allows me to use only two coats of the final color, as opposed to several coats if they are not undercoated first.

21



21. Paint the entire structure with the base color to prepare it for detail painting and weathering.



contents



index

## STEP 8: Painting and weathering *Continued ...*

I paint the completed sections all by brush. Masking to use an airbrush would take double the amount of time.

The brick color is very stark. This is dulled considerably when the weathering powders and/or washes are added.

22



22. The brick color is very stark, but comes alive when weathering powders and washes are added.



## STEP 8: Painting and weathering *Continued ...*

I generally use PollyScale “Aged Concrete” acrylic paint for the detail sections. This is a light gray with hints of yellow. Painting by hand gives it a weathered effect, as the base color shows through in places and adds a nice variety. After the structure has been painted, weather with either a wash and/or weathering powders.

23



23. PollyScale “Aged Concrete” highlights the detail. Painting by hand gives a slightly uneven finish as the base color shows through and adds variety.



contents



index

24



24. Washes of darker, grimy colors blend the different tones, and weathering powders finish off the “well-used but well-maintained” look.



**Reader  
Feedback**  
(click here)





## Tools

Sprue cutters  
Needlenose pliers  
Tweezers  
X-Acto knife  
Pencil  
Ruler (various sizes)

## Materials

Walthers - Cornerstone  
Series, Modular Kits:  
Wall Columns & Caps  
Walthers # 933-3725  
Small Walls w/Large Metal  
Sash Windows  
Walthers # 933-3732

## Evergreen Scale Models:

HO scale strip, 4 x 6, .043" x  
.066", 1.1mm x 1.7mm, Part  
No - 8408 (Pack of t 10)

## Bob Smith Industries:

CA Glue Maxi-Cure  
Accelerator Insta-Set

## PollyScale Acrylic Paints:

Aged Concrete  
Special Oxide Red  
Roof Brown  
D&H Grey

## AIM Weathering Powders:

Sand  
Dirty White  
Grimy Black

*Advertisement*



**Rusty Stumps**  
Scale Models

WE ONLY SELL WHAT WE MANUFACTURE

**DETAILS** IN HO, O, S  
& N SCALES

LASER CUT SHINGLES, DOORS & WINDOWS,  
FENCES, SIDING, CRATES. Also RESIN and  
WHITE METAL DETAILING CASTINGS.

**CRAFTSMAN KITS**  
IN HO, O & S SCALES

CHECK IT ALL OUT AT  
**WWW.RUSTYSTUMPS.COM**

Send \$3.50 for Catalog - Specify Scale

**RUSTY STUMPS SCALE MODELS**

6785 Cherry Blossom W. Dr., Fishers IN 46038

Phone (317) 595-9489







Jason, 41, lives in Diamond Creek in Victoria, Australia. He is married to Linden and has two sons, Lachlan (7) and Toby (3) with Labrador Becks, and Cat Annie. He is a full time Leading Firefighter in Victoria, and when not working, spends his time looking after the boys, holidaying down the coast with the family and working on the layout.

Jason got his start in model railroading about three years ago after Linden told him “to get a hobby.” He still thinks she regrets making that statement, but she is a very supportive wife and knows how much he enjoys this. The layout is being built to enjoy quality father and son time with Lachlan and Toby, hopefully giving Lachlan who is autistic and intellectually disabled something to do later on in life at home with his Dad.

### Advertisement

# Rslaserkits

Coming soon in HO and N scales

Courter Building Supply & Manufacturing

Custom Milling, Furniture and widows

Building was across

the tracks from

Cobleskill Coal

in Cobleskill, NY

Dealers welcome

Salem, OR

503-371-4290



Custom Laser Cutting

and design

Sales@rslaserkits.com







**Many species of  
Conifer trees available!**

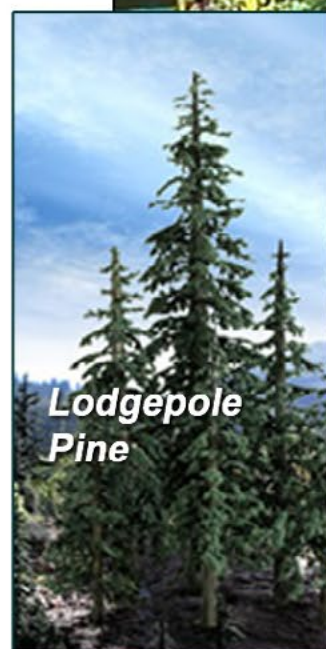

**Lodgepole  
Pine**



**Green  
Spruce**



**Blue  
Spruce**

**Also see our other  
conifer offerings ...**





Delivery May 2015

# Bowser

## EXECUTIVE LINE

### HO N8 Caboose

Features: Assembled, window glass, separate grab railing, metal wheels, and where indicated Train Phone antenna (designed using the PRR drawings).

MSRP: with Antenna \$35.95 each

Without Antenna \$27.95 each

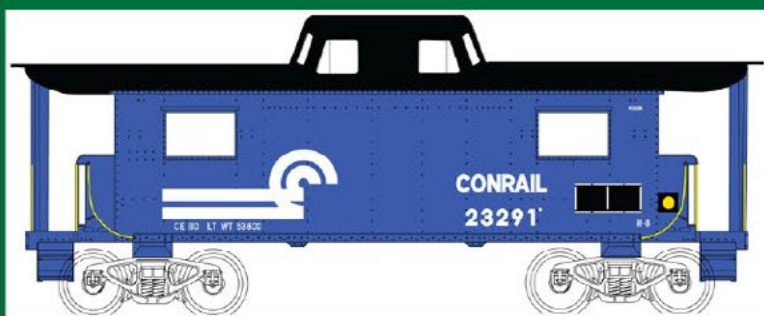

Conrail

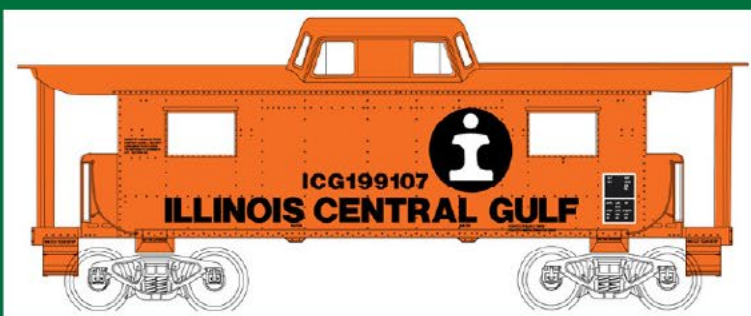

ICG 4 Paint Schemes



Penn Central 3 Paint Schemes



PRR 5 Paint Schemes



PRR 5 Paint Schemes

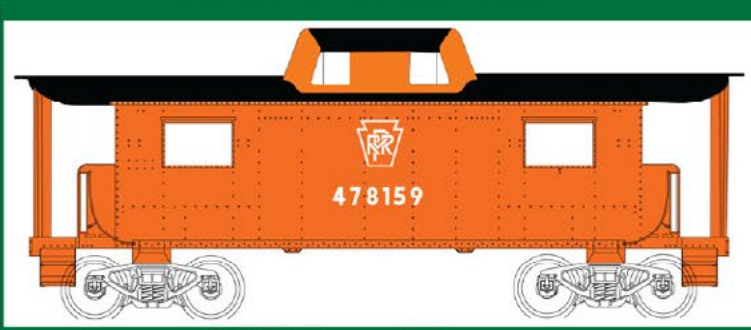

PRR Focal Orange

Click here to check out the details for these and other great Bowser products!

[www.bowser-trains.com](http://www.bowser-trains.com)







# Iowa Scaled Engineering

## Fast clock

by Joe Atkinson

 [Reader Feedback](#)   
(click here)



### 1. The master unit in use at my dispatchers desk.

I am not a fast clock guy. My layout is about the last place you'd imagine needing one, since I model a small regional railroad with very laid-back operations. I didn't want my crews to feel pressured by a fast clock, or to make their moves too quickly in order to beat the clock.

Imagine my surprise, then, when they began asking me to install a fast clock. Apparently, their absence added some pressure. They assumed the time must be later in their shift than



it really was, and they began struggling with the temptation to operate unprototypically fast in order to get things done. They also told me it was just nice to know the scale time of day as it adds to the realism of the job they're doing. They may have just eaten dinner before they arrived, but if a fast clock tells them it's now 6:15 a.m., that helps to transport them into the illusion I'm trying to create.

So, I began shopping for a fast clock system. I was quickly reminded of the need to string wire for them. Wiring might be my least favorite part of the hobby. The idea of a clumsy guy like me wiring fast clocks near finished layout scenes just seemed like asking for trouble. With all the wireless devices available today, I was wishing that someone had applied that technology to fast clocks.

Fortunately, someone has. Michael Petersen of Iowa Scaled Engineering (ISE) saw my pleas for help on the Yahoo



**2. Master clock in Hold mode, also showing my chosen fast clock ratio of 4.2/1.**





### 3. Here's the master clock with the three start times I have configured.

Proto-Layouts list. He and ISE co-owner Nathan Holmes contacted me regarding a wireless fast clock system they were developing, the only such system on the market. They later provided a beta system for me to try out and asked me for objective feedback.

From the outset, I was extremely impressed. The ISE Fast Clock system is exactly what I hoped for, but easier to configure and use than I ever would have imagined. I especially enjoyed the ease of installation. I went from taking the system out of the box to having it configured and running in around 20 minutes. The master unit plugs into a wall outlet and each secondary display has a simple two-wire power connection to either a DCC bus or DC power supply. I run DCC, so I wired mine to my bus through an adapter.



ISE provides excellent documentation in the form of a PDF manual, but configuration of the system was so simple and intuitive that I didn't even consult the doc when setting mine up. Their system supports, among other things, 12 or 24 hour time display formats individually configurable for real time and fast time, "Hold" mode for time out during an operating session, and an unlimited number of secondary display clocks. The fast clock ratio is configurable down to tenths, supporting values from 1.0/1 to 99.9/1. I simulate a 10½ to 12 hour prototype day in about a 2½ to 3 hour session, so I set my ratio to 4.2/1 (10.5 divided by 2.5 = 4.2).

One of my favorite features of the ISE Fast Clock is a testament to ISE's desire to listen to customers and incorporate feedback. During initial discussions, I was asked what I'd like to see in a



**4. One of two slave clock locations in my main layout room.**



# IOWA SCALED ENGINEERING

Put the easiest-to-use,  
most advanced fast  
clock on the market to  
work on your model  
railroad.



Master clock



Remote clock



Unlimited remote clocks  
function wirelessly!

Visit us at: [www.iascaled.com](http://www.iascaled.com)



- Any fast clock ratio from 1.0:1 to 99.9:1
- 12 or 24 hour time display formats
- Three configurable start times
- "Hold" mode for time out during an operating session

TO LEARN MORE,  
CLICK HERE



# END OF TRAIN DEVICE

FLASH CIRCUIT  
UNDER TRUCK

TRACK  
POWERED



READY TO RUN!

**Bright Red  
Flashing Light!**

Installs in minutes  
with no freight car  
modification required!

**RE RING**  
ENGINEERING

Patented Technology - US Patent 7,549,609

Does not affect Load!

↓ Car without Load ↓

↓ Car with Load ↓



For video  
and more  
click here!





5



## 5. The installation in [4] from a distance of approximately 15 feet.

fast clock system. The only item on my list that ISE didn't already support was the ability to configure multiple start/reset times. Rather than always resetting to midnight and manually forwarding the clock to the start time for your operating session, the user would configure multiple start times of their own. My operating sessions are meant to represent only a portion of a day, and I wanted to be able to reset to one time to represent the start of my morning session, and another time for my afternoon session. ISE responded by adding the ability to configure up to three custom start/reset times, each easily selected with its own assigned button [5].

Another example of ISE's responsiveness occurred during testing. I found that the secondary display units were sometimes losing signal due to the one-foot-thick brick walls in my basement, between the secondary and the master. ISE provided more robust wireless units for the secondary units, solving the problem.



For me, the most difficult part of installing the system was finding the best locations for the secondary displays. They're readable from 15 to 20 feet away and probably farther, but in an old house like ours, with the basement layout space divided into multiple rooms, finding spots where two secondary units were sufficiently visible was a challenge. I eventually found locations where each could be seen throughout its respective room, and even from some vantage points in the other. Since the ISE system supports an unlimited number of secondary clocks, another option to increase visibility is to simply add more displays: [4], [5], and [6] are photos of my installations.

I was extremely impressed with the Iowa Scaled Engineering Fast Clock system, and can't say enough great things about it. For a knuckle-dragger like me who's a complete electronics neophyte, the ISE wireless fast clocks could not have been more simple to install. Whether you're in the market for a fast clock system, or you're like I was and think you have no need for one, this is the product for you.

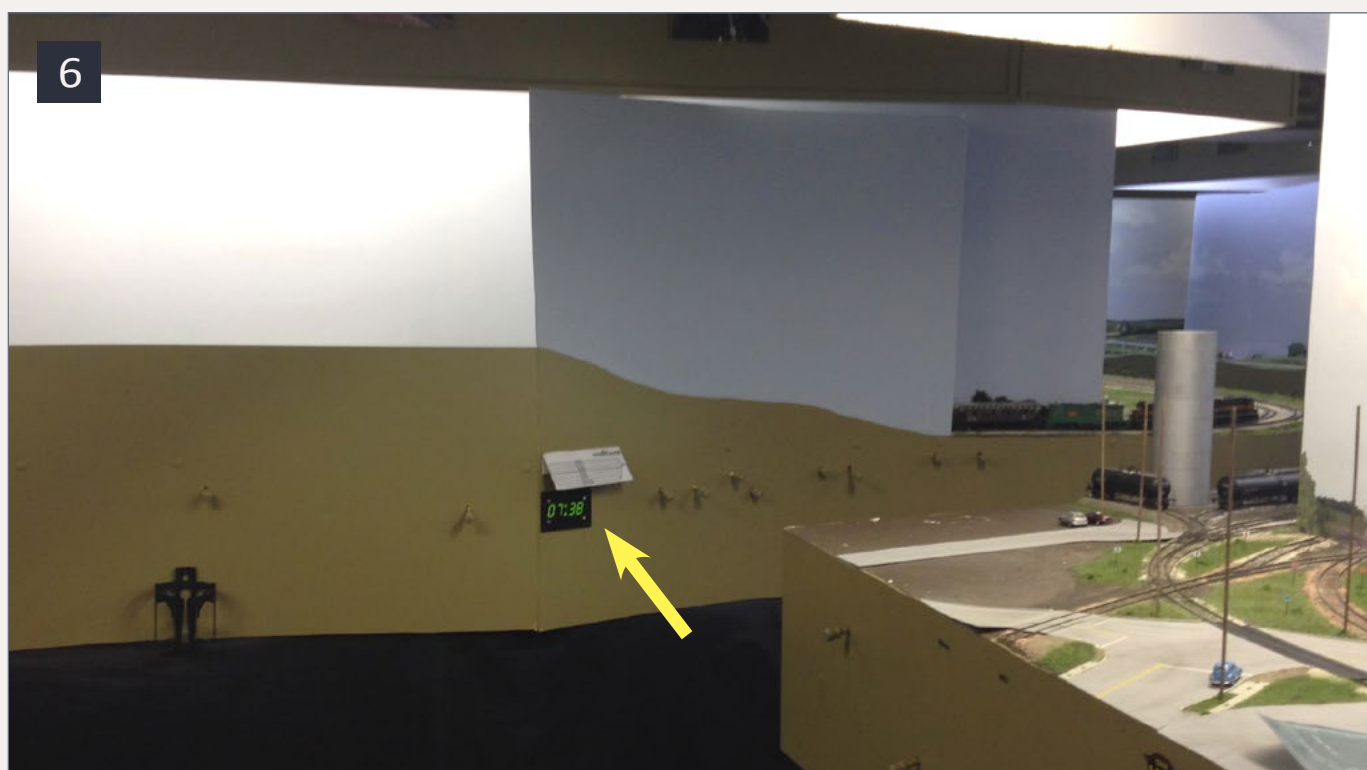

**6. My second slave clock location, just outside the staging yard.**



contents



index

The Iowa Scaled Engineering (ISE) Fast Clock is available through the ISE store at [iascaled.com/store/ModelRailroad/FastClocks](http://iascaled.com/store/ModelRailroad/FastClocks). The wireless master unit is \$125, while the secondary units are \$75 each. A wired version is also available, with the master and secondary units being \$25 less each. 



Joe Atkinson is a Principal Engineer working for an electronic payments software provider. He and wife Kim have two grown children. Joe's other interests include bicycling, sports, and Bible study.





# The Amherst Railway Society Railroad Hobby Show

Our 2015 Show will be

# January 24 & 25, 2015

## Save the dates!

### About The Show

Every year late in January or early in February, the Amherst Railway Society holds its Railroad Hobby Show at the Eastern States Exposition Fairgrounds (The home of The Big E) in West Springfield, Massachusetts. More than 25,000 railfans and public attended the Show each of the past three years.

The event features real life railroads and scale model railroads, historical societies, travel agencies, art shows, flea market dealers, importers, manufacturers and photographers. You have to see it to believe it!



**Click  
to learn  
more ...**





# HO EMD GP35 Diesels In All New Roadnames

Now Arriving  
At Your Local Dealer



80-2230-1 Chessie GP-35 Diesel with Proto-Sound 3.0

**Features Include:**

- Intricately Detailed ABS Body
- Metal Chassis
- Metal Body Side Grilles
- (2) Engineer Cab Figures
- Authentic Paint Scheme
- Metal Wheels and Axles
- RP25 Metal Wheels
- (2) Operating Kadee Compatible Remote Controlled Proto-Couplers
- Prototypical Rule 17 Lighting
- Directionally Controlled Constant Voltage LED Headlights
- Lighted Cab Interior
- Illuminated Number Boards
- Powerful 5-Pole Precision Flywheel-Equipped Skew-Wound Balanced Motor
- Locomotive Speed Control In Scale MPH Increments
- Operates On Code 70, 83 and 100 Track
- 1:87 Scale Proportions
- Built-In 28-Function DCC Decoder
- Proto-Sound 3.0 With The Digital Command System Featuring Freight Yard Proto-Effects
- Operates On 18" Radius Curves



HO TRAINS THAT DO MORE



[www.mthHOtrains.com](http://www.mthHOtrains.com)

Check out the latest roadnames offered in our HO GP35 diesel locomotive at your local M.T.H. Authorized Retailer. You'll find a state-of-the-art locomotive outfitted with a powerful five-pole skew wound flywheel equipped motor, LED lighting, remotely operated Kadee® compatible couplers, user-installed Kadee® replacement couplers, full digital sound and a 28-function DCC decoder with Advance Consisting, Feature Mapping and Speed Mapping make this and all M.T.H. diesel locomotives HO's best motive power value.

©2014 M.T.H. Electric Trains





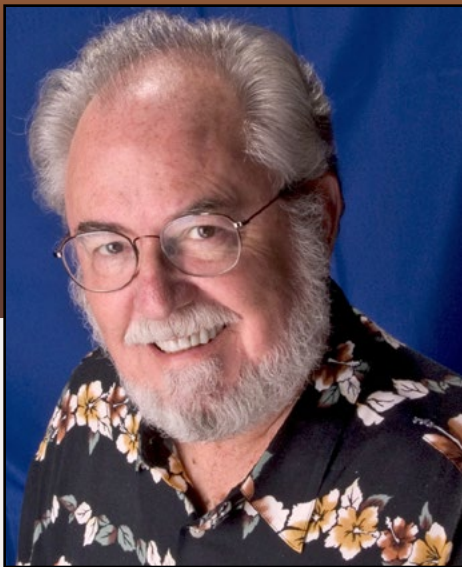

*The Old  
Yardmaster*



**Reader  
Feedback**  
(click here)



## **November 2014: The latest model railroad products, news & events**

*by Richard Bale and Jeff Shultz*

### **Famous layouts to be auctioned**

Four professionally built display layouts will be auctioned on November 11. The best-known of the four is “The Station,, an extravagant layout that has been displayed in the lobby of the Citigroup Center building in New York City during the Christmas season for nearly two decades. Collectively the four layouts are valued at about \$1.5 million. The auction will be conducted online, and live in Pottersville, NY. Complete details including photos are available at:

[adamsauctions.com/live/documents/370/Railroadsonparade.pdf](http://adamsauctions.com/live/documents/370/Railroadsonparade.pdf) ...

**Classic Metal Works** is finishing the tooling for an HO scale 1960 Ford truck which will eventually be available in a variety of configurations including pickups, utility, stake bed, flat bed, and more. CMW has put a call out for prototype photos or diagrams of trucks decorated for any of America’s major railroads. CMW will provide a sample gratis to anyone who submits art the



company is able to use. For additional information contact Bill Giacci at [billg@classicmetalworks.com](mailto:billg@classicmetalworks.com) ...



In support of Breast Cancer Awareness, Kadee is selling a special pink coupler key chain. The special key chain sells for \$3.00 with all proceeds going toward the

Breast Cancer Survivor Fund. To order go to [kadee.com/store/index.php?main\\_page=product\\_info&products\\_id=828](http://kadee.com/store/index.php?main_page=product_info&products_id=828) ...

---

## NEW PRODUCTS FOR ALL SCALES

Atlas Model Railroad Company at [shop.atlasrr.com/d-115-sales-and-specials.aspx](http://shop.atlasrr.com/d-115-sales-and-specials.aspx) is selling a large assortment of N, HO, and O scale items consisting of discontinued models, items displayed at trade shows, preproduction samples, and shells for both locomotives and other rolling stock. To view the listing go directly to the above website.

---

**The Milwaukee Road Historical Association ([MRHA.com](http://MRHA.com))** is accepting pre-publication orders for “Hiawatha - Nothing Faster on Rails” at \$84.95 including free shipping in the US. After December 1, 2014, the price will be \$99.95 plus \$10.00 shipping. The 250-page hardcover spiral-bound book details the development of lightweight passenger car construction by the Chicago, Milwaukee, St. Paul & Pacific Railroad, and the development of the Milwaukee Road’s lightweight high-speed trains including the Hiawathas of 1936, 1939, and 1942. Over 347 B&W and 20 color photographs, and more than 100 drawings are presented in an 11” x 14” format. Included are HO



scale plans and 26 color side elevations of cars produced by the Milwaukee Shops from 1936 to 1942. The book may be ordered from the company store at the above website.

---

**RP CYC Publishing Company** (PO Box 451, Chesterfield, MO 63006-0451) has released Volume 29 of the Railway Prototype Cyclopedia. This volume includes two exhaustive studies: World War II Emergency Composite Hopper Cars, and ACF Carbuilders End 50-ton, 40' 6" Box Cars. More details about Volume 29 can be viewed at [rpcycpub.com/v29.html](http://rpcycpub.com/v29.html). The book has an MSRP of \$29.95. It is available direct or through hobby dealers.

---

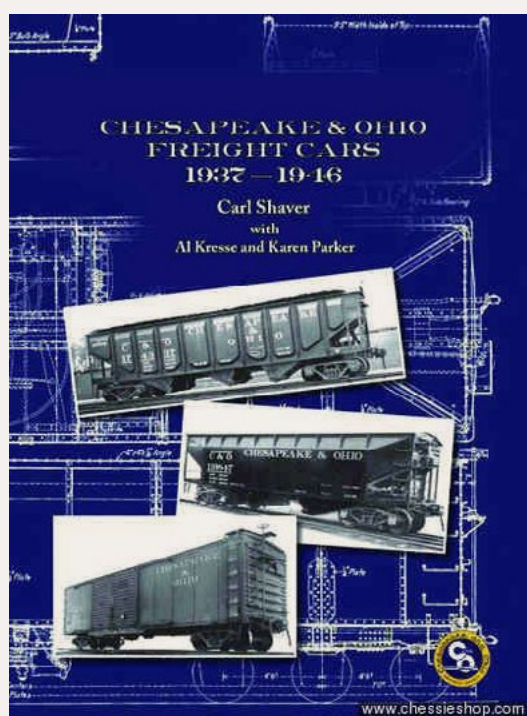

**The Chesapeake & Ohio Historical Society** ([chessieshop.com](http://chessieshop.com)) is selling a new book titled "C&O Freight Cars 1937-1946." Co-authored by Carl Shaver, Al Kresse, and Karen Parker, the 224 page hardcover book covers provides details on all 77 classes of freight cars on the C&O roster between 1937 and 1946. Over 300 drawings and photos are included. The book is available through the above website at \$34.95.

---

**Morning Sun Books** ([morningsunbooks.com](http://morningsunbooks.com)) has released three new all-color books including "Trackside around San Francisco 1956-1976" by Donald V. Jewell, "Delaware & Hudson Facilities In Color" by Chuck Yungkurth, and a new book by Douglas Peters, "Red Arrow Lines In Color," that documents



contents



index

the Philadelphia suburban transit system that used equipment ranging from Brill Bullets to former North Shore Electroliners. Visit the website for details.

---

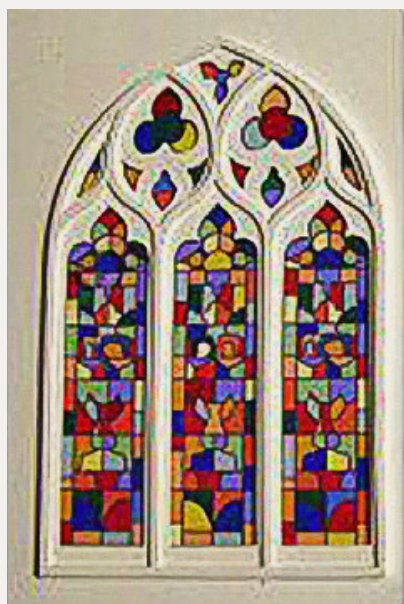

**York Modelmaking** ([yorkmodelmaking.co.uk](http://yorkmodelmaking.co.uk)) is a UK-based firm that supplies a wide range of laser-cut architectural components in N, OO, S, and O scale. Recent additions include church windows and self-adhesive Cornish slate roofing tiles. Visit the above website for ordering information and a look at an interesting assortment of items for scratchbuilders.

---

## O SCALE PRODUCT NEWS



**Atlas O** ([atlaso.com](http://atlaso.com)) plans to release O scale ready-to-run models of 60' auto parts box-

cars in the second quarter of 2015. American Car & Foundry began building the prototype in the late 1960s to provide more efficient service between assembly plants and auto parts suppliers. Atlas will offer both single and double-door versions of the model. Cars with single doors will be available decorated for Conrail, SSW-Cotton Belt, and Norfolk & Western. Double-door versions will include Detroit, Toledo & Ironton; Canadian National; and Chesapeake & Ohio. Three-rail models will have an MSRP of \$64.95 with two-rail versions listing at \$69.95.

---





**Boulder Valley Models ([bouldervalleymodels.com](http://bouldervalleymodels.com))** has reissued body kits for its popular On30 Mighty Midget 5-ton industrial switch-

ers. Both M1 offset-cab (right) and M2 center-cab have been reissued. Availability is limited and BVM cautions that locating a suitable power truck may be a challenge. Visit the above website for full details.

---

## S SCALE PRODUCT NEWS



**P-B-L ([p-b-l.com](http://p-b-l.com))** is taking reservations for a new production run of D&RGW narrow gauge K-36 and K-37 Mikado locomotives. The brass Sn3 scale narrow gauge steam locomotives will be handcrafted in Korea. Availability is expected late next summer. Number 492 shown here is from a previous production run. Preproduction pilot models are expected to be available for review at the Sn3 Symposium to be held in Seattle, WA in April 2015.

---



contents



index

# HO SCALE PRODUCT NEWS



Accurail ([accurail.com](http://accurail.com)) has scheduled a number of HO scale kits for release late this month or early in December. The 89' partially enclosed auto carrier will be available with a Chicago North Western rack mounted on a TTBX Trailer Train flat car. This kit (item 9413) will have an MSRP of \$23.98. All Accurail kits include appropriate trucks and Accumate couplers.



Another car from the contemporary-era is this 50' Montana Rail Link steel boxcar with exterior posts. The kit

(item 56421) has an MSRP of \$16.98.

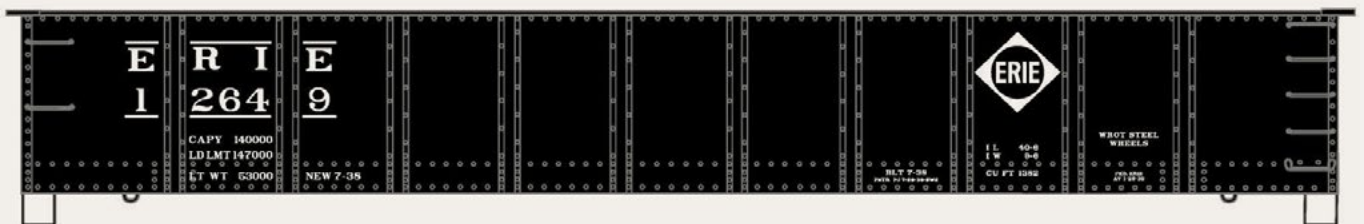

Accurail has released this Erie 41' AAR 11-panel steel gondola as an individual kit (item 3755) at \$16.98 and as a 3-pack (item 37554) with three different road numbers at \$49.98.

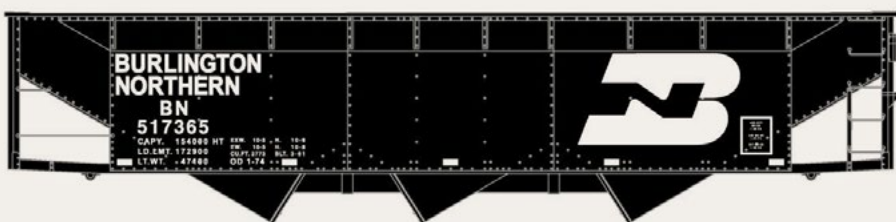

Accurail's HO scale kit for a BN triple-bay hopper with offset sides is



based on an AAR design for 70-ton coal haulers. Between the late 1930s and early 1970s tens of thousands of these cars were in use by a large number of North American railroads. The HO scale kit features realistic Wine hopper doors and locking handles, Bettendorf-type solid-bearing trucks, and an AB brake system including a nicely-rendered Equipco brake wheel. In view of current prices, Accurail's MSRP of \$16.98 for this kit (item 7549) makes it an excellent value.



Accurail's kit for a 40' six-panel single-sheathed boxcar lettered with data only is back in stock. The kit is available in both

mineral red (item 7298, above) and oxide red (item 7299). The kits have an MSRP of \$16.98 each.

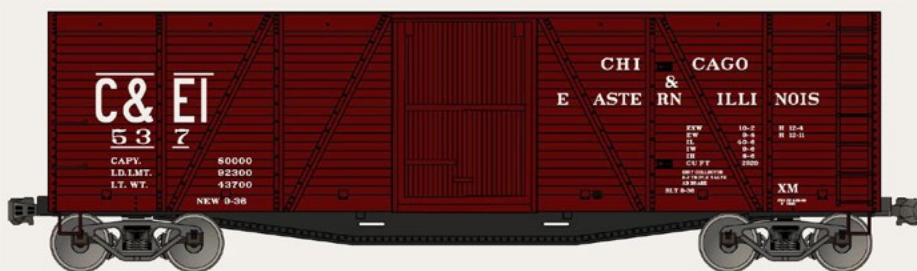

HO scale kits with decorated versions of 40' six-panel single-sheathed boxcars include

this Chicago & Eastern Illinois car.



Accurail also offers 40' single-sheathed boxcars with eight side panels. The kit for this Richmond,

Fredericksburg & Potomac car has a list price of \$16.98.



contents



index



**Alkem Scale Models ([alkemscalemodels.com](http://alkemscalemodels.com))** is selling a craftsman kit for an HO scale DODX 41000 series flat car. The U.S. Army designed the prototype specifically to transport M1 Abrams tanks that are 12' wide and weigh up to 68 tons.

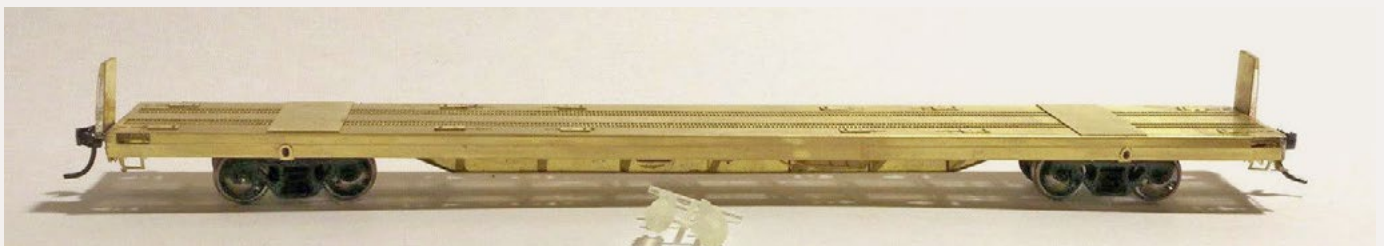

The kit is composed of photo-etched brass, a laser-cut acrylic core, and 3D printed detail parts. The components feature engineered slots and tabs that self-jig and simplify assembly with CA. No soldering is required. Of note are the photo-etched chains, tie-downs, shackles, and rings that come with the kit along with appropriate decals. Couplers and trucks (Athearn 100-ton trucks are recommended) are not included. The kit is available at \$39.99 each through the above website. A three-pack of kits is priced at \$99.99. Additional tie-down chains are available separately for \$14.99.

Alkem owner Bernie Kempinski, who took the above prototype photo at Fort Hood, TX notes that Chris Mears, Dave Olsen, and Gene Gounley all contributed to this project.

---

**Athearn ([athearn.com](http://athearn.com))** has scheduled the next release of its Genesis series MP15AC diesel switcher for June 2015. The HO





scale model features an illuminated Stratolite beacon on the cab roof, square air filter box, and Blomberg-B trucks. The switcher will be

available with or without sound. Models decorated for Soo Line will be available with all-weather windows (1532, shown here) or with an all-weather window only on the engineer's side of the cab (road number 1534). Other roads will be CSX (boxcar scheme), GATX, Long Island Railroad, and Nacionales de México.

A Ready-to-Roll series SD45 diesel locomotive is also listed on Athearn's June release schedule. Road names will be Delaware & Hudson, Frisco, Southern Railway, Southern Pacific, Union Pacific, and Norfolk Southern in the Horsehead scheme.

Freight cars coming next June include a 50' steel gondola, an 85' TOFC flat car, and another production run of Athearn's Trinity-built 5161 cu.ft. covered hopper car in both 10-panel and 12-panel versions.



Also set for release in June is a 40' derrick flat car. It will be available for Santa Fe, Baltimore & Ohio, Burlington Northern,

Canadian Pacific, and CSX.



contents



index



For passenger train modelers, Athearn has included a group of Southern Pacific 77' chair cars in its June schedule. The HO scale Genesis series models feature operating diaphragms and constant interior lighting. Paint schemes will include Daylight (seen here), Challenger, Golden State, and SP general service gray. The HO scale models require a 24" minimum radius for reliable operation.



Athearn will release several HO scale Read-to-Roll models decorated for the Napa Valley Wine Train. They include F7A diesel units, a bay-window caboose, and both single and triple dome versions of a tank car. Also a 40' steel boxcar with separate wire grab irons, Youngstown doors, and Dreadnaught ends.







NVWT passenger equipment will be three dining cars (Gourmet Express, Le Petit Gourmet, and Silverado Trail, shown here), two coaches (Zinfandel and Merlot), and two observation cars (Cabernet Sauvignon and Chardonnay). The heavyweight cars have body-mounted McHenry couplers and six-wheel trucks.



Completing Athearn's June release is a Ford C-Series box van with rubber tires, separate steering wheels, and clear window glazing. In addition to the Railway Express Agency scheme shown here, the

trucks will be available for Bekins, Roadway, Penn Yan Express, UPS, and Napa Valley Wine.

---

**Atlas Model Railroad Company ([atlasrr.com](http://atlasrr.com))** reports that it has redesigned its HO scale version of Alco's 1,000 hp S-2 diesel switcher. The hood and cab have been retooled along with the trucks which now have some separately applied details. The



contents



index

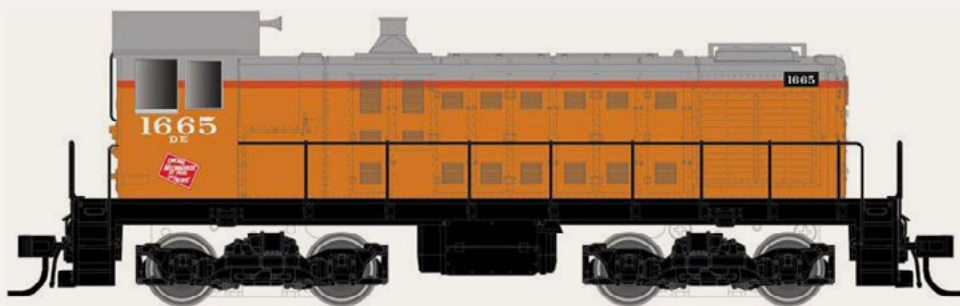

chassis has been redesigned to accommodate DCC and a LokSound

Select Dual-Mode decoder. Road names will be Alaska Railroad, Canadian National, Central of Vermont, Grand Trunk Western, Lehigh Valley, Denver & Rio Grande, Union Pacific, Seaboard Coast Line, and Milwaukee Road. Visit the above website for additional details including pricing.



Beginning in the late 1960s, American Car & Foundry began building 60' boxcars spe-

cifically to provide more efficient service between automobile assembly plants and auto parts suppliers. Both single- and double-door versions of the auto parts cars were built with many continuing in service today. Atlas plans to deliver HO scale ready-to-run versions of the car in the second quarter of 2015. Cars with single doors will be decorated for Conrail, Cotton Belt, Norfolk & Western, and Western Maryland. Double-door versions of the auto parts car will be available for Detroit, Toledo & Ironton; Canadian National, Canadian Pacific (CPAA), and Chesapeake & Ohio. The MSRP will be \$27.95. An undecorated model will list at \$23.95.





Also available from Atlas during the second quarter of next year will be a new release of both single- and paired-window heavyweight coaches. Single-window versions of the HO scale ready-to-run cars will be decorated for Lackawanna, Louisville & Nashville, Nacionales de México, and Great Northern as shown here.



Coaches with paired-windows will be produced for Toronto, Hamilton & Buffalo; Baltimore & Ohio, Florida East Coast, and Union Pacific. Visit the their website for additional details and pricing.



**BLMA** ([blmamodels.com](http://blmamodels.com)) is selling individual Carrier X2 refrigeration units. See your dealer or visit the website for details.



contents



index



**Broadway Limited** ([broadway-limited.com](http://broadway-limited.com)) plans to release its Santa Fe 3800 class 2-10-2 next month. The HO scale model replicates a modernized version of the

steam locomotive with a switching footboard pilot, modified cab, raised running board, and a disc main driver. The hybrid model has an ABS plastic superstructure and a heavy diecast metal chassis.



Another production run of BLI's Pennsylvania Railroad class H10 2-8-0 steam locomotives is scheduled to arrive in January 2015. The HO scale model has

a diecast body and chassis. Both of the new BLI steam locomotives feature Paragon2 Sound and control system. Visit the website for pricing, detailed specifications, and availability of specific locomotive numbers.



**Bowser Trains** ([bowser-trains.com](http://bowser-trains.com)) is booking orders now for the next production run of its HO scale



Pennsylvania Railroad N8 caboose. Orders will be accepted through November 12, 2014 for delivery in May 1015.



Features of the Executive Series ready-to-run model include clear window glass, separate grab irons and railings cast in acetal plastic, PRR trucks

with metal wheelsets, and Kadee #5 couplers. Nineteen authentic decorating schemes will be offered including eleven Pennsy schemes, one Conrail scheme, and three each for Penn Central and Illinois Central Gulf.



Models with PRR trainphone antennas will have an MSRP of \$35.95 each. Models without an antenna will list at \$27.95. This release will be for

ready-to-run models. Bowser also offers many of these same cars in kit form. Visit the website for current availability.

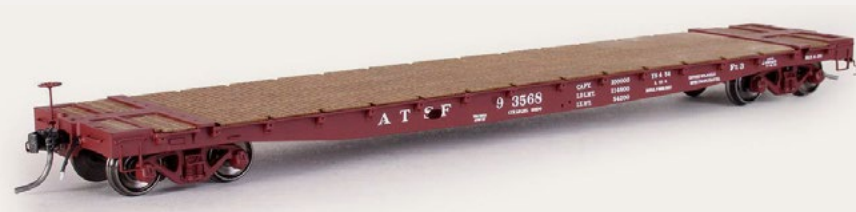

**ExactRail ([exactrail.com](http://exactrail.com))** has released the production version of the HO scale General Steel

Casting 53'6" flat car with 43'3" truck centers we previewed in the August edition of MRH ([mrhpub.com/2014-08-aug/land/#151](http://mrhpub.com/2014-08-aug/land/#151)). GSC constructed the prototype as a single casting



contents



index

resulting in a car that is essentially a single piece of solid steel. The cars were virtually indestructible and many are still in active MoW service more than 60 years after they were built.

ExactRail's model comes with Kadee #158 couplers and ASF 70-ton Ride-Control trucks with 33" machined wheels. The Platinum series flat car is not quite ready-to-run because it comes with separate laser-etched wood decking that is to be applied by the hobbyist.

The GSC 53' 6" flat car with 43' 3" truck centers is available in six paint schemes: Union Pacific in the road's 1962 as-delivered scheme, UP Maintenance of Way car number 59560 with unique artwork on the left and right car sides, UP MoW car number 909447 in UP Kenefick Green paint and labeled for Tie Service, Santa Fe in 1954 as-delivered paint scheme; Santa Fe MoW car number 209098 which is still in service on the BNSF; and Northern Pacific in 1965 as-delivered scheme with separately applied etched builders plates.



Serious modelers have come to expect a lot from ExactRail and this new flat car does not disappoint. The detail work, as seen in this view of the underframe, is noteworthy.

In other news, ExactRail has expanded the selection of individual parts available for scratch-builders and those upgrading other models. The assortment includes door tracks and bars, draft boxes and lids, ladders and stirrup steps, roofs, and underframes. A complete listing is available at the website.





Imagine That Laser Art ([imaginethatlaserart.com](http://imaginethatlaserart.com)) has introduced Grimsby Station, an HO scale structure based on a building that once served the CN/GTR Toronto-to-Niagara Falls main

line in Grimsby, Ontario. Distinctive features of the laser-cut craftsman kit include two styles of “witches-hat” roof turrets. Assembling the kit is simplified by the use of modular wall components with tabs that fit into the platform base. Laser-cut rafters support roof panels with etched shingle detail. Board & batten walls, wainscoting, shingles, and planking on the passenger platform and freight dock are all laser-etched. Platform benches, wood pallets, and the train order signal shown in the photo are all included. As a special service, ITLA will customize the station name board at no charge. Visit the website for pricing and ordering information.

---

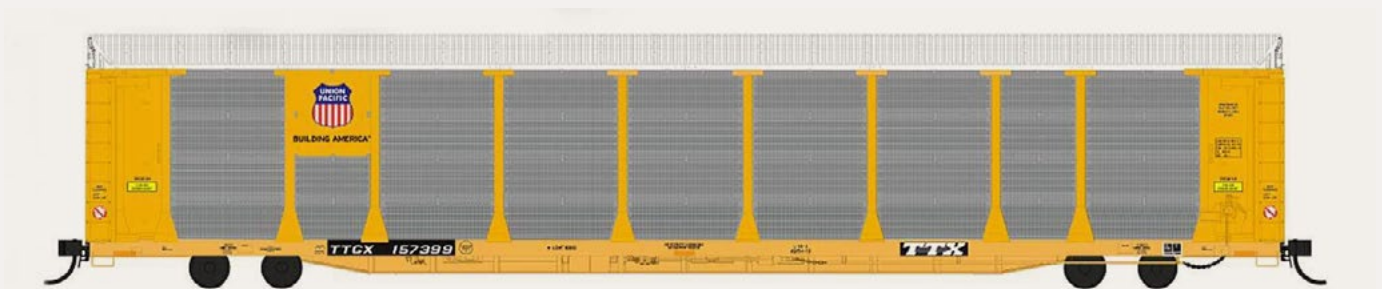

InterMountain Railway ([intermountain-railway.com](http://intermountain-railway.com)) is scheduled to release a new run of 89’ bi-level auto rack cars late this month in early December. Auto racks decorated for Union Pacific (two versions), Ferromex, Southern Railway, and Grand Trunk Railroad will all be mounted on flats with TTX reporting marks. Chessie System-B&O and Soo Line auto racks will be mounted on Trailer Train flats. Also in the run is a car decorated for Providence & Worcester.



contents



index



InterMountain has scheduled a production run of HO scale 40' PS-1 boxcars for release in March.

Models decorated

for Southern (modern scheme, above), Soo Line, Chesapeake & Ohio, and U.S. Air Force will have 8' Youngstown doors. Six-foot Youngstown doors will be on cars decorated for Canadian Pacific, ATSF, and Erie Lackawanna. D&RGW and Union Pacific cars will have a 6' Creco door. All of the cars will have running boards, full-height ladders, and PS "washboard" ends.

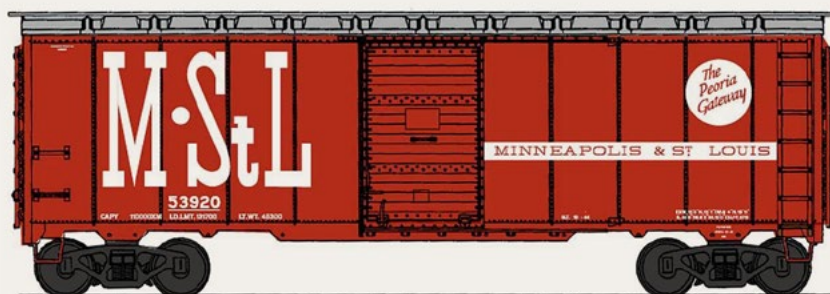

Ready-to-run models of 1937 AAR 40' boxcars are coming from InterMountain in March. In addition to the

Minneapolis & St Louis scheme shown, road names on the HO scale model will include Northern Pacific, Atlantic Coast Line, Central of Georgia, Boston & Maine, Southern Pacific, Norfolk Southern, and Nashville Chattanooga & St Louis.



A production run of R-40-23 refrigerator cars coming in April will include three versions of PFE cars. The original 1947 scheme shown

above has both SP and UP heralds – the latter in color. The roof and ends are red, and the ladders, grabs, door hardware, and side sill are painted black. This scheme is accurate for 1947.





The ladders, door hardware, and side sills of the 1952 version are orange. The heralds have traded position and the UP shield is black and white.



The 1962 version has black ends and undercarriage and a silver roof. Newly designed heralds have been repositioned and the lettering has been changed to modern Gothic. InterMountain will also offer this model decorated for Armour, MDT, and Northern Pacific.

InterMountain will also offer this model decorated for Armour, MDT, and Northern Pacific.



The initial product from InterMountain's recently announced "Value Line" will

be 14-panel Coalporter cars. The HO scale models will be produced from upgraded tooling previously used by LBF and E&C models. The bolsters have been redesigned and the new ready-to-run model will be equipped with InterMountain 100-ton trucks with 36" wheels. It will also have factory installed Kadee trucks. A release date of May/June 2015 is scheduled for the Coalporters. Although still not firm, the MSRP is expected to be about \$26.95. In addition to the Portland Gas & Electric (rose) car shown here, announced road names include BN, Canadian National, Oklahoma Gas & Electric, Union Pacific, American



contents



index

Electric Power, Kansas City Power & Light, Central Illinois Power, Northern Indiana Public Service, and Somerset Railroad.

---



**Kadee** ([kadee.com](http://kadee.com)) is working on an HO scale Boston & Maine 50' PS-1 boxcar for release in December. The model replicates a

prototype car built in 1956 with 12-panel welded sides, Pullman Standard dart-less ends, and 9' Youngstown sliding doors. Note the absence of tabs on the side sill. The model will be decorated in B&M's blue and black repaint circa 1971. The production run will be completed by the time you read this report. We understand that quantities will be limited and the ready-to-run model is expected to sell out quickly.



Kadee's January releases include two 40' PS-1 boxcars. The Western Pacific model shown here has 7' Youngstown sliding

doors. It represents a prototype from 1951 with 10 welded side panels, narrow bolster sill tabs, and a high tack board on the PS dart-less "washboard" ends.



The second model scheduled for release in January is also a PS-1 40' boxcar, but this version is fitted with five-panel Creco sliding doors. The decorating scheme duplicates an



11-year-old Vermont Railway car as repainted in 1965. Note the low tack board position on the doors and end, and the wide bolster sill tab. Pricing information is available at the website.



**KatoUSA**

([katousa.com](http://katousa.com))

has announced a new production run of EMD GP35 Phase 1a diesel

locomotives. Road names for the HO scale ready-to-run model will be Santa Fe and New York Central with prototype appropriate dynamic or non-dynamic brake hatches. The models will be available as both standard analog for DC operation or with non-sound DCC installed. An undecorated version of the GP35 will be available to dealers on a preorder basis only. It will come with both styles of roof hatches. Delivery is expected early in 2015.

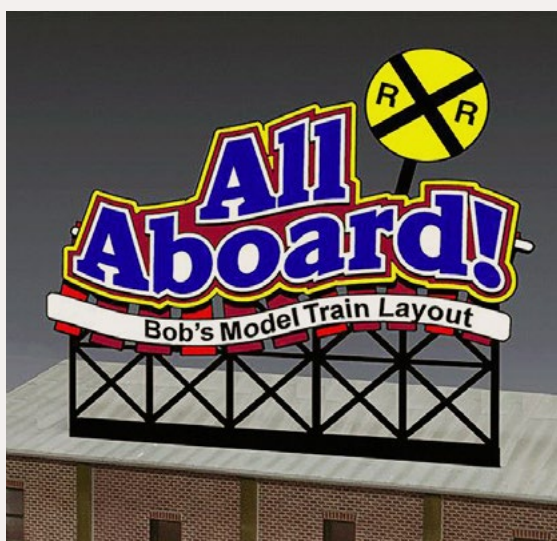
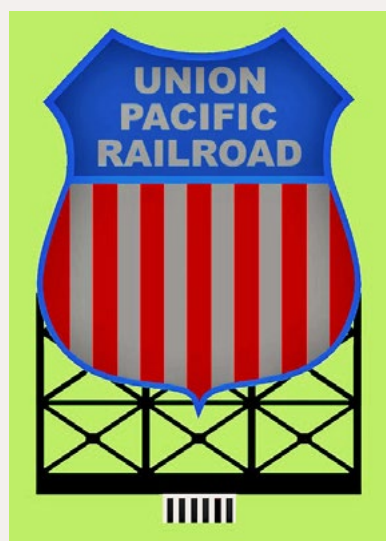

**Miller**

**Engineering**

([microstru.com/index.html](http://microstru.com/index.html))

has released a new version of its flashing Union Pacific billboard. It is available in two sizes: 5.4" h

x 3.6" w, and 2.7" h x 1.8" w. The All Aboard sign comes with a lengthy list of men's names printed on peel & stick material



contents



index

that makes it easy to create a custom sign. For additional details including prices and a demonstration of the flashing sign visit [microstru.com/New-Releases.html](http://microstru.com/New-Releases.html).

---

## Monster Model Works

([monstermodel-works.com](http://monstermodel-works.com)) is selling Wormser Furniture Company, an HO scale craftsman kit based on an historic structure in Fresno's Warehouse Row. The sturdy brick structure dates from the first decade of



the twentieth century, reflecting the growth spurred by the construction of the Santa Fe Railroad and the emergence of Fresno, CA as an important agricultural center.

Monster Model Works uses several interesting techniques to create the limited-edition kit; only 100 will be produced. The American Bond brick siding, wrap-around brick cornice and caps, and aged brick corners are all 3D-engraved. The loading dock ramp and drain downspouts are produced by 3D printing. The tar paper roofing, as well as the windows and doors, are peel and stick material. The kit has a stencil for creating the sign on the exterior brick surface. The finished structure is 6.75" high, and has a footprint of 10.687" x 6.125". Visit the website for pricing and availability.

---

**New England Rail Service** (PO Box 1059, Leesburg, VA 20177) anticipates releasing the HO scale 36' wood meat reefer shown here by mid-November. The ready-to-run model is decorated





for Cudahy Car Lines – C.R.L.X. in a scheme accurate for the prototype from the late 1930s until the last of the cars were retired in the early

1960s. Two car numbers are available. Note that the doors on the car have only four hinges on each side rather than the usual six. Additional features of the plastic injection molded model include 40-ton Bettendorf-style solid bearing trucks and separately-applied grab irons and corner stirrups. The model is based on an Atlas Master series product and is correct for the two car numbers offered by NERS. This is a very limited production run. They are priced at \$44.00 each (check or money order) plus \$6.00 shipping for a single car or \$8.00 for two. Questions may be directed to Don Valentine at [newrail@surf-global.net](mailto:newrail@surf-global.net).

---



Reservations are being booked now for another

run of **Red Caboose** 42' fishbelly flat cars. Road names on the tentative production schedule include Baltimore & Ohio, Chesapeake & Ohio, Great Northern, Pennsylvania Railroad, Canadian Pacific, Union Pacific, Chicago & North Western, Southern Pacific, Pere Marquette, Central of Georgia, and Canada Southern. The B&O car shown is from a previous release. InterMountain Railway markets Red Caboose products. Contact your dealer for reservations or InterMountain Railway direct at [intermountain-railway.com](http://intermountain-railway.com).

---



contents



index



**Rivarossi's** new General Electric U25C diesel locomotive is now available from hobby dealers.

Although Rivarossi offered an **HO scale** U25C in the 1960s, this new version has been produced from all-new tooling. The ready-to-run model features separately applied details including horn, handrails, and grab irons, knuckle couplers, and NMRA RP-25 profile wheels. The locomotive has some road-specific detailing and lighting configurations per prototype practice. Both standard DC (DCC ready) and DCC sound equipped versions are available. In addition to the Northern Pacific scheme shown here, the U25C will be available in multiple road numbers decorated for Chicago, Burlington & Quincy; Pennsylvania Railroad; and Atlantic Coast Line.

The Rivarossi brand is owned by the Hornby Group of the UK. Hornby America is a subsidiary of the Hornby Group and is the official importer of the Rivarossi line in North America. For additional information including dealer inquiries visit [hornby-america.com/shop/hornby/rivarossi/diesel-locos](http://hornby-america.com/shop/hornby/rivarossi/diesel-locos).

---



**Roundhouse Division of Athearn** ([athearn.com](http://athearn.com)) has scheduled production of 36' wood stock cars for release in June 2015.

The Ready-to-Roll model has been upgraded with wire truss rods and arch bar trucks with machined metal wheels. In addition to the Chicago Great Western car shown here, road names will include Kansas City, México & Orient Railway; Santa Fe; Canadian National; Denver & Rio Grande; and Clinchfield.

---





Walthers ([walthers.com](http://walthers.com)) is selling a 40' steel boxcar in its ready-to-run Mainline series at an MSRP of \$24.98.

The HO scale model features Dreadnaught ends and wood running boards. Road names include Canadian National, New York New Haven & Hartford, New York Central, Pennsylvania, Union Pacific, and B&O as shown here.



Also available now from Walthers is a Mainline series 40' double-sheathed wood refrigerator car with a horizontal

brake wheel on a vertical shaft.



Road names include Canadian National, Merchants Despatch, Pacific Fruit Express, PFE with a Western Pacific herald, Santa Fe (map scheme), and

ART as shown here with Wabash and Missouri Pacific heralds. The ready-to-run model has an MSRP of \$24.98.



Walthers has released an EMD F40PH diesel locomotive in its ready-to-run Trainline

series. The DC locomotive has an MSRP of \$64.98. Road names are Metrolink, Amtrak, Tri-Rail, and Boston MBTA.



contents



index



53' NSC well cars are scheduled for release in December. The Mainline series models will be sold singly, and in 3-unit sets. Decorating schemes will be CN/GTW, Canadian Pacific, TTX, and TTX new logo. Visit the website for pricing information.



Also due for release next month is a new run of 10,000 gallon 36' tank cars. Decorating schemes on the HO scale Mainline series

models will be Gulf-GRCX, Shell-SCCX, Interstate Fuel & Oil, Standard Oil, Union 76-UOCX and, as seen here, Mobilgas-SVX.

Walthers will soon release an EMD GP15-1 with a DCC decoder and Soundtraxx Sound. Road names will include Chicago North Western (Operation Lifesaver), Burlington Northern (green), Chessie System, Missouri Pacific, and Canadian Pacific.

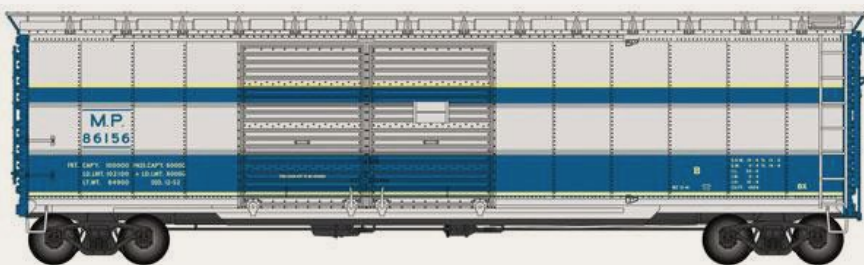

A Proto series 50' AAR boxcar equipped for express service is scheduled for release in

December. Selected

trucks and single or double Youngstown doors will be as appropriate to the prototype. Three Santa Fe cars painted medium green will be offered. All will have double doors. Two of the SF cars (express service and billboard scheme) will ride on Barber S2 trucks. The third SF car (Chief scheme) will be equipped with Allied Full-Cushion trucks. A Kansas City Southern car will have single doors and Barber S2 trucks. Single doors will also be on a Chicago North Western car but it will have Allied trucks. A



Missouri Pacific car (seen here) will have double doors and GSC BX trucks. The MSRP on this Proto series ready-to-run model will be \$39.98.



Walthers is working toward a February release of its Proto series EMD GP60 diesel locomotives.

Road names, with several road specific details, will be Santa Fe (blue and yellow with American flag), Norfolk Southern (black and white horse head scheme), Union Pacific (SSW Cotton Belt patch), and Southern Pacific (speed lettering, above). The ready-to-run model will be available for DC operation at an MSRP of \$199.98. GP60s equipped for DCC operation with a Tsunami sound decoder will list at \$299.98.

---

## N SCALE PRODUCT NEWS



**Atlas** ([atlasrr.com](http://atlasrr.com)) has scheduled another run of its N scale Shay locomotive for release during the second quarter of 2015. Familiar paint schemes in the re-run will be Crown Willamette Paper and Sugar Pine Lumber. New road names include Argentine Central, East Side Logging, New York & Pennsylvania,



contents



index

and Pickering Lumber. Undecorated and painted but unlettered models will also be available. The MSRP will be \$199.95.



Beginning in the late 1960s, American Car & Foundry began building 60' boxcars

specifically to provide more efficient service between automobile assembly plants and auto parts suppliers. Both single and double door versions of the auto parts cars were built with many continuing in service today. Atlas plans to deliver N scale ready-to-run versions of the car in the second quarter of 2015. Cars with single doors will be decorated for Conrail, Cotton Belt, Norfolk & Western, and Western Maryland. Double-door versions of the auto parts car will be available for Detroit, Toledo & Ironton; Canadian National; Canadian Pacific (CPAA); and Chesapeake & Ohio. The MSRP will be \$19.95. An undecorated version will list at \$14.95.



Also due from Atlas in the second quarter of next year is a Louisville & Nashville 70-ton triple-bay

open hopper car. The N scale ready-to-run model is based on a prototype Pullman-Standard built beginning in the mid-1950s.



Atlas will offer the same model decorated for Alaska Railroad, Louisville & Nashville, and

Seaboard Systems. It will represent a nearly identical car Pullman-Standard introduced in the mid- 60s. P-S used the



same length underframe but applied slightly taller sides resulting in a prototype rated at 80 tons with a capacity of 2960 cu.ft.

A rerun of Atlas's N scale version of the EMD six-axle 2,500 hp SD35 locomotive is scheduled to arrive during the third quarter



of 2015. The ready-to-run model will be available with a high nose decorated for VMV Leasing and Southern Railway.

Low-nose versions of the SD35 will be available for Seaboard System, Chessie

System-B&O, Chessie System-C&O, Penn

Central, Penn Central (red P), and Southern

Pacific as seen here in the Kodachrome



scheme. Models for standard DC operation will have an MSRP of \$114.95. Models equipped with a DCC decoder will list at \$149.95.



**Broadway Limited Imports ([broadway-limited.com](http://broadway-limited.com))** is taking reservations for N scale models of Pennsylvania Railroad class M1a

and M1b 4-8-2 steam locomotives. The feature-laden ready-to-run models are based on PRR's 1930s-era dual-service



contents



index

prototypes. They will be equipped with Paragon2 Sound for DC/DCC operation. The MSRP is \$349.99.

---



**BLMA** ([blma-models.com](http://blma-models.com))

is working on a new GSC 60'

flat car for release early next year. The ready-to-run model follows a prototype manufactured in the mid-1950s by General Steel Casting of Granite City, Illinois. With a frame composed of a single steel casting, the prototype was assured of strength and durability with many of the original cars still in use today. BLMA's N scale version adheres closely to the prototype with such features as body-mounted knuckle couplers and 70-ton ASF Ride-Control trucks with 33" metal wheels. Four road numbers each will be available for Burlington Northern, Cotton Belt (SSW), Illinois Central, Pennsylvania (class F-47), Wabash, and ATSF in the original 1956 Santa Fe scheme.

numbers each will be available for Burlington Northern, Cotton Belt (SSW), Illinois Central, Pennsylvania (class F-47), Wabash, and ATSF in the original 1956 Santa Fe scheme.



BLMA is now selling the Carrier X2 refrigeration units used on refrigerator cars separately. See your dealer or visit the website for details.

---

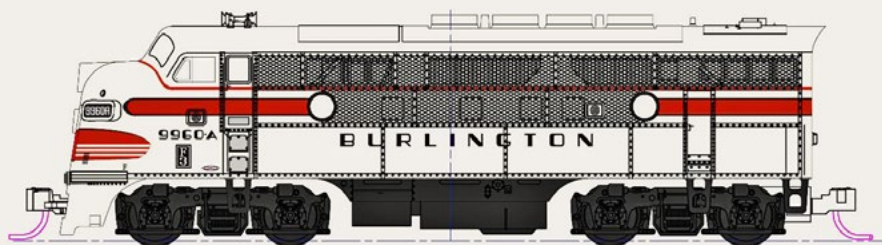

**KatoUSA**

([katousa.com](http://katousa.com))

has added several new roads to its list of

EMD F3A and F3B locomotives due for release in February



2015. In addition to the previously announced Santa Fe war-bonnet scheme, Kato will produce freight versions of F3 units for Chicago Burlington & Quincy, Union Pacific, and Southern Pacific (black widow scheme).

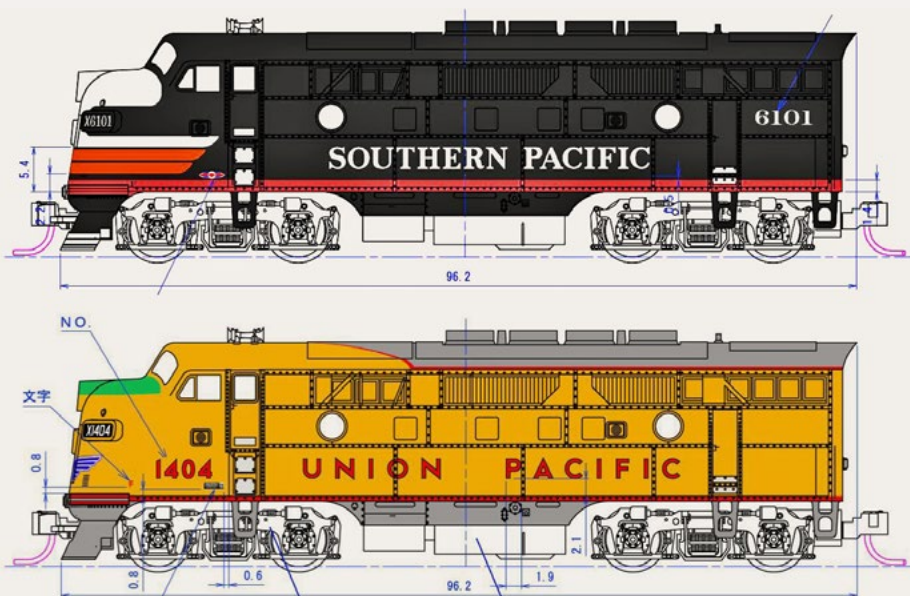

The MSRP for the N scale ready-to-run models have been tentatively set at \$90.00 for A units and \$85.00 for B units.

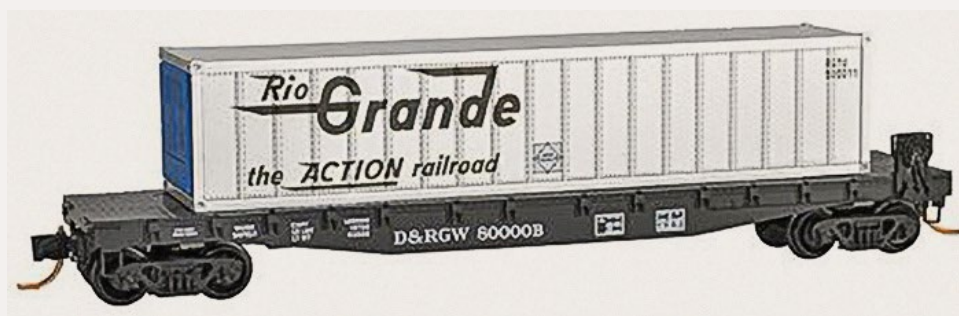

**Micro-Trains Line** ([micro-trains.com](http://micro-trains.com)) has released several new N scale ready-to-run

models including a Denver & Rio Grande 50' flat car with fish-belly sides. It comes with a specialized container.



Also new is a GATX-General American Transportation Corp 56' general purpose tank car.



contents



index



Micro-Trains' new Baltimore & Ohio 50' boxcar features double Youngstown doors and a

Cushion Underframe slogan.



This new N scale 40' Milwaukee Road double-deck stock car has Murphy corrugated steel ends.



Completing our listing of new ready-to-run N scale models from Micro-Trains

is a PRR 50' steel gondola with fishbelly sides and drop ends.

---

## NEW DECALS, SIGNS AND FINISHING PRODUCTS

Great Decals (PO Box 994, Herndon, VA 20172) has released white lettering sets for Piedmont & Northern boxcars. Each set includes material to authentically decorate one car including the "Service with Courtesy" slogan. The HO decals are \$3.49 each, postpaid.

---





**Herald King** ([heraldkingdecals.com](http://heraldkingdecals.com)), the venerable line of silk-screened decals for HO scale hobbyists, is once again available. Although the company was acquired some time ago, the new owners elected to spend several years refreshing the line and digitizing the art work before reintroducing the respected brand. Of the approximately 1,000 decal sets in the original line, about 75 percent are now available. Additional information, including a listing of available decals, is available at the website.

---

New decal sets recently released by **Microscale** ([microscale.com](http://microscale.com)) include Department of Defense (DODX) freight cars; Ferromex Railway (FXE) 53' container and chassis; TankTrain (GATX) road numbers for renumbering Athearn Genesis semi-permanently interconnected TankTrain cars; and Denver & Rio Grande Western (DRGW) early diesel switchers including Fairbanks-Morse, EMD, GE, Baldwin, and Alco.

Previously released items that are now back in stock include decal sets for Union Pacific steam locomotive silver lettering, and the Santa Fe yellow warbonnet scheme.

---

**Dan Kohlberg** ([home.mindspring.com/~paducah](http://home.mindspring.com/~paducah)) has added seven new HO decal sets to his line. They are Gulf Mobile & Ohio red 50' PS-1 boxcar 1969+, Illinois Central orange cabooses 1967+, Illinois Central Gulf orange cabooses 1972, Illinois Central Gulf 40' MOW mechanical department training boxcar 1978+, Kansas Milling Company GATC



contents



index

Airslide covered hopper 1957+, Milwaukee Road PC&F 50' brown box-car 1971+, and Ross Industries GATC Airslide covered hopper 1960+. All decal sets include a detailed lettering diagram. Photos and pricing are available at the website.

## DISCLAIMER ..

The opinions expressed in this column are those of the writer and do not necessarily reflect the opinion of Model Railroad Hobbyist or its sponsors. Every effort is made to provide our readers with accurate and responsible news and information, however, neither Model Railroad Hobbyist or the writer of this column can be held responsible for any inaccuracies or typographical errors that may inadvertently appear in this column.

Advertisement



# Archer

**FINE TRANSFERS**  
PROUDLY SERVING MODEL BUILDERS SINCE 1989

**THE ORIGINAL  
SURFACE DETAILS™**

**THANK YOU FOR 25  
WONDERFUL YEARS!**

**NOVEMBER 15TH - 30TH**

**TWO SURFACE  
DETAILS™ FOR  
\$25!**

**BUY ANY TWO \$17.95  
SURFACE DETAILS™  
AT REGULAR PRICE  
AND RECEIVE AN  
ALMOST INSTANT  
REBATE.**

**YOU WILL RECEIVE YOUR REFUND WHEN  
YOUR ORDER IS PROCESSED, WITHIN  
ONE BUSINESS DAY.**

**UNCONDITIONAL GUARANTEE**

*"Archer rivets  
are easy to apply  
and look great.  
To me, they are  
now a vital tool  
in building  
railroad models."*

Tony Thompson, Model  
Railroad Author/Historian

 **MADE IN THE USA**

Archer Fine Transfers • PO Box 1277 • Youngsville, NC 27596 • USA  
(919) 570-1026 • info@archertransfers.com • archertransfers.com



## Send us your product announcements

If you are a hobby manufacturer with a product announcement, just [click here](#) and submit your announcement to us. Our web site and free magazine reach continues to grow, so get on board with this new media train that's hard to stop!



**Reader  
Feedback**  
(click here)



Email



Phone



contents



index



## Combo Right Clamp™

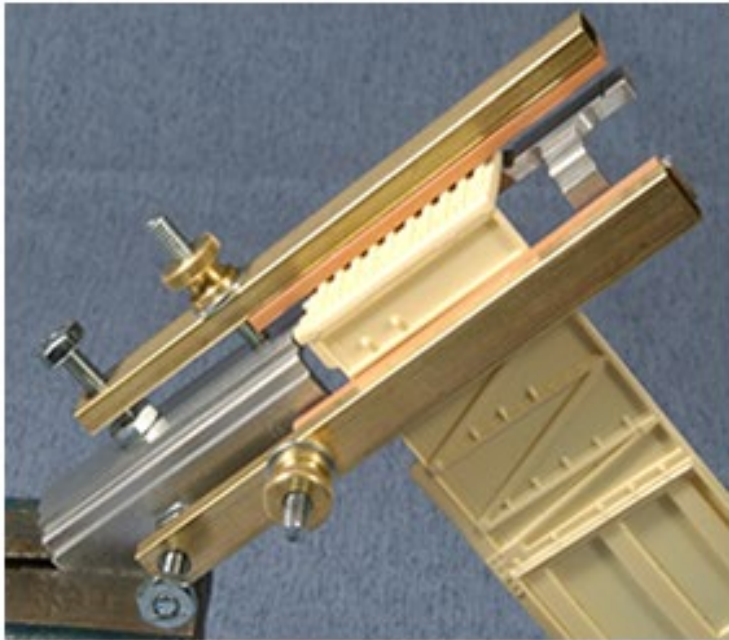

Combo Right Clamp™  
with cast resin boxcar

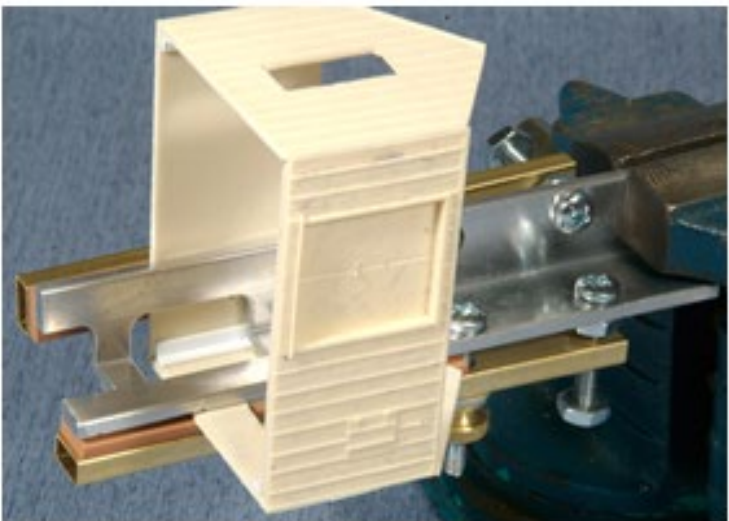

Combo Right Clamp™  
with Wolf Design Pump House

[Click here for  
all our products ...](#)

Tools for Modelers

Coffman Graphic Solutions Co.  
1500 River Circle, Richmond,  
KY 40475-7907

**Want to  
help keep  
MRH free?  
Then click  
on Ads!**

**When talking  
to hobby  
vendors,  
please  
remember  
to mention  
MRH.**



contents



index

## Briefly noted at press time...

... **Westerfield** ([westerfieldmodels.com](http://westerfieldmodels.com)) has just released upgraded HO scale resin kits for Santa Fe class Sk stock cars. Three versions of the prototype are available, including the original cars built in 1910 that remained in service until 1935, and a 1935 rebuilt version that operated until 1965. Also a kit for a modern version of the Sk stock car built in 1942/43 and actively used until 1965.

... **Athearn** ([athearn.com](http://athearn.com)) will produce its ES44AC diesel next summer with new road numbers for BNSF, CP Rail, and Union Pacific. Details on the Genesis series model reflect General Electric's 2005-2006 production of the prototype with such unique details as a nose door on the left side, flush mounted top radiator grilles, and grab irons on the side of the long hood. The HO scale models will also have many road-specific details. Also coming from Athearn next summer is an HO scale Ready-to-Roll AC4400 diesel decorated for BNSF, Chicago & North Western, CSX, General Electric (demonstrator), and CEFX (CIT Equipment Finance Corp).

... **Rapido** ([rapidotrains.com](http://rapidotrains.com)) will add N scale versions of a 37' wood meat reefer currently available only in its HO line of products. The new 1:160 ready-to-run models will have factory-installed Micro-Trains couplers. Delivery is planned for fall 2015. ■



# Live Operating Session on ...

# Mike Confalone's ALLAGASH RAILWAY



DVD media  
~~\$29.99~~  
**\$24.99**  
+ shipping/handling

Instant download  
~~\$14.99~~  
**\$9.99**

HD  
format

Running time: 1 hr 52 min

 **Get Allagash Ops Live - 5**

from the  
**Model Railroad  
Hobbyist**  
*Store*





*Have you seen this?*

**CHECK IT  
OUT!**



**kenpatterson.com**

*click here to ...*

**Visit Ken's website**

**Ken Patterson  
reveals his modeling  
secrets on video!**



## Selected Events



### November 2014

**AUSTRALIA, NEW SOUTH WALES, ARMIDALE,** November 15-16, Bi-Annual Convention of the New England Model Railway Club Inc, at Armidale Bowling Club, Dumeresq Street. Preregistration required. Phone 61 02 6732 5711 for information (also [newenglandmodel-railwayclub.com/content/convention.shtml](http://newenglandmodel-railwayclub.com/content/convention.shtml)).

**CANADA, BRITISH COLUMBIA, BURNABY,** November 8-9, Trains 2014 32nd Annual Model Train Show featuring operating trains, dioramas, kids activities, and vendors. For registrants there are operating sessions (November 7), clinics, model contests, layout tours, a prototype modelers meet, and banquet. At Cameron Center, 9523 Cameron Street. info at [bctrains.sbcrailway.ca](http://bctrains.sbcrailway.ca).

**CANADA, NEW BRUNSWICK, QUISPAMISIS,** November 1, Annual Model Train Show, sponsored by Saint John Society of Model Railroaders, at Island View Lions Club, 8 Market Street. Info at [sites.google.com/site/sjfallshow](http://sites.google.com/site/sjfallshow).

**CANADA, ONTARIO, HAMILTON,** November 1, Hamilton District Layout Tour. Home and club layouts in Burlington, Beamsville, Fenwick, Caledonia, and Hamilton. Guide books will be available in October at local model railway shops. Info from Brandon Bayer at [brandon1@cogeco.com](mailto:brandon1@cogeco.com).

**ARKANSAS, CONWAY,** December 6, Christmas Open House, featuring operating layouts, sponsored by Central Arkansas Model Railroad Club, at McGee Center, 3800 College Avenue. Info at [artrains.org/index.php5?title=Main\\_Page](http://artrains.org/index.php5?title=Main_Page).

**CALIFORNIA, LOS ANGELES,** November 15, 16, 18, 22, and 23, Fall Open House at Sierra Pacific Lines layout sponsored by the Pasadena Model Railroad Club. One of the largest operating

layouts in the world with a 1,700 foot mainline and a total of more than 30,000 feet of hand laid steel rail, all in a club owned 5,000 square foot structure at 5458 Alhambra Ave. Info at [pmrrc.org/#OPENHOUSE](http://pmrrc.org/#OPENHOUSE).

**CALIFORNIA, ROSEVILLE**, November 8-9, 38th International Railfair, featuring operating railroads, American and European model railroads, and vendor tables, plus Thomas, Lionel, and live steam riding train. Kids can earn a Junior Engineer Badge for operating one of the children's layouts. At Placer County Fairgrounds, 800 All America City Blvd. Info at [internationalrail-fair.com](http://internationalrail-fair.com).

**CALIFORNIA, TEHACHAPI**, November 15-16, Model train Show, at West Park, 491 West D Street, sponsored by the Tehachapi Loop Railroad Club. Info at [tehachapilooprailroadclub.org/shows&events.html](http://tehachapilooprailroadclub.org/shows&events.html).

**COLORADO, COLORADO SPRINGS**, December 6-7, TECO-Train Expo Colorado, sponsored by Pike's Peak Division of NMRA Rocky Mountain Region, at Freedom Financial Services Expo Center, 3600 N. Nevada Avenue. Info at [tecoshow.org](http://tecoshow.org).

**COLORADO, WOODLAND PARK**, November 15-16, 33rd Annual Slim Rail Show, with clinics for both beginning and advanced modelers, prototype historical presentations on the Colorado Midland Railroad, plus special tours of the nearby Ute Pass Historical Society Museum. Info at [slimrail.org](http://slimrail.org).

**ILLINOIS, BELLEVILLE (St Louis metro area)**, November 1 & 2, NMRA Gateway Division Annual Model Railroad Train Show & Model Contest, at OC Joseph Chrysler, 3795 West State Route 15. Info at [gatewaynmra.org/st-louis-train-show](http://gatewaynmra.org/st-louis-train-show).

**INDIANA, DANVILLE**, November 22, NMRA Central Indiana Division Train Show, at Hendricks County Fair Grounds. Info at [cid.railfan.net](http://cid.railfan.net).





**MAINE, BREWER**, November 22, Eastern Maine Model Railroad Club Show with operating layouts and dealer tables, at Jeff's Catering, 15 Littlefield Way East, West Industrial Park. Info from Geoff Anthony, at [dahak@roadrunner.com](mailto:dahak@roadrunner.com).

**MICHIGAN, EAST LANSING**, November 9, Lansing Model Railroad Club Show and Sale, at Michigan State University Pavilion, 4301 Farm Lane. Info at [lmrc.org/trainshow](http://lmrc.org/trainshow).

**MISSOURI, JOPLIN**, November 29, Model Train Show, swap and trade event plus displays of Z, N, O and G scale trains and a large HO club layout, at Joplin Museum Complex, Schifferdecker Park 7th & Schifferdecker. Info at [tristatemodel-railroaders.com](http://tristatemodel-railroaders.com).

**NEW JERSEY, BURLINGTON**, November 1, Model Train Show sponsored by the Burlington Masonic Lodge. Buy, sell, and trade model trains of all kinds plus see operating layouts on display. At Masonic Lodge, 2308 Mt. Holly Road (Route 541). Info at [burlington32.org](http://burlington32.org).

**NEW JERSEY, UNION**, November 29-30, December 5-7, and December 12-14, Annual Light & Sound Show and Open House sponsored by The Model Railroad Club, Inc., at 295 Jefferson Avenue (behind Home Depot). Info at [tmrci.org](http://tmrci.org).

**NEW YORK, BALDWIN**, November 1, NMRA Sunrise Trail Division Annual Convention featuring clinics, modular layouts, model and photo contest, bargain tables, door prizes, and more. Baldwin United Methodist Church, 881 Merrick Road. Info at [sunrise-traildiv.com](http://sunrise-traildiv.com).

**NEW YORK, SYRACUSE**, November 1-2, 40th Annual Great New York State Model Train Fair sponsored by the Central New York Chapter, National Railway Historical Society at State Fair Grounds. Info at [modeltrainfair.com](http://modeltrainfair.com).



contents



index

**OREGON, MEDFORD**, November 29-30, Rogue River Railroad Show at Medford Armory, 1701 S. Pacific Highway. All proceeds benefit Medford Railroad Park. Info at [rvmrc.net/show%20archives.html](http://rvmrc.net/show%20archives.html).

**PENNSYLVANIA, MONACA**, November 13, Beaver County Fall Model Train Show, at Center Stage, 1495 Old Brodhead Road. Info at [bcmrr.railfan.net](http://bcmrr.railfan.net).

**SOUTH CAROLINA, MYRTLE BEACH**, November 15-16, 5th Annual Train Show & Sale, sponsored by the Grand Strand Model Railroaders, Inc., at Lakewood Conference Center, 5837 South Kings Hwy. Info at [gsmrrc.org](http://gsmrrc.org).

**VIRGINIA, FREDERICKSBURG**, November 22-23, Trains at Christmas, model train show and sale at Fredericksburg National Armory located at US Route 1 and VA Route 3. Sponsored by the Rappahannock Chapter of the National Railway Historical Society. Info at [rcnrhs.com](http://rcnrhs.com).

**VIRGINIA, WINCHESTER**, November 8, Annual Fall Hobby Show & Sale, hosted by Winchester Model Railroad Club, at Friendship Fire Company meeting hall, 627 N. Pleasant Valley Road. Info at [wmrrc.org/index\\_files/Page771.htm](http://wmrrc.org/index_files/Page771.htm).

**WISCONSIN, WEST ALLIS**, November 8-9, Trainfest Model Railroad Show, featuring manufacturers exhibits, numerous clinics, and operating layouts. At Wisconsin Exposition Center, State Fair Park, 8200 West Greenfield Avenue. Info at [trainfest.com](http://trainfest.com).

## December 2014

**FLORIDA, PALM BAY**, December 21, HO Scale Module Display, at Franklin T. Degroot Memorial Library, 6475 Minton Road. Sponsored by Palm Bay Model Railroad Club.





## Future 2015 (by location)

**AUSTRALIA, CANBERRA**, March 28-29, 2015, 27th Annual Canberra Model Railway Expo, hosted by Canberra Model Railway Club, at University of Canberra High School, 104 Baldwin Drive. Info at [canberra-model-railway-club.webs.com](http://canberra-model-railway-club.webs.com).

**CALIFORNIA, NEWARK**, May 13-17, 2015, NMRA Pacific Coast Region Convention, at Newark-Fremont Double Tree by Hilton Hotel, 39900 Balentine Drive. Info at [pcrnmra.org/conv2015](http://pcrnmra.org/conv2015).

**CALIFORNIA, SANTA CLARA**, February 5-7, 2015, O Scale West and S West 9 Convention, Hyatt Regency Hotel, 5101 Great America Parkway. Hotel reservations at 800-233-1234. Details including vendor information at [oscalewest.com](http://oscalewest.com).

**FLORIDA, COCOA BEACH**, January 8-10, 2015, Prototype Rails RPM meet with over 80 clinics presented by a blue ribbon group of experts. Schedule includes Friends of the Freight Car lunch on Saturday. Event hosted by Mike Brock, at Cocoa Beach Hilton Hotel, 1550 North Atlantic Avenue. Info at [prototyperrails.com](http://prototyperrails.com).

**ILLINOIS, NAPERVILLE**, October 15-17, 2015, 22st Annual Naperville RPM Conference, hosted by Joe D'elia, at Sheraton Lisle-Chicago Hotel, 3000 Warrenville Road, Lisle. Info at [railroadprototypemodelers.org/naper\\_meet.htm](http://railroadprototypemodelers.org/naper_meet.htm).

**MARYLAND, TIMONIUM**, April 11-12, 2015, Brass Expo in conjunction with the Great Scale Model Train Show, presented by Howard Zane, at Maryland State Fairgrounds, 2200 York Road. Info at Brass Expo Train Show Home Page. Info at [brassexpo.com/index.htm](http://brassexpo.com/index.htm).



contents



index

**OREGON, PORTLAND**, August 23-30, 2015, NMRA National Convention, at Double Tree by Hilton Hotel Portland. Info at [nmra2015.org](http://nmra2015.org).

**OREGON, PORTLAND**, August 28-30, 2015, National Train Show, at Portland Expo Center. Info at [nmra2015.org/trainshow](http://nmra2015.org/trainshow).

**PENNSYLVANIA, PHILADELPHIA**, May 15-17, 2015, Biennial Meet of the East Penn Traction Club, at Pennsylvania Convention Center. Info at [eastpenn.org/2015\\_meet\\_announcement.htm](http://eastpenn.org/2015_meet_announcement.htm).

**PENNSYLVANIA, SCRANTON**, March 26-27, 2015, The Fine Scale Model Railroad Expo, a specialty event dedicated to the art of craftsman kit structures and scenery building, with clinics, demonstrations, and displays. At Hilton Scranton Hotel & Conference Center, 100 Adams Avenue. Info at [modelrail-roadexpo.com](http://modelrail-roadexpo.com).

**TEXAS, HOUSTON**, September 2-5, 2015, 35th National Narrow Gauge Convention. Info at [nngc-2015.com](http://nngc-2015.com).

**WASHINGTON, BELLEVUE**, April 16-18, 2015, 30th Annual Sn3 Symposium, at Bellevue Sheraton Hotel, 100 112th Ave NE. Info at [sn3symposium-2015.com](http://sn3symposium-2015.com).

## **Future 2016-2017 (by location)**

**COLORADO, DENVER**, 2017, National Narrow Gauge Convention.

**INDIANA, INDIANAPOLIS**, July 3-10, 2016, NMRA National Convention and National Train Show. Info at [nmra2016.org](http://nmra2016.org).



**MAINE, AUGUSTA**, Sept. 7-10, 2016, 36th National Narrow Gauge Convention. Info at [nngc2016.org](http://nngc2016.org). ■





Advertisement



TOP QUALITY PRODUCTS  
FOR THE MODEL RAILROAD CRAFTSMAN

WWW.GLXSCALEMODELS.COM

**MAIN STREET  
FRONT AND  
CENTER!**

**\$ 39**  
+ S&H



**CAMERON  
BLOCK**

CAST RESIN BUILDING  
FRONT  
LASER CUT WINDOWS

EASY ASSEMBLY  
WITH DETAILED INSTRUCTIONS

HO SCALE  
SIGNAGE NOT INCLUDED



Advertisement

**The Fine Scale  
Model Railroader Expo**

THE EXPO STEAMS INTO  
SCRANTON, PA

MARCH 26-27

**\$1000**  
CASH PRIZE  
MODEL CONTEST

**2015**

THE ONLY SHOW DEDICATED  
TO THE ART OF SCALE MODEL  
STRUCTURE BUILDING



LEARN. BUILD. CREATE.  
ENJOY MODELING AT ITS BEST.

**modelrailroadexpo.com**



# Clickable advertiser index – 1

[Accu-Lites](#)

[Adam's Auction](#)

[American Ltd \(San Juan\)](#)

[Amherst Show](#)

[An Affair With Trains](#)

[Archer Fine Transfers](#)

[Atlas Model Railroad Co.](#)

[Bachmann](#)

[Backdrop Junction](#)

[Berrett Hill Trains](#)

[Blair Line](#)

[BLMA](#)

[Bowser](#)

[Caboose Hobbies](#)

[Canyon Creek Scenics](#)

[Clever Models](#)

[Coastmans Scenic Products](#)

[Coffman Graphics](#)

[Con-Cor](#)

[Credit Valley Railway](#)

[Dave's Model Railway Stuff](#)

[DCC by Design](#)

[Digitrax \(2 page spread\)](#)

[East Penn Traction Club](#)

[ESU LokSound](#)

[Fast Tracks](#)

[Fifer Hobby Supply](#)

[Fine Scale MR Expo](#)

[Fox Valley Models](#)

[GLX Scale Models](#)

[Great Decals](#)

[Hobby-On \(MRS Hobby\)](#)

[Iowa Scaled Engineering](#)

[Iwata-Medea](#)

[Jelsma Graphics](#)

[Laser Modeling 3](#)

[Ken Patterson.com](#)

[Litchfield Station](#)

[Logic Rail Technologies](#)

[Microscale](#)

[Minimalist Model Railroad](#)

[Model Railroad Tunnels](#)

[Model Rectifier Corporation](#)

[Monroe Models](#)

[Motrak Models](#)

[Mr. Detail Parts](#)

[MRH Store \(Model Trains Video\) \(1\)](#)

[MRH Store \(Model Trains Video\) \(2\)](#)

[M.T.H.](#)

[Nano-Oil](#)

[NCE \(2 page spread\)](#)

[Nick & Nora Designs](#)

[North American Railcar](#)

[NYC Sys. Historical Society](#)

[O Scale \(Mullet River\)](#)

[Pre-size Model Specialities](#)

[RailMaster Hobbies](#)

[Railroad Explorer](#)

[Rapido \(1\)](#)

[Rapido \(2\)](#)

[Rapido \(3\)](#)

[Rapido \(4\)](#)

[Ring Engineering \(1\)](#)

[Ring Engineering \(2\)](#)

[RR-CirKits](#)

[RSlaserKits, Inc.](#)

[Rulers-of-the-World](#)

[Rusty Stumps](#)

[Streamlined Backshop](#)

[Scenic Express](#)





# Clickable advertiser index – 2

[Scotty Mason Show](#)

[Soundtraxx](#)

[Southern Digital](#)

[TAM Valley Depot](#)

[TCS](#)

[T-Kits](#)

[Tony's Train Exchange](#)

[TrainMasters TV](#)

[Traintek](#)

[TrainWorld](#)

[True Line Trains](#)

[True Scene Modeling](#)

[TSG Multimedia](#)

[Westerfield Models](#)

[Yankee Dabblers](#)

[Yarmouth Model Works](#)

## Clickable “other” index

---

[Other – Bonus Extras](#)

[Other – Cover](#)

[Other – Derailments](#)

[Other – Hobby Marketplace](#)

[Other – MRH Sponsors](#)

[Other – Staff Notes](#)

[Other – Table of Contents](#)



# How absurd: watching someone else run trains

## Reverse Running: Stepping outside the box with a contrary view

by Joe Fugate

**N**ot everyone in the hobby is into realistic operations; in fact the majority of model railroaders are *not* into serious ops.

For the people who don't get serious operation, when I tell them about our Ops Live videos, they say things like, "now why would I

want to get a video to watch someone else run trains?"

If you've been in the hobby for more than a few months, you've probably discovered how boring just running trains round-and-round can get. You need something more.

At this point, a modeler can go two ways:

- You can be a builder / collector and go build or get something new to run, so you can railfan it. This is how you get your kicks when you're running trains – otherwise it's back to building something new to run.
- You can decide there's got to be more to running trains and see what all this realistic operation flap is about.

For me, operating is the reason I do the hobby. All this other stuff – building benchwork, track laying, wiring, kitbashing locos and rolling stock, scenery, structures and so on – it's all so I can run trains realistically, as in operate them like the real thing.





Yes, some will remark, “but that sounds like work, and this is supposed to be a hobby!” Sure, it does take some thinking, but then so does a challenging game of cards. For me, my favorite part of operation is that it can be a team sport.

I thoroughly enjoy having the guys over for an op session every so often and watching my model railroad come to life! Yes, I can operate all by myself (and I have sometimes) just like I’ve played solitaire once in a while. But like cards, I find realistic operation is a lot more fun with several operators.

So what will you learn by watching an Ops Live video? First, you get to be a “bug on the wall” at a realistic operating session, so you can see for yourself if it’s fun or just a pain. If you’ll take a look, you’ll find that like any good card game, there’s some strategy involved. And you’ll find you can play off each other as well.

You’ll also find there’s some good natured fun involved! Situations can develop (similar to the real thing) that can take some teamwork to resolve. The other thing you’ll see by looking at Ops Live videos from different layouts (we have three different layouts) that there’s quite a difference in how the op sessions unfold. Ops Live 1 and 2 are two different operating sessions on my Siskiyou Line, and Ops Live 3 and 4 are two different operating sessions on Charlie Comstock’s Bear Creek & South Jackson. Even the op sessions on the same layouts vary!

The most recent Ops Live is volume 5 on Mike Confalone’s Allagash Railway. You will find Mike’s layout op session has its own unique feel to it, and some of the situations that arise will surprise you.

So yes, there’s a lot to be gained by watching someone else run trains on video. I think it’s model railroading reality TV at it’s best!



contents



index

# Deraillments

humor and bizarre facts (allegedly)



## MODEL RAILROADING UNLIMITED (19 min)

In 1975 Kalmbach contracted with a California producer (who had some ties to Disney) to promote the hobby of model railroading in a fun-loving and somewhat tongue-in-cheek way. The producers took just about every misconception the public has of model railroaders and made light of it in this film. You can also find an edited version of this video on the Kalmbach website at:

[www.kalmbach.com/Videos/2008/07/Model%20Railroading%20Unlimited.aspx](http://www.kalmbach.com/Videos/2008/07/Model%20Railroading%20Unlimited.aspx)





# For the love of model trains

## Coming in December

- The story of relocating the Aberfoyle Junction club layout
- Painting and finishing a resin box car
- John Wilkes builds a coal loader
- Adding sound to N scale locos
- Maintenance flags and signs
- Loksound DCC decoders in-depth
- ...and lots more!

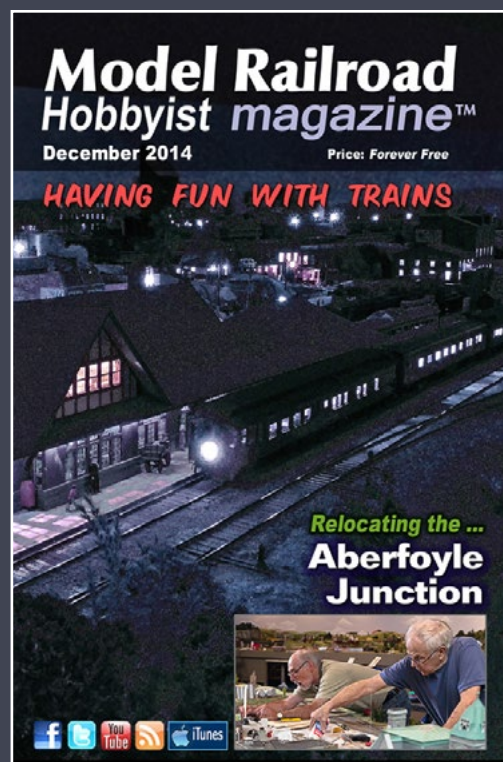

Scott Sackett

“When Reg says he handlays *his own* track, he does it *all* himself, including rolling his own rail ...”

Coming next issue



contents



index